

DODGE 



2011

USER GUIDE

DURANGO

If you are the first registered owner of your vehicle, you may obtain a complimentary printed copy of the Owner's Manual, Navigation/Media Center Manuals or Warranty Booklet by calling 1-800-423-6343 (U.S.) or 1-800-387-1143 (Canada) or by contacting your dealer.

The driver's primary responsibility is the safe operation of the vehicle. Driving while distracted can result in loss of vehicle control, resulting in a collision and personal injury. Chrysler Group LLC strongly recommends that the driver use extreme caution when using any device or feature that may take their attention off the road. Use of any electrical devices such as cell phones, computers, portable radios, vehicle navigation or other devices by the driver while the vehicle is moving is dangerous and could lead to a serious collision. Texting while driving is also dangerous and should never be done while the vehicle is moving. If you find yourself unable to devote your full attention to vehicle operation, pull off the road to a safe location and stop your vehicle. Some States or Provinces prohibit the use of cellular telephones or texting while driving. It is always the driver's responsibility to comply with all local laws.

IMPORTANT: This User Guide is intended to familiarize you with the important features of your vehicle. The DVD enclosed contains your Owner's Manual, Navigation/Media Center Manuals, Warranty Booklets, Tire Warranty and 24-Hour Towing Assistance (new vehicles purchased in the U.S.) or Roadside Assistance (new vehicles purchased in Canada) in electronic format. We hope you find it useful. Replacement DVD kits may be purchased by visiting www.techauthority.com. Copyright 2011 Chrysler Group LLC.

TABLE OF CONTENTS

INTRODUCTION/WELCOME

Welcome From Chrysler Group LLC	2
---	---

CONTROLS AT A GLANCE

Driver Cockpit	4
Instrument Cluster	6

GETTING STARTED

Key FOB	8
Remote Start	9
Keyless Enter-N-Go	10
Theft Alarm	12
Seat Belt	13
Supplemental Restraint System (SRS) — Airbags	13
Child Restraints	14
Front Seats	16
Rear Seats	19
Power Folding Third Row Head Restraints	20
Heated/Ventilated Seats	21
Heated Steering Wheel	22
Tilt/Telescoping Steering Column	22

OPERATING YOUR VEHICLE

Headlight Switch	24
Turn Signal/Wiper/Washer/High Beam Lever	25
Auto Dimming Mirrors	26
Speed Control	26
Electronic Range Selection (ERS)	29
Automatic Temperature Controls (ATC)	30
Parksense® Rear Park Assist	31
Parkview® Rear Back-Up Camera	32
Blind Spot Monitoring	32
Power Sunroof	33
Wind Buffeting	35

ELECTRONICS

Your Vehicle's Sound System	36
Non-Touch-Screen Radios	38
Touch-Screen Radios	40
Steering Wheel Audio Controls	46
Uconnect™ Phone	47
Uconnect™ Voice Command	49
iPod®/USB/MP3 Control	50
Video Entertainment System (VES)™	51
Electronic Vehicle Information Center (EVIC)	53
Programmable Features	54

Universal Garage Door Opener (HomeLink®)	54
Power Inverter	56
Power Outlet	57

OFF-ROAD CAPABILITIES

All-Wheel Drive Operation	58
-------------------------------------	----

UTILITY

Roof Luggage Rack	60
Trailer Towing Weights (Maximum Trailer Weight Ratings)	61
Tow/Haul Mode	62
Recreational Towing (Behind Motorhome, Etc.)	62

WHAT TO DO IN EMERGENCIES

24-Hour Towing Assistance	64
Instrument Cluster Warning Lights	64
If Your Engine Overheats	67
Jacking And Tire Changing	69
Jump-Starting	72
Emergency Tow Hooks	75
Shift Lever Override	75
Towing A Disabled Vehicle	76
Event Data Recorder (EDR)	77

MAINTAINING YOUR VEHICLE

Opening The Hood	78
Fuel Door Release	78
Engine Compartment	80
Fluids And Capacities	82
Maintenance Chart	84
Fuses	87
Tire Pressures	90
Wheel And Wheel Trim Care	91
Exterior Bulbs	91

CONSUMER ASSISTANCE

Chrysler Group LLC Customer Center	92
Chrysler Canada Inc. Customer Center	92
Assistance For The Hearing Impaired	92
Publications Ordering	92
Reporting Safety Defects In The 50 United States And Washington, D.C.	93

MOPAR ACCESSORIES

Authentic Accessories By MOPAR®	94
---	----

INDEX	95
-----------------	----

INTRODUCTION/WELCOME

WELCOME FROM CHRYSLER GROUP LLC

Congratulations on selecting your new Chrysler Group LLC vehicle. Be assured that it represents precision workmanship, distinctive styling, and high quality - all essentials that are traditional to our vehicles.

Your new Chrysler Group LLC vehicle has characteristics to enhance the driver's control under some driving conditions. These are to assist the driver and are never a substitute for attentive driving. They can never take the driver's place. Always drive carefully.

Your new vehicle has many features for the comfort and convenience of you and your passengers. Some of these should not be used when driving because they take your eyes from the road or your attention from driving. Never text while driving or take your eyes more than momentarily off the road.

This guide illustrates and describes the operation of features and equipment that are either standard or optional on this vehicle. This guide may also include a description of features and equipment that are no longer available or were not ordered on this vehicle. Please disregard any features and equipment described in this guide that are not available on this vehicle. Chrysler Group LLC reserves the right to make changes in design and specifications and/or make additions to or improvements to its products without imposing any obligation upon itself to install them on products previously manufactured.

This User Guide has been prepared to help you quickly become acquainted with the important features of your vehicle. It contains most things you will need to operate and maintain the vehicle, including emergency information.

The DVD includes a computer application containing detailed owner's information which can be viewed on a personal computer or MAC computer. The multimedia DVD also includes videos which can be played on any standard DVD player (including the Media Center Touch-Screen Radios). Additional DVD operational information is located on the back of the DVD sleeve.

For complete owner information, refer to your Owner's Manual on the DVD in the owner's kit provided at the time of new vehicle purchase. For your convenience, the information contained on the DVD may also be printed and saved for future reference.

Chrysler Group LLC is committed to protecting our environment and natural resources. By converting from paper to electronic delivery for the majority of the user information for your vehicle, together we greatly reduce the demand for tree-based products and lessen the stress on our environment.

Vehicles Sold In Canada

With respect to any vehicles sold in Canada, the name Chrysler Group LLC shall be deemed to be deleted and the name Chrysler Canada Inc. used in substitution therefore.

INTRODUCTION/WELCOME

Rollover Warning

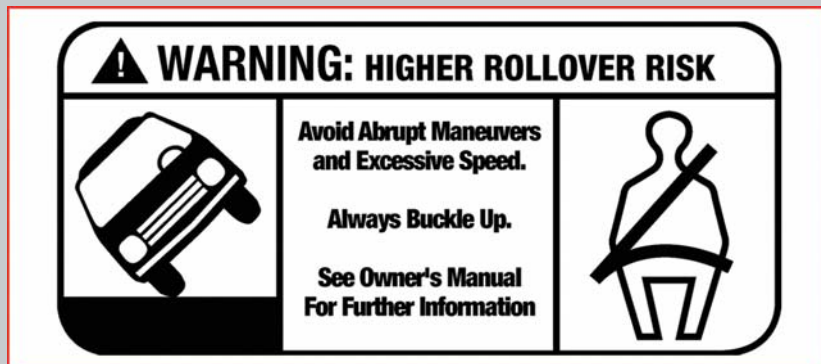

WARNING!

- Pedals that cannot move freely can cause loss of vehicle control and increase the risk of serious personal injury.
- Always make sure that objects cannot fall into the driver foot well while the vehicle is moving. Objects can become trapped under the brake pedal and accelerator pedal causing a loss of vehicle control.
- Failure to properly follow floor mat installation or mounting can cause interference with the brake pedal and accelerator pedal operation causing loss of control of the vehicle.
- Refer to your Owner's Manual on the DVD for further details.
- Never use the 'PARK' position as a substitute for the parking brake. Always apply the parking brake fully when parked to guard against vehicle movement and possible injury or damage.

USE OF AFTERMARKET PRODUCTS (ELECTRONICS)

The use of aftermarket devices including cell phones, MP3 players, GPS systems, or chargers may affect the performance of on-board wireless features including Keyless Enter-N-Go and Remote Start range. If you are experiencing difficulties with any of your wireless features, try disconnecting your aftermarket devices to see if the situation improves. If your symptoms persist, please see an authorized dealer.

CHRYSLER, DODGE, JEEP, RAM TRUCK, ATF+4, MOPAR and Uconnect are registered trademarks of Chrysler Group LLC.

COPYRIGHT ©2011 CHRYSLER GROUP LLC



CONTROLS AT A GLANCE

DRIVER COCKPIT



CONTROLS AT A GLANCE



IGNITION SWITCH
(BEHIND STEERING WHEEL)

AUDIO SYSTEM
(TOUCH-SCREEN
RADIO SHOWN)

CRUISE
CONTROL

CLIMATE
CONTROLS

POWER OUTLET

TRANSMISSION
GEAR SELECTOR

SWITCH PANEL
ELECTRONIC STABILITY CONTROL (ESC) OFF
TOW/HAU[†]*
HEATED STEERING WHEEL*
HAZARD
POWER INVERTER*
PARKSENSE[®] REAR PARK ASSIST OFF*
POWER FOLDING THIRD ROW HEAD RESTRAINTS

*IF EQUIPPED

CONTROLS AT A GLANCE



INSTRUMENT CLUSTER

Warning Lights



- Low Fuel Warning Light



- Charging System Light**



- Oil Pressure Warning Light**



- Engine Temperature Warning Light



- Transmission Temperature Warning Light



- Anti-Lock Brake (ABS) Light**



- Airbag Warning Light**



- Electronic Throttle Control (ETC) Light



- Tire Pressure Monitoring System (TPMS) Light



- Seat Belt Reminder Light

BRAKE

- Brake Warning Light**



- Malfunction Indicator Light (MIL)**



- Electronic Stability Control (ESC) Activation/Malfunction Indicator Light*



















- SERV (Service) AWD Indicator Light

(See page 64 for more information.)

CONTROLS AT A GLANCE



Indicators

- | | | | |
|---|--|---|---|
|  | - Turn Signal Indicators |  | - Adaptive Cruise Control (ACC) ON Indicator* |
|  | - High Beam Indicator |  | - Adaptive Cruise Control (ACC) SET Indicator* |
|  | - Front Fog Light Indicator* |  | - Park/Headlight ON Indicator* |
|  | - Vehicle Security Indicator* |  | - Electronic Stability Control (ESC) Off Indicator* |
|  | - TOW/HAUL Indicator* |  | - Windshield Washer Fluid Low Indicator |
|  | - AWD LOW Indicator |  | - Door Ajar Indicator |
|  | - Loose Gas Cap Indicator |  | - Forward Collision Warning (FCW) OFF Indicator* |
|  | - Electronic Speed Control ON Indicator |  | - Liftgate Ajar Indicator |
|  | - Electronic Speed Control SET Indicator | | |

* If equipped

** Bulb Check with Key On

GETTING STARTED

KEY FOB



Locking And Unlocking The Doors/Liftgate

- Press the LOCK button once to lock all the doors and the liftgate. Press the UNLOCK button once to unlock the driver's door only and twice within five seconds to unlock all the doors and liftgate.
- All doors can be programmed to unlock on the first press of the UNLOCK button. Refer to Programmable Features in this guide.

Power Liftgate

- Press the LIFTGATE button twice within five seconds to power open/close the Power Liftgate. If the button is pressed while the liftgate is being power closed, the liftgate will reverse to the full open position.
- Also, the power liftgate may be closed by pressing the Liftgate switch located on the left rear trim, near the liftgate opening. Pressing once will close the liftgate only. This button cannot be used to open the liftgate.

Panic Alarm

- Press the PANIC button once to turn the panic alarm on.
- Wait approximately three seconds and press the button a second time to turn the panic alarm off.

Express Window Feature

- To remotely lower both front door windows at the same time, press and release the UNLOCK button and then immediately press and hold the UNLOCK button until the windows lower to the level desired or until they lower completely.

Emergency Key

- Should the battery in the vehicle or the Key Fob transmitter go dead, there is an emergency key located in the Key Fob that can be used for locking and unlocking the doors. To remove the emergency key, slide the button at the top of the Key Fob sideways with your thumb and then pull the key out with your other hand.

NOTE:

- This device complies with part 15 of the FCC rules and RSS 210 of Industry Canada. Operation is subject to the following conditions:
 - This device may not cause harmful interference.
 - This device must accept any interference received, including interference that may cause undesired operation.
- Changes or modifications not expressly approved by the party responsible for compliance could void the user's authority to operate the equipment.

GETTING STARTED

CAUTION!

- If your vehicle battery becomes low or dead, your Key Fob will become locked in the ignition.
- Do not attempt to remove the Key Fob while in this condition, damage could occur to the Key Fob or ignition module. Only remove the emergency key for locking and unlocking the doors.
- Leave the Key Fob in the ignition and either:
 - Jump Start the vehicle.
 - Charge the battery.
 - Contact your dealer for assistance on how to remove the Key Fob using the manual over ride method.

WARNING!

- Leaving unattended children in a vehicle is dangerous for a number of reasons. A child or others could be severely injured or killed. Children should be warned not to touch the parking brake, brake pedal, or the shift lever. Do not leave the Key Fob inside the vehicle or in the ignition. A child could start the vehicle, operate power windows, other controls, or move the vehicle.
- Do not leave children or animals inside parked vehicles in hot weather. Interior heat build-up may cause them to be severely injured or killed.
- Keep Key Fob transmitters away from children. Operation of the Remote Start System, windows, door locks or other controls could cause serious injury or death.
- Driving with the liftgate open can allow poisonous exhaust gases into your vehicle. You and your passengers could be injured by these fumes. Keep the flipper glass closed when you are operating the vehicle.

REMOTE START

- Press the REMOTE START button  twice within five seconds. Pressing the REMOTE START button a third time shuts the engine off.
- To drive the vehicle, with a valid Keyless Enter-N-Go Key Fob within 5 ft (1.5m) of the driver's side of the vehicle, grab the front driver door handle to unlock the driver's door automatically, then press the Start/Stop switch. Or press the UNLOCK button, insert the Key Fob in the ignition and turn to the ON/RUN position.
- With remote start, the engine will only run for 15 minutes (timeout) unless the ignition is placed in the ON/RUN position.
- The vehicle must be started with the Key Fob after two consecutive timeouts.

GETTING STARTED

WARNING!

- Do not start or run an engine in a closed garage or confined area. Exhaust gas contains Carbon Monoxide (CO) which is odorless and colorless. Carbon Monoxide is poisonous and can cause you or others to be severely injured or killed when inhaled.
- Keep Key Fob transmitters away from children. Operation of the Remote Start System, windows, door locks or other controls could cause you and others to be severely injured or killed.

KEYLESS ENTER-N-GO

- The Keyless Enter-N-Go system is an enhancement to the vehicle's Key Fob. This feature allows you to lock and unlock the vehicle's door(s) and liftgate without having to press the Key Fob lock or unlock buttons, as well as starting and stopping the vehicle with the press of a button.

To Unlock From The Driver or Passenger Side:

- With a valid Keyless Enter-N-Go Key Fob located outside the vehicle and within 5 ft (1.5m) of the driver or passenger side door handle, grab either front door handle to unlock the door automatically.

To Lock the Vehicle:



- Both front door handles have LOCK buttons located on the outside of the handle. With one of the vehicle's Keyless Enter-N-Go Key Fobs located outside the vehicle and within 5 ft (1.5m) of the driver's or passenger front door handle, press the door handle LOCK button to lock all four doors and liftgate.

NOTE:

- If "Unlock All Doors 1st Press" is programmed all doors will unlock when you grab hold of the front driver's door handle. To select between "Unlock Driver Door 1st Press" and "Unlock All Doors 1st Press", refer to the Electronic Vehicle Information Center (EVIC) in your vehicle's Owner's Manual on the DVD or Programmable Features in this guide for further information.
- If "Unlock All Doors 1st Press" is programmed all doors and liftgate will unlock when you press the liftgate button. If "Unlock Driver Door 1st Press" is programmed only the liftgate will unlock when you press the liftgate button. To select between "Unlock Driver Door 1st Press" and "Unlock All Doors 1st Press", refer to the Electronic Vehicle Information Center (EVIC) in your vehicle's Owner's Manual on the DVD or Programmable Features in this guide for further information.

GETTING STARTED

- If a Key Fob is detected in the vehicle when locking the vehicle using the power door lock switch, the doors and liftgate will unlock and the horn will chirp three times. On the third attempt, your Key Fob can be locked inside the vehicle.
- After pressing the Keyless Enter-N-Go LOCK button, you must wait 2 seconds before you can lock or unlock the vehicle using the door handle.
- If a Keyless Enter-N-Go door handle has not been used for 72 hours, the Keyless Enter-N-Go feature for that handle may time out. Pulling the deactivated front door handle will reactivate the door handle's Keyless Enter-N-Go feature.

Lock or Unlock the Liftgate:



- With a valid Keyless Enter-N-Go Key Fob within 3 ft (1.0m) of the liftgate, press the button located to the right of the liftgate handle to unlock the liftgate. Press the button a second time to lock the liftgate.

NOTE:

- Refer to your Owner's Manual on the DVD for further information.

Engine Starting/Stopping



Starting

- With a valid Keyless Enter-N-Go Key Fob inside the vehicle.
- Place the shift lever in PARK or NEUTRAL.
- While pressing the brake pedal, press the ENGINE START/STOP button once. If the engine fails to start, the starter will disengage automatically after 10 seconds.

- To stop the cranking of the engine prior to the engine starting, press the button again.

Stopping

- Place the shift lever in PARK.
- Press the ENGINE START/STOP button once. The ignition switch will return to the OFF position.
- **If the shift lever is not in PARK, the ENGINE START/STOP button must be held for two seconds and vehicle speed must be above 5 mph (8 km/h) before the engine will shut off.**

GETTING STARTED

Accessory Positions with Engine Off

NOTE: The following functions are with the driver's foot OFF the Brake Pedal (Transmission in PARK or NEUTRAL Position).

Starting With The Ignition Switch In The OFF Position:

- Press the ENGINE START/STOP button once to change the ignition switch to the ACC position.
- Press the ENGINE START/STOP button a second time to change the ignition switch to the ON/RUN position.
- Press the ENGINE START/STOP button a third time to return the ignition switch to the OFF position.

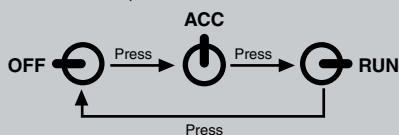

NOTE: If the ignition switch is left in the ACC or ON/RUN (engine not running) position and the transmission is in PARK, the system will automatically time out after 30 minutes of inactivity and the ignition will switch to the OFF position.

THEFT ALARM

To Arm

- **Keyless Enter-N-Go button installed:** Press the Keyless Enter-N-Go Start/Stop button until the Electronic Vehicle Information Center (EVIC) indicates that the vehicle ignition is "OFF". Press the power door lock switch while the door is open, press the Key Fob LOCK button, or with one of the Key Fobs located outside the vehicle and within 5 ft (1.5m) of the driver's and passenger front door handles, press the Keyless Enter-N-Go LOCK button located on the door handle.
- **Keyless Enter-N-Go button not installed:** Turn the ignition switch to the "OFF" position. Press the power door lock switch while the door is open, press the Key Fob LOCK button, or with one of the Key Fobs located outside the vehicle and within 5 ft (1.5m) of the driver's and passenger front door handles, press the Keyless Enter-N-Go LOCK button located on the door handle.

NOTE: After pressing the Keyless Enter-N-Go LOCK button, you must wait 2 seconds before you can lock or unlock the vehicle via the door handle.

To Disarm

- **Keyless Enter-N-Go button installed:** Press the Key Fob UNLOCK button or with one of the Key Fobs located outside the vehicle and within 5 ft (1.5m) of the driver's and passenger front door handles, grab the Keyless Enter-N-Go door handle and enter the vehicle, then press the Keyless Enter-N-Go Start/Stop button (requires at least one valid Key Fob in the vehicle).
- **Keyless Enter-N-Go button not installed:** Press the Key Fob UNLOCK button or with one of the Key Fobs located outside the vehicle and within 5 ft (1.5m) of the driver's and passenger front door handles, grab the Keyless Enter-N-Go door handle and enter the vehicle, then turn the ignition to the ON/RUN position.

GETTING STARTED

SEAT BELT

- Be sure everyone in your vehicle is in a seat and using a seat belt properly.
- Position the lap belt across your thighs, below your abdomen. To remove slack in the lap portion, pull up a bit on the shoulder belt. To loosen the lap belt if it is too tight, tilt the latch plate and pull on the lap belt. A snug belt reduces the risk of sliding under the belt in a collision.
- Position the shoulder belt on your chest so that it is comfortable and not resting on your neck. The retractor will withdraw any slack in the belt.
- A shoulder belt placed behind you will not protect you from injury during a collision. You are more likely to hit your head in a collision if you do not wear your shoulder belt. The lap and shoulder belt are meant to be used together.
- A belt that is too loose will not protect you properly. In a sudden stop you could move too far forward, increasing the possibility of injury. Wear your seat belt snugly.
- A frayed or torn belt could rip apart in a collision and leave you with no protection. Inspect the belt system periodically, checking for cuts, frays, or loose parts. Damaged parts must be replaced immediately. Do not disassemble or modify the system. Seat belt assemblies must be replaced after a collision if they have been damaged (bent retractor, torn webbing, etc.).
- The seat belts for both front seating positions are equipped with pretensioning devices that are designed to remove slack from the seat belt in the event of a collision.
- A deployed pretensioner or a deployed airbag must be replaced immediately.

WARNING!

In a collision, you and your passengers can suffer much greater injuries if you are not buckled up properly. You can strike the interior of your vehicle or other passengers, or you can be thrown out of the vehicle. Always be sure you and others in your vehicle are buckled up properly.

SUPPLEMENTAL RESTRAINT SYSTEM (SRS) — AIRBAGS

- This vehicle has Advanced Front Airbags for both the driver and right front passenger as a supplement to the seat belt restraint system. The Advanced Front Airbags will not deploy in every type of collision.
- Advanced Front Airbags are designed to provide additional protection by supplementing the seat belts in certain frontal collisions depending on the severity and type of collision. Advanced Front Airbags are not expected to reduce the risk of injury in rear, side, or rollover collisions.
- This vehicle is equipped with Supplemental Side Airbag Inflatable Curtains to protect the driver, front and rear passengers sitting next to a window.
- This vehicle is equipped with Supplemental Seat-Mounted Side Airbags to provide enhanced protection to help protect an occupant during a side impact.

GETTING STARTED

- If the Airbag Warning Light  is not on during starting, stays on, or turns on while driving, have the vehicle serviced by an authorized service center immediately.
- Refer to the Owner's Manual on the DVD for further details regarding the Supplemental Restraint System (SRS).

WARNING!

- Relying on the airbags alone could lead to more severe injuries in a collision. The airbags work with your seat belt to restrain you properly. In some collisions, the airbags won't deploy at all. Always wear your seat belts even though you have airbags.
- Being too close to the steering wheel or instrument panel during Advanced Front Airbag deployment could cause serious injury, including death. Airbags need room to inflate. Sit back, comfortably extending your arms to reach the steering wheel or instrument panel.
- Supplemental Side Airbag Inflatable Curtains and Supplemental Seat-Mounted Side Airbags need room to inflate. Do not lean against the door or window. Sit upright in the center of the seat.
- Being too close to the Supplemental Side Airbag Inflatable Curtain and/or Seat-Mounted Side Airbag during deployment could cause you to be severely injured or killed.
- Do not drive your vehicle after the airbags have deployed. If you are involved in another collision, the airbags will not be in place to protect you.
- After any collision, the vehicle should be taken to an authorized dealer immediately.

CHILD RESTRAINTS

- Children 12 years and under should ride properly buckled up in a rear seat, if available. According to crash statistics, children are safer when properly restrained in the rear seats rather than in the front.
- Every state in the United States and all Canadian provinces require that small children ride in proper restraint systems. This is the law, and you can be prosecuted for ignoring it.

Installing The LATCH - Compatible Child Restraint System

- Your vehicle's second row passenger seats are equipped with the child restraint anchorage system called LATCH, which stands for Lower Anchors and Tether for Children.
- Second and third row seating positions have lower anchorages that are capable of accommodating LATCH-compatible child seats having flexible, webbing-mounted lower attachments.
- Child seats with fixed lower attachments must be installed in the outboard positions only.

GETTING STARTED

- Never install LATCH-compatible child seats such that two seats share a common lower anchorage.



- Loosen the child seat adjusters on the lower straps and tether straps so that you can attach the hook or connector to the lower tether anchorages more easily.
- Attach the lower hooks or connectors over the top of the anchorage bars. The rear seat lower anchorages are round bars, located at the rear of the seat cushion where it meets the seatback.

- The tether strap should be attached to the tether anchor on the rear of the seatback (behind the gap panel) using the most direct path. **DO NOT USE** the cargo tie down loops located on the load floor.

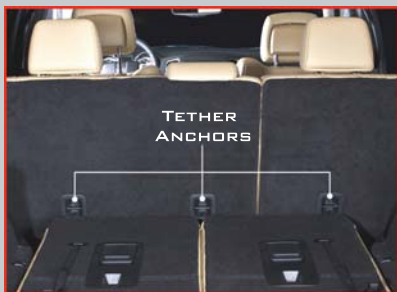

- Tighten both straps as you push the child restraint rearward and downward into the seat.



GETTING STARTED

Installing The Child Restraint Using The Vehicle Seat Belts

- To install a child restraint, first pull enough of the seat belt webbing from the retractor to route it through the belt path of the child restraint and slide the seat belt latch plate into the buckle.
- Next, extract all the seat belt webbing out of the retractor and then allow the belt to retract into the retractor. Finally, pull on any excess webbing to tighten the lap portion around the child restraint. Any seat belt system will loosen with time, so check the belt occasionally, and pull it tight if necessary.
- Once you have completed securing the child restraint with the seat belt, secure the top tether strap. The tether strap should be attached to the tether anchor on the rear of the seatback (behind the gap panel) using the most direct path. **DO NOT USE** the cargo tie down loops located on the load floor.

WARNING!

- In a collision, an unrestrained child, even a tiny baby, can become a projectile inside the vehicle. The force required to hold even an infant on your lap could become so great that you could not hold the child, no matter how strong you are. The child and others could be severely injured or killed. Any child riding in your vehicle should be in a proper restraint for the child's size.
- Improper installation of a child restraint to the LATCH anchorages can lead to failure of an infant or child restraint. The child could be severely injured or killed. Follow the manufacturer's directions exactly when installing an infant or child restraint.
- An incorrectly anchored tether strap could lead to increased head motion and possible injury to the child. Use only the anchor positions directly behind the child seat to secure a child restraint top tether strap.
- Rearward-facing child seats must never be used in the front seat of a vehicle with a front passenger airbag. An airbag deployment could cause infants in this position to be severely injured or killed.

FRONT SEATS

Power Seats

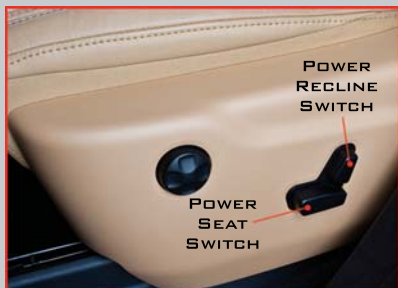

- The power recline switch, located on the outboard side of the seat, controls seatback adjustment.
- The power seat switch controls forward/back, up/down and tilt adjustment.

GETTING STARTED

Power Lumbar



- Push the switch forward to increase the lumbar support. Push the switch rearward to decrease the lumbar support.
- Pushing upward or downward on the switch will raise and lower the position of the support.

Memory Seat



- The memory seat feature allows you to save two different driver seating positions (excluding lumbar position), driver's outside mirror, tilt/telescoping steering column position, and radio station preset settings. The memory seat buttons are located on the driver's door panel.
 - Adjust all memory profile settings, press the SET button then press 1 or 2 within five seconds.
- To program a Key Fob to the memory position, place the ignition switch in the LOCK position and remove the Key Fob, press and release the LOCK button on the Key Fob to be programmed within 5 seconds of pressing button 1 or 2.
 - Place the ignition switch in the ON/RUN position, select Remote Linked to Memory in the Electronic Vehicle Information Center (EVIC) and enter Yes.
 - Press 1 or 2 to recall the saved positions, or press UNLOCK on the programmed Key Fob.
 - Refer to the Owner's Manual on the DVD for further details.

GETTING STARTED

Manual Seat Adjustment

Forward/Rearward

- Lift up on the adjusting bar located at the front of the seat near the floor and release when seat is in desired position.



Recliner

- Lift the rear lever located on the outboard side of the seat, lean back and release when seat is in desired position.



Fold-Flat Front Passenger Seat



- The front passenger seat can be folded flat to allow for extended cargo space. Pull up on the recliner lever and fold the seatback forward and down to a flat position.

GETTING STARTED

CAUTION!

Do not place any article under a power seat or impede its ability to move as it may cause damage to the seat controls. Seat travel may become limited if movement is stopped by an obstruction in the seat's path.

WARNING!

- Adjusting a seat while the vehicle is moving is dangerous. The sudden movement of the seat could cause you to lose control. The seat belt might not be properly adjusted, and you could be severely injured or killed. Only adjust a seat while the vehicle is parked.
- Do not ride with the seatback reclined so that the seat belt is no longer resting against your chest. In a collision, you could slide under the seat belt and be severely injured or killed. Use the recliner only when the vehicle is parked.

REAR SEATS

60/40 Second Row Folding Seat



Fold and Tumble - Second Row Seat – If Equipped

- The left or right side of the second row seatback can be lowered. The left and right side of the second row seat can also be tumbled forward to allow access to the third row seat.
- Pull upward on the release lever to release the seat.

NOTE: Also, pulling upward on this handle allows the outboard seating positions to be reclined.

- Tumble the seat forward using the red pull strap located behind the seatback.

NOTE: If sitting in the third row seat, pull rearward on the tumble pull strap located at the rear of the seat and tumble the seat forward.

GETTING STARTED



50/50 Third Row Folding Seat – If Equipped

- Either or both third row seats can be folded forward to increase the rear cargo storage area.
- After opening the liftgate, either seat can be folded flat by pulling up the release handle on the back of the seat.
- A seat that is folded flat can be returned to the upright position by using the pull strap located on the back of the seat next to the release handle.

NOTE: The second row seats must be in their full upright position, or tumbled when folding the third row seats.

- To raise the seat, pull the seat toward you using the strap located on the back of the seat.

Power Folding Third Row Head Restraints

For improved visibility, the third row head restraints can be folded using a switch, located on the instrument panels switch bank.

NOTE: The head restraints can only be folded downward using the power folding switch. The head restraints must be raised manually when occupying the third row.

WARNING!

Do not drive the vehicle with the second row seats in the tumbled position. The second row seats are only intended to be tumbled for entry and exit to the third row seat. Failure to follow these instructions could result in personal injury.

POWER FOLDING THIRD ROW HEAD RESTRAINTS



For improved visibility, the third row head restraints can be folded using a switch, located on the instrument panels switch bank.

NOTE: The head restraints can only be folded downward using the power folding switch. The head restraints must be raised manually when occupying the third row.

GETTING STARTED

HEATED/VENTILATED SEATS

Front Heated Seats



- The controls for front heated seats are located in the climate controls near the center of the instrument panel.
- Press the switch once to select High-level heating. Press the switch a second time to select Low-level heating. Press the switch a third time to shut the heating elements Off.

- If the High-level setting is selected, the system will automatically switch to Low-level after approximately 55 minutes. The Low-level setting will turn Off automatically after approximately 45 minutes.

Front Ventilated Seats

- Located in the seat cushion and seatback are small fans that draw the air from the passenger compartment and blow air through fine perforations in the seat cover to help keep the driver and front passenger cooler in higher ambient temperatures.
- The ventilated seat switches are located in the climate controls near the center of the instrument panel. Press the switch once to select High speed. Press the switch a second time to select Low speed. Press the switch a third time to turn the fans Off.

Rear Heated Seats



- Second row heated seat switches are located on the rear of the center console.
- Press the switch once to select High-level heating. Press the switch a second time to select Low-level heating. Press the switch a third time to shut the heating elements Off.

- If the High-level setting is selected, the system will automatically switch to Low-level after approximately 55 minutes. The Low-level setting will turn Off automatically after approximately 45 minutes.

GETTING STARTED

WARNING!

- Persons who are unable to feel pain to the skin because of advanced age, chronic illness, diabetes, spinal cord injury, medication, alcohol use, exhaustion or other physical conditions must exercise care when using the seat heater. It may cause burns even at low temperatures, especially if used for long periods of time.
- Do not place anything on the seat that insulates against heat, such as a blanket or cushion. This may cause the seat heater to overheat. Sitting in a seat that has been overheated could cause serious burns due to the increased surface temperature of the seat.

HEATED STEERING WHEEL



- The steering wheel contains a heating element that heats the steering wheel to one temperature setting.
- The heated steering wheel switch is located on the center instrument panel below the climate controls.
- Press the switch once to turn the heating element On. Press the switch a second time to turn the heating element Off.

- Once the heated steering wheel has been turned on, it will operate for approximately 58 to 70 minutes before automatically shutting off. The heated steering wheel can shut off early or may not turn on when the steering wheel is already warm.

TILT/TELESCOPING STEERING COLUMN

Manual - Tilt/Telescoping Steering Column



- The tilt/telescoping control handle is located below the steering wheel at the end of the steering column.
- Push the handle down to unlock the steering column.
- To tilt the steering column, move the steering wheel upward or downward as desired. To lengthen or shorten the steering column, pull the steering wheel outward or push it inward as desired.

- Pull up on the handle to lock the column firmly in place.

GETTING STARTED

Power - Tilt/Telescoping Steering Column



- The power tilt/telescoping steering control is located below the turn signal/wiper/washer/high beam lever on the steering column.
- To tilt the steering column, move the power tilt/telescoping control up or down as desired. To lengthen or shorten the steering column, pull the control toward you or push the control away from you as desired.

WARNING!



- Do not adjust the steering wheel while driving. The tilt/telescoping adjustment must be locked while driving. Adjusting the steering wheel while driving or driving without the tilt/telescoping adjustment locked could cause the driver to lose control of the vehicle. Failure to follow this warning may result in you and others being severely injured or killed.
- Moving the steering column while the vehicle is moving is dangerous. Without a stable steering column, you could lose control of the vehicle and have a collision. Adjust the column only while the vehicle is stopped.

OPERATING YOUR VEHICLE

HEADLIGHT SWITCH



Automatic Headlights/Parking Lights/Headlights

- Rotate the headlight switch, located on the instrument panel to the left of the steering wheel, to the first detent for parking lights  and to the second detent for headlights .
- With the parking lights or low beam headlights on, push the headlight switch once for fog lights.
- Rotate the headlight switch to "AUTO" for AUTO headlights.

- When set to AUTO, the system automatically turns the headlights on or off based on ambient light levels.

SmartBeams™

- This system automatically controls the use of the headlight high beams. Refer to Programmable Features in Electronics for further details.

Instrument Panel Dimmer

- Rotate the dimmer control to the extreme bottom position to fully dim the instrument panel lights and prevent the interior lights from illuminating when a door is opened.
- Rotate the dimmer control up to increase the brightness of the instrument panel when the parking lights or headlights are on.
- Rotate the dimmer control up to the next detent position to fully brighten the odometer and radio when the parking lights or headlights are on. Refer to your Media Center/Radio User Manual on the DVD for display dimming.
- Rotate the dimmer control up to the last detent position to turn on the interior lighting.

OPERATING YOUR VEHICLE

TURN SIGNAL/WIPER/WASHER/HIGH BEAM LEVER

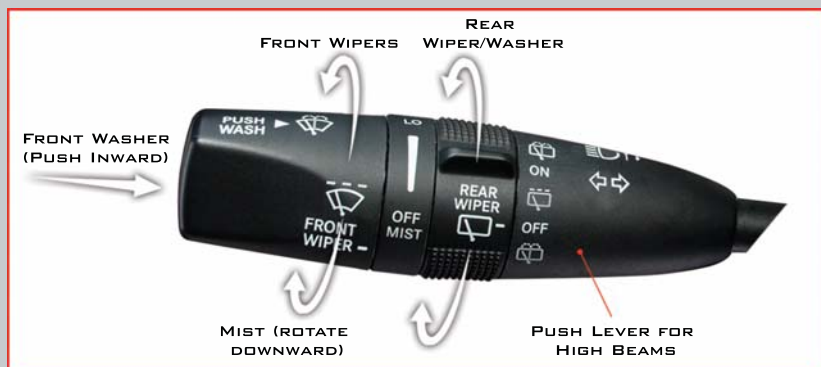

Turn Signal/Lane Change Assist

- Tap the lever up or down once and the turn signal (right or left) will flash three times and automatically turn off.

Front Wipers

Intermittent, Low And High Operation

- Rotate the end of the lever to the first detent position for one of four intermittent settings, the second detent for low wiper operation and the third detent for high wiper operation.

Washer Operation

- Push inward on the end of the lever and hold for as long as spray is desired.

Mist

- Rotate the end of the lever downward when a single wipe is desired.

Rain Sensing Wipers

- This feature senses moisture on the vehicle's windshield and automatically activates the wipers for the driver when the switch is in the intermittent position. Rotate the end of the lever to one of four settings to activate this feature and adjust sensitivity.
- This feature can be activated/deactivated using the Electronic Vehicle Information Center (EVIC). Refer to the Programmable Features under the Electronics section in this guide.
- Refer to the Owner's Manual on the DVD for further details.

Rear Wiper

Wiper Operation

- Rotate the center portion of the lever forward to the first detent for intermittent operation and to the second detent for rear wiper operation.

OPERATING YOUR VEHICLE

Washer Operation

- Rotate the center portion of the lever past the second detent to activate the rear washer.

High Beam Operation

- Push the lever forward to activate the high beams. Pull the lever toward you for flash to pass.

NOTE: For safe driving, turn off high beams when oncoming traffic is present to prevent headlight glare and as a courtesy to other motorists.

AUTO DIMMING MIRRORS

- The rearview and driver side exterior mirror automatically adjusts for headlight glare from vehicles behind you.
- You can turn the feature on or off by pressing the button at the base of the rearview mirror. A light next to the button will illuminate to indicate when the dimming feature is activated.

SPEED CONTROL



- The speed control switches are located on the steering wheel.

NOTE: The MODE button and DISTANCE SETTING button are only available on vehicles equipped with Adaptive Cruise Control (ACC).

Cruise ON/OFF

- Push the ON/OFF button to activate the Speed Control.
- CRUISE READY  will appear on the instrument cluster to indicate the Speed Control is on.
- Push the ON/OFF button a second time to turn the system off.

Set

- With the Speed Control on, push and release the SET – button to set a desired speed.

OPERATING YOUR VEHICLE

Accel/Decel

- Once a speed is set, pushing the RES + button once or the SET – button once will increase or decrease the set speed approximately 1 mph (2 km/h).

Resume

- To resume a previously selected set speed in memory, push the RES + button and release.

Cancel

- Push the CANCEL button, or apply the brakes to cancel the set speed and maintain the set speed memory.
- Push the ON/OFF button to turn the system off and erase the set speed memory.

Adaptive Cruise Control (ACC)

- If your vehicle is equipped with adaptive cruise control the controls operate exactly the same as the standard cruise control with one difference. You can set a specified distance you would like to maintain between you and the vehicle in front of you.
- If the ACC sensor detects a vehicle ahead, ACC will apply limited braking or acceleration automatically to maintain a preset following distance, while matching the speed of the vehicle ahead.
- If the sensor does not detect a vehicle directly ahead of you, it functions like a standard cruise control system, maintaining the speed you set.

Accel/Decel (ACC Only)

- Once a speed is set, pushing the RES + button once or the SET – button once will increase or decrease the set speed approximately 1 mph (1 km/h).
- Push and hold the RES + button to accelerate in 5mph (10 km/h) increments or push and hold the SET – button to decelerate in 5mph (10 km/h) increments; release the button to save the new set speed.

Distance Setting (ACC Only)

- To set or change the distance setting, press the Distance button and release. Each time the button is pressed, the distance setting adjusts between long (3), medium (2), and short (1). The distance setting will default to the last set mode the next time the vehicle is restarted and the ACC system is turned on.
- The specified following distance for ACC can be set by varying the distance setting between 3 (long), 2 (medium), and 1 (short). Using this distance setting and the vehicle speed, ACC calculates and sets the distance to the vehicle ahead. This distance setting displays in the EVIC.

Mode (ACC Only)

- If desired, the Adaptive Cruise Control mode can be turned off and the system can be operated as a standard (fixed speed) Cruise Control. When in the standard (fixed speed) Cruise Control mode the distance setting feature will be disabled and the system will maintain the speed you set.

OPERATING YOUR VEHICLE

- To change modes, press the MODE button when the system is in either the OFF, READY, or SET position. Cruise Off will be displayed if the system was in ACC READY, ACC SET or the ACC OFF position. To switch back to Adaptive Cruise Control mode, press the MODE button a second time.
- Each press of the MODE button will be followed by an audible chime.
- Refer to your Owner's Manual on the DVD for further information.

Forward Collision Warning

- Forward Collision Warning (FCW) warns the driver of a potential collision with the vehicle in front of you and prompts the driver to take action in order to avoid the collision. A warning message (both audible and visual) will be displayed on the EVIC.
- Refer to your Owner's Manual on the DVD for further information.

WARNING!

- Leaving the Electronic or Adaptive Speed Control system on when not in use is dangerous. You could accidentally set the system or cause it to go faster than you want. You could lose control and have a collision. Always leave the Electronic or Adaptive Speed Control system off when you are not using it.
- Electronic Speed Control can be dangerous where the system cannot maintain a constant speed. Your vehicle could go too fast for the conditions, and you could lose control. A collision could be the result. Do not use Electronic Speed Control in heavy traffic or on roads that are winding, icy, snow-covered or slippery.
- Adaptive Cruise Control (ACC) is a convenience system. It is not a substitute for active driving involvement. Pay attention to road, traffic, and weather conditions, vehicle speed, distance to the vehicle ahead, and brake operation to ensure safe operation of the vehicle under all road conditions. Your attention is always required while driving to maintain safe control of your vehicle. Failure to follow these warnings can result in a collision or serious personal injury.

The ACC system:

- Does not react to pedestrians, oncoming vehicles, and stationary objects (i.e., a stopped vehicle in a traffic jam or a disabled vehicle).
- Cannot take street, traffic, and weather conditions into account, and may be limited upon adverse sight distance conditions.
- Does not predict the lane curvature or the movement of preceding vehicles and will not compensate for such changes.
- Does not always fully recognize complex driving conditions, which can result in wrong or missing distance warnings.
- Can only apply a maximum of 25% of the vehicle's braking capability, and will not bring the vehicle to a complete stop.

You should switch off the ACC system:

(Continued)

OPERATING YOUR VEHICLE

WARNING! *(Continued)*

- When driving in fog, heavy rain, heavy snow, sleet, heavy traffic, and complex driving situations (i.e., in highway construction zones).
- When entering a turn lane or highway off ramp; when driving on roads that are winding, icy, snow-covered, slippery, or have steep uphill or downhill slopes; and when towing a trailer.
- When circumstances do not allow safe driving at a constant speed.
- Failure to follow these warnings can result in a collision.
- Forward Collision Warning (FCW) is not intended to avoid a collision on its own. The driver has the responsibility to avoid a collision by controlling the vehicle via braking and steering. Failure to follow this warning could lead to serious injury or death.

ELECTRONIC RANGE SELECTION (ERS)



- Electronic Range Select (ERS) allows you to limit the highest available transmission gear, and can be activated during any driving condition. When towing a trailer, using ERS shift control will help you maximize both performance and engine braking.

- To switch from DRIVE mode to ERS mode, tap the shift lever to the left (-) once. The instrument cluster will display the current gear (the transmission may downshift), and the transmission will not upshift beyond that gear. Tapping the shift lever to the left (-) or right (+) will decrease or increase the top available gear. To disable ERS, simply hold the shift lever to the right (+) until "D" is again displayed in the instrument cluster.
- Switching between ERS and DRIVE mode can be done at any vehicle speed.
- Refer to your Owner's Manual on the DVD for further details.

OPERATING YOUR VEHICLE

AUTOMATIC TEMPERATURE CONTROLS (ATC)



Automatic Operation

- Press the AUTO button.
- Select the desired temperature by pressing the Temperature Control buttons.
- The system will maintain the set temperature automatically.

Air Conditioning

- If the air conditioning button is pressed while in the AUTO mode, the indicator light may flash three times to indicate the cabin air is being controlled automatically.

SYNC Temperature Button

- Press the SYNC button once to control driver and passenger temperatures simultaneously. Press the SYNC button a second time to control the temperatures individually.

Air Recirculation

- Use recirculation for maximum A/C operation.
- For window defogging, press air recirculation button off.
- If the recirculation button is pressed while in the AUTO mode, the indicator light may flash three times to indicate the cabin air is being controlled automatically.

OPERATING YOUR VEHICLE

Rear Temperature Controls

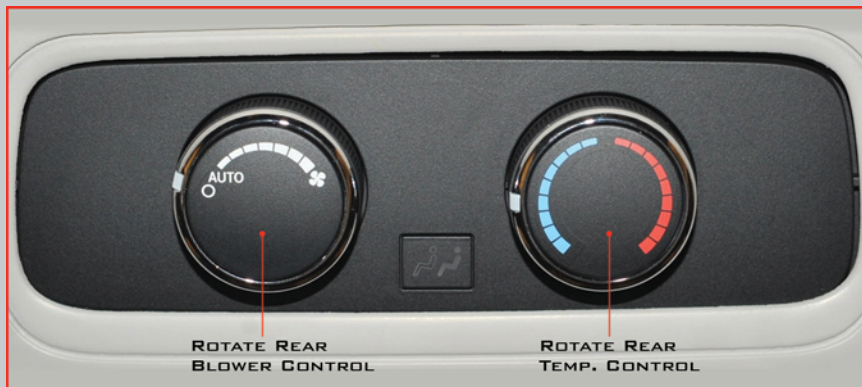

- The rear controls for the ATC System are located in the headliner, near the center of the vehicle.
- The rear temperature controls can be turned on two ways:
 - Press the REAR control button on the front temperature controls and adjust to the desired rear temperature.
 - Rotate the Rear Temperature Control or the Rear Blower Control knobs on the rear temperature controls.
- Press the REAR button and then the OFF button on the front temperature controls to turn the rear controls off.

PARKSENSE[®] REAR PARK ASSIST

- The four ParkSense[®] sensors, located in the rear fascia/bumper, monitor the area behind the vehicle that is within the sensors' field of view.
- When an object is detected within two meters behind the rear bumper while the vehicle is in REVERSE, a warning will display in the Electronic Vehicle Information Center (EVIC) and a chime will sound (when Sound and Display is selected from the Customer Programmable Features section of the EVIC). As the vehicle moves closer to the object, the chime rate will change from slow, to fast, to continuous.

Cleaning the ParkSense[®] Sensors

- If "CLEAN PARK ASSIST SENSORS" appears in the Electronic Vehicle Information Center (EVIC), clean the ParkSense[®] sensors with water, car wash soap and a soft cloth. Do not use rough or hard cloths. Do not scratch or poke the sensors. Otherwise, you could damage the sensors.

NOTE: When the Instrument Cluster reads either Clean Sensor or Blinded, please clean off the bumper sensors to see if the condition is corrected.

OPERATING YOUR VEHICLE

PARKVIEW[®] REAR BACK-UP CAMERA

- You can see an on-screen image of the rear of your vehicle whenever the shift lever is put into REVERSE. The ParkView[®] Rear Back-Up Camera image will be displayed on the radio display screen, located on the center stack of the instrument panel.
- If the radio display screen appears foggy, clean the camera lens located on the liftgate.

WARNING!

Drivers must be careful when backing up even when using the ParkView[®] Rear Back-Up Camera. Always check carefully behind your vehicle, and be sure to check for pedestrians, animals, other vehicles, obstructions, or blind spots before backing up. You must continue to pay attention while backing up. Failure to do so can result in serious injury or death.

BLIND SPOT MONITORING

- The Blind Spot Monitoring (BSM) system uses two radar-based sensors, located inside the rear bumper fascia, to detect Highway licensable vehicles (automobiles, trucks, motorcycles etc.) that enter the blind spot zones from the rear/front/side of the vehicle.
- The Blind Spot Monitoring (BSM) system warning light, located in the outside mirrors, will illuminate if a vehicle moves into a blind spot zone.
- The BSM system can also be configured to sound an audible (chime) alert and mute the radio to notify you of objects that have entered the detection zones.
- Refer to your owner's manual on the DVD for further details.

OPERATING YOUR VEHICLE

POWER SUNROOF

EXPRESS OPEN: PRESS THE SWITCH REARWARD AND RELEASE. THE SUNROOF WILL FULLY OPEN AND STOP AUTOMATICALLY.

EXPRESS CLOSE: PRESS THE SWITCH FORWARD AND RELEASE. THE SUNROOF WILL CLOSE AUTOMATICALLY FROM ANY POSITION.

EXPRESS VENTING: PRESS AND RELEASE THE "VENT" BUTTON, AND THE SUNROOF WILL OPEN TO THE VENT POSITION.



THE POWER SUNROOF SWITCHES ARE LOCATED ON THE OVERHEAD CONSOLE.

Manual Open/Close

- Press and hold the switch rearward to open or forward to close the sunroof. Any release of the switch will stop the movement, and the sunroof will remain in a partially open or closed position until the switch is pressed again.

Pinch Protection Feature

- This feature will detect an obstruction in the opening of the sunroof or the shade during Express Close operation. If an obstruction in the path of the sunroof or shade is detected, the sunroof or shade will automatically return to the open position.

NOTE: Pinch protection is disabled while the switch is pressed and held during manual opening and closing of the sunroof or shade.

WARNING!

- Never leave children in a vehicle with the key in the ignition switch. Occupants, particularly unattended children, can become entrapped by the power sunroof while operating the power sunroof switch. Such entrapment may result in serious injury or death.
- In a collision, there is a greater risk of being thrown from a vehicle with an open sunroof. You could also be severely injured or killed. Always fasten your seat belt properly and make sure all passengers are properly secured.

(Continued)

OPERATING YOUR VEHICLE

WARNING! *(Continued)*

- Do not allow small children to operate the sunroof. Never allow your fingers, other body parts, or any object to project through the sunroof opening. Injury may result.

OPERATING YOUR VEHICLE

WIND BUFFETING

- Wind buffeting can be described as a helicopter-type percussion sound. If buffeting occurs with the rear windows open, adjust the front and rear windows together.
- If buffeting occurs with the sunroof open, adjust the sunroof opening, or adjust any window. This will minimize buffeting.

ELECTRONICS

YOUR VEHICLE'S SOUND SYSTEM



STEERING WHEEL
AUDIO CONTROLS
(BACK OF STEERING
WHEEL)

UCONNECT™ VOICE
COMMAND BUTTON

UCONNECT™ PHONE
BUTTON

BLUETOOTH STREAMING
AUDIO - ALLOWS YOU TO
CONTROL YOUR BLUETOOTH DEVICE THROUGH
THE RADIO, STEERING WHEEL AUDIO CONTROLS
OR VOICE COMMANDS. SEE UCONNECT™
PHONE IN THIS SECTION FOR MORE DETAILS.
ALSO, BLUETOOTH DEVICE MUST BE
COMPATIBLE. REFER TO YOUR BLUETOOTH
DEVICE'S MANUAL TO SEE IF IT SUPPORTS
A2DP+AVCRP 1.3 PROTOCOL.

ELECTRONICS

STEERING WHEEL
AUDIO CONTROLS
(BACK OF STEERING
WHEEL)

USB PORT
ON RADIO -
FOR COPYING
FILES FROM A
MEMORY STICK
TO YOUR RADIO'S
HARD DRIVE.

AUDIO JACK -
WORKS WITH
iPOD® DEVICES
OR OTHER
PLAYERS WITH A
HEADPHONES
JACK AND A 3.5MM
CABLE.

YOUR RADIO
SALES CODE

USB PORT (LOCATED
INSIDE CENTER CONSOLE) -
WHEN CONNECTED, ALLOWS
YOU TO CONTROL YOUR iPOD®
OR MEMORY STICK USING THE
RADIO OR STEERING WHEEL
AUDIO CONTROLS.

ELECTRONICS

NON-TOUCH-SCREEN RADIOS

Media Center 130 (Sales Code RES)

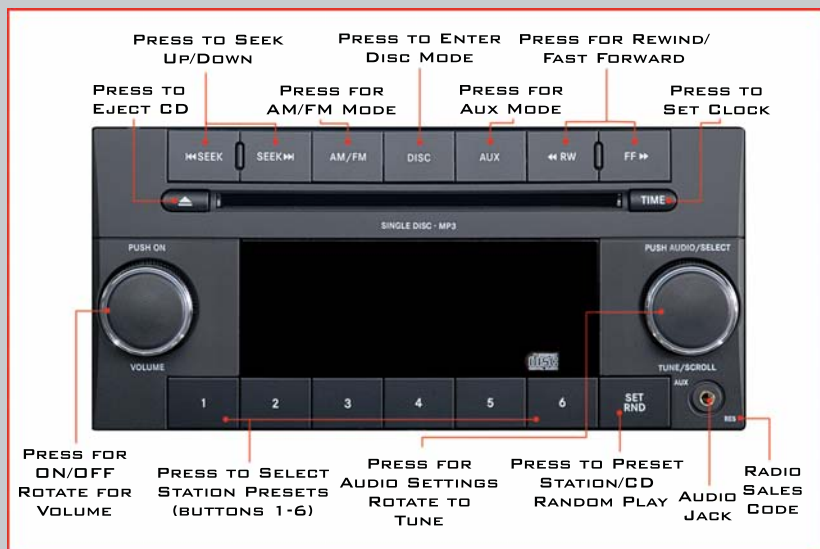

Media Center 130 with Satellite Radio (Sales Code RES + RSC)

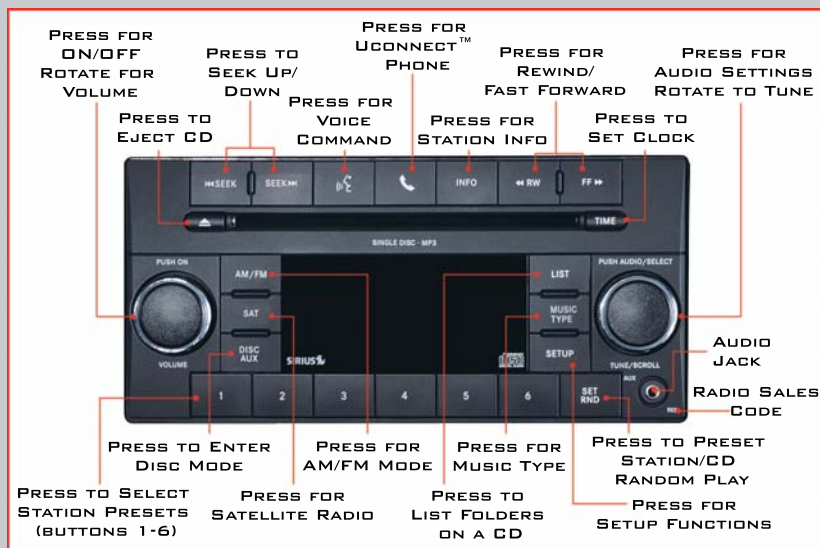

NOTE: Your radio may not be equipped with the Uconnect™ Voice Command and Uconnect™ Phone features. To determine if your radio has these features, press the Voice Command button on the radio. You will hear a voice prompt if you have the feature, or see a message on the radio stating “Uconnect Phone not available” if you do not.

- Your radio has many features that add to the comfort and convenience of you and your passengers. Some of these radio features should not be used when driving because they take your eyes from the road or your attention from driving.
- The radio sales code is located on the lower right side of the radio faceplate.

Seek Up/Down Buttons

- Press to seek through radio stations in AM, FM, or SAT bands. Seek through tracks in CD, iPod®, or USB modes.
- Hold either button to bypass stations without stopping.

Audio Settings

- Press the TUNE/SCROLL control knob and BASS, MID, TREBLE, BALANCE and FADE will display. Rotate the TUNE/SCROLL control knob to select the desired setting.

Audio Jack

- The Audio Jack allows a portable device, such as an MP3 player or a cassette player, to be plugged into the radio and utilize the vehicle's audio system, using a 3.5 mm audio cable, to amplify the source and play through the vehicle speakers.
- Pressing the AUX button will change the mode to auxiliary device if the Audio Jack is connected, allowing the music from your portable device to be heard through the vehicle's speakers.
- The functions of the portable device are controlled using the device buttons. The volume may be controlled using the radio or portable device.

Clock Setting

- Press and hold the TIME button until the hours blink; turn the TUNE/SCROLL control knob to set the hours.
- Press the TUNE/SCROLL control knob until the minutes begin to blink; turn the TUNE/SCROLL control knob to set the minutes.
- Press the TUNE/SCROLL control knob to save the time change.
- To exit, press any button/knob or wait five seconds.

Store Radio Presets

- Press the SET/RND button once and SET 1 will show in the display. Then select the button (1–6).
- A second station may be added to each push button. Press the SET/RND button twice and SET 2 will show in the display, then select button (1–6).

ELECTRONICS

TOUGH-SCREEN RADIOS

Media Center 730N CD/DVD/HDD/NAV (Sales Code RHR)

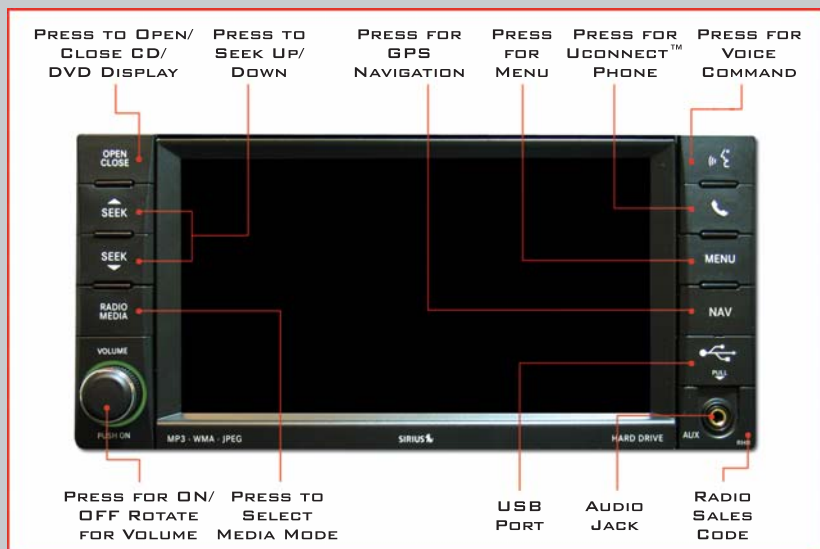

Media Center 430/430N CD/DVD/HDD (Sales Code RBZ/RHB)

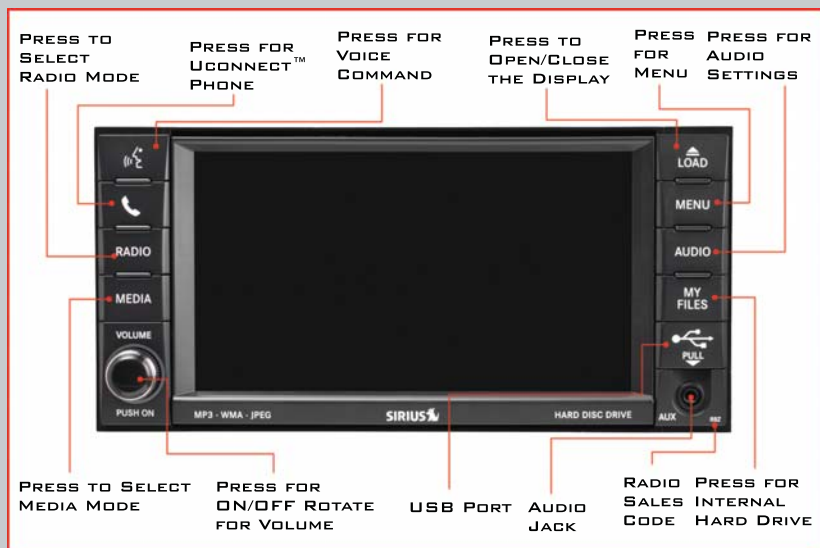

NOTE: Your radio may not be equipped with the Uconnect™ Voice Command and Uconnect™ Phone features. To determine if your radio has these features, press the Voice Command button on the radio. You will hear a voice prompt if you have the feature, or see a message on the radio stating “Uconnect Phone not available” if you do not.

- Your radio has many features that add to the comfort and convenience of you and your passengers. Some of these radio features should not be used when driving because they take your eyes from the road or your attention from driving.
- The radio sales code is located on the lower right side of the radio faceplate.

Seek Up/Down

- Media Center 730N: Press the SEEK hard-key to seek through radio stations in AM, FM, or SAT bands. Seek through tracks in CD or iPod® modes or through songs in the HDD playlist.
- Media Center 430/430N: Press the SEEK up/down arrow soft-keys to change the currently playing station in AM, FM or SAT bands. Seek through tracks in CD or iPod® modes or through songs in the HDD playlist.

Audio Jack

- The Audio Jack allows a portable device, such as an MP3 player or a cassette player, to be plugged into the radio and utilize the vehicle's audio system, using a 3.5 mm audio cable, to amplify the source and play through the vehicle speakers.
- Pressing the AUX button will change the mode to auxiliary device if the Audio Jack is connected, allowing the music from your portable device to be heard through the vehicle's speakers.
- The functions of the portable device are controlled using the device buttons. The volume may be controlled using the radio or portable device.

Clock Setting

- Turn the radio on, then touch the screen where the time is displayed.
- Touch the USER CLOCK soft-key (Navigation radio only).
- To adjust the hours, touch either the HOUR FORWARD or HOUR BACKWARD soft-key.
- To adjust the minutes, touch either the MINUTE FORWARD or MINUTE BACKWARD soft-key.
- To save the new time setting, touch the screen where the word “Save” is displayed.

Store Radio Presets

- Media Center 730N: Press the RADIO/MEDIA hard-key until AM FM SAT is displayed in the upper left corner of the screen.
- Media Center 430/430N: Press the RADIO hard-key to display AM FM SAT in the upper left corner of the screen.
- Select the radio band by touching either the AM, FM, or SAT soft-key.
- Find the station to store by either pressing the SEEK UP/DOWN hard-keys (Media Center 730N), touching the right and left arrow soft-keys (Media Center 430/430N), touching the SCAN soft-key, or by using the DIRECT TUNE soft-key.

ELECTRONICS

- Once the station is found, touch and hold one of the PRESET soft-keys in the list to the right, until you hear a confirmation beep.

Hard Disk Drive Operation

Copy Complete Audio Disc To Hard-Drive

- Media Center 730N: Press the OPEN/CLOSE hard-key.
- Media Center 430/430N: Press the LOAD hard-key.
- Insert a disc, then press the MENU hard-key.
- Touch the MY FILES soft-key, then select MY MUSIC.
- Touch the Add Music Files to HDD soft-key, then touch the From Disc soft-key in the next screen to start the process.

Copying From USB

- The USB port on the radio face plate allows you to copying files to your hard drive. To access, lift up on the cover.
- Insert a USB device (e.g. thumb drive or memory stick), then select MY MUSIC.
- Touch the Add Music Files to HDD soft-key, then touch the From USB soft-key in the next screen.
- Select the folders or titles you would like to copy, then touch the DONE soft-key to start the copy process.

Copy Pictures To The Hard-Drive

- Insert either a CD or a USB device containing your pictures in JPEG format into the USB port on the radio face.
- Touch the MY FILES soft-key, then go to the MANAGE MY FILES screen.
- Touch the MY PICTURES soft-key to get an overview of the currently stored images.
- Touch one of the ADD PICTURES soft-keys, then select the type of media inserted.
- Use the PAGE soft-keys to page through a list of pictures and press the picture you would like to import.
- Confirm your selection by touching the YES or SAVE soft-key. The imported picture is now available in the MANAGE MY PICTURES screen.
- In order to display the imported picture in the radio screen, touch the desired picture soft-key.
- Select this picture by pressing the PICTURE VIEW soft-key. A check mark indicates the currently used picture.

Cleaning Your Touch-Screen Radio

- Do not spray any liquid or caustic chemicals directly on the screen. Use a clean and dry micro fiber lens cleaning cloth in order to clean the touch-screen.
- If necessary, use a lint-free cloth dampened with a cleaning solution such as isopropyl alcohol or an isopropyl alcohol and water solution ratio of 50:50. Be sure to follow the solvent manufacturer's precautions and directions.

USB Port

- The USB Port on the radio allows you to copy songs from a connected USB drive or supported media device onto your Media Center hard drive. You can also playback music from your USB device through the USB Port on the radio. The USB Port on a Media Center 730N allows you to support iPod® devices or USB drives for music playback, charging, control through radio or steering wheel buttons, voice commands and song selection by voice.
- The USB port located in the center console also offers the ability to play songs from connected USB drives, or supported media devices. Supported devices may be controlled through the vehicles steering wheel or radio controls, or even with voice commands, and may be charged through the USB port. If equipped, you may also select songs by name.

Navigation – Media Center 730N (Sales Code RHR) Only

- Navigation radios require digital data from a navigation database. The data in the navigation database is licensed from Navigation Technologies®. Not all roads are digitized.
- For software updates, visit <http://www.navteq.com> website, or contact your authorized dealer for the latest available software.

NOTE: Many features of this radio are speed dependent. For your own safety, it is not possible to use the touch-screen keyboard to enter a name (e.g., street name) while the vehicle is in motion. Pull over at a safe location to complete your task or use Voice Command.

- The Navigation system receives GPS signals from satellites to display the position of your vehicle.

Map

- Press the NAV hard-key to access the Navigation Main Menu.
- Touch the MAP soft-key to display a map of your current position.

New Destination

- Press the NAV hard-key to access the Navigation Main Menu.
- Touch the NEW DESTINATION soft-key to program a destination, then select the destination soft-key of your choice.
- Media Center 730N allows destinations to be input by voice while in motion. Press the Voice Command button on the radio to begin.

Program/Storing Home Address

- Press the NAV hard-key to access the Navigation Main Menu.
- Touch the GUIDE ME HOME soft-key, then touch the STREET ADDRESS soft-key.
- Touch the STATE soft-key, then enter your state name into the speller; select your state from the list and press the CHANGE soft-key.
- Touch the INPUT STREET NAME soft-key and enter your street name into the speller.
- Touch the CONTINUE soft-key and enter your address into the speller; touch the CONTINUE soft-key again.

ELECTRONICS

- Touch the city name and touch the SAVE soft-key to complete programming.

Change Stored Home Address

- Press the MENU hard-key, then touch the MY FILES soft-key.
- Touch the MY ADDRESS BOOK soft-key, then touch the HOME soft-key.
- In the Home Address Information screen, touch the EDIT CONTACT soft-key, then touch the CHANGE ADDRESS soft-key in the next screen.
- Touch the INPUT STREET NAME soft-key and enter your street name into the speller.
- Touch the CONTINUE soft-key and enter your address into the speller; touch the CONTINUE soft-key again.
- Touch the city name and touch the SAVE soft-key to complete programming.

Guide Me Home

- Press the NAV hard-key to access the Navigation Main Menu.
- Touch the GUIDE ME HOME soft-key to route you back to your home destination from your current location. Touch the GO soft-key to start your trip.

Local Address Book Features

- Your navigation-equipped radio can store destinations into its local address book so that you can recall them later.
- To save your current location to the local address book, touch the cursor on the screen, next touch SELECT, then touch CURSOR POINT, next touch OPTIONS, then touch SAVE DESTINATION, and lastly touch ADDRESS BOOK.
- To add or delete destinations from your local address book stored on the radio, press the MENU hard key, then touch MY FILES, next touch ADDRESS BOOK, and last touch DEFAULT FOLDER (or any added folder).
- To route to a destination that is saved in your local address book, press the MENU hard key, then touch MY FILES, next touch ADDRESS BOOK, and last touch DEFAULT FOLDER and select the contact you want to route to.

Navigation – Media Center 430N (Sales Code RHB) Only

- For software updates, visit <http://www.garmin.com/chrysler> website, or contact your authorized dealer for the latest available software.
- The Navigation system receives GPS signals from satellites to display the position of your vehicle. You may experience interruptions or delays in receiving navigation information in garages, tunnels, large cities, or other situations where the vehicle does not have a direct line of sight to the sky.
- Voice Command is not available for navigation commands on this radio (although Voice Command functions for all other radio functions).

Map

- Touch the NAV soft-key in the upper-right corner of your radio screen, to access the Navigation system.
- Touch the **View Map** soft-key to display a map of your current position.

Entering a Destination/Finding a Point of Interest

- Touch the NAV soft-key in the upper-right corner of your radio screen, to access the Navigation system.
- Touch the **Where To?** soft-key to program a destination.
- Next touch one of the subcategories to search for your destination. Address, Points of Interest, Recently Found, Favorites and Intersection are a few of the options.
- After touching one of the subcategories, follow the on-screen steps to complete the process and be routed to your destination.

Setting a Home Location

- Touch the NAV soft-key in the upper-right corner of your radio screen, to access the Navigation system.
- Touch the **Where To?** soft-key, then touch **Go Home**.
- Next, select from:
 - Enter My Address – enter an address for the location using the on-screen keyboard.
 - Use my current location – sets your current location as your Home Location.
 - Choose from Recently Found – select a location from your recently found locations.
- After you set your Home Location, touch **Where To?** , then touch **Go Home**.

Editing Home Location

- Touch the NAV soft-key in the upper-right corner of your radio screen, to access the Navigation system.
- Touch the **Where To?** soft-key, then touch **Favorites**.
- Touch the location you want to edit.
- Next, touch **Press for More**.
- Touch **Edit**.
- Follow the on-screen steps for editing the Home Location.

Go Home

- Touch the NAV soft-key in the upper-right corner of your radio screen, to access the Navigation system.
- Touch **Where To?** , then touch **Go Home**.

ELECTRONICS

SIRIUS Travel Link

- To access SIRIUS Travel Link, press the MENU hard-key, then touch the Travel Link soft-key.

NOTE: SIRIUS Travel Link requires a subscription, sold separately after trial subscription included with vehicle purchase.

- SIRIUS Travel Link brings a wealth of useful information into your vehicle and right to your fingertips:
 - **Weather**
 - View detailed weather conditions at your current location.
 - **Ski Info**
 - View ski and snowboarding conditions at ski resorts.
 - **Fuel Prices**
 - Check detailed price information for fuel stations near your current location.
 - **Movie Listings**
 - Check which movies (includes start times, ratings, run lengths and summaries) are playing at theaters near your current location.
 - **Sports Scores**
 - View scores and upcoming events for all major sports.
- Your favorite location, theater and sports teams can be stored for quick access.
- Refer to your Media Center 730N (RHR) User's Manual or Media Center 430/430N (RBZ/RHB) User's Manual for more details.

STEERING WHEEL AUDIO CONTROLS



- The steering wheel audio controls are located on the rear surface of the steering wheel.

Right Switch

- Press the switch up or down to increase or decrease the volume.
- Press the button in the center to change modes
AM/FM/DISC/SAT/HDD/AUX.

Left Switch

- Press the switch up or down to search for the next listenable station or select the next or previous CD or HDD track.
- Press the button in the center to select the next preset station (radio) or to change CDs if equipped with a CD Changer.

UCONNECT™ PHONE

- To determine if your vehicle is equipped with Uconnect™ Phone, press the Uconnect™ Phone button . If your vehicle has this feature, after a couple seconds you will hear a voice prompt. If not, you will see a message on the radio “Uconnect phone not available”.
- The Uconnect™ Phone is a voice-activated, hands-free, in-vehicle communications system with Voice Command Capability (see Voice Command section).
- The Uconnect™ Phone allows you to dial a phone number with your mobile phone using simple voice commands.
- For vehicles equipped with Video Entertainment System (VES)™, refer to the Uconnect™ Phone section of the Uconnect™ User's Manual on the DVD for further details.
- For vehicles not equipped with VES™, refer to your vehicle Owner's Manual on the DVD for further details.

NOTE: The Uconnect™ Phone requires a mobile phone equipped with the Bluetooth® Hands-Free Profile, Version 0.96 or higher. For Uconnect™ customer support, call 1-877-855-8400 or visit www.dodge.com/uconnect.

Phone Pairing

NOTE: Pairing is a one-time initial setup before using the phone. You will also need to follow the Bluetooth® instructions in your cell phone user guide to complete the phone pairing setup.

- Press the Phone button  on either the radio or steering wheel to begin.
- Wait for the “ready” prompt and BEEP.
- (After the BEEP), say “Uconnect setup”.
- (After the BEEP), say “phone pairing”.
- (After the BEEP), say “pair a phone”.
- Follow the audible prompts.
- You will be asked to enter a four-digit Personal Identification Number (PIN), which you will later need to enter into your mobile phone. You can enter any four-digit PIN. You will not need to remember this PIN after the initial pairing process.
- You will then be prompted to give the phone pairing a name (each phone paired should have a unique name).
- Next you will be asked to give this new pairing a priority of 1 thru 7 (up to seven phones may be paired); 1 is the highest and 7 is the lowest priority. The system will only connect to the highest priority phone that exists within the proximity of the vehicle.

Making A Phone Call



- Press the Phone button  on either the radio or steering wheel.
- (After the BEEP), say “dial” (or “call” a name).
- (After the BEEP), say number (or name).

ELECTRONICS

Phonebook Edit

- Press the Phone button  on either the radio or steering wheel.
- (After the BEEP), say “phonebook”.
- (After the BEEP), say “new entry” or “list names” or “delete”.
- Follow the prompts.

Receiving A Call – Accept (And End)

- When an incoming call rings/is announced on Uconnect™, press the Phone button  on either the radio or steering wheel.
- To end a call, press the Phone button  on either the radio or steering wheel.

Mute (Or Unmute) Microphone During Call

- During a call, press the Voice Command button  VR on either the radio or steering wheel.
- (After the BEEP), say “mute” (or “mute off”) or touch the MUTE soft-key on the radio screen

Transfer Ongoing Call Between Handset And Vehicle

- During a call, press the Voice Command button  VR on either the radio or steering wheel.
- (After the BEEP), say “transfer call” or touch the TRANSFER CALL soft-key on the radio screen.

Changing The Volume



- Start a dialogue by pressing the Phone button  on either the radio or steering wheel, then adjust the volume during a normal call.
- Use the radio ON/OFF VOLUME rotary knob to adjust the volume to a comfortable level while the Uconnect™ system is speaking. Please note the volume setting for Uconnect™ is different than the audio system.

NOTE: To access the tutorial, press the Uconnect™ hard-key. After the BEEP, say “tutorial”. Press any hard-key/button or touch the display (Touch-Screen radio) to cancel the tutorial.

WARNING!

- Any voice commanded system should be used only in safe driving conditions following local laws and phone use. All attention should be kept on the roadway ahead. Failure to do so may result in a collision causing you and others to be severely injured or killed.
- In an emergency, to use Uconnect™ Phone, your mobile phone must be:
 - turned on,
 - paired to Uconnect™ Phone,
 - and have network coverage.

Uconnect™ VOICE COMMAND

- The Uconnect™ Voice Command system allows you to control your AM, FM radio, satellite radio, disc player, HDD, Uconnect™ Phone, a memo recorder, and supported portable media devices.
- When you press the Voice Command button  VR located on the radio faceplate or steering wheel, you will hear a beep. The beep is your signal to give a command. If you do not say a command within a few seconds, the system will present you with a list of options. If you ever wish to interrupt the system while it lists options, press the Voice Command button , listen for the BEEP, and say your command.

Voice Command for Text Messaging

- If equipped with Uconnect™ Voice Command, your Media Center 430N radio may be able to play incoming SMS messages through the vehicle sound system.
- It also allows you to respond by selecting from various pre-defined phrases.
- Not all phones are compatible with this feature. Refer to the phone compatibility list at www.dodge.com/uconnect. Connected mobile phones must be bluetooth-compatible, and paired with your radio.

Changing The Volume

- Start a dialogue by pressing the Voice Command button  VR, then say a command (for example, “tutorial”).
- Use the radio ON/OFF VOLUME rotary knob to adjust the volume to a comfortable level while the Voice Command system is speaking. The volume setting for Voice Command is different than the audio system.
- For vehicles equipped with Video Entertainment System (VES)™, refer to the Uconnect™ Voice Command section of the Uconnect™ User's Manual on the DVD for further details.
- For vehicles not equipped with VES™, refer to your vehicle Owner's Manual on the DVD for Uconnect™ Voice Command information.

NOTE: To access the tutorial, press the Voice Command button  VR. After the BEEP, say “tutorial”. Press any hard-key/button or touch the display (Touch-Screen radio) to cancel the tutorial.

WARNING!

Any voice commanded system should be used only in safe driving conditions following local laws and phone use. All attention should be kept on the roadway ahead. Failure to do so may result in a collision causing you and others to be severely injured or killed.

ELECTRONICS

iPod®/USB/MP3 CONTROL

- There are many ways to play music from iPod® players or other portable devices through your vehicle's speakers. Your choices depend on what radio your vehicle is equipped with.
- The radio sales code is located on the lower right side of the radio faceplate.

If Equipped with Media Center 130 with Satellite Radio (Sales Code RES + RSC) or Media Center 430/430N (Sales Code RBZ/RHB)



- The USB port located within the center console, allows you to plug an iPod® into the vehicle's sound system.
- To hear audio from devices connected to this port from a non-touch-screen radio, press the AUX button on the radio faceplate. From a touch-screen radio, press the MEDIA hard-key, then touch the AUX soft-key.

- When connected to this feature:
 - The iPod® audio can be played on the vehicle's sound system.
 - The iPod® can be controlled using the radio buttons to Play, Browse, and List the iPod® or external devices contents. Refer to the Owner's Manual on the DVD for details.
 - The iPod® battery charges when plugged into the USB port (if supported by the specific audio device).
 - Compatible iPod® devices may also be controllable using voice commands (Media Center 430/430N with Uconnect™ Phone required). Refer to the Owner's Manual on the DVD for details.

NOTE:

- The USB port supports certain Mini, Classic, Nano, Touch, and iPhone® devices. The USB port also supports playing music from compatible external USB Mass Storage Class memory devices. For supported audio file formats, refer to the USB Port section on the Owner's Manual on the DVD. Refer to www.dodge.com/uconnect website for a list of tested iPod®s. Some iPod® software versions may not fully support the USB port features. Please visit Apple's website for iPod® software updates.

Bluetooth® Streaming Audio (Media Center 430/430N/230/130 only)

- If equipped with Uconnect™ Voice Command, your bluetooth-equipped iPod® devices, cellphones or other media players, may also be able to stream music to your vehicle's speakers. Your connected device must be bluetooth-compatible, and paired with your Media Center radio (see Uconnect™ Phone for pairing instructions). Press the AUX button on the radio faceplate until "BT" is displayed on the radio screen.

WARNING!

Do not plug in or remove the iPod® or external device while driving. Failure to follow this warning could result in a collision.

VIDEO ENTERTAINMENT SYSTEM (VES)™



System Operation

- The screen is located on the headliner behind the front seat. To lower the screen, press the release button located in the rear of the overhead console.
- The system may be controlled by the front seat occupants using the touch-screen radio, or by the rear seat occupants using the remote control.

- The video screen displays information in a split-screen format. The left side of the screen is referred to as Channel 1 and the right side of the screen is referred to as Channel 2. All modes except video modes are displayed in a split-screen format.
- To use the headphones, press the power button located on the right ear cup. Select the channel on the headphones (1 or 2) that corresponds to the channel selected on the VES™ screen.

Operation Of The Touch-Screen Radio

- To view a DVD video, press the OPEN/CLOSE or LOAD hard-key and insert the disc. Playback will begin automatically after the DVD is recognized by the disc drive. If playback does not begin automatically, follow these steps:
 - Press the MENU hard-key, then touch the Rear VES™ soft-key. If a chapter list appears on the right side of the screen touch the HIDE LIST soft-key to display the Rear VES™ Control screen.
 - Touch the 1 soft-key to select an audio channel, then touch the DISC soft-key in the MEDIA column.

ELECTRONICS

SIRIUS Backseat TV™

- Press the MENU hard-key, then touch the Rear VES™ soft-key. If a chapter list appears on the right side of the screen, touch the HIDE LIST soft key to display the Rear VES™ Control screen.
- Touch the 1 soft-key to select an audio channel, then touch the TV soft-key in the RADIO column to select SIRIUS Backseat TV™.
- To view SIRIUS Backseat TV™ using the remote, set the remote control channel selector switch to channel 1. Press the MODE button, then using the arrow buttons select TV and press ENTER.

Operation Of The Remote

- The remote control operates similarly to any DVD remote you have used before and allows the rear seat passengers to change stations, tracks, discs and audio/video modes.
- The remote control is designed to control either channel by using the selector switch located on the right side of the remote.
- Pressing the power button will turn the VES™ system ON/OFF.
- Pressing the MODE button causes the Mode Selection menu to appear on the VES™ screen. Use the remote control arrow buttons to scroll through the available modes, then press ENTER to select the desired mode.

Auxiliary Audio/Video Input Jacks

- The Aux jacks are located on the rear of the center console.
- Connect the video game or other external media devices to the AUX jacks following the color coding for VES™ jacks.
- Using either the touch-screen radio or remote control, select AUX from the Rear VES™ Control or Mode Selection screen.
- Refer to “Uconnect™ Multimedia – Video Entertainment System (VES)™” in the Uconnect™ User's Manual on the DVD for further details.

ELECTRONIC VEHICLE INFORMATION CENTER (EVIC)



- The EVIC features a driver interactive display that is located in the instrument cluster. Pressing the controls on the left side of the steering wheel allows the driver to select vehicle information and Personal Settings. For additional information, refer to Programmable Features in this guide.
- Press and release the UP Δ button to scroll upward through the main menus (Fuel Economy, Vehicle Info, Tire PSI, Cruise, Messages, Units, System Setup) and sub menus.

- Press and release the DOWN ∇ button to scroll downward through the main menus and sub menus.
- Press and release the SELECT \blacktriangleright button for access to main menus, sub menus or to select a personal setting in the setup menu.
- Press the BACK button to scroll back to a previous menu or sub menu.

NOTE: Refer to the Driver Cockpit image in Controls At A Glance to see EVIC Display and EVIC Controls location.

Compass Calibration

- This compass is self-calibrating, which eliminates the need to set the compass manually. When the vehicle is new, the compass may appear erratic and the EVIC will display "CAL" until the compass is calibrated.
- You may also calibrate the compass manually by selecting Setup (Customer-Programmable Features) in the EVIC, then select Compass Variance and then enter the correct variance. Next, select Calibrate Compass in the Setup menu to start the calibration process. The "CAL" indicator will be displayed in the EVIC. Complete one or more 360 degree turns (in an area free from large metal or metallic objects) until the "CAL" message displayed in the EVIC turns off. The compass will now function normally.

ECO

- The ECO message will appear in your EVIC display whenever you are driving in a fuel efficient manner.
- This feature allows you to monitor when you are driving in a fuel efficient manner, and it can be used to modify driving habits in order to increase fuel economy.

ELECTRONICS

PROGRAMMABLE FEATURES

Electronic Vehicle Information Center (EVIC) – If Equipped

- The EVIC can be used to program the following Personal Settings. Press the UP Δ or DOWN ∇ button until System Setup displays, then press the SELECT \triangleright button. Scroll through the settings using the UP or DOWN buttons. Press the SELECT \triangleright button to change the setting. Press the BACK button to scroll back to a previous menu or sub menu.
- Select Language
- Nav – Turn By Turn
- Auto Unlock Doors
- Remote Unlock Sequence
- RKE Linked To Memory
- Remote Start Comfort Sys.
- Horn with Remote Lock
- Horn With Remote Start
- Flash Lamps With Lock
- Headlamp Off Delay
- Headlamps with Wipers
- Easy Entry/Exit Seat
- Tilt Mirror in Reverse
- Key-Off Power Delay
- Illuminated Approach
- Hill Start Assist (HSA)
- Display ECO Symbol
- Keyless Enter-N-Go
- Gauge Glow Rings
- Auto High Beams
- Intermittent Wiper – If Equipped
- Blind Spot Alert
- Forward Collision Warning
- Park Assist System
- Display Units of Measure In:
- Calibrate Compass
- Compass Variance

UNIVERSAL GARAGE DOOR OPENER

(HOMELINK[®])



Programming HomeLink[®]

Begin Programming

- The HomeLink[®] buttons are located in the overhead console.
 - Erase all channels before you begin programming by holding the two outside buttons for up to 20 seconds until the red indicator flashes.
 - Park your vehicle outside of the garage and turn the ignition switch to the ON/RUN position or push the ENGINE START/STOP button until "RUN" is displayed in the EVIC.
- Place the hand-held transmitter 1 to 3 in (3 to 8 cm) from the HomeLink[®] buttons while keeping the indicator light in view.

- Simultaneously, press and hold both the chosen HomeLink® button and the hand-held transmitter button until the HomeLink® indicator flash rate changes from a slow to a rapidly blinking light, then release both the HomeLink® and the hand-held transmitter buttons. This may take up to 30 seconds, or longer in rare cases.
- Press and hold the just-programmed HomeLink® button; if the indicator light stays on constantly, programming is complete and the garage door should open.

NOTE:

- Only use this transceiver with a garage door opener that has a “stop and reverse” feature as required by Federal safety standards. This includes most garage door opener models manufactured after 1982. Do not use a garage door opener without these safety features. Call toll-free 1-800-355-3515 or, on the Internet, at www.HomeLink.com for safety information or assistance.
- If you are having difficulty programming your HomeLink® and your garage door opener was manufactured after 1995, you may have a rolling code. Follow the steps below for Programming A Rolling Code System.

Programming A Rolling Code System

- At the garage door opener motor (in the garage), locate the “learn” or “programming” button. This can usually be found where the hanging antenna wire is attached to the garage door opener motor (it is NOT the button normally used to open and close the door).
- Firmly press and release the “learn” or “programming” button. The name and color of the button may vary by manufacturer. Within 30 seconds, return to the vehicle and press the programmed HomeLink® button twice (holding the button for two seconds each time). If the device is plugged in and activates, programming is complete.
- If the device does not activate, press the button a third time (for two seconds) to complete the programming.

Using HomeLink®

- To operate, simply press and release the programmed HomeLink® button and the programmed device will operate.
- Refer to your Owner’s Manual on the DVD for further details. If you have any problems programming HomeLink®, or require assistance, please call toll-free 1-800-355-3515 or, on the Internet, at www.HomeLink.com.

WARNING!

- Your motorized door or gate will open and close while you are programming the universal transceiver. Do not program the transceiver if people or pets are in the path of the door or gate.

ELECTRONICS

WARNING! (Continued)

- Do not run your vehicle in a closed garage or confined area while programming the transceiver. Exhaust gas from your vehicle contains Carbon Monoxide (CO) which is odorless and colorless. Carbon Monoxide is poisonous when inhaled and can cause you and others to be severely injured or killed.

POWER INVERTER



- There is a 115 Volt, 150 Watt power inverter outlet located on the back of the center console. This outlet can power cellular phones, electronics and other low power devices requiring power up to 150 Watts.
- Press the switch located in the switch bank on the lower instrument panel to turn the power inverter on. The indicator light will turn on to indicate the inverter is producing AC power.

- Press the switch again to turn the power inverter off. The indicator light will turn off.

NOTE: The power inverter is designed with built-in overload protection. If the power rating of 150 Watts is exceeded, the power inverter will automatically shut down. Once the electrical device has been removed from the outlet, the inverter should automatically reset. If the power rating exceeds approximately 170 Watts, the power inverter may have to be reset manually. To reset the inverter manually, unplug the device and plug it in again. To avoid overloading the circuit, check the power ratings on electrical devices prior to using the inverter.

WARNING!

To Avoid Serious Injury or Death: Do not use a three-prong adaptor. Do not insert any objects into the receptacles. Do not touch with wet hands. Close the lid when not in use. If this outlet is mishandled, it may cause an electric shock and failure.

ELECTRONICS

POWER OUTLET



- The front power outlet is located in the front center storage bin of the instrument panel.
- A second front power outlet is located inside the center console.
- The rear power outlet is located in the right rear cargo area.

- The power outlets are labeled with either a “key” or a “battery” symbol to indicate how the outlet is powered. Power outlets labeled with a “key” are powered when the ignition switch is in the ON/RUN or ACC position, while the outlets labeled with a “battery” are connected directly to the battery and powered at all times.

NOTE:

- Do not exceed the maximum power of 160 Watts (13 Amps) at 12 Volts. If the 160 Watt (13 Amp) power rating is exceeded, the fuse protecting the system will need to be replaced. See below image for fuse locations.
- All accessories connected to the “battery” powered outlets should be removed or turned off when the vehicle is not in use to protect the battery against discharge.

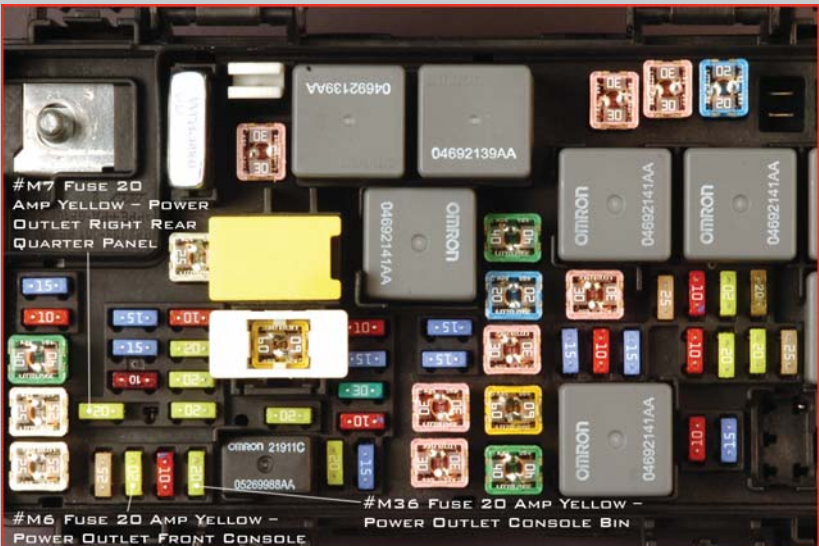

OFF-ROAD CAPABILITIES

ALL-WHEEL DRIVE OPERATION

Single-Speed Operating Instructions/Precautions

- This system contains a single-speed (HI range only) transfer case, which provides convenient full-time all-wheel drive. No driver interaction is required. The Brake Traction Control (BTC) System, which combines standard ABS and Traction Control, provides resistance to any wheel that is slipping to allow additional torque transfer to wheels with traction.

NOTE: This system is not appropriate for conditions where AWD LOW range is recommended. Refer to “Off-Road Driving Tips” in “Starting and Operating” on the DVD for further information.

Electronically Shifted Transfer Case (Three-Position Switch)



- This is an electronic shift transfer case and is operated by the AWD Control Switch (Transfer Case Switch), which is located on the center console.

- This electronically shifted transfer case provides three mode positions:
 - All-wheel drive automatic range (AWD AUTO)
 - All-wheel drive low range (LOW RANGE)
 - Neutral (NEUTRAL)
- When additional traction is required, the LOW RANGE position can be used to lock the front and rear driveshafts together forcing the front and rear wheels to rotate at the same speed. The LOW RANGE position are designed for loose, slippery road surfaces only. Driving in the LOW RANGE positions on dry hard surfaced roads may cause increased tire wear and damage to the driveline components.
- When operating your vehicle in LOW RANGE, the engine speed is approximately three times that of the AWD HI position at a given road speed. Take care not to overspeed the engine and do not exceed 25 mph (40 km/h).

NOTE: The “SERV AWD Warning Light” monitors the electronic shift all-wheel drive system. If this light remains on after engine start up or illuminates during driving, it means that the all-wheel drive system is not functioning properly and that service is required.

OFF-ROAD CAPABILITIES

Shifting Procedures

AWD AUTO To LOW RANGE

NOTE: When shifting into or out of LOW RANGE some gear noise may be heard. This noise is normal and is not detrimental to the vehicle or occupants.

- Shifting can be performed with the vehicle rolling 2 to 3 mph (3 to 5 km/h) or completely stopped. Use either of the following procedures:

Preferred Procedure

- With the engine running, slow the vehicle to 2 to 3 mph (3 to 5 km/h).
- Shift the transmission into NEUTRAL.
- While still rolling, rotate the transfer case control switch to the desired position.
- After the desired position indicator light is ON (not flashing), shift the transmission back into gear.

Alternate Procedure

- Bring the vehicle to complete stop.
- With the ignition switch in the ON position and the engine either OFF or running, shift the transmission into NEUTRAL.
- Rotate the transfer case control switch to the desired position.
- After the desired position indicator light is ON (not flashing), shift the transmission back into gear.

NOTE:

- If Steps 1 or 2 of either the Preferred or Alternate Procedure are not satisfied prior to attempting the shift or if they no longer are being met while the shift attempt is in process, the desired position indicator light will flash continuously while the original position indicator light is ON, until all requirements have been met.
- The ignition switch must be in the ON position for a shift to take place and for the position indicator lights to be operable. If the ignition switch is not in the ON position, then the shift will not take place and no position indicator lights will be on or flashing.

WARNING!

- Always engage the parking brake when powering down the vehicle if the "SERV AWD Warning Light" is illuminated. Not engaging the parking brake may allow the vehicle to roll which may cause personal injury.
- You or others could be injured if you leave the vehicle unattended with the transfer case in the NEUTRAL position without first fully engaging the parking brake. The transfer case NEUTRAL position disengages both the front and rear driveshafts from the powertrain and will allow the vehicle to move regardless of the transmission position. The parking brake should always be applied when the driver is not in the vehicle.

UTILITY

ROOF LUGGAGE RACK

- The crossbars on your vehicle are delivered stowed within the roof rack side rails. When installed, the roof rack can hold a maximum of 150 lbs (68 kg) of evenly distributed weight.

Installing The Crossbars

- To install the crossbars, completely loosen the thumb screws at both ends and lift the crossbar from its stowed position.
- Bend the pivot points at each end of the crossbar and slide the thumb screw down.

- Set the crossbars into position and tighten the thumb screws.

NOTE: Position the crossbars across the roof making sure the letters on the crossbar align with the matching letters on the side rail.

- Refer to the Owner's Manual on the DVD for further details.

TRAILER TOWING WEIGHTS (MAXIMUM TRAILER WEIGHT RATINGS)

Engine	Model	GCWR (Gross Combined Wt. Rating)	Frontal Area	Max. GTW (Gross Trailer Wt.)	Max. Trailer Tongue Wt. (See Note)
3.6L	RWD	11,600 lbs (5 262 kg)	40 sq ft (3.72 sq m)	6,200 lbs (2 812 kg)	620 lbs (281 kg)
3.6L	AWD	11,600 lbs (5 262 kg)	40 sq ft (3.72 sq m)	6,200 lbs (2 812 kg)	620 lbs (281 kg)
5.7L	RWD	13,100 lbs (5 942 kg)	60 sq ft (5.57 sq m)	7,200 lbs (3 266 kg)	720 lbs (327 kg)
5.7L	AWD	13,100 lbs (5 942 kg)	60 sq ft (5.57 sq m)	7,200 lbs (3 266 kg)	720 lbs (327 kg)

Refer to local laws for maximum trailer towing speeds.

NOTE: The trailer tongue weight must be considered as part of the combined weight of occupants and cargo, and should never exceed the weight referenced on the Tire and Loading Information placard. The addition of passengers and cargo may require reducing trailer tongue load and Gross Trailer Weight (GTW). Redistributing cargo (to the trailer) may be necessary to avoid exceeding Rear Gross Axle Weight Rating (GAWR) of 3,900 lbs (1 769 kg).

- If the gross trailer weight is 3,500 lbs (1587 kg) or more, it is mandatory to use a weight-distributing hitch to ensure stable handling of your vehicle.

NOTE: Vehicles not factory equipped with trailer tow package are limited to 3,500 lbs (350 lbs tongue weight).

UTILITY

TOW/HAUL MODE

- When driving in hilly areas, towing a trailer, carrying a heavy load, etc., and frequent transmission shifting occurs, press the TOW/HAUL switch to select TOW/HAUL mode. This will improve performance and reduce the potential for transmission overheating or failure due to excessive shifting. When operating in TOW/HAUL mode, transmission upshifts are delayed, and the transmission will automatically downshift (for engine braking) during steady braking maneuvers.



TOW/HAUL Switch

- The “TOW/HAUL Indicator Light” will illuminate in the instrument cluster to indicate that TOW/HAUL mode has been activated. Pressing the switch a second time restores normal operation. If the TOW/HAUL mode is desired, the switch must be pressed each time the engine is started.

RECREATIONAL TOWING (BEHIND MOTORHOME, ETC.)

Rear-Wheel Drive Models

- **Recreational towing is not allowed.**

All-Wheel Drive Models (Single-Speed Transfer Case)

- **Recreational towing is not allowed.**
This model does not have a NEUTRAL position in the transfer case.

All-Wheel Drive Models (Two-Speed Transfer Case)

NOTE: The transfer case must be in the NEUTRAL position, and the transmission must be in the PARK position for recreational towing.

Shifting Into NEUTRAL

- Use the following procedure to prepare your vehicle for recreational towing.
- Bring the vehicle to a complete stop and shift the transmission to PARK. Turn the engine off.
- For vehicles with Keyless Enter-N-Go, remove the Keyless Enter-N-Go button and use the Key Fob to complete this procedure.
- Turn the ignition switch to the ON/RUN position, but do not start the engine.
- Press and hold the brake pedal and shift the transmission into NEUTRAL.
- Press and hold the transfer case N (Neutral) button for four seconds, until the light next to the N symbol starts to blink, indicating shift in progress. The light will stop blinking (stay on solid) when the shift to N (Neutral) is complete.

- Start the engine and shift the transmission into REVERSE.
- Release the brake pedal for five seconds and ensure that there is no vehicle movement.
- Turn the engine off and firmly apply the parking brake.
- Shift the transmission into PARK and remove the Key Fob.
- Attach the vehicle to the tow vehicle using a suitable tow bar and release the parking brake.

CAUTION!

- Towing with the rear wheels on the ground will cause severe transmission damage. Damage from improper towing is not covered under the New Vehicle Limited Warranty.
- Front or rear wheel lifts should not be used. Internal damage to the transmission or transfer case will occur if a front or rear wheel lift is used when recreational towing.
- It is necessary to follow these steps to be certain that the transfer case is fully in NEUTRAL before recreational towing to prevent damage to internal parts.

WARNING!

You or others could be injured if you leave the vehicle unattended with the transfer case in the NEUTRAL position without first fully engaging the parking brake. The transfer case NEUTRAL position disengages both the front and rear driveshafts from the powertrain and will allow the vehicle to move even if the transmission is in PARK. The parking brake should always be applied when the driver is not in the vehicle.

WHAT TO DO IN EMERGENCIES

24-HOUR TOWING ASSISTANCE

- Dial toll-free 1-800-521-2779 or 1-800-363-4869 for Canadian residents.
- Provide your name, vehicle identification number and license plate number.
- Provide your location, including telephone number, from which you are calling.
- Briefly describe the nature of the problem and answer a few simple questions.
- You will be given the name of the service provider and an estimated time of arrival. If you feel you are in an “unsafe situation”, please let us know. With your consent, we will contact local police or safety authorities.

INSTRUMENT CLUSTER WARNING LIGHTS

(!) - Tire Pressure Monitoring System (TPMS) Light

- Each tire, including the spare (if provided), should be checked monthly, when cold and inflated to the inflation pressure recommended by the vehicle manufacturer on the vehicle placard or tire inflation pressure label. (If your vehicle has tires of a different size than the size indicated on the vehicle placard or tire inflation pressure label, you should determine the proper tire inflation pressure for those tires.)
- As an added safety feature, your vehicle has been equipped with a Tire Pressure Monitoring System (TPMS) that illuminates a low tire pressure telltale when one or more of your tires is significantly under-inflated. Accordingly, when the low tire pressure telltale illuminates, you should stop and check your tires as soon as possible, and inflate them to the proper pressure. Driving on a significantly under-inflated tire causes the tire to overheat and can lead to tire failure. Under-inflation also reduces fuel efficiency and tire tread life, and may affect the vehicle's handling and stopping ability.
- **IF THE LIGHT STARTS FLASHING INDICATING A LOW TIRE PRESSURE, ADJUST THE AIR PRESSURE IN THE LOW TIRE TO THE AIR PRESSURE SHOWN ON THE VEHICLE PLACARD OR TIRE INFLATION PRESSURE LABEL LOCATED ON THE DRIVER'S DOOR. NOTE: AFTER INFLATION, THE VEHICLE MAY NEED TO BE DRIVEN FOR 20 MINUTES BEFORE THE FLASHING LIGHT WILL TURN OFF.**
- Please note that the TPMS is not a substitute for proper tire maintenance, and it is the driver's responsibility to maintain correct tire pressure, even if under-inflation has not reached the level to trigger illumination of the TPMS low tire pressure telltale.
- Your vehicle has also been equipped with a TPMS malfunction indicator to indicate when the system is not operating properly. The TPMS malfunction indicator is combined with the low tire pressure telltale. When the system detects a malfunction, the telltale will flash for approximately one minute and then remain continuously illuminated. This sequence will continue each time the vehicle is restarted as long as the malfunction exists.

WHAT TO DO IN EMERGENCIES

- When the malfunction indicator is illuminated, the system may not be able to detect or signal low tire pressure as intended. TPMS malfunctions may occur for a variety of reasons, including the installation of replacement or alternate tires or wheels on the vehicle that prevent the TPMS from functioning properly. Always check the TPMS malfunction telltale after replacing one or more tires or wheels on your vehicle, to ensure that the replacement or alternate tires and wheels allow the TPMS to continue to function properly.

CAUTION!

The TPMS has been optimized for the original equipment tires and wheels. TPMS pressures and warning have been established for the tire size equipped on your vehicle. Undesirable system operation or sensor damage may result when using replacement equipment that is not of the same size, type, and/or style. Aftermarket wheels can cause sensor damage. Do not use tire sealant from a can, or balance beads if your vehicle is equipped with a TPMS, as damage to the sensors may result.

BRAKE - Brake Warning Light

- The Brake Warning light illuminates when there is either a system malfunction or the parking brake is applied. If the light is on and the parking brake is not applied, it indicates a possible brake hydraulic malfunction, brake booster problem or an Anti-Lock Brake System problem.
- We recommend you drive to the nearest service center and have the vehicle serviced immediately.

WARNING!

Driving a vehicle with the red brake light on is dangerous. Part of the brake system may have failed. It will take longer to stop the vehicle. You could have a collision. Have the vehicle checked immediately.

- Malfunction Indicator Light (MIL)

- Certain conditions, such as a loose or missing gas cap, poor fuel quality, etc., may illuminate the MIL after engine start. The vehicle should be serviced if the light stays on through several typical driving cycles. In most situations, the vehicle will drive normally and not require towing.
- If the MIL flashes when the engine is running, serious conditions may exist that could lead to immediate loss of power or severe catalytic converter damage. We recommend you do not operate the vehicle. Have the vehicle serviced immediately.

WHAT TO DO IN EMERGENCIES

- Electronic Stability Control (ESC) Activation/Malfunction Indicator Light

- If the “ESC Activation/Malfunction Indicator Light” comes on continuously with the engine running, a malfunction has been detected in the ESC system. If this light remains on after several ignition cycles, and the vehicle has been driven several miles (kilometers) at speeds greater than 30 mph (48 km/h), we recommend you drive to the nearest service center and have the vehicle serviced immediately.
- The “ESC Activation/Malfunction Indicator Light” starts to flash as soon as the tires lose traction and the ESC system becomes active. If the light begins to flash during acceleration, ease up on the accelerator and apply as little throttle as possible. Be sure to adapt your speed and driving to the prevailing road conditions. The light also flashes when TCS is active. To improve the vehicle's traction when starting off in deep snow, sand or gravel, it may be desirable to switch the ESC system to Partial Off mode by momentarily pressing the ESC Off  switch located below the climate controls, on the switch panel.

- Charging System Light

- This light shows the status of the electrical charging system. If the charging system light remains on, it means that the vehicle is experiencing a problem with the charging system.
- We recommend you do not continue driving if the charging system light is on. Have the vehicle serviced immediately.

- Oil Pressure Warning Light

- This light indicates low engine oil pressure. If the light turns on while driving, stop the vehicle and shut off the engine as soon as possible. A chime will sound for four minutes when this light turns on.
- We recommend you do not operate the vehicle or engine damage will occur. Have the vehicle serviced immediately.

- Anti-Lock Brake (ABS) Light

- This light monitors the Anti-Lock Brake System (ABS).
- If the light is not on during starting, stays on, or turns on while driving, we recommend you drive to the nearest service center and have the vehicle serviced immediately.

- Electronic Throttle Control (ETC) Light

- This light informs you of a problem with the Electronic Throttle Control (ETC) system.
- If a problem is detected, the light will come on while the engine is running. Cycle the ignition key when the vehicle has completely stopped and the shift lever is placed in the PARK position; the light should turn off.
- If the light remains lit with the engine running, your vehicle will usually be drivable; however, see an authorized service center immediately. If the light is flashing when the engine is running, immediate service is required and you may experience reduced performance, an elevated/rough idle or engine stall and your vehicle may require towing.

WHAT TO DO IN EMERGENCIES

- Airbag Warning Light

- If the light is not on during starting, stays on, or turns on while driving, have the vehicle serviced by an authorized service center immediately.

Fuel Cap/Loose Gas Cap Message

- If a “gas cap” message (shown as Check GasCap) appears, tighten the gas cap until a “clicking” sound is heard.
- If the message continues to appear for more than three days after tightening the gas cap, have the vehicle serviced by an authorized service center immediately.

Oil Change Indicator Message

- If an “oil change” message (shown as Oil Change Required) appears and a single chime sounds, it is time for your next required oil change.

Vehicles Equipped With Keyless Enter-N-Go

- Without pressing the brake pedal, push the ENGINE START/STOP button and cycle the ignition to the ON/RUN position (Do not start the engine.)
- Fully depress the accelerator pedal, slowly, three times within 10 seconds.
- Without pressing the brake pedal, push the ENGINE START/STOP button once to return the ignition to the OFF/LOCK position.

Vehicles Not Equipped With Keyless Enter-N-Go

- Turn the ignition switch to the ON/RUN position (Do not start the engine.)
- Fully depress the accelerator pedal, slowly, three times within 10 seconds.
- Turn the ignition switch to the OFF/LOCK position.

IF YOUR ENGINE OVERHEATS

- In any of the following situations, you can reduce the potential for overheating by taking the appropriate action.
 - On the highways — slow down.
 - In city traffic — while stopped, shift transmission into NEUTRAL, but do not increase engine idle speed.

NOTE: There are steps that you can take to slow down an impending overheat condition:

- If your air conditioner (A/C) is on, turn it off. The A/C system adds heat to the engine cooling system and turning the A/C off can help remove this heat.
- You can also turn the Temperature Control to maximum heat, the Mode Control to floor and the Fan Control to high. This allows the heater core to act as a supplement to the radiator and aids in removing heat from the engine cooling system.
- If the temperature reading does not return to normal, turn the engine off immediately.
- We recommend that you do not operate the vehicle or engine damage will occur. Have the vehicle serviced immediately.

WHAT TO DO IN EMERGENCIES

CAUTION!

Driving with a hot cooling system could damage your vehicle. If the temperature gauge reads HOT (H), pull over and stop the vehicle. Idle the vehicle with the air conditioner turned off until the pointer drops back into the normal range. If the pointer remains on HOT (H), and you hear continuous chimes, turn the engine off immediately and call for service.

WARNING!

You or others can be badly burned by hot engine coolant (antifreeze) or steam from your radiator. If you see or hear steam coming from under the hood, do not open the hood until the radiator has had time to cool. Never try to open a cooling system pressure cap when the radiator or coolant bottle is hot.

WHAT TO DO IN EMERGENCIES

JACKING AND TIRE CHANGING

Jack Location



- The scissor-type jack and tire changing tools are located in the rear cargo area, below the load floor.

Preparations For Jacking

- Park on a level surface away from traffic.
- Place the transmission in park, set the parking brake and activate the Hazard Warning flashers.

WHAT TO DO IN EMERGENCIES



- Block the diagonally opposite wheel.

NOTE: Passengers should not remain in the vehicle when the vehicle is being jacked.

Jacking And Tire Changing Instructions

- Rotate the thumb screw on the jack to loosen the assembly and remove the jack from the bracket.
- Remove the jack tools from the bag.
- Raise the rubber mat and remove the plug from storage compartment floor.
- The spare tire is stowed under the rear of the vehicle by means of a cable winch mechanism. To remove or stow the spare, use the jack handle/lug wrench connected to the square socket extension to rotate the “spare tire drive” nut located under the removable plug.
- Use the lug wrench handle and extension to completely lower the spare tire. Keep turning the handle until the winch stops.

NOTE: Do not use power tools to operate the winch.

- Slide the tire out from under the vehicle and rotate it vertically behind the rear bumper.
- Spread the retaining tabs on the plastic plate and pull the metal stamping toward you to release it from the plastic plate.



- Slide the metal stamping up the steel extension tube and winch cable. Rotate the metal stamping and push it through the hole in the plastic plate and wheel.
- Pinch the three short and two long tubes to remove the plastic plate from the steel spare wheel.

WHAT TO DO IN EMERGENCIES

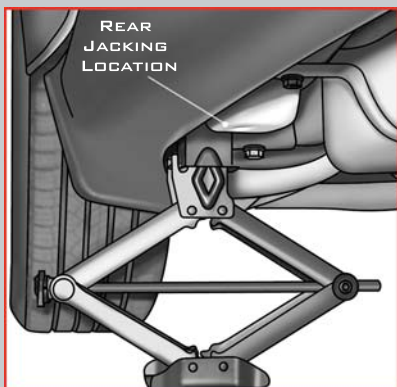
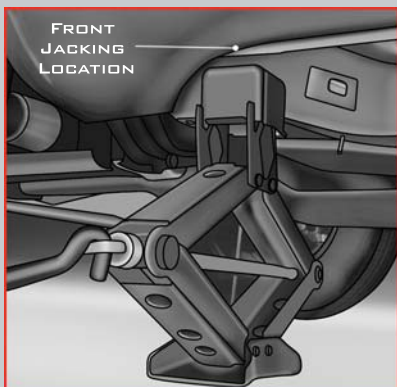

- Determine the jacking location on the side of the vehicle. Add the cap to the top of the jack and raise the jack until the cap is fully engaged on the body flange by the notches on the sill trim.
- Loosen the lug nuts on the road wheel one turn, but do not remove.
- Raise the vehicle just enough to remove the flat tire.
- Install the temporary spare and lightly tighten the lug nuts prior to lowering.
- Lower the vehicle and tighten the lug nuts twice to 110 ft-lbs (150 Nm).
- Push out the Dodge center cap and snap the plastic plate on the aluminum road wheel.

NOTE: The plastic plate will prevent the road wheel from being scratched when sliding it under the vehicle.

- Stand the wheel up against the bumper with the plastic plate facing you.
 - Slide the cable end, spring and metal tube through the wheel and plastic plate. Rotate the stamping on the cable and push it through the wheel and plastic plate. Snap the stamping into place.
- Slide the wheel on the ground to position it under the vehicle.
 - Use the lug wrench handle and extension to completely raise the wheel. Rotate the handle until the winch clicks three times.
 - Return the tools to the bag and reinstall the jack and tool kit on the bracket.
 - Remove the blocks from the opposite tire.
 - Repair the road tire and/or wheel as soon as possible and return the spare to the designed location.

WARNING!

- Do not attempt to change a tire on the side of the vehicle close to moving traffic. Pull far enough off the road to avoid the danger of being hit when operating the jack or changing the wheel.

(Continued)

WHAT TO DO IN EMERGENCIES

WARNING! *(Continued)*

- Getting under a jacked-up vehicle is dangerous. The vehicle could slip off the jack and fall on you. You could be crushed. Never get any part of your body under a vehicle that is on a jack. If you need to get under a raised vehicle, take it to a service center where it can be raised on a lift.
- The jack is designed to use as a tool for changing tires only. The jack should not be used to lift the vehicle for service purposes. The vehicle should be jacked on a firm, level surface only. Avoid ice or slippery areas.
- If it is necessary to retrieve the spare tire from under the vehicle on the side of the vehicle close to moving traffic, pull far enough off the road to avoid the danger of being hit.
- Carefully follow these tire changing procedures to help prevent personal injury or damage to your vehicle: Always park on a firm, level surface as far from the edge of the roadway as possible before raising the vehicle.
- Raising the vehicle higher than necessary can make the vehicle less stable and could cause it to slip off the jack and hurt someone near it. Raise the vehicle only enough to remove the tire.
- A loose tire or jack, thrown forward in a collision or hard stop, could endanger the occupants of the vehicle. Always stow the jack parts and the spare tire in the places provided.

JUMP-STARTING

- If your vehicle has a discharged battery it can be jump-started using a set of jumper cables and a battery in another vehicle or by using a portable battery booster pack.
- Jump-starting can be dangerous if done improperly so please follow the procedures in this section carefully.

NOTE: When using a portable battery booster pack follow the manufacturer's operating instructions and precautions.

WHAT TO DO IN EMERGENCIES

Preparations for Jump-Start



- The battery in your vehicle is located under the passengers front seat. There are remote locations under the hood to assist in jump starting.
- Set the parking brake, shift the automatic transmission into PARK and turn the ignition to LOCK.
- Turn off the heater, radio, and all unnecessary electrical accessories.
- Remove the protective cover over the remote positive (+) battery post. Pull upward on the cover to remove it.

- If using another vehicle to jump-start the battery, park the vehicle within the jumper cables reach, set the parking brake and make sure the ignition is OFF.

Jump-Starting Procedure

- Connect the positive (+) end of the jumper cable to the remote positive (+) post of the discharged vehicle.
- Connect the opposite end of the positive (+) jumper cable to the positive (+) post of the booster battery.
- Connect the negative end (-) of the jumper cable to the negative (-) post of the booster battery.
- Connect the opposite end of the negative (-) jumper cable to the remote negative (-) post of the vehicle with the discharged battery.
- Start the engine in the vehicle that has the booster battery, let the engine idle a few minutes, and then start the engine in the vehicle with the discharged battery. Once the engine is started, remove the jumper cables in the reverse sequence:
- Disconnect the negative (-) jumper cable from the remote negative (-) post of the vehicle with the discharged battery.
- Disconnect the negative end (-) of the jumper cable from the negative (-) post of the booster battery.
- Disconnect the opposite end of the positive (+) jumper cable from the positive (+) post of the booster battery.
- Disconnect the positive (+) end of the jumper cable from the remote positive (+) post of the discharged vehicle.
- Reinstall the protective cover over the remote positive (+) battery post of the discharged vehicle.
- If frequent jump-starting is required to start your vehicle you should have the battery and charging system inspected at your authorized dealer.

WHAT TO DO IN EMERGENCIES

CAUTION!

- Do not use a portable battery booster pack or any other booster source with a system voltage greater than 12 Volts or damage to the battery, starter motor, alternator or electrical system may occur.
- Failure to follow these procedures could result in damage to the charging system of the booster vehicle or the discharged vehicle.
- Accessories that can be plugged into the vehicle power outlets draw power from the vehicle's battery, even when not in use (i.e., cellular phones, etc.). Eventually, if plugged in long enough, the vehicle's battery will discharge sufficiently to degrade battery life and/or prevent the engine from starting.

WARNING!

- When temperatures are below the freezing point, electrolyte in a discharged battery may freeze. Do not attempt jump-starting because the battery could rupture or explode and cause personal injury. Battery temperature must be brought above freezing point before attempting a jump-start.
- Take care to avoid the radiator cooling fan whenever the hood is raised. It can start anytime the ignition switch is on. You can be injured by moving fan blades.
- Remove any metal jewelry, such as watch bands or bracelets, that might make an inadvertent electrical contact. You could be severely injured.
- Batteries contain sulfuric acid that can burn your skin or eyes and generate hydrogen gas which is flammable and explosive. Keep open flames or sparks away from the battery.
- Do not allow vehicles to touch each other as this could establish a ground connection and personal injury could result.
- Failure to follow this procedure could result in personal injury or property damage due to battery explosion.
- Do not connect the cable to the negative post (-) of the discharged battery. The resulting electrical spark could cause the battery to explode and could result in personal injury.

WHAT TO DO IN EMERGENCIES

EMERGENCY TOW HOOKS

- If your vehicle is equipped with tow hooks, they are mounted in the front and the rear.

NOTE: For off-road recovery, it is recommended to use both of the front tow hooks to minimize the risk of damage to the vehicle.

CAUTION!

Tow hooks are for emergency use only, to rescue a vehicle stranded off-road. Do not use tow hooks for tow truck hookup or highway towing. You could damage your vehicle. Tow straps are recommended when towing the vehicle; chains may cause vehicle damage.

WARNING!

- Chains are not recommended for freeing a stuck vehicle. Chains may break, causing serious injury or death.
- Stand clear of vehicles when pulling with tow hooks. Tow straps may become disengaged, causing serious injury.

SHIFT LEVER OVERRIDE

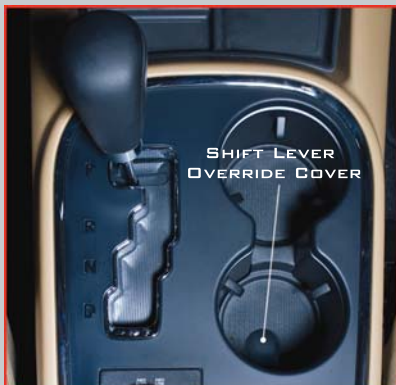

- If a malfunction occurs and the shift lever cannot be moved out of the PARK position, you can use the following procedure to temporarily move the shift lever:
 - To access the shift lever override, remove the rubber cupholder liner to the right of the shift lever.
 - Firmly set the parking brake.
 - Turn the ignition switch to the ACC or ON position without starting the engine.
 - Press and maintain firm pressure on the brake pedal.

- Using a screwdriver or similar tool, press and hold the override tab through the access port on the center console.
- Move the shift lever into the NEUTRAL position.
- The vehicle may then be started in NEUTRAL.
- Reinstall the override cover.

WHAT TO DO IN EMERGENCIES

TOWING A DISABLED VEHICLE

Towing Condition	Wheels OFF the Ground	RWD Models	AWD Models
Flat Tow	NONE	<ul style="list-style-type: none"> • Trans in NEUTRAL • 30 mph (48 km/h) • 15 miles (24 km) max distance 	<ul style="list-style-type: none"> • Trans in PARK • T/case in NEUTRAL • Tow in Forward direction
	Front		
Wheel Lift or Dolly Tow	Rear	OK	NO
Flatbed	ALL	BEST METHOD	BEST METHOD

WHAT TO DO IN EMERGENCIES

EVENT DATA RECORDER (EDR)

- This vehicle is equipped with an event data recorder (EDR). The main purpose of an EDR is to record, in certain crash or near crash-like situations, such as an air bag deployment or hitting a road obstacle, data that will assist in understanding how a vehicle's systems performed. The EDR is designed to record data related to vehicle dynamics and safety systems for a short period of time, typically 30 seconds or less. The EDR in this vehicle is designed to record such data as:
 - How various systems in your vehicle were operating;
 - Whether or not the driver and passenger safety belts were buckled/fastened;
 - How far (if at all) the driver was depressing the accelerator and/or brake pedal; and,
 - How fast the vehicle was traveling.
- These data can help provide a better understanding of the circumstances in which crashes and injuries occur.

NOTE: EDR data are recorded by your vehicle only if a non-trivial crash situation occurs; no data are recorded by the EDR under normal driving conditions and no personal data (e.g. name, gender, age, and crash location) are recorded. However, other parties, such as law enforcement, could combine the EDR data with the type of personally identifying data routinely acquired during a crash investigation.

- To read data recorded by an EDR, special equipment is required, and access to the vehicle or the EDR is needed. In addition to the vehicle manufacturer, other parties such as law enforcement, that have the special equipment, can read the information if they have access to the vehicle or the EDR.

MAINTAINING YOUR VEHICLE

OPENING THE HOOD



- Pull the hood release lever located below the steering wheel at the base of the instrument panel.
- Reach into the opening beneath the center of the hood and move the safety latch lever while lifting the hood at the same time.

WARNING!

Be sure the hood is fully latched before driving your vehicle. If the hood is not fully latched, it could open when the vehicle is in motion and block your vision. Failure to follow this warning could result in serious injury or death.

FUEL DOOR RELEASE



- The fuel door release button is located on the instrument panel below the headlight switch.
- Push the button once and release to open the fuel door.

MAINTAINING YOUR VEHICLE

Fuel Door Emergency Release



- To manually open the fuel door, remove the storage bin located in the left rear cargo area.
- Pull the release cable located in the storage bin opening.

MAINTAINING YOUR VEHICLE

ENGINE COMPARTMENT

3.6L ENGINE

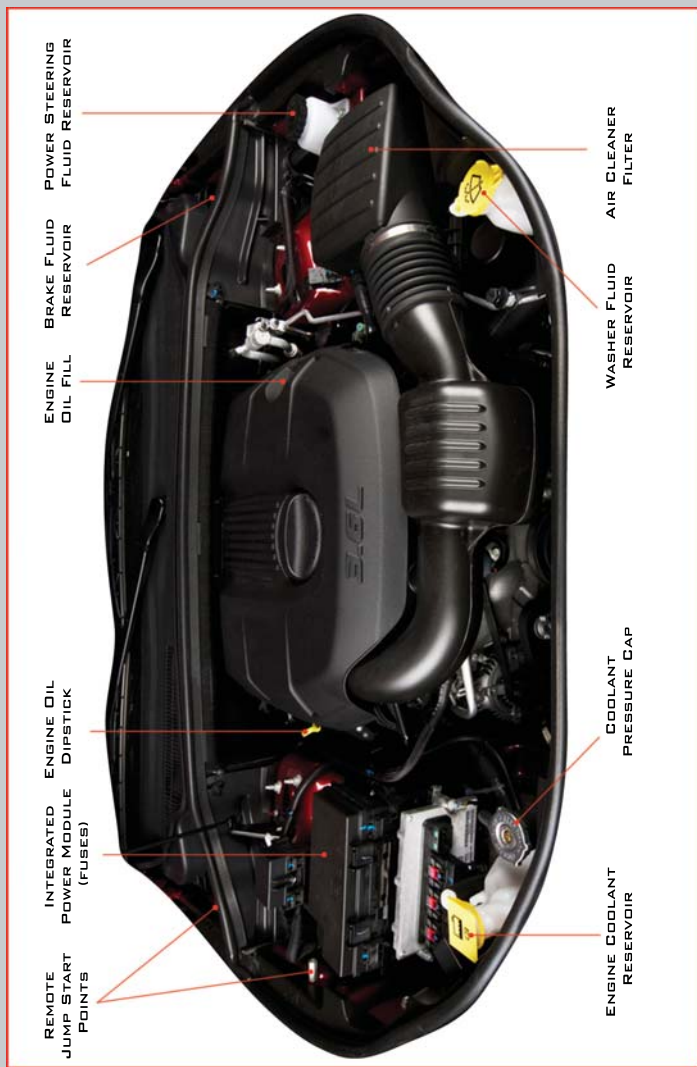

MAINTAINING YOUR VEHICLE

5.7L Engine

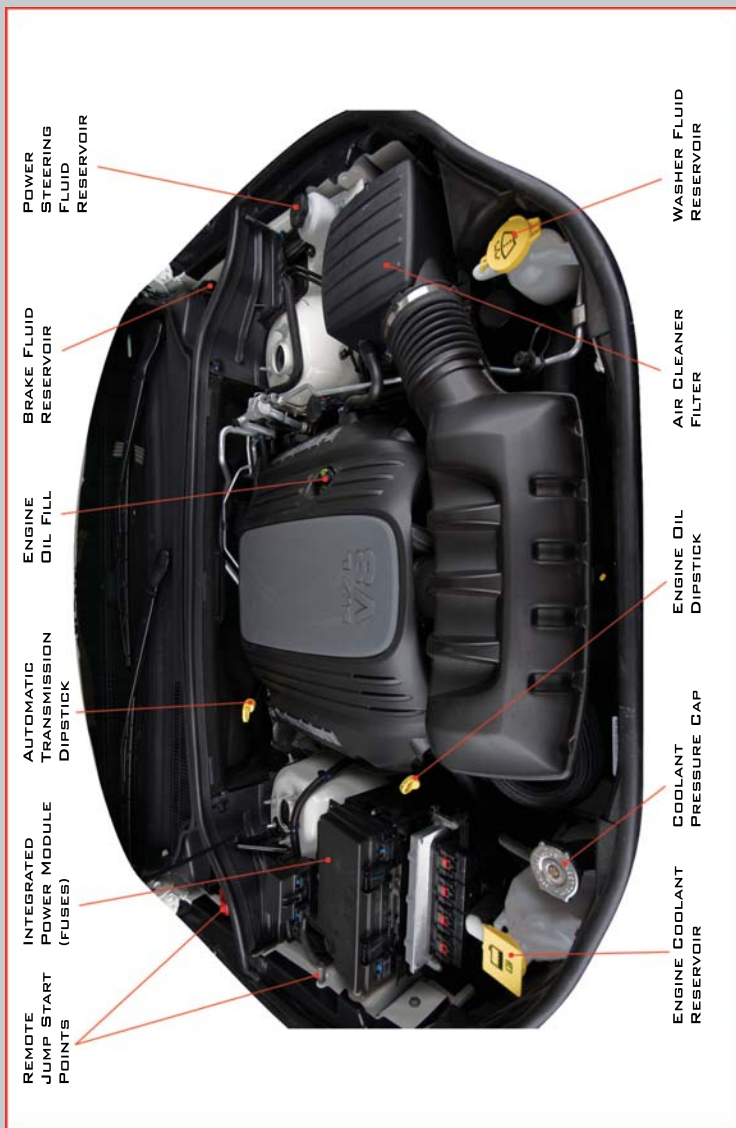

MAINTAINING YOUR VEHICLE

FLUIDS AND CAPACITIES

Component	Fluid, Lubricant, or Genuine Part	Capacities
3.6L Engine	MOPAR [®] Engine Coolant/Antifreeze 5-Year/100,000 Mile Formula or equivalent	10.4 Quarts (9.9 Liters)
5.7 Liter Engine – Without Trailer Tow Package	MOPAR [®] Engine Coolant/Antifreeze 5-Year/100,000 Mile Formula or equivalent	15.4 Quarts (14.6 Liters)
5.7 Liter Engine – With Trailer Tow Package	MOPAR [®] Engine Coolant/Antifreeze 5-Year/100,000 Mile Formula or equivalent	16 Quarts (15.2 Liters)
Engine Oil with Filter 3.6L	API certified 5W-30 engine oil, meeting the requirements of Chrysler Material Standard MS-6395. Refer to your oil filler cap for correct SAE grade.	6 Quarts (5.6 Liters)
Engine Oil with Filter 5.7L	API certified 5W-20 engine oil, meeting the requirements of Chrysler Material Standard MS-6395. Refer to your oil filler cap for correct SAE grade.	7 Quarts (6.6 Liters)
Fuel Selection 3.6L, 5.7L	87 Octane acceptable. 89 Octane recommended for 5.7L.	24 Gallons (91 Liters)
Engine Oil Filter 3.6L, 5.7L	MOPAR [®] Engine Oil Filter or equivalent.	—
Spark Plug 3.6L	RER8ZWYCB4 (Gap 0.043 in [1.1 mm])	—
Spark Plug 5.7L	LZFR5C-11G (Gap 0.043 in [1.09 mm])	—
Automatic Transmission	MOPAR [®] ATF+4 [®] Automatic Transmission Fluid or equivalent licensed ATF+4 [®] product.	—
Transfer Case (MP2010 Single Speed Only)	MOPAR [®] ATF+4 [®] Automatic Transmission Fluid or equivalent licensed ATF+4 [®] product.	—

MAINTAINING YOUR VEHICLE

Component	Fluid, Lubricant, or Genuine Part	Capacities
Transfer Case (MP3023 Two Speed Only)	MOPAR® NV 247/245 Transfer Case Lubricant or equivalent.	—
Axle Differential (Front/Rear)	We recommend you use MOPAR® GL-5 Synthetic Axle Lubricant SAE 75W-85.	—
Axle Differential (Rear) 5.7L Engine With Electronic Limited-Slip Differential (ELSD)	We recommend you use MOPAR® GL-5 Synthetic Axle Lubricant SAE 75W-85 with friction modifier additive.	—
Axle Differential (Rear) 5.7L Engine Without Electronic Limited-Slip Differential (ELSD)	We recommend you use MOPAR® GL-5 Synthetic Axle Lubricant SAE 75W-85.	—
Brake Master Cylinder	MOPAR® DOT 3 and SAE J1703 should be used or equivalent. If DOT 3 is not available, then DOT 4 is acceptable. Use only recommended brake fluids.	—
Power Steering Reservoir – 3.6L Engine	MOPAR® Hydraulic Fluid or equivalent meeting MS-11655, such as Fuchs EG ZH 3044 or Pentosin CHF 11s.	—
Power Steering Reservoir – 5.7L Engine	MOPAR® Power Steering Fluid +4, MOPAR® ATF+4® Automatic Transmission Fluid meeting MS-9602 or equivalent licensed ATF+4® product.	—

MAINTAINING YOUR VEHICLE

MAINTENANCE CHART

	8,000	16,000	24,000	32,000	40,000	48,000	56,000	64,000	72,000	80,000	88,000	96,000	104,000
Miles: Or Months: Or Kilometers:	6 13,000	12 26,000	18 39,000	24 52,000	30 65,000	36 78,000	42 91,000	48 104,000	54 117,000	60 130,000	66 143,000	72 156,000	78 169,000
Change the engine oil and engine oil filter.	X	X	X	X	X	X	X	X	X	X	X	X	X
Rotate the tires, rotate at the first sign of irregular wear, even if it occurs before scheduled maintenance.		X	X	X	X	X	X	X	X	X	X	X	X
If using your vehicle for any of the following: dusty or off-road conditions. Inspect the engine air cleaner filter; replace if necessary.		X				X				X			
Inspect the brake linings; replace if necessary.		X		X				X		X		X	
Inspect the CV joints.			X			X			X			X	
Inspect the exhaust system.		X	X			X			X			X	
Inspect the transfer case fluid and change if necessary.				X				X				X	
Adjust the parking brake on vehicles equipped with four wheel disc brakes.				X				X				X	
Change the automatic transmission fluid and filter if using your vehicle for any of the following: police, taxi, fleet or frequent trailer towing.								X					
Inspect the front and rear axle fluid, change if necessary.			X						X			X	
Inspect front suspension, tie rod ends, and boot seals, for cracks or leaks and all parts for damage, wear, improper looseness or end play; replace if necessary.		X		X		X		X		X		X	
Replace the engine air cleaner.				X				X				X	
Flush and replace the engine coolant at 60 months or 104,000 miles (169,000 km) whichever comes first.										X			

MAINTAINING YOUR VEHICLE

	Miles:		24,000		32,000		40,000		48,000		56,000		64,000		72,000		80,000		88,000		96,000		104,000		
	Or Months:	6	12	18	24	30	36	42	48	54	60	66	72	78	84	90	96	102	108	114	120	126	132	138	144
Flush and replace the engine coolant at 104,000 miles (169,000 km) or 60 months whichever comes first.	13,000	26,000	39,000	52,000	65,000	78,000	91,000	104,000	117,000	130,000	143,000	156,000	169,000												
Replace the spark plugs (5.7L engine)				X																					
Replace the spark plugs (3.6L engine)																									
Inspect and replace PCV valve.*																									

- * This maintenance is recommended by the manufacturer to the owner, but is not required to maintain emissions warranty.
- Refer to the Owner's Manual on the DVD for complete maintenance schedule.

MAINTAINING YOUR VEHICLE

Maintenance Record

	Odometer	Date	Signature, Authorized Service Center
8,000 Miles (13,000 km) or 6 Months			
16,000 Miles (26,000 km) or 12 Months			
24,000 Miles (39,000 km) or 18 Months			
32,000 Miles (52,000 km) or 24 Months			
40,000 Miles (65,000 km) or 30 Months			
48,000 Miles (78,000 km) or 36 Months			
56,000 Miles (91,000 km) or 42 Months			
64,000 Miles (104,000 km) or 48 Months			
72,000 Miles (117,000 km) or 54 Months			
80,000 Miles (130,000 km) or 60 Months			
88,000 Miles (143,000 km) or 66 Months			
96,000 Miles (156,000 km) or 72 Months			
104,000 Miles (169,000 km) or 78 Months			

MAINTAINING YOUR VEHICLE

FUSES

Integrated Power Module (fuses)

The integrated power module is located on the right side of the engine compartment. This center contains cartridge fuses and mini fuses. A description of each fuse and component may be stamped on the inside cover, otherwise the cavity number of each fuse is stamped on the inside cover that corresponds to the following chart.

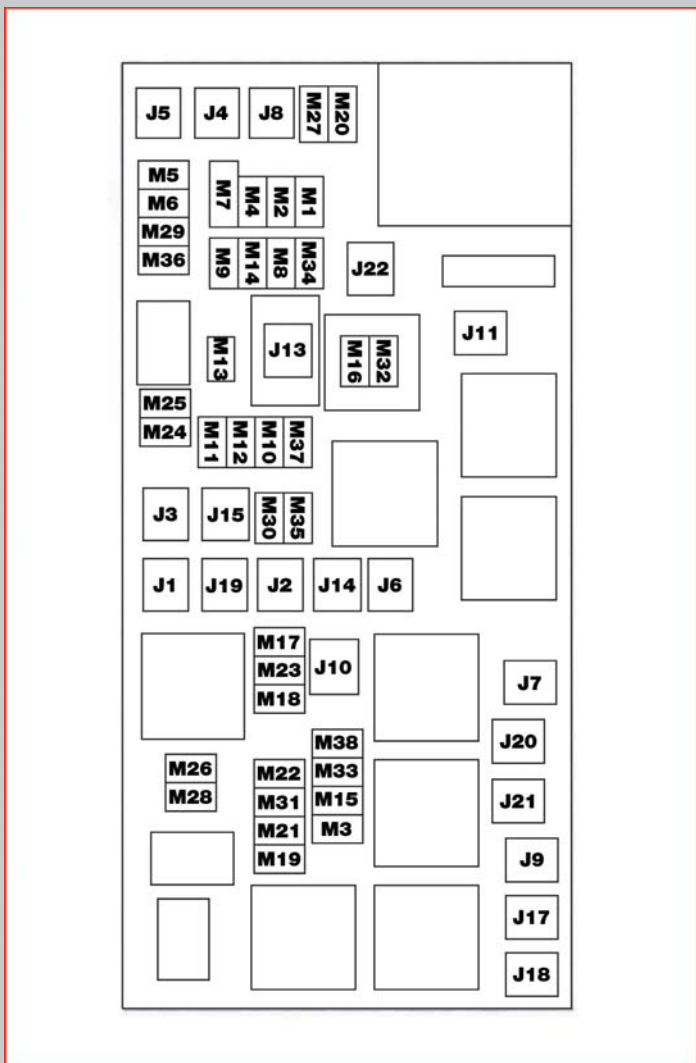

MAINTAINING YOUR VEHICLE

Cavity	Cartridge Fuse	Mini Fuse	Description
J01	40 Amp Green		–
J02	30 Amp Pink		Power Liftgate Module
J03	30 Amp Pink		Trailer Tow
J04	25 Amp Natural		Driver Door Node
J05	25 Amp Natural		Passenger Door Node
J06	40 Amp Green		Antilock Brakes Pump/Stability Control System
J07	30 Amp Pink		Antilock Brakes Valve/Stability Control System
J08	40 Amp Green		Power Seat
J09	30 Amp Pink		E-Brake
J10	30 Amp Pink		Headlamp Wash Relay Contact
J11	30 Amp Pink		Drive Train Control Module
J12	30 Amp Pink		Rear Defroster
J13	60 Amp Yellow		Main Ignition Off Draw (IOD)
J14	20 Amp Blue		Trailer Tow Lamps/Park Lamps
J15	40 Amp Green		Front Cabin Fan/Blower
J17	40 Amp Green		Starter Motor Solenoid
J18	20 Amp Blue		Powertrain Control Module/ Powertrain Control Module Transmission Range
J19	60 Amp Yellow		Radiator Fan Motor HI/Radiator Fan Motor Low
J20	30 Amp Pink		Front Wiper
J21	20 Amp Blue		Front/Rear Washer Control
J22	25 Amp Natural		Sunroof Module
M1		15 Amp Blue	Stop Lamp
M2		20 Amp Yellow	–
M3		20 Amp Yellow	Liftgate Unlock/DRL Relay/Third Row Headrest
M5		25 Amp Natural	115V AC Power Inverter
M6		20 Amp Yellow	Rain Sensor/Cigar Lighter
M7		20 Amp Yellow	Power Outlet #2 (Switchable)
M8		20 Amp Yellow	Front Heated Seat & Steering Wheel
M9		20 Amp Yellow	Rear Heated Seats
M10		15 Amp Blue	Video/Universal Garage Door Opener/Hands Free/Vanity Lamps
M11		10 Amp Red	Heating, Ventilation & Air Conditioning (Climate Control System)

MAINTAINING YOUR VEHICLE

Cavity	Cartridge Fuse	Mini Fuse	Description
M12		30 Amp Green	Radio/Amplifier
M13		20 Amp Yellow	Instrument Cluster/Ignition Module
M14		20 Amp Yellow	Back Up Camera
M15		20 Amp Yellow	Power Seat Module(s)/Adaptive Cruise Control/Audio Telematics/Daytime Running Lights Relay/Instrument Cluster
M16		10 Amp Red	Occupant Restraint Controller
M19		25 Amp Natural	Automatic Shutdown 1 and 2
M20		15 Amp Blue	Instrument Cluster/Steering Wheel Switches
M21		20 Amp Yellow	Automatic Shutdown 3
M22		10 Amp Red	Horns (Low/High) – Right
M23		10 Amp Red	Horns (Low/High) – Left
M24		25 Amp Natural	Rear Wiper
M25		20 Amp Yellow	Fuel Pump Motor Output
M26		10 Amp Red	Switch Bank/Interior Lighting
M27		10 Amp Red	Ignition Switch/Wireless Control Module/Keyless Entry Module
M28		15 Amp Blue	Powertrain Controller/Transmission Controller
M29		10 Amp Red	Tire Pressure Monitor
M30		15 Amp Blue	J1962 Diag Connector
M31		20 Amp Yellow	Backup Lamps
M32		10 Amp Red	Occupant Restraint Controller
M33		10 Amp Red	Powertrain Controller/Transmission Controller
M34		10 Amp Red	Park Assist Module/Climate Control System Module/IR Sensor/Compass Module
M35		15 Amp Blue	LH Rear Parklamps
M36		20 Amp Yellow	Power Outlet
M37		10 Amp Red	Antilock Brakes/Stability Control System Module/Stoplamp Switch Sensor
M38		25 Amp Natural	All Door Lock &Unlock

MAINTAINING YOUR VEHICLE

CAUTION!

- When installing the integrated power module cover, it is important to ensure the cover is properly positioned and fully latched. Failure to do so may allow water to get into the integrated power module and possibly result in an electrical system failure.
- When replacing a blown fuse, it is important to use only a fuse having the correct amperage rating. The use of a fuse with a rating other than indicated may result in a dangerous electrical system overload. If a properly rated fuse continues to blow, it indicates a problem in the circuit that must be corrected.

TIRE PRESSURES

- Check the inflation pressure of each tire, including the spare tire, at least monthly and inflate to the recommended pressure for your vehicle.
- The tire pressures recommended for your vehicle are found on the “Tire and Loading Information” label located on the driver’s side door opening.

NOTE: Refer to the Owner’s Manual on the DVD for more information regarding tire warnings and instructions.

WARNING!

- Overloading of your tires is dangerous. Overloading can cause tire failure, affect vehicle handling, and increase your stopping distance. Use tires of the recommended load capacity for your vehicle. Never overload them.
- Improperly inflated tires are dangerous and can cause collisions. Under-inflation is the leading cause of tire failure and may result in severe cracking, component separation, or “blow out”. Over-inflation reduces a tire’s ability to cushion shock. Objects on the road and chuck holes can cause damage that results in tire failure. Unequal tire pressures can cause steering problems. You could lose control of your vehicle. Over-inflated or under-inflated tires can affect vehicle handling and can fail suddenly, resulting in loss of vehicle control.

MAINTAINING YOUR VEHICLE

WHEEL AND WHEEL TRIM CARE

- All wheels and wheel trim, especially aluminum and chrome plated wheels, should be cleaned regularly with a mild soap and water to prevent corrosion.
- To remove heavy soil and/or excessive brake dust, use MOPAR® Wheel Cleaner or equivalent or select a non-abrasive, non-acidic cleaner.

CAUTION!

Do not use scouring pads, steel wool, a bristle brush, or metal polishes. Do not use oven cleaner. These products may damage the wheel's protective finish. Avoid automatic car washes that use acidic solutions or harsh brushes that may damage the wheel's protective finish. Only MOPAR® Wheel Cleaner or equivalent is recommended.

EXTERIOR BULBS

LIGHT BULBS – Exterior	Bulb Number
Tail, Stop, Turn Lamp	3057
Backup Lamps	921 (W16W)
Center High-Mounted Stop Lamp (CHMSL)	LED (*)
Fog Lamp – If Equipped	PSX24W
Front Park/Turn Signal	7444NA
Front Side Marker, License Lamp	W5W
Headlamp – High Intensity Discharge (HID)	Service at Authorized Dealer (**)
Headlamp – Low Beam	H11
Headlamp – High Beam	9005

* CHMSL is not serviceable. It is a LED lamp. To replace the LED, the entire CHMSL assembly must be replaced.

** The headlamps are a type of high-voltage discharge tube. High voltage can remain in the circuit even with the headlamp switch off and the Key Fob removed. Because of this, you should not attempt to service a headlamp bulb yourself. If a headlamp bulb fails, take your vehicle to an authorized dealer for service.

CONSUMER ASSISTANCE

CHRYSLER GROUP LLC CUSTOMER CENTER

P.O. Box 21-8004

Auburn Hills, MI 48321-8004

Phone: 1-800-423-6343

CHRYSLER CANADA INC. CUSTOMER CENTER

P.O. Box 1621

Windsor, Ontario N9A 4H6

Phone: 1-800-465-2001 (English)

Phone: 1-800-387-9983 (French)

ASSISTANCE FOR THE HEARING IMPAIRED

- To assist customers who have hearing difficulties, the manufacturer has installed special TDD (Telecommunication Devices for the Deaf) equipment at its customer center. Any hearing or speech impaired customer, who has access to a TDD or a conventional teletypewriter (TTY) in the United States, can communicate with the manufacturer by dialing 1-800-380-CHRY. Canadian residents with hearing difficulties that require assistance can use the special needs relay service offered by Bell Canada. For TTY teletypewriter users, dial 711 and for Voice callers, dial 1-800-855-0511 to connect with a Bell Relay Service operator.

WARNING!

Engine exhaust, some of its constituents, and certain vehicle components contain, or emit, chemicals known to the State of California to cause cancer and birth defects, or other reproductive harm. In addition, certain fluids contained in vehicles and certain products of component wear contain, or emit, chemicals known to the State of California to cause cancer and birth defects, or other reproductive harm.

PUBLICATIONS ORDERING

- **If you are the first registered retail owner of your vehicle**, you may obtain one free printed copy of the Owner's Manual, Warranty Booklet or Radio Manuals on your DVD by calling 1-800-423-6343 (U.S.) or 1-800-387-1143 (Canada) or by contacting your dealer.
- Replacement User Guide kits or DVDs or, if you prefer, additional printed copies of the Owner's Manual, Warranty Booklet or Radio Manuals may be purchased by visiting www.techauthority.com or by calling 1-800-890-4038 (U.S.) or 1-800-387-1143 (Canada). Visa, Master Card, American Express and Discover orders are accepted. If you prefer mailing your order, please call the above numbers for an order form.

NOTE: A street address is required when ordering manuals (no P.O. Boxes).

CONSUMER ASSISTANCE

NOTE:

- The Owner's Manual and User Guide electronic files are also available on the Chrysler, Jeep, Ram Truck and Dodge websites.
- Click on the "For Owners" tab, select "Owner/Service Manuals", then select your desired model year and vehicle from the drop down lists.

REPORTING SAFETY DEFECTS IN THE 50 UNITED STATES AND WASHINGTON, D.C.

- If you believe that your vehicle has a defect that could cause a collision or cause injury or death, you should immediately inform the National Highway Traffic Safety Administration (NHTSA) in addition to notifying the manufacturer.
- If NHTSA receives similar complaints, it may open an investigation, and if it finds that a safety defect exists in a group of vehicles, it may order a recall and remedy campaign. However, NHTSA cannot become involved in individual problems between you, your authorized dealer, and the manufacturer.

- To contact NHTSA, you may either call the Auto Safety Hotline toll free at 1-888-327-4236 (TTY: 1-800-424-9153), or go to <http://www.safercar.gov>; or write to: Administrator, NHTSA, 1200 New Jersey Avenue, SE., West Building, Washington, D.C. 20590. You can also obtain other information about motor vehicle safety from <http://www.safercar.gov>.

In Canada

- If you believe that your vehicle has a safety defect, you should contact the Customer Service Department immediately. Canadian customers who wish to report a safety defect to the Canadian government should contact Transport Canada, Motor Vehicle Defect Investigations and Recalls at 1-800-333-0510 or go to <http://www.tc.gc.ca/roadsafety/>
- French Canadian customers who wish to report a safety defect to the Canadian government should contact Transport Canada, Motor Vehicle Defect Investigations and Recalls at 1-800-333-0510 or go to <http://www.tc.gc.ca/securiteroutiere/>

MOPAR ACCESSORIES

AUTHENTIC ACCESSORIES BY MOPAR®

- The following highlights just some of the many Authentic Dodge Accessories by Mopar featuring a fit, finish, and functionality specifically for your Dodge Durango.
- In choosing Authentic Accessories you gain far more than expressive style, premium protection, or extreme entertainment, you also benefit from enhancing your vehicle with accessories that have been thoroughly tested and factory-approved.
- For the full line of Authentic Dodge Accessories by Mopar, visit your local Dodge dealership or online at mopar.com.

EXTERIOR:

- Molded Running Boards
- Chrome Front Air Deflector
- Chrome Tubular Side Steps
- Front End Cover
- Winter Wheels
- Molded Splash Guards
- Wheels
- Hitch Receiver
- Chrome Grille
- Black Tubular Side Steps

INTERIOR:

- Premium Carpet Floor Mats
- Door Sill Guards
- Molded Cargo Tray
- Rubber All Weather Mats
- Katzkin Leather Interiors
- Bright Pedal Kit
- Heated Seats

ELECTRONICS:

- Portable Navigation Systems
- Uconnect™ Web (WiFi)
- Sirius Satellite Radio
- iPod® Adapter
- Media Center 730N (RHR) Radio
- Media Center 430/430N (RBZ/RHB) Radio
- Remote Start
- Rear View Camera
- Park Distance Sensors

CARRIERS:

- Hitch-mount Bike Carrier
- Roof Box Cargo Carrier
- Roof Mount Bike Carrier
- Roof Mount Ski and Snowboard Carrier
- Roof Mount Water Sports Carrier
- Cargo Basket

iPod® is a registered trademark of Apple, Inc.

INDEX

- Adaptive Cruise Control (ACC)
(Cruise Control) 27
- Air Conditioning 30
- Airbag 13
- Airbag Light 67
- Alarm, Panic 8
- All Wheel Drive (AWD) 58
- Anti-Lock Brake System (ABS) 66
- Arming Theft System
(Security Alarm) 12
- Audio Jack 41
- Audio Settings 39
- Automatic Dimming Mirror 26
- Automatic Headlights 24
- Automatic Temperature Control
(ATC) 30
 - Air Recirculation 30
 - Automatic Operation 30
 - Rear Temperature Control 30
 - SYNC Temperature Button 31
- Automatic Transmission
 - Fluid Type 82
- Auxiliary Audio/Video Input Jacks . . . 52
- Axle Fluid 82,83
- Axle Lubrication (Axle Fluid) 83

- Back-Up Camera 32
- Battery
 - Charging System Light 66
- Belts, Seat 13
- Blind Spot Monitoring 32
- Brake Fluid 82,83
- Brake System
 - Warning Light 65
- Bulb Replacement 91

- Calibration, Compass 53
- Cargo Compartment
 - Luggage Carrier 60
- Change Oil Indicator 67
- Charging System Light 66
- Check Engine Light
(Malfunction Indicator Light) 65
- Child Restraint 14
- Child Restraint Tether Anchors 14
- Climate Control 30
- Clock Setting 39,41

- Compass Calibration 53
- Cooling System
 - Coolant Capacity 82
- Cruise Control (Speed Control) 26
- Cruise Light 26
- Customer Assistance 92

- Defects, Reporting 93
- Dimmer Control 24
- Dimmer Switch, Headlight 24
- Disarming, Theft System 12
- Driver Cockpit 4

- ECO 53
- Electronic Range Select (ERS) 29
- Electronic Speed Control
(Cruise Control) 26
- Electronic Stability Control (ESC) . . . 66
- Electronic Throttle Control
Warning Light 66
- Electronic Vehicle Information Center
(EVIC) 53,54
- Electronically Shifted Transfer Case . . 58
- Electronics
 - Your Vehicle's Sound System 36
- Emergency Key 8
- Engine
 - Compartment 80
 - Coolant (Antifreeze) 82
 - Malfunction Indicator
(Check Engine) 65
 - Oil 82
 - Oil Filter 82
 - Oil Selection 82
 - Overheating 67
 - Starting 11
 - Stopping 11
- Event Data Recorder 77
- Express Down Windows 8
- Exterior Lights 91

- Fluid Capacities 82
- Fluids 82
- Fog Lights 24
- Folding Front Passenger Seat 18
- Folding Power Third Row Head
Restraints 20

INDEX

- Folding Rear Seat 19,20
- Four Wheel Drive 58
 - Operation 58
 - Systems 58
- Four Wheel Drive Operation 58
- Front Heated Seats 21
- Fuel
 - Filler Cap (Gas Cap) 67
 - Filler Door (Gas Cap) 78
 - Filler Door Emergency Release 79
 - Specifications 82
- Fuses 87
- Garage Door Opener (HomeLink®) 54
- Gas Cap (Fuel Filler Cap) 67
- Hard Disk Drive 42
- Head Restraints
 - Power Folding Third Row 20
- Headlights 24
 - Automatic 24
 - Dimmer Switch 24
 - High Beam 26
 - High Beam/Low Beam Select Switch 26
- Heated Seats 21
- Heated Steering Wheel 22
- High Beam/Low Beam Select (Dimmer) Switch 26
- HomeLink® (Garage Door Opener) Transmitter 54
- Hood Release 78
- Instrument Cluster 6
 - Indicators 7
- Instrument Cluster Warning Lights 6,64
- Integrated Power Module (Fuses) 87
- Intermittent Wipers (Delay Wipers) 25
- Introduction 2
- Inverter Outlet (115V) 56
- Inverter, Power 56
- iPod®/USB/MP3 Control 50
- Jack Location 69
- Jump Starting 72
- Key Fob 8
- Keyless Enter-N-Go 10
 - Lock/Unlock 10,11
 - Starting/Stopping 11
- Lane Change Assist 25
- LATCH (Lower Anchors and Tether for CHildren) 14
- Liftgate, Power 8
- Light Bulbs 91
- Lights
 - Warning (Instrument Cluster Description) 6
- Luggage Rack (Roof Rack) 60
- Maintenance Record 86
- Maintenance Schedule 84
- Malfunction Indicator Light (Check Engine) 65
- Media Center Radio 38,40
- Memory Seat 17
- Mirrors
 - Automatic Dimming 26
- MOPAR® Accessories 94
- Navigation 43,44
- Non-Touch-Screen Radio 38
- Oil Change Indicator 67
- Oil Change Indicator, Reset 67
- Oil Pressure Light 66
- Oil, Engine
 - Capacity 82
- Outlet
 - Power 57
- Overheating, Engine 67
- Panic Alarm 8
- Park Sense Sensors, Cleaning 31
- Park Sense System, Rear 31
- Phone (Pairing) 47
- Phone (Uconnect) 47
- Pinch Protection Feature 33
- Power
 - Folding Third Row Head Restraints 20
 - Glass Sunroof 33

INDEX

- Inverter 56
- Lift Gate 8
- Outlet (Auxiliary Electrical Outlet) . . 57
- Seats 16
- Steering 82,83
- Tilt/Telescoping Steering Column . . 23
- Preparation for Jacking 69
- Programmable Electronic Features . . 54

- Radio
 - Non-Touch-Screen 38
 - Touch-Screen 40
- Radio Operation 38,40
- Rain Sensitive Wiper System 25
- Rear Camera 32
- Rear Cross Path 32
- Rear Heated Seats 21
- Rear Park Sense System 31,32
- Rear Seat, Folding 19
- Recreational Towing 62
 - Shifting into Transfer Case
 - Neutral (N) 62
- Remote Starting System 9
- Replacement Bulbs 91
- Reporting Safety Defects 93
- Restraints, Child 14
- Roll Over Warning 3
- Roof Rack (Luggage Rack) 60

- Seat Belts 13
 - Child Restraint 16
- Seats 16
 - Adjustment 18
 - Fold and Tumble Rear 19
 - Folding Front Passenger 18
 - Heated 21
 - Lumbar Support 17
 - Memory 17
 - Power 16
 - Rear Folding 19,20
 - Ventilated 21
- Seek Button 39,41
- Setting the Clock 39,41
- Shift Lever Override 75
- Signals, Turn 25
- Sirius Backseat TV™ 52
- SIRIUS Travel Link 46
- SmartBeams 24

- Spark Plugs 82
- Speed Control
 - Accel/Decel 26
 - Accel/Decel (ACC Only) 27
 - Cancel 27
 - Distance Setting (ACC Only) 27
 - Mode Setting (ACC Only) 27
 - Resume 28
- Speed Control (Cruise Control) 26
- Starting
 - Remote 9
- Steering
 - Tilt Column 22
 - Wheel, Heated 22
- Steering Wheel Audio Controls 46
- Store Radio Presets 39,41
- Sun Roof 33
- Supplemental Restraint System -
Airbag 13

- Temperature Control, Automatic
(ATC) 30
- Theft Alarm (Security Alarm) 12
- Theft System Arming 12
- Theft System Disarming 12
- Tilt Steering Column 22

- Tires
 - Air Pressure 90
 - Pressure Warning Light 64
- Touch-Screen Radio 40
- Tow Hooks, Emergency 75
- Tow/Haul 62
- Towing 61
 - 24-Hour Towing Assistance 64
 - Disabled Vehicle 76
 - Recreational 62
- Towing Vehicle Behind a Motorhome . . 62
- Trailer Towing
 - Trailer and Tongue Weight 61
- Trailer Weight 61
- Transfer Case
 - Electronically Shifted 58
 - Fluid 82,83
- Transmission
 - Fluid 82
- Turn Signals 25

INDEX

Uconnect™ Phone	47	Warning Lights	64
Uconnect™ Voice Command	49	Washer	
Universal Garage Door Opener		Rear	25
(HomeLink®)	54	Washers, Windshield	25
USB Port	43,50	Wheel and Wheel Trim Care	91
		Wind Buffeting	35
Ventilated Seats	21	Windows, Express Down	8
Video Entertainment System™		Windshield Washers	25
(Rear Seat Video System)	51	Windshield Wipers	25
Voice Command	49	Wiper, Rear	25
		Wipers, Intermittent	25
		Wipers, Rain Sensitive	25



Driving and Alcohol: Drunken driving is one of the most frequent causes of collisions. Your driving ability can be seriously impaired with blood alcohol levels far below the legal minimum. If you are drinking, don't drive. Ride with a designated non-drinking driver, call a cab, a friend, or use public transportation.

WARNING!

Driving after drinking can lead to a collision. Your perceptions are less sharp, your reflexes are slower, and your judgment is impaired when you have been drinking. Never drink and then drive.

This guide has been prepared to help you get quickly acquainted with your new Dodge and to provide a convenient reference source for common questions. However, it is not a substitute for your Owner's Manual.

For complete operational instructions, maintenance procedures and important safety messages, please consult your Owner's Manual, Navigation/Media Center Manuals, Multimedia User Manual and other Warning Labels in your vehicle.

Not all features shown in this guide may apply to your vehicle. For additional information on accessories to help personalize your vehicle, visit www.mopar.com or your local Dodge dealer.

DODGE



11WD01-926-AA
Durango
Fifth Edition
User Guide