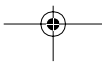

TABLE OF CONTENTS

SECTION		PAGE	
1	INTRODUCTION	3	1
2	THINGS TO KNOW BEFORE STARTING YOUR VEHICLE.....	7	2
3	UNDERSTANDING THE FEATURES OF YOUR VEHICLE.....	51	3
4	UNDERSTANDING YOUR INSTRUMENT PANEL	81	4
5	STARTING AND OPERATING.....	133	5
6	WHAT TO DO IN EMERGENCIES.....	185	6
7	MAINTAINING YOUR VEHICLE	203	7
8	MAINTENANCE SCHEDULES	247	8
9	IF YOU NEED CONSUMER ASSISTANCE	255	9
10	INDEX	261	10



INTRODUCTION

1

CONTENTS

■ Introduction	4	■ Vehicle Safety Certification Label, Sample and Location	5
■ How to Use this Manual	4	■ Vehicle / Engine Emission Label, Sample and Location	6
■ Warnings and Cautions	4		
■ Vehicle Identification Number, Sample and Location	5		

4 INTRODUCTION

INTRODUCTION

This manual has been prepared with the assistance of service and engineering specialists to acquaint you with the operation and maintenance of your new vehicle. It is supplemented by a Warranty Information Booklet and various customer oriented documents. You are urged to read these publications carefully. Following the instructions and recommendations in this manual will help assure safe and enjoyable operation of your vehicle.

NOTE: After you read the manual, it should be stored in the vehicle for convenient reference and remain with the vehicle when sold.

When it comes to service, remember that your dealer knows your vehicle best, has the factory-trained technicians and genuine Mopar® parts, and is interested in your satisfaction.

WARNING!

Engine exhaust, some of its constituents, and certain vehicle components contain or emit chemicals known to the State of California to cause cancer and birth defects or other reproduction harm. In addition, certain fluids contained in vehicles, and certain products of component wear, contain chemicals known to the State of California to cause cancer and birth defects or other reproductive harm.

HOW TO USE THIS MANUAL

Consult the table of contents to determine which section contains the information you desire.

The detailed index, at the rear of this manual, contains a complete listing of all subjects.

WARNINGS AND CAUTIONS

This manual contains **WARNINGS** against operating procedures which could result in an accident or bodily injury. It also contains **CAUTIONS** against procedures which could result in damage to your vehicle. If you do not read this entire manual you may miss important information. Observe all Warnings and Cautions.

VEHICLE IDENTIFICATION NUMBER, SAMPLE AND LOCATION

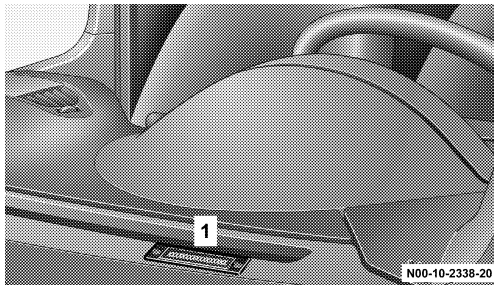

Vehicle identification number, visible (location: lower edge of windshield)

VEHICLE SAFETY CERTIFICATION LABEL, SAMPLE AND LOCATION

Location: below the driver's seat on an outwardfacing position of the mounting pillar.

1

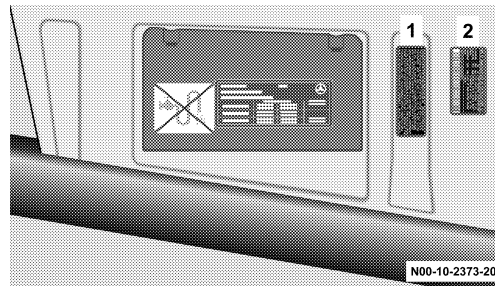

1. Incomplete vehicle certification label for chassis-cab.
2. Type plate (vehicle identification number, permissible weights)

6 INTRODUCTION

Sample Incomplete Vehicle Certification Label (Label 1)

CHASSIS-CAB MFD BY DAIMLERCHRYSLER AG WDIXD641725123456
 THIS CHASSIS-CAB CONFORMS TO FEDERAL MOTOR VEHICLE SAFETY
 STANDARDS NOS. 101-106, 108, 111, 113, 114, 116, 118, 120, 124, 201,
 210, 212, 214, 219, 301&302. IF IT IS COMPLETED IN ACCORDANCE
 WITH THE INSTRUCTIONS CONTAINED IN THE INCOMPLETE VEHICLE
 DOCUMENT FURNISHED PURSUANT TO 49 CFR PART 568.4, CONFORMITY
 TO THE OTHER SAFETY STANDARDS APPLICABLE TO THIS VEHICLE WHEN
 COMPLETED IS NOT SUBSTANTIALLY AFFECTED BY THE DESIGN OF THE
 CHASSIS-CAB, AND THAT THE INCOMPLETE VEHICLE MANUFACTURER
 MAKES NO REPRESENTATION AS TO CONFORMITY WITH THE STANDARDS.

N00-10-2375-2C

Sample Type Plate (Label 2)

MFG BY: DAIMLERCHRYSLER AG			
	KG	LB	TYPE-TRUCK/CAM DATE OF MFG 05/02
GVWR/PNBV	3878	8550	THIS VEHICLE CONFORMS TO ALL FEDERAL MOTOR VEHICLE SAFETY STANDARDS IN EFFECT ON THE DATE OF MANUFACTURE SHOWN ABOVE
GAWR/PNBE	1751	3860	
FRONT			
GAWR/PNBE	2431	5360	
REAR			
WD2YD24163560903			

N00-10-2374-20

VEHICLE/ENGINE EMISSION LABEL, SAMPLE AND LOCATION

Location: on valve cover of the engine

Sample:

Important Engine Information

DaimlerChrysler AG, Stuttgart, Germany

Mercedes-Benz Engine, Model	OM 612 LA	CID 164
Engine Family / Engine Code	2 MBXH2.69DJB / Code I	
Exhaust Emission Control System	TC, EMC, CAC, CAT, EGR	

Date of engine manufacture	2002
Advertised output (SAE gr.)	115 kW (154 HP) / 3800 rpm
Fuel rate at adv. Output	58 - 62 mm ³ / stroke
Valve lash cold (ins.)	hydr. int. tappet exh.
Basic injection timing	14.5 ± 1 degrees BTDC
Idle speed	680 ± 50 rpm

This engine conforms to US EPA and Canada regulations applicable to 2004 Model Year.

This engine has a primary intended service application as a light HD diesel engine.

This engine is not certified for use in an urban bus as defined at 40 CFR 86.093-2. Sales of this engine for use in an urban bus is a violation of Federal Law under the Clean Air Act.

This engine is certified to be operated on diesel fuel.

THINGS TO KNOW BEFORE STARTING YOUR VEHICLE

2

CONTENTS

■ Ignition Lock / Starter Switch	9	□ Audible Alarm	20
□ Immobilizer	10	□ Visual Alarm	20
■ Central Locking (Optional)	11	□ Switching off the Alarm	20
□ Unlocking:	12	■ Towing Protection and Passenger Compartment	
□ Locking:	12	Protection Switch (Optional).....	20
□ Central Locking Switch	13	□ Towing Protection	20
□ Locking Status Display	14	□ Switching off the Towing Protection	20
□ Locking and Unlocking	15	□ Passenger Compartment Protection	21
□ To Program the Automatic Lock Feature when		□ Switching off the Passenger Compartment	
Starting the Engine	15	Protection	21
■ Remote Keyless Entry (Optional)	16	□ Alarm Pushbutton (Vehicles with Security	
□ Unlocking with Remote Keyless Entry	17	Systems only)	22
□ Locking with Remote Keyless Entry	18	■ Opening/Closing doors	23
■ Replacing Batteries in Remote Keyless Entry ...	18	□ Sliding Door	26
■ Security System with Towing and Passenger		□ Rear Cargo Doors	29
Compartment Protection (Optional)	19	□ Passenger/Cargo Area Door	33
		■ Occupant Restraints	35

8 THINGS TO KNOW BEFORE STARTING YOUR VEHICLE

- Seat Belts 37
 - Seat Belt Warning Lamp and Airbag Malfunction 38
 - Fastening and Removing 38
 - Belt Height Adjustment 40
- Airbag and Belt Tensioners 40
 - SRS Malfunction Indicator Lamp 40
 - Driver's Airbag 41
 - Front Seat Passenger Airbag (not in conjunction with folding seat in partition wall) 42
 - Belt Tensioners 43
 - Safety Precautions for the Airbag 44
- Pedals 46
- Engine Break-In Specifications 46
 - The first 1,000 miles (about 1,500 km) 46
 - Engine Oil Consumption 47
- Safety Tips 47
- Inhalation of Exhaust Gas 48
- Tie Down Rings (Optional) 48

THINGS TO KNOW BEFORE STARTING YOUR VEHICLE 9

IGNITION LOCK/STARTER SWITCH

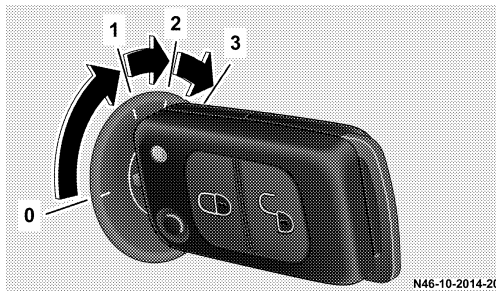

0 The steering wheel is locked when the key is removed

To remove the key, place the selector lever in position "P"; rotate the key in the ignition lock to position 0; and remove the key.

- 1 The steering wheel is unlocked
- 2 Preheating and driving position
- 3 Start position

To engage the steering wheel lock:

After removing the key, turn the steering wheel until the steering wheel lock engages.

2

To release the steering wheel lock:

Turn the steering wheel slightly while turning the key to position 1.

NOTE: If the driver's or passenger's door is opened with the key in position 0 or 1 in the ignition lock, a warning buzzer sounds.

WARNING!

Do not remove the key from the ignition lock unless the vehicle is stationary. Always remove the key from the ignition lock when leaving the vehicle to prevent children or unauthorized persons from starting the engine.

10 THINGS TO KNOW BEFORE STARTING YOUR VEHICLE

Immobilizer

The immobilizer is automatically activated when the key is removed from the ignition lock. The engine cannot be started. As soon as the correct key is inserted into the ignition lock, the immobilizer is deactivated.

For notes on the remote keyless entry, refer to "Remote Keyless Entry".

NOTE: If the engine cannot be started and the displays **Start** and **Error** appear alternately in the multi-function indicator when the key is in position 2 in the ignition lock, a fault has developed or the key used has not been activated.

Remove the key and repeat the starting procedure. If the engine still cannot be started, consult an authorized Sprinter Dealer.

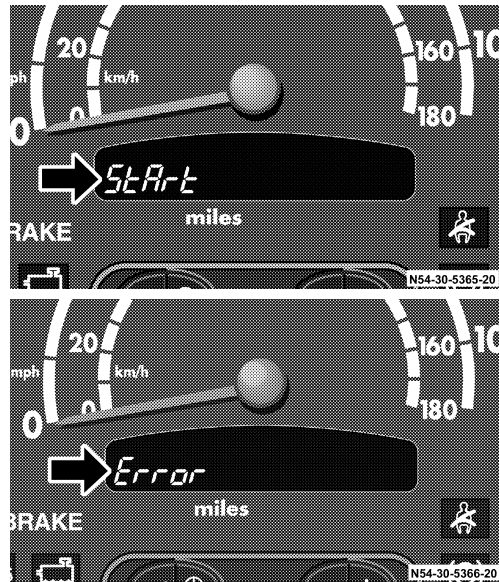

CENTRAL LOCKING (OPTIONAL)

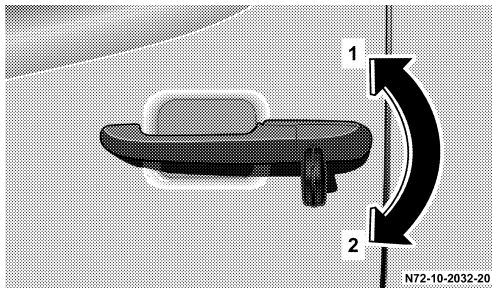

To unlock (1)

To lock (2)

CAUTION!

An unlocked vehicle is an invitation to thieves. Always remove the key from the ignition and lock all doors when leaving the vehicle unattended.

WARNING!

For personal security and safety in the event of an accident, lock the vehicle doors when you drive as well as when you park and leave the vehicle.

2

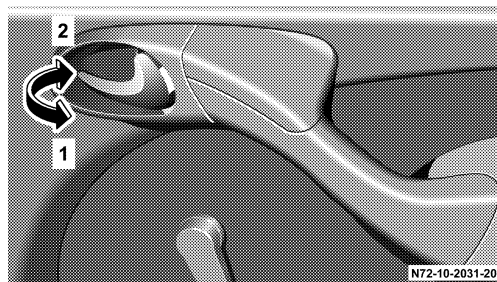

To unlock (1)

To lock (2)

12 THINGS TO KNOW BEFORE STARTING YOUR VEHICLE

WARNING!

When leaving the vehicle always remove the key from the ignition lock, and lock your vehicle.

Do not leave children unsupervised in the vehicle, even if they are secured by a child restraint system. The children could

- injure themselves on parts of the vehicles
- release the child-proof locks by pressing the central locking button and could thereby open the doors and
- cause injury to others as a result
- get out of the vehicle and could either injure themselves when doing so or they could be injured by the traffic approaching from the rear
- suffer serious or fatal effects in the event of long periods of hot weather
- release the parking brake. The vehicle could then start moving of its own accord.

Unsupervised use of vehicle equipment may cause severe personal injuries, death and property damage.

Unlocking:

If a door lock or interior handle on the driver or front-seat passenger door is unlocked, only the driver or front-seat passenger door will be unlocked.

NOTE: If a door lock or interior handle on the sliding door or tailgate is unlocked, only the sliding door or tailgate will be unlocked.

Locking:

All doors are automatically locked if a door lock or interior handle is locked.

NOTE: If the central locking automatically unlocks again after having been locked, at least one door is closed incorrectly.

If it then locks again within about 5 seconds, then all closed doors are locked.

The central locking displays vehicle locking with one or more open doors by means of a special function sequence (locking, unlocking, locking). Once closing has been completed, an open door will not automatically be locked.

THINGS TO KNOW BEFORE STARTING YOUR VEHICLE 13

After the engine is started (about 1 second), all doors with the exception of the driver-side door are locked automatically.

CAUTION!

In case of an accident, rescue from the outside may be more difficult if the vehicle is locked.

To unlock the vehicle after the engine is started, refer to "Central Locking Switch".

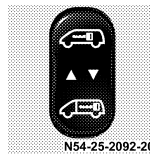

Central Locking Switch

The central locking switch is located on the center section of the dashboard.

2

The entire vehicle or just the passenger door and the cargo doors can be locked or unlocked from inside the vehicle with the central locking switch.

After the engine is started (about 1 second), all doors with the exception of the driver-side door are locked (standard setting).

14 THINGS TO KNOW BEFORE STARTING YOUR VEHICLE

WARNING!

When leaving the vehicle always remove the key from the ignition lock, and lock your vehicle.

Do not leave children unsupervised in the vehicle, even if they are secured by a child restraint system. The children could

- **injure themselves on parts of the vehicles**
- **release the child-proof locks by pressing the central locking button and could thereby open the doors and**
- **cause injury to others as a result**
- **get out of the vehicle and could either injure themselves when doing so or they could be injured by the traffic approaching from the rear**
- **suffer serious or fatal effects in the event of long periods of hot weather**
- **release the parking brake. The vehicle could then start moving of its own accord.**

Unsupervised use of vehicle equipment may cause severe personal injuries, death and property damage.

Locking Status Display

Left-hand indicator lamp is illuminated:
The driver's door is locked.

Right-hand indicator lamp is illuminated:
Front-seat passenger door and rear-seat passenger area/cargo area are locked.

Both indicator lamps are illuminated:
The entire vehicle is locked.

If an indicator lamp flashes:
At least one door has not been properly closed.

NOTE: The indicator lamps go out, once the remote keyless entry transmitter has been used to completely lock the vehicle;

if the ignition lock is in the position 0, and once the interior handles/closing cylinders have been used to completely lock the vehicle;

after about 15 minutes in position 0 in the ignition lock.

The display can be reactivated by pressing the central locking switch, located on the center section of the dashboard.

Locking and Unlocking

To lock entire vehicle:

Press top of central locking switch.
The left and the right indicator lamp in the switch illuminate. If one of the two indicator lamps blinks, at least one door is not closed properly.

To unlock entire vehicle:

Press top of central locking switch again.

To lock the front-seat passenger door and the rear-seat passenger area/cargo area:

Press bottom of central locking switch.
The right indicator lamp in the switch illuminates. If the indicator lamp blinks, at least one door is not closed properly.

To unlock the front-seat passenger door and the rear-seat passenger area/cargo area:

Press bottom of central locking switch again.

To Program the Automatic Lock Feature when Starting the Engine

Place the key in position 2 in the ignition lock and close all doors.

2

To switch off automatic locking of the front-seat passenger door and the rear-seat passenger area/cargo area:

Press the central locking switch at the bottom and hold it there for about 5 seconds. The right indicator lamp flashes twice. Automatic locking when the engine is started is switched off.

To switch on automatic locking of the front-seat passenger door and the rear-seat passenger area/cargo area:

Press the central locking switch at the bottom and hold it there for about 5 seconds. The right indicator lamp flashes four times. Automatic locking when the engine is started is switched on (standard setting).

NOTE: A door which is closed after the engine has been started will not be locked automatically.

16 THINGS TO KNOW BEFORE STARTING YOUR VEHICLE

CAUTION!

In case of an accident, rescue from the outside may be more difficult if the vehicle is locked.

To unlock the vehicle after the engine is started, refer to "Central Locking Switch".

Automatic Unlocking in Case of an Accident

The doors will unlock in the event of certain accidents, provided that the power supply is still maintained.

REMOTE KEYLESS ENTRY (OPTIONAL)

This transmitter complies with FCC rules part 15 and with RS-210 of Industry Canada. Operation is subject to the following two conditions: (1) this device may not cause harmful interference and (2) this device must accept any interference that may be received, including interference that may cause undesired operation.

NOTE: Any unauthorized modification to this device could void the user's authority to operate the equipment.

NOTE: Included with your vehicle are 2 remote keyless entry transmitters plus removable mechanical key.

Keys which were not included with delivery must be activated at an authorized Sprinter Dealer before they can be used.

If a non-activated key is used, after the fourth attempt to start, the starting process will be blocked for 1 minute.

The multi-function display will alternately show **SLP-E** and **ERR-E**, refer to "Immobilizer".



Malfunctions could occur if the remote keyless entry transmitter is exposed to moisture. As a precaution, both remote keyless entry transmitters should always be carried.

The remote keyless entry transmitter transmits in all directions. It does not have to be pointed at the vehicle. Do not expose the remote keyless entry transmitter to high levels of electromagnetic radiation in order to avoid the risk of malfunctions.

The remote keyless entry transmitter has an average range of about 32 ft (about 10 m). Always verify the

THINGS TO KNOW BEFORE STARTING YOUR VEHICLE 17

correct operation of the remote keyless entry transmitter by listening for the locking noise and by checking that the white patch on the interior door handle is visible.

When pressing the  or  buttons, the indicator lamp illuminates. If the indicator lamp does not illuminate, the batteries must be replaced. For instructions on replacing the batteries in the remote keyless entry transmitter.

The remote keyless entry transmitter will not function when there is a vehicle key inserted in the ignition lock.

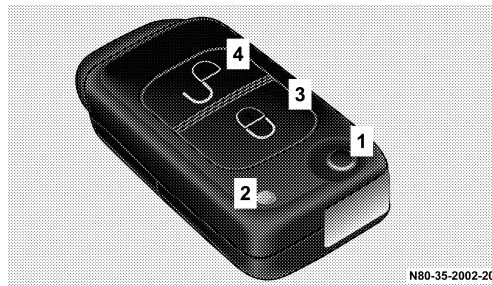

Release button for mechanical key (1)

Indicator lamp (2)

Lock button  (3)

Unlock button  (4)

Unlocking with Remote Keyless Entry

Press the  button once. The driver's door is unlocked and the hazard warning lamp, as well as the remote keyless entry transmitter indicator lamp, blink once.

2

18 THINGS TO KNOW BEFORE STARTING YOUR VEHICLE

Press the  button a second time. The passenger door and cargo doors are unlocked and the turn signal lamps, as well as the remote keyless entry transmitter indicator lamp, blink once again. The button must be pressed a second time within about 2.5 seconds, otherwise the second request to open can not be performed.

NOTE: The vehicle is automatically locked again, if within about 40 seconds of unlocking with the remote keyless entry transmitter, none of the doors are opened. The hazard warning lamp does not blink.

Locking with Remote Keyless Entry

Press the  button. The entire vehicle is locked and the hazard warning lamp blinks three times. The remote keyless entry transmitter indicator lamp blinks once.

If the hazard warning lamp does not blink, at least one door is improperly closed. Check to see if there is a door that is not properly closed or if there is a key in the ignition lock. Remove key from ignition lock and/or close doors properly and press the  button again.

REPLACING BATTERIES IN REMOTE KEYLESS ENTRY

Do not touch the battery contact surfaces (insert the batteries with a lint-free cloth).

WARNING!

Keep batteries away from children.

Consult a doctor immediately if a battery is swallowed.

Dispose of used batteries in an environmentally responsible manner.

Danger of explosion if the battery is not correctly replaced. Replacements should always be either of the same type or one which has been recommended by the manufacturer.

NOTE: Do not operate the remote control while the battery is being replaced.

Replacing Batteries

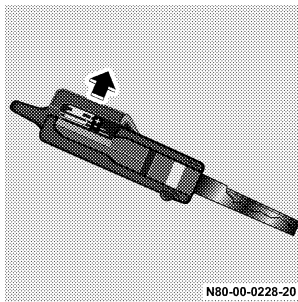

Rated voltage: 6 V
DC (2x 3V)

Rated current: 10 mA

1. Release the mechanical key by pressing the release button.
2. Remove the battery cover.

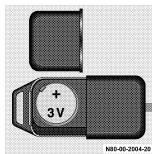

3. Remove the battery and install new one (note correct polarity; positive terminal up).
4. Press on the battery cover until it snaps into place.

SECURITY SYSTEM WITH TOWING AND PASSENGER COMPARTMENT PROTECTION (OPTIONAL)

2

The security system is ready for operation, if the vehicle is locked with the remote keyless entry transmitter.

If a door is open, the security system is not switched on during the locking process.

Security system activation is indicated by the turn signal lamps flashing three times in succession.

For a function check, when the security system is switched on, the indicator lamps in the towing protection/passenger compartment protection switch flash.

The security system will switch off if the vehicle is unlocked using the remote keyless entry transmitter. The turn signal lamps flash once.

20 THINGS TO KNOW BEFORE STARTING YOUR VEHICLE

The alarm is triggered if the security system has been activated and

- A door is opened,
- a door is unlocked from inside,
- the engine cover is opened,
- the key is used to unlock the vehicle at any door,
- the key is turned to position 2 in the ignition lock.

Audible Alarm

The horn sounds for about 25 seconds.

Visual Alarm

The turn signal lamps flash for about 4 minutes.

Switching off the Alarm

The alarm will switch off immediately if the vehicle is unlocked using the remote keyless entry transmitter.

NOTE: Do not manually unlock the doors as this will trigger the alarm.

TOWING PROTECTION AND PASSENGER COMPARTMENT PROTECTION SWITCH (OPTIONAL)

See Section 4, Understanding Your Instrument Panel, for switch locations.

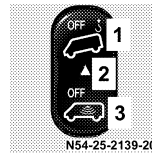

Switch off the towing protection

Indicator lamp

As a function check, (1) the indicator lamp (2) flashes when the security system is switched on.

Switch off the passenger compartment protection.

Towing Protection

The towing protection is ready for operation after 30 seconds as the security system has been activated. The alarm is triggered if the vehicle is lifted while the security system is activated.

Switching off the Towing Protection

If the vehicle is to be transported or loaded, the towing protection must be switched off in order to avoid a false alarm.

THINGS TO KNOW BEFORE STARTING YOUR VEHICLE 21

1. Place the key in position 0 or 1 in the ignition lock.
2. Press the switch up (1) to switch off the towing protection.
The indicator lamp (2) is briefly illuminated.

If passenger compartment protection will be switched off as well, wait until the indicator lamp (2) goes out, and

3. Press switch (3) downward.
The indicator lamp (2) flashes about 10 times.
To activate the setting (towing protection/passenger compartment protection switched off):
4. Keep the key in locking position in the driver's door lock for more than 2 seconds or
5. lock the vehicle using the remote keyless entry transmitter.

The towing protection will remain switched off until the vehicle is locked again with the remote keyless entry transmitter.

NOTE: The alarm will switch off immediately if the vehicle is centrally unlocked using the remote keyless entry transmitter.

Passenger Compartment Protection

The passenger compartment protection is ready for operation 30 seconds after the security system has been activated. The alarm is triggered if movement inside the vehicle is registered while the security system is activated.

NOTE: Close the side windows and the glass tilting roof.

Do not leave any objects (mascots, hangers) on the interior mirror or on the roof grab handles, as these could trigger a false alarm.

Switching off the Passenger Compartment Protection

If persons or animals remain in the locked vehicle, switch off the passenger compartment protection to prevent a false alarm.

1. Place the key in position 0 or 1 in the ignition lock.
2. Press the switch downward (3) to switch off the passenger compartment protection. The indicator lamp (2) flashes about 10 times.

If towing protection is to be switched off as well, wait until the indicator lamp (2) goes out, and

22 THINGS TO KNOW BEFORE STARTING YOUR VEHICLE

3. Press switch up (1).
The indicator lamp (2) is briefly illuminated.
To activate the setting (passenger compartment/
towing protection switched off):
4. Lock the vehicle using the remote keyless entry
transmitter.

The passenger compartment protection will remain
switched off until the vehicle is locked again with the
remote keyless entry transmitter.

NOTE: The alarm will switch off immediately if the
vehicle is centrally unlocked using the remote keyless
entry transmitter.

Alarm Pushbutton (Vehicles with Security Systems only)

See Section 4, Understanding Your Instrument Panel,
for switch locations.



Trigger the alarm manually/lock the
vehicle.

The audible and visual alarm can be
triggered manually by using the
alarm pushbutton.

Audible Alarm

The horn sounds until the alarm is switched off.

Visual Alarm

The turn signal lamps flash until the alarm is switched
off.

Trigger the alarm manually and lock the vehicle.

Press the alarm pushbutton upward once.
The indicator lamp flashes in the towing/passenger
compartment protection switch.

The vehicle will be centrally locked if all doors are closed.

Switching Off the Alarm and Unlocking the Vehicle

Press the alarm pushbutton up one more time.

The vehicle will be centrally unlocked if it was not centrally locked before the alarm was manually triggered.

OPENING/CLOSING DOORS

Front Doors

WARNING!

Do not leave children unsupervised in the vehicle, even if they are secured by a child restraint system. The children could

- injure themselves on parts of the vehicle
- release the child-proof locks by pressing the central locking button and could thereby open the doors and
- cause injury to others as a result
- get out of the vehicle and could either injure themselves when doing so or they could be injured by the traffic approaching from the rear
- suffer serious or fatal effects in the event of long periods of hot weather
- release the parking brake. The vehicle could then start moving of its own accord.

Unsupervised use of vehicle equipment may cause severe personal injuries, death and property damage.

24 THINGS TO KNOW BEFORE STARTING YOUR VEHICLE

WARNING!

Only drive with the doors properly closed. You could lose the load, for example, and endanger vehicle occupants or other road users if the doors are open.

Only open the doors when road and traffic conditions permit.

Do not leave children alone in the vehicle. They could open a locked door from the inside despite the road and traffic conditions, thereby endangering themselves and others.

To prevent severe personal injuries and death, always keep hands and fingers away from the door opening when closing a door. Be especially careful when small children are around.

From the Outside

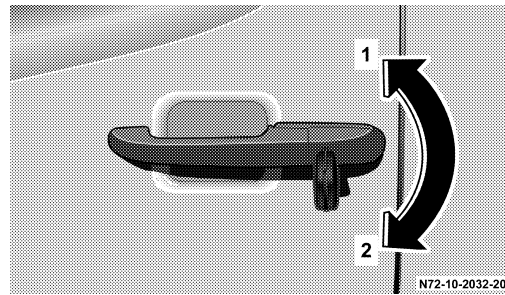

To unlock (1)

To lock (2)

To open the door:
Pull the handle to open the door.

From the Inside

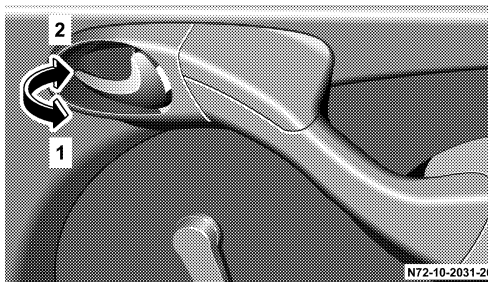

To unlock (1)

To lock (2)

To unlock and open

Pull handle.

To lock:

Press the handle in. All closed doors will be locked. The door is locked when the white patch in the handle can be seen. If an open door is detected, refer to "Central Locking".

CAUTION!

In case of an accident, rescue from the outside may be more difficult if the vehicle is locked.

To unlock the vehicle after the engine is started, refer to "Central Locking Switch".

2

NOTE: The driver's and passenger's doors cannot be locked when they are open (lockout protection).

In vehicles without central locking only the respective door will be locked or unlocked.

Please note anti-theft alarm system: The anti-theft alarm will be triggered when the doors are manually unlocked. Cancel alarm by pressing button . The anti-theft alarm system will not be activated when the doors are manually locked.

26 THINGS TO KNOW BEFORE STARTING YOUR VEHICLE

Sliding Door

WARNING!

Only drive with the doors properly closed. You could lose the load, for example, and endanger vehicle occupants or other road users if the doors are open.

To prevent possible personal injury, always keep hands and fingers away from the door opening when closing a door. Be especially careful when small children are around.

Only open the doors when road and traffic conditions permit.

Do not leave children alone in the vehicle. They could open a locked door from the inside despite the road and traffic conditions, thereby endangering themselves and others.

Do not leave doors open on uphill or downhill grades. Doors could be released from the door support and slam shut. If they are not closed properly, sliding doors can open on their own. This could result in severe injury. Be especially careful when small children are around.

From the Outside

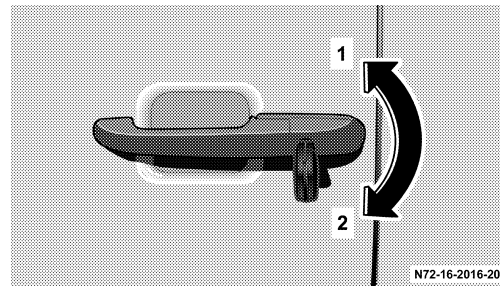

To unlock (1)

To lock (2)

To open the door:

Pull the handle and slide the door back to the stop.

To close the door:

Slide it forwards by the handle until it latches.

From the Inside without Lock Button

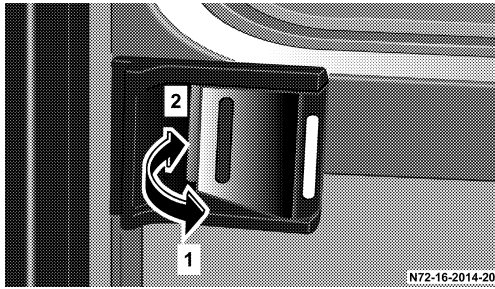

To unlock (1)
To lock (2)
To unlock and open:
Pull handle.
To lock:
Press the handle in.
The door is locked when the white patch in the handle can be seen. If an open door is detected, refer to "Central Locking".

From the Inside with Lock Button

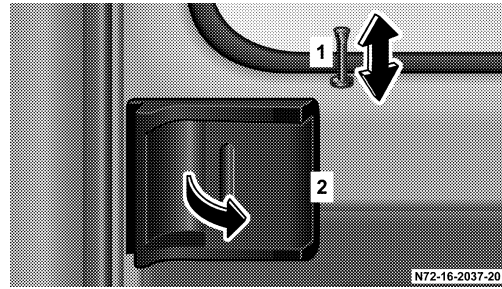

Lock button (1)
Handle (2)
To unlock and open:
Pull lock button (1)
(the door is unlocked, all other doors remain locked).
Pull handle (2).
To lock:

28 THINGS TO KNOW BEFORE STARTING YOUR VEHICLE

Press lock button (1)
(all doors are locked)

If the central locking automatically unlocks again after having been locked, at least one door is closed incorrectly.

If it then locks again within about 5 seconds, then all closed doors are locked.

The central locking displays vehicle locking with one or more open doors by means of a special function sequence (locking, unlocking, locking). Once closing has been completed, an open door will not automatically be locked.

CAUTION!

In case of an accident, rescue from the outside may be more difficult if the vehicle is locked.

To unlock the vehicle after the engine is started, refer to "Central Locking Switch".

NOTE: If an open sliding door is locked before being closed, then only the sliding door will be locked.

In vehicles without central locking only the respective door will be locked or unlocked.

Please note anti-theft alarm system: The anti-theft alarm will be triggered when the doors are manually unlocked. Cancel alarm by pressing button **5**. The anti-theft alarm system will not be activated when the doors are manually locked.

Rear Cargo Doors

WARNING!

Only drive with the doors properly closed. You could lose the load, for example, and endanger vehicle occupants or other road users if the doors are open.

To prevent possible personal injury, always keep hands and fingers away from the door opening when closing a door. Be especially careful when small children are around.

Only open the doors when road and traffic conditions permit.

Do not leave children alone in the vehicle. They could open a locked door from the inside despite the road and traffic conditions, thereby endangering themselves and others.

When the rear cargo doors are opened to an angle of 90° (catch position), more than 50% of the rear lamps are concealed. When the door is open in this manner, you should warn others in accordance with legal requirements.

From the Outside

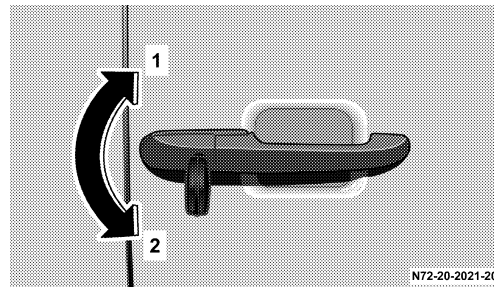

To unlock (1)

To lock (2)

To open the door:

Pull the handle to open the door.

30 THINGS TO KNOW BEFORE STARTING YOUR VEHICLE

From the Inside without Lock Button

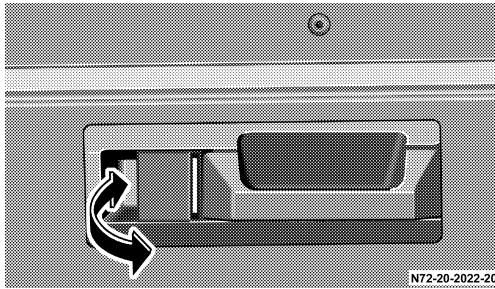

To unlock and open:

Pull handle.

To lock:

Press the handle in.

The door is locked when the white patch in the handle can be seen. If an open door is detected, refer to "Central Locking".

From the Inside with Lock Button

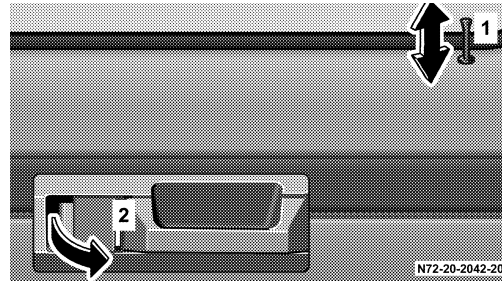

Lock button (1)

Handle (2)

To unlock and open:

Pull lock button (1)

(the door is unlocked, all other doors remain locked).

Pull handle (2).

To lock:

Press lock button (1)

(all doors are locked).

THINGS TO KNOW BEFORE STARTING YOUR VEHICLE 31

If the central locking automatically unlocks again after having been locked, at least one door is closed incorrectly.

If it then locks again within about 5 seconds, then all closed doors are locked.

The central locking displays vehicle locking with one or more open doors by means of a special function sequence (locking, unlocking, locking). Once closing has been completed, an open door will not automatically be locked.

NOTE: In vehicles without central locking only the respective door will be locked or unlocked.

Opening Left-Hand Door

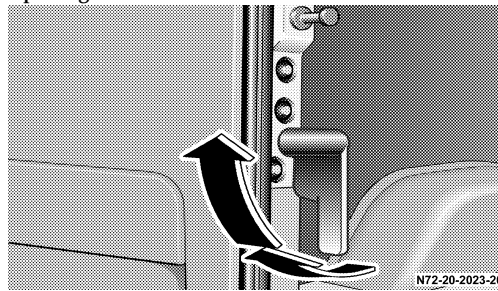

To open:

Move the handle up.

To close:

Close the door until it engages.

32 THINGS TO KNOW BEFORE STARTING YOUR VEHICLE

To lock manually:

Move the handle down until it is in the vertical position.

Automatic locking:

If the left-hand door is closed, it will be automatically locked as soon as the right-hand door has been closed.

NOTE: If an open tailgate is locked before being closed, then only the tailgate will be locked.

Please note anti-theft alarm system: The anti-theft alarm system will be triggered when the doors are manually unlocked. Cancel alarm by pressing button **[6]**. The anti-theft alarm system will not be activated when the doors are manually locked.

Opening Angle 270°

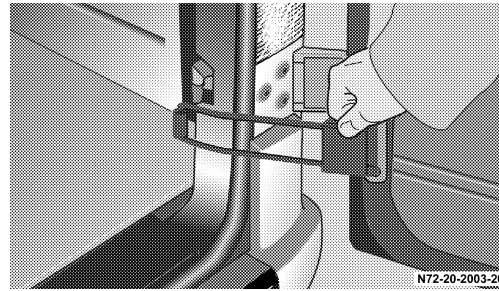

To open:

Unhinge the door check strap.

Open the door 270° and press the door stay against the outer sidewalls. The doors will be kept in this position by retaining plates.

THINGS TO KNOW BEFORE STARTING YOUR VEHICLE 33

To close:

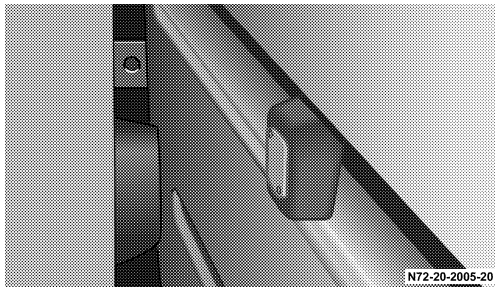

Pull the doors away from the retaining plates on the outer sidewalls.

Passenger/Cargo Area Door

WARNING!

Always drive with the doors properly closed, because if the vehicle is operated with the doors open, serious personal injury may result.

To prevent possible personal injury, always keep hands and fingers away from the door opening when closing a door. Be especially careful when small children are around.

NOTE: The maximum cargo area door height is 5 feet 7 inches (176 cm).

2

34 THINGS TO KNOW BEFORE STARTING YOUR VEHICLE

To Unlock the Door from the Passenger Area

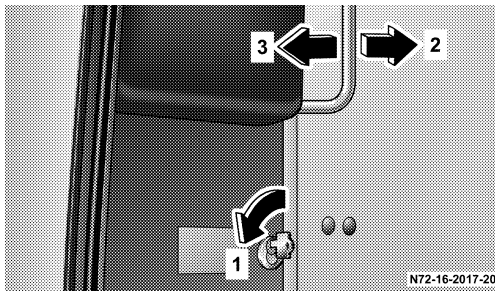

- To unlock, turn key to left (1)
- To open door (2)
- To close door and lock (3)

To Unlock the Door from the Cargo Area (Optional)

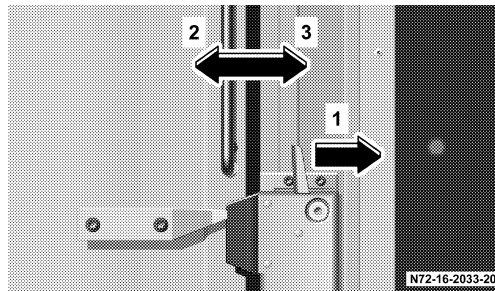

- To unlock, press latch in direction (1)
- To open door (2)
- To close door and lock (3)

OCCUPANT RESTRAINTS

Seat belts, belt tensioners, airbag and child restraint systems are independent restraint systems whose functions complement each other.

All states and provinces require use of child restraints that comply with U.S. Federal Motor Vehicle Safety Standard 213 and Canadian Motor Vehicle Safety Standard 213.

All child restraint systems are designed to be secured in vehicle seats by lap belts or the lap belt portion of a lap-shoulder belt.

For your safety and that of your passengers, you must use the seat belts and child restraint systems and use them properly. We strongly recommend their use.

WARNING!

In a collision, you and your passengers can suffer injuries, including fatalities, if you are not properly buckled up. You can strike the interior of your vehicle or other passengers, or you can be thrown out of the vehicle. Always be sure you and others in your vehicle are buckled up properly.

WARNING!

An airbag system component integrated in the steering wheel gets hot after the airbag has inflated. Do not touch.

No modifications of any kind may be made to any components or wiring of the restraint system.

Keep area between airbag and occupants free of objects (e.g. packages, purses, umbrellas, etc.).

In addition, through improper work there is the risk of rendering the restraint system inoperative. Work on the restraint system must therefore only be performed by an authorized Sprinter Dealer.

When discarding of the airbag unit or emergency tensioning retractor, you must follow our safety instructions. These instructions are available at your Sprinter Dealer.

Given the considerable deployment speed and the textile structure of the airbag, there is the possibility of injuries and even death resulting from being positioned too close to the airbag when it deploys.

2

36 THINGS TO KNOW BEFORE STARTING YOUR VEHICLE

Do not seat children less than 5 feet tall or 12 years and under in the front. The back seat is the safest place for children. If the vehicle is not equipped with a back seat, children less than 5 feet tall or 12 years and under must never ride in this vehicle.

Children less than 5 feet tall or 12 years and under require a special restraint system for protection in the event of an accident as they may be too small to wear seat belts properly.

Never place an infant seat on the front passenger seat.

Children should never ride sitting on the lap of another occupant. In an accident they will be completely without protection and could even be injured by the person they are sitting on. For the safety of all occupants read the child restraint system manufacturer's instructions carefully when fitting any child restraint system.

When the child restraint is not in use, remove it from the vehicle or secure it with the seat belt to prevent the child restraint from becoming a projectile in the event of an accident.

Do not leave children unsupervised in the vehicle, even if they are secured by a child restraint system.

SEAT BELTS

WARNING!

- Wearing a seat belt incorrectly is dangerous. Seat belts are designed to go around the large bones of your body. These are the strongest parts of your body and can take the forces of a collision the best. Wearing your belt in the wrong place could make your injuries in a collision much worse. You might suffer internal injuries, or you could even slide out of part of the belt. Follow these instructions to wear your seat belt safely and to keep your passengers safe, too.
- Two people should never be belted into a single seat belt. People belted together can crash into one another in an accident, hurting one another badly. Never use a lap/shoulder belt or a lap belt for more than one person, no matter what their size.

WARNING!

A belt that is buckled into the wrong buckle will not protect you properly. The lap portion could ride too high on your body, possibly causing injuries. Always buckle your belt into the buckle nearest you.

A belt that is too loose will not protect you as well. In a sudden stop you could move too far forward, increasing the possibility of injury. Wear your seat belt snugly.

A belt that is worn under your arm is very dangerous. Your body could strike the inside surfaces of the vehicle in a collision, increasing head and neck injury. A belt worn under the arm can cause internal injuries. Ribs aren't as strong as shoulder bones. Wear the belt over your shoulder so that your strongest bones will take the force in a collision.

A shoulder belt placed behind you will not protect you from injury during a collision. You are more likely to hit your head in a collision if you do not wear your shoulder belt. The lap and shoulder belt are meant to be used together.



2

38 THINGS TO KNOW BEFORE STARTING YOUR VEHICLE

Seat Belt Warning Lamp and Airbag Malfunction

When the key is in position 2 in the ignition lock, the warning lamp  lights up for about 6 seconds; this takes place whether or not the driver's seat belt is fastened.

The warning lamp  must go out after about 6 seconds.

If the warning lamp  flashes after about 6 seconds, the malfunction indicator lamp  is defective.

The fault should be repaired as soon as possible by an authorized Sprinter Dealer.

NOTE: When the key is turned to position 2 in the ignition lock, a warning buzzer sounds for about 6 seconds if the driver's safety belt is not pressed into the belt buckle. The buzzer stops as soon as the safety belt is fastened. Press the safety belt into the belt buckle.

Fastening and Removing

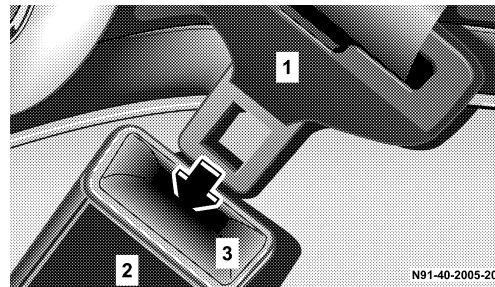

Belt tongue (1)

Belt buckle (2)

Release button (3)

Fastening Seat Belts

1. Pull the seat belt over the body. The seat belt must not be twisted or you could be injured.
2. Press the tongue into the buckle and make sure that it is heard to engage.
3. The seat belt must be tight across the body. Check this immediately after fastening the seat belt, and at regular intervals during the trip. If necessary, tension the lap belt by pulling the shoulder strap up in front of the body.

WARNING!

A lap belt worn too high can increase the risk of internal injury in a collision. The belt forces won't be at the strong hip and pelvic bones, but across your abdomen. Always wear the lap part as low as possible and keep it snug.

A twisted belt cannot do its job as well. In a collision it could even cut into you. Be sure the belt is straight. If you cannot straighten a belt in your vehicle, take it to your dealer and have it fixed.

Removing Seat Belts

1. Press the release button in the belt buckle.
2. Guide the seat belt back to its rest position.

2

WARNING!

A frayed or torn belt could rip apart in a collision and leave you with no protection. Inspect the belt system periodically, checking for cuts, frays, or loose parts. Damaged parts must be replaced immediately. Do not disassemble or modify the system. Seat belt assemblies must be replaced after a collision if they have been damaged (bent retractor, torn webbing, etc.).

Seat Belt Warning System

When the key is turned to position 2 in the ignition lock, a warning buzzer sounds for about 6 seconds if the driver's safety belt is not pressed into the belt buckle. The buzzer stops as soon as the safety belt is fastened. Press the safety belt into the belt buckle.

40 THINGS TO KNOW BEFORE STARTING YOUR VEHICLE

Belt Height Adjustment

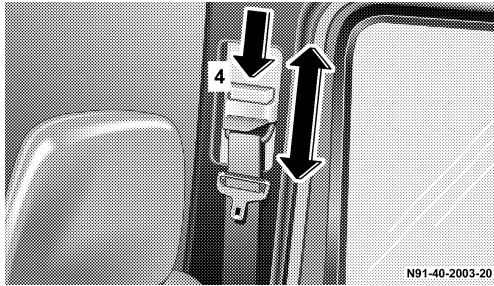

Belt height adjustment button 4

Do not adjust the belt height while the vehicle is moving.

To lower:

Press the button and move the belt sash guide down.

To raise:

Move the belt sash guide up.

The shoulder strap must pass between the neck and the shoulder.

AIRBAG AND BELT TENSIONERS

The vehicle is equipped with an airbag for the driver and the front seat passenger as well as belt tensioners for the driver and the front passenger. The system is known as a Supplemental Restraint System (SRS). It has been designed to work together with the seat belt and to supplement.

WARNING!

Do not put anything on or around the front airbag covers or attempt to manually open them. You may damage the airbags and you could be injured because the airbags are not there to protect you. These protective covers for the airbag cushions are designed to open only when the airbags are inflating.

SRS Malfunction Indicator Lamp

When the key is in position 2 in the ignition lock, the malfunction indicator lamp **SRS** will light up in the instrument cluster for about 4 seconds as a function check.

WARNING!

If the malfunction indicator lamp **SRS** does not light up when the key is in position 2 in the ignition lock, if it flickers or lights up while the vehicle is moving, there might be a problem in the airbag system. There is then a danger that the airbag will not deploy in the event of an accident or will deploy when it should not do so. Have the vehicle inspected and repaired by an authorized Sprinter Dealer without delay.

Driver's Airbag

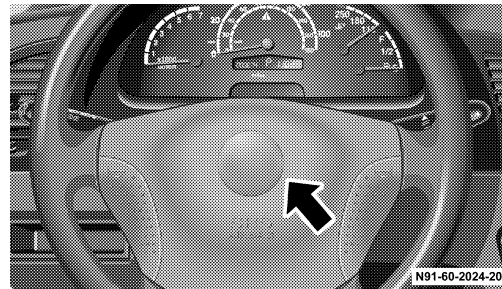

The driver's airbag is located within the padded center of the steering wheel.

42 THINGS TO KNOW BEFORE STARTING YOUR VEHICLE

WARNING!

To reduce the risk of injury when the front airbag inflates, it is very important for the driver to always be in a properly seated position and to wear the seat belt. Since the airbag inflates with considerable speed and force, a proper seating position with hands on the steering wheel will help to keep you in a safe distance from the airbag. Keep hands on the outside of the steering wheel rim. Placing hands and arms inside the rim can increase the risk and the potential severity of hand/arm injury when the driver front airbag inflates.

Front Seat Passenger Airbag (not in conjunction with folding seat in partition wall)

The airbag is located behind the lining section of the dashboard.



WARNING!

To reduce the risk of injury when the front airbag inflates, it is very important for the passenger to always be in a properly seated position and to wear the seat belt. Since the airbag inflates with considerable speed and force, a proper seating position will help to keep you in a safe distance from the airbag.

Do not place any pieces on the top of the mounting lid above the airbag. If the airbag is activated the pieces could be thrown into the passenger compartment. This could result in severe personal injuries and death.

Belt Tensioners

The belt tensioners are located on the three-point seat belts of the driver's and front passenger seats.

The belt tensioners will not operate unless the key has been turned to position 1 or 2 in the ignition lock.

The airbag and / or belt tensioners are designed to only trigger in certain frontal impacts as not all accidents call for airbag and / or belt tensioner deployment.

2

44 THINGS TO KNOW BEFORE STARTING YOUR VEHICLE

Safety Precautions for the Airbag

WARNING!

Airbags can seriously injure or kill you, especially if you are close to the airbag when it deploys.

Always wear your seat belt. Airbags do not replace seat belts but instead supplement the protection offered by seat belts. Wearing a seat belt also makes it less likely that you will be out of position and will not be injured or killed as the airbag deploys.

Never place an infant seat which faces to the rear on the front passenger seat. Children 12 years old and under, and any child who cannot wear a seat belt properly, must never ride in the front of this vehicle.

The airbag does offer an additional degree of protection, especially to belted occupants, but the following precautions should still be taken to prevent injuries when the airbag is inflating.

Do not position the seat closer than necessary to the airbag inflation point.

Do not lean forward when the vehicle is in motion.

Only hold the steering wheel by the outer rim so that the airbag can inflate unhindered.

No objects should be positioned on the airbag or between the airbag and the vehicle's occupants.

If children are traveling, they should always use an appropriate child restraint system.

Do not touch any hot parts after the airbag has inflated. Airbags which have triggered in an accident must be replaced.

The center of the padded steering wheel must not be covered by any materials or have any labels or stickers attached to it, or else the airbag may not function reliably.

Do not modify any components of the restraint systems or their wiring.

Observe relevant safety precautions when discarding off airbag units. Any authorized Sprinter Dealer can provide information and assistance.

THINGS TO KNOW BEFORE STARTING YOUR VEHICLE 45

Make sure to give any new owner of your vehicle this Owner's Manual so that the new owner will be aware of all safety warnings.

If the instrument cluster indicates a malfunction of the "SRS", as explained above, we strongly recommend that you visit an authorized Sprinter Dealer immediately to have the system checked; otherwise the "SRS" may not be activated when needed in an accident, which could result in serious or fatal injury, or it might deploy unexpectedly and unnecessarily, which could also result in injury or death.

The activation of the "SRS" temporarily releases a small amount of dust from the airbag. This dust, however, is neither injurious to your health, nor does it indicate a fire in the vehicle. The dust might cause some temporary breathing difficulty for people with asthma or other breathing trouble. To avoid this, you may wish to get out of the vehicle as soon as it is safe to do so. If you have any breathing difficulty but cannot get out of the vehicle after the airbag inflates, then get fresh air by opening a window or door.

Given the considerable deployment speed and the textile structure of the airbag, there is a risk of abrasions and injuries due to airbag deployment.

2

46 THINGS TO KNOW BEFORE STARTING YOUR VEHICLE

PEDALS

The freedom of movement of the pedals must not be impaired in any way, such as by floor mats.

WARNING!

Do not lay any objects in the driver's footwell. Be careful that floor mats or carpets in the driver's footwell have sufficient clearance for the pedals.

During sudden driving or braking maneuvers the objects could get caught between the pedals. You could then no longer brake or accelerate. This could cause an accident which could in turn lead to injuries.

ENGINE BREAK-IN SPECIFICATIONS

The first 1,000 miles (about 1,500 km)

The more cautiously you treat your vehicle during the break-in period, the more satisfied you will be with its performance later on. Therefore, drive your vehicle during the first 1,000 miles (1,500 km) at moderate vehicle and engine speed.

Avoid depressing the accelerator pedal beyond the pressure point (kickdown). Do not manually shift down.

Avoid accelerating by kickdown. It is not recommended to brake the vehicle by manually shifting to a lower gear. We recommend that you select positions "3", "2" or "1" only at moderate speeds (for hill driving).

After 1,000 miles (about 1,500 km) you can gradually increase road and engine speeds to normal driving and requirements.

THINGS TO KNOW BEFORE STARTING YOUR VEHICLE 47

Engine Oil Consumption

When the engine has passed the break-in period, oil consumption may reach 0.5 % of the fuel consumption recorded in actual operating circumstances. In isolated cases and in arduous operating conditions, oil consumption may increase to 1 % of the fuel consumption recorded in actual operating circumstances.

Engine oil consumption depends on the driving style adopted and the operating conditions. It can only be judged after the engine has passed the break-in period.

For engine oil level.

SAFETY TIPS

- Check the vehicle's lights and the general condition of the vehicle before each trip.
- Keep tires at the recommended inflation pressure.
- All occupants should fasten their seat belts before each trip.
- Driving in an environmentally responsible manner will reduce noise, fuel consumption and exhaust emissions.

- Allow the engine to warm up under low load use.
- Avoid unnecessarily hard acceleration, driving with the throttle fully open, and carrying loads not specifically needed on the journey.
- Stop the engine during lengthy waiting periods, for example at traffic lights.
- Remove ancillary parts, such as wind deflectors and roof racks, as soon as they are no longer needed.

48 THINGS TO KNOW BEFORE STARTING YOUR VEHICLE

INHALATION OF EXHAUST GAS

WARNING!

Inhalation of exhaust gas is hazardous to your health. All exhaust gas contains carbon monoxide and inhaling it can cause unconsciousness and lead to death.

Do not run the engine in confined areas (such as a garage) which are not properly ventilated. If you think that exhaust gas fumes are entering the vehicle while driving, have the cause determined and corrected immediately. If you must drive under these conditions, drive only with at least one window fully open.

TIE DOWN RINGS (OPTIONAL)

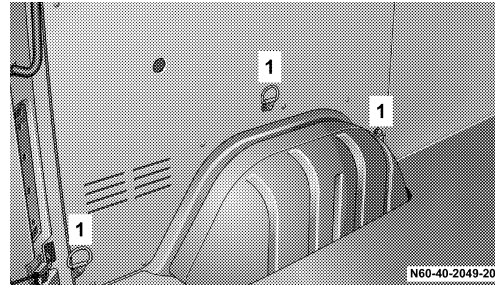

1. Tie Down Rings

The rings (1) are used to attach the load with the help of tension belts. Place the tension belt around the load, secure it on the rings (1) and tie it down.

THINGS TO KNOW BEFORE STARTING YOUR VEHICLE 49

WARNING!

If you tension the tensioning belts between the sidewalls, the maximum permissible load for the lashing rings could be exceeded if the brakes are applied suddenly or in the event of an accident. The load would no longer be secured, which could result in serious injuries caused by the load slipping.

For this reason, do not tension a tensioning belt between the side walls.

Observe the loading guidelines.

NOTE: Use neither elastic fastening straps nor nets when lashing down the load. These are only intended as anti-slip protection for lighter loads.

The means used to tie down the load must not be run over sharp edges or corners. Sharp edges or corners should be given protective padding. Observe the operating instructions for the material used to tie down the material. Spread the load evenly between the anchorages. If using a tensioning device, do not overstress the lashing rings.

2

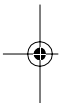

UNDERSTANDING THE FEATURES OF YOUR VEHICLE

CONTENTS

3

■ Mirror Adjustment	53	■ Fog Lamp Switch (Optional)	62
□ Interior Mirror (Optional)	53	■ Interior Lighting	63
□ Electrically Adjustable Exterior Mirror (Optional)	53	□ Interior Lamps in the Driver and Rear-Seat Passenger Area/Cargo Area	63
■ Seat Adjustment	54	□ Interior Lamps with Interior Sensor Protection (Optional)	63
□ Driver's and Front Passenger's Seat	54	□ Interior Lighting with Reading Lamp, Front Passenger Space Only	64
□ Lumbar Support	55	□ Interior Cargo Area Lighting (Optional)	65
□ Armrest (Optional)	56	■ Multifunction Switch	66
□ Head Restraint	56	■ Window Operation	68
□ Folding Seat at Partition (Optional)	57	□ Mechanical Window Operation	68
■ Seat Heater (Optional)	57	□ Electric Window Operation (Optional)	68
■ Rear Seat Bench Removal and Installation	58	■ Windshield Wiper Switch	69
□ Retrofitting Seat Mounting Cups	59	□ Windshield wipers with rain sensor (Optional)	70
■ Hood	60		
■ Headlamp Range Control	62		



52 UNDERSTANDING THE FEATURES OF YOUR VEHICLE

■ Speed Control (Optional)	71	■ Electrical Outlet	77
■ Sunroof	73	■ Cup Holder	78
□ Manual Sun Roof (Optional)	74	■ Glove Compartment	79
□ Electric Sun Roof (Optional)	74	□ Glove Compartment Lockable (Optional)	79
□ Mechanical Sun Roof Operation	75	■ Compartments in Front Doors	79
■ Ashtray/Cigar Lighter	76		



MIRROR ADJUSTMENT Interior Mirror (Optional)

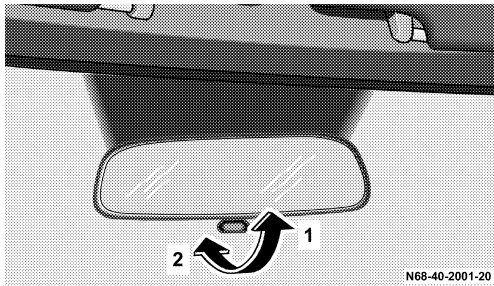

1. Normal position (DAY)
2. Anti-glare position (NIGHT)

Electrically Adjustable Exterior Mirror (Optional)

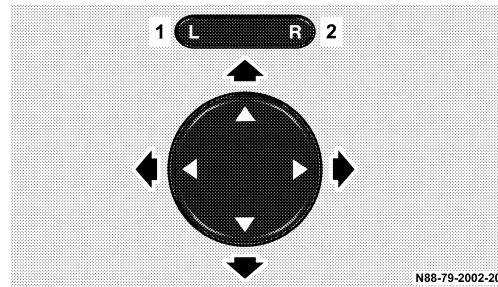

The switch is located in the door lining next to the door handle.

Mirror adjustment, left (1)

Mirror adjustment, right (2)

When the key is in position 2 in the ignition lock, each mirror may be adjusted by pressing the adjustment button.

NOTE: The exterior mirror is heated automatically (optional equipment) when outdoor temperatures are low.

54 UNDERSTANDING THE FEATURES OF YOUR VEHICLE

SEAT ADJUSTMENT

Driver's and Front Passenger's Seat

WARNING!

Adjusting a seat while the vehicle is moving is dangerous. The sudden movement of the seat could cause you to lose control. The seat belt might not be properly adjusted and you could be injured. Adjust the seat only while the vehicle is parked.

WARNING!

Do not ride with the seat back reclined so that the shoulder belt is no longer resting against your chest. In a collision, you could slide under the seat belt and be seriously or even fatally injured. Use the recliner only when the vehicle is parked.

WARNING!

The rear area of the vehicle should not be used as a play area by children when the vehicle is in motion. They could be seriously injured in an accident. Children should be seated and using the proper restraint system.

WARNING!

It is extremely dangerous to ride in a cargo area, inside or outside of a vehicle. In a collision, people riding in these area are more likely to be seriously injured or killed.

Do not allow people to ride in any area of your vehicle that is not equipped with seats and seat belts.

Be sure everyone in your vehicle is in a seat and using a seat belt properly.

Comfortseat (Optional)

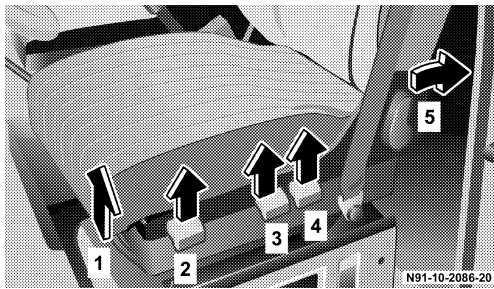

- Seat adjustment, fore/aft (1)
- Seat cushion depth (Optional) (2)
- Seat height adjustment, front (3)
- Seat height adjustment, rear (4)
- Backrest tilt (5)

Lumbar Support

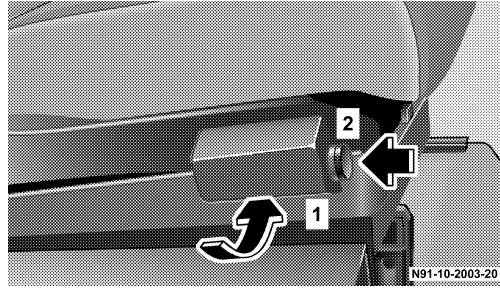

- Hand pump (1)
- Bleeder valve (2)
- Reinforce support:
Use hand pump (1).
- Relieve support:
Press bleeder valve (2).

56 UNDERSTANDING THE FEATURES OF YOUR VEHICLE

Armrest (Optional)

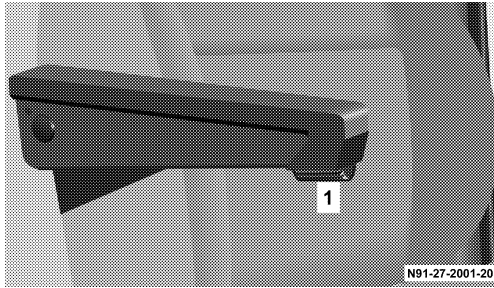

Tilt adjustment (1)

By adjusting the tilt adjustment (thumbwheel) (1) the tilt of the armrest can be changed.

Head Restraint

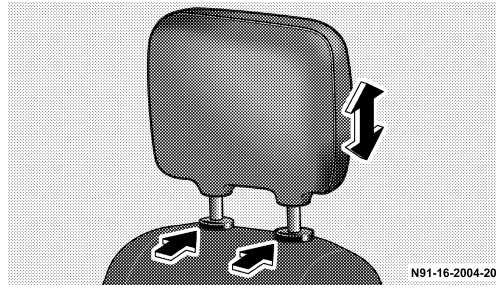

If you need to remove the head restraint, press the catch at the head restraint socket and pull the head restraint up and out.

WARNING!

You should never drive the vehicle if the head restraint has been removed for an occupied seat. This could result in severe personal injuries and death in case of an accident. Adjust the head restraint so that it touches the back of the head at about ear level.

Folding Seat at Partition (Optional)

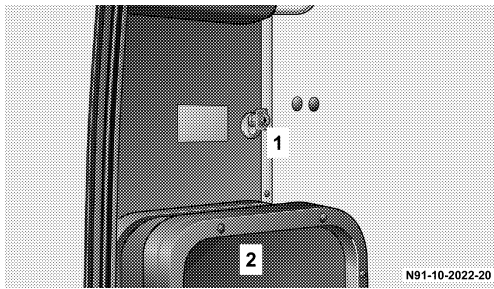

Key (1)

Seat cushion (2)

Fold down the seat cushion of the folding seat.

WARNING!

When folding down the seat cushion, make sure that nobody can become trapped.

The risk of injury to the front-passenger is increased in the event of sharp steering movements or an accident if a key is inserted in the passenger/cargo area sliding door lock. Remove the key from the load compartment sliding door before using the folding seat.

3



SEAT HEATER (OPTIONAL)

The seat heater switch is located on the center section of the dashboard.

The seat heater only works when the key is in position 2 in the ignition lock .

Low heating output, press top of the seat heater switch. The left indicator lamp in the switch illuminates.

High heating output, press bottom of seat heater switch. The right indicator lamp in the switch illuminates.

58 UNDERSTANDING THE FEATURES OF YOUR VEHICLE

REAR SEAT BENCH REMOVAL AND INSTALLATION

WARNING!

The integrated seat belt can only offer the degree of protection for which it is designed if you install the specified rear bench seats correctly. Never operate vehicle unless all rear bench seats are properly installed and all release levers are locked.

When retrofitting seat benches, make sure that the exterior seat shells have four cross-ribs.

Keep the seat bench mounting cups in the vehicle floor free from dirt and foreign objects. This is the only way to guarantee that the locking mechanisms will engage securely.

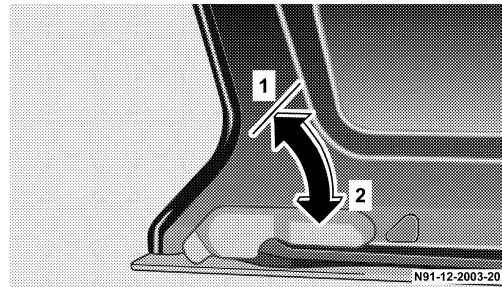

Unlocked (1)

Locked (2)

To remove:

1. Turn all release levers on the legs of the appropriate rear bench seat up. The rear bench seat can then move in the seat mounting cups.
2. Lift the rear bench seat up and out of the seat mounting cups.

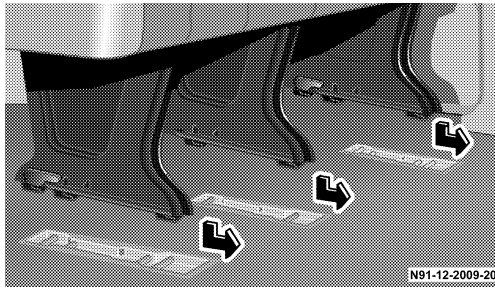

To install:

1. With the rear bench seat facing in the direction of travel, insert the legs of the rear bench seat in the respective seat mounting cups on the floor.
2. Slide the rear bench seat forwards with some force as far as it will go, until the release levers are heard to engage and all release levers are parallel to the vehicle floor.

Retrofitting Seat Mounting Cups

WARNING!

Additional rear bench seats can be added if seat mounting cups are properly installed.

Seat mounting cups may only be installed by an authorized Sprinter Dealer.

Never exceed the maximum permissible number of rear bench seats for the specific vehicle.

For more information contact your authorized Sprinter Dealer.

3

60 UNDERSTANDING THE FEATURES OF YOUR VEHICLE

HOOD

WARNING!

When the hood is open, there is a risk of injury due to very hot engine components.

When the engine is running or the key is in position 2 in the ignition lock, there is a risk of injury due to moving engine components and the electrical system.

The engine is equipped with a transistorized ignition system. Because of the high voltage it is dangerous to touch any components (ignition coils, spark plug sockets, diagnostic socket) of the ignition system with the engine running, while starting or if the ignition is on and the engine is turned manually.

To help prevent severe personal injuries and death, stay clear of moving parts when the hood is open and the engine is running.

If you see flames or smoke coming from the engine compartment, or if the coolant\temperature gauge indicates that the engine is overheated, do not open the hood. Move away from vehicle and do not open the hood until the engine has cooled. If necessary, call the fire department.

To open:

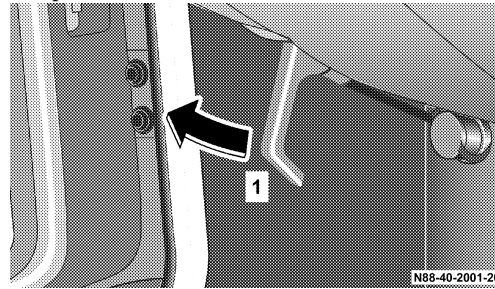

1. Pull the release lever (1).
The hood then opens slightly and is restrained by the safety catch.

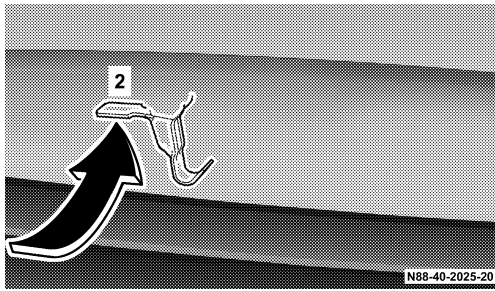

2. Open the safety catch (2).
3. Swing the hood up until the support strut (3) engages.

To close:

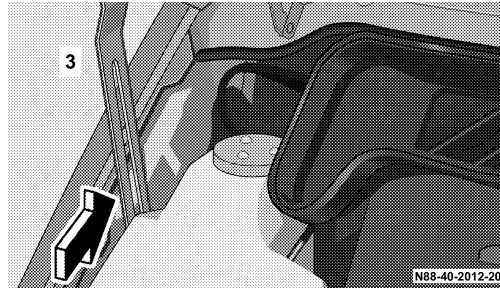

1. Lift the hood up slightly.
2. Press the support strut (3) down.
3. Swing the hood down and make sure that it engages in its retaining catch.
4. Check that the hood is engaged properly by pulling on the front edge.

62 UNDERSTANDING THE FEATURES OF YOUR VEHICLE

WARNING!

Be sure the hood is properly closed before driving. If the hood is not fully latched, it could fly up when the vehicle is moving and block your forward vision. Be sure all hood latches are latched fully before driving.

When closing the hood, use extreme caution not to catch hands or fingers.

HEADLAMP RANGE CONTROL

See Section 4, Understanding Your Instrument Panel, for switch locations.



The range of the headlamps can be adjusted to the load in the vehicle.

Turn the thumbwheel down to headlamp beam down.

Turn the thumbwheel up to headlamp beam up.

When the vehicle is not loaded (driver only), the thumbwheel must be in position 0.

Where necessary, adjust the headlamp range with the thumbwheel to 82 yards (75 m).

Always keep the headlamp range less than 110 yards (100 m), so that oncoming traffic is not blinded.

FOG LAMP SWITCH (OPTIONAL)

See Section 4, Understanding Your Instrument Panel, for switch locations.



Lamp switch position 

To switch on:

Press the upper section of the switch.

To switch off:

Press the lower section.

INTERIOR LIGHTING

Interior Lamps in the Driver and Rear-Seat Passenger Area/Cargo Area

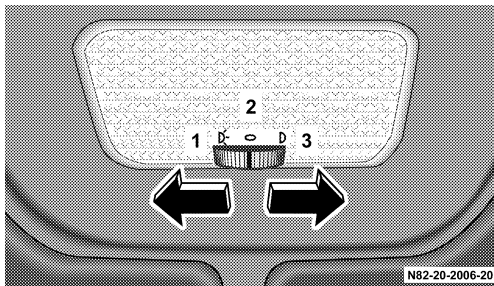

1. Permanently on
2. Off
3. Interior lamps are switched on/off by the door contact switches

Interior Lamps with Interior Sensor Protection (Optional)

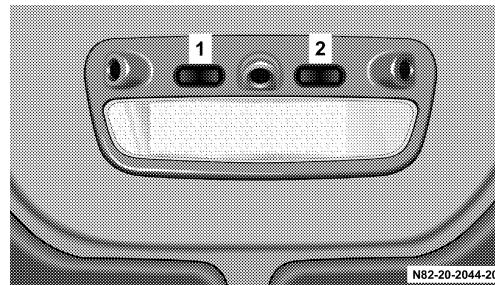

- Interior lamp switch (1)
Reading lamp switch (2)

3

64 UNDERSTANDING THE FEATURES OF YOUR VEHICLE

Operation of Interior Lamps

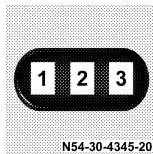

Position 1: Continuous operation

Position 2: The door contact switches are used to switch the interior lamps on and off

Position 3: Switched off

Operation of Reading Lamps

Position 1: Left-hand reading lamp switched on

Position 2: Switched off

Position 3: Right-hand reading lamp switched on

Interior Lighting with Reading Lamp, Front Passenger Space Only

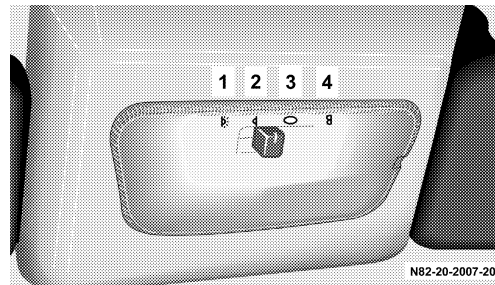

Continuous operation (1)

The door contact switches are used to switch the interior lamps on and off (2)

Switched off (3)

Reading lamp (4)

Interior Cargo Area Lighting (Optional)



The switch is located on the center section of the dashboard.

To switch on:

Press top of switch:

The indicator lamp in the switch will illuminate.

To switch off:

Press bottom of switch.

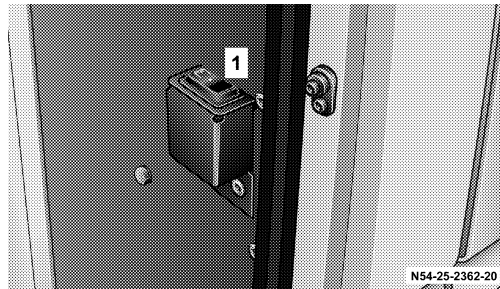

The switch (1) is located on the right side of the cargo area at the entrance for the sliding door.

To switch on:

Press top of switch – the indicator lamp in the switch will illuminate.

To switch off:

Press bottom of switch.

66 UNDERSTANDING THE FEATURES OF YOUR VEHICLE

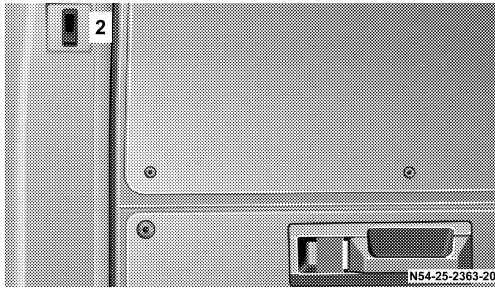

The switch (2) is located in the right rear of the cargo area.

To switch on:

Press top of switch, the indicator lamp in the switch will illuminate.

To switch off:

Press bottom of switch.

NOTE: The interior cargo area lighting will shut off automatically after 15 min.

MULTIFUNCTION SWITCH

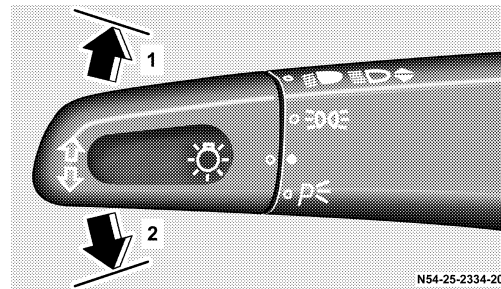

Turn signal indicator lamp, right (1)

Turn signal indicator lamp, left (2)

Short turn signal, press combination switch to pressure point.



Continuous turn signal, engage combination switch.

If a turn signal on the vehicle fails, the indicator lamp in the instrument cluster flashes at twice the normal rate.

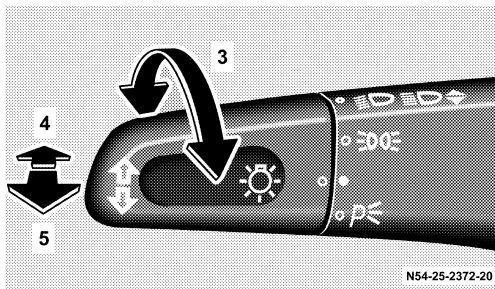
UNDERSTANDING THE FEATURES OF YOUR VEHICLE 67



Lamp switch (3)

-  Side lamps, license plate and instrument lighting
-  Low beam headlamps, high beam headlamps
-  Marker lamps, right, combination switch up (1)
Marker lamps, left, combination switch down (2)

High beam headlamps (lamp switch position  (4)

Headlamp flasher (also when turn signals are on) (5)

NOTE: When the key is in the ignition lock in the 0 position and the driver's or passenger's door is open, a warning buzzer sounds, if the vehicle exterior lighting (except for the marker lamps) has been switched on.

3

On vehicles with automatic switching-off of high beam, with the key in 0 position and the lamp switch position  on low and high beam, parking lamps are automatically switched on. When the driver's or passenger's door is opened, a warning buzzer also sounds.

For high beam (4) and headlamp flasher (5), the indicator lamp  in the combination instrument lights up.

68 UNDERSTANDING THE FEATURES OF YOUR VEHICLE

WINDOW OPERATION
Mechanical Window Operation

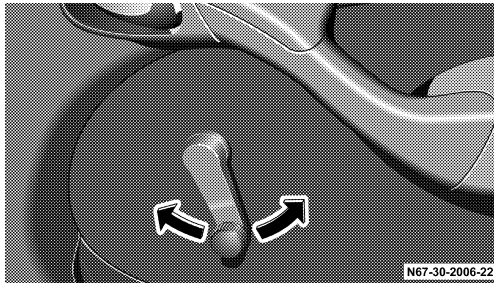

To open the window:

Turn the manual window control in a counterclockwise direction.

To close the window:

Turn the manual window control in a clockwise direction.

Electric Window Operation (Optional)



The window operation switches are located on the driver's and front-passenger doors.

WARNING!

Make certain that no one gets caught when the side windows are closed.

The key should be removed from the ignition lock even if the vehicle will only be left for a short time to prevent situations such as children or unauthorized persons opening and closing the windows and becoming caught.

Place the key in position 2 in the ignition lock.

To open the window:

Keep switch pressed downward until the window has reached the desired position.

To close the window:

Keep switch pressed upward until the window has reached the desired position.

WINDSHIELD WIPER SWITCH

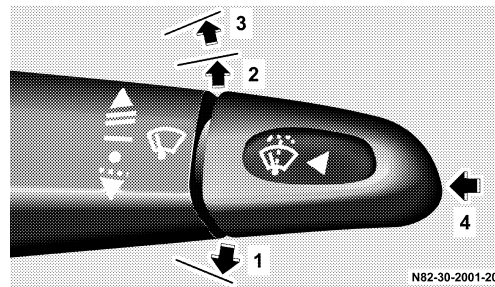

3

Intermittent wipe and rain sensor (optional) (1)

Normal wipe (2)

Rapid wipe (3)

Windshield washer system (4)

70 UNDERSTANDING THE FEATURES OF YOUR VEHICLE

WARNING!

Sudden loss of visibility through the windshield caused by e. g. ice, steam, fog or water could lead to an accident. You might not see other vehicles or other obstacles. To avoid sudden icing of the windshield during freezing weather, warm the windshield with the defroster or with the windshield heater (optional) before and during windshield washer use.

Follow the recommended settings for de-fogging and de-icing the front windows given in Section 4.

Touch-wipe:

Press the windshield wiper switch up to the pressure point.

NOTE: Smears may form on the glass when the windshield wipers are in use. In this case, operate the windshield washer, even in rainy weather.

Check wiper blades regularly for damage and contamination.

Windshield wipers with rain sensor (Optional)

To switch on:

Turn the windshield wiper switch to Intermittent wipe.

When switched on, the windshield wipers wipe one time. After that the wiping interval and wiping speed (normal and rapid), depend on wetness of the windshield and are controlled automatically.

CAUTION!

Do not leave windshield wipers in intermittent setting when vehicle is taken to an automatic car wash or during windshield cleaning and/or de-icing. Wipers will operate if the windshield gets wet, and wipers may be damaged as a result.

SPEED CONTROL (OPTIONAL)

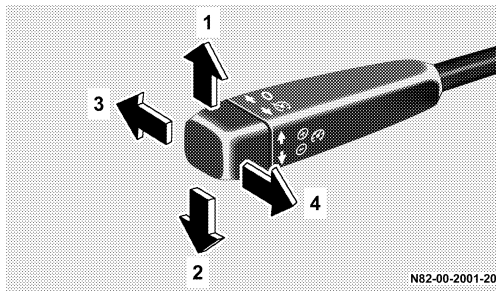

- Set / accelerate speed (1)
- Set / decelerate speed (2)
- Off (3)
- Resume set speed (4)

The speed control allows you to drive in a more relaxed manner, for example over long distances, as it automatically maintains the set speed by actively regulating the throttle setting.

The speed control lever on the steering column is used to activate and operate the speed control.

NOTE: The responsibility for the driving speed is always that of the driver. The cruise control is only an aid for the driver.

NOTE: A change of gear does not shut off the cruise control.

Every speed traveled above 25 mph (40 km/h) can be set.

Once the speed is set, it is maintained constant by the speed control, the accelerator pedal can be released.

3

72 UNDERSTANDING THE FEATURES OF YOUR VEHICLE

WARNING!

Leaving the Speed Control on when not in use is dangerous. You could accidentally set the system or cause it to go faster than you want. You could lose control and have an accident. Always turn the system off when you are not using it.

Setting momentary speed

Briefly push speed control lever up (1) or down (2).

Cancel speed control

Push speed control lever forwards (3) or step on the brake pedal.

Increase set speed

Push up speed control lever (1) briefly – speed increase of 0.6 mph (1 km/h) each time.
To increase speed steadily = hold the speed control lever in the push-up position.

Decrease set speed

Push down speed control lever (2) briefly – speed decrease of 0.6 mph (1 km/h) each time.
To decrease speed steadily, hold the speed control lever in the push-down position.

Resume set speed (after shutting off)

Push speed control lever back (4).

With the accelerator pedal the set speed can be increased (for passing).

When the accelerator pedal is released again, the set speed regulates itself again.

With the key in position 0 or 1 in the ignition lock the set speed is cancelled.

WARNING!

The speed control does not adapt itself automatically to road conditions; therefore do not use cruise control on icy roads. There is a risk of skidding and loss of vehicle control. This could cause an accident resulting in severe personal injuries, death and property damage.

NOTE: On uphill and downhill grades it may not be possible to maintain speed.

SUNROOF

WARNING!

In an accident, there is a greater risk of being thrown from a vehicle with an open sun roof. You could also be seriously injured or killed. Always fasten your seatbelt properly and make sure all passengers are properly secured too.

Do not allow small children to operate the electric sun roof.

Never allow fingers or other body parts, or any object to project through the sun roof opening. Injury may result.

Make certain that no one gets caught when the electric sun roof is closed. The key should be removed from the ignition lock even if the vehicle will only be left for a short time to prevent situations such as children or unauthorized persons opening and closing the electric sun roof and becoming caught.

3

74 UNDERSTANDING THE FEATURES OF YOUR VEHICLE

Manual Sun Roof (Optional)

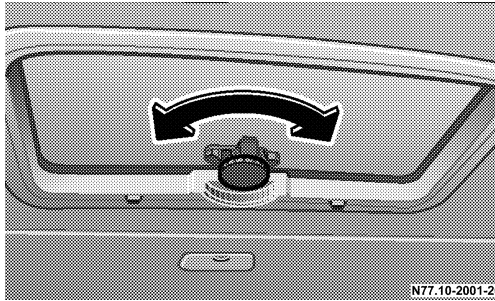

- To open, turn the handwheel counterclockwise.
Maximum opening = turn until the stop is reached.
- To close, turn the handwheel clockwise until the stop is reached.

WARNING!

Never allow fingers or other body parts, or any object to project through the sun roof opening. Injury may result.

Electric Sun Roof (Optional)

See Section 4, Understanding Your Instrument Panel, for switch locations.



Place the key in position 2 in the ignition lock.

To open the sun roof:

Keep switch pressed upward until the sun roof has reached the desired position or the end position.

To close the sun roof:

Keep switch pressed downward until the sun roof has reached the desired position or is completely closed.

Mechanical Sun Roof Operation

The sun roof does not open or close:

Check electrical fuse. Electrical fuses refer to "Electrical Fuses".

If the fuse works correctly, the sun roof can also be closed or opened manually.

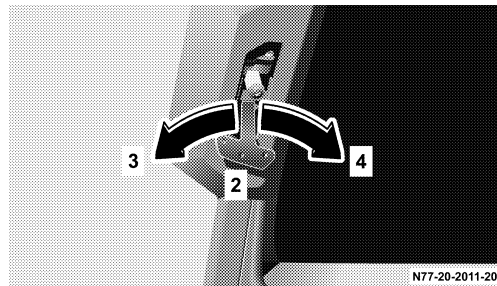
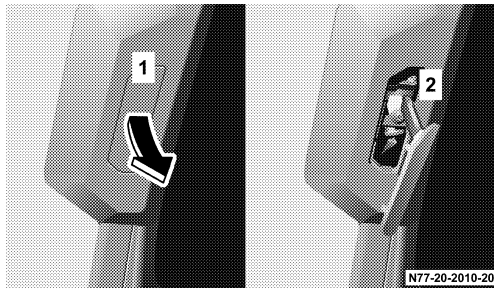

Remove cover (1) at the front frame of the sun roof.

Remove tool (2) from the cover (1) and insert.

Open manually:

Press in tool (2) and turn counterclockwise (3).

Close manually:

Press in tool (2) and turn clockwise (4).

Have malfunctions rectified by an authorized Sprinter Dealer.

3

76 UNDERSTANDING THE FEATURES OF YOUR VEHICLE

ASHTRAY/CIGAR LIGHTER

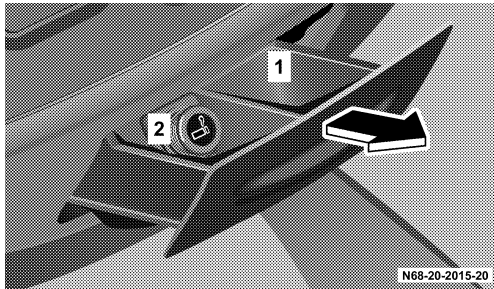

Ashtray in the driver's compartment.

Ashtray (1)

Cigar lighter (2)

To open the ashtray (1):

Pull the ashtray (1) out until it locks into place.

To close the ashtray (1):

Push the ashtray (1) forward over the working point until it reaches the stop.

To switch on the cigar lighter (2):

Press in the cigar lighter (2), it will automatically spring back as soon as the filament begins to glow.

Ashtray in the rear passenger compartment.

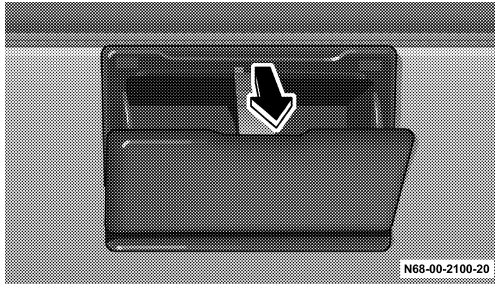

The ashtrays are located in the side linings in the passenger compartment.



ELECTRICAL OUTLET

The electrical outlet is located on the lower right in the center of the dashboard.

NOTE: Maximum capacity: 180 VA

3

CAUTION!

- Many accessories that can be plugged in draw power from the vehicle's battery, even when not in use (i.e. cellular phones, etc.). Eventually, if plugged in long enough, the vehicle's battery will discharge sufficiently to degrade battery life and/or prevent engine starting.
- Accessories that draw higher power (i.e., coolers, vacuum cleaners, lights, etc.), will degrade the battery even more quickly. Only use these intermittently and with greater caution.
- After the use of high power draw accessories, or long periods of the vehicle not being started (with accessories still plugged in), the vehicle must be driven a sufficient length of time to allow the alternator to recharge the vehicle's battery.

78 UNDERSTANDING THE FEATURES OF YOUR VEHICLE

CUP HOLDER

The cup holder in the driver's compartment is located below the instrument panel between the driver's and front passenger's seats.

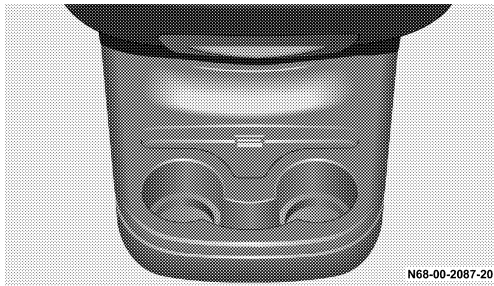

The cup holders in the passenger compartment are located in the center below the seat benches.

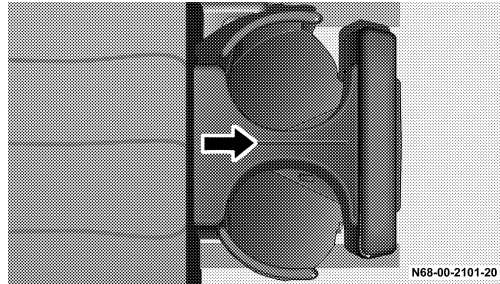

Pull out cup holder in the direction of arrow.

GLOVE COMPARTMENT Glove Compartment Lockable (Optional)

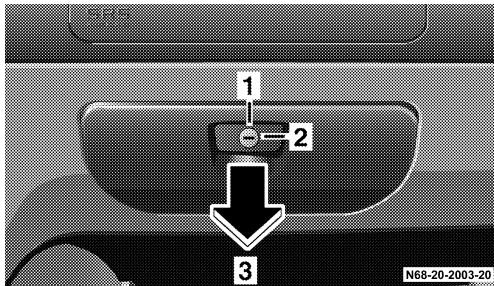

- Locked (1)
- Unlocked (2)
- Open (3)

COMPARTMENTS IN FRONT DOORS

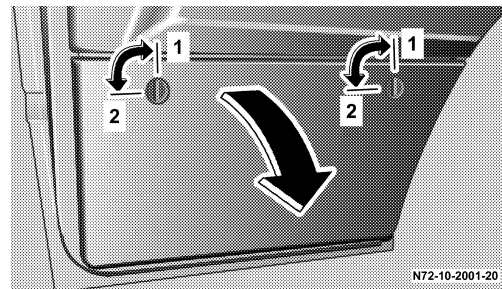

- Locked (1)
- Unlocked (2)

3

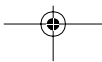
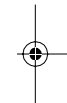
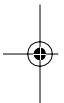

UNDERSTANDING YOUR INSTRUMENT PANEL

CONTENTS

■ Instruments and Controls	83	■ ASSYST Maintenance Computer (Optional)	103
■ Instrument Cluster and Indicator Lamps	85	□ Engine Oil Level – Display in Instrument Cluster (Vehicles with ASSYST Maintenance Computer only)	105
□ Multi-Function Indicator	87	□ Displaying Engine Oil Level with Engine Off	106
□ Clock	89	■ Engine Oil Level Indicator in Instrument Cluster (Vehicles without ASSYST Maintenance Computer)	108
□ Odometer and Trip Meter	90	■ Heating, Ventilation	109
□ Instrument and Display Lighting	90	□ Ventilation	110
□ Outside Temperature Display	91	□ Air Recirculation	110
□ Tachometer (Engine rpm)	92	□ Heating	111
□ Coolant Temperature Gauge	93	□ De-Fogging and De-Icing The Front Windows	112
□ Fuel Gauge with Reserve Fuel Indicator Lamp	94	□ Side Air Vents and Center Air Vents	113
□ Battery Charge Indicator Lamp	95	□ Upper Air Vents	113
□ Water in Fuel Indicator Lamp	96	□ Heated Rear Window (Optional)	114
□ Engine Oil Level Indicator Lamp	97		
□ Coolant Level Indicator Lamp	98		
□ Engine Control Unit Indicator Lamp	99		
□ Indicator Lamp Symbols	99		
■ Switch Locations	101		

82 UNDERSTANDING YOUR INSTRUMENT PANEL

- Windshield Heater (Optional) 114
- Residual Engine Heat Utilization (REST) 115
- Air Conditioning, Regulated (Optional) 115
 - Climate Control (on Vehicles with Air Conditioning) 116
 - Dehumidification (on Vehicles with Air Conditioning) 117
 - Air Conditioner for the Rear Passenger Compartment (Optional) 118
 - Air Recirculation 119
 - Air Strainer 120
- Electric Blower (Optional) 121
- Heater Booster 122
- Auxiliary Heater – Water or Air Heater (Optional) 123
 - Auxiliary Heater Switch (Water Heater only) 124
 - Timer Auxiliary Heater (Water and Air Heater) 125
 - Settings with the Auxiliary Heater switched on (only with Water Heater) 129
- Auxiliary Heat Exchanger in Load Compartment, only with Auxiliary Water Heater (Optional) 129
- Auxiliary Heater – Tips for Coping with Problems 130
 - Overheating (Water Heater) 131
 - Overheating (Air Heater) 131

INSTRUMENTS AND CONTROLS

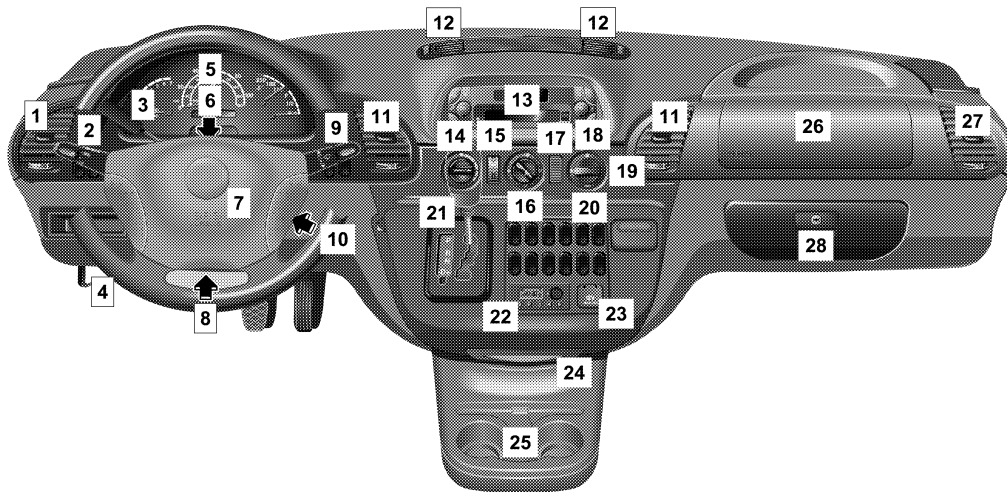

N68-10-2152-29



84 UNDERSTANDING YOUR INSTRUMENT PANEL

Legend For Instruments And Controls

1. Left-hand air vent.
2. Multifunction switch.
3. Cruise control.
4. Hood release lever.
5. Instrument cluster, refer to "Instrument Cluster and Indicator Lamps".
6. Hazard warning flasher switch.
7. Steering wheel with horn, front driver airbag.
8. Fuse box.
9. Windshield wiper switch, refer to "Windshield Wiper Switch".
10. Ignition lock/starter switch.
11. Center air vents.
12. Upper air vents.
13. Radio, see individual manual.
14. Temperature control switch.
15. Airflow control switch.
16. Air distribution switch.
17. Temperature sensor, automatic heating control / air conditioning, regulated.
18. Air conditioning switch.
19. Heater booster switch.
20. Residual engine heat utilization switch.
21. Gear selector lever (automatic transmission)
22. Timer for auxiliary heater (water- or air heater).
23. Electrical outlet.
24. Ashtray.
25. Cup holder.
26. Front passenger airbag.
27. Right-hand air vent.
28. Glove compartment.



INSTRUMENT CLUSTER AND INDICATOR LAMPS

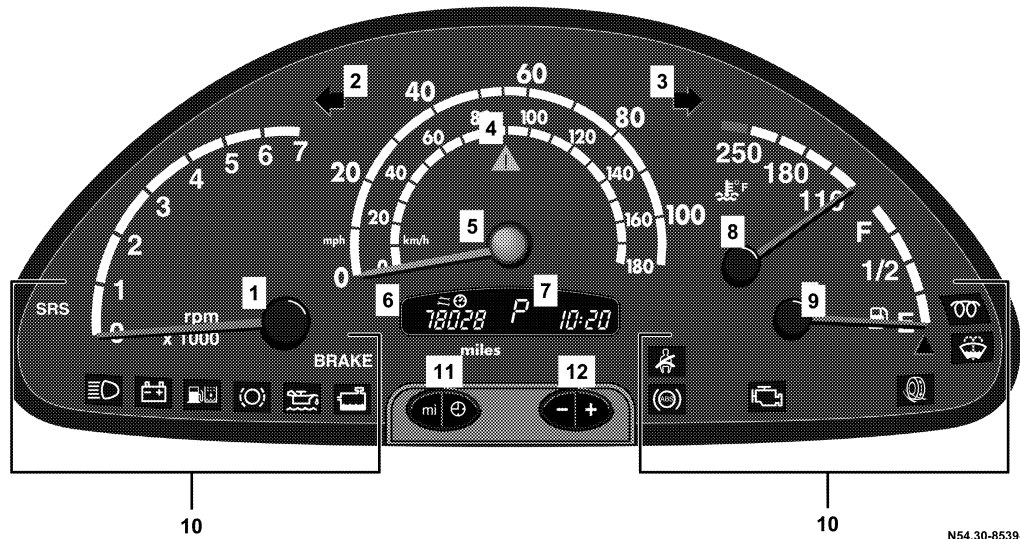

N54.30-8539-29



86 UNDERSTANDING YOUR INSTRUMENT PANEL

Legend For Instrument Cluster And Indicator Lamps

1. Tachometer (Engine rpm), refer to "Tachometer (Engine rpm)".
2. Turn signal indicator lamp (left), refer to "Combination Switch".
3. Turn signal indicator lamp (right), refer to "Combination switch".
4. ASR warning lamp or ESP warning lamp.
5. Speedometer.
6. Multi-function indicator, refer to "Multi-Function Indicator".
7. Gear selector lever position.
8. Coolant temperature gauge, refer to "Coolant Temperature Gauge".
9. Fuel gauge with reserve fuel indicator lamp (yellow), refer to "Fuel Gauge with Reserve Fuel Indicator Lamp".
10. Warning and indicator lamps.
11. Odometer/trip meter selector, refer to "Odometer and Trip Meter".
Clock/outside temperature display selector, refer to "Clock and Outside Temperature Display".
12. Instrument lighting brighter/dimmer, refer to "Instrument Lighting".



Multi-Function Indicator

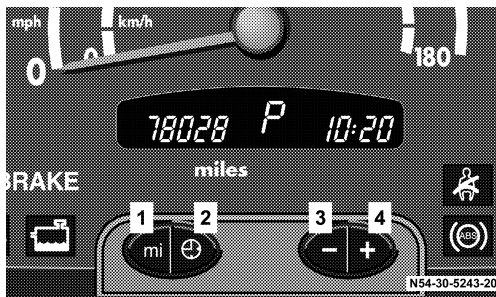

WARNING!

Never operate buttons (1, 2, 3 and 4) in the multi-function indicator while driving.

To operate these buttons the driver must reach through the steering wheel, which could significantly impede its movement.

Your attention will also be diverted from the road and traffic conditions.

This could cause you to lose control of the vehicle and could lead to an accident and result in severe personal injuries or death.

For this reason, make sure that the traffic conditions are safe before pressing the buttons, so that nobody may be endangered.

When possible, reach around the steering wheel to operate the multi-function indicator buttons. Do not rest your head or chest on the steering wheel or dashboard when operating the buttons.

4

88 UNDERSTANDING YOUR INSTRUMENT PANEL

The multi-function indicator can be used to call up the odometer, trip meter, clock and outside temperature, or information such as remaining time/distance until the next service is due, or the engine oil level.

The multi-function indicator is activated by:

Turning the key to position 2 in the ignition lock,

opening the driver's door,

pressing one of the buttons **mi (km)**, **⊖**, **—** or **+**,

switching the side lights on, refer to "Combination Switch".

1. Press the button **mi (km)** to switch between the odometer and the trip meter, and to reset the trip meter.
Press the button **mi (km)** to activate the ASSYST maintenance computer.
2. Press the **⊖** button to switch between the time and outside temperature and to activate the time adjustment.
3. Press the **—** to adjust (dim) the display and instrument lighting and to adjust the clock.
4. Press the **+** to adjust (brighten) the display and instrument lighting and to adjust the clock.

Clock

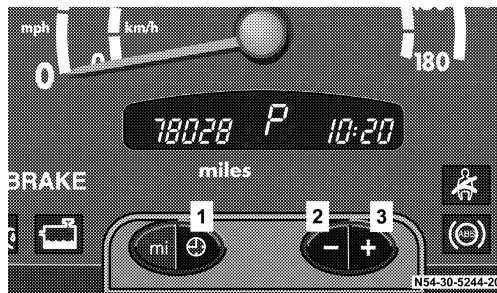

Activate the multi-function indicator, refer to "Multi-Function Indicator".

Button  – to reverse the time adjustment/switch between hours and minutes (1)

Button  – to turn the time back (2)

Button  – to advance the time (3)

To switch between Time and Outside Temperature Display (Optional)











Press the  button briefly.

If button  is pressed twice within one second, the display will revert to the original mode after 20 seconds.

4

To Adjust the Time

Call up time display:

1. Press button  and hold – the hours display will flash.
To change the time by one hour = briefly press button  or .
To change the time by several hours = press and hold button  or .
2. Briefly press button  – the minutes display will flash.
To change the time by one minute = briefly press button  or .
To change the time by several minutes = press and hold button  or .
3. Briefly press button  – the set time is accepted.

90 UNDERSTANDING YOUR INSTRUMENT PANEL

Odometer and Trip Meter



Activate the multi-function indicator. The total distance covered by the vehicle will be shown.

1. To switch between the odometer and the trip meter, press button (1) briefly.
2. To reset the trip meter, call up trip meter. Press button (1) and hold until the trip meter shows 0000.

Instrument and Display Lighting



Display lighting:

3. Press button **-**, to display lighting dimmer
4. Press button **+**, to display lighting brighter

Instrument and display lighting:

1. Switch on the marker lamps, refer to "Combination Switch"
2. Press button **-**, to instrument and display lighting dimmer
3. Press button **+**, to instrument display lighting brighter

Outside Temperature Display

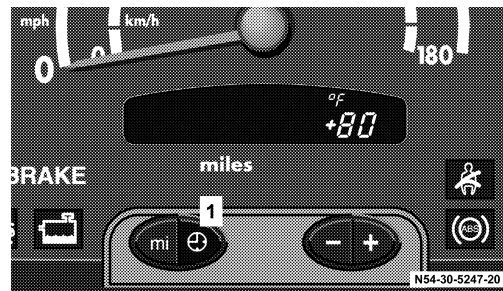

1. Clock/outside temperature display selector
Press button **mi** briefly. The display will switch to the required mode.
If button **mi** is pressed twice within one second, the display will revert to the original mode after 20 seconds.

92 UNDERSTANDING YOUR INSTRUMENT PANEL

The outside temperature is displayed when the multi-function indicator is activated. Sudden changes in temperature, for instance when leaving a garage, are only shown after a certain delay.

NOTE: Outside temperature display

°F in USA only.

°C in Canada only.

WARNING!

Even if the display still reads a few degrees above 32°F (0°C), the road surface may be icy, particularly in woods or on bridges. You could skid and lose control over your vehicle and thereby cause an accident.

Adapt your speed and driving style to the prevailing road and weather conditions to prevent an accident and possible personal injury or property damage.

Tachometer (Engine rpm)

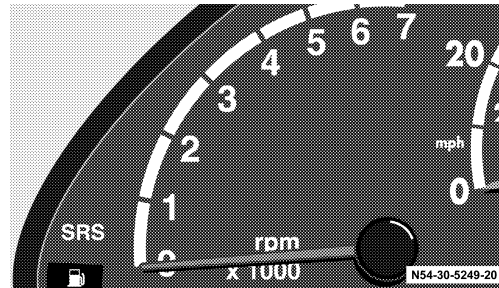

Do not exceed the maximum permissible engine speed.

NOTE: To protect the engine, its fuel supply is interrupted when the maximum rpm is reached. Despite this, the maximum rpm can still be exceeded in overrun mode (e.g. when driving downhill).

Coolant Temperature Gauge

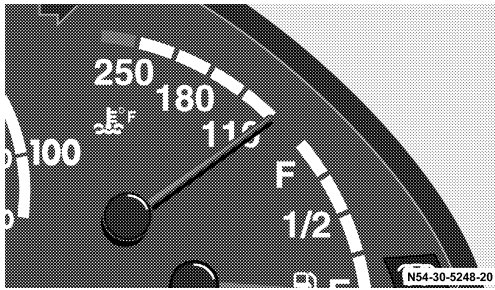

The coolant temperature is displayed when the key is in position 2 in the ignition lock.

If corrosion inhibitor/antifreeze is present in the correct concentration in the coolant, the coolant temperature will be between 185 °F (+85 °C) and 250 °F (+120 °C), depending on operating conditions.

If the needle reaches the red section, do not continue to drive the vehicle.

CAUTION!

Do not leave your vehicle unattended with the engine running as you would not be able to react to the temperature indicator if the engine overheats. This would lead in turn to engine damage.

4

For coolant level indicator lamp , refer to "Coolant Level Indicator Lamp".

NOTE: Coolant temperature display

°F in USA only.

°C in Canada only.

94 UNDERSTANDING YOUR INSTRUMENT PANEL

WARNING!

Driving when your engine is badly overheated can cause some fluids which may have leaked into the engine compartment to catch fire. You could be seriously burned. Steam from an overheated engine can cause serious burns and can occur just by opening the engine hood. Stay away from the engine if you see or hear steam coming from it. Turn off the engine, get out of the vehicle and do not stand near the vehicle until it cools down.

Fuel Gauge with Reserve Fuel Indicator Lamp

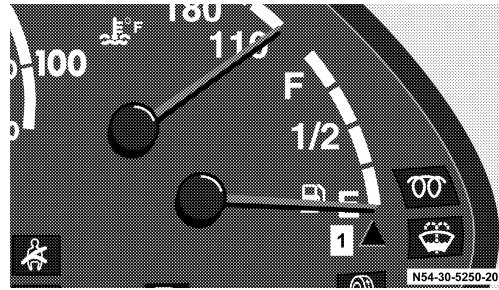

The fuel level is displayed when the key is in position 2 in the ignition lock.

The reserve fuel indicator lamp (1) lights up for about 2 seconds.

If the reserve fuel indicator lamp remains on or lights up again when the engine is running, the fuel in the tank has reached reserve level.

Reserve level: about 2.8 US gal (10.5 liters).

NOTE: If the fuel gauge sensor is damaged, the reserve fuel indicator lamp (1) will light up and the needle will vary its position between the maximum and minimum marks. Have the malfunction traced and rectified by an authorized Sprinter Dealer.

Battery Charge Indicator Lamp

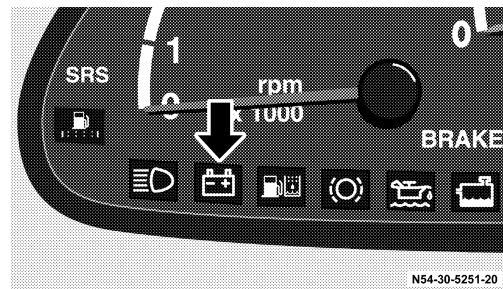

When the key is in position 2 in the ignition lock, the battery charge indicator lamp  will light up in the instrument cluster. It must go out when the engine is running.

If the battery charge indicator lamp  remains on or lights up again while the vehicle is moving, a fault has developed in the battery charge circuit.

Do not drive on. Take your vehicle to an authorized Sprinter Dealer to have the problem corrected.

96 UNDERSTANDING YOUR INSTRUMENT PANEL

Water in Fuel Indicator Lamp

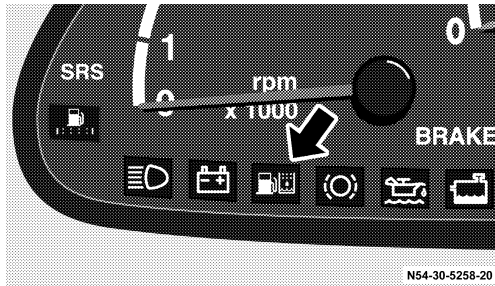

When the key is turned to position 2 in the ignition lock, the fuel filter indicator lamp  in the instrument cluster lights up for about 7 seconds. It must go out when the engine is running.

If water in fuel indicator lamp  does not go out or comes on with the engine running, drain the water from the fuel filter as soon as possible.

NOTE: Should the water in fuel indicator lamp  still not go out after the fuel filter has been drained, the cause should be examined by an authorized Sprinter Dealer.

If the indicator lamp  does not light up for about 7 seconds with the key in the ignition lock in position 2, there is a malfunction in the water separator system. Have the cause rectified by an authorized Sprinter Dealer.

Engine Oil Level Indicator Lamp

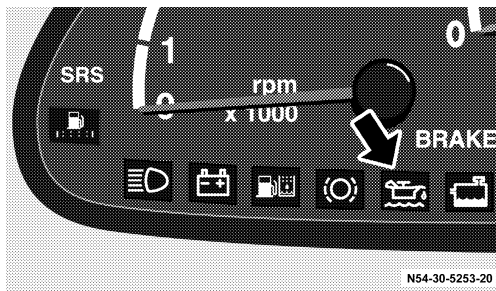

The engine oil level indicator lamp  lights up in the instrument cluster when the key is turned to position 2 in the ignition lock. It must go out when the engine is running.

If the engine oil level indicator lamp  does not go out, or if it lights up again while the vehicle is moving, the engine oil level has dropped to a point close to the minimum level mark on the dipstick.

The indicator lamp  lights up only briefly at first, becoming permanent as the oil level drops further.

Stop the engine immediately and check the engine oil level. If no obvious leak is visible, correct the oil level.

4

If the engine oil level indicator lamp  lights up, even if the engine oil level is sufficient, have the cause traced and rectified by an authorized Sprinter Dealer.

For approved engine oils, please contact your authorized Sprinter Dealer.

98 UNDERSTANDING YOUR INSTRUMENT PANEL

Coolant Level Indicator Lamp

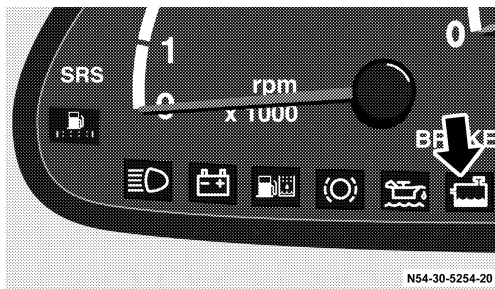

When the key is turned to position 2 in the ignition lock, the coolant level indicator lamp / in the instrument cluster lights up for about 2 seconds. It must go out when the engine is running.

If the coolant level indicator lamp / remains on or lights up again when the engine is running, the coolant level is too low.

Do not drive on. Switch the engine off and add coolant.

If a large quantity of coolant is being lost, or if smaller amounts are lost at regular intervals, have the engine cooling system examined by an authorized Sprinter Dealer.

CAUTION!

Never run the engine if the coolant level is too low. This could cause the engine to overheat, leading in turn to engine damage.

WARNING!

Driving when your engine is badly overheated can cause some fluids which may have leaked into the engine compartment to catch fire. You could be seriously burned. Steam from an overheated engine can cause serious burns and can occur just by opening the engine hood. Stay away from the engine if you see or hear steam coming from it. Turn off the engine, get out of the vehicle and do not stand near the vehicle until it cool downs.

Engine Control Unit Indicator Lamp

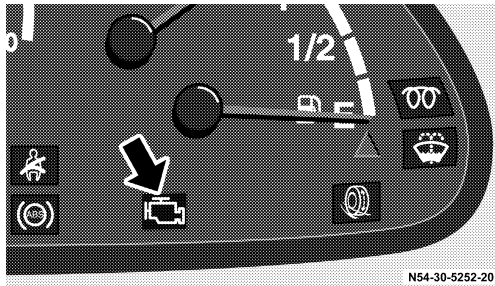









N54-30-5252-20

When the key is in position 2 in the ignition lock, the engine control unit indicator lamp  will light up in the instrument cluster. It must go out when the engine is running.







If the engine control unit indicator lamp  remains on or lights up again while the vehicle is moving, the fuel tank was run empty or a fault has developed in the engine control unit. The engine's power output may be reduced.

Refuel and bleed the fuel system or have the cause traced and rectified by an authorized Sprinter Dealer.

Indicator Lamp Symbols

-  Acceleration skid control (ASR), or electronic stability program (ESP), or slippery surface warning.
- SRS**  Airbag malfunction (USA only).
-  High beam on.
-  Battery not being charged.
-  Water in fuel filter.
-  Brake pads worn.
-  Engine oil level too low.
-  Coolant level too low.
- BRAKE**  Brake fluid level too low and electronic brake force distribution (EBV) malfunction (USA only).

100 UNDERSTANDING YOUR INSTRUMENT PANEL

-  Brake fluid level too low and electronic brake force distribution (EBV) malfunction (Canada only).
-  Seat belt warning lamp.
-  ABS malfunction and electronic brake force distribution (EBV) malfunction.
-  Engine control unit malfunction.
-  Acceleration skid control (ASR) malfunction and brake assist system (BAS)¹ malfunction.
-  Fluid level in windshield washer low.
-  Preheating.

SWITCH LOCATIONS



4



102 UNDERSTANDING YOUR INSTRUMENT PANEL

Legend for Switch Locations

1. Fog lamp switch (Optional), refer to "Fog Lamp Switch".
2. Headlamp range control, refer to "Headlamp Range Control".
3. Auxiliary heat exchanger switch (Optional).
4. Heated rear window (Optional).
5. Left-hand seat heater switch (Optional).
6. Central locking switch with load compartment lock (Optional).
7. Alarm pushbutton.
8. Deactivate Acceleration skid control (ASR) switch.
9. Switch for auxiliary heater – water heater only (Optional)
10. Right-hand seat heater switch (Optional),
11. Sun roof operation switch (Optional).
12. Interior cargo area lighting (Optional), refer to "Interior Cargo Area Lighting".
13. Towing/passenger compartment protection switch (Optional).
14. Airflow switch for the air conditioner for rear passenger compartment (Optional).
15. Temperature control (Optional).
16. Electric blower switch (Optional).
17. Windshield heater switch (Optional).
18. Constant RPM switch (Optional).



UNDERSTANDING YOUR INSTRUMENT PANEL 103

ASSYST MAINTENANCE COMPUTER (OPTIONAL)



Function button **mi (km)** (1)

Approximately one month or 2,000 miles (3,000 km) before a service is due, the maintenance symbol

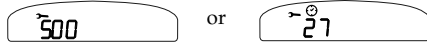

lights up when the key is turned to position 2 in the ignition lock.

If the remaining time (in days) is shown, the additional symbol  also appears in the multi-function indicator.

If additional maintenance operations are due, the maintenance indicator

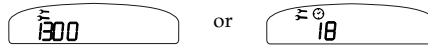

lights up when the key is turned to position 2 in the ignition lock.

For additional maintenance operations, see Sprinter Service Booklet. **4**

If a service deadline is exceeded, the display will flash with a minus sign in front when the key is turned to position 2 in the ignition lock.

The display will be cancelled when the button **mi (km)** is pressed, or automatically after 10 seconds.

The remaining time or remaining distance can also be called up manually.

To manually call up the remaining time/distance:

Activate the multi-function indicator, refer to "Multi-Function Indicator".

Briefly press the button **mi (km)** twice.

104 UNDERSTANDING YOUR INSTRUMENT PANEL

Depending on the driving style, the mileage covered and the operating conditions, the next service due is displayed either as a remaining distance in "mi" (in km) or as a remaining time in "days". The length of time between services should not exceed 2 years.

The display will be cancelled when the button **mi (km)** is pressed, or automatically after 10 seconds.

When a service has been performed, have the ASSYST maintenance computer reset by an authorized Sprinter Dealer.

Should your Sprinter for any reason not be serviced by an authorized Sprinter Dealer, the ASSYST maintenance computer can, in exceptional circumstances, be reset as follows:

Turn the key to position 2 in the ignition lock and immediately press the button **mi (km)** twice.

Within 10 seconds, return the key to position 0 in the ignition lock.

Press and hold the button **mi (km)**. Turn the key to position 2 in the ignition lock. Keep the button **mi (km)** pressed.

The maintenance indicator with the current remaining time/distance is shown.

After about 10 seconds, an acoustic signal will sound and the maintenance indicator is displayed with the new remaining time/distance.

Release the button **mi (km)**.

NOTE: The ASSYST maintenance computer provides information on the optimum maintenance requirements.

If maintenance intervals are not observed, resulting damage will not be covered by Warranty.

The ASSYST maintenance computer is not an engine oil gauge.

Engine oil level – for display in instrument cluster, see next page.

If the engine oil level indicator lamp lights up, refer to "Engine Oil Level Indicator Lamp".

If the battery is disconnected, the time is not recorded by the ASSYST maintenance computer. Such periods must be considered if maintenance intervals are measured by time.

**Engine Oil Level – Display in Instrument Cluster
(Vehicles with ASSYST Maintenance Computer only)**

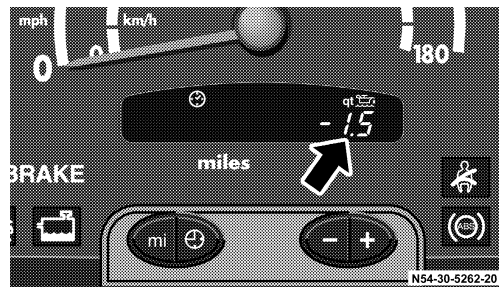

If the  indicator lamp lights up briefly when the engine is running, the engine oil level has dropped to the minimum mark. Check the engine oil level without delay and add oil to the upper mark on the dipstick.

If no engine oil is added and the engine oil level drops further, a warning buzzer will also sound and



will appear in the multi-function indicator. 2.0 quarts (about 2.1 liters) of oil must be added.

CAUTION!

If the  indicator lamp lights up, the warning symbol in the multi-function indicator appears and the warning buzzer sounds, the operating safety of the engine is endangered (possibility of engine damage).

A sudden decrease or absence of oil pressure may indicate a mechanical failure. Bring the vehicle to a safe stop, and investigate the cause to prevent further damage. Do not operate the engine until the cause has been determined and corrected.

106 UNDERSTANDING YOUR INSTRUMENT PANEL

If the warning



is displayed in the multi-function indicator while the engine is running, the engine oil level is above maximum.

CAUTION!

Do not operate the engine if the oil level is above maximum. There is a danger of damage to the engine or catalytic converter.

Siphon or drain off engine oil until the engine oil level is between the lower and upper marks on the dipstick. Check the engine oil level again.



must be displayed.

NOTE: If the oil level is correct and a fault warning is still given, have the fault traced and rectified by an authorized Sprinter Dealer.

Displaying Engine Oil Level with Engine Off

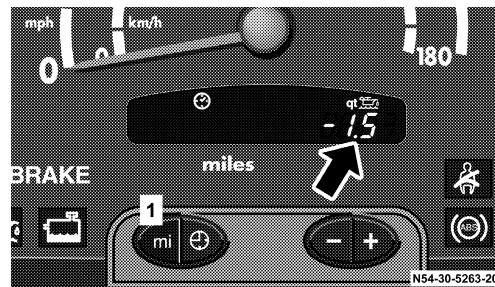





If the engine has reached normal operating temperature, the engine oil level can be displayed on the multi-function indicator for about 5 minutes after the engine has been switched off.

The vehicle must be standing on a level surface when the engine oil is being checked.

Turn the key to position 2 in the ignition lock and wait about 10 seconds until the multi-function indicator shows the  symbol.

Briefly press button (1) twice within 1 second.

The following displays can then appear in the multi-function indicator:

	It is not necessary to add engine oil.
	1 quart (about 1 liter) of engine oil must be added.
	1.5 quarts (about 1.6 liters) of engine oil must be added.
	2 quarts (about 2.1 liters) of engine oil must be added.
	Excess engine oil must be drained or siphoned off.

CAUTION!

If the engine oil level is too high or too low the engine can be damaged.

Add engine oil or siphon or drain off engine oil until the engine oil level is between the lower and upper marks on the dipstick. Only add engine oil up to the upper mark-do not overfill.

If the engine oil level is above maximum, there is a danger of damage to the engine or catalytic converter.

4

NOTE: If the engine oil level is correct and a warning that the engine oil level is too high or too low is still given, have the fault traced and rectified by an authorized Sprinter Dealer.

If it is not possible to measure the engine oil level correctly, the  symbol will flash in the multi-function indicator – repeat the measurement after waiting a short time.

If no engine oil level reading is shown again, the engine oil level can still be checked with the dipstick.

Consult an authorized Sprinter Dealer to have the system checked.

108 UNDERSTANDING YOUR INSTRUMENT PANEL

ENGINE OIL LEVEL INDICATOR IN INSTRUMENT CLUSTER (VEHICLES WITHOUT ASSYST MAINTENANCE COMPUTER)

If the  indicator lamp lights up when the engine is running, the engine oil level has dropped to the minimum mark. Check the engine oil level without delay and add engine oil up to the upper mark on the dipstick.

If there is no engine oil in the oil sump, a warning buzzer will sound if the key is turned to position 2 in the ignition lock or if the vehicle is being driven, and the warning



will appear in the multi-function indicator. About 2 quarts (1.9 liters) of oil must be added.

Check the engine oil level without delay and add engine oil to the upper mark on the dipstick.

CAUTION!

If the  indicator lamp lights up, the warning symbol in the multi-function indicator appears and the warning buzzer sounds, the operating safety of the engine is endangered (possibility of engine damage).

Safely pull off the road and turn off the engine (do not restart the engine). Determine the cause of the problem. If there are no obvious signs of leakage, add engine oil. The engine oil level must be between the lower and upper marks on the dipstick. Only add engine oil up to the upper mark – do not overfill.

If the engine oil level is above maximum, there is a danger of damage to the engine or catalytic converter.

HEATING, VENTILATION

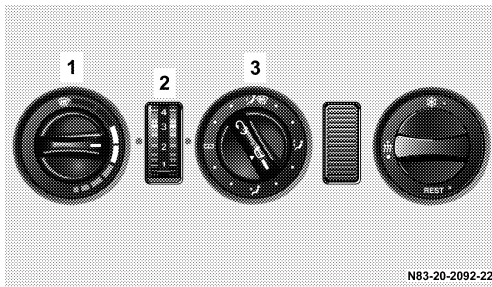

- Temperature control (1)
- Airflow control (2)
- Air distribution control (3)

- Air to the windshield and from the air vents
- Air to the windshield and footwell and from the air vents
- Air to the footwell and from the air vents
- Air from the air vents

NOTE: If the vehicle interior has been heated up by intense sunlight, ventilate the interior briefly before driving the vehicle.

Only with automatic heater control (Optional):
The selected temperature is reached as quickly as possible in heater mode and then held constant.

WARNING!

Follow the recommended settings for heating and cooling given on the following pages. Otherwise the windows could fog up, impairing visibility and endangering you and others.

4

110 UNDERSTANDING YOUR INSTRUMENT PANEL

Ventilation

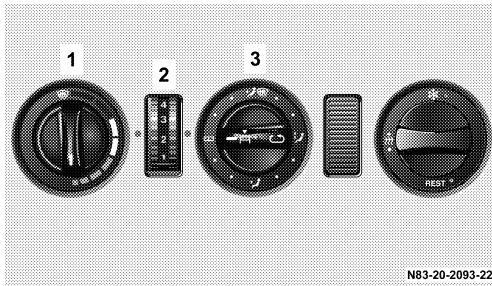

1. Set the airflow control (2) to position 3 or 4.
2. Set the temperature control (1) as illustrated (heater switched off).
3. Set the air distribution control (3) to .

NOTE: Adjust the air vents as required, refer to "Side Air Vents and Center Air Vents".

Air Recirculation



1. Air recirculation indicator lamp
2. Air recirculation button

To switch on air recirculation:

- Press the air recirculation button – the indicator lamp lights up.

To switch off air recirculation:

- Press the air recirculation button again – the indicator lamp goes out.



Select air recirculation if dust or unpleasant odors enter the vehicle.

NOTE: Prolonged air recirculation can worsen the air quality and lead to fogging up of the windows. Shut off air recirculation as soon as possible.

Only with automatic heat regulation and regulated air conditioning (Optional):
Air recirculation is automatically switched off after about 15 minutes or when engine is shut off.

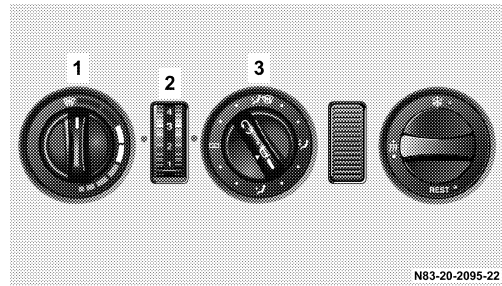
Heating





1. Set the airflow control (2) as required.
2. Set the temperature control (1) as required.
3. Set the air distribution control (3) between  and .
4. Switch off air recirculation, refer to "Air Recirculation".
5. Adjust the air vents as required, refer to "Side Air Vents and Center Air Vents".

112 UNDERSTANDING YOUR INSTRUMENT PANEL

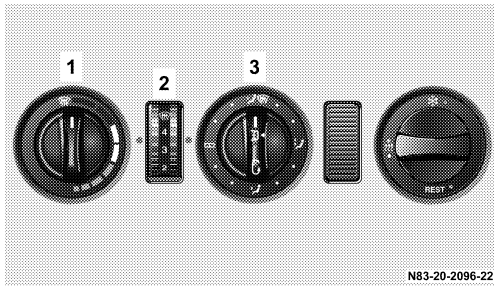
De-Fogging and De-Icing The Front Windows



1. Set the airflow control (2) to position 3 or 4.
2. Set the temperature control (1) to .
3. Set the air distribution control (3) to .
4. Switch off air recirculation, refer to "Air Recirculation".

NOTE: On vehicles with auxiliary heater (water heater):

The additional heat exchanger in the load compartment should be switched off to quickly de-fog and de-ice the windshield and front side windows, refer to "Auxiliary Heat Exchanger in Load Compartment".

For how to switch on heater booster mode, refer to "Heater Booster".

On vehicles with air conditioner (Optional):

At outside temperatures above 41 °F (+5 °C), switch on the air conditioner for quicker dehumidification, refer to "Air Conditioning, Regulated".

Side Air Vents and Center Air Vents

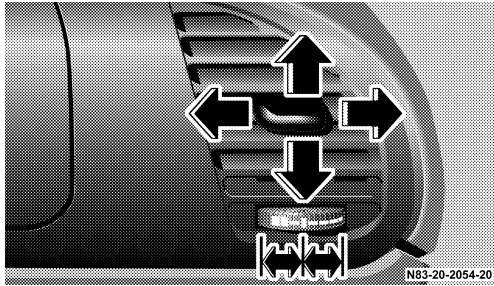

To open, turn the thumbwheel outwards.
To close, turn the thumbwheel inwards.
Intermediate settings are possible.

Upper Air Vents

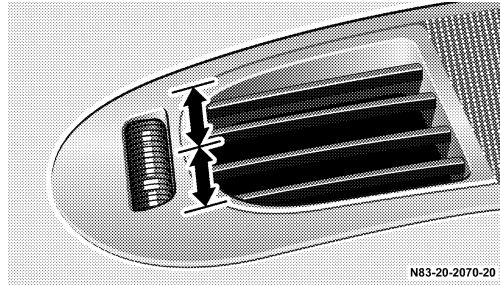

4

The upper air vents supply fresh air (not heated) to the passenger/load compartment.
To open, turn the thumbwheel forwards.
To close, turn the thumbwheel rearwards.

114 UNDERSTANDING YOUR INSTRUMENT PANEL

Heated Rear Window (Optional)



The switch for the heated rear window is located on the right-hand side next to the steering column.

It can be used only when the engine is running.

To switch it on:

- Press upward; the indicator lamp in the switch will light up.

To switch off:

- Press upward one more time.

NOTE: The heated rear window will automatically switch off after about 15 minutes or when the engine is turned off.

Windshield Heater (Optional)



The switch for the windshield heater is located on the center section of the dashboard.

It can be used only when the engine is running.

To switch it on:

- Press upward; the indicator lamp in the switch will light up.

To switch off:

- Press upward one more time.

NOTE: The windshield heater will automatically switch off after about 5 minutes or when the engine is turned off.

Residual Engine Heat Utilization (REST)

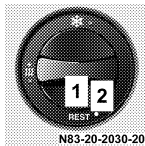

The REST switch (1) is located on the center section of the dashboard.

The residual engine heat utilization system can be used to keep the vehicle interior warm for some time after the engine is switched off.

Turn the key to position 0 in the ignition lock or remove it altogether.

To switch on:

1. Press the residual engine heat utilization switch (1), the indicator lamp (2) lights up.
The blower will run at speed 1 regardless of the setting of the airflow control.
2. Set the temperature control as required, refer to "Heating, Ventilation".

To switch off:

Press the residual engine heat utilization switch (1) again, the indicator lamp (2) goes out.

The residual engine heat utilization is automatically switched off if:

1. If the key is turned to position 2 in the ignition lock,
2. after about 30 minutes,
3. if the battery voltage is too low.

AIR CONDITIONING, REGULATED (OPTIONAL)

4

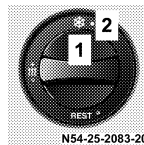

The air conditioning switch (1) is located on the center section of the dashboard.

The air conditioning can be used to cool or dehumidify the air in the vehicle. The selected temperature is reached as quickly as possible and then held constant.

The air conditioning is only operational when the engine is running.

116 UNDERSTANDING YOUR INSTRUMENT PANEL

To switch on:

Press switch (1), the indicator lamp (2) in the switch lights up.

To switch off:

Press switch (1) again, the indicator lamp (2) goes out.

NOTE: Run the air conditioning at least once a month for about 10 minutes.

It is possible that the air conditioning will automatically switch off at outside temperatures below 41 °F (+5 °C). Dehumidification is then also not possible.

Condensation may emerge from the underside of the vehicle.

The air conditioner only uses the refrigerant R-134a. This refrigerant does not damage the earth's ozone layer.

WARNING!

While driving, deactivate the air conditioning only temporarily to prevent window fogging.

Climate Control (on Vehicles with Air Conditioning)

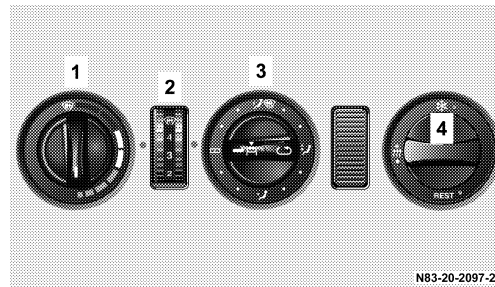



1. Set the airflow control (2) to position 1 to 4. Position 4 gives maximum cooling.
2. Set the temperature switch (1) as required (The interior temperature is regulated by the Tempmatik. If the interior temperature falls below the preset temperature, warm air is automatically supplied).
3. Set the air distribution control (3) to .
4. To switch on air conditioning, press switch (4).

NOTE: Open and adjust the air vents as required, refer to "Side Air Vents and Center Air Vents".

At high outside temperatures, a better cooling performance is achieved by switching on air recirculation. For note on air recirculation, refer to "Air Recirculation".

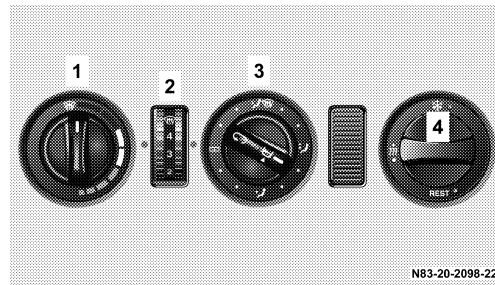
Dehumidification (on Vehicles with Air Conditioning)



1. Set the airflow control (2) to position 3 or 4.
2. Set the temperature control (1) as required.
3. Set the air distribution control (3) between  and .

118 UNDERSTANDING YOUR INSTRUMENT PANEL

NOTE: It is possible that the air conditioning will automatically switch off at outside temperatures below 41 °F (+5 °C). Dehumidification is then also not possible.

To switch on air conditioner, press switch (4).

Open the side air vents as required, refer to "Side Air Vents and Center Air Vents".

Air Conditioner for the Rear Passenger Compartment (Optional)

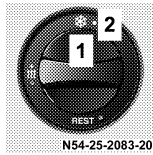

The air conditioner for the rear passenger compartment must be used in conjunction with "Air Conditioning, Regulated", refer to "Air Conditioning, Regulated".

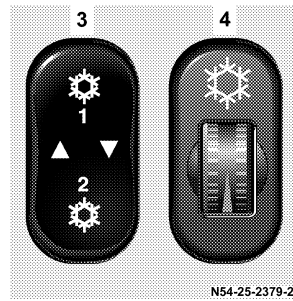

1. Air conditioning, regulated switch
2. Air conditioning, regulated indicator lamp
3. Airflow switch
4. Temperature control

To switch it on:

1. Press switch (1) on air conditioning, regulated.
The indicator lamp (2) will light up.
2. Operate the airflow switch (3).
Blower level 1, press the airflow switch (3) upwards; the left-hand indicator lamp will light up.
Blower level 2, press the airflow switch (3) downwards; the right-hand indicator lamp will light up.
3. Set temperature control (4) as needed.
Increase cooling turn upwards.
Decrease cooling turn downwards.

To switch off:

1. Switch the airflow switch (3) to the center position.
2. Press switch (1) air conditioning, regulated; the indicator lamp (2) will go out.

Air Recirculation

Recirculation mode can now be assisted by the air conditioner for rear passenger compartment.

To switch it on:

Operate the airflow switch (3)
Blower level 1, press the airflow switch (3) upwards; the left-hand indicator lamp will light up.
Blower level 2, press the airflow switch (3) downwards; the right-hand indicator lamp will light up.

4

To switch off:

Switch the airflow switch (3) to the center position.

120 UNDERSTANDING YOUR INSTRUMENT PANEL

Air Strainer

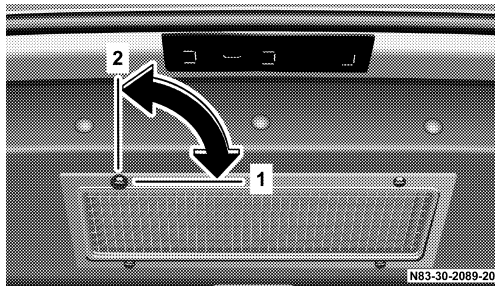

To lock fasteners (1)

To unlock fasteners (2)

The air strainer is located at the rear of the air conditioner for rear passenger compartment.

Increased quantities of sand or dust may settle on the air conditioner for rear passenger compartment air strainer when driving on dusty or sandy streets. The air strainer must be either cleaned or replaced in the event of visible contamination.

Removing and Cleaning the Air strainer

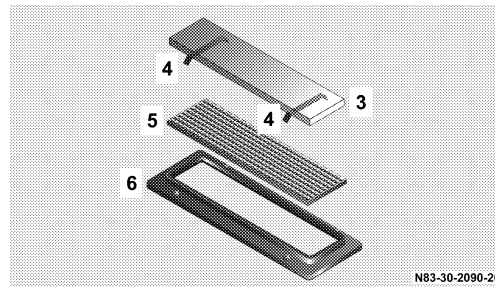

1. Unlock all quick-acting fasteners (2).
2. Remove the cover and air strainer (3).
3. Remove the Velcro closure (4) from the cover (6) and the grating (5).
4. Remove the air strainer (3) from the grating.
5. Wash out the air strainer (3) with clean water.
6. Let the air strainer (3) dry.

NOTE: The air strainer (3) must not be cleaned or dried by machine.

Installing the Air Strainer

1. Affix the air strainer (3) to the grating (5) (make certain that the ends project evenly).
2. Replace the air strainer (3) and grating (5) on the cover and press the Velcro closure (4) on the cover (6).
3. Insert the air strainer (3) with the cover and grating (5).
4. Lock (1) all quick-acting fasteners.

CAUTION!

Never operate the air conditioner for rear passenger compartment without an air strainer.

Never install a damaged air strainer.

If the air strainer with visible contamination is neither cleaned nor replaced, damage to the air conditioner for rear passenger compartment may result; such damage is not covered by the Warranty.

ELECTRIC BLOWER (OPTIONAL)

See Section 4, Understanding Your Instrument Panel, for switch locations.



The electric blower can be used to aerate or deaerate the cargo area. This feeds fresh air into the cargo area or extracts warm air.

4

Deaeration:

Press switch upward.

Aeration:

Press switch downward.

To switch off:

Switch the airflow switch to the center position.

122 UNDERSTANDING YOUR INSTRUMENT PANEL

HEATER BOOSTER

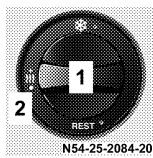

The switch (1) for activating the heater booster system is located in the center section of the dashboard. The heater booster system can be switched on while the vehicle is being driven to help the engine to reach its normal operating temperature more quickly, which will help to heat up the passenger compartment as quickly as possible when the heating is switched on.

To switch on with the engine running:

Press switch (1), the indicator lamp (2) lights up.

To switch off:

Press switch (1) again or switch the engine off. The heater booster will then switch to run-on mode (about 2 minutes).

NOTE: When the vehicle is being driven and a coolant temperature of over 185 °F (+80 °C) is reached, the heater booster system will switch to regulation mode. If the coolant temperature drops to below 167 °F (+75 °C) with the heater booster system switched on, heat output is increased again.

If the key is turned to position 0 in the ignition lock (run-on for about 2 minutes), the last setting selected at switch (1) is retained when the engine is restarted (memory function).

The operation of the heater booster system is usually not required at outside temperatures above 41 °F (+5 °C).

AUXILIARY HEATER – WATER OR AIR HEATER (OPTIONAL)

WARNING!

The auxiliary heating must not be operated at gas stations due to the risk of fire and explosion. For this reason, switch off the auxiliary heating before refuelling.

Auxiliary heaters emit fumes when in operation, including carbon monoxide.

Inhaling carbon monoxide is a health hazard and can result in unconsciousness and death.

For this reason, do not operate auxiliary heating in enclosed spaces without ventilation or an extractor system, e.g. in a garage. Otherwise you could endanger yourself and others.

WARNING!

Vehicles for transporting hazardous goods:
Observe the relevant safety regulations.

NOTE: The auxiliary heater (water or air heating device) can be used whether or not the engine is running.

The auxiliary heater should be run at least once a month for about 10 minutes.

The maximum heating period is 120 minutes. For more information, refer to "Switching the Auxiliary Heater On and Off - Ignition On".

The auxiliary heater will automatically switch off if the fuel level is under about 4 US gal (15 l).

In case of faults, refer to "Auxiliary Heater – Tips for Coping with Problems".

124 UNDERSTANDING YOUR INSTRUMENT PANEL

WARNING!

Aerosols, gas cartridges and other pressurized containers transported in the vehicle may be highly flammable and could explode when heated.

Make sure, particularly on vehicles with an air heater, that such containers are not placed in the flow of hot air of the auxiliary heating system

Otherwise there is a risk of severe personal injuries, death and property damage due to explosion.

WARNING!

Vehicles with air heater:

For safety reasons, we strongly recommend that the heat exchanger be replaced by an authorized Sprinter Dealer after 10 years of use.

If the vehicle is sold, the owner is required to inform the buyer of this requirement. This should be done when the Operator's Manual is transferred to the buyer.

Auxiliary Heater Switch (Water Heater only)



will switch over to after-running mode (about 2 minutes).

To switch off:

Press the switch downward.
The indicator lamp in the switch will go out.

To switch it on:

Press the switch upward.
The indicator lamp in the switch will light up.

The auxiliary heater will automatically switch off after about 120 minutes. The auxiliary heater

UNDERSTANDING YOUR INSTRUMENT PANEL 125

Timer Auxiliary Heater (Water and Air Heater)

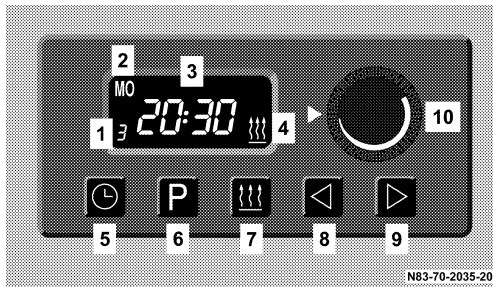

NOTE: The timer water heater has no adjustable temperature selection transformer (10).

1. Memory location (1 – 3)
2. Current day or preselected day
3. Current time or preselected time
4. Symbol – Status display
5. Button – Set time and day

6. Button – Select memory (1 – 3), activate preselected time
7. Button – Switch on heater
8. Button – Set time, day, and preselected time; shorten heating period (min. 1 minute)
9. Button – Set time, day, and preselected time; lengthen heating period (max. 120 minutes)
10. Air Heater only, adjustable temperature selection transformer – adjustment range from 50 °F to 86 °F (+10 °C to +30 °C)

NOTE: All symbols and digits in the display will flash if the battery voltage has been interrupted over a longer period of time. The timer must be reset.

The heater cannot be switched on until the time of day has been set.

The timer lights up when the heater is switched on.

4



126 UNDERSTANDING YOUR INSTRUMENT PANEL

Switching the Auxiliary Heater On and Off - Ignition Off

To switch it on:

Press button .

The vehicle-side blower automatically switches on.

Display: Symbol  and remaining heating period. The remaining heating period can be lengthened by using the button  (max. of 120 minutes); it may be shortened by using the button  (min. of 1 minute).

To switch off:

Press button  again.

The blower inside the vehicle automatically switches off. The auxiliary heater will automatically switch off after about 3 minutes.

Display: Current time and current day of the week (about 15 seconds).



Switching the Auxiliary Heater On and Off - Ignition On

To switch it on:

Press the button .

The auxiliary heater is running.

Display: Symbol , current time and current day of the week.

If the ignition is switched off, the auxiliary heater will remain on for another 15 minutes before automatically switching off. The remaining heating period can be lengthened by using the button  (max. of 120 minutes); it may be shortened by using the button  (min. of 1 minute).

To switch off:



Press the button  again.

The auxiliary heater will automatically switch off after about 3 minutes.

Display: Current time and current day of the week.

Setting the time and day

Press the button  until the "Time" display begins to flash.

Use either the button  or  to set the current time. The current time has been saved when the display stops flashing or the button  is used for confirmation.

The "Day" display then flashes.

Use either the button **<** or **>** to set the current day of the week. The current day has been saved when the display stops flashing or the button **⏻** is used for confirmation.

When the ignition is switched on, the current time and day remain on display. When the ignition is switched off, the display disappears after about 15 seconds.

Setting/Activating Preselected Times

3 preselected times may be saved.

Setting preselected times:

Press the button **P** repeatedly until the desired memory (1 – 3) flashes.

Briefly press the button **<** or **>** – the preselected time will flash.

Use either the button **<** or **>** to set the preselected time. The current preselected time has been saved when the display stops flashing.

Activate the preselected time (up to 24 hours):

Press the button **P** until the desired memory (1 – 3) and the preselected time both flash.

The preselected time has been activated when the display stops flashing. Within the next 24 hours, the heater will switch on at the preselected time displayed.

Activate the preselected time (from 24 hours to a max. of 7 days):

4

A preselected time may be chosen up to 7 days beforehand.

Press the button **P** until the desired memory (1 – 3) and the preselected time both flash.

After about 5 seconds, the "Preselected Day" display will appear – use either the button **<** or **>** to set the preselected day.

The preselected time and day have been activated when the display stops flashing and when the current time, activated memory, and the flashing symbol **!!!** appear in the display.

To call up the activated memory:

Briefly press the button **P** – the preselected day and time will be displayed for about 5 seconds.

128 UNDERSTANDING YOUR INSTRUMENT PANEL

Switching off preselected times:

Press the button **P** repeatedly until no memory is displayed – no preselected time is activated.

Setting the Heating Period

Settings between 1 minute and 120 minutes may be set for heating periods to run when the ignition is switched off.

Do not switch on the heater.

Press the button **◀** until the current heating period begins to flash.

Use either the button **◀** or **▶** to set the desired heating period. The new heating period will be saved as soon as the display disappears.

Auxiliary Heater Operation

The symbol  appears in the timer display as soon as the heater is switched on. After about 20 to 50 seconds, the heater runs with the complete flow of heat, so that the operating temperature is reached as soon as possible.

Heat operation:

Different operating conditions will be in effect depending on the heat level required.

The integrated control unit adjusts the heat flow using the following operating levels:

Water heater: High – Low – Off

Air heater: Power – High – Medium – Low – Off

Safety Equipment

For safety reasons, the heater will automatically switch off if faults occur which cause the device to overheat.

Tips for Coping with Problems; refer to "Auxiliary Heater – Tips for Coping with Problems".

The integrated control unit contains a diagnostic system which detects and stores faults. The error can be read by means of the vehicle diagnosis. If a fault occurs while the heater is switched on, the symbol  will flash and the error code for that fault will be displayed in the timer.

The fault should be corrected as soon as possible by an authorized Sprinter Dealer.

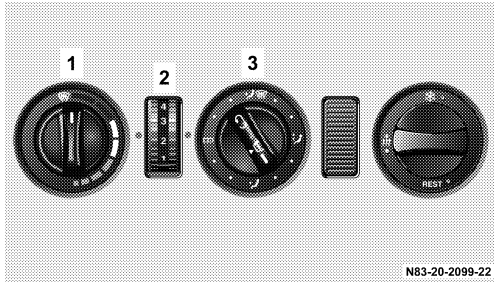

**Settings with the Auxiliary Heater switched on
(only with Water Heater)**



In preheat mode, the blower is automatically switched on at blower speed 1 when the water heater is switched on. When driving, the airflow control switch (2) can be set as desired.

NOTE: Only on vehicles with automatic heater control/regulated air conditioner:

Before switching on the heater or entering the switch-on time, the temperature control (1) must be set to maximum heater output (as illustrated).

Set the air distribution control (3) as required between  and .

4

**AUXILIARY HEAT EXCHANGER IN LOAD
COMPARTMENT, ONLY WITH AUXILIARY WATER
HEATER (OPTIONAL)**



The auxiliary heat exchanger switch is located on the right next to the steering column.

130 UNDERSTANDING YOUR INSTRUMENT PANEL

To switch on at blower speed 1:

Press the upper section, the left-hand indicator lamp in the switch lights up.

To switch on at blower speed 2:

Press the lower section, the right-hand indicator lamp in the switch lights up.

To switch off :

Press the switch to the middle position.

Operation is only possible when the key is turned to position 2 in the ignition lock.

NOTE: The auxiliary heat exchanger in the load compartment should be switched off at coolant temperatures below 176 °F (+80 °C) to quickly de-fog and de-ice the windshield and front side windows.

AUXILIARY HEATER – TIPS FOR COPING WITH PROBLEMS

The heater either does not switch on or automatically switches off:

- Insufficient fuel, fill up the fuel tank. Start up heater several times, until the fuel lines are filled.
- The auxiliary heater will automatically switch off if the fuel level is under about 4 US gal (15 l).
- The fuses in the fuse box are damaged. Electric fuses.
- The battery voltage is too low, an undervoltage protector switches off the heater if the battery voltage falls below about 10 volts.

The heater motor does not run

- The battery voltage is too low, check the battery. Batteries.
- The fuses in the fuse box are damaged. Electric fuses.
- The heater motor is damaged.

Overheating (Water Heater)

- Insufficient coolant, check coolant level.
- The heater will remain switched off after it has been overheated a number of times (about 10 times in succession). Have the fault repaired by an authorized Sprinter Dealer.

Overheating (Air Heater)

- The air channels are clogged.
The heater can be restarted once the fault has been repaired. When this is done, the heater should be switched on and off.
- The heater will remain switched off after it has been overheated a number of times (about 3 times in succession). Have the fault repaired by an authorized Sprinter Dealer.

4

NOTE: Repairs should only be made by an authorized Sprinter Dealer.

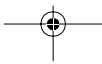

STARTING AND OPERATING

CONTENTS

■ Power assistance	135	■ Brakes	146
■ Starting the Engine	135	□ Service Brake	146
□ Maximum Engine Speed	136	□ Brake Pad Wear Indicator	147
□ Constant RPMs (Optional)	137	□ Brake Indicator and Electronic Brake Force Distribution (EBD) Indicator Lamp	148
■ Stopping the Engine	138	□ Parking Brake Indicator Lamp	149
■ Automatic Transmission	139	□ Parking Brake	150
□ Driving	139	□ Driving Systems	151
□ Accelerator Position	140	□ Anti-Lock Brake System (ABS) Indicator Lamp	152
□ Stopping	140	□ Anti-Lock Brake System (ABS)	153
□ Maneuvering	140	□ Electronic Brake Force Distribution (EBD) ..	155
□ Selector Lever Position	141	□ Acceleration Skid Control Indicator Lamp (ASR) and Brake Assist System (BAS) if equipped	155
□ Gear Selection for Special Circumstances	142	□ Acceleration Skid Control (ASR) Warning Lamp and Electronic Stability Program (ESP)- if equipped	157
■ Transmission Selector Lever, Manually Unlocking	144	□ Acceleration Skid Control (ASR)	158
■ Loading the Vehicle	144		
□ Loading Guidelines	145		

134 STARTING AND OPERATING

<ul style="list-style-type: none"> □ Deactivating the Acceleration Skid Control (ASR) 159 □ Brake Assist System (BAS) (Cargo/passenger vans type 2500 C/HC/SHC only) 160 □ Indicator Lamp Electronic Stability Program (ESP) (Cargo/passenger vans type 2500 C/HC/SHC only) 161 □ Electronic Stability Program (ESP) (Cargo/passenger vans type 2500 C/HC/SHC only) .. 162 ■ Steering 163 ■ Wheels and Tires 163 <ul style="list-style-type: none"> □ Tire Grip 165 □ Hydroplaning 165 ■ Tire Pressures 165 <ul style="list-style-type: none"> □ Tire Pressures of Loaded Vehicle in PSI (kPa) . 167 □ Tire Pressures of Loaded Vehicle in PSI (kPa) . 168 □ Comfort Tire Pressures in PSI (kPa) 169 □ Comfort Tire Pressures in PSI (kPa) 169 ■ Snow Chains 170 ■ Fuels 170 <ul style="list-style-type: none"> □ Fuel Filter with Water Separator 170 □ Diesel Fuels for Use at Very Low Temperatures 171 	<ul style="list-style-type: none"> ■ Refueling 172 <ul style="list-style-type: none"> □ Capacity 173 ■ Programmed Top Speed (Optional) 173 ■ Bleeding Diesel Fuel System 174 ■ Draining Fuel Filter with Water Separator 175 <ul style="list-style-type: none"> □ Bleeding the Diesel Fuel System 176 ■ Permissible Roof Load 177 ■ Trailer Towing 177 <ul style="list-style-type: none"> □ Trailer Hitches (Optional) 177 □ Electrical Connections (Optional) 177 □ Vehicle and Trailer Weights and Ratings 178 □ Loading a Trailer 178 □ Checking Weights of Vehicle and Trailer 179 □ Attaching a Trailer 179 □ Towing a Trailer 180 □ Parking a Trailer 182 ■ Emissions Control System (Catalytic Converter). 183 ■ Fording (Wading Capability) 183 ■ Body Builder Guideline 183 <ul style="list-style-type: none"> □ A Special Note Concerning Vehicle Alteration 184
--	--

POWER ASSISTANCE

WARNING!

When the engine is not running, there is no power assistance for the brake and steering system. In this case, it is important to keep in mind that a considerably higher degree of effort is necessary to brake and steer the vehicle.

STARTING THE ENGINE

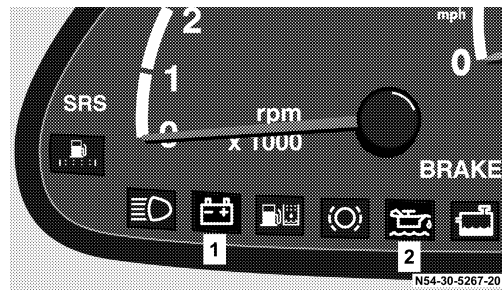

Battery charge warning lamp (1)

Engine oil level indicator lamp (2)

Preheater indicator lamp (3)

136 STARTING AND OPERATING

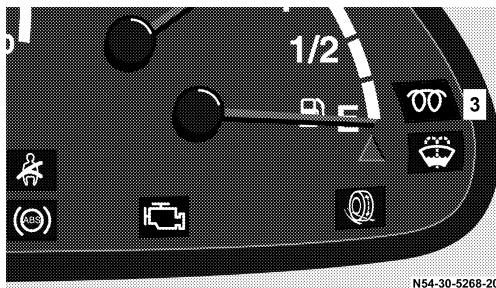

N54-30-5268-20

1. Apply the parking brake.
2. Automatic transmission, shift selector lever to "P" or "N" position, refer to "Automatic Transmission".
3. Do not depress the accelerator pedal.
4. Turn the key to position 2 in the ignition lock. The preheater indicator lamp lights up.
5. Turn the key clockwise to the stop as soon as the preheater indicator lamp goes out. If the engine is at its normal operating temperature, the preheater indicator lamp will only light up briefly.

Release the key as soon as the engine is running.

NOTE: The key must be returned to position 0 in the ignition lock before repeating the starting procedure.

If the display lights up alternately with in the multi-function display, there is an immobilizer malfunction or the key used has not been programmed.

The engine oil level warning lamp and the battery charge warning lamp must go out after the engine is started.

If either lamp remains on, stop the engine at once and have the cause traced and repaired by an authorized Sprinter Dealer.

During the trip, check the displays and the warning/indicator lamps in the instrument cluster at regular intervals.

For instrument cluster and indicator lamps.

Maximum Engine Speed

The maximum engine speed for all vehicles is 4,200 rpm.



Constant RPMs (Optional)

The switch for the Constant RPMs is located on the center section of the dashboard.

Constant RPMs increases the engine-idling RPMs to a set working-RPM level and maintains this level regardless of work load.

It can only be used when the vehicle is stationary, the parking brake is engaged and the gear selector level is in position "P".

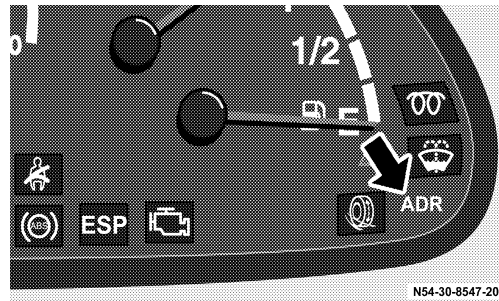

5

Constant RPMs indicator lamp

To switch it on:

- Press the top of the switch; the indicator lamp in the switch and the constant RPMs indicator lamp **ADR** will light up.

To switch off

- Press bottom of switch.

138 STARTING AND OPERATING

NOTE: The Constant RPMs will automatically switch off when the parking brake is released, the vehicle is in motion or the control unit detects a malfunction.

The Constant RPMs will also automatically switch off when you depress the brake pedal. In this case it will automatically switch on again as soon as you release the brake pedal.

STOPPING THE ENGINE

After having brought the vehicle to a stop:

1. Do not depress the accelerator pedal.
2. Apply the parking brake.
3. Turn the key back to position 0 in the ignition lock.

NOTE: When the engine is very hot, such as after climbing a long steep slope, allow the engine to idle for 1 to 2 minutes so that it can return to its normal operating temperature.

For notes on the parking brake.

AUTOMATIC TRANSMISSION

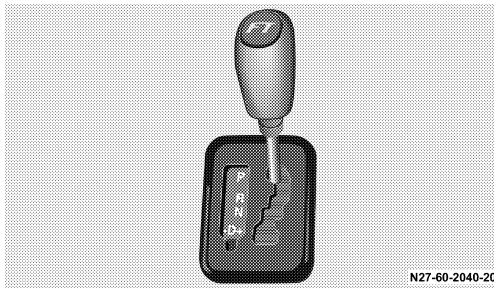

The automatic transmission selects individual gears automatically, dependent upon:

- Selector lever position
- Accelerator position
- Vehicle speed

The gear shifting process is continuously adapted, dependent on the driving style, the driving situation and the road characteristics.

NOTE: When parking the vehicle or before working on the vehicle with the engine running, apply the parking brake and shift the selector lever into "P".

Driving

The selector lever is automatically locked while in position "P". To move the selector lever out of position "P", the service brake is applied and the key in position 2 in the ignition lock or the engine running before the shift lock will release.

Shift selector lever to the desired position only when the engine is idling normally and the service brake is applied. Do not release the brake until ready to drive. The vehicle may otherwise start creeping when the selector lever is in drive or reverse position.

5

WARNING!

It is dangerous to shift the selector lever out of "P" or "N" if the engine speed is higher than idle speed. If your foot is not firmly on the brake pedal, the vehicle could accelerate quickly forward or in reverse. You could lose control of the vehicle and hit someone or something. Only shift into gear when the engine is idling normally and when your right foot is firmly on the brake pedal.

140 STARTING AND OPERATING

NOTE: After selecting any driving position from "N" or "P", wait a moment to allow the gear to fully engage before accelerating, especially when the engine is cold.

Accelerator Position

Partial throttle, for early upshifting and normal acceleration

Full throttle, for later upshifting and rapid acceleration

Kickdown, (depressing the accelerator beyond full throttle) for downshifting to a lower gear and maximum acceleration. Once the desired speed is attained, ease up on the accelerator, the transmission shifts up again.

Stopping

For brief stops, such as at traffic lights, leave the transmission in gear and hold vehicle with the service brake.

For longer stops with the engine idling, shift into "N" or "P" and hold the vehicle with the service brake.

When stopping the vehicle on an uphill grade, do not hold it with the accelerator, use the brake. This avoids unnecessary transmission heat build up.

Maneuvering

To maneuver in tight areas, such as when pulling into a parking space, control the vehicle speed by gradually releasing the brakes. Accelerate gently and never abruptly step on the accelerator.

To rock a vehicle out of soft ground (mud or snow), alternately shift from forward to reverse, while applying slight partial throttle.

WARNING!

Getting out of your vehicle with the selector lever not fully engaged in position "P" is dangerous. Also, when parked on an incline, position "P" alone may not prevent your vehicle from moving, possibly hitting people or objects.

Always set the parking brake in addition to shifting to position "P".

When parked on an incline, also turn front wheel against curb.

Selector Lever Position

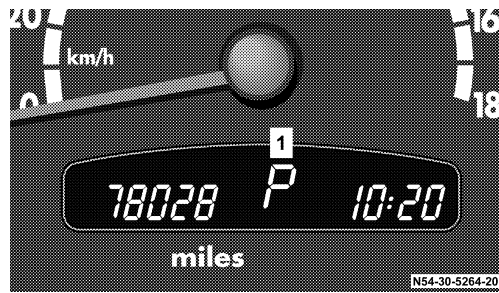

The current selector lever position (1) is indicated in the gear range indicator display. The automatic gear shifting process can be adapted to specific operating conditions using the selector lever.

P Park Position

The park position is to be used when parking the vehicle. Engage only with the vehicle stopped. The park position is not intended to serve as a brake when the vehicle is parked. Rather, the driver should always use the parking brake in addition to placing the selector lever in park position to secure the vehicle.

NOTE: With a malfunction in the vehicle's electrical system the selector lever could remain locked in position "P". To unlock the selector lever manually, refer to "Transmission Selector Lever, Manually Unlocking".

5

R Reverse Gear

Shift to reverse gear only with the vehicle stopped.

N Neutral

No power is transmitted from the engine to the drive axle. When the brakes are released, the vehicle can be moved freely (pushed or towed). Do not engage "N" while driving as you may otherwise lose control of the vehicle.

142 STARTING AND OPERATING

NOTE: Coasting the vehicle, or driving with selector lever in "N" can result in transmission damage that is not covered by the Sprinter Warranty.

- The transmission automatically upshifts through 5th gear. Position "D" provides optimum driving characteristics under all normal operating conditions.

Gear Selection for Special Circumstances

The transmission gear ranges for special circumstances can be selected by pushing the selector lever to the right or the left with the selector lever in position "D".

The gear range currently selected is indicated in the instrument cluster display.

Briefly press selector lever in the **←** direction:
The transmission downshifts, one gear range at a time, in the order "4", "3", "2", "1".

Press and hold selector lever in the **←** direction:
The transmission will shift to a gear range which favorably accelerates or decelerates the vehicle. This way downshiftings can be caused.

Briefly press selector lever in the **→** direction:
The transmission will shift from the current gear range to the next higher gear range. If the transmission is already in gear range "D", an additional upshift of one gear is not possible.

Press and hold selector lever in the **→** direction:
The transmission will shift from the current gear range directly to gear range "D".

WARNING!

On slippery road surfaces, never downshift in order to slow the vehicle down. This could result in drive wheel slip and reduced vehicle control. Your vehicle's ABS will not prevent this type of loss of control.

NOTE: With transmission in gear range "D", "4" or "3", upshifting from 1st to 2nd to 3rd gear is delayed depending on vehicle speed and engine temperature. This allows the catalytic converter to heat up more quickly to operating temperatures.

During the brief warm-up period this delayed upshift and increased engine noise might be perceived as a malfunction. However, neither the engine nor

transmission are negatively affected by this mode of operation.

The delayed upshift is effective with vehicle speeds below 31 mph (50 km/h) at partial throttle and engine temperatures below 95 °F (+35 °C).

To avoid overrevving the engine when the selector lever is moved to a lower gear, the transmission will not shift to a lower gear if the engine's revolutions per minute limit would be exceeded. In this case there will be no downshift, even when the vehicle speed reaches the engine's rpm limit of that gear, for example by applying the service brakes.

To prevent the engine from laboring at low rpm when driving uphill grades or with your vehicle heavily loaded, the automatic transmission will downshift when necessary to maintain engine rpm within the best torque range.

Gear

- 4** Upshift through 4th gear only. Suitable for performance driving.
- 3** Upshift through 3rd gear only. Suitable for moderately steep hills. Since the transmission does not shift higher than 3rd gear, this gear selection will allow use of the engine's braking power downhill.
- 2** Upshift through 2nd gear only. For driving in mountainous regions or under extreme operating conditions. This gear selection will allow use of the engine's braking power when descending steep grades.
- 1** Use this position, which makes maximum use of the engine's braking effect, while descending very steep or lengthy downgrades and only at speeds below 25 mph (38 km/h).

5

144 STARTING AND OPERATING

TRANSMISSION SELECTOR LEVER, MANUALLY UNLOCKING

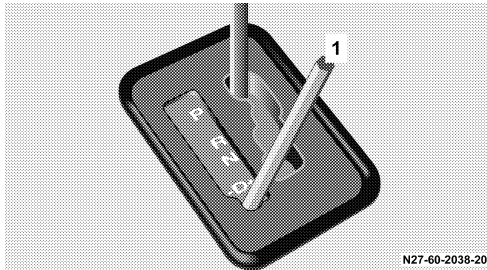

In the case of power failure the transmission selector lever can be manually unlocked (for vehicle towing).

To do so, insert a pin (1) (ball point pen), into the covered opening below the position "D" of the shift pattern. While pushing the pin down, move selector lever from position "P".

After removal of the pin from the opening, the cover will not close fully. Only after moving the selector lever to positions "D+" and "D-" does the cover return to its closed position.

LOADING THE VEHICLE

WARNING!

Do not overload the tires by exceeding the specified vehicle capacity weight (as indicated by the label on the base of the driver's seat). Overloading the tires can overheat them, possibly causing a blowout, which could cause an accident and personal injury.

In addition, braking and stopping distances can be significantly longer if the vehicle is overloaded.

WARNING!

Always close the sliding and rear doors when driving.

Otherwise exhaust fumes could enter the vehicle interior and poison you.

WARNING!

Unsecured or poorly secured loads, and seats that have been removed, could move around the vehicle interior uncontrollably in the event of sudden braking, a rapid change in direction or an accident. This increases the risk of injury to occupants in these situations.

Secure and position a load as described in the following loading guidelines.

Piling up heavy objects or placing them on upper shelves or loading them otherwise high up in the vehicle will significantly raise the center of gravity of the vehicle. Placing excessive loads on individual points of the load surface or behind the rear axle will also adversely affect the handling characteristics of your vehicle and may lead to loss of control over the vehicle.

Road safety and tire durability are adversely affected if the permissible axle loads or gross vehicle weight are exceeded due to the vehicle's load. Braking and stopping distances can be significantly longer.

The handling characteristics of a vehicle when laden are dependent on the type of load and the distribution of the load within the vehicle.

Carrying heavy or bulky loads may alter the vehicle's handling characteristic.

Loading Guidelines

Please note and comply with the following information when loading and transporting goods.

5

- Do not allow the load, including passengers, to exceed the permitted gross vehicle weight or the permitted axle loads for the vehicle. Bear in mind that the unladen weight could be increased by installing items of optional equipment and accessories.
- Distribute the load uniformly. Excessive loads on individual points of the load surface could cause damage to the floor covering.
- Transport heavy loads between the axles near the rear axle as low as possible in the vehicle.
- Secure any kind of load with sufficient wear and tear-resistant load restraints. Lashing rings.

146 STARTING AND OPERATING

- Protect sharp edges with padding.
- Check the tire pressures after loading the vehicle.

For passenger vans:

- Do not stack loads higher than the upper edge of the backrests.
- Always place the load against the backrests of the seat benches.
- Whenever possible, transport loads behind seats that are not occupied.
- Distribute the load in such a way that the permissible axle loads are not exceeded when the vehicle is equipped with the maximum number of seats. Loading the luggage compartment up to the maximum payload would cause the permissible rear axle load to be exceeded.

BRAKES Service Brake

WARNING!

When the engine is not running, the brake and steering systems are without power assistance. Under these circumstances, a much greater effort is necessary to stop or steer the vehicle.

After driving in heavy rain for some time without applying the brakes or through water deep enough to wet brake components, the first braking action may be somewhat reduced and increased pedal pressure may be necessary. Be sure to maintain a safe distance from vehicles in front.

Resting your foot on the brake pedal will cause excessive and premature wear of the brake pads. It can also result in the brakes overheating, thereby significantly reducing their effectiveness. It may not be possible to stop the vehicle in sufficient time to avoid an accident.

NOTE: On long and steep downhill slopes, reduce the load on the brakes by shifting down a gear to utilize the braking effect of the engine.

To prevent corrosion on the brake pads, after driving on very wet roads, especially if road salts have been used, apply brakes before parking the vehicle. The heat generated will help to dry the brake disks.

Brake Pad Wear Indicator

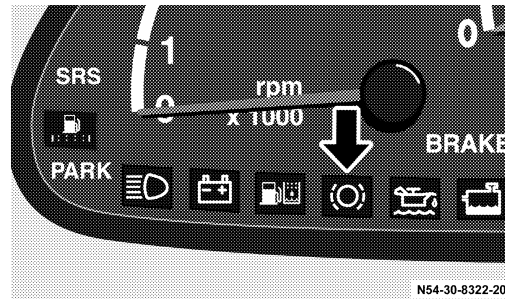

When the key is turned to position 2 in the ignition lock, the indicator lamp  in the instrument cluster lights up for about 2 seconds. It must go out when the engine is running.

If the  indicator lamp lights up while the engine is running, the brake pads are worn almost to their limit.

Have the brake system examined as soon as possible by an authorized Sprinter Dealer.

148 STARTING AND OPERATING

Brake Indicator and Electronic Brake Force Distribution (EBD) Indicator Lamp

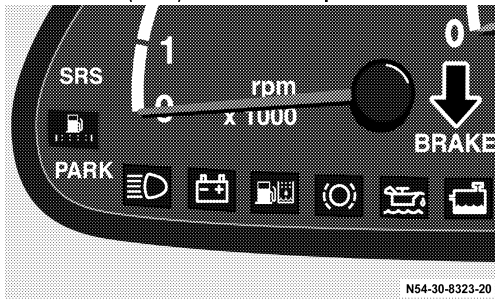

BRAKE USA only

(Ⓣ) Canada only

With the key in position 2 in the ignition lock and the parking brake released, the indicator lamp **BRAKE** **(Ⓣ)** lights up for about 2 seconds.

If the indicator lamp does not go out after about 2 seconds, the brake fluid level has sunk below the minimum filling capacity.

If the brake indicator lamp comes on while driving, the brake fluid level is below the minimum filling capacity or the electronic brake force distribution (EBD) is malfunctioning.

For information on the electronic brake force distribution, refer to "Electronic Brake Force Distribution (EBD)".

WARNING!

Driving with the brake indicator lamp **BRAKE** () illuminated can result in an accident. There may be a malfunction in the brake system or in the electronic brake force distribution. The braking characteristics are affected and the vehicle could skid if it is braked hard.

Have your brake system checked immediately if the brake indicator lamp **BRAKE** () stays on. Do not add brake fluid before checking the brake system. Overfilling the brake fluid reservoir can result in spilling brake fluid on hot engine parts and the brake fluid catching fire. There is a risk of injury due to hot engine parts or hot steam.

NOTE: If you find that the minimum mark on the brake fluid reservoir is reached, have the brake system checked for pad thickness and leaks.

Parking Brake Indicator Lamp

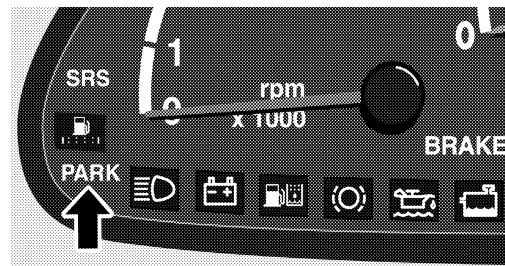

With the key in position 2 in the ignition lock and the parking brake released, the indicator lamp **PARK** lights up for about 2 seconds.

If the parking brake is on, the indicator lamp **PARK** does not go out before the parking brake is released.

150 STARTING AND OPERATING

Parking Brake

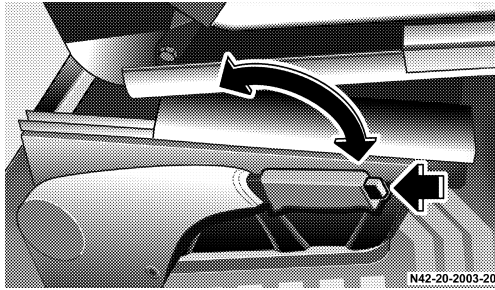

Only apply the parking brake when the vehicle is stationary.

To apply:

Pull the lever up as many notches as possible. When the key is in position 2 in the ignition lock, the parking brake indicator lamp **PARK** will light up in the instrument cluster.

To release:

Lift the lever up slightly, press the button on the lever in and move the lever down to the stop. The parking brake indicator lamp **PARK** should go out.

WARNING!

Always fully apply the parking brake when leaving your vehicle, or vehicle may roll and cause damage or injury.

WARNING!

On uphill or downhill grades steeper than 15% the vehicle must be safeguarded. Vehicles which are not secured could roll away and result in severe personal injuries, death and property damage.

Safeguard an unloaded vehicle by chocking the front axle.

Safeguard a loaded vehicle by chocking the rear axle.

WARNING!

When leaving the vehicle always remove the key from the ignition lock, and lock your vehicle.

Do not leave children unsupervised in the vehicle, even if they are secured by a child restraint system. The children could

- injure themselves on parts of the vehicle
- release the child-proof locks by pressing the central locking button and could thereby open the doors and
- cause injury to others as a result
- get out of the vehicle and could either injure themselves when doing so or they could be injured by the traffic approaching from the rear
- suffer serious or fatal effects in the event of long periods of hot weather
- release the parking brake. The vehicle could then start moving of its own accord.

Unsupervised use of vehicle equipment may cause severe personal injuries, death and property damage.

Driving Systems

The vehicle can be equipped with the following Driving Safety Systems:

- Anti-lock brake system (ABS)
- Electronic brake force distribution (EBV)
- Acceleration skid control (ASR)
- Brake assist system (BAS)¹
- Electronic stability program (ESP)¹

NOTE: The maximum effectiveness of ABS, EBV, ASR and ESP is only achieved if you drive with correct tire pressures and adjust tire pressures to correspond with the vehicle's load. In winter operation, the maximum effectiveness of the ABS and the ESP is only achieved with winter tires (M+S tires), or snow chains as required.

152 STARTING AND OPERATING

WARNING!

The following factors increase the risk of accidents:

- Excessive speed, especially in turns
- Wet and slippery road surfaces
- Following another vehicle too closely

The ABS, EBV, ASR, BAS and ESP cannot reduce this risk nor can they prevent the natural laws of physics from acting on the vehicle.

Always adapt your speed and driving style to the prevailing road, traffic and weather conditions and maintain a safe distance between your vehicle and other road users as well as objects on the road.

Anti-Lock Brake System (ABS) Indicator Lamp

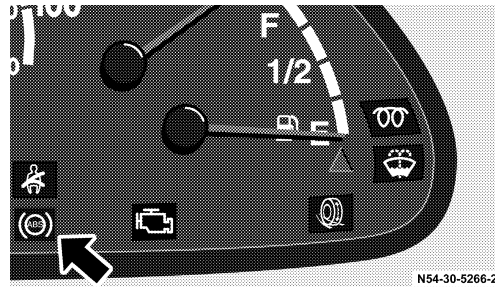

When the key is in position 2 in the ignition lock, the ABS indicator lamp  will light up in the instrument cluster. It goes out after about 2 seconds.

If the ABS indicator lamp  remains on or lights up when the engine is running, the ABS is malfunctioning.

NOTE: If the voltage in the vehicle's electrical system drops below 10 volts, the ABS indicator lamp  will also light up in the instrument cluster and the ABS will be deactivated. The indicator lamp will go out as soon

as the voltage reaches this level again – the ABS is then reactivated.

If ABS malfunctions, the other driving safety systems are deactivated. The handling and braking characteristics of your vehicle change. The other braking and driving systems still function normally.

WARNING!

If the ABS indicator lamp  does not go out or lights up again while driving, the ABS is malfunctioning. If ABS malfunctions, the other driving safety systems are deactivated. The vehicle's braking characteristics may be affected. There is an increased risk that your vehicle could skid in the event of sharp braking. Have the malfunction traced and repaired without delay by an authorized Sprinter Dealer.

Adapt your speed and driving style to the prevailing road, traffic and weather conditions. Driving too fast increases the risk of an accident.

Anti-Lock Brake System (ABS)

ABS prevents the wheels from locking at any speed above about 5 mph (8 km/h), regardless of road surface conditions. The vehicle remains steerable even if the brakes are applied fully.

A light vibrating of the steering wheel and pulsating of the brake pedal indicate that the ABS is working.

On slippery road surfaces, the ABS will respond even with light brake pedal pressure because of the increased likelihood of locking wheels. The pulsating brake pedal can be an indication of hazardous road conditions and works as a reminder to take extra care while driving.

5

154 STARTING AND OPERATING

WARNING!

Do not reduce the force applied to the brake pedal if it is necessary to brake the vehicle further. This will negate the main benefit of ABS – the ability to brake without affecting the steerability of the vehicle.

In the event of an emergency stop, fully depress the brake pedal. Do not pump the brake pedal, rather use firm, steady brake pedal pressure. Pumping the pedal defeats the purpose of ABS and significantly reduces braking effectiveness.

WARNING!

Anti-lock brake system (ABS) cannot prevent the natural laws of physics from acting on the vehicle, nor can it increase braking or steering efficiency beyond that afforded by the condition of the vehicle brakes and tires or the traction afforded.

The ABS cannot prevent accidents, including those resulting from excessive speed in turns, following another vehicle too closely, or hydroplaning. Only a safe, attentive, and skillful driver can prevent accidents.

The capabilities of an ABS equipped vehicle must never be exploited in a reckless or dangerous manner which could jeopardize the user's safety or the safety of others.

Adapt your speed and driving style to the prevailing road, traffic and weather conditions. Driving too fast increases the risk of an accident.

Electronic Brake Force Distribution (EBD)

The electronic brake force distribution (EBD) prevents the rear wheels from being overbraked when there is little load on the rear axle or if there is not much friction between the tires and road (e.g., if the road is wet).

WARNING!

If the brake indicator lamp **BRAKE** (☹) does not go out or lights up again while driving, the brake fluid level may not necessarily have dropped below the minimum filling capacity but a malfunction may have occurred in the EBD. In this case continue driving, but with even greater care.

The wheels of the rear axle could lock if the vehicle is braked hard. This could lead to a skidding of the vehicle. Have the malfunction traced and repaired without delay by an authorized Sprinter Dealer.

Adapt your speed and driving style to the prevailing road, traffic and weather conditions. Driving too fast increases the risk of an accident.

Acceleration Skid Control Indicator Lamp (ASR) and Brake Assist System (BAS) if equipped

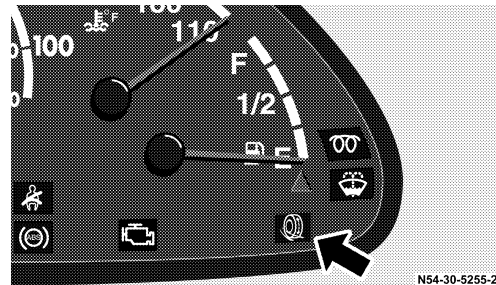

5

When the key is in position 2 in the ignition lock, the indicator lamp **ASR/BAS** will light up in the instrument cluster as a function check. It goes out when the engine is running.

NS4-30-5255-20

156 STARTING AND OPERATING

If the indicator lamp  remains on or lights up when the engine is running, the acceleration skid control (ASR) or the brake assist system (BAS) is malfunctioning.

Then the ASR will be switched off automatically.

NOTE: If the ABS is malfunctioning or the voltage in the vehicle's electrical system drops below 10 volts, the indicator lamp  will also light up in the instrument cluster and the ASR and the BAS will be deactivated. The indicator lamp will go out as soon as the voltage reaches this level again or the ABS is operational again – the ASR and the BAS are then reactivated.

If a malfunction is present in the acceleration skid control (ASR), the engine's power output may be reduced.

WARNING!

If the indicator lamp  remains on, the acceleration skid control (ASR) or the brake assist system (BAS) is malfunctioning.

Your vehicle's handling characteristics can change. Drive with extra caution.

Have the malfunction traced and repaired as soon as possible by an authorized Sprinter Dealer.

Acceleration Skid Control (ASR) Warning Lamp and Electronic Stability Program (ESP) – if equipped

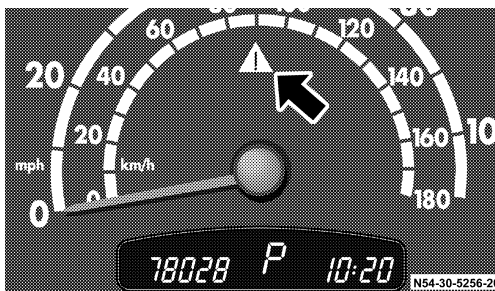

When the key is in position 2 in the ignition lock, the warning lamp  in the speedometer will light up for about 2 seconds. It must go out when the engine is running.

The warning lamp  flashes when:

- The ASR or ESP is activated.
- The drive wheels spin with the ASR shut off.

The warning lamp  lights up when the ASR is shut off.

Deactivate the acceleration skid control, refer to "Deactivating Acceleration Skid Control (ASR)".

WARNING!

If the warning lamp  in the speedometer lights up or flashes:

- Do not deactivate the acceleration skid control (ASR).
- Only depress the accelerator pedal as far as necessary when pulling away.
- Ease off on the accelerator pedal when driving at a steady speed.
- Adapt your speed and driving style to the prevailing road, traffic and weather conditions.

Failure to heed these warnings could cause the vehicle to enter a skid and may result in an accident.

158 STARTING AND OPERATING

Acceleration Skid Control (ASR)

ASR makes it possible to pull away and accelerate on a slippery surface. A spinning wheel is braked and its tractive power is transferred to the wheel with full grip.

The acceleration skid control (ASR) improves driving stability at all speeds only on vehicles of the chassis and cargo/passenger vans type 3500 C/HC/SHC (without ESP).

The engine's torque is limited to improve driving stability. When this is happening, the warning lamp  in the speedometer flashes.

If the road surface is not capable of providing traction, bearing in mind the tires, load and grade, it may not be possible to pull away even with ASR.

If wheels with tires of a different size than those offered by an authorized Sprinter Dealer are used, the correct operation of the ASR cannot be guaranteed.

WARNING!

ASR cannot prevent the natural laws of physics from acting on the vehicle, nor can it increase the traction afforded.

The ASR cannot prevent accidents, including those resulting from excessive speed in turns, following another vehicle too closely, or hydroplaning. Only a safe, attentive, and skillful driver can prevent accidents.

The capabilities of an ASR equipped vehicle must never be exploited in a reckless or dangerous manner which could jeopardize the user's safety or the safety of others.

If the ASR function is used for a prolonged period of time, the rear axle brakes may fail due to overheating.

If the vehicle is to be towed away with the front wheels clear of the ground, or if the brakes are to be tested on a brake dynamometer, do not pull the key in position 2 in the ignition lock, because the drive wheels could lock.

Deactivating the Acceleration Skid Control (ASR)

See Section 4, Understanding Your Instrument Panel, for switch locations.



When driving with snow chains, in deep snow, or on sand or gravel, it can be beneficial to deactivate the acceleration skid control (ASR).

The engine's torque is then no longer limited and the drive wheels are free to spin, which can help them cut into loose surfaces.

The ASR can only be shut off with the engine running. If the engine is shut off with the ASR deactivated, the ASR is automatically re-activated after the engine is started again.

WARNING!

On a slippery road surface if both drive wheels start to spin there is a risk of skidding. Adapt your speed and driving style to the prevailing road, traffic and weather conditions.

Cargo/passenger vans type 2500 C/HC/SHC only:

If there is a danger of skidding, and/or starting at a speed of 38 mph (60 km/h) ESP activates ASR automatically.

WARNING!

Vehicles type 2500 C/HC/SHC only:

Even when ASR is deactivated, ESP remains active and regulates braking to improve stability as necessary. The warning lamp  flashes in the speedometer.

The danger of your vehicle's brake system overheating and being damaged is increased during long, demanding application of the brakes. Furthermore, an overheated brake system could result in a longer stopping distance.

Thus, only deactivate ASR if it is absolutely necessary.

160 STARTING AND OPERATING

To deactivate the ASR:

– Press the upper section of the switch – the warning lamp  in the speedometer lights up.

Traction control continues to cut in if, for example, a wheel on one side of the vehicle reaches its limit of adhesion. The wheel is then braked to increase the vehicle's overall traction.

The warning lamp  will flash in the speedometer at any speed when a tire reaches its limit of adhesion.

To activate the ASR:

– Press the upper section of the switch again – the warning lamp  in the speedometer goes out.

Brake Assist System (BAS) (Cargo/passenger vans type 2500 C/HC/SHC only)

The Brake Assist System (BAS) operates in emergency situations. If you apply the brakes very quickly, the BAS automatically provides full brake boost, thereby potentially reducing braking distance.

Apply continuous full braking pressure until the emergency braking situation is over.

The ABS will prevent the wheels from locking.

When you release the brake pedal, the brakes function again as normal. The BAS is then deactivated.

WARNING!

If the indicator lamp  remains on, a malfunction may not only have occurred in the ASR system but also in the BAS.

The handling and braking characteristics of your vehicle change. Drive with extra caution.

Have the malfunction traced and repaired as soon as possible by an authorized Sprinter Dealer.

For the indicator lamp  refer to "Indicator Lamp Acceleration Skid Control (ASR) and Brake Assist System (BAS)".

WARNING!

The Brake Assist system (BAS) cannot prevent the natural laws of physics from acting on the vehicle, nor can it increase braking efficiency beyond that afforded by the condition of the vehicle brakes and tires or the traction afforded.

The BAS cannot prevent accidents, including those resulting from excessive speed in turns, following another vehicle too closely, or hydroplaning. Only a safe, attentive, and skillful driver can prevent accidents.

The capabilities of an BAS equipped vehicle must never be exploited in a reckless or dangerous manner which could jeopardize the user's safety or the safety of others.

Adapt your speed and driving style to the prevailing road, traffic and weather conditions. Driving too fast increases the risk of an accident.

**Indicator Lamp Electronic Stability Program (ESP)
(Cargo/passenger vans type 2500 C/HC/SHC only)**

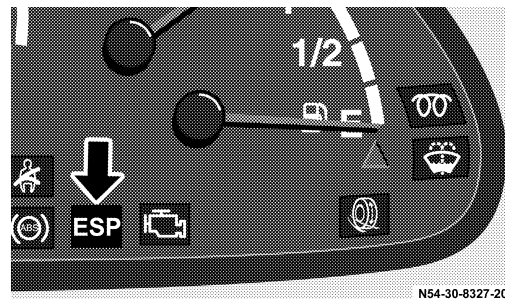

N54-30-8327-20

5

When the key is in position 2 in the ignition lock, the ESP indicator lamp  will light up in the instrument cluster as a function check. It goes out when the engine is running.

If the indicator lamp  remains on or lights up when the engine is running, the electronic stability program (ESP) is malfunctioning and switched off automatically. The engine's power output may be then reduced.

162 STARTING AND OPERATING

NOTE: If the ABS is malfunctioning or the voltage in the vehicle's electrical system drops below 10 volts, the indicator lamp  will also light up in the instrument cluster and the ESP will be deactivated. The indicator lamp will go out as soon as the voltage reaches this level again or the ABS is operational again – the ESP is then reactivated.

WARNING!

If the ESP indicator lamp  remains on, the electronic stability program (ESP) is malfunctioning. The vehicle stability will no longer be automatically regulated in good time.

The danger that your vehicle breaks into a skid, is increased in certain driving situations. Drive with extra caution.

Have the ESP repaired as soon as possible by an authorized Spinter Dealer.

Electronic Stability Program (ESP) (Cargo/passenger vans type 2500 C/HC/SHC only)

The Electronic Stability Program (ESP) monitors the vehicle's traction (force of adhesive friction between the tires and the road surface) and handling.

The ESP recognizes when a wheel is spinning or if the vehicle starts to skid. By applying brakes to the appropriate wheel and by limiting engine output, the ESP works to stabilize the vehicle. The ESP is especially useful while driving off and on wet or slippery wet surfaces.

The warning lamp  in the speedometer flashes when the ESP is engaged, refer also to "Warning Lamp Acceleration Skid Control (ASR) and Electronic Stability Program (ESP)".

If wheels with tires of a different size than those offered by an authorized Sprinter Dealer are used, the correct operation of the ESP cannot be guaranteed.

WARNING!

ESP cannot prevent the natural laws of physics from acting on the vehicle, nor can it increase the traction afforded.

The ESP cannot prevent accidents, including those resulting from excessive speed in turns, following another vehicle too closely, or hydroplaning. Only a safe, attentive, and skillful driver can prevent accidents.

The capabilities of an ESP equipped vehicle must never be exploited in a reckless or dangerous manner which could jeopardize the user's safety or the safety of others.

If the vehicle is to be towed away with the front wheels clear of the ground, or if the brakes are to be tested on a brake dynamometer, do not put the key in position 2 in the ignition lock because the ESP would engage the brakes to stabilize the vehicle.

If the ESP function is used for a prolonged period of time, the rear axle brakes may fail due to overheating.

STEERING

When the engine is not running, there is no power assistance for the steering. Greater force will be required to steer the vehicle.

WHEELS AND TIRES

Check tires regularly for even tread wear, tread depth (note legal requirements) and signs of external damage.

Only use wheels and tires of the same size, make and pattern.

Do not install tires that are not approved for the size and type of wheel installed on the vehicle itself. Only use those wheel sizes which were delivered to you by your authorized Sprinter Dealer.

Use only wheels and tires which have been tested and approved by the vehicle manufacturer.

Break in new tires at moderate speeds for a distance of about 65 miles (about 100 km).

164 STARTING AND OPERATING

WARNING!

Fitting other wheel sizes to the vehicle will change the vehicle's handling characteristics and may lead to an accident resulting in severe personal injuries, death and property damage.

Do not use retreaded/ remolded tires. This process does not always permit previous damage to the detected. Therefore vehicle safety cannot be guaranteed if retreaded/remolded tires are fitted.

WARNING!

A wheel could work loose. To avoid the risk of serious or fatal injuries or vehicle damage, please bear the following points in mind:

- Always replace wheel bolts that are damaged or rusted.
- Never apply oil or grease to wheel bolts.

If a wheel hub thread is damaged, you must not drive the vehicle. Consult a qualified specialist workshop.

- Be sure to use correct mounting bolts. Check tightness of wheel bolts or nuts regularly and retighten with a torque wrench, if necessary. Tighten wheel bolts or nuts in a cross-pattern sequence.

Mounting bolts and tightening torque, see Chapter 12, "Installing a Wheel".

- After changing a wheel, the wheel bolts or nuts must be tightened once the vehicle has been driven for about 30 miles (50 km).

If new or repainted wheels are fitted, the wheel bolts or nuts must be retightened again after about 600 to 3,000 miles (about 1,000 to 5,000 km).

Tire Grip

Tire grip is greatly reduced on a wet or icy road. Speed and driving style must therefore be adapted to suit road conditions.

In winter, install M+S radial tires.

Below a tread depth of 1/8 inch (3 mm), tire grip begins to decrease rapidly on wet roads.

Hydroplaning

Depending on the depth of the water layer on the road, hydroplaning may occur, even at low speeds and with new tires. Reduce vehicle speed, avoid grooves in the road, and apply brakes cautiously in the rain.

TIRE PRESSURES

WARNING!

If tire pressures are too low, there is a risk of the tire's tread deteriorating and sudden loss of pressure due to the excessive temperature of the tire. This has an adverse effect on road safety and increases the risk of an accident.

The limiting speed for the tires (tires and tire pressure) must not be exceeded. Exceeding the permissible maximum speed causes tire damage, which can lead to loss of control of the vehicle.

Do not overinflate tires. Overinflating tires can result in sudden deflation (blowout) because they are more likely to become punctured or damaged by road debris, potholes, etc. Follow recommended inflation pressures.

Do not overload the tires by exceeding the specified vehicle capacity weight as indicated by the label on the base of the driver's seat. Overloading the tires can overheat them, possibly causing a blowout, which could cause an accident resulting in severe personal injuries, death and property damage.

166 STARTING AND OPERATING

The vehicle's safety on the road depends to a great extent on tire condition and correct tire pressure.

If tire pressures are too high or too low, handling characteristics will be adversely affected and fuel consumption and tire wear will increase. Check tire pressures regularly (each time the vehicle is refueled).

Check tire pressures (including the spare wheel) with the tires cold. The pressure difference between the tires on a single axle should not exceed 1.5 psi (10 kPa). If tire pressure in individual tires is too low: check the valves, wheels and tires for signs of leaks.

After a period of fast driving, or in hot weather, tire pressures can increase by as much as 14.5 psi (100 kPa). Never release air from a warm tire or else the tire pressure will be too low.

NOTE: Tire pressure changes by about 1.5 psi (10 kPa) for every 18 °F (+10 °C) change in air temperature. For this reason, do not release pressure from tires when they are warm.

Remember to allow for this when checking tire pressures indoors, particularly in winter.

Example:

Room temperature: about 68 °F (+20 °C)

Outside temperature: about 32 °F (0 °C)

Required tire pressure, specified tire pressure 3 psi (20 kPa).

Information on tires can be obtained from any authorized Sprinter Dealer.

WARNING!

Correct the tire pressures before loading the vehicle fully. If the tire pressure is too low driving safety and tire mileage are decreased.

Tire Pressures of Loaded Vehicle in PSI (kPa)

Front Axle						
Size	Application	Axle loads in lbs (kg), see type plate				
		2,976 (1,350)	3,219 (1,460)	3,527 (1,600)	3,638 (1,650)	3,858 (1,750)
195/70 R 15 C 104/102 R	Single	47 (325)	51 (350)	–	58 (400)	65 (450)
225/70 R 15 C 112/110 R (115 N)	Single	36 (250)	36 (250)	40 (275)	–	51 (350)
LT 225/75 R 16 115 N	Single					55 (380)

168 STARTING AND OPERATING

Tire Pressures of Loaded Vehicle in PSI (kPa)

Rear Axle					
Size	Application	Axle loads in lbs (kg), see type plate			
		5,070 (2,300)	6,172 (2,800)	6,613 (3,000)	7,054 (3,200)
195/70 R 15 C 104/102 R	Double	40 (275)	51 (350)	55 (380)	65 (450)

Rear Axle							
Size	Application	Axle loads in lbs (kg), see type plate					
		3,307 (1,500)	3,748 (1,700)	3,968 (1,800)	4,409 (2,000)	4,938 (2,240)	5,357 (2,430)
225/70 R 15 C 112/110 R (115 N)	Single	43 (300)	47 (325)	51 (350)	58 (400)	65 (450)	70 (480)
LT 225/75 R 16 115 N	Single						80 (550)

Comfort Tire Pressures in PSI (kPa)

For reasons of comfort, we recommend setting the tire pressures according to the table below, depending on axle loads, on longer journeys with an unloaded or only partially loaded vehicle.

Front Axle					
Size	Application	Axle loads in lbs (kg), see type plate			
		2,315 (1,050)	2,646 (1,200)	2,976 (1,350)	3,219 (1,460)
195/70 R 15 C 104 / 102 R	Single	36 (250)	40 (275)	47 (325)	51 (350)
225/70 R 15 C 112 / 110 R (115 N)	Single	33 (225)	36 (250)	36 (250)	36 (250)

Comfort Tire Pressures in PSI (kPa)

Rear Axle						
Size	Appli- cation	Axle loads in lbs (kg), see type plate				
		1,764 (800)	2,205 (1,000)	2,646 (1,200)	3,307 (1,500)	3,748 (1,700)
195/70 R 15 C 104 / 102 R	Double	-	36 (250)	-	-	-
225/70 R 15 C 112 / 110 R (115 N)	Single	33 (225)	33 (225)	36 (250)	43 (300)	47 (325)

5

WARNING!

Correct the tire pressures before loading the vehicle fully. If the tire pressure is too low driving safety and tire mileage are decreased.

170 STARTING AND OPERATING

SNOW CHAINS

Install snow chains on rear wheels only. Install snow chains on exterior wheel in vehicles with double tires. Comply with the manufacturer's installation instructions.

NOTE: Vehicles with snow chains installed are only to be driven on a snow-covered surface. The snow chains must be removed on road surfaces free of snow.



FUELS

Use only commercially available vehicular diesel fuels No. 2 or No. 1 (ASTM D 975 No. 2-D or No. 1-D).

If diesel fuels are used with a sulphur content exceeding 0.05 % by weight, engine oil change intervals must be shortened. Please contact your Sprinter Dealer to obtain the necessary information. Marine diesel fuel, heating oil or the like must not be used.

Refueling from drums or canisters may lead to the fuel becoming contaminated. This in turn can cause faults in the fuel system. Always filter the fuel before adding it to the vehicle's tank.

Fuel Filter with Water Separator

Check the water separator when the fuel indicator lamp  does not go out or comes on while the engine is running. For more information on the indicator lamp .

The interval for changing the fuel filter is reduced to 10,000 miles (about 15,000 km).

Diesel Fuels for Use at Very Low Temperatures

At very low temperatures the fluidity of No. 2 diesel fuel may become insufficient due to paraffin separation. For this reason the vehicle comes equipped with a fuel preheater. It permits a troublefree engine operation to a temperature of approximately 14 °F (-10 °C) when using No. 2 diesel fuel.

To avoid malfunctions, No. 2 diesel fuel of a lowered cloud point is marketed during the cold season.

At temperatures below 14 °F (-10 °C) use winterized or No. 1 diesel fuel only. If not available, a certain quantity of kerosene or fuel flow improver may be added. Mixing only to be done within the vehicle's fuel tank. Kerosene has to be filled in before the diesel fuel.

Engine power may drop according to the proportion of kerosene. For this reason, keep percentage of kerosene added to the minimum necessitated by the ambient temperature.

The following information can be used as a reference, if adding of kerosene becomes necessary. The mixing ratios shown refer to the total mixture.

Ambient temperature:

14 °F to -4 °F (-10 °C to -20 °C)

No. 2 Diesel Fuel: 70%

Kerosene: 30%

Ambient temperature:

below -4 °F to (-20 °C)

No. 2 Diesel Fuel: 50 %

Kerosene: 50 %

Even in extreme climatic conditions, the maximum mixture ratio should not exceed 50 %.

Adding of kerosene to No. 1 diesel fuel is not recommended even at low temperatures.

Do not blend other specific fuel additives with diesel fuel except for fuel flow improver. They only result in unnecessary cost, and may be harmful to the engine operation.

Damage or malfunctions resulting from poor fuel quality or from blending specific fuel additives are not covered by the Sprinter Warranty.

172 STARTING AND OPERATING

WARNING!

Under no circumstances should gasoline be mixed with diesel fuel.

Due to the high pressure and high temperature in the injection system, there is a risk of fire and explosion.

In addition, there is a risk of engine damage.

Always follow basic safety rules when working with any combustible material.

REFUELING

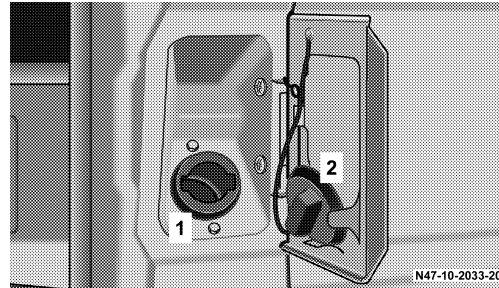

The fuel filler neck (1) is located behind the fuel filler flap next to the driver's door. The fuel filler flap can be opened when the driver's door is open. Turn the fuel filler cap (2) on the fuel filler neck (1) counterclockwise and take it off. For cargo/passenger vans, place the fuel filler cap (2) in the holder on the inside of the fuel filler flap.

When you have finished refueling, install the fuel filler cap (2).

NOTE: Only fill the fuel tank until the fill nozzle cuts off, do not overfill.

NOTE: Holder on the inside of the fuel filler flap only for cargo/passenger vans.

WARNING!

Always handle fuel with great care.

Shut off the engine and the auxiliary heater before refueling.

Fuel is flammable and explosive. Keep open flames away from the fuel.

Refrain from smoking as well as use of any electrical equipment (such as cell phones). This also applies to places where the characteristic smell of fuel is evident.

If diesel fumes are noticed inside the vehicle, have the cause traced and rectified immediately by an authorized Sprinter Dealer.

Capacity

Fuel tank including reserve fuel about 26.4 US gal (100 l).

PROGRAMMED TOP SPEED (OPTIONAL)

NOTE: The top speed of this vehicle can be electronically limited to a speed between 19 mph (30 km/h) and 82 mph (132 km/h). The vehicle's electronic speed controller should be programmed only by a qualified technician by an authorized Sprinter Dealer.

5

When programming the electronic speed controller, the circumference of the specific tires actually mounted on the vehicle must be determined and that circumference must be correctly programmed into the vehicle's electronic speed controller. It is critical that the correct tire circumference be programmed accurately into the vehicle's electronic speed controller. Accurate tire circumference information should be confirmed each time the electronic speed controller is programmed and each time new wheels or tires are mounted on the vehicle.

174 STARTING AND OPERATING

WARNING!

Possible tire damage resulting in serious personal injury or death may occur if the vehicle's electronic speed controller is programmed at a speed above the maximum speed allowed by the manufacturer of the specific tires mounted on the vehicle. The maximum speed of the tires prescribed by the tire manufacturer must be determined and accurately programmed into the electronic speed controller. The electronic speed controller must never be programmed at a speed greater than the maximum allowable tire speed as prescribed by the manufacturer of the specific tires mounted on the vehicle.

BLEEDING DIESEL FUEL SYSTEM

If the fuel tank was run empty, the diesel fuel system must be bled after refueling before starting the engine.

- Turn the key in the ignition lock to position 2 for at least 30 seconds.
- Return the key to position 0.
- Start the engine.

NOTE: Too many attempts to start the engine could drain the battery. If the engine does not start after several attempts, consult an authorized Sprinter Dealer.

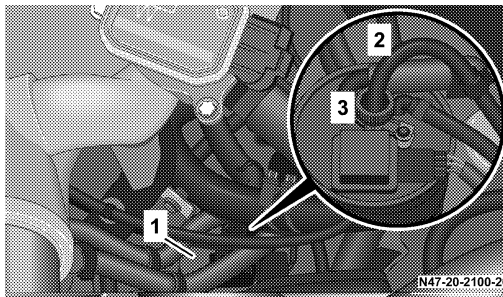

DRAINING FUEL FILTER WITH WATER SEPARATOR

1. Fuel filter
2. Drain hose
3. Water drain screw

The fuel filter (1) is located in the engine compartment.

NOTE: The fuel filter must be drained as soon as the water in fuel indicator lamp  lights up.

CAUTION!

Delaying draining of the fuel filter for a considerable time after the indicator lamp lights up may lead to engine damage.

NOTE: Prior to opening water drain screw (3), place a suitable receptacle underneath the drain hose (2). Turn water drain screw (3) on and off only by hand.

Diesel fuels and diesel fuel mixtures must be disposed of properly; we recommend water be drained from fuel filters by an authorized Sprinter Dealer.

Draining Fuel Filter

- Stop the engine.
- Shift gear selector lever to "P" position.
- Open the hood.
- Place a suitable receptacle underneath the drain hose (2).
- Turn the key in the ignition lock to position 2.

5

176 STARTING AND OPERATING

- Open immediately the water drain screw (3) about 1 turn (counterclockwise) until fluid emerges. Ensure that the fluid is collected in the receptacle.
- Close the water drain screw (3) as soon as about 0.25 US qt (0.2 liters) are emerged.
- After draining, return the key in the ignition lock to position 0.
- Dispose of the collected fluid in an environmentally responsible manner.
- If the filter is still saturated, drain the filter once more.

After draining, the engine may run briefly but stall for lack of fuel. If this occurs, bleed the system.

NOTE: Should the water in the fuel indicator lamp  still not go out after the fuel filter has been drained twice, the cause should be examined by an authorized Sprinter Dealer.

Bleeding the Diesel Fuel System

The diesel fuel system is bled before starting the engine.

- Turn the key in the ignition lock position 2 for at least 30 seconds.
- Return the key to position 0.
- Start the engine three to four times. The engine control unit indicator lamp  must go out.

NOTE: Too many attempts to start the engine could drain the battery. If the engine does not start after several attempts, consult an authorized Sprinter Dealer.

PERMISSIBLE ROOF LOAD

The maximum permissible roof load is:

- Vehicles with low roof 660 lbs (300 kg)
- Vehicles with high roof 330 lbs (150 kg)
- The weight of any load carried on the roof, including the roof rack, must not exceed the maximum permissible roof load.

TRAILER TOWING

WARNING!

Failure to use proper equipment and driving technique can result in a loss of vehicle control when towing a trailer.

Improper towing or failure to follow the instructions contained in this guide can result in serious injury. Follow the guidelines below carefully to assure safe trailer operation.

Ask your authorized Sprinter Dealer, if you require an explanation of information contained in this guide.

Trailer Hitches (Optional)

Only install a trailer hitch receiver approved for your vehicle. For information on availability and installation, please see your authorized Sprinter Dealer.

The bumpers on your vehicle are not designed for use with clamp-type hitches. Do not attach rental hitches or other bumper-type hitches to them.

To reduce the possibility of damage, remove the hitch ball adaptor from the receiver when not in use.

Electrical Connections (Optional)

The Sprinter is available with a variety of pre-installed conditions (lines and turn signal indicator and brake module installed and / or not installed). Make sure that the correct trailer hitch receiver kit is used. For further information, please see your authorized Sprinter Dealer.

In order to prevent possible damage to the vehicle's electrical system by incorrectly installing the trailer wiring plug, we recommend having the harness connected at an authorized Sprinter Dealer.

178 STARTING AND OPERATING

Vehicle and Trailer Weights and Ratings

Gross Vehicle Weight Rating (GVWR) is the maximum permissible vehicle weight: 8,550 lbs (3,878 kgs) or 9,990 lbs (4,531 kgs)

NOTE: The weight of your Sprinter is indicated on the type plate. For type plate, see Identification Labels.

Gross Vehicle Weight (GVW): comprises weight of vehicle including fuel, tools, spare wheel, installed accessories, passengers, cargo and trailer tongue. It must never exceed the GVWR.

Gross Axle Weight Rating (GAWR) is the maximum permissible axle weight:

Type	GVWR	GAWR (FA)	GAWR (RA)
2500 C/HC/ SHC	8,550 lbs 3,878 kgs	3,860 lbs (1,751 kgs)	5,360 lbs (2,431 kgs)
3500 C/HC/ SHC	9,990 lbs 4,531 kgs	3,860 lbs (1,751 kgs)	7,060 lbs (3,202 kgs)

Gross Trailer Weight (GTW) is the maximum permissible trailer weight to be towed: 5,000 lbs. (2,260 kgs)

Trailer Tongue Weight Rating (TWR) is the maximum permissible weight of the trailer tongue: 500 lbs. (225 kgs) limit for Sprinter approved hitch receiver.

Loading a Trailer

When loading a trailer, you should observe that neither the permissible GTW, nor the GVWR are exceeded.

Maximum permissible values are listed on the safety compliance certification labels for the vehicle and for the trailer to be towed. The lowest value listed must be selected when determining how the vehicle and trailer are loaded.

We recommend loading the trailer in such a manner that it has a tongue weight (TW) between 10% and 15% of the GTW.

The tongue weight at the hitch ball must be added to the GVW to prevent exceeding your Sprinter tow vehicle's rear GAWR.

Checking Weights of Vehicle and Trailer

To assure that the tow vehicle and trailer are in compliance with the maximum permissible weight limits, and to know the actual weights, have the loaded vehicle-trailer combination (tow vehicle including driver, passengers and cargo, trailer fully loaded) weighed on a commercial scale.

Check the vehicle's front and rear Gross Axle Weight (GAW), the GTW and TW. The values as measured must not be exceeded, according to the weight listed under "Vehicle and trailer weight and ratings".

Attaching a Trailer

Please observe maximum permitted trailer dimensions (width and length).

Most states and all Canadian provinces require safety chains between your tow vehicle and the trailer. The chains should be crisscrossed under the trailer tongue. They must be attached to the hitch receiver, and not to the vehicle's bumper or axle. Be sure to leave enough slack in the chains to permit turning corners.

Most states and all Canadian provinces require a separate brake system at various trailer weights.

WARNING!

Do not connect a trailer brake system (if trailer is so equipped) directly to the vehicle's hydraulic brake system as your vehicle is equipped with antilock brakes. If you do, neither the vehicle's brakes nor the trailer's brakes will function properly. This could cause an accident resulting in property damage, injury or death to you or others.

The provided vehicle electrical wiring harness for trailer towing has a brake signal wire for hook-up to a brake controller.

Most states and all Canadian provinces require a break-away switch on trailers with a separate brake system. The switch activates the trailer brakes in the possible event that the trailer might separate from the tow vehicle.

You should consider using a trailer sway control system. For further information see your authorized Sprinter Dealer.

5

180 STARTING AND OPERATING

Towing a Trailer

There are many different laws, including speed limit restrictions, having to do with trailer towing. Make sure that your vehicle-trailer combination will be legal, not only for where you reside, but also for where you will be driving. A good source for this information can be the police or local authorities.

Before you start driving with the trailer, check the trailer hitch, break-away switch, safety chains, electrical connections, lighting and tires. Also adjust the mirrors to permit unobstructed view beyond rear of trailer.

If the trailer has electric brakes, start your vehicle and trailer moving slowly, and then apply only the trailer brake controller by hand to be sure the brakes are working properly.

When towing a trailer, check occasionally to be sure that the load is secure, and that lighting and trailer brakes (if so equipped) are functioning properly.

Always secure items in the trailer to prevent load shifts while driving.

Take into consideration that when towing a trailer, the handling characteristics are different and less stable from those when operating the vehicle without a trailer. It is important to avoid sudden maneuvers. The vehicle and trailer combination is heavier, and therefore is limited in acceleration and climbing ability, and requires longer stopping distances. It is more prone to reacting to side wind gusts, and requires more sensitive steering input.

In order to gain skill and an understanding of the vehicle's behavior, you should practice turning, stopping and backing up in an area which is free from traffic.

If possible, do not brake abruptly, but rather engage the brake slightly at first to permit the trailer to activate its brake. Then increase the braking force.

WARNING!

Take into consideration that when towing a trailer, the handling characteristics are different and less stable from those when operating the vehicle without a trailer.

It is important to avoid sudden maneuvers. Sudden maneuvers may lead to loss of control over the vehicle-trailer combination. This could cause an accident resulting in property damage or injury to you or others.

CAUTION!

If the transmission hunts between gears on inclines, manually shift to a lower gear (select "4", "3", "2" or "1"). A lower gear and reduction of speed reduces the chance of engine overloading and/or overheating.

When going down a long hill, shift into a lower gear and use the engine's braking effect. Avoid riding the brakes, thus overheating the vehicle and trailer brakes.

If the engine coolant rises to an extremely high temperature (coolant temperature needle approaching the red zone) when the air conditioner is on, turn off the air conditioner. Engine coolant heat can be additionally vented by opening the windows, switching the climate control fan speed to high and setting the temperature control to the maximum hot position.

5

182 STARTING AND OPERATING

Extreme care must be exercised since your vehicle with a trailer will require additional passing distance ahead than when driving without a trailer. Because your vehicle and trailer is longer than your vehicle alone, you will also need to go much farther ahead of the passed vehicle before you can return to your lane.

Parking a Trailer

WARNING!

To reduce the risk of personal injury, or damage to the vehicle powertrain, as a result of vehicle/trailer movement, always:

Keep right foot on brake pedal.

Shift gear selector lever to position "N".

Have a second person place wheel chocks on downhill side of left and right trailer wheels.

Slowly release brake pedal and let vehicle and trailer roll into chocks until stopped.

Firmly depress parking brake pedal.

Move gear selector lever to position "P".

On inclines turn front wheels towards the road curb.

EMISSIONS CONTROL SYSTEM (CATALYTIC CONVERTER)

WARNING!

When driving or parking the vehicle, make sure that its exhaust system does not come into contact with flammable material (such as dry leaves) as these materials may otherwise catch fire.

FORDING (WADING CAPABILITY)

Avoid fording flooded roads or passing through water unless you are certain as to how deep it is. Driving through deep water can cause damage to the vehicle, including but not limited to the electrical components, engine, transmission, etc. This type of damage is not covered under the Warranty.

BODY BUILDER GUIDELINE

If you intend on making any alterations to the vehicle, we strongly recommend that you call DaimlerChrysler Corporation at telephone 704-655-1050 or 704-655-1054 to request a copy of the Sprinter Body Builder Guideline.

WARNING!

Any modifications or alterations of the Sprinter vehicle not in compliance with the Sprinter Body Builder Guideline and the Sprinter Operator's Manual may seriously inhibit its roadworthiness and safety and may lead to an accident resulting in serious personal injury or death. Consult the Sprinter Body Builder Guideline and the Sprinter Operator's Manual prior to initiating any alterations or modifications.

5

Body Builders and Dealers who makes any modifications which may affect the final certification of the engine, vehicle or equipment assume the sole responsibility for the vehicle, including labeling and documentation, affected by their modifications.

184 STARTING AND OPERATING

It is their responsibility to certify that the altered vehicle conforms to all applicable standards and regulations affected by the vehicle alteration or continues to comply with the Motor Vehicle Safety standards and Emissions regulations.

They are responsible for ensuring that modifications or equipment installation does not affect the safety of the vehicle.

A Special Note Concerning Vehicle Alteration

WARNING!

Any modifications or alterations of the Sprinter vehicle not in compliance with the Sprinter Body Builder Guideline and the Sprinter Operator's Manual may seriously inhibit its roadworthiness and safety and may lead to an accident resulting in serious personal injury or death. Consult the Sprinter Body Builder Guideline and the Sprinter Operator's Manual prior to initiating any alterations or modifications.

The Manufacturer is not responsible for any final certification or claims sounding in product liability, or warranty claims, which result from any component, assembly, or system being altered, or which cause non-compliance with any of the emission control standards or motor vehicle safety standards, or which would otherwise cause the vehicle to be or become defective or unsafe.

The Manufacturer does not assume the responsibility as the final stage manufacturer or the consequential product liability.

Please also see **Chapter 13** of this Operator's Manual.

WHAT TO DO IN EMERGENCIES

CONTENTS

■ Hazard Warning Flasher Switch	186	■ Installing a Wheel	196
■ Vehicle Tool Kit	187	■ Jump Starting	198
■ Changing the Tire	187	■ Towing the Vehicle	200
□ Spare Wheel Location	189	□ If the Engine is Damaged	201
■ Jack	192	□ If the Transmission is Damaged	201
□ Using the Jack	193	□ If the Front Axle is Damaged	202
■ Removing a Wheel	195	□ If the Rear Axle is Damaged	202

186 WHAT TO DO IN EMERGENCIES

HAZARD WARNING FLASHER SWITCH

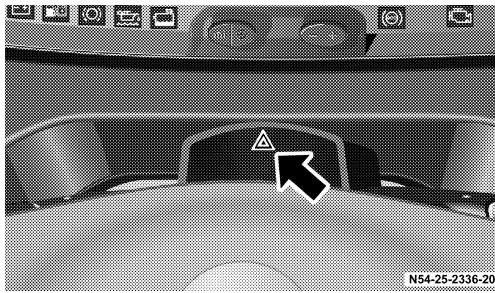

The switch is located on top of the steering column housing.

When the hazard warning flasher switch is switched on, the indicator lamp in the switch and the turn signal indicator lamp in the instrument cluster both flash.

WARNING!

If the rear cargo doors are opened to 90° (detent position), the rear lights will be concealed. The vehicle is then not sufficiently safeguarded at the rear and may only be seen by other road users when they are close to the vehicle. This could lead to an accident.

The vehicle must then be clearly marked in accordance with state and local laws, e.g., with a warning triangle.

VEHICLE TOOL KIT

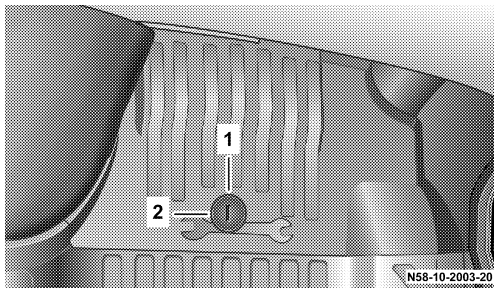

- 1. Locked
- 2. Unlocked

The vehicle tool kit and the jack are located under the hatch in the front passenger footwell.

CHANGING THE TIRE

If you get a flat tire while driving, gradually decrease your speed. Hold the steering wheel firmly and slowly move to a safe place on the side of the road. The pressure of the spare wheel always has to be checked regularly (at least after every tenth time at the filling station).

188 WHAT TO DO IN EMERGENCIES

WARNING!

The jack is designed exclusively for jacking up the vehicle at the jack take-up brackets built into either side of the vehicle. To help avoid personal injury, use the jack only to lift the vehicle during a wheel change. Never get beneath the vehicle while it is supported by the jack only.

Keep hands and feet away from the area under the lifted vehicle. Always firmly set parking brake and block wheels before raising vehicle with jack. Do not disengage parking brake while the vehicle is raised.

Always use the jack on a level surface.

Do not change wheels on either steep uphill or downhill grades. Be sure that the jack arm end is fully seated in the jack take-up bracket. The vehicle may begin to move and fall from the jack which could cause serious or fatal personal injury and property damage.

Always lower the vehicle onto sufficient capacity jack stands before working under the vehicle.

Precautions when changing a wheel:

For the torque, refer to "Installing a wheel";

Do not damage, grease or oil wheel bolts or their threads.

Do not jack the vehicle up more than 1.2 in (30 mm) between the tire and the surface. Otherwise, the vehicle may tip over and may cause serious injury or death to you or others.

Precautions when changing a wheel:

For the torque, refer to "Installing a wheel";

Do not damage, grease or oil wheel bolts or their threads.

Procedure:

1. Park the vehicle on a firm, level, non-slippery surface.
2. Switch on the hazard warning flasher switch, apply the parking brake, and place the transmission selector in "P".

3. Everyone must leave the vehicle before you jack it up.
4. Everyone must leave the danger zone, before jacking the vehicle.
5. The vehicle must be safeguarded in accordance with legal regulations (such as using a warning triangle).
6. Prevent vehicle from rolling away by blocking wheels with wheel chocks (not supplied with vehicle) or sizable wood block or stone.
On a level road, place one chock in front of and one behind the wheel that is diagonally opposite to the wheel being changed.
When changing a wheel on mild uphill or downhill grades, place chocks on the downhill side blocking both wheels of the other axle.

WARNING!

Do not change wheels on either steep uphill or downhill grades. The vehicle may begin to move and fall from the jack which could cause personal injury and property damage.

Spare Wheel Location

WARNING!

If the rear cargo doors are opened to 90° (detent position), the rear lights will be concealed. The vehicle is then not sufficiently safeguarded at the rear and may only be seen by other road users when they are close to the vehicle. This could lead to an accident.

The vehicle must then be clearly marked in accordance with state and local laws, e.g., with a warning triangle.

6

190 WHAT TO DO IN EMERGENCIES

WARNING!

The spare wheel holder should be reattached once the wheel has been changed.

Regularly check the spare wheel fastening.

A loose spare wheel or spare wheel holder could be loosen or could move around the vehicle interior uncontrollably in the event of sudden braking, a rapid change in direction or an accident. This increases the risk of injury to vehicle occupants and other road users in these situations.

Do not use retreaded/remolded tires. This process does not always permit previous damage to be detected. Therefore vehicle safety cannot be guaranteed if retreaded/remolded tires are fitted.

NOTE: Lug wrench and jack, refer to "Vehicle Tool Kit". For reasons of safety, check at regular intervals that the spare wheel is properly secured.

Spare Wheel Beneath the End of the Frame

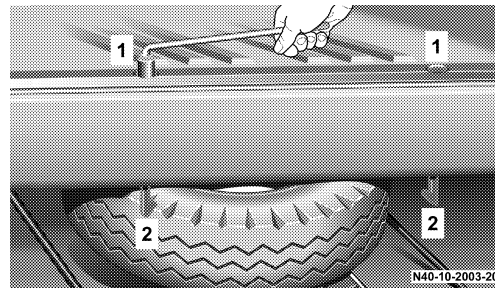

Retaining screws for the spare wheel structural member (1)

Hook (2)

1. Open the cargo doors and remove the retaining screws (1) with the lug wrench from the vehicle tool kit.
2. Lift the spare wheel structural member, unhinge the hooks (2), and lower the spare wheel structural member. Remove the spare wheel.

Spare Wheel in Cargo Area (Optional)

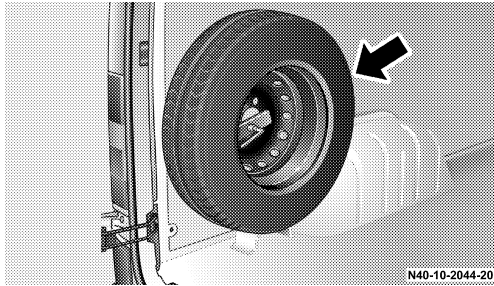

1. Open the rear cargo doors.

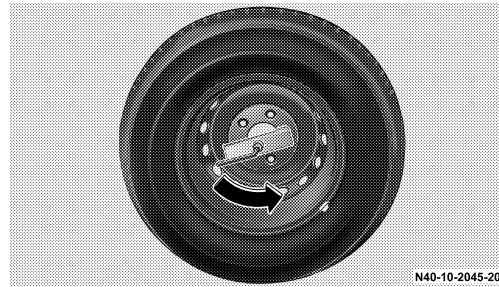

2. Turn spare wheel holder to loosen.
3. Remove the spare wheel.

6

192 WHAT TO DO IN EMERGENCIES

Spare Wheel Location for Chassis

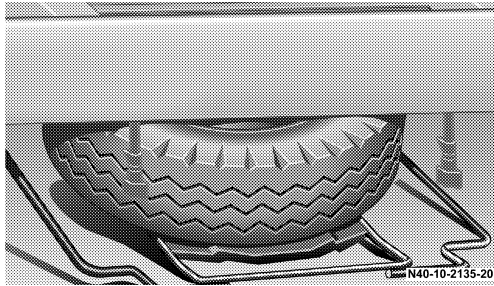

1. Loosen thumb nuts by hand and remove.
2. Use wrench to loosen fixing nut to the thread end.
3. Lift spare wheel holder.
4. Turn hooks to the side and lower spare wheel holder. Remove the spare wheel.

JACK

WARNING!

To avoid the risk of serious or fatal injuries or vehicle damage, please bear the following points in mind:

- The jack is intended only for raising the vehicle briefly, for instance, when changing a wheel. If it is not designed to enable work to be carried out underneath the vehicle.

Do not crawl under the jacked-up vehicle. For work under the vehicle, stands must be used.

- The jack must be placed on a firm, flat surface only.
- Do not change wheels on uphill or downhill gradients under any circumstances.
- Make sure that no persons are present in the vehicle when jacking up the vehicle.
- Do not start the engine while the vehicle is raised.
- Make sure that the distance between the underside of the tires and the ground does not exceed 1.2 in (30 mm). Otherwise the vehicle may tip over.

Using the Jack

The jack is located together with the vehicle tool kit under the hatch in the front passenger footwell, refer to "Vehicle Tool Kit".

1. Loosen the wheel bolts before raising the vehicle.
2. Close the release valve on the jack.
3. Assemble the pump lever provided and insert it into the socket on the jack.
4. Secure the lever by turning it clockwise in the socket.

Position the jack under the appropriate jack point and raise the vehicle by pumping the lever.

Front Axle Jack Point (All Vehicles)

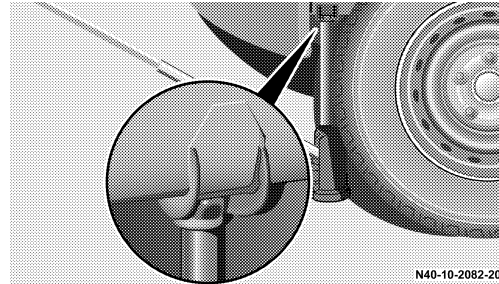

The vehicle jacking point is located under the longitudinal member in front of the front axle.

194 WHAT TO DO IN EMERGENCIES

**Rear Axle Jack Point for 8,550 lbs (3,880 kgs)
(Vehicle type 2500 HC/SHC)**

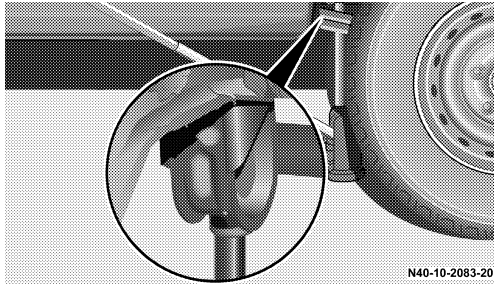

The vehicle jacking point is located under the longitudinal member in front of the rear axle.

CAUTION!

Do not position the jack at the leaf spring or the differential housing.

**Rear Axle Jack Point for 9,990 lbs (4,530 kgs)
(Vehicle type 3500 HC/SHC)**

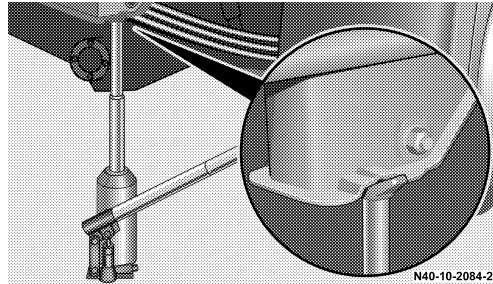

The vehicle jacking point is located under the longitudinal member in front of the rear axle.

CAUTION!

Do not position the jack at the leaf spring or the differential housing.

**Rear Axle Jack Point for Chassis
(Vehicle type 2500 C and 3500 C)**

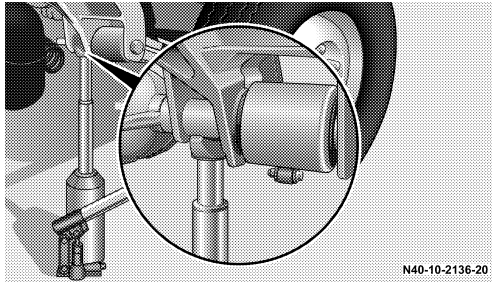

The vehicle jacking point is locked next to the front recess for the leaf spring.

CAUTION!

Do not position the jack at the leaf spring or the differential housing.

REMOVING A WHEEL

1. Loosen the wheel bolts.
2. Jack up the vehicle until the wheel is clear of the ground.
3. Unscrew the wheel bolts and remove the wheel (keep the wheel bolts clean).

NOTE: If the vehicle moves forwards or backwards while it is being jacked-up, lower it again and reposition the jack. When the vehicle is jacked-up, the jack must stand vertically (plumb-line).

196 WHAT TO DO IN EMERGENCIES

INSTALLING A WHEEL

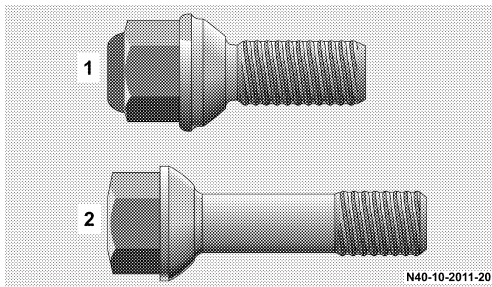

Wheel bolts for pressed steel wheels (1)

Wheel bolts for light-alloy wheels (Optional) (2)

WARNING!

Different wheel bolts are required for pressed steel and light-alloy wheels.

Incorrect wheel lug bolts for the wheels could work loose, thereby causing you to lose control of the vehicle. This could cause an accident resulting in severe personal injuries and and property damage.

NOTE: The optional light alloy wheels are supplied with 5 short wheel lug bolts enclosed for the steel spare wheel in the vehicle tool kit.

- Before fitting the spare wheel, clean rust and dirt off the contact surfaces of the wheel and the wheel hub, and from the wheel bolts.
- Note the specified wheel and tire size, tire load capacity and speed code.
- Do not change the tire's direction of rotation.
- Do not damage, grease or oil wheel bolts or their threads.

WARNING!

Incorrect mounting bolts or improperly tightened mounting bolts can cause the wheel to come off. To avoid the risk of serious or fatal injuries or vehicle damage, please bear the following points in mind:

- Always replace wheel bolts that are damaged or rusted.
- Never apply oil or grease to wheel bolts
- If a wheel hub thread is damaged, you must not drive the vehicle. Consult a qualified specialist workshop.

Centering wheels with wheel bolts

- If dual assemblies are used, before placement the inner wheel should be inspected to ensure that all ball bearing rings are in proper position.
- Install the wheel and snug the wheel bolts.
- Slightly tighten wheel bolts.
- Slowly open jack release valve to lower vehicle until tire is resting on ground.

WARNING!

Do not tighten the wheel bolts and wheel nuts completely while the vehicle is still jacked up. The vehicle could tip.

6

- Tighten the wheel bolts in a crosswise pattern to the specified torque with a torque wrench.

Tightening torque for 8,550 lbs (3,880 kgs)
(vehicle type 2500 C/HC/SHC):
Steel wheel – 177 lbf.ft ±7 lbf.ft (240 N.m ±10 N.m)
Light alloy wheel – 138 lbf.ft ±14 lbf.ft
(190 N.m ±20 N.m)

198 WHAT TO DO IN EMERGENCIES

Tightening torque for 9,990 lbs (4,530 kgs)
(vehicle type 3500 C/HC/SHC):
Steel wheel – 138 lbf.ft ±14 lbf.ft (190 N.m ±20 N.m)

- Remove jack and stow it in the vehicle tool kit.
- Check the tire pressure.
- Re-tighten the wheel bolts to the specified torque with a torque wrench after a distance of 30 miles (about 50 km).

WARNING!

After changing a wheel, you must, for safety reasons,

- have the specified tightening torque checked. The wheels could otherwise work loose.
- check the tire pressure and correct it if necessary.
- retighten the wheel bolts and wheel nuts to the specified tightening torque once the vehicle has been driven for 30 miles (50 km).
- have a reversed direction of tire rotation corrected as soon as possible at a qualified specialist workshop. The vehicle handling characteristics could otherwise be affected.

JUMP STARTING

If the battery is dead, the engine can be started with jumper cables from another vehicle's battery.

WARNING!

A battery will also produce hydrogen gas, which is flammable and very explosive. Avoid open flames and the formation of sparks in the vicinity of the batteries. Refrain from smoking or cell phone use. Avoid improper connection of jumper cables.

Observe safety precautions when handling batteries.

Exercise care near moving engine components and electrical cables.

Failure to follow these directions will cause damage to the electronic components and can lead to a battery explosion and severe injury or death.

Battery fluid contains sulfuric acid. Do not allow this fluid to come in contact with eyes, skin or clothing. In case it does, immediately flush affected area with water, and seek medical help.

The battery housing could be damaged. Never lean over batteries while connecting or jump-starting. You might get injured.

Read all instructions before proceeding.

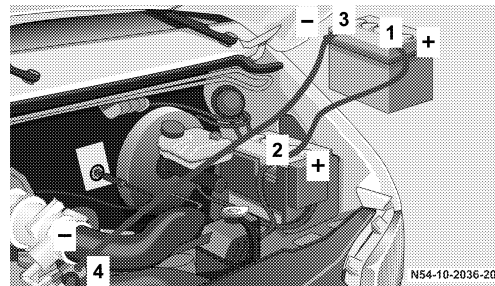

6

- A dead battery can freeze at a temperature of 14 °F (-10 °C). Never try to start the engine if the battery is frozen. Thaw the battery out first.
- Only use a battery of the same rated voltage and of approximately the same capacity for jump-starting.
- The two vehicles must not touch.
- Switch off all electrical accessories.
- Run the vehicle with the booster battery at idle.
- Connect the jumper cables in the sequence given in the illustration.

200 WHAT TO DO IN EMERGENCIES

1. First connect the positive terminals of the two batteries (see illustration, Items 1 + 2). Start with the booster battery.
2. Then connect the negative terminal of the vehicle with the booster battery to a vehicle ground point of the vehicle with the discharged battery, such as to the engine block (see illustration, Items 3 + 4). Start with the booster battery.
3. Start the engine in the customary manner.
4. Allow the engine to run for a short time.
5. Before disconnecting the jumper cables from the vehicle with the booster battery, switch on an electrical consumer (e.g. the blower, but not the lamps).
6. Disconnect the jumper cables in the reverse order to that in which they were connected.
7. Disconnect the jumper cable from negative terminal and vehicle ground point first (see illustration, items 3 + 4), then from positive terminals of the batteries (see illustration 1 + 2).

NOTE: Never try to start the engine with the aid of a battery quick-charge unit.

TOWING THE VEHICLE

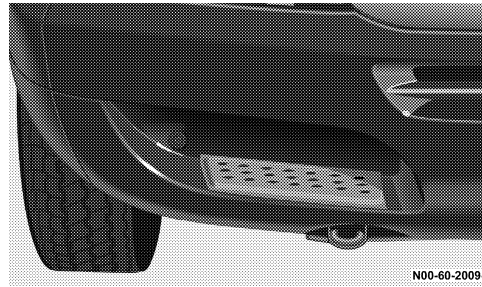

WARNING!

Do not tow the vehicle if the key cannot be turned in the ignition lock.

If the key cannot be turned, the ignition lock remains locked and the vehicle cannot be steered.

With the engine not running there is no power assistance for the braking and steering systems.

In this case, it is important to keep in mind that a considerably higher degree of effort is necessary to brake and steer the vehicle.

The vehicle must not be towed with the front axle raised and the key in position 2 in the ignition lock as the drive wheels could then lock due to the acceleration skid control (ASR) or the optional Electronic Stability Program (ESP).

If the Engine is Damaged

For towing distances up to 30 miles (about 50 km)

- Shift selector lever to "N" position.
- Do not exceed a towing speed of 30 mph (50 km/h).

For towing distances greater than 30 miles (about 50 km)

- Remove the propeller shafts leading to the drive axles.
The vehicle can be towed without restriction.

If the Transmission is Damaged

- Remove the propeller shafts leading to the drive axles.



202 WHAT TO DO IN EMERGENCIES

If the Front Axle is Damaged

- Raise the front axle.
- Observe the same towing restrictions as for engine damage.

If the Rear Axle is Damaged

- Raise the rear axle.
- NOTE:** Comply with local legal regulations regarding towing vehicles.

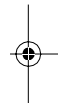
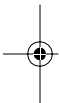

MAINTAINING YOUR VEHICLE

CONTENTS

■ Engine Compartment	205	□ Checking Coolant Level	213
■ Sprinter Original Parts	207	■ Winter Operation	215
■ Service Products	207	■ Batteries	216
□ Disposal of Service Products	208	□ Disconnecting the Battery	216
■ Emission Related Component Warranty Statement	208	□ Reconnecting the Battery	217
■ Regular Checks	208	□ Charging the Battery	217
□ Windshield Washer System Fluid Reservoir .	209	■ Replacing Wiper Blades	218
□ Air Filter Restriction Indicator (Optional) .	209	□ Appearance Car and Corrosion Protection .	219
□ Engine Oils	209	□ Power Washer	220
□ Engine Oil Level	210	□ Automatic Car Wash	221
□ Ribbed V-Belt	211	□ Tar Stains	221
□ Hydraulic Brake System, Clutch Mechanism Fluid Level	211	□ Paintwork, Painted Body Components	221
□ Brake fluid	212	□ Engine Cleaning	221
□ Engine Coolant	212	□ Vehicle Washing	222
		□ Ornamental Moldings	222
		□ Headlamps, Taillamps, Turn Signal Lenses .	222
		□ Window Cleaning	223

204 MAINTAINING YOUR VEHICLE

- Wiper Blade 223
- Light Alloy Wheels 224
- Instrument Cluster 224
- Steering Wheel and Gear Selector Lever 224
- Cup Holder 224
- Seat Belts 224
- Headliner and Shelf Below Rear Window 224
- Upholstery 224
- Hard Plastic Trim Items 225
- Plastic and Rubber Parts 225
- Electrical Fuses 225
 - Standard Fuse and Relay Equipment 226
 - Relay Assignment, Standard Equipment 230
 - Fuse and Relay Optional Equipment 230
- Bulb Replacement 233
 - Front Lamp Unit 233
 - Taillamps 238
 - License Plate Lamps
(Cargo/Passenger Vans Only) 240
 - Additional Brake Lamp
(Cargo/Passenger Vans Only) 240
 - Side-Mounted Turn Signals 241
 - Side-Marker Lamps,
Standing Lamps (Optional) 241
 - Interior Lighting in Passenger Compartment
and Load Compartment 242
 - Interior Lighting with Reading Lamp 242
 - Interior Lighting with Interior Sensor
Protection 243
 - Exit Lamps (Optional) 243
- Capacities 244
 - Recommended Fluids and Lubricants 245

ENGINE COMPARTMENT

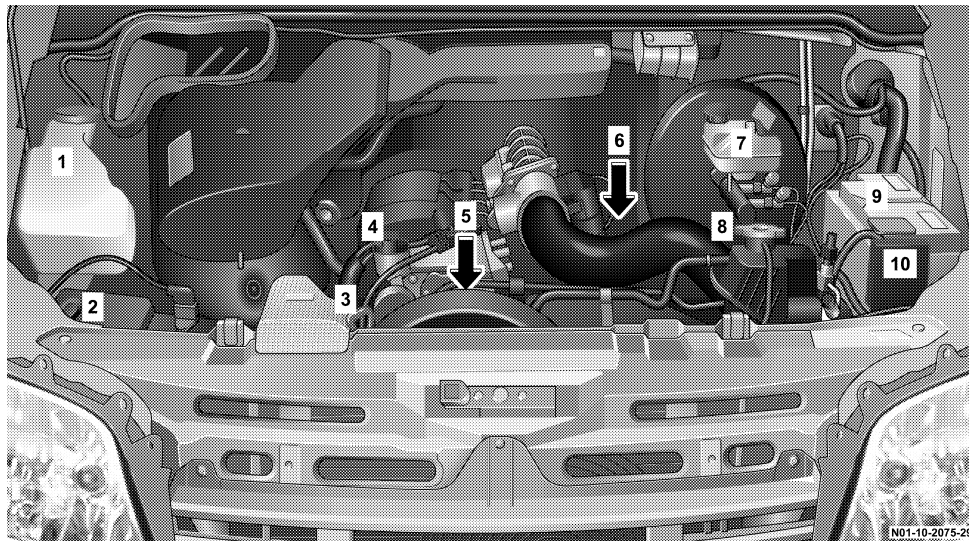

NO1-10-2075-29

7



206 MAINTAINING YOUR VEHICLE

Legend For Engine Compartment

1. Windshield washer system fluid reservoir.
2. Maintenance indicator for air cleaner element (Optional).
3. Oil dipstick.
4. Oil filler neck.
5. Ribbed V-belt.
Auxiliary drive (Optional) refer to "Auxiliary drive".
6. Fuel filter with water separator.
7. Hydraulic brake fluid reservoir.
8. Coolant reservoir.
9. Battery
The auxiliary battery is located underneath the front passenger seat (optional equipment).
10. Fuse box
(These special fuses should only be replaced at by an authorized Sprinter Dealer).



SPRINTER ORIGINAL PARTS

Every authorized Sprinter Dealer maintains a stock of Sprinter original parts for maintenance and repair work.

Sprinter original parts are subjected to the most stringent quality inspections and will ensure that the vehicle is maintained at a high level of operating efficiency and safety, and that it maintains its value. Each part has been specifically designed and manufactured or selected and approved for use in Sprinter vehicles.

It is therefore best to use only Sprinter original parts.

For cost-effective repairs in accordance with sound recycling principles, the use of non-genuine parts and accessories not authorized by the manufacturer could damage the vehicle or compromise its durability or safety.

When ordering original parts, always provide the vehicle identification number and the engine number.

SERVICE PRODUCTS

Mechanical elements and the lubricants used for them must be carefully matched.

For this reason, only brands tested and approved by the manufacturer should be used. Please contact your Sprinter Dealer to obtain the necessary information. No lubricant additives should be used.

The use of such additives could affect your warranty rights. Information is available from any authorized Sprinter Dealer.

For specifications of engine oils, coolant and brake fluid, contact your authorized Sprinter Dealer.

7

WARNING!

If handled incorrectly, service products can constitute a health risk for people and an environmental hazard.

Always observe relevant guidelines for handling, storing and disposing of service products.

208 MAINTAINING YOUR VEHICLE

Disposal of Service Products

Dispose of service products and of parts which come into contact with them (e.g. filters) in an environmentally responsible manner. Comply with applicable bars and regulations.

EMISSION RELATED COMPONENT WARRANTY STATEMENT

The Manufacturer warrants to the original and each subsequent owner of a MERCEDES-BENZ heavy-duty on highway diesel engine that:

- (1) the engine was designed, built and equipped so as to conform at the time of sale with the applicable regulations adopted by the Federal Environmental Protection Agency
- (2) the emission control system of such engine is free from defects in materials and workmanship which would cause it not to conform with those regulations for a period of use of five years or 100 000 miles or 3 000 hours of engine operation, whichever occurs first.

REGULAR CHECKS

The following checks should be performed at regular intervals (for example once a week or each time the vehicle is refueled):

- Windshield cleaner system – fluid reservoir.
- Air strainer, in vehicles with an air strainer element maintenance indicator (optional equipment).
- Engine oil level.
- Checking ribbed V-belt.
- Hydraulic brake system, clutch mechanism fluid level.
- Coolant level.
- Tire and spare wheel condition and pressures of the same. For more information, refer to "Wheels and Tires".
- Vehicle lighting.

Windshield Washer System Fluid Reservoir

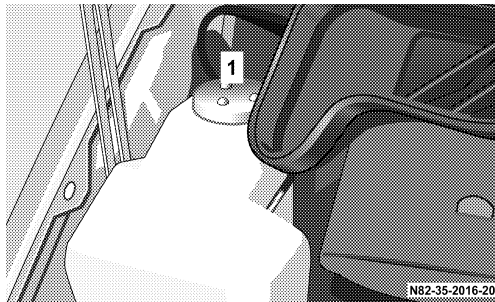

1. Washer system fluid reservoir

When topping off, add windshield washer fluid ("S" for summer or "W" for winter) to the water.

Capacity of fluid reservoir (1): about 7.4 US qt (7 liters).

Air Filter Restriction Indicator (Optional)

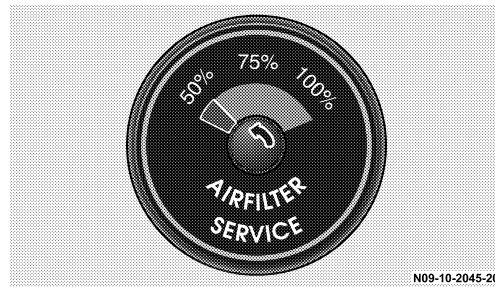

The indicator on the air filter housing in the engine compartment shows the degree of contamination in the air filter element. If the red field reaches the 100 % range, the air filter element should be replaced as soon as possible.

Engine Oils

Use engine oils approved to MB 228.3 or MB 228.5 that are also licensed to API CI-4.

210 MAINTAINING YOUR VEHICLE

Engine Oil Level

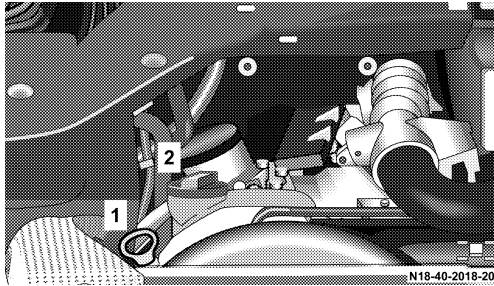

1. Oil dipstick
2. Oil filler neck

Check the engine oil level at regular intervals with the vehicle standing on a level surface.

- Check engine oil level about 5 minutes after stopping the engine, which should have reached its regular operating temperature. The normal operating temperature should have been reached and maintained for some time.
- Wipe the dipstick clean with a lint-free cloth before checking.

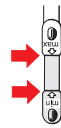

The engine oil level must be between the lower (MIN) and upper (MAX) marks on the dipstick.

Add engine oil only up to the MAX mark. Excess oil must be drained or siphoned off.

- For approved engine oils, contact your Sprinter Dealer.

Ribbed V-Belt

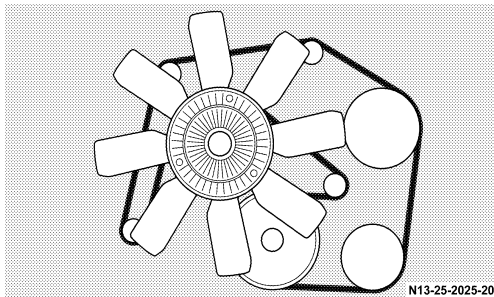

The ribbed V-belt drives the accessories, such as generator, coolant pump and hydraulic steering pump. The ribbed V-belt is automatically kept tensioned.

Check the state of the ribbed V-belt regularly, such as at every engine oil level check.

The belt must not be damaged, worn, oiled or glazed. There must be no cracks in the belt running surface.

Replace damaged belts.

Hydraulic Brake System, Clutch Mechanism Fluid Level

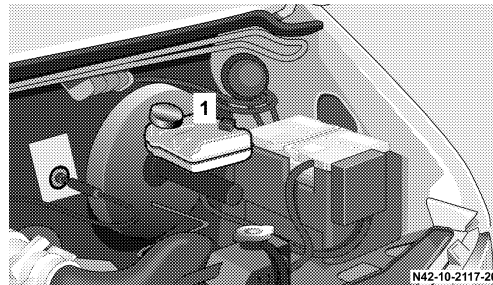

1. Brake fluid reservoir

Brake fluid level must be between the MIN and MAX marks in the reservoir (1).

If the brake fluid is below the MIN mark, there may be a fault in the hydraulic system. Have the system checked as soon as possible by an authorized Sprinter Dealer.

212 MAINTAINING YOUR VEHICLE

Brake fluid

Use brake fluid approved to MB 331.0, or a DOT 4 brake fluid with: minimum dry boiling point (ERBP) 500°F, minimum wet boiling point (WERBP) 356°F, maximum viscosity 1500 mm²/s, conforming to FMVSS116 and ISO 4925.

In the course of its service life, the boiling point of the brake fluid will fall due to the continuous absorption of moisture from the atmosphere.

If the brakes are placed under heavy loads (e.g., on steep hills) bubbles of steam can then form in the brake system.

This will adversely affect the brakes' effectiveness.

Engine Coolant

The coolant is a mixture of water and a corrosion inhibitor/antifreeze additive. Within the cooling system, the corrosion inhibitor/antifreeze ensures

- anti-corrosion protection
- antifreeze protection
- a higher boiling point.

The coolant added in the factory ensures adequate antifreeze and anti-corrosion protection.

Use coolant approved to MB 325.0, such as Valvoline GO5, or an equivalent Extended Life Coolant.

To avoid damage to the cooling system, only use manufacturer approved corrosion inhibitor/antifreeze additives.

Information on the corrosion inhibitor/antifreeze additive is available from any Sprinter Dealer.

For reasons of anti-corrosion protection and to increase the boiling point, the coolant added to the cooling system is designed for all year round operation – even in countries with high prevailing temperatures.

Have the coolant renewed at least every five years or after 100,000 miles.

When the coolant is renewed, the new coolant should contain 50% antifreeze/corrosion inhibitor by volume. This corresponds to antifreeze protection down to $-37^{\circ}\text{C}/-35^{\circ}\text{F}$.

Do not exceed a proportion of about 55 % by volume (antifreeze protection down to about $-45^{\circ}\text{C}/-49^{\circ}\text{F}$) as the heat dissipation properties then deteriorate.

In the event of coolant loss, do not add water only, but sufficient antifreeze/corrosion inhibitor to maintain the correct concentration.

The water in the coolant must satisfy certain requirements. These are often met by tap supply drinking water.

The water must be specially prepared if the water quality does not come up to the required standards.

Have the corrosion inhibitor/antifreeze concentration in the coolant checked at the outset of winter, respectively once a year in countries with high prevailing temperatures.

A regular check is included in the maintenance service.

Checking Coolant Level

Coolant reservoir (1)

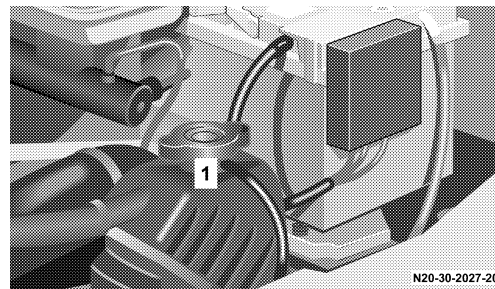

The cooling system is pressurized. Only check the coolant level with the vehicle parking on a level surface and with the engine switched off.

- Wait until the coolant temperature has dropped below 194°F ($+90^{\circ}\text{C}$).

214 MAINTAINING YOUR VEHICLE

WARNING!

In order to avoid any possibly serious burns:

- If you see flames or smoke coming from the engine compartment, or if the coolant temperature gauge indicates that the engine is overheated, do not open the hood. Move away from the vehicle and do not open the hood until the engine has cooled. If necessary, call the fire department.
- Do not remove pressure cap on coolant reservoir if engine temperature is above 194 °F (+90 °C). Allow engine to cool down before removing cap. The coolant reservoir contains hot fluid and is under pressure.
- Using a rag, slowly open cap approximately 1/2 turn to relieve excess pressure. If opened immediately, scalding hot fluid and steam will be blown out under pressure.

- Do not spill antifreeze on hot engine parts. Antifreeze contains ethylene glycol which may burn if it comes into contact with hot engine parts.
- Check coolant level only with the engine switched off and the key in position 0 in the ignition lock.

- Open the hood.
- At first, only turn the radiator cap to the first detent to release the pressure from the cooling system. Only then should the radiator cap be removed completely.
- To add coolant:
If the engine is cold:
Add coolant until the coolant level reaches the base area which is visible through the filler opening (area moistened).

If the engine is already at its regular operating temperature:
Add coolant until the coolant level is about 0.6 inch

(1.5 cm) above the base area which is visible through the filler opening.

- Replace and tighten the radiator cap.

If a large quantity of coolant has been lost, or if smaller amounts are lost at regular intervals, have the engine cooling system examined by an authorized Sprinter Dealer.

For coolant composition and water quality, contact your Sprinter Dealer.

WINTER OPERATION

Have your vehicle winterized by an authorized Sprinter Dealer before the onset of winter.

- Have the engine oil changed, if the engine oil filled is not approved for winter use.
- Coolant: antifreeze/anti-corrosion concentration in the coolant checked.
- Windshield washer system: add winter concentrate to the washer fluid.
- Battery: the battery will lose capacity as temperatures drop. Only a well-charged battery will ensure reliable engine starting even at low outside temperatures.
- Tires: fit M+S radial tires, taking note of the maximum permissible speed of the tires fitted.

216 MAINTAINING YOUR VEHICLE

BATTERIES

WARNING!

Failure to follow these instructions can result in severe personal injuries and death.

Never lean over batteries while connecting, you might get injured, if the battery explodes.

Battery fluid contains sulfuric acid. Do not allow this fluid to come in contact with eyes, skin or clothing. In case it does, immediately flush affected area with water and seek medical help if necessary.

A battery will also produce hydrogen gas, which is flammable and explosive. Keep flames or sparks away from battery, avoid improper connection of jumper cables, smoking etc.

Use only impact-resistant batteries with a central gas release cover to prevent corrosion damage and to prevent occupants from caustic burns in the event of an accident.

The standard battery is located in the engine compartment.

The auxiliary battery is located underneath the front passenger seat (optional equipment).

The battery will not achieve its maximum service life unless it is kept adequately charged at all times. If the vehicle is used primarily for short distances, or left parked for lengthy periods, have the battery charge checked more frequently.

Disconnecting the Battery

CAUTION!

Do not loosen or remove the battery terminal clamps while the engine is running or the key is in the ignition lock as this could damage electrical or electronic equipment beyond repair. All electrical consumers must be switched off.

Do not place any metal objects on the battery. Doing so may cause a short-circuit.

Loosen and remove the negative terminal clamp first, then the positive terminal.

Afterwards disconnect vent tube from the fitting.

Reconnecting the Battery

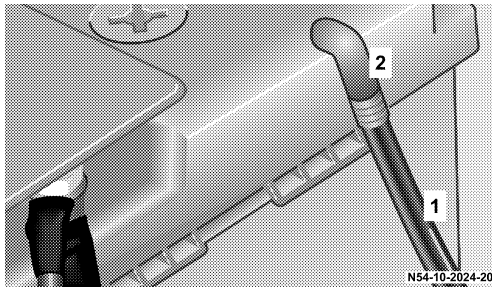

1. Vent tube
2. Fitting

All electrical consumers must be switched off. First connect and tighten the positive terminal clamp, then the negative terminal. Make sure that the terminal clamps are not switched.

NOTE: If batteries have to be replaced, only use batteries with a central vent cap as this will prevent corrosion damage.

Connect the battery vent tube (1) to the fitting (2).

Charging the Battery

Disconnect the battery before charging it with a battery charger.

Comply with the operating instructions for the battery charger.

To ensure that the battery is disposed of in an environmentally responsible manner, it should only be replaced by an authorized Sprinter Dealer.

Batteries contain material that can harm the environment with improper disposal.

Large 12 volt storage batteries contain lead.

Recycling of batteries is the preferred method of disposal.

Many states require sellers of batteries to accept old batteries for recycling.

218 MAINTAINING YOUR VEHICLE

REPLACING WIPER BLADES

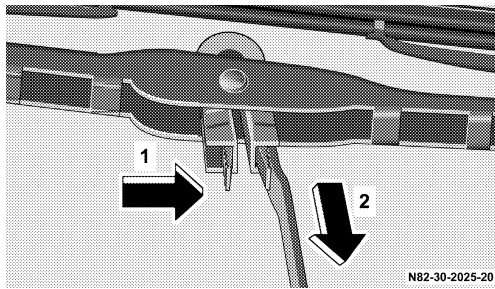

1. Fold over the wiper arm (2) and place the wiper blade crosswise.
2. Press the retaining spring (1) and push the wiper blade out of the end of the wiper arm (2).
3. Remove the wiper blade.

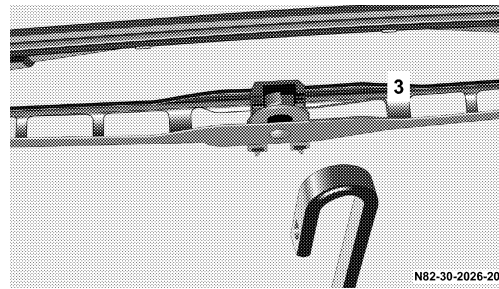

4. Insert the end of the wiper arm (2) into the larger cutout (3) of the wiper blade.
5. Push the wiper blade into the end of the wiper arm (2) until the retaining spring (1) engages.

Appearance Car and Corrosion Protection

WARNING!

Many cleaning products can be hazardous. Some are poisonous, others are flammable. Always follow the instructions on the particular container. Always open your vehicle's doors or windows when cleaning the inside.

Never use fluids or solvents that are not designed for cleaning your vehicle. Do not use fuel as a cleaning agent. Fuel is flammable and constitutes a health hazard.

In operation, your vehicle is subjected to varying external influences which, if gone unchecked, can attack the paintwork as well as the underbody and cause lasting damage.

Such damage is caused not only by extreme and varying climatic conditions, but also by air pollution, road salt, tar, gravel and stone chipping. Grease and oil, fuel, coolant, brake fluid, bird droppings, insects, tree resins etc. should be removed immediately to avoid paint damage. Frequent washing reduces and/

or eliminates the aggressiveness and potency of the above adverse influences.

More frequent washings are necessary to deal with unfavorable conditions; for example operation near the ocean, in industrial areas (smoke, exhaust emissions), or during the winter months.

You should check your vehicle from time to time for stone chipping or other damage. Any damage should be repaired as soon as possible to prevent the start of corrosion.

In doing so, do not neglect the underside of the vehicle. A prerequisite for a thorough check is a washing of the underbody followed by a thorough inspection. Damaged areas need to be undercoated again.

Your vehicle has been treated at the factory with a wax-base rustproofing in the body cavities which will last for the lifetime of the vehicle. Post-production treatment is neither necessary nor recommended by DaimlerChrysler Corporation.

Because of the possibility of incompatibility between materials used in the production process and others applied later.

220 MAINTAINING YOUR VEHICLE

WARNING!

Never use openings in the bodywork as steps. You could otherwise damage the vehicle and it could lead to an accident.

CAUTION!

Do not use abrasive or strong cleaning materials such as steel wool or scouring powder, which will scratch metal and painted surfaces.

Scratches, corrosive deposits, corrosion or damage due to negligent or incorrect care cannot always be removed or repaired with car-care products. In such cases it is best to seek aid by your authorized Sprinter Dealer.

The following topics deal with the cleaning and care of your vehicle and give important "how-to" information as well as references to car-care products.

Power Washer

When using a power washer for cleaning the vehicle always observe manufacturers' operating instructions.

CAUTION!

The intense jet of water of a round nozzle can result in damage to the tire. Therefore never use a round nozzle to power wash tires.

Always replace a damaged tire.

Always keep the jet of water moving across the surface. To avoid damaging the vehicle, do not aim the water jet directly at electrical components, end of electrical lines, electrical connectors, intake or ventilation openings, brake hoses, door joints, seals, other rubber parts.

Automatic Car Wash

If the vehicle is very dirty, prewash it before you drive into the car wash.

WARNING!

Smears impair visibility, which is impaired further by unfavourable conditions (e.g. fog, darkness, driving snow).

If a wax preservative is sprayed on after washing the vehicle, wipe off the wax from the windshield and the wiper blade rubbers. This will prevent smears forming on the windshield.

Fold in the exterior mirrors before washing the vehicle in an automatic car wash and make sure that the windshield wiper switch is in position 0.

The exterior mirrors and windshield wipers could otherwise be damaged.

Make sure that mirrors are fully folded out after leaving the automatic car wash.

Tar Stains

Quickly remove tar stains before they dry and become more difficult to remove. A tar remover is recommended.

Paintwork, Painted Body Components

Paint care should be applied when water drops on the paint surface do not "bead up", normally every 3 to 5 months, depending on climate and washing detergent used.

Paint cleaner should be applied if paint surface shows signs of dirt embedding (i.e. loss of gloss).

Do not apply any of these products or wax if your vehicle is parked in the sun or if the hood is still hot.

Use the appropriate paint stick for quick and provisional repairs of minor paint damage (i.e., chips from stones, vehicle doors etc.).

Engine Cleaning

Prior to cleaning the engine compartment, make sure to protect electrical components and connectors from the intrusion of water and cleaning agents.

222 MAINTAINING YOUR VEHICLE

Corrosion protection, such as anticorrosion wax should be applied to the engine compartment after every engine cleaning. Before applying, all control linkage bushings and joints should be lubricated. The poly-V-belt and all pulleys should be protected from any wax.

Vehicle Washing

Do not use hot water or wash your vehicle in direct sunlight. Use only a mild car wash detergent.

Thoroughly spray the vehicle with a diffused jet of water. Direct only a very weak spray towards the ventilation intake. Use plenty of water and rinse the sponge and chamois frequently.

Rinse with clear water and thoroughly wipe dry with a chamois. Do not allow cleaning agents to dry on the finish.

Due to the width of the vehicle, prior to running the vehicle through an automatic car wash, fold back the outside mirrors to prevent them from getting damaged.

In the winter, thoroughly remove all traces of road salt as soon as possible.

When washing the underbody, do not forget to clean the inner sides of the wheels.

WARNING!

Dirty or iced-up steps and entrances create a risk of slipping or falling.

Keep steps, entrances and footwear free from dirt (e.g. mud, clay, snow and ice).

Ornamental Moldings

For regular cleaning and care of very dirty chrome-plated parts, use a chrome cleaner.

Headlamps, Taillamps, Turn Signal Lenses

Use a mild car wash detergent with plenty of water.

To prevent scratches, never apply strong force and use only a soft, non-scratchy cloth when cleaning the lenses. Do not attempt to wipe dirty lenses with a dry cloth or sponge.

Window Cleaning

Use a window cleaning solution on all glass surfaces. An automotive glass cleaner is recommended.

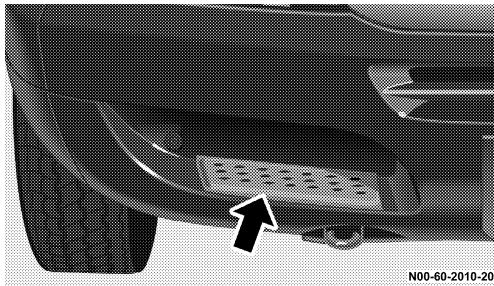

There are 2 steps in the front bumper. This makes it easier to clean the windshield.

WARNING!

For safety reasons, remove key from ignition lock before cleaning the windshield, otherwise the wiper motor can suddenly turn on and cause injury.

Dirty or iced-up steps create a risk of slipping or falling. Do not use the step in the front bumper when it is icy or dirty.

Wiper Blade

Clean the wiper blade rubber with a clean cloth and detergent solution.

7

WARNING!

For safety reasons, remove key from ignition lock before cleaning the wiper blade, otherwise the wiper motor can suddenly turn on and cause severe personal injuries and death.

224 MAINTAINING YOUR VEHICLE

Light Alloy Wheels

A wheel care product should be used for regular cleaning of the light alloy wheels.

If possible, clean wheels once a week, using a soft bristle brush and a strong spray of water.

Follow instructions on container.

NOTE: Use only acid-free cleaning materials. The acid could lead to corrosion.

Instrument Cluster

Use a gentle dishwashing detergent or mild detergent for delicate fabrics as a washing solution. Wipe with a cloth moistened in lukewarm solution. Do not use scouring agents.

Steering Wheel and Gear Selector Lever

Wipe with a damp cloth and dry thoroughly or clean with a leather care product.

Cup Holder

Use a gentle dishwashing detergent or mild detergent for delicate fabrics as a washing solution. Wipe with a cloth moistened in lukewarm solution. Do not use scouring agents.

Seat Belts

The webbing must not be treated with chemical cleaning agents. Use only clear, lukewarm water and soap. Do not dry the webbing at temperatures above 176 °F (+80 °C) or in direct sunlight.

WARNING!

Do not bleach or dye seat belts as this may severely weaken them. In a crash they may not be able to provide adequate protection.

Headliner and Shelf Below Rear Window

Clean with soft bristle brush, or use a dry-shampoo cleaner in case of excessive dirt.

Upholstery

Using aftermarket seat covers or wearing clothing that have the tendency to give off coloring (e.g. when wet

etc.) may cause the upholstery to become permanently discolored. By lining the seats with a proper intermediate cover, contact discoloration will be prevented.

Leather Upholstery

Wipe leather upholstery with a damp cloth and dry thoroughly or clean with a leather care product. Exercise particular care when cleaning perforated leather as its underside should not become wet.

Cloth Upholstery

Clean with soft bristle brush, or use a dry-shampoo cleaner in case of excessive dirt.

Tex Upholstery

Pour an interior care product onto soft lint-free cloth and apply with light pressure.

Hard Plastic Trim Items

Pour an interior care product onto soft lint-free cloth and apply with light pressure.

Plastic and Rubber Parts

Do not use oil or wax on these parts.

ELECTRICAL FUSES

Damaged fuses are recognizable from their burnt-out filament.

Prior to exchanging a fuse, turn the key in the ignition-column lock to the 0 position and switch off the consumer involved.

NOTE: Fuses must not be bridged. Replace fuses with specified rated current. Only replace fuses when the cause of the malfunction has been rectified.

NOTE: Fuses and relays (standard equipment) are on the underside of the ignition column, refer to "Fuses and Relays Standard Equipment".

Fuses, relays and diodes (optional equipment) are below the driver's seat, refer to "Optional Fuse and Relay Equipment".

CAUTION!

When replacing a blown fuse, it is important to use only a fuse having the correct amperage rating. The use of a fuse with a rating other than indicated may result in a dangerous electrical system overload. If a properly rated fuse continues to blow, it indicates a problem in the circuit that must be corrected.

Standard Fuse and Relay Equipment

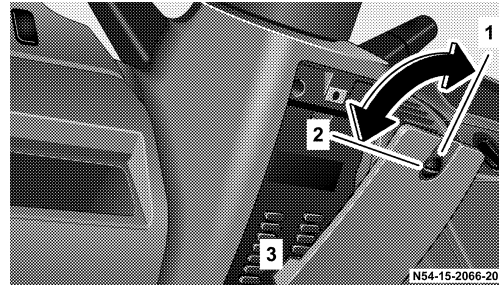

1. Locked
2. Unlocked
3. Detent spring – engage when the cover is fitted

Position of fuses and relays

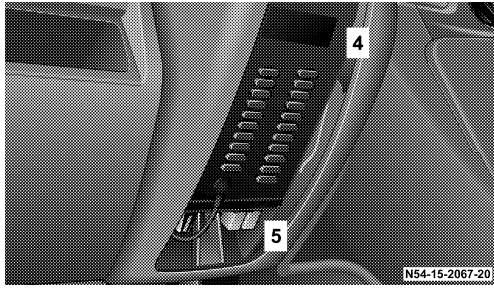

- 4. Fuses
- 5. Relays

Fuse Assignment, Standard Equipment

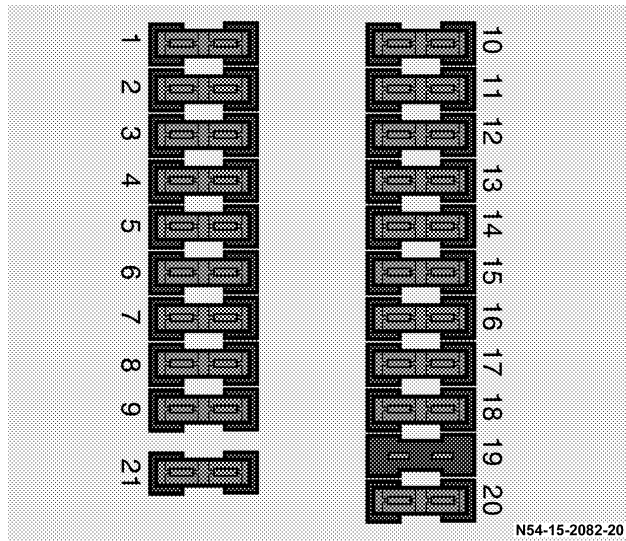

MAINTAINING YOUR VEHICLE 229

No.	Rated	Circuit
1.	10A	Parking lamp right, taillamp right
2.	10A	High beam head lamp, right
3.	10A	High beam head lamp, left, high beam indicator lamp
4.	10A	Backup lamp
5.	10A	Brake lamp
6.	20A	Windshield wiper motor
7.	15A	Horn, heated rear window, air recirculation switch, optional equipment relay (terminal 15)
8.	20A	Interior lighting, cigarette lighter, radio (terminal 30)
9.	15A	Clock, hazard warning lamps, parking lamps
10.	10A	Instrument lighting, license plate lamp daytime driving lamps
11.	10A	Side lamp, left; taillamp, left
12.	10A	Low beam headlamp, right
13.	10A	Low beam headlamp, left
14.	15A	Fog lamp
15.	10A	Radio (terminal 15)
16.	25A	Engine control unit
17.	15A	Engine control unit
18.	15A	Ignition (terminal 15)
19.	15A	Not in use
20.	15A	Heater controls (terminal 30)
21.	30A	Heater blower (terminal 30)

230 MAINTAINING YOUR VEHICLE

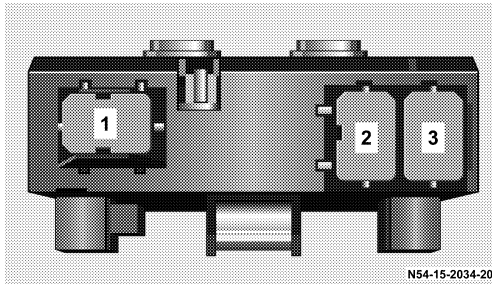

Relay Assignment, Standard Equipment

1. Windshield wiper motor (W)
2. Diesel engine control unit (M)
3. Turn signals (B)

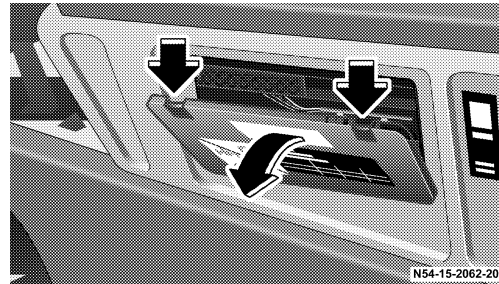

Fuse and Relay Optional Equipment

The cover is located below the driver's seat.

Remove cover:

1. Press both detent springs down and remove cover.

Install cover:

2. Position cover at bottom and engage both detent springs.

Fuse, Relay, and Diode Assignments – Optional Equipment

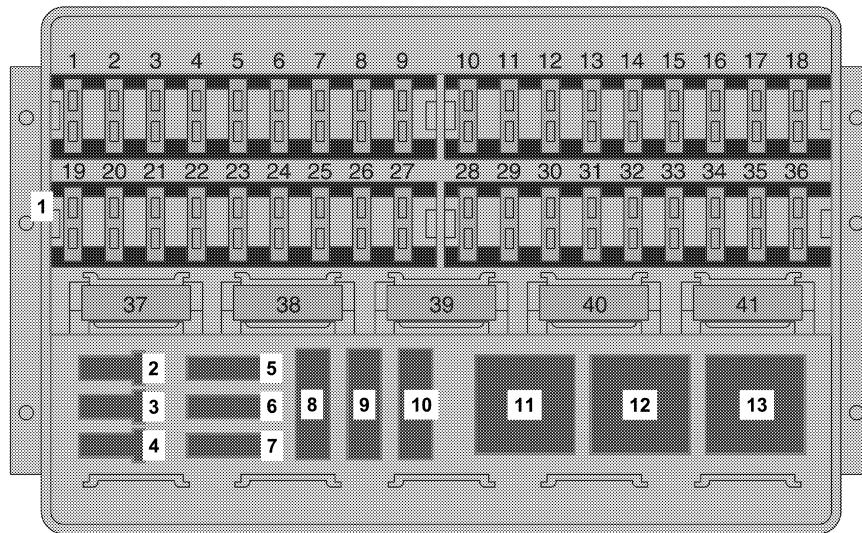

N54-15-2057-24

232 MAINTAINING YOUR VEHICLE

NOTE: The arrangement of the fuses (1) depends on the optional equipment installed on the vehicle. The assignments are shown on the inside of the cover of the fuse box.

Diodes:

No.	Circuit
1.	Not in use
2.	Not in use
3.	Not in use
4.	Not in use

Fuses:

No.	Rated	Circuit
5.	10A	Immobilizer
6.	7.5A	Anti-lock brake system (ABS)
7.	25A	Anti-lock brake system (ABS)
8.	40A	Not in use
9.	40A	Anti-lock brake system (ABS)
10.		Not in use

Relays:

No.	Circuit
11.	Not in use
12.	Starter relay
13.	Not in use

BULB REPLACEMENT

WARNING!

Bulbs and bulb holders can become very hot. Allow the lamp to cool down before changing the bulb.

Keep bulbs out of reach of children.

Do not use bulbs which have been dropped or which show signs of scratches on the glass. They could explode.

Changing an H7 bulb:
The bulb is pressurized. Always wear eye and hand protection.

Switch the lights off to prevent short circuits.

Only touch new bulbs with a clean, lint-free cloth. Do not touch bulbs with wet or greasy fingers.

Only fit 12 volt bulbs of the same type as before and with the correct wattage rating.

Front Lamp Unit

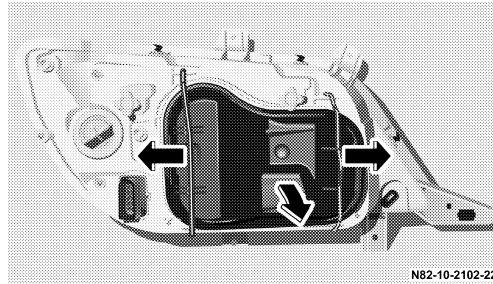

7

Bulbs are changed from inside the engine compartment.

Move the retainer bar to the side and remove the housing cover.

234 MAINTAINING YOUR VEHICLE

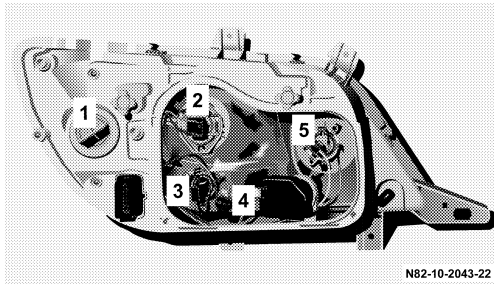

1. Turn signal lamp and sidemarker lamp, 3457 NA – 12V 28 / 7.5W, yellow glass
2. Low beam headlamp, H7 – 12V 55W
3. Fog lamp, H1 – 12V 55W
4. Side and parking lamps, W5W – 12V 5W
5. High beam headlamps, H1 – 12V 55

Turn Signal Lamps and Side-Marker Lamps

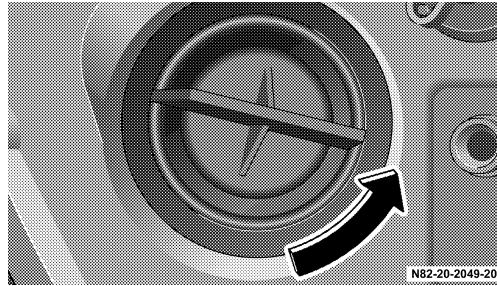

1. Turn bulb holder, together with bulb, counterclockwise and remove.
2. Remove the bulb from the bulb holder.
3. Insert a new bulb in the bulb holder.
4. Insert the bulb holder together with the bulb and turn clockwise to the stop.

Low Beam Headlamps

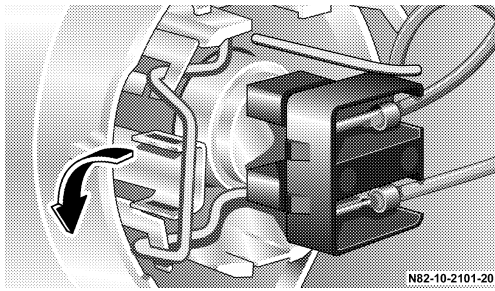

1. Unplug the cable connector from the bulb.
2. Unclip in the retaining springs. Press the retaining springs towards the headlamps and down (direction of arrow).

3. Remove the bulb.
4. Insert the new bulb so that the retaining lugs are fed into the recesses in the reflector section of the bulb holder.
5. Clip in the retaining springs.
6. Press on the cable connector.
7. Secure the housing cap.

236 MAINTAINING YOUR VEHICLE

Fog Lamp (Optional)

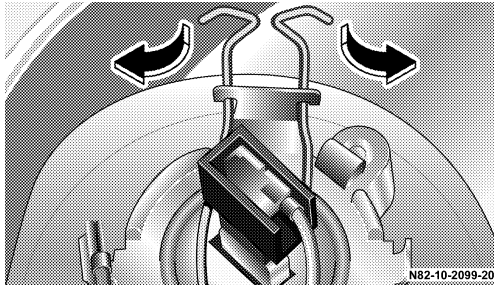

1. Remove the cable connector from the bulb holder.
2. Press both retaining springs in the direction of the headlamps and then outward (in the direction of the arrow).

3. Remove the bulb.
4. Put in the new bulb so that the retaining lugs on the bulb holder are inserted into the recesses in the bulb holder reflector section.
5. Secure both retaining springs.
6. Press on the cable connector.
7. Secure the housing cap.

Side and Parking Lamps

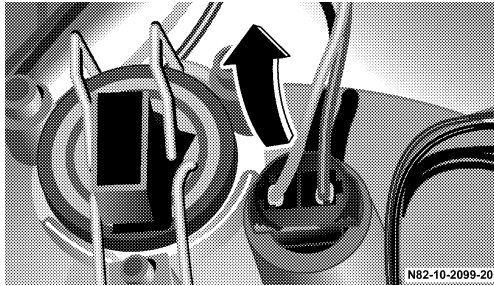

1. Pull out the bulb holder with the bulb.
2. Replace the bulb.
3. Insert the bulb holder.
4. Secure the housing cap.

High Beam Headlamp

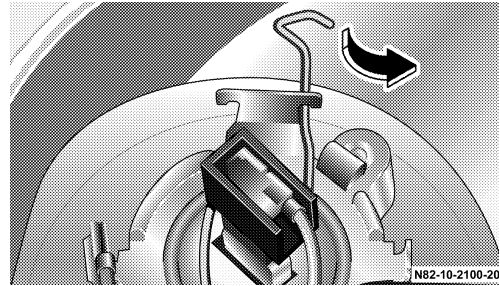

1. Unplug the cable connector from the bulb.
2. Press the retaining spring towards the headlamps and outwards (direction of arrow).
3. Remove the bulb.
4. Insert the new bulb so that the retaining lugs are fed into the recesses in the reflector section of the bulb holder.
5. Clip in the retaining springs.
6. Press on the cable connector.
7. Secure the housing cap.

7

238 MAINTAINING YOUR VEHICLE

Taillamps Cargo/Passenger Van

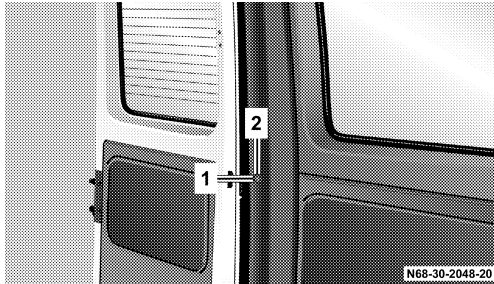

1. Locked
2. Unlocked

Bulbs are changed from inside the cargo area.

The rear lamp cluster bulb holder is located behind the interior paneling. Remove the paneling.

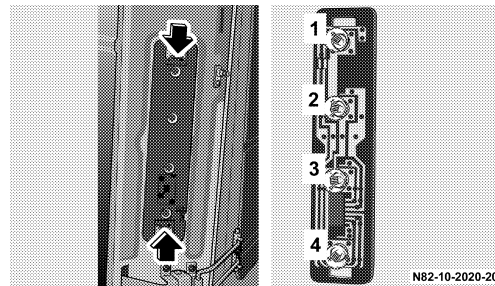

Brake lamp, taillamp, standing lamp,
P21/5W – 12V 21/5W

Backup lamp, P21W – 12V 21W

Turn signal lamp, P21W – 12V 21W

Side-marker lamp, R5W – 12V 5W

1. Unclip and remove the bulb socket.
2. To change a bulb, press the bulb into the bulb socket, turn it counterclockwise and remove.
3. Insert the new bulb.
4. Clip the bulb socket into place.

Chassis

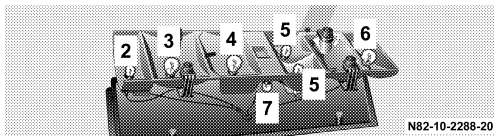
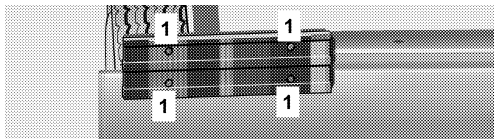

1. Loosen retaining screw a and remove lamp housing.
2. To change a bulb, press the bulb into the bulb socket, turn it counterclockwise and remove.
3. Insert the new bulb.
4. Install lamp housing.

Retaining screws

Clearance lamp, R5W - 12V 5W

Turn signal lamp, P21W - 12V 21W

Stop lamp, P21W - 12V 21W

Taillamp, R5W - 12V 5W

Backup lamp, P21W - 12V 21W

License plate lamp (driver's side only),
R5W - 12V 5W

240 MAINTAINING YOUR VEHICLE

License Plate Lamps (Cargo/Passenger Vans Only)

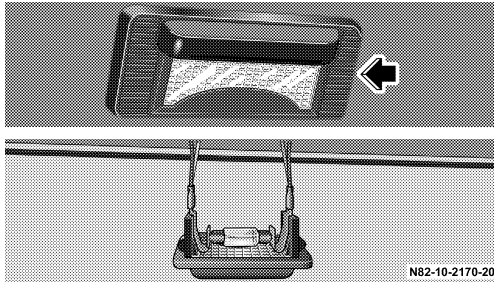

1. Press the bulb socket to the left, against the force of the spring, and remove.
2. Replace the bulb, C5W – 12V 5W.
3. Install the cover.
4. Re-install the bulb socket.

Additional Brake Lamp (Cargo/Passenger Vans Only)

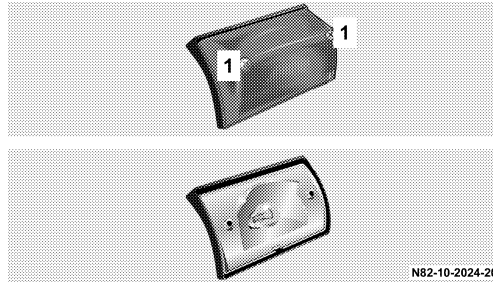

Retaining screws

1. Take out the retaining screws (1) and remove the lamp housing.
2. To change a bulb, P21W – 12V 21W
Press the bulb into the bulb socket, turn it counterclockwise and remove.
3. Insert the new bulb.
4. Install the lamp housing.

Side-Mounted Turn Signals

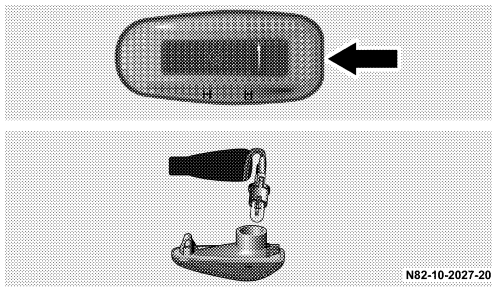

1. Press the lamp housing to the front, against the force of the spring, and remove.
2. Replace the bulb, W5W - 12V 5W
3. Install the bulb socket.

Side-Marker Lamps, Standing Lamps (Optional)

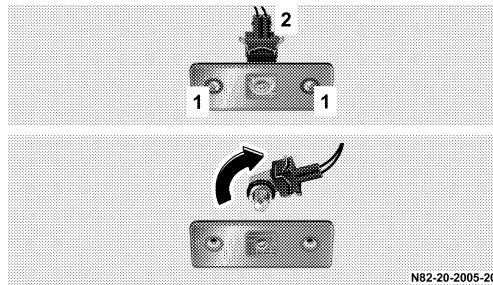

Retaining screws (1) Bulb socket (2)

1. Take out the retaining screws (1) and remove the lamp housing.
2. Turn the bulb socket (2) counterclockwise and remove.
3. Replace the bulb, W3W - 12V 3W.
4. Install the bulb socket (2).

242 MAINTAINING YOUR VEHICLE

Interior Lighting in Passenger Compartment and Load Compartment

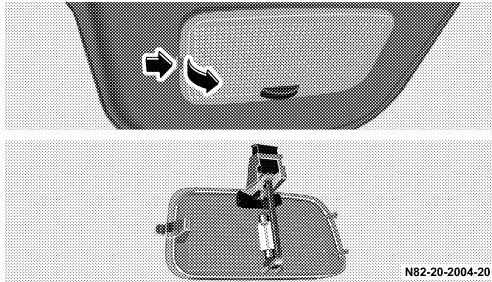

1. Align a screwdriver on the retaining spring, press it in and pry the lamp housing out.
2. Replace the bulb, K - 12V 18W
3. Install the lamp housing.

Interior Lighting with Reading Lamp

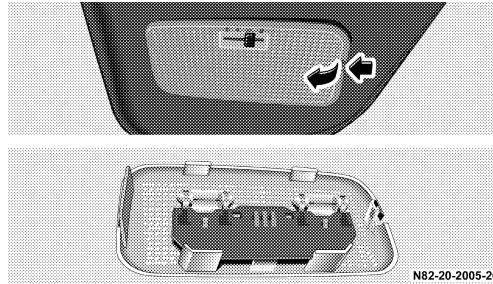

1. Use a screwdriver on the catch spring to press in and remove the bulb housing.
2. Replace the bulb, K - 12V 10W.
3. Install the lamp housing.

Interior Lighting with Interior Sensor Protection

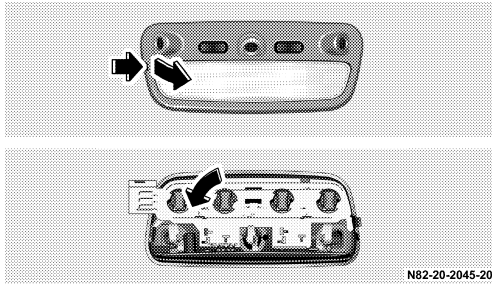

1. Use a screwdriver on the catch spring, remove the bulb housing.
2. Turn the bulb holder with the bulb in the direction of the arrow and remove it.
3. Replace the bulb holder and bulb, K - 12V 6W
4. Install the lamp housing.

Exit Lamps (Optional)

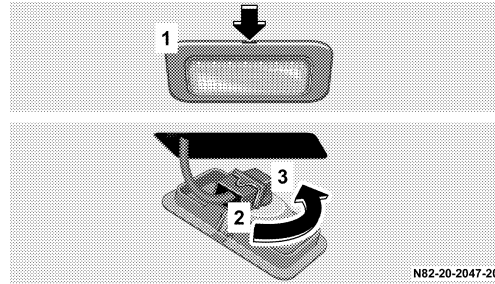

- Lamp housing (1) Cable connector (2) Bulb holder (3)
1. Use a screwdriver on the catch spring to remove the lamp housing (1).
 2. Press the locating spring on the cable connector (2), hold it down, and remove the cable connector (2).
 3. Turn the bulb holder (3) to the left and remove it.
 4. Replace the bulb, W5W - 12V 5W.
 5. Install the bulb holder (3) and attach the cable connector (2).

244 MAINTAINING YOUR VEHICLE

CAPACITIES

	Engine with oil filter Engine oil	Fuel tank		Cooling system	Windshield washer system
			Including reserve fuel		
All vehicles	about 9.5 US qt (9.0 l)	about 26.4 US gal (100 l)	about 2.8 US gal (10.5 l)	about 2.7 US gal (10.0 l)	about 7.4 US qt (7.0 l)

Recommended Fluids and Lubricants

Component	Recommended Fluid
Brake	Use brake fluid approved to MB 331.0, or a DOT 4 brake fluid with: minimum dry boiling point (ERBP) 500°F, minimum wet boiling point (WERBP) 356°F, maximum viscosity 1500 mm ² /s, conforming to FMVSS 116 and ISO 4925.
Coolant	Use coolant approved to MB 325.0, such as Valvoline GO5, or an equivalent Extended Life Coolant.
Engine	Use engine oils approved to MB 228.3 or MB 228.5 that are also licensed to API CI-4.
Automatic Transmission	Use ATF approved to MB 236.10, MB 236.12. Synthetic Dexron III® Automatic Transmission Fluid may be substituted.
Power Steering	No fluid service required. Use Power Steering Fluid approved to MB 341. Dexron III® Automatic Transmission Fluid may be substituted.
Rear Axle	Use oils approved to MB 235.0, such as Shell Spirax MB 90. Reduced axle durability may result if an unapproved product is used.

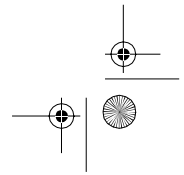
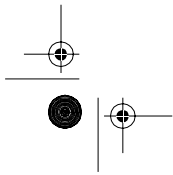
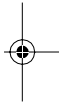
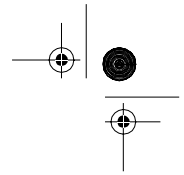
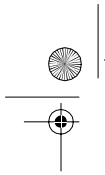

MAINTENANCE SCHEDULES

CONTENTS

■ Introduction	248	□ Dust Filter for Heating/Ventilation Replacement	251
■ Warranty	248	■ Engine Oil Change and Filter Replacement	251
■ Maintenance - Without ASSYST Maintenance Computer	249	□ Once a Year	251
□ Maintenance Intervals	249	■ Scope of Work for Maintenance service	252
■ Maintenance - With ASSYST Maintenance Computer	250	□ Oil Service	252
■ Regular Check-Ups	250	□ Additional Maintenance Work	254
■ Special Maintenance Requirements	251	□ Additional Maintenance Work After ... Years	254
□ Brake Fluid	251		
□ Coolant	251		

248 MAINTENANCE SCHEDULES

INTRODUCTION

This is intended as a guide to the service requirements of your vehicle.

It contains all necessary instructions concerning service intervals and operations which have to be carried out.

Scope and frequency of maintenance work primarily depend on the vehicle's operating conditions.

In the interest of maintaining the vehicle's operating safety, the specified work should be performed regularly and in good time.

Our vehicles are subject to ongoing development. Technical progress may also affect the scope of service work performed.

"Daily vehicle checks" before starting a journey are the responsibility of the driver.

WARRANTY

The Sprinter Dealer network is at your disposal for maintenance work. Each of these workshops has the equipment and tools, the specially trained, skilled and experienced personnel and receives regular technical instruction from DaimlerChrysler Corporation to ensure that your vehicle is inspected and maintained thoroughly and in accordance with the latest procedures.

Please follow the instructions given in this Owner's Manual and ensure that they are observed, even if you hand the vehicle over to a third party for use or care. By not observing these instructions you may void your warranty rights.

If the specified oil and maintenance services are not carried out regularly or at the time intervals specified, a decision as to the validity of a warranty claim can only be made after DaimlerChrysler Corporation has investigated your claim.

The use of Special lubricant additives is not recommended. The use of such additives may affect your warranty rights. With regard to legal stipulations concerning emissions control, please note that engines have to be serviced and adjusted in accordance with special instructions and using special measuring equipment. Modifications to or interference with the emissions control systems are not permissible.

All Sprinter Dealer are familiar with the relevant and applicable regulations.

**MAINTENANCE - WITHOUT ASSYST
MAINTENANCE COMPUTER**

Maintenance Intervals

	Normal Operation
Oil service – Refer to	every 10,000 miles or 16,000 km or 12 months
Maintenance service	every 30,000 miles or 48,000 km

Additional work must be carried out at yearly intervals.

As a general rule, to avoid unnecessary visits to the workshop you should try to have necessary repair work performed together with other maintenance work.



250 MAINTENANCE SCHEDULES

MAINTENANCE - WITH ASSYST MAINTENANCE COMPUTER

ASSYST provides you with information on the best possible timing for maintenance work.

NOTE: The engine manufacturer strongly recommends the use of synthetic engine oils, such as Mobil 1 SAE 0W-40.

When the next maintenance service is due, this will be indicated in the multi-function display with the symbol

-  Oil service
-  Maintenance service - displayed in km/miles or days.
- 

If the display shows the number of days, the symbol  will also appear in the multi-function display.

You should have the maintenance performed within the stated period/distance.

The service indicator will be reset by your Sprinter Dealer after an oil service and/or maintenance service has been performed.

REGULAR CHECK-UPS

To maintain the safe operation of your vehicle, it is recommended that you perform the following tasks on a regular basis (i.e., weekly or whenever the vehicle is refueled). Check:

- Engine oil level
- Brake system, clutch mechanism – fluid level
- Battery – acid level
- Windshield washer system and headlamp cleaning system – fluid level
- Mechanical assemblies (e. g. ,engine, transmission, etc.) – check for leaks
- Condition of tires and tire pressures
- All exterior lights

SPECIAL MAINTENANCE REQUIREMENTS

If bodies built by manufacturers other than DaimlerChrysler Corporation are fitted to the vehicle, the maintenance requirements and lubrication intervals specified by the body manufacturer must be adhered to, in addition to all standard maintenance requirements.

Brake Fluid

Only use brake fluids approved by the manufacturer (DOT 4 plus). Information about brake fluids is available from your Sprinter Dealer.

Coolant

Have the corrosion inhibitor/antifreeze concentration in the coolant checked before the onset of winter (once a year in countries with high prevailing temperatures).

Have the coolant renewed every five years or 100,000 miles.

Dust Filter for Heating/Ventilation Replacement

The dust filter and the tailgate interior filter are renewed during routine maintenance service. However, if operating conditions are dusty, these filters should be renewed more frequently.

ENGINE OIL CHANGE AND FILTER REPLACEMENT

In a minimum, change the engine oil and oil filter once a year - even if the vehicle mileage per year is extremely low. For standard oil service schedules, please see the chapter oil service and maintenance service.

Once a Year

Select the viscosity of the engine oil (SAE classes) according to the outside air temperature.

Only use engine oil approved by DaimlerChrysler Corporation if following the ASSYST system guidelines. Information is available from your Sprinter Dealer.

If the fuel used has a sulphur content exceeding 0.05 % by weight, the service intervals should be split in half.

If the sulphur content of the fuel used is between 0.3% and 0.8% by weight, the service intervals should be split in half (i.e. every 5,000 miles instead of every 10,000 miles).

252 MAINTENANCE SCHEDULES

SCOPE OF WORK FOR MAINTENANCE SERVICE

Oil Service

Oil change

Engine:

Oil change and filter replacement

Check fluid levels of the following system, refill as necessary.

If fluid is lost, trace and eliminate cause – as a separate order.

Power-assisted steering

Lubrication work:

Trailer tow hitch (original equipment)

Maintenance

ASSYST maintenance computer reset

Function check

Signalling system, warning and indicator lamps

Headlamps, exterior lighting

Windscreen wipers, windscreen washer system

Check for leaks and damage.

Check for abrasion points and ensure that lines are correctly routed!

All assemblies:

Engine, transmission, transfer case, front axle, rear axle, steering, power steering pump

All lines and hoses, sensor cables

Rubber boots on front axle drive shafts, rubber boots on front axle suspension ball joints, shock absorbers

Check fluid levels for the following systems, correct as necessary.

Should there be a loss of fluid which cannot be explained by regular use, trace and eliminate the cause.

Engine cooling system
Check corrosion inhibitor/antifreeze, refill as necessary.

Hydraulic brake system

Battery

Windscreen washer system

Engine

Fuel filter renewal

Air cleaner with maintenance indicator:
Check degree of contamination.
Air cleaner filter element renewed as necessary.

Chassis and body

Trailer coupling:
Check operation, play and retaining fixtures

Secondary rubber springs:
Visual check

Tire pressures:
Correct as necessary, including spare tyre

Check thickness of brake pads

Brake test

Check condition of brake disks. Brake disks renewal as necessary – as a separate order

Check condition of steering mechanism

Heating/ventilation dust filter renewal

254 MAINTENANCE SCHEDULES

Additional Maintenance Work

**Automatic transmission once only at 80,000 miles/
128000km**

Oil and filter change

During every second maintenance service

Air cleaner without maintenance indicator:
Air cleaner filter element renewal

Check poly-V-belt for wear and signs of damage

During every sixth maintenance service

Rear axle

Additional Maintenance Work After ... Years

Every 3 years

Air cleaner filter element renewal
(note installation date)

Every 5 years or 100,000 miles

Coolant renewal
Note coolant composition

IF YOU NEED CONSUMER ASSISTANCE

CONTENTS

■ Suggestions For Obtaining Service For Your Vehicle	256	■ If You Need Assistance	256
□ Prepare for the Appointment	256	■ Warranty Information	259
□ Prepare a List	256	■ Mopar® Parts	259
□ Be Reasonable with Request	256	■ Reporting safety Defects	259

256 IF YOU NEED CONSUMER ASSISTANCE

SUGGESTIONS FOR OBTAINING SERVICE FOR YOUR VEHICLE

Prepare for the Appointment

If you're having warranty work done, be sure to have the right papers with you. Take your warranty folder. All work to be performed may not be covered by the warranty, discuss additional charges with the service manager. Keep a maintenance log of your vehicle's service history. This can often provide a clue to the current problem.

Prepare a List

Make a written list of your vehicle's problems or the specific work you want done. If you've had an accident, or work done that is not on your maintenance log, let the service advisor know.

Be Reasonable with Request

If you list a number of items, and you must have your vehicle by the end of the day, discuss the situation with the service advisor and list the items in order of priority. At many dealers you may obtain a rental vehicle at a minimal daily charge. If you need a rental, it is advisable to make these arrangements when you call for an appointment.

IF YOU NEED ASSISTANCE

The manufacturer and its dealers are vitally interested in your satisfaction. We want you to be happy with our products and services.

Your selling dealer is best equipped and most anxious to provide prompt resolution for any warranty issue or related matter that you may experience. The manufacturer's dealer have the facilities, factory-trained technicians, special tools, and the latest information to assure your vehicle is fixed correctly and in a timely manner. The manufacturer has empowered its dealers to make warranty and repair decisions that ensure you are not inconvenienced. There are no need for you to wait for a decision from the manufacturer. If a special circumstance occurs that requires information from the manufacturer, we have asked the dealer's service management to make the contact on your behalf.

This is why you should always talk to your dealer's service manager first. Most matters can be resolved with this process.

IF YOU NEED CONSUMER ASSISTANCE 257

- If for some reason you are still not satisfied, talk to the general manager or owner of the dealership. They want to know if you need assistance.
- If your dealership is unable to resolve the concern, you may contact the Manufacturer's Customer Center.

Any communication to the Manufacturer's Customer Center should include the following information:

- Owner's name and address
- Owner's telephone number (home and office)
- Dealership name
- Vehicle identification number
- Vehicle delivery date and mileage

DaimlerChrysler Motors Corporation Customer Center

P.O. Box 21-8004

Auburn Hills, MI 48321-8004

Phone: (800) 992-1997

DaimlerChrysler Canada, Inc. Customer Center

P.O. Box 1621

Windsor, Ontario N9A 4H6

Phone: (800) 465-2001

In Mexico contact:

Av. Prolongacion Paseo de la Reforma, 1240

Sante Fe C.P. 05109

Mexico, D.F.

In Mexico (915) 729-1248 or 729-1240

Outside Mexico (525) 729-1248 or 729-1240

Customer Assistance For The Hearing Impaired Or Speech Impaired (TDD/ TTY)

To assist customers who have hearing difficulties, the manufacturer has installed special TDD (Telecommunication Devices for the Deaf) equipment at its Customer Center. Any hearing or speech impaired customer who has access to a TDD or a conventional teletypewriter (TTY) in the United States can communicate with the manufacturer by dialing 1-800-380-CHRY.

258 IF YOU NEED CONSUMER ASSISTANCE

Service Contract

You may have purchased a service contract for your vehicle to help protect you from the high cost of unexpected repairs after your manufacturer's new vehicle limited warranty expires. The manufacturer stands behind only the manufacturer's Service Contracts. If you purchased a manufacturer's Service Contract, you will receive Plan Provisions and an Owner Identification Card in the mail within three weeks of your vehicle delivery date. If you have any questions about your service contract, call the manufacturer's Service Contract National Customer Hotline at 1-800-521-9922.

The manufacturer will not stand behind any service contract that is not the manufacturer's Service Contract. It is not responsible for any service contract other than the manufacturer's Service Contract. If you purchased a service contract that is not a manufacturer's Service Contract, and you require service after your manufacturer's new vehicle limited warranty expires, please refer to your contract documents and contact the person listed in those documents.

We appreciate that you have made a major investment when you purchased your new vehicle. Your dealer has also made a major investment in facilities, tools, and training to assure that you are absolutely delighted with your ownership experience. You'll be pleased with their sincere efforts to resolve any warranty issues or related concerns.

WARRANTY INFORMATION

See your manufacturer's Warranty Information Booklet for information on your warranty coverage and transfer of warranty.

MOPAR® PARTS

Mopar® fluids, lubricants, parts, and accessories are available from your dealer. They will help you keep your vehicle operating at its best.

REPORTING SAFETY DEFECTS

In the 50 United States and Washington D.C.: If you believe that your vehicle has a defect which could cause a crash or cause injury or death, you should immediately inform the National Highway Traffic Safety Administration (NHTSA) in addition to notifying the manufacturer.

If NHTSA receives similar complaints, it may open an investigation, and if it finds that a safety defect exists in a group of vehicles, it may order a recall and remedy campaign. However, NHTSA cannot become involved in individual problems between you, your dealer, and the manufacturer.

To contact NHTSA, you may either call the Auto Safety Hotline toll free at 1-800-424-9393 (or 202-366-0123 if you are in the Washington, D.C. area) or write to: NHTSA, U.S. Department of Transportation, Washington, D.C. 20590. You can also obtain other information about motor vehicle safety from the Hotline.

In Canada:

If you believe that your vehicle has a safety defect, you should contact the Customer Service Department immediately. Canadian customers who wish to report a safety defect to the Canadian government should write to: Transport Canada, Motor Vehicle Defect Investigations and Recalls, 2780 Sheffield Road, Ottawa, Ontario, K1B 3V9.



Freightliner-all.book Page 260 Monday, December 1, 2003 2:54 PM

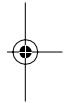

INDEX

A Special Note Concerning Vehicle Alteration . . .	184	Air Conditioning, Regulated	115
Acceleration Skid Control	155	Air Filter Restriction Indicator	209
Deactivating	159	Air Recirculation	110
Indicator Lamp	155	Air Vents	
Warning Lamp	137, 157	Center	113
Acceleration Skid Control (ASR)	157, 158	Side	113
Air Bag, Front Seat Passenger	42	Upper	113
Air Conditioner for the Rear Passenger		Airbag	40
Compartment		Driver's	41
Air Recirculation	119	Malfunction	38
Air Strainer	120	Passenger	42
Air Conditioning		Safety Precautions	44
Climate Control	116	Airbag Malfunction	38
Dehumidification	117	Airbag, Drivers	41
Rear Passenger Compartment	117	Alarm Pushbutton	22

262 INDEX

Anti-Lock Brake System (ABS) Indicator Lamp . . .	152	Batteries	216
Appearance	219	Charging the Battery	217
Armrest	56	Disconnecting the Battery	216
Ashtray	76	Reconnecting the Battery	217
ASSYST	249	Replacing Batteries in Remote Keyless Entry	18
ASSYST Maintenance Computer	103	Battery Charge Indicator Lamp	95
Automatic Lock Feature	15	Belt Tensioners	40
Automatic Transmission	139	Location	43
Accelerator Position	140	Bleeding the Diesel Fuel System	176
Driving	139	Body Builder Guideline	183
Maneuvering	140	Brake Assist System (BAS)	160
Selector Lever Manually Unlocking	144	Brake fluid	212
Selector Lever Position	141	Brake Fluid Reservoir	211
Stopping	140	Brake Indicator Lamp	148
Auxiliary Heat Exchanger	129	Brake Pad Wear Indicator	147
Auxiliary Heater		Brake System	155
Settings	129	Fluid Level	211
Timer Auxiliary Heater (Water and		Brake System, Anti-Lock	153
Air Heater)	125	Brakes	146
Tips for Coping with Problems	130	Brake Fluid	212

Service Brake	146	To Program the Automatic Lock Feature	15
Bulbs		Chains, Snow	170
Bulb Replacement	233	Changing a Bulb	
Front Lamp Unit	233	Additional Brake Lamp	240
Capacities	244	Exit Lamps	243
Care of Vehicle		Front Lamp Unit	233
Engine Cleaning	221	Interior Lighting	242
Headlamps, Taillamps, Turn Signal Lenses	222	Interior Lighting with Interior Sensor Protection	243
Vehicle Washing	222	License Plate Lamp	240
Care of vehicle		Reading Lamp	242
Paintwork, painted body components	221	Side-Marker Lamp	241
Power washer	220	Side-Mounted Turn Signal	241
Tar stains	221	Taillamp	238
Catalytic Converter	183	Changing the Tire	187
Central Locking	11	Charging the Battery	217
Locking	12	Checking Coolant Level	213
Central Locking Switch	13	Checking Weights of Vehicle and Trailer	179
Locking and Unlocking	15	Cigar Lighter	76
Locking Status Display	14		

264 INDEX

Cleaning	
Cup Holder	224
Hard Plastic Trim Items	225
Instrument Cluster	224
Light Alloy Wheels	224
Plastic and Rubber Parts	225
Seat Belts	224
Steering Wheel and Gear Selector Lever	224
Upholstery	224
Wiper Blade	223
Climate Control	116
Clock	89
Comfort Tire Pressures	169
Compartments in Front Doors	79
Constant RPMs	137
Consumer Assistance	
Be Reasonable with Request	256
If You Need Assistance	256
Prepare a List	256
Prepare for the Appointment	256
Coolant Level Indicator Lamp	98
Coolant Temperature Gauge	93
Corrosion Protection	219
Cup Holder	78
De-Fogging	112
Dehumidification	117
De-Icing	112
Diesel Fuels for Use at Very Low Temperatures	171
Displaying Engine Oil Level	106
Doors	
Front Doors	23
Rear Cargo Doors	29
Sliding Door	26
Draining Fuel Filter with Water Separator	175
Driver's Airbag	41
Electric Sun Roof	74
Electrical Fuses	225
Fuse and Relay Optional Equipment	230

Fuse, Relay, and Diode Assignments - Optional Equipment	231	Engine Oils	209
Relay Assignment, Standard Equipment	230	Engine oils	210
Standard Fuse and Relay Equipment	226	Engine Speed, Maximum	136
Electrical Outlet	77	Engine, Stopping	138
Electronic Brake Force Distribution	155	Exhaust Gas, Inhalation of	48
Electronic Brake Force Distribution Lamp.	148	Fog Lamp Switch	62
Electronic Stability Program	157	Folding Seat at Partition	57
Emission Label, Vehicle/Engine	6	Fording	183
Emission Related Component	208	Front Seat Passenger Airbag	42
Emissions Control System	183	Fuel Filter	175
Engine Break-in Recommendations	46	Fuel Filter with Water Separator	170
Engine Cleaning	221	Fuel Gauge	94
Engine Control Unit Indicator Lamp	99	Fuel Tank Capacity	173
Engine Coolant.	212	Fuels.	170
Engine Oil Consumption	47	Bleeding the Diesel Fuel System	176
Engine Oil Level	210	Diesel Fuels for Use at Very Low	
Indicator in Instrument Cluster	108	Temperatures.	171
Engine Oil Level - Display in Instrument Cluster	105	Draining Fuel Filter with Water Separator	175
Engine Oil Level Indicator Lamp	97	Fuel Filter with Water Separator	170

266 INDEX

Fuel Tank Capacity	173	Ignition	
Refueling	172	Lock	9
Fuse and Relay Optional Equipment	230	Starter Switch	9
Fuse, Relay, and Diode Assignments - Optional		Immobilizer	10
Equipment	230	Indicator Lamp Symbols	99
Fuses, Electrical	225	Inhalation of Exhaust Gas	48
Glove Compartment	79	Installing a Wheel	196
Lockable Glove Compartment	79	Instrument and Display Lighting	90
Hazard Warning Flasher Switch	186	Instrument Cluster	
Head Restraint	56	Battery Charge Indicator Lamp	95
Headlamp Range Control	62	Clock	89
Headlamps, taillamps, turn signal lenses	222	Coolant Level Indicator Lamp	98
Heated Rear Window	114	Coolant Temperature Gauge	93
Heater, Seat	57	Engine Control Unit Indicator Lamp	99
Heating	109, 111	Engine Oil Level Indicator Lamp	97
Hood	60	Tachometer	92
How to Use this Manual	4	Trip Meter	90
Hydroplaning	165	Water in Fuel Indicator Lamp	96
		Instrument Cluster and Indicator Lamps	85
		Instruments and Controls	83

Interior Lighting	63	Brake System	155
Cargo Area	65	Coolant Level Indicator Lamp	98
Driver and Rear-Seat Passenger/Cargo Area . . .	63	Electronic Brake Force Distribution	148
Interior Sensor Protection	63	Engine Control Unit Indicator Lamp	99
Reading Lamp	64	Engine Oil Level	108
Intervals, Maintenance	249	Engine Oil Level Indicator Lamp	97
Introduction	4	Exit Lamps	243
Instrument Cluster		Indicator Lamps	85
Fuel Gauge	94	License Plate Lamp	240
Jack	192	Reading Lamp	242
Location	193	Reserve Fuel Indicator Lamp	94
Jump Starting	198	Seat Belt Warning Lamp	38
Lamps		Side-Marker Lamp	241
Acceleration Skid Control	155	SRS Malfunction Indicator Lamp	40
Acceleration Skid Control Warning Lamp	137, 157	Taillamp	238
Additional Brake Lamp	240	Water in Fuel Indicator Lamp	96
Anti-Lock Brake System (ABS) Indicator Lamp . . .	152	Lifting Points	193
Battery Charge Indicator Lamp	95	Lighter, Cigar	76
Brake Lamp	148	Lighting, Interior	63
		Loading	144

268 INDEX

Lock, Ignition	9	Without ASSYST Maintenance Computer	249
Locking, Central.	11	Maximum Engine Speed.	136
Lumbar Support	55	Mechanical Sun Roof.	75
Maintenance Computer	103	Mechanical Sun Roof Operation	75
Maintenance Intervals.	249	Mirror Adjustment	53
Maintenance Schedules		Mirrors	
Additional Maintenance Work		Adjustment	53
After ... Years	254	Exterior	53
Brake Fluid.	251	Interior	53
Coolant	251	Mopar® Parts	259
Dust Filter for Heating/Ventilation		Multi-Function Indicator	87
Replacement	251	Multifunction Switch.	66
Engine Oil Change and Filter Replacement	251	Occupant Restraints	35
Introduction.	248	Odometer	90
Oil Service	252	Opening/Closing doors	23
Once a Year	251	Operation, Window.	68
Regular Check-Ups.	250	Ornamental Moldings.	222
Scope of Work for Maintenance service	252	Outlet, Electrical.	77
Warranty	248	Outside Temperature Display	91
With ASSYST Maintenance Computer	250		

Overheating (Air Heater)	131	Removing a Wheel	195
Overheating (Water Heater)	131	Replacing Wiper Blades	218
Passenger Compartment Protection	21	Reporting safety Defects	259
Alarm Pushbutton	22	Reserve Fuel Indicator Lamp	94
Switching off	21	Residual Engine Heat Utilization	115
Pedals	46	Residual Engine Heat Utilization (REST)	115
Permissible Roof Load	177	Restraints, Occupant	35
Programmed Top Speed	173	Retrofitting Seat Mounting Cups	59
Rear Cargo Doors	29	Ribbed V-Belt	211
Rear Seat Bench	58	Roof Load	177
Removal and Installation	58	RPMs, Constant	137
Recommended Fluids and Lubricants	245	Safety Tips	47
Refueling	172	Seat Belt Warning Lamp and Airbag Malfunction	38
Regular Checks	208	Seat Belts	37
Relay Assignment, Standard Equipment	230	Belt Tensioners	43
Remote Keyless Entry	16	Fastening and Removing	38
Locking	18	Height Adjustment	40
Replacing Batteries	18	Seat Heater	57
Unlocking	17		

270 INDEX

Seats	
Adjustment	54
Armrest	56
Driver's and Front Passenger's Seat	54
Folding Seat	57
Head Restraint	56
Heater	57
Lumbar Support	55
Rear Seat Bench	58
Security System with Towing and Passenger Compartment Protection	19
Audible Alarm	20
Switching off the Alarm	20
Visual Alarm	20
Selector Lever Position	141
Service Products	207
Disposal of Service Products	208
Skid Control, Acceleration	155
Sliding Door	26
Snow Chains	170
Spare Wheel Location	189
Special Maintenance Requirements	251
Speed Control	71
Sprinter Original Parts	207
SRS Malfunction Indicator Lamp	40
Standard Fuse and Relay Equipment	226
Starter Switch	9
Starting the Engine	135
Steering	163
Stopping the Engine	138
Suggestions For Obtaining Service For Your Vehicle	256
Sun Roof	
Electrical	74
Mechanical Operation	75
Sun Roof, Electrical	74
Switch Locations	101
Switch, Starter	9
Tachometer	92

Tie Down Rings	48	Switching off	20
Tire Grip	165	Towing Protection and Passenger Compartment Protection Switch	20
Tire Pressure Table	167	Towing the Vehicle	200
Tire Pressures	165	If the Engine is Damaged	201
Tires		If the Front Axle is Damaged	202
Changing the Tire	187	If the Rear Axle is Damaged	202
Comfort Tire Pressures	169	If the Transmission is Damaged	201
Hydroplaning	165	Trailer	177
Installing	196	Attaching a Trailer	179
Jack	192	Checking Weights of Vehicle and Trailer	179
Removing	195	Electrical Connections	177
Snow Chains	170	Loading a Trailer	178
Spare Wheel Location	189	Parking a Trailer	182
Tire Grip	165	Towing	177
Tire Pressures	165	Towing a Trailer	180
Tire Pressures Table	167	Trailer Hitches	177
Tires, Wheels	163	Vehicle and Trailer Weights	178
Towing	177	Transmission, Automatic	139
Towing a Trailer	180	Trip Meter	90
Towing Protection	20		

272 INDEX

Using the Jack	193	Water in Fuel Indicator Lamp	96
Vehicle / Engine Emission Label	6	Wheels and Tires	163
Vehicle Alteration	184	Window Cleaning	223
Vehicle and Trailer Weights.	178	Window Operation	68
Vehicle Identification Number	5	Electric	68
Vehicle Loading	144	Mechanical	68
Vehicle Safety Certification Label	5	Windows	
Vehicle Tool Kit	187	De-Fogging.	112
Vehicle Washing	222	De-Icing	112
Ventilation	110	Windshield Heater.	114
Ventilation, Heating	109	Windshield Washer System Fluid Reservoir	209
Wading Capability	183	Windshield Wiper Switch.	69
Warnings and Cautions	4	Windshield wipers with rain sensor.	70
Warranty Information.	259	Winter Operation	215