

2003

AURORA



The 2003 Oldsmobile Aurora Owner Manual

Seats and Restraint Systems	1-1	Driving Your Vehicle	4-1
Front Seats	1-2	Your Driving, the Road, and Your Vehicle	4-2
Safety Belts	1-8	Towing	4-33
Child Restraints	1-28	Service and Appearance Care	5-1
Air Bag Systems	1-47	Service	5-3
Restraint System Check	1-55	Fuel	5-5
Features and Controls	2-1	Checking Things Under the Hood	5-12
Keys	2-3	Headlamp Aiming	5-50
Doors and Locks	2-10	Bulb Replacement	5-54
Windows	2-17	Windshield Wiper Blade Replacement	5-59
Theft-Deterrent Systems	2-19	Tires	5-60
Starting and Operating Your Vehicle	2-23	Appearance Care	5-82
Mirrors	2-35	Vehicle Identification	5-90
OnStar [®] System	2-39	Electrical System	5-91
HomeLink [®] Transmitter	2-41	Capacities and Specifications	5-100
Storage Areas	2-45	Normal Maintenance Replacement Parts	5-101
Sunroof	2-47	Maintenance Schedule	6-1
Vehicle Personalization	2-48	Maintenance Schedule	6-2
Instrument Panel	3-1	Customer Assistance Information	7-1
Instrument Panel Overview	3-2	Customer Assistance Information	7-2
Climate Controls	3-23	Reporting Safety Defects	7-8
Warning Lights, Gages and Indicators	3-30	Index	1
Driver Information Center (DIC)	3-45		
Audio System(s)	3-59		



GENERAL MOTORS, GM, the GM Emblem, OLDSMOBILE, the OLDSMOBILE Rocket Emblem and the AURORA emblem are registered trademarks of General Motors Corporation. "AURORA" is used with the permission of Hankook Tire.

This manual includes the latest information at the time it was printed. We reserve the right to make changes after that time without further notice. For vehicles first sold in Canada, substitute the name "General Motors of Canada Limited" for Oldsmobile Division whenever it appears in this manual.

Please keep this manual in your vehicle, so it will be there if you ever need it when you're on the road. If you sell the vehicle, please leave this manual in it so the new owner can use it.

Litho in U.S.A.
Part No. 25735873 A First Edition

Canadian Owners

You can obtain a French copy of this manual from your dealer or from:

Helm, Incorporated
P.O. Box 07130
Detroit, MI 48207

How to Use This Manual

Many people read their owner's manual from beginning to end when they first receive their new vehicle. If you do this, it will help you learn about the features and controls for your vehicle. In this manual, you'll find that pictures and words work together to explain things.

Index

A good place to look for what you need is the Index in back of the manual. It's an alphabetical list of what's in the manual, and the page number where you'll find it.

© Copyright General Motors Corporation 06/19/02
All Rights Reserved

Safety Warnings and Symbols

You will find a number of safety cautions in this book. We use a box and the word CAUTION to tell you about things that could hurt you if you were to ignore the warning.

CAUTION:

These mean there is something that could hurt you or other people.

In the caution area, we tell you what the hazard is. Then we tell you what to do to help avoid or reduce the hazard. Please read these cautions. If you don't, you or others could be hurt.



You will also find a circle with a slash through it in this book. This safety symbol means "Don't," "Don't do this" or "Don't let this happen."

Vehicle Damage Warnings

Also, in this book you will find these notices:

Notice: These mean there is something that could damage your vehicle.

A notice will tell you about something that can damage your vehicle. Many times, this damage would not be covered by your warranty, and it could be costly. But the notice will tell you what to do to help avoid the damage.

When you read other manuals, you might see CAUTION and NOTICE warnings in different colors or in different words.

You'll also see warning labels on your vehicle. They use the same words, CAUTION or NOTICE.

Vehicle Symbols

































Your vehicle may be equipped with components and labels that use symbols instead of text. Symbols, used on your vehicle, are shown along with the text describing the operation or information relating to a specific component, control, message, gage or indicator.

If you need help figuring out a specific name of a component, gage or indicator reference the following topics in the Index:

- "Engine Compartment Overview"
- "Instrument Panel Overview"
- "Climate Controls"
- "Audio Systems"

Also see *Warning Lights, Gages and Indicators* on page 3-30.

These are some examples of vehicle symbols you may find on your vehicle:

CAUTION POSSIBLE INJURY		LATCH BOTH LAP AND SHOULDER BELTS TO PROTECT OCCUPANT DO NOT TWIST SAFETY BELT WHEN ATTACHING	 	MASTER LIGHTING SWITCH		ENGINE COOLANT TEMP		FUSE BOX ACCESS			
PROTECT EYES BY SHIELDING		FASTEN SEAT BELTS		AIR BAG		TURN SIGNALS		BATTERY CHARGING SYSTEM		ENGINE COOLANT FAN	
CAUSTIC BATTERY ACID COULD CAUSE BURNS		MOVE SEAT FULLY REARWARD SECURE CHILD SEAT		DO NOT INSTALL A REAR-FACING CHILD RESTRAINT IN THIS SEATING POSITION		PARKING LAMPS		BRAKE		FUEL	
AVOID SPARKS OR FLAMES		PULL BELT OUT COMPLETELY THEN SECURE CHILD SEAT		DO NOT INSTALL A FORWARD-FACING CHILD RESTRAINT IN THIS SEATING POSITION		HAZARD WARNING FLASHER		COOLANT		OWNER'S MANUAL	
SPARK OR FLAME COULD EXPLODE BATTERY		POWER WINDOW		DOOR LOCK UNLOCK		DAYTIME RUNNING LAMPS		ENGINE OIL PRESSURE		SERVICE	
						FOG LAMPS		ANTI-LOCK BRAKES		SERVICE MANUAL	

Section 1 Seats and Restraint Systems

Front Seats	1-2	Where to Put the Restraint	1-37
Manual Passenger Seat	1-2	Top Strap	1-38
Power Seats	1-2	Top Strap Anchor Location	1-39
Manual Lumbar	1-3	Lower Anchorages and Top Tethers for Children (LATCH System)	1-40
Power Lumbar	1-4	Securing a Child Restraint Designed for the LATCH System	1-42
Heated Seats	1-5	Securing a Child Restraint in a Rear Seat Position	1-42
Reclining Seatbacks	1-5	Securing a Child Restraint in the Right Front Seat Position	1-44
Head Restraints	1-7	Air Bag Systems	1-47
Safety Belts	1-8	Where Are the Air Bags?	1-49
Safety Belts: They Are for Everyone	1-8	When Should an Air Bag Inflate?	1-51
Questions and Answers About Safety Belts	1-12	What Makes an Air Bag Inflate?	1-52
How to Wear Safety Belts Properly	1-13	How Does an Air Bag Restrain?	1-52
Driver Position	1-14	What Will You See After an Air Bag Inflates? ...	1-52
Safety Belt Use During Pregnancy	1-20	Servicing Your Air Bag-Equipped Vehicle	1-54
Right Front Passenger Position	1-21	Restraint System Check	1-55
Rear Seat Passengers	1-21	Checking Your Restraint Systems	1-55
Rear Safety Belt Comfort Guides for Children and Small Adults	1-25	Replacing Restraint System Parts After a Crash	1-56
Safety Belt Extender	1-27		
Child Restraints	1-28		
Older Children	1-28		
Infants and Young Children	1-30		
Child Restraint Systems	1-34		

Front Seats

Manual Passenger Seat

⚠ CAUTION:

You can lose control of the vehicle if you try to adjust a manual driver's seat while the vehicle is moving. The sudden movement could startle and confuse you, or make you push a pedal when you don't want to. Adjust the driver's seat only when the vehicle is not moving.

Pull up on the control bar located under the front of the seat to unlock it. Slide the seat to where you want it and release the bar. Try to move the seat with your body to make sure the seat is locked into place.

Power Seats

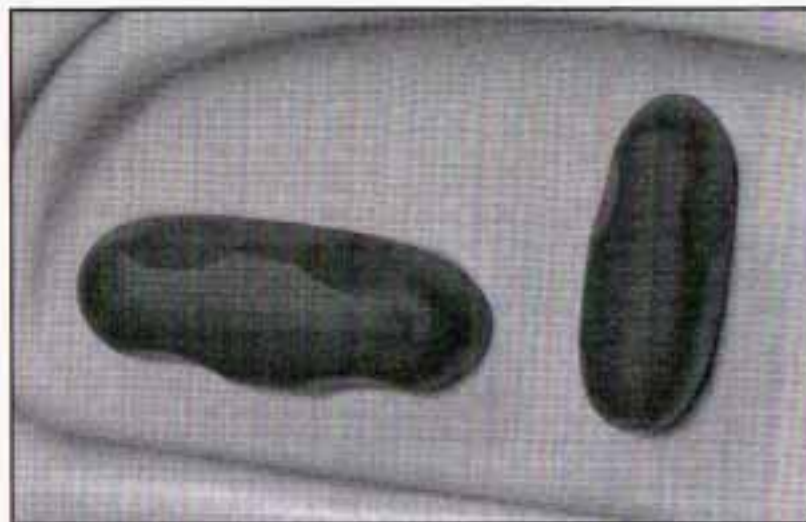

The power seat controls are located on the outboard side of the driver's front seat. The front passenger's seat may also have power seat controls located on the outboard side of the seat.

To adjust the power seats, do the following:

Horizontal Control: Raise or lower the front of the seat cushion by pressing the forward edge of the control up or down.

Raise or lower the rear of the seat cushion by pressing the rear edge of the control up or down.

Move the seat forward or rearward by pressing the control toward the front or rear of the vehicle.

Move the seat higher or lower by holding the whole control up or down.

Vertical Control (Option): Move the seatback into a reclined position by pressing the top of the control backward.

Move the seatback forward by pressing the top of the control forward.

Manual Lumbar



If your vehicle has this feature, the knob that controls it is located on the outboard side of the driver's seat. Turn the knob toward the front of the vehicle to increase lumbar support. Turn the knob toward the rear of the vehicle to decrease lumbar support.

If you have the independent front cushion moved down as far as it will go, you may feel the lumbar support higher in your back. Readjust the location of the cushion until you are comfortable. You may also want to adjust the seatback for maximum comfort.

Power Lumbar



If your vehicle has this feature, the power lumbar control is located on the outboard side of each front seat. Use the power seat control first to get the proper position. Then continue with the lumbar adjustment.

To reshape the lower seatback, press the lumbar control forward to increase support and rearward to decrease support. Press the control up or down to raise or lower the support mechanism.

Keep in mind that as your seating position changes, as it may during long trips, so should the position of your lumbar support. Adjust the seat as needed.

If you have the independent front cushion moved down as far as it will go, you may feel the lumbar support higher in your back. Readjust the location of the cushion until you are comfortable. You may also want to adjust the seatback for maximum comfort.

Heated Seats



If your vehicle has this option, the heated seat switch is located next to the console shifter.

Push the ON part of the switch once for a HI setting or twice for a LO setting. Push the OFF part of the switch to turn the heated seat off. The LO setting warms the seatback and cushion until the seat approximates body temperature. The HI setting heats the seatback and cushion to a slightly higher temperature.

The heated seats can only be used when the ignition is turned on. When the ignition is turned off, the heating element is also turned off.

Reclining Seatbacks



If your vehicle has a power recliner, the vertical control described previously in this section reclines the front seatbacks.

If your vehicle has the manual recliner, lift the lever on the outboard side of the seat and move the seatback to the desired position. Release the lever to lock the seatback. Pull up on the lever without pushing on the seatback and the seatback will go to an upright position.

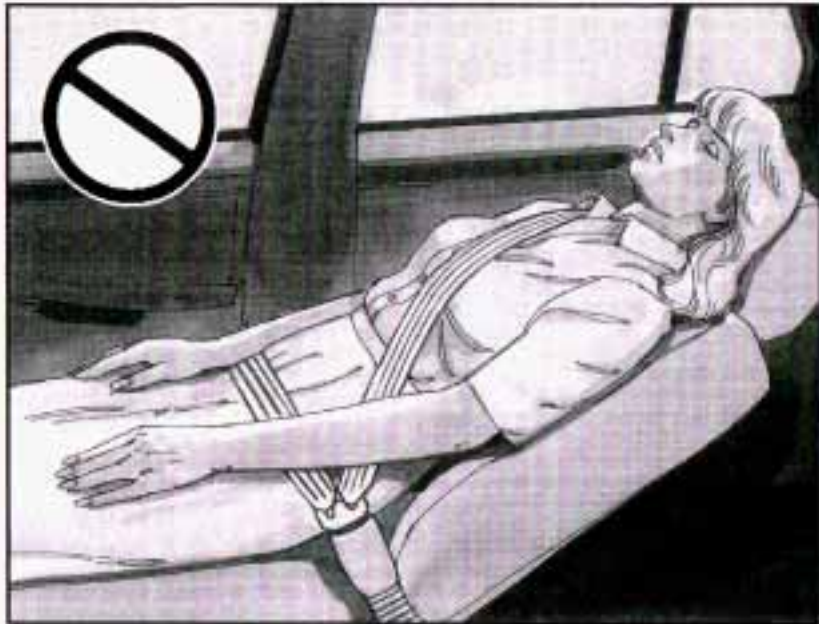

But don't have a seatback reclined if your vehicle is moving.

CAUTION:

Sitting in a reclined position when your vehicle is in motion can be dangerous. Even if you buckle up, your safety belts can't do their job when you're reclined like this.

The shoulder belt can't do its job. In a crash, you could go into it, receiving neck or other injuries.

The lap belt can't do its job either. In a crash the belt could go up over your abdomen. The belt forces would be there, not at your pelvic bones. This could cause serious internal injuries.

For proper protection when the vehicle is in motion, have the seatback upright. Then sit well back in the seat and wear your safety belt properly.

Head Restraints



Adjust your head restraint so that the top of the restraint is closest to the top of your head. This position reduces the chance of a neck injury in a crash.

Safety Belts

Safety Belts: They Are for Everyone

This part of the manual tells you how to use safety belts properly. It also tells you some things you should not do with safety belts.

CAUTION:

Don't let anyone ride where he or she can't wear a safety belt properly. If you are in a crash and you're not wearing a safety belt, your injuries can be much worse. You can hit things inside the vehicle or be ejected from it. You can be seriously injured or killed. In the same crash, you might not be, if you are buckled up. Always fasten your safety belt, and check that your passengers' belts are fastened properly too.

CAUTION:

It is extremely dangerous to ride in a cargo area, inside or outside of a vehicle. In a collision, people riding in these areas are more likely to be seriously injured or killed. Do not allow people to ride in any area of your vehicle that is not equipped with seats and safety belts. Be sure everyone in your vehicle is in a seat and using a safety belt properly.



Your vehicle has a light that comes on as a reminder to buckle up. See *Safety Belt Reminder Light* on page 3-33.

In most states and in all Canadian provinces, the law says to wear safety belts. Here's why: *They work.*

You never know if you'll be in a crash. If you do have a crash, you don't know if it will be a bad one.

A few crashes are mild, and some crashes can be so serious that even buckled up, a person wouldn't survive. But most crashes are in between. In many of them, people who buckle up can survive and sometimes walk away. Without belts they could have been badly hurt or killed.

After more than 30 years of safety belts in vehicles, the facts are clear. In most crashes buckling up does matter... a lot!

Why Safety Belts Work

When you ride in or on anything, you go as fast as it goes.

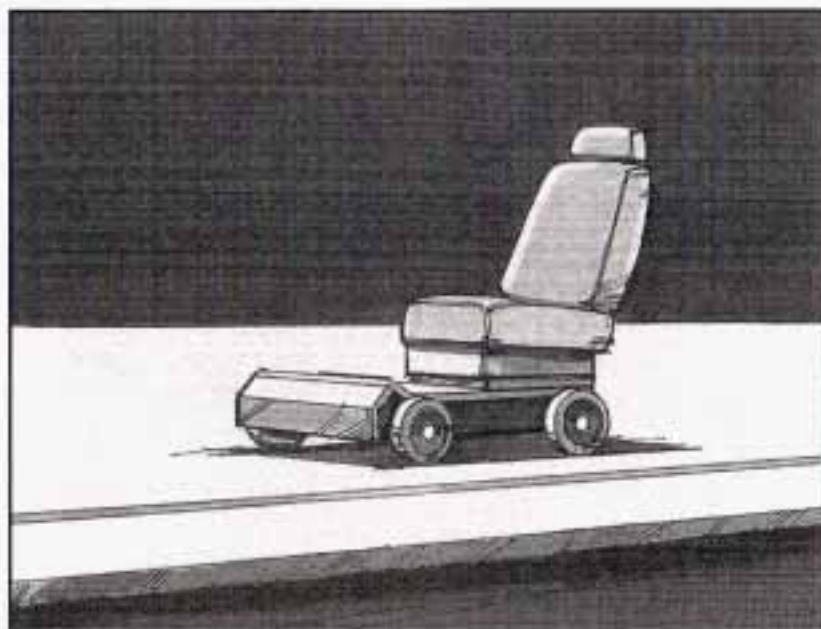

Take the simplest vehicle. Suppose it's just a seat on wheels.

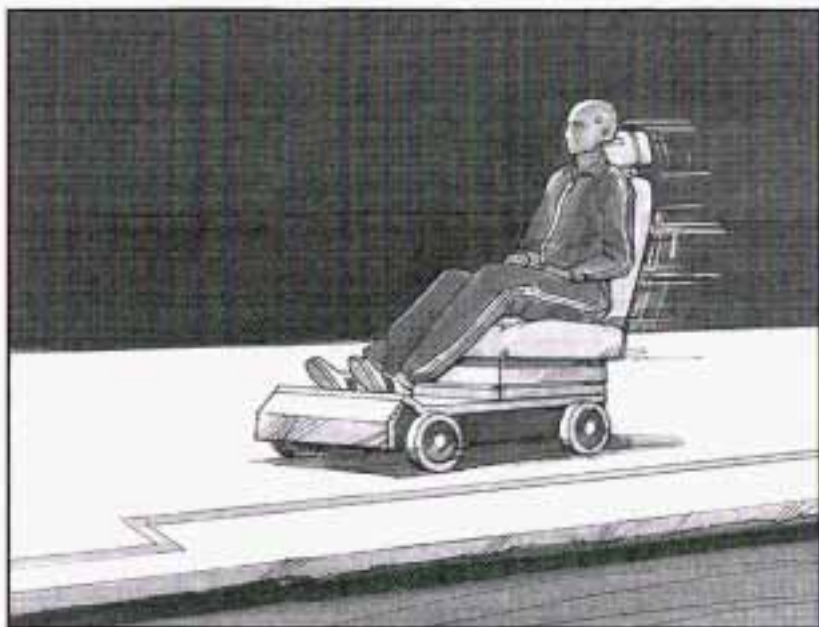

Put someone on it.

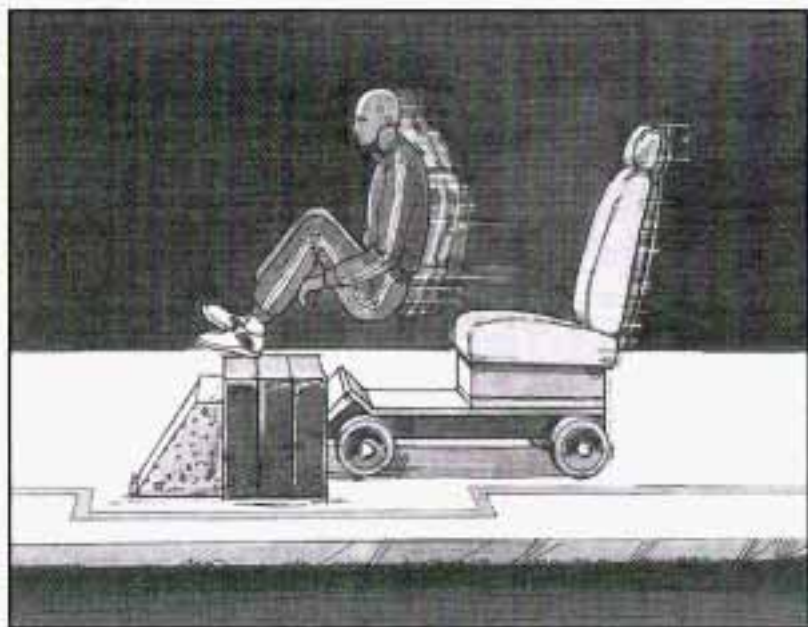

Get it up to speed. Then stop the vehicle. The rider doesn't stop.



The person keeps going until stopped by something. In a real vehicle, it could be the windshield...



or the instrument panel...



Questions and Answers About Safety Belts

Q: Won't I be trapped in the vehicle after an accident if I'm wearing a safety belt?

A: You *could* be – whether you're wearing a safety belt or not. But you can unbuckle a safety belt, even if you're upside down. And your chance of being conscious during and after an accident, so you *can* unbuckle and get out, is *much* greater if you are belted.

or the safety belts!

With safety belts, you slow down as the vehicle does. You get more time to stop. You stop over more distance, and your strongest bones take the forces. That's why safety belts make such good sense.

Q: If my vehicle has air bags, why should I have to wear safety belts?

A: Air bags are in many vehicles today and will be in most of them in the future. But they are supplemental systems only; so they work *with* safety belts – not instead of them. Every air bag system ever offered for sale has required the use of safety belts. Even if you're in a vehicle that has air bags, you still have to buckle up to get the most protection. That's true not only in frontal collisions, but especially in side and other collisions.

Q: If I'm a good driver, and I never drive far from home, why should I wear safety belts?

A: You may be an excellent driver, but if you're in an accident – even one that isn't your fault – you and your passengers can be hurt. Being a good driver doesn't protect you from things beyond your control, such as bad drivers.

Most accidents occur within 25 miles (40 km) of home. And the greatest number of serious injuries and deaths occur at speeds of less than 40 mph (65 km/h).

Safety belts are for everyone.

How to Wear Safety Belts Properly

This part is only for people of adult size.

Be aware that there are special things to know about safety belts and children. And there are different rules for smaller children and babies. If a child will be riding in your vehicle, see *Older Children on page 1-28* or *Infants and Young Children on page 1-30*. Follow those rules for everyone's protection.

First, you'll want to know which restraint systems your vehicle has.

We'll start with the driver position.

Driver Position

This part describes the driver's restraint system.

Lap-Shoulder Belt

The driver has a lap-shoulder belt. Here's how to wear it properly.

1. Close and lock the door.
2. Adjust the seat so you can sit up straight. To see how, see "Seats" in the Index.



3. Pick up the latch plate and pull the belt across you. Don't let it get twisted.

The lap-shoulder belt may lock if you pull the belt across you very quickly. If this happens, let the belt go back slightly to unlock it. Then pull the belt across you more slowly.

4. Push the latch plate into the buckle until it clicks.

Pull up on the latch plate to make sure it is secure. If the belt isn't long enough, see *Safety Belt Extender* on page 1-27.

Make sure the release button on the buckle is positioned so you would be able to unbuckle the safety belt quickly if you ever had to.

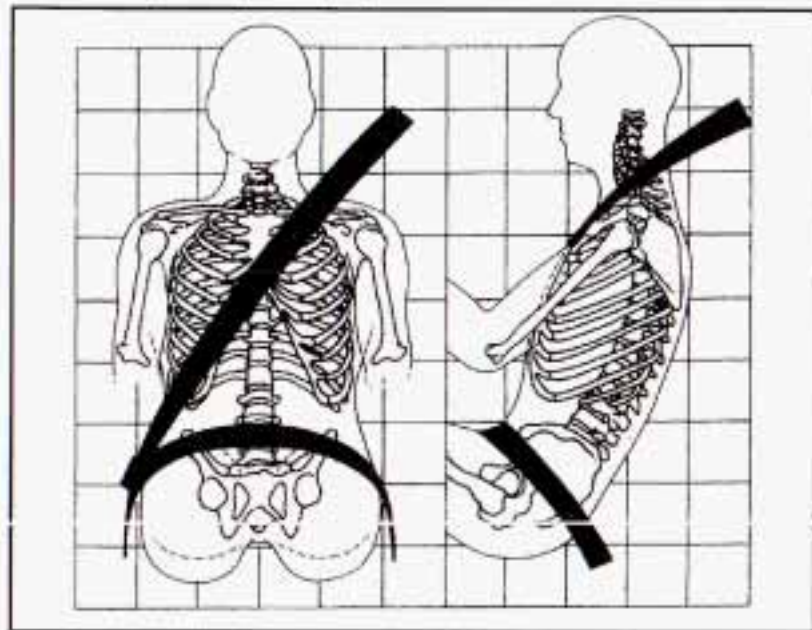

The lap part of the belt should be worn low and snug on the hips, just touching the thighs. In a crash, this applies force to the strong pelvic bones. And you'd be less likely to slide under the lap belt. If you slid under it, the belt would apply force at your abdomen. This could cause serious or even fatal injuries. The shoulder belt should go over the shoulder and across the chest. These parts of the body are best able to take belt restraining forces.

The safety belt locks if there's a sudden stop or crash, or if you pull the belt very quickly out of the retractor.

Q: What's wrong with this?

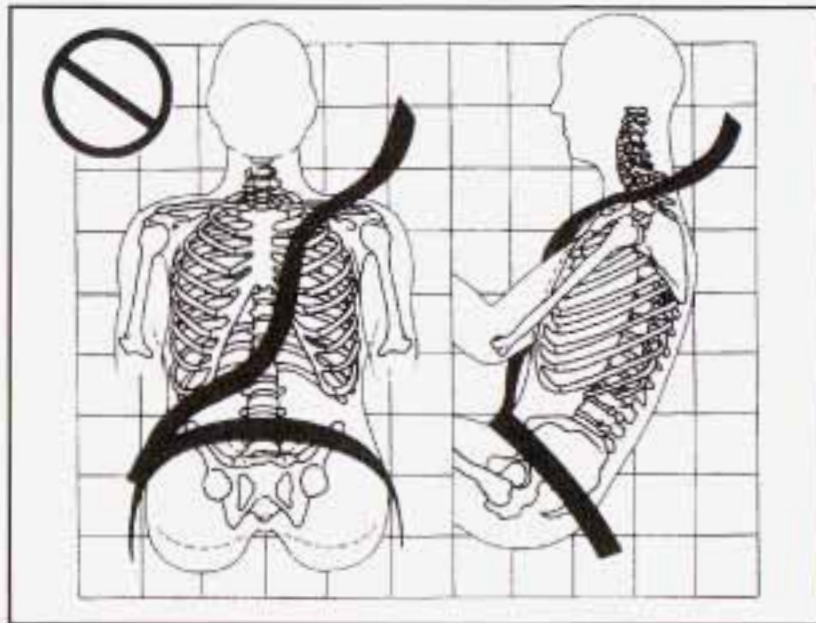

A: The shoulder belt is too loose. It won't give nearly as much protection this way.

⚠ CAUTION:

You can be seriously hurt if your shoulder belt is too loose. In a crash, you would move forward too much, which could increase injury. The shoulder belt should fit against your body.

Q: What's wrong with this?

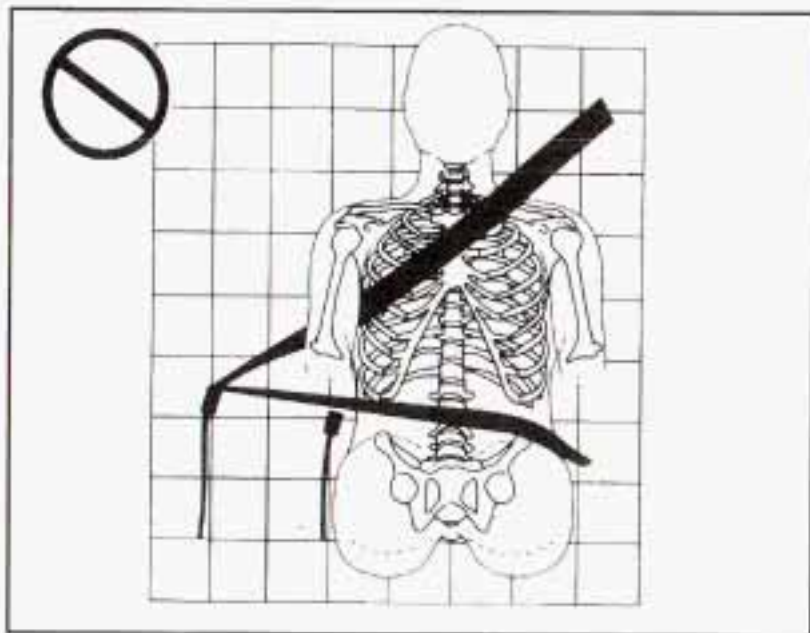

A: The belt is buckled in the wrong place.

⚠ CAUTION:

You can be seriously injured if your belt is buckled in the wrong place like this. In a crash, the belt would go up over your abdomen. The belt forces would be there, not at the pelvic bones. This could cause serious internal injuries. Always buckle your belt into the buckle nearest you.

Q: What's wrong with this?

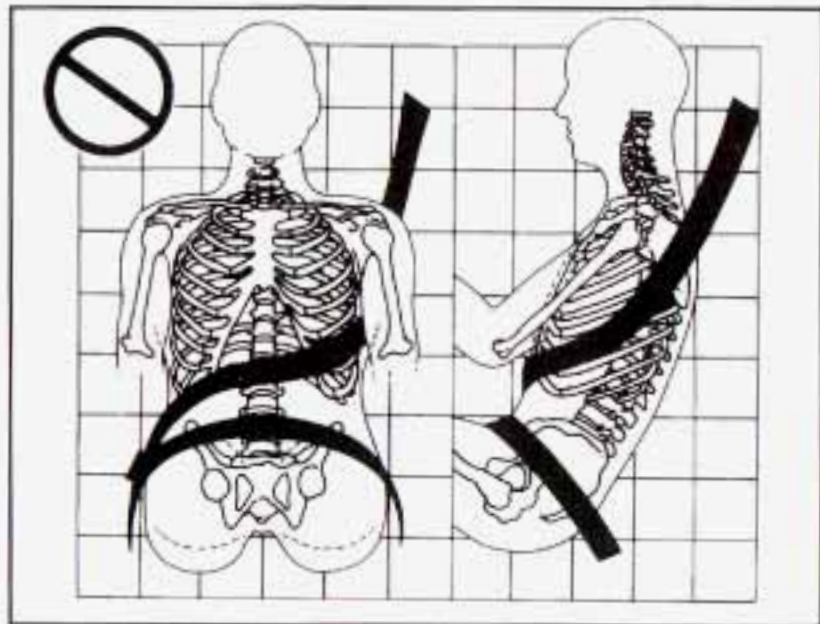

A: The shoulder belt is worn under the arm. It should be worn over the shoulder at all times.

⚠ CAUTION:

You can be seriously injured if you wear the shoulder belt under your arm. In a crash, your body would move too far forward, which would increase the chance of head and neck injury. Also, the belt would apply too much force to the ribs, which aren't as strong as shoulder bones. You could also severely injure internal organs like your liver or spleen.

Q: What's wrong with this?

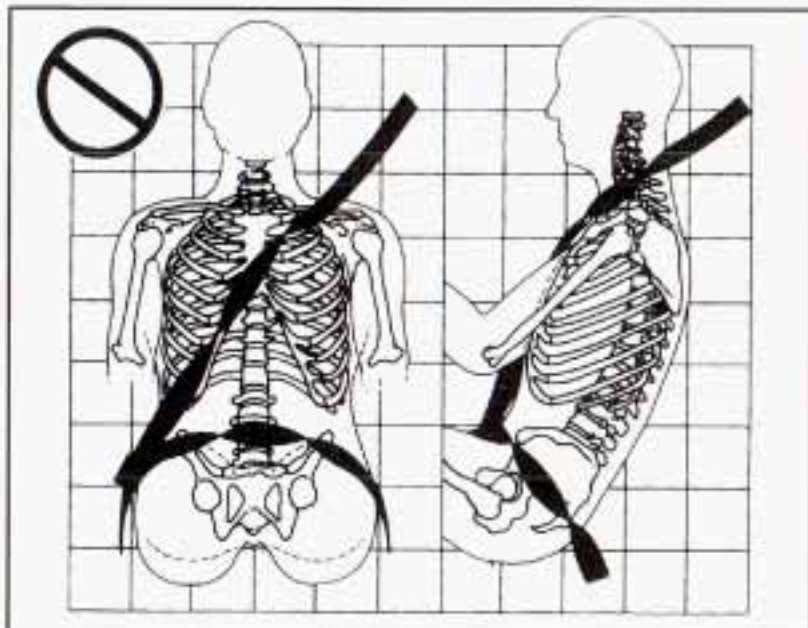

A: The belt is twisted across the body.

⚠ CAUTION:

You can be seriously injured by a twisted belt. In a crash, you wouldn't have the full width of the belt to spread impact forces. If a belt is twisted, make it straight so it can work properly, or ask your dealer to fix it.



To unlatch the belt, just push the button on the buckle. The belt should go back out of the way.

Before you close the door, be sure the belt is out of the way. If you slam the door on it, you can damage both the belt and your vehicle.

Safety Belt Use During Pregnancy

Safety belts work for everyone, including pregnant women. Like all occupants, they are more likely to be seriously injured if they don't wear safety belts.

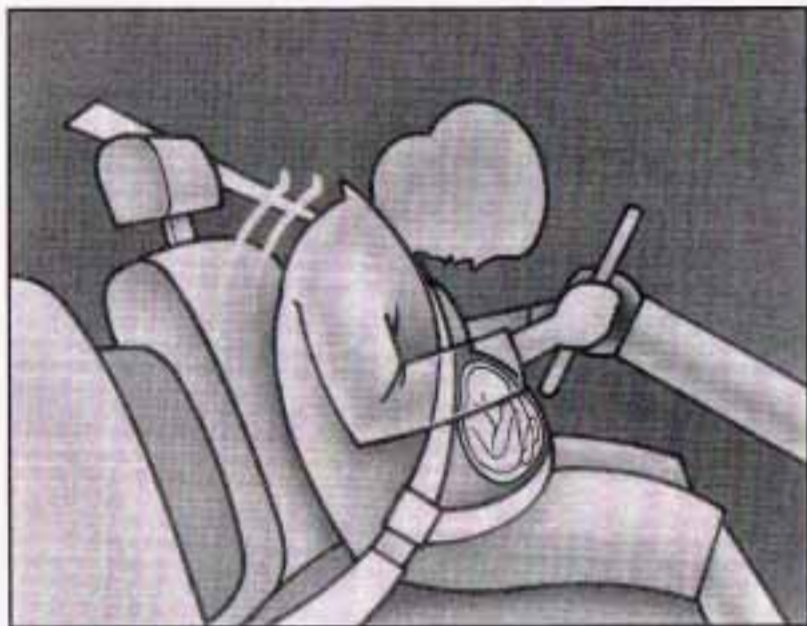

A pregnant woman should wear a lap-shoulder belt, and the lap portion should be worn as low as possible, below the rounding, throughout the pregnancy.

The best way to protect the fetus is to protect the mother. When a safety belt is worn properly, it's more likely that the fetus won't be hurt in a crash. For pregnant women, as for anyone, the key to making safety belts effective is wearing them properly.

Right Front Passenger Position

To learn how to wear the right front passenger's safety belt properly, see *Driver Position on page 1-14*.

The right front passenger's safety belt works the same way as the driver's safety belt — except for one thing. If you ever pull the lap portion of the belt out all the way, you will engage the child restraint locking feature. If this happens, just let the belt go back all the way and start again.

Rear Seat Passengers

It's very important for rear seat passengers to buckle up! Accident statistics show that unbelted people in the rear seat are hurt more often in crashes than those who are wearing safety belts.

Rear passengers who aren't safety belted can be thrown out of the vehicle in a crash. And they can strike others in the vehicle who are wearing safety belts.

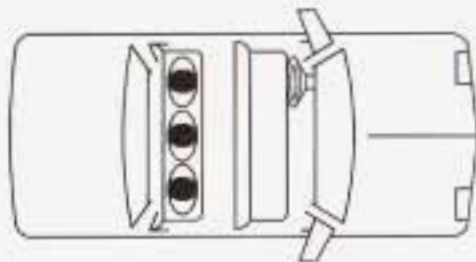

Lap-Shoulder Belt

All rear seating positions have lap-shoulder belts. Here's how to wear one properly.



1. Pick up the latch plate and pull the belt across you. Don't let it get twisted.

The shoulder belt may lock if you pull the belt across you very quickly. If this happens, let the belt go back slightly to unlock it. Then pull the belt across you more slowly.

2. Push the latch plate into the buckle until it clicks.



If the belt stops before it reaches the buckle, tilt the latch plate and keep pulling until you can buckle it.

Pull up on the latch plate to make sure it is secure.

If the belt is not long enough, see *Safety Belt Extender* on page 1-27.

Make sure the release button on the buckle is positioned so you would be able to unbuckle the safety belt quickly if you ever had to.

3. To make the lap part tight, pull down on the buckle end of the belt as you pull up on the shoulder part.

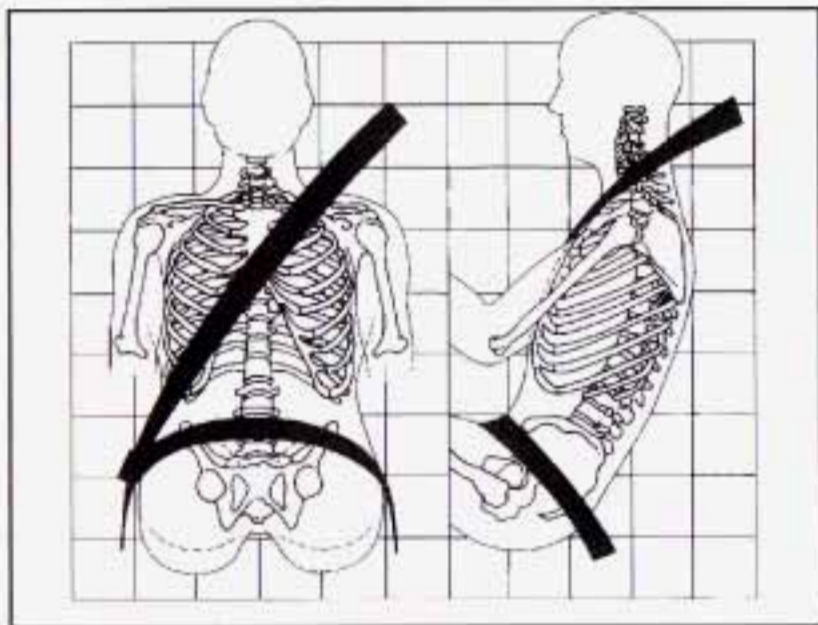

The lap part of the belt should be worn low and snug on the hips, just touching the thighs. In a crash this applies force to the strong pelvic bones. And you'd be less likely to slide under the lap belt. If you slid under it, the belt would apply force at your abdomen. This could cause serious or even fatal injuries. The shoulder belt should go over the shoulder and across the chest. These parts of the body are best able to take belt restraining forces.

The safety belt locks if there's a sudden stop or a crash, or if you pull the belt very quickly out of the retractor.

CAUTION:

You can be seriously hurt if your shoulder belt is too loose. In a crash, you would move forward too much, which could increase injury. The shoulder belt should fit against your body.



To unlatch the belt, just push the button on the buckle.

Rear Safety Belt Comfort Guides for Children and Small Adults

Your vehicle may have this feature already. If it doesn't, you can get it from any GM dealer.

Rear shoulder belt comfort guides provide added safety belt comfort for older children who have outgrown booster seats and for small adults. When installed on a shoulder belt, the comfort guide better positions the belt away from the neck and head.

There is one guide available for each outside passenger position in the rear seat. To provide added safety belt comfort for children who have outgrown child restraints and booster seats and for smaller adults, the comfort guides may be installed on the shoulder belts. Here's how to install a comfort guide and use the safety belt:



1. Remove the guide from its storage pocket on the side of the seatback.



2. Slide the guide under and past the belt. The elastic cord must be under the belt. Then, place the guide over the belt, and insert the two edges of the belt into the slots of the guide.



3. Be sure that the belt is not twisted and it lies flat. The elastic cord must be under the belt and the guide on top.



Safety Belt Extender

If the vehicle's safety belt will fasten around you, you should use it.

But if a safety belt isn't long enough to fasten, your dealer will order you an extender. It's free. When you go in to order it, take the heaviest coat you will wear, so the extender will be long enough for you. The extender will be just for you, and just for the seat in your vehicle that you choose. Don't let someone else use it, and use it only for the seat it is made to fit. To wear it, just attach it to the regular safety belt.

4. Buckle, position and release the safety belt as described in *Rear Seat Passengers* on page 1-21. Make sure that the shoulder belt crosses the shoulder.

To remove and store the comfort guides, squeeze the belt edges together so that you can take them out of the guides. Slide the guide into its storage pocket on the side of the seatback.

Child Restraints

Older Children



Older children who have outgrown booster seats should wear the vehicle's safety belts.

Q: What is the proper way to wear safety belts?

A: If possible, an older child should wear a lap-shoulder belt and get the additional restraint a shoulder belt can provide. The shoulder belt should not cross the face or neck. The lap belt should fit snugly below the hips, just touching the top of the thighs. It should never be worn over the abdomen, which could cause severe or even fatal internal injuries in a crash.

Accident statistics show that children are safer if they are restrained in the rear seat.

In a crash, children who are not buckled up can strike other people who are buckled up, or can be thrown out of the vehicle. Older children need to use safety belts properly.



⚠ CAUTION:

Never do this.

Here two children are wearing the same belt. The belt can't properly spread the impact forces. In a crash, the two children can be crushed together and seriously injured. A belt must be used by only one person at a time.

Q: What if a child is wearing a lap-shoulder belt, but the child is so small that the shoulder belt is very close to the child's face or neck?

A: If the child is sitting in a seat next to a window, move the child toward the center of the vehicle. If the child is sitting in the center rear seat passenger position, move the child toward the safety belt buckle. In either case, be sure that the shoulder belt still is on the child's shoulder, so that in a crash the child's upper body would have the restraint that belts provide. If the child is sitting in a rear seat outside position, see *Rear Safety Belt Comfort Guides for Children and Small Adults* on page 1-25.



CAUTION:

Never do this.

Here a child is sitting in a seat that has a lap-shoulder belt, but the shoulder part is behind the child. If the child wears the belt in this way, in a crash the child might slide under the belt. The belt's force would then be applied right on the child's abdomen. That could cause serious or fatal injuries.

Wherever the child sits, the lap portion of the belt should be worn low and snug on the hips, just touching the child's thighs. This applies belt force to the child's pelvic bones in a crash.

Infants and Young Children

Everyone in a vehicle needs protection! This includes infants and all other children. Neither the distance traveled nor the age and size of the traveler changes the need, for everyone, to use safety restraints. In fact, the law in every state in the United States and in every Canadian province says children up to some age must be restrained while in a vehicle.

Every time infants and young children ride in vehicles, they should have the protection provided by appropriate restraints. Young children should not use the vehicle's adult safety belts alone, unless there is no other choice. Instead, they need to use a child restraint.



⚠ CAUTION:

People should never hold a baby in their arms while riding in a vehicle. A baby doesn't weigh much – until a crash. During a crash a baby will become so heavy it is not possible to hold it. For example, in a crash at only 25 mph (40 km/h), a 12-lb. (5.5 kg) baby will suddenly become a 240-lb. (110 kg) force on a person's arms. A baby should be secured in an appropriate restraint.



⚠ CAUTION:

Children who are up against, or very close to, any air bag when it inflates can be seriously injured or killed. Air bags plus lap-shoulder belts offer outstanding protection for adults and older children, but not for young children and infants. Neither the vehicle's safety belt system nor its air bag system is designed for them. Young children and infants need the protection that a child restraint system can provide.

Q: What are the different types of add-on child restraints?

A: Add-on child restraints, which are purchased by the vehicle's owner, are available in four basic types. Selection of a particular restraint should take into consideration not only the child's weight, height and age but also whether or not the restraint will be compatible with the motor vehicle in which it will be used.

For most basic types of child restraints, there are many different models available. When purchasing a child restraint, be sure it is designed to be used in a motor vehicle. If it is, the restraint will have a label saying that it meets federal motor vehicle safety standards.

The restraint manufacturer's instructions that come with the restraint state the weight and height limitations for a particular child restraint. In addition, there are many kinds of restraints available for children with special needs.

 **CAUTION:**

Newborn infants need complete support, including support for the head and neck. This is necessary because a newborn infant's neck is weak and its head weighs so much compared with the rest of its body. In a crash, an infant in a rear-facing seat settles into the restraint, so the crash forces can be distributed across the strongest part of an infant's body, the back and shoulders. Infants always should be secured in appropriate infant restraints.

 **CAUTION:**

The body structure of a young child is quite unlike that of an adult or older child, for whom the safety belts are designed. A young child's hip bones are still so small that the vehicle's regular safety belt may not remain low on the hip bones, as it should. Instead, it may settle up around the child's abdomen. In a crash, the belt would apply force on a body area that's unprotected by any bony structure. This alone could cause serious or fatal injuries. Young children always should be secured in appropriate child restraints.

Child Restraint Systems

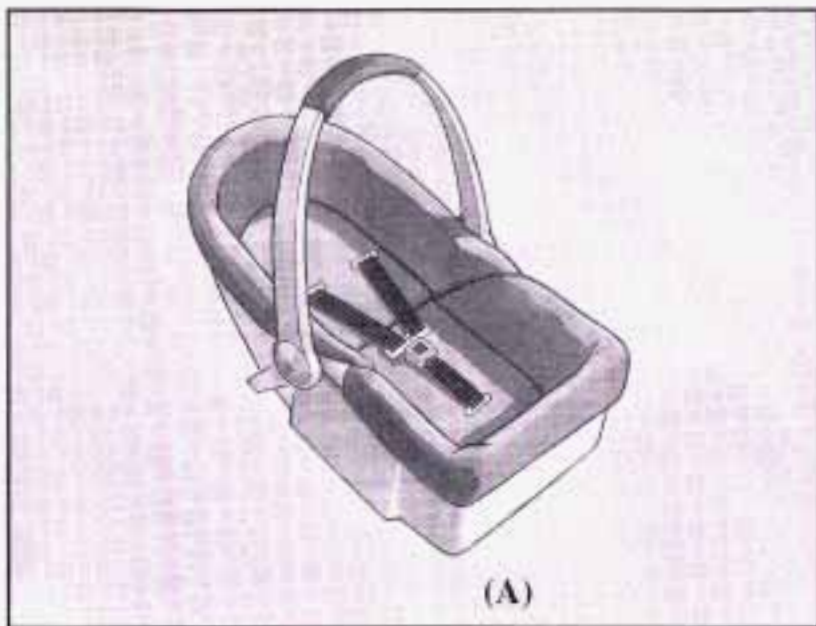

An infant car bed (A), a special bed made for use in a motor vehicle, is an infant restraint system designed to restrain or position a child on a continuous flat surface. Make sure that the infant's head rests toward the center of the vehicle.

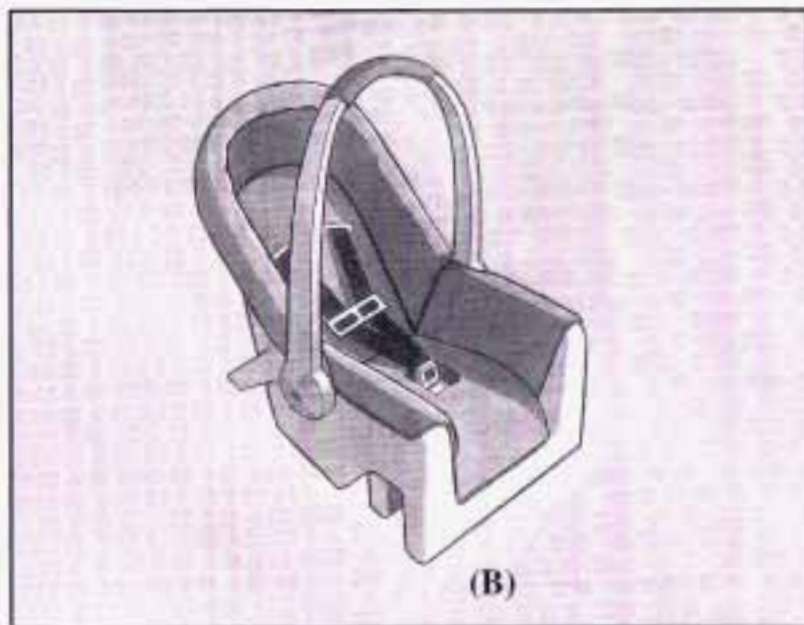

A rear-facing infant seat (B) provides restraint with the seating surface against the back of the infant. The harness system holds the infant in place and, in a crash, acts to keep the infant positioned in the restraint.

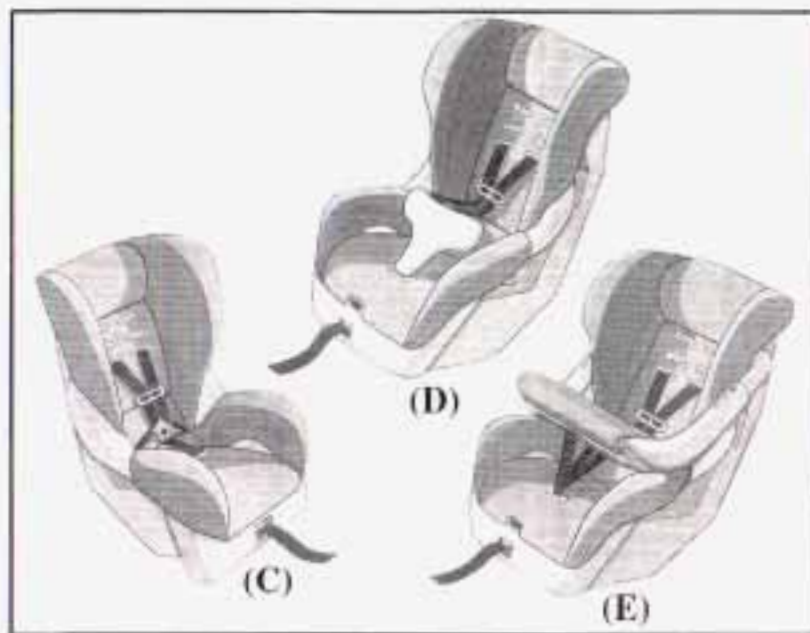

A forward-facing child seat (C-E) provides restraint for the child's body with the harness and also sometimes with surfaces such as T-shaped or shelf-like shields.

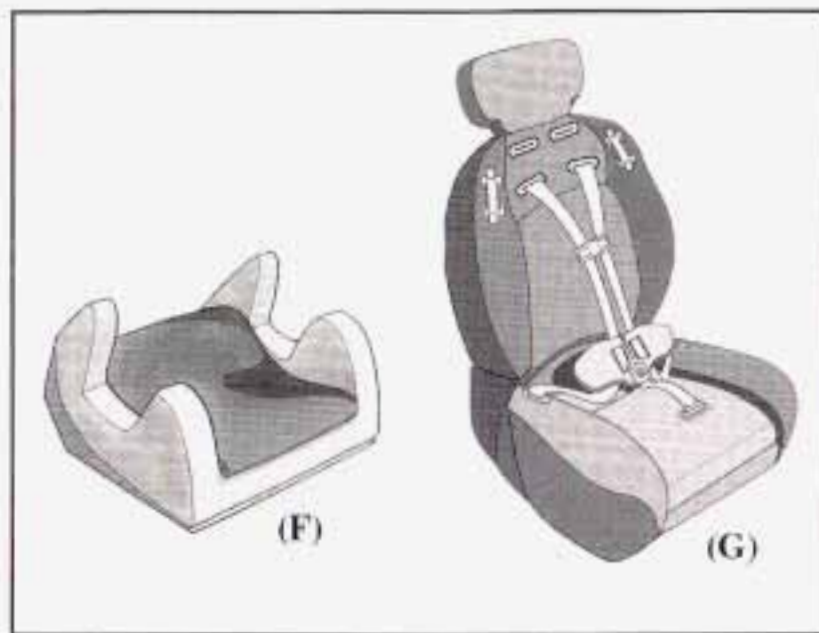

A booster seat (F-G) is a child restraint designed to improve the fit of the vehicle's safety belt system. Some booster seats have a shoulder belt positioner, and some high-back booster seats have a five-point harness. A booster seat can also help a child to see out the window.

Q: How do child restraints work?

A: A child restraint system is any device designed for use in a motor vehicle to restrain, seat, or position children. A built-in child restraint system is a permanent part of the motor vehicle. An add-on child restraint system is a portable one, which is purchased by the vehicle's owner.

For many years, add-on child restraints have used the adult belt system in the vehicle. To help reduce the chance of injury, the child also has to be secured within the restraint. The vehicle's belt system secures the add-on child restraint in the vehicle, and the add-on child restraint's harness system holds the child in place within the restraint.

One system, the three-point harness, has straps that come down over each of the infant's shoulders and buckle together at the crotch. The five-point harness system has two shoulder straps, two hip straps and a crotch strap. A shield may take the place of hip straps. A T-shaped shield has shoulder straps that are attached to a flat pad which rests low against the child's body. A shelf- or armrest-type shield has straps that are attached to a wide, shelf-like shield that swings up or to the side.

When choosing a child restraint, be sure the child restraint is designed to be used in a vehicle. If it is, it will have a label saying that it meets federal motor vehicle safety standards.

Then follow the instructions for the restraint. You may find these instructions on the restraint itself or in a booklet, or both. These restraints use the belt system in your vehicle, but the child also has to be secured within the restraint to help reduce the chance of personal injury. When securing an add-on child restraint, refer to the instructions that come with the restraint which may be on the restraint itself or in a booklet, or both, and to this manual. The child restraint instructions are important, so if they are not available, obtain a replacement copy from the manufacturer.

Where to Put the Restraint

Accident statistics show that children are safer if they are restrained in the rear rather than the front seat. General Motors, therefore, recommends that child restraints be secured in a rear seat, including an infant riding in a rear-facing infant seat, a child riding in a forward-facing child seat and an older child riding in a booster seat. *Never* put a rear-facing child restraint in the front passenger seat. Here's why:

CAUTION:

A child in a rear-facing child restraint can be seriously injured or killed if the right front passenger's air bag inflates. This is because the back of the rear-facing child restraint would be very close to the inflating air bag. Always secure a rear-facing child restraint in a rear seat.

You may secure a forward-facing child restraint in the right front seat, but before you do, always move the front passenger seat as far back as it will go. It's better to secure the child restraint in a rear seat.

Wherever you install it, be sure to secure the child restraint properly.

Keep in mind that an unsecured child restraint can move around in a collision or sudden stop and injure people in the vehicle. Be sure to properly secure any child restraint in your vehicle – even when no child is in it.

Top Strap

Some child restraints have a top strap, or “top tether”. It can help restrain the child restraint during a collision. For it to work, a top strap must be properly anchored to the vehicle. Some top strap-equipped child restraints are designed for use with or without the top strap being anchored. Others require the top strap always to be anchored. Be sure to read and follow the instructions for your child restraint. If yours requires that the top strap be anchored, don’t use the restraint unless it is anchored properly.

If the child restraint does not have a top strap, one can be obtained, in kit form, for many child restraints. Ask the child restraint manufacturer whether or not a kit is available.

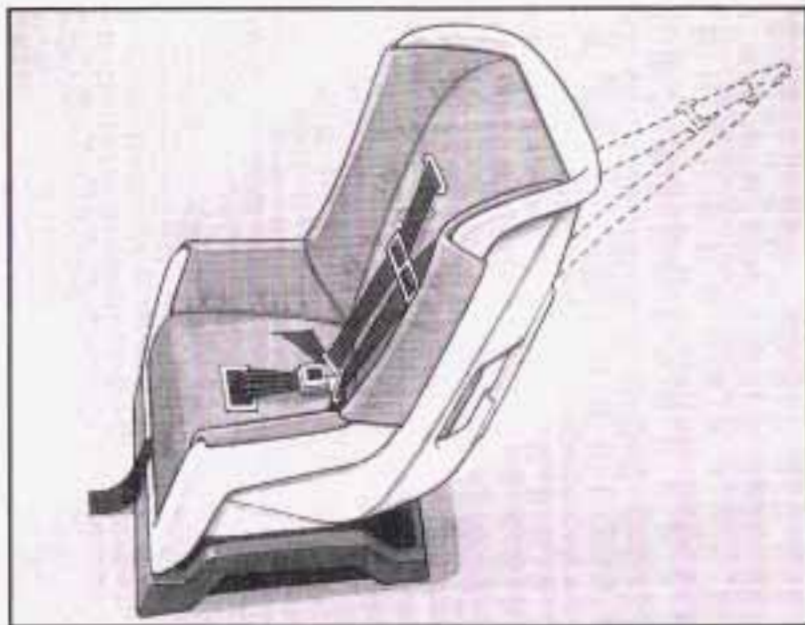

In Canada, the law requires that forward-facing child restraints have a top strap, and that the strap be anchored. In the United States, some child restraints also have a top strap. If your child restraint has a top strap, it should be anchored.

Anchor the top strap to one of the following anchor points. Be sure to use an anchor point located on the same side of the vehicle as the seating position where the child restraint will be placed.

Once you have the top strap anchored, you'll be ready to secure the child restraint itself. Tighten the top strap when and as the child restraint manufacturer's instructions say.

Top Strap Anchor Location

Your vehicle has top strap anchors already installed for the rear seating positions. You'll find them behind the rear seat on the filler panel.

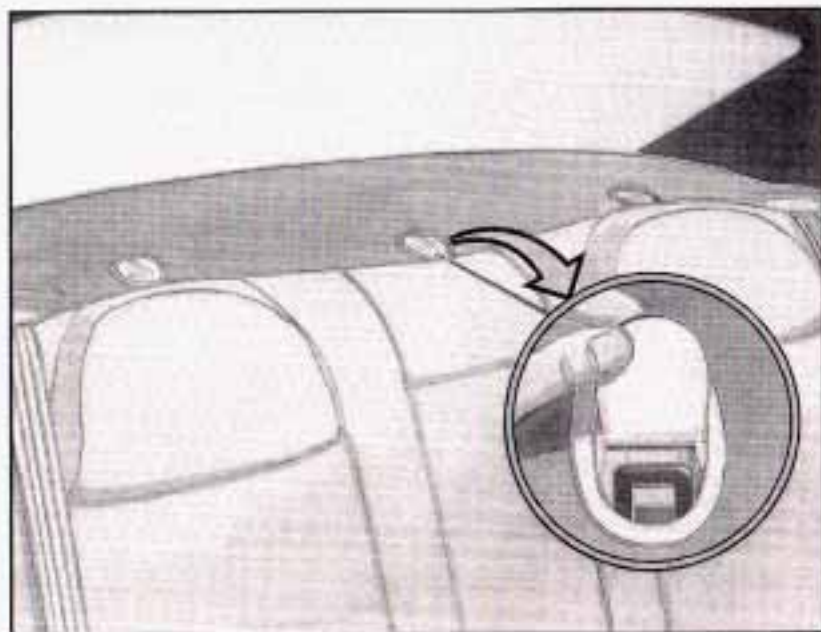

In order to get to a bracket, you'll have to open the trim cover.

Lower Anchorages and Top Tethers for Children (LATCH System)

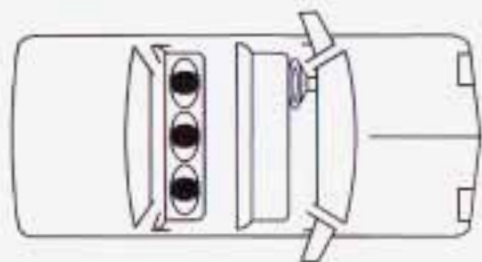

Your vehicle has the LATCH system. You'll find anchors (A) in all three rear seat positions.



To assist you in locating the lower anchors for this child restraint system, each seating position with the LATCH system will have a label sewn into the seatback at each anchor point.

In order to use the system, you need either a forward-facing child restraint that has attaching points (B) at its base and a top tether anchor (C), or a rear-facing child restraint that has attaching points (B), as shown here.

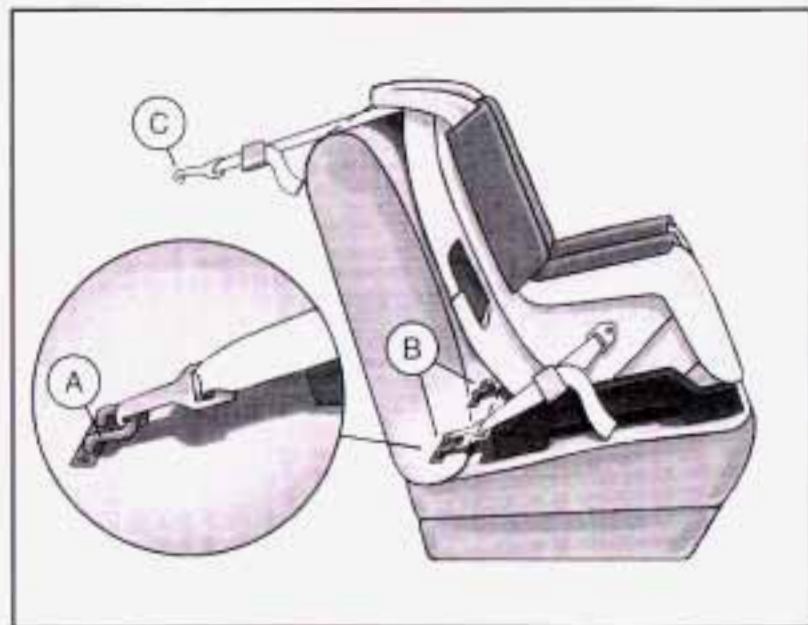

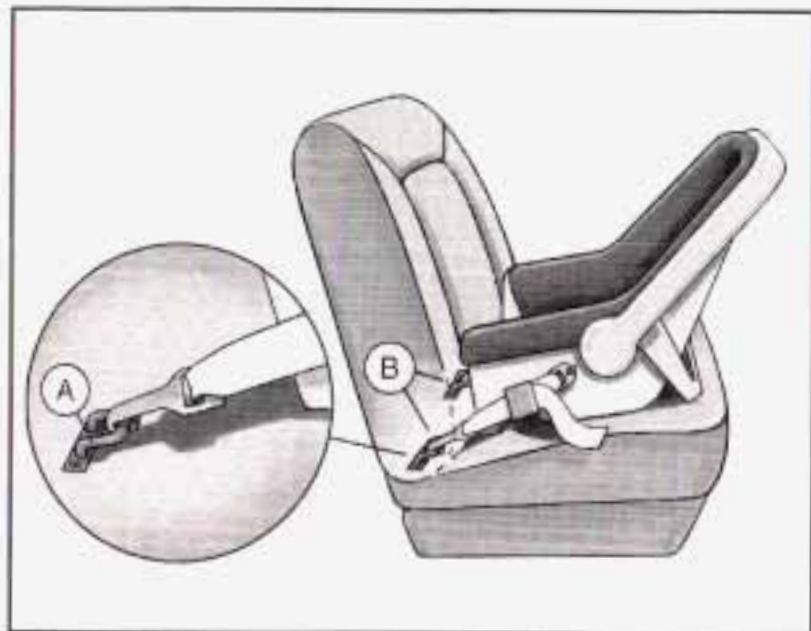

With this system, use the LATCH system instead of the vehicle's safety belts to secure a child restraint.

⚠ CAUTION:

If a LATCH-type child restraint isn't attached to its anchorage points, the restraint won't be able to protect a child sitting there. In a crash, the child could be seriously injured or killed. Make sure that a LATCH-type child restraint is properly installed using the anchorage points, or use the vehicle's safety belts to secure the restraint. See "Securing a Child Restraint Designed for the LATCH System" or "Securing a Child Restraint in a Rear Seat Position" in the Index for information on how to secure a child restraint in your vehicle.

Securing a Child Restraint Designed for the LATCH System

1. Find the anchors for the seating position you want to use, where the bottom of the seatback meets the back of the seat cushion.
2. Put the child restraint on the seat.
3. Attach the anchor points on the child restraint to the anchors in the vehicle. The child restraint instructions will show you how.
4. If the child restraint is forward-facing, attach the top strap to the top strap anchor. See *Top Strap on page 1-38*. Tighten the top strap according to the child restraint instructions.
5. Push and pull the child restraint in different directions to be sure it is secure.

To remove the child restraint, simply unhook the top strap from the top tether anchor and then disconnect the anchor points.

Securing a Child Restraint in a Rear Seat Position

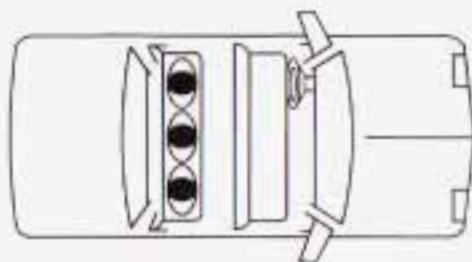

If your child restraint is equipped with the LATCH system, see *Lower Anchorages and Top Tethers for Children (LATCH System) on page 1-40*.

You'll be using the lap-shoulder belt. See *Top Strap on page 1-38* if the child restraint has one. Be sure to follow the instructions that came with the child restraint. Secure the child in the child restraint when and as the instructions say.

1. Put the restraint on the seat.
2. Pick up the latch plate, and run the lap and shoulder portions of the vehicle's safety belt through or around the restraint. The child restraint instructions will show you how.

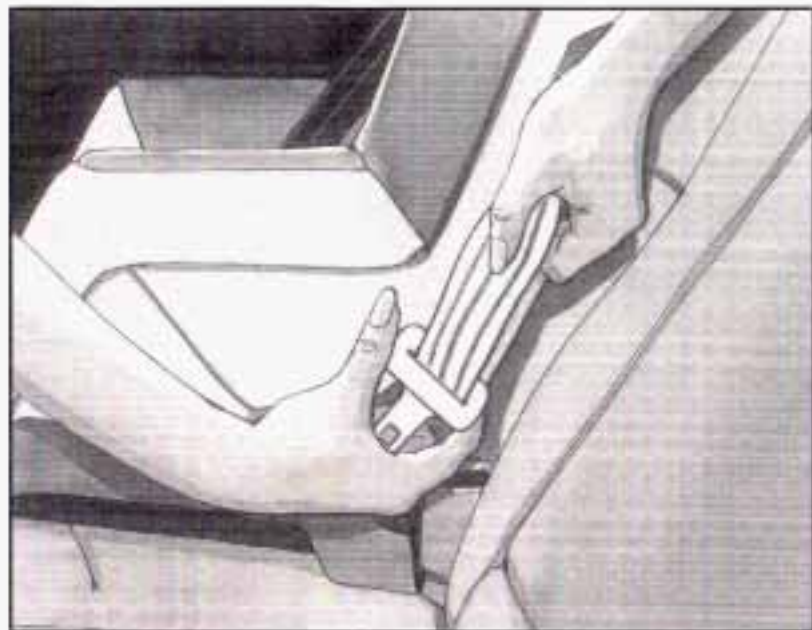

Tilt the latch plate to adjust the belt if needed.



3. Buckle the belt. Make sure the release button is positioned so you would be able to unbuckle the safety belt quickly if you ever had to.



To remove the child restraint, just unbuckle the vehicle's safety belt and let it go back all the way. The safety belt will move freely again and be ready to work for an adult or larger child passenger.

Securing a Child Restraint in the Right Front Seat Position

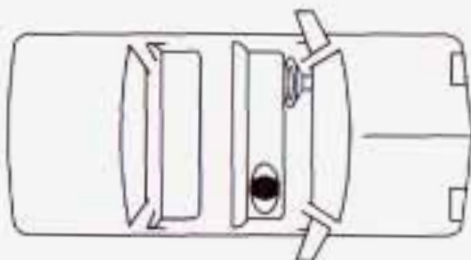

4. To tighten the belt, pull up on the shoulder belt while you push down on the child restraint. If you're using a forward-facing child restraint, you may find it helpful to use your knee to push down on the child restraint as you tighten the belt.
5. Push and pull the child restraint in different directions to be sure it is secure.

Your vehicle has a right front passenger air bag. Never put a rear facing child restraint in this seat. Here's why:

⚠ CAUTION:

A child in a rear-facing child restraint can be seriously injured or killed if the right front passenger's air bag inflates. This is because the back of the rear-facing child restraint would be very close to the inflating air bag. Always secure a rear-facing child restraint in a rear seat.

Although a rear seat is a safer place, you can secure a forward-facing child restraint in the right front seat.

You'll be using the lap-shoulder belt. See *Top Strap* on page 1-38 if the child restraint has one. Be sure to follow the instructions that came with the child restraint. Secure the child in the child restraint when and as the instructions say.

1. Because your vehicle has a right front passenger air bag, always move the seat as far back as it will go before securing a forward-facing child restraint. See *Power Seats* on page 1-2.

2. Put the restraint on the seat.
3. Pick up the latch plate, and run the lap and shoulder portions of the vehicle's safety belt through or around the restraint. The child restraint instructions will show you how.



4. Buckle the belt. Make sure the release button is positioned so you would be able to unbuckle the safety belt quickly if you ever had to.



5. Pull the rest of the lap belt all the way out of the retractor to set the lock.

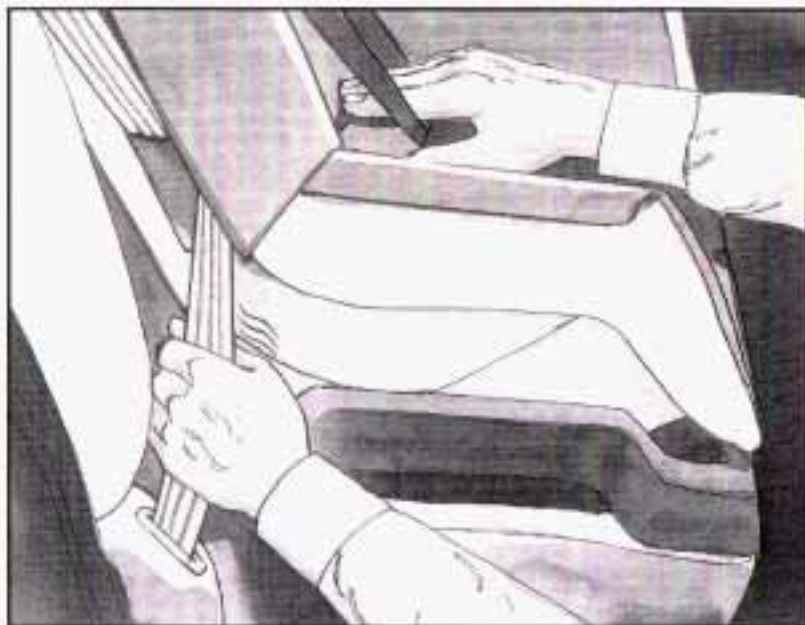

6. To tighten the belt, feed the lap belt back into the retractor while you push down on the child restraint. You may find it helpful to use your knee to push down on the child restraint as you tighten the belt.
7. Push and pull the child restraint in different directions to be sure it is secure.

To remove the child restraint, just unbuckle the vehicle's safety belt and let it go back all the way. The safety belt will move freely again and be ready to work for an adult or larger child passenger.

Air Bag Systems

This part explains the frontal and side impact air bag systems.

Your vehicle has four air bags – a frontal air bag for the driver, another frontal air bag for the right front passenger, a side impact air bag for the driver, and another side impact air bag for the right front passenger.

Frontal air bags are designed to help reduce the risk of injury from the force of an inflating air bag. But these air bags must inflate very quickly to do their job and comply with federal regulations.

Here are the most important things to know about the air bag system:

CAUTION:

You can be severely injured or killed in a crash if you aren't wearing your safety belt — even if you have air bags. Wearing your safety belt during a crash helps reduce your chance of hitting things inside the vehicle or being ejected from it.

CAUTION: (Continued)

CAUTION: (Continued)

Air bags are designed to work with safety belts but don't replace them.

Frontal air bags for the driver and right front passenger are designed to deploy only in moderate to severe frontal and near frontal crashes. They aren't designed to inflate at all in rollover, rear or low-speed frontal crashes, or in many side crashes. And, for some unrestrained occupants, frontal air bags may provide less protection in frontal crashes than more forceful air bags have provided in the past.

The side impact air bags for the driver and right front passenger are designed to inflate only in moderate to severe crashes where something hits the side of your vehicle. They aren't designed to inflate in frontal, in rollover or in rear crashes.

Everyone in your vehicle should wear a safety belt properly — whether or not there's an air bag for that person.

⚠ CAUTION:

Both frontal and side impact air bags inflate with great force, faster than the blink of an eye. If you're too close to an inflating air bag, as you would be if you were leaning forward, it could seriously injure you. Safety belts help keep you in position for air bag inflation before and during a crash. Always wear your safety belt, even with frontal air bags. The driver should sit as far back as possible while still maintaining control of the vehicle. Front occupants should not lean on or sleep against the door.

⚠ CAUTION:

Anyone who is up against, or very close to, any air bag when it inflates can be seriously injured or killed.

CAUTION: (Continued)

CAUTION: (Continued)

Air bags plus lap-shoulder belts offer the best protection for adults, but not for young children and infants. Neither the vehicle's safety belt system nor its air bag system is designed for them. Young children and infants need the protection that a child restraint system can provide. Always secure children properly in your vehicle. To read how, see the part of this manual called "Older Children" or "Infants and Young Children".



There is an air bag readiness light on the instrument panel, which shows the air bag symbol.

The system checks the air bag electrical system for malfunctions. The light tells you if there is an electrical problem. See *Air Bag Readiness Light* on page 3-34.

Where Are the Air Bags?



The driver's frontal air bag is in the middle of the steering wheel.

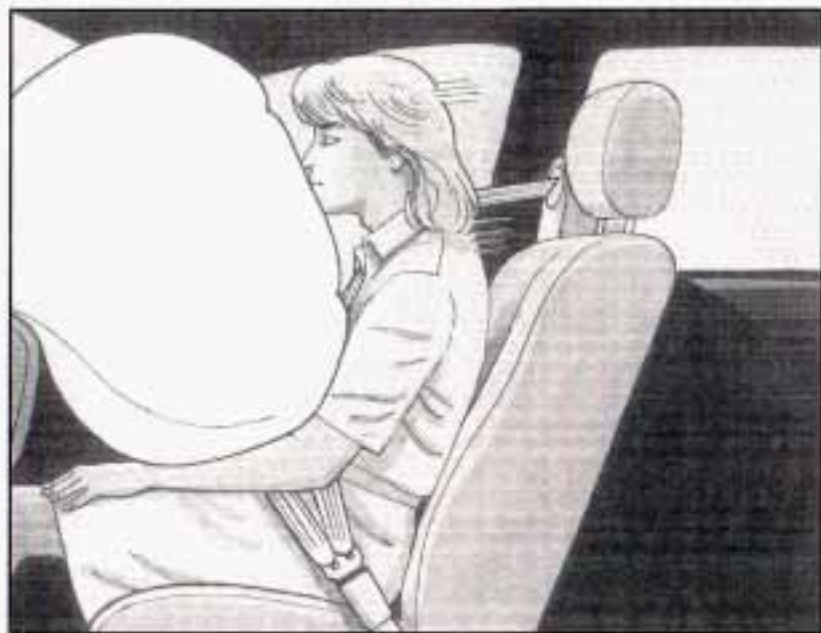

The right front passenger's frontal air bag is in the instrument panel on the passenger's side.

The driver's side impact air bag is in the side of the driver's seatback closest to the door.



The right front passenger's side impact air bag is in the side of the passenger's seatback closest to the door.

⚠ CAUTION:

If something is between an occupant and an air bag, the bag might not inflate properly or it might force the object into that person causing severe injury or even death. The path of an inflating air bag must be kept clear. Don't put anything between an occupant and an air bag, and don't attach or put anything on the steering wheel hub or on or near any other air bag covering. Don't let seat covers block the inflation path of a side impact air bag.

When Should an Air Bag Inflate?

The driver's and right front passenger's frontal air bags are designed to inflate in moderate to severe frontal or near-frontal crashes. But they are designed to inflate only if the impact speed is above the system's designed "threshold level".

In addition, your vehicle has "dual stage" frontal air bags, which adjust the amount of restraint according to crash severity. For moderate frontal impacts, these air bags inflate at a level less than full deployment. For more severe frontal impacts, full deployment occurs. If the front of your vehicle goes straight into a wall that doesn't move or deform, the threshold level for the reduced deployment is about 10 to 16 mph (18 to 26 km/h), and the threshold level for a full deployment is about 18 to 24 mph (29 to 38.5 km/h). The threshold level can vary, however, with specific vehicle design, so that it can be somewhat above or below this range.

If your vehicle strikes something that will move or deform, such as a parked car, the threshold level will be higher. The driver's and right front passenger's frontal air bags are not designed to inflate in rollovers, rear impacts, or in many side impacts because inflation would not help the occupant.

The side impact air bags are designed to inflate in moderate to severe side crashes. A side impact air bag will inflate if the crash severity is above the system's designed "threshold level". The threshold level can vary with specific vehicle design. Side impact air bags are not designed to inflate in frontal or near-frontal impacts, rollovers or rear impacts, because inflation would not help the occupant. A side impact air bag will only deploy on the side of the vehicle that is struck.

In any particular crash, no one can say whether an air bag should have inflated simply because of the damage to a vehicle or because of what the repair costs were. For frontal air bags, inflation is determined by the angle of the impact and how quickly the vehicle slows down in frontal and near-frontal impacts. For side impact air bags, inflation is determined by the location and severity of the impact.

What Makes an Air Bag Inflate?

In an impact of sufficient severity, the air bag sensing system detects that the vehicle is in a crash. For both frontal and side impact air bags, the sensing system triggers a release of gas from the inflator, which inflates the air bag. The inflator, the air bag and related hardware are all part of the air bag modules inside the steering wheel, the instrument panel, and the side of the front seatbacks closest to the door.

How Does an Air Bag Restrain?

In moderate to severe frontal or near frontal collisions, even belted occupants can contact the steering wheel or the instrument panel. In moderate to severe side collisions, even belted occupants can contact the inside of the vehicle. The air bag supplements the protection provided by safety belts. Air bags distribute the force of the impact more evenly over the occupant's upper body, stopping the occupant more gradually. But the frontal air bags would not help you in many types of collisions, including rollovers, rear impacts, and many side impacts, primarily because an occupant's motion is not toward the air bag. Side impact air bags would not help you in many types of collisions, including frontal or near frontal collisions, rollovers, and rear impacts, primarily because an occupant's motion is not toward

those air bags. Air bags should never be regarded as anything more than a supplement to safety belts, and then only in moderate to severe frontal or near-frontal collisions for the driver's and right front passenger's frontal air bags, and only in moderate to severe side collisions for the driver's and right front passenger's side impact air bag.

What Will You See After an Air Bag Inflates?

After the air bag inflates, it quickly deflates, so quickly that some people may not even realize the air bag inflated. Some components of the air bag module — the steering wheel hub for the driver's air bag, the instrument panel for the right front passenger's bag, the side of the seatback closest to the door for the driver and right front passenger's side impact air bags — will be hot for a short time. The parts of the bag that come into contact with you may be warm, but not too hot to touch. There will be some smoke and dust coming from the vents in the deflated air bags. Air bag inflation doesn't prevent the driver from seeing or being able to steer the vehicle, nor does it stop people from leaving the vehicle.

 **CAUTION:**

When an air bag inflates, there is dust in the air. This dust could cause breathing problems for people with a history of asthma or other breathing trouble. To avoid this, everyone in the vehicle should get out as soon as it is safe to do so. If you have breathing problems but can't get out of the vehicle after an air bag inflates, then get fresh air by opening a window or a door. If you experience breathing problems following an air bag deployment, you should seek medical attention.

Your vehicle has a feature that will automatically unlock the doors and turn the interior lamps on when the air bags inflate (if battery power is available). You can lock the doors again and turn the interior lamps off by using the door lock and interior lamp controls.

In many crashes severe enough to inflate an air bag, windshields are broken by vehicle deformation. Additional windshield breakage may also occur from the right front passenger air bag.

- Air bags are designed to inflate only once. After an air bag inflates, you'll need some new parts for your air bag system. If you don't get them, the air bag system won't be there to help protect you in another crash. A new system will include air bag modules and possibly other parts. The service manual for your vehicle covers the need to replace other parts.
- Your vehicle is equipped with an electronic frontal sensor, which helps the sensing system distinguish between a moderate frontal impact and a more severe frontal impact. Your vehicle is also equipped with a crash sensing and diagnostic module, which records information about the frontal air bag system. The module records information about the readiness of the system, when the system commands air bag inflation and driver's safety belt usage at deployment. The module also records speed, engine RPM, brake and throttle data.

- Let only qualified technicians work on your air bag systems. Improper service can mean that an air bag system won't work properly. See your dealer for service.

Notice: If you damage the covering for the driver's or the right front passenger's air bag, or the air bag covering on the driver's and right front passenger's seatback, the bag may not work properly. You may have to replace the air bag module in the steering wheel, both the air bag module and the instrument panel for the right front passenger's air bag, or both the air bag module and seatback for the driver's and right front passenger's side impact air bag. Do not open or break the air bag coverings.

Servicing Your Air Bag-Equipped Vehicle

Air bags affect how your vehicle should be serviced. There are parts of the air bag systems in several places around your vehicle. Your dealer and the service manual have information about servicing your vehicle and the air bag systems. To purchase a service manual, see *Service Publications Ordering Information on page 7-9*.

CAUTION:

For up to 10 seconds after the ignition key is turned off and the battery is disconnected, an air bag can still inflate during improper service. You can be injured if you are close to an air bag when it inflates. Avoid yellow connectors. They are probably part of the air bag system. Be sure to follow proper service procedures, and make sure the person performing work for you is qualified to do so.

The air bag systems do not need regular maintenance.

Restraint System Check

Checking Your Restraint Systems

Now and then, make sure the safety belt reminder light and all your belts, buckles, latch plates, retractors and anchorages are working properly. Look for any other loose or damaged safety belt system parts. If you see anything that might keep a safety belt system from doing its job, have it repaired.

Torn or frayed safety belts may not protect you in a crash. They can rip apart under impact forces. If a belt is torn or frayed, get a new one right away.

Also look for any opened or broken air bag covers, and have them repaired or replaced. (The air bag system does not need regular maintenance.)

Replacing Restraint System Parts After a Crash

CAUTION:

A crash can damage the restraint systems in your vehicle. A damaged restraint system may not properly protect the person using it, resulting in serious injury or even death in a crash. To help make sure your restraint systems are working properly after a crash, have them inspected and any necessary replacements made as soon as possible.

If you've had a crash, do you need new belts or LATCH system parts?

After a very minor collision, nothing may be necessary. But if the belts were stretched, as they would be if worn during a more severe crash, then you need new parts.

If the LATCH system was being used during a more severe crash, you may need new LATCH system parts.

If belts are cut or damaged, replace them. Collision damage also may mean you will need to have LATCH system, safety belt or seat parts repaired or replaced. New parts and repairs may be necessary even if the belt or LATCH system wasn't being used at the time of the collision.

If your seat adjuster won't work after a crash, the special part of the safety belt that goes through the seat to the adjuster may need to be replaced.

If an air bag inflates, you'll need to replace air bag system parts. See the part about the air bag system earlier in this manual.

Section 2 Features and Controls

Keys	2-3	Starting and Operating Your Vehicle	2-23
Remote Keyless Entry System	2-5	New Vehicle Break-In	2-23
Remote Keyless Entry System Operation	2-6	Ignition Positions	2-23
Doors and Locks	2-10	Starting Your Engine	2-24
Door Locks	2-10	Engine Coolant Heater	2-25
Central Door Unlocking System	2-11	Automatic Transaxle Operation	2-26
Power Door Locks	2-11	Parking Brake	2-29
Door Ajar Reminder	2-11	Shifting Into Park (P)	2-30
Delayed Locking	2-11	Shifting Out of Park (P)	2-32
Programmable Automatic Door Locks	2-12	Parking Over Things That Burn	2-32
Rear Door Security Locks	2-13	Engine Exhaust	2-33
Lockout Protection	2-14	Running Your Engine While You Are Parked ...	2-34
Leaving Your Vehicle	2-14	Mirrors	2-35
Trunk	2-14	Automatic Dimming Rearview Mirror with	
Windows	2-17	Compass	2-35
Power Windows	2-18	Outside Power Mirrors	2-37
Sun Visors	2-18	Outside Curb view Assist Mirror	2-37
Theft-Deterrent Systems	2-19	Outside Convex Mirror	2-38
Universal Theft-Deterrent	2-19	Outside Heated Mirrors	2-38
PASS-Key [®] III	2-21		
PASS-Key [®] III Operation	2-21		

Section 2 Features and Controls

OnStar® System	2-39	Assist Handles	2-45
HomeLink® Transmitter	2-41	Floor Mats	2-46
HomeLink® Transmitter	2-41	Rear Storage Area	2-46
Programming the HomeLink Transmitter	2-42	Convenience Net	2-46
Storage Areas	2-45	Sunroof	2-47
Glove Box	2-45	Vehicle Personalization	2-48
Front Storage Area	2-45	Memory Seat and Mirrors	2-48

Keys

CAUTION:

Leaving children in a vehicle with the ignition key is dangerous for many reasons. A child or others could be badly injured or even killed.

They could operate the power windows or other controls or even make the vehicle move.

Don't leave the keys in a vehicle with children.





The master key works in all of the lock cylinders (driver's door, trunk, ignition and glove box).



The VALET key only operates the driver's door and the ignition.

Your vehicle has the PASS-Key[®] III vehicle theft system. Both the master and VALET key have a transponder in the key head that matches a decoder in the vehicle's steering column. If a replacement key or any additional key is needed, you must purchase this key from your dealer. The key will have PK3[®] stamped on it. Keep the bar code tag that came with the original keys. Give this tag to your dealer if you need a new key made.

Any new PASS-Key[®] III key must be programmed before it will start your vehicle. See *PASS-Key[®] III Operation on page 2-21* for more information on programming your new key.

If your vehicle is equipped with the OnStar[®] System with an active subscription and you lock your keys inside the vehicle, OnStar[®] may be able to send a command to unlock your vehicle. See *OnStar[®] System on page 2-39* for more information.

Notice: Your vehicle has a number of features that can help prevent theft. You can have a lot of trouble getting into your vehicle if you ever lock your keys inside. You may even have to damage your vehicle to get in. So be sure you have spare keys.

Remote Keyless Entry System

Your keyless entry system operates on a radio frequency subject to Federal Communications Commission (FCC) Rules and with Industry Canada.

This device complies with Part 15 of the FCC Rules. Operation is subject to the following two conditions:

1. This device may not cause interference, and
2. This device must accept any interference received, including interference that may cause undesired operation of the device.

This device complies with RSS-210 of Industry Canada. Operation is subject to the following two conditions:

1. This device may not cause interference, and
2. This device must accept any interference received, including interference that may cause undesired operation of the device.

Changes or modifications to this system by other than an authorized service facility could void authorization to use this equipment.

At times you may notice a decrease in range. This is normal for any remote keyless entry system. If the transmitter does not work or if you have to stand closer to your vehicle for the transmitter to work, try this:

- Check the distance. You may be too far from your vehicle. You may need to stand closer during rainy or snowy weather.
- Check the location. Other vehicles or objects may be blocking the signal. Take a few steps to the left or right, hold the transmitter higher, and try again.
- Check to determine if battery replacement is necessary. See "Battery Replacement" under *Remote Keyless Entry System Operation on page 2-6*.
- If you are still having trouble, see your dealer or a qualified technician for service.

Remote Keyless Entry System Operation

With this feature, you can lock and unlock your doors or unlock your trunk from about 3 feet (1 m) up to 30 feet (9 m) away using the remote keyless entry transmitter supplied with your vehicle.

The numbers on the back of your transmitter correspond to DRIVER #1 and DRIVER #2 on the DIC. For more information see *Driver Information Center (DIC)* on page 3-45.





 **(Unlock):** The driver's door will unlock and the exterior lights will flash twice when this button is pressed.

If the unlock button is pressed again within five seconds, all doors will unlock, the exterior lamps will flash twice and the horn may sound. See "Security Feedback" later in this section.

Pressing the unlock button will also illuminate the interior lamps. See "Entry Lighting" under *Interior Lamps* on page 3-17.

 **(Lock):** All doors will lock, the exterior lamps will flash once and the horn may sound when this button is pressed.

 **(Trunk):** The trunk will unlock when this button is pressed when the ignition is in OFF. This button will also work when the ignition is on, but only while the transaxle is in PARK (P) or NEUTRAL (N).

 **(Instant Alarm):** When this button is pressed, the horn will sound and the headlamps and taillamps will flash for up to 30 seconds. This can be turned off by pressing the button again, unlocking the vehicle with a key or by turning the ignition on.

Personalization Features

The following list of features available on your vehicle can be programmed to the driver's preference for each transmitter.

- **Automatic Door Locks:** This feature programs your door locks to automatically lock or unlock when shifting in and out of PARK (P) or when the key is turned to OFF.
- **Security Feedback:** This feature provides feedback to the driver when the vehicle receives a command from the remote keyless entry transmitter.
- **Delayed Locking:** This feature lets the driver delay the actual locking of the vehicle. When all doors have been closed, the doors will lock automatically after five seconds.
- **Perimeter Lighting:** When the unlock symbol on the remote keyless entry transmitter is pressed, the Daytime Running Lamps (DRL), parking lamps and back-up lamps will turn on if it is dark enough outside.

For more detailed information and programming instructions for each feature mentioned, refer to *DIC Vehicle Personalization* on page 3-52.

Security Feedback

This feature provides feedback to the driver when the vehicle receives a command from the remote keyless entry transmitter and all doors are closed.

You must program this feature through the Driver Information Center (DIC). See *DIC Vehicle Personalization on page 3-52*.

The following settings can be programmed for each of the remote keyless entry transmitters:

- No feedback when locking or unlocking vehicle.
- Parking lamps and the Daytime Running Lamps (DRL) will flash twice when unlocking the vehicle and flash once when locking the vehicle.
- Horn chirps when all doors are unlocked (second unlock button press) and when locking the vehicle.
- Parking lamps and the DRL will flash twice each time the button with the unlock symbol is pressed; the horn chirps when all doors are unlocked. Parking lamps and the exterior lamps flash once and the horn chirps when locking the vehicle.

Matching Transmitter(s) to Your Vehicle

Each remote keyless entry transmitter is coded to prevent another transmitter from unlocking your vehicle. If a transmitter is lost or stolen, a replacement can be purchased through your dealer. Remember to bring any remaining transmitters with you when you go to your dealer. When the dealer matches the replacement transmitter to your vehicle, any remaining transmitters must also be matched. Once your dealer has coded the new transmitter, the lost transmitter will not unlock your vehicle. Each vehicle can have a maximum of four transmitters matched to it.

See your dealer to match transmitters to another vehicle.

Battery Replacement

Under normal use, the battery in your remote keyless entry transmitter should last about four years.

You can tell the battery is weak if the transmitter won't work at the normal range in any location. If you have to get close to your vehicle before the transmitter works, it's probably time to change the battery.

Notice: When replacing the battery, use care not to touch any of the circuitry. Static from your body transferred to these surfaces may damage the transmitter.



To replace the battery, do the following:

1. Insert a coin, or similar object, into the notch near the key ring. Turn it counterclockwise to separate the two halves of the transmitter.
2. Once the transmitter is separated, use a pencil eraser to remove the old battery. Do not use a metal object.
3. Replace the battery as the instructions under the cover indicate. Use a Duracell® battery, type DL-2032, or a similar type.
4. Snap the transmitter back together tightly to be sure no moisture can enter.
5. Check the operation of the transmitter.

Doors and Locks

Door Locks

CAUTION:

Unlocked doors can be dangerous.

- Passengers — especially children — can easily open the doors and fall out of a moving vehicle. When a door is locked, the handle won't open it. You increase the chance of being thrown out of the vehicle in a crash if the doors aren't locked. So, wear safety belts properly and lock the doors whenever you drive.
- Young children who get into unlocked vehicles may be unable to get out. A child can be overcome by extreme heat and can suffer permanent injuries or even death from heat stroke. Always lock your vehicle whenever you leave it.
- Outsiders can easily enter through an unlocked door when you slow down or stop your vehicle. Locking your doors can help prevent this from happening.

There are several ways to lock and unlock your vehicle. From the outside, use your key or remote keyless entry transmitter.



To unlock a door from the inside, move the manual door lock control, located above the door handle, rearward. To lock the door, move the manual door lock control forward.

Central Door Unlocking System

If the key is held in the outside key cylinder unlock position for more than two seconds, all doors will unlock. All doors will also unlock if the key is turned to the unlock position twice within three seconds.

Power Door Locks

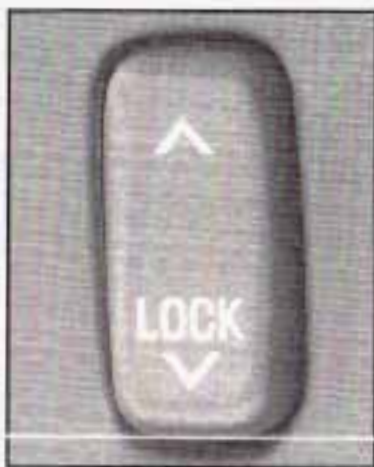

With power door locks, you can lock or unlock all the doors on your vehicle using the driver's or the front passenger's door lock switch.

Door Ajar Reminder

If a door is not fully closed when the transaxle is in gear, a chime will sound and the DIC will display one of these messages:

- DRIVERS DOOR AJAR
- PASSENGER DOOR AJAR
- LEFT REAR DOOR AJAR
- RIGHT REAR DOOR AJAR

Delayed Locking

This personalization feature lets the driver delay the actual locking of the vehicle. When the driver's power door lock switch, or the lock symbol on the remote keyless entry is pressed with the key removed from the ignition and the driver's door open, a chime will sound three times to signal that the lock delay mode is active. When all doors have been closed, the doors will lock automatically after five seconds. If any door is opened before this, the five-second timer will reset itself once all the doors have been closed again.

Pressing the driver's or passenger's door lock switch or the lock symbol on the remote keyless entry a second time will override this feature.

You must program this feature through the Driver Information Center (DIC). See *DIC Vehicle Personalization* on page 3-52.

Programmable Automatic Door Locks

This is a personalization feature that programs your door locks to automatically lock or unlock your vehicle.

This feature allows you to program the vehicle to lock all doors when shifting out of PARK (P). Or, you can program the door locks to do one of the following:

- Unlock only the driver's door when shifting back into PARK (P),
- unlock all doors when shifting back into PARK (P),
- unlock only the driver's door when turning the ignition to OFF,
- unlock all doors when turning the ignition to OFF, or
- no automatic door unlock when shifting into PARK (P) or turning the ignition to OFF.

You can also program this feature to be turned off. Then you will not have automatic door lock or unlock.

This feature will function when you close the doors and turn on the ignition. If someone needs to get out while you're not in PARK (P), have that person use the manual or power door lock. When the door is closed again, it will not lock automatically. Use the manual or power lock to lock the door again.

You must program this feature through the DIC. See *DIC Vehicle Personalization on page 3-52*.

Overriding Lock Delay

If you need to lock your doors before shifting out of PARK (P), use the manual or power door lock switch to lock the doors.

Rear Door Security Locks



Your vehicle is equipped with rear door security locks that prevent passengers from opening the rear doors of your vehicle from the inside.

To use one of these locks, do the following:

1. Open the rear door you want to lock.
2. Move the lever located on the inside door edge, all the way up to the lock symbol.
3. Close the door.
4. Do the same thing to the other rear door lock.

The rear doors of your vehicle cannot be opened from the inside when this feature is in use.

To open a rear door when the security lock is on, do the following:

1. Unlock the door.
2. Open the door from the outside.

If you don't cancel the security lock feature, adults or older children who ride in the rear seat won't be able to open the rear door from the inside. You should let adults and older children know how these security locks work, and how to cancel the locks.

To cancel the rear door lock, do the following:

1. Unlock and open the door from the outside.
2. Move the lever all the way down to the unlock symbol.
3. Do the same for the other rear door.

The rear door locks will now work normally.

Lockout Protection

The power door locks will not work if the key is in the ignition and any door is open. You can override this feature by holding the driver's power door lock switch for more than three seconds.

Leaving Your Vehicle

If you are leaving the vehicle, take your keys, open your door and set the locks from the inside. Then get out and close the door. Or, press the lock button on the remote keyless entry transmitter after shutting the doors.

If your vehicle has a theft-deterrent system, see *Universal Theft-Deterrent on page 2-19*.

Trunk

CAUTION:

It can be dangerous to drive with the trunk lid open because carbon monoxide (CO) gas can come into your vehicle. You can't see or smell CO. It can cause unconsciousness and even death. If you must drive with the trunk lid open or if electrical wiring or other cable connections must pass through the seal between the body and the trunk lid:

- Make sure all other windows are shut.
- Turn the fan on your heating or cooling system to its highest speed and select the control setting that will force outside air into your vehicle. See "Climate Controls" in the Index.
- If you have air outlets on or under the instrument panel, open them all the way.

See "Engine Exhaust" in the Index.

Trunk Lock Release

To unlock the trunk from the outside, insert the master key and turn it.

Remote Trunk Release



Press the trunk release button located on the lower portion of the driver's door to release the trunk lid. The trunk release lockout switch must be OFF for this button to work.

The system also works with the remote keyless entry transmitter. The trunk will unlock when the trunk symbol is pressed while the vehicle is in PARK (P) or NEUTRAL (N) and the trunk release lockout switch is in OFF.

Trunk Release Lockout



The trunk release lockout switch in the glove box allows you to secure items in the trunk, and disable the fuel door release and the HomeLink[®] Transmitter.

Move the trunk release lockout switch to ON, lock the glove box and take the master key and remote keyless entry transmitter with you. Now the remote trunk release button will not open the trunk, the fuel door release button will not open the fuel door and the HomeLink Transmitter will not operate.

Emergency Trunk Release Handle



Notice: The emergency trunk release handle is not designed to be used to tie down the trunk lid or as an anchor point when securing items in the trunk. Improper use of the emergency trunk release handle could damage it.

There is a glow-in-the-dark emergency trunk release handle located near the trunk latch. This handle will glow following exposure to light. Pull the release handle up to open the trunk from the inside.

Windows

CAUTION:

Leaving children in a vehicle with the windows closed is dangerous. A child can be overcome by the extreme heat and can suffer permanent injuries or even death from heat stroke. Never leave a child alone in a vehicle, especially with the windows closed in warm or hot weather.



Power Windows



Switches on the driver's door armrest control each of the windows while the ignition is on or when Retained Accessory Power (RAP) is active. In addition, each passenger's door armrest has a separate window switch.

Express-Down Window

The driver's and right front passenger's windows have an express-down feature. When a window switch is pressed all the way rearward and then released, the window will lower completely. The window can be opened in smaller amounts by pressing the switch rearward slightly, to the first stop.

To stop the window while it is lowering in the express mode, press the switch again, then release. To raise the window, hold the switch forward.

Window Lock Out

Press the LOCK button on the driver's door armrest to disable all passenger window controls. When the passenger's windows are disabled, the driver's window switches will still be operable. You can also use the Driver Information Center (DIC) to lock out only the rear window controls. See *Driver Information Center (DIC)* on page 3-45.

Press the LOCK button again to allow passengers to use their window controls.

Sun Visors

To block out glare, you can swing down the visors. You can also remove them from the center mount and swing them to the side, while the auxiliary visor remains to block glare from the front.

To extend the visor at the sides, pull out the extension.

Lighted Visor Vanity Mirror

When you open the cover to the driver's or passenger's side visor vanity mirror, the lamps will come on.

Theft-Deterrent Systems

Vehicle theft is big business, especially in some cities. Although your vehicle has a number of theft-deterrent features, we know that nothing we put on it can make it impossible to steal.

Universal Theft-Deterrent

Your vehicle has a theft-deterrent alarm system. With this system, if your ignition is off, the SECURITY light will flash as you open the door.



United States



Canada

This light reminds you to activate the theft-deterrent system. To activate it do the following:

1. Open the door.
2. Lock the door with the power door lock switch or remote keyless entry system. The SECURITY light should come on and stay on.
3. Close all doors. The SECURITY light should go off after about 30 seconds. The security system is not armed until the SECURITY light is off. If the SECURITY light stays on or flashes when the ignition is turned on, there is a problem with the system and the vehicle should be serviced.

If the SECURITY light comes on for one minute and then shuts off while the ignition is on, the security system has detected a problem. See your dealer for service.

If a door or the trunk is opened without the key or remote keyless entry transmitter, the alarm will go off. Your vehicle's lamps will flash and the horn will sound for 30 seconds, then will go off to save battery power.

Remember, the theft-deterrent system won't activate if you lock the doors with a key or manual door lock. It only activates if you use the power door lock switch or remote keyless entry transmitter. You should also remember that you can start your vehicle with the correct ignition key if the alarm has been set off. This also shuts off the alarm.

Here's how to avoid setting off the alarm by accident:

- If you don't want to activate the theft-deterrent system, lock the door either using a key or the manual door lock switch.
- Always unlock a door with a key, or use the remote keyless entry system. Unlocking a door any other way will set off the alarm.

If you set off the alarm by accident, unlock the driver's door with your key.

You can also turn off the alarm by pressing the unlock symbol on the remote keyless entry transmitter. The alarm won't stop if you try to unlock a door any other way.

Testing the Alarm

The alarm can be tested by following these steps:

1. From inside the vehicle, roll down the driver's window and open the driver's door.
2. Activate the system by locking the doors with the power door lock switch while the door is open, or with the remote keyless entry transmitter.
3. Get out of the car, close the door and wait for the SECURITY light to go out.
4. Then reach in through the window, unlock the door with the manual door lock and open the door. This should set off the alarm.

If the alarm does not sound when it should, but the vehicle's lamps flash, check to see if the horn works. The horn fuse may be blown. See *Fuses and Circuit Breakers on page 5-92*.

If the alarm does not sound, or the vehicle's lamps do not flash, the vehicle should be serviced by an authorized service center.

PASS-Key® III

Your PASS-Key® III system operates on a radio frequency subject to Federal Communications Commission (FCC) Rules and with Industry Canada.

This device complies with Part 15 of the FCC Rules. Operation is subject to the following two conditions: (1) this device may not cause harmful interference, and (2) this device must accept any interference received, including interference that may cause undesired operation.

This device complies with RSS-210 of Industry Canada. Operation is subject to the following two conditions: (1) this device may not cause interference, and (2) this device must accept any interference received, including interference that may cause undesired operation of the device.

Changes or modifications to this system by other than an authorized service facility could void authorization to use this equipment.

PASS-Key® III uses a radio frequency transponder in the key that matches a decoder in your vehicle.

PASS-Key® III Operation



Your vehicle is equipped with the PASS-Key® III (Personalized Automotive Security System) theft-deterrent system. PASS-Key® III is a passive theft-deterrent system.

This means you don't have to do anything different to arm or disarm the system. It works when you insert or remove the key from the ignition.

When the PASS-Key® III system senses that someone is using the wrong key, it shuts down the vehicle's starter and fuel systems. The starter will not work and fuel will stop being delivered to the engine. Anyone using a trial-and-error method to start the vehicle will be discouraged because of the high number of electrical key codes.

When trying to start the vehicle, if the engine does not start and the SECURITY light comes on, the key may have a damaged transponder. Turn the ignition off and try again.

If the engine still does not start, and the key appears to be undamaged, try another ignition key. At this time, you may also want to check the fuse. See *Fuses and Circuit Breakers on page 5-92*. If the engine still does not start with the other key, your vehicle needs service. If your vehicle does start, the first key may be faulty. See your dealer who can service the PASS-Key[®] III to have a new key made.

It is possible for the PASS-Key[®] III decoder to learn the transponder value of a new or replacement key. Up to 10 keys may be programmed for the vehicle. This procedure is for learning additional keys only.

Canadian Owners: If you lose or damage your keys, only a GM dealer can service PASS-Key[®] III to have new keys made. To program additional keys you will require two current driver's keys. You must add a step to the following procedure. After Step 2 repeat Steps 1 and 2 with the second current driver's key. Then continue with Step 3.

To program the new key, do the following:

1. Verify that the new key has PK3[®] stamped on it.
2. Insert the current driver's key in the ignition and start the engine. If the engine will not start, see your dealer for service.
3. After the engine has started, turn the key to OFF, and remove the key.
4. Insert the key to be programmed and turn it to ON within 10 seconds of removing the previous key.
5. The SECURITY telltale light will turn off once the key has been programmed. It may not be apparent that the SECURITY light went on due to how quickly the key is programmed.
6. Repeat Steps 1 through 4 if additional keys are to be programmed.

If you are ever driving and the SECURITY light comes on and stays on, you will be able to restart your engine if you turn it off. Your PASS-Key[®] III system, however, is not working properly and must be serviced by your dealer. Your vehicle is not protected by the PASS-Key[®] III system at this time.

If you lose or damage a PASS-Key[®] III key, see your dealer to have a new key made.

Starting and Operating Your Vehicle

New Vehicle Break-In

Notice: Your vehicle doesn't need an elaborate "break-in." But it will perform better in the long run if you follow these guidelines:

- Don't drive at any one speed — fast or slow — for the first 500 miles (805 km). Don't make full-throttle starts.
- Avoid making hard stops for the first 200 miles (322 km) or so. During this time your new brake linings aren't yet broken in. Hard stops with new linings can mean premature wear and earlier replacement. Follow this breaking-in guideline every time you get new brake linings.
- Don't tow a trailer during break-in. See "Towing a Trailer" in the Index for more information.

Ignition Positions

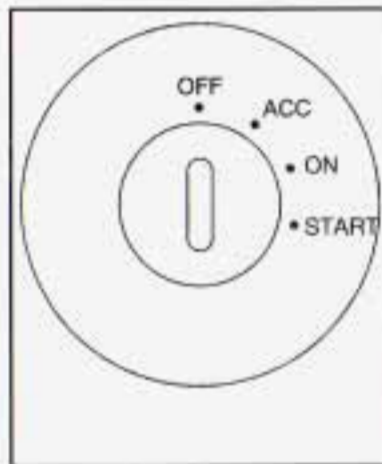

With the ignition key in the ignition switch, you can turn the switch to four different positions.

Notice: If your key seems stuck in OFF and you can't turn it, be sure you are using the correct key; if so, is it all the way in? If it is, then turn the steering wheel left and right while you turn the key hard. Turn the key only with your hand. Using a tool to force it could break the key or the ignition switch. If none of these works, then your vehicle needs service.

OFF: This is the only position in which you can remove the key. This position locks your ignition and transaxle. It's a theft-deterrent feature.

ACC (Accessory): This position lets you use your electrical accessories such as power windows, power sunroof (option), radio and the windshield wipers.

ON: This is the position the switch returns to after you start your engine and release the switch. This is the position for normal driving. Even when the engine is not running, you can use ON to operate your electrical accessories and to display some instrument panel warning lights.

START: This position starts your engine. When the engine starts, release the key. The ignition switch will return to ON for normal driving.

Key Reminder Warning

If you leave your key in the OFF ignition position, you will hear a warning chime when you open the driver's door.

Always leave your key in OFF. If you leave it in any other position, you will drain the battery power.

Retained Accessory Power (RAP)

After you turn the ignition off and remove the key, you will still have power to accessories such as the power windows, audio steering wheel controls, clock, sunroof (option), accessory power outlet and the radio for up to 10 minutes. The instrument panel cluster lights will stay on for a few seconds, then go out. Once you open a door, the power will shut off.

Starting Your Engine

Move your shift lever to PARK (P) or NEUTRAL (N). Your engine won't start in any other position – that's a safety feature. To restart when you're already moving, use NEUTRAL (N) only.

Notice: Don't try to shift to PARK (P) if your vehicle is moving. If you do, you could damage the transaxle. Shift to PARK (P) only when your vehicle is stopped.

1. With your foot off the accelerator pedal, turn your ignition key to START. When the engine starts, let go of the key. The idle speed will go down as your engine gets warm.

Notice: Holding your key in START for longer than 15 seconds at a time will cause your battery to be drained much sooner. And the excessive heat can damage your starter motor. Wait about 15 seconds between each try to help avoid draining your battery or damaging your starter.

2. If it doesn't start within 10 seconds, hold your key in START for about 10 seconds at a time until your engine starts. Wait about 15 seconds between each try.

3. If your engine still won't start (or starts but then stops), it could be flooded with too much gasoline. Try pushing your accelerator pedal all the way to the floor and holding it there as you hold the key in START for about three seconds. If the vehicle starts briefly but then stops again, do the same thing. This time keep the pedal down for five or six seconds to clear the extra gasoline from the engine. After waiting about 15 seconds, repeat the normal starting procedure.

Notice: Your engine is designed to work with the electronics in your vehicle. If you add electrical parts or accessories, you could change the way the engine operates. Before adding electrical equipment, check with your dealer. If you don't, your engine might not perform properly.

Engine Coolant Heater

If your vehicle has this feature, in very cold weather, 0°F (-18°C) or colder, the engine coolant heater can help. You'll get easier starting and better fuel economy during engine warm-up. Usually, the coolant heater should be plugged in a minimum of four hours prior to starting your vehicle. At temperatures above 32°F (0°C), use of the coolant heater is not required.

To Use the Engine Coolant Heater

1. Turn off the engine.
2. Open the hood and unwrap the electrical cord.
The engine coolant heater cord is located on the passenger's side of the vehicle, above the headlamp assembly.
3. Plug it into a normal, grounded 110-volt AC outlet.

CAUTION:

Plugging the cord into an ungrounded outlet could cause an electrical shock. Also, the wrong kind of extension cord could overheat and cause a fire. You could be seriously injured. Plug the cord into a properly grounded three-prong 110-volt AC outlet. If the cord won't reach, use a heavy-duty three-prong extension cord rated for at least 15 amps.

4. Before starting the engine, be sure to unplug and store the cord as it was before to keep it away from moving engine parts. If you don't, it could be damaged.

How long should you keep the coolant heater plugged in? The answer depends on the outside temperature, the kind of oil you have, and some other things. Instead of trying to list everything here, we ask that you contact your dealer in the area where you'll be parking your vehicle. The dealer can give you the best advice for that particular area.

Automatic Transaxle Operation

P
R
N
D
3
2
1

There are several different positions for your shift lever.

PARK (P): This position locks your front wheels. It's the best position to use when you start your engine because your vehicle can't move easily.

CAUTION:

It is dangerous to get out of your vehicle if the shift lever is not fully in **PARK (P)** with the parking brake firmly set. Your vehicle can roll. Don't leave your vehicle when the engine is running unless you have to. If you have left the engine running, the vehicle can move suddenly. You or others could be injured. To be sure your vehicle won't move, even when you're on fairly level ground, always set your parking brake and move the shift lever to **PARK (P)**. See "Shifting Into Park (P)" in the Index. If you're pulling a trailer, see "Towing a Trailer" in the Index.

Ensure the shift lever is fully in PARK (P) before starting the engine. Your vehicle has an automatic transaxle shift lock control system. You have to fully apply your regular brakes before you can shift from PARK (P) when the ignition key is in ON.

REVERSE (R): Use this gear to back up.

Notice: Shifting to REVERSE (R) while your vehicle is moving forward could damage your transaxle. Shift to REVERSE (R) only after your vehicle is stopped.

To rock your vehicle back and forth to get out of snow, ice or sand without damaging your transaxle, see *If You Are Stuck: In Sand, Mud, Ice or Snow* on page 4-32.

NEUTRAL (N): In this position, your engine doesn't connect with the wheels. To restart when you're already moving, use NEUTRAL (N) only. Also, use NEUTRAL (N) when your vehicle is being towed.

CAUTION:

Shifting into a drive gear while your engine is "racing" (running at high speed) is dangerous. Unless your foot is firmly on the brake pedal, your vehicle could move very rapidly. You could lose control and hit people or objects. Don't shift into a drive gear while your engine is racing.

Notice: Damage to your transaxle caused by shifting into a drive gear with the engine racing isn't covered by your warranty.

AUTOMATIC OVERDRIVE (D): This position is for normal driving. If you need more power for passing, and you're:

- Going less than approximately 35 mph (55 km/h), push your accelerator pedal about halfway down.
- Going about 35 mph (55 km/h) or more, push the accelerator all the way down.

You'll shift down to the next gear and have more power.

THIRD (3): This position is also used for normal driving, however, it offers more power and lower fuel economy than AUTOMATIC OVERDRIVE (ⓓ). Here are some times you might choose THIRD (3) instead of AUTOMATIC OVERDRIVE (ⓓ):

- When driving on hilly, winding roads,
- when towing a trailer, so there is less shifting between gears, or
- when going down a steep hill.

SECOND (2): This position gives you more power but lower fuel economy than AUTOMATIC OVERDRIVE (ⓓ) or THIRD (3). You can use SECOND (2) on hills. It can help control your speed as you go down steep mountain roads, but then you would also want to use your brakes off and on.

FIRST (1): This position gives you even more power but lower fuel economy than SECOND (2). You can use it on very steep hills, or in deep snow or mud. If the shift lever is put in FIRST (1), the transaxle won't shift into FIRST (1) until the vehicle is going slowly enough.

Notice: If your front wheels won't turn, don't try to drive. This might happen if you were stuck in very deep sand or mud or were up against a solid object. You could damage your transaxle. Also, if you stop when going uphill, don't hold your vehicle there with only the accelerator pedal. This could overheat and damage the transaxle. Use your brakes to hold your vehicle in position on a hill.

Parking Brake



Your vehicle has a PUSH TO RELEASE parking brake. To set the parking brake, hold the regular brake pedal down with your right foot. Push down the parking brake pedal with your left foot.

If the ignition is on, the brake system warning light will come on while the parking brake is set and a single chime will be heard.

To release the parking brake, hold the regular brake pedal down with your right foot and push the parking brake pedal with your left foot. When you lift your left foot, the parking brake pedal will follow it to the release position.

If you try to drive approximately 20 feet (6.1 m) with the parking brake on, the brake light stays on and a chime sounds until you release the parking brake.

Notice: Driving with the parking brake on can cause your rear brakes to overheat. You may have to replace them, and you could also damage other parts of your vehicle.

If you are towing a trailer and are parking on any hill, see *Towing a Trailer on page 4-36*. That section shows what to do first to keep the trailer from moving.

Shifting Into Park (P)

CAUTION:

It can be dangerous to get out of your vehicle if the shift lever is not fully in PARK (P) with the parking brake firmly set. Your vehicle can roll. If you have left the engine running, the vehicle can move suddenly. You or others could be injured. To be sure your vehicle won't move, even when you're on fairly level ground, use the steps that follow. If you're pulling a trailer, see "Towing a Trailer" in the Index.

1. Hold the brake pedal down with your right foot and set the parking brake by pushing down the parking brake pedal with your left foot.
2. Move the shift lever into PARK (P) by pushing the lever all the way forward.

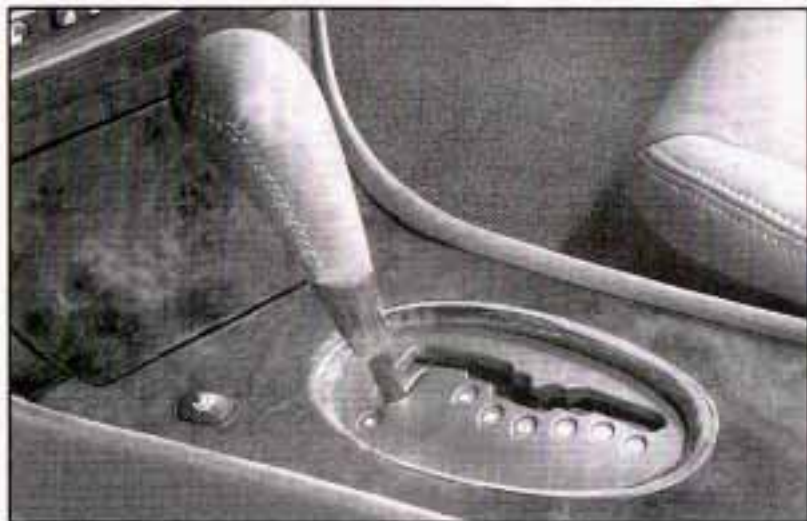

3. Turn the ignition key to OFF.
4. Remove the key and take it with you. If you can leave your vehicle with the ignition key in your hand, your vehicle is in PARK (P).

Leaving Your Vehicle With the Engine Running

CAUTION:

It can be dangerous to leave your vehicle with the engine running. Your vehicle could move suddenly if the shift lever is not fully in PARK (P) with the parking brake firmly set. And, if you leave the vehicle with the engine running, it could overheat and even catch fire. You or others could be injured. Don't leave your vehicle with the engine running.

If you have to leave your vehicle with the engine running, be sure your vehicle is in PARK (P) and your parking brake is firmly set before you leave it. After you've moved the shift lever into PARK (P), hold the regular brake pedal down. Then, see if you can move the shift lever away from PARK (P).

If you can, it means the shift lever wasn't fully locked into PARK (P).

Torque Lock

If you are parking on a hill and you don't shift your transaxle into PARK (P) properly, the weight of the vehicle may put too much force on the parking pawl in the transaxle. You may find it difficult to pull the shift lever out of PARK (P). This is called "torque lock." To prevent torque lock, set the parking brake and then shift into PARK (P) properly before you leave the driver's seat. To find out how, see "Shifting Into PARK (P)" previously in this section.

When you are ready to drive, move the shift lever out of PARK (P) *before* you release the parking brake.

If torque lock does occur, you may need to have another vehicle push yours a little uphill to take some of the pressure from the parking pawl in the transaxle, so you can pull the shift lever out of PARK (P).

Shifting Out of Park (P)

Your vehicle has an automatic transaxle shift lock control system. You have to fully apply your regular brake before you can shift from PARK (P) when the ignition is in ON. See *Automatic Transaxle Operation* on page 2-26.

If you cannot shift out of PARK (P), ease pressure on the shift lever – push the shift lever all the way into PARK (P) as you maintain brake application. Then move the shift lever into the gear you want. If you ever hold the brake pedal down but still can't shift out of PARK (P), try the following:

1. Turn the key to the OFF ignition position.
2. Apply and hold the brake until the end of Step 4.
3. Shift to NEUTRAL (N).
4. Start the vehicle and then shift to the drive gear you want.
5. Take your vehicle to an authorized service center as soon as you can.

Parking Over Things That Burn



CAUTION:

Things that can burn could touch hot exhaust parts under your vehicle and ignite. Don't park over papers, leaves, dry grass or other things that can burn.

Engine Exhaust

CAUTION:

Engine exhaust can kill. It contains the gas carbon monoxide (CO), which you can't see or smell. It can cause unconsciousness and death.

You might have exhaust coming in if:

- Your exhaust system sounds strange or different.
- Your vehicle gets rusty underneath.
- Your vehicle was damaged in a collision.
- Your vehicle was damaged when driving over high points on the road or over road debris.
- Repairs weren't done correctly.
- Your vehicle or exhaust system had been modified improperly.

If you ever suspect exhaust is coming into your vehicle:

- Drive it only with all the windows down to blow out any CO; and
- Have your vehicle fixed immediately.

Running Your Engine While You Are Parked

It's better not to park with the engine running. But if you ever have to, here are some things to know.

CAUTION:

Idling the engine with the climate control system off could allow dangerous exhaust into your vehicle. See the earlier Caution under "Engine Exhaust."

Also, idling in a closed-in place can let deadly carbon monoxide (CO) into your vehicle even if the fan is at the highest setting. One place this can happen is a garage. Exhaust — with CO — can come in easily. **NEVER** park in a garage with the engine running.

Another closed-in place can be a blizzard. See "Winter Driving" in the Index.

CAUTION:

It can be dangerous to get out of your vehicle if the shift lever is not fully in PARK (P) with the parking brake firmly set. Your vehicle can roll. Don't leave your vehicle when the engine is running unless you have to. If you've left the engine running, the vehicle can move suddenly. You or others could be injured. To be sure your vehicle won't move, even when you're on fairly level ground, always set your parking brake and move the shift lever to PARK (P).

Follow the proper steps to be sure your vehicle won't move. See *Shifting Into Park (P)* on page 2-30.

If you are parking on a hill and if you're pulling a trailer, also see *Towing a Trailer* on page 4-36.

Mirrors

Automatic Dimming Rearview Mirror with Compass

Your vehicle may have an automatic dimming rearview mirror with a compass. Your vehicle's mirror may also contain OnStar[®] controls. See *OnStar[®] System on page 2-39* for more information.

The mirror also includes an eight-point compass display in the upper right corner of the mirror face.

When cleaning the mirror, use a paper towel or similar material dampened with glass cleaner. Do not spray glass cleaner directly on the mirror as that may cause the liquid cleaner to enter the mirror housing.

Mirror Operation

MIRROR: Press this button to turn on the automatic dimming feature. Press it again to turn off the automatic dimming feature.

 **(On/Off):** For mirrors equipped with OnStar[®] controls, press and hold this button for several seconds to turn on the automatic dimming feature. Press and hold it again to turn the automatic dimming feature off.

The green indicator light will come on when this feature is active. The automatic dimming feature will be active each time the vehicle is started.

Compass Operation

COMPASS: Press this button once to turn the compass on or off.

 **(On/Off):** For mirrors equipped with OnStar[®] controls, press this button once to turn the compass on or off.

When the ignition and the compass feature are on, the compass will show two character boxes for approximately two seconds. After two seconds, the mirror will display the compass heading.

Compass Calibration

When on, the compass automatically calibrates as the vehicle is driven. If, after two seconds, the display does not show a compass heading (N for North, for example), there may be a strong magnetic field interfering with the compass. Such interference may be caused by a magnetic antenna mount, magnetic note pad holder or a similar magnetic item. If the letter C should ever appear in the compass window, the compass may need calibration.

The mirror can be calibrated by driving the vehicle in circles at 5 mph (8 km/h) or less until the display reads a direction.

Mirrors equipped with OnStar[®] controls can be placed in calibration mode by pressing and holding the on/off button until a C is shown in the compass display.

Compass Variance

The mirror is set in zone eight upon leaving the factory. It will be necessary to adjust the compass to compensate for compass variance if you live outside zone eight. Under certain circumstances, as during a long distance cross-country trip, it will be necessary to adjust for compass variance. Compass variance is the difference between earth's magnetic north and true geographic north. If not adjusted to account for compass variance, your compass could give false readings.

To adjust for compass variance, do the following:

1. Find your current location and variance zone number on the following zone map.
2. Press and hold COMPASS (or the on/off button for mirrors equipped with OnStar[®] controls) until a zone number appears in the display.

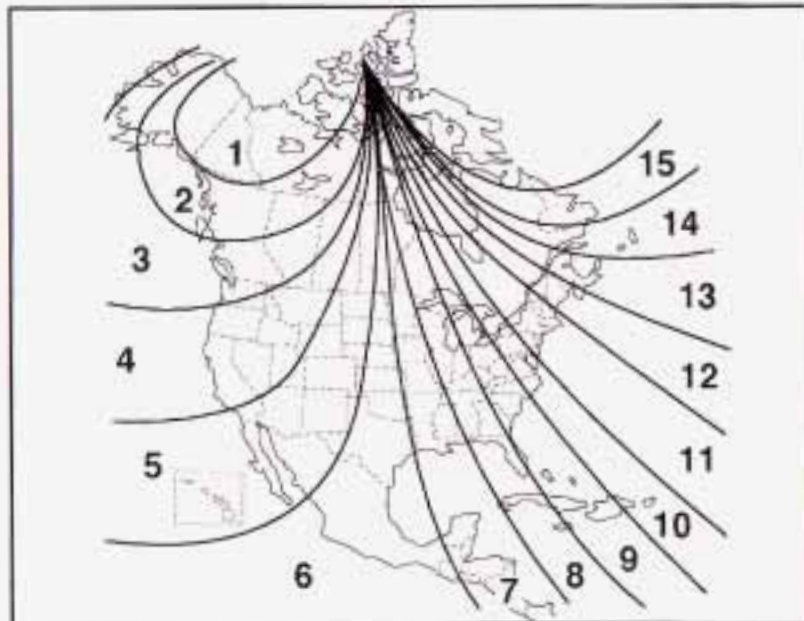

3. Once a zone number appears in the display, press the COMPASS button (or the on/off button for mirrors equipped with OnStar[®] controls) quickly until the correct zone number appears in the display. Stop pressing the button and the mirror will return to normal operation. If C appears in the compass window, the compass may need calibration. See "Compass Calibration" explained previously.

Outside Power Mirrors



The controls for the outside power mirrors are located on the driver's door armrest.

Press the left or right side of the L/R selector switch located beneath the control pad to choose the left or right mirror.

To adjust the mirror, use one of the four arrows located on the control pad to move the mirror in the direction you want it to go. When finished adjusting the mirrors, leave the L/R selector switch in the center position, to prevent unwanted mirror movement in case the

control pad is accidentally bumped while driving. Adjust each outside mirror so that you can see a little of your vehicle and the area behind your vehicle.

If your vehicle is equipped with the memory function, the mirrors and driver's seat position can be stored into memory. See *Memory Seat and Mirrors* on page 2-48.

Outside Curb View Assist Mirror

If you have the memory seat and mirrors feature, the passenger's outside power mirror also includes a tilt-down feature that operates when the shift lever is in REVERSE (R). When the vehicle is shifted out of REVERSE (R), the passenger's mirror will return to its original position after a five-second delay. This delay prevents movement of the mirror if multiple gear transitions (REVERSE (R) to DRIVE (D) to REVERSE (R)) occur during a parallel parking maneuver. This feature can be programmed on or off through the DIC. See *Driver Information Center (DIC)* on page 3-45 or *DIC Vehicle Personalization* on page 3-52 for programming instructions. Vehicles are delivered with this feature off.

Outside Convex Mirror

Your passenger's side mirror is convex. A convex mirror's surface is curved so you can see more from the driver's seat.

CAUTION:

A convex mirror can make things (like other vehicles) look farther away than they really are. If you cut too sharply into the right lane, you could hit a vehicle on your right. Check your inside mirror or glance over your shoulder before changing lanes.

Outside Heated Mirrors

When you operate the rear window defogger, the heated driver's and passenger's outside rearview mirrors also warm up to help clear them of ice and snow. See "Rear Window Defogger" under *Automatic Climate Control System* on page 3-23.

OnStar[®] System



OnStar[®] uses global positioning system (GPS) satellite technology, wireless communications, and state of the art call centers to provide you with a wide range of safety, security, information and convenience services. An OnStar[®] subscription plan is included in the price of your vehicle. You can easily upgrade or extend your OnStar[®] services to meet your personal needs.

A complete OnStar[®] user's guide and the terms and conditions of the OnStar[®] Subscription Service Agreement are included in your OnStar[®]-equipped vehicle's glove box literature. For more information, visit www.onstar.com, contact OnStar[®] at 1-888-4-ONSTAR (1-888-466-7827), or press the blue OnStar[®] button to speak to an OnStar[®] advisor 24 hours a day, 7 days a week.

OnStar[®] Services

OnStar[®] provides a number of service plans to closely meet your needs. Some of the services currently provided by OnStar[®] are:

- Automatic Notification of Air Bag Deployment
- Emergency Services
- Roadside Assistance Stolen Vehicle Tracking
- AccidentAssist
- Remote Door Unlock
- Remote Diagnostics
- OnStar[®] MED-NET (Requires separate activation and annual fee on some plans)
- Online and Personal Concierge Services
- Route Support
- RideAssist
- Information and Convenience Services

OnStar[®] Personal Calling

With OnStar[®] Personal Calling, you have a safer way to stay connected while driving. It's a hands-free wireless phone that's integrated into your vehicle. You can place calls nationwide using voice-activated dialing with no contracts, no roaming charges and no access fees. To find out more about OnStar[®] Personal Calling, refer to the OnStar[®] owner's guide in your vehicle's glove box, or call OnStar[®] at 1-888-4-ONSTAR (1-888-466-7827).

OnStar[®] Virtual Advisor

With OnStar[®] Virtual Advisor you can listen to your favorite news, entertainment and information topics, such as traffic and weather reports, stock quotes and sports scores. You listen to your e-mail through your vehicle's speakers, and reply with your hands on the wheel and your eyes on the road.

A completed Subscription Service Agreement is required prior to delivery of OnStar[®] services and prepaid calling minutes are also required for OnStar[®] Personal Calling and OnStar[®] Virtual Advisor use. Terms and conditions of the Subscription Service Agreement can be found at www.onstar.com.

HomeLink[®] Transmitter

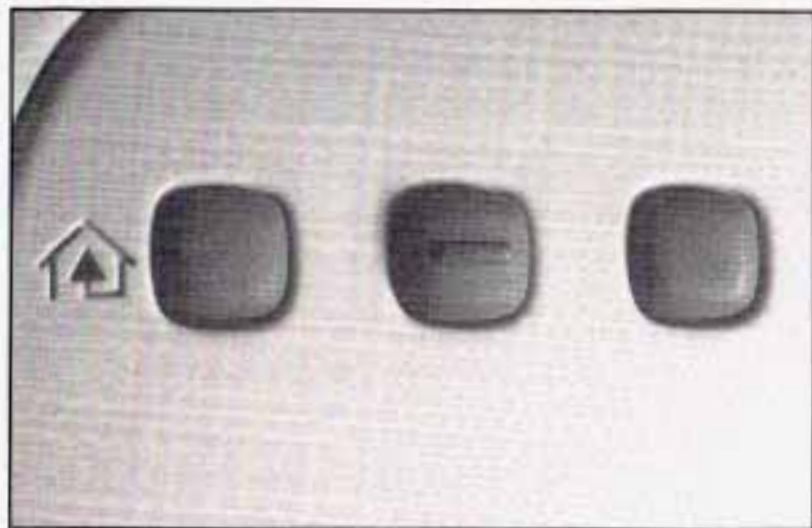

HomeLink[®], a combined universal transmitter and receiver, provides a way to replace up to three hand-held transmitters used to activate devices such as gate operators, garage door openers, entry door locks, security systems and home lighting. Additional HomeLink[®] information can be found on the internet at www.homelink.com or by calling 1-800-355-3515.

If your vehicle is equipped with the HomeLink[®] Transmitter, it complies with Part 15 of the FCC Rules. Operation is subject to the following two conditions:
(1) this device may not cause harmful interference, and

(2) this device must accept any interference received, including interference that may cause undesired operation.

This device complies with RSS-210 of Industry Canada. Operation is subject to the following two conditions:
(1) this device may not cause interference, and (2) this device must accept any interference, including interference that may cause undesired operation of the device.

Changes and modifications to this system by other than an authorized service facility could void authorization to use this equipment.

Programming the HomeLink® Transmitter

Do not use the HomeLink® Transmitter with any garage door opener that does not have the "stop and reverse" feature. This includes any garage door opener model manufactured before April 1, 1982.

Keep the original transmitter for use in other vehicles as well as for future HomeLink® programming. It is also recommended that upon the sale of the vehicle, the programmed HomeLink® buttons should be erased for security purposes. Refer to "Erasing HomeLink® Buttons" or, for assistance, contact HomeLink® on the internet at: www.homelink.com or by calling 1-800-355-3515.

Be sure that people and objects are clear of the garage door or gate operator you are programming. When programming a garage door, it is advised to park outside of the garage.

It is recommended that a new battery be installed in your hand-held transmitter for quicker and more accurate transmission of the radio frequency.

Your vehicle's engine should be turned off while programming the transmitter. Follow these steps to program up to three channels:

1. Press and hold down the two outside buttons, releasing only when the indicator light begins to flash, after 20 seconds. Do not hold down the

buttons for longer than 30 seconds and do not repeat this step to program a second and/or third transmitter to the remaining two HomeLink® buttons.

2. Position the end of your hand-held transmitter about 1 to 3 inches (3 to 8 cm) away from the HomeLink® buttons while keeping the indicator light in view.
3. Simultaneously press and hold both the desired button on HomeLink® and the hand-held transmitter button. Do not release the buttons until Step 4 has been completed.

Some entry gates and garage door openers may require you to substitute Step 3 with the procedure noted in "Gate Operator and Canadian Programming" later in this section.

4. The indicator light will flash slowly at first and then rapidly after HomeLink® successfully receives the frequency signal from the hand-held transmitter. Release both buttons.
5. Press and hold the newly-trained HomeLink® button and observe the indicator light.

If the indicator light stays on constantly, programming is complete and your device should activate when the HomeLink® button is pressed and released.

To program the remaining two HomeLink® buttons, begin with Step 2 under "Programming HomeLink®." Do not repeat Step 1 as this will erase all of the programmed channels.

If the indicator light blinks rapidly for two seconds and then turns to a constant light, continue with Steps 6 through 8 following to complete the programming of a rolling-code equipped device (most commonly, a garage door opener).

6. At the garage door opener receiver (motor-head unit) in the garage, locate the "Learn" or "Smart" button. This can usually be found where the hanging antenna wire is attached to the motor-head unit.
7. Firmly press and release the "Learn" or "Smart" button. The name and color of the button may vary by manufacturer.

You will have 30 seconds to start Step 8.

8. Return to the vehicle. Firmly press and hold the programmed HomeLink[®] button for two seconds, then release. Repeat the press/hold/release sequence a second time, and depending on the brand of the garage door opener (or other rolling code device), repeat this sequence a third time to complete the programming.

HomeLink[®] should now activate your rolling code equipped device.

To program the remaining two HomeLink[®] buttons, begin with Step 2 of "Programming HomeLink[®]." Do not repeat Step 1.

Gate Operator and Canadian Programming

Canadian radio-frequency laws require transmitter signals to "time out" or quit after several seconds of transmission. This may not be long enough for HomeLink[®] to pick up the signal during programming. Similarly, some U.S. gate operators are manufactured to "time out" in the same manner.

If you live in Canada, or you are having difficulty programming a gate operator by using the "Programming HomeLink[®]" procedures (regardless of where you live), replace Step 3 under "Programming HomeLink[®]" with the following:

Continue to press and hold the HomeLink[®] button while you press and release every two seconds (cycle) your hand-held transmitter until the frequency signal has been successfully accepted by HomeLink[®]. The indicator light will flash slowly at first and then rapidly. Proceed with Step 4 under "Programming HomeLink[®]" to complete.

Using HomeLink®

Press and hold the appropriate HomeLink® button for at least half of a second. The indicator light will come on while the signal is being transmitted.

Erasing HomeLink® Buttons

To erase programming from the three buttons do the following:

1. Press and hold down the two outside buttons until the indicator light begins to flash, after 20 seconds.
2. Release both buttons. Do not hold for longer than 30 seconds.

HomeLink® is now in the train (learning) mode and can be programmed at any time beginning with Step 2 under "Programming HomeLink®."

Individual buttons can not be erased, but they can be reprogrammed. See "Reprogramming a Single HomeLink® Button" next.

Reprogramming a Single HomeLink® Button

To program a device to HomeLink® using a HomeLink® button previously trained, follow these steps:

1. Press and hold the desired HomeLink® button. Do not release the button.
2. The indicator light will begin to flash after 20 seconds. While still holding the HomeLink® button, proceed with Step 2 under "Programming HomeLink®."

Resetting Defaults

To reset HomeLink® to default settings do the following:

1. Hold down the two outside buttons for about 20 seconds until the indicator light begins to flash.
2. Continue to hold both buttons until the HomeLink® indicator light turns off.
3. Release both buttons.

For questions or comments, contact HomeLink® at 1-800-355-3515, or on the internet at www.homelink.com.

Storage Areas

Glove Box

Use the master key to lock and unlock the glove box. To open it, lift the latch release on the left side of the glove box door.

The VALET key will not work in the glove box door lock.

Front Storage Area

The front armrest opens into a storage area. To open it, push the latch at the front center of the armrest. When the latch disengages, pull up on the armrest to open it. Inside you will find storage for cassettes, compact discs and coins.

In front of the storage area is a cupholder. Press and release the cupholder cover to open. Do not try to pull it out. Press the cupholder back to its recessed position when not in use.

Assist Handles

A handle above each rear door and the front passenger's door can be used to help you get in or out of your vehicle.

Floor Mats

Your vehicle is equipped with floor mats. The driver's side floor mat is held in place by a locator hook.

To remove the driver's side floor mat, slide the floor mat towards the driver's seat to unhook it. Then pick up the floor mat to remove it.

To reinstall the floor mat, line up the opening in the floor mat over the locator hook and push it down into place.

Rear Storage Area

Your vehicle may have a rear storage armrest with cupholders and a pass-through feature.

Lift the front of the cover on the armrest to reveal the storage space.

Pull down the interior door to access the trunk.

Convenience Net

Your vehicle may have a convenience net. You'll see it just inside the back wall of the trunk.

Put small loads, like grocery bags, behind the net. It can help keep them from falling over during sharp turns or quick starts and stops.

The net isn't for larger, heavier loads. Store them in the trunk as far forward as you can.

You can unhook the net so that it will lie flat when you're not using it.

Sunroof

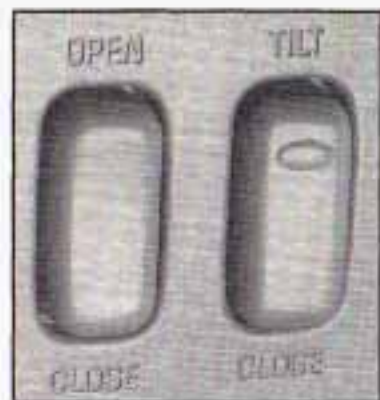

If your vehicle has this option, the switches are located on the headliner between the sun visors.

There are two switches that operate the sunroof. The switches will only work when the ignition is on or when RAP is active. See "Retained Accessory Power (RAP)" under *Ignition Positions on page 2-23*.

The OPEN/CLOSE switch has positions for open or close and express open. The TILT/CLOSE switch has positions for tilt or close.

Open: Press and hold the OPEN/CLOSE switch to the first position to open the glass panel and sunshade. The sunshade can also be opened by hand.

Comfort Stop: Press and release the OPEN/CLOSE switch rearward to the second position to express open the glass panel to the comfort stop position. The comfort stop position is designed to help reduce noise and make the passengers more comfortable.

Express Open: The glass panel may be fully opened by pressing the OPEN/CLOSE switch rearward again. When the glass panel is express opening, pressing either switch in any direction will stop it. If you press and hold the OPEN/CLOSE switch in the express open position for more than one and a half seconds, the express open operation will be overridden and the sunroof will operate manually.

Tilt: To tilt open the glass panel, press and hold the TILT/CLOSE switch. The sunshade must be opened by hand.

Close: To close the glass panel, press and hold the OPEN/CLOSE or TILT/CLOSE switch in the close position. As the glass panel reaches the closed position, it will open slightly towards the tilt position and then drop down to the closed position to provide a better seal.

Vehicle Personalization

Memory Seat and Mirrors

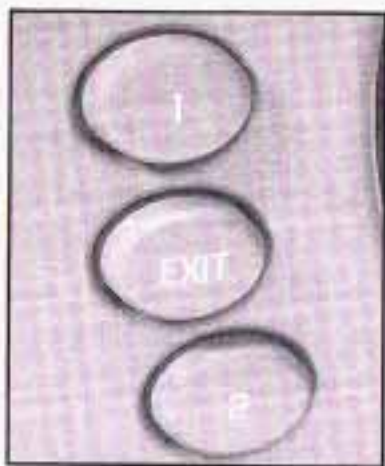

If your vehicle has this feature, the controls are located on the driver's door panel, and are used to program and recall memory settings for the driver's seating, outside mirror positions and climate controls. See *Automatic Climate Control System on page 3-23* for more information.

To save your seat and mirror positions into memory, use the following procedure:

1. First identify the DRIVER # on the Driver Information Center (DIC) by pressing the MEMORY button (1 or 2) or by pressing the button with the unlock symbol on the remote keyless entry transmitter. See *Driver Information Center (DIC) on page 3-45*.

2. Adjust the driver's seat and lumbar position to a safe and comfortable driving position. Adjust both outside mirrors to suit you. See *Outside Power Mirrors on page 2-37*.
3. Press and hold the MEMORY button (1 or 2) corresponding with your DRIVER # displayed on the DIC for longer than three seconds. You will hear two beeps confirming that the seat and mirror positions have been entered into memory.

To set the seat and mirror positions for a second driver, follow the previous steps, but start by pressing the button with the unlock symbol on the transmitter that displays the other DRIVER # on the DIC. Be sure to use the MEMORY button (1 or 2) which corresponds to the DRIVER # identified by the second transmitter.

To recall your memory positions, your vehicle must be in PARK (P). Push and release the MEMORY button (1 or 2) corresponding to the desired driving position. The seat and mirrors will move to the position previously stored for the identified driver. You will hear one beep.

To store the exit position for an easy exit, use the following procedure:

1. First identify the DRIVER # by pressing the MEMORY button (1 or 2) or by pressing the button with the unlock symbol on the transmitter.
2. Adjust the driver's seat to the desired exit position.
3. Press and hold the EXIT button for longer than three seconds. You will hear two beeps confirming that the seat exit position has been entered into memory.

To set the exit position for a second driver, follow the previous steps, but start by pressing the button with the unlock symbol on the transmitter that displays the other DRIVER # on the DIC. Be sure to use the MEMORY button (1 or 2) which corresponds to the DRIVER # identified by the other transmitter.

To recall the exit position, your vehicle must be in PARK (P). Push and release the EXIT button and the seat will move to the exit position previously stored for the currently identified driver. You will hear one beep. If an exit position has not been stored for the current identified driver, the seat will move all the way back.

To stop recall movement of the seat at any time, press the driver's power seat control located on the outboard side of the front seat.

Mirrors and lumbar positions will not be stored or recalled for the exit position.

If you would like your stored driving or exit position to be recalled when unlocking your vehicle with the transmitter, see *DIC Vehicle Personalization on page 3-52*.

✎ NOTES

Section 3 Instrument Panel

Instrument Panel Overview	3-2	Traction Control System (TCS) Warning Light ...	3-37
Hazard Warning Flashers	3-4	Traction Control System Active Light	3-38
Other Warning Devices	3-5	Engine Coolant Temperature Gage	3-38
Horn	3-5	Malfunction Indicator Lamp	3-39
Tilt Wheel	3-5	Oil Pressure Light	3-42
Turn Signal/Multifunction Lever	3-6	Cruise Control Light	3-43
Exterior Lamps	3-14	Fuel Gage	3-44
Interior Lamps	3-17	Driver Information Center (DIC)	3-45
Accessory Power Outlets	3-21	DIC Warnings and Messages	3-50
Ashtrays and Cigarette Lighter	3-22	DIC Vehicle Personalization	3-52
Climate Controls	3-23	Audio System(s)	3-59
Automatic Climate Control System	3-23	Setting the Time	3-59
Outlet Adjustment	3-27	Radio with Cassette and CD	3-60
Steering Wheel Climate Controls	3-28	Navigation/Radio System	3-69
Climate Controls Personalization	3-29	Trunk-Mounted CD Changer	3-70
Warning Lights, Gages and Indicators	3-30	Personal Choice Radio Controls	3-73
Instrument Panel Cluster	3-31	Theft-Deterrent Feature	3-73
Speedometer and Odometer	3-32	Audio Steering Wheel Controls	3-74
Tachometer	3-33	Understanding Radio Reception	3-74
Safety Belt Reminder Light	3-33	Care of Your Cassette Tape Player	3-74
Air Bag Readiness Light	3-34	Care of Your CDs	3-75
Battery Warning Light	3-35	Care of Your CD Player	3-76
Brake System Warning Light	3-35	Diversity Antenna System	3-76
Anti-Lock Brake System Warning Light	3-36	Chime Level Adjustment	3-76

Instrument Panel Overview

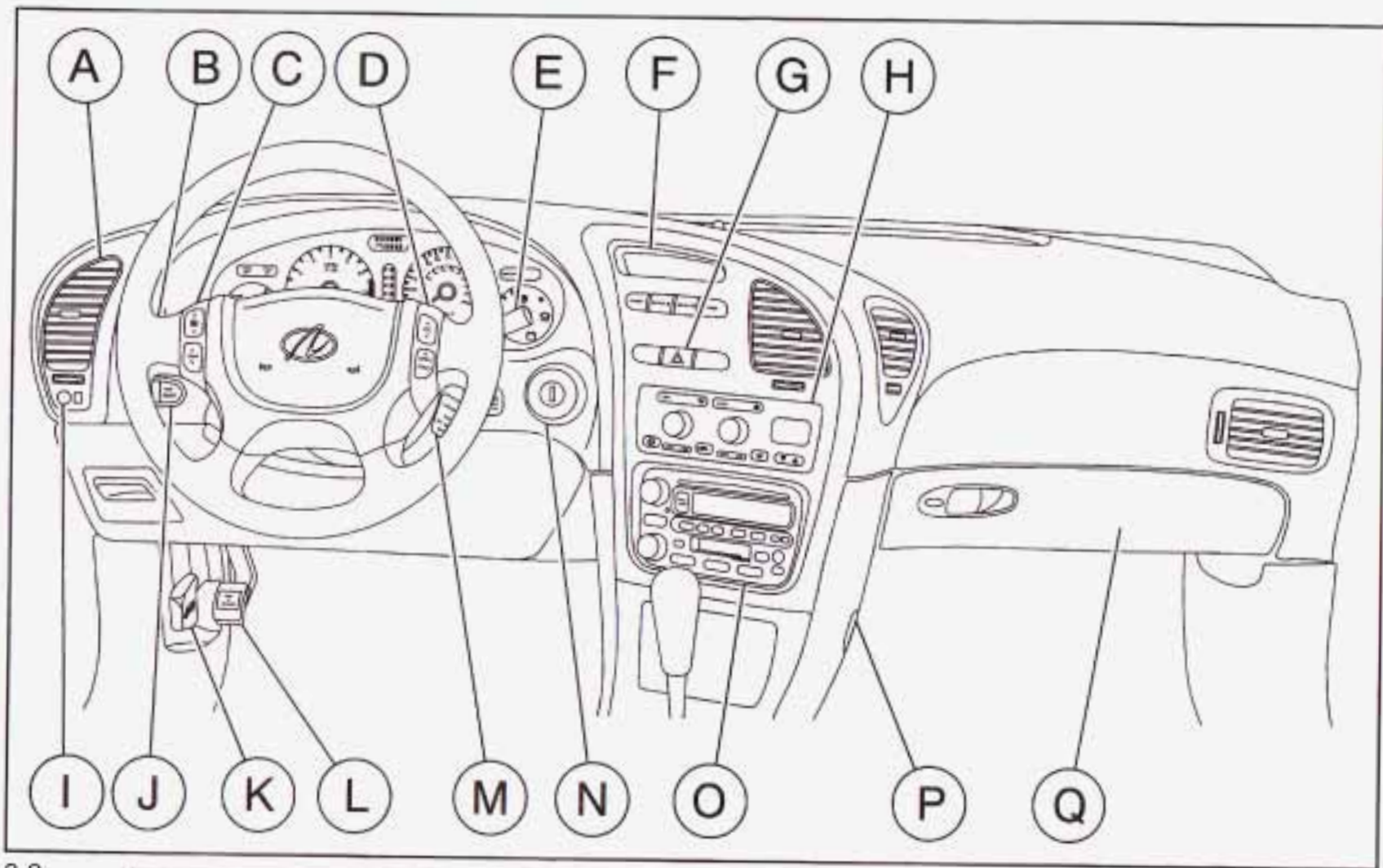

The main components of your instrument panel are the following:

- A. Air Outlet
- B. Turn Signal/Multifunction Lever
- C. Steering Wheel Controls for Climate Control System
- D. Steering Wheel Controls for Audio System
- E. Windshield Wiper/Washer Control
- F. Driver Information Center (DIC)
- G. Hazard Warning Flasher Button
- H. Climate Control System
- I. Instrument Panel Brightness Knob
- J. Trip Odometer Buttons
- K. Hood Release
- L. Parking Brake
- M. Cruise Control Lever
- N. Ignition Switch
- O. Audio System
- P. Accessory Power Outlet
- Q. Glove Box (Trunk Release Lockout Switch inside)

Hazard Warning Flashers

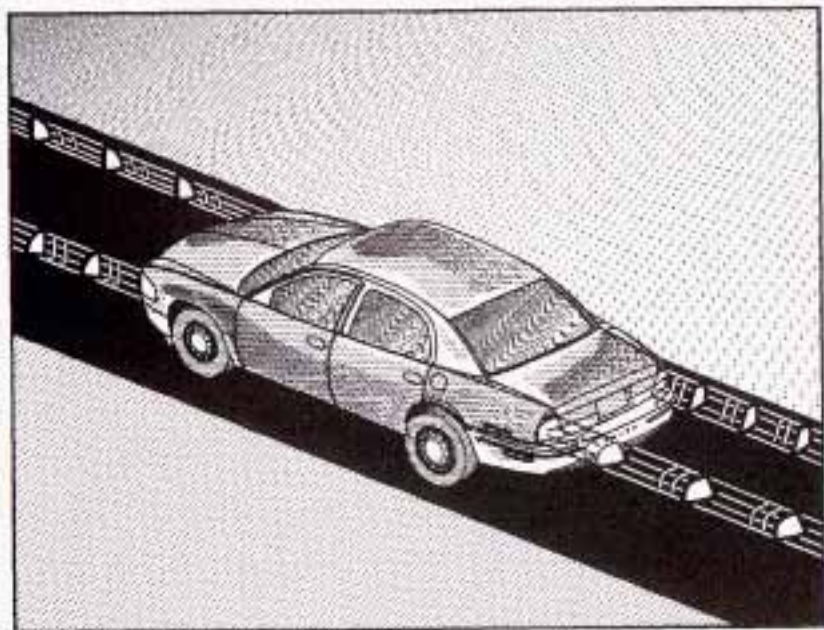

Your hazard warning flashers let you warn others. They also let police know you have a problem. Your front and rear turn signal lamps will flash on and off.

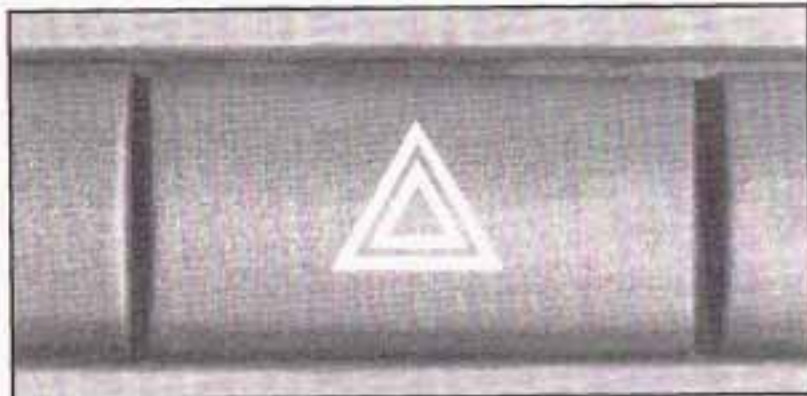

The hazard warning flasher button is located in the center of the instrument panel.

Your hazard flashers work no matter what position your key is in, and even if the key isn't in.

Press the button to make the front and rear turn signal lamps flash on and off. To turn off the flashers, press the button again.

When the hazard warning flashers are on, your turn signals won't work.

Other Warning Devices

If you carry reflective triangles, you can set one up at the side of the road about 300 feet (100 m) behind your vehicle.

Horn

Press the center area of the steering wheel to sound the horn.

Tilt Wheel

A tilt wheel allows you to adjust the steering wheel before you drive. You can also raise it to the highest level to give your legs more room when you exit and enter the vehicle.

The lever that allows you to tilt the steering wheel is located on the left side of the steering column.



To tilt the wheel, hold the wheel and pull the lever toward you. Then move the wheel to a comfortable position and release the lever to lock the wheel in place.

Turn Signal/Multifunction Lever

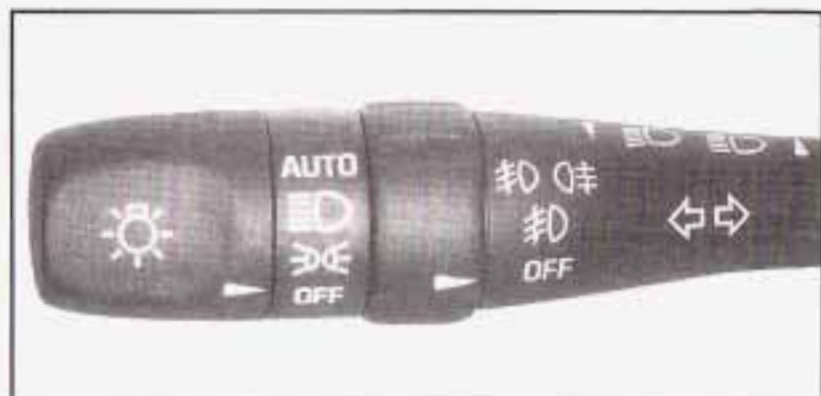

The lever on the left side of the steering column includes the following:

- Turn and Lane-Change Signals
- Headlamp High/Low-Beam Changer
- Flash-To-Pass

For information on exterior lamps, see "Exterior Lamps" later in this section.

Turn and Lane-Change Signals

The turn signal has two upward (for right) and two downward (for left) positions. These positions allow you to signal either a turn or a lane change.

To signal a turn, move the lever all the way up or down. When the turn is finished, the lever will return automatically.

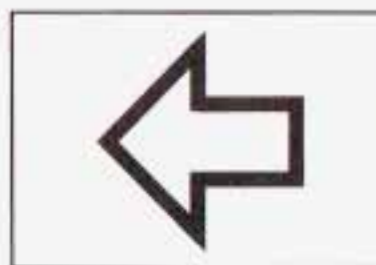

An arrow on the instrument panel cluster will flash in the direction of the turn or lane change.

To signal a lane change, just raise or lower the lever until the arrow starts to flash. Hold it there until you complete your lane change. The lever will return by itself when you release it.

As you signal a turn or a lane change, if the arrows flash very fast, a bulb may be burned out and other drivers won't see your turn signal.

If a bulb is burned out, replace it to help avoid an accident.

If the arrows don't go on at all when you signal a turn, check the fuse (see *Fuses and Circuit Breakers on page 5-92*) and check for burned-out bulbs.

Turn Signal On Chime

If your turn signal is left on for more than 0.8 miles (1.3 km), a chime will sound at each flash of the turn signal and the DIC will display the TURN SIGNAL ON? reminder message. To turn off the chime and message, move the turn signal lever to the off position. To turn off the DIC message while the turn signal is still active, press any button on the DIC. See *Driver Information Center (DIC) on page 3-45* for more information.

Headlamp High/Low-Beam Changer

To change the headlamps from low beam to high, push the lever away from you until you hear a click. Then release it.



When the high beams are on, this light on the instrument panel cluster will also be on.

If the fog lamps are on when you turn on the high-beam headlamps, the fog lamps will turn off. The fog lamps will turn back on when you turn off the high-beam headlamps.

Flash-to-Pass

This feature lets you use your high-beam headlamps to signal a driver in front of you that you want to pass. It works even if your headlamps are off.

To use it, pull the turn signal lever toward you.

Your high-beam headlamps will turn on. They'll stay on as long as you hold the lever there. Release the lever to turn them off.

If your headlamps are on, and on high beam, your headlamps will switch to low beam when the lever is released. To get back to high beam, push the lever away from you.

Windshield Wipers

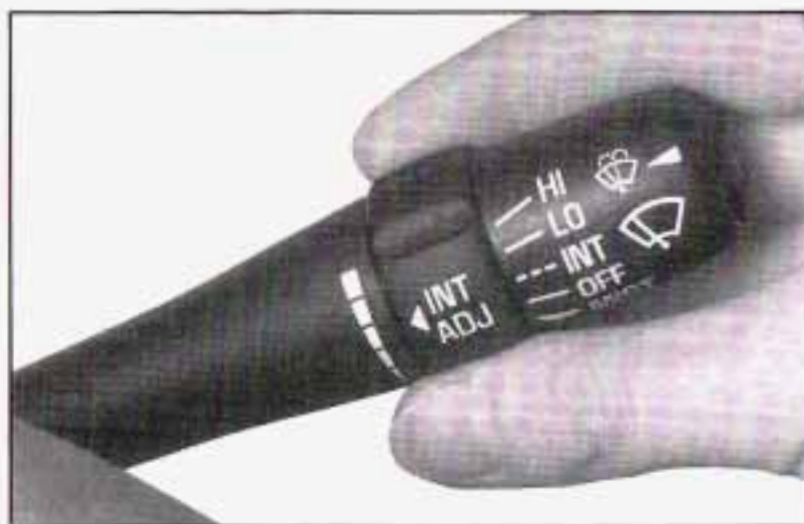

The lever on the right side of your steering column operates your windshield wipers.

If your windshield wipers are on for more than six seconds while you are driving, the low-beam headlamps, instrument panel cluster backlighting and the taillamps will turn on. For more information see "Wiper-Activated Headlamps" under *Exterior Lamps on page 3-14*.

For a single wiping cycle, move the lever down to MIST. Hold it there until the wipers start, then release it. The wipers will stop after one cycle. If you want more cycles, hold the lever on MIST longer.

For steady wiping at low speed, move the lever up to the LO position. For high-speed wiping, move the lever up further, to HI. To stop the wipers, move the lever to OFF.

You can set the wiper speed for a long or short delay between wiper cycles. Move the lever up to the first detent, INT (Intermittent). Turn the band labeled INT ADJ (Intermittent Adjustment) down toward the shorter lines for fewer wiper passes per minute. As you turn the band toward the longer lines, the wiper cycles per minute will increase.

Remember that damaged wiper blades may prevent you from seeing well enough to drive safely. To avoid damage, be sure to clear ice and snow from the wiper blades before using them. If they're frozen to the windshield, carefully loosen or thaw them. If your blades do become damaged, get new blades or blade inserts. See *Windshield Wiper Blade Replacement on page 5-59*.

Heavy snow or ice can overload your wipers. A circuit breaker will stop them until the motor cools. Clear away snow or ice to prevent an overload.

Rainsense™ II Wipers

The moisture sensor is mounted on the interior side of the windshield below the rearview mirror and is used to automatically operate the windshield wipers. This system operates by monitoring the amount of moisture build-up on the windshield. Wipes occur as needed to clear the windshield depending on the driving conditions and sensitivity setting. In light rain or snow, fewer wipes will occur. In heavy rain or snow, wipes will occur more frequently. The system will operate in the delay, low speed and high speed modes. If the system is left on for long periods of time, occasional wipes may occur without any moisture on the windshield. This is normal and indicates that the Rainsense™ system is activated.

The Rainsense™ system is activated by moving the wiper lever up to the INT position and turning the INT ADJ band to one of the five sensitivity levels within the delay area. The bottom INT ADJ position is the lowest sensitivity setting, level one. This allows more rain or snow to collect on the windshield between wipes. You can increase the sensitivity of the system and the frequency of wipes by turning the INT ADJ band away from you to the higher sensitivity levels. The top position is the highest sensitivity setting, level five. A single wipe will occur each time you turn the INT ADJ band to a higher sensitivity level to indicate that the sensitivity level has been increased.

Notice: The wipers must be turned off when going through a car wash to avoid damage.

The MIST and wash cycles operate as normal and are not affected by the Rainsense™ function. The system can be overridden at any time by manually changing the wiper control to LO or HI speed.

Notice: Do not place stickers or other items on the exterior glass surface directly in front of the rainsensor. Doing this could cause the rainsensor to malfunction.

Windshield Washer

The lever on the right side of your steering column also controls your windshield washer. To spray washer fluid on the windshield, push the button on the end of the lever. The wipers will clear the window and then either stop or return to your preset speed. For more washer cycles, push and hold the button.

CAUTION:

In freezing weather, don't use your washer until the windshield is warmed. Otherwise the washer fluid can form ice on the windshield, blocking your vision.

Ice build up can block washer nozzles. Remove ice for proper operation.

If the fluid level in the windshield washer bottle is low, the message LOW WASHER FLUID will appear on the DIC. See *Windshield Washer Fluid* on page 5-38.

Cruise Control

With cruise control, you can maintain a speed of about 25 mph (40 km/h) or more without keeping your foot on the accelerator. This is helpful on long trips.

Cruise control does not work at speeds below about 25 mph (40 km/h).

When you apply your brakes, the cruise control shuts off.

CAUTION:

- Cruise control can be dangerous where you can't drive safely at a steady speed. So, don't use your cruise control on winding roads or in heavy traffic.
- Cruise control can be dangerous on slippery roads. On such roads, fast changes in tire traction can cause needless wheel spinning, and you could lose control. Don't use cruise control on slippery roads.

If your vehicle is in cruise control when the traction control system begins to limit wheel spin, the cruise control will automatically disengage. See *Traction Control System (TCS)* on page 4-8. When road conditions allow you to safely use it again, you may turn the cruise control back on.

Setting Cruise Control

CAUTION:

If you leave your cruise control on when you're not using cruise, you might hit a button and go into cruise when you don't want to. You could be startled and even lose control. Keep the cruise control switch off until you want to use cruise control.



1. Push the cruise control switch, located on the right side of the steering column at the end of the lever, in to ON.
2. Get up to the speed you want.
3. Push the lever down to SET-CST (Coast) and release it. The CRUISE light on the instrument panel cluster will come on.
4. Take your foot off the accelerator pedal.

Resuming a Set Speed

Setting the cruise control at a desired speed and then applying the brake will end the cruise control function.

Once you're going about 25 mph (40 km/h) or more, you can briefly push the cruise control lever up to RES-ACC (Resume-Accelerate) to reset. This returns you to the desired preset speed.

Remember, if you hold the lever up at RES-ACC, the vehicle will accelerate until you release the lever or apply the brake. So unless you want to go faster, don't hold the lever at RES-ACC.

Increasing Speed While Using Cruise Control

There are three ways to go to a higher speed:

- Use the accelerator pedal to go to a higher speed. Push the lever down, then release the lever and the accelerator pedal. You'll now cruise at the higher speed.
- Move the cruise lever up to RES-ACC. Hold it there until you reach a desired speed and then release the lever.

- To increase your speed in very small amounts, move the lever up to RES-ACC briefly and then release it. Each time you do this, your vehicle will go about 1 mph (1.6 km/h) faster.

The accelerate feature will only work after you have set the cruise control speed by pushing the lever down to SET-CST.

Reducing Speed While Using Cruise Control

There are two ways to reduce your speed while using cruise control:

- Push the lever down until you reach a desired lower speed then release it.
- To slow down in very small amounts, push the lever down briefly. Each time you do this, you'll go about 1 mph (1.6 km/h) slower.

Passing Another Vehicle While Using Cruise Control

Use the accelerator pedal to increase your speed. When you take your foot off the pedal, your vehicle will slow down to the cruise control speed you set earlier.

Using Cruise Control on Hills

How well your cruise control will work on hills depends upon your speed, load, and the steepness of the hills. When going up steep hills, you may have to step on the accelerator pedal to maintain your speed. When going downhill, you may have to brake or shift to a lower gear to keep your speed down. Of course, applying the brake takes you out of cruise control. Many drivers find this to be too much trouble and don't use cruise control on steep hills.

Ending Cruise Control Without Erasing the Set Speed

There are two ways to turn off the cruise control:

- Step lightly on the brake pedal, or
- pull the cruise lever towards you to cancel cruise.

To resume the set speed see "Resuming a Set Speed" earlier in this section.

Erasing Speed Memory

When you turn off the cruise control or the ignition, your cruise control set speed memory is erased.

Exterior Lamps



The lever on the left side of the steering column operates the exterior lamps.

 : Turn the outside part of the lever with this symbol on it, to operate the lamps. The exterior lamp switch has three positions.

OFF: Turning the switch to this position turns off all lamps and lights, except the Daytime Running Lamps (DRL).

 (**Parking Lamps**): Turning the switch to this position turns on the parking lamps, together with the following:

- Sidemarkers Lamps
- Taillamps
- License Plate Lamps
- Instrument Panel Lights

 (**Headlamps**): Turning the switch to this position turns on the headlamps, together with the previously listed lamps and lights.

AUTO (Automatic Headlamps): Turning the exterior lamps control to AUTO will turn the headlamps, taillamps and parking lamps on and off, while the ignition is on, by sensing how dark it is outside. See "Automatic Headlamp System" later in this section for more information.

Wiper-Activated Headlamps

This feature turns on the low-beam headlamps, instrument panel cluster backlighting and taillamps after the windshield wipers have been in use for approximately six seconds. To operate, the exterior lamps control must be in AUTO and it must be dark enough outside.

When the exterior lamps control is in OFF or the parking lamp position and the windshield wiper control is on (LO, HI or INT), the HEADLAMPS SUGGESTED message will appear on the DIC.

When you turn the key to OFF, the wiper-activated headlamps will immediately turn off. The wiper-activated headlamps will also turn off if you turn the exterior lamps control to OFF or turn off the windshield wipers.

Headlamps on Reminder

If the exterior lamps control is left on, you'll hear a warning chime when you turn the ignition off, remove the key from the ignition and open the driver's door.

Daytime Running Lamps

Daytime Running Lamps (DRL) can make it easier for others to see the front of your vehicle during the day. DRL can be helpful in many different driving conditions, but they can be especially helpful in the short periods after dawn and before sunset. Fully functional daytime running lamps are required on all vehicles first sold in Canada.

A light sensor on top of the instrument panel makes the DRL work, so be sure it isn't covered.

The DRL system will make your high-beam headlamps come on at reduced brightness in daylight when the following conditions are met:

- The ignition is on,
- the exterior lamps control is off, and
- the transaxle is not in PARK (P).

When the DRL are on, only your high-beam headlamps will be on. The parking lamps, taillamps, sidemarker and other lamps won't be on.

With your headlamp control in AUTO when it is dark enough outside, your low-beam headlamps will automatically come on. The other lamps that turn on with your headlamps will also turn on. When it is bright enough outside, the regular lamps will go off, and your high-beam headlamps change to the reduced brightness of DRL.

To turn off all exterior lighting at night when you are parked, turn the exterior lamps control all the way toward OFF. The DRL will turn on automatically and the HEADLAMPS SUGGESTED message will be displayed on the DIC when you move the transaxle out of PARK (P).

If the exterior lamps control is in the parking lamps position at night, only the parking lamps will be on. If the transaxle is out of PARK (P), only the parking lamps will be active and the HEADLAMPS SUGGESTED message will be displayed on the DIC.

As with any vehicle, you should turn on the regular headlamp system when you need it.

Automatic Headlamp System

The automatic headlamp system will keep your headlamps on when it is dark outside and the ignition is in ON.

It's possible that your headlamps may go out if you drive from a dark area into a bright area like a lighted parking lot. If this happens, turn on your headlamps with the exterior lamps control.

Light Sensor

Your automatic headlamps and DRL work with the light sensor on top of the instrument panel. Don't cover it up. If you do it will read "dark" and the automatic headlamp lighting will turn on.

Fog Lamps



To turn on only the front fog lamps, turn the fog lamp band to the single fog lamp symbol. To turn on both the front and rear fog lamps, turn the fog lamp band to the double fog lamp symbol.

Turning on the front fog lamps only will automatically activate the parking lamps. Turning on the front and rear fog lamps will automatically activate the parking lamps and headlamps.

To turn off the fog lamps, turn the band to OFF. The front fog lamps will also turn off when you turn on your high-beam headlamps, but will turn on again when you switch to low beams.

Continuous use of the fog lamps will shorten bulb life. Limit use as necessary.

Exterior Lighting Battery Saver

If the exterior lamps control has been left on, the exterior lamps will turn off approximately 10 minutes after the ignition is turned to OFF and any door has been opened. This protects against draining the battery in case you have accidentally left the headlamps or parking lamps on. If you need to leave the lamps on for more than 10 minutes, use the exterior lamps control to turn the lamps back on after the ignition has been turned to OFF and any door has been opened.

Interior Lamps

Instrument Panel Brightness

This feature controls the brightness of the instrument panel lights.



The knob for this feature is located on the driver's side of the instrument panel.

Turn the knob clockwise to brighten the instrument panel cluster lights and displays. Turn the knob counterclockwise to dim the instrument panel cluster lights and displays.

If it is day and your parking lamps are on, the instrument panel cluster lights and displays will come on at full intensity and will not be adjustable. If it is dark enough outside and your parking lamps are on, the instrument panel cluster lights and displays and the backlighting for the door switches will come on, and can also be adjusted.

Courtesy Lamps

If it is dark enough outside and the front reading lamp slider lever, located on the overhead console, is in the DOOR position, when any door is opened all of the vehicles courtesy lamps will come on. See "Front Reading Lamps" and "Rear Reading Lamps" later in this section for more information. They make it easier for you to enter and leave the vehicle. The courtesy lamps will remain on for about 25 seconds after all doors have been closed. They will then theater dim to off.

Move the front reading lamp slider lever to ON to turn on the interior courtesy lamps. When the control is moved back to either OFF or DOOR, the courtesy lamps will immediately turn off.

If the control is OFF when the doors are opened, only the lower instrument panel courtesy lamps will come on. Also, if the control is OFF when illuminated entry or delayed exit lighting are active, only the lower instrument panel courtesy lamps will be on.

If a door is left ajar, your interior lamps will turn off after 10 minutes to save your battery.

Entry Lighting

If it is dark enough outside and you press the unlock symbol on the remote keyless entry transmitter while all doors are closed, the interior courtesy lamps will come on and stay on for approximately 40 seconds. When the 40 seconds are up, the lights will automatically fade until they turn off. The lamps will turn off immediately by pressing the lock symbol on the remote keyless entry transmitter, by turning the ignition key to ON or by activating the power door locks.

Delayed Entry Lighting

When you open the door to enter your vehicle, the interior lamps will come on if it is dark enough outside. When you close the door with the ignition off, the interior lamps will stay on for 25 seconds. When the 25 seconds are up the lights will automatically fade until they turn off. Locking the doors with the power door lock switch or with the lock symbol on the remote keyless entry transmitter, will override the delayed entry lighting and the lamps will turn off immediately.

Theater Dimming

This feature allows for a three to five-second fade out of the overhead courtesy lamps instead of immediate turn off after you remove the key from the ignition. They will not fade if the interior lamps are manually turned on. The lower instrument panel courtesy lamps will not fade out.

Delayed Exit Lighting

This feature will turn on the interior lamps for 25 seconds after you remove the key from the ignition while the doors are closed and it is night. This will give you time to find the door handle or lock switches as you exit the vehicle. When the 25 seconds are up, or if the key is reinserted into the ignition, the lights will be turned off by the theater dimming system. The lamps will turn off immediately by pressing the lock symbol on the remote keyless entry transmitter, by turning the ignition key to ON or by activating the power door locks.

Parade Dimming

To activate the instrument panel backlighting during the day, turn the exterior lamps control to the parking lamp position. Dimming of the instrument panel display is not possible during daylight hours. The instrument panel display can only be adjusted when the parking lamps are on and it is dark outside.

Perimeter Lighting

When the unlock symbol on the remote keyless entry transmitter is pressed, the DRL headlamps, parking lamps and back-up lamps will turn on for approximately 25 seconds if it is dark enough outside.

This feature can be programmed to be on or off for each transmitter. You can also program how long the exterior lamps will stay on after unlocking the vehicle.

You must program this feature through the DIC. See *DIC Vehicle Personalization on page 3-52*.

Front Reading Lamps



These lamps and the interior courtesy lamps will come on when you open a door. They will turn off when you turn on the ignition. If a door is left open, they will turn off after about 10 minutes.

To turn on the reading lamps when the doors are closed, press the button under the lamp you want on. Press it again to turn the lamp off.

These lamps work even when the ignition is off. To avoid draining your vehicle's battery, be sure to turn off all front and rear reading lamps when leaving your vehicle.

Rear Reading Lamps



These lamps will come on when you open the doors. You can also turn them on by pressing the button on the side of the lamp. Press it again to turn them off.

Inadvertent Power Battery Saver

This feature is designed to protect your vehicle's battery against drainage from the interior lamps, trunk lamp, glove box lamp or cigarette lighters. When the ignition is turned off, the power to these features will automatically turn off after 10 minutes. Power will be restored for an additional 10 minutes if any door is opened, the trunk is opened or the courtesy lamp control is turned on. To restore power to the cigarette lighters, the ignition must be turned back to ON.

Battery Load Management

The battery load management feature is designed to monitor the vehicle's electrical load and determine when the battery is in a heavy discharge condition. During times of high electrical loading, the engine may idle at a higher rpm setting than normal to make sure the battery charges. High electrical loads may occur when several of the following are on: headlamps, high beams, fog lamps, rear window defogger, blower fan, heated seats and engine cooling fans.

If your vehicle's battery remains in a heavy discharge condition for a long period of time, the fan, rear defogger, heated seats and heated mirrors will be disabled and the DIC will display BATTERY SAVER ACTIVE. This can happen either under long periods of idling or low speed driving with high electrical loading, or in the event of a charging system fault.

Accessory Power Outlets

With accessory power outlets you can plug in auxiliary electrical equipment such as a cellular telephone or CB radio.

The accessory power outlet (12-volt) is located on the front passenger's side of the vehicle, near the floor on the console.

Your vehicle may have a small cap that must be pulled down to access the accessory power outlet. If it does, when not using the outlet be sure to cover it with the protective cap.

The accessory power outlet will only operate when the ignition is in ON and for 10 minutes after turning the ignition off. If you would like the accessory power outlet to operate regardless of ignition position, and for extended periods of time, see "Engine Compartment Fuse Block" under *Fuses and Circuit Breakers* on page 5-92 or contact your dealer.

Notice: When using an accessory power outlet, maximum electrical load must not exceed 15 amps. Always turn off any electrical equipment when not in use. Leaving electrical equipment on for extended periods will drain your battery.

Certain electrical accessories may not be compatible with the accessory power outlet and could result in blown vehicle or adapter fuses. If you experience a problem, see your dealer for additional information on accessory power outlets.

Notice: Adding some electrical equipment to your vehicle can damage it or keep other things from working as they should. This wouldn't be covered by your warranty. Check with your dealer before adding electrical equipment, and never use anything that exceeds the amperage rating.

When adding electrical equipment, be sure to follow the proper installation instructions included with the equipment.

Notice: Power outlets are designed for accessory plugs only. Do not hang any type of accessory or accessory bracket from the plug. Improper use of the power outlet can cause damage not covered by your warranty.

Ashtrays and Cigarette Lighter

Push and release the cover to reveal the front ashtray and cigarette lighter.

Notice: Don't put papers or other flammable items into your ashtrays. Hot cigarettes or other smoking materials could ignite them, causing a damaging fire.

To clean an ashtray, make sure the cover is open fully, then lift out the ashtray by pulling on the snuffer.

To use a lighter, push the center all the way in and let it go. When it's ready, the center will pop back out by itself. Pull out the entire unit to use it.

Notice: Don't hold a cigarette lighter in with your hand while it is heating. If you do, it won't be able to back away from the heating element when it's ready. That can make it overheat, damaging the lighter and the heating element.

The cigarette lighter will only operate when the ignition is in ON and for 10 minutes after turning the ignition off. If you would like the lighter to operate regardless of the ignition position, and for extended periods of time, see "Engine Compartment Fuse Block" under *Fuses and Circuit Breakers* on page 5-92 or see your dealer.

Leaving an accessory on for a long period of time can drain the vehicle's battery.

Climate Controls

Automatic Climate Control System

With this system you can control the heating, cooling and ventilation for your vehicle.

Automatic Operation

AUTO (Automatic): When both the mode knob and the fan knob are in the AUTO mode and the temperature is set, the system will automatically control the inside temperature, the air delivery mode and the fan speed.

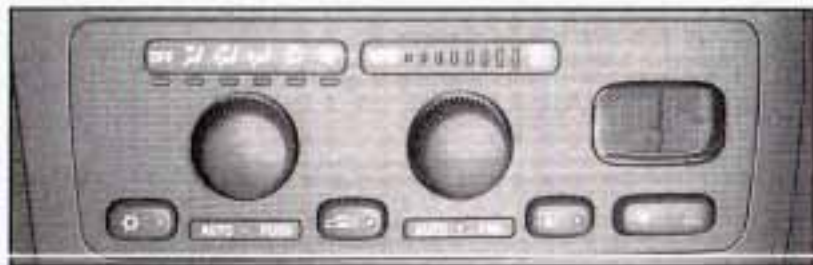

1. Press both the mode and the fan knobs to place the system in AUTO.
2. Adjust the temperature to 75° F (24° C) on the display.

Choosing the coldest or warmest temperature setting will not cause the system to heat or cool any faster. If you set the system at the warmest temperature setting, the system will remain in manual mode at that temperature and it will not go into automatic mode.

In cold weather, the system will start at reduced fan speeds to avoid blowing cold air into your vehicle until warmer air is available. The system will start out blowing air at the floor but may change modes automatically as the vehicle warms up to maintain the chosen temperature setting. The length of time needed for warm up will depend on the outside temperature and the length of time that has elapsed since your vehicle was last driven.

3. Wait for the system to regulate. This may take from 10 to 30 minutes. Then adjust the temperature, if necessary.

Do not cover the solar sensor located in the center of the instrument panel, near the windshield. For more information on the solar sensor, see "Sensors" later in this section.

To change the automatic climate control display from an English display to a metric display, push the OFF button located in the Driver Information Center (DIC) for several seconds. The display in the DIC will also change from an English to a metric display. To return to an English display, repeat the procedure.

Manual Operation

FAN: Turn the right knob clockwise or counterclockwise to increase or decrease the fan speed. Turning this knob cancels automatic operation and places the system in manual mode. Press the knob to return to automatic operation.

Temperature Control: Maintain the temperature inside the vehicle using the red and blue arrows located below the digital display. Push the red arrow for a warmer temperature level and the blue arrow for a cooler temperature level. Your selected temperature setting will be shown on the digital display for five seconds, and then the outside temperature will be displayed.

To change the current mode, use the left knob to select one of the following:

OFF: Turning the left knob to OFF will cause the fan to turn off and the airflow to be directed through the floor outlets. The display will show the outside temperature when the system is set to OFF.

 **(Vent):** This mode directs air to the instrument panel outlets.

 **(Bi-Level):** This mode directs approximately half of the air to the instrument panel outlets, and then directs most of the remaining air to the floor outlets. Some air may be directed toward the windshield. In automatic operation, cooler air is directed to the upper outlets and warmer air to the floor outlets.

 **(Floor):** This mode directs most of the air to the floor outlets with some air directed to the outboard outlets (for the side windows) and some air directed to the windshield.

The left knob can also be used to select the defog or defrost mode. Information on defogging and defrosting can be found later in this section.

 **(Recirculation):** Press this button to limit the amount of outside air coming into the vehicle. It can be used to prevent outside air and odors from entering your vehicle or to help heat or cool the air inside your vehicle more quickly. Press this button to turn the recirculation mode on or off. When the button is pressed, an indicator light will come on. The recirculation mode cannot be used with the defrost mode.

 **A/C (Air Conditioning):** Press this button to override the automatic system and turn the air conditioning system on or off. When A/C is pressed, an indicator light in the button will come on to let you know that air conditioning is activated. When in AUTO the air conditioning compressor will come on automatically, as necessary.

On hot days, open the windows to let hot inside air escape; then close them. This helps reduce the time it takes for your vehicle to cool down. It also helps the system to operate more efficiently.

For quick cool down on hot days, do the following:

1. Select the vent mode.
2. Select the recirculation mode.
3. Select A/C.

4. Select the coolest temperature.
5. Select the highest fan speed.

Using these settings together for long periods of time may cause the air inside of your vehicle to become too dry. To prevent this from happening, after the air in your vehicle has cooled, turn the recirculation mode off.

The air conditioning system removes moisture from the air, so you may sometimes notice a small amount of water dripping underneath your vehicle while idling or after turning off the engine. This is normal.

Sensors

The solar sensor on your vehicle monitors the solar radiation and the air inside of your vehicle, then uses the information to maintain the selected temperature by initiating needed adjustments to the temperature, the fan speed and the air delivery system. The system may also supply cooler air to the side of the vehicle facing the sun. The recirculation mode will also be activated, as necessary. Do not cover the solar sensor located in the center of the instrument panel, near the windshield, or the system will not work properly.

Defogging and Defrosting

There are two modes to clear fog or frost from your windshield. Use the defog mode to clear the windows of fog or moisture and warm the passengers. Use the defrost mode to remove fog or frost from the windshield more quickly.

 **(Defog):** This mode directs the air equally between the windshield and the floor outlets. When you select this mode, the system turns off recirculation and runs the air conditioning compressor unless the outside temperature is at or below freezing.

 **(Defrost):** This mode directs most of the air to the windshield and the outboard outlets (for the side windows), with some air directed to the floor outlets. In this mode, the system will automatically run the air conditioning compressor, unless the outside temperature is at or below freezing. Recirculation cannot be selected while in the defrost mode.

Rear Window Defogger

The rear window defogger uses a warming grid to remove fog or frost from the rear window.

 : Press this button to turn the rear window defogger on or off. Be sure to clear as much snow from the rear window as possible.

At speeds above 30 mph (48 km/h), the defogger will operate continuously until you press the REAR button again. After 10 minutes of driving below 30 mph (48 km/h), the defogger will turn off automatically. If you need additional warming time, push the button again. The system will then operate for five minutes before going off by itself.

If your vehicle has heated outside rearview mirrors, the mirrors will heat to help clear fog or frost from the surface of the mirror when the rear window defogger button is pressed.

Notice: Don't use a razor blade or something else sharp on the inside of the rear window. If you do, you could cut or damage the defogger and the repairs would not be covered by your warranty. Do not attach a temporary vehicle license, tape, a decal or anything similar to the defogger grid.

Passenger Temperature Control

If your vehicle has this feature, the driver and the front-seat passenger can select separate temperature settings. This feature allows the passenger to select a temperature that is 8° F (4° C) warmer or cooler than the driver's selected temperature.

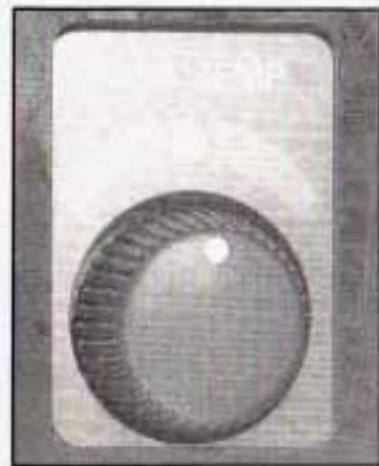

The knob for this feature is located on the passenger's door. Turn the knob clockwise or counterclockwise to a warmer or cooler setting.

Outlet Adjustment

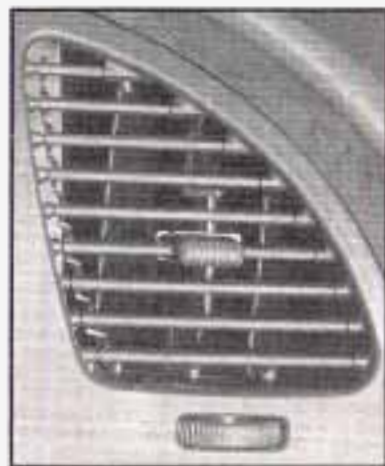

Use the lever located in the center of each front outlet to change the direction of the airflow. Use the thumbwheel located below each front outlet to turn the outlets on and off.

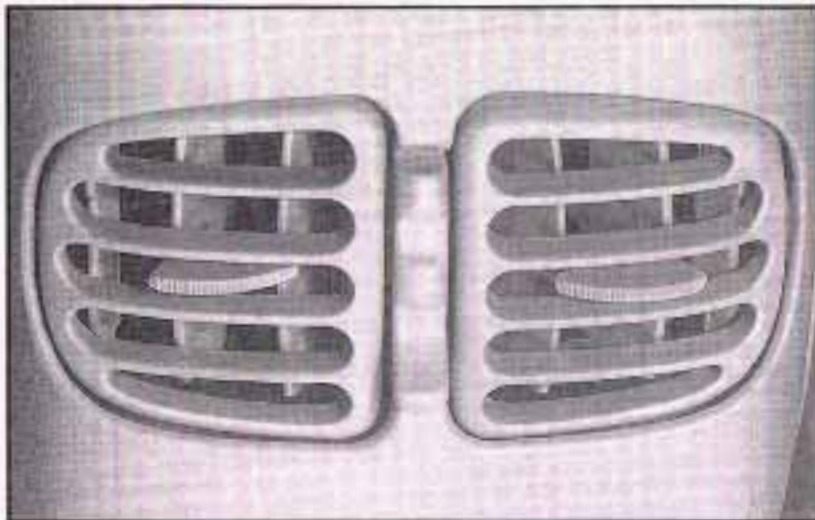

Move the control between the rear outlets up to direct airflow through the upper outlets. Move the control down to direct airflow through the floor outlets. Adjust the direction of the airflow with the levers located in the center of each rear outlet.

Operation Tips

- Clear away any ice, snow or leaves from the air inlets at the base of the windshield that may block the flow of air into your vehicle.
- Use of non-GM approved hood deflectors may adversely affect the performance of the system.
- Keep the path under the front seats clear of objects to help circulate the air inside of your vehicle more effectively.

Steering Wheel Climate Controls



With this feature some heating and cooling controls can be adjusted at the steering wheel.

^  v (Fan): Press the up or down arrow on the fan button to override the automatic fan control and increase or decrease the fan speed.

^ TEMP v (Temperature): Press either arrow on the TEMP button once to display your current temperature setting in the digital display. Press the up or down arrow again to provide a warmer or cooler temperature setting.

Climate Controls Personalization

If your vehicle is equipped with this feature, up to two drivers are able to store and recall climate control settings for the temperature, the fan speed and the direction of the airflow.

Memory buttons 1 and 2 are located on the driver's door panel and correspond to the numbers 1 or 2 found on the back of each remote keyless entry transmitter.

To store settings, do the following:

1. Select the desired temperature, fan speed and airflow mode. If desired, a separate temperature setting may also be selected for the front seat passenger. For information on how to do this, see *Automatic Climate Control System on page 3-23*.

2. Locate memory buttons 1 and 2 on the driver's door panel.
3. Press the memory button on the door panel that corresponds to the number on the back of the transmitter you are programming, until you hear two beeps. The beeps confirm that your selection has been saved and can now be recalled. For more information on the memory feature, see *Memory Seat and Mirrors on page 2-48*.

Follow these steps each time you want to change the stored settings.

To recall the climate control settings last stored on your transmitter, press the unlock button on your remote keyless entry transmitter and put the ignition in ACC (Accessory) or ON. The settings will be recalled.

Warning Lights, Gages and Indicators

This part describes the warning lights and gages that may be on your vehicle. The pictures will help you locate them.

Warning lights and gages can signal that something is wrong before it becomes serious enough to cause an expensive repair or replacement. Paying attention to your warning lights and gages could also save you or others from injury.

Warning lights come on when there may be or is a problem with one of your vehicle's functions. As you will see in the details on the next few pages, some warning lights come on briefly when you start the engine just to let you know they're working. If you are familiar with this section, you should not be alarmed when this happens.

Gages can indicate when there may be or is a problem with one of your vehicle's functions. Often gages and warning lights work together to let you know when there's a problem with your vehicle.

When one of the warning lights comes on and stays on when you are driving, or when one of the gages shows there may be a problem, check the section that tells you what to do about it. Please follow this manual's advice. Waiting to do repairs can be costly – and even dangerous. So please get to know your warning lights and gages. They're a big help.

Your vehicle has a Driver Information Center (DIC) that works along with the warning lights and gages. See *Driver Information Center (DIC)* on page 3-45.

Instrument Panel Cluster

Your vehicle is equipped with this instrument panel cluster, which includes indicator warning lights and gauges that are explained on the following pages. The instrument panel is designed to let you know at a glance how your vehicle is running. You'll know how fast you're going, how much fuel you're using, and many other things you'll need to drive safely and economically.

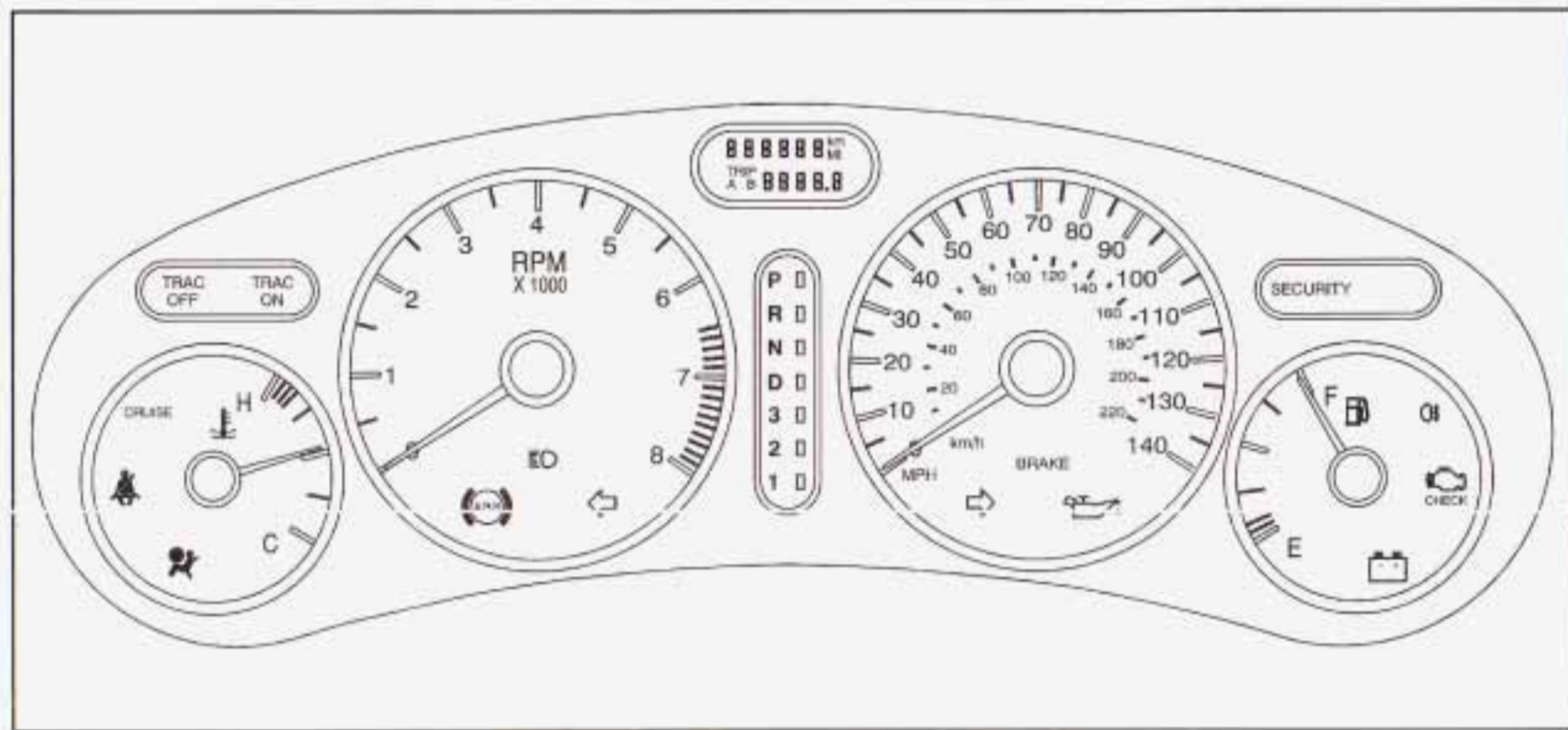

United States version shown, Canada similar

Speedometer and Odometer

Your speedometer lets you see your speed in both miles per hour (mph) and kilometers per hour (km/h). Your odometer shows how far your vehicle has been driven, in either miles (used in the United States) or kilometers (used in Canada).

The speedometer shows a top speed of 140 mph (220 km/h). This is not intended to be the vehicle's top speed.

You may wonder what happens if your vehicle needs a new odometer installed. If the new one can be set to the mileage total of the old odometer, then it must be. But if it can't, then it's set at zero and a label must be put on the driver's door to show the old mileage reading when the new odometer was installed.

Trip Odometers

Your trip odometer tells you how far you have driven since you last reset it. Your vehicle is equipped with two trip odometers, A and B. The buttons for this feature are located to the left of the steering column. The trip odometer displays are located in the center of the instrument panel cluster. Press the TRIP A/B button to change which trip odometer is displayed.

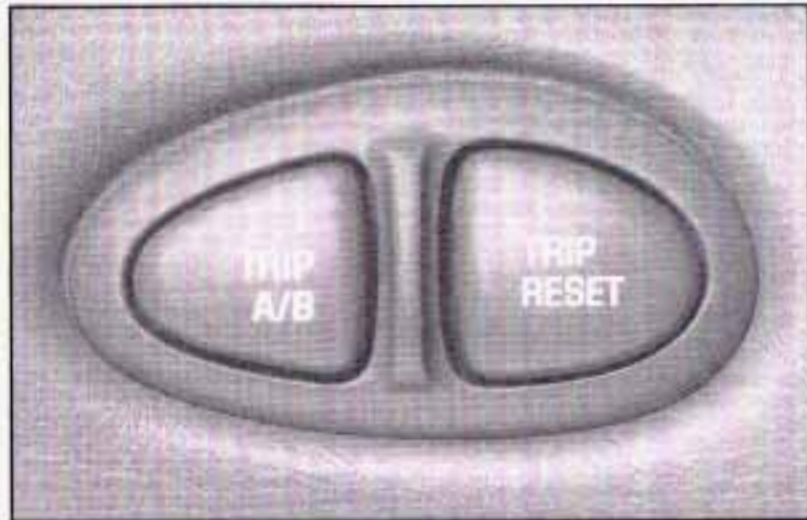

Press and hold the TRIP RESET button to reset the trip odometer that is currently being displayed.

Tachometer



The tachometer displays the engine speed in revolutions per minute (rpm).

If your engine speed equals or exceeds the safe limit for operation, the message **HOT...REDUCE ENG RPM** is displayed on the DIC.

Notice: Do not operate the engine with the tachometer in the shaded area, or when the message **HOT...REDUCE ENG RPM** is displayed. Engine damage may occur.

Safety Belt Reminder Light

When the key is turned to ON or START, a chime will come on for several seconds to remind people to fasten their safety belts.



The safety belt light will also come on and stay on for several seconds, then flash for several more.

If the driver's belt is already buckled, the light will come on briefly, but the chime will not sound.

Air Bag Readiness Light

There is an air bag readiness light on the instrument panel, which shows the air bag symbol. The system checks the air bag's electrical system for malfunctions. The light tells you if there is an electrical problem. The system check includes the air bag sensors, the air bag modules, the wiring and the crash sensing and diagnostic module. For more information on the air bag system, see *Air Bag Systems on page 1-47*.



This light will come on when you start your vehicle, and it will flash for several seconds. Then the light should go out. This means the system is ready.

If the air bag readiness light stays on after you start the vehicle or comes on when you are driving, your air bag system may not work properly. Have your vehicle serviced right away.

CAUTION:

If the air bag readiness light stays on after you start your vehicle, it means the air bag system may not be working properly. The air bags in your vehicle may not inflate in a crash, or they could even inflate without a crash. To help avoid injury to yourself or others, have your vehicle serviced right away if the air bag readiness light stays on after you start your vehicle.

The air bag readiness light should flash for a few seconds when you turn the ignition key to ON. If the light doesn't come on then, have it fixed so it will be ready to warn you if there is a problem.

On the DIC an AIR BAG PROBLEM message will be displayed when there is a problem with the air bag system. See *DIC Warnings and Messages on page 3-50* for more information.

Battery Warning Light

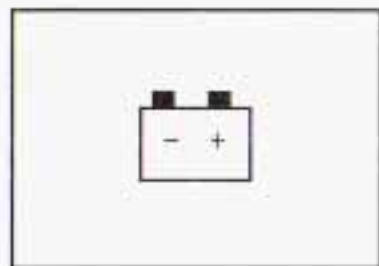

This light will come on briefly when you start the vehicle, as a check to show you it is working; then it should go out.

If it stays on, or comes on while you are driving, you may have a problem with the electrical charging system. Have it checked right away. Driving while this light is on could drain your battery and result in a vehicle that may stall.

If you must drive a short distance with the light on, be certain to turn off all your accessories, such as the radio and climate control system.

On the DIC, a CHECK CHARGE SYSTEM message will be displayed and a warning chime will sound. See *DIC Warnings and Messages on page 3-50* for more information.

Brake System Warning Light

Your vehicle's hydraulic brake system is divided into two parts. If one part isn't working, the other part can still work and stop you. For good braking, though, you need both parts working well.

If the warning light comes on, there is a brake problem. Have your brake system inspected right away.



United States

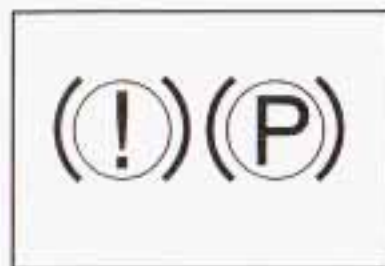

Canada

This light should come on briefly when you turn the ignition key to ON. If it doesn't come on then, have it fixed so it will be ready to warn you if there's a problem.

When the ignition is on, the brake system warning light will also come on when you set your parking brake. The light will stay on if your parking brake doesn't release fully. If you try to drive off with the parking brake set, a chime will also come on until you release the parking brake. If the light stays on after your parking brake is fully released, it means you have a brake problem.

A PARK BRAKE SET message will be displayed on the Driver Information Center (DIC) while the parking brake is set and the vehicle is moving. The message will not come on if the transaxle is in PARK (P).

If the light comes on while you are driving, pull off the road and stop carefully. You may notice that the pedal is harder to push. Or, the pedal may go closer to the floor. It may take longer to stop. If the light is still on, have the vehicle towed for service. See *Towing Your Vehicle* on page 4-33.

CAUTION:

Your brake system may not be working properly if the brake system warning light is on. Driving with the brake system warning light on can lead to an accident. If the light is still on after you've pulled off the road and stopped carefully, have the vehicle towed for service.

Anti-Lock Brake System Warning Light



With the anti-lock brake system, the light(s) will come on when your engine is started and may stay on for several seconds. That's normal.

If the light stays on, turn the ignition to OFF. Or, if the light comes on when you're driving, stop as soon as possible and turn the ignition off. Then start the engine again to reset the system. If the light still stays on, or comes on again while you're driving, your vehicle needs service. If the regular brake system warning light isn't on, you still have brakes, but you don't have anti-lock brakes. If the regular brake system warning light is also on, you don't have anti-lock brakes and there's a problem with your regular brakes. See *Brake System Warning Light* on page 3-35 earlier in this section.

The anti-lock brake system warning light will come on briefly when you turn the ignition key to ON. This is normal. If the light doesn't come on then, have it fixed so it will be ready to warn you if there is a problem.

Traction Control System (TCS) Warning Light



United States



Canada

This warning light should come on briefly when the engine is started.

If the warning light doesn't come on then, have it fixed so it will be ready to warn you if there's a problem. If it stays on, or comes on when you're driving, there may be a problem with your traction control system and your vehicle may need service. When this warning light is on, the system will not limit wheel spin. Adjust your driving accordingly.

The traction control system warning light may come on for the following reasons:

- If you turn the system off by pressing the TC button located on the center console, the warning light will come on and stay on. To turn the system back on, press the button again. The warning light should go off. See *Traction Control System (TCS)* on page 4-8 for more information.
- If there's a brake system problem that is specifically related to traction control, the traction control system will turn off and the warning light will come on. If your brakes begin to overheat, the traction control system will turn off and the warning light will come on until your brakes cool down.
- If the traction control system is affected by an engine-related problem, the system will turn off and the warning light will come on.

If the traction control system warning light comes on and stays on for an extended period of time when the system is turned on, your vehicle needs service.

Traction Control System Active Light



United States

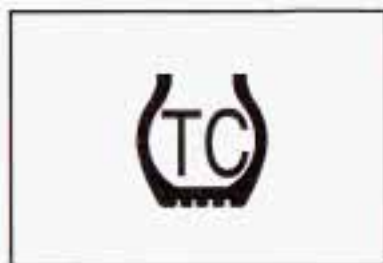

Canada

When your traction control system is limiting wheel spin, this light will come on. Slippery road conditions may exist if the traction control system active light comes on, so adjust your driving accordingly.

The light will stay on for a few seconds after the traction control system stops limiting wheel spin.

Engine Coolant Temperature Gage

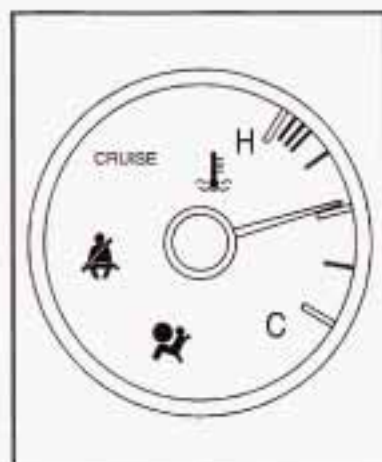

United States

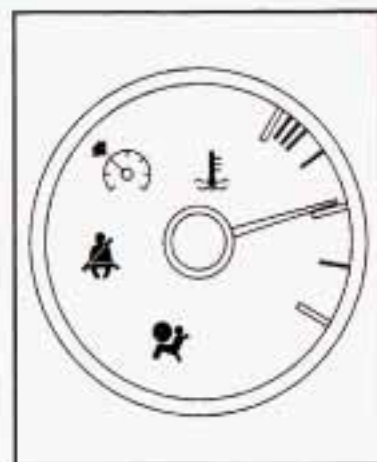

Canada

This gage shows the engine coolant temperature. If the gage pointer moves into the shaded warning zone, your engine is hot.

To prevent engine overheating, the air conditioning compressor will turn off automatically, a fast-pulsed chime will sound, and the message ENGINE HOT...A/C OFF will appear in the Driver Information Center (DIC). As the engine cools down, the air conditioning compressor will automatically turn back on.

If the coolant temperature is over 262°F (128°C), the message HOT...IDLE ENGINE will appear. It means you should reduce the engine load and speed to prevent the engine from overheating.

If the coolant temperature is over 268°F (131°C), the message HOT...STOP ENGINE will appear. It means that your engine coolant has overheated. You should pull off the road, stop your vehicle and turn off the engine as soon as possible.

Your vehicle is equipped with an Overheated Engine Protection Operating Mode. See *Engine Overheating on page 5-28* for more information.

If your coolant level is low, the message LOW ENGINE COOLANT will appear on the Driver Information Center. Check your coolant level as soon as possible. See *Engine Coolant on page 5-24*.

Malfunction Indicator Lamp

Check Engine Light



United States

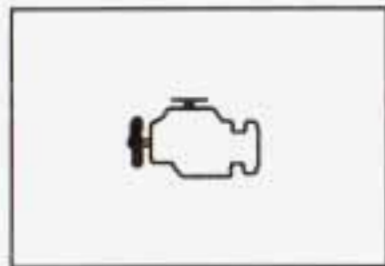

Canada

Your vehicle is equipped with a computer which monitors operation of the fuel, ignition and emission control systems.

This system is called OBD II (On-Board Diagnostics-Second Generation) and is intended to assure that emissions are at acceptable levels for the life of the vehicle, helping to produce a cleaner environment. The CHECK ENGINE light comes on to indicate that there is a problem and service is required. Malfunctions often will be indicated by the system before any problem is apparent. This may prevent more serious damage to your vehicle. This system is also designed to assist your service technician in correctly diagnosing any malfunction.

Notice: If you keep driving your vehicle with this light on, after a while, your emission controls may not work as well, your fuel economy may not be as good and your engine may not run as smoothly. This could lead to costly repairs that may not be covered by your warranty.

Notice: Modifications made to the engine, transaxle, exhaust, intake or fuel system of your vehicle or the replacement of the original tires with other than those of the same Tire Performance Criteria (TPC) can affect your vehicle's emission controls and may cause this light to come on. Modifications to these systems could lead to costly repairs not covered by your warranty. This may also result in a failure to pass a required Emission Inspection/Maintenance test.

This light should come on, as a check to show you it is working, when the ignition is on and the engine is not running. If the light doesn't come on, have it repaired. This light will also come on during a malfunction in one of two ways:

- **Light Flashing** — A misfire condition has been detected. A misfire increases vehicle emissions and may damage the emission control system on your vehicle. Dealer or qualified service center diagnosis and service may be required.
- **Light On Steady** — An emission control system malfunction has been detected on your vehicle. Dealer or qualified service center diagnosis and service may be required.

If the Light Is Flashing

The following may prevent more serious damage to your vehicle:

- Reducing vehicle speed.
- Avoiding hard accelerations.
- Avoiding steep uphill grades.
- If you are towing a trailer, reduce the amount of cargo being hauled as soon as it is possible.

If the light stops flashing and remains on steady, see "If the Light Is On Steady" following.

If the light continues to flash, when it is safe to do so, *stop the vehicle*.

Find a safe place to park your vehicle. Turn the key off, wait at least 10 seconds and restart the engine. If the light remains on steady, see "If the Light Is On Steady" following. If the light is still flashing, follow the previous steps, and drive the vehicle to your dealer or qualified service center for service.

If the Light Is on Steady

You also may be able to correct the emission system malfunction by considering the following:

Did you recently put fuel into your vehicle?

If so, reinstall the fuel cap, making sure to fully install the cap. See *Filling Your Tank on page 5-7*. The diagnostic system can determine if the fuel cap has been left off or improperly installed. A loose or missing fuel cap will allow fuel to evaporate into the atmosphere. A few driving trips with the cap properly installed should turn the light off.

Did you just drive through a deep puddle of water?

If so, your electrical system may be wet. The condition will usually be corrected when the electrical system dries out. A few driving trips should turn the light off.

Are you low on fuel?

As your engine starts to run out of fuel, your engine may not run as efficiently as designed since small amounts of air are sucked into the fuel line causing a misfire. The system can detect this. Adding fuel should correct this condition. Make sure to install the fuel cap properly. See *Filling Your Tank on page 5-7*. It will take a few driving trips to turn the light off.

Have you recently changed brands of fuel?

If so, be sure to fuel your vehicle with quality fuel. See *Gasoline Octane on page 5-5*. Poor fuel quality will cause your engine not to run as efficiently as designed. You may notice this as stalling after start-up, stalling when you put the vehicle into gear, misfiring, hesitation on acceleration or stumbling on acceleration. (These conditions may go away once the engine is warmed up.) This will be detected by the system and cause the light to turn on.

If you experience one or more of these conditions, change the fuel brand you use. It will require at least one full tank of the proper fuel to turn the light off.

If none of the above steps have made the light turn off, have your dealer or qualified service center check the vehicle. Your dealer has the proper test equipment and diagnostic tools to fix any mechanical or electrical problems that may have developed.

Emissions Inspection and Maintenance Programs

Some state/provincial and local governments have or may begin programs to inspect the emission control equipment on your vehicle. Failure to pass this inspection could prevent you from getting a vehicle registration.

Here are some things you need to know to help your vehicle pass an inspection:

Your vehicle will not pass this inspection if the CHECK ENGINE light is on or not working properly.

Your vehicle will not pass this inspection if the OBD (on-board diagnostic) system determines that critical emission control systems have not been completely diagnosed by the system. The vehicle would be considered not ready for inspection. This can happen if you have recently replaced your battery or if your battery has run down. The diagnostic system is designed to evaluate critical emission control systems during normal driving. This may take several days of routine driving. If you have done this and your vehicle still does not pass the inspection for lack of OBD system readiness, see your dealer or qualified service center to prepare the vehicle for inspection.

Oil Pressure Light

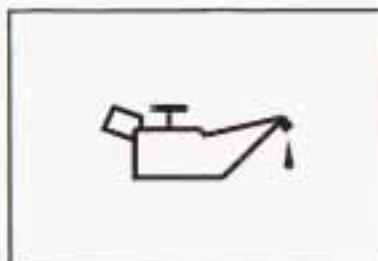

If you have a problem with your oil, this light may stay on after you start your engine, or come on when you are driving.

A warning chime and the DIC message LOW OIL PRESSURE may also come on.

These indicate that oil is not going through your engine quickly enough to keep it cool. The engine could be low on oil, or could have some other oil problem. Have it fixed right away.

The oil light could also come on briefly when the ignition is on but the engine is not running. The light will come on as a test to show you it is working, but the light will go out about five seconds after you turn the ignition to START. If it doesn't come on with the ignition on, you may have a problem with the fuse or bulb. Have it fixed right away.

⚠ CAUTION:

Don't keep driving if the oil pressure is low. If you do, your engine can become so hot that it catches fire. You or others could be burned. Check your oil as soon as possible and have your vehicle serviced.

Notice: Damage to your engine from neglected oil problems can be costly and is not covered by your warranty.

Cruise Control Light



United States



Canada

The CRUISE light comes on whenever you set your cruise control. See "Cruise Control" under *Turn Signal/Multifunction Lever* on page 3-6.

This light will come on for a few seconds when you turn the ignition key to ON to let you know it is working.

Fuel Gage

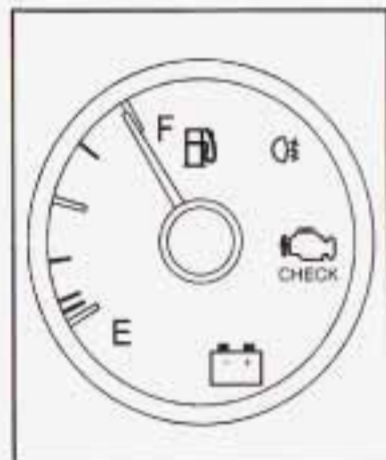

United States

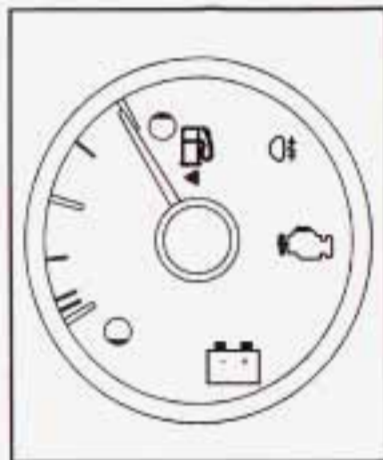

Canada

When the ignition is on, your fuel gage tells you about how much fuel you have left.

When you have less than 3.5 gallons (13.2 L) of fuel remaining, the DIC message LOW FUEL will be displayed and a chime will sound. You need to get more fuel right away.

Here are four things that some owners ask about. None of these show a problem with your fuel gage:

- At the service station, the gas pump shuts off before the gage reads full.
- It takes a little more or less fuel to fill up than the gage indicated. For example, the gage may have indicated the tank was half full, but it actually took a little more or less than half the tank's capacity to fill the tank.
- The gage moves a little when you turn a corner or speed up.
- The tank is not necessarily empty when the gage reads empty. There is a reserve of about 1.5 gallons (5.6 L) in the tank. You should still get more fuel as soon as possible.

Driver Information Center (DIC)

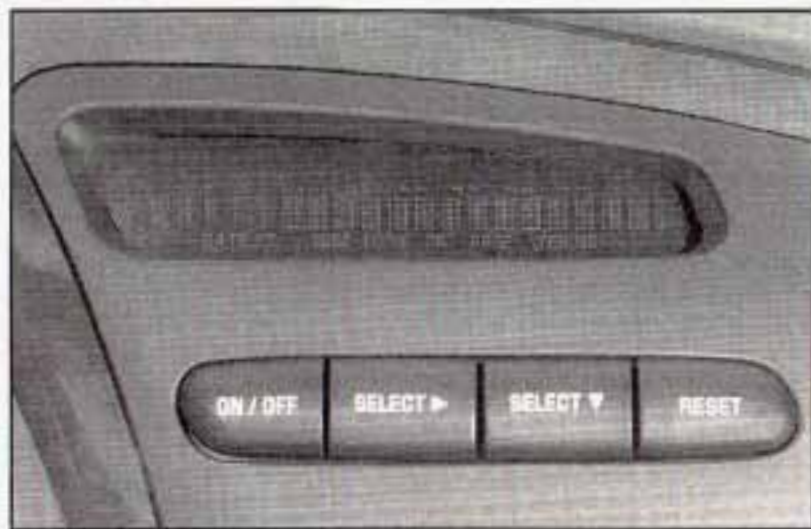

The DIC has different display modes which can be accessed by pressing the four buttons on the DIC. These buttons are labeled ON/OFF, SELECT right arrow, SELECT down arrow and RESET. The functions of these buttons is explained in the following sections.

Turn the system on or off by pressing the ON/OFF button once. When you turn on the ignition, the DIC will be in the mode last displayed when the engine was turned off.

To turn off messages on the DIC (except LOW OIL PRESSURE, LOW BRAKE FLUID, PARK BRAKE SET, STARTING DISABLED and the HOT...STOP ENGINE warning), press the RESET button.

Pressing the SELECT right arrow button will allow you to access the following modes, DATE/ET, FUEL, ECON, OIL and GAGE. While in any of these modes, warning messages can interrupt and take over the display until you acknowledge the message, or the condition causing the problem goes away.

English/Metric

The DIC can display information in either English or metric. To change the display, press and hold the ON/OFF button for about three seconds. This will also change the digital screen for the climate control system between English and metric.

Date/Elapsed Time

Pressing the SELECT down arrow while in DATE/ET mode will allow you to choose between the date and the elapsed time menus.

Date

To set the date, press and hold the RESET button for about three seconds while the date is being displayed on the DIC. When the date set mode is entered the display will show the following:

YEAR? ____MM/DD/00

The year will be flashing. To increase the item that is flashing press SELECT right arrow. To decrease the item that is flashing press SELECT down arrow.

When you reach the current year press the RESET button. The DIC will ask for the month. The month will flash the same as the year. Use the SELECT buttons to reach the current month and press RESET. The DIC will then ask for the day. The day will flash the same as the year. Use the SELECT buttons to reach the current day. Press the RESET button again and the set display will stop flashing and go back to the normal operation mode.

Elapsed Time (ET)

When the ignition is on, the DIC can be used as a stopwatch. The display will show hours and minutes. The elapsed time indicator will record up to 100 hours, then it will reset to zero and continue counting. Press SELECT down arrow while in the DATE/ET mode, and the display will show the amount of time that has elapsed since the elapsed time indicator was last reset (not including time the ignition is off), such as:

01:08 ELAPSED TIME

To start or stop the counting of time, press the RESET button briefly. If the colon (:) in the time is flashing, time is being counted. Time is displayed in hours and minutes. Seconds are not displayed. Time will continue to be counted as long as the ignition is on, even if another display is being shown on the DIC.

To reset elapsed time to zero, press the RESET button for three seconds while the elapsed time is displayed.

Fuel

Press the SELECT down arrow while in the FUEL mode to see how much fuel has been used and the fuel range functions.

Fuel Used

While in the FUEL USED function the display will show a reading such as:

FUEL USED: 10.4 GAL or FUEL USED: 39.4 L

To learn how much fuel will be used from a specific starting point, first enter the FUEL USED mode to display FUEL USED, then press and hold the RESET button for three seconds.

Don't confuse fuel used with the amount of fuel in your tank.

Fuel Range

The FUEL RANGE mode calculates the remaining distance you can drive without refueling. It's based on fuel economy and the fuel remaining in the tank.

The display will show a reading such as:

FUEL RANGE: 235 MI or FUEL RANGE: 378 KM

If the range is less than 50 miles (80 km), the display will read LOW FUEL RANGE.

The fuel economy data used to determine fuel range is an average of recent driving conditions. As your driving conditions change, this data is gradually updated. Fuel range cannot be reset.

Fuel Economy

Pressing the SELECT down arrow while in the ECON mode displays average fuel economy and instantaneous fuel economy calculated for your specific driving conditions.

Average fuel economy will be shown in a reading such as:

25.2 AVG MI/GAL or 9.3 AVG L/100 KM

Instantaneous fuel economy will be shown in a reading such as:

28 INST MI/GAL or 8.4 INST L/100 KM

The average fuel economy is viewed as a long-term approximation of your overall driving conditions.

If you press and hold RESET for three seconds in this mode while you're driving, the system will begin figuring average fuel economy from that point in time. Instantaneous fuel economy cannot be reset.

Oil Life

The GM Oil Life System™ is the only function accessible in the OIL mode. Engine oil life is displayed in a reading such as the following:

OIL LIFE 30%

This is an estimate of the oil's remaining useful life. It will show 100% when the system is reset after an oil change. It will alert you to change your oil on a schedule consistent with your driving conditions.

When the remaining oil life is low, the system will alert you with this message:

CHANGE OIL SOON

Always reset the OIL LIFE reminder after an oil change. To reset the oil life system, see "How to Reset the Oil Life System" under *Engine Oil on page 5-15*.

Remember, you must reset the OIL LIFE yourself after each oil change. It will not reset itself. Also, be careful not to reset the OIL LIFE accidentally at any time other than when the oil has just been changed. It can't be reset accurately until the next oil change.

The DIC does not replace the need to maintain your vehicle as recommended in the Maintenance Schedule in this manual. Also, the oil change reminder will not detect dusty conditions or engine malfunctions that may affect the oil. If you drive in dusty areas, change your oil after every 3,000 miles (5 000 km) or three months, whichever occurs first, unless the DIC instructs you to do so sooner. Also, the oil change reminder does not measure how much oil you have in your engine. So, be sure to check your oil level often. See *Engine Oil on page 5-15*.

Gage

Pressing the SELECT down arrow while in GAGE mode will allow you to access the battery volts, oil pressure and tire pressure displays. Pressing and holding the RESET button for three seconds while in average speed and tire pressure displays will reset them.

Pressing the SELECT down arrow in GAGE mode will show the following displays:

- Battery voltage, such as the following:
VOLTS:13.8
- Oil pressure, such as the following:
OIL PRESSURE 40 PSI or OIL PRESSURE
276 KPA
- Average speed, such as the following:
AVG SPEED 55 MPH or AVG SPEED 90 KM/H

- Tire pressure status, such as the following:

TIRE PRESSURE NORMAL or TIRE
PRESSURE LOW

TIRE PRESSURE NORMAL appears when the check tire pressure system believes your vehicle's tire pressures are normal. If a potential tire pressure problem is detected, the display will show TIRE PRESSURE LOW. If you see this message, you should stop as soon as you can and check all four tires for damage. If a tire is flat, see *If a Tire Goes Flat on page 5-70*. Also check the tire pressure in all four tires as soon as you can. See *Inflation -- Tire Pressure on page 5-60*.

There are times when you will have to reset (calibrate) the check tire pressure system. Pressing the RESET button while the TIRE PRESSURE LOW warning is displayed does not automatically reset the tire pressure monitoring system. See *Check Tire Pressure System on page 5-62* for more information.

DIC Warnings and Messages

Other messages or warnings may appear in the DIC display. For Canadian drivers, in addition to the DIC message your DIC will display EXP with a number after it which reflects the following messages:

EXP (Export ID)	Warning Message
1	AIR BAG PROBLEM
3	CHANGE OIL SOON
4	CHECK CHARGE SYSTEM
5	CHECK OIL LEVEL
6	TRANS HOT...IDLE ENG
7	CONFIRM TIME & DATE
8	DRIVERS DOOR AJAR
9	ENGINE HOT...A/C OFF
10	HOT...REDUCE ENG RPM
11	HOT...STOP ENGINE *
12	THEFT SYSTEM FAULT
13	LEFT REAR DOOR AJAR
14	LOW BRAKE FLUID*
15	LOW ENGINE COOLANT
16	LOW FUEL
17	LOW OIL PRESSURE *

EXP (Export ID)	Warning Message
18	LOW TIRE PRESSURE
19	LOW WASHER FLUID
20	PARK BRAKE SET*
21	PASSENGER DOOR AJAR
22	RIGHT REAR DOOR AJAR
23	SERVICE VEHICLE SOON
24	TURN SIGNAL ON?
25	THEFT ATTEMPTED
26	SERV STABILITY SYS
27	HEADLAMPS SUGGESTED
28	TRUNK AJAR
29	BATTERY SAVER ACTIVE
32	HOT...IDLE ENGINE
33	STARTING DISABLED*
36	CHECK GAS CAP
42	STABILITY ACTIVE

The EXP codes are used to make translation from English to other languages easier. Pressing the RESET button will remove the above messages or warnings from the DIC display, unless noted by an asterisk (*).

CHECK OIL LEVEL – 5: If you ever see the CHECK OIL LEVEL message, it indicates that the engine oil level is 1 to 1 1/2 quarts (0.9 L to 1.4 L) low. The message will appear only if the engine is running and it has been at least eight minutes since the engine was last running. If the message appears, check the oil dipstick level. If it reads low, your oil level should be brought up to the proper level. See *Engine Oil on page 5-15*. After bringing the oil to the proper level, the ignition must be off for eight minutes to allow the majority of oil to drain into the oil pan.

SERV STABILITY SYS – 26: If you ever see the SERV STABILITY SYS message, it means there may be a problem with your stability enhancement system. If you see this message, try to reset the system (stop; turn off the engine; then start the engine again). If the SERV STABILITY SYS message still comes on, it means there is a problem. You should see your dealer for service. Reduce your speed and drive accordingly.

STABILITY ACTIVE – 25: You may see the STABILITY ACTIVE message on the Driver Information Center (DIC). It means that an advanced, computer-controlled system has come on to help your vehicle continue to go in the direction in which you're steering. This stability enhancement system activates when the computer senses that your vehicle is just starting to spin, as it might if you hit a patch of ice or other slippery spot on the road. When the system is on, you may hear a noise or feel a vibration in the brake pedal. This is normal.

When the STABILITY ACTIVE message is on, you should continue to steer in the direction you want to go. The system is designed to help you in bad weather or other difficult driving situations by making the most of whatever road conditions will permit. If the STABILITY ACTIVE message comes on, you'll know that something has caused your vehicle to start to spin, so you should consider slowing down.

DIC Vehicle Personalization

The DIC can be used to program the following personal choice features available with your vehicle:

- Automatic Door Locks
- Window Lock Out
- Security Feedback
- Delayed Locking
- Perimeter Lighting
- Driver ID
- Memory Seats
- Outside Curb View Assist Mirror

To access the personalization menu, the vehicle must be in PARK (P) with the ignition in ON and no warning messages displayed on the DIC. You must then press and hold both of the SELECT buttons for three seconds. This will display the personalization menu.

The DIC display will show the following:

FEATURE PROGRAMMING
PRESS SELECT DOWN TO
SELECT MENU OPTIONS
PRESS SELECT RIGHT TO
CHANGE SETTINGS

The next item to be displayed is DRIVER 1 or DRIVER 2. To change the driver number, press the SELECT right arrow. The driver number that you select should correspond with the number on the back of your remote keyless entry transmitter. Once the correct driver number has been selected, press the SELECT down arrow to enter your choice and move on to the next selection.

The DIC is used to program the personal choices of two drivers. The drivers are recognized as DRIVER 1 and DRIVER 2. You will let the DIC and the vehicle know which driver you are by using your remote keyless entry transmitter or by pressing the appropriate memory seat button located on the driver's door or choosing the driver with the DIC. Each remote keyless entry transmitter was pre-programmed to belong to DRIVER 1 or DRIVER 2. The personalization features may be programmed differently for each driver.

When you press the unlock symbol on the transmitter, the DIC will automatically change driver numbers and the vehicle will recall the personal choice settings that were last made to correspond to your transmitter, including your radio and comfort control settings. See *Climate Controls Personalization* on page 3-29.

If you unlock the vehicle using the door key instead of the transmitter, the personal choice settings will correspond to the previous driver of the vehicle as identified by the transmitter, the memory seat control or the DIC. If this happens and you were not the last driver of the vehicle, press the correct driver number on the door panel for the memory seats, press the unlock symbol on the transmitter or select the personalization programming mode and choose the correct driver number.

After you have the correct driver number on the display use the SELECT down arrow button to scroll through the following messages and feature options:

- DOORS LOCK IN GEAR – YES/NO
- DOORS UNLOCK – YES/NO
- ALL DOORS IN PARK – YES/NO
- ALL DOORS AT KEY OFF – YES/NO
- DRIVERS DOOR IN PARK – YES/NO
- DRIVERS DOOR KEY OFF – YES/NO
- PASS WINDOW LOCKOUT – YES/NO
- KEY FOB FLASH LIGHTS – YES/NO
- KEY FOB CHIRP HORN – YES/NO
- DELAY LOCK OF DOORS – YES/NO

- PERIMETER LIGHTS – YES/NO
- EXT LIGHT TIMEOUT – 5 to 30 Seconds
- DISPLAY DRIVER ID – YES/NO
- KEY FOB MEMORY SEAT – YES/NO
- DRIVING POSITION – YES
- EXIT POSITION – YES
- TILT MIRROR REVERSE – YES/NO

If you would like to exit the selection mode without moving through each of the personal choice features, simply press a different button on the DIC or turn off the ignition. The personal choices you made will still be retained, even without passing through each of the features. In order for your personal choices to save, you must press the SELECT down arrow after making your selections.

If you happen to move past a selection you would like to make a personal choice for, press unlock on the transmitter or press the appropriate driver number on the door panel for the memory seats. This will return you to the beginning of the optional feature programming mode.

A description of each feature programmable through the DIC follows.

Automatic Door Locks

You can program the automatic door lock feature to change to one of the following modes:

Mode 0: No automatic door lock or unlock.

Mode 1: All doors automatically lock when shifted out of PARK (P). No automatic door unlock.

Mode 2: All doors automatically lock when shifted out of PARK (P). Only the driver's door automatically unlocks when shifted into PARK (P).

Mode 3: All doors automatically lock when shifted out of PARK (P). All doors automatically unlock when shifted into PARK (P).

Mode 4: All doors automatically lock when shifted out of PARK (P). Only the driver's door automatically unlocks when the key is turned to OFF.

Mode 5: All doors automatically lock when shifted out of PARK (P). All doors automatically unlock when the key is turned to OFF.

You can change the mode your vehicle is in by different selections of the following DIC displays:

- DOORS LOCK IN GEAR – YES/NO
- DOORS UNLOCK – YES/NO

- ALL DOORS IN PARK – YES/NO
- ALL DOORS AT KEY OFF – YES/NO
- DRIVERS DOOR IN PARK – YES/NO
- DRIVERS DOOR KEY OFF – YES/NO

Press the SELECT right arrow button to toggle between your choices and change the settings. Press the SELECT down arrow button to store your changes in memory and move on to the next selection.

If you would like to program your vehicle to Mode 0, select NO for DOORS LOCK IN GEAR. Your door locks will operate normally with no automatic feature.

If you would like to program your vehicle to Mode 1, do the following:

1. Select YES for DOORS LOCK IN GEAR.
2. Select NO for DOORS UNLOCK.

If you would like to program your vehicle to Mode 2, do the following:

1. Select YES for DOORS LOCK IN GEAR.
2. Select YES for DOORS UNLOCK
3. Select NO for ALL DOORS IN PARK.
4. Select NO for ALL DOORS AT KEY OFF.
5. Select YES for DRIVERS DOOR IN PARK.

If you would like to program your vehicle to Mode 3, do the following:

1. Select YES for DOORS LOCK IN GEAR.
2. Select YES for DOORS UNLOCK.
3. Select YES for ALL DOORS IN PARK.

If you would like to program your vehicle to Mode 4, do the following:

1. Select YES for DOORS LOCK IN GEAR.
2. Select YES for DOORS UNLOCK.
3. Select NO for ALL DOORS IN PARK.
4. Select NO for ALL DOORS AT KEY OFF.
5. Select NO for DRIVERS DOOR IN PARK.
6. Select YES for DRIVERS DOOR KEY OFF.

If you would like to program your vehicle to Mode 5, do the following:

1. Select YES for DOORS LOCK IN GEAR.
2. Select YES for DOORS UNLOCK.
3. Select NO for ALL DOORS IN PARK.
4. Select YES for ALL DOORS AT KEY OFF.

See *Programmable Automatic Door Locks on page 2-12* for more information about this feature.

Window Lock Out

The number of passenger windows locked out by the window LOCK switch can be programmed through the DIC.

Press the SELECT right arrow button to toggle between your choices and change the settings. Press the SELECT down arrow button to store your changes in memory and move on to the next selection.

If you select YES for PASS WINDOW LOCKOUT, all three passenger window switches will be locked out when the window LOCK switch is on.

If you select NO for PASS WINDOW LOCKOUT, only the two rear passenger window switches will be locked out when the window LOCK switch is on.

For more information on this feature, see "Window Lock Out" under *Power Windows on page 2-18*.

Security Feedback

You can program the security feedback feature to change to the following modes:

Mode 1: No feedback when locking or unlocking the vehicle.

Mode 2: Parking lamps and the DRL will flash twice when unlocking the vehicle and flash once when locking the vehicle.

Mode 3: Horn chirps when all doors are unlocked (second unlock button press) and when locking the vehicle.

Mode 4: Parking lamps and the DRL will flash twice each time the button with the unlock symbol is pressed; the horn chirps when all doors are unlocked. Parking lamps and the exterior lamps flash once and the horn chirps when locking the vehicle.

You can change these modes by different selections of the following DIC displays:

- KEY FOB LIGHTS FLASH – YES/NO
- KEY FOB HORN CHIRP – YES/NO

Press the SELECT right arrow button to toggle between your choices and change the settings. Press the SELECT down arrow button to store your changes in memory and move on to the next selection.

If you would like to program your vehicle to Mode 1, do the following:

1. Select NO for KEY FOB LIGHTS FLASH.
2. Select NO for KEY FOB HORN CHIRP.

If you would like to program your vehicle to Mode 2, do the following:

1. Select YES for KEY FOB LIGHTS FLASH.
2. Select NO for KEY FOB HORN CHIRP.

If you would like to program your vehicle to Mode 3, do the following:

1. Select NO for KEY FOB LIGHTS FLASH.
2. Select YES for KEY FOB HORN CHIRP.

If you would like to program your vehicle to Mode 4, do the following:

1. Select YES for KEY FOB LIGHTS FLASH.
2. Select YES for KEY FOB HORN CHIRP.

For more information on this feature, see "Security Feedback" under *Remote Keyless Entry System Operation* on page 2-6.

Delayed Locking

The delayed locking feature, which delays the actual locking of the vehicle, can be made active or inactive through the DIC. When DELAY LOCK OF DOORS appears on the display, use the SELECT right arrow button to toggle between YES and NO. When you have made your choice, press the SELECT down arrow button to record your selection and move on to the next choice.

For more information on this feature, see *Delayed Locking* on page 2-11.

Perimeter Lighting

When the unlock symbol on the remote keyless entry transmitter is pressed, the DRL, parking lamps and back-up lamps will turn on if it is dark enough outside.

You can control activation of this feature by choosing YES or NO when the PERIMETER LIGHTS choice is displayed on the DIC. Make your choice by pressing the SELECT right arrow button and record your choice by pressing the SELECT down arrow button. You will then be prompted to choose a TIMEOUT period.

The EXT LIGHTS TIMEOUT feature can be changed to the desired setting by using the SELECT right arrow button to toggle from 5 to 30 seconds. Each toggle will increase the time by five seconds. Once the desired timeout is displayed, press the SELECT down arrow to record your choice and move on to the next personal choice feature.

For more information on this feature, see "Perimeter Lighting" under *Interior Lamps* on page 3-17.

Driver ID

This feature displays the driver ID, as identified by the DIC. If you choose YES when DISPLAY DRIVER ID is shown on the DIC, the driver number will be displayed every time the ignition is turned on. If you choose NO when DISPLAY DRIVER ID is shown on the DIC, the driver number can be displayed by pressing either a button on the remote keyless entry transmitter or a memory seat button.

Memory Seats

This feature recalls the position of the driver's seat. When this feature is active, the memory seat and mirror positions will be recalled for the identified driver when the remote keyless entry transmitter is used to enter the vehicle.

You can program this feature to be active by choosing YES when the KEY FOB MEMORY SEAT choice appears, or inactive by choosing NO when the KEY FOB MEMORY SEAT choice appears on the DIC. Make your choices by pressing the SELECT right arrow button and store them in memory by pressing the SELECT down arrow button.

You can also program this feature to recall your memory seat position or the exit seat position. Select YES for KEY FOB MEMORY SEAT then use the SELECT right arrow button to toggle between DRIVING POSITION – YES and EXIT POSITION – YES. When the desired position is displayed on the DIC, press the SELECT down arrow button to save that position in memory and move on to the next selection.

For more information on this feature, see *Memory Seat and Mirrors on page 2-48*.

Outside Curb View Assist Mirror

The parallel park assist mirror, which tips the passenger mirror while the vehicle is in REVERSE (R), can be made active or inactive through the DIC. When TILT MIRROR REVERSE appears on the display, use the SELECT right arrow button to toggle the arrow between YES and NO. When you have made your choice, press the SELECT down arrow button to record your selection. For more information on this feature, see *Memory Seat and Mirrors on page 2-48*.

Audio System(s)

Notice: Before you add any sound equipment to your vehicle – like a tape player, CB radio, mobile telephone or two-way radio – be sure you can add what you want. If you can, it's very important to do it properly. Added sound equipment may interfere with the operation of your vehicle's engine, Delphi Electronics radio or other systems, and even damage them. Your vehicle's systems may interfere with the operation of sound equipment that has been added improperly.

So, before adding sound equipment, check with your dealer and be sure to check federal rules covering mobile radio and telephone units.

Your audio system has been designed to operate easily and to give years of listening pleasure. You will get the most enjoyment out of it if you acquaint yourself with it first. Find out what your audio system can do and how to operate all of its controls to be sure you're getting the most out of the advanced engineering that went into it.

Your vehicle has a feature called Retained Accessory Power (RAP). With RAP, you can play your audio system even after the ignition is turned off. See "Retained Accessory Power (RAP)" under *Ignition Positions* on page 2-23.

Setting the Time

Press and hold HR until the correct hour appears on the display. The letters AM or PM will also appear. Then, press and hold MN until the correct minute appears on the display. The time may be set with the ignition on or off.

To synchronize the time with an FM station broadcasting Radio Data System (RDS) information, press and hold HR and MN at the same time until UPDATED appears on the display. If the time is not available from the station, NO UPDATE will appear on the display instead.

Radio with Cassette and CD



Standard Radio – Bose® Not Shown

Playing the Radio

POWER: Press this knob to turn the system on and off.

VOLUME: Turn the knob to increase or to decrease volume.

SCV (Speed-Compensated Volume): With SCV, your audio system adjusts automatically to make up for road and wind noise as you drive.

Set the volume at the desired level. Press this button to select MIN, MED or MAX. Each higher choice allows for more volume compensation at faster vehicle speeds. Then, as you drive, SCV automatically increases the volume, as necessary, to overcome noise at any speed. The volume level should always sound the same to you as you drive. If you don't want to use SCV, select OFF.

Finding a Station

BAND: Press this button to switch between AM, FM1 and FM2. The display will show your selection.

TUNE: Turn this knob to select radio stations.

< SEEK >: Press the right or the left arrow to go to the next or to the previous station and stay there.

The radio will seek only to stations to stations that are in the selected band and only to those with a strong signal.

< SCAN > : Press and hold either arrow for two seconds until SC appears on the display and you hear a beep. The radio will go to a station, play for a few seconds, then go on to the next station. Press either SCAN arrow again to stop scanning.

To scan preset stations, press and hold either SCAN arrow for more than four seconds. PRESET SCAN will appear on the display. You will hear a double beep and the P will blink with the preset number. The radio will go to the first preset station stored on your pushbuttons, play for a few seconds, then go on to the next preset station. Press either SCAN arrow again to stop scanning presets.

The radio will scan only to stations that are in the selected band and only to those with a strong signal.

Setting Preset Stations

The six numbered pushbuttons let you return to your favorite stations. You can set up to 18 stations (six AM, six FM1 and six FM2), by performing the following steps.

1. Turn the radio on.
2. Press BAND to select AM, FM1 or FM2.

3. Tune in the desired station.
4. Press AUTO EQ to select the equalization that best suits the type of station selected.
5. Press and hold one of the six numbered pushbuttons until you hear a beep. Whenever you press that numbered pushbutton, the station you set will return and the equalization that you selected will also be automatically selected for that pushbutton.
6. Repeat the steps for each pushbutton.

Setting the Tone (Bass/Treble)

AUDIO: Press and release the AUDIO button until BASS, MID or TREB appears on the display. Press the knob above the AUDIO button to extend it, then turn the knob to increase or to decrease. If a station is weak or noisy, you may want to decrease the treble.

Pressing and holding the AUDIO button for at least two seconds will return all tone settings, including balance and fade to flat.

AUTO EQ (Automatic Equalizer): Press this button to choose bass, midrange and treble equalization settings designed for country, jazz, talk, pop, rock and classical program types.

To return to the manual mode, press the AUTO EQ button until MANUAL appears on the display. Then you will be able to manually adjust the bass, midrange and treble using the AUDIO button.

If your vehicle has the Bose radio, the AUTO EQ button will work the same, except the radio will display EQ1 through EQ6 as the choices instead of displaying the equalization setting names. These settings can be used while listening to the radio or the CD player.

The radio will save separate AUTO EQ settings for each preset and source.

Adjusting the Speakers (Balance/Fade)

AUDIO: To adjust the balance between the right and the left speakers, press and release the AUDIO button until BAL appears on the display. Press the knob above the AUDIO button to extend it, then turn the knob to move the sound toward the left or the right speakers.

To adjust the fade between the front and the rear speakers, press and release the AUDIO button until FAD appears on the display. Press the knob above the AUDIO button to extend it, then turn the knob to move the sound toward the front or the rear speakers.

Pressing and holding the AUDIO button for at least two seconds will return all tone settings, including bass and treble to flat.

Using RDS

Your audio system is equipped with a Radio Data System (RDS). RDS features are available for use only on FM stations that broadcast RDS information. Using this system, the radio can do the following:

- Seek to stations broadcasting the selected type of programming,
- receive announcements concerning local and national emergencies,
- display messages from radio stations, and
- seek to stations with traffic announcements.

This system relies upon receiving specific information from these stations and will only work when the information is available. In rare cases, a radio station may broadcast incorrect information that will cause the radio features to work improperly. If this happens, contact the radio station.

While you are tuned to an RDS station, the station name or the call letters will appear on the display instead of the frequency. RDS stations may also provide the time of day, a program type (PTY) for current programming and the name of the program being broadcast.

Finding a PTY Station

To select and find a desired PTY perform the following:

1. Press the P-TYPE button. PTY will be displayed on the screen and the light next to the button will turn on. The last selected PTY will appear on the display for five seconds.
2. Select a category by turning the P-TYPE knob.
3. Once the desired category is displayed, press either SEEK arrow to select the category and take you to the category's first station.

If a station with the selected PTY is not found, NONE FOUND will appear on the display.

4. If you want to go to another station within that category and the category is displayed, press either SEEK arrow once. If the category is not displayed, press either SEEK arrow twice to display the category and then to go to another station.

To use the PTY interrupt feature, press and hold the P-TYPE button until you hear a beep on the PTY you want to interrupt on. An asterisk will appear next to the PTY name (for example CLASSICAL*). When you are listening to a compact disc, the last selected RDS station will interrupt play if that selected PTY format is broadcast.

If both P-TYPE and TRAF are on, the radio will search for stations with the selected PTY and traffic announcements.

SCAN: You can also scan through the stations within a category by performing the following steps:

1. Press the P-TYPE button. PTY will be displayed on the screen and the light next to the button will turn on. The last selected PTY will appear on the display for five seconds.
2. Select a category by turning the P-TYPE knob.
3. Once the desired category is displayed, press and hold either SCAN arrow, the radio will begin scanning within your chosen category.

If a station with the selected PTY is not found, NONE FOUND will appear on the display.

4. Press either SCAN arrow again to stop at a particular station.

BAND (Alternate Frequency): Alternate frequency allows the radio to switch to a stronger station with the same program type. Press and hold BAND for two seconds to turn alternate frequency on. AF ON will appear on the display. The radio may switch to stronger stations. Press and hold BAND again for two seconds to turn alternate frequency off. AF OFF will appear on the display. The radio will not switch to other stations. When you turn the ignition off and then on again, the alternate frequency feature will automatically be turned on.

Setting Preset PTYs

The six numbered pushbuttons let you return to your favorite program types (PTYs). These pushbuttons have factory PTY presets. You can set up to 12 PTYs (six FM1 and six FM2) by performing the following steps:

1. Press BAND to select FM1 or FM2.
2. Press the P-TYPE button to activate program type select mode.
3. Turn the P-TYPE knob to select a PTY.
4. Press and hold one of the six numbered pushbuttons until you hear a beep. Whenever you press that numbered pushbutton, the PTY you set will return.
5. Repeat the steps for each pushbutton.

RDS Messages

ALERT!: Alert warns of local or national emergencies. When an alert announcement comes on the current radio station, ALERT! will appear on the display. You will hear the announcement, even if the volume is muted or a cassette tape or compact disc is playing. If the cassette tape or compact disc player is playing, play will stop during the announcement. You will not be able to turn off alert announcements.

ALERT! will not be affected by tests of the emergency broadcast system. This feature is not supported by all RDS stations.

INFO (Information): If the current station has a message, INFO will appear on the display. Press this button to see the message. The message may display the artist and song title, call in phone numbers, etc.

If the whole message is not displayed, parts of it will appear every three seconds. To scroll through the message at your own speed, press the INFO button repeatedly. A new group of words will appear on the display with each press. Once the complete message has been displayed, INFO will disappear from the display until another new message is received. The old message can be displayed by pressing the INFO button until a new message is received or a different station is tuned to.

TRAF (Traffic): Press this button to seek to a station that broadcasts traffic announcements. TRAF will appear on the display. If no station is found, NO TRAF will appear on the display.

When a traffic announcement comes on the current station or on a related network station, you will hear it, even if the volume is muted or a cassette tape or a compact disc is playing. If the cassette tape or the compact disc player is being used, play will stop during the announcement.

Playing a Cassette Tape

Your tape player is built to work best with tapes that are up to 30 to 45 minutes long on each side. Tapes longer than that are so thin they may not work well in this player. The longer side with the tape visible should face to the right. If the ignition is on, but the radio is off, the tape can be inserted and will begin playing. If you hear nothing but a garbled sound, the tape may not be in squarely. Press the eject button, located next to the cassette tape slot, to remove the tape and start over.

While the tape is playing, use the VOLUME, POWER, AUDIO, AUTO EQ, and the SEEK controls just as you do for the radio. The display will show TAPE and an arrow showing which side of the tape is playing. The tape player automatically begins playing the other side when it reaches the end of the tape.

Your tape bias is set automatically when a metal or chrome tape is inserted. If you want to insert a tape while the ignition is off, first press the button with the eject symbol on it or the RCL knob.

If an error appears on the radio display, the tape won't play because of an error. See "Cassette Tape Message" later in this section.

1 REV (Reverse): Press this pushbutton to reverse the tape rapidly. Press it again to return to playing speed. The radio will play while the tape reverses. You may select stations during reverse operation by using the TUNE knob.

2 FWD (Forward): Press this pushbutton to advance quickly to another part of the tape. Press this pushbutton again to return to playing speed. The radio will play while the tape advances. You may select stations during forward operation by using the TUNE knob.

5 SIDE: Press this pushbutton to play the other side of the tape.

AUTO EQ (Automatic Equalizer): Press AUTO EQ to select the desired equalization setting while playing a cassette tape. The equalization will be automatically set whenever you play a cassette tape. See "AUTO EQ" listed previously for more information.

< SEEK >: Your tape must have at least three seconds of silence between each selection for seek to work. Press the right or the left arrow to search for the next or the previous selection on the tape. You can skip as many as nine selections up or down on the tape. Choose how many selections you want to skip, then press the right or left SEEK arrows that many times. The number of selections to be skipped will appear on the display.

< SCAN >: Press and hold either arrow for more than two seconds until you hear a beep and SCAN appears on the display. The tape will go to the next selection, play for a few seconds, then go on to the next selection. Press this button again to stop scanning.

BAND: Press this button to listen to the radio when a cassette tape is playing. The tape will stop but remain in the player.

TP CD (TAPE): Press this button to play a cassette tape or a CD when listening to the radio. Press TP CD to switch between the tape and compact disc if both are loaded. The inactive tape or CD will remain safely inside the radio for future listening. The display will show the TAPE and CD symbols.

If you have the optional CD changer and it is loaded, the TP CD button will activate the changer and a symbol will be lit on the display.

△ (Eject): Press this button, located next to the cassette tape slot, to eject a tape. Eject may be activated with either the ignition or radio off. Cassettes may be loaded with the radio and ignition off if this button is pressed first.

Cassette Tape Messages

If an error occurs while trying to play a cassette tape, it could be for one of the following reasons:

TIGHT TAPE: When this message is displayed, the tape is tight and the player can't turn the tape hubs. Remove the tape. Hold the tape with the open end down and try to turn the right hub counterclockwise with a pencil. Turn the tape over and repeat. If the hubs do not turn easily, your tape may be damaged and should not be used in the player. Try a new tape to make sure your player is working properly.

BROKEN TAPE: If this message is displayed, the tape is broken. Try a new tape.

WRAPPED: When this message is displayed, the tape is wrapped around the tape head. Attempt to get the cassette out. Try a new tape.

CLEAN PLAYR (Clean Player): This message may also appear on the radio display to indicate that the cassette tape player needs to be cleaned. It will still play tapes, but you should clean it as soon as possible to prevent damage to the tapes and player. For additional information see *Care of Your Cassette Tape Player* on page 3-74.

If any error occurs repeatedly or if an error can't be corrected, contact your dealer. If your radio displays an error message, write it down and provide it to your dealer when reporting the problem.

Playing a Compact Disc

With the ignition on, insert a disc partway into the slot, label side up. The player will pull it in and the disc should begin playing. If you want to insert a CD when the ignition is off, first press the eject button or the RCL knob.

When the disc is inserted, the CD symbol will be displayed. If you select an EQ setting for your CD, it will be activated each time you play a CD.

As each new track starts to play, the track number will appear on the display.

If an error appears on the display, see "Compact Disc Messages" later in this section.

1 REV (Reverse): Press and hold this pushbutton to reverse quickly within a track. You will hear sound at a reduced volume. Release it to play the passage. The display will show elapsed time.

2 FWD (Forward): Press and hold this pushbutton to advance quickly within a track. You will hear sound at a reduced volume. Release it to play the passage. The display will show elapsed time.

4 RDM (Random): Press this pushbutton to hear the tracks in random, rather than sequential, order. RDM and the track number will appear on the display. Press this pushbutton again to turn off random mode.

AUTO EQ (Automatic Equalizer): Press this button to select the desired equalization setting while playing a compact disc. The equalization will be automatically set whenever you play a compact disc. See "AUTO EQ" listed previously for more information.

< SEEK >: Press the left arrow to go to the start of the current track if more than eight seconds have played. Press the right arrow to go to the next track. If you hold this button or press it more than once, the player will continue moving backward or forward through the disc.

< SCAN > : Press and hold either arrow for more than two seconds until you hear a beep and SCAN appears on the display. The disc will go to the next track, play for a few seconds, then go on to the next track. SCAN and the track number will appear on the display. Press this button again to stop scanning.

RCL (Recall): Press this knob to see how long the current track has been playing. To change what is normally shown on the display (track or elapsed time), press the knob until you see the display you want, then hold the knob until the display flashes. While elapsed time is showing, EL TM will appear on the display.

BAND: Press this button to listen to the radio when a CD is playing.

TP CD (Tape): Press this button to play a cassette tape or a CD when listening to the radio. Press TP CD to switch between the tape and compact disc if both are loaded. The inactive tape or CD will remain safely inside the radio for future listening. The display will show the TAPE and CD symbols.

If you have the optional CD changer and the CD changer is loaded, the TP CD button will activate the changer and a symbol will be lit in the display.

 (Eject): Press this button to eject a CD. Eject may be activated with either the ignition or radio off. CDs may be loaded with the radio and ignition off if this button is pressed first.

Compact Disc Messages

CHECK CD: If this message appears on the radio display and the disc comes out, it could be for one of the following reasons:

- You're driving on a very rough road. When the road becomes smoother, the disc should play.
- The disc is dirty, scratched, wet or upside down.
- The air is very humid. If so, wait about an hour and try again.

If the CD is not playing correctly, for any other reason, try a known good CD.

If any error occurs repeatedly or if an error can't be corrected, contact your dealer. If your radio displays an error message, write it down and provide it to your dealer when reporting the problem.

Navigation/Radio System

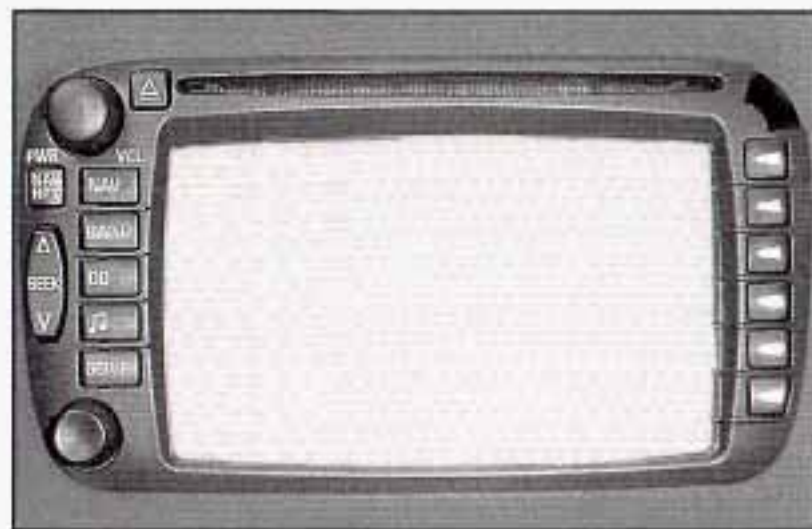

Your vehicle may have the optional navigation radio system that includes Radio Data System (RDS) which will seek out the kind of music you want to listen to. The radio system can also communicate with your navigation system to broadcast announcements on traffic and emergency alert communications. For information on how to use this system, see the "Navigation/Radio System" supplement.

Trunk-Mounted CD Changer

With the optional compact disc changer, you can play up to 12 discs continuously. Normal size discs may be played using the trays supplied in the magazine.

The small discs (8 cm) can be played only with specially designed trays.

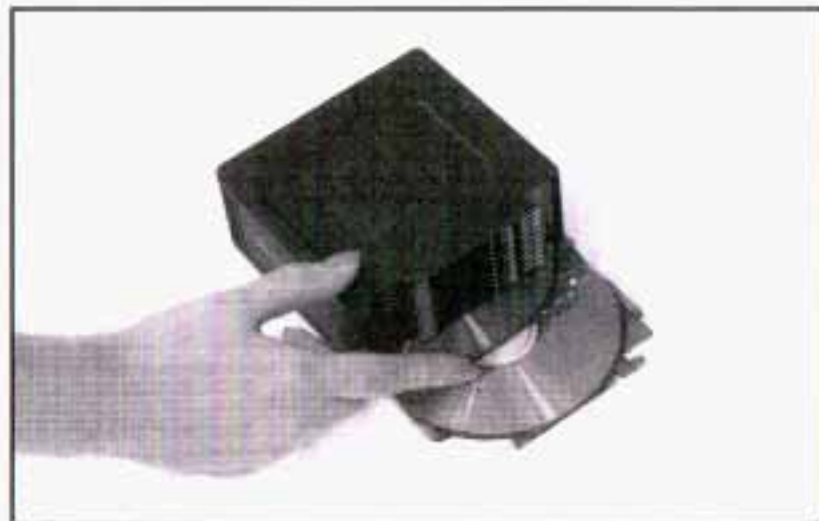

You must first load the magazine with discs before you can play a compact disc. Each of the 12 trays holds one disc. Slide the button on the back of the magazine and pull gently on one of the trays. Load the trays from top to bottom, placing a disc on the tray label side up. If you load a disc label side down, the disc will

not play and an error will occur. Gently push the tray back into the magazine slot until it locks into place. Repeat this procedure for loading up to 12 discs in the magazine.



Once you have loaded the discs in the magazine, slide open the door of the compact disc (CD) changer. Push the magazine into the changer in the direction of the arrow marked on top of the magazine.

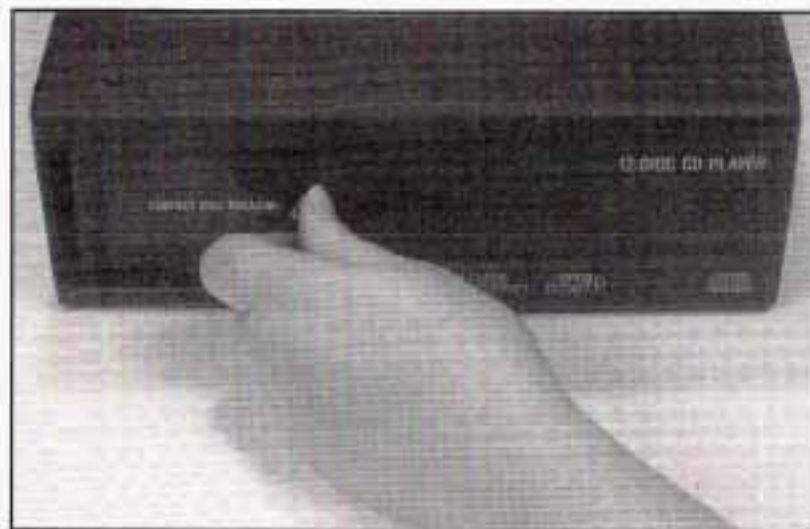

Close the door by sliding it all the way to the right. If the door is left partially open, the changer will not operate and an error will occur. When the door is closed, the changer will begin checking for discs in the magazine. This will continue for up to two minutes depending on the number of discs loaded.

To eject the magazine from the player, slide the CD changer door all the way open. The magazine will automatically eject. Remember to keep the door closed whenever possible to keep dirt and dust from getting inside the changer.

All of the CD functions are controlled by the radio pushbuttons except for ejecting the magazine. Whenever a CD magazine with discs is loaded in the changer, the compact disc symbol will appear on the radio display. If the CD changer is checking the magazine for CDs, the compact disc symbol will flash on the display until the changer is ready to play. If CD changer mode is entered during initialization, **LOADING** will appear on the display. When a CD begins playing, a disc and track number will be displayed. The disc numbers are listed on the front of the magazine.

Playing a Compact Disc

If an error appears on the display, see "Compact Disc Messages" later in this section.

1 REV (Reverse): Press and hold this pushbutton to quickly reverse within a track. As the CD reverses, elapsed time will be displayed with a flashing arrow to help you find the correct passage.

2 FWD (Forward): Press and hold this pushbutton to quickly advance within a track. As the CD advances, elapsed time will be displayed with a flashing arrow to help you find the correct passage.

4 RDM (Random): Press this pushbutton to play the tracks on the discs in random, rather than sequential, order. If you press SEEK while in the random mode, discs and tracks will be scanned randomly. Press this button again to turn off the random feature and return to normal operation.

5 SIDE: Press this pushbutton to select the next disc in the magazine. Each time you press SIDE, the disc number will be displayed.

RCL (Recall): Press this knob to see what track is currently playing. Press RCL again within five seconds to see how long the track has been playing. EL TM will appear on the display when in elapsed time mode. When a new track starts to play, the track number will also appear. Press RCL a third time and the time of day will be displayed.

< SEEK >: Press the right or the left arrow to go to the next or to the previous tracks on the disc.

< SCAN >: Press and hold the right arrow until SCAN appears on the display. The disc will scan to the next track, play for a few seconds, then go on to the next track. Press this button again to stop scanning.

To scan a few seconds of each loaded disc, press and hold the right arrow for two seconds until P SCAN appears on the display. Press SCAN again to stop scanning.

AM FM: Press this button to listen to the radio when a CD is playing.

TP/CD (Tape): Press this button to play a CD when listening to the radio. You can also press this button to switch between playing a cassette tape, a CD and the CD changer.

Compact Disc Errors

If an error appears on the display, an error has occurred and the compact disc temporarily cannot play.

The CD changer will send an error message to the receiver to indicate:

- **PLAYER OPEN:** CD Changer Door Open. Completely close the door to restore normal operation.
- **NO CD'S:** CD Changer Cartridge Empty. Try the magazine again with a disc loaded on one of the trays.

CHECK CD #: If this error message is displayed while trying to play a CD in the compact disc player or changer, the following conditions may have caused the error:

- You're driving on a very rough road. When the road becomes smoother the disc should play.
- The disc is dirty, scratched, wet or upside down.
- The air is very humid. If so, wait about an hour and try again.

If any error occurs repeatedly or if an error cannot be corrected, contact your dealer. If your radio displays an error number, write it down and provide it to your dealership when reporting the problem.

Personal Choice Radio Controls

If your vehicle has this feature it will enable two drivers to store and recall personal settings for radio presets, last tuned station, volume, tone and audio source (radio, cassette or CD).

The memory buttons (1 or 2) for this feature are located on the driver's door panel and correspond to the numbers (1 or 2) found on the back of each remote keyless entry transmitter.

To recall audio sources, press the unlock button on the remote keyless entry transmitter and turn the ignition on. The source last listened to will be recalled for the identified driver (1 or 2).

To program this feature, do the following:

1. Set all radio preferences. For more information see "Setting Preset Stations" and "Setting the Tone" listed for your particular radio.
2. Locate the memory buttons on the driver's door panel.

3. Press one of the memory buttons (1 or 2) until you hear two beeps. The beeps confirm that your selection has been saved and can now be recalled.

Follow these steps each time you want to change the stored settings.

Theft-Deterrent Feature

THEFTLOCK[®] is designed to discourage theft of your radio. It works by using a secret code to disable all radio functions whenever battery power is removed and the radio is placed in a different vehicle. This feature requires no user input to be activated. It is automatically armed when it is put into the vehicle for the first time.

When the radio is turned off, the blinking red light indicates that THEFTLOCK[®] is armed.

If THEFTLOCK[®] is activated, your radio will not operate if stolen. The radio will display LOCKED and a red LED indicator light will come on above the THEFTLOCK[®] logo to indicate a locked condition. If this occurs, the radio will need to be returned to the dealer.

Audio Steering Wheel Controls



With this feature, you can control certain radio functions using the buttons on your steering wheel.

^ VOL (Volume) v: Press the up or the down arrow to increase or to decrease volume.

^ SEEK: Press this button to seek to the next radio station. When playing a cassette tape or compact disc, press this button to hear the next selection. There must be at least a three-second gap between selections on a cassette tape.

PROG (Program): Press this button to tune to the next preset radio station. When playing a cassette tape, press this button to hear the other side of a tape that is playing. When listening to a disc in the CD changer, press this button to select the next loaded disc.

Understanding Radio Reception

AM

The range for most AM stations is greater than for FM, especially at night. The longer range, however, can cause stations to interfere with each other. AM can pick up noise from things like storms and power lines. Try reducing the treble to reduce this noise if you ever get it.

FM

FM stereo will give you the best sound, but FM signals will reach only about 10 to 40 miles (16 to 65 km). Tall buildings or hills can interfere with FM signals, causing the sound to come and go.

Care of Your Cassette Tape Player

A tape player that is not cleaned regularly can cause reduced sound quality, ruined cassettes or a damaged mechanism. Cassette tapes should be stored in their cases away from contaminants, direct sunlight and extreme heat. If they aren't, they may not operate properly or may cause failure of the tape player.

Your tape player should be cleaned regularly after every 50 hours of use. Your radio may display CLEAN PLAYR to indicate that you have used your tape player for 50 hours without resetting the tape clean timer. If this message appears on the display, your cassette tape player needs to be cleaned. It will still play tapes, but you should clean it as soon as possible to prevent damage to your tapes and player. If you notice a reduction in sound quality, try a known good cassette to see if the tape or the tape player is at fault. If this other cassette has no improvement in sound quality, clean the tape player.

For best results, use a scrubbing action, non-abrasive cleaning cassette with pads which scrub the tape head as the hubs of the cleaner cassette turn. The recommended cleaning cassette is available through your dealership.

The cut tape detection feature of your cassette tape player may identify the cleaning cassette as a damaged tape, in error. To prevent the cleaning cassette from being ejected, use the following steps.

1. Turn the ignition on.
2. Turn the radio off.
3. Press and hold the TP CD button for five seconds.
4. Insert the scrubbing action cleaning cassette.
5. Eject the cleaning cassette after the manufacturer's recommended cleaning time.

You may also choose a non-scrubbing action, wet-type cleaner which uses a cassette with a fabric belt to clean the tape head. This type of cleaning cassette will not eject on its own. A non-scrubbing action cleaner may not clean as thoroughly as the scrubbing type cleaner. The use of a non-scrubbing action, dry-type cleaning cassette is not recommended.

After you clean the player, press and hold the eject button for five seconds to reset the CLEAN PLAYR indicator. The radio will display CLEANED to show the indicator was reset.

Cassettes are subject to wear and the sound quality may degrade over time. Always make sure the cassette tape is in good condition before you have your tape player serviced.

Care of Your CDs

Handle discs carefully. Store them in their original cases or other protective cases and away from direct sunlight and dust. If the surface of a disc is soiled, dampen a clean, soft cloth in a mild, neutral detergent solution and clean it, wiping from the center to the edge.

Be sure never to touch the side without writing when handling discs. Pick up discs by grasping the outer edges or the edge of the hole and the outer edge.

Care of Your CD Player

The use of CD lens cleaner discs is not advised, due to the risk of contaminating the lens of the CD optics with lubricants internal to the CD mechanism.

Diversity Antenna System

Your AM-FM antennas are located in the windshield and rear window. Be sure that the inside surfaces of the windshield and rear window are not scratched and that the lines on the glass are not damaged. If the inside surfaces are damaged, they could interfere with radio reception. Also, for proper radio reception, the antenna connectors at the top-center of the front windshield and the rear window need to be properly attached to the posts on the glass.

Do not apply aftermarket glass tinting. The metallic film in some tinting materials will interfere with or distort the incoming radio reception.

Notice: Do not try to clear frost or other material from the inside of the front windshield or rear window with a razor blade or anything else that is sharp. This may damage the rear defogger grid and affect your radio's ability to pick up stations clearly. This repairs wouldn't be covered by your warranty.

If, when you turn on your rear window defogger, you hear static on your radio station, it could mean that a defogger grid line has been damaged. If this is true, the grid line must be repaired.

If you choose to add an aftermarket cellular telephone to your vehicle, and the antenna needs to be attached to the glass, be sure that you do not damage the grid lines for the AM-FM antennas or place the cellular telephone antenna over the grid lines.

Chime Level Adjustment

The volume level of the vehicle's chimes can be controlled by the radio. To change the volume level, press and hold pushbutton 6 with the ignition on and the radio power off. The chime volume level will change from the normal level to loud, and LOUD will be displayed on the radio. To change back to the default or normal setting, press and hold pushbutton 6 again. The chime level will change from the loud level to normal, and NORMAL will be displayed.

Section 4 Driving Your Vehicle

Your Driving, the Road, and Your Vehicle	4-2	City Driving	4-21
Defensive Driving	4-2	Freeway Driving	4-22
Drunken Driving	4-2	Before Leaving on a Long Trip	4-23
Control of a Vehicle	4-5	Highway Hypnosis	4-24
Braking	4-6	Hill and Mountain Roads	4-24
Traction Control System (TCS)	4-8	Winter Driving	4-26
Steering	4-10	If You Are Stuck: In Sand, Mud, Ice or Snow ...	4-32
Off-Road Recovery	4-13	Towing	4-33
Passing	4-13	Towing Your Vehicle	4-33
Loss of Control	4-15	Recreational Vehicle Towing	4-33
Driving at Night	4-16	Loading Your Vehicle	4-34
Driving in Rain and on Wet Roads	4-18	Towing a Trailer	4-36

Your Driving, the Road, and Your Vehicle

Defensive Driving

The best advice anyone can give about driving is: Drive defensively.

Please start with a very important safety device in your vehicle: Buckle up. See *Safety Belts: They Are for Everyone on page 1-8*.

Defensive driving really means “be ready for anything.” On city streets, rural roads or freeways, it means “always expect the unexpected.”

Assume that pedestrians or other drivers are going to be careless and make mistakes. Anticipate what they might do. Be ready for their mistakes.

Rear-end collisions are about the most preventable of accidents. Yet they are common. Allow enough following distance. It’s the best defensive driving maneuver, in both city and rural driving. You never know when the vehicle in front of you is going to brake or turn suddenly.

Defensive driving requires that a driver concentrate on the driving task. Anything that distracts from the driving task — such as concentrating on a cellular telephone call, reading, or reaching for something on

the floor — makes proper defensive driving more difficult and can even cause a collision, with resulting injury. Ask a passenger to help do things like this, or pull off the road in a safe place to do them yourself. These simple defensive driving techniques could save your life.

Drunken Driving

Death and injury associated with drinking and driving is a national tragedy. It’s the number one contributor to the highway death toll, claiming thousands of victims every year.

Alcohol affects four things that anyone needs to drive a vehicle:

- Judgment
- Muscular Coordination
- Vision
- Attentiveness.

Police records show that almost half of all motor vehicle-related deaths involve alcohol. In most cases, these deaths are the result of someone who was drinking and driving. In recent years, more than 16,000 annual motor vehicle-related deaths have been associated with the use of alcohol, with more than 300,000 people injured.

Many adults — by some estimates, nearly half the adult population — choose never to drink alcohol, so they never drive after drinking. For persons under 21, it's against the law in every U.S. state to drink alcohol. There are good medical, psychological and developmental reasons for these laws.

The obvious way to eliminate the leading highway safety problem is for people never to drink alcohol and then drive. But what if people do? How much is "too much" if someone plans to drive? It's a lot less than many might think. Although it depends on each person and situation, here is some general information on the problem.

The Blood Alcohol Concentration (BAC) of someone who is drinking depends upon four things:

- The amount of alcohol consumed
- The drinker's body weight
- The amount of food that is consumed before and during drinking
- The length of time it has taken the drinker to consume the alcohol.

According to the American Medical Association, a 180 lb (82 kg) person who drinks three 12 ounce (355 ml) bottles of beer in an hour will end up with a BAC of about 0.06 percent. The person would reach the

same BAC by drinking three 4 ounce (120 ml) glasses of wine or three mixed drinks if each had 1 – 1/2 ounces (45 ml) of a liquor like whiskey, gin or vodka.

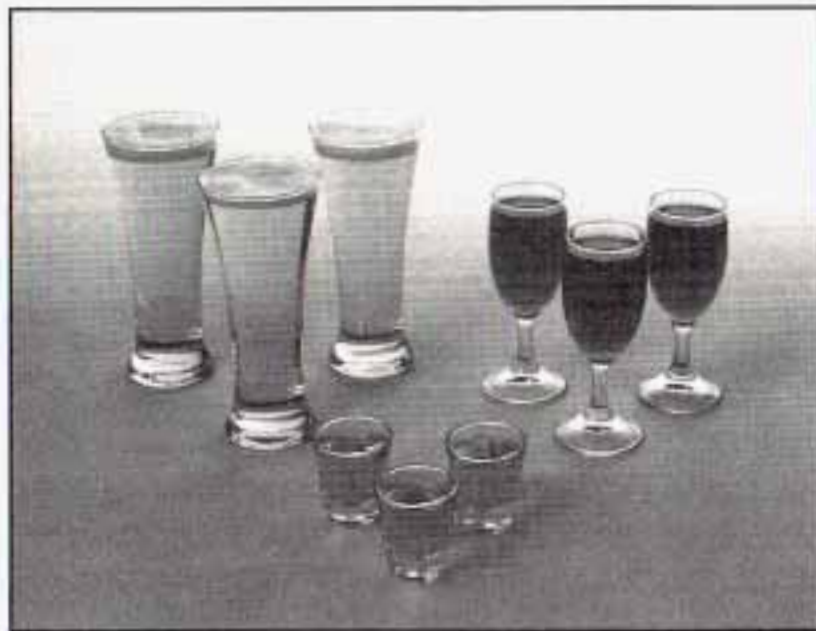

It's the amount of alcohol that counts. For example, if the same person drank three double martinis (3 ounces or 90 ml of liquor each) within an hour, the person's BAC would be close to 0.12 percent. A person who consumes food just before or during drinking will have a somewhat lower BAC level.

There is a gender difference, too. Women generally have a lower relative percentage of body water than men. Since alcohol is carried in body water, this means that a woman generally will reach a higher BAC level than a man of her same body weight when each has the same number of drinks.

The law in an increasing number of U.S. states, and throughout Canada, sets the legal limit at 0.08 percent. In some other countries, the limit is even lower. For example, it is 0.05 percent in both France and Germany. The BAC limit for all commercial drivers in the United States is 0.04 percent.

The BAC will be over 0.10 percent after three to six drinks (in one hour). Of course, as we've seen, it depends on how much alcohol is in the drinks, and how quickly the person drinks them.

But the ability to drive is affected well below a BAC of 0.10 percent. Research shows that the driving skills of many people are impaired at a BAC approaching 0.05 percent, and that the effects are worse at night. All drivers are impaired at BAC levels above 0.05 percent. Statistics show that the chance of being in a collision increases sharply for drivers who have a BAC of

0.05 percent or above. A driver with a BAC level of 0.06 percent has doubled his or her chance of having a collision. At a BAC level of 0.10 percent, the chance of this driver having a collision is 12 times greater; at a level of 0.15 percent, the chance is 25 times greater!

The body takes about an hour to rid itself of the alcohol in one drink. No amount of coffee or number of cold showers will speed that up. "I'll be careful" isn't the right answer. What if there's an emergency, a need to take sudden action, as when a child darts into the street? A person with even a moderate BAC might not be able to react quickly enough to avoid the collision.

There's something else about drinking and driving that many people don't know. Medical research shows that alcohol in a person's system can make crash injuries worse, especially injuries to the brain, spinal cord or heart. This means that when anyone who has been drinking — driver or passenger — is in a crash, that person's chance of being killed or permanently disabled is higher than if the person had not been drinking.

⚠ CAUTION:

Drinking and then driving is very dangerous. Your reflexes, perceptions, attentiveness and judgement can be affected by even a small amount of alcohol. You can have a serious—or even fatal—collision if you drive after drinking. Please don't drink and drive or ride with a driver who has been drinking. Ride home in a cab; or if you're with a group, designate a driver who will not drink.

Control of a Vehicle

You have three systems that make your vehicle go where you want it to go. They are the brakes, the steering and the accelerator. All three systems have to do their work at the places where the tires meet the road.

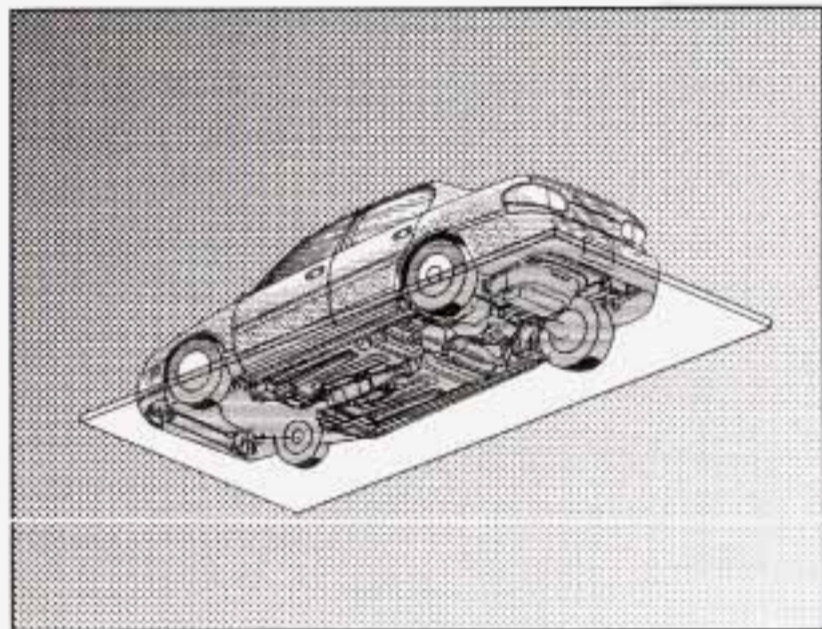

Sometimes, as when you're driving on snow or ice, it's easy to ask more of those control systems than the tires and road can provide. That means you can lose control of your vehicle. Also see *Traction Control System (TCS)* on page 4-8.

Braking

Braking action involves *perception time* and *reaction time*.

First, you have to decide to push on the brake pedal. That's *perception time*. Then you have to bring up your foot and do it. That's *reaction time*.

Average *reaction time* is about 3/4 of a second. But that's only an average. It might be less with one driver and as long as two or three seconds or more with another. Age, physical condition, alertness, coordination and eyesight all play a part. So do alcohol, drugs and frustration. But even in 3/4 of a second, a vehicle moving at 60 mph (100 km/h) travels 66 feet (20 m). That could be a lot of distance in an emergency, so keeping enough space between your vehicle and others is important.

And, of course, actual stopping distances vary greatly with the surface of the road (whether it's pavement or gravel); the condition of the road (wet, dry, icy); tire tread; the condition of your brakes; the weight of the vehicle and the amount of brake force applied.

Avoid needless heavy braking. Some people drive in spurts — heavy acceleration followed by heavy braking — rather than keeping pace with traffic. This is a mistake. Your brakes may not have time to cool between hard stops. Your brakes will wear out much faster if you do a lot of heavy braking. If you keep pace with the traffic and allow realistic following distances, you will eliminate a lot of unnecessary braking. That means better braking and longer brake life.

If your engine ever stops while you're driving, brake normally but don't pump your brakes. If you do, the pedal may get harder to push down. If your engine stops, you will still have some power brake assist. But you will use it when you brake. Once the power assist is used up, it may take longer to stop and the brake pedal will be harder to push.

Anti-lock Brake System (ABS)

Your vehicle has anti-lock brakes. ABS is an advanced electronic braking system that will help prevent a braking skid.

When you start your engine and begin to drive away, your anti-lock brake system will check itself. You may hear a momentary motor or clicking noise while this test is going on, and you may even notice that your brake pedal moves a little. This is normal.



If there's a problem with the anti-lock brake system, this warning light will stay on. See *Anti-Lock Brake System Warning Light* on page 3-36.



Let's say the road is wet and you're driving safely. Suddenly, an animal jumps out in front of you. You slam on the brakes and continue braking. Here's what happens with ABS:

A computer senses that wheels are slowing down. If one of the wheels is about to stop rolling, the computer will separately work the brakes at each front wheel and at both rear wheels.

The anti-lock system can change the brake pressure faster than any driver could. The computer is programmed to make the most of available tire and road

conditions. This can help you steer around the obstacle while braking hard.



As you brake, your computer keeps receiving updates on wheel speed and controls braking pressure accordingly.

Remember: Anti-lock doesn't change the time you need to get your foot up to the brake pedal or always decrease stopping distance. If you get too close to the vehicle in front of you, you won't have time to apply

your brakes if that vehicle suddenly slows or stops. Always leave enough room up ahead to stop, even though you have anti-lock brakes.

Using Anti-Lock

Don't pump the brakes. Just hold the brake pedal down firmly and let anti-lock work for you. You may hear a motor or clicking noise during a hard stop, but this is normal.

Braking in Emergencies

With anti-lock, you can steer and brake at the same time. In many emergencies, steering can help you more than even the very best braking.

Traction Control System (TCS)

Your vehicle may have a traction control system that limits wheel spin. This is especially useful in slippery road conditions. The system operates only if it senses that one or both of the front wheels are spinning or beginning to lose traction. When this happens, the system works the front brakes and reduces engine power to limit wheel spin.



United States

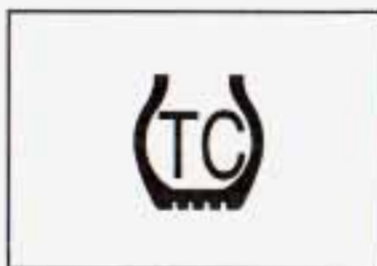

Canada

This light will come on when your traction control system is limiting wheel spin. See *Traction Control System Active Light on page 3-38*.

You may feel or hear the system working, but this is normal.

If your vehicle is in cruise control when the traction control system begins to limit wheel spin, the cruise control will automatically disengage. When road conditions allow you to safely use it again, you may reengage the cruise control. See "Cruise Control" under *Turn Signal/Multifunction Lever on page 3-6*.



United States



Canada

This light should come on briefly when you start the engine. If it stays on or comes on while you are driving, there's a problem with your traction control system.

See *Traction Control System (TCS) Warning Light on page 3-37*. When this warning light is on, the system will not limit wheel spin. Adjust your driving accordingly.

The traction control system automatically comes on whenever you start your vehicle. To limit wheel spin, especially in slippery road conditions, you should always leave the system on. But you can turn the traction control system off if you ever need to. You should turn the system off if your vehicle ever gets stuck in sand, mud or snow and rocking the vehicle is required. See "Rocking Your Vehicle To Get It Out" under *If You Are Stuck: In Sand, Mud, Ice or Snow on page 4-32*.



To turn the system off, press the TC button on the center console.

The traction control system warning light will come on and stay on. If the system is limiting wheel spin when you press the button, the warning light will come on — but the system won't turn off right away. It will wait until there's no longer a current need to limit wheel spin.

You can turn the system back on at any time by pressing the button again. The traction control system warning light should go off.

Steering

Power Steering

If you lose power steering assist because the engine stops or the system is not functioning, you can steer but it will take much more effort.

Magnetic-Speed Variable Assist Steering

Your vehicle is equipped with a steering system that continuously adjusts the effort you feel when steering at all vehicle speeds. It provides ease when parking, yet a firm, solid feel at highway speeds.

Steering Tips

Driving on Curves

It's important to take curves at a reasonable speed.

A lot of the "driver lost control" accidents mentioned on the news happen on curves. Here's why:

Experienced driver or beginner, each of us is subject to the same laws of physics when driving on curves. The traction of the tires against the road surface makes it possible for the vehicle to change its path when you turn the front wheels. If there's no traction, inertia will keep the vehicle going in the same direction. If you've ever tried to steer a vehicle on wet ice, you'll understand this.

The traction you can get in a curve depends on the condition of your tires and the road surface, the angle at which the curve is banked, and your speed. While you're in a curve, speed is the one factor you can control.

Suppose you're steering through a sharp curve. Then you suddenly accelerate. Both control systems — steering and acceleration — have to do their work where the tires meet the road. Adding the sudden acceleration can demand too much of those places. You can lose control. See *Traction Control System (TCS)* on page 4-8.

What should you do if this ever happens? Ease up on the accelerator pedal, steer the vehicle the way you want it to go, and slow down.

If you have StabiliTrak[®], you may see the STABILITY ACTIVE message on the Driver Information Center. See "Stability Active Message" under *DIC Warnings and Messages* on page 3-50.

Speed limit signs near curves warn that you should adjust your speed. Of course, the posted speeds are based on good weather and road conditions. Under less favorable conditions you'll want to go slower.

If you need to reduce your speed as you approach a curve, do it before you enter the curve, while your front wheels are straight ahead.

Try to adjust your speed so you can "drive" through the curve. Maintain a reasonable, steady speed. Wait to accelerate until you are out of the curve, and then accelerate gently into the straightaway.

Steering in Emergencies

There are times when steering can be more effective than braking. For example, you come over a hill and find a truck stopped in your lane, or a car suddenly pulls out from nowhere, or a child darts out from between parked cars and stops right in front of you. You can avoid these problems by braking — if you can stop in time. But sometimes you can't; there isn't room. That's the time for evasive action — steering around the problem.

Your vehicle can perform very well in emergencies like these. First apply your brakes.

See *Braking on page 4-6*. It is better to remove as much speed as you can from a possible collision. Then steer around the problem, to the left or right depending on the space available.



An emergency like this requires close attention and a quick decision. If you are holding the steering wheel at the recommended 9 and 3 o'clock positions, you can turn it a full 180 degrees very quickly without removing either hand. But you have to act fast, steer quickly, and just as quickly straighten the wheel once you have avoided the object.

The fact that such emergency situations are always possible is a good reason to practice defensive driving at all times and wear safety belts properly.

Off-Road Recovery

You may find that your right wheels have dropped off the edge of a road onto the shoulder while you're driving,

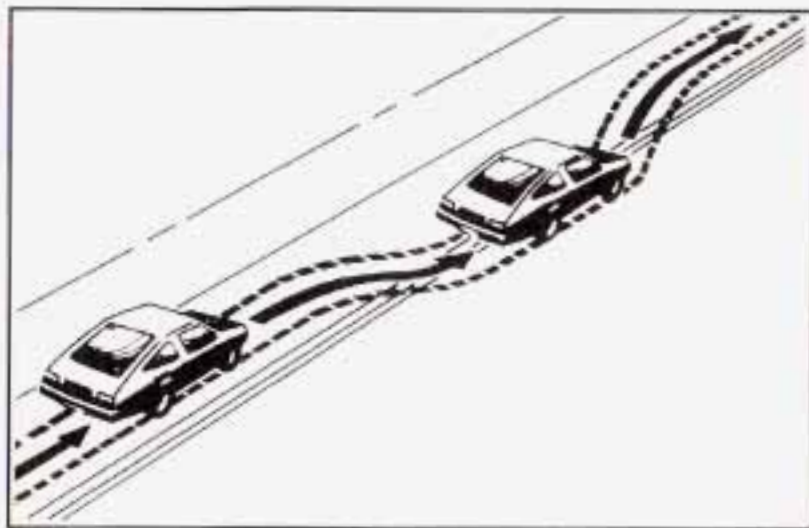

If the level of the shoulder is only slightly below the pavement, recovery should be fairly easy. Ease off the accelerator and then, if there is nothing in the way, steer so that your vehicle straddles the edge of the pavement. You can turn the steering wheel up to one-quarter turn until the right front tire contacts the pavement edge. Then turn your steering wheel to go straight down the roadway.

Passing

The driver of a vehicle about to pass another on a two-lane highway waits for just the right moment, accelerates, moves around the vehicle ahead, then goes back into the right lane again. A simple maneuver?

Not necessarily! Passing another vehicle on a two-lane highway is a potentially dangerous move, since the passing vehicle occupies the same lane as oncoming traffic for several seconds. A miscalculation, an error in judgment, or a brief surrender to frustration or anger can suddenly put the passing driver face to face with the worst of all traffic accidents — the head-on collision.

So here are some tips for passing:

- "Drive ahead." Look down the road, to the sides and to crossroads for situations that might affect your passing patterns. If you have any doubt whatsoever about making a successful pass, wait for a better time.
- Watch for traffic signs, pavement markings and lines. If you can see a sign up ahead that might indicate a turn or an intersection, delay your pass. A broken center line usually indicates it's all right to pass (providing the road ahead is clear). Never cross a solid line on your side of the lane or a double solid line, even if the road seems empty of approaching traffic.
- Do not get too close to the vehicle you want to pass while you're awaiting an opportunity. For one thing, following too closely reduces your area of vision, especially if you're following a larger vehicle. Also, you won't have adequate space if the vehicle ahead suddenly slows or stops. Keep back a reasonable distance.
- When it looks like a chance to pass is coming up, start to accelerate but stay in the right lane and don't get too close. Time your move so you will be increasing speed as the time comes to move into the other lane. If the way is clear to pass, you will have a "running start" that more than makes up for the distance you would lose by dropping back. And if something happens to cause you to cancel your pass, you need only slow down and drop back again and wait for another opportunity.
- If other vehicles are lined up to pass a slow vehicle, wait your turn. But take care that someone isn't trying to pass you as you pull out to pass the slow vehicle. Remember to glance over your shoulder and check the blind spot.
- Check your mirrors, glance over your shoulder, and start your left lane change signal before moving out of the right lane to pass. When you are far enough ahead of the passed vehicle to see its front in your inside mirror, activate your right lane change signal and move back into the right lane. (Remember that your right outside mirror is convex. The vehicle you just passed may seem to be farther away from you than it really is.)

- Try not to pass more than one vehicle at a time on two-lane roads. Reconsider before passing the next vehicle.
- Don't overtake a slowly moving vehicle too rapidly. Even though the brake lamps are not flashing, it may be slowing down or starting to turn.
- If you're being passed, make it easy for the following driver to get ahead of you. Perhaps you can ease a little to the right.

Loss of Control

Let's review what driving experts say about what happens when the three control systems (brakes, steering and acceleration) don't have enough friction where the tires meet the road to do what the driver has asked.

In any emergency, don't give up. Keep trying to steer and constantly seek an escape route or area of less danger.

Skidding

In a skid, a driver can lose control of the vehicle. Defensive drivers avoid most skids by taking reasonable care suited to existing conditions, and by not "overdriving" those conditions. But skids are always possible.

The three types of skids correspond to your vehicle's three control systems. In the braking skid, your wheels aren't rolling. In the steering or cornering skid, too much speed or steering in a curve causes tires to slip and lose cornering force. And in the acceleration skid, too much throttle causes the driving wheels to spin.

A cornering skid is best handled by easing your foot off the accelerator pedal.

Remember: Any traction control system helps avoid only the acceleration skid. If your traction control system is off, then an acceleration skid is also best handled by easing your foot off the accelerator pedal.

If your vehicle starts to slide, ease your foot off the accelerator pedal and quickly steer the way you want the vehicle to go. If you start steering quickly enough, your vehicle may straighten out. Always be ready for a second skid if it occurs.

If you have StabiliTrak[®], you may see the STABILITY ACTIVE message on the Driver Information Center. See “Stability Active Message” under *DIC Warnings and Messages* on page 3-50.

Of course, traction is reduced when water, snow, ice, gravel or other material is on the road. For safety, you’ll want to slow down and adjust your driving to these conditions. It is important to slow down on slippery surfaces because stopping distance will be longer and vehicle control more limited.

While driving on a surface with reduced traction, try your best to avoid sudden steering, acceleration or braking (including engine braking by shifting to a lower gear). Any sudden changes could cause the tires to slide. You may not realize the surface is slippery until your vehicle is skidding. Learn to recognize warning clues — such as enough water, ice or packed snow on the road to make a “mirrored surface” — and slow down when you have any doubt.

Remember: Any anti-lock brake system (ABS) helps avoid only the braking skid.

Driving at Night

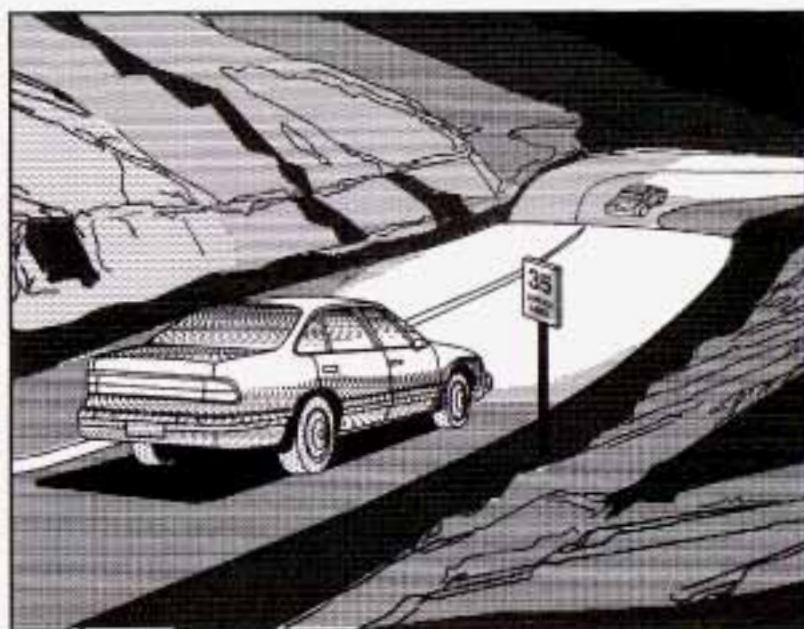

Night driving is more dangerous than day driving. One reason is that some drivers are likely to be impaired — by alcohol or drugs, with night vision problems, or by fatigue.

Here are some tips on night driving.

- Drive defensively.
- Don't drink and drive.

- Adjust your inside rearview mirror to reduce the glare from headlamps behind you.
- Since you can't see as well, you may need to slow down and keep more space between you and other vehicles.
- Slow down, especially on higher speed roads. Your headlamps can light up only so much road ahead.
- In remote areas, watch for animals.
- If you're tired, pull off the road in a safe place and rest.

No one can see as well at night as in the daytime. But as we get older these differences increase. A 50-year-old driver may require at least twice as much light to see the same thing at night as a 20-year-old.

What you do in the daytime can also affect your night vision. For example, if you spend the day in bright sunshine you are wise to wear sunglasses. Your eyes will have less trouble adjusting to night. But if you're driving, don't wear sunglasses at night. They may cut down on glare from headlamps, but they also make a lot of things invisible.

You can be temporarily blinded by approaching headlamps. It can take a second or two, or even several seconds, for your eyes to readjust to the dark. When you are faced with severe glare (as from a driver who doesn't lower the high beams, or a vehicle with misaimed headlamps), slow down a little. Avoid staring directly into the approaching headlamps.

Keep your windshield and all the glass on your vehicle clean — inside and out. Glare at night is made much worse by dirt on the glass. Even the inside of the glass can build up a film caused by dust. Dirty glass makes lights dazzle and flash more than clean glass would, making the pupils of your eyes contract repeatedly.

Remember that your headlamps light up far less of a roadway when you are in a turn or curve. Keep your eyes moving; that way, it's easier to pick out dimly lighted objects. Just as your headlamps should be checked regularly for proper aim, so should your eyes be examined regularly. Some drivers suffer from night blindness — the inability to see in dim light — and aren't even aware of it.

Driving in Rain and on Wet Roads



Rain and wet roads can mean driving trouble. On a wet road, you can't stop, accelerate or turn as well because your tire-to-road traction isn't as good as on dry roads. And, if your tires don't have much tread left, you'll get even less traction. It's always wise to go slower and be cautious if rain starts to fall while you are driving. The surface may get wet suddenly when your reflexes are tuned for driving on dry pavement.

The heavier the rain, the harder it is to see. Even if your windshield wiper blades are in good shape, a heavy rain can make it harder to see road signs and traffic signals, pavement markings, the edge of the road and even people walking.

It's wise to keep your windshield wiping equipment in good shape and keep your windshield washer tank filled with washer fluid. Replace your windshield wiper inserts when they show signs of streaking or missing areas on the windshield, or when strips of rubber start to separate from the inserts.

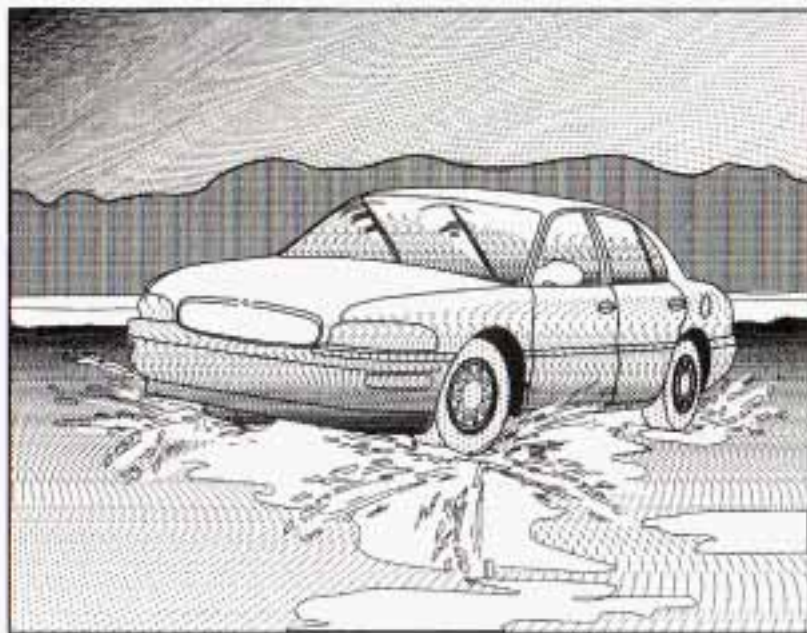

Driving too fast through large water puddles or even going through some car washes can cause problems, too. The water may affect your brakes. Try to avoid puddles. But if you can't, try to slow down before you hit them.

CAUTION:

Wet brakes can cause accidents. They won't work as well in a quick stop and may cause pulling to one side. You could lose control of the vehicle.

After driving through a large puddle of water or a car wash, apply your brake pedal lightly until your brakes work normally.

Hydroplaning

Hydroplaning is dangerous. So much water can build up under your tires that they can actually ride on the water. This can happen if the road is wet enough and you're going fast enough. When your vehicle is hydroplaning, it has little or no contact with the road.

Hydroplaning doesn't happen often. But it can if your tires do not have much tread or if the pressure in one or more is low. It can happen if a lot of water is standing on the road. If you can see reflections from trees, telephone poles or other vehicles, and raindrops "dimple" the water's surface, there could be hydroplaning.

Hydroplaning usually happens at higher speeds. There just isn't a hard and fast rule about hydroplaning. The best advice is to slow down when it is raining.

Driving Through Deep Standing Water

Notice: If you drive too quickly through deep puddles or standing water, water can come in through your engine's air intake and badly damage your engine. Never drive through water that is slightly lower than the underbody of your vehicle. If you can't avoid deep puddles or standing water, drive through them very slowly.

Driving Through Flowing Water

CAUTION:

Flowing or rushing water creates strong forces. If you try to drive through flowing water, as you might at a low water crossing, your vehicle can be carried away. As little as six inches of flowing water can carry away a smaller vehicle. If this happens, you and other vehicle occupants could drown. Don't ignore police warning signs, and otherwise be very cautious about trying to drive through flowing water.

Some Other Rainy Weather Tips

- Besides slowing down, allow some extra following distance. And be especially careful when you pass another vehicle. Allow yourself more clear room ahead, and be prepared to have your view restricted by road spray.
- Have good tires with proper tread depth. See *Tires* on page 5-60.

City Driving



One of the biggest problems with city streets is the amount of traffic on them. You'll want to watch out for what the other drivers are doing and pay attention to traffic signals.

Here are ways to increase your safety in city driving:

- Know the best way to get to where you are going. Get a city map and plan your trip into an unknown part of the city just as you would for a cross-country trip.
- Try to use the freeways that rim and crisscross most large cities. You'll save time and energy. See the next part, "Freeway Driving."
- Treat a green light as a warning signal. A traffic light is there because the corner is busy enough to need it. When a light turns green, and just before you start to move, check both ways for vehicles that have not cleared the intersection or may be running the red light.

Freeway Driving

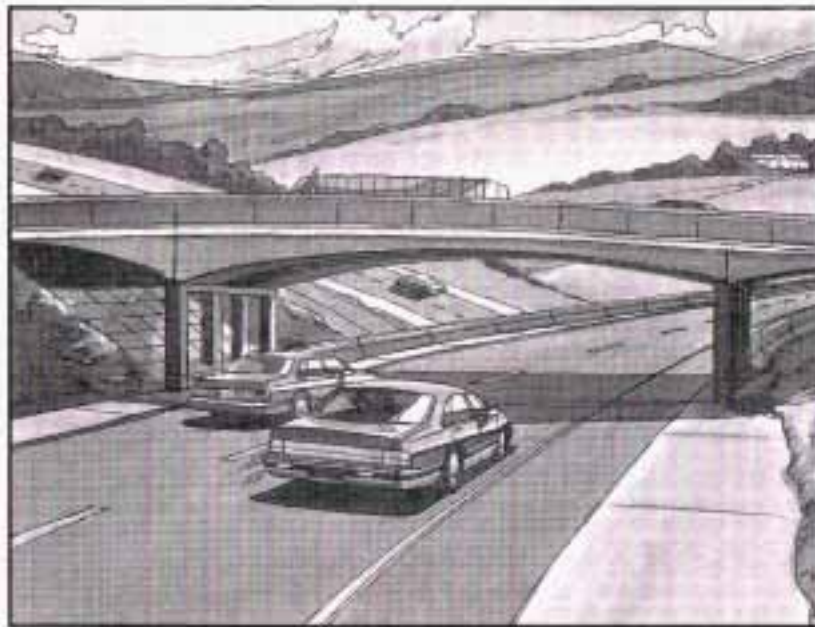

Mile for mile, freeways (also called thruways, parkways, expressways, turnpikes or superhighways) are the safest of all roads. But they have their own special rules.

The most important advice on freeway driving is: Keep up with traffic and keep to the right. Drive at the same speed most of the other drivers are driving. Too-fast or too-slow driving breaks a smooth traffic flow. Treat the left lane on a freeway as a passing lane.

At the entrance, there is usually a ramp that leads to the freeway. If you have a clear view of the freeway as you drive along the entrance ramp, you should begin to check traffic. Try to determine where you expect to blend with the flow. Try to merge into the gap at close to the prevailing speed. Switch on your turn signal, check your mirrors and glance over your shoulder as often as necessary. Try to blend smoothly with the traffic flow.

Once you are on the freeway, adjust your speed to the posted limit or to the prevailing rate if it's slower. Stay in the right lane unless you want to pass.

Before changing lanes, check your mirrors. Then use your turn signal.

Just before you leave the lane, glance quickly over your shoulder to make sure there isn't another vehicle in your "blind" spot.

Once you are moving on the freeway, make certain you allow a reasonable following distance.

Expect to move slightly slower at night.

When you want to leave the freeway, move to the proper lane well in advance. If you miss your exit, do not, under any circumstances, stop and back up. Drive on to the next exit.

The exit ramp can be curved, sometimes quite sharply. The exit speed is usually posted. Reduce your speed according to your speedometer, not to your sense of motion. After driving for any distance at higher speeds, you may tend to think you are going slower than you actually are.

Before Leaving on a Long Trip

Make sure you're ready. Try to be well rested. If you must start when you're not fresh — such as after a day's work — don't plan to make too many miles that first part of the journey. Wear comfortable clothing and shoes you can easily drive in.

Is your vehicle ready for a long trip? If you keep it serviced and maintained, it's ready to go. If it needs service, have it done before starting out. Of course, you'll find experienced and able service experts in dealerships all across North America. They'll be ready and willing to help if you need it.

Here are some things you can check before a trip:

- *Windshield Washer Fluid:* Is the reservoir full? Are all windows clean inside and outside?
- *Wiper Blades:* Are they in good shape?
- *Fuel, Engine Oil, Other Fluids:* Have you checked all levels?
- *Lamps:* Are they all working? Are the lenses clean?
- *Tires:* They are vitally important to a safe, trouble-free trip. Is the tread good enough for long-distance driving? Are the tires all inflated to the recommended pressure?
- *Weather Forecasts:* What's the weather outlook along your route? Should you delay your trip a short time to avoid a major storm system?
- *Maps:* Do you have up-to-date maps?

Highway Hypnosis

Is there actually such a condition as “highway hypnosis”? Or is it just plain falling asleep at the wheel? Call it highway hypnosis, lack of awareness, or whatever.

There is something about an easy stretch of road with the same scenery, along with the hum of the tires on the road, the drone of the engine, and the rush of the wind against the vehicle that can make you sleepy. Don't let it happen to you! If it does, your vehicle can leave the road in *less than a second*, and you could crash and be injured.

What can you do about highway hypnosis? First, be aware that it can happen.

Then here are some tips:

- Make sure your vehicle is well ventilated, with a comfortably cool interior.
- Keep your eyes moving. Scan the road ahead and to the sides. Check your rearview mirrors and your instruments frequently.
- If you get sleepy, pull off the road into a rest, service or parking area and take a nap, get some exercise, or both. For safety, treat drowsiness on the highway as an emergency.

Hill and Mountain Roads



Driving on steep hills or mountains is different from driving in flat or rolling terrain.

If you drive regularly in steep country, or if you're planning to visit there, here are some tips that can make your trips safer and more enjoyable.

- Keep your vehicle in good shape. Check all fluid levels and also the brakes, tires, cooling system and transaxle. These parts can work hard on mountain roads.
- Know how to go down hills. The most important thing to know is this: let your engine do some of the slowing down. Shift to a lower gear when you go down a steep or long hill.

 **CAUTION:**

If you don't shift down, your brakes could get so hot that they wouldn't work well. You would then have poor braking or even none going down a hill. You could crash. Shift down to let your engine assist your brakes on a steep downhill slope.

 **CAUTION:**

Coasting downhill in NEUTRAL (N) or with the ignition off is dangerous. Your brakes will have to do all the work of slowing down. They could get so hot that they wouldn't work well. You would then have poor braking or even none going down a hill. You could crash. Always have your engine running and your vehicle in gear when you go downhill.

- Know how to go uphill. Drive in the highest gear possible.
- Stay in your own lane when driving on two-lane roads in hills or mountains. Don't swing wide or cut across the center of the road. Drive at speeds that let you stay in your own lane.
- As you go over the top of a hill, be alert. There could be something in your lane, like a stalled car or an accident.
- You may see highway signs on mountains that warn of special problems. Examples are long grades, passing or no-passing zones, a falling rocks area or winding roads. Be alert to these and take appropriate action.

Winter Driving

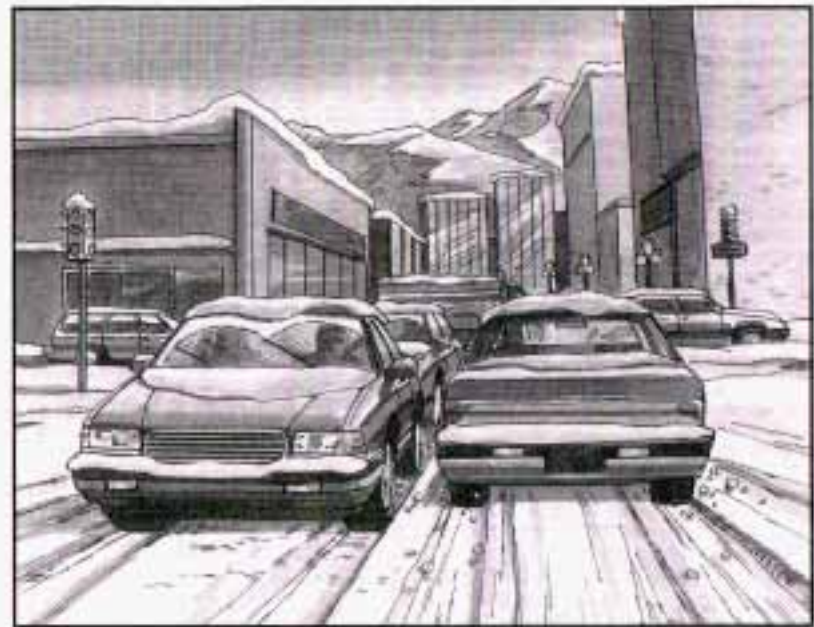

Here are some tips for winter driving:

- Have your vehicle in good shape for winter.
- You may want to put winter emergency supplies in your trunk.



Include an ice scraper, a small brush or broom, a supply of windshield washer fluid, a rag, some winter outer clothing, a small shovel, a flashlight, a red cloth and a couple of reflective warning triangles. And, if you will be driving under severe conditions, include a small bag of sand, a piece of old carpet or a couple of burlap bags to help provide traction. Be sure you properly secure these items in your vehicle.

Driving on Snow or Ice

Most of the time, those places where your tires meet the road probably have good traction.

However, if there is snow or ice between your tires and the road, you can have a very slippery situation.

You'll have a lot less traction or "grip" and will need to be very careful.



What's the worst time for this? "Wet ice." Very cold snow or ice can be slick and hard to drive on. But wet ice can be even more trouble because it may offer the least traction of all. You can get wet ice when it's about freezing (32°F; 0°C) and freezing rain begins to fall. Try to avoid driving on wet ice until salt and sand crews can get there.

Whatever the condition — smooth ice, packed, blowing or loose snow — drive with caution.

Keep your traction control system on. It improves your ability to accelerate when driving on a slippery road. Even though your vehicle has a traction control system, you'll want to slow down and adjust your driving to the road conditions. See *Traction Control System (TCS)* on page 4-8.

Your anti-lock brakes improve your vehicle's stability when you make a hard stop on a slippery road. Even though you have the anti-lock braking system, you'll want to begin stopping sooner than you would on dry pavement. See *Braking on page 4-6*.

- Allow greater following distance on any slippery road.
- Watch for slippery spots. The road might be fine until you hit a spot that's covered with ice. On an otherwise clear road, ice patches may appear in shaded areas where the sun can't reach: around clumps of trees, behind buildings or under bridges. Sometimes the surface of a curve or an overpass may remain icy when the surrounding roads are clear. If you see a patch of ice ahead of you, brake before you are on it. Try not to brake while you're actually on the ice, and avoid sudden steering maneuvers.

If You're Caught in a Blizzard



If you are stopped by heavy snow, you could be in a serious situation. You should probably stay with your vehicle unless you know for sure that you are near help and you can hike through the snow. Here are some things to do to summon help and keep yourself and your passengers safe:

- Turn on your hazard flashers.

- Tie a red cloth to your vehicle to alert police that you've been stopped by the snow.
- Put on extra clothing or wrap a blanket around you. If you have no blankets or extra clothing, make body insulators from newspapers, burlap bags, rags, floor mats — anything you can wrap around yourself or tuck under your clothing to keep warm.

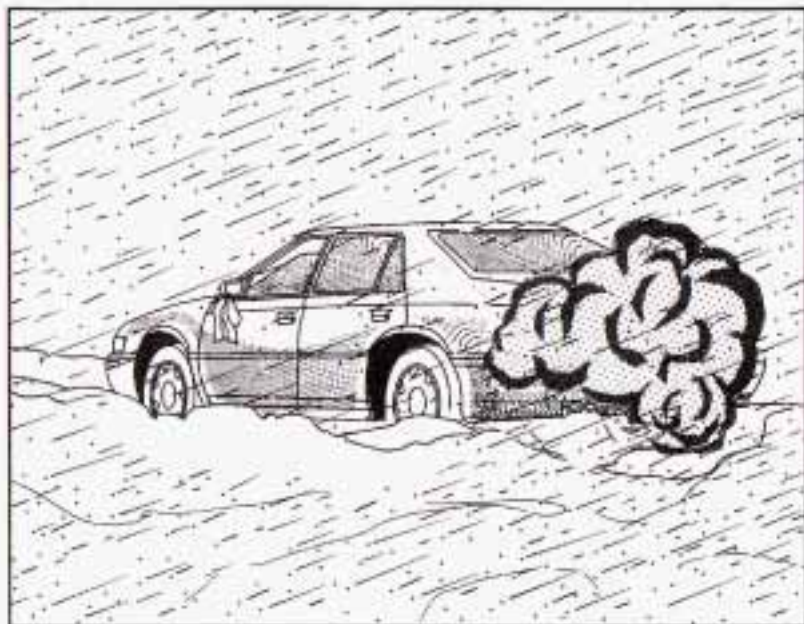

You can run the engine to keep warm, but be careful.

 **CAUTION:**

Snow can trap exhaust gases under your vehicle. This can cause deadly CO (carbon monoxide) gas to get inside. CO could overcome you and kill you. You can't see it or smell it, so you might not know it is in your vehicle. Clear away snow from around the base of your vehicle, especially any that is blocking your exhaust pipe. And check around again from time to time to be sure snow doesn't collect there.

Open a window just a little on the side of the vehicle that's away from the wind. This will help keep CO out.

Run your engine only as long as you must. This saves fuel. When you run the engine, make it go a little faster than just idle. That is, push the accelerator slightly. This uses less fuel for the heat that you get and it keeps the battery charged. You will need a well-charged battery to restart the vehicle, and possibly for signaling later on with your headlamps. Let the heater run for a while.

Then, shut the engine off and close the window almost all the way to preserve the heat. Start the engine again and repeat this only when you feel really uncomfortable from the cold. But do it as little as possible. Preserve the fuel as long as you can. To help keep warm, you can get out of the vehicle and do some fairly vigorous exercises every half hour or so until help comes.

If You Are Stuck: In Sand, Mud, Ice or Snow

In order to free your vehicle when it is stuck, you will need to spin the wheels, but you don't want to spin your wheels too fast. The method known as "rocking" can help you get out when you're stuck, but you must use caution.

CAUTION:

If you let your tires spin at high speed, they can explode, and you or others could be injured. And, the transaxle or other parts of the vehicle can overheat. That could cause an engine compartment fire or other damage. When you're stuck, spin the wheels as little as possible. Don't spin the wheels above 35 mph (55 km/h) as shown on the speedometer.

Notice: Spinning your wheels can destroy parts of your vehicle as well as the tires. If you spin the wheels too fast while shifting your transaxle back and forth, you can destroy your transaxle. See "Rocking Your Vehicle To Get It Out."

For information about using tire chains on your vehicle, see *Tire Chains* on page 5-70.

Rocking Your Vehicle To Get It Out

First, turn your steering wheel left and right. That will clear the area around your front wheels. If your vehicle has traction control, you should turn the system off. See *Traction Control System (TCS)* on page 4-8. Then shift back and forth between REVERSE (R) and a forward gear, spinning the wheels as little as possible. Release the accelerator pedal while you shift, and press lightly on the accelerator pedal when the transaxle is in gear. By slowly spinning your wheels in the forward and reverse directions, you will cause a rocking motion that may free your vehicle. If that doesn't get you out after a few tries, you may need to be towed out. If you do need to be towed out, see "Towing Your Vehicle" following.

Towing

Towing Your Vehicle

Consult your dealer or a professional towing service if you need to have your disabled vehicle towed. See *Roadside Assistance Program on page 7-5*.

If you want to tow your vehicle behind another vehicle for recreational purposes (such as behind a motorhome), see "Recreational Vehicle Towing" following.

Recreational Vehicle Towing

Recreational vehicle towing means towing your vehicle behind another vehicle – such as behind a motorhome. The two most common types of recreational vehicle towing are known as "dinghy towing" (towing your vehicle with all four wheels on the ground) and "dolly towing" (towing your vehicle with two wheels on the ground and two wheels up on a device known as a "dolly").

With the proper preparation and equipment, many vehicles can be towed in these ways. See "Dinghy Towing" and "Dolly Towing," following.

Here are some important things to consider before you do recreational vehicle towing:

- What's the towing capacity of the towing vehicle? Be sure you read the tow vehicle manufacturer's recommendations.
- How far will you tow? Some vehicles have restrictions on how far and how long they can tow.
- Do you have the proper towing equipment? See your dealer or trailering professional for additional advice and equipment recommendations.
- Is your vehicle ready to be towed? Just as you would prepare your vehicle for a long trip, you'll want to make sure your vehicle is prepared to be towed. See *Before Leaving on a Long Trip on page 4-23*.

Dinghy Towing

Notice: Towing your vehicle with all four wheels on the ground will damage drivetrain components.

Your vehicle was not designed to be towed with all four wheels on the ground. If your vehicle must be towed, you should use a dolly. See "Dolly Towing" that follows for more information.

Dolly Towing

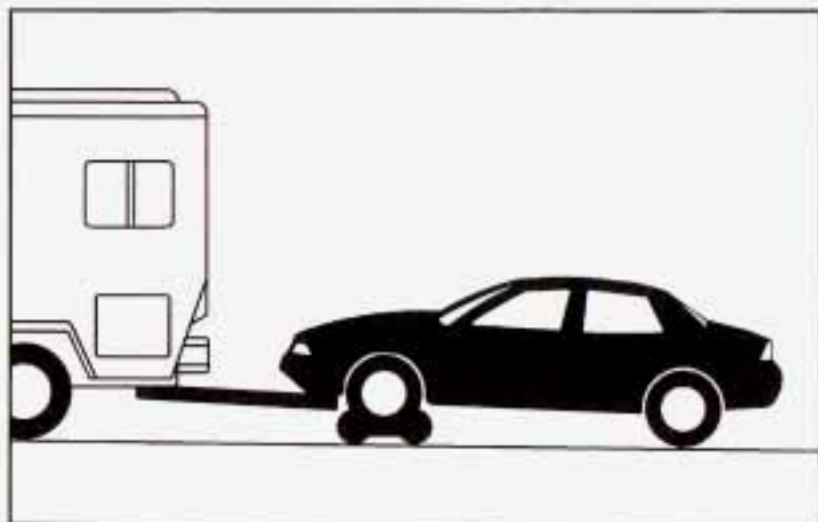

Your vehicle can be towed using a dolly. To tow your vehicle using a dolly, follow these steps:

1. Put the front wheels on the dolly.
2. Put the vehicle in PARK (P).
3. Set the parking brake and then remove the key.
4. Clamp the steering wheel in a straight-ahead position.
5. Release the parking brake.

Loading Your Vehicle

GM TIRE-LOADING INFORMATION

OCCUPANTS				VEHICLE CAP.	
FRT.	CTR.	RR.	TOTAL	KG	LB
<input type="checkbox"/>	<input type="checkbox"/>	<input type="checkbox"/>	<input type="checkbox"/>		
MAX. LOADING @ GVWR SAME AS VEHICLE CAP. WEIGHT					
2000					
MODEL: _____					
TIRE SIZE _____ SPEED _____ COLD TIRE PRESSURE _____					
FRT	CTR.	RR.			
_____	_____	_____			
_____	_____	_____			
_____	_____	_____			
TIRES ARE HOT, ADD 28KPA(4PSI)					
SEE OWNER'S MANUAL FOR MORE INFORMATION					

EXAMPLE

Two labels on your vehicle show how much weight it may properly carry. The Tire-Loading Information label found on the rear edge of the driver's door tells you the proper size, speed rating and recommended inflation pressures for the tires on your vehicle. It also gives you important information about the number of people that can be in your vehicle and the total weight that you can carry. This weight is called the Vehicle Capacity Weight and includes the weight of all occupants, cargo and all nonfactory-installed options.



The other label is the Certification label, found on the rear edge of the driver's door. It tells you the gross weight capacity of your vehicle, called the Gross Vehicle Weight Rating (GVWR). The GVWR includes the weight of the vehicle, all occupants, fuel and cargo. Never exceed the GVWR for your vehicle, or the Gross Axle Weight Rating (GAWR) for either the front or rear axle.

And, if you do have a heavy load, you should spread it out. Don't carry more than 176 lbs. (80 kg) in your trunk.

⚠ CAUTION:

Do not load your vehicle any heavier than the GVWR, or either the maximum front or rear GAWR. If you do, parts on your vehicle can break, and it can change the way your vehicle handles. These could cause you to lose control and crash. Also, overloading can shorten the life of your vehicle.

Notice: Your warranty does not cover parts or components that fail because of overloading.

If you put things inside your vehicle – like suitcases, tools, packages, or anything else – they will go as fast as the vehicle goes. If you have to stop or turn quickly, or if there is a crash, they'll keep going.

CAUTION:

Things you put inside your vehicle can strike and injure people in a sudden stop or turn, or in a crash.

- Put things in the trunk of your vehicle. In a trunk, put them as far forward as you can. Try to spread the weight evenly.
- Never stack heavier things, like suitcases, inside the vehicle so that some of them are above the tops of the seats.
- Don't leave an unsecured child restraint in your vehicle.
- When you carry something inside the vehicle, secure it whenever you can.

Automatic Level Control

This feature keeps the rear of your vehicle level as the load changes. It is automatic – you do not need to adjust anything.

Towing a Trailer

CAUTION:

If you don't use the correct equipment and drive properly, you can lose control when you pull a trailer. For example, if the trailer is too heavy, the brakes may not work well – or even at all. You and your passengers could be seriously injured. You may also damage your vehicle; the resulting repairs would not be covered by your warranty. Pull a trailer only if you have followed all the steps in this section. Ask your dealer for advice and information about towing a trailer with your vehicle.

Your vehicle can tow a trailer if it is equipped with the proper trailer towing equipment. To identify what the vehicle trailering capacity is for your vehicle, you should read the information in "Weight of the Trailer" that appears later in this section. But trailering is different than just driving your vehicle by itself. Trailering means changes in handling, durability and fuel economy. Successful, safe trailering takes correct equipment, and it has to be used properly.

That's the reason for this part. In it are many time-tested, important trailering tips and safety rules. Many of these are important for your safety and that of your passengers. So please read this section carefully before you pull a trailer.

Load-pulling components such as the engine, transaxle, wheel assemblies and tires are forced to work harder against the drag of the added weight. The engine is required to operate at relatively higher speeds and under greater loads, generating extra heat. What's more, the trailer adds considerably to wind resistance, increasing the pulling requirements.

If You Do Decide To Pull A Trailer

If you do, here are some important points:

- There are many different laws, including speed limit restrictions, having to do with trailering. Make sure your rig will be legal, not only where you live but also where you'll be driving. A good source for this information can be state or provincial police.
- Consider using a sway control. You can ask a hitch dealer about sway controls.
- Don't tow a trailer at all during the first 1,000 miles (1 600 km) your new vehicle is driven. Your engine, axle or other parts could be damaged.
- Then, during the first 500 miles (800 km) that you tow a trailer, don't drive over 50 mph (80 km/h) and don't make starts at full throttle. This helps your engine and other parts of your vehicle wear in at the heavier loads.
- Obey speed limit restrictions when towing a trailer. Don't drive faster than the maximum posted speed for trailers, or no more than 55 mph (90 km/h), to save wear on your vehicle's parts.

Three important considerations have to do with weight:

- the weight of the trailer,
- the weight of the trailer tongue
- and the total weight on your vehicle's tires.

Weight of the Trailer

How heavy can a trailer safely be?

It should never weigh more than 1,000 lbs (450 kg). But even that can be too heavy.

It depends on how you plan to use your rig. For example, speed, altitude, road grades, outside temperature and how much your vehicle is used to pull a trailer are all important. And, it can also depend on any special equipment that you have on your vehicle.

You can ask your dealer for our trailering information or advice, or you can write us at:

Oldsmobile Customer Assistance Center
P.O. Box 33171
Detroit, MI 48232-5171

In Canada, write to:

General Motors of Canada Limited
Customer Communication Centre, 163-005
1908 Colonel Sam Drive
Oshawa, Ontario L1H 8P7

Weight of the Trailer Tongue

The tongue load (A) of any trailer is an important weight to measure because it affects the total or gross weight of your vehicle. The Gross Vehicle Weight (GVW) includes the curb weight of the vehicle, any cargo you

may carry in it, and the people who will be riding in the vehicle. And if you tow a trailer, you must add the tongue load to the GVW because your vehicle will be carrying that weight, too. See *Loading Your Vehicle* on page 4-34 for more information about your vehicle's maximum load capacity.

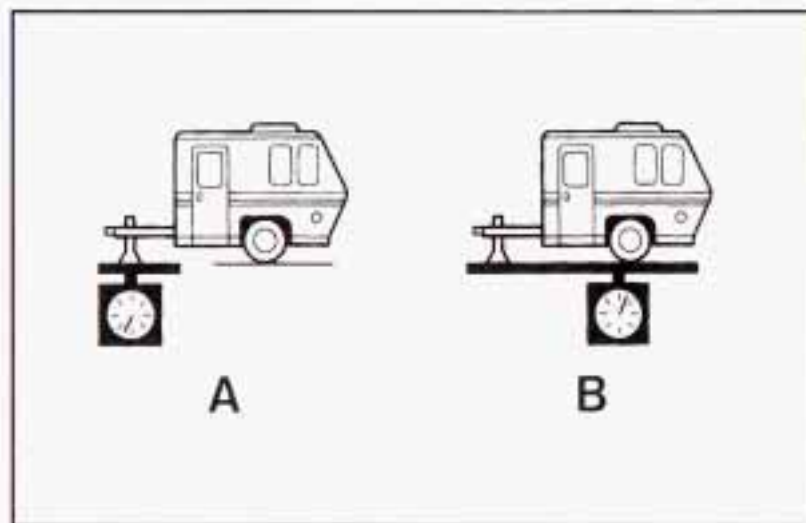

If you're using a weight-carrying hitch or a weight-distributing hitch, the trailer tongue (A) should weigh 10–15 percent of the total loaded trailer weight (B).

After you've loaded your trailer, weigh the trailer and then the tongue, separately, to see if the weights are proper. If they aren't, you may be able to get them right simply by moving some items around in the trailer.

Total Weight on Your Vehicle's Tires

Be sure your vehicle's tires are inflated to the upper limit for cold tires. You'll find these numbers on the Tire-Loading Information label at the rear edge of the driver's door or see *Loading Your Vehicle on page 4-34*. Then be sure you don't go over the GVW limit for your vehicle, including the weight of the trailer tongue.

Hitches

It's important to have the correct hitch equipment. Crosswinds, large trucks going by and rough roads are a few reasons why you'll need the right hitch. Here are some rules to follow:

- The rear bumper on your vehicle is not intended for hitches. Do not attach rental hitches or other bumper-type hitches to it. Use only a frame-mounted hitch that does not attach to the bumper.

- Will you have to make any holes in the body of your vehicle when you install a trailer hitch? If you do, then be sure to seal the holes later when you remove the hitch. If you don't seal them, deadly carbon monoxide (CO) from your exhaust can get into your vehicle. See *Engine Exhaust on page 2-33*. Dirt and water can also enter the vehicle.

Safety Chains

You should always attach chains between your vehicle and your trailer. Cross the safety chains under the tongue of the trailer so that the tongue will not drop to the road if it becomes separated from the hitch. Instructions about safety chains may be provided by the hitch manufacturer or by the trailer manufacturer. Follow the manufacturer's recommendation for attaching safety chains and do not attach them to the bumper. Always leave just enough slack so you can turn with your rig. And, never allow safety chains to drag on the ground.

Trailer Brakes

Does your trailer have its own brakes?

Be sure to read and follow the instructions for the trailer brakes so you'll be able to install, adjust and maintain them properly.

Because you have anti-lock brakes, do not try to tap into your vehicle's brake system. If you do, both brake systems won't work well, or at all.

Trailer Wiring Harness

All of the electrical circuits required for your trailer lighting system can be accessed at the driver's side rear lamp connector. This connector is located under the carpet in the rear corner of the trunk compartment.

Driving with a Trailer

Towing a trailer requires a certain amount of experience. Before setting out for the open road, you'll want to get to know your rig. Acquaint yourself with the feel of handling and braking with the added weight of the trailer. And always keep in mind that the vehicle you are driving is now a good deal longer and not nearly as responsive as your vehicle is by itself.

Before you start, check the trailer hitch and platform (and attachments), safety chains, electrical connector, lamps, tires and mirror adjustment. If the trailer has electric brakes, start your vehicle and trailer moving and then apply the trailer brake controller by hand to be sure the brakes are working. This lets you check your electrical connection at the same time.

During your trip, check occasionally to be sure that the load is secure, and that the lamps and any trailer brakes are still working.

Following Distance

Stay at least twice as far behind the vehicle ahead as you would when driving your vehicle without a trailer. This can help you avoid situations that require heavy braking and sudden turns.

Passing

You'll need more passing distance up ahead when you're towing a trailer. And, because you're a good deal longer, you'll need to go much farther beyond the passed vehicle before you can return to your lane.

Backing Up

Hold the bottom of the steering wheel with one hand. Then, to move the trailer to the left, just move that hand to the left. To move the trailer to the right, move your hand to the right. Always back up slowly and, if possible, have someone guide you.

Making Turns

Notice: Making very sharp turns while trailering could cause the trailer to come in contact with the vehicle. Your vehicle could be damaged. Avoid making very sharp turns while trailering.

When you're turning with a trailer, make wider turns than normal. Do this so your trailer won't strike soft shoulders, curbs, road signs, trees or other objects. Avoid jerky or sudden maneuvers. Signal well in advance.

Turn Signals When Towing a Trailer

When you tow a trailer, your vehicle may need a different turn signal flasher and/or extra wiring. Check with your dealer. The arrows on your instrument panel will flash whenever you signal a turn or lane change. Properly hooked up, the trailer lamps will also flash, telling other drivers you're about to turn, change lanes or stop.

When towing a trailer, the arrows on your instrument panel will flash for turns even if the bulbs on the trailer are burned out. Thus, you may think drivers behind you are seeing your signal when they are not. It's important to check occasionally to be sure the trailer bulbs are still working.

Driving On Grades

Reduce speed and shift to a lower gear *before* you start down a long or steep downgrade. If you don't shift down, you might have to use your brakes so much that they would get hot and no longer work well.

Parking on Hills

CAUTION:

You really should not park your vehicle, with a trailer attached, on a hill. If something goes wrong, your rig could start to move. People can be injured, and both your vehicle and the trailer can be damaged.

But if you ever have to park your rig on a hill, here's how to do it:

1. Apply your regular brakes, but don't shift into PARK (P) yet.
2. Have someone place chocks under the trailer wheels.
3. When the wheel chocks are in place, release the regular brakes until the chocks absorb the load.
4. Reapply the regular brakes. Then apply your parking brake, and then shift to PARK (P).
5. Release the regular brakes.

When You Are Ready to Leave After Parking on a Hill

1. Apply your regular brakes and hold the pedal down while you:
 - start your engine,
 - shift into a gear, and
 - release the parking brake.
2. Let up on the brake pedal.
3. Drive slowly until the trailer is clear of the chocks.
4. Stop and have someone pick up and store the chocks.

Maintenance When Trailer Towing

Your vehicle will need service more often when you're pulling a trailer. See the Maintenance Schedule for more on this. Things that are especially important in trailer operation are automatic transaxle fluid (don't overfill), engine oil, drive belt, cooling system and brake system. Each of these is covered in this manual, and the Index will help you find them quickly. If you're trailering, it's a good idea to review this information before you start your trip.

Check periodically to see that all hitch nuts and bolts are tight.

Engine Cooling When Trailer Towing

Your cooling system may temporarily overheat during severe operating conditions. See *Engine Overheating on page 5-28*.

 **NOTES**

Section 5 Service and Appearance Care

Service	5-3	Brakes	5-39
Doing Your Own Service Work	5-4	Battery	5-42
Adding Equipment to the Outside of Your Vehicle	5-4	Jump Starting	5-44
Fuel	5-5	Headlamp Aiming	5-50
Gasoline Octane	5-5	Bulb Replacement	5-54
Gasoline Specifications	5-5	Halogen Bulbs	5-54
California Fuel	5-6	Headlamps	5-55
Additives	5-6	Front Turn Signal and Parking Lamps	5-57
Fuels in Foreign Countries	5-7	Taillamps, Turn Signal, Stoplamps and Back-up Lamps	5-58
Filling Your Tank	5-7	Replacement Bulbs	5-58
Filling a Portable Fuel Container	5-11	Windshield Wiper Blade Replacement	5-59
Checking Things Under the Hood	5-12	Tires	5-60
Hood Release	5-13	Inflation – Tire Pressure	5-60
Engine Compartment Overview	5-14	Check Tire Pressure System	5-62
Engine Oil	5-15	Tire Inspection and Rotation	5-63
Engine Air Cleaner/Filter	5-21	When It Is Time for New Tires	5-65
Automatic Transaxle Fluid	5-22	Buying New Tires	5-66
Engine Coolant	5-24	Uniform Tire Quality Grading	5-67
Coolant Surge Tank Pressure Cap	5-28	Wheel Alignment and Tire Balance	5-68
Engine Overheating	5-28	Wheel Replacement	5-68
Cooling System	5-31	Tire Chains	5-70
Power Steering Fluid	5-37	If a Tire Goes Flat	5-70
Windshield Washer Fluid	5-38	Changing a Flat Tire	5-71
		Compact Spare Tire	5-81

Section 5 Service and Appearance Care

Appearance Care	5-82	Vehicle Identification	5-90
Cleaning the Inside of Your Vehicle	5-82	Vehicle Identification Number (VIN)	5-90
Care of Safety Belts	5-84	Service Parts Identification Label	5-90
Weatherstrips	5-84	Electrical System	5-91
Cleaning the Outside of Your Vehicle	5-85	Add-On Electrical Equipment	5-91
Sheet Metal Damage	5-87	Headlamp Wiring	5-91
Finish Damage	5-87	Windshield Wiper Fuses	5-91
Underbody Maintenance	5-87	Power Windows and Other Power Options	5-91
Chemical Paint Spotting	5-87	Fuses and Circuit Breakers	5-92
GM Vehicle Care/Appearance Materials	5-88	Removing the Rear Seat Cushion	5-95
		Capacities and Specifications	5-100
		Normal Maintenance Replacement Parts	5-101

Service

Your dealer knows your vehicle best and wants you to be happy with it. We hope you'll go to your dealer for all your service needs. You'll get genuine GM parts and GM-trained and supported service people.

We hope you'll want to keep your GM vehicle all GM. Genuine GM parts have one of these marks:

ACDelco

GENUINE
GM Parts

GM
Goodwrench

Doing Your Own Service Work

If you want to do some of your own service work, you'll want to use the proper service manual. It tells you much more about how to service your vehicle than this manual can. To order the proper service manual, see *Service Publications Ordering Information on page 7-9*.

Your vehicle has an air bag system. Before attempting to do your own service work, see *Servicing Your Air Bag-Equipped Vehicle on page 1-54*.

You should keep a record with all parts receipts and list the mileage and the date of any service work you perform. See *Part E: Maintenance Record on page 6-16*.

CAUTION:

You can be injured and your vehicle could be damaged if you try to do service work on a vehicle without knowing enough about it.

- **Be sure you have sufficient knowledge, experience, the proper replacement parts and tools before you attempt any vehicle maintenance task.**
- **Be sure to use the proper nuts, bolts and other fasteners. "English" and "metric" fasteners can be easily confused. If you use the wrong fasteners, parts can later break or fall off. You could be hurt.**

Adding Equipment to the Outside of Your Vehicle

Things you might add to the outside of your vehicle can affect the airflow around it. This may cause wind noise and affect windshield washer performance. Check with your dealer before adding equipment to the outside of your vehicle.

Fuel

Use of the recommended fuel is an important part of the proper maintenance of your vehicle.

Gasoline Octane

Use regular unleaded gasoline with a posted octane of 87 or higher. However, for best performance and for trailer towing, you may wish to use middle grade or premium unleaded gasoline. If the octane is less than 87, you may get a heavy knocking noise when you drive. If this occurs, use a gasoline rated at 87 octane or higher as soon as possible. Otherwise, you might damage your engine.

Gasoline Specifications

It is recommended that gasoline meet specifications which were developed by the American Automobile Manufacturers Association and endorsed by the Canadian Vehicle Manufacturers Association for better vehicle performance and engine protection. Gasoline meeting these specifications could provide improved driveability and emission control system performance compared to other gasoline.



In Canada, look for the “Auto Makers’ Choice” label on the pump.

Canada Only

California Fuel

If your vehicle is certified to meet California Emission Standards (see the underhood emission control label), it is designed to operate on fuels that meet California specifications. If this fuel is not available in states adopting California emissions standards, your vehicle will operate satisfactorily on fuels meeting federal specifications, but emission control system performance may be affected. The malfunction indicator lamp may turn on (see *Malfunction Indicator Lamp on page 3-39*) and your vehicle may fail a smog-check test. If this occurs, return to your authorized GM dealer for diagnosis. If it is determined that the condition is caused by the type of fuel used, repairs may not be covered by your warranty.

Additives

To provide cleaner air, all gasolines in the United States are now required to contain additives that will help prevent engine and fuel system deposits from forming, allowing your emission control system to work properly. You should not have to add anything to your fuel. Gasolines containing oxygenates, such as ethers and ethanol, and reformulated gasolines may be available in your area to contribute to clean air. General Motors recommends that you use these gasolines, particularly if they comply with the specifications described earlier.

Notice: Your vehicle was not designed for fuel that contains methanol. Don't use fuel containing methanol. It can corrode metal parts in your fuel system and also damage the plastic and rubber parts. That damage wouldn't be covered under your warranty.

Some gasolines that are not reformulated for low emissions may contain an octane-enhancing additive called methylcyclopentadienyl manganese tricarbonyl (MMT); ask the attendant where you buy gasoline whether the fuel contains MMT. General Motors does not recommend the use of such gasolines. Fuels containing MMT can reduce the life of spark plugs and the performance of the emission control system may be affected. The malfunction indicator lamp may turn on. If this occurs, return to your authorized GM dealer for service.

Fuels in Foreign Countries

If you plan on driving in another country outside the United States or Canada, the proper fuel may be hard to find. Never use leaded gasoline or any other fuel not recommended in the previous text on fuel. Costly repairs caused by use of improper fuel wouldn't be covered by your warranty.

To check the fuel availability, ask an auto club, or contact a major oil company that does business in the country where you'll be driving.

Filling Your Tank

CAUTION:

Fuel vapor is highly flammable. It burns violently, and that can cause very bad injuries. Don't smoke if you're near fuel or refueling your vehicle. Keep sparks, flames and smoking materials away from fuel.

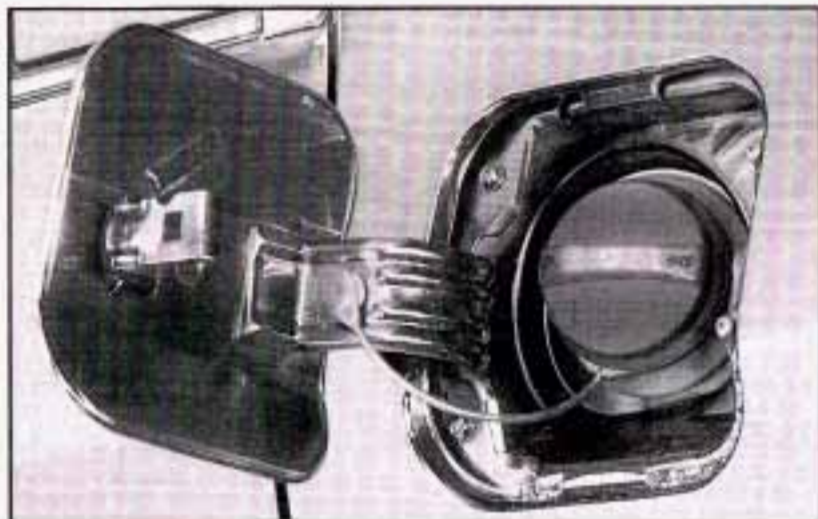

The fuel cap is located behind a hinged fuel door on the driver's side of the vehicle.



To open the fuel door, press the button located on the driver's door trim near the trunk release button.

The ignition does not need to be on. The remote fuel door release will work in all transaxle positions. The trunk release lockout switch must be in OFF for the fuel door to open.

The fuel door can be opened manually in case of a power failure. To do this, first open the trunk. The release mechanism is located on the driver's side of the vehicle, at the top of the trunk compartment.



Pull the tab toward you to release the fuel door.

Notice: Prying on a locked fuel filler door can damage it. Use the remote fuel door manual release located in the trunk in the case of a power failure.

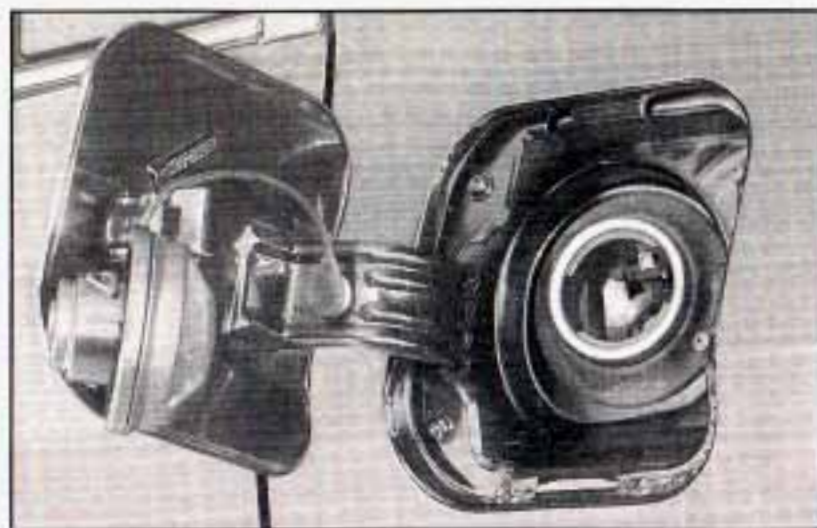

While refueling, hang the tethered fuel cap from the hook on the fuel door.

To remove the fuel cap, turn it slowly to the left (counterclockwise). The fuel cap has a spring in it; if you let go of the cap too soon, it will spring back to the right.

 **CAUTION:**

If you get fuel on yourself and then something ignites it, you could be badly burned. Fuel can spray out on you if you open the fuel cap too quickly. This spray can happen if your tank is nearly full, and is more likely in hot weather. Open the fuel cap slowly and wait for any “hiss” noise to stop. Then unscrew the cap all the way.

Be careful not to spill fuel. Clean fuel from painted surfaces as soon as possible. See *Cleaning the Outside of Your Vehicle* on page 5-85. When filling the tank do not overfill by squeezing in much more fuel after the pump shuts off.

When you put the fuel cap back on, turn it to the right (clockwise) until you hear a clicking sound. Make sure you fully install the cap. The diagnostic system can determine if the fuel cap has been left off or improperly installed. This would allow fuel to evaporate into the atmosphere. See *Malfunction Indicator Lamp* on page 3-39.

The CHECK GAS CAP DIC message will come on if the fuel cap is not properly reinstalled.

Notice: If you need a new fuel cap, be sure to get the right type. Your dealer can get one for you. If you get the wrong type, it may not fit properly. This may cause your malfunction indicator lamp to light and may damage your fuel tank and emissions system. See “Malfunction Indicator Lamp” in the Index.

Filling a Portable Fuel Container

CAUTION:

Never fill a portable fuel container while it is in your vehicle. Static electricity discharge from the container can ignite the gasoline vapor. You can be badly burned and your vehicle damaged if this occurs. To help avoid injury to you and others:

- Dispense gasoline only into approved containers.

CAUTION: (Continued)

CAUTION: (Continued)

- Do not fill a container while it is inside a vehicle, in a vehicle's trunk, pickup bed or on any surface other than the ground.
- Bring the fill nozzle in contact with the inside of the fill opening before operating the nozzle. Contact should be maintained until the filling is complete.
- Don't smoke while pumping gasoline.

Checking Things Under the Hood

CAUTION:

An electric fan under the hood can start up and injure you even when the engine is not running. Keep hands, clothing and tools away from any underhood electric fan.

CAUTION:

Things that burn can get on hot engine parts and start a fire. These include liquids like fuel, oil, coolant, brake fluid, windshield washer and other fluids, and plastic or rubber. You or others could be burned. Be careful not to drop or spill things that will burn onto a hot engine.

Hood Release

To open the hood, do the following:



1. Pull the hood release handle, located to the left of the steering wheel under the instrument panel.

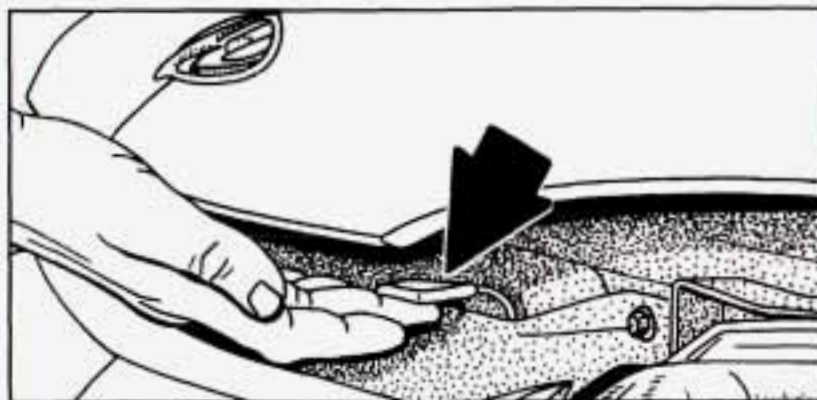

2. Then go to the front of the vehicle and pull up on the secondary hood release.
3. Lift the hood.
Before closing the hood, be sure all the filler caps are on properly. Then pull the hood down and close it firmly.

Engine Compartment Overview

When you open the hood on the engine, here's what you'll see:

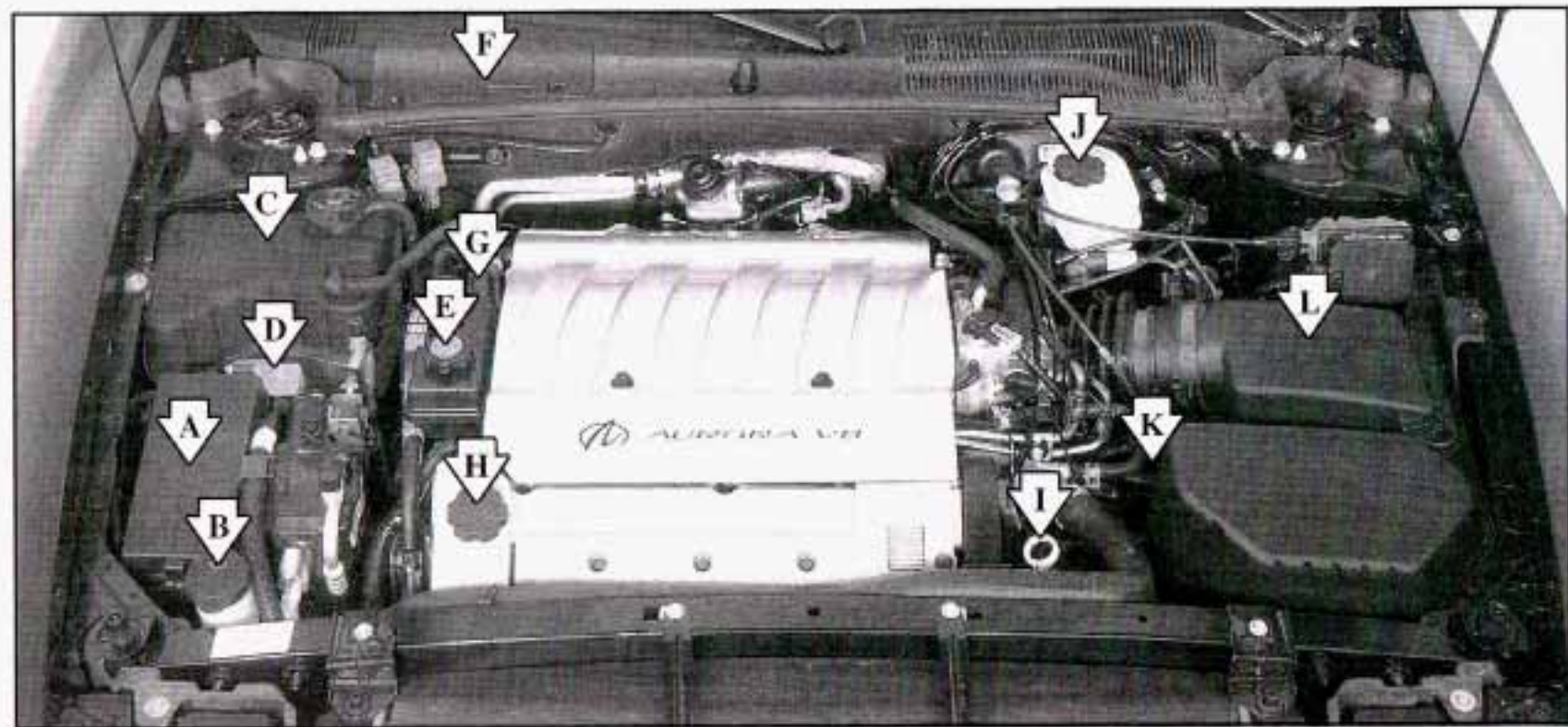

- A. Engine Compartment Fuse Block
- B. Windshield Washer Fluid Reservoir
- C. Engine Coolant Surge Tank
- D. Remote Positive (+) Battery Terminal
- E. Power Steering Fluid Reservoir
- F. Passenger Compartment Air Filter
- G. Remote Negative (-) Terminal
- H. Engine Oil Fill Cap
- I. Engine Oil Dipstick
- J. Brake Fluid Reservoir
- K. Automatic Transaxle Fluid Dipstick
- L. Engine Air Cleaner/Filter

Engine Oil

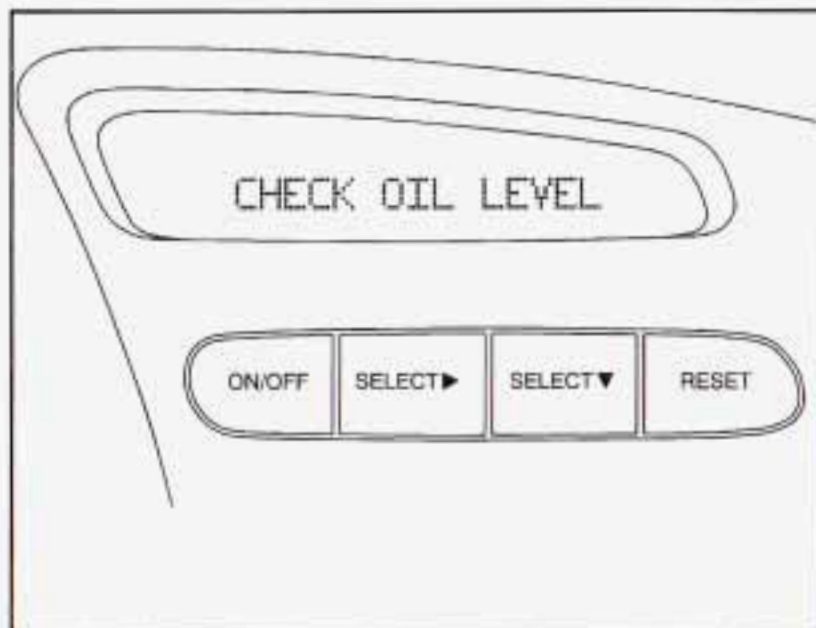

If the CHECK OIL LEVEL message appears on the instrument cluster, it means you need to check your engine oil level right away. For more information, see *DIC Warnings and Messages on page 3-50*.

You should check your engine oil level regularly; this is an added reminder.

Checking Engine Oil

It's a good idea to check your engine oil every time you get fuel. In order to get an accurate reading, the oil must be warm and the vehicle must be on level ground.



The engine oil dipstick is located near the front of the engine compartment. The top of the dipstick is a round yellow loop. See *Engine Compartment Overview on page 5-14* for more information on location.

Turn off the engine and give the oil several minutes to drain back into the oil pan. If you don't, the oil dipstick might not show the actual level.

Pull out the dipstick and clean it with a paper towel or cloth, then push it back in all the way. Remove it again, keeping the tip down, and check the level.



When to Add Engine Oil

If the oil is at or below the cross-hatched area at the tip of the dipstick, then you'll need to add at least one quart of oil. But you must use the right kind. This part explains what kind of oil to use. For engine oil crankcase capacity, see *Capacities and Specifications on page 5-100*.

Notice: Don't add too much oil. If your engine has so much oil that the oil level gets above the upper mark that shows the proper operating range, your engine could be damaged.



The engine oil fill cap is located near the front of the engine compartment. See *Engine Compartment Overview on page 5-14* for more information on location.

Be sure to fill it enough to put the level somewhere in the proper operating range. Push the dipstick all the way back in when you're through.

What Kind of Engine Oil to Use

Oils recommended for your vehicle can be identified by looking for the starburst symbol.

This symbol indicates that the oil has been certified by the American Petroleum Institute (API). Do not use any oil which does not carry this starburst symbol.



If you choose to perform the engine oil change service yourself, be sure the oil you use has the starburst symbol on the front of the oil container. If you have your oil changed for you, be sure the oil put into your engine is American Petroleum Institute certified for gasoline engines.

You should also use the proper viscosity oil for your vehicle, as shown in the viscosity chart.

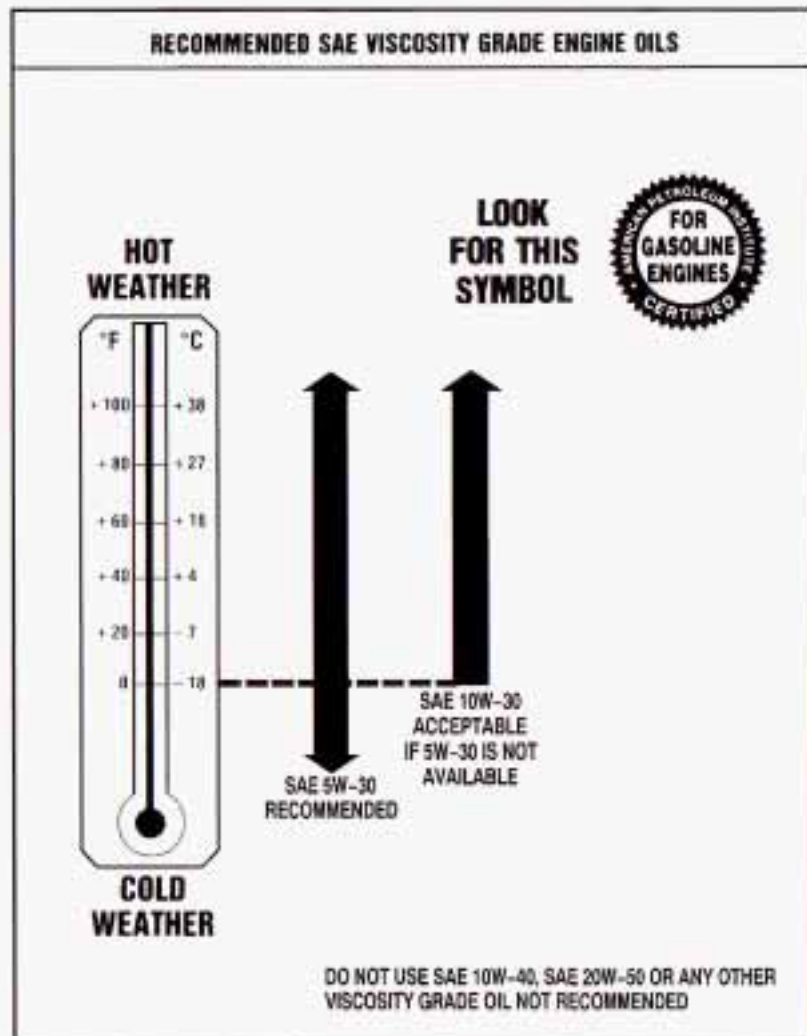

As in the chart shown previously, SAE 5W-30 is the only viscosity grade recommended for your vehicle. You should look for and use only oils which have the API Starburst symbol and which are also identified as SAE 5W-30. If you cannot find such SAE 5W-30 oils, you can use an SAE 10W-30 oil which has the API Starburst symbol, if it's going to be 0°F (-18°C) or above. Do not use other viscosity grade oils, such as SAE 10W-40 or SAE 20W-50 under any conditions.

Notice: Use only engine oil with the American Petroleum Institute Certified For Gasoline Engines starburst symbol. Failure to use the recommended oil can result in engine damage not covered by your warranty.

GM Goodwrench[®] oil meets all the requirements for your vehicle.

If you are in an area of extreme cold, where the temperature falls below -20°F (-29°C), it is recommended that you use either an SAE 5W-30 synthetic oil or an SAE 0W-30 oil. Both will provide easier cold starting and better protection for your engine at extremely low temperatures.

Engine Oil Additives

Don't add anything to your oil. The recommended oils with the starburst symbol are all you will need for good performance and engine protection.

When to Change Engine Oil (GM Oil Life System™)

Your vehicle has a computer system that lets you know when to change the engine oil and filter. This is based on engine revolutions and engine temperature, and not on mileage. Based on driving conditions, the mileage at which an oil change will be indicated can vary considerably. For the oil life system to work properly, you must reset the system every time the oil is changed.

When the system has calculated that oil life has been diminished, it will indicate that an oil change is necessary. A CHANGE OIL SOON message will come on. Change your oil as soon as possible within the next two times you stop for fuel. It is possible that, if you are driving under the best conditions, the oil life system may not indicate that an oil change is necessary for over a year. However, your engine oil and filter must be changed at least once a year and at this time the system must be reset. It is also important to check your oil regularly and keep it at the proper level.

If the system is ever reset accidentally, you must change your oil at 3,000 miles (5,000 km) since your last oil change. Remember to reset the oil life system whenever the oil is changed.

How to Reset the Oil Life System

The GM Oil Life System™ calculates when to change your engine oil and filter based on vehicle use. Anytime your oil is changed, reset the system so it can calculate when the next oil change is required. If a situation occurs where you change your oil prior to a CHANGE OIL SOON message being turned on, reset the system.

Always reset the engine Oil Life System to 100% after every oil change. It will not reset itself.

To reset the OIL LIFE reminder, do the following:

1. With the ignition on, press the SELECT right arrow on the DIC until you enter the OIL mode. The current OIL LIFE percentage will be displayed.
2. Press and hold the DIC RESET button for about five seconds. After five seconds, the display will show OIL LIFE XXX%. If OIL LIFE XXX% does not appear on the display after about five seconds, see your dealer for service. After you release the DIC RESET button, OIL LIFE 100% will appear on the display.

What to Do with Used Oil

Used engine oil contains certain elements that may be unhealthy for your skin and could even cause cancer. Don't let used oil stay on your skin for very long. Clean your skin and nails with soap and water, or a good hand cleaner. Wash or properly dispose of clothing or rags containing used engine oil. See the manufacturer's warnings about the use and disposal of oil products.

Used oil can be a threat to the environment. If you change your own oil, be sure to drain all the oil from the filter before disposal. Never dispose of oil by putting it in the trash, pouring it on the ground, into sewers, or into streams or bodies of water. Instead, recycle it by taking it to a place that collects used oil. If you have a problem properly disposing of your used oil, ask your dealer, a service station or a local recycling center for help.

Engine Air Cleaner/Filter

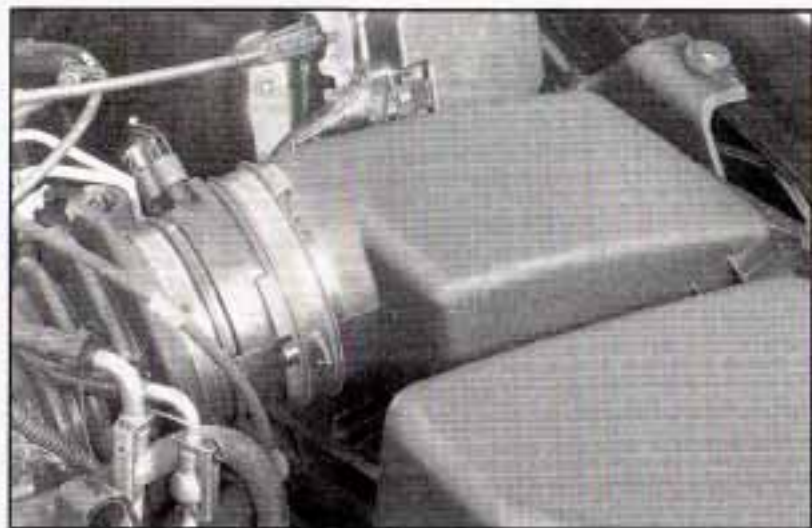

The engine air cleaner/filter is in the engine compartment on the driver's side of the vehicle. See *Engine Compartment Overview* on page 5-14 for more information on location.

To check or replace the engine air cleaner/filter do the following:

1. Unscrew the two wing screws on the outboard side of the housing cover.
2. Remove the cover.
3. Remove the engine air cleaner/filter.

4. Install a new engine air cleaner/filter if needed.
5. Reverse Steps 1 and 2 to reinstall the cover. Be sure the tabs of the cover fit into the slots of the housing.

See *Part A: Scheduled Maintenance Services* on page 6-4 to determine when to replace the air filter.

CAUTION:

Operating the engine with the air cleaner/filter off can cause you or others to be burned. The air cleaner not only cleans the air, it stops flame if the engine backfires. If it isn't there and the engine backfires, you could be burned. Don't drive with it off, and be careful working on the engine with the air cleaner/filter off.

Notice: If the air cleaner/filter is off, a backfire can cause a damaging engine fire. And, dirt can easily get into your engine, which will damage it. Always have the air cleaner/filter in place when you're driving.

Automatic Transaxle Fluid

When to Check and Change

A good time to check your automatic transaxle fluid level is when the engine oil is changed.

Change both the fluid and filter every 50,000 miles (83 000 km) if the vehicle is mainly driven under one or more of these conditions:

- In heavy city traffic where the outside temperature regularly reaches 90°F (32°C) or higher.
- In hilly or mountainous terrain.
- When doing frequent trailer towing.
- Uses such as found in taxi, police or delivery service.

If you do not use your vehicle under any of these conditions, change the fluid and filter at 100,000 miles (166 000 km).

See *Part A: Scheduled Maintenance Services on page 6-4* for automatic transaxle fluid change intervals.

How to Check

Because this operation can be a little difficult, you may choose to have this done at the dealership service department.

If you do it yourself, be sure to follow all the instructions here, or you could get a false reading on the dipstick.

Notice: Too much or too little fluid can damage your transaxle. Too much can mean that some of the fluid could come out and fall on hot engine or exhaust system parts, starting a fire. Too little fluid could cause the transaxle to overheat. Be sure to get an accurate reading if you check your transaxle fluid.

Wait at least 30 minutes before checking the transaxle fluid level if you have been driving:

- When outside temperatures are above 90°F (32°C).
- At high speed for quite a while.
- In heavy traffic – especially in hot weather.
- While pulling a trailer.

To get the right reading, the fluid should be at normal operating temperature, which is 180°F to 200°F (82°C to 93°C).

Get the vehicle warmed up by driving about 15 miles (24 km) when outside temperatures are above 50°F (10°C). If it's colder than 50°F (10°C), you may have to drive longer.

Checking the Fluid Level

Prepare your vehicle as follows:

- Park your vehicle on a level place. Keep the engine running.
- With the parking brake applied, place the shift lever in PARK (P).
- With your foot on the brake pedal, move the shift lever through each gear range, pausing for about three seconds in each range. Then, position the shift lever in PARK (P).
- Let the engine run at idle for three to five minutes.

Then, without shutting off the engine, follow these steps:

The automatic transaxle fluid dipstick is located near the front of the engine compartment on the driver's side of the vehicle. See *Engine Compartment Overview on page 5-14* for more information on location.

1. Pull out the dipstick and wipe it with a clean rag or paper towel.
2. Push it back in all the way, wait three seconds and then pull it back out again.



3. Check both sides of the dipstick, and read the lower level. The fluid level must be in the cross-hatched area.
4. If the fluid level is in the acceptable range, push the dipstick back in all the way.

How to Add Fluid

Refer to the Maintenance Schedule to determine what kind of transaxle fluid to use. See *Part D: Recommended Fluids and Lubricants* on page 6-15.

If the fluid level is low, add only enough of the proper fluid to bring the level into the cross-hatched area on the dipstick.

1. Pull out the dipstick.
2. Using a long-neck funnel, add enough fluid at the dipstick hole to bring it to the proper level.

It doesn't take much fluid, generally less than one pint (0.5 L). *Don't overfill.*

Notice: We recommend you use only fluid labeled DEXRON[®]-III, because fluid with that label is made especially for your automatic transaxle. **Damage caused by fluid other than DEXRON[®]-III is not covered by your new vehicle warranty.**

3. After adding fluid, recheck the fluid level as described under "How to Check," earlier in this section.
4. When the correct fluid level is obtained, push the dipstick back in all the way.

Engine Coolant

The cooling system in your vehicle is filled with DEX-COOL[®] engine coolant. This coolant is designed to remain in your vehicle for 5 years or 150,000 miles (240 000 km), whichever occurs first, if you add only extended life coolant.

The following explains your cooling system and how to add coolant when it is low. If you have a problem with engine overheating, see *Engine Overheating* on page 5-28.

A 50/50 mixture of clean, drinkable water and DEX-COOL[®] coolant will:

- Give freezing protection down to -34°F (-37°C).
- Give boiling protection up to 265°F (129°C).
- Protect against rust and corrosion.
- Help keep the proper engine temperature.
- Let the warning lights and gages work as they should.

Notice: When adding coolant, it is important that you use only DEX-COOL[®] (silicate-free) coolant. If coolant other than DEX-COOL[®] is added to the system, premature engine, heater core or radiator corrosion may result. In addition, the engine coolant will require change sooner -- at 30,000 miles (50,000 km) or 24 months, whichever occurs first. Damage caused by the use of coolant other than DEX-COOL[®] is not covered by your new vehicle warranty.

What to Use

Use a mixture of one-half *clean, drinkable water* and one-half DEX-COOL[®] coolant which won't damage aluminum parts. If you use this coolant mixture, you don't need to add anything else.

CAUTION:

Adding only plain water to your cooling system can be dangerous. Plain water, or some other liquid such as alcohol, can boil before the proper coolant mixture will. Your vehicle's coolant warning system is set for the proper coolant mixture. With plain water or the wrong mixture, your engine could get too hot but you wouldn't get the overheat warning. Your engine could catch fire and you or others could be burned. Use a 50/50 mixture of clean, drinkable water and DEX-COOL[®] coolant.

Notice: If you use an improper coolant mixture, your engine could overheat and be badly damaged. The repair cost wouldn't be covered by your warranty. Too much water in the mixture can freeze and crack the engine, radiator, heater core and other parts.

If you have to add coolant more than four times a year, have your dealer check your cooling system.

Notice: If you use the proper coolant, you don't have to add extra inhibitors or additives which claim to improve the system. These can be harmful.

Checking Coolant



The engine coolant surge tank is located in the engine compartment on the passenger's side of the vehicle, near the windshield. See *Engine Compartment Overview* on page 5-14 for more information on location.

CAUTION:

Turning the surge tank pressure cap when the engine and radiator are hot can allow steam and scalding liquids to blow out and burn you badly. Never turn the surge tank pressure cap — even a little — when the engine and radiator are hot.

The vehicle must be on a level surface. When your engine is cold, the coolant level should be at the cold level mark.

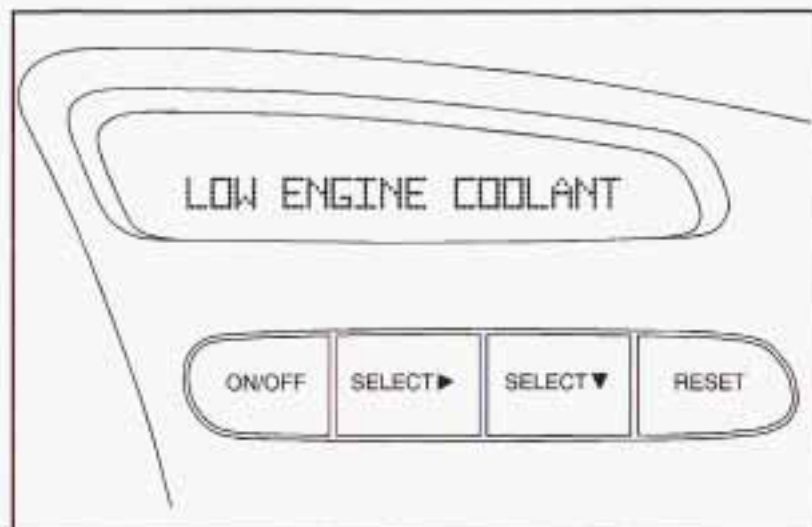

If the LOW ENGINE COOLANT DIC message comes on and stays on, it means you're low on engine coolant.

Adding Coolant

If you need more coolant, add the proper DEX-COOL[®] coolant mixture *at the surge tank*, but only when the engine is cool.

CAUTION:

You can be burned if you spill coolant on hot engine parts. Coolant contains ethylene glycol, and it will burn if the engine parts are hot enough. Don't spill coolant on a hot engine.

When replacing the pressure cap, make sure the arrow lines up with the tube.

Coolant Surge Tank Pressure Cap

The cooling system pressure cap is located on the surge tank.

Notice: Your cooling system pressure cap is a pressure-type cap and must be tightly installed to prevent coolant loss and possible engine damage from overheating.

Engine Overheating

You will find a coolant temperature gage on your vehicle's instrument panel. Your Driver Information Center (DIC) will also display messages about engine overheating. See *Engine Coolant Temperature Gage on page 3-38*.

Overheated Engine Protection Operating Mode

If an overheated engine condition exists and the message HOT STOP ENGINE is displayed, an overheat protection mode which alternates firing groups of cylinders helps prevent engine damage. In this mode, you will notice a loss in power and engine performance. This operating mode allows your vehicle to be driven to a safe place in an emergency. Driving extended miles (km) and/or towing a trailer in the overheat protection mode should be avoided.

Notice: After driving in the overheated engine protection operating mode, to avoid engine damage, allow the engine to cool before attempting any repair. The engine oil will be severely degraded. Repair the cause of coolant loss, change the oil and reset the oil life system. See "Engine Oil" in the Index.

If Steam Is Coming From Your Engine



⚠ CAUTION:

Steam from an overheated engine can burn you badly, even if you just open the hood. Stay away from the engine if you see or hear steam coming from it. Just turn it off and get everyone away from the vehicle until it cools down. Wait until there is no sign of steam or coolant before you open the hood.

If you keep driving when your engine is overheated, the liquids in it can catch fire. You or others could be badly burned. Stop your engine if it overheats, and get out of the vehicle until the engine is cool.

See "Overheated Engine Protection Operating Mode" in the Index for information on driving to a safe place in an emergency.

Notice: If your engine catches fire because you keep driving with no coolant, your vehicle can be badly damaged. The costly repairs would not be covered by your warranty. See "Overheated Engine Protection Operating Mode" in the Index for information on driving to a safe place in an emergency.

If No Steam Is Coming From Your Engine

An overheat warning, along with a low coolant message, can indicate a serious problem. See “Low Coolant Message” under *DIC Warnings and Messages* on page 3-50.

If you get an engine overheat warning with no low coolant message, but see or hear no steam, the problem may not be too serious. Sometimes the engine can get a little too hot when you:

- Climb a long hill on a hot day.
- Stop after high-speed driving.
- Idle for long periods in traffic.
- Tow a trailer.

If you get the overheat warning with no sign of steam, try this for a minute or so:

1. In heavy traffic, let the engine idle in NEUTRAL (N) while stopped. If it is safe to do so, pull off the road, shift to PARK (P) or NEUTRAL (N) and let the engine idle.
2. Turn on your heater to full hot at the highest fan speed and open the window as necessary.

If you no longer have the overheat warning, you can drive. Just to be safe, drive slower for about 10 minutes. If the warning doesn't come back on, you can drive normally.

If the warning continues and you have not stopped, pull over, stop, and park your vehicle right away.

If there's still no sign of steam, you can idle the engine for three minutes while you're parked. If you still have the warning, *turn off the engine and get everyone out of the vehicle* until it cools down. Also, see “Overheated Engine Protection Operating Mode” listed previously in this section.

You may decide not to lift the hood but to get service help right away.

Cooling System

When you decide it's safe to lift the hood, here's what you'll see:

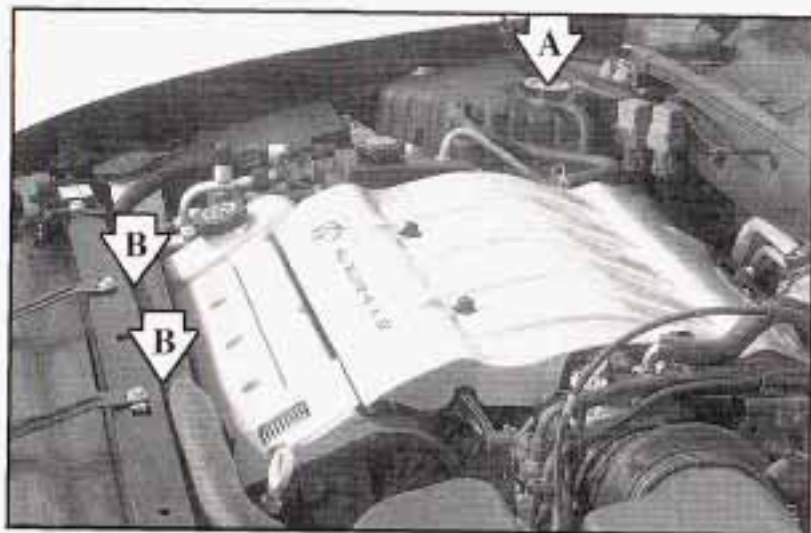

- A. Coolant Surge Tank with Pressure Cap
- B. Two Electric Engine Cooling Fans

CAUTION:

An electric engine cooling fan under the hood can start up even when the engine is not running and can injure you. Keep hands, clothing and tools away from any underhood electric fan.

If the coolant inside the coolant recovery tank is boiling, don't do anything else until it cools down. The vehicle should be parked on a level surface.



A low coolant level should be indicated by a LOW ENGINE COOLANT message on the Driver Information Center. If it is, you may have a leak at the pressure cap or in the radiator hoses, heater hoses, radiator, water pump or somewhere else in the cooling system.

CAUTION:

Heater and radiator hoses, and other engine parts, can be very hot. Don't touch them. If you do, you can be burned.

Don't run the engine if there is a leak. If you run the engine, it could lose all coolant. That could cause an engine fire, and you could be burned. Get any leak fixed before you drive the vehicle.

If there seems to be no leak, with the engine on, check to see if the electric engine cooling fans are running. If the engine is overheating, both fans should be running. If they aren't, your vehicle needs service.

Notice: Engine damage from running your engine without coolant isn't covered by your warranty. See "Overheated Engine Protection Operating Mode" in the Index for information on driving to a safe place in an emergency.

Notice: When adding coolant, it is important that you use only DEX-COOL[®] (silicate-free) coolant. If coolant other than DEX-COOL is added to the system, premature engine, heater core or radiator corrosion may result. In addition, the engine coolant will require change sooner — at 30,000 miles (50 000 km) or 24 months, whichever occurs first. Damage caused by the use of coolant other than DEX-COOL[®] is not covered by your new vehicle warranty.

How to Add Coolant to the Coolant Surge Tank

If you haven't found a problem yet, check to see if coolant is visible in the surge tank. If coolant is visible but the coolant level isn't at or above the FULL COLD fill mark line (4.5 inches (11 cm) from the top of the filler neck), add a 50/50 mixture of *clean, drinkable water* and DEX-COOL[®] coolant at the coolant surge tank, but be sure the cooling system, including the coolant surge tank pressure cap, is cool before you do it. See *Engine Coolant* on page 5-24 for more information.

If no coolant is visible in the surge tank, add coolant as follows:

CAUTION:

Steam and scalding liquids from a hot cooling system can blow out and burn you badly. They are under pressure, and if you turn the coolant surge tank pressure cap -- even a little -- they can come out at high speed. Never turn the cap when the cooling system, including the coolant surge tank pressure cap, is hot. Wait for the cooling system and coolant surge tank pressure cap to cool if you ever have to turn the pressure cap.

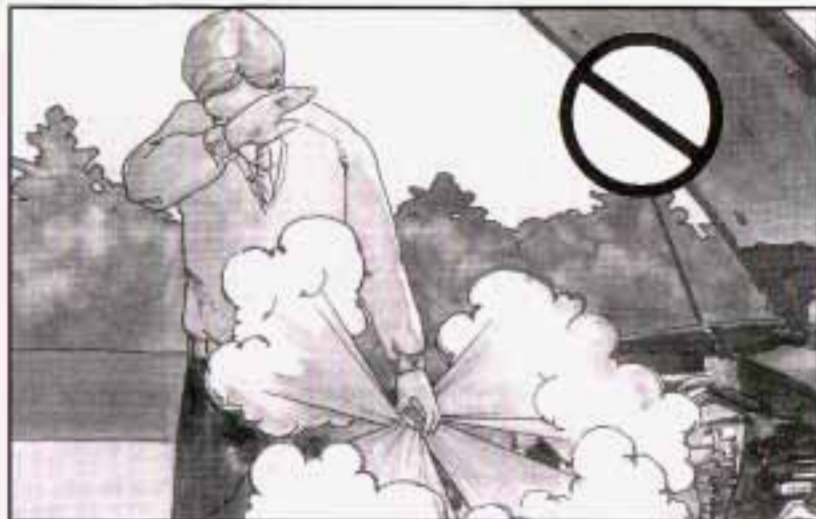

CAUTION: (Continued)

With plain water or the wrong mixture, your engine could get too hot but you wouldn't get the overheat warning. Your engine could catch fire and you or others could be burned. Use a 50/50 mixture of clean, drinkable water and DEX COOL[®] coolant.

Notice: In cold weather, water can freeze and crack the engine, radiator, heater core and other parts. Use the recommended coolant and the proper coolant mixture.

⚠ CAUTION:

Adding only plain water to your cooling system can be dangerous. Plain water, or some other liquid such as alcohol, can boil before the proper coolant mixture will. Your vehicle's coolant warning system is set for the proper coolant mixture.

CAUTION: (Continued)

⚠ CAUTION:

You can be burned if you spill coolant on hot engine parts. Coolant contains ethylene glycol and it will burn if the engine parts are hot enough. Don't spill coolant on a hot engine.



1. Park the vehicle on a level surface. You can remove the coolant surge tank pressure cap when the cooling system, including the coolant surge tank pressure cap and upper radiator hose, is no longer hot. Turn the pressure cap slowly counterclockwise (left) about one-quarter turn and then stop.

If you hear a hiss, wait for that to stop. A hiss means there is still some pressure left.



2. Then keep turning the pressure cap slowly, and remove it.



3. Then fill the coolant surge tank with the proper mixture, to the FULL COLD fill mark line (4.5 inches (11 cm) from the top of the filler neck).



4. With the coolant surge tank pressure cap off, start the engine and let it run until you can feel the upper radiator hose getting hot. Watch out for the engine cooling fans.

By this time, the coolant level inside the coolant surge tank may be lower. If the level is lower, add more of the proper mixture to the coolant surge tank until the level reaches about 4.5 inches (11 cm) from the top of the filler neck.



5. Then replace the pressure cap. Be sure the arrow on the pressure cap lines up like this.

Power Steering Fluid



The power steering fluid reservoir is near the center of the engine compartment on the passenger's side of the vehicle. See *Engine Compartment Overview* on page 5-14 for more information on location.

When to Check Power Steering Fluid

It is not necessary to regularly check power steering fluid unless you suspect there is a leak in the system or you hear an unusual noise. A fluid loss in this system could indicate a problem. Have the system inspected and repaired. See *Engine Compartment Overview* on page 5-14 for reservoir location.

How to Check Power Steering Fluid

Turn the key off, let the engine compartment cool down, wipe the cap and the top of the reservoir clean, then unscrew the cap and wipe the dipstick with a clean rag. Replace the cap and completely tighten it. Then remove the cap again and look at the fluid level on the dipstick.

The level should be at the FULL COLD mark. If necessary, add only enough fluid to bring the level up to the mark.

What to Use

To determine what kind of fluid to use, see *Part D: Recommended Fluids and Lubricants* on page 6-15. Always use the proper fluid. Failure to use the proper fluid can cause leaks and damage hoses and seals.

Windshield Washer Fluid

What to Use

When you need windshield washer fluid, be sure to read the manufacturer's instructions before use. If you will be operating your vehicle in an area where the temperature may fall below freezing, use a fluid that has sufficient protection against freezing. See *Engine Compartment Overview on page 5-14* for reservoir location.

Adding Washer Fluid



Open the cap with the washer symbol on it. Add washer fluid until the tank is full.

Notice:

- When using concentrated washer fluid, follow the manufacturer's instructions for adding water.
- Don't mix water with ready-to-use washer fluid. Water can cause the solution to freeze and damage your washer fluid tank and other parts of the washer system. Also, water doesn't clean as well as washer fluid.
- Fill your washer fluid tank only three-quarters full when it's very cold. This allows for expansion if freezing occurs, which could damage the tank if it is completely full.
- Don't use engine coolant (antifreeze) in your windshield washer. It can damage your washer system and paint.

Brakes

Brake Fluid



Your master cylinder reservoir is on the driver's side of the engine compartment. It is filled with DOT-3 brake fluid. See *Engine Compartment Overview* on page 5-14.

There are only two reasons why the brake fluid level in the reservoir might go down. The first is that the brake fluid goes down to an acceptable level during normal brake lining wear. When new linings are put in, the fluid level goes back up. The other reason is that fluid is leaking out of the brake system. If it is, you should have

your brake system fixed, since a leak means that sooner or later your brakes won't work well, or won't work at all.

So, it isn't a good idea to "top off" your brake fluid. Adding brake fluid won't correct a leak. If you add fluid when your linings are worn, then you'll have too much fluid when you get new brake linings. You should add (or remove) brake fluid, as necessary, only when work is done on the brake hydraulic system

CAUTION:

If you have too much brake fluid, it can spill on the engine. The fluid will burn if the engine is hot enough. You or others could be burned, and your vehicle could be damaged. Add brake fluid only when work is done on the brake hydraulic system.

When your brake fluid falls to a low level, your brake warning light will come on. A chime will sound if you try to drive with this warning light on. See *Brake System Warning Light* on page 3-35.

What to Add

When you do need brake fluid, use only DOT-3 brake fluid. Refer to *Part D: Recommended Fluids and Lubricants* on page 6-15. Use new brake fluid from a sealed container only.

Always clean the brake fluid reservoir cap and the area around the cap before removing it. This will help keep dirt from entering the reservoir.

CAUTION:

With the wrong kind of fluid in your brake system, your brakes may not work well, or they may not even work at all. This could cause a crash. Always use the proper brake fluid.

Notice:

- Using the wrong fluid can badly damage brake system parts. For example, just a few drops of mineral-based oil, such as engine oil, in your brake system can damage brake system parts so badly that they'll have to be replaced. Don't let someone put in the wrong kind of fluid.
- If you spill brake fluid on your vehicle's painted surfaces, the paint finish can be damaged. Be careful not to spill brake fluid on your vehicle. If you do, wash it off immediately. See "Appearance Care" in the Index.

Brake Wear

Your vehicle has four-wheel disc brakes.

Disc brake pads have built-in wear indicators that make a high-pitched warning sound when the brake pads are worn and new pads are needed. The sound may come and go or be heard all the time your vehicle is moving (except when you are pushing on the brake pedal firmly).

CAUTION:

The brake wear warning sound means that soon your brakes won't work well. That could lead to an accident. When you hear the brake wear warning sound, have your vehicle serviced.

Notice: Continuing to drive with worn-out brake pads could result in costly brake repair.

Some driving conditions or climates may cause a brake squeal when the brakes are first applied or lightly applied. This does not mean something is wrong with your brakes.

Properly torqued wheel nuts are necessary to help prevent brake pulsation. When tires are rotated, inspect brake pads for wear and evenly tighten wheel nuts in the proper sequence to GM torque specifications.

Brake linings should always be replaced as complete axle sets.

See *Brake System Inspection* on page 6-14.

Brake Pedal Travel

See your dealer if the brake pedal does not return to normal height, or if there is a rapid increase in pedal travel. This could be a sign of brake trouble.

Brake Adjustment

Every time you apply the brakes, with or without the vehicle moving, your brakes adjust for wear.

Replacing Brake System Parts

The braking system on a vehicle is complex. Its many parts have to be of top quality and work well together if the vehicle is to have really good braking. Your vehicle was designed and tested with top-quality GM brake parts. When you replace parts of your braking system – for example, when your brake linings wear down and you need new ones put in – be sure you get new approved GM replacement parts. If you don't, your brakes may no longer work properly. For example, if someone puts in brake linings that are wrong for your vehicle, the balance between your front and rear brakes can change – for the worse. The braking performance you've come to expect can change in many other ways if someone puts in the wrong replacement brake parts.

Battery

Your new vehicle comes with a maintenance free ACDelco[®] battery. When it's time for a new battery, get one that has the replacement number shown on the original battery's label. We recommend an ACDelco battery.

Warning: Battery posts, terminals and related accessories contain lead and lead compounds, chemicals known to the State of California to cause cancer and reproductive harm. Wash hands after handling.

The battery is located under the rear seat cushion. To access the battery, see *Removing the Rear Seat Cushion on page 5-95*. You don't need to access the battery to jump start your vehicle. See *Jump Starting on page 5-44*.

CAUTION:

A battery that isn't properly vented can let sulfuric acid fumes into the area under the rear seat cushion. These fumes can damage your rear seat safety belt systems. You may not be able to see this damage, and the safety belts might not provide the protection needed in a crash. If a replacement battery is ever needed, it must be vented in the same manner as the original battery. Always make sure that the vent hose is properly reattached before reinstalling the seat cushion.

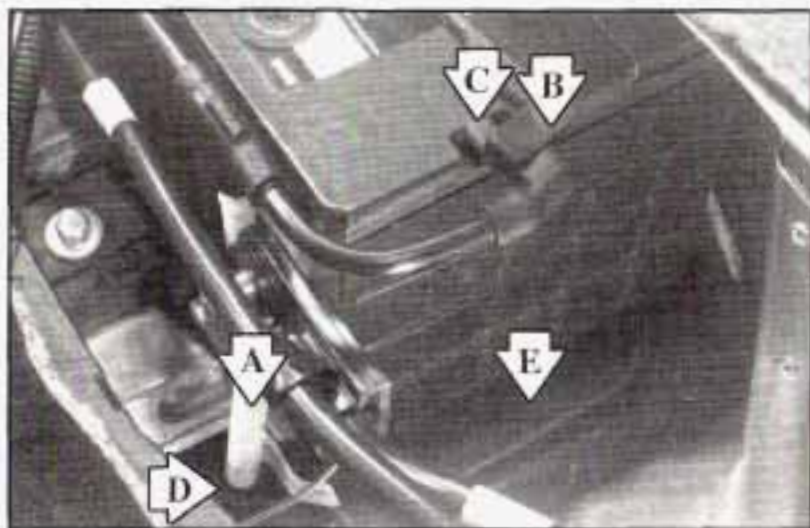

To be sure the vent hose (A) is properly attached, the vent hose connectors (B) must be securely reattached to the vent outlets (C) on each side of the battery, and the vent assembly grommet (D) must be secured to the floor pan (E).

Vehicle Storage

If you're not going to drive your vehicle for 25 days or more, remove the black, negative (-) cable from the battery. This will help keep your battery from running down.

CAUTION:

Batteries have acid that can burn you and gas that can explode. You can be badly hurt if you aren't careful. See "Jump Starting" next for tips on working around a battery without getting hurt.

Contact your dealer to learn how to prepare your vehicle for longer storage periods.

Also, for your audio system, see *Theft-Deterrent Feature* on page 3-73.

Jump Starting

If your battery has run down, you may want to use another vehicle and some jumper cables to start your vehicle. Be sure to follow the steps below to do it safely.

CAUTION:

Batteries can hurt you. They can be dangerous because:

- They contain acid that can burn you.
- They contain gas that can explode or ignite.
- They contain enough electricity to burn you.

If you don't follow these steps exactly, some or all of these things can hurt you.

Notice: Ignoring these steps could result in costly damage to your vehicle that wouldn't be covered by your warranty.

Trying to start your vehicle by pushing or pulling it won't work, and it could damage your vehicle.

1. Check the other vehicle. It must have a 12-volt battery with a negative ground system.

Notice: If the other system isn't a 12-volt system with a negative ground, both vehicles can be damaged.

2. Get the vehicles close enough so the jumper cables can reach, but be sure the vehicles aren't touching each other. If they are, it could cause a ground connection you don't want. You wouldn't be able to start your vehicle, and the bad grounding could damage the electrical systems.

To avoid the possibility of the vehicles rolling, set the parking brake firmly on both vehicles involved in the jump start procedure. Put an automatic transaxle in PARK (P) or a manual transaxle in NEUTRAL before setting the parking brake.

Notice: If you leave your radio on, it could be badly damaged. The repairs wouldn't be covered by your warranty.

3. Turn off the ignition on both vehicles. Unplug unnecessary accessories plugged into the cigarette lighter or in the accessory power outlet. Turn off the radio and all lamps that aren't needed. This will avoid sparks and help save both batteries. And it could save your radio!

4. Open the hood on the other vehicle and locate the positive (+) and the negative (-) terminal locations on that vehicle.

Open the hood on your vehicle and find the remote positive (+) terminal located in the engine compartment on the passenger side of the vehicle.



5. To access the remote positive (+) terminal, remove the cover.

Your vehicle has a remote negative (-) terminal, marked "GND," located near the power steering fluid reservoir.

See *Engine Compartment Overview* on page 5-14 for more information on location.

You will not see the battery of your vehicle under the hood. It is located under the rear passenger seat. You will not need to access the battery for jump starting. The remote positive (+) terminal is for that purpose.

⚠ CAUTION:

An electric fan can start up even when the engine is not running and can injure you. Keep hands, clothing and tools away from any underhood electric fan.

 **CAUTION:**

Using a match near a battery can cause battery gas to explode. People have been hurt doing this, and some have been blinded. Use a flashlight if you need more light.

Be sure the battery has enough water. You don't need to add water to the ACDelco[®] battery installed in your new vehicle. But if a battery has filler caps, be sure the right amount of fluid is there. If it is low, add water to take care of that first. If you don't, explosive gas could be present.

Battery fluid contains acid that can burn you. Don't get it on you. If you accidentally get it in your eyes or on your skin, flush the place with water and get medical help immediately.

 **CAUTION:**

Fans or other moving engine parts can injure you badly. Keep your hands away from moving parts once the engine is running.

6. Check that the jumper cables don't have loose or missing insulation. If they do, you could get a shock. The vehicles could be damaged too.

Before you connect the cables, here are some basic things you should know. Positive (+) will go to positive (+) or to a remote positive (+) terminal if the vehicle has one. Negative (-) will go to a heavy, unpainted metal engine part or to a remote negative (-) terminal if the vehicle has one.

Don't connect positive (+) to negative (-) or you'll get a short that would damage the battery and maybe other parts too. And don't connect the negative (-) cable to the negative (-) terminal on the dead battery because this can cause sparks.

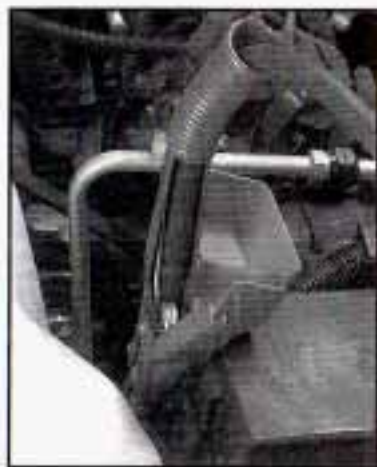

7. Connect the red positive (+) cable to the remote positive (+) terminal of the dead battery. Use a remote positive (+) terminal if the vehicle has one.



9. Now connect the black negative (-) cable to the negative (-) terminal of the good battery. Use a remote negative (-) terminal if the vehicle has one.



8. Don't let the other end touch metal. Connect it to the positive (+) terminal of the good battery. Use a remote positive (+) terminal if the vehicle has one.

Don't let the other end touch anything until the next step. The other end of the negative (-) cable *doesn't* go to the dead battery. It goes to a heavy, unpainted metal engine part or to a remote negative (-) terminal on the vehicle with the dead battery.



10. Connect the other end of the negative (-) cable at least 18 inches (45 cm) away from the dead battery, but not near engine parts that move.

11. Now start the vehicle with the good battery and run the engine for a while.
12. Try to start the vehicle that had the dead battery. If it won't start after a few tries, it probably needs service.

Notice: Damage to your vehicle may result from electrical shorting if jumper cables are removed incorrectly. To prevent electrical shorting, take care that the cables don't touch each other or any other metal. The repairs wouldn't be covered by your warranty.

The electrical connection is just as good there, and the chance of sparks getting back to the battery is much less.

Use a remote negative (-) terminal if the vehicle has one. Your vehicle has a remote negative (-) terminal marked "GND."

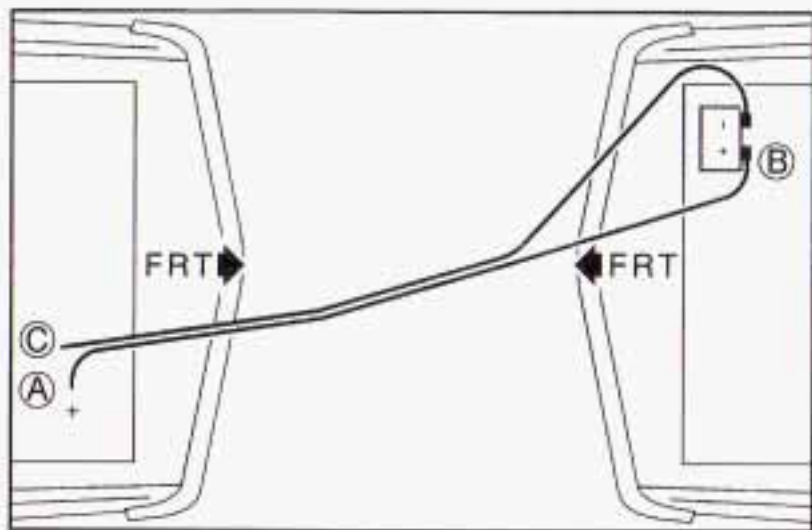

Jumper Cable Removal

- A. Dead Battery or Remote positive (+) Terminal
- B. Good Battery or Remote positive (+) or Remote Negative (-) Terminals
- C. Heavy, Unpainted Metal Engine Part or Remote Negative (-) Terminal

To disconnect the jumper cables from both vehicles, do the following:

1. Disconnect the black negative (-) cable from the vehicle that had the dead battery.
2. Disconnect the black negative (-) cable from the vehicle with the good battery.
3. Disconnect the red positive (+) cable from the vehicle with the good battery.
4. Disconnect the red positive (+) cable from the other vehicle.
5. Return the positive (+) remote terminal cover to its original position.

Headlamp Aiming

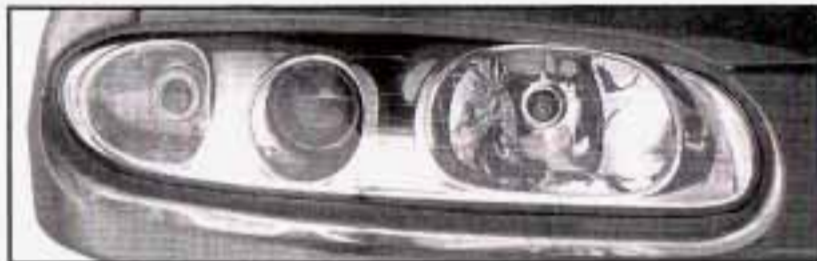

Your vehicle has a visual optical headlamp aiming system equipped with horizontal aim indicators. The aim has been preset at the factory and should need no further adjustment. This is true even though your horizontal aim indicators may not fall exactly on the "0" (zero) marks on their scales.

If your vehicle is damaged in an accident, the headlamp aim may be affected. Aim adjustment to the low beam may be necessary if it is difficult to see lane markers (for horizontal aim), or if oncoming drivers flash their high beams at you (for vertical aim). If you believe your headlamps need to be re-aimed, we recommend that you take your vehicle to your dealer for service. However, it is possible for you to re-aim your headlamps as described in the following procedure.

Notice: To make sure your headlamps are aimed properly, read all the instructions before beginning. Failure to follow these instructions could cause damage to headlamp parts.

The vehicle should be properly prepared as follows:

- The vehicle should be placed so the headlamps are 25 ft. (7.6 m) from a light colored wall or other flat surface.
- The vehicle must have all four tires on a perfectly level surface which is level all the way to the wall or other flat surface.
- The vehicle should be placed so it is perpendicular to the wall or other flat surface.
- The vehicle should not have any snow, ice or mud attached to it.
- The vehicle should be fully assembled and all other work stopped while headlamp aiming is being done.
- The vehicle should be normally loaded with a full tank of fuel and one person or 160 lbs (75 kg) on the driver's seat.
- Tires should be properly inflated.

Headlamp aiming is done with the vehicle's low beam lamps. The high beam lamps will be correctly aimed if the low beam lamps are aimed properly.

The headlamp aiming devices are under the hood near the headlamps.



If you believe your headlamps need horizontal (left/right) adjustment, follow the horizontal aiming procedure. If you believe your headlamps need only vertical (up/down) adjustment, follow only the vertical aiming procedure.

Adjustment screws can be turned with an E8 Torx[®] socket or T15 Torx[®] screwdriver.

Headlamp Horizontal Aiming

Turn the horizontal aiming screw (A) until the indicator (B) is lined up with zero.

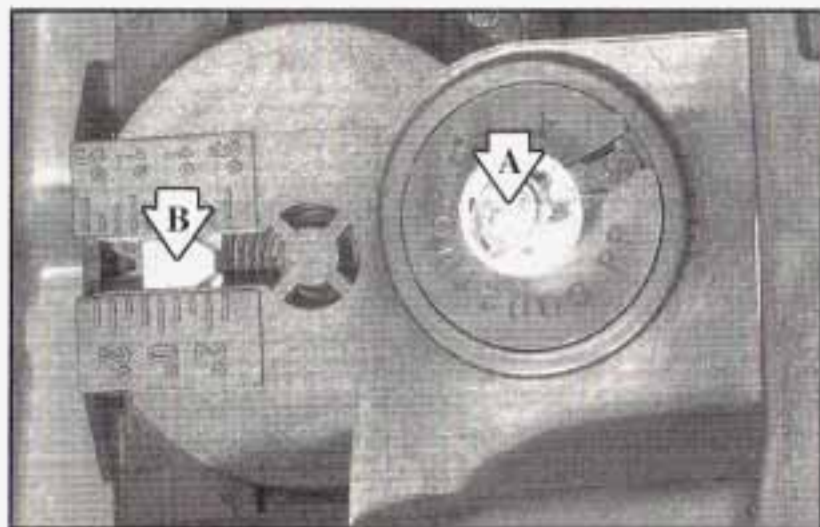

Once the horizontal aim is adjusted, then adjust the vertical aim.

Headlamp Vertical Aiming

Notice: Horizontal aiming must be performed before making any adjustments to the vertical aim. Adjusting the vertical aim first will result in an incorrect headlamp aim.

1. Find the aim dot on the lens of the low beam lamps.

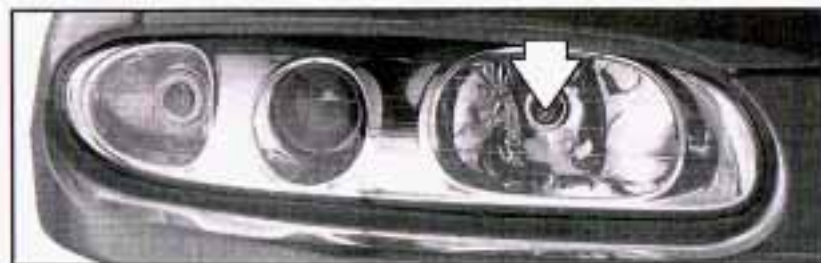

2. Measure the distance from the ground to the aim dot on each lamp; if left low beam, subtract two inches. Record this distance.
3. At the wall or other flat surface, measure from the ground upward the recorded distance from Step 2 and draw or tape a horizontal line the width of the vehicle.

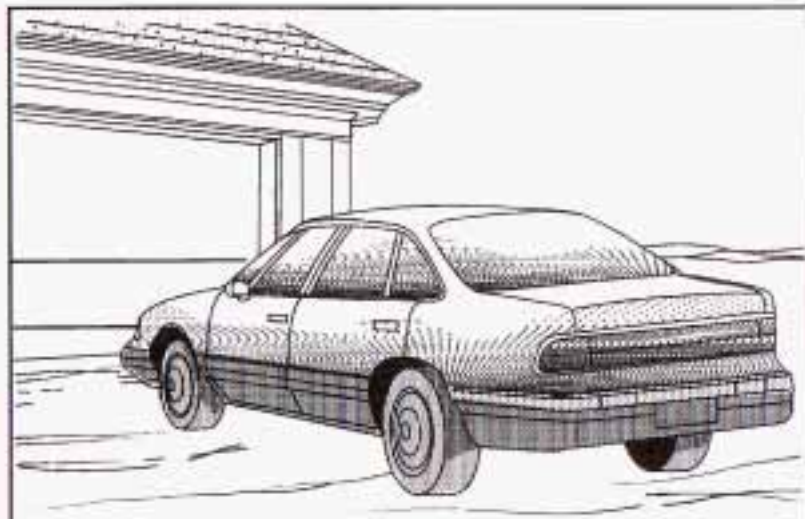

4. Turn on the low-beam headlamps and place a piece of cardboard or equivalent in front of the headlamp not being aimed. This should allow only the beam of light from the headlamp being aimed to be seen on the flat surface.

Notice: Do not cover a headlamp to improve beam cut-off when aiming. Covering a headlamp may cause excessive heat build-up which may cause damage to the headlamp.

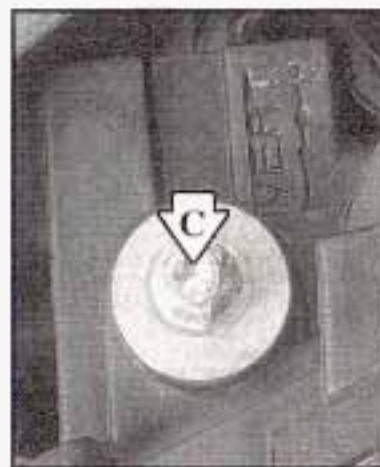
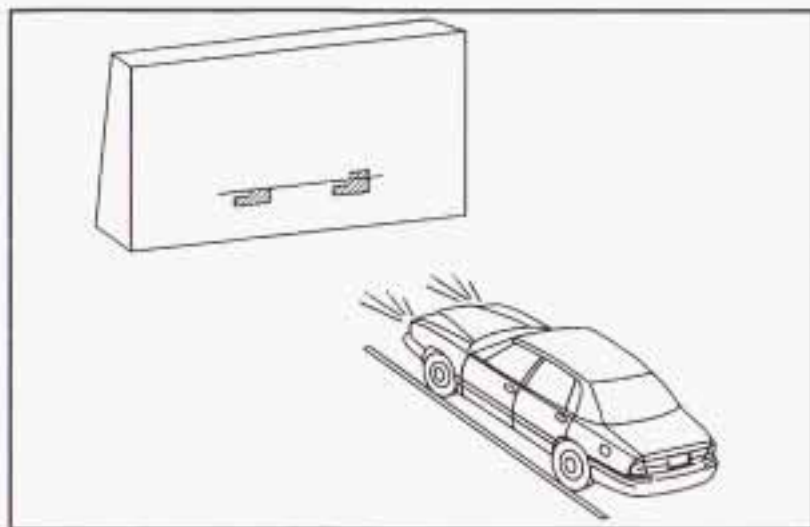

5. Turn the vertical aiming screw (C) until the headlamp beam is aimed to the horizontal tape line.

The top edge of the cut-off should be positioned at the bottom edge of the horizontal tape line.

6. Repeat Steps 4 and 5 for the opposite headlamp.

Bulb Replacement

For the type of bulb to use, see *Replacement Bulbs on page 5-58*.

For any bulb changing procedure not listed in this section, contact your dealer.

Halogen Bulbs



⚠ CAUTION:

Halogen bulbs have pressurized gas inside and can burst if you drop or scratch the bulb. You or others could be injured. Be sure to read and follow the instructions on the bulb package.

Headlamps



1. Remove the two bolts from the headlamp assembly.
2. Use a large screwdriver by the outside mount to separate the lamp assembly from the outboard snap mounting pin. Slide the headlamp assembly outward and lift it out.



3. Disconnect the wiring harness from the headlamp assembly.



4. Lift the tabs to remove the bulb from the assembly.
5. Replace the bulb.
6. Push the bulb assembly in and turn it clockwise to install the bulb assembly into the headlamp assembly.
7. Then reconnect the wiring harness to the lamp assembly.

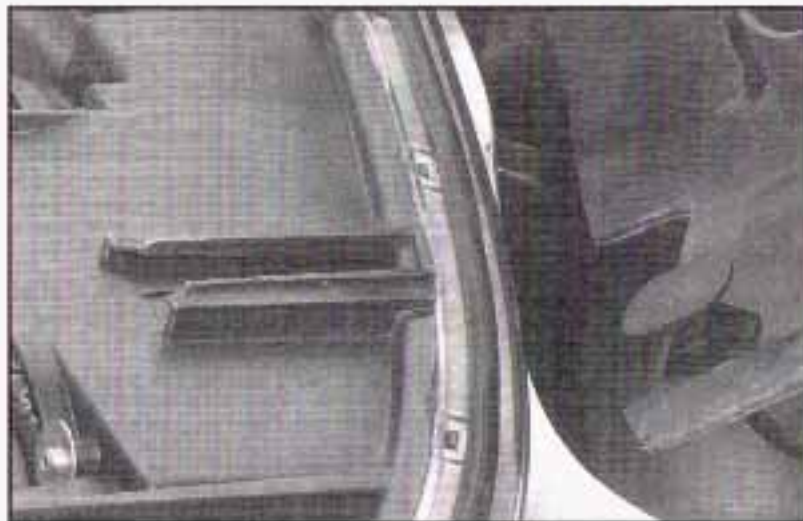

8. Slide the lamp assembly back into place by lining up the track on the bottom of the assembly with the guide on the vehicle.
9. Then connect the outboard snap mounting pin.
10. Secure the lamp assembly with the two bolts.

Front Turn Signal and Parking Lamps

Once the headlamp assembly has been removed from the vehicle, the front turn signal and parking lamps can be accessed. See *Headlamps on page 5-55* for more information on location.



1. Tip the headlamp assembly and while pressing the release, turn the bulb and socket counterclockwise to remove them.
2. Replace the bulb in the socket.
3. Then reconnect the socket wiring harness to the lamp assembly.
4. Reinstall the headlamp assembly into the vehicle.

Taillamps, Turn Signal, Stoplamps and Back-up Lamps

1. Open the trunk.
2. Turn the screws located inside of the trunk counterclockwise and remove them.
3. Remove the plastic trim piece from the trunk.
4. Pull the carpeting away from the rear corner of the trunk.



5. Remove the three nuts holding the lamp in place and remove the lamp assembly.
6. While pressing the release, turn the bulb socket assembly counterclockwise to remove it from the lamp assembly.
7. Pull the bulb straight out to remove it from the socket.
8. Replace the bulb and reverse the steps to reinstall the lamp assembly.

Replacement Bulbs

Exterior Lamp	Bulb Number
Front	
Low Beam Headlamps	9006
High Beam Headlamps	9005
Front Turn Signal Lamps	3157NA
Rear	
Back-Up Lamps	3155
Stop/Taillamps	3057
Rear Turn Signal Lamps	3057
For any bulb not listed here contact your dealer.	

Windshield Wiper Blade Replacement

Windshield wiper blades should be inspected at least twice a year for wear or cracking. See "Wiper Blade Check" under *Part B: Owner Checks and Services on page 6-9* for more information.

To replace the wiper blade assembly do the following:

1. Lift the wiper up from the windshield and set it into the vertically-locked position.

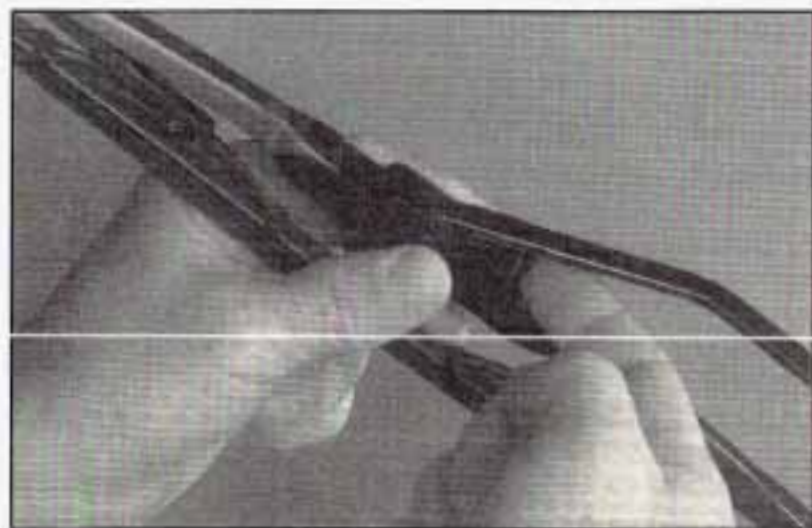

2. Push the tab on the wiper blade assembly and pull the assembly down enough to release it from the "U" hooked end of the wiper arm. Slide the assembly away from the arm.
3. Remove the blade.
4. To reinstall the wiper blade assembly, slide it over the wiper arm to engage the "U" hooked end on the wiper blade assembly. Pull up on the assembly to lock it into place.

For the proper windshield wiper blade assembly replacement length and type, see *Normal Maintenance Replacement Parts on page 5-101*.

Tires

Your new vehicle comes with high-quality tires made by a leading tire manufacturer. If you ever have questions about your tire warranty and where to obtain service, see your Oldsmobile Warranty booklet for details.

CAUTION:

Poorly maintained and improperly used tires are dangerous.

- **Overloading your tires can cause overheating as a result of too much friction. You could have an air-out and a serious accident. See "Loading Your Vehicle" in the Index.**
- **Underinflated tires pose the same danger as overloaded tires. The resulting accident could cause serious injury. Check all tires frequently to maintain the recommended pressure. Tire pressure should be checked when your tires are cold.**

CAUTION: (Continued)

CAUTION: (Continued)

- **Overinflated tires are more likely to be cut, punctured or broken by a sudden impact — such as when you hit a pothole. Keep tires at the recommended pressure.**
- **Worn, old tires can cause accidents. If your tread is badly worn, or if your tires have been damaged, replace them.**

Inflation -- Tire Pressure

The Tire-Loading Information label, which is on the rear edge of the driver's door, shows the correct inflation pressures for your tires when they're cold. "Cold" means your vehicle has been sitting for at least three hours or driven no more than 1 mile (1.6 km).

Notice: Don't let anyone tell you that underinflation or overinflation is all right. It's not. If your tires don't have enough air (underinflation), you can get the following:

- Too much flexing
- Too much heat
- Tire overloading
- Bad wear
- Bad handling
- Bad fuel economy

If your tires have too much air (overinflation), you can get the following:

- Unusual wear
- Bad handling
- Rough ride
- Needless damage from road hazards

When to Check

Check your tires once a month or more.

Don't forget your compact spare tire. It should be at 60 psi (420 kPa).

How to Check

Use a good quality pocket-type gage to check tire pressure. You can't tell if your tires are properly inflated simply by looking at them. Radial tires may look properly inflated even when they're underinflated.

Be sure to put the valve caps back on the valve stems. They help prevent leaks by keeping out dirt and moisture.

Check Tire Pressure System

The check tire pressure system can alert you to a large change in the pressure of one tire. The system won't alert you before you drive that a tire is low or flat. You must begin driving before the system will work properly.

The LOW TIRE PRESSURE message will appear on the Driver Information Center (DIC) if pressure difference (low pressure) is detected in one tire. The check tire pressure system may not alert you if:

- more than one tire is low,
- the vehicle is moving faster than 65 mph (105 km/h),
- the system is not yet calibrated,
- the tire treadwear is uneven,
- the compact spare tire is installed,
- tire chains are being used, or
- the vehicle is being driven on a rough or frozen road.

If the anti-lock brake system warning light comes on, the check tire pressure system may not be working properly. See your dealer for service. Also, see *Anti-Lock Brake System Warning Light on page 3-36*.

The check tire pressure system detects differences in tire rotation speeds that are caused by changes in tire pressure. The system can alert you about a low tire – but it doesn't replace normal tire maintenance. See *Tires on page 5-60*.

When the LOW TIRE PRESSURE message appears on the Driver Information Center, you should stop as soon as you can and check all your tires for damage. If a tire is flat, see *If a Tire Goes Flat on page 5-70*. Also check the tire pressure in all four tires as soon as you can. See *Inflation -- Tire Pressure on page 5-60*.

Any time you adjust a tire's pressure or have one or more tires repaired or replaced, you'll need to reset (calibrate) the check tire pressure system. You'll also need to reset the system whenever you rotate the tires, buy new tires and install or remove the compact spare.

Don't reset the check tire pressure system without first correcting the cause of the problem and checking and adjusting the pressure in all four tires. If you reset the system when the tire pressures are incorrect, the check tire pressure system will not work properly and may not alert you when a tire is low or high.

To reset (calibrate) the system:

1. Turn the ignition switch to ON.
2. Press the SELECT right arrow on the DIC until you enter the GAGE mode. Then press the SELECT down arrow until TIRE PRESSURE appears on the display.
3. Press and hold the DIC RESET button for about five seconds. After five seconds, the display will show TIRE PRESSURE RESET. If TIRE PRESSURE RESET does not appear on the display after about five seconds, see your dealer for service. After you release the DIC RESET button, TIRE PRESSURE NORMAL will appear on the display.

The system completes the calibration process during driving. Calibration time can take 45 to 90 minutes, depending on your driving habits. After the system has been calibrated, the system will alert the driver that a tire is low, up to a maximum speed of 65 mph (105 km/h).

Tire Inspection and Rotation

Tires should be rotated every 7,500 miles (12 500 km).

Any time you notice unusual wear, rotate your tires as soon as possible and check wheel alignment. Also check for damaged tires or wheels. See *When It Is Time for New Tires on page 5-65* and *Wheel Replacement on page 5-68* for more information.

The purpose of regular rotation is to achieve more uniform wear for all tires on the vehicle. The first rotation is the most important. See "Part A: Scheduled Maintenance Services," in Section 6, for scheduled rotation intervals.

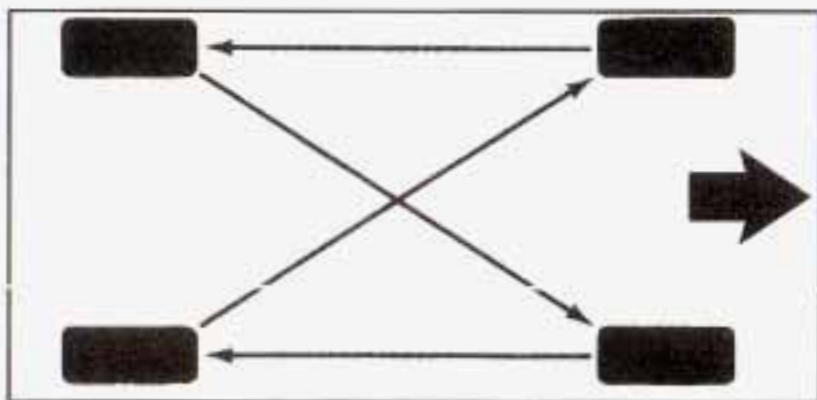

When rotating your tires, always use the correct rotation pattern shown here.

Don't include the compact spare tire in your tire rotation.

After the tires have been rotated, adjust the front and rear inflation pressures as shown on the Tire-Loading Information label.

Reset the Check Tire Pressure System. See *Check Tire Pressure System on page 5-62*.

Make certain that all wheel nuts are properly tightened. See *Wheel Nut Torque in Capacities and Specifications on page 5-100*.

 **CAUTION:**

Rust or dirt on a wheel, or on the parts to which it is fastened, can make wheel nuts become loose after a time. The wheel could come off and cause an accident. When you change a wheel, remove any rust or dirt from places where the wheel attaches to the vehicle. In an emergency, you can use a cloth or a paper towel to do this; but be sure to use a scraper or wire brush later, if you need to, to get all the rust or dirt off. See "Changing a Flat Tire" in the Index.

When It Is Time for New Tires

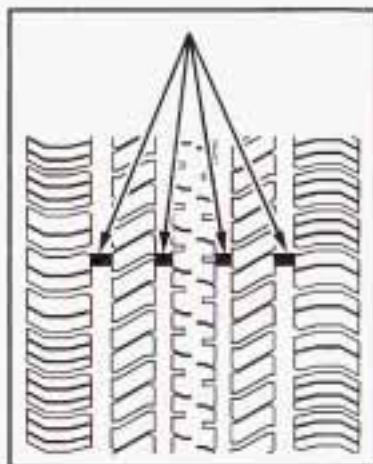

One way to tell when it's time for new tires is to check the treadwear indicators, which will appear when your tires have only 1/16 inch (1.6 mm) or less of tread remaining.

You need a new tire if any of the following statements are true:

- You can see the indicators at three or more places around the tire.
- You can see cord or fabric showing through the tire's rubber.
- The tread or sidewall is cracked, cut or snagged deep enough to show cord or fabric.
- The tire has a bump, bulge or split.
- The tire has a puncture, cut or other damage that can't be repaired well because of the size or location of the damage.

Buying New Tires

To find out what kind and size of tires you need, look at the Tire-Loading Information label.

The tires installed on your vehicle when it was new had a Tire Performance Criteria Specification (TPC Spec) number on each tire's sidewall. When you get new tires, get ones with that same TPC Spec number. That way your vehicle will continue to have tires that are designed to give proper endurance, handling, speed rating, traction, ride and other things during normal service on your vehicle. If your tires have an all-season tread design, the TPC number will be followed by an "MS" (for mud and snow).

If you ever replace your tires with those not having a TPC Spec number, make sure they are the same size, load range, speed rating and construction type (bias, bias-belted or radial) as your original tires.

CAUTION:

Mixing tires could cause you to lose control while driving. If you mix tires of different sizes or types (radial and bias-belted tires), the vehicle may not handle properly, and you could have a crash. Using tires of different sizes may also cause damage to your vehicle. Be sure to use the same size and type tires on all wheels. It's all right to drive with your compact spare, though. It was developed for use on your vehicle.

CAUTION:

If you use bias-ply tires on your vehicle, the wheel rim flanges could develop cracks after many miles of driving. A tire and/or wheel could fail suddenly, causing a crash. Use only radial-ply tires with the wheels on your vehicle.

Uniform Tire Quality Grading

Quality grades can be found where applicable on the tire sidewall between tread shoulder and maximum section width. For example:

Treadwear 200 Traction AA Temperature A

The following information relates to the system developed by the United States National Highway Traffic Safety Administration, which grades tires by treadwear, traction and temperature performance. (This applies only to vehicles sold in the United States.)

The grades are molded on the sidewalls of most passenger car tires. The Uniform Tire Quality Grading system does not apply to deep tread, winter-type snow tires, space-saver or temporary use spare tires, tires with nominal rim diameters of 10 to 12 inches (25 to 30 cm), or to some limited-production tires.

While the tires available on General Motors passenger cars and light trucks may vary with respect to these grades, they must also conform to federal safety requirements and additional General Motors Tire Performance Criteria (TPC) standards.

Treadwear

The treadwear grade is a comparative rating based on the wear rate of the tire when tested under controlled conditions on a specified government test course. For example, a tire graded 150 would wear one and a half (1.5) times as well on the government course as a tire graded 100. The relative performance of tires depends upon the actual conditions of their use, however, and may depart significantly from the norm due to variations in driving habits, service practices and differences in road characteristics and climate.

Traction – AA, A, B, C

The traction grades, from highest to lowest, are AA, A, B, and C. Those grades represent the tire's ability to stop on wet pavement as measured under controlled conditions on specified government test surfaces of asphalt and concrete. A tire marked C may have poor traction performance. Warning: The traction grade assigned to this tire is based on straight-ahead braking traction tests, and does not include acceleration, cornering, hydroplaning, or peak traction characteristics.

Temperature – A, B, C

The temperature grades are A (the highest), B, and C, representing the tire's resistance to the generation of heat and its ability to dissipate heat when tested under controlled conditions on a specified indoor laboratory test wheel. Sustained high temperature can cause the material of the tire to degenerate and reduce tire life, and excessive temperature can lead to sudden tire failure. The grade C corresponds to a level of performance which all passenger car tires must meet under the Federal Motor Vehicle Safety Standard No. 109. Grades B and A represent higher levels of performance on the laboratory test wheel than the minimum required by law.

Warning: The temperature grade for this tire is established for a tire that is properly inflated and not overloaded. Excessive speed, underinflation, or excessive loading, either separately or in combination, can cause heat buildup and possible tire failure.

Wheel Alignment and Tire Balance

The wheels on your vehicle were aligned and balanced carefully at the factory to give you the longest tire life and best overall performance.

Scheduled wheel alignment and wheel balancing are not needed. However, if you notice unusual tire wear or your vehicle pulling one way or the other, the alignment may need to be reset. If you notice your vehicle vibrating when driving on a smooth road, your wheels may need to be rebalanced.

Wheel Replacement

Replace any wheel that is bent, cracked or badly rusted or corroded. If wheel nuts keep coming loose, the wheel, wheel bolts and wheel nuts should be replaced. If the wheel leaks air, replace it (except some aluminum wheels, which can sometimes be repaired). See your dealer if any of these conditions exist.

Your dealer will know the kind of wheel you need.

Each new wheel should have the same load-carrying capacity, diameter, width, offset and be mounted the same way as the one it replaces.

If you need to replace any of your wheels, wheel bolts or wheel nuts, replace them only with new GM original equipment parts. This way, you will be sure to have the right wheel, wheel bolts and wheel nuts for your vehicle.

 **CAUTION:**

Using the wrong replacement wheels, wheel bolts or wheel nuts on your vehicle can be dangerous. It could affect the braking and handling of your vehicle, make your tires lose air and make you lose control. You could have a collision in which you or others could be injured. Always use the correct wheel, wheel bolts and wheel nuts for replacement.

Notice: The wrong wheel can also cause problems with bearing life, brake cooling, speedometer or odometer calibration, headlamp aim, bumper height, vehicle ground clearance and tire or tire chain clearance to the body and chassis.

See *Changing a Flat Tire* on page 5-71 for more information.

Used Replacement Wheels

 **CAUTION:**

Putting a used wheel on your vehicle is dangerous. You can't know how it's been used or how far it's been driven. It could fail suddenly and cause a crash. If you have to replace a wheel, use a new GM original equipment wheel.

Tire Chains

CAUTION:

If your vehicle has P235/55R17 size tires, don't use tire chains, there's not enough clearance.

Tire chains used on a vehicle without the proper amount of clearance can cause damage to the brakes, suspension or other vehicle parts. The area damaged by the tire chains could cause you to lose control of your vehicle and you or others may be injured in a crash.

Use another type of traction device only if its manufacturer recommends it for use on your vehicle and tire size combination and road conditions. Follow that manufacturer's instructions. To help avoid damage to your vehicle, drive slowly, readjust or remove the device if it's contacting your vehicle, and don't spin your wheels.

If you do find traction devices that will fit, install them on the front tires.

Notice: If your vehicle has a tire size other than P235/55R17 size tires, use tire chains only where legal and only when you must. Use only SAE Class "S" type chains that are the proper size for your tires. Install them on the front tires and tighten them as tightly as possible with the ends securely fastened. Drive slowly and follow the chain manufacturer's instructions. If you can hear the chains contacting your vehicle, stop and retighten them. If the contact continues, slow down until it stops. Driving too fast or spinning the wheels with chains on will damage your vehicle.

If a Tire Goes Flat

It's unusual for a tire to "blow out" while you're driving, especially if you maintain your tires properly. If air goes out of a tire, it's much more likely to leak out slowly. But if you should ever have a "blowout", here are a few tips about what to expect and what to do:

If a front tire fails, the flat tire will create a drag that pulls the vehicle toward that side. Take your foot off the accelerator pedal and grip the steering wheel firmly. Steer to maintain lane position, and then gently brake to a stop well out of the traffic lane.

A rear blowout, particularly on a curve, acts much like a skid and may require the same correction you'd use in a skid. In any rear blowout, remove your foot from the accelerator pedal. Get the vehicle under control by steering the way you want the vehicle to go. It may be very bumpy and noisy, but you can still steer. Gently brake to a stop — well off the road if possible.

If a tire goes flat, the next part shows how to use your jacking equipment to change a flat tire safely.

Changing a Flat Tire

If a tire goes flat, avoid further tire and wheel damage by driving slowly to a level place. Turn on your hazard warning flashers.

CAUTION:

Changing a tire can cause an injury. The vehicle can slip off the jack and roll over you or other people. You and they could be badly injured. Find a level place to change your tire. To help prevent the vehicle from moving:

- 1. Set the parking brake firmly.**
- 2. Put the shift lever in PARK (P).**
- 3. Turn off the engine.**

To be even more certain the vehicle won't move, you can put blocks at the front and rear of the tire farthest away from the one being changed. That would be the tire on the other side of the vehicle, at the opposite end.

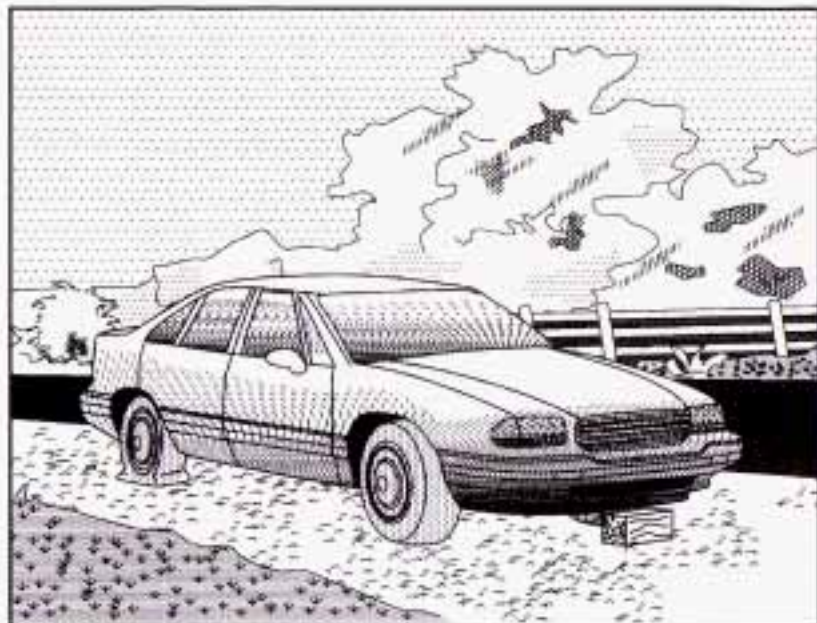

The following steps will tell you how to use the jack and change a tire.

Removing the Spare Tire and Tools

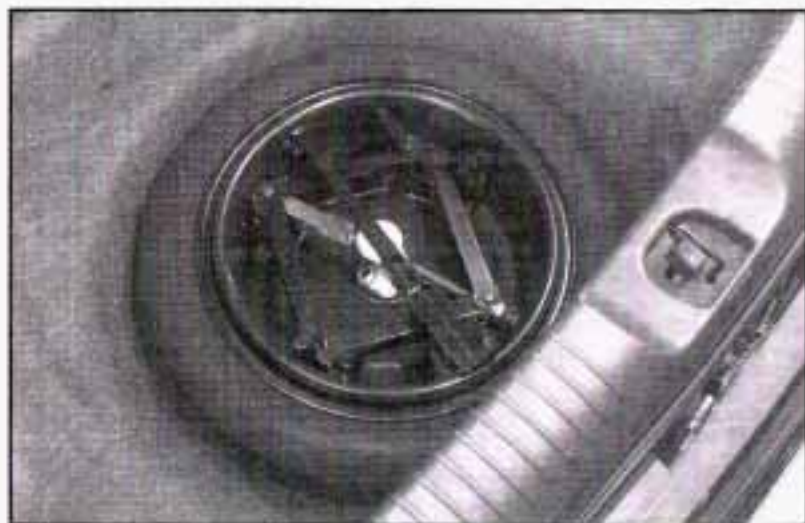

The equipment you'll need is in the trunk.

Instructions for changing your tires are on the inside of the tire cover. You can rest the cover near you for easy reference while you change the tire.

1. Lift the tire cover to gain access to the compact spare tire and jacking equipment. See *Compact Spare Tire* on page 5-81 for more information.

2. Remove the wheel wrench and jack from the jack container.
3. Remove the compact spare tire from the trunk.

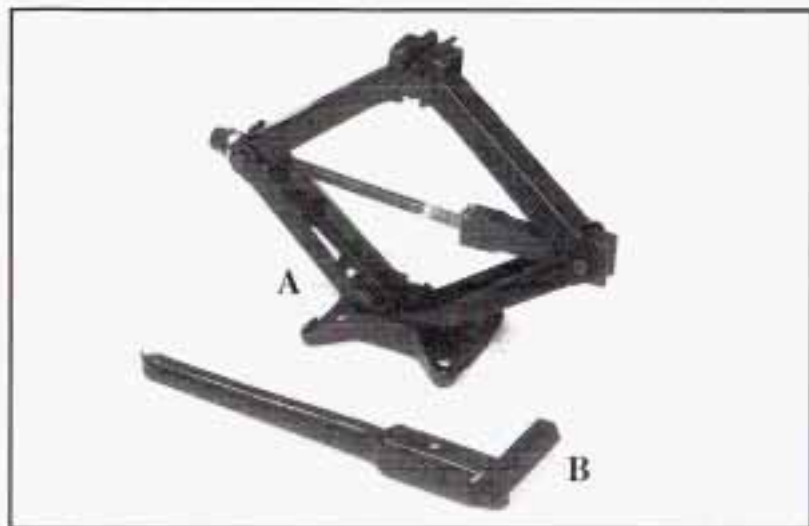

The tools you'll be using include the jack (A) and wheel wrench (B).

Removing the Wheel Covers



Insert the hooked end of the wheel wrench in one of the two small notches in the center cover and pry the cover off. Do not drop the cover or lay it face down, as it could be scratched or damaged.

Removing the Flat Tire and Installing the Spare Tire

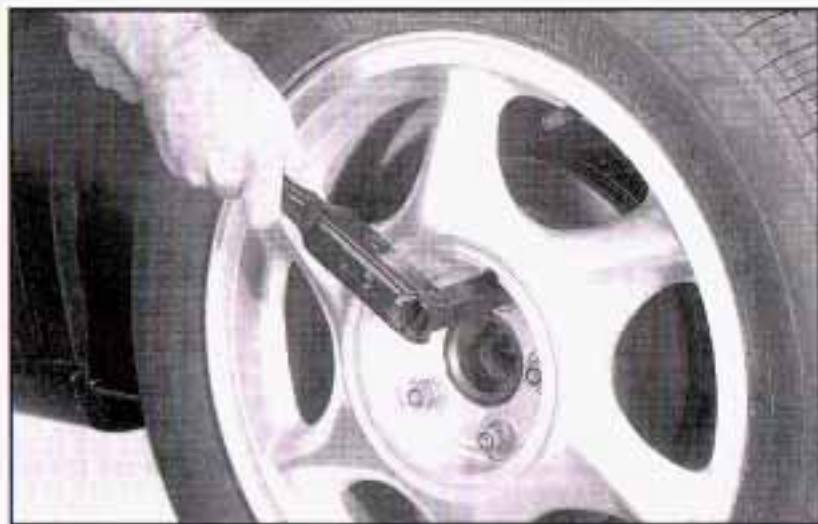

1. Position the wheel wrench securely over the wheel nuts and turn the wrench counterclockwise to loosen the wheel nuts, but don't remove them.
2. Attach the wheel wrench to the bolt on the end of the jack to create a jack handle.

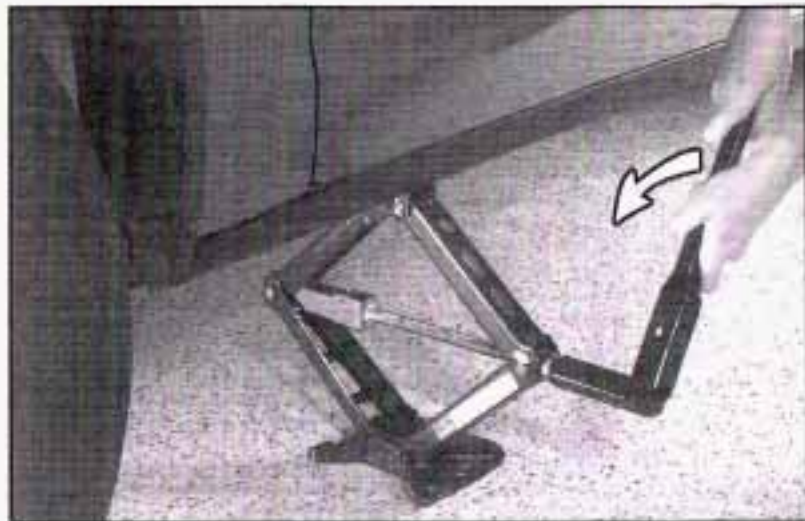

3. Turn the wheel wrench counterclockwise by hand to lower the jack head until it fits under the vehicle.

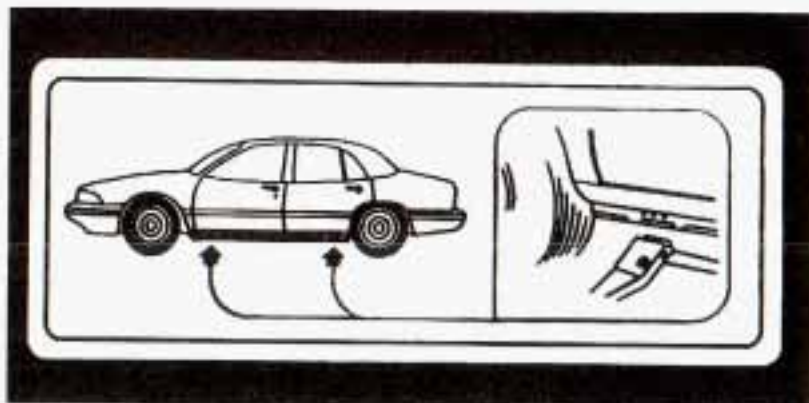

4. Near each wheel well is a notch in the frame to position the jack head. Position the jack under the vehicle and raise the jack head until it fits firmly against the sheet metal. Do not raise the vehicle yet. Put the compact spare tire near you.

⚠ CAUTION:

Getting under a vehicle when it is jacked up is dangerous. If the vehicle slips off the jack you could be badly injured or killed. Never get under a vehicle when it is supported only by a jack.

⚠ CAUTION:

Raising your vehicle with the jack improperly positioned can damage the vehicle and even make the vehicle fall. To help avoid personal injury and vehicle damage, be sure to fit the jack lift head into the proper location before raising the vehicle.

5. Raise the vehicle by turning the wheel wrench clockwise on the jack. Raise the vehicle far enough off the ground so there's enough room for the compact spare tire to fit underneath the wheel well.
6. Remove all the wheel nuts and take off the flat tire.

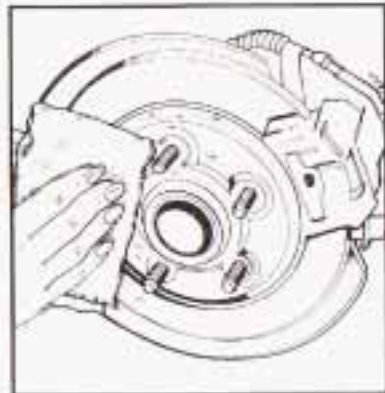

7. Remove any rust or dirt from the wheel bolts, mounting surfaces and spare wheel.

⚠ CAUTION:

Never use oil or grease on studs or nuts. If you do, the nuts might come loose. Your wheel could fall off, causing a serious accident.

8. Place the compact spare tire on the wheel-mounting surface.

⚠ CAUTION:

Rust or dirt on the wheel, or on the parts to which it is fastened, can make the wheel nuts become loose after a time. The wheel could come off and cause an accident. When you change a wheel, remove any rust or dirt from the places where the wheel attaches to the vehicle. In an emergency, you can use a cloth or a paper towel to do this; but be sure to use a scraper or wire brush later, if you need to, to get all the rust or dirt off.

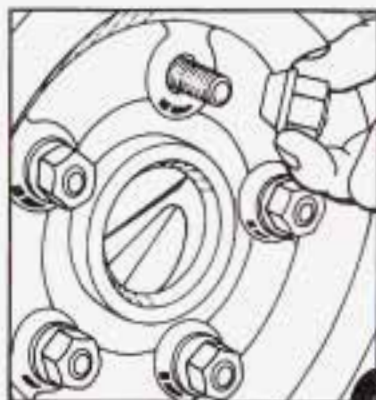

9. Put the wheel nuts back on with the rounded end of the nuts toward the wheel. Tighten each nut by hand until the wheel is held against the hub.

If a nut cannot be tightened by hand, use the wheel wrench, and see your dealer right away.

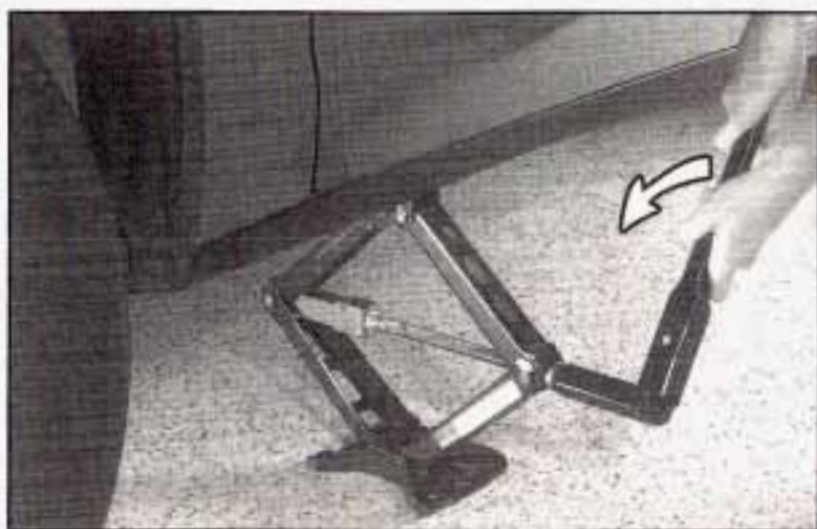

10. Lower the vehicle by turning the wheel wrench counterclockwise. Lower the jack completely.

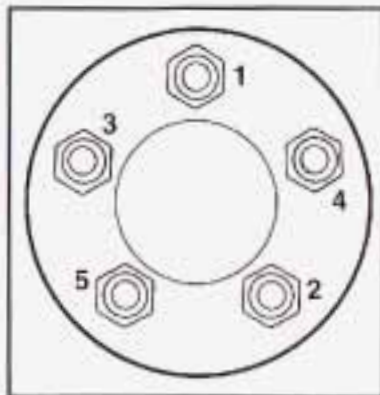

11. Using the wheel wrench, tighten the wheel nuts firmly in a crisscross sequence as shown.

⚠ CAUTION:

Incorrect wheel nuts or improperly tightened wheel nuts can cause the wheel to come loose and even come off. This could lead to an accident. Be sure to use the correct wheel nuts. If you have to replace them, be sure to get new GM original equipment wheel nuts. Stop somewhere as soon as you can and have the nuts tightened with a torque wrench to the proper torque specification. See "Capacities and Specifications" in the Index for wheel nut torque specification.

Notice: Improperly tightened wheel nuts can lead to brake pulsation and rotor damage. To avoid expensive brake repairs, evenly tighten the wheel nuts in the proper sequence and to the proper torque specification. See "Capacities and Specifications" in the index for the wheel nut torque specification.

12. When the flat tire has been repaired or replaced, reinstall the wheel cover. Be sure to position the alignment pin on the cover with the notch in the wheel. Apply pressure around the edge of the cap to snap it in place. Do not use a hammer or mallet to reinstall the cover.

Store the wheel cover in the trunk until you have replaced the compact spare tire with a regular tire.

Notice: Wheel covers won't fit on your compact spare. If you try to put a wheel cover on your compact spare, you could damage the cover or the spare.

Storing the Flat Tire and Tools

CAUTION:

Storing a jack, a tire or other equipment in the passenger compartment of the vehicle could cause injury. In a sudden stop or collision, loose equipment could strike someone. Store all these in the proper place.

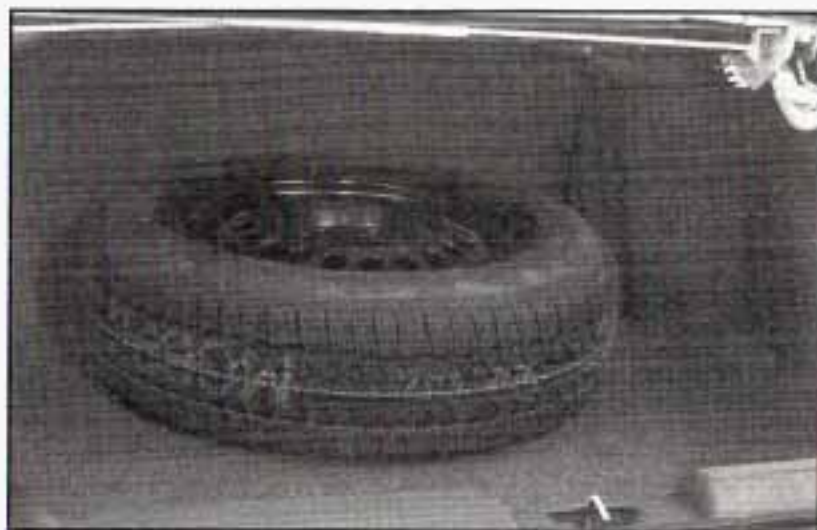

Store the flat tire as far forward in the trunk as possible. Store the jack and wheel wrench in their compartment in the trunk. For storage, the jack must be raised until the screw end is flush with the edge of the jack.

Storing the Spare Tire and Tools

CAUTION:

Storing a jack, a tire or other equipment in the passenger compartment of the vehicle could cause injury. In a sudden stop or collision, loose equipment could strike someone. Store all these in the proper place.

The compact spare tire is for temporary use only. Replace the compact spare tire with a full-size tire as soon as you can. See "Compact Spare Tire" later in this section. See the storing instructions label to return your compact spare tire into your trunk properly.

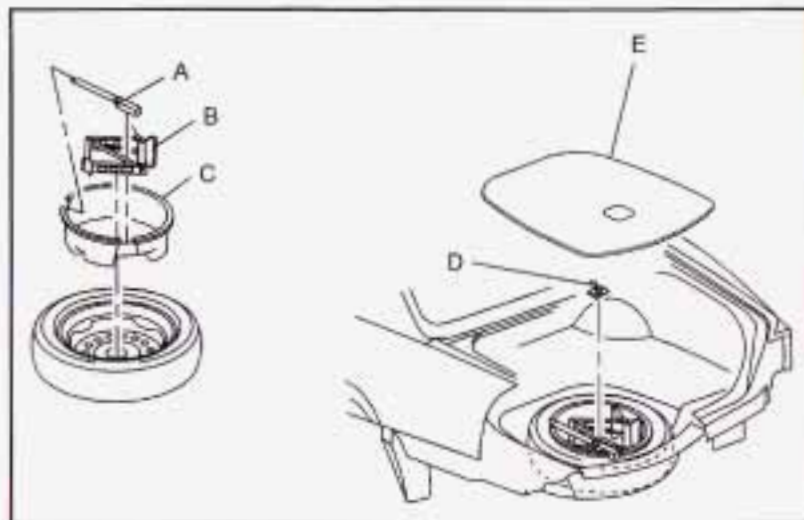

- A. Wrench
- B. Jack
- C. Jack Container

- D. Retainer
- E. Compact Spare Tire Cover

Compact Spare Tire

Although the compact spare tire was fully inflated when your vehicle was new, it can lose air after a time. Check the inflation pressure regularly. It should be 60 psi (420 kPa).

After installing the compact spare on your vehicle, you should stop as soon as possible and make sure your spare tire is correctly inflated. The compact spare is made to perform well at speeds up to 65 mph (105 km/h) for distances up to 3,000 miles (5 000 km), so you can finish your trip and have your full-size tire repaired or replaced where you want. You must calibrate the Check Tire Pressure System after installing or removing the compact spare. See *Check Tire Pressure System on page 5-62*. Of course, it's best to replace your spare with a full-size tire as soon as you can. Your spare will last longer and be in good shape in case you need it again.

Notice: When the compact spare is installed, don't take your vehicle through an automatic car wash with guide rails. The compact spare can get caught on the rails. That can damage the tire and wheel, and maybe other parts of your vehicle.

Don't use your compact spare on other vehicles.

And don't mix your compact spare tire or wheel with other wheels or tires. They won't fit. Keep your compact spare tire and its wheel together.

Notice: Tire chains won't fit your compact spare. Using them can damage your vehicle and can damage the chains too. Don't use tire chains on your compact spare.

Appearance Care

Remember, cleaning products can be hazardous. Some are toxic. Others can burst into flames if you strike a match or get them on a hot part of the vehicle. Some are dangerous if you breathe their fumes in a closed space. When you use anything from a container to clean your vehicle, be sure to follow the manufacturer's warnings and instructions. And always open your doors or windows when you're cleaning the inside.

Never use these to clean your vehicle:

- Gasoline
- Benzene
- Naphtha
- Carbon Tetrachloride
- Acetone
- Paint Thinner
- Turpentine
- Lacquer Thinner
- Nail Polish Remover

They can all be hazardous — some more than others —and they can all damage your vehicle, too.

Don't use any of these unless this manual says you can. In many uses, these will damage your vehicle:

- Alcohol
- Laundry Soap
- Bleach
- Reducing Agents

Cleaning the Inside of Your Vehicle

Use a vacuum cleaner often to get rid of dust and loose dirt. Wipe vinyl, leather, plastic and painted surfaces with a clean, damp cloth.

Fabric/Carpet

Your dealer has cleaners for the cleaning of fabric and carpet. They will clean normal spots and stains very well.

You can get GM – approved cleaning products from your dealer. See *GM Vehicle Care/Appearance Materials* on page 5-88.

Here are some cleaning tips:

- Always read the instructions on the cleaner label.
- Clean up stains as soon as you can – before they set.
- Carefully scrape off any excess stain.
- Use a clean cloth or sponge, and change to a clean area often. A soft brush may be used if stains are stubborn.
- If a ring forms on fabric after spot cleaning, clean the entire area immediately or it will set.

Vinyl

Use warm water and a clean cloth.

- Rub with a clean, damp cloth to remove dirt. You may have to do this more than once.
- Things like tar, asphalt and shoe polish will stain if you don't get them off quickly. Use a clean cloth and vinyl/leather cleaner. See your dealer for this product.

Leather

Use a soft cloth with lukewarm water and a mild soap or saddle soap and wipe dry with a soft cloth. Then, let the leather dry naturally. Do not use heat to dry.

- For stubborn stains, use a leather cleaner. See your dealer for this product.
- *Never* use oils, varnishes, solvent-based or abrasive cleaners, furniture polish or shoe polish on leather.
- Soiled or stained leather should be cleaned immediately. If dirt is allowed to work into the finish, it can harm the leather.

Top of the Instrument Panel

Use only mild soap and water to clean the top surfaces of the instrument panel. Sprays containing silicones or waxes may cause annoying reflections in the windshield and even make it difficult to see through the windshield under certain conditions.

Interior Plastic Components

Use only a mild soap and water solution on a soft cloth or sponge. Commercial cleaners may affect the surface finish.

Wood Panels

Use a clean cloth moistened in warm, soapy water (use mild dish washing soap). Dry the wood immediately with a clean cloth.

Glass Surfaces

Glass should be cleaned often. GM Glass Cleaner or a liquid household glass cleaner will remove normal tobacco smoke and dust films on interior glass. See *GM Vehicle Care/Appearance Materials on page 5-88*.

Notice: Don't use abrasive cleaners on glass, because they may cause scratches. Avoid placing decals on the inside rear window, since they may have to be scraped off later. If abrasive cleaners are used on the inside of the rear window, an electric defogger element may be damaged. Any temporary license should not be attached across the defogger grid.

Care of Safety Belts

Keep belts clean and dry.

CAUTION:

Do not bleach or dye safety belts. If you do, it may severely weaken them. In a crash, they might not be able to provide adequate protection. Clean safety belts only with mild soap and lukewarm water.

Weatherstrips

Silicone grease on weatherstrips will make them last longer, seal better, and not stick or squeak. Apply silicone grease with a clean cloth at least every six months. During very cold, damp weather more frequent application may be required. See *Part D: Recommended Fluids and Lubricants on page 6-15*.

Cleaning the Outside of Your Vehicle

The paint finish on your vehicle provides beauty, depth of color, gloss retention and durability.

Washing Your Vehicle

The best way to preserve your vehicle's finish is to keep it clean by washing it often with lukewarm or cold water.

Don't wash your vehicle in the direct rays of the sun. Use a car washing soap. Don't use strong soaps or chemical detergents. Be sure to rinse the vehicle well, removing all soap residue completely. You can get GM-approved cleaning products from your dealer. See *GM Vehicle Care/Appearance Materials on page 5-88*. Don't use cleaning agents that are petroleum based, or that contain acid or abrasives. All cleaning agents should be flushed promptly and not allowed to dry on the surface, or they could stain. Dry the finish with a soft, clean chamois or an all-cotton towel to avoid surface scratches and water spotting.

High pressure car washes may cause water to enter your vehicle.

Cleaning Exterior Lamps/Lenses

Use only lukewarm or cold water, a soft cloth and a car washing soap to clean exterior lamps and lenses. Follow instructions under "Washing Your Vehicle."

Finish Care

Occasional waxing or mild polishing of your vehicle by hand may be necessary to remove residue from the paint finish. You can get GM-approved cleaning products from your dealer. See *GM Vehicle Care/Appearance Materials on page 5-88*.

If your vehicle has a "basecoat/clearcoat" paint finish. The clearcoat gives more depth and gloss to the colored basecoat. Always use waxes and polishes that are non-abrasive and made for a basecoat/clearcoat paint finish.

Notice: Machine compounding or aggressive polishing on a basecoat/clearcoat paint finish may dull the finish or leave swirl marks.

Foreign materials such as calcium chloride and other salts, ice melting agents, road oil and tar, tree sap, bird droppings, chemicals from industrial chimneys, etc., can damage your vehicle's finish if they remain on painted surfaces. Wash the vehicle as soon as possible. If necessary, use non-abrasive cleaners that are marked safe for painted surfaces to remove foreign matter.

Exterior painted surfaces are subject to aging, weather and chemical fallout that can take their toll over a period of years. You can help to keep the paint finish looking new by keeping your vehicle garaged or covered whenever possible.

Windshield and Wiper Blades

If the windshield is not clear after using the windshield washer, or if the wiper blade chatters when running, wax, sap or other material may be on the blade or windshield.

Clean the outside of the windshield with a full-strength glass cleaning liquid. The windshield is clean if beads do not form when you rinse it with water.

Grime from the windshield will stick to the wiper blades and affect their performance. Clean the blade by wiping vigorously with a cloth soaked in full-strength windshield washer solvent. Then rinse the blade with water.

Check the wiper blades and clean them as necessary; replace blades that look worn.

Aluminum or Chrome-Plated Wheels

Your vehicle may be equipped with either aluminum or chrome-plated wheels.

Keep your wheels clean using a soft clean cloth with mild soap and water. Rinse with clean water. After rinsing thoroughly, dry with a soft clean towel. A wax may then be applied.

The surface of these wheels is similar to the painted surface of your vehicle. Don't use strong soaps, chemicals, abrasive polishes, abrasive cleaners, cleaners with acid, or abrasive cleaning brushes on them because you could damage the surface. Do not use chrome polish on aluminum wheels.

Use chrome polish only on chrome-plated wheels, but avoid any painted surface of the wheel, and buff off immediately after application.

Don't take your vehicle through an automatic car wash that has silicone carbide tire cleaning brushes. These brushes can also damage the surface of these wheels.

Tires

To clean your tires, use a stiff brush with tire cleaner.

Notice: When applying a tire dressing, always take care to wipe off any overspray or splash from all painted surfaces on the body or wheels of the vehicle. Petroleum-based products may damage the paint finish and tires.

Sheet Metal Damage

If your vehicle is damaged and requires sheet metal repair or replacement, make sure the body repair shop applies anti-corrosion material to parts repaired or replaced to restore corrosion protection.

Original manufacturer replacement parts will provide the corrosion protection while maintaining the warranty.

Finish Damage

Any stone chips, fractures or deep scratches in the finish should be repaired right away. Bare metal will corrode quickly and may develop into major repair expense.

Minor chips and scratches can be repaired with touch-up materials available from your dealer or other service outlets. Larger areas of finish damage can be corrected in your dealer's body and paint shop.

Underbody Maintenance

Chemicals used for ice and snow removal and dust control can collect on the underbody. If these are not removed, accelerated corrosion (rust) can occur on the underbody parts such as fuel lines, frame, floor pan and exhaust system even though they have corrosion protection.

At least every spring, flush these materials from the underbody with plain water. Clean any areas where mud and debris can collect. Dirt packed in close areas of the frame should be loosened before being flushed. Your dealer or an underbody car washing system can do this for you.

Chemical Paint Spotting

Some weather and atmospheric conditions can create a chemical fallout. Airborne pollutants can fall upon and attack painted surfaces on your vehicle. This damage can take two forms; blotchy, ringlet-shaped discolorations, and small irregular dark spots etched into the paint surface.

Although no defect in the paint job causes this, GM will repair, at no charge to the owner, the surfaces of new vehicles damaged by this fallout condition within 12 months or 12,000 miles (20 000 km) of purchase, whichever occurs first.

GM Vehicle Care/Appearance Materials

See your GM dealer for more information on purchasing the following products.

GM Vehicle Care/Appearance Materials

Description	Usage
Polishing Cloth Wax-Treated	Interior and exterior polishing cloth.
Tar and Road Oil Remover	Removes tar, road oil and asphalt.
Chrome Cleaner and Polish	Use on chrome or stainless steel.
White Sidewall Tire Cleaner	Removes soil and black marks from whitewalls.
Vinyl Cleaner	Cleans vinyl tops, upholstery and convertible tops.

GM Vehicle Care/Appearance Materials (cont'd)

Description	Usage
Glass Cleaner	Removes dirt, grime, smoke and fingerprints.
Chrome and Wire Wheel Cleaner	Removes dirt and grime from chrome wheels and wire wheel covers.
Finish Enhancer	Removes dust, fingerprints, and surface contaminants, Spray on wipe off.
Swirl Remover Polish	Removes swirl marks, fine scratches and other light surface contamination.
Cleaner Wax	Removes light scratches and protects finish.
Foaming Tire Shine Low Gloss	Cleans, shines and protects in one easy step, no wiping necessary.

GM Vehicle Care/Appearance Materials (cont'd)

Description	Usage
Wash Wax Concentrate	Medium foaming shampoo. Cleans and lightly waxes. Biodegradable and phosphate free.
Spot Lifter	Quickly and easily removes spots and stains from carpets, vinyl and cloth upholstery.

GM Vehicle Care/Appearance Materials (cont'd)

Description	Usage
Odor Eliminator	Odorless spray odor eliminator used on fabrics, vinyl, leather and carpet.
See your General Motors parts department for these products. See <i>Part D: Recommended Fluids and Lubricants</i> on page 6-15.	

Vehicle Identification

Vehicle Identification Number (VIN)



This is the legal identifier for your vehicle. It appears on a plate in the front corner of the instrument panel, on the driver's side. You can see it if you look through the windshield from outside your vehicle. The VIN also appears on the Vehicle Certification and Service Parts labels and the certificates of title and registration.

Engine Identification

The 8th character in your VIN is the engine code. This code will help you identify your engine, specifications and replacement parts.

Service Parts Identification Label

You'll find this label on the underside of the spare tire cover. It's very helpful if you ever need to order parts. On this label is:

- your VIN,
- the model designation,
- paint information and
- a list of all production options and special equipment.

Be sure that this label is not removed from the vehicle.

Electrical System

Add-On Electrical Equipment

Notice: Don't add anything electrical to your vehicle unless you check with your dealer first. Some electrical equipment can damage your vehicle and the damage wouldn't be covered by your warranty. Some add-on electrical equipment can keep other components from working as they should.

Your vehicle has an air bag system. Before attempting to add anything electrical to your vehicle, see *Servicing Your Air Bag-Equipped Vehicle on page 1-54*.

Headlamp Wiring

The headlamp wiring is protected by a circuit breaker in the wiring harness. An electrical overload will cause the lamps to go on and off, or in some cases to remain off. If this happens, have your headlamp system checked right away.

Windshield Wiper Fuses

The windshield wiper motor is protected by an internal circuit breaker and a fuse. If the motor overheats due to heavy snow, etc., the wiper will stop until the motor cools. If the overload is caused by some electrical problem, have it fixed.

Power Windows and Other Power Options

Circuit breakers in the fuse panel protect the power windows and other power accessories. When the current load is too heavy, the circuit breaker opens and closes, protecting the circuit until the problem is fixed.

Fuses and Circuit Breakers

The wiring circuits in your vehicle are protected from short circuits by a combination of fuses and circuit breakers. This greatly reduces the chance of fires caused by electrical problems.

Look at the silver-colored band inside the fuse. If the band is broken or melted, replace the fuse. Be sure you replace a bad fuse with a new one of the identical size and rating. If a MaxiFuse[®] should blow, see your dealer for service immediately.

If you ever have a problem on the road and don't have a spare fuse, you can "borrow" one that has the same amperage. Pick some feature of your vehicle that you can get along without – like the radio or cigarette lighter – and use its fuse, if it is the correct amperage. Replace it as soon as you can. You will find a fuse puller clipped in both of the fuse blocks. Snap the wide end of the fuse puller at the side indentations and pull the fuse out.

The MaxiFuses[®] are located in two fuse blocks, one located in the engine compartment and the other under the rear seat. If a MaxiFuse[®] should blow, have your vehicle serviced by your dealer immediately.

Engine Compartment Fuse Block



The engine compartment fuse block is located near the front on the passenger's side of the vehicle. See *Engine Compartment Overview* on page 5-14 for more information on location.

Lift the cover to gain access. Fuse 22 or 23 can be moved to the outer position to provide continuous power to the accessory power outlet or cigarette lighter when the ignition is not on. See your dealer for additional assistance, if needed.

Leaving an accessory on for a long period of time can drain the vehicle's battery.

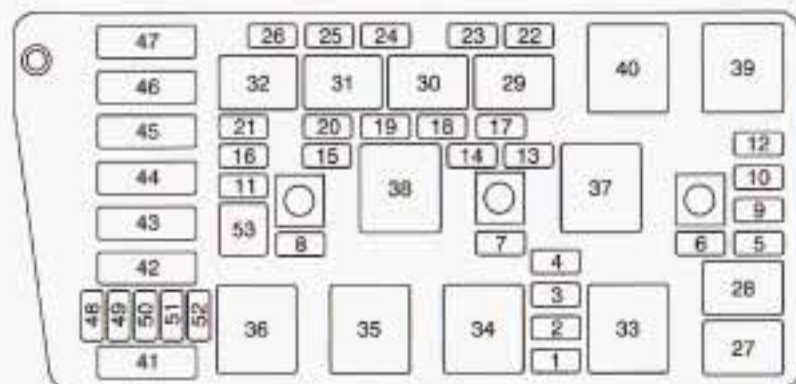

Fuses	Usage
1	Not Used
2	Accessory
3	Windshield Wipers
4	Not Used
5	Left Low-Beam Headlamp
6	Right Low-Beam Headlamp
7	Spare

Fuses	Usage
8	Powertrain Control Module Battery
9	Right High-Beam Headlamp
10	Left High-Beam Headlamp
11	Ignition 1
12	Not Used
13	Transaxle
14	Cruise Control
15	Direct Ignition System
16	Injector Bank #2
17	Not Used
18	Not Used
19	Powertrain Control Module Ignition
20	Oxygen Sensor
21	Injector Bank #1
22	Auxiliary Power
23	Cigarette Lighter
24	Fog Lamps/Daytime Running Lamps
25	Horn
26	Air Conditioning Clutch

Relays	Usage	Circuit Breakers	Usage
27	High-Beam Headlamp	41	Starter
28	Low-Beam Headlamp		
29	Fog Lamps		
30	Daytime Running Lamps	Fuses	Usage
31	Horn	42	Not Used
32	Air Conditioner Clutch	43	Empty
33	HVAC Solenoid	44	ABS
34	Accessory	45	Air Pump A
35	Air Pump	46	Cooling Fan 1
36	Starter 1	47	Cooling Fan 2
37	Cooling Fan 1	48	Spare
38	Ignition 1	49	Spare
39	Cooling Fan Series/Parallel	50	Spare
40	Cooling Fan 2	51	Spare
		52	Spare
		53	Fuse Puller

Removing the Rear Seat Cushion

To access the battery and rear compartment fuse panels, the rear seat cushion must be removed. This procedure is somewhat difficult. You may wish to have your dealer do this for you.

Notice: The battery and main fuse blocks are located under the rear seat cushion. The battery's ground terminal and some relay wires are exposed. To help avoid damage to the battery and wires, be careful when removing or reinstalling the seat cushion. Do not remove covers from covered parts. Do not store anything under the seat, as objects could touch exposed wires and cause a short.

To remove the rear seat cushion, do the following:

1. Pull up on the front of the cushion to release the front hooks.
2. Pull the cushion up and out toward the front of the vehicle.

To reinstall the rear seat cushion, do the following:



CAUTION:

A safety belt that isn't properly routed through the seat cushion or is twisted won't provide the protection needed in a crash. If the safety belt hasn't been routed through the seat cushion at all, it won't be there to work for the next passenger. The person sitting in that position could be badly injured. After reinstalling the seat cushion, always check to be sure that the safety belts are properly routed and are not twisted.

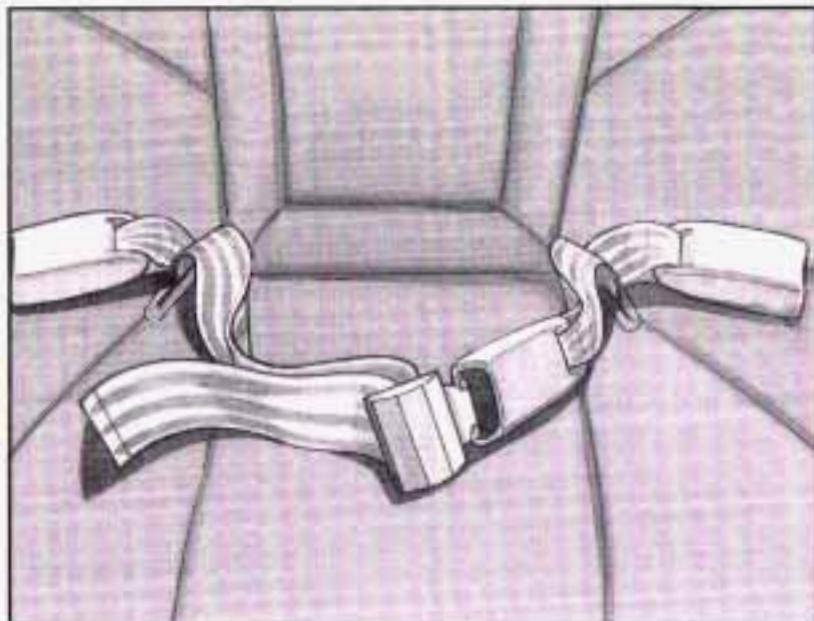

1. Buckle the center passenger position safety belt, then route the safety belts through the proper slots in the seat cushion. Don't let the safety belts get twisted.
2. Slide the rear of the cushion up and under the seatback so the rear locating guides hook into the wire loops on the back frame.

3. With the seat cushion lowered, push rearward and then press down on the seat cushion until the spring locks on both ends engage.
4. Check to make sure the safety belts are properly routed and that no portion of any safety belt is trapped under the seat. Also make sure the seat cushion is secured.

Rear Underseat Fuse Block

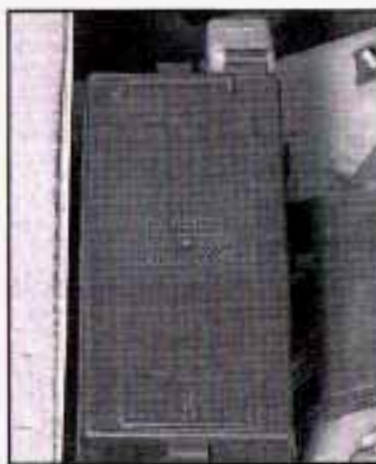

The rear fuse block is located below the rear seat on the driver's side. The rear seat cushion must be removed to access the fuse block. See *Removing the Rear Seat Cushion* on page 5-95.



Fuses	Usage
1	Fuel Pump
2	HVAC Blower
3	Memory
4	ALDL
5	Rear Fog Lamps
6	Compact Disc (CD)
7	Driver's Door Module
8	Air Bag System
9	Not Used
10	Right Parking Lamp

Fuses	Usage
11	Vent Solenoid
12	Ignition 1
13	Left Parking Lamp
14	Dimmer
15	Spare
16	Left Front Heated Seat
17	Not Used
18	Rear Door Module
19	Stoplamp
20	Park/Reverse
21	Audio
22	Retained Accessory Power (RAP)
23	Not Used
24	Not Used
25	Passenger Door Module
26	Body
27	Interior Lamps
28	Not Used
29	Ignition Switch
30	Instrument Panel
31	Right Front Heated Seat
32	Not Used
33	HVAC
34	Ignition 3 Rear

Fuses	Usage
35	Anti-lock Brake System (ABS)
36	Turn Signal/Hazard
37	HVAC Battery
38	Dimmer

Relays	Usage
39	Fuel Pump
40	Parking Lamp
41	Ignition 1
42	Rear Fog Lamp
43	Not Used
44	Park

Relays	Usage
45	Reverse
46	Retained Accessory Power (RAP)
47	Fuel Tank Door Lock
48	Not Used
49	Ignition 3
50	Fuel Tank Door Release
51	Interior Lamps
52	Trunk Release
53	Front Courtesy Lamps
54	Not Used
55	Electronic Level Control (ELC)

		Fuses	Usage
Circuit Breakers	Usage	73	Spare
56	Power Seats	74	Spare
57	Power Windows	75	Fuse Puller
Relays	Usage		
58	Cigar		
59	Rear Defogger		
Fuses	Usage		
60	Not Used		
61	Rear Defog		
62	Not Used		
63	Audio Amplifier		
64	Electronic Level Control (ELC)		
65	Cigar		
66	Not Used		
67	Not Used		
68	Not Used		
69	Spare		
70	Spare		
71	Spare		
72	Spare		

Capacities and Specifications

The following approximate capacities are given in English and metric conversions. Please refer to *Part D: Recommended Fluids and Lubricants* on page 6-15 for more information.

Capacities

Application	Capacities	
	English	Metric
Automatic Transaxle	11 quarts	10.4 L
Engine Cooling System	13.0 quarts	12.3 L
Engine Oil with Filter	7.0 quarts	6.7 L
Fuel Tank	18.5 gallons	70.0 L
Air Conditioning Refrigerant R134a	2.2 lbs	1.0 kg
Wheel Nut Torque	100 lb-ft	140 N•m

All capacities are approximate. When adding, be sure to fill to the appropriate level, as recommended in this manual.

Engine Specifications

Engine	Vin Code	Transmission	Spark Plug Gap	Firing Order
V8 (L47)	C	Automatic	0.050 inch (1.27 mm)	1-2-7-3-4-5-6-8

Normal Maintenance Replacement Parts

Part	Number
Engine Air Cleaner Element	A1096C*
Passenger Compartment Air Filter	GM Part # 25654414
Engine Oil Filter	PF-58*
Fuel Filter	GF-627*
Spark Plugs	41-987* GM Part # 12571535
Windshield Wiper Blades Type Length	Shepherd's Hook 22.0 inches (56.0 cm)
*ACDelco® part number	

Section 6 Maintenance Schedule

Maintenance Schedule	6-2	At Least Once a Year	6-10
Introduction	6-2	Part C: Periodic Maintenance Inspections	6-13
Your Vehicle and the Environment	6-2	Steering, Suspension and Front Drive Axle	
Maintenance Requirements	6-2	Boot and Seal Inspection	6-13
How This Section is Organized	6-3	Exhaust System Inspection	6-13
Part A: Scheduled Maintenance Services	6-4	Fuel System Inspection	6-13
Using Your Maintenance Schedule	6-4	Engine Cooling System Inspection	6-14
Scheduled Maintenance	6-5	Throttle System Inspection	6-14
Part B: Owner Checks and Services	6-9	Brake System Inspection	6-14
At Each Fuel Fill	6-9	Part D: Recommended Fluids and Lubricants ...	6-15
At Least Once a Month	6-9	Part E: Maintenance Record	6-16
At Least Twice a Year	6-10		

Maintenance Schedule

Introduction

IMPORTANT:
KEEP ENGINE OIL
AT THE PROPER
LEVEL AND CHANGE AS
RECOMMENDED



Have you purchased the GM Protection Plan? The Plan supplements your new vehicle warranties. See your Warranty and Owner Assistance booklet or your dealer for details.

Your Vehicle and the Environment

Proper vehicle maintenance not only helps to keep your vehicle in good working condition, but also helps the environment. All recommended maintenance procedures are important. Improper vehicle maintenance can even affect the quality of the air we breathe. Improper fluid levels or the wrong tire inflation can increase the level of emissions from your vehicle. To help protect our environment, and to keep your vehicle in good condition, please maintain your vehicle properly.

Maintenance Requirements

Maintenance intervals, checks, inspections and recommended fluids and lubricants as prescribed in this manual are necessary to keep your vehicle in good working condition. Any damage caused by failure to follow recommended maintenance may not be covered by warranty.

How This Section is Organized

This maintenance schedule is divided into five parts:

“Part A: Scheduled Maintenance Services” explains what to have done and how often. Some of these services can be complex, so unless you are technically qualified and have the necessary equipment, you should let your dealer’s service department or another qualified service center do these jobs.

CAUTION:

Performing maintenance work on a vehicle can be dangerous. In trying to do some jobs, you can be seriously injured. Do your own maintenance work only if you have the required know-how and the proper tools and equipment for the job. If you have any doubt, have a qualified technician do the work.

If you want to get the service information, see *Service Publications Ordering Information* on page 7-9.

“Part B: Owner Checks and Services” tells you what should be checked and when. It also explains what you can easily do to help keep your vehicle in good condition.

“Part C: Periodic Maintenance Inspections” explains important inspections that your dealer’s service department or another qualified service center should perform.

“Part D: Recommended Fluids and Lubricants” lists some recommended products necessary to help keep your vehicle properly maintained. These products, or their equivalents, should be used whether you do the work yourself or have it done.

“Part E: Maintenance Record” is a place for you to record and keep track of the maintenance performed on your vehicle. Keep your maintenance receipts. They may be needed to qualify your vehicle for warranty repairs.

Part A: Scheduled Maintenance Services

This part contains engine oil scheduled maintenance which explains the engine oil life system and how it indicates when to change the engine oil and filter. Also, listed are scheduled maintenance services which are to be performed at the mileage intervals specified.

Using Your Maintenance Schedule

We at General Motors want to keep your vehicle in good working condition. But we don't know exactly how you'll drive it. You may drive short distances only a few times a week. Or you may drive long distances all the time in very hot, dusty weather. You may use your vehicle in making deliveries. Or you may drive it to work, to do errands or in many other ways.

Because of the different ways people use their vehicles, maintenance needs may vary. You may need more frequent checks and replacements. So please read the following and note how you drive. If you have questions on how to keep your vehicle in good condition, see your dealer.

This part tells you the maintenance services you should have done and when you should schedule them. When you go to your dealer for your service needs, you'll know that GM-trained and supported service people will perform the work using genuine GM parts.

The proper fluids and lubricants to use are listed in Part D. Make sure whoever services your vehicle uses these. All parts should be replaced and all necessary repairs done before you or anyone else drives the vehicle.

This schedule is for vehicles that:

- carry passengers and cargo within recommended limits. You will find these on your vehicle's Tire-Loading Information label. See *Loading Your Vehicle on page 4-34*.
- are driven on reasonable road surfaces within legal driving limits.
- use the recommended fuel. See *Gasoline Octane on page 5-5*.

Scheduled Maintenance

The services shown in this schedule up to 100,000 miles (166 000 km) should be repeated after 100,000 miles (166 000 km) at the same intervals for the life of this vehicle. The services shown at 150,000 miles (240 000 km) should be repeated at the same interval after 150,000 miles (240 000 km) for the life of this vehicle.

See *Part B: Owner Checks and Services* on page 6-9 and *Part C: Periodic Maintenance Inspections* on page 6-13.

Footnotes

† *The U.S. Environmental Protection Agency or the California Air Resources Board has determined that the failure to perform this maintenance item will not nullify the emission warranty or limit recall liability prior to the completion of the vehicle 's useful life. We, however, urge that all recommended maintenance services be performed at the indicated intervals and the maintenance be recorded.*

@ *Whenever the tires are rotated, the Check Tire Pressure System must be reset.*

+ *A good time to check your brakes is during tire rotation. See Brake System Inspection on page 6-14.*

Engine Oil Scheduled Maintenance

Change engine oil and filter as indicated by the GM Oil Life System™ (or every 12 months, whichever occurs first). Reset the system.

Your vehicle has a computer system that lets you know when to change the engine oil and filter. This is based on engine revolutions and engine temperature, and not on mileage. Based on driving conditions, the mileage at which an oil change will be indicated can vary considerably. For the oil life system to work properly, you must reset the system every time the oil is changed.

When the system has calculated that oil life has been diminished, it will indicate that an oil change is necessary. A CHANGE OIL SOON light will come on. Change your oil as soon as possible within the next two times you stop for fuel. It is possible that, if you are driving under the best conditions, the oil life system may not indicate that an oil change is necessary for over a year. However, your engine oil and filter must be changed at least once a year and at this time the system must be reset. It is also important to check your oil regularly and keep it at the proper level.

If the system is ever reset accidentally, you must change your oil at 3,000 miles (5 000 km) since your last oil change. Remember to reset the oil life system whenever the oil is changed. See *Engine Oil* on page 5-15 for information on resetting the system.

After the services are performed, record the date, odometer reading and who performed the service on the maintenance record pages in Part E of this schedule.

An Emission Control Service.

7,500 Miles (12 500 km)

- Rotate tires. See *Tire Inspection and Rotation on page 5-63* for proper rotation pattern and additional information. (See footnote @.) (See footnote +.)

15,000 Miles (25 000 km)

- Inspect engine air cleaner filter if you are driving in dusty conditions. Replace filter if necessary. *An Emission Control Service.* (See footnote †.)
- Rotate tires. See *Tire Inspection and Rotation on page 5-63* for proper rotation pattern and additional information. (See footnote @.) (See footnote +.)

22,500 Miles (37 500 km)

- Rotate tires. See *Tire Inspection and Rotation on page 5-63* for proper rotation pattern and additional information. (See footnote @.) (See footnote +.)

30,000 Miles (50 000 km)

- Inspect throttle body bore and valve plates for deposits, open the throttle valve and inspect all surfaces. Clean as required. *An Emission Control Service.* (See footnote †.)
- Rotate tires. See *Tire Inspection and Rotation on page 5-63* for proper rotation pattern and additional information. (See footnote @.) (See footnote +.)
- Replace engine air cleaner filter. *An Emission Control Service.*

37,500 Miles (62 500 km)

- Rotate tires. See *Tire Inspection and Rotation on page 5-63* for proper rotation pattern and additional information. (See footnote @.) (See footnote +.)

45,000 Miles (75 000 km)

- Inspect engine air cleaner filter if you are driving in dusty conditions. Replace filter if necessary. *An Emission Control Service.* (See footnote †.)
- Rotate tires. See *Tire Inspection and Rotation on page 5-63* for proper rotation pattern and additional information. (See footnote @.) (See footnote +.)

50,000 Miles (83 000 km)

- ❑ Change automatic transaxle fluid and bottom screens if the vehicle is mainly driven under one or more of these conditions:
 - In heavy city traffic where the outside temperature regularly reaches 90°F (32°C) or higher.
 - In hilly or mountainous terrain.
 - When doing frequent trailer towing.
 - Uses such as found in taxi, police or delivery service.

If you do not use your vehicle under any of these conditions, change the fluid and filter at 100,000 miles (166 000 km).

52,500 Miles (87 500 km)

- ❑ Rotate tires. See *Tire Inspection and Rotation* on page 5-63 for proper rotation pattern and additional information. (See footnote @.) (See footnote +.)

60,000 Miles (100 000 km)

- ❑ Inspect throttle body bore and valve plates for deposits, open the throttle valve and inspect all surfaces. Clean as required. *An Emission Control Service.* (See footnote †.)

- ❑ Rotate tires. See *Tire Inspection and Rotation* on page 5-63 for proper rotation pattern and additional information. (See footnote @.) (See footnote +.)
- ❑ Replace engine air cleaner filter. *An Emission Control Service.*

67,500 Miles (112 500 km)

- ❑ Rotate tires. See *Tire Inspection and Rotation* on page 5-63 for proper rotation pattern and additional information. (See footnote @.) (See footnote +.)

75,000 Miles (125 000 km)

- ❑ Inspect engine air cleaner filter if you are driving in dusty conditions. Replace filter if necessary. *An Emission Control Service.* (See footnote †.)
- ❑ Rotate tires. See *Tire Inspection and Rotation* on page 5-63 for proper rotation pattern and additional information. (See footnote @.) (See footnote +.)

82,500 Miles (137 500 km)

- ❑ Rotate tires. See *Tire Inspection and Rotation* on page 5-63 for proper rotation pattern and additional information. (See footnote @.) (See footnote +.)

90,000 Miles (150 000 km)

- ❑ Inspect throttle body bore and valve plates for deposits, open the throttle valve and inspect all surfaces. Clean as required. *An Emission Control Service.* (See footnote †.)
- ❑ Replace engine air cleaner filter. *An Emission Control Service.*
- ❑ Rotate tires. See *Tire Inspection and Rotation* on page 5-63 for proper rotation pattern and additional information. (See footnote @.) (See footnote +.)

97,500 Miles (162 500 km)

- ❑ Rotate tires. See *Tire Inspection and Rotation* on page 5-63 for proper rotation pattern and additional information. (See footnote @.) (See footnote +.)

100,000 Miles (166 000 km)

- ❑ Replace spark plugs. *An Emission Control Service.*
- ❑ Change automatic transaxle fluid and bottom screens if the vehicle is mainly driven under one or more of these conditions:
 - In heavy city traffic where the outside temperature regularly reaches 90°F (32°C) or higher.
 - In hilly or mountainous terrain.
 - When doing frequent trailer towing.
 - Uses such as found in taxi, police or delivery service.

- ❑ If you haven't used your vehicle under severe service conditions listed previously and therefore, haven't changed your automatic transaxle fluid, change both the fluid and filter.

150,000 Miles (240 000 km)

- ❑ Drain, flush and refill cooling system (or every 60 months since last service, whichever occurs first). See *Engine Coolant* on page 5-24 for what to use. Inspect hoses. Clean radiator, condenser, pressure cap and neck. Pressure test the cooling system and pressure cap. *An Emission Control Service.*
- ❑ Inspect engine accessory drive belt. *An Emission Control Service.*

Part B: Owner Checks and Services

Listed in this part are owner checks and services which should be performed at the intervals specified to help ensure the safety, dependability and emission control performance of your vehicle.

Be sure any necessary repairs are completed at once. Whenever any fluids or lubricants are added to your vehicle, make sure they are the proper ones, as shown in Part D.

At Each Fuel Fill

It is important for you or a service station attendant to perform these underhood checks at each fuel fill.

Engine Oil Level Check

Check the engine oil level and add the proper oil if necessary. See *Engine Oil* on page 5-15 for further details.

Engine Coolant Level Check

Check the engine coolant level and add DEX-COOL[®] coolant mixture if necessary. See *Engine Coolant* on page 5-24 for further details.

Windshield Washer Fluid Level Check

Check the windshield washer fluid level in the windshield washer tank and add the proper fluid if necessary. See *Windshield Washer Fluid* on page 5-38 for further details.

At Least Once a Month

Tire Inflation Check

Make sure tires are inflated to the correct pressures. Don't forget to check your spare tire. See *Tires* on page 5-60 for further details.

Cassette Tape Player Service

Clean cassette tape player. Cleaning should be done every 50 hours of tape play. See *Audio System(s)* on page 3-59 for further details.

At Least Twice a Year

Restraint System Check

Make sure the safety belt reminder light and all your belts, buckles, latch plates, retractors and anchorages are working properly. Look for any other loose or damaged safety belt system parts. If you see anything that might keep a safety belt system from doing its job, have it repaired. Have any torn or frayed safety belts replaced.

Also look for any opened or broken air bag coverings, and have them repaired or replaced. (The air bag system does not need regular maintenance.)

Wiper Blade Check

Inspect wiper blades for wear or cracking. Replace blade inserts that appear worn or damaged or that streak or miss areas of the windshield. Also see "Windshield Wiper and Wiper Blades" under *Cleaning the Outside of Your Vehicle* on page 5-85.

Weatherstrip Lubrication

Silicone grease on weatherstrips will make them last longer, seal better, and not stick or squeak. Apply silicone grease with a clean cloth. During very cold, damp weather more frequent application may be required. See *Part D: Recommended Fluids and Lubricants* on page 6-15.

Automatic Transaxle Check

Check the transaxle fluid level; add if needed. See *Automatic Transaxle Fluid* on page 5-22. A fluid loss may indicate a problem. Check the system and repair if needed.

At Least Once a Year

Key Lock Cylinders Service

Lubricate the key lock cylinders with the lubricant specified in Part D.

Body Lubrication Service

Lubricate all body door hinges. Also lubricate all hinges and latches, including those for the hood, rear compartment, glove box door, console door and any folding seat hardware. Part D tells you what to use. More frequent lubrication may be required when exposed to a corrosive environment.

Starter Switch Check

CAUTION:

When you are doing this check, the vehicle could move suddenly. If it does, you or others could be injured. Follow the steps below.

1. Before you start, be sure you have enough room around the vehicle.
2. Firmly apply both the parking brake and the regular brake. See *Parking Brake* on page 2-29 if necessary.
Do not use the accelerator pedal, and be ready to turn off the engine immediately if it starts.
3. Try to start the engine in each gear. The starter should work only in PARK (P) or NEUTRAL (N). If the starter works in any other position, your vehicle needs service.

Automatic Transaxle Shift Lock Control System Check

CAUTION:

When you are doing this check, the vehicle could move suddenly. If it does, you or others could be injured. Follow the steps below.

1. Before you start, be sure you have enough room around the vehicle. It should be parked on a level surface.
2. Firmly apply the parking brake. See *Parking Brake* on page 2-29 if necessary.
Be ready to apply the regular brake immediately if the vehicle begins to move.
3. With the engine off, turn the key to the ON position, but don't start the engine. Without applying the regular brake, try to move the shift lever out of PARK (P) with normal effort. If the shift lever moves out of PARK (P), your vehicle needs service.

Ignition Transaxle Lock Check

While parked, and with the parking brake set, try to turn the ignition key to OFF in each shift lever position.

- The key should turn to OFF only when the shift lever is in PARK (P).
- The key should come out only in OFF.

Parking Brake and Automatic Transaxle Park (P) Mechanism Check

CAUTION:

When you are doing this check, your vehicle could begin to move. You or others could be injured and property could be damaged. Make sure there is room in front of your vehicle in case it begins to roll. Be ready to apply the regular brake at once should the vehicle begin to move.

Park on a fairly steep hill, with the vehicle facing downhill. Keeping your foot on the regular brake, set the parking brake.

- To check the parking brake's holding ability: With the engine running and transaxle in NEUTRAL (N), slowly remove foot pressure from the regular brake pedal. Do this until the vehicle is held by the parking brake only.
- To check the PARK (P) mechanism's holding ability: With the engine running, shift to PARK (P). Then release the parking brake followed by the regular brake.

Underbody Flushing Service

At least every spring, use plain water to flush any corrosive materials from the underbody. Take care to clean thoroughly any areas where mud and other debris can collect.

Part C: Periodic Maintenance Inspections

Listed in this part are inspections and services which should be performed at least twice a year (for instance, each spring and fall). *You should let your dealer's service department or other qualified service center do these jobs. Make sure any necessary repairs are completed at once.*

Proper procedures to perform these services may be found in a service manual. See *Service Publications Ordering Information on page 7-9.*

Steering, Suspension and Front Drive Axle Boot and Seal Inspection

Inspect the front and rear suspension and steering system for damaged, loose or missing parts, signs of wear or lack of lubrication. Inspect the power steering lines and hoses for proper hook-up, binding, leaks, cracks, chafing, etc. Clean and then inspect the drive axle boot seals for damage, tears or leakage. Replace seals if necessary.

Exhaust System Inspection

Inspect the complete exhaust system. Inspect the body near the exhaust system. Look for broken, damaged, missing or out-of-position parts as well as open seams, holes, loose connections or other conditions which could cause a heat build-up in the floor pan or could let exhaust fumes into the vehicle. See *Engine Exhaust on page 2-33.*

Fuel System Inspection

Inspect the complete fuel system for damage or leaks.

Engine Cooling System Inspection

Inspect the hoses and have them replaced if they are cracked, swollen or deteriorated. Inspect all pipes, fittings and clamps; replace as needed. Clean the outside of the radiator and air conditioning condenser. To help ensure proper operation, a pressure test of the cooling system and pressure cap is recommended at least once a year.

Throttle System Inspection

Inspect the throttle system for interference or binding, and for damaged or missing parts. Replace parts as needed. Replace any components that have high effort or excessive wear. Do not lubricate accelerator and cruise control cables.

Brake System Inspection

Inspect the complete system. Inspect brake lines and hoses for proper hook-up, binding, leaks, cracks, chafing, etc. Inspect disc brake pads for wear and rotors for surface condition. Inspect other brake parts, including calipers, parking brake, etc. You may need to have your brakes inspected more often if your driving habits or conditions result in frequent braking.

Part D: Recommended Fluids and Lubricants

Fluids and lubricants identified below by name, part number or specification may be obtained from your dealer.

Usage	Fluid/Lubricant
Engine Oil	Engine oil with the American Petroleum Institute Certified for Gasoline Engines starburst symbol of the proper viscosity. To determine the preferred viscosity for your vehicle's engine, see <i>Engine Oil on page 5-15</i> .
Engine Coolant	50/50 mixture of clean, drinkable water and use only DEX-COOL Coolant. See <i>Engine Coolant on page 5-24</i> .
Hydraulic Brake System	Delco Supreme 11 Brake Fluid or equivalent DOT-3 brake fluid.
Windshield Washer Solvent	GM Optikleen Washer Solvent or equivalent.
Parking Brake Cable Guides	Chassis Lubricant (GM Part No. U.S. 12377985, in Canada 88901242, or equivalent) or lubricant meeting requirements of NLGI #2, Category LB or GC-LB.
Power Steering System	GM Power Steering Fluid (GM Part No. U.S. 1052884, in Canada 993294, or equivalent).

Usage	Fluid/Lubricant
Automatic Transaxle	DEXRON-III Automatic Transmission Fluid.
Key Lock Cylinders	Multi-Purpose Lubricant, Superlube (GM Part No. U.S. 12346241, in Canada 10953474, or equivalent).
Floor Shift Linkage	Lubriplate Lubricant Aerosol (GM Part No. U.S. 12346293, in Canada 992723, or equivalent) or lubricant meeting requirements of NLGI #2, Category LB or GC-LB.
Hood Latch Assembly, Secondary Latch, Pivots, Spring Anchor and Release Pawl	Lubriplate Lubricant Aerosol (GM Part No. U.S. 12346293, in Canada 992723, or equivalent) or lubricant meeting requirements of NLGI #2, Category LB or GC-LB.
Hood and Door Hinges	Multi-Purpose Lubricant, Superlube (GM Part No. U.S. 12346241, in Canada 10953474, or equivalent).
Fuel Door, Glove Box Door, Console Door and Rear Compartment Lid Hinges	Multi-Purpose Lubricant, Superlube (GM Part No. U.S. 12346241, in Canada 10953474, or equivalent).
Weatherstrip Conditioning	Dielectric Silicone Grease (GM Part No. U.S. 12345579, in Canada 1974984, or equivalent).

Part E: Maintenance Record

After the scheduled services are performed, record the date, odometer reading and who performed the service and any additional information from "Owner Checks and Services" or "Periodic Maintenance" on the following record pages. Also, you should retain all maintenance receipts.

Maintenance Record

Date	Odometer Reading	Serviced By	Maintenance Record

Maintenance Record (cont'd)

Date	Odometer Reading	Serviced By	Maintenance Record

Maintenance Record (cont'd)

Date	Odometer Reading	Serviced By	Maintenance Record

Section 7 Customer Assistance Information

Customer Assistance Information	7-2	Courtesy Transportation	7-6
Customer Satisfaction Procedure	7-2	Reporting Safety Defects to the United States Government	7-8
Customer Assistance for Text Telephone (TTY) Users	7-3	Reporting Safety Defects to the Canadian Government	7-9
Customer Assistance Offices	7-3	Reporting Safety Defects to General Motors	7-9
GM Mobility Program for Persons with Disabilities	7-5	Service Publications Ordering Information	7-9
Roadside Assistance Program	7-5		

Customer Assistance Information

Customer Satisfaction Procedure

Your satisfaction and goodwill are important to your dealer and to Oldsmobile. Normally, any concerns with the sales transaction or the operation of your vehicle will be resolved by your dealer's sales or service departments. Sometimes, however, despite the best intentions of all concerned, misunderstandings can occur. If your concern has not been resolved to your satisfaction, the following steps should be taken:

STEP ONE: Discuss your concern with a member of dealership management. Normally, concerns can be quickly resolved at that level. If the matter has already been reviewed with the sales, service or parts manager, contact the owner of the dealership or the general manager.

STEP TWO: If after contacting a member of dealership management, it appears your concern cannot be resolved by the dealership without further help, contact the Oldsmobile Customer Assistance Center by calling 1-800-442-6537. In Canada, contact GM of Canada Customer Communication Centre in Oshawa by calling 1-800-263-3777 (English) or 1-800-263-7854 (French).

We encourage you to call the toll-free number in order to give your inquiry prompt attention. Please have the following information available to give the Customer Assistance Representative:

- Vehicle Identification Number (This is available from the vehicle registration or title, or the plate at the top left of the instrument panel and visible through the windshield.)
- Dealership name and location
- Vehicle delivery date and present mileage

When contacting Oldsmobile, please remember that your concern will likely be resolved at a dealer's facility. That is why we suggest you follow Step One first if you have a concern.

STEP THREE: Both General Motors and your dealer are committed to making sure you are completely satisfied with your new vehicle. However, if you continue to remain unsatisfied after following the procedure outlined in Steps One and Two, you should file with the GM/BBB Auto Line Program to enforce any additional rights you may have. Canadian owners refer to your Warranty and Owner Assistance Information booklet for information on the Canadian Motor Vehicle Arbitration Plan (CAMVAP).

The BBB Auto Line Program is an out of court program administered by the Council of Better Business Bureaus to settle automotive disputes regarding vehicle repairs or the interpretation of the New Vehicle Limited Warranty. Although you may be required to resort to this informal dispute resolution program prior to filing a court action, use of the program is free of charge and your case will generally be heard within 40 days. If you do not agree with the decision given in your case, you may reject it and proceed with any other venue for relief available to you.

You may contact the BBB using the toll-free telephone number or write them at the following address:

BBB Auto Line
Council of Better Business Bureaus, Inc.
4200 Wilson Boulevard
Suite 800
Arlington, VA 22203-1804

Telephone: 1-800- 955-5100

This program is available in all 50 states and the District of Columbia. Eligibility is limited by vehicle age, mileage and other factors. General Motors reserves the right to change eligibility limitations and/or discontinue its participation in this program.

Customer Assistance for Text Telephone (TTY) Users

To assist customers who are deaf, hard of hearing, or speech-impaired and who use Text Telephones (TTYs), Oldsmobile has TTY equipment available at its Customer Assistance Center. Any TTY user can communicate with Oldsmobile by dialing: 1-800-833-OLDS (6537). (TTY users in Canada can dial 1-800-263-3830.)

Customer Assistance Offices

Oldsmobile encourages customers to call the toll-free number for assistance. If a U.S. customer wishes to write to Oldsmobile, the letter should be addressed to Oldsmobile's Customer Assistance Center.

United States

Oldsmobile Customer Assistance Center
P.O. Box 33171
Detroit, MI 48232-5171

1-800-442-6537
1-800-833-6537 (For Text Telephone devices (TTYs))
Roadside Assistance: 1-800-442-OLDS (6537)
Fax Number: 313-381-0022

From Puerto Rico:
1-800-496-9992 (English)
1-800-496-9993 (Spanish)
Fax Number: 313-381-0022

From U.S. Virgin Islands:
1-800-496-9994
Fax Number: 313-381-0022

Canada

General Motors of Canada Limited
Customer Communication Centre, 163-005
1908 Colonel Sam Drive
Oshawa, Ontario L1H 8P7
1-800-263-3777 (English)
1-800-263-7854 (French)
1-800-263-3830 (For Text Telephone devices (TTYs))
Roadside Assistance: 1-800-268-6800

All Overseas Locations

Please contact the local General Motors Business Unit.

Mexico, Central America and Caribbean Islands/Countries (Except Puerto Rico and U.S. Virgin Islands)

General Motors de Mexico, S. de R.L. de C.V.
Customer Assistance Center
Paseo de la Reforma # 2740
Col. Lomas de Bezares
C.P. 11910 Mexico, D.F.
01-800-508-0000
Long Distance: 011-52-53 29 0 800

GM Mobility Program for Persons with Disabilities



This program, available to qualified applicants, can reimburse you up to \$1,000 toward aftermarket driver or passenger adaptive equipment you may require for your vehicle (hand controls, wheelchair/scooter lifts, etc.).

This program can also provide you with free resource information, such as area driver assessment centers and mobility equipment installers. The program is available for a limited period of time from the date of vehicle purchase/lease. See your dealer for more details or call the GM Mobility Assistance Center at 1-800-323-9935. Text telephone (TTY) users, call 1-800-833-9935.

GM of Canada also has a Mobility Program. Call 1-800-GM-DRIVE (463-7483) for details. All TTY users call 1-800-263-3830.

Roadside Assistance Program Security While You Travel

1-800-442-OLDS (6537)

As the proud owner of a new Oldsmobile vehicle, you are automatically enrolled in the Oldsmobile Roadside Assistance program. This value-added service is intended to provide you with peace of mind as you drive in the city or travel the open road.

Oldsmobile's Roadside Assistance toll-free number is staffed by courteous and capable Roadside Assistance Representatives who are available 24 hours a day, 365 days a year.

We will provide the following services during the Bumper-to-Bumper warranty period, at no expense to you:

- Fuel delivery
- Lock-out service (identification required)
- Tow to the nearest dealership for warranty service or in the event of a vehicle-disabling accident
- Flat tire change
- Jump starts
- Minor repairs to disabled vehicles
- Assistance when vehicle is mired in sand, mud or snow

- Trip routing
- Trip interruption expense benefits
- Dealership locator service

Oldsmobile Roadside Assistance specifically excludes coverage for mounting, dismounting or changing of snow tires, chains or other traction devices.

In some cases, where service is impractical, the driver may be authorized to obtain other service for which reimbursement is provided.

In many instances, mechanical failures are covered under Oldsmobile's comprehensive warranty. However, when other services are utilized, our Roadside Assistance Representatives will explain any payment obligations you might incur.

For prompt and efficient assistance when calling, please provide the following to the Roadside Assistance Representative:

- Location of vehicle
- Telephone number of your location
- Vehicle model, year and color
- Mileage of vehicle

- Vehicle Identification Number (VIN)
- Vehicle license plate number

Oldsmobile reserves the right to limit services or reimbursement to an owner or driver when, in Oldsmobile's judgement, the claims become excessive in frequency or type of occurrence.

While we hope you never have the occasion to use our service, it is added security while traveling for you and your family. Remember, we're only a phone call away. Oldsmobile Roadside Assistance: 1-800-442-OLDS (6537), text telephone (TTY) users, call 1-888-889-2438.

Canadian Roadside Assistance

Vehicles purchased in Canada have an extensive roadside assistance program accessible from anywhere in Canada or the United States. Please refer to the Warranty and Owner Assistance Information book.

Courtesy Transportation

Oldsmobile has always exemplified quality and value in its offering of motor vehicles. To enhance your ownership experience, we and our participating dealers are proud to offer Courtesy Transportation, a customer support program for new vehicles.

The Courtesy Transportation program is offered to retail purchase/lease customers in conjunction with the Bumper-to-Bumper coverage provided by the New Vehicle Limited Warranty. Several transportation options are available when warranty repairs are required. This will reduce your inconvenience during warranty repairs.

Plan Ahead When Possible

When your vehicle requires warranty service, you should contact your dealer and request an appointment. By scheduling a service appointment and advising your service consultant of your transportation needs, your dealer can help minimize your inconvenience.

If your vehicle cannot be scheduled into the service department immediately, keep driving it until it can be scheduled for service, unless, of course, the problem is safety-related. If it is, please call your dealership, let them know this, and ask for instructions.

If the dealer requests that you simply drop the vehicle off for service, you are urged to do so as early in the work day as possible to allow for same day repair.

Transportation Options

Warranty service can generally be completed while you wait. However, if you are unable to wait Oldsmobile helps minimize your inconvenience by providing several transportation options. Depending on the circumstances, your dealer can offer you one of the following:

Shuttle Service

Participating dealers can provide you with shuttle service to get you to your destination with minimal interruption of your daily schedule. This includes a one way shuttle ride to a destination up to 10 miles from the dealership.

Public Transportation or Fuel Reimbursement

If your vehicle requires overnight warranty repairs, reimbursement up to \$30 per day (five days maximum) may be available for the use of public transportation such as taxi or bus. In addition, should you arrange transportation through a friend or relative, reimbursement for reasonable fuel expenses up to \$10 per day (five day maximum) may be available. Claim amounts should reflect actual costs and be supported by original receipts.

Courtesy Rental Vehicle

When your vehicle is unavailable due to overnight warranty repairs, your dealer may arrange to provide you with a courtesy rental vehicle or reimburse you for a rental vehicle you obtained, at actual cost, up to a maximum of \$30.00 per day supported by receipts. This requires that you sign and complete a rental agreement and meet state, local and rental vehicle provider requirements. Requirements vary and may include minimum age requirements, insurance coverage, credit card, etc. You are responsible for fuel usage charges and may also be responsible for taxes, levies, usage fees, excessive mileage or rental usage beyond the completion of the repair.

Generally it is not possible to provide a like-vehicle as a courtesy rental.

Additional Program Information

Courtesy Transportation is available during the Bumper-to-Bumper warranty coverage period, but it *is not* part of the New Vehicle Limited Warranty. A separate booklet entitled *Warranty and Owner Assistance Information* furnished with each new vehicle provides detailed warranty coverage information.

Courtesy Transportation is available only at participating dealers and all program options, such as shuttle service, may not be available at every dealer. Please contact your dealer for specific information about availability. All Courtesy Transportation arrangements will be administered by appropriate dealer personnel.

Canadian Vehicles: For warranty repairs during the Complete Vehicle Coverage period of the General Motors of Canada New Vehicle Limited Warranty, alternative transportation may be available under the Courtesy Transportation Program. Please consult your dealer for details.

General Motors reserves the right to unilaterally modify, change or discontinue Courtesy Transportation at any time and to resolve all questions of claim eligibility pursuant to the terms and conditions described herein at its sole discretion.

Reporting Safety Defects to the United States Government

If you believe that your vehicle has a defect which could cause a crash or could cause injury or death, you should immediately inform the National Highway Traffic Safety Administration (NHTSA), in addition to notifying General Motors.

If NHTSA receives similar complaints, it may open an investigation, and if it finds that a safety defect exists in a group of vehicles, it may order a recall and remedy campaign. However, NHTSA cannot become involved in individual problems between you, your dealer or General Motors.

To contact NHTSA, you may either call the Auto Safety Hotline toll-free at 1-800-424-9393 (or 366-0123 in the Washington, D.C. area) or write to:

NHTSA, U.S. Department of Transportation
Washington, D.C. 20590

You can also obtain other information about motor vehicle safety from the hotline.

Reporting Safety Defects to the Canadian Government

If you live in Canada, and you believe that your vehicle has a safety defect, you should immediately notify Transport Canada, in addition to notifying General Motors of Canada Limited. You may write to:

Transport Canada
330 Sparks Street
Tower C
Ottawa, Ontario K1A 0N5

Reporting Safety Defects to General Motors

In addition to notifying NHTSA (or Transport Canada) in a situation like this, we certainly hope you'll notify us. Please call us at 1-800-442-6537, or write:

Oldsmobile Customer Assistance Center
P.O. Box 33171
Detroit, MI 48232-5171

In Canada, please call us at 1-800-263-3777 (English) or 1-800-263-7854 (French). Or, write:

General Motors of Canada Limited
Customer Communication Centre 163-005
1908 Colonel Sam Drive
Oshawa, Ontario L1H 8P7

Service Publications Ordering Information

Service Manuals

Service Manuals have the diagnosis and repair information on engines, transmission, axle, suspension, brakes, electrical, steering, body, etc.

RETAIL SELL PRICE: \$120.00

Transmission, Transaxle, Transfer Case Unit Repair Manual

This manual provides information on unit repair service procedures, adjustments, and specifications for GM transmissions, transaxles, and transfer cases.

RETAIL SELL PRICE: \$50.00

Service Bulletins

Service Bulletins give technical service information needed to knowledgeably service General Motors cars and trucks. Each bulletin contains instructions to assist in the diagnosis and service of your vehicle.

In Canada, information pertaining to Product Service Bulletins can be obtained by contacting your General Motors dealer or by calling 1-800-GM-DRIVE (1-800-463-7483).

Owner's Information

Owner publications are written specifically for owners and intended to provide basic operational information about the vehicle. The owner's manual will include the Maintenance Schedule for all models.

In-Portfolio: Includes a Portfolio, Owner's Manual, and Warranty Booklet.

RETAIL SELL PRICE: \$35.00

Without Portfolio: Owner's Manual only.

RETAIL SELL PRICE: \$25.00

Current and Past Model Order Forms

Service Publications are available for current and past model GM vehicles. To request an order form, please specify year and model name of the vehicle.

ORDER TOLL FREE: 1-800-551-4123

**Monday-Friday 8:00 AM - 6:00 PM
Eastern Time**

For Credit Card Orders Only
(VISA-MasterCard-Discover), visit Helm, Inc. on the World Wide Web at: www.helminc.com

Or you can write to:

Helm, Incorporated
P. O. Box 07130
Detroit, MI 48207

Prices are subject to change without notice and without incurring obligation. Allow ample time for delivery.

Note to Canadian Customers: All listed prices are quoted in U.S. funds. Canadian residents are to make checks payable in U.S. funds.

A

Accessory Power Outlets	3-21	Appearance Care (cont.)	
Adding Washer Fluid	5-38	Chemical Paint Spotting	5-87
Additional Program Information	7-8	Cleaning the Inside of Your Vehicle	5-82
Additives, Fuel	5-6	Cleaning the Outside of Your Vehicle	5-85
Add-On Electrical Equipment	5-91	Finish Damage	5-87
Adjusting the Speakers (Balance/Fade)	3-62	GM Vehicle Care/Appearance Materials	5-88
Air Bag		Sheet Metal Damage	5-87
Readiness Light	3-34	Underbody Maintenance	5-87
Air Bag Systems	1-47	Weatherstrips	5-84
How Does an Air Bag Restrain?	1-52	Ashtrays	3-22
Servicing Your Air Bag-Equipped Vehicle	1-54	Assist Handles	2-45
What Makes an Air Bag Inflate?	1-52	Audio System(s)	3-59
What Will You See After an Air Bag Inflates?	1-52	Audio Systems	
When Should an Air Bag Inflate?	1-51	Audio Steering Wheel Controls	3-74
Where Are the Air Bags?	1-49	Care of Your Cassette Tape Player	3-74
Air Cleaner/Filter, Engine	5-21	Care of Your CD Player	3-76
All Overseas Locations	7-4	Care of Your CDs	3-75
Aluminum or Chrome-Plated Wheels	5-86	Chime Level Adjustment	3-76
AM	3-74	Diversity Antenna System	3-76
Antenna, Diversity	3-76	Navigation/Radio System	3-69
Anti-Lock Brake System (ABS)	4-7	Personal Choice Radio Controls	3-73
Anti-Lock Brake, System Warning Light	3-36	Radio with Cassette and CD	3-60
Appearance Care	5-82	Setting the Time	3-59
Care of Safety Belts	5-84	Theft-Deterrent Feature	3-73
		Trunk-Mounted CD Changer	3-70
		Understanding Radio Reception	3-74

Automatic Climate Control System	3-23
Automatic Door Locks	3-54
Automatic Headlamp System	3-16
Automatic Level Control	4-36
Automatic Operation	3-23
Automatic Transaxle	
Fluid	5-22
Operation	2-26
Automatic Transaxle Check	6-10
Automatic Transaxle Shift Lock Control System	
Check	6-11

B

Backing Up	4-41
Battery	5-42
Battery Load Management	3-21
Battery Replacement	2-9
Battery Warning Light	3-35
Before Leaving on a Long Trip	4-23
Body Lubrication Service	6-10
Brake	
Parking	2-29
System Inspection	6-14
System Warning Light	3-35

Brake Fluid	5-39
Brake Wear	5-41
Brakes	5-39
Braking	4-6
Braking in Emergencies	4-8
Break-In, New Vehicle	2-23
Bulb Replacement	5-54
Front Turn Signal and Parking Lamps	5-57
Halogen Bulbs	5-54
Headlamp Aiming	5-50
Headlamps	5-55
Replacement Bulbs	5-58
Taillamps, Turn Signal, Stoplamps and	
Back-up Lamps	5-58
Buying New Tires	5-66

C

California Fuel	5-6
Canada	7-4
Canadian Owners	ii
Canadian Roadside Assistance	7-6
Capacities and Specifications	5-100
Carbon Monoxide	4-26, 4-36, 2-14, 2-33

Care of		
Safety Belts	5-84	
Care of Your		
Cassette Tape Player	3-74	
CD Player	3-76	
CDs	3-75	
Cassette Tape Messages	3-66	
Cassette Tape Player Service	6-9	
CD Changer, Trunk-Mounted	3-70	
Chains, Tires	5-70	
Check		
Engine Light	3-39	
Tire Pressure System	5-62	
Check Engine Light	3-39	
Checking Coolant	5-26	
Checking Engine Oil	5-16	
Checking Things Under the Hood	5-12	
Checking Your Restraint Systems	1-55	
Chemical Paint Spotting	5-87	
Child Restraints		
Child Restraint Systems	1-34	
Infants and Young Children	1-30	
Lower Anchorages and Top Tethers for Children (LATCH System)	1-40	
Older Children	1-28	
Securing a Child Restraint Designed for the LATCH System	1-42	
Securing a Child Restraint in a Rear Seat Position	1-42	
Child Restraints (cont.)		
Securing a Child Restraint in the Right Front Seat Position	1-44	
Top Strap	1-38	
Top Strap Anchor Location	1-39	
Where to Put the Restraint	1-37	
Chime Level Adjustment	3-76	
Cigarette Lighter	3-22	
Cleaning		
Inside of Your Vehicle	5-82	
Outside of Your Vehicle	5-85	
Underbody Maintenance	5-87	
Weatherstrips	5-84	
Cleaning Exterior Lamps/Lenses	5-85	
Climate Control System		
Automatic	3-23	
Climate Controls Personalization	3-29	
Outlet Adjustment	3-27	
Steering Wheel Controls	3-28	
Compact Disc Errors	3-72	
Compact Disc Messages	3-68	
Compact Spare Tire	5-81	
Compass Calibration	2-35	
Compass Operation	2-35	
Compass Variance	2-36	
Control of a Vehicle	4-5	
Convenience Net	2-46	

Coolant	
Engine Temperature Gage	3-38
Heater, Engine	2-25
Surge Tank Pressure Cap	5-28
Cooling System	5-31
Courtesy Lamps	3-18
Cruise Control	3-11
Cruise Control Light	3-43
Current and Past Model Order Forms	7-10
Customer Assistance Information	
Courtesy Transportation	7-6
Customer Assistance for Text Telephone (TTY)	
Users	7-3
Customer Assistance Offices	7-3
Customer Satisfaction Procedure	7-2
GM Mobility Program for Persons with	
Disabilities	7-5
Reporting Safety Defects to General Motors	7-9
Reporting Safety Defects to the Canadian	
Government	7-9
Reporting Safety Defects to the United States	
Government	7-8
Roadside Assistance Program	7-5
Service Publications Ordering Information	7-9

D

Date/Elapsed Time	3-45
Daytime Running Lamps	3-15
Defensive Driving	4-2
Defogging and Defrosting	3-26
Delayed Entry Lighting	3-18
Delayed Exit Lighting	3-19
Delayed Locking	2-11, 3-57
Dinghy Towing	4-33
Diversity Antenna	3-76
Doing Your Own Service Work	5-4
Dolly Towing	4-34
Door	
Central Door Unlocking System	2-11
Delayed Locking	2-11
Door Ajar Reminder	2-11
Locks	2-10
Power Door Locks	2-11
Programmable Automatic Door Locks	2-12
Rear Door Security Locks	2-13
Driver	
Position, Safety Belt	1-14
Driver ID	3-57

Driver Information Center (DIC)	3-45
DIC Vehicle Personalization	3-52
DIC Warnings and Messages	3-50
Driving	
At Night	4-16
City	4-21
Defensive	4-2
Drunken	4-2
Freeway	4-22
Hill and Mountain Roads	4-24
In Rain and on Wet Roads	4-18
Winter	4-26
Driving On Grades	4-42
Driving on Snow or Ice	4-28
Driving Through Deep Standing Water	4-20
Driving Through Flowing Water	4-20
Driving with a Trailer	4-40

E

Electrical System	
Add-On Equipment	5-91
Fuses and Circuit Breakers	5-92
Headlamp Wiring	5-91
Power Windows and Other Power Options	5-91
Removing the Rear Seat Cushion	5-95
Windshield Wiper Fuses	5-91
Emergency Trunk Release Handle	2-16
Emissions Inspection and Maintenance	
Programs	3-42

Engine	
Air Cleaner/Filter	5-21
Battery	5-42
Check and Service Engine Soon Light	3-39
Coolant	5-24
Coolant Heater	2-25
Coolant Temperature Gage	3-38
Cooling System Inspection	6-14
Engine Compartment Overview	5-14
Exhaust	2-33
Oil	5-15
Overheating	5-28
Starting	2-24
Engine Compartment Fuse Block	5-92
Engine Coolant Level Check	6-9
Engine Cooling When Trailer Towing	4-43
Engine Oil Additives	5-19
Engine Oil Level Check	6-9
Engine Oil Scheduled Maintenance	6-5
Engine Specifications	5-100
English/Metric	3-45
Entry Lighting	3-18
Erasing HomeLink [®] Buttons	2-44
Express-Down Window	2-18
Extender, Safety Belt	1-27
Exterior Lamps	3-14
Exterior Lighting Battery Saver	3-17

F

Fabric/Carpet	5-82
Filter	
Engine Air Cleaner	5-21
Finding a PTY Station	3-63
Finding a Station	3-60
Finish Care	5-85
Finish Damage	5-87
Flash-to-Pass	3-8
Flat Tire	5-70
Flat Tire, Changing	5-71
Floor Mats	2-46
Fluid	
Automatic Transaxle	5-22
Power Steering	5-37
Windshield Washer	5-38
FM	3-74
Fog Lamps	3-16
Following Distance	4-40
Footnotes	6-5
Front Reading Lamps	3-20
Front Storage Area	2-45
Fuel	3-46, 5-5
Additives	5-6
California Fuel	5-6
Filling a Portable Fuel Container	5-11
Filling Your Tank	5-7

Fuel (cont.)	
Fuels in Foreign Countries	5-7
Gage	3-44
Gasoline Octane	5-5
Gasoline Specifications	5-5
System Inspection	6-13
Fuel Economy	3-47
Fuses	
Fuses and Circuit Breakers	5-92
Windshield Wiper	5-91

G

Gage	3-49
Engine Coolant Temperature	3-38
Fuel	3-44
Speedometer	3-32
Tachometer	3-33
Garage Door Opener	2-41
Gasoline	
Octane	5-5
Specifications	5-5
Gate Operator and Canadian Programming	2-43
Glass Surfaces	5-84
Glove Box	2-45
GM Mobility Program for Persons with Disabilities	7-5

H

Hazard Warning Flashers	3-4
Head Restraints	1-7
Headlamp	
Aiming	5-50
Headlamp High/Low-Beam Changer	3-7
Headlamp Horizontal Aiming	5-51
Headlamp Vertical Aiming	5-52
Headlamp Wiring	5-91
Headlamps	5-55
Bulb Replacement	5-54
Front Turn Signal and Parking Lamps	5-57
Halogen Bulbs	5-54
Headlamps on Reminder	3-15
Heated Seats	1-5
Highway Hypnosis	4-24
Hill and Mountain Roads	4-24
Hitches	4-39
HomeLink Transmitter, Programming	2-42
HomeLink® Transmitter	2-41
Hood	
Checking Things Under	5-12
Release	5-13
Horn	3-5
How to Add Coolant to the Coolant Surge Tank ..	5-33
How to Add Fluid	5-24
How to Check	5-22, 5-61

How to Check Power Steering Fluid	5-37
How to Use This Manual	ii
How to Wear Safety Belts Properly	1-13
Hydroplaning	4-19

I

If No Steam Is Coming From Your Engine	5-30
If Steam Is Coming From Your Engine	5-29
If the Light Is Flashing	3-40
If the Light Is on Steady	3-41
If You Are Stuck in Sand, Mud, Ice or Snow	4-32
If You Do Decide To Pull A Trailer	4-37
If You're Caught in a Blizzard	4-29
Ignition Positions	2-23
Ignition Transaxle Lock Check	6-12
Inadvertent Power Battery Saver	3-20
Infants and Young Children, Restraints	1-30
Inflation -- Tire Pressure	5-60
Inspection	
Brake System	6-14
Engine Cooling System	6-14
Exhaust System	6-13
Fuel System	6-13
Part C - Periodic Maintenance	6-13
Steering, Suspension and Front Drive Axle	
Boot and Seal	6-13
Throttle System	6-14

Instrument Panel	
Cluster	3-31
Overview	3-2
Instrument Panel Brightness	3-17
Interior Lamps	3-17
Interior Plastic Components	5-83

J

Jump Starting	5-44
---------------------	------

K

Key Lock Cylinders Service	6-10
Key Reminder Warning	2-24
Keyless Entry System	2-5
Keys	2-3

L

Lamps	
Exterior	3-14
Interior	3-17
Lap-Shoulder Belt	1-14, 1-22
LATCH System	
Child Restraints	1-40
Securing a Child Restraint Designed for the LATCH System	1-42
Leather	5-83

Leaving Your Vehicle	2-14
Leaving Your Vehicle With the Engine Running	2-31
Light	
Air Bag Readiness	3-34
Anti-Lock Brake System Warning	3-36
Battery Warning	3-35
Brake System Warning	3-35
Cruise Control	3-43
Malfunction Indicator	3-39
Oil Pressure	3-42
Safety Belt Reminder	3-33
TCS Warning Light	3-37
Traction Control System Active	3-38
Traction Control System (TCS) Warning	3-37
Lighted Visor Vanity Mirror	2-18
Loading Your Vehicle	4-34
Lockout Protection	2-14
Locks	
Central Door Unlocking System	2-11
Delayed Locking	2-11
Door	2-10
Leaving Your Vehicle	2-14
Lockout Protection	2-14
Power Door	2-11
Programmable Automatic Door Locks	2-12
Rear Door Security Locks	2-13
Loss of Control	4-15
Lumbar	
Manual Controls	1-3
Power Controls	1-4

M

Magnetic-Speed Variable Assist Steering	4-10
Maintenance, Normal Replacement Parts	5-101
Maintenance Schedule	
At Each Fuel Fill	6-9
At Least Once a Month	6-9
At Least Once a Year	6-10
At Least Twice a Year	6-10
Brake System Inspection	6-14
Engine Cooling System Inspection	6-14
Exhaust System Inspection	6-13
Fuel System Inspection	6-13
How This Section is Organized	6-3
Introduction	6-2
Maintenance Requirements	6-2
Part A - Scheduled Maintenance Services	6-4
Part B - Owner Checks and Services	6-9
Part C - Periodic Maintenance Inspections	6-13
Part D - Recommended Fluids and Lubricants	6-15
Part E - Maintenance Record	6-16
Scheduled Maintenance	6-5
Steering, Suspension and Front Drive Axle	
Boot and Seal Inspection	6-13
Throttle System Inspection	6-14
Using Your	6-4

Maintenance Schedule (cont.)	
Your Vehicle and the Environment	6-2
Maintenance When Trailer Towing	4-43
Making Turns	4-41
Malfunction Indicator Light	3-39
Manual Lumbar Controls	1-3
Manual Operation	3-24
Manual Passenger Seat	1-2
Matching Transmitter(s) to Your Vehicle	2-8
Memory Mirrors	2-48
Memory Seat	2-48
Memory Seats	3-58
Message	
DIC Warnings and Messages	3-50
Mexico, Central America and Caribbean Islands/ Countries (Except Puerto Rico and U.S. Virgin Islands)	7-4
Mirror Operation	2-35
Mirrors	
Automatic Dimming Rearview with Compass	2-35
Memory	2-48
Outside Convex Mirror	2-33
Outside Curb View Assist Mirror	2-37
Outside Heated Mirrors	2-38
Outside Power Mirrors	2-37

N

Navigation System	3-69
New Vehicle Break-In	2-23
Normal Maintenance Replacement Parts	5-101

O

Odometer	3-32
Off-Road Recovery	4-13
Oil	
Engine	5-15
Pressure Light	3-42
Oil Life	3-48
Older Children, Restraints	1-28
OnStar [®] System	2-39
OnStar [®] Personal Calling	2-40
OnStar [®] Services	2-39
OnStar [®] Virtual Advisor	2-40
Other Warning Devices	3-5
Outlet Adjustment	3-27
Outside	
Convex Mirror	2-38
Curb View Assist Mirror	2-37
Heated Mirrors	2-38
Power Mirrors	2-37

Outside Curb View Assist Mirror	3-58
Overheated Engine Protection Operating Mode ...	5-28
Overriding Lock Delay	2-12
Owners, Canadian	ii
Owner's Information	7-10

P

Parade Dimming	3-19
Park (P)	
Shifting Into	2-30
Shifting Out of	2-32
Parking	
Brake	2-29
Over Things That Burn	2-32
Parking Brake and Automatic Transaxle Park (P)	
Mechanism Check	6-12
Parking on Hills	4-42
Part A - Scheduled Maintenance Services	6-4
Part B - Owner Checks and Services	6-9
Part C - Periodic Maintenance Inspections	6-13
Part D - Recommended Fluids and Lubricants	6-15
Part E - Maintenance Record	6-16
Passenger Temperature Control	3-27
Passing	4-13, 4-41
PASS-Key [®] III	2-21
PASS-Key [®] III Operation	2-21

Perimeter Lighting	3-19, 3-57
Personalization, Climate Controls	3-29
Personalization Features	2-7
Plan Ahead When Possible	7-7
Playing a Cassette Tape	3-65
Playing a Compact Disc	3-67, 3-71
Playing the Radio	3-60
Power	
Accessory Outlets	3-21
Door Locks	2-11
Electrical System	5-91
Lumbar Controls	1-4
Seat	1-2
Steering Fluid	5-37
Windows	2-18
Power Steering	4-10
Programmable Automatic Door Locks	2-12
Programming the HomeLink [®] Transmitter	2-42

Q

Questions and Answers About Safety Belts	1-12
--	------

R

Radios	3-59
Care of Your Cassette Tape Player	3-74
Care of Your CD Player	3-76
Care of Your CDs	3-75
Navigation System	3-69
Personal Choice Radio Controls	3-73
Radio with Cassette and CD	3-60
Setting the Time	3-59
Theft-Deterrent	3-73
Trunk-Mounted CD Changer	3-70
Understanding Reception	3-74
Rainsense [™] II Wipers	3-9
RDS Messages	3-64
Rear Reading Lamps	3-20
Rear Safety Belt Comfort Guides	1-25
Rear Seat Passengers, Safety Belts	1-21
Rear Storage Area	2-46
Rear Underseat Fuse Block	5-96
Rear Window Defogger	3-26
Rearview Mirror, Automatic Dimming with Compass	2-35

Reclining Seatbacks	1-5
Recreational Vehicle Towing	4-33
Remote Keyless Entry System	2-5
Remote Keyless Entry System, Operation	2-6
Remote Trunk Release	2-15
Removing the Flat Tire and Installing the Spare Tire	5-74
Removing the Spare Tire and Tools	5-72
Removing the Wheel Covers	5-73
Replacement Bulbs	5-58
Replacing Brake System Parts	5-42
Replacing Restraint System Parts After a Crash	1-56
Reporting Safety Defects	
Canadian Government	7-9
General Motors	7-9
United States Government	7-8
Reprogramming a Single HomeLink® Button	2-44
Resetting Defaults	2-44
Restraint System Check	6-10
Checking Your Restraint Systems	1-55
Replacing Restraint System Parts After a Crash	1-56
Restraint Systems	
Checking	1-55
Replacing Parts	1-56
Restraints, Head	1-7
Retained Accessory Power (RAP)	2-24

Right Front Passenger Position, Safety Belts	1-21
Roadside Assistance Program	7-5
Rocking Your Vehicle To Get It Out	4-32
Running Your Engine While You Are Parked	2-34

S

Safety Belt	
Reminder Light	3-33
Safety Belts	
Care of	5-84
Driver Position	1-14
How to Wear Safety Belts Properly	1-13
Questions and Answers About Safety Belts	1-12
Rear Safety Belt Comfort Guides for Children and Small Adults	1-25
Rear Seat Passengers	1-21
Right Front Passenger Position	1-21
Safety Belt Extender	1-27
Safety Belt Use During Pregnancy	1-20
Safety Belts Are for Everyone	1-8
Safety Chains	4-39
Safety Warnings and Symbols	iii
Scheduled Maintenance	6-5

Seats	
Head Restraints	1-7
Heated Seats	1-5
Manual Lumbar	1-3
Manual Passenger	1-2
Memory	2-48
Power Lumbar	1-4
Power Seats	1-2
Reclining Seatbacks	1-5
Securing a Child Restraint	
Designed for the LATCH System	1-42
Rear Seat Position	1-42
Right Front Seat Position	1-44
Security Feedback	2-8, 3-56
Security While You Travel	7-5
Sensors	3-25
Service	5-3
Adding Equipment to the Outside of Your Vehicle	5-4
Doing Your Own Work	5-4
Engine Soon Light	3-39
Publications Ordering Information	7-9
Service Bulletins	7-10
Service Manuals	7-9
Setting Preset Stations	3-61
Setting Preset PTYs	3-64
Setting the Time	3-59
Setting the Tone (Bass/Treble)	3-61
Sheet Metal Damage	5-87
Shifting Into Park (P)	2-30
Shifting Out of Park (P)	2-32
Skidding	4-15
Some Other Rainy Weather Tips	4-20
Specifications, Capacities	5-100
Speedometer	3-32
Starter Switch Check	6-11
Starting Your Engine	2-24
Steering	4-10
Steering in Emergencies	4-12
Steering, Suspension and Front Drive Axle Boot and Seal Inspection	6-13
Steering Tips	4-11
Steering Wheel Climate Controls	3-28
Steering Wheel Controls, Audio	3-74
Storage Areas	
Convenience Net	2-46
Front Storage Area	2-45
Glove Box	2-45
Rear Storage Area	2-46
Storing the Flat Tire and Tools	5-79
Storing the Spare Tire and Tools	5-80
Stuck in Sand, Mud, Ice or Snow	4-32
Sun Visors	2-18
Sunroof	2-47

T

Tachometer	3-33
Taillamps	
Turn Signal, Stoplamps and Back-up Lamps	5-58
TCS Active Light	3-38
TCS Warning Light	3-37
Testing the Alarm	2-20
Theater Dimming	3-19
Theft-Deterrent, Radio	3-73
Theft-Deterrent Systems	2-19
PASS-Key [®] III	2-21
PASS-Key [®] III Operation	2-21
Universal Theft-Deterrent	2-19
Throttle System Inspection	6-14
Tilt Wheel	3-5
Tire Inflation Check	6-9
Tires	5-60, 5-86
Buying New Tires	5-66
Chains	5-70
Changing a Flat Tire	5-71
Check Tire Pressure System	5-62
Compact Spare Tire	5-81
If a Tire Goes Flat	5-70
Inflation -- Tire Pressure	5-60
Inspection and Rotation	5-63
Uniform Tire Quality Grading	5-67
Tires (cont.)	
Wheel Alignment and Tire Balance	5-68
Wheel Replacement	5-68
When It Is Time for New Tires	5-65
To Use the Engine Coolant Heater	2-25
Top of the Instrument Panel	5-83
Top Strap	1-38
Top Strap Anchor Location	1-39
Torque Lock	2-31
Total Weight on Your Vehicle's Tires	4-39
Towing	
Recreational Vehicle	4-33
Towing a Trailer	4-36
Your Vehicle	4-33
Traction	
Control System Active Light	3-38
Control System (TCS)	4-8
Control System Warning Light	3-37
Trailer Brakes	4-40
Trailer Wiring Harness	4-40
Transaxle	
Fluid, Automatic	5-22
Transaxle Operation, Automatic	2-26
Transmission, Transaxle, Transfer Case Unit	
Repair Manual	7-10
Transportation Options	7-7

Trip Odometers	3-32
Trunk	2-14
Trunk Lock Release	2-15
Trunk Release Lockout	2-15
Turn and Lane-Change Signals	3-6
Turn Signal/Multifunction Lever	3-6
Turn Signals When Towing a Trailer	4-41

U

Underbody Flushing Service	6-12
Understanding Radio Reception	3-74
Uniform Tire Quality Grading	5-67
United States	7-4
Used Replacement Wheels	5-69
Using HomeLink®	2-44
Using RDS	3-62

V

Vehicle	
Control	4-5
Damage Warnings	iv
Loading	4-34
Symbols	iv
Vehicle Identification	
Number (VIN)	5-90
Service Parts Identification Label	5-90

Vehicle Personalization	
DIC	3-52
Memory Seat and Mirrors	2-48
Vehicle Storage	5-43
Ventilation Adjustment	3-27
Vinyl	5-83
Visors	2-18

W

Warning Lights, Gages and Indicators	3-30
Warnings	
DIC Warnings and Messages	3-50
Hazard Warning Flashers	3-4
Other Warning Devices	3-5
Safety and Symbols	iii
Vehicle Damage	iv
Washing Your Vehicle	5-85
Weatherstrip Lubrication	6-10
Weight of the Trailer	4-38
Weight of the Trailer Tongue	4-38
What Kind of Engine Oil to Use	5-18
What to Do with Used Oil	5-20
What to Use	5-25, 5-37, 5-38
Wheels	
Alignment and Tire Balance	5-68
Replacement	5-68
When to Add Engine Oil	5-17

When to Change Engine Oil (GM Oil Life System™)	5-19
When to Check	5-61
When to Check and Change	5-22
When to Check Power Steering Fluid	5-37
When You Are Ready to Leave After Parking on a Hill	4-43
Where to Put the Restraint	1-37
Why Safety Belts Work	1-9
Window Lock Out	2-18, 3-55
Windows	2-17
Power	2-18
Windshield and Wiper Blades	5-86
Windshield Washer Fluid	3-10 5-38

Windshield Washer Fluid Level Check	6-9
Windshield Wiper Blade Replacement	5-59
Fuses	5-91
Windshield Wipers	3-8
Winter Driving	4-26
Wiper Blade Check	6-10
Wiper-Activated Headlamps	3-15
Wood Panels	5-84

Y

Your Vehicle and the Environment	6-2
--	-----

