

Table of contents

Introduction	2
Instrumentation	6
Controls and features	13
Starting	17
Driving	22
Roadside emergencies	29
Maintenance and care	46
Capacities and specifications	72
Reporting Safety Defects	72
Index	76

All rights reserved. Reproduction by any means, electronic or mechanical including photocopying, recording or by any information storage and retrieval system or translation in whole or part is not permitted without written authorization from Ford Motor Company. Ford may change the contents without notice and without incurring obligation.

Copyright © 1999 Ford Motor Company

Introduction

The following warning may be required by California law:

CALIFORNIA Proposition 65 Warning

 **WARNING:** Engine exhaust, some of its constituents, and certain vehicle components contain or emit chemicals known to the State of California to cause cancer and birth defects or other reproductive harm. In addition, certain fluids contained in vehicles and certain products of component wear contain or emit chemicals known to the State of California to cause cancer and birth defects or other reproductive harm.

ICONS

Indicates a safety alert. Read the following section on *Warnings*.



Indicates vehicle information related to recycling and other environmental concerns will follow.



Correct vehicle usage and the authorized disposal of waste cleaning and lubrication materials are significant steps towards protecting the environment.

Indicates a message regarding child safety restraints. Refer to *Seating and safety restraints* for more information.



Indicates that this Owner Guide contains information on this subject. Please refer to the Index to locate the appropriate section which will provide you more information.



WARNINGS

Warnings provide information which may reduce the risk of personal injury and prevent possible damage to others, your vehicle and its equipment.

BREAKING-IN YOUR VEHICLE

There are no particular breaking-in rules for your vehicle. During the first 1 600 km (1 000 miles) of driving, vary speeds frequently. This is necessary to give the moving parts a chance to break in.

INFORMATION ABOUT THIS GUIDE

The information found in this guide was in effect at the time of printing. Ford may change the contents without notice and without incurring obligation.

SPECIAL NOTICES

Notice to owners of pickup trucks and utility type vehicles



Utility vehicles have a significantly higher rollover rate than other types of vehicles.

Before you drive your vehicle, please read this Owner's Guide carefully. Your vehicle is not a passenger car. As with other vehicles of this type, failure to operate this vehicle correctly may result in loss of control or an accident.

Be sure to read *Driving off road* in the *Driving* chapter as well as the "Four Wheeling" supplement included with 4WD and utility type vehicles.

Introduction

These are some of the symbols you may see on your vehicle.

Vehicle Symbol Glossary

Safety Alert		See Owner's Guide	
Fasten Safety Belt		Air Bag-Front	
Air Bag-Side		Child Seat	
Child Seat Installation Warning		Child Seat Tether Anchorage	
Brake System		Anti-Lock Brake System	
Brake Fluid - Non-Petroleum Based		Traction Control	
Master Lighting Switch		Hazard Warning Flasher	
Fog Lamps-Front		Fuse Compartment	
Fuel Pump Reset		Windshield Wash/Wipe	
Windshield Defrost/Demist		Rear Window Defrost/Demist	
Power Windows Front/Rear		Power Window Lockout	

Vehicle Symbol Glossary

Child Safety Door
Lock/Unlock



Interior Luggage
Compartment Release
Symbol



Panic Alarm



Engine Oil



Engine Coolant



Engine Coolant
Temperature



Do Not Open When Hot



Battery



Avoid Smoking, Flames,
or Sparks



Battery Acid



Explosive Gas



Fan Warning



Power Steering Fluid



Maintain Correct Fluid
Level



Emission System



Engine Air Filter



Passenger Compartment
Air Filter



Jack



Instrumentation

WARNING LIGHTS AND CHIMES

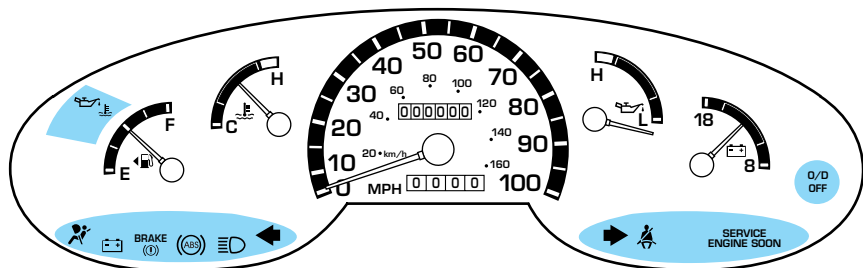

Service engine soon

Your vehicle is equipped with a computer that monitors the engine's emission control system. This system is commonly known as the On Board Diagnostics System (OBD II). The OBD II system protects the environment by ensuring that your vehicle continues to meet government emission standards. The OBD II system also assists the service technician in properly servicing your vehicle.

**SERVICE
ENGINE
SOON**

The *Service Engine Soon* indicator light illuminates when the ignition is first turned to the ON position to check the bulb. If it comes on after the engine is started, one of the engine's emission control systems may be malfunctioning. The light may illuminate without a driveability concern being noted. The vehicle will usually be drivable and will not require towing.

What you should do if the Service Engine Soon light illuminates **Light turns on solid:**

This means that the OBD II system has detected a malfunction.

Temporary malfunctions may cause your *Service Engine Soon* light to illuminate. Examples are:

1. The vehicle has run out of fuel. (The engine may misfire or run poorly.)
2. Poor fuel quality or water in the fuel.
3. The fuel cap may not have been properly installed and securely tightened.

Instrumentation

These temporary malfunctions can be corrected by filling the fuel tank with high quality fuel of the recommended octane and/or properly installing and securely tightening the gas cap. After three driving cycles without these or any other temporary malfunctions present, the *Service Engine Soon* light should turn off. (A driving cycle consists of a cold engine startup followed by mixed city/highway driving.) No additional vehicle service is required.

If the *Service Engine Soon* light remains on, have your vehicle serviced at the first available opportunity.

Light is blinking:

Engine misfire is occurring which could damage your catalytic converter. You should drive in a moderate fashion (avoid heavy acceleration and deceleration) and have your vehicle serviced at the first available opportunity.



Under engine misfire conditions, excessive exhaust temperatures could damage the catalytic converter, the fuel system, interior floor coverings or other vehicle components, possibly causing a fire.

Safety belt

Momentarily illuminates when the ignition is turned to the ON position to remind you to fasten your safety belts. For more information, refer to the *Seating and safety restraints* chapter.



Brake system warning

Momentarily illuminates when the ignition is turned to the ON position. Also illuminates if the parking brake is engaged. If the brake warning lamp does not illuminate at these times, seek service immediately. Illumination after releasing the parking brake indicates low brake fluid level and the brake system should be inspected immediately.



Instrumentation

Anti-lock brake system (ABS) (If equipped)

Momentarily illuminates when the ignition is turned to the ON position. If the light stays on, the ABS needs to be serviced. With the ABS light on, the anti-lock brake



system is disabled and normal braking is still effective unless the brake warning light also remains illuminated with the parking brake released.

O/D off (if equipped)

Illuminates when the Transmission Control Switch (TCS), refer to *Overdrive control* in the *Controls and Features* chapter, has been



pushed turning the transmission overdrive function OFF. When the light is on, the transmission does not operate in the overdrive mode, refer to the *Driving* chapter for transmission function and operation.

The light may also flash steadily if a transmission malfunction is detected. If the light does not come on when the Transmission Control Switch is depressed or if the light flashes steadily, have your vehicle serviced as soon as possible, damage to the transmission could occur.

Turn signal

Illuminates when the left or right turn signal or the hazard lights are turned on. If one or both of the indicators stay on continuously, check for a burned-out turn signal

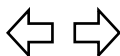

bulb. Refer to *Exterior bulbs* in the *Maintenance and care* chapter.

High beams

Illuminates when the high beam headlamps are turned on.



Charging system

Illuminates when the ignition is turned to the ON position and the engine is off. The light also illuminates when the battery is not charging properly, requiring electrical system service.

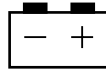

Safety belt warning chime

Sounds to remind you to fasten your safety belts.

For information on the safety belt warning chime, refer to the *Seating and safety restraints* chapter.

GAUGES

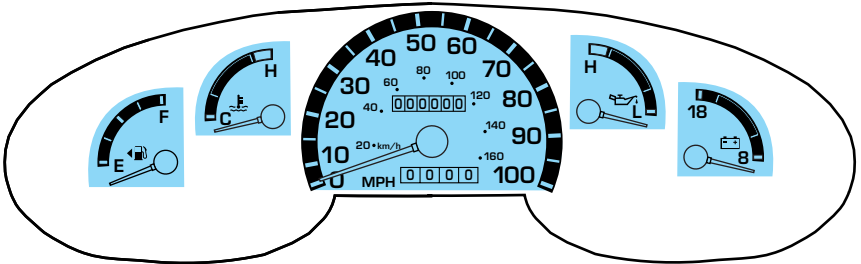

Speedometer

Indicates the current vehicle speed.

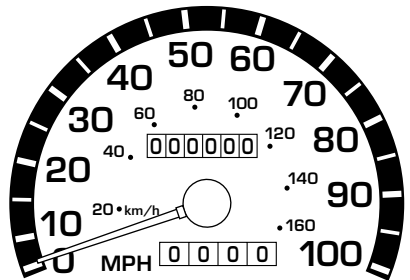

Instrumentation

Engine coolant temperature gauge

Indicates the temperature of the engine coolant. At normal operating temperature, the needle remains within the normal area (the area between the “H” and “C”). If it enters the red section, the engine is overheating. Stop the vehicle as soon as safely possible, switch off the engine immediately and let the engine cool. Refer to *Engine coolant* in the *Maintenance and care* chapter.

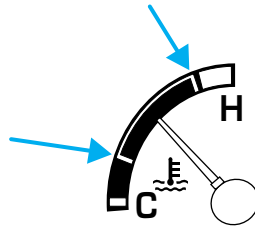

Never remove the coolant reservoir cap while the engine is running or hot.

This gauge indicates the temperature of the engine coolant, not the coolant level. If the coolant is not at its proper level the gauge indication will not be accurate. If the gauge enters the red section, the oil pressure/engine coolant and *Check Engine/Service Engine Soon* indicators illuminate, refer to *What you should know about fail-safe cooling* in the *Maintenance and care* chapter.

Odometer

Registers the total kilometers (miles) of the vehicle.

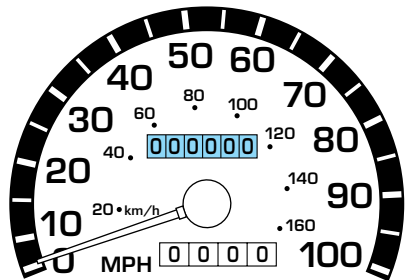

Trip odometer

Registers the kilometers (miles) of individual journeys. To reset, depress the control.

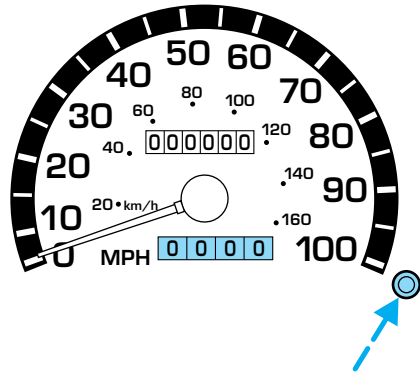

Battery voltage gauge

This shows the battery voltage when the ignition is in the ON position. If the pointer moves and stays outside the normal operating range (as indicated), have the vehicle's electrical system checked as soon as possible.

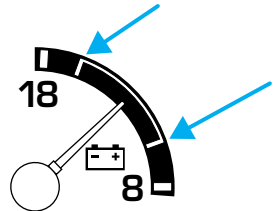

Engine oil pressure gauge

This shows the engine oil pressure in the system. Sufficient pressure exists as long as the needle remains in the normal range (the area between the "L" and "H").

If the gauge indicates low pressure, stop the vehicle as soon as safely possible and switch off the engine immediately. Check the oil level.

Add oil if needed (refer to *Engine oil* in the *Maintenance and care* chapter).

If the oil level is correct, have your vehicle checked at your dealership or by a qualified technician.

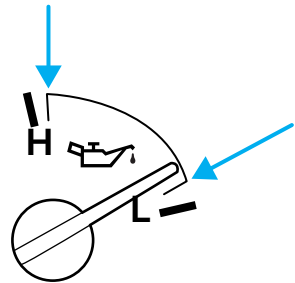

Instrumentation

Fuel gauge

Displays approximately how much fuel is in the fuel tank (when the key is in the ON position). The fuel gauge may vary slightly when the vehicle is in motion. The ignition should be in the OFF position while the vehicle is being refueled. When the gauge first indicates empty, there is a small amount of reserve fuel in the tank. When refueling the vehicle from an empty indication, the amount of fuel that can be added will be less than the advertised capacity due to the reserve fuel.

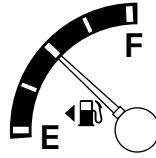

When the gauge first indicates empty, there is a small amount of reserve fuel in the tank. When refueling the vehicle from an empty indication, the amount of fuel that can be added will be less than the advertised capacity due to the reserve fuel.

Controls and features

HEADLAMP CONTROL ☀️

- Pull the headlamp control toward you to the first position to turn on the parking lamps, tail lamps, license plate lamps and marker lamps.
- Pull the headlamp control toward you to the outer position to turn on the headlamps (in addition to the previous lamps).

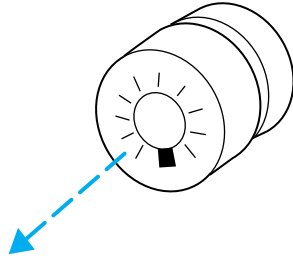

PANEL DIMMER CONTROL 🕒

To adjust the brightness of the instrument panel:

- Rotate clockwise/counterclockwise when the headlamp control is in the parking lamp or low-beam position.

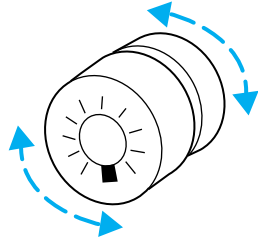

To turn on the courtesy lamp:

- Rotate fully counterclockwise.

High beams ≡D

Push forward to activate.

Pull toward you to deactivate.

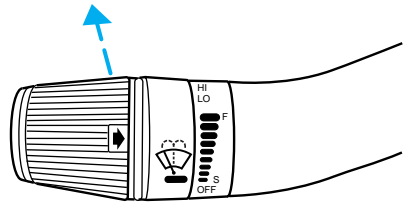

Controls and features

Flash to pass

Pull toward you to activate and release to deactivate.

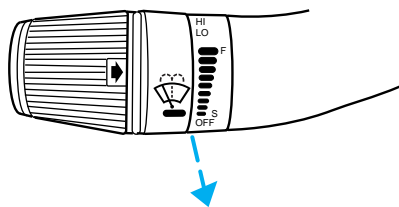

POSITIONS OF THE IGNITION

1. LOCK, locks the steering wheel, gearshift lever (automatic transaxle only) and allows key removal. On vehicles with a manual transaxle push the key in while turning to lock.

2. ACCESSORY, allows the electrical accessories such as the radio to operate while the engine is not running.

3. ON, all electrical circuits operational. Warning lights illuminated. Key position when driving.

4. START, cranks the engine. Release the key as soon as the engine starts.

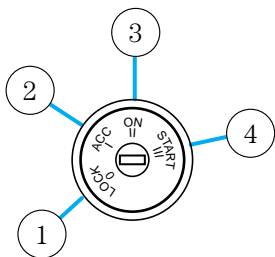

Controls and features

TILT STEERING WHEEL

Pull the tilt steering control toward you to move the steering wheel up or down. Hold the control while adjusting the wheel to the desired position, then release the control to lock the steering wheel in position.

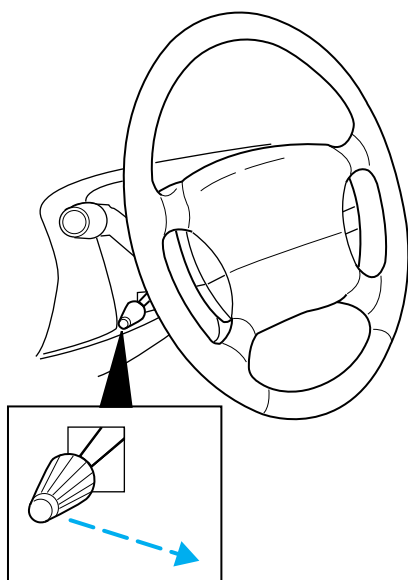

Never adjust the steering wheel when the vehicle is moving.

WINDSHIELD WIPER/WASHER CONTROLS

Rotate the windshield wiper control to the desired interval, low or high speed position.

The bars of varying length are for intermittent wipers. When in this position rotate the control upward for fast intervals and downward for slow intervals.

Push the control on the end of the stalk to activate washer. Push and hold for a longer wash cycle. The washer will automatically shut off after ten seconds of continuous use.

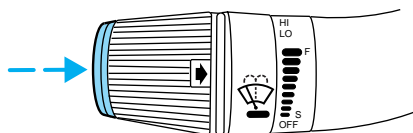
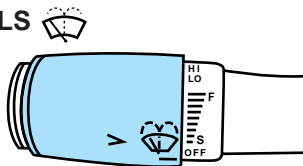

Controls and features

TURN SIGNAL CONTROL ⇐⇒

- Push down to activate the left turn signal.
- Push up to activate the right turn signal.

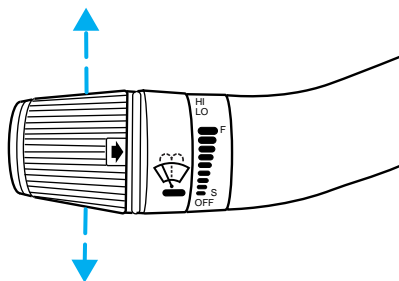

OVERDRIVE CONTROL

Activating overdrive

D (Overdrive) is the normal drive position for the best fuel economy. The overdrive function allows automatic upshifts and downshifts through all available gears.

Deactivating overdrive

Press the Transmission Control Switch (TCS) located on the end of the gearshift lever. The Transmission Control Indicator Light (TCIL) will illuminate on the instrument cluster.

The transmission will operate in all gears except overdrive. To return to normal overdrive mode, press the Transmission Control Switch again. The TCIL will no longer be illuminated.

When you shut off and re-start your vehicle, the transmission will automatically return to normal **D** (Overdrive) mode.

For additional information about the gearshift lever and the transmission control switch operation refer to the *Automatic Transmission Operation* section of the *Driving* chapter.

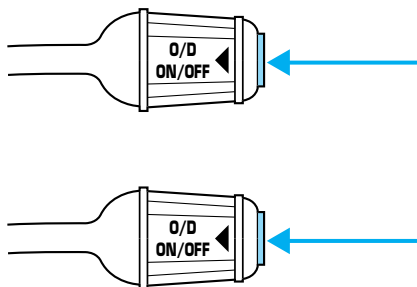

PREPARING TO START YOUR VEHICLE

Engine starting is controlled by the powertrain control system. This system meets all Canadian Interference-Causing Equipment standard requirements regulating the impulse electrical field strength of radio noise.

When starting a fuel-injected engine, avoid pressing the accelerator before or during starting. Only use the accelerator when you have difficulty starting the engine. For more information on starting the vehicle, refer to *Starting the engine* in this chapter.



Extended idling at high engine speeds can produce very high temperatures in the engine and exhaust system, creating the risk of fire or other damage.



Do not park, idle, or drive your vehicle in dry grass or other dry ground cover. The emission system heats up the engine compartment and exhaust system, which can start a fire.



Do not start your vehicle in a closed garage or in other enclosed areas. Exhaust fumes can be toxic. Always open the garage door before you start the engine. See *Guarding against exhaust fumes* in this chapter for more instructions.



If you smell exhaust fumes inside your vehicle, have your dealer inspect your vehicle immediately. Do not drive if you smell exhaust fumes.

Important safety precautions

A computer system controls the engine's idle revolutions per minute (RPM). When the engine starts, the idle RPM runs faster to warm the engine. If the engine idle speed does not slow down automatically, have the vehicle checked.

Before starting the vehicle:

1. Make sure all vehicle occupants have buckled their safety belts. For more information on safety belts and their proper usage, refer to the *Seating and safety restraints* chapter.
2. Make sure the vehicle accessories are off.

Starting

- Make sure the parking brake is set.

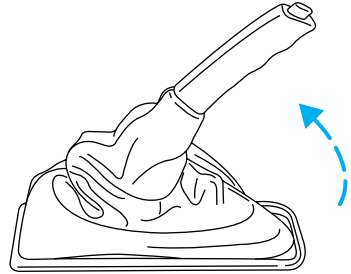

- Make sure the gearshift is in P (Park).



3. Turn the key to 4 (ON) without turning the key to 5 (START).

If there is difficulty in turning the key, firmly rotate the steering wheel left and right until the key turns freely. This condition may occur when:

- front wheels are turned
- front wheel is against the curb
- steering wheel is turned when getting in or out of the vehicle

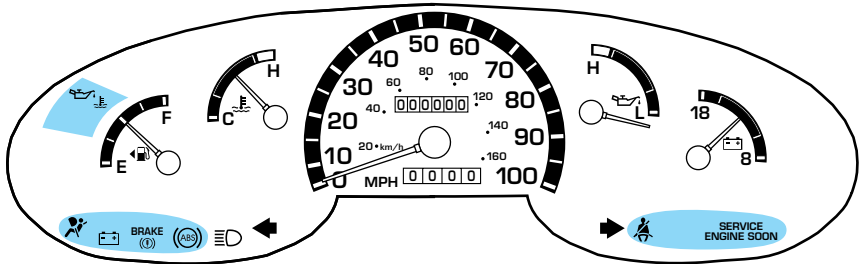
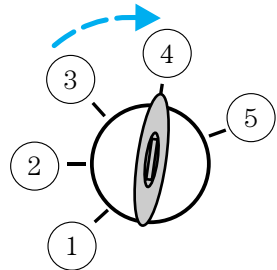

Make sure the corresponding lights illuminate briefly. If a light fails to illuminate, have the vehicle serviced.

- If the driver's safety belt is fastened, the  light may not illuminate.

STARTING THE ENGINE



Whenever you start your vehicle, release the key as soon as the engine starts. Excessive cranking could damage the starter.

1. Turn the key to 4 (START) without pressing the accelerator pedal and release as soon as the engine starts. The key will return to 3 (ON).

2. If the temperature is above -12°C (10°F) and the engine does not start within five seconds on the first try, turn the key to OFF, wait 10 seconds and try again.

3. If the temperature is below -12°C (10°F) and the engine does not start in 15 seconds on the first try, turn the key OFF and wait 10 seconds and try again. If the engine does not start in two attempts, Press the accelerator pedal all the way to floor and hold. Turn the key to START position.

4. When the engine starts, release the key, then release the accelerator pedal gradually as the engine speeds up.

5. After idling for a few seconds, apply the brake and release the parking brake.

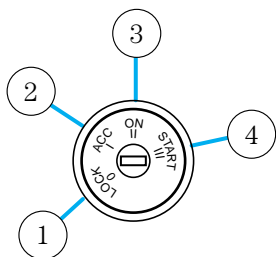

Cold weather starting

Your flexible fuel vehicle is equipped with an engine block heater. The standard 110V AC (male) plug is located at the front of the vehicle in the upper left-hand air inlet opening, under the bumper.

When the temperature is expected to be -12°C (10°F) below and your vehicle has fuel ethanol (E_{85}) in the fuel tank, you should plug in the engine block heater to ensure a quick start.

If temperatures are expected to remain below -12°C (10°F), it is recommended that you reduce the alcohol content in your fuel tank to about 70% by adding unleaded gasoline if your tank is not already full. Thirteen liters (3 gallons) of gasoline will reduce the alcohol in 3/4 full tank from 85% to about 70%. In some areas, winter blends of E85 will already contain the extra gasoline. See the *Refueling* section of this supplement for more information on alcohol fuels.

Starting

If you should unexpectedly have 85% alcohol in your fuel tank in extremely cold temperatures with no way to use the engine block heater, the engine may require extended crank times and several attempts to start.

If the engine fails to start using the preceding instructions

1. Press the accelerator pedal 1/3 to 1/2 of the way to floor and hold.
2. Turn the key to START position.
3. When the engine starts, release the key, then release the accelerator pedal gradually as the engine speeds up.
4. If the engine still fails to start, repeat steps one through three.
5. After the engine starts, hold your foot on the brake pedal, put the gearshift lever in gear and release the parking brake. Slowly release the brake pedal and drive away in a normal manner.

Guarding against exhaust fumes

Although odorless and colorless, carbon monoxide is present in exhaust fumes. Take precautions to avoid its dangerous effects.



If you ever smell exhaust fumes of any kind inside your vehicle, have your dealer inspect and fix your vehicle immediately. Do not drive if you smell exhaust fumes. These fumes are harmful and could kill you.

Have the exhaust and body ventilation systems checked whenever:

- the vehicle is raised for service.
- the sound of the exhaust system changes.
- the vehicle has been damaged in a collision.



WARNING: Engine exhaust, some of its constituents, and certain vehicle components contain or emit chemicals known to the State of California to cause cancer and birth defects or other reproductive harm. In addition, certain fluids contained in vehicles and certain products of component wear contain or emit chemicals known to the State of California to cause cancer and birth defects or other reproductive harm.

Important ventilating information

If the engine is idling while the vehicle is stopped in an open area for long periods of time, open the windows at least 2.5 cm (one inch).

Adjust the heating or air conditioning (if equipped) to bring in fresh air.

Improve vehicle ventilation by keeping all air inlet vents clear of snow, leaves and other debris.

Driving

BRAKES

Your service brakes are self-adjusting. Refer to the scheduled maintenance guide for scheduled maintenance.

Occasional brake noise is normal and often does not indicate a performance concern with the vehicle's brake system. In normal operation, automotive brake systems may emit occasional or intermittent squeal or groan noises when the brakes are applied. Such noises are usually heard during the first few brake applications in the morning; however, they may be heard at any time while braking and can be aggravated by environmental conditions such as cold, heat, moisture, road dust, salt or mud. If a "metal-to-metal," "continuous grinding" or "continuous squeal" sound is present while braking, the brake linings may be worn-out and should be inspected by a qualified service technician.

Four-wheel anti-lock brake system (ABS)

This vehicle is equipped with an anti-lock braking system (ABS). A noise from the hydraulic pump motor and pulsation in the pedal may be observed during ABS braking events. Pedal pulsation coupled with noise while braking under panic conditions or on loose gravel, bumps, wet or snowy roads is normal and indicates proper functioning of the vehicle's anti-lock brake system. The ABS performs a self-check after you start the engine and begin to drive away. A brief mechanical noise may be heard during this test. This is normal. If a malfunction is found, the ABS warning light will come on. If the vehicle has continuous vibration or shudder in the steering wheel while braking, the vehicle should be inspected by a qualified service technician.

The ABS operates by detecting the onset of wheel lockup during brake applications and compensates for this tendency. The wheels are prevented from locking even when the brakes are firmly applied. The accompanying illustration depicts the advantage of an ABS equipped vehicle (on bottom) to a non-ABS equipped vehicle (on top) during hard braking with loss of front braking traction.

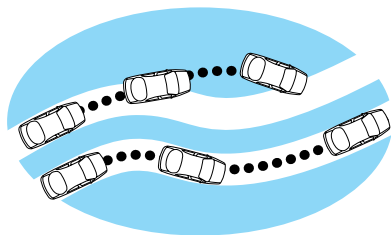

ABS warning lamp (ABS)

The (ABS) warning lamp in the instrument cluster momentarily illuminates when the ignition is turned to the ON position. If the light does not illuminate momentarily at start up, remains on or continues to flash, the ABS needs to be serviced.

With the ABS light on, the anti-lock brake system is disabled and normal braking is still effective unless the brake warning light also remains illuminated with parking brake released. (If your brake warning lamp illuminates, have your vehicle serviced immediately.)

BRAKE
(!)

Using ABS

- In an emergency or when maximum efficiency from the ABS is required, apply continuous force on the brake. The ABS will be activated immediately, thus allowing you to retain full steering control of your vehicle and, providing there is sufficient space, will enable you to avoid obstacles and bring the vehicle to a controlled stop.
- The Anti-Lock system does not decrease the time necessary to apply the brakes or always reduce stopping distance. Always leave enough room between your vehicle and the vehicle in front of you to stop.
- We recommend that you familiarize yourself with this braking technique. However, avoid taking any unnecessary risks.

Parking brake (P)

Apply the parking brake whenever the vehicle is parked. To set the parking brake, pull the handle up.

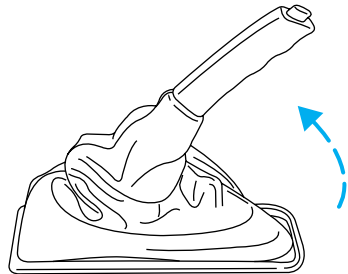

Driving

The BRAKE warning lamp in the instrument cluster illuminates and remains illuminated (when the ignition is turned ON) until the parking brake is released.

BRAKE



The parking brake is not recommended to stop a moving vehicle. However, if the normal brakes fail, the parking brake can be used to stop your vehicle in an emergency. Since the parking brake applies only the rear brakes, the vehicle's stopping distance will increase greatly and the handling of your vehicle will be adversely affected.



Always set the parking brake fully and make sure that the gearshift is securely latched in P (Park) (automatic transmission) or in 1 (First) (manual transmission).

Push the control on the end of the parking brake and push the handle down to release the brake. Driving with the parking brake on will cause the brakes to wear out quickly and reduce fuel economy.

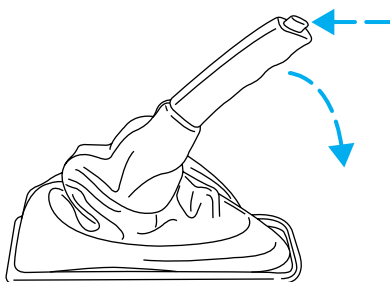

STEERING

Your vehicle is equipped with power steering. Power steering uses energy from the engine to help steer the vehicle.

To prevent damage to the power steering pump:

- Never hold the steering wheel to the extreme right or the extreme left for more than a few seconds when the engine is running.
- Do not operate the vehicle with a low power steering pump fluid level (below the MIN mark on the reservoir).

If the power steering system breaks down (or if the engine is turned off), you can steer the vehicle manually, but it takes more effort.

If the steering wanders or pulls, the condition could be caused by any of the following:

- underinflated tire(s) on any wheel(s)
- high crown in center of road
- high crosswinds
- wheels out of alignment
- loose or worn components in steering linkage

AUTOMATIC TRANSMISSION OPERATION (IF EQUIPPED)

Brake-shift interlock

This vehicle is equipped with a brake-shift interlock feature that prevents the gearshift lever from being moved from P (Park) when the ignition is in the ON position unless brake pedal is depressed.

If you cannot move the gearshift lever out of P (Park) with ignition in the ON position and the brake pedal depressed:

1. Apply the parking brake, turn ignition key to LOCK, then remove the key.
2. Insert the key and turn it to OFF. Apply the brake pedal and shift to N (Neutral).
3. Start the vehicle.

If it is necessary to use the above procedure to move the gearshift lever, it is possible that a fuse has blown or the vehicle's brakelamps are not operating properly. Refer to *Fuses and relays* in the *Roadside emergencies* chapter.



Do not drive your vehicle until you verify that the brakelamps are working.

If your vehicle gets stuck in mud or snow it may be rocked out by shifting between forward and reverse gears, stopping between shifts, in a steady pattern. Press lightly on the accelerator in each gear.

Do not rock the vehicle if the engine is not at normal operating temperature or damage to the transmission may occur.

Do not rock the vehicle for more than a few minutes or damage to the transmission and tires may occur or the engine may overheat.

Driving

 Always set the parking brake fully and make sure the gearshift is latched in P (Park). Turn off the ignition whenever you leave your vehicle.

 If the parking brake is fully released, but the brake warning lamp remains illuminated, the brakes may not be working properly. See your dealer or a qualified service technician.

Driving with a 5-speed automatic transmission

Understanding gearshift positions

 Hold the brake pedal down while you move the gearshift lever from P (Park) to another position. If you do not hold the brake pedal down, your vehicle may move unexpectedly and injure someone.

P (Park)

To put your vehicle in gear, start the engine, depress the brake pedal, then move gearshift lever out of P (Park).

Always come to a complete stop before shifting into P (Park). Make sure the gearshift lever is securely latched in P (Park). This position locks the transmission and prevents the rear wheels from turning.



 Always set the parking brake fully and make sure the gearshift is latched in P (Park). Turn off the ignition whenever you leave your vehicle.

R (Reverse)

With the gearshift in R (Reverse), the vehicle will move backward. Always come to a complete stop before shifting into and out of R (Reverse).



N (Neutral)

With the gearshift lever in N (Neutral), the vehicle can be started and is free to roll. Hold the brake pedal down while in this position.



D (Overdrive)

The normal driving position for the best fuel economy. Transmission operates in gears one through five.



D (Overdrive) can be deactivated by pressing the transmission control switch on the end of the gearshift lever.

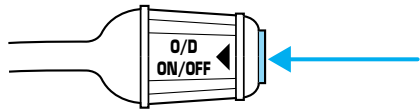

Drive – Not shown on the gearshift position display. Activate by pressing the transmission control switch on the end of the gearshift lever with the gearshift lever in the D position. The Transmission Control Indicator Light (TCIL) will illuminate on the instrument cluster. The transmission operates in gears one through four. D (Drive) provides more engine braking than D (Overdrive) and is useful whenever driving conditions (i.e., city traffic, hilly terrain, etc.) cause the transmission to excessively shift between D (Overdrive) and D (Drive). Also deactivate D (Overdrive) when:

- driving with a heavy load.
- towing a trailer up or down steep hills.
- additional engine braking is desired. If towing a trailer, refer to *Driving while you tow* in the *Trailer Towing* chapter.

To return to D (Overdrive) mode, press the transmission control switch.

Each time the vehicle is started, the transmission will automatically return to normal overdrive mode.

2 (Second)

Use 2 (Second) to start-up on slippery roads or to provide additional engine braking on downgrades.



Driving

1 (First)

Use 1 (First) to provide maximum engine braking on steep downgrades. Upshifts can be made by shifting to 2 (Second) or to **D** (Overdrive). Selecting 1 (Low) at

higher speeds causes the transmission to shift to a lower gear and will shift to 1 (First) after the vehicle decelerates to the proper vehicle speed.



Forced Downshifts

To gain acceleration in **D** (Overdrive) or Drive (O/D OFF) when passing another vehicle, push the accelerator to the floor. The transmission will downshift to the appropriate gear: fourth, third, second or first gear.

Roadside emergencies

RESETTING THE FUEL PUMP SHUT-OFF SWITCH

The fuel pump shut-off switch is a device intended to stop the electric fuel pump when your vehicle has been involved in a substantial jolt.

After a collision, if the engine cranks but does not start, the fuel pump shut-off switch may have been activated.

The fuel pump shut-off switch is located in the center of the dash on the dash panel.

Use the following procedure to reset the fuel pump shut-off switch.

1. Turn the ignition to the OFF position.
2. Check the fuel system for leaks.
3. If no fuel leak is apparent, reset the fuel pump shut-off switch by pushing in on the reset button.
4. Turn the ignition to the ON position. Pause for a few seconds and return the key to the OFF position.
5. Make a further check for leaks in the fuel system.

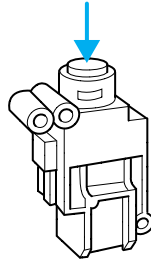

FUSES AND RELAYS

Fuses

If electrical components in the vehicle are not working, a fuse may have blown. Blown fuses are identified by a broken wire within the fuse. Check the appropriate fuses before replacing any electrical components.

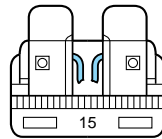

Always replace a fuse with one that has the specified amperage rating. Using a fuse with a higher amperage rating can cause severe wire damage and could start a fire.

Roadside emergencies

Standard fuse amperage rating and color

COLOR					
Fuse Rating	Mini Fuses	Standard Fuses	Maxi Fuses	Cartridge Maxi Fuses	Fuse Link Cartridge
2A	Grey	Grey	—	—	—
3A	Violet	Violet	—	—	—
4A	Pink	Pink	—	—	—
5A	Tan	Tan	—	—	—
7.5A	Brown	Brown	—	—	—
10A	Red	Red	—	—	—
15A	Blue	Blue	—	—	—
20A	Yellow	Yellow	Yellow	Blue	Blue
25A	Natural	Natural	—	—	—
30A	Green	Green	Green	Pink	Pink
40A	—	—	Orange	Green	Green
50A	—	—	Red	Red	Red
60A	—	—	Blue	—	Yellow
70A	—	—	Tan	—	Brown
80A	—	—	Natural	—	Black

Passenger compartment fuse panel

The fuse panel is located beneath the right side of the instrument panel.

To remove a fuse use the fuse puller tool provided on the fuse panel cover.

Roadside emergencies

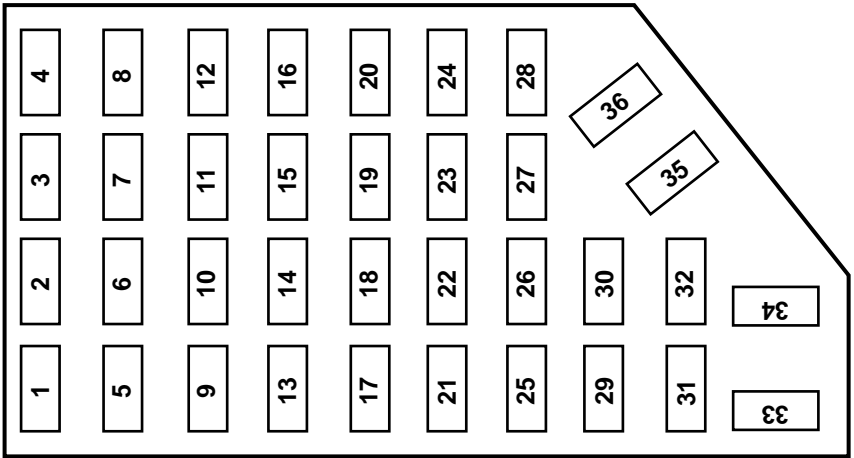

The fuses are coded as follows:

Fuse/Relay Location	Fuse Amp Rating	Passenger Compartment Fuse Panel Description
1	—	Not Used
2	7.5A	Blower Motor Relay
3	—	Not Used
4	15A	Left Headlamp
5	10A	Data Link Connector (OBD II)
6	20A	Defrost/Fan
7	—	Not Used
8	15A	Right Headlamp
9	—	Not Used
10	7.5A	Shift Lock Actuator, Turn Signals
11	7.5A	Instrument Cluster (Warning Lamps)
12	—	Not Used
13	15A	EEC System, Stop Lamps, Four Wheel Anti-Lock Brake System (4WABS)
14	10A	Four Wheel Anti-Lock Brake System (4WABS) Module, 4WABS Main Relay

Roadside emergencies

Fuse/Relay Location	Fuse Amp Rating	Passenger Compartment Fuse Panel Description
15	7.5A	Alternator
16	30A	Windshield Wiper Motor, Wiper Hi-Lo Relay, Wiper Run/Park Relay
17	25A	Cigar Lighter
18	—	Not Used
19	25A	EEC System, Ignition Coil
20	—	Not Used
21	15A	Flasher (Hazard)
22	—	Not Used
23	—	Not Used
24	7.5A	Starter Interrupt Relay
25	7.5A	Speedometer
26	10A	Interior Lamp Relay
27	15A	Backup Lamps , Overdrive Cancel
28	—	Not Used
29	—	Not Used
30	—	Not Used
31	—	Not Used
32	—	Not Used
33	5A	Headlamps (Highbeams)
34	—	Not Used
35	7.5A	RH Park Lamps
36	7.5A	LH Park Lamps

Power distribution box

The power distribution box is located in the engine compartment. The power distribution box contains high-current fuses that protect your vehicle's main electrical systems from overloads.



Always disconnect the battery before servicing high current fuses.

Roadside emergencies



Always replace the cover to the Power Distribution Box before reconnecting the battery or refilling fluid reservoirs.

If the battery has been disconnected and reconnected, refer to the *Battery* section of the *Maintenance and care* chapter.

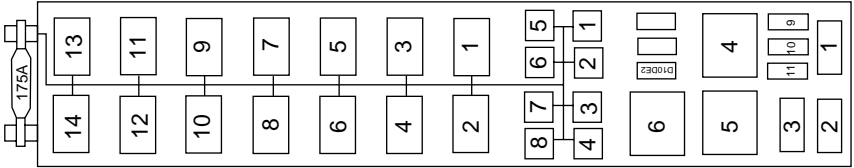

The high-current fuses are coded as follows:

Fuse/Relay Location	Fuse Amp Rating	Power Distribution Box Description
1	—	Not Used
2	30A**	EEC Power
3	20A**	Fuel System
4	30A**	Headlamps
5	50A**	ABS System
6	30A**	ABS System
7	—	Not Used
8	—	Not Used
9	40A**	Blower Motor
10	—	Not Used
11	—	Not Used
12	—	Not Used
13	60A**	I/P Fuse Panel
14	50A**	Ignition
1	15A*	Parking Lamps
2	—	Not Used
3	—	Not Used
4	—	Not Used
5	10A*	EEC Memory
6	—	Not Used

Roadside emergencies

Fuse/Relay Location	Fuse Amp Rating	Power Distribution Box Description
7	15A*	Horn
8	—	Not Used
9	—	Not Used
10	30A*	Alternator System
11	15A*	EEC Hego System
1	—	LH Headlamp Relay
2	—	Horn Relay
3	—	RH Headlamp Relay
4	—	Starter Relay
5	—	EEC Power Relay
6	—	Blower Relay
Diode 2	—	EEC Diode

* Mini Fuses ** Maxi Fuses

Relay module

The relay box is located in the right front corner of the engine compartment.

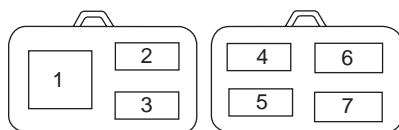

The relays are coded as follows:

Relay location	Description
1	Side Marker Isolation Relay
2	Fuel Pump Relay
3	LH Repeater/Marker Relay
4	RH Repeater/Marker Relay
5	Rear Hazard Isolation Relay
6	LH Turn/Hazard Relay
7	RH Turn/Hazard Relay

Roadside emergencies

CHANGING THE TIRES

If you get a flat tire while driving, do not apply the brake heavily. Instead, gradually decrease your speed. Hold the steering wheel firmly and slowly move to a safe place on the side of the road.

Tire change procedure



To prevent the vehicle from moving when you change a tire, be sure the parking brake is set, then block (in both directions) the wheel that is diagonally opposite (other side and end of the vehicle) to the tire being changed.



If the vehicle slips off the jack, you or someone else could be seriously injured.

1. Park on a level surface, activate hazard flashers and set the parking brake.
2. Place gearshift lever in P (Park) and turn engine OFF.



When one of the rear wheels is off the ground, the transmission alone will not prevent the vehicle from moving or slipping off the jack, even if the transmission is in P (Park).

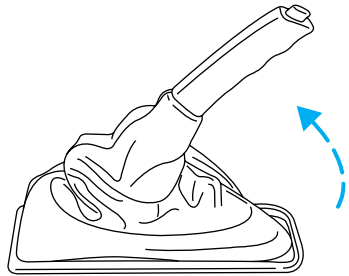

3. Block the diagonally opposite wheel.

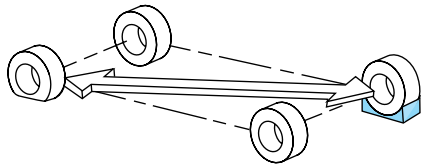

Roadside emergencies

4. Loosen each wheel lug nut, but do not remove them until the wheel is raised off the ground.

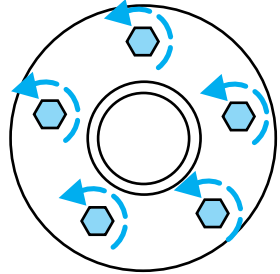

5. Position the jack according to the following guides and turn the jack handle clockwise until the tire is a maximum of 25 mm (1 inch) off the ground.

- Front

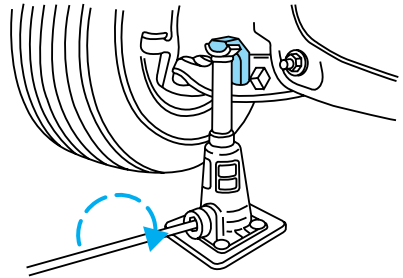

- Rear

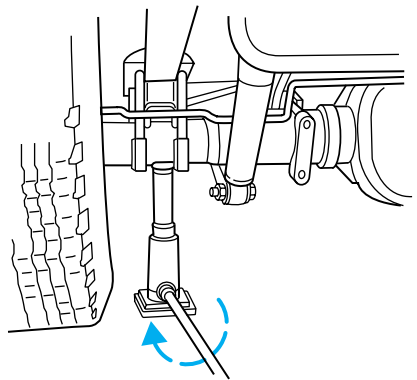

Roadside emergencies



To lessen the risk of personal injury, do not put any part of your body under the vehicle while changing a tire. Do not start the engine when your vehicle is on the jack. The jack is only meant for changing the tire.

- **Never use the front or rear differential as a jacking point.**

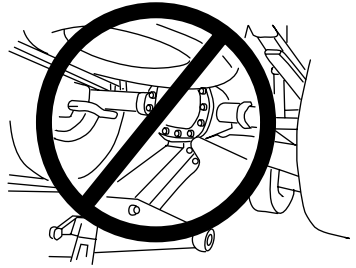

6. Remove the lug nuts with the lug wrench.
7. Replace the flat tire with the spare tire, making sure the valve stem is facing outward. Reinstall the lug nuts, cone side in, until the wheel is snug against the hub. Do not fully tighten the lug nuts until the wheel has been lowered.
8. Lower the wheel by turning the jack handle counterclockwise.
9. Remove the jack and fully tighten the lug nuts in the order shown.
10. Stow the flat tire, jack and lug wrench. Make sure the jack is fastened so it does not rattle when you drive.
11. Unblock the wheels.

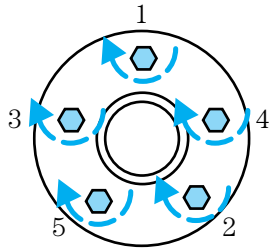

JUMP STARTING YOUR VEHICLE



The gases around the battery can explode if exposed to flames, sparks, or lit cigarettes. An explosion could result in injury or vehicle damage.



Do not push start your vehicle. You could damage the catalytic converter.



Batteries contain sulfuric acid which can burn skin, eyes, and clothing, if contacted.

Roadside emergencies

Do not attempt to push start your vehicle. Automatic transmissions do not have push-start capability.

Preparing your vehicle

When the battery is disconnected or a new battery is installed, the transmission must relearn its adaptive strategy. As a result of this, the transmission may shift firmly. This operation is considered normal and will not effect function or durability of the transmission. Over time, the adaptive learning process will fully update transmission operation to its optimum shift feel.

1. Use only a 12-volt supply to start your vehicle.

2. Do not disconnect the battery of the disabled vehicle as this could damage the vehicle's electrical system.

3. Park the booster vehicle close to the hood of the disabled vehicle making sure the two vehicles **do not** touch. Set the parking brake on both vehicles and stay clear of the engine cooling fan and other moving parts.

4. Check all battery terminals and remove any excessive corrosion before you attach the battery cables. Ensure that vent caps are tight and level.

5. Turn the heater fan on in both vehicles to protect any electrical surges. Turn all other accessories off.

Connecting the jumper cables

1. Connect the positive (+) booster cable to the positive (+) terminal of the discharged battery.

Note: In the illustrations, *lightning bolts* are used to designate the assisting (boosting) battery.

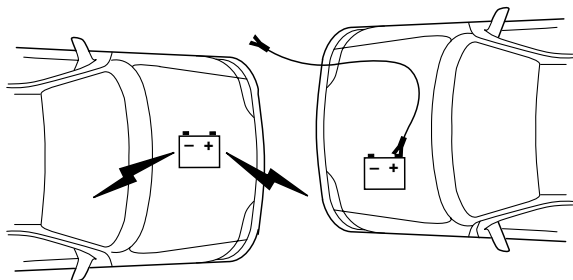

Roadside emergencies

2. Connect the other end of the positive (+) cable to the positive (+) terminal of the assisting battery.

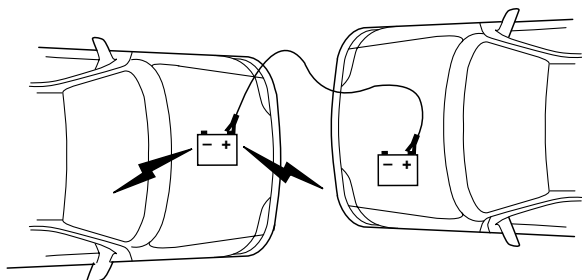

3. Connect the negative (-) cable to the negative (-) terminal of the assisting battery.

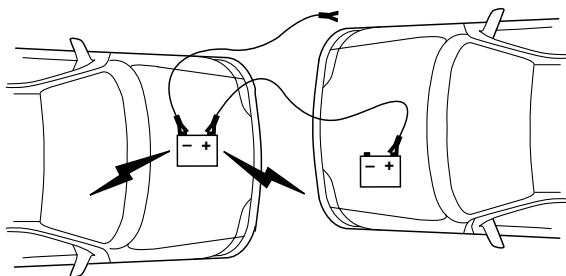

4. Make the final connection of the negative (-) cable to an exposed metal part of the stalled vehicle's engine, away from the battery and the carburetor/fuel injection system.

Do not use fuel lines, engine rocker covers or the intake manifold as *grounding* points.

 Do not connect the end of the second cable to the negative (-) terminal of the battery to be jumped. A spark may cause an explosion of the gases that surround the battery.

Roadside emergencies

- Engines except 4.0L SOHC

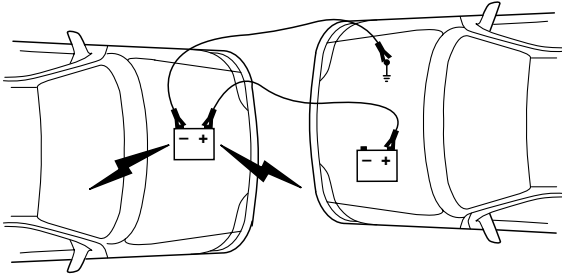

- 4.0L SOHC

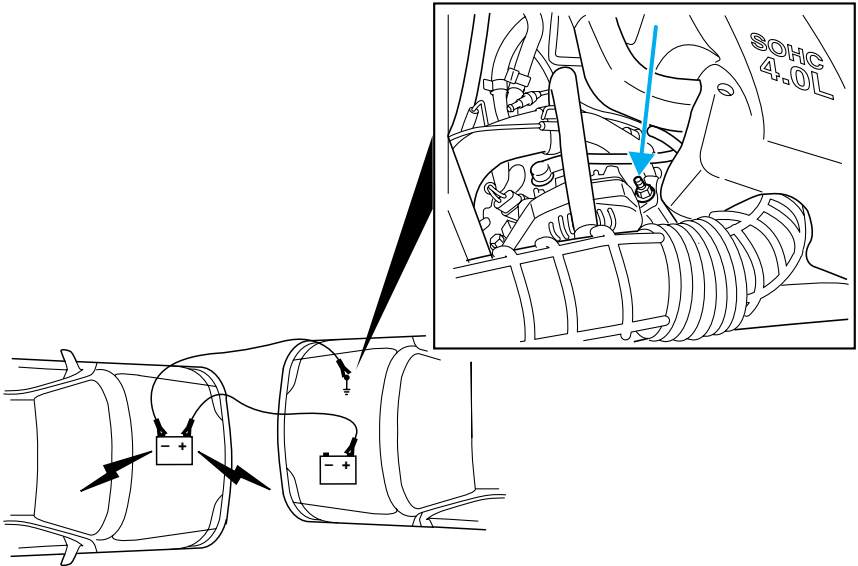

5. Ensure that the cables are clear of fan blades, belts, moving parts of both engines, or any fuel delivery system parts.

Jump starting

1. Start the engine of the booster vehicle and run the engine at moderately increased speed.

Roadside emergencies

2. Start the engine of the disabled vehicle.

3. Once the disabled vehicle has been started, run both engines for an additional three minutes before disconnecting the jumper cables.

Removing the jumper cables

Remove the jumper cables in the reverse order that they were connected.

1. Remove the jumper cable from the *ground* metal surface.

- Engines except 4.0L SOHC

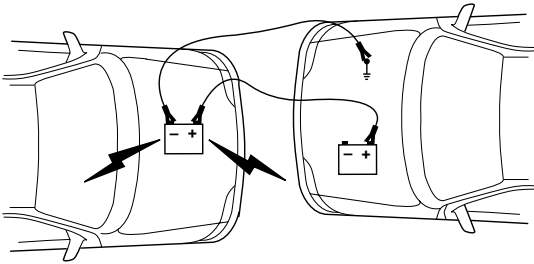

- 4.0L SOHC

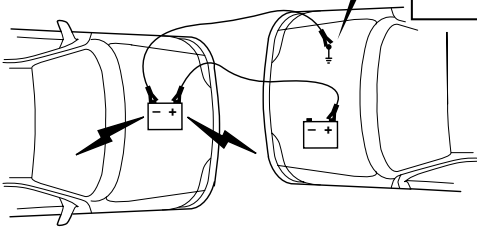
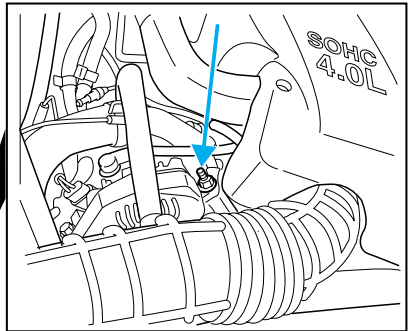

Roadside emergencies

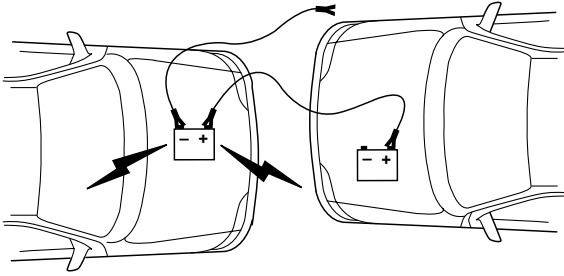

2. Remove the jumper cable on the negative (-) connection of the booster vehicle's battery.

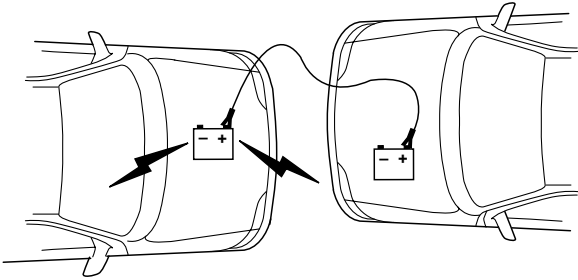

3. Remove the jumper cable from the positive (+) terminal of the booster vehicle's battery.

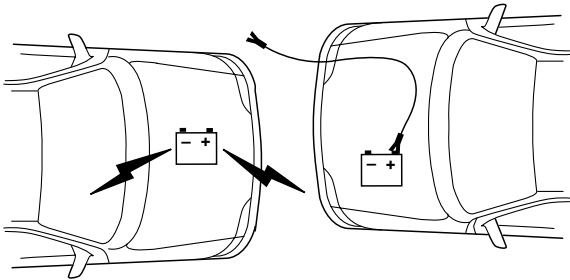

4. Remove the jumper cable from the positive (+) terminal of the disabled vehicle's battery.

Roadside emergencies

After the disabled vehicle has been started and the jumper cables removed, allow it to idle for several minutes so the engine computer can *relearn* its idle conditions.

WRECKER TOWING

If the vehicle needs towing, a wheel lift or flatbed equipment is recommended.

If a slingbelt or J-hook method is used, towing the vehicle from the rear is recommended.

If the vehicle must be towed from the front with a slingbelt or J-hook, the air dam may be damaged unless it is protected by using a wooden crossbeam and spacer block assembly.

- Place the transmission in N(Neutral).
- Do not exceed a distance of 80 km (50 miles).
- Do not exceed 56 km/h (35 mph) vehicle speed.

If a distance of 80 km (50 miles) and/or a vehicle speed of 56 km/h (35 mph) must be exceeded, the drive shaft must be removed prior to towing.

Roadside emergencies

To protect the air dam, refer to the following instructions and illustrations

1. Position the wooden crossbeam and spacer block assembly under the frame rails, behind the front bumper and air dam.
2. Install the tow chains through the notches in the air dam and below the crossbeam and spacer block assembly.
3. Hook the tow chains over the curved cradles on the top of the lower suspension A-arms.

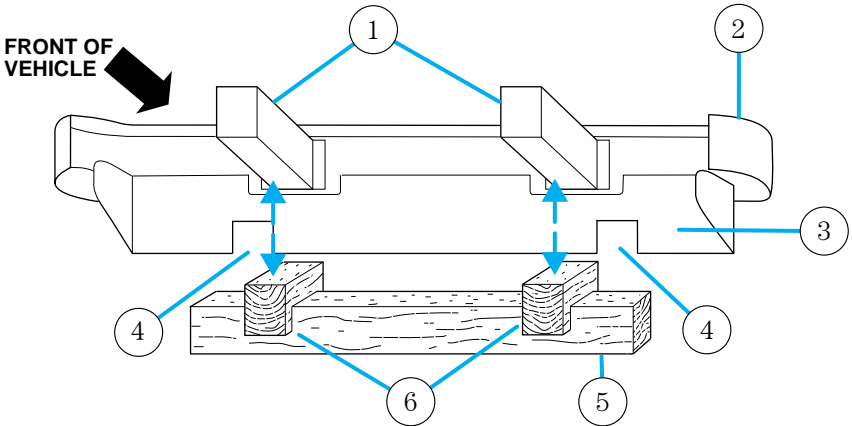

Item	Description
1	Frame rails
2	Front bumper
3	Air dam
4	Tow chain notches
5	Wooden beam
6	Wooden spacer blocks

Roadside emergencies

The following is list of materials required for the wooden crossbeam and spacer block assembly.

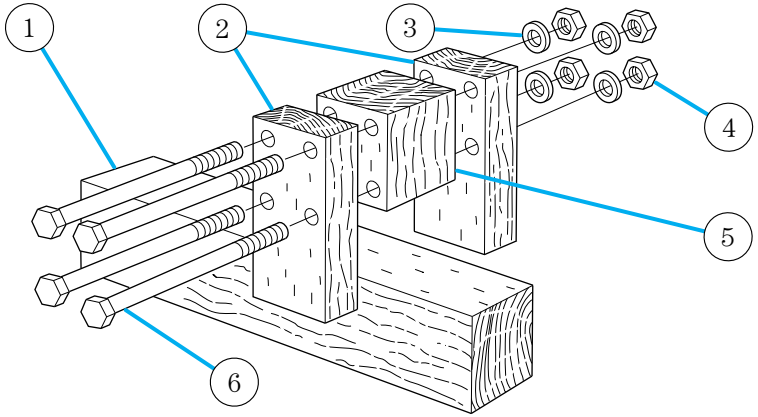

Item	Quantity	Description
1	1	4 x 4 x 60 inch wood beam
2	4	2 x 4 x 6 inch wood block
3	8	1/4 inch flat washer
4	8	1/4 inch hex nut
5	2	4 x 4 x 3 1/2 inch wood block
6	8	1/4 x 7 inch carriage bolt

Maintenance and care

SERVICE RECOMMENDATIONS

To help you service your vehicle:

- We highlight do-it-yourself items in the engine compartment for easy location.
- We provide a Scheduled Maintenance Guide which makes tracking routine service easy.

If your vehicle requires professional service, your dealership can provide necessary parts and service. Check your “Warranty Guide” to find out which parts and services are covered.

Use only recommended fuels, lubricants, fluids and service parts conforming to specifications. Motorcraft parts are designed and built to provide the best performance in your vehicle.

PRECAUTIONS WHEN SERVICING YOUR VEHICLE

Be especially careful when inspecting or servicing your vehicle.

- Do not work on a hot engine.
- When the engine is running, make sure that loose clothing, jewelry or long hair does not get caught up in moving parts.
- Do not work on a vehicle with the engine running in an enclosed space, unless you are sure you have enough ventilation.
- Keep all lit cigarettes, open flames and other lit material away from the battery and all fuel related parts.

If you disconnect the battery, the engine must “relearn” its idle conditions before your vehicle will drive properly, as explained in *Battery* in this chapter.

Working with the engine off

1. Set the parking brake and ensure the gearshift is securely latched in P (Park).
2. Turn off the engine and remove the key.
3. Block the wheels to prevent the vehicle from moving unexpectedly.

Working with the engine on

1. Set the parking brake and ensure the gearshift is securely latched in P (Park).
2. Block the wheels to prevent the vehicle from moving unexpectedly.

Maintenance and care



Do not start your engine with the air cleaner removed and do not remove it while the engine is running.

IDENTIFYING COMPONENTS IN THE ENGINE COMPARTMENT

4.0L SOHC V6 ENGINE

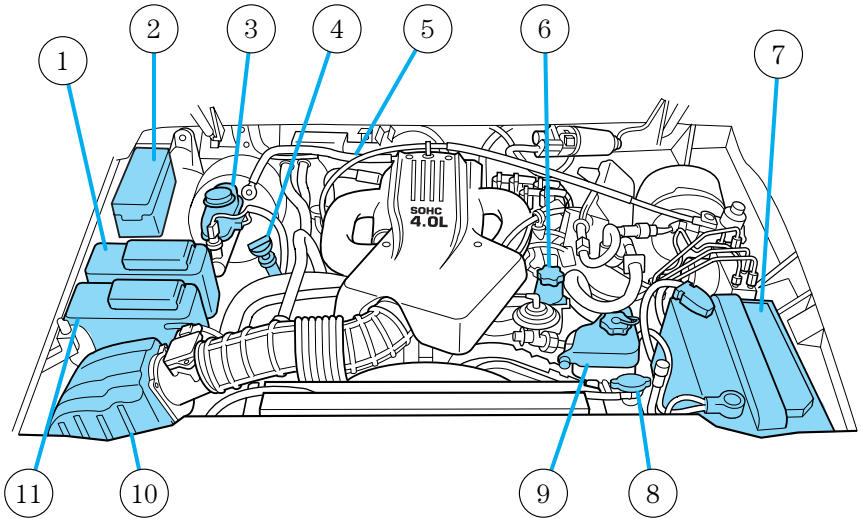

1. Windshield washer fluid reservoir
2. Power distribution box
3. Brake fluid reservoir
4. Engine oil dipstick
5. Automatic transmission fluid dipstick
6. Engine oil filler cap
7. Battery
8. Radiator cap
9. Power steering fluid reservoir
10. Air filter assembly
11. Engine coolant reservoir

Maintenance and care

ENGINE OIL

Checking the engine oil

Refer to the scheduled maintenance guide for the appropriate intervals for checking the engine oil.

1. Make sure the vehicle is on level ground.
2. Turn the engine off and wait a few minutes for the oil to drain into the oil pan.
3. Set the parking brake and ensure the gearshift is securely latched in P (Park).
4. Open the hood. Protect yourself from engine heat.
5. Locate and carefully remove the engine oil level indicator (dipstick).
6. Wipe the indicator clean. Insert the indicator fully, then remove it again.

- If the oil level is **between the MIN and MAX marks**, the oil level is acceptable. **DO NOT ADD OIL.**
 - If the oil level is below the MIN mark, add enough oil to raise the level within the MIN-MAX range.
 - Oil levels above the MAX mark may cause engine damage. Some oil must be removed from the engine by a qualified service technician.
7. Put the indicator back in and ensure it is fully seated.

Adding engine oil

1. Check the engine oil. For instructions, refer to *Checking the engine oil* in this chapter.
2. If the engine oil level is not within the normal range, add only certified engine oil of the recommended viscosity. Remove the engine oil filler cap and use a funnel to pour the engine oil into the opening.
3. Recheck the engine oil level. Make sure the oil level is not above the MAX mark on the engine oil level indicator (dipstick).
4. Install the indicator and ensure it is fully seated.
5. Fully install the engine oil filler cap by turning the filler cap clockwise until three clicks are heard or until it is latched.

To avoid possible oil loss, DO NOT operate the vehicle with the engine oil level indicator and/or the engine oil filler cap removed.

Engine oil and filter recommendations

Look for this certification trademark.

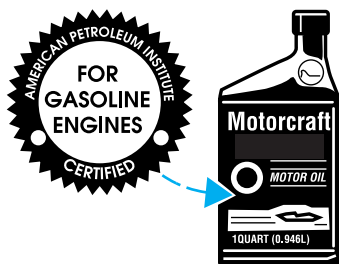

Use SAE 5W-30 motor oil certified for gasoline engines by the American Petroleum Institute (API).

Motor oil displaying the API certification trademark will meet all requirements for your vehicle's engine.

Ford oil specification is WSS-M2C153-G.

Do not use supplemental engine oil additives, oil treatments or engine treatments. They are unnecessary and could, under certain conditions, lead to engine damage which is not covered by your warranty.

Change your engine oil and filter according to the appropriate schedule listed in the scheduled maintenance guide.

Ford production and aftermarket (Motorcraft) oil filters are designed for added engine protection and long life. If a replacement oil filter is used that does not meet Ford material and design specifications, start-up engine noises or knock may be experienced.

It is recommended you use the appropriate Motorcraft oil filter (or another brand meeting Ford specifications) for your engine application.

Maintenance and care

BRAKE FLUID (⚠)

Checking and adding brake fluid

Brake fluid should be checked and refilled as needed. Refer to the scheduled maintenance guide for the service interval schedules.

1. Clean the reservoir cap before removal to prevent dirt or water from entering the reservoir.

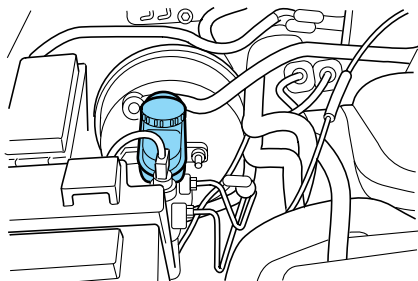

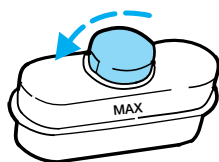

2. Visually inspect the fluid level.

3. If necessary, add brake fluid from a clean un-opened container until the level reaches MAX. Do not fill above this line.



4. Use only a DOT 3 brake fluid certified to meet Ford specifications. Refer to *Lubricant specifications* in the *Capacities and specifications* chapter.

 Brake fluid is toxic. If brake fluid contacts the eyes, flush eyes with running water for 15 minutes. Seek medical attention if irritation persists. If taken internally, drink water and induce vomiting. Seek medical attention immediately.

 If you use a brake fluid that is not DOT 3, you will cause permanent damage to your brakes.

 Do not let the reservoir for the master cylinder run dry. This may cause the brakes to fail.

WINDSHIELD WASHER FLUID

Checking and adding washer fluid

Check the washer fluid whenever you stop for fuel. The reservoir is highlighted with a  symbol.

If the level is low, add enough fluid to fill the reservoir. In very cold weather, do not fill the reservoir all the way.

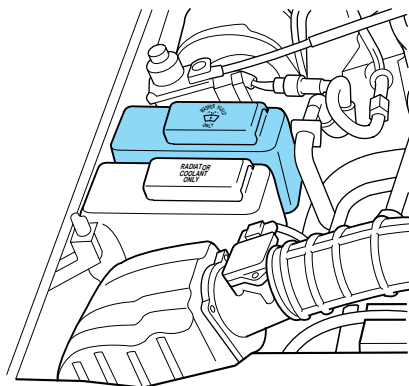

Only use a washer fluid that meets Ford specifications. Refer to *Lubricant specifications* in the *Capacities and specifications* chapter.

State or local regulations on volatile organic compounds may restrict the use of methanol, a common windshield washer antifreeze additive. Washer fluids containing non-methanol antifreeze agents should be used only if they provide cold weather protection without damaging the vehicle's paint finish, wiper blades or washer system.

 Do not put washer fluid in the engine coolant reservoir. Washer fluid placed in the cooling system may harm engine and cooling system components.

ENGINE COOLANT

Checking engine coolant

Your engine's cooling system has been factory-filled with a 50/50 mixture of distilled water and Ford Premium Engine Coolant E2FZ-19549-AA (in Canada, Motorcraft CXC-10), or an equivalent premium engine coolant that meets Ford specification ESE-M97B44-A.

Maintenance and care

A **50/50 mixture** of distilled water and Ford Premium Engine Coolant provides:

- **maximum cooling system efficiency.**
- **freeze protection down to -36°C (-34°F).**
- **boiling protection up to 129°C (265°F).**
- **protection against rust and other forms of corrosion.**
- **an accurate temperature readout from the engine coolant gauge.**

The engine coolant must be maintained at the correct fluid level and concentration to work properly. If the engine coolant fluid level and concentration is not maintained correctly, damage to the engine and cooling system may result.

When the engine is cold, check the level of the engine coolant in the reservoir.

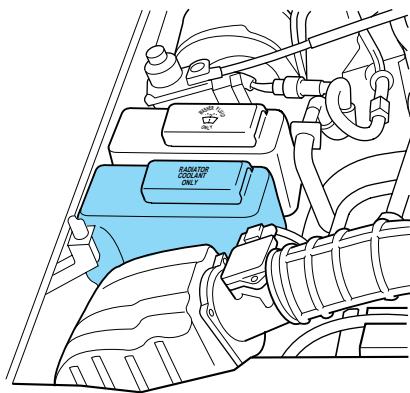

- The engine coolant should be at the “cold fill level” or within the “cold fill range” as listed on the engine coolant reservoir (depending upon application).
- Refer to the Scheduled Maintenance Guide for service interval schedules.
- Be sure to read and understand *Precautions when servicing your vehicle* in this chapter.

If the engine coolant has not been checked at the recommended interval, the engine coolant reservoir may become low or empty. If the reservoir is low or empty, add engine coolant to the reservoir. Refer to *Adding engine coolant* in this chapter.

Maintenance and care



Automotive fluids are not interchangeable; do not use engine coolant, antifreeze or windshield washer fluid outside of its specified function and vehicle location.

Adding engine coolant

Use only **Ford Premium Engine Coolant E2FZ-19549-AA** (in Canada, **Motorcraft CXC-10**) or a premium engine coolant that meets **Ford specification ESE-M97B44-A**.

- **DO NOT USE Ford Extended Life Engine Coolant F6AZ-19544-AA (orange in color).**
- **DO NOT USE a DEX-COOL® engine coolant or an equivalent engine coolant that meets Ford specification WSS-M97B44-D.**
- **DO NOT USE alcohol or methanol antifreeze or any engine coolants mixed with alcohol or methanol antifreeze.**
- **DO NOT USE supplemental coolant additives in your vehicle. These additives may harm your engine's cooling system.**
- **DO NOT MIX recycled coolant and conventional coolant together in your vehicle. Mixing of engine coolants may harm your engine's cooling system.**
- **The use of an improper coolant may harm engine and cooling system components and may void the warranty of your vehicle's engine cooling system. If you are unsure which type of coolant your vehicle requires, contact your local dealer.**



Do not put engine coolant in the windshield washer fluid reservoir. If engine coolant is sprayed onto the windshield, it could make it difficult to see through the windshield.

When the engine is cool, add a **50/50 mixture** of engine coolant and distilled water to the engine coolant reservoir, until the coolant is at the “cold fill level” or within the “cold fill range” as listed in the engine coolant reservoir (depending upon application).

- **NEVER increase the coolant concentration above 60%.**
- **NEVER decrease the coolant concentration below 40%.**

Maintenance and care

- **Engine coolant concentrations above 60% or below 40% will decrease the freeze protection characteristics of the engine coolant and may cause engine damage.**

Plain water may be added in an emergency, but you **must** replace it with a 50/50 mixture of engine coolant and distilled water as soon as possible.

Check the coolant level in the reservoir before you drive your vehicle the next few times (with the engine cool). If necessary, add a **50/50 mixture** of engine coolant and distilled water to the engine coolant reservoir until the coolant level is at the “cold fill level” or within the “cold fill range” as listed on the reservoir (depending upon application).

Have your dealer check the engine cooling system for leaks if you have to add more than 1.0 liter (1.0 quart) of engine coolant per month.



To avoid scalding hot steam or coolant from being released from the engine cooling system, never remove the reservoir cap while the engine is running or hot. Failure to follow this warning may result in damage to the engine's cooling system and possible severe personal injury.

If you must remove the coolant cap, follow these steps to avoid personal injury:

1. Before you remove the cap, turn the engine off and let it cool.
2. When the engine is cool, wrap a thick cloth around the cap. Slowly turn cap counterclockwise until pressure begins to release.
3. Step back while the pressure releases.
4. When you are sure that all the pressure has been released, use the cloth to turn it counterclockwise and remove the cap.

Recycled engine coolant

Ford Motor Company recommends the use of a recycled engine coolant produced by Ford-approved processes.

Not all coolant recycling processes produce coolant which meets Ford specification ESE-M97B44-A. Use of a recycled engine coolant which does not meet the Ford specification may harm engine and cooling system components.



Always dispose of used automotive fluids in a responsible manner. Follow your community's regulations and standards for recycling and disposing of automotive fluids.

Coolant refill capacity

To find out how much fluid your vehicle's cooling system can hold, refer to *Refill capacities* in the *Capacities and specifications* chapter.

Fill your engine coolant reservoir as outlined in *Adding engine coolant* in this chapter.

Severe climates

If you drive in extremely cold climates (less than -36°C [-34°F):

- **it may be necessary to increase the coolant concentration above 50%.**
- **NEVER increase the coolant concentration above 60%.**
- **increased engine coolant concentrations above 60% will decrease the overheat protection characteristics of the engine coolant and may cause engine damage.**
- **refer to the chart on the coolant container to ensure the coolant concentration in your vehicle will provide adequate freeze protection at the temperatures in which you drive in the winter months.**

If you drive in extremely hot climates:

- **it is still necessary to maintain the coolant concentration above 40%.**
- **NEVER decrease the coolant concentration below 40%.**
- **decreased engine coolant concentrations below 40% will decrease the corrosion protection characteristics of the engine coolant and may cause engine damage.**
- **decreased engine coolant concentrations below 40% will decrease the freeze protection characteristics of the engine coolant and may cause engine damage.**
- **refer to the chart on the coolant container to ensure the coolant concentration in your vehicle will provide adequate protection at the temperatures in which you drive.**

Maintenance and care

Vehicles driven year-round in non-extreme climates should use a 50/50 mixture of engine coolant and distilled water for optimum cooling system and engine protection.

CHECKING AND ADDING POWER STEERING FLUID

Check the power steering fluid. Refer to the scheduled maintenance guide for the service interval schedules. If adding fluid is necessary, use only MERCON® ATF.

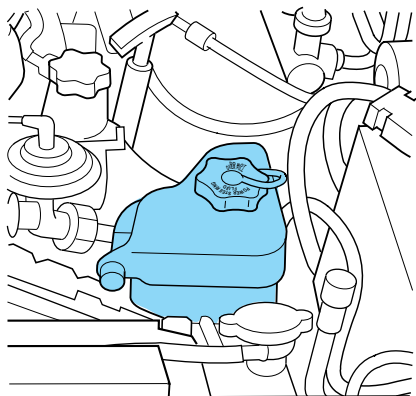

1. Start the engine and let it run until it reaches normal operating temperature (the engine coolant temperature gauge indicator will be near the center of the normal area between H and C).
2. While the engine idles, turn the steering wheel left and right several times.
3. Turn the engine off.
4. Check the fluid level in the reservoir.
5. The fluid level should be between the MIN and MAX lines. Do not add fluid if the level is in this range.
6. If the fluid is low, add fluid in small amounts, continuously checking the level until it reaches the correct operating range. Be sure to put the cap back on the reservoir.

TRANSMISSION FLUID

Checking automatic transmission fluid

Refer to your scheduled maintenance guide for scheduled intervals for fluid checks and changes. Your transmission does not consume fluid. However, the fluid level should be checked if the transmission is not

Maintenance and care

working properly, i.e., if the transmission slips or shifts slowly or if you notice some sign of fluid leakage.

Automatic transmission fluid expands when warmed. To obtain an accurate fluid check, drive the vehicle until it is at normal operating temperature (approximately 30 km [20 miles]). If your vehicle has been operated for an extended period at high speeds, in city traffic during hot weather or pulling a trailer, the vehicle should be turned off for about 30 minutes to allow fluid to cool before checking.

1. Drive the vehicle 30 km (20 miles) or until it reaches normal operating temperature.
2. Park the vehicle on a level surface and engage the parking brake.
3. With the parking brake engaged and your foot on the brake pedal, start the engine and move the gearshift lever through all of the gear ranges. Allow sufficient time for each gear to engage.
4. Latch the gearshift lever in P (Park) and leave the engine running.
5. Remove the dipstick, wiping it clean with a clean, dry lint free rag. If necessary, refer to *Identifying components in the engine compartment* in this chapter for the location of the dipstick.
6. Install the dipstick making sure it is fully seated in the filler tube.
7. Remove the dipstick and inspect the fluid level. The fluid should be in the designated area for normal operating temperature or ambient temperature.

Low fluid level

Do not drive the vehicle if the fluid level is at the bottom of the dipstick and the ambient temperature is above 10°C (50°F).



Correct fluid level

The transmission fluid should be checked at normal operating temperature 66°C-77°C (150°F-170°F) on a level surface. The normal operating temperature can be reached after approximately 30 km (20 miles) of driving.

You can check the fluid without driving if the ambient temperature is above 10°C (50°F). However, if fluid is added at this time, an overfill condition could result when the vehicle reaches normal operating temperature.

Maintenance and care

The transmission fluid should be in this range if at normal operating temperature (66°C-77°C [150°F-170°F]).

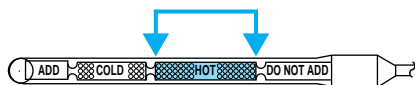

The transmission fluid should be in this range if at ambient temperature (10°C-35°C [50°F-95°F]).



High fluid level

Fluid levels above the safe range may result in transmission failure.

An overfill condition of transmission fluid may cause shift and/or engagement concerns and/or possible damage.



High fluid levels can be caused by an overheating condition.

Adjusting automatic transmission fluid levels

Before adding any fluid, make sure the correct type is used. The type of fluid used is normally indicated on the dipstick and also in the *Lubricant specifications* section in the *Capacities and specifications* chapter.

Use of a non-approved automatic transmission fluid may cause internal transmission component damage.

If necessary, add fluid in 250 mL (1/2 pint) increments through the filler tube until the level is correct.

If an overfill occurs, excess fluid should be removed by a qualified technician.



An overfill condition of transmission fluid may cause shift and/or engagement concerns and/or possible damage.

DRIVELINE UNIVERSAL JOINT AND SLIP YOKE

Your vehicle may be equipped with universal joints that require lubrication. Refer to the scheduled maintenance guide for maintenance intervals. If the original universal joints are replaced with universal joints equipped with grease fittings, lubrication will also be necessary.

BATTERY

Your vehicle is equipped with a Motorcraft maintenance-free battery which normally does not require additional water during its life of service.

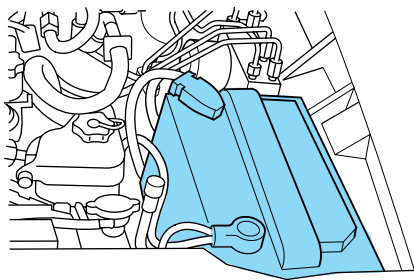

However, for severe usage or in high temperature climates, check the battery electrolyte level. Refer to the scheduled maintenance guide for the service interval schedules.

Keep the electrolyte level in each cell up to the “level indicator”. Do not overfill the battery cells.

If the electrolyte level in the battery is low, you can add plain tap water to the battery, as long as you do not use hard water (water with a high mineral or alkali content). If possible, however, try to only fill the battery cells with distilled water. If the battery needs water often, have the charging system checked.

If your battery has a cover/shield, make sure it is reinstalled after the battery has been cleaned or replaced.

For longer, trouble-free operation, keep the top of the battery clean and dry. Also, make certain the battery cables are always tightly fastened to the battery terminals.

If you see any corrosion on the battery or terminals, remove the cables from the terminals and clean with a wire brush. You can neutralize the acid with a solution of baking soda and water.

When the battery is disconnected or a new battery installed, the transmission must learn its adaptive strategy. As a result of this, the transmission may shift firmly. This operation is considered normal and will fully update transmission operation to its optimum shift feel.

Maintenance and care

 Batteries normally produce explosive gases which can cause personal injury. Therefore, do not allow flames, sparks or lighted substances to come near the battery. When working near the battery, always shield your face and protect your eyes. Always provide proper ventilation.

 When lifting a plastic-cased battery, excessive pressure on the end walls could cause acid to flow through the vent caps, resulting in personal injury and/or damage to the vehicle or battery. Lift the battery with a battery carrier or with your hands on opposite corners.

 Keep batteries out of reach of children. Batteries contain sulfuric acid. Avoid contact with skin, eyes or clothing. Shield your eyes when working near the battery to protect against possible splashing of acid solution. In case of acid contact with skin or eyes, flush immediately with water for a minimum of 15 minutes and get prompt medical attention. If acid is swallowed, call a physician immediately.

 Battery posts, terminals and related accessories contain lead and lead compounds. **Wash hands after handling** .

Because your vehicle's engine is electronically controlled by a computer, some control conditions are maintained by power from the battery. When the battery is disconnected or a new battery is installed, the engine must relearn its idle and fuel trim strategy for optimum driveability and performance. To begin this process:

1. With the vehicle at a complete stop, set the parking brake.
2. Put the gearshift in P (Park) (automatic transmission) or the neutral position (manual transmission), turn off all accessories and start the engine.
3. Run the engine until it reaches normal operating temperature.
4. Allow the engine to idle for at least one minute.
5. Turn the A/C on and allow the engine to idle for at least one minute.
6. Drive the vehicle to complete the relearning process.

Maintenance and care

- The vehicle may need to be driven to relearn the idle and fuel trim strategy.
- **If you do not allow the engine to relearn its idle trim, the idle quality of your vehicle may be adversely affected until the idle trim is eventually relearned.**

When the battery is disconnected or a new battery installed, the transmission must relearn its adaptive strategy. As a result of this, the transmission may shift firmly. This operation is considered normal and will not affect function or durability of the transmission. Over time the adaptive learning process will fully update transmission operation to its optimum shift feel.

If the battery has been disconnected or a new battery has been installed, the clock and the preset radio stations must be reset once the battery is reconnected.

- Always dispose of automotive batteries in a responsible manner. Follow your local authorized standards for disposal. Call your local authorized recycling center to find out more about recycling automotive batteries.

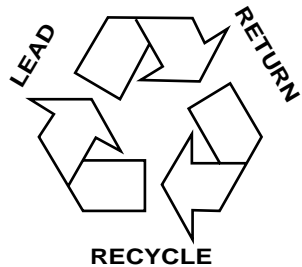

INFORMATION ABOUT UNIFORM TIRE QUALITY GRADING

New vehicles are fitted with tires that have a rating on them called Tire Quality Grades. The Quality grades can be found where applicable on the tire sidewall between tread shoulder and maximum section width. For example:

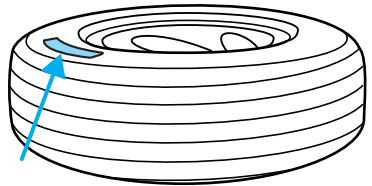

- **Treadwear 200 Traction AA Temperature A**

These Tire Quality Grades are determined by standards that the United States Department of Transportation has set.

Maintenance and care

Tire Quality Grades apply to new pneumatic tires for use on passenger cars. They do not apply to deep tread, winter-type snow tires, space-saver or temporary use spare tires, tires with nominal rim diameters of 10 to 12 inches or limited production tires as defined in Title 49 Code of Federal Regulations Part 575.104(c)(2).

U.S. Department of Transportation-Tire quality grades: The U.S. Department of Transportation requires Ford to give you the following information about tire grades exactly as the government has written it.

Treadwear

The treadwear grade is a comparative rating based on the wear rate of the tire when tested under controlled conditions on a specified government test course. For example, a tire graded 150 would wear one and one-half (1 1/2) times as well on the government course as a tire graded 100. The relative performance of tires depends upon the actual conditions of their use, however, and may depart significantly from the norm due to variations in driving habits, service practices, and differences in road characteristics and climate.

Traction AA A B C

The traction grades, from highest to lowest are AA, A, B, and C. Those grades represent the tire's ability to stop on wet pavement as measured under controlled conditions on specified government test surfaces of asphalt and concrete. A tire marked C may have poor traction performance.



The traction grade assigned to this tire is based on straight-ahead braking traction tests, and does not include acceleration, cornering, hydroplaning or peak traction characteristics.

Temperature A B C

The temperature grades are A (the highest), B, and C, representing the tire's resistance to the generation of heat and its ability to dissipate heat when tested under controlled conditions on a specified indoor laboratory test wheel. Sustained high temperature can cause the material of the tire to degenerate and reduce tire life, and excessive temperature can lead to sudden tire failure. The grade C corresponds to a level of performance which all passenger car tires must meet under the Federal Motor Vehicle Safety Standard No. 109. Grades B and A represent higher levels of performance on the laboratory test wheel than the minimum required by law.

Maintenance and care



The temperature grade for this tire is established for a tire that is properly inflated and not overloaded. Excessive speed, underinflation, or excessive loading, either separately or in combination, can cause heat buildup and possible tire failure.

SERVICING YOUR TIRES

Checking the tire pressure

- Use an accurate tire pressure gauge.
- Check the tire pressure when tires are cold, after the vehicle has been parked for at least one hour or has been driven less than 5 km (3 miles).
- Adjust tire pressure to recommended specifications found on the Certification Label or the Tire Label.



Improperly inflated tires can affect vehicle handling and can fail suddenly, possibly resulting in loss of vehicle control.

Tire rotation

Because your vehicle's tires perform different jobs, they often wear differently. To make sure your tires wear evenly and last longer, rotate them as indicated in the Scheduled Maintenance Guide. If you notice that the tires wear unevenly, have them checked.

- Four tire rotation

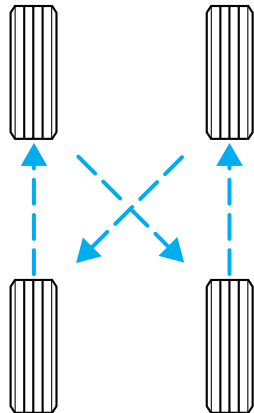



Maintenance and care

Replacing the tires

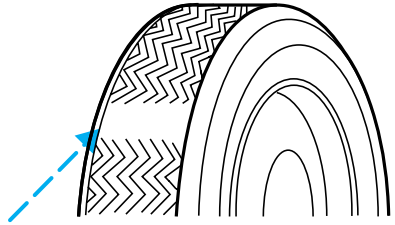
Replace the tires when the wear band is visible through the tire treads.



 When replacing full size tires, never mix radial bias-belted, or bias-type tires. Use only the tire sizes that are listed on the Certification Label. Make sure that all tires are the same size, speed rating, and load-carrying capacity. Use only the tire combinations recommended on the label. If you do not follow these precautions, your vehicle may not drive properly and safely.

 Make sure that all replacement tires are of the same size, type, load-carrying capacity and tread design (e.g., “All Terrain”, etc.), as originally offered by Ford.

 Do not replace your tires with “high performance” tires or larger size tires.

 Failure to follow these precautions may adversely affect the handling of the vehicle and make it easier for the driver to lose control and roll over.

Tires that are larger or smaller than your vehicle’s original tires may also affect the accuracy of your speedometer.

USING SNOW TIRES AND TRACTION DEVICES

 Snow tires must be the same size and grade as the tires you currently have on your vehicle.

Maintenance and care

The tires on your vehicle have all-weather treads to provide traction in rain and snow. However, in some climates, using snow tires and traction devices may be necessary. Ford offers tire cables as a Ford approved accessory and recommends use of these or their equivalents. See your dealer or qualified service technician for more information on tire cables for your vehicle.

Follow these guidelines when using snow tires and traction devices:

- Install cables securely, verifying that the cables do not touch any wiring, brake lines or fuel lines.
- Drive cautiously. If you hear the cables rub or bang against the vehicle, stop and retighten them. If this does not work, remove the cables to prevent vehicle damage.
- Avoid overloading your vehicle.
- Remove the tire cables when they are no longer needed.
- Do not use cables on dry roads.
- The suspension insulation and bumpers will help prevent vehicle damage. Do not remove these components from the vehicle when using snow tires and traction devices.
- Do not exceed 48 km/h (30 mph) with tire cables on your vehicle.

Consult your dealer for information on other Ford approved methods of traction control.

WHAT YOU SHOULD KNOW ABOUT AUTOMOTIVE FUELS

Important safety precautions





Do not overfill the fuel tank. The pressure in an overfilled tank may cause leakage and lead to fuel spray and fire.



The fuel system may be under pressure. If the fuel filler cap is venting vapor or if you hear a hissing sound, wait until it stops before completely removing the fuel filler cap. Otherwise, fuel may spray out and injure you or others.

Maintenance and care

 If you do not use the proper fuel filler cap, excessive pressure or vacuum in the fuel tank may damage the fuel system or cause the fuel cap to disengage in a collision, which may result in possible personal injury.

 Automotive fuels can cause serious injury or death if misused or mishandled.

 Gasoline may contain benzene, which is a cancer-causing agent.

Observe the following guidelines when handling automotive fuel:

- Extinguish all smoking materials and any open flames before fueling your vehicle.
- Always turn off the vehicle before fueling.
- Automotive fuels can be harmful or fatal if swallowed. Fuel such as gasoline is highly toxic and if swallowed can cause death or permanent injury. If fuel is swallowed, call a physician immediately, even if no symptoms are immediately apparent. The toxic effects of fuel may not be visible for hours.
- Avoid inhaling fuel vapors. Inhaling too much fuel vapor of any kind can lead to eye and respiratory tract irritation. In severe cases, excessive or prolonged breathing of fuel vapor can cause serious illness and permanent injury.
- Avoid getting fuel liquid in your eyes. If fuel is splashed in the eyes, remove contact lenses (if worn), flush with water for 15 minutes and seek medical attention. Failure to seek proper medical attention could lead to permanent injury.
- Fuels can also be harmful if absorbed through the skin. If fuel is splashed on the skin and/or clothing, promptly remove contaminated clothing and wash skin thoroughly with soap and water. Repeated or prolonged skin contact with fuel liquid or vapor causes skin irritation.

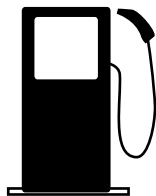

Maintenance and care

- Be particularly careful if you are taking “Antabuse” or other forms of disulfiram for the treatment of alcoholism. Breathing gasoline vapors, or skin contact could cause an adverse reaction. In sensitive individuals, serious personal injury or sickness may result. If fuel is splashed on the skin, promptly wash skin thoroughly with soap and water. Consult a physician immediately if you experience an adverse reaction.



When refueling always shut the engine off and never allow sparks or open flames near the filler neck. Never smoke while refueling. Fuel vapor is extremely hazardous under certain conditions. Care should be taken to avoid inhaling excess fumes.



The flow of fuel through a fuel pump nozzle can produce static electricity, which can cause a fire if fuel is pumped into an ungrounded fuel container.

Use the following guidelines to avoid static build-up when filling an ungrounded fuel container:

- Place approved fuel container on the ground.
- DO NOT fill a fuel container while it is in the vehicle.
- Keep the fuel pump nozzle in contact with the fuel container while filling.
- DO NOT use a device that would hold the fuel pump handle in the fill position.

Choosing the right fuel

Use only UNLEADED FUEL. The use of leaded fuel is prohibited by law and could damage your vehicle.

Do not use fuel containing methanol. It can damage critical fuel system components.

Your vehicle was not designed to use fuel or fuel additives with metallic compounds, including manganese-based compounds containing MMT.

Repairs to correct the effects of using a fuel for which your vehicle was not designed may not be covered by your warranty.

Maintenance and care

Octane recommendations

Your vehicle is designed to use “Regular” unleaded gasoline with tank (R+M)/2 octane rating of 87. We do not recommend the use of gasolines labeled as “Regular” that are sold with octane ratings of 86 or lower in high altitude areas.



Do not be concerned if your engine sometimes knocks lightly. However, if it knocks heavily under most driving conditions while you are using fuel with the recommended octane rating, see your dealer or a qualified service technician to prevent any engine damage.

Fuel quality

If you are experiencing starting, rough idle or hesitation driveability problems during a cold start, try a different brand of “Regular” unleaded gasoline. “Premium” unleaded gasoline is not recommended (particularly in the United States) because it may cause these problems to become more pronounced. If the problems persist, see your dealer or a qualified service technician.

It should not be necessary to add any aftermarket products to your fuel tank if you continue to use high quality fuel of the recommended octane rating. Aftermarket products could cause damage to the fuel system. Repairs to correct the effects of using an aftermarket product in your fuel may not be covered by your warranty.

Many of the world’s automakers issued the World-wide Fuel Charter that recommends gasoline specifications to provide improved performance and emission control system protection for your vehicle. Gasolines that meet the World-wide Fuel Charter should be used when available. Ask your fuel supplier about gasolines that meet the World-wide Fuel Charter. In Canada, look for fuels that display the Automaker’s Choice Logo.

Cleaner air

Ford approves the use of reformulated “cleaner-burning” gasolines to improve air quality. These gasolines may contain oxygenates up to 10% ethanol or 15% MTBE.

Running out of fuel

Avoid running out of fuel because this situation may have an adverse affect on powertrain components.

If you have run out of fuel:

- You may need to cycle the ignition from OFF to ON several times after refueling, to allow the fuel system to pump the fuel from the tank to the engine.
- Your “Check Engine” indicator may come on. For more information on the “Check Engine” indicator, refer to the *Instrumentation* chapter.

Fuel Filler Cap

Your fuel tank filler cap has an indexed design with a 1/8 turn on/off feature.

When fueling your vehicle:

1. Turn the engine off.
2. Carefully turn the filler cap counterclockwise 1/8 of a turn until it stops.
3. Pull to remove the cap from the fuel filler pipe.
4. To install the cap, align the tabs on the cap with the notches on the filler pipe.
5. Turn the filler cap clockwise 1/8 of a turn until it stops.

If the “Service Engine Soon/Check Engine” indicator comes on and stays on after you start the engine, the fuel filler cap may not be properly installed. Turn off the engine, remove the fuel filler cap, align the cap properly and reinstall it.

If you must replace the fuel filler cap, replace it with a fuel filler cap that is designed for your vehicle. The customer warranty may be void for any damage to the fuel tank or fuel system if the correct genuine Ford or Motorcraft fuel filler cap is not used.



The fuel system may be under pressure. If the fuel filler cap is venting vapor or if you hear a hissing sound, wait until it stops before completely removing the fuel filler cap. Otherwise, fuel may spray out and injure you or others.

Maintenance and care



If you do not use the proper fuel filler cap, excessive pressure or vacuum in the fuel tank may damage the fuel system or cause the fuel cap to disengage in a collision, which may result in possible personal injury.

Fuel Filter

Your vehicle is equipped with a fuel filter which is fuel ethanol compatible. charging system warning light, Refer to the scheduled maintenance guide for the appropriate intervals for changing the fuel filter.

Replace the fuel filter with an authorized Motorcraft part. The customer warranty may be void for any damage to the fuel system if an authorized Motorcraft fuel filter is not used.

EMISSION CONTROL SYSTEM

Your vehicle is equipped with various emission control components and a catalytic converter which will enable your vehicle to comply with applicable exhaust emission standards. To make sure that the catalytic converter and other emission control components continue to work properly:

- Use only the specified fuels listed.
- Avoid running out of fuel.
- Do not turn off the ignition while your vehicle is moving, especially at high speeds.
- Have the items listed in your scheduled maintenance guide performed according to the specified schedule.

The scheduled maintenance items listed in the scheduled maintenance guide are essential to the life and performance of your vehicle and to its emissions system.

If other than Ford, Motorcraft or Ford-authorized parts are used for maintenance replacements or for service of components affecting emission control, such non-Ford parts should be equivalent to genuine Ford Motor Company parts in performance and durability.



Do not park, idle, or drive your vehicle in dry grass or other dry ground cover. The emission system heats up the engine compartment and exhaust system, which can start a fire.

Maintenance and care

Illumination of the “Check Engine” light, charging system warning light or the temperature warning light, fluid leaks, strange odors, smoke or loss of engine power, could indicate that the emission control system is not working properly.



Exhaust leaks may result in entry of harmful and potentially lethal fumes into the passenger compartment.

Do not make any unauthorized changes to your vehicle or engine. By law, vehicle owners and anyone who manufactures, repairs, services, sells, leases, trades vehicles, or supervises a fleet of vehicles are not permitted to intentionally remove an emission control device or prevent it from working. Information about your vehicle's emission system is on the Vehicle Emission Control Information Decal located on or near the engine. This decal identifies engine displacement and gives some tune up specifications.

Please consult your “Warranty Guide” for complete emission warranty information.

Readiness for Inspection/Maintenance (I/M) testing

In some localities, it may be a legal requirement to pass an I/M test of the on-board diagnostics system. If your “Check Engine/Service Engine Soon” light is on, refer to the description in the *Warning Lights and Chimes* section of the *Instrumentation* chapter. Your vehicle may not pass the I/M test with the “Check Engine/Service Engine Soon” light on.

If the vehicle's powertrain system or its battery has just been serviced, the on-board diagnostics system is reset to a “not ready for I/M test” condition. To ready the on-board diagnostics system for I/M testing, a minimum of 30 minutes of city and highway driving is necessary as described below:

- First, at least 10 minutes of driving on an expressway or highway.
- Next, at least 20 minutes driving in stop-and-go, city-type traffic with at least four idle periods.

Allow the vehicle to sit for at least eight hours without starting the engine. Then, start the engine and complete the above driving cycle. The engine must warm up to its normal operating temperature. Once started, do not turn off the engine until the above driving cycle is complete.

Capacities and specifications

MOTORCRAFT PART NUMBERS

Component	4.0L SOHC V6 engine
Air filter element	FA-1658
Fuel filter	FG-1002
Battery	BXT-65-650
Oil filter	FL-1A
PCV valve	EV-225
Spark plugs*	AGSF-22PP

* Refer to Vehicle Emissions Control Information (VECI) decal for spark plug gap information.

REFILL CAPACITIES

Fluid	Ford Part Name	Capacity
Brake fluid	High Performance DOT 3 Motor Vehicle Brake Fluid	Fill to line on reservoir.
Engine oil (including filter change)	Motorcraft SAE 5W-30 Super Premium Motor Oil	4.7L (5.0 quarts)
Fuel tank	N/A	78.7L (20.8 gallons)
Power steering fluid	Motorcraft MERCON® ATF	Fill to MAX line on reservoir.
Transmission fluid	Motorcraft MERCON®V ATF	9.5L (10.0 quarts)
Engine coolant ¹	Premium Engine Coolant	13.2L (14.0 quarts)
Rear axle ^{2,3} lubricant	Motorcraft SAE 80W-90 Premium Rear Axle Lubricant	2.9-3.1L (5.5-5.8 pints)
Windshield washer fluid	Ultra-Clear Windshield Washer Concentrate	2.6L (2.7 quarts)

¹ Use Ford Premium Engine Coolant (green in color). DO NOT USE Ford Extended Life Engine Coolant (orange in color). Refer to *Adding engine coolant*, in the *Maintenance and Care* chapter.

² Fill to 6 mm to 14 mm (1/4 inch to 9/16 inch) below bottom of fill hole.

³ Your vehicle is equipped with a conventional rear axle. Refer to your scheduled maintenance guide for axle fluid change intervals.

Capacities and specifications

LUBRICANT SPECIFICATIONS

Item	Ford Part Name or equivalent	Ford Part Number	Ford Specification
Automatic transmission	Motorcraft MERCON®V ATF	XT-5-QM	MERCON®V
Brake fluid	High Performance DOT 3 Motor Vehicle Brake Fluid	C6AZ-19542-AB	ESA-M6C25-A and DOT 3
Driveshaft, slip spline, universal joints	Premium Long Life Grease	XG-1-C or XG-1-T or XG-1-K	ESA-M1C75-B
Engine coolant ¹	Ford Premium Engine Coolant	E2FZ-19549-AA (in Canada, Motorcraft CXC-8-B)	ESE-M97B44-A
Engine oil	Motorcraft SAE 5W-30 Super Premium Motor Oil	XO-5W30-QSP	WSS-M2C153-G with API Certification Mark
Power steering fluid	Motorcraft MERCON®ATF	XT-2-QDX	MERCON®
Rear axle	Motorcraft SAE 80W-90 Premium Rear Axle Lubricant	XY-80W90-QL	WSP-M2C197-A
Windshield washer fluid	Ultra-clear Windshield Washer Concentrate	C9AZ-19550-AC	ESR-M17P5-A

¹ DO NOT USE Ford Extended Life Engine Coolant F6AZ-19544-AA, meeting Ford specification WSS-M97B44-D (orange in color) Refer to *Adding engine coolant*, in the *Maintenance and Care* chapter.

Capacities and specifications

ENGINE DATA

Engine	4.0L SOHC V6 engine
Cubic inches	245
Required fuel	87 octane and/or E85
Firing order	1-4-2-5-3-6
Spark plug gap	1.3-1.4 mm (0.052-0.056 inch)
Ignition system	EDIS
Compression ratio	9.7:1

VEHICLE IDENTIFICATION NUMBER

Incomplete vehicles

On completed derivations of incomplete vehicles, the certification label is affixed at a location determined by a subsequent stage manufacturer of the completed vehicle. In these cases the completed vehicle is manufactured in two or more stages by two or more separate manufacturers.

Reporting Safety Defects

REPORTING SAFETY DEFECTS (U.S. ONLY)

If you believe that your vehicle has a defect that could cause a crash, or could cause injury or death, you should immediately inform the National Highway Traffic Safety Administration (NHTSA) in addition to notifying Ford Motor Company.



If NHTSA receives similar complaints, it may open an investigation, and if it finds that a safety defect exists in a group of vehicles, it may order a recall and remedy campaign. However, NHTSA cannot become involved in individual problems between you, your dealer or Ford Motor Company.

To contact NHTSA, you may either call the Auto Safety Hotline toll-free at 1-800-424-9393 (202-366-0123 in the Washington D.C. area) or write to:

NHTSA
U.S. Department of Transportation
400 Seventh Street
Washington D.C. 20590

You can also obtain other information about motor vehicle safety from the Hotline.

Index

- Air cleaner filter72
- Antifreeze
 - (see Engine coolant)51
- Anti-lock brake system
 - (see Brakes)22,23
- Automatic transmission
 - driving an automatic
 - overdrive26
 - fluid, adding56
 - fluid, checking56
 - fluid, refill capacities72
 - fluid, specification74
- Axle
 - lubricant specifications73,74
 - refill capacities72
- Battery59
 - acid, treating emergencies59
 - charging system warning light ..9
 - jumping a disabled battery37
 - maintenance-free59
 - replacement, specifications72
 - servicing59
 - voltage gauge11
- Brakes22
 - anti-lock22,23
 - anti-lock brake system
 - (ABS) warning light8,23
 - brake warning light7
 - fluid, checking and adding50
 - fluid, refill capacities72
 - fluid, specifications73,74
 - lubricant specifications73,74
 - shift interlock25
- Break-in period3
- Capacities for refilling fluids72
- Coolant
 - checking and adding51
 - refill capacities55,72
 - specifications73,74
- Dipstick
 - automatic transmission fluid ...56
 - engine oil48
- Doors
 - lubricant specifications73
- Driveline universal joint and slip yoke58
- Emergencies, roadside
 - jump-starting37
- Emission control system70
- Engine74
 - check engine/service engine soon light6
 - coolant51
 - idle speed control59
 - lubrication specifications73,74
 - refill capacities72
 - service points47
 - starting after a collision29
- Engine oil48
 - checking and adding48
 - dipstick48
 - filter, specifications49,72
 - recommendations49
 - refill capacities72
 - specifications73,74
- Exhaust fumes20
- Fluid capacities72
- Fuel65
 - cap69
 - capacity72
 - choosing the right fuel67
 - detergent in fuel68
 - filling your
 - vehicle with fuel65,69
 - filter, specifications70,72
 - fuel pump shut-off switch29
 - gauge12
 - octane rating68,74
 - quality68
 - running out of fuel69
 - safety information relating to automotive fuels65
- Fuses29,30
- Gas cap (see Fuel cap)69

- Gauges9
 - battery voltage gauge11
 - engine coolant temperature gauge10
 - engine oil pressure gauge11
 - fuel gauge12
 - odometer10
 - speedometer9
 - trip odometer11
- Headlamps13
 - flash to pass14
 - high beam8,13
 - turning on and off13
- Ignition14,74
- Inspection/maintenance (I/M) testing71
- Instrument panel
 - cluster6
 - lighting up panel and interior13
- Jump-starting your vehicle37
- Keys
 - positions of the ignition14
- Lamps
 - cargo lamps13
 - headlamps13
 - headlamps, flash to pass14
 - instrument panel, dimming13
- Lane change indicator (see Turn signal)16
- Lights, warning and indicator6
 - anti-lock brakes (ABS)8,23
 - brake7
 - charging system9
 - high beam8
 - overdrive off8
 - safety belt7
 - service engine soon6
 - turn signal indicator8
- Lubricant specifications73,74
- Manual transmission
 - fluid capacities72
 - lubricant specifications74
- Motorcraft parts70,72
- Octane rating68
- Odometer10
- Oil (see Engine oil)48
- Overdrive16
- Parking brake23
- Parts (see Motorcraft parts)72
- Power distribution box (see Fuses)32
- Power steering24
 - fluid, checking and adding56
 - fluid, refill capacity72
 - fluid, specifications73,74
- Relays29,34
- Safety defects, reporting75
- Safety restraints
 - warning light and chime7,9
- Servicing your vehicle46
- Spark plugs, specifications72,74
- Special notice3
 - utility-type vehicles3
- Specification chart, lubricants73,74
- Speedometer9
- Starting your vehicle17,19
 - jump starting37
- Steering wheel
 - tilting15
- Tires35,61,62,63
 - changing35
 - checking the pressure63
 - replacing64
 - rotating63
 - snow tires and chains64
 - tire grades62
 - treadwear62
- Towing63
 - wrecker43
- Transmission25
 - fluid, checking and adding (automatic)56

Index

- fluid, refill capacities72
- lubricant specifications73,74
- Trip odometer11
- Turn signal8,16
- Vehicle Identification Number
(VIN)74
- Ventilating your vehicle21
- Warning chimes9
- Warning lights (see Lights)6
- Washer fluid51
- Windshield washer fluid and
wipers
 - checking and adding fluid51
 - operation15
- Wrecker towing43

Filling station information

Item	Information
Required fuel	Refer to "Octane recommendations" in the <i>Maintenance and care</i> chapter.
Fuel tank capacity	78.7L (20.8 gallons)
Engine oil capacity (includes filter change)	4.7L (5.0 quarts). Use Motorcraft SAE 5W-30 Super Premium Motor Oil, Ford specification WSS-M2C153-G.
Tire size and pressure	Refer to the Certification Label on inside of driver's door.
Hood release	Pull handle under the instrument panel.
Coolant capacity ¹	13.2L (14.0 quarts)
Power steering fluid capacity	Fill to MAX line on reservoir. Use Motorcraft MERCON® ATF.
Automatic transmission fluid capacity ²	9.5L (10.0 quarts). Use Motorcraft MERCON® V ATF.

¹ Use Ford Premium Engine Coolant (green in color). DO NOT USE Ford Extended Life Engine Coolant (orange in color). Refer to *Adding engine coolant*, in the *Maintenance and Care* chapter.

² Ensure the correct automatic transmission fluid is used. Transmission fluid requirements are indicated on the dipstick or on the dipstick handle. MERCON® and MERCON® V are not interchangeable. DO NOT mix MERCON® and MERCON® V. Refer to your scheduled maintenance guide to determine the correct service interval.