

Contents

Before driving

Introduction	2
---------------------	----------

Instrumentation	7
------------------------	----------

Controls and features	20
------------------------------	-----------

Seating and safety restraints	58
--------------------------------------	-----------

Starting and driving

Starting	77
-----------------	-----------

Driving	81
----------------	-----------

Roadside emergencies	114
-----------------------------	------------

Servicing

Maintenance and care	126
-----------------------------	------------

Capacities and specifications	168
--------------------------------------	------------

General maintenance information	175
--	------------

Customer assistance	194
----------------------------	------------

Reporting safety defects	204
---------------------------------	------------

Index	205
--------------	------------

All rights reserved. Reproduction by any means, electronic or mechanical including photocopying, recording or by any information storage and retrieval system or translation in whole or part is not permitted without written authorization from Ford Motor Company. Ford may change the contents without notice and without incurring obligation.

Copyright © 1999 Ford Motor Company

Introduction

The following warning may be required by California law:

CALIFORNIA Proposition 65 Warning



Engine exhaust, some of its constituents, and certain vehicle components contain or emit chemicals known to the State of California to cause cancer, or birth defects or other reproductive harm.

ICONS

Indicates a safety alert. Read the following section on *Warnings*.



Indicates vehicle information related to recycling and other environmental concerns will follow.



Correct vehicle usage and the authorized disposal of waste cleaning and lubrication materials are significant steps towards protecting the environment.

Indicates a message regarding child safety restraints. Refer to *Seating and safety restraints* for more information.



Indicates that this Owner Guide contains information on this subject. Please refer to the Index to locate the appropriate section which will provide you more information.



WARNINGS

Warnings provide information which may reduce the risk of personal injury and prevent possible damage to others, your vehicle and its equipment.

Introduction

INFORMATION ABOUT THIS GUIDE

The information found in this guide was in effect at the time of printing. Ford may change the contents without notice and without incurring obligation.

Federal Highway Administration regulation

Regulations such as those issued by the Federal Highway Administration or issued pursuant to the Occupational Safety and Health Act (OSHA), and/or state and local laws and regulations may require additional equipment for the way you intend to use the vehicle. It is the responsibility of the registered owner to determine the applicability of such laws and regulations to your intended use for the vehicle, and to arrange for the installation of required equipment. Your Ford dealer has information about the availability of equipment which may be ordered for your vehicle.



















Introduction

These are some of the symbols you may see on your vehicle.

Vehicle Symbol Glossary

Safety Alert		See Owner's Guide	
Fasten Safety Belt		Air Bag-Front	
Air Bag-Side		Child Seat	
Child Seat Installation Warning		Child Seat Tether Anchorage	
Brake System		Anti-Lock Brake System	
Brake Fluid - Non-Petroleum Based		Traction Control	
Master Lighting Switch		Hazard Warning Flasher	
Fog Lamps-Front		Fuse Compartment	
Fuel Pump Reset		Windshield Wash/Wipe	
Windshield Defrost/Demist		Rear Window Defrost/Demist	
Power Windows Front/Rear		Power Window Lockout	

Vehicle Symbol Glossary

Child Safety Door Lock/Unlock		Interior Luggage Compartment Release Symbol	
Panic Alarm		Engine Oil	
Engine Coolant		Engine Coolant Temperature	
Do Not Open When Hot		Battery	
Avoid Smoking, Flames, or Sparks		Battery Acid	
Explosive Gas		Fan Warning	
Power Steering Fluid		Maintain Correct Fluid Level	
Emission System		Engine Air Filter	
Passenger Compartment Air Filter		Jack	

Introduction

ENTERING, EXITING AND/OR CLIMBING ON THIS VEHICLE

You must be careful and deliberate to minimize the possibility of personal injury from a slip and fall when entering, exiting and/or climbing on this vehicle. Always use the steps and assist handles before climbing. Do not skip any steps or assist handles. Use three point contact at all times with at least two feet and one hand or two hands and one foot firmly placed during all phases of entering, exiting and/or climbing. Always keep your shoe soles and hands clean. Keep the steps and assist handles free of snow, ice, oil, grease, substances or debris. Be sure to use extra care in bad weather. Avoid wearing thick gloves. Always perform trailer hook-up while standing on the ground.



Do not carry items while entering, exiting, and/or climbing. Make sure you keep a firm grip. Always FACE the VEHICLE STEP and HANDLE SYSTEM while climbing up and down. Do not climb behind the cab unless you have three point contact with a step and handle system at all times.

Instrumentation

Instrumentation

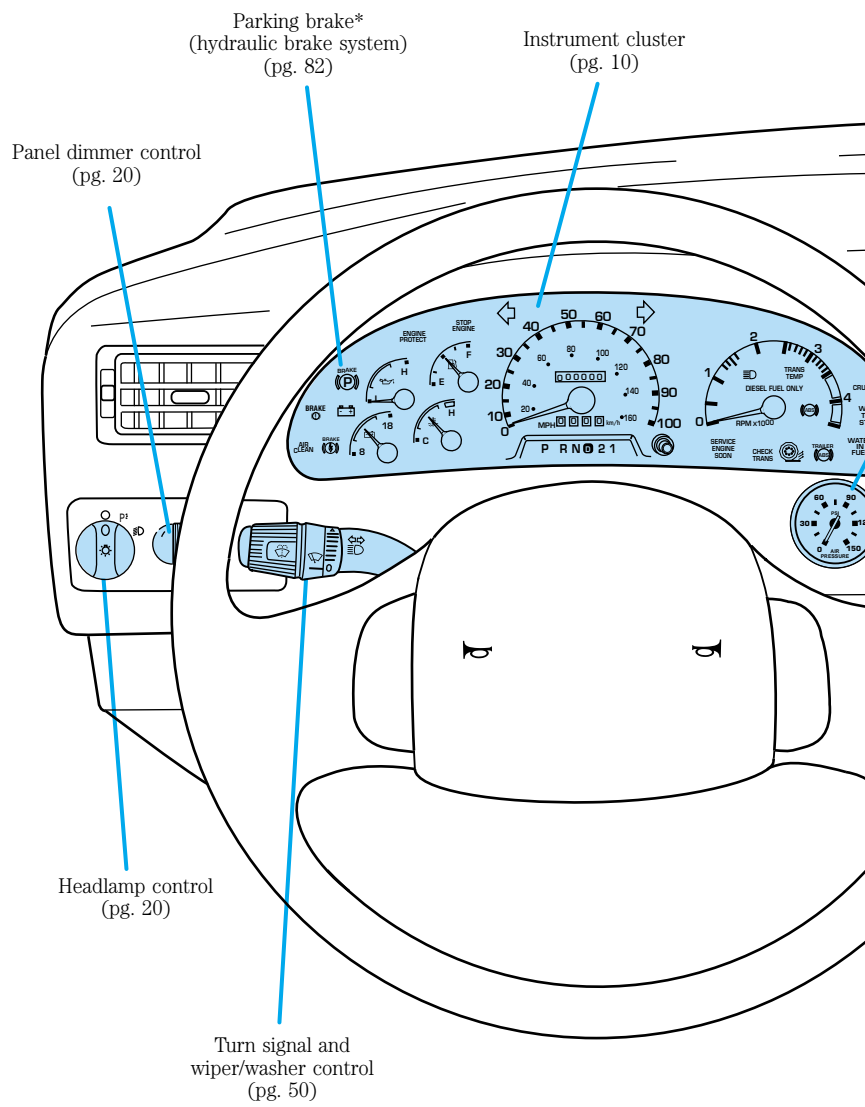

Instrumentation

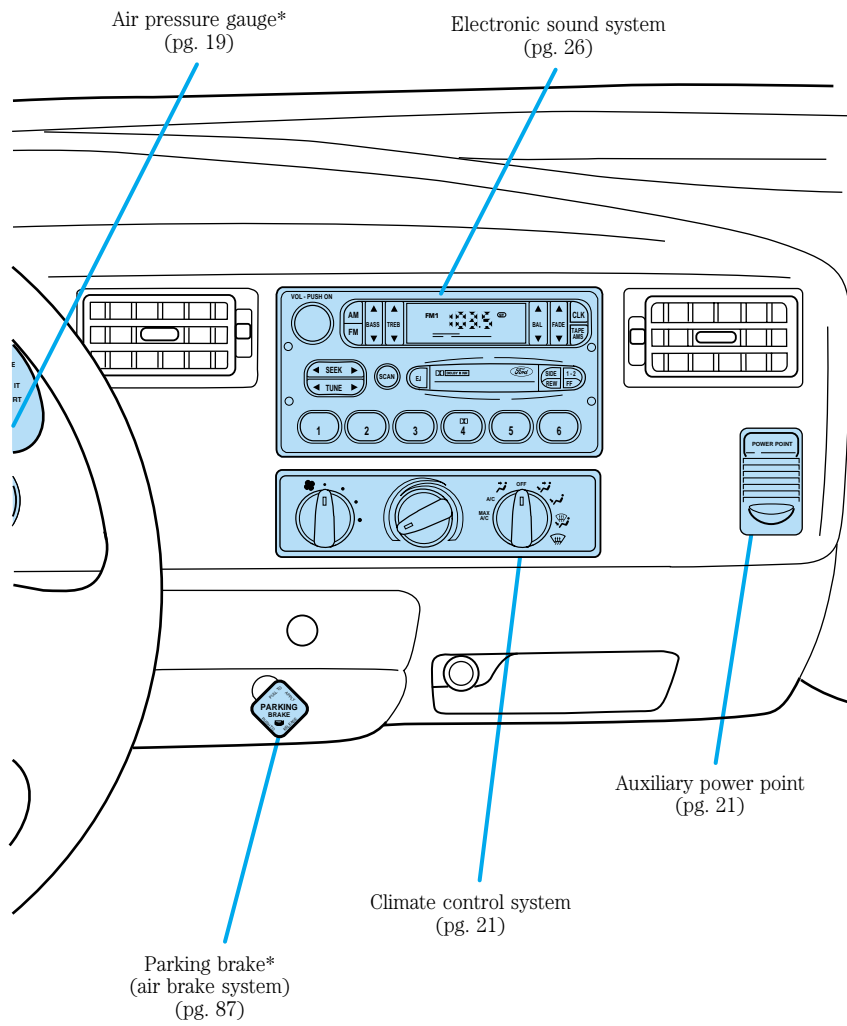

*if equipped

Instrumentation

WARNING LIGHTS AND CHIMES

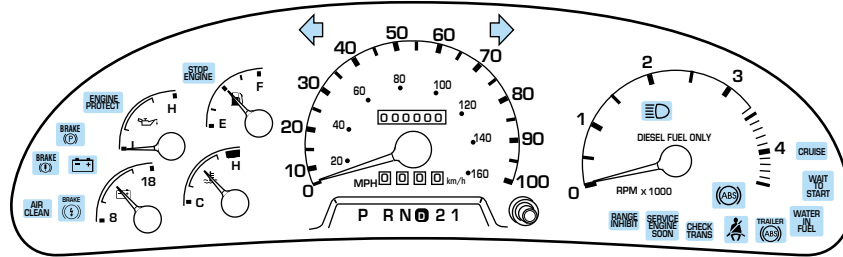

Air clean warning (if equipped)

Illuminates when the ignition is turned to the ON position and the engine is off. The light also illuminates when the air system is restricted (dirty, clogged).

**AIR
CLEAN**

Brake reserve system warning (if equipped)

Illuminates to indicate normal Hydromax booster reserve system activation when the engine is OFF and the service brake pedal is applied, or when the ignition is in the ON or START position.

BRAKE

This light may also illuminate momentarily if the engine is running and the driver turns the steering wheel fully in one direction while braking.

If the light remains on while the engine is running, this indicates inadequate hydraulic booster pressure or reserve pump system failure. Stop the vehicle safely as soon as possible and seek service immediately.

Charging system

Illuminates when the ignition is turned to the ON position and the engine is off. The light also illuminates when there is no alternator output, or an over voltage condition requiring electrical system service.

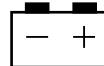

Instrumentation

Parking brake warning (if equipped)

Momentarily illuminates when the ignition is turned to the ON position and the engine is off.



If the warning lamp remains illuminated after engine start up, this indicates a system failure in the master cylinder of the brake system. Stop the vehicle safely as soon as possible and seek service immediately.

If equipped with an air brake system, the warning light stays on until the air pressure builds up to 414 kPa (60 psi). If the air pressure drops below 414 kPa (60 psi) during operation, the remaining brake system is still operational but the stopping distance will be greater.

Parking brake warning

Momentarily illuminates when the ignition is turned to the ON position and the engine is off. If the brake warning lamp does not illuminate at this time, seek service immediately. Also illuminates when the parking brake is engaged.



Engine protect warning (Cummins engine only)

Illuminates when there is a fault in the electronic subsystem but the vehicle can be driven, and indicates one of the following conditions:

- low oil pressure
- low coolant level
- high coolant temperature
- high intake manifold temperature

Refer to the Engine Operator's Manual.



Instrumentation

Stop engine (if equipped)

This light is used in conjunction with the electronic engine control.

**STOP
ENGINE**

Refer to the Engine Operator's Manual for specific information regarding this feature.

If the engine shuts down, it can be restarted and operated for 30 seconds at a time or until the problem is corrected. Refer to *Engine shutdown system* in the *Starting* chapter.



Drivers of electronically controlled engines should know the extent of warning engine shutdown system before operating the vehicle. This information can be obtained from your dealer.

Turn signal

Illuminates when the left or right turn signal or the hazard lights are turned on. If one or both of the indicators stay on continuously or flash faster, check for a burned-out turn signal bulb. Refer to *Exterior bulbs* in the *Maintenance and care* chapter.



High beams

Illuminates when the high beam headlamps are turned on.



Anti-lock brake system (ABS)

Momentarily illuminates when the ignition is turned to the ON position and the engine is off. If the light remains on after the vehicle is started, continues to flash or fails to illuminate, have the system serviced immediately. With the ABS light on,



Instrumentation

the anti-lock brake system is disabled and normal braking is still effective unless the brake warning light also remains illuminated.

Wait to start

Indicates the air intake heater is in operation and special starting procedures are required. Refer to the *Starting* chapter.

**WAIT
TO
START**



If equipped with an air intake heater, DO NOT use ether or any other starting fluids. The use of starting fluids (ether) in an engine equipped with an air intake heater could result in damage and/or personal injury.

Water in fuel (if equipped)

During refueling it is possible for water-contaminated diesel fuel to be pumped into your fuel tank. Your vehicle fuel system is equipped with a fuel filter/water separator to remove water from the fuel. The water in fuel indicator light illuminates when the fuel filter/water separator has a significant quantity of water, or when the ignition key is switched to the START position. If the light illuminates when the engine is running, stop the vehicle as soon as safely possible, shut off the engine and drain the filter bowl. Allowing water to stay in the system could result in extensive damage to, or failure of, the fuel injection system.

**WATER
IN
FUEL**

To drain the fuel filter/water separator (refer to *Maintenance and Care* section for procedure). Rotate the valve at the bottom of the filter assembly allowing water to drain from the system. Close the valve upon completion.

Do not drain water separator while engine is running. Fuel may ignite if separator is drained while engine is running or vehicle is moving.

Instrumentation

Check trans (Allison automatic transmission)

The lamp will illuminate for several seconds after the ignition is turned to the ON position. Illumination of this light indicates that a problem has been detected and shifting may be restricted. Depending upon the severity of the problem, the read-out digit on the shifter display may be blank. Operation may

continue in order or reach service assistance. The ECU may not respond to shift selector requests, since operating limitations are being placed on the transmission, i.e. upshifts and downshifts may be restricted. Direction changes will not occur.

Refer to the *Maintenance and Care* chapter.

**CHECK
TRANS**

Safety belt

Momentarily illuminates when the ignition is turned to the ON position to remind you to fasten your safety belts. For more information, refer to the *Seating and safety restraints* chapter.



Service engine soon

The *Service Engine Soon* indicator light illuminates when the ignition is first turned to the ON position to check the bulb. If it comes on after the engine is started, one of the engine's control systems may be malfunctioning. The light may illuminate without a driveability concern being noted. The vehicle will usually be drivable and will not require towing.

**SERVICE
ENGINE
SOON**

Temporary malfunctions may cause your *Service Engine Soon* light to illuminate. Examples are:

1. The vehicle has run out of fuel. (The engine may misfire or run poorly.)
2. Poor fuel quality or water in the fuel.

Instrumentation

These and other temporary malfunctions can be corrected by filling the fuel tank with good quality fuel. After three driving cycles without these or any other temporary malfunctions present, the *Service Engine Soon* light should turn off. (A driving cycle consists of a cold engine startup followed by mixed city/highway driving.) No additional vehicle service is required.

If the *Service Engine Soon* light remains on, have your vehicle serviced at the first available opportunity.



Under engine misfire conditions, excessive exhaust temperatures could damage the fuel system, interior floor coverings or other vehicle components, possibly causing a fire.

Key-in-ignition warning chime

Sounds when the ignition key is left in the ignition in the OFF/LOCK or ACC position and the driver's door is opened.

Headlamps on warning chime

Sounds when the headlamps or parking lamps are on, the ignition is off (and the key is not in the ignition) and the driver's door is opened.

Safety belt warning chime

Sounds to remind you to fasten your safety belts.

For information on the safety belt warning chime, refer to the *Seating and safety restraints* chapter.

Instrumentation

GAUGES

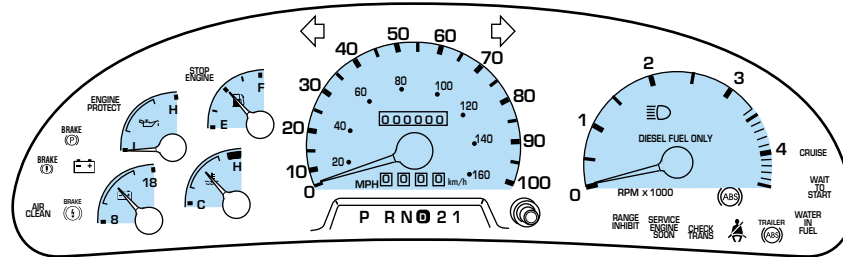

Fuel gauge

Displays approximately how much fuel is in the fuel tank (when the key is in the ON position). The fuel gauge may vary slightly when the vehicle is in motion. The ignition should be in the OFF position while the vehicle is being refueled. When the gauge first indicates empty, there is a small amount of reserve fuel in the tank. When refueling the vehicle from an empty indication, the amount of fuel that can be added will be less than the advertised capacity due to the reserve fuel.

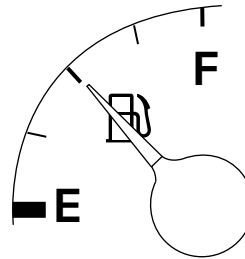

Engine coolant temperature gauge

Indicates the temperature of the engine coolant. At normal operating temperature, the needle remains within the normal area (the area between the "H" and "C"). If it enters the red section, the engine is overheating. Stop the vehicle as soon as safely possible, switch off the engine immediately and let the engine cool. Refer to *Engine coolant* in the *Maintenance and care* chapter.

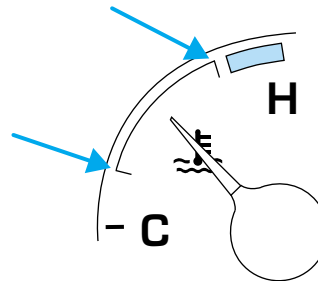

Instrumentation



Never remove the coolant reservoir cap while the engine is running or hot.

This gauge indicates the temperature of the engine coolant, not the coolant level. If the coolant is not at its proper level the gauge indication will not be accurate.

Speedometer

Indicates the current vehicle speed.

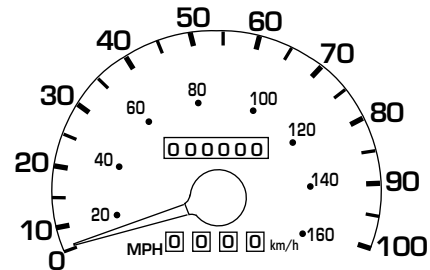

Odometer

Registers the total kilometers (miles) of the vehicle.

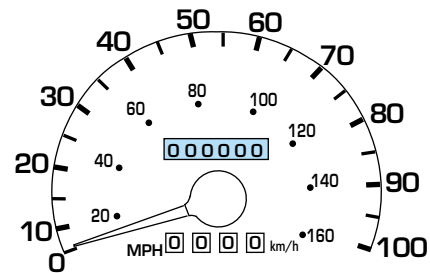

Instrumentation

Trip odometer

Registers the kilometers (miles) of individual journeys. To reset, depress the control.

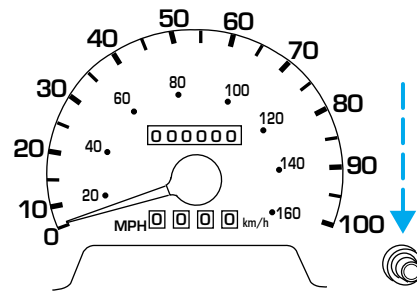

Tachometer

Indicates the engine speed in revolutions per minute.

Driving with your tachometer pointer in the red zone may damage the engine.

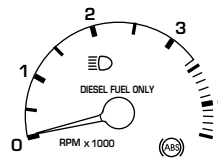

Battery voltage gauge

This shows the battery voltage when the ignition is in the ON position. If the pointer moves and stays outside the normal operating range (as indicated), have the vehicle's electrical system checked as soon as possible.

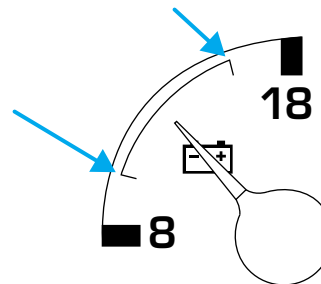

Instrumentation

Engine oil pressure gauge

This shows the engine oil pressure in the system. Sufficient pressure exists as long as the needle remains in the normal range (the area between the “L” and “H”).

If the gauge indicates low pressure, stop the vehicle as soon as safely possible and switch off the engine immediately. Check the oil level. Add oil if needed (refer to *Engine oil* in the *Maintenance and care* chapter). If the oil level is correct, have your vehicle checked at your dealership or by a qualified technician.

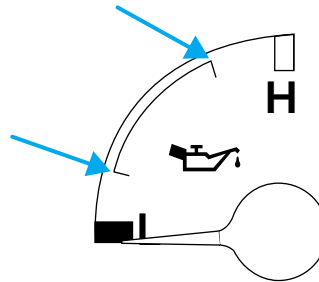



Air pressure gauge and warning buzzer (if equipped)

Indicates the amount of air pressure in the brake system (green=primary, red=secondary) in pounds per square inch. When the pressure is too low for normal brake operation (less than 414 kPa [60 psi]) and the ignition is turned to ON:

- a warning buzzer sounds
- the warning light illuminates

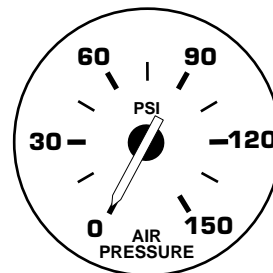
All vehicles have a dual-pointer air pressure gauge to indicate the pressure in both brake circuits.



 Do not drive the vehicle when the low air pressure buzzer is sounding or the warning light is lit. These warnings indicate there is not enough air pressure for the brake system to operate properly.

Controls and features

HEADLAMP CONTROL

Rotate the headlamp control to the first position to turn on the parking lamps. Rotate to the second position to also turn on the headlamps.

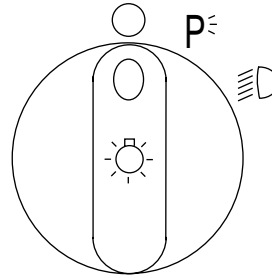

PANEL DIMMER CONTROL

Use to adjust the brightness of the instrument panel during headlamp and parklamp operation.

- Rotate up to brighten.
- Rotate down to dim.
- Rotate to full up position (past detent) to turn on interior lamps.

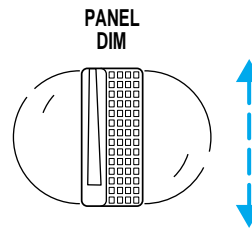

Daytime running lamps (DRL) (if equipped)

Turns the headlamps on with a reduced output. To activate:

- the ignition must be in the ON position and
- the headlamp control is in the OFF or Parking lamps position.

 Always remember to turn on your headlamps at dusk or during inclement weather. The Daytime Running Light (DRL) System does not activate your tail lamps and generally may not provide adequate lighting during these conditions. Failure to activate your headlamps under these conditions may result in a collision.

Controls and features

AUXILIARY POWER POINT 12V

The auxiliary power point is located on the instrument panel.

Do not plug optional electrical accessories into the cigarette lighter. Use the power point.

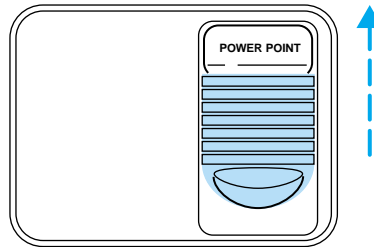

CLIMATE CONTROL SYSTEM

Heater only system (if equipped)



Fan speed control

Controls the volume of air circulated in the vehicle.



Temperature control

Controls the temperature of the airflow inside the vehicle. On heater-only systems, the air cannot be cooled below the outside temperature.

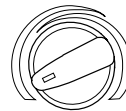





Mode selector control

Controls the direction of the airflow to the inside of the vehicle.



-  (Panel) -Distributes outside air through the instrument panel registers.

Controls and features

- OFF-Outside air is shut out and the fan will not operate.
-  (Panel and floor) -Distributes outside air through the instrument panel registers and the floor ducts.
-  (Floor) -Allows for maximum heating. Distributes outside air through the floor ducts.
-  (Floor and defrost) -Distributes outside air through the floor ducts and the windshield defroster ducts.
-  (Defrost) -Distributes outside air through the windshield defroster ducts. It can be used to clear ice or fog from the windshield.

Operating tips

- In humid weather, select  before driving. This will reduce fogging on your windshield. After a few minutes, select any desired position.
- To reduce humidity buildup inside the vehicle, don't drive with the climate control system in the OFF position.
- Don't put objects under the front seat that will interfere with the airflow to the rear seats (if equipped).
- Remove any snow, ice or leaves from the air intake area (at the bottom of the windshield under the hood).

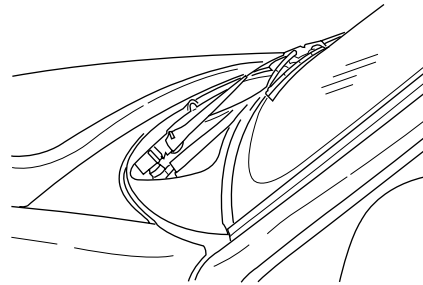

- Do not place objects over the defroster outlets. These objects can block airflow and reduce your ability to see through your windshield. Also, avoid placing small objects on top of your instrument panel. These objects can fall down into the defroster outlets and block airflow and possibly damage your climate control system.



Do not place objects on top of the instrument panel, as these objects may become projectiles in a collision or a sudden stop.

Controls and features

Manual heating and air conditioning system



Fan speed control

Controls the volume of air circulated in the vehicle.



Temperature control knob

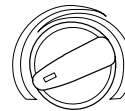

Controls the temperature of the airflow inside the vehicle.

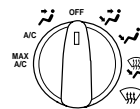

Mode selector control

Controls the direction of the airflow to the inside of the vehicle.







The air conditioning compressor will operate in all modes except  (Panel) and  (Floor). However, the air conditioning will only function if the outside temperature is about 10°C (50°F) or higher.

Since the air conditioner removes considerable moisture from the air during operation, it is normal if clear water drips on the ground under the air conditioner drain while the system is working and even after you have stopped the vehicle.

- MAX A/C-Uses recirculated air to cool the vehicle. MAX A/C is noisier than A/C but more economical and will cool the inside of the vehicle faster. Airflow will be from the instrument panel registers. This mode can also be used to prevent undesirable odors from entering the vehicle.
- A/C-Uses outside air to cool the vehicle. It is quieter than MAX A/C but not as economical. Airflow will be from the instrument panel registers.

Controls and features

-  (Panel) -Distributes outside air through the instrument panel registers. However, the air will not be cooled below the outside temperature because the air conditioning does not operate in this mode.
- OFF-Outside air is shut out and the fan will not operate. For short periods of time only, use this mode to prevent undesirable odors from entering the vehicle.
-  (Panel and floor) -Distributes outside air through the instrument panel registers and the floor ducts. Heating and air conditioning capabilities are provided in this mode. For added customer comfort, when the temperature control knob is anywhere in between the full hot and full cold positions, the air distributed through the floor ducts will be slightly warmer than the air sent to the instrument panel registers.
-  (Floor) -Allows for maximum heating by distributing outside air through the floor ducts. However, the air will not be cooled below the outside temperature because the air conditioning does not operate in this mode.
-  (Floor and defrost) -Distributes outside air through the windshield defroster ducts and the floor ducts. Heating and air conditioning capabilities are provided in this mode. For added customer comfort, the air distributed through the floor ducts will be slightly warmer than the air sent to the windshield defroster ducts. If the temperature is about 10°C (50°F) or higher, the air conditioner will automatically dehumidify the air to reduce fogging.
-  (Defrost) -Distributes outside air through the windshield defroster ducts. It can be used to clear ice or fog from the windshield. If the temperature is about 10°C (50°F) or higher, the air conditioner will automatically dehumidify the air to reduce fogging.

Operating tips

- In humid weather, select  before driving. This will reduce fogging on your windshield. After a few minutes, select any desired position.
- To prevent humidity buildup inside the vehicle, don't drive with the climate control system in the OFF or MAX A/C position.
- Don't put objects under the front seat that will interfere with the airflow to the rear seats (if equipped).

Controls and features

- Remove any snow, ice or leaves from the air intake area (at the bottom of the windshield under the hood).

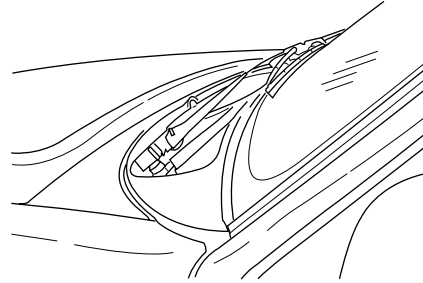

- If your vehicle has been parked with the windows closed during hot weather, the air conditioner will do a much faster job of cooling if you drive for two or three minutes with the windows open. This will force most of the hot, stale air out of the vehicle. Then operate your air conditioner as you would normally.
- Do not place objects over the defroster outlets. These objects can block airflow and reduce your ability to see through your windshield. Also, avoid placing small objects on top of your instrument panel. These objects can fall down into the defroster outlets and block airflow and possibly damage your climate control system.



Do not place objects on top of the instrument panel, as these objects may become projectiles in a collision or sudden stop.

Controls and features

USING YOUR AUDIO SYSTEM

AM/FM Stereo

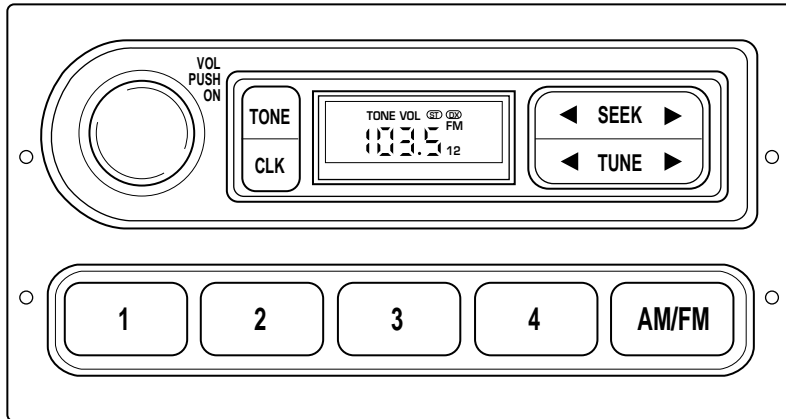

AM/FM Stereo

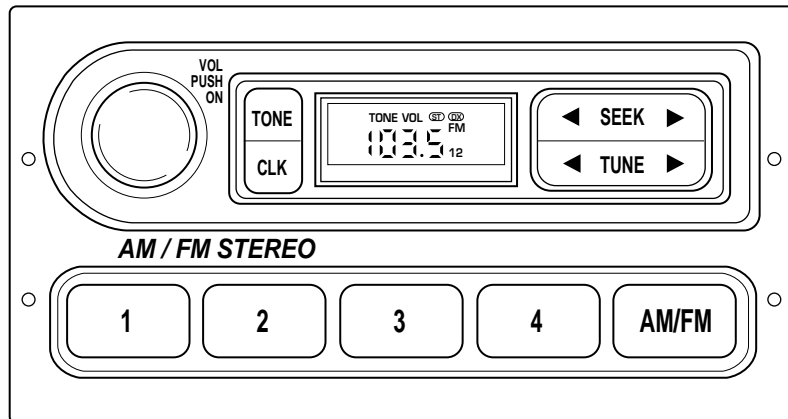

Controls and features

Volume/power control

Press the control to turn the audio system on or off.

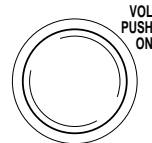

Turn the control to raise or lower volume.

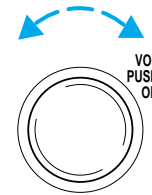

If the volume is set above a certain level and the ignition is turned off, the volume will come back on at a “nominal” listening level when the ignition switch is turned back on.

AM/FM select

The AM/FM select control works in radio mode.



AM/FM select in radio mode

This control allows you to select AM or FM frequency bands. Press the control to switch between AM, FM1 or FM2 memory preset stations.

Tune adjust

The tune control works in radio mode.

Tune adjust in radio mode

- Press ◀ to move to the next frequency down the band (whether or not a listenable station is located there). Hold the control to move through the frequencies quickly.



Controls and features

- Press ► to move to the next frequency up the band (whether or not a listenable station is located there). Hold for quick movement.

Seek function

The seek function control works in radio mode.

Seek function in radio mode

- Press ◀ to find the next listenable station down the frequency band.
- Press ► to find the next listenable station up the frequency band.

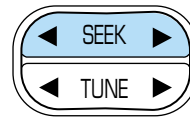

Radio station memory preset

The radio is equipped with four station memory preset controls. These controls can be used to select up to four preset AM stations and eight FM stations (four in FM1 and four in FM2).

Setting memory preset stations

1. Select the frequency band with the AM/FM select control.
2. Select a station. Refer to *Tune adjust* or *Seek function* for more information on selecting a station.
3. Press and hold a memory preset control until the sound returns, indicating the station is held in memory on the control you selected.



Bass adjust

The bass adjust control allows you to increase or decrease the audio system's bass output.

Press the TONE control once, then use the volume knob to adjust the desired level.

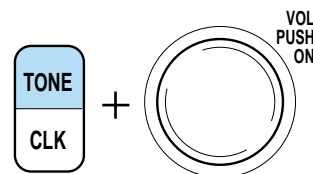

Controls and features

Treble adjust

The treble adjust control allows you to increase or decrease the audio system's treble output.

Press the TONE control twice, then use the volume knob to adjust the desired level.

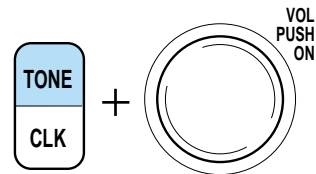

Speaker balance adjust

Speaker sound distribution can be adjusted between the right and left speakers.

Press the TONE control three times, then use the volume knob to adjust the desired level.

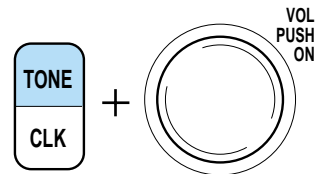

Speaker fade adjust (if equipped)

Speaker sound can be adjusted between the front and rear speakers.

Press the TONE control four times, then use the volume knob to adjust the desired level.

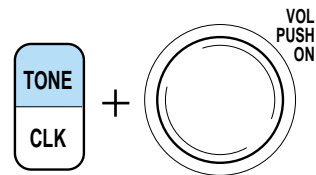

Setting the clock

Press CLK to toggle between listening frequencies and clock mode.

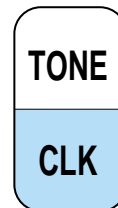

Controls and features

To set the hour, press and hold the CLK control until CLOCK SET appears in the display and press the SEEK control:

- ◀ to decrease hours and
- ▶ to increase hours.

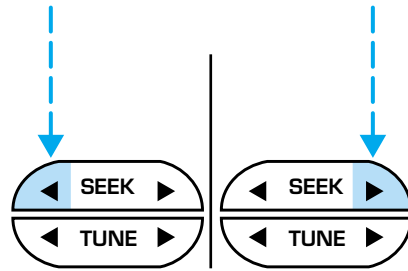

To set the minute, press and hold the CLK control until CLOCK SET appears in the display and press the TUNE control:

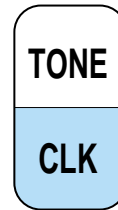

- ◀ to decrease minutes and
- ▶ to increase minutes.

The CLK control will allow you to switch between media display mode (radio station, stereo information, etc.) and clock display mode (time). When in clock mode, the media information will display for ten seconds, when the radio is turned on, and then revert to clock

information. Anytime that the media is changed, (new radio station, etc.), the media information will again display for ten seconds before reverting back to the clock. In media mode, the media information will always be displayed.

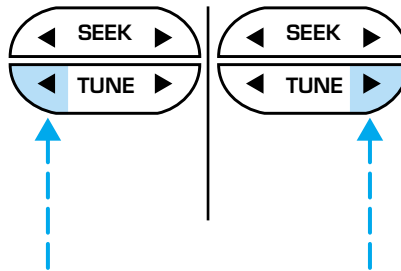

Controls and features

AM/FM stereo cassette

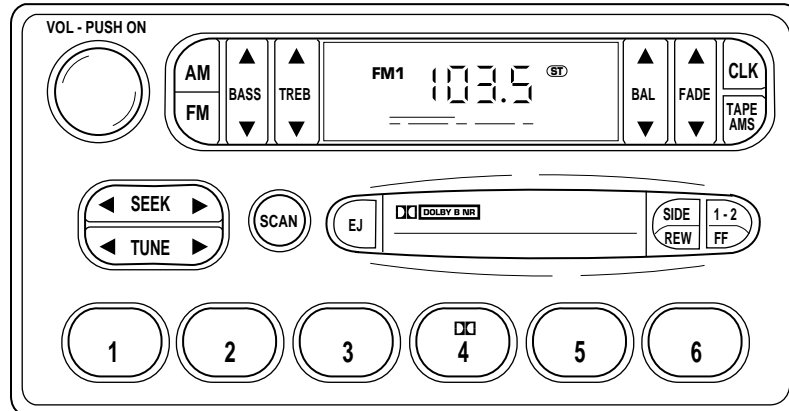

Volume/power control

Press the control to turn the audio system on or off.

VOL - PUSH ON

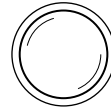

Turn the control to raise or lower volume.

VOL - PUSH ON

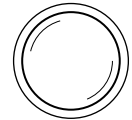

If the volume is set above a certain level and the ignition is turned off, the volume will come back on at a “nominal” listening level when the ignition switch is turned back on.

Controls and features

AM/FM select

The AM/FM select control works in radio and tape modes.

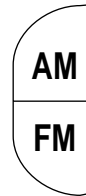

AM/FM select in radio mode

This control allows you to select AM or FM frequency bands. Press the AM control to select from AM selections, and press the FM control to select from FM1 or FM2 memory preset stations.

AM/FM select in tape mode

Press this control to stop tape play and begin radio play.

Tune adjust

The tune control works in radio mode.

Tune adjust in radio mode

- Press ◀ to move to the next frequency down the band (whether or not a listenable station is located there). Hold the control to move through the frequencies quickly.
- Press ▶ to move to the next frequency up the band (whether or not a listenable station is located there). Hold for quick movement.



Seek function

The seek function control works in radio mode.

Seek function in radio mode

- Press ◀ to find the next listenable station down the frequency band.
- Press ▶ to find the next listenable station up the frequency band.



Controls and features

Scan function

The scan function works in radio mode.



Scan function in radio mode

Press the SCAN control to hear a brief sampling of all listenable stations on the frequency band. Press the SCAN control again to stop the scan mode.

Radio station memory preset

The radio is equipped with six station memory preset controls. These controls can be used to select up to six preset AM stations and twelve FM stations (six in FM1 and six in FM2).

Setting memory preset stations

1. Select the frequency band with the AM or the FM select control.
2. Select a station. Refer to *Tune adjust* or *Seek function* for more information on selecting a station.
3. Press and hold a memory preset control until the sound returns, indicating the station is held in memory on the control you selected.

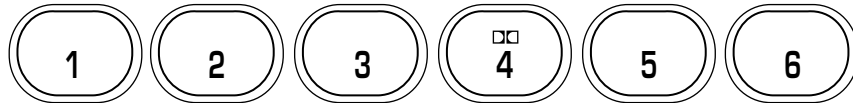

Bass adjust

The bass adjust control allows you to increase or decrease the audio system's bass output.

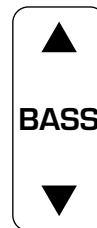

Controls and features

Treble adjust

The treble adjust control allows you to increase or decrease the audio system's treble output.



Speaker balance adjust

Speaker sound distribution can be adjusted between the right and left speakers.

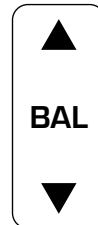

Speaker fade adjust

Speaker sound can be adjusted between the front and rear speakers.



Tape select

- To enter tape mode while in radio mode, press the TAPE AMS control.



Controls and features

Automatic Music Search

The Automatic Music Search feature allows you to quickly locate the beginning of the tape selection being played or to skip to the next selection.

To activate the feature, momentarily depress the TAPE AMS button. Then, press either REW (for the beginning of the current selection) or FF (to advance to the next selection). The tape deck stops and returns to play mode when the AMS circuit senses a blank section on the tape.

In order to ensure proper operation of the AMS feature, the tape **MUST** have a blank section of at least four seconds duration between programs.



Rewind

The rewind control works in tape mode.

To rewind in tape mode, press the REW control.

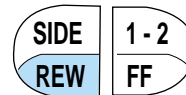

Fast forward

The fast forward control works in tape mode.

- In the tape mode, tape direction will automatically reverse when the end of the tape is reached.



Tape direction select

Press SIDE and 1-2 at the same time to play the alternate side of a tape.

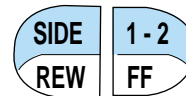

Eject function

Press the control to stop and eject a tape.



Controls and features

Dolby® noise reduction

Dolby® noise reduction operates only in tape mode. Dolby® noise reduction reduces the amount of hiss and static during tape playback.

Press the  control to activate (and deactivate) Dolby® noise reduction.

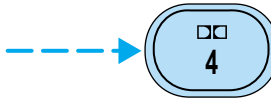

Dolby® noise reduction is manufactured under license from Dolby® Laboratories Licensing Corporation. “Dolby®” and the double-D symbol are trademarks of Dolby Laboratories Licensing Corporation.



Setting the clock

Press CLK to toggle between listening frequencies and clock mode while in radio mode.

To set the hour, press and hold the CLK control and press the SEEK control:

-  to decrease hours and
-  to increase hours.

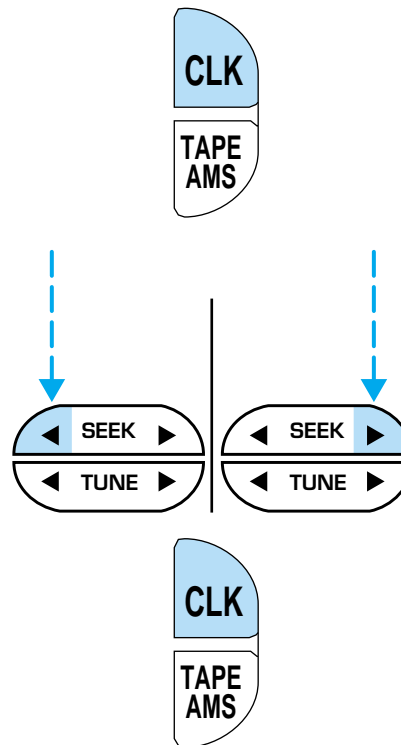

To set the minute, press and hold the CLK control and press the TUNE control:

Controls and features

- ◀ to decrease minutes and
- ▶ to increase minutes.

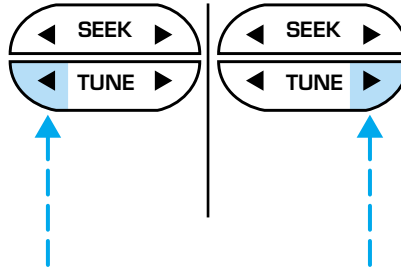

The CLK control will allow you to switch between media display mode (radio station, stereo information, etc.) and clock display mode (time). When in clock mode, the media information will display for 10 seconds, when the radio is turned on, and then revert to clock information. Anytime that the media is changed, (new radio station, etc.), the media information will again display for 10 seconds before reverting back to the clock. In media mode, the media information will always be displayed.

Premium AM/FM Stereo/Cassette/Single CD

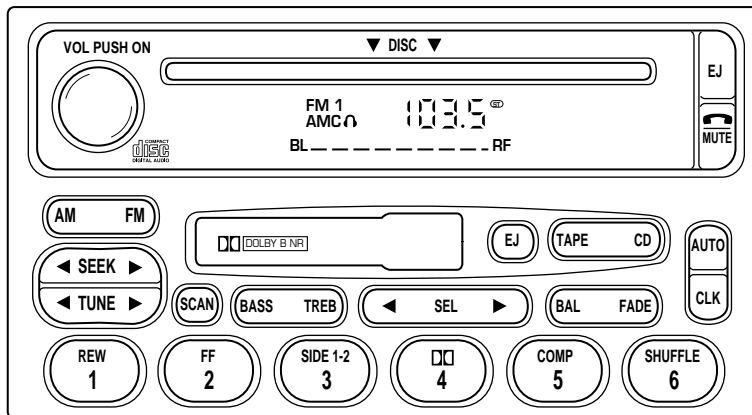

Controls and features

Volume/power control

Press the control to turn the audio system on or off.

Audio power can also be turned on by pressing the AM/FM select control or the tape/CD select control. Audio power is turned off by using the volume/power control.

VOL - PUSH ON

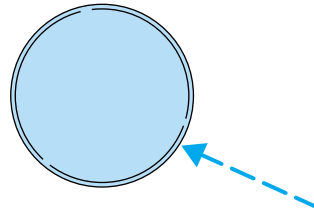

Turn control to raise or lower volume.

VOL - PUSH ON

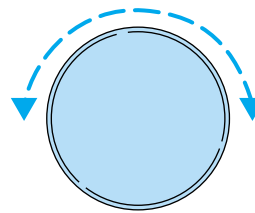

If the volume is set above a certain level and the ignition is turned off, the volume will come back on at a “nominal” listening level when the ignition switch is turned back on.

AM/FM select

The AM/FM select control works in radio, tape and CD modes.



AM/FM select in radio mode

This control allows you to select AM or FM frequency bands. Press the control to switch between AM, FM1 or FM2 memory preset stations.

AM/FM select in tape mode

Press this control to stop tape play and begin radio play.

Tune adjust

The tune control works in radio mode.

Controls and features

Tune adjust in radio mode

- Press ◀ to move to the next frequency down the band (whether or not a listenable station is located there). Hold the control to move through the frequencies quickly.
- Press ▶ to move to the next frequency up the band (whether or not a listenable station is located there). Hold for quick movement.

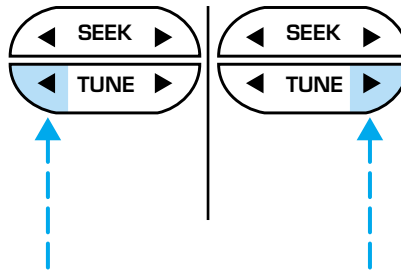

Seek function

The seek function control works in radio, tape or CD mode.

Seek function in radio mode

- Press ◀ to find the next listenable station down the frequency band.
- Press ▶ to find the next listenable station up the frequency band.

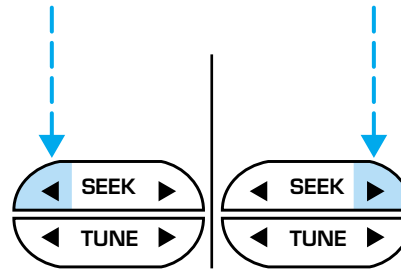

Seek function in tape mode

- Press ◀ to listen to the previous selection on the tape.
- Press ▶ to listen to the next selection on the tape.

Controls and features

Seek function in CD mode

- Press ◀ to seek to the previous track of the current disc.
- Press ▶ to seek forward to the next track of the current disc. After the last track has been completed, the first track of the current disc will automatically replay.

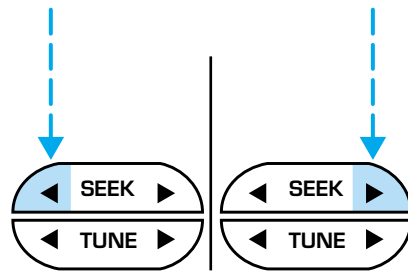

Scan function

The scan function works in radio, tape or CD mode.



Scan function in radio mode

Press the SCAN control to hear a brief sampling of all listenable stations on the frequency band. Press the control again to stop the scan mode.

Scan function in tape mode

Press the SCAN control to hear a short sampling of all selections on the tape. (The tape scans in a forward direction. At the end of the tape's first side, direction automatically reverses to the opposite side of the tape.) To stop on a particular selection, press the control again.

Scan function in CD mode

Press the SCAN control to hear a short sampling of all selections on the CD. (The CD scans in a forward direction, wrapping back to the first track at the end of the CD.) To stop on a particular selection, press the control again.

Radio station memory preset

The radio is equipped with six station memory preset controls. These controls can be used to select up to six preset AM stations and twelve FM stations (six in FM1 and six in FM2).

Controls and features

Setting memory preset stations



1. Select the frequency band with the AM/FM select control.
2. Select a station. Refer to *Tune adjust* or *Seek function* for more information on selecting a station.

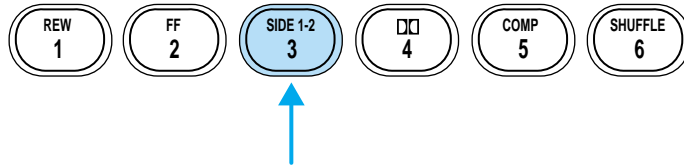

3. Press and hold a memory preset control until the sound returns, indicating the station is held in memory on the control you selected.

Autoset memory preset

Autoset allows you to set strong radio stations without losing your original manually set preset stations. This feature is helpful on trips when you travel between cities with different radio stations.

Starting autoset memory preset

1. Select a frequency using the AM/FM select controls.
2. Press the AUTO control.
3. When the first six strong stations are filled, the station stored in memory preset control 1 will start playing.

If there are less than six strong stations available on the frequency band, the remaining memory preset controls will all store the last strong station available.

These stations are temporarily stored in the memory preset controls (until deactivated) and are accessed in the same manner of your original presets.

To deactivate autoset and return to your audio system's manually set memory stations, press the AUTO control again.

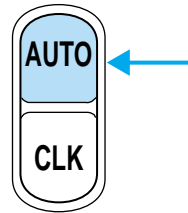

Controls and features

Bass adjust

The bass adjust control allows you to increase or decrease the audio system's bass output.

Press the BASS control then press:

- ◀ to decrease the bass output and
- ▶ to increase the bass output.

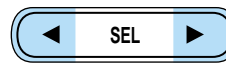
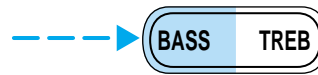

Treble adjust

The treble adjust control allows you to increase or decrease the audio system's treble output.

Press the TREB control then press:

- ◀ to decrease the treble output and
- ▶ to increase the treble output.



Speaker balance adjust

Speaker sound distribution can be adjusted between the right and left speakers.



Controls and features

Press the BAL control then press:

- ◀ to shift sound to the left and
- ▶ to shift sound to the right.

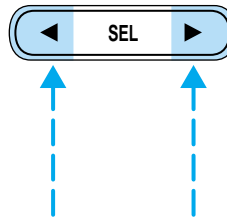

Speaker fade adjust

Speaker sound can be adjusted between the front and rear speakers.

Press the FADE control then press:

- ▶ to shift the sound to the front and
- ◀ to shift the sound to the rear.

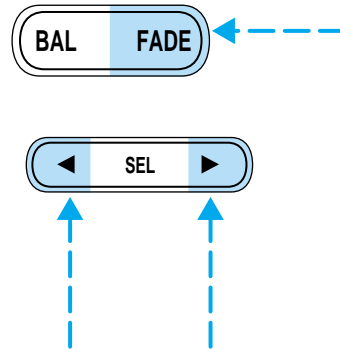

Tape select

- To begin tape play (with a tape loaded into the audio system) while in the radio or CD mode, press the TAPE control. Press the button during rewind or fast forward to stop the rewind or fast forward function.



Rewind

The rewind control works in tape and CD modes.

- In tape mode, radio play will continue until rewind is stopped (with the TAPE control) or the beginning of the tape is reached.
- In CD mode, pressing the REW control rewinds the CD within the current track.

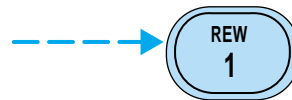

Controls and features

Fast forward

The fast forward control works in tape and CD modes.

- In the tape mode, tape direction will automatically reverse when the end of the tape is reached.
- In CD mode, pressing the control fast forwards the CD within the current track.

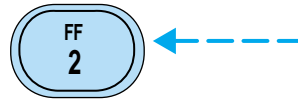

Tape direction select

Press SIDE 1-2 to play the alternate side of a tape.

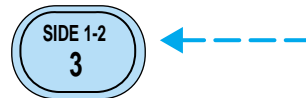

Eject function

Press the EJ control to stop and eject a tape.

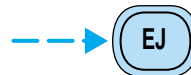

Press the EJ control to stop and eject a CD.

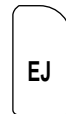

Dolby® noise reduction

Dolby® noise reduction operates in tape mode. Dolby® noise reduction reduces the amount of hiss and static during tape playback.

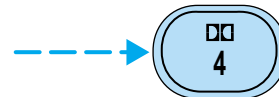

Press the DD control to activate (and deactivate) the Dolby® noise reduction.

Dolby® noise reduction is manufactured under license from Dolby® Laboratories Licensing Corporation. “Dolby®” and the double-D symbol DD are trademarks of Dolby® Laboratories Licensing Corporation.

Controls and features

Compression adjust

Compression adjust brings soft and loud CD passages together for a more consistent listening level.

Press the COMP control to activate and deactivate compression adjust.

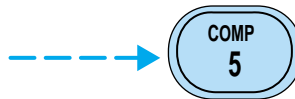

Shuffle feature

The shuffle feature operates in CD mode and plays all tracks on the current disc in random order.

Press the SHUFFLE control to start this feature. Random order play will continue until the SHUFFLE control is pressed again.

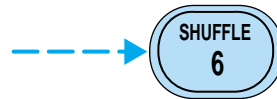

Setting the clock

To set the hour, press and hold the CLK control and press SEEK:

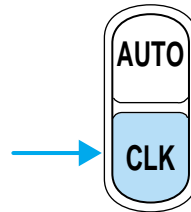

- ◀ to decrease hours and
- ▶ to increase hours.

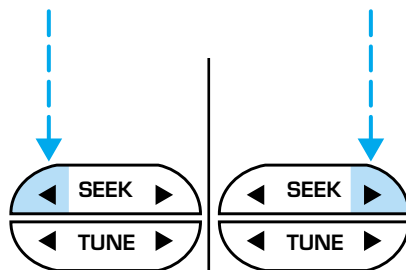

Controls and features

To set the minute, press and hold the CLK control and press TUNE:

- ◀ to decrease minutes and
- ▶ to increase minutes.

If your vehicle has a separate clock module, (other than the digital radio display), the CLK button will not function in the above manner.

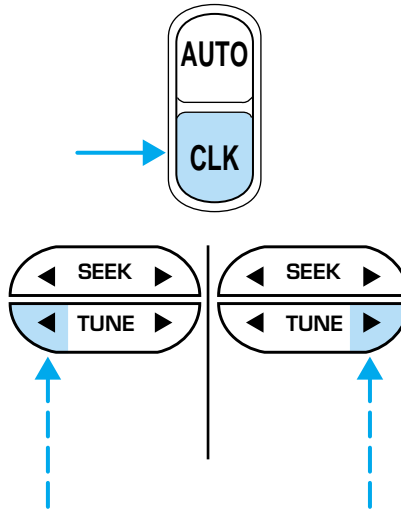

The CLK button will allow you to switch between media display mode (radio station, stereo information, etc.) and clock display mode (time). When in clock mode, the media information will display for 10 seconds, when the radio is turned on, and then revert to clock information. Anytime that the media is changed, (new radio station, etc.), the media information will again display for 10 seconds before reverting back to the clock. In media mode, the media information will always be displayed.

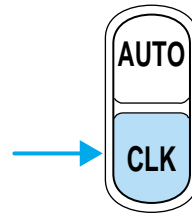

Mute mode

Press the control to mute the playing media. Press the control again to return to the playing media.

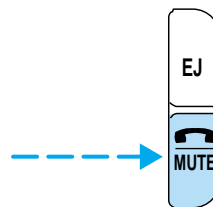

Controls and features

Troubleshooting the CD player



The laser beam used in the compact disc player is harmful to the eyes. Do not attempt to disassemble the case.

If sound skips:

- You may be traveling on a rough road, playing badly scratched discs or the disc may be dirty. Skipping will not scratch the discs or damage the player.

If player does not work:

- The disc is inserted with the label surface downward.
- The disc is dusty or defective.
- A disc with format and dimensions not within industry standards is inserted.

Cleaning compact discs

Inspect all discs for contamination before playing. If necessary, clean discs only with an approved CD cleaner and wipe the center out to the edge. Do not use circular motion.

CD and CD player care

- Handle discs by their edges only. Never touch the playing surface.
- Do not insert more than one disc at a time.
- Do not expose discs to direct sunlight or heat sources for extended periods of time.
- After playing, store the disc in its case.

Cleaning cassette player (if equipped)

Clean the tape player head with a cassette cleaning cartridge after 10 to 12 hours of play in order to maintain the best sound and operation.

Cassette and cassette player care

- Use only cassettes that are 90 minutes long or less.
- Do not expose tapes to direct sunlight, high humidity, extreme heat or extreme cold. Allow tapes that may have been exposed to extreme temperatures to reach a moderate temperature before playing.

Controls and features

- Tighten very loose tapes by inserting a finger or pencil into the hole and turning the hub.
- Remove loose labels before inserting tapes.
- Do not leave tapes in the cassette player for a long time when not being played.

Radio frequency information

The Federal Communications Commission (FCC) and the Canadian Radio and Telecommunications Commission (CRTC) establish the frequencies AM and FM stations may use for their broadcasts. Allowable frequencies are:

AM 530, 540–1600, 1610 kHz

FM 87.7, 87.9–107.7, 107.9 MHz

Not all frequencies are used in a given area.

Radio reception factors

Three factors can affect radio reception:

- **Distance/strength.** The further an FM signal travels, the weaker it is. The listenable range of the average FM station is approximately 40 km (24 miles). This range can be affected by “signal modulation.” Signal modulation is a process radio stations use to increase their strength/volume relative to other stations.
- **Terrain.** Hills, mountains and tall buildings between your vehicle’s antenna and the radio station signal can cause FM reception problems. Static can be caused on AM stations by power lines, electric fences, traffic lights and thunderstorms. Moving away from an interfering structure (out of its “shadow”) returns your reception to normal.
- **Station overload.** Weak signals are sometimes captured by stronger signals when you pass a broadcast tower. A stronger signal may temporarily overtake a weaker signal and play while the weak station frequency is displayed.

The audio system automatically switches to single channel reception if it will improve the reception of a station normally received in stereo.

Audio system warranties and service

Refer to the “Warranty Guide” for audio system warranty information.

If service is necessary, see your dealer or a qualified technician.

Controls and features

POSITIONS OF THE IGNITION

1. ACCESSORY, allows the electrical accessories such as the radio to operate while the engine is not running.
2. LOCK, locks the steering wheel, automatic transmission gearshift lever and allows key removal.
3. OFF, shuts off the engine and all accessories without locking the steering wheel.
4. ON, all electrical circuits operational. Warning lights illuminated. Key position when driving.
5. START, cranks the engine. Release the key as soon as the engine starts.

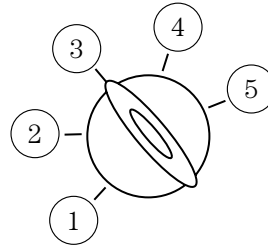

HAZARD FLASHER

For information on the hazard flasher control, refer to *Hazard flasher* in the *Roadside emergencies* chapter.

TURN SIGNAL CONTROL ⇐⇒

- Push down to activate the left turn signal.
- Push up to activate the right turn signal.

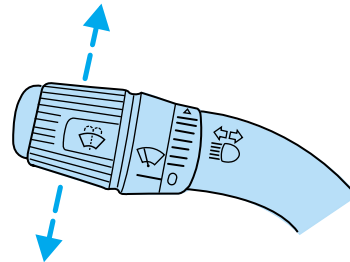

Controls and features

WINDSHIELD WIPER/WASHER CONTROLS

Rotate the windshield wiper control to the desired interval, low or high speed position.

The bars of varying length are for intermittent wipers. When in this position rotate the control upward for fast intervals and downward for slow intervals.

Push the control on the end of the stalk to activate washer. Push and hold for a longer wash cycle. The washer will automatically shut off after ten seconds of continuous use.

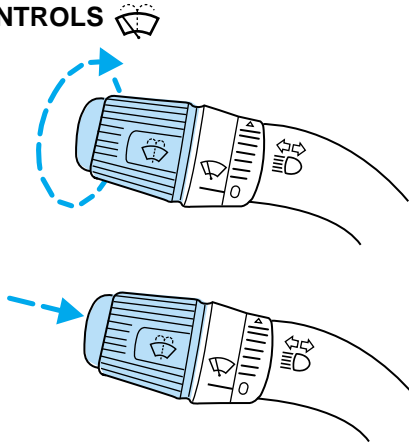

HIGH BEAMS

Push forward to activate.

Pull toward you to deactivate.

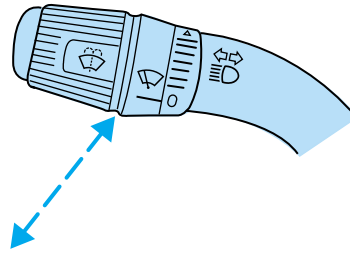

FLASH TO PASS

Pull toward you to activate and release to deactivate.

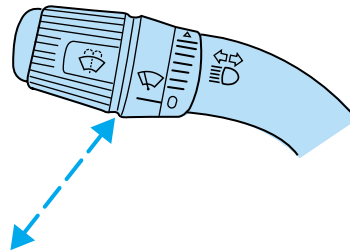

Controls and features

SPEED CONTROL (IF EQUIPPED)

To turn speed control on

- Press ON.

Vehicle speed cannot be controlled until the vehicle is traveling at or above 48 km/h (30 mph).

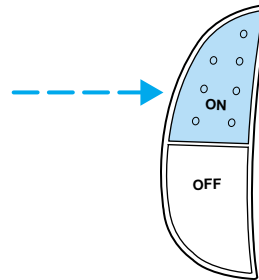

Do not use the speed control in heavy traffic or on roads that are winding, slippery, or unpaved.



Do not shift the gearshift lever into N (Neutral) with the speed control on.

To turn speed control off

- Press OFF or
- Turn off the vehicle ignition.

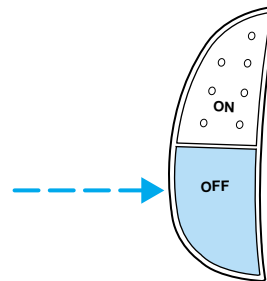

Once speed control is switched off, the previously programmed set speed will be erased.

Controls and features

To set a speed

- Press SET ACCEL. For speed control to operate, the speed control must be ON and the vehicle speed must be greater than 48 km/h (30 mph).

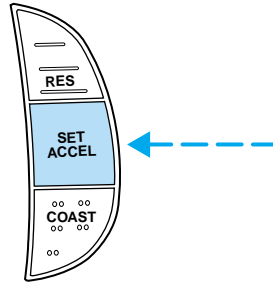

If you drive up or down a steep hill, your vehicle speed may vary momentarily slower or faster than the set speed. This is normal.

Speed control cannot reduce the vehicle speed if it increases above the set speed on a downhill. If your vehicle speed is faster than the set speed while driving on a downhill, you may want to shift to the next lower gear or apply the brakes to reduce your vehicle speed.

If your vehicle slows down more than 16 km/h (10 mph) below your set speed on an uphill, your speed control will disengage. This is normal. Pressing RES will re-engage it.



Do not use the speed control in heavy traffic or on roads that are winding, slippery, or unpaved.

To set a higher set speed

- Press and hold SET ACCEL. Release the control when the desired vehicle speed is reached or
- Press and release SET ACCEL. Each press will increase the set speed by 1.6 km/h (1 mph) or
- Accelerate with your accelerator pedal. When the desired vehicle speed is reached, press and release SET ACCEL.

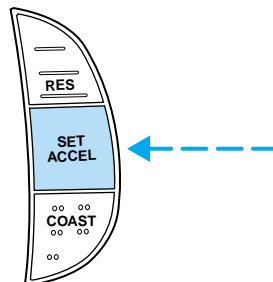

Controls and features

You can accelerate with the accelerator pedal at any time during speed control usage. Releasing the accelerator pedal will return your vehicle to the previously programmed set speed.

To set a lower set speed

- Press and hold COAST. Release the control when the desired speed is reached or
- Press and release COAST. Each press will decrease the set speed by 1.6 km/h (1 mph) or
- Depress the brake pedal. When the desired vehicle speed is reached, press SET ACCEL.

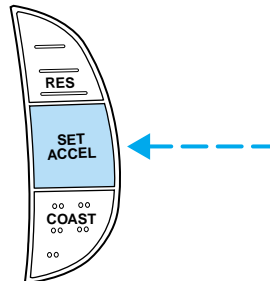
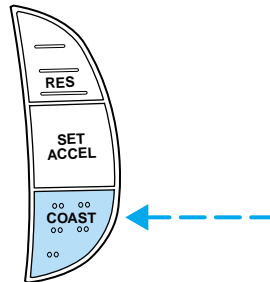

Controls and features

To disengage speed control

- Depress the brake pedal or

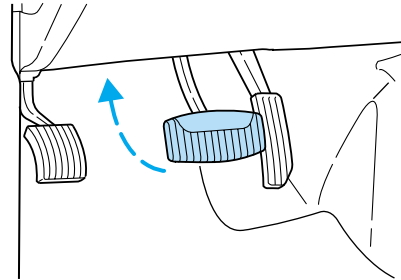

- Depress the clutch pedal (if equipped).

Disengaging the speed control will not erase the previously programmed set speed.

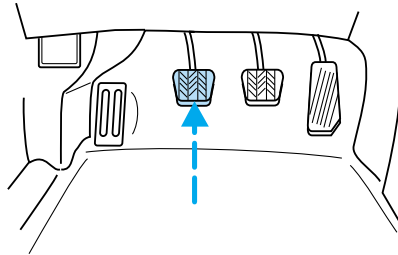

Pressing OFF will erase the previously programmed set speed.

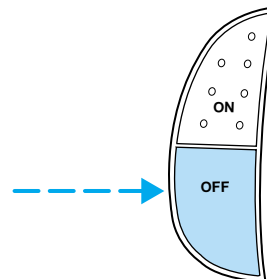

Controls and features

To return to a previously set speed

- Press RES. For RES to operate, the vehicle speed must be faster than 48 km/h (30 mph).

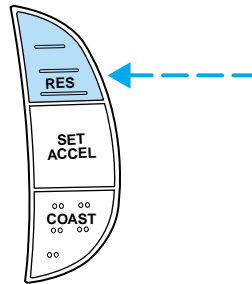

POWER WINDOWS (IF EQUIPPED)

Press and hold the rocker switches to open and close windows.

- Press the top portion of the rocker switch to close.

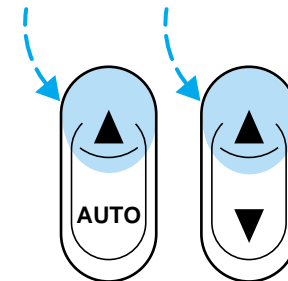

- Press the bottom portion of the rocker switch to open.

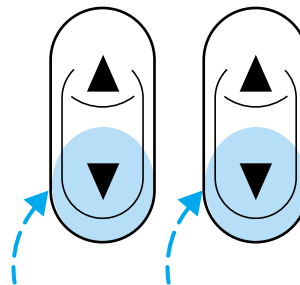

Controls and features

One touch down

- Press AUTO completely down and release quickly. The driver's window will open fully. Depress again to stop window operation.

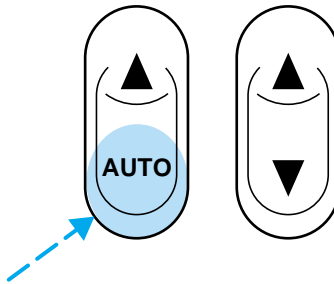

Window lock (if equipped)

The window lock feature allows only the driver to operate the power windows.

To lock out all the window controls except for the driver's press the left side of the control. Press the right side to restore the window controls.

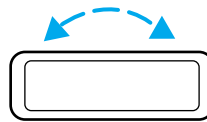

POWER DOOR LOCKS (IF EQUIPPED)

Press U to unlock all doors and L to lock all doors.

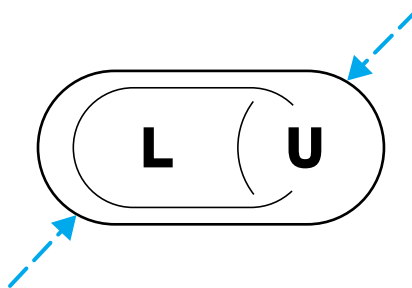

Controls and features

MIRRORS

With the doors closed and the seat adjusted for proper comfort, move the mirrors to maximize rear viewing area by adjusting the western mirrors left or right as required.

Adjust the auxiliary convex mirrors. Convex mirrors are a ball-stud design for precise adjustment to maximize viewing area.

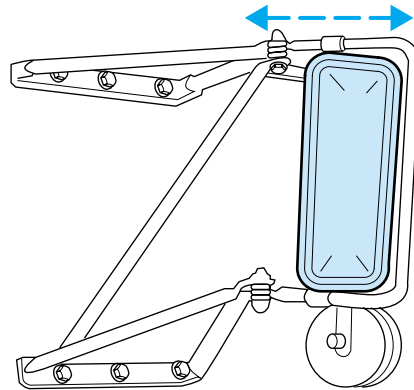

Seating and safety restraints

SEATING

Driver's seat adjustment



Never adjust the driver's seat or seatback when the vehicle is moving.



Always drive and ride with your seatback upright and the lap belt snug and low across the hips.



Reclining the seatback can reduce the effectiveness of the seat's safety belt in the event of a collision.

Fixed-back seat

Move handle to the left to move seat forward or backward.

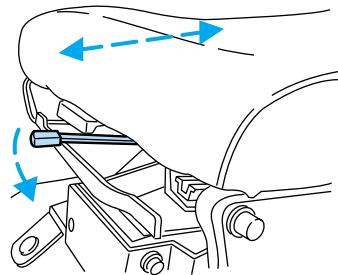

Recline seat (if equipped)

Move handle to the left to move seat forward or backward.

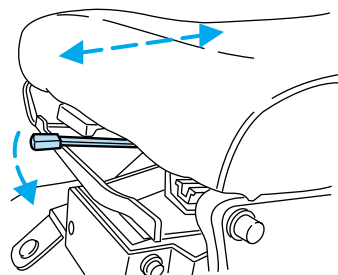

Seating and safety restraints

Rotate control to adjust seatback.

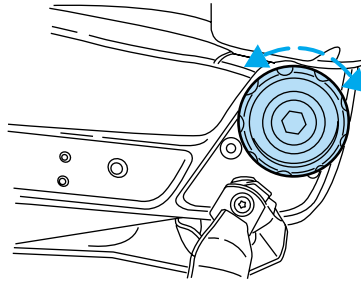

Easy-Aire seat (if equipped)

Move handle to the left to move seat forward or backward.

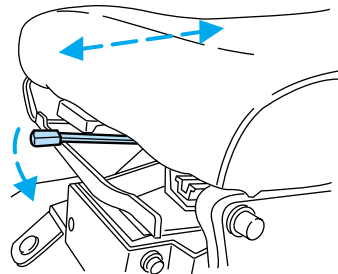

Rotate control to adjust seatback.

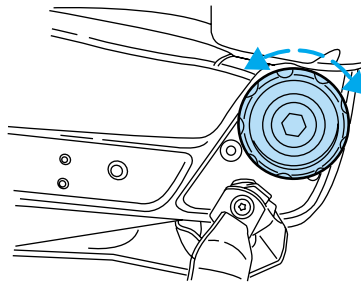

Seating and safety restraints

Pump handle to raise seat height.

Push handle full down to lower.

Always adjust the seat height **before** fastening seatbelt.

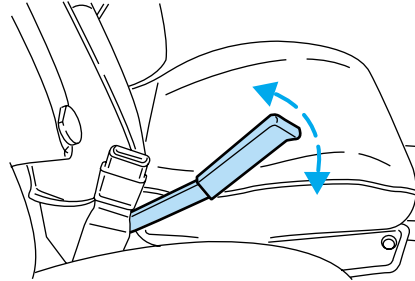

Rear folding bench seat (if equipped)

Folding down the rear seats

 All safety belts should be properly stowed in the seat pockets before folding down the rear seat.

Make sure that no objects such as books, purses or briefcases are on the floor in front of the second row seats before folding them down.

1. Locate the strap on the rear of the lower seat cushion.
2. Lift the strap and rotate the lower seat cushion toward the front of the vehicle.

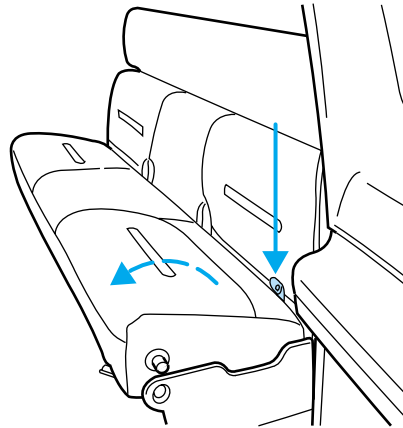

Seating and safety restraints

3. Locate the strap below the seatback.
4. Pull downward on the strap to release the seatback.
5. Rotate the seatback forward.

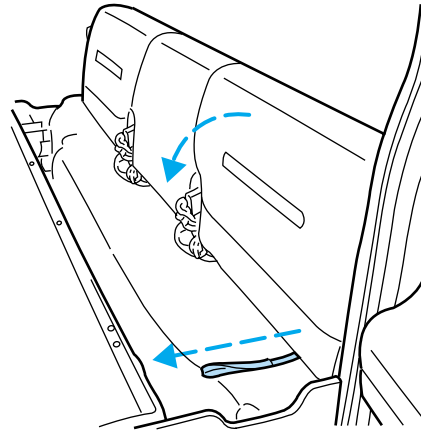

Returning the seat to upright



Always latch the vehicle seat to the floor, whether the seat is occupied or empty. If not latched, the seat may cause injury during a sudden stop.

1. Lift/rotate the seatback toward the rear of the vehicle and make sure it latches securely.
2. Lift/rotate the lower seat cushion to its seating position.

SAFETY RESTRAINTS

Safety restraints precautions



Always drive and ride with your seatback upright and the lap belt snug and low across the hips.





To reduce the risk of injury, make sure children sit where they can be properly restrained.





Never let a passenger hold a child on his or her lap while the vehicle is moving. The passenger cannot protect the child from injury in a collision.

Seating and safety restraints

 All occupants of the vehicle, including the driver, should always properly wear their safety belts, even when an air bag SRS is provided.

 It is extremely dangerous to ride in a cargo area, inside or outside of a vehicle. In a collision, people riding in these areas are more likely to be seriously injured or killed. Do not allow people to ride in any area of your vehicle that is not equipped with seats and safety belts. Be sure everyone in your vehicle is in a seat and using a safety belt properly.

 In a rollover crash, an unbelted person is significantly more likely to die than a person wearing a seat belt.

 Each seating position in your vehicle has a specific safety belt assembly which is made up of one buckle and one tongue that are designed to be used as a pair. 1) Use the shoulder belt on the outside shoulder only. Never wear the shoulder belt under the arm. 2) Never swing the safety belt around your neck over the inside shoulder. 3) Never use a single belt for more than one person.

 Always transport children 12 years old and under in the back seat and always properly use appropriate child restraints.

Combination lap and shoulder belts

1. Insert the belt tongue into the proper buckle (the buckle closest to the direction the tongue is coming from) until you hear a snap and feel it latch. Make sure the tongue is securely fastened in the buckle.

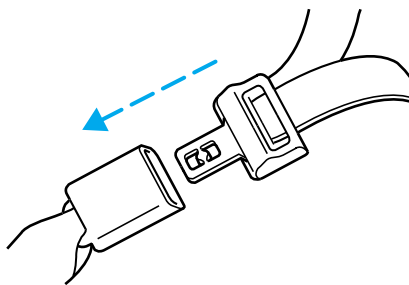

Seating and safety restraints

2. To unfasten, push the release button and remove the tongue from the buckle.

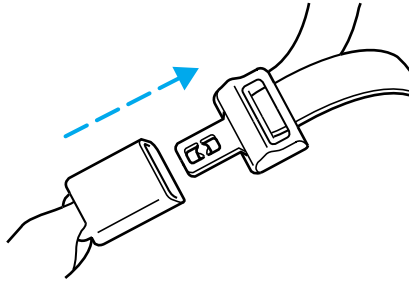

The front and rear outboard safety restraints in the vehicle are combination lap and shoulder belts. The front and rear seat passenger outboard safety belts have vehicle sensitive emergency locking retractors.

Vehicle sensitive retractor

The vehicle sensitive retractor allows free shoulder belt length adjustment to your movements and locks in response to vehicle movement. For example, if the driver brakes suddenly or turns a corner sharply, or the vehicle receives an impact of approximately 8 km/h (5 mph) or more, the combination safety belts will lock to help reduce forward movement of the driver and passengers.

Front safety belt height adjustment

SuperCab and CrewCab vehicle has safety belt height adjustments for the driver and front passenger. Adjust the height of the shoulder belt so the belt rests across the middle of your shoulder.

Seating and safety restraints

- 4-door SuperCab

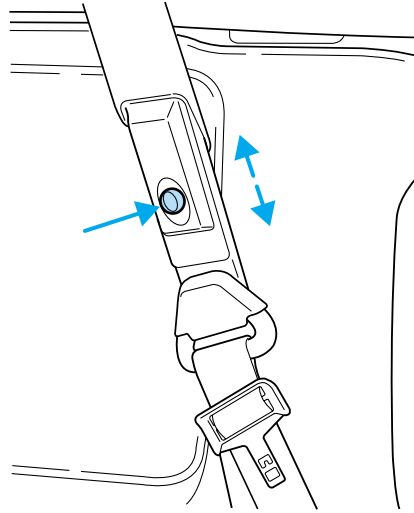

- 4-door CrewCab

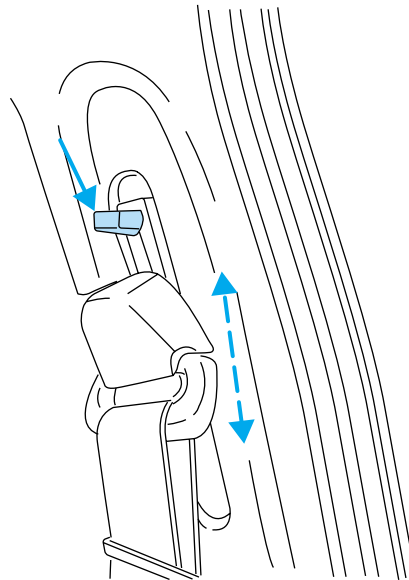

Seating and safety restraints

To lower the shoulder belt height, push the button and slide the height adjuster down. To raise the height of the shoulder belt, slide the height adjuster up. Pull down on the height adjuster to make sure it is locked in place.

 Position the shoulder belt height adjusters so that the belt rests across the middle of your shoulder. Failure to adjust the safety belt properly could reduce the effectiveness of the seat belt and increase the risk of injury in a collision.

Lap belts

Adjusting the lap belt

The lap belt does not adjust automatically.

 The lap belts should fit snugly and as low as possible around the hips, not around the waist.

Insert the tongue into the correct buckle (the buckle closest to the direction the tongue is coming from). To lengthen the belt, turn the tongue at a right angle to the belt and pull across your lap until it reaches the buckle. To tighten the belt, pull the loose end of the belt through the tongue until it fits snugly across the hips.

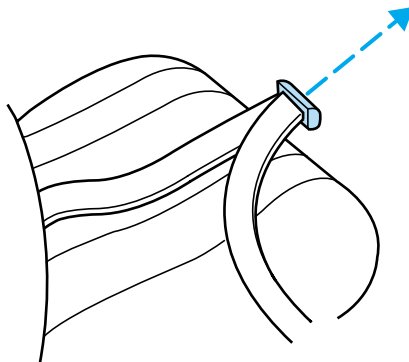

Seating and safety restraints

Shorten and fasten the belt when not in use.

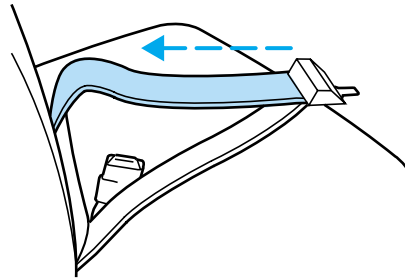

Safety belt extension assembly

If the safety belt assembly is too short, even when fully extended, 20 cm (8 inches) can be added to the safety belt assembly by adding a safety belt extension assembly (part number 611C22). Safety belt extension assemblies can be obtained from your dealer at no cost.

Use only extensions manufactured by the same supplier as the safety belt. Manufacturer identification is located at the end of the webbing on the label. Also, use the safety belt extension only if the safety belt is too short for you when fully extended. Do not use extensions to change the fit of the shoulder belt across the torso.

Safety belt warning light and indicator chime

The seat belt warning light illuminates in the instrument cluster and a chime sounds to remind the occupants to fasten their safety belts.

Conditions of operation

If...	Then...
The driver's safety belt is not buckled before the ignition switch is turned to the ON position...	The safety belt warning light illuminates 1-2 minutes and the warning chime sounds 4-8 seconds.
The driver's safety belt is buckled while the indicator light is illuminated and the warning chime is sounding...	The safety belt warning light and warning chime turn off.
The driver's safety belt is buckled before the ignition switch is turned to the ON position...	The safety belt warning light and indicator chime remain off.

Seating and safety restraints

Belt minder (if equipped)

The Belt Minder feature is a supplemental warning to the safety belt warning function. This feature provides additional reminders to the driver that the driver's safety belt is unbuckled by intermittently sounding a chime and illuminating the safety belt warning lamp in the instrument cluster.

If...	Then...
The driver's safety belt is not buckled before the vehicle has reached at least 5 km/h (3 mph) and 1-2 minutes have elapsed since the ignition switch has been turned to ON...	The Belt Minder feature is activated - the safety belt warning light illuminates and the warning chime sounds for 6 seconds every 30 seconds, repeating for approximately 5 minutes or until safety belt is buckled.
The driver's safety belt is buckled while the safety belt indicator light is illuminated and the safety belt warning chime is sounding...	The Belt Minder feature will not activate.
The driver's safety belt is buckled before the ignition switch is turned to the ON position...	The Belt Minder feature will not activate.

The purpose of the Belt Minder is to remind occasional wearers to wear safety belts all of the time.

Seating and safety restraints

The following are reasons most often given for not wearing safety belts:
(All statistics based on U.S. data)

Reasons given...	Consider...
"Crashes are rare events"	36 700 crashes occur every day. The more we drive, the more we are exposed to "rare" events, even for good drivers. <i>1 in 4 of us will be seriously injured in a crash during our lifetime.</i>
"I'm not going far"	3 of 4 fatal crashes occur within 25 miles of home.
"Belts are uncomfortable"	Ford designs its safety belts to enhance comfort. If you are uncomfortable - try different positions for the safety belt upper anchorage and seatback which should be as upright as possible; this can improve comfort.
"I was in a hurry"	Prime time for an accident. Belt Minder reminds us to take a few seconds to buckle up.
"Seat belts don't work"	Safety belts , when used properly, reduce risk of death to front seat occupants by 45% in cars , and by 60% in light trucks .
"Traffic is light"	Nearly 1 of 2 deaths occur in single-vehicle crashes , many when no other vehicles are around.
"Belts wrinkle my clothes"	Possibly, but a serious crash can do much more than wrinkle your clothes, particularly if you are unbelted.
"The people I'm with don't wear belts"	Set the example, teen deaths occur 4 times more often in vehicles with TWO or MORE people. Children and younger brothers/sisters imitate behavior they see.
"I have an air bag"	Air bags offer greater protection when used with safety belts. Frontal airbags are not designed to inflate in rear and side crashes or rollovers.
"I'd rather be thrown clear"	Not a good idea, people who are ejected are 40 times more likely to DIE . Safety belts help prevent ejection, WE CAN'T "PICK OUR CRASH".



Do not sit on top of a buckled safety belt to avoid the Belt Minder chime. Sitting on the safety belt will increase risk of injury in an accident. To disable (one-time) or deactivate the Belt Minder feature please follow the directions stated below.

Seating and safety restraints

One time disable

Anytime the safety belt is buckled and then unbuckled during an ignition ON cycle, Belt Minder will be disabled for that ignition cycle only.

Deactivating/activating the belt minder feature

Read steps 1 - 9 thoroughly before proceeding with the deactivation/activation programming procedure.

The Belt Minder feature can be deactivated/activated by performing the following procedure:

Before following the procedure, make sure that:

- the parking brake is set
- the gearshift is in P (Park) (automatic transmission) or the neutral position (manual transmission).
- the ignition switch is in the OFF position
- all vehicle doors are closed
- the driver's safety belt is unbuckled
- the parklamps/headlamps are in OFF position (If vehicle is equipped with Autolamps, this will not affect the procedure.)



To reduce the risk of injury, do not deactivate/activate the Belt Minder feature while driving the vehicle.

1. Turn the ignition switch to the RUN (or ON) position. (DO NOT START THE ENGINE)
2. Wait until the safety belt warning light turns off. (Approximately 1–2 minutes)
 - Steps 3–5 must be completed within 60 seconds or the procedure will have to be repeated.
3. Buckle then unbuckle the safety belt three times, ending with the safety belt unbuckled. This can be done before or during Belt Minder warning activation.
4. Turn on the parklamps/headlamps, turn off the parklamps/headlamps.
5. Buckle then unbuckle the safety belt three times, ending with the safety belt unbuckled.
 - After step 5 the safety belt warning light will be turned on for three seconds.

Seating and safety restraints

6. Within seven seconds of the safety belt warning light turning off, buckle then unbuckle the safety belt.
 - This will disable Belt Minder if it is currently enabled, or enable Belt Minder if it is currently disabled.
7. Confirmation of disabling Belt Minder is provided by flashing the safety belt warning light four times per second for three seconds.
8. Confirmation of enabling Belt Minder is provided by flashing the safety belt warning light four times per second for three seconds, followed by three seconds with the safety belt warning light off, then followed by flashing the safety belt warning light four times per second for three seconds again.
9. After receiving confirmation, the deactivation/activation procedure is complete.

Safety belt maintenance

Inspect the safety belt systems periodically to make sure they work properly and are not damaged. Inspect the safety belts to make sure there are no nicks, wears or cuts, replacing if necessary. All safety belt assemblies, including retractors, buckles, front seat belt buckle assemblies, buckle support assemblies (slide bar-if equipped), shoulder belt height adjusters (if equipped), shoulder belt guide on seatback (if equipped), child safety seat tether bracket assemblies (if equipped), and attaching hardware, should be inspected after a collision. Ford recommends that all safety belt assemblies used in vehicles involved in a collision be replaced. However, if the collision was minor and a qualified technician finds that the belts do not show damage and continue to operate properly, they do not need to be replaced. Safety belt assemblies not in use during a collision should also be inspected and replaced if either damage or improper operation is noted.



Failure to inspect and if necessary replace the safety belt assembly under the above conditions could result in severe personal injuries in the event of a collision.

Refer to *Cleaning and maintaining the safety belts* in the *Maintenance and care* section.

Seating and safety restraints

SAFETY RESTRAINTS FOR CHILDREN

Important child restraint precautions

You are required by law to use safety restraints for children in the U.S. and Canada. If small children ride in your vehicle (generally children who are four years old or younger and who weigh 18 kg [40 lbs] or less), you must put them in safety seats made especially for children. Check your local and state or provincial laws for specific requirements regarding the safety of children in your vehicle.



Never let a passenger hold a child on his or her lap while the vehicle is moving. The passenger cannot protect the child from injury in a collision.

Always follow the instructions and warnings that come with any infant or child restraint you might use.

When possible, always place children under age 12 in the rear seat of your vehicle. Accident statistics suggest that children are safer when properly restrained in the rear seating positions than in the front seating position.

Children and safety belts

If the child is the proper size, restrain the child in a safety seat.

Seating and safety restraints

Children who are too large for child safety seats (as specified by your child safety seat manufacturer) should always wear safety belts.

Follow all the important safety restraint precautions that apply to adult passengers in your vehicle.

If the shoulder belt portion of a combination lap and shoulder belt can be positioned so it does not cross or rest in front of the child's face or neck, the child should wear the lap and shoulder belt. Moving the child closer to the center of the vehicle may help provide a good shoulder belt fit.



Do not leave children, unreliable adults, or pets unattended in your vehicle.

To improve the fit of lap and shoulder belts on children who have outgrown child safety seats, Ford recommends use of a belt-positioning booster seat that is labelled as conforming to all Federal motor vehicle safety standards. Belt-positioning booster seats raise the child and provide a shorter, firmer seating cushion that encourages safer seating posture and better fit of lap and shoulder belts on the child.

A belt-positioning booster should be used if the shoulder belt rests in front of the child's face or neck, or if the lap portion of the belt does not fit snugly on both thighs, or if the thighs are too short to let the child sit all the way back on the seat cushion when the lower legs hang over the edge of the seat cushion. You may wish to discuss the special needs of your child with your pediatrician.

SAFETY SEATS FOR CHILDREN



Seating and safety restraints

Child and infant or child safety seats

Use a safety seat that is recommended for the size and weight of the child. Carefully follow all of the manufacturer's instructions with the safety seat you put in your vehicle. If you do not install and use the safety seat properly, the child may be injured in a sudden stop or collision.

When installing a child safety seat:

- Use the correct safety belt buckle for that seating position.
- Insert the belt tongue into the proper buckle until you hear a snap and feel it latch. Make sure the tongue is securely fastened in the buckle.
- Keep the buckle release button pointing up and away from the safety seat, with the tongue between the child seat and the release button, to prevent accidental unbuckling.
- Place seat back in upright position.

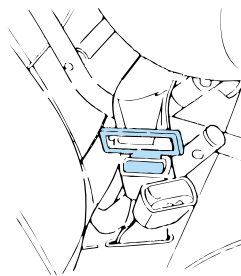

Ford recommends the use of a child safety seat having a top tether strap. Install the child safety seat in a seating position which is capable of providing a tether anchorage. For more information on top tether straps, refer to *Attaching safety seats with tether straps*.



Carefully follow all of the manufacturer's instructions included with the safety seat you put in your vehicle. If you do not install and use the safety seat properly, the child may be injured in a sudden stop or collision.

Seating and safety restraints

Installing child safety seats in combination lap and shoulder belt seating positions

1. Position the child safety seat in a seat with a combination lap and shoulder belt.

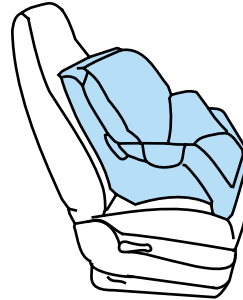

Children should always be restrained in the rear seat when possible.

2. While holding the shoulder and lap belt portions together, route the tongue through the child seat according to the child seat manufacturer's instructions. Be sure the belt webbing is not twisted.

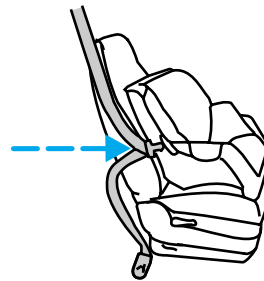

Seating and safety restraints

3. Buckle the seat belt. Push down on the childseat and pull on the shoulder portion of the belt to snug the lap belt. Hold the lap and shoulder belts next to the tongue and unbuckle the belt.

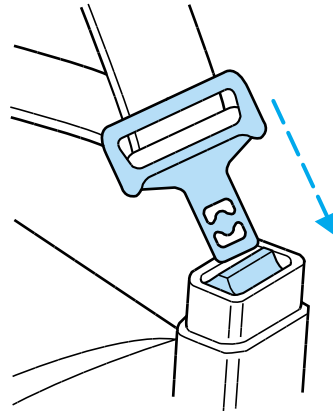

4. Install a locking clip over both lap and shoulder belt portions next to the sliding tongue. Rebuckle the belt. Obtain the locking clip kit (Part Number FO3Z-5461248-A) at no charge from an authorized Ford or Lincoln-Mercury dealer.

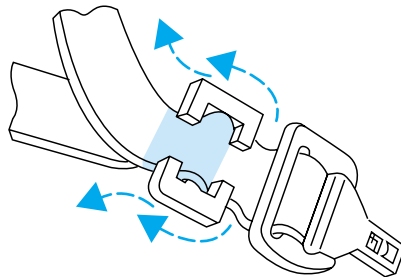

5. Before placing the child in the seat, forcibly tilt the seat forward and back to make sure the seat is securely held in place. If the child seat is not tight enough, unbuckle the seat belt, move the tongue and locking clip to shorten the lap portion and push down hard on the childseat while you rebuckle the belt.

Check to make sure the child seat is properly secured before each use.

Attaching safety seats with tether straps

Some manufacturers make safety seats that include a tether strap that goes over the back of the vehicle seat and attaches to an anchoring point. Other manufacturers offer the tether strap as an accessory. Contact the manufacturer of your child safety seat for information about ordering a tether strap.

Seating and safety restraints

Tether anchorage hardware

A tethered seat can be installed in the front seat. Put the tether strap over the seatback and attach it to an anchor bracket.

An anchor bracket can be installed to the inside of the back panel of your vehicle.

The anchor bracket must be installed using the instructions provided with the tether anchorage hardware kit.

Tether anchorage hardware kits (part number 613D74) including instructions, may be obtained at no charge from any Ford or Lincoln/Mercury dealer.

If you have a Super Cab or Crew Cab, Ford recommends you attach tether safety seats in the rear seating position (if possible) with the tether strap attached to the tether anchorage bracket as shown in the instructions provided with the tether anchor kit.



Tighten the anchor according to specifications. Otherwise, the safety seat may not be properly secured and the child may be injured in a sudden stop or collision.

Starting

STARTING PROCEDURES

Operating precautions

- Always shift to a lower gear at high altitudes to prevent engine smoking.
- Avoid extended and unnecessary idling.

 Do not operate a diesel engine where the vapors can be combustible. These vapors can be sucked through the air intake system and cause engine acceleration and overspeeding, which may result in bodily injury and extensive property damage. The equipment owner and operator are responsible for safe operation in a hostile environment.

STARTING THE ENGINE

1. Ensure headlamps and all accessories are turned off and the parking brake is applied.
2. **Automatic transmissions**, ensure gearshift is in N (Neutral).
3. **Manual transmissions**, ensure gearshift is in neutral position and clutch pedal depressed.

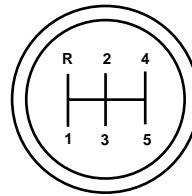

If your vehicle is equipped with an air intake heater, the heater will activate in cooler weather. If the Wait to Start light illuminates, **do not** crank the engine until the light goes off.

**WAIT
TO
START**

Starting

 If equipped with an air intake heater, DO NOT use ether or any other starting fluids. The use of starting fluids (ether) in an engine equipped with an air intake heater could result in damage and/or personal injury.

4. Do not depress the accelerator during starting the engine.
5. Start the engine.

If the engine does not start after 30 seconds of cranking, allow two minutes for the starter to cool before trying again. Excessive cranking may damage the starter.

After the engine starts:

- On some engines, the Wait to Start light should illuminate after the engine starts. Allow the engine to idle about three minutes or until the engine coolant temperature gauge begins to rise. Maintain idle speed until the Wait to Start light cycles off to indicate the air intake heater has shut off (approximately six minutes). Operating the engine at higher speeds will reduce the effectiveness of the air inlet heater.
- Do not increase engine speed until the oil pressure gauge indicates normal pressure.
- Ensure engine oil pressure is indicated on the gauge within 15 seconds after starting.
- Idle the engine for three to five minutes before operating with a full load.
- Try to limit engine idle to 10 minutes. Excessive idling reduces fuel economy.
- When starting a cold engine, increase the engine speed (RPM) slowly to make sure adequate lubrication is available to the bearings.

**WAIT
TO
START**

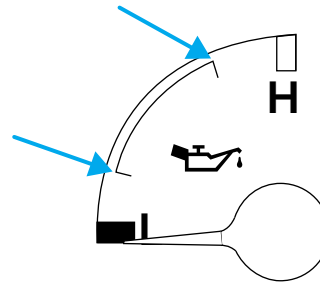

RESTARTING AFTER RUNNING OUT OF FUEL

The fuel system may need to be purged of air, refer to *Running out of fuel* in the *Maintenance and care* chapter.

OPERATING THE ENGINE

Do not operate the engine at full throttle below peak torque engine speed (RPM) for more than one minute at a time (peak torque RPM varies from 1200-1500 RPM depending on engine rated speed).

Monitor the oil pressure and coolant temperature gauges frequently.

If the gauges indicate any reading is not in the normal operating range, stop your vehicle as soon as possible, shut the engine off and check the appropriate fluid level. If an overheating condition starts to occur, release the throttle pressure or shift the transmission into a lower gear, or both, until the temperature returns to normal operating range.

Continuous operation with low coolant temperature, below 60°C (140°F) or high coolant temperature 100°C (212°F) can damage the engine.

Most failures give some kind of early warning. Look and listen for changes in performance, sound or engine appearance that can indicate service or engine repair is needed. Some changes to look and/or listen for:

- Engine misfires
- Loss of power
- Sudden changes in engine operating temperature or oil pressure
- Excessive smoke
- Fuel, oil or coolant leaks
- Vibration
- Increased oil or fuel consumption

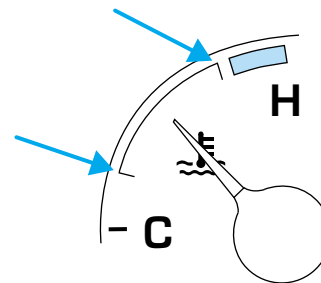
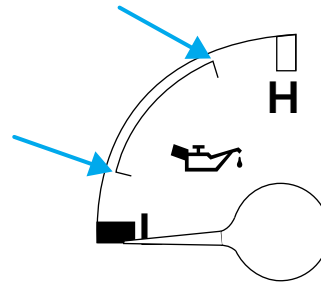

Starting

Excessive full throttle operation below peak torque RPM will shorten engine life to overhaul and can cause serious engine damage. Operation of the engine below peak torque RPM can occur during gear shifting due to difference of gear ratios.

COLD WEATHER STARTING

Perform the following to assure efficient starting in cold weather:

- Use the proper grade oil for your climate. Refer to your engine operator's manual for proper grade oil.
- Test the battery more frequently to assure ample power for starting.
- All electrical connections should be tight and in good condition to prevent losses through loose or corroded connections.

USING THE ENGINE BLOCK HEATER (IF EQUIPPED)

An engine block heater warms the engine coolant, which improves starting, warms up the engine faster and allows the heater-defroster system to respond quickly. Use of an engine block heater is strongly recommended if you live in a region where temperatures reach -23°C (-10°F) or below.

For best results, plug the heater in at least three hours before starting the vehicle. Using the heater for longer than three hours will not harm the engine, so the heater can be plugged in the night before starting the vehicle.



To prevent electrical shock, do not use your heater with ungrounded electrical systems or two-pronged (cheater) adapters.

ENGINE SHUTDOWN SYSTEM (IF EQUIPPED)

This system is designed to help prevent engine damage that could result from operating the engine during a prolonged period of low engine oil pressure, high engine coolant temperature or low coolant level. If any of these conditions occur, a warning light will illuminate and a chime will sound warning the operator that the engine will shutdown in 30 seconds. This is to allow time for the operator to move the vehicle off the road. If additional time is required, the engine can be restarted and run each time for approximately 30 seconds.

Do not attempt to use this restarting feature to drive the vehicle, serious engine damage could result.

Driving

EXHAUST FUMES



Never idle the engine in closed areas. Never sit in a parked or stopped vehicle for any amount of time with engine running.



If you ever smell exhaust fumes of any kind inside your vehicle, have your dealer inspect and fix your vehicle immediately. Do not drive if you smell exhaust fumes. These fumes are harmful and could kill you.

In order to guard against fumes entering your vehicle, the exhaust system and body ventilation system should be checked by a qualified technician:

- Each time the vehicle is raised for service.
- Whenever a change in exhaust system noise is noted.
- Whenever the vehicle has been damaged by impact from another vehicle, object or road obstruction.

In order to afford proper operation, all air inlet vents should be kept clear of snow, leaves and other debris.

If you run the engine while stopped (idled) in an unconfined area, open the windows at least 2.5 cm (one inch) and adjust the heating or air conditioning to draw outside air into the vehicle as follows:

- If your vehicle has outside air control vents, open them fully.
- Set fan speed on high with function control to any position except OFF or MAX A/C and the temperature control on any desired position.
- Adjust air control system to force outside air into the vehicle.

BACKING UP



To avoid the possibility of personal injury while backing the vehicle, always be sure your vehicle's path is clear.

Before backing your vehicle, be sure you can do so safely. If anything behind the cab limits your view, do not rely on mirrors alone to assure that your intended path is clear. If other persons are in the vicinity, have someone standing well behind the vehicle and outside your intended path - visible through an exterior mirror - guide you as you back up.

Driving

Although OSHA or other governmental regulations may require use of an electrical or mechanical back-up alarm to warn bystanders, such an alarm does not assure that the intended path is clear.

An electrical back-up alarm, if installed, is connected to the back-up lamp circuit.

HYDRAULIC BRAKES (IF EQUIPPED)

Your service brakes are self-adjusting. Refer to the Scheduled maintenance guide for scheduled maintenance.

Occasional brake noise is normal and often does not indicate a performance concern with the vehicle's brake system. In normal operation, automotive brake systems may emit occasional or intermittent squeal or groan noises when the brakes are applied. Such noises are usually heard during the first few brake applications in the morning; however, they may be heard at any time while braking and can be aggravated by environmental conditions such as cold, heat, moisture, road dust, salt or mud. If a "metal-to-metal," "continuous grinding" or "continuous squeal" sound is present while braking, the brake linings may be worn-out and should be inspected by a qualified service technician.



If you are driving down a long or steep hill, shift to a lower gear. Do not apply your brakes continuously, as they may overheat and become less effective.

Four-wheel anti-lock brake system (ABS)

On vehicles equipped with an anti-lock braking system (ABS), a noise from the hydraulic pump motor and pulsation in the pedal may be observed during ABS braking events. Pedal pulsation coupled with noise while braking under panic conditions or on loose gravel, bumps, wet or snowy roads is normal and indicates proper functioning of the vehicle's anti-lock brake system. If the vehicle has continuous vibration or shudder in the steering wheel while braking, the vehicle should be inspected by a qualified service technician.

Driving

The ABS operates by detecting the onset of wheel lockup during brake applications and compensating for this tendency. The wheels are prevented from locking even when the brakes are firmly applied. The accompanying illustration depicts the advantage of an ABS equipped vehicle (on bottom) to a non-ABS equipped vehicle (on top) during hard braking with loss of front braking traction.

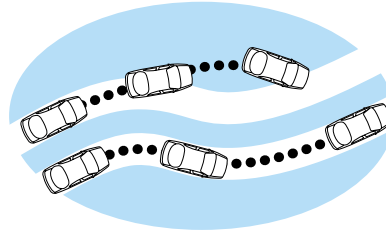

Servicing or replacing ABS module

1. Remove any contamination from the exterior of the module assembly before disconnecting any brake tubes. Keep the contamination away from all open ports and brake tubes.
2. Mark and tag all brake tubes and electrical connectors before disassembly.
3. Perform the necessary repair.
4. Using the marked tags from disassembly, connect the brake tubes and electrical connectors.



Always mark and tag the brake tubes and the electrical connectors prior to disassembly to ensure correct assembly and prevent brake failure.

ABS warning lamp

The  warning lamp in the instrument cluster momentarily illuminates when the ignition is turned on and the engine is off. If the light does not illuminate momentarily at start up, remains on after the vehicle reaches 10 to 15 km/h (5 to 10 mph), or continues to flash, the ABS needs to be serviced.

With the ABS light on, the anti-lock brake system is disabled and normal braking is still effective unless the brake warning light also remains illuminated. (If your parking brake warning lamp illuminates, have your vehicle serviced immediately).

Driving

Using ABS

- In an emergency or when maximum efficiency from the ABS is required, apply continuous full force on the brake. The ABS will be activated immediately, thus allowing you to retain full steering control of your vehicle and, providing there is sufficient space, will enable you to avoid obstacles and bring the vehicle to a controlled stop.
- The Anti-Lock system does not decrease the time necessary to apply the brakes or always reduce stopping distance. Always leave enough room between your vehicle and the vehicle in front of you to stop.
- We recommend that you familiarize yourself with this braking technique. However, avoid taking any unnecessary risks.

Hydraulic brake booster system (Hydromax)

The Hydromax systems receive fluid pressure from the power steering pump to provide power assist during braking.

The Hydromax booster receives backup pressure from the reserve system electric pump whenever the fluid in the power steering system is not flowing. When the engine is OFF, the pump will turn on if the brake pedal is applied, or if the ignition is turned to the ON position.

The sound of the pump operating may be heard by the driver, but this is a normal characteristic of the system.

The reserve system provides reduced braking power, so the vehicle should be operated under these conditions with caution, and only to seek service repair and remove the vehicle from the roadway.

For Hydromax under normal operating conditions noise of the fluid flowing through the booster may be heard whenever the brake is applied. This condition is normal. Vehicle service is not required.

If braking performance or pedal response becomes very poor, even when the pedal is strongly applied, this may indicate the presence of air in the hydraulic system or fluid leakage. Stop the vehicle safely as soon as possible and seek service immediately.

If the red BRAKE warning lamp in the instrument cluster remains illuminated after engine start up, this indicates a system failure in the master cylinder of the brake system.

Stop the vehicle safely as soon as possible and seek service immediately.

BRAKE
(!)

Driving

If the yellow BRAKE RESERVE (E-motor) warning light remains on while the engine is running, this indicates inadequate hydraulic booster pressure or reserve pump system failure. Stop the vehicle safely as soon as possible and seek service immediately.



Parking brake

Apply the parking brake whenever the vehicle is parked. To set the parking brake, pull handle up until it snaps into the locked position.

A properly adjusted parking brake requires approximately 116 Nm (90 lb-ft) to activate. For maximum parking brake effectiveness turn handle clockwise to adjust for wear. When the parking brake is out of adjustment, seek service immediately.

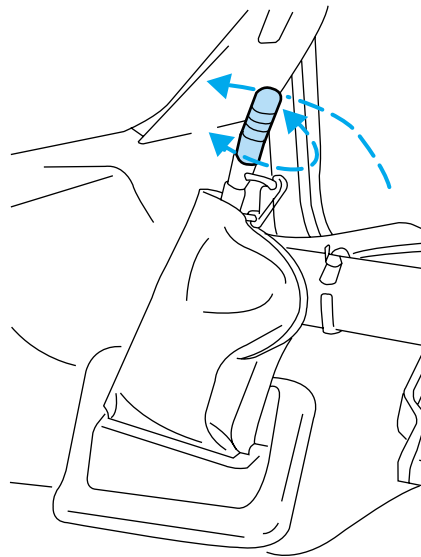

The parking BRAKE warning lamp in the instrument cluster illuminates and remains illuminated (when the ignition is turned ON) until the parking brake is released.



Driving

 Do not use the gearshift selector in place of the parking brake. Always set the parking brake fully AND make sure the gearshift selector is in R (Reverse) for vehicles equipped with manual transmission or N (Neutral) for vehicles with automatic transmission.

 Unexpected and possible sudden vehicle movement may occur if these precautions are not taken.

The parking brake is not recommended to stop a moving vehicle. However, if the normal brakes fail, the parking brake can be used to stop your vehicle in an emergency. Since the parking brake only applies retardation to the rear wheels, the vehicle's stopping distance will increase greatly and the handling of your vehicle will be adversely affected.

Push the palm release lever on the parking brake handle and push down as far as possible to release the brake. Driving with the parking brake on will cause the brakes to wear out quickly and reduce fuel economy.

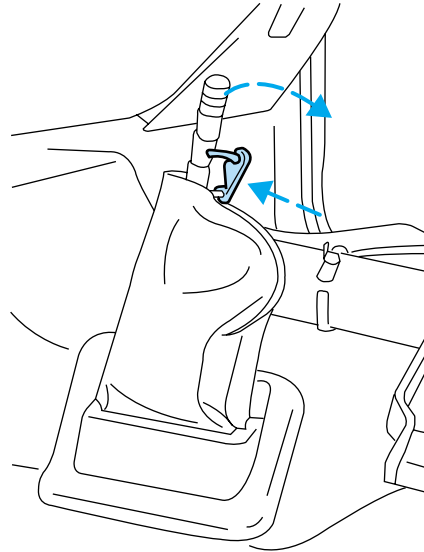

Burnish procedure

For optimal performance of a new parking brake system/new linings perform the following procedure:

1. Make ten stops from 40 km/h (20 mph) with the parking brake lever force set at 18kg (40 lbs).
2. While driving the vehicle at 40 km/h (20 mph) apply the parking brake (with applicable force to set to approximately 18kg [40 lbs.]). Allow the vehicle to come to a complete stop, release the parking brake.
3. Drive 16.8 km (1.5 miles) to cool the brakes.
4. Repeat steps 1 through 3 ten times.

AIR BRAKES (if equipped)

Foot service brakes

Air brakes are operated by a standard dash-mounted foot pedal.

All standard equipment brakes are designed to be self-adjusting. Automatic adjustment, when required, occurs whenever the brakes are applied and released during forward or reverse operation.

Know the required stopping distances for all driving conditions that may be encountered. For longer brake lining life, take full advantage of engine braking power when coming to a stop.

Before descending a long or steep hill, shift to a lower gear and avoid continuous application of the brakes.

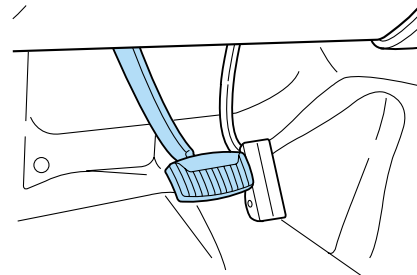

Do not drive with your foot resting on the brake pedal. This will result in abnormally high brake temperatures, excessive lining wear and increased stopping distances.



Continuous application of the brakes will cause the brakes to overheat, resulting in a temporary loss of braking.

Occasional or intermittent brake squeal may result from environmental conditions such as cold, hot, wet, snow, salt, mud, etc. This condition will

Driving

not affect braking effectiveness. The brakes should be checked only if squeal occurs continuously with every application.

If brakes do not grip well

- If you have been driving through deep water, gently apply the brakes several times while the vehicle is moving slowly.
- Let the brakes cool if you have been using them excessively, as in mountain driving or after several fast, high speed stops.
- Check brake adjustment.
- Check brake linings for excessive wear.
- Check system air pressure.

Air brakes

After starting the engine, give the air compressor time to build up the air pressure to 414 kPa (60 psi) before moving the vehicle.

 Do not drive or continue to drive if the low air pressure buzzer is sounding or the brake warning light is lit. These warnings indicate that air pressure is not to normal operating level. Continued use of the vehicle could result in loss of braking ability.

 Avoid repeated light application of the brake pedal. This will deplete air pressure faster and could result in loss of braking capability.

Periodically check the air pressure gauge while driving. Pressure should range between approximately 703 to 930 kPa (105-135 psi). The air compressor governor cut-in and cut-out pressure settings are preset at the factory and are not adjustable.

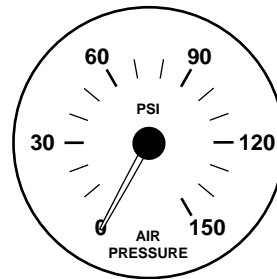

When air pressure is insufficient (below 534 kPa [60 psi]), a warning light illuminates and a buzzer sounds when the ignition is in the ON position.

BRAKE
(!)

This condition may be caused by excessive brake applications depleting the system air pressure. If this condition occurs, stop driving the vehicle until the compressor has fully recharged the air system. Do not move the vehicle in this condition because the brake system may be inoperative.

Select a gear ratio to help slow your vehicle before descending grades. Supplement with brakes as required to safely slow the vehicle and avoid overspeeding the engine.

Air chamber stroke indication

All Ford air chamber push rods have orange stroke indicator stripes that alert the operator when the braking system requires adjustment or repair. The orange stripe is painted on the air chamber push rod at the slack adjuster readjustment stroke dimension.

Air brake inspection and adjustment should be performed by a qualified service technician in accordance with the instructions in the Ford Truck Service Manual.

Cam brakes—automatic slack adjusters

Standard air brakes (cam) are equipped with automatic brake adjusters. Automatic adjustment occurs during forward and reverse brake applications. Inspect brakes for proper adjustment at the intervals listed in the vehicle Service Maintenance Guide.

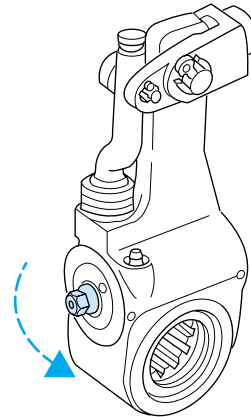

Driving

Emergency air brake

All vehicles are equipped with a dual brake system. In the unlikely event of a failure of one system, the second system will function for emergency stopping. These systems are all controlled by the brake pedal in the same manner as for normal stops.



Do not continue to operate the vehicle with a failure of one of the systems. Take the vehicle to your dealer for service immediately.

Anti-lock braking system (if equipped)

For information on the anti-lock braking system (ABS), refer to *Hydraulic brakes* in this chapter.

Driving with ABS

The ABS system functions just like a standard air brake system. Maintain a steady brake pedal application; you do not need to pump or remove your foot from the pedal. The ABS keeps the wheels rolling during braking to maintain control and reduce stopping distances.

Parking brake



Do not use the gearshift selector in place of the parking brake. Always set the parking brake fully AND make sure the gearshift selector is in R (Reverse) for vehicles equipped with manual transmission or N (Neutral) for vehicles with automatic transmission.



Unexpected and possible sudden vehicle movement may occur if these precautions are not taken.

If the service brakes should fail to operate while the vehicle is in motion, you can make an emergency stop with the parking brake. The stopping distance, however, will be much greater than normal. Repairs should be made immediately to an inoperative air brake system circuit.

Parking brake control

Pull the yellow parking brake knob out to apply the parking brake. Push the knob in to release the parking brake.



This control is used for parking only. Do not leave the vehicle unattended after setting the parking brake without placing the transmission in R (Reverse) for manual transmission or N (Neutral) for automatic transmission. Use of wheel chocks is also recommended in hilly or off-road usage.



Releasing spring brake with air pressure

The air system in all vehicles with spring-actuated rear wheel parking brakes is equipped with a tank valve located on the supply or service air tank for connection to an outside air supply. The valve permits the system to be recharged with air from an outside source, releasing the spring-actuated parking brakes. The vehicle may then be towed in an emergency.

An outside air source can be used only if the protected system is in operating condition. If air pressure cannot be restored in the protected air system, the spring-actuated brakes must be released manually.

Releasing spring brake manually



Do not attempt to disassemble the parking brake chamber under any circumstances. The high spring load may cause serious injury if the chamber clamps are removed.

If air pressure is released from the spring brake chamber the power spring applies the brake and, unless air pressure can be re-established, the spring brake must be released as follows in order to move the vehicle.

Driving



Block the wheels to prevent the vehicle from moving.



Unexpected and possibly sudden vehicle movement may occur if these precautions are not taken.

Impact wrenches should not be used as they may damage the piston and prevent proper caging of the spring. Do not apply more than 68 Nm (50 lb-ft) torque to the release bolt nut.

1. Remove the stud tool and nut from the carrying pocket on the brake chamber assembly.
2. Remove the access plug from the end of the spring chamber.
3. Insert the release stud through the opening in the chamber and into the spring pressure plate.
4. Turn the release stud one-quarter turn to engage the stud tangs with the slot in the pressure plate. Keep the stud engaged and install the nut on the release stud.
5. Tighten the nut until the spring is fully caged and the brakes are released. Do not loosen or remove the release stud and nut unless the brake chamber is completely assembled and is securely clamped.

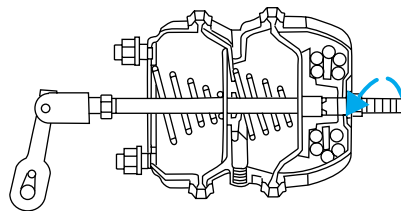
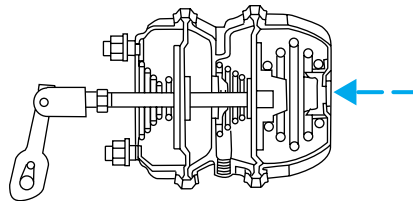

Trailer brake

During normal operation, the trailer brakes operate whenever the tractor brakes are applied. A manual control lever is provided so the trailer brakes can be applied separately, if required. To apply the trailer brakes, pull the trailer brake control downward to the APPLIED position.



Do not use the trailer brake manual control lever for parking.

Trailer air supply control (MV-3) (Tractor package)

The MV-3 control module is a two-button, push-pull control valve housed in a single body which includes a dual circuit supply valve and a check valve.

Operation

During initial charge, with the system completely discharged, both buttons are out.

When system pressure reaches 448 kPa (65 psi), the red control (trailer supply) may be pushed in, charging the trailer system and releasing the trailer brakes.



The yellow control (parking brake) may now be pushed in, which will supply air to the tractor spring brakes, releasing them.



Driving

Normal operating position

With both controls pushed in, air is supplied to the trailer and to the tractor spring brakes; all brakes are released.

Actuation of trailer parking or emergency brakes

To actuate the trailer brakes only, pull out the red control (trailer air supply), exhausting the trailer supply line. The trailer brakes are now applied either by air emergency or spring brakes, depending on the type of trailer system. This mode would be used to uncouple from the trailer during bob-tail operation.

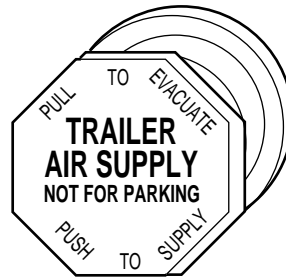

System park

With both controls in for normal run modes, the parking brakes on both tractor and trailer may be actuated by pulling the yellow control (parking brake) out, which exhausts the air from the tractor spring brakes and simultaneously causes the red control (trailer supply) to pop out, applying the trailer brakes. This complies with federal regulations stating one control must apply all the parking brakes on the vehicle.

Trailer charge

If both controls are out when parking the combination vehicle and it is desired to recharge the trailer (leaving the tractor spring brakes applied), the trailer air supply control may be pushed in, repressurizing the trailer supply line. This mode could also be used to park a combination vehicle with air actuated emergency brakes on the trailer to provide demonstrated parking capability with tractor spring brakes only.

Automatic application

With both controls in (in the normal run configuration), if the supply pressure to the push-pull valves is reduced to approximately 240 to 310 kPa (35-45 psi), the red control (trailer supply valve) must pop out, applying the emergency or parking brakes on the trailer. If the red control is held in manually and the pressure decreases to approximately 172 to 240 kPa (25-35 psi), a tripper piston within the MV-3 valve will move upward. This will exhaust the trailer supply, causing the required

Driving

non-override feature. The yellow control (parking brake) will pop out at approximately 138 to 207 kPa (20-30 psi).

Reservoir selection

The number one service reservoir will at all times be selected as the primary supply source for the MV-3. This is accomplished automatically by the function of the dual circuit supply valve contained in the body of the MV-3. Only in the event of a pressure drop of more than 207 kPa (30 psi) below that of the number two service reservoir will the dual circuit supply valve shuttle and establish the front service reservoir as the supply.

Air brake reservoir draining



Failure to drain air brake reservoirs can result in a reduction or loss of braking ability due to fluid accumulation in the reservoir and/or possible freeze-up during cold weather.

Drain all the air brake reservoirs daily, completely to 0 kPa/psi, by opening the draincock at the bottom of the tanks. Close draincock after complete draining. Air tanks equipped with automatic moisture ejector valves may also be drained manually as required to maintain a dry air system. Contact your dealer if you are unsure of the air reservoir locations or the draining procedure.

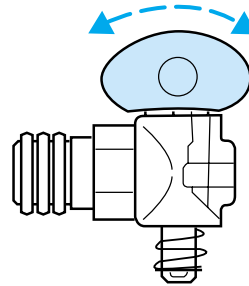

STEERING

Your vehicle is equipped with power steering. Power steering uses energy from the engine to help steer the vehicle.

Never hold the steering wheel to the extreme right or the extreme left for more than a few seconds when the engine is running. This action could damage the power steering pump.

Driving

Suspension and steering

The suspension and steering linkage in your vehicle should be inspected periodically for the following:

- Spring leaf damage
- Spring sag
- Abnormal looseness
- Damaged seals.

The following changes indicate a need to inspect and service your vehicle:

- Changes in steering action.
- Hard steering.
- Excessive free play.
- Unusual sounds when turning or parking.

If the steering wanders or pulls

This condition can be caused by any of the following conditions:

- Underinflated tire(s) on any wheel(s)
- Front end out of alignment
- Total vehicle out of alignment (i.e. rear axle[s] out of alignment with front axle)
- Improper adjustment in the steering gear
- Vehicle overloaded or unevenly loaded
- High crosswinds
- High crown in center of road
- Components in steering linkage loose or worn
- Wheel bearings improperly adjusted
- Excessive lash in steering shaft or universal joints

If the vehicle steers hard

Hard steering can be caused by any of the following conditions:

- Underinflated tire(s) on any wheel(s)
- Vehicle overload
- Misalignment of the front tires

Driving

- Lack of lubricant in the front spindle bearings or linkage components
- Low oil level in the power steering system
- Broken or loose power steering pump direct drive connection
- Malfunctioning relief valve in power steering gear or steering pump
- Malfunctioning power steering pump
- Restriction in power steering lines
- Improperly set turn stops
- Air entrapped in power steering system fluid

DRIVING WITH A MANUAL TRANSMISSION, IF EQUIPPED

 Continued use of a damaged or worn clutch, prolonged clutch slippage or downshifting at excessive speeds can result in a failure of the engine, transmission or clutch components.

 To avoid premature clutch wear and failure, do not drive with your foot resting on the clutch pedal or use it to hold the vehicle at a standstill on an upgrade as when waiting for a traffic light.

Manual transmission shift patterns are displayed on the shift lever knob.

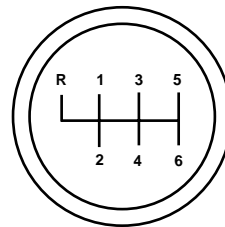

Study this information carefully before you drive the vehicle even though you may be familiar with similar units. Do not attempt to drive the vehicle without knowing the exact shift pattern of the transmission. Consult your authorized dealer if any questions exist as to the shifting instructions posted in your vehicle.

 Do not coast the vehicle with the clutch pedal depressed or with the transmission in neutral. This practice could result in loss of vehicle control.

Driving

Always use a gear ratio low enough to allow the engine to operate above the minimum engine operation speed range. Do not lug the engine. When more power is required, shift to a lower gear and accelerate the engine near the governed speed.

Driving hints

The following driving hints are provided as a brief, general guide in operating the different manual transmissions used in your vehicle.

- Always use the lowest gear to start the vehicle.
- Do not slam or jerk lever into gear.
- When shifting into 1 (First) or R (Reverse) with vehicle standing still, quickly release and depress the clutch pedal (if necessary to complete gear engagement).

Operating the Eaton FS-4205A and FS-5205A 5-speed transmissions

The 5-speed transmission is equipped with five forward gears and one reverse. All forwards gears are synchronized. The shift pattern is embossed on the gear shift knob.

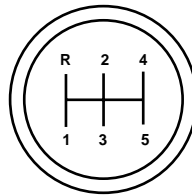

Do not shift the transmission into R (Reverse) while the vehicle is moving as this could damage the transmission.

To go forward

With the engine idling, depress the clutch pedal and shift into 1 (First). Engage the clutch while pressing the accelerator to start forward. Operate the clutch and upshift as required by driving conditions.

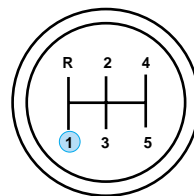

To go backward

Reverse is obtained by putting the gearshift lever in R (Reverse) and engaging the clutch while pressing lightly on the accelerator.

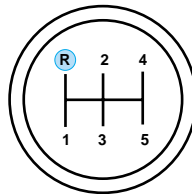

Operating the Eaton FS-5306A and FS-6306A 6-speed transmissions

These 6-speed transmissions are equipped with six forward gears and one reverse. The 2nd, 3rd, 4th, 5th and 6th gears are synchronized. The shift pattern is embossed on the gear shift knob.

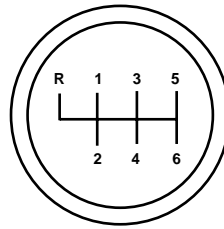

Do not shift the transmission into 1 (First) or R (Reverse) while the vehicle is moving as this could damage the transmission.

To go forward

With the engine idling, depress the clutch pedal and shift into 1 (First). Engage the clutch while pressing the accelerator to start forward. Operate the clutch and upshift as required by driving conditions.

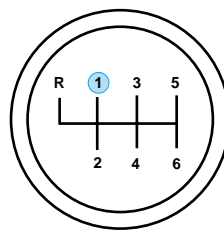

Driving

To go backward

Reverse is obtained by putting the gearshift lever in R (Reverse) and engaging the clutch while pressing lightly on the accelerator.

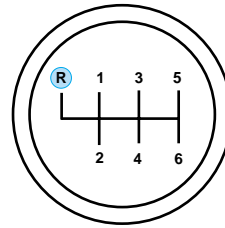

Operating the Spicer ES52-7B and ES066-7B 7-speed transmissions

These 7-speed transmissions are equipped with seven forward gears and one reverse. The 2nd, 3rd, 4th, 5th, 6th and 7th gears are synchronized. The shift pattern is embossed on the gear shift knob.

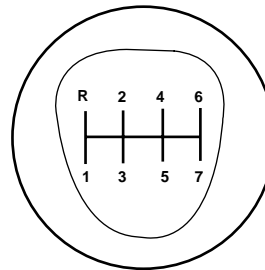

Do not shift the transmission into 1 (First) or R (Reverse) while the vehicle is moving as this could damage the transmission.

To go forward

With the engine idling, depress the clutch pedal and shift into 1 (First). Engage the clutch while pressing the accelerator to start forward. Operate the clutch and upshift as required by driving conditions.

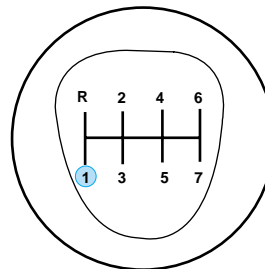

To go backward

Reverse is obtained by putting the gearshift lever in R (Reverse) and engaging the clutch while pressing lightly on the accelerator.

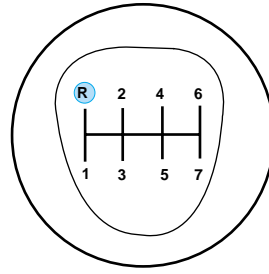

Removing key from ignition

- Turn the ignition key to position 2.
- Push the release lever forward and rotate the key towards you and remove.

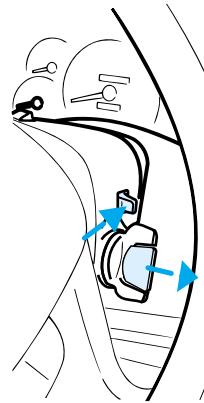

Power-take off operation (PTO) with a manual transmission

Transmission-mounted power take-off units are available for local installation on Ford vehicles. See your Body Builder's Layout Book for restrictions on use and installation of power take-off units.

To engage the PTO unit, stop the vehicle and place the transmission control in neutral. Depress the clutch and allow the gears to stop rotating, then engage the PTO unit. The PTO can also be selected with the transmission in gear as long as the clutch is depressed.

Driving

When operating the PTO unit with the vehicle stationary, first set the parking brake (chock the wheels if the vehicle is on a hill or other unlevel surface).

DRIVING WITH AN AUTOMATIC TRANSMISSION, IF EQUIPPED

Allison automatic transmission

 Do not allow your vehicle to coast in N (Neutral). Transmission braking is not available in N (Neutral). Allowing the vehicle to coast in N (Neutral) could result in loss of vehicle control and severe transmission damage.

The Allison automatic transmissions are a torque converter type, full power shifting and fully automatic. They also have the added flexibility of manually selecting and holding in the lower drive ranges which permit the drive selection of the most suitable gear range to match varying road and load conditions. To prevent destructive overspeeding of the engine, the hold feature is not infinite, resulting in upshifts from the hold range to the next higher range at some speed above the no-load governed speed of the engine.

Allison AT-545

 These transmissions have no P (Park) position. Before leaving the driver's seat, always shift into N (Neutral) and set the parking brake. Shut off the engine and remove your ignition key. Always use wheel chocks for hilly or off-road parking. Unexpected and possibly sudden vehicle movement may occur if these precautions are not taken.

This transmission provides four forward speeds and one reverse range.

R (Reverse)

Use this position to back the vehicle. Completely stop the vehicle before shifting from R (Reverse) to any forward gear (1, 2, 3 or D). The reverse warning signal will sound when the selector is in R (Reverse). Reverse has only one gear and provides the greatest gear reduction.

Driving

N (Neutral)

Place the selector in N (Neutral) before starting the engine. Shift to N (Neutral) and set the parking brake any time the engine is to be running while the operator is not at the controls. The engine should be at idle speed when any shift from N (Neutral) to a drive range is made.

D (Drive-Normal driving position)

The transmission starts in first gear and automatically shifts through second, third and fourth depending on load and speed demands. This range is used for highway driving under normal conditions.

3 and 2 (Third and Second)

Use these ranges when road, load or traffic conditions require a lower gear. These ranges provide greater engine braking than D (Drive). When conditions are improved that no longer require these lower gears, shift back to D (Drive).

1 (First)

The transmission has to be manually shifted into 1 (First) and will not shift into a higher gear. This range is used for extra heavy loads or where maximum reduction is required.

Allison MD Series transmissions



These transmissions have no P (Park) position. Before leaving the driver's seat, always shift into N (Neutral) and set the parking brake. Shut off the engine and remove your ignition key. Always use wheel chocks for hilly or off-road parking. Unexpected and possibly sudden vehicle movement may occur if these precautions are not taken.

These transmissions are electronically controlled and have a push button shifter. MD transmissions are available in five- or six-speed driving ranges.

Driving

The push button shifter has a R (Reverse), N (Neutral) and D (Drive) selections as well as a MODE button, up arrow (for upshifts) and a down arrow (downshift) and a digital display. When a range button is pressed, a tone will sound, the SELECT indicator displays a chosen operation (if the Electronic Control Unit determines the shift is acceptable) and the transmission will shift to the starting range. In D (Drive), selection of a specific gear can be accomplished by pressing the up or down arrow button. If the CHECK TRANS light (located on the instrument panel) is illuminated, the shifter control pad may be disabled, tones will not be heard, shifts may not occur and directional shift changes will not be able to be performed.

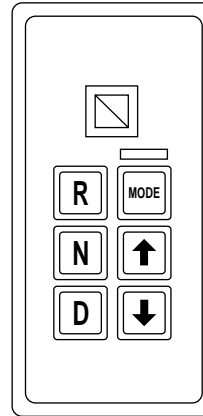

The MODE button may be used to activate a second shift schedule (this is typically programmed for **Economy** which will enable the transmission to shift at a lower RPM to conserve fuel).

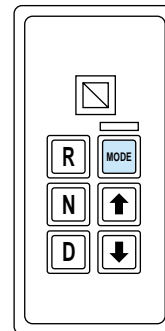

These transmissions incorporate a hold feature to prohibit upshifting above the gear selected during normal driving. During downhill operation, the transmission may upshift from the selected gear if the Electronic Control Unit detects the possibility of engine damage from exceeding the governed engine speed.

Driving



These transmissions have no P (Park) position. Before leaving the driver's seat, always shift into N (Neutral) and set the parking brake. Shut the engine off and remove your ignition key. Always use wheel chocks for hilly or off-road parking. Unexpected and possibly sudden vehicle movement may occur if these precautions are not taken.

Gearshift positions

R (Reverse) - Use this position to back the vehicle. Completely stop the vehicle before shifting from R (Reverse) to any forward gear. The reverse warning signal will sound when the selector is in R (Reverse). Reverse has only one gear and provides the greatest traction. The Select and Monitor indicators will display R when reverse is attained.

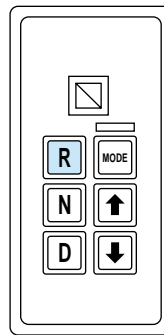

N (Neutral) - Use N (Neutral) for starting the engine. If the engine starts in any gear other than N (Neutral), the start circuit should be serviced immediately. Shift to N (Neutral) and set the parking brake any time the engine is to be running while the operator is not at the controls. The engine should be at idle speed when any shift from N (Neutral) to a drive range is made. The Select and Monitor indicators will display N.

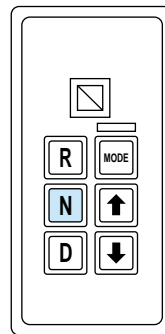

Do not allow your vehicle to coast in N (Neutral). Transmission braking is not available in N (Neutral). This practice can also result in transmission damage.

Driving

D (Drive) - The vehicle will attain first gear, and as the speed increases, the transmission will automatically upshift through each gear. As the vehicle slows down, the transmission will automatically downshift. The Select indicator will display the highest gear available.

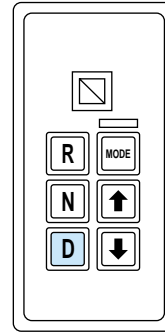

5th or 4th- 2nd gears (depending on application) - Road conditions, load or traffic can make it desirable to restrict the automatic shifting to a lower gear. These positions also provide progressively greater engine braking for descending grades (the lower the gear, the greater the braking effect).

The push button selector uses up and down arrow buttons to select the desired gear. The select indicator will display your choice and the monitor will display the gear selected.

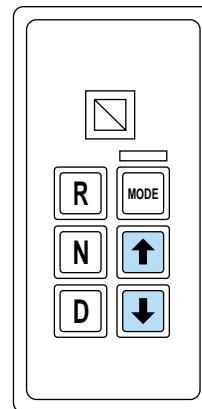

1st gear - Use for pulling through mud or deep snow, when maneuvering in tight spaces or when driving up or down steep grades. 1st gear provides maximum driving power and engine braking.

Driving

In case of engine shutdown (i.e - running out of fuel), while the transmission is in gear, the transmission will remain in gear until the ignition key is turned to the OFF position. After the ignition is turned off, the transmission will automatically shift to N (Neutral) and the monitor on the shift pad will display N (Neutral) when the ignition key is turned to the ON position.

Allison 2000 series



These transmissions have no P (Park) position. Before leaving the driver's seat, always shift into N (Neutral) and set the parking brake. Shut off the engine and remove your ignition key. Always use wheel chocks for hilly or off-road parking. Unexpected and possibly sudden vehicle movement may occur if these precautions are not taken.

This transmission provides three forward ranges and one reverse range.

R (Reverse)

Use this position to back the vehicle. Completely stop the vehicle before shifting from R (Reverse) to any forward gear (1, 2, 4 or D). The reverse warning signal will sound when the selector is in R (Reverse). Reverse has only one gear and provides the greatest gear reduction.

N (Neutral)

Place the selector in N (Neutral) before starting the engine. Shift to N (Neutral) and set the parking brake any time the engine is to be running while the operator is not at the controls. The engine should be at idle speed when any shift from N (Neutral) to a drive range is made.



Do not allow your vehicle to coast in N (Neutral). Engine braking is not available in N (Neutral). Allowing your vehicle to coast in N (Neutral) may result in loss of vehicle control and severe internal transmission damage.

D (Drive-Normal driving position)

In this position, the transmission starts in first gear and automatically shifts through second, third and fourth depending on load and speed demands. When the vehicle is slowing down, the transmission will automatically downshift. This range is used for highway driving under normal conditions.

Driving

4 and 2 (Fourth and Second)

Use these ranges when road, load or traffic conditions require a lower gear. These ranges provide greater engine braking than D (Drive). When conditions are improved that no longer require these lower gears, shift back to D (Drive).

1 (First)

The transmission has to be manually shifted into 1 (First) and will not shift into a higher gear. Use this position when pulling through mud or snow, driving up steep grades, hauling extra heavy loads or where maximum reduction is required.

Allison 2400 series

This transmission provides four ranges and one reverse range.

P (Park)

Use this position when you start the engine. The engine is designed to start in the P (Park) or N (Neutral) position only.

Always come to a complete stop before shifting into P (Park). Make sure the gearshift is securely latched in P (Park). This position locks the transmission and prevents the rear wheels from turning.



Always set the parking brake fully and make sure the gearshift lever is latched in P (Park). Turn off the ignition whenever you leave your vehicle.

When parking on hilly or off-road terrains, be sure to set the parking brake fully and chock the wheels to prevent unexpected and possibly sudden vehicle movement.

R (Reverse)

Use this position to move the vehicle backwards. Completely stop the vehicle before shifting from a forward gear (1, 2, 4 or D) to R (Reverse), or from R (Reverse) to any forward gear. The reverse warning signal will sound when the selector is in R (Reverse). Reverse has only one gear and provides the greatest gear reduction.

N (Neutral)

This position can be used when starting the engine. The engine is designed to start in the P (Park) or N (Neutral) position only. The engine should be at idle speed when any shift from N (Neutral) to a drive range is made.

The N (Neutral) position may also be used during stationary operation of the Power Take-Off (PTO), if equipped.



Do not allow your vehicle to coast in N (Neutral). Engine braking is not available in N (Neutral). Allowing your vehicle to coast in N (Neutral) may result in loss of vehicle control and severe internal transmission damage.

D (Drive—Normal driving position)

In this position, the transmission starts in first gear and automatically shifts through second, third and fourth depending on load and speed demands. When the vehicle is slowing down, the transmission will automatically downshift. This range is used for highway driving under normal conditions.

4 and 2 (Fourth and Second)

Use this position when road, load or traffic conditions make it desirable to restrict the automatic shifting to a lower range. These ranges provide greater engine braking than D (Drive). When conditions no longer require these lower gears, shift back to D (Drive).

1 (First)

The transmission has to be manually shifted into 1 (First) and will not shift into a higher gear. Use this position when pulling through mud or snow, driving up steep grades, hauling extra heavy loads or where maximum reduction is required.

Power take-off (PTO) operation with an Allison automatic transmission (except MD applications and vehicles equipped with a Caterpillar 3126E engine)

The power take-off can be operated while the vehicle is standing or moving.

To engage the PTO, apply the brakes and shift to any gear other than N (Neutral) - this stops the rotation of the PTO drive gear in the transmission - then engage the PTO.

Driving

If engagement is prevented by the gear teeth not meshing properly, release the brakes and allow the vehicle to creep slightly - or shift the selector to N (Neutral) and then back in gear. The PTO should never be engaged by clashing the gear teeth. This may damage the PTO unit and the transmission PTO drive gear teeth. This could result in further damage to the transmission and PTO.

PTO operation with vehicle stationary

To operate the power take-off, stop the vehicle, idle the engine and set the parking brake. Make sure the gear selector is in any forward drive range, then engage the PTO. After the PTO is engaged for stationary vehicle operation, move the range selector to N (Neutral). Increase the engine speed until the desired power take-off operation speed is obtained. To disengage the PTO after operation with the vehicle standing, release the throttle, allow the drive equipment to come to a stop, and then disengage the PTO.



When the PTO is operated with the vehicle stationary, the transmission must be placed in N (Neutral). If the transmission is not in N (Neutral) and is equipped with a remote throttle control, an increase in engine speed can overpower the parking brake and cause the vehicle to move, possibly resulting in personal and/or property damage.

PTO operation while vehicle is moving

After the PTO is engaged for driven vehicle operation, shift to the desired range and drive the vehicle. The speed of the PTO, during this period of operation, will always maintain direct relation to vehicle speed. PTO speed will decrease in relation to vehicle (transmission output) speed as shifts to a higher gear occur. When operating the PTO while the vehicle is moving, the PTO may be disengaged whenever it is no longer required. When there is no load on the PTO gear, it can be pulled out of engagement.

Power take-off (PTO) operation with an Allison automatic transmission (MD applications)

The PTO drive gear is engine driven and provides direct engine power. The PTO can be operated when the vehicle is either stationary or moving.

Driving

The PTO gear is in constant mesh with the drive gear in the torque converter housing. A friction clutch or constant drive is used to transmit power to the PTO.

Power take-off (PTO) operation on vehicles equipped with a Caterpillar 3126E engine

If your vehicle is equipped with a Caterpillar 3126E engine, the PTO will only operate if the vehicle is in Neutral. This feature can be overridden by a special service tool; see your dealer or service representative for more information.

MAXIMUM VEHICLE LOADING

Every vehicle manufactured by Ford Motor Company is supplied with information on the Vehicle Rating Decal listing the maximum loading for the vehicle (GVWR), and its axle systems (GAWR) at the tire to ground interface.

MFD. BY FORD MOTOR CO. IN U.S.A.						
DATE: XXXXX	GVWR: XXXXX	LB/	XXXXX	KG		
FGAWR: XXXXX/XXXXXXXX		RGAWR: XXXXX/XXXXXXXX				
XXXXXXXXXXXX	W/TIRES	XXXXXXXXXXXX	W/TIRES			
XXXXXXXXXXXX	RIMS	XXXXXXXXXXXX	RIMS			
AT XXX PSI COLD		AT XXX PSI COLD				
THIS VEHICLE CONFORMS TO ALL APPLICABLE FEDERAL MOTOR VEHICLE SAFETY STANDARDS IN EFFECT ON THE DATE OF MANUFACTURE SHOWN ABOVE.						
VIN: XXXXXXXXXXXXXXXXX		REAR REAR GAWR				
TYPE: XXXXXXXXXXXXXXXXX		XXXXXXXXXXXXXX				
						
WB	TYPE/GVV	BODY	TRANS	AXLE	EXT PNT	DSO
XXX	XXXXXX	XXX	XXX	XXX	XXXX	XXXXXX
VFOHT-15294A10-GA						

Under no circumstances should your vehicle be loaded in excess of the GVWR or GAWR. It is the operator's responsibility to assure that neither the axle capacities, spring capacities, tire capacities nor the vehicle rated GVWR is exceeded. For tire capacities, refer to *Specifications and capacities* chapter.

Unloaded or lightly loaded vehicles

The braking system has been designed to safely stop your vehicle when fully loaded to its GVWR.



When operating empty or lightly loaded, sudden or hard braking may induce wheel lockup with loss of vehicle control and the possibility of accident and serious injury, especially on wet or slippery road surfaces.

Driving

Driving through water

Do not drive quickly through standing water, especially if the depth is unknown. Traction or brake capability may be limited and if the ignition system gets wet, your engine may stall. Water may also enter your engine's air intake and severely damage your engine.

If driving through deep or standing water is unavoidable, proceed very slowly. Never drive through water that is higher than the bottom of the hubs (for trucks) or the bottom of the wheel rims (for cars).

Once through the water, always try the brakes. Wet brakes do not stop the vehicle as effectively as dry brakes. Drying can be improved by moving your vehicle slowly while applying light pressure on the brake pedal.

Driving through deep water where the transmission vent tube is submerged may allow water into the transmission and cause internal transmission damage.

FUEL CONSUMPTION IMPROVEMENT MEASURES

There are two important factors you can control to improve fuel economy: the mechanical condition of your vehicle and how you drive it.

A properly maintained vehicle will deliver better performance than a neglected vehicle. Always follow your maintenance schedule to keep your vehicle in top operating condition.

Also, your driving habits have a significant influence on use of fuel. By following these suggestions, you can stretch your fuel use:

- Avoid changes in speed as much as possible.
- Anticipate changing traffic conditions. Sudden stops and fast acceleration waste fuel.
- Avoid extensive idling.
- Do not drive with your foot resting on the brake pedal.

WINTER FRONTS

If using an aftermarket winter front (not recommended), it must have a permanent opening directly in line with the center of the fan drive. The minimum opening size must be at least 774 square cm (120 square inches).

The use of an aftermarket winter front or other air flow restriction device mounted in front of the radiator is not recommended on vehicles equipped with chassis mounted air-to-air aftercooling. Air flow restriction will cause high exhaust temperatures, power loss, excessive fan usage and a reduction in fuel economy.

Roadside emergencies

GETTING ROADSIDE ASSISTANCE

To fully assist you should you have a vehicle concern, Ford offers a complimentary roadside assistance program. This program is separate from the New Vehicle Limited Warranty. The service is available:

- 24-hours, seven days a week
- for the New Vehicle Limited Warranty period (U.S.) of two years (unlimited miles)

Roadside assistance will cover:

- jump-starts
- lock-out assistance
- towing to the nearest Ford Motor Company dealership, or towing to your selling dealership if within 56 km (35 miles). Even non-warranty related tows, like accidents or getting stuck in the mud or snow, are covered (some exclusions apply, such as impound towing or repossession).

Using roadside assistance

Complete the roadside assistance identification card and place it in your wallet for quick reference. This card is found in the Owner Guide portfolio in the glove compartment.

To receive roadside assistance in the United States, call 1-800-241-3673. In Canada call 1-800-665-2006.

Should you need to arrange roadside assistance for yourself, Ford will reimburse a reasonable amount. To obtain information about reimbursement, call 1-800-241-3673.

Roadside emergencies

HAZARD FLASHER

Use only in an emergency to warn traffic of vehicle breakdown, approaching danger, etc. The hazard flashers can be operated when the ignition is off.

- The hazard lights control is located on top of the steering column.
- Depress hazard lights control to activate all hazard flashers simultaneously.
- Depress control again to turn the flashers off.

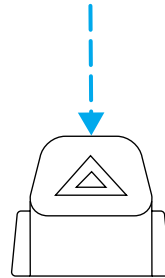

FUSES AND RELAYS

Fuses

If electrical components in the vehicle are not working, a fuse may have blown. Blown fuses are identified by a broken wire within the fuse. Check the appropriate fuses before replacing any electrical components.

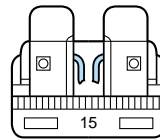

Always replace a fuse with one that has the specified amperage rating. Using a fuse with a higher amperage rating can cause severe wire damage and could start a fire.

Roadside emergencies

Standard fuse amperage rating and color

COLOR					
Fuse Rating	Mini Fuses	Standard Fuses	Maxi Fuses	Cartridge Maxi Fuses	Fuse Link Cartridge
2A	Grey	Grey	—	—	—
3A	Violet	Violet	—	—	—
4A	Pink	Pink	—	—	—
5A	Tan	Tan	—	—	—
7.5A	Brown	Brown	—	—	—
10A	Red	Red	—	—	—
15A	Blue	Blue	—	—	—
20A	Yellow	Yellow	Yellow	Blue	Blue
25A	Natural	Natural	—	—	—
30A	Green	Green	Green	Pink	Pink
40A	—	—	Orange	Green	Green
50A	—	—	Red	Red	Red
60A	—	—	Blue	—	Yellow
70A	—	—	Tan	—	Brown
80A	—	—	Natural	—	Black

Passenger compartment fuse panel

The fuse panel is located below and to the left of the steering wheel by the brake pedal. Remove the panel cover to access the fuses.

To remove a fuse use the fuse puller tool provided on the fuse panel cover.

Roadside emergencies

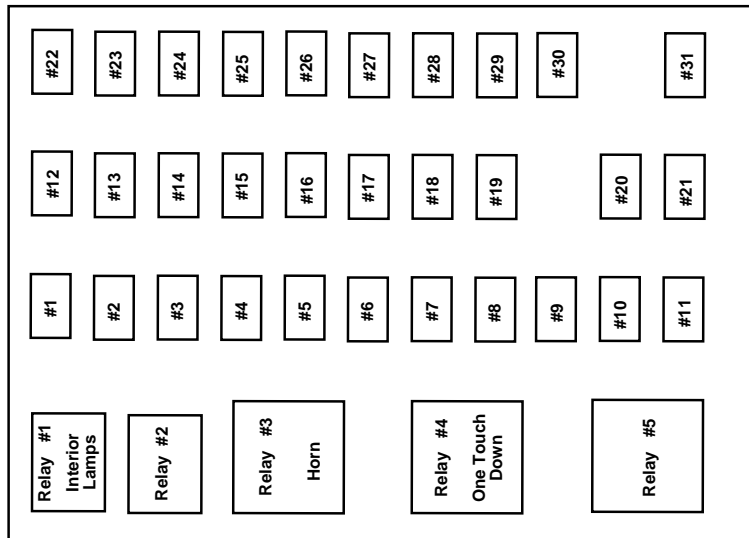

The fuses are coded as follows.

Fuse/Relay Location	Fuse Amp Rating	Passenger Compartment Fuse Panel Description
1	20A	Horn
2	15A	Turn/Hazard Lamps
3	20A	Cigar Lighter
4	10A	Diagnostic Connectors
5	15A	Back-Up Lamps, DRL Relays, Blend Door Actuator
6	—	Not Used
7	—	Not Used
8	5A	Radio, GEM
9	5A	Switch Illumination (Headlamp, Power Windows, Power Door Locks), Power Window Relay
10	—	Not Used
11	30A	Wiper Motor, Washer Pump Relay
12	10A	Stoplamp Switch (Hydraulic Vehicles Only)

Roadside emergencies

Fuse/Relay Location	Fuse Amp Rating	Passenger Compartment Fuse Panel Description
13	20A	Radio, Cluster, 7.3L Power Stroke Powertrain Control Module (PCM), Keep Alive Memory
14	10A	Interior Lamps
15	10A	GEM, Interior Lamp Relay
16	15A	Highbeams
17	—	Not Used
18	5A	Headlamp switch, GEM
19	15A	Engine, Cluster, Cummins PC M, CAT PCM, 7.3L Power Stroke PCM (Idle Valid Switch Input)
20	15A	Starter Relay, GEM
21	10A	Daytime Running Lamps (DRL)
22	15A	Not Used (Spare)
23	10A	Electronic Flasher
24	15A	Vacuum Pump, Air Dryer, ABS, Fuel Heater Relay
25	10A	Blower Motor Relay
26	10A	Right Low Beam Headlamp
27	—	Not Used
28	10A	Left Low Beam Headlamp
29	10A	Cluster, GEM, 7.3L Power Stroke PCM (clutch switch input), APCM (7.3L Power Stroke only)
30	30A	7.3L Power Stroke PCM Diode, 7.3L Power Stroke Fuel Heater
31	15A	Allison MD Transmission, Neutral Start Relay and PCM (7.3L Power Stroke only)
Relay 1	—	Interior Lamps
Relay 2	—	Not Used
Relay 3	—	Horn
Relay 4	—	One Touch Down
Relay 5	—	Not Used

Roadside emergencies

Power distribution box

The power distribution box is located in the engine compartment. The power distribution box contains high-current fuses that protect your vehicle's main electrical systems from overloads.



Always disconnect the battery before servicing high current fuses.



Always replace the cover to the Power Distribution Box before reconnecting the battery or refilling fluid reservoirs.

If the battery has been disconnected and reconnected, refer to the *Battery* section of the *Maintenance and care* chapter.

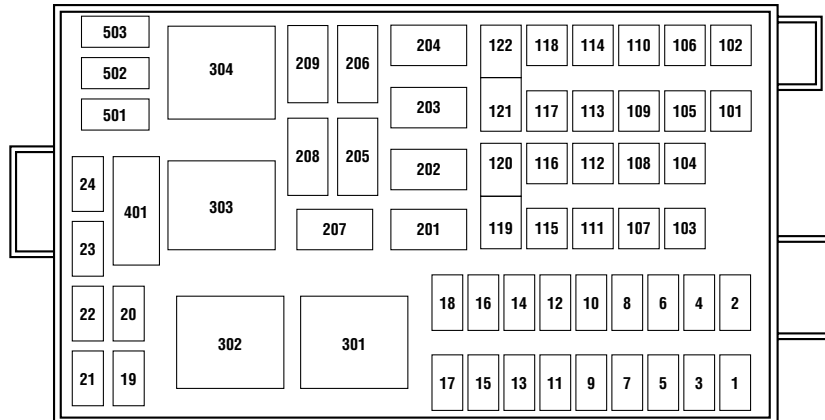

The high-current fuses and relays are coded as follows.

Fuse/Relay Location	Fuse Amp Rating	Power Distribution Box Description
1	15A*	Park Lamps, Roof Lamps
2	25A*	Cummins Powertrain Control Module (PCM)
3	10A*	Generator
4	15A*	Washer Pump
5	15A*	Air Intake Heater Relay (CAT), Cummins PCM
6	20A*	CAT PCM, Cummins PCM

Roadside emergencies

Fuse/Relay Location	Fuse Amp Rating	Power Distribution Box Description
7	15A*	Stop Lamps
8	25A*	C AT Fuel Heater
9	—	Not Used
10	15A*	Shift Modulator (Allison AT trans only)
11	20A*	Allison MD Trans
12	—	Not Used
13	—	Not Used
14	—	Not Used
15	7.5A*	Body Builder Prep (Hydraulic Vehicles Only)
16	—	Not Used
17	—	Not Used
18	—	Not Used
19	—	Not Used
20	—	Not Used
21	10A*	GEM (Hydraulic Vehicles Only)
22	—	Not Used
23	—	Not Used
24	—	Not Used
101	40A**	ABS (Air Only)
102	20A**	Body Builder Prep Run Feed
103	50A**	Ignition Switch (JB fuses 8, 9, 11, 19, 20, 22, 23, 24, 25, 29, 30, 31)
104	20A**	Power Point
105	20A**	Power Door Locks
106	30A**	Headlamps
107	50A**	Junction Box Battery Feed (fuses 1, 2, 3, 4, 12, 13, 14, 15)
108	40A**	Cummins Fuel Heater
109	40A**	Power Windows
110	—	Not Used
111	30A**	Body Builder Prep

Roadside emergencies

Fuse/Relay Location	Fuse Amp Rating	Power Distribution Box Description
112	40A**	Blower Motor
113	—	Not Used
114	—	Not Used
115	40A**	Ignition Switch (JB fuses 5, 8, 9, 11, 21)
116	30A**	Body Builder Prep
117	20A**	7.3L Power Stroke PCM
118	30A**	IDM (7.3L Power Stroke only)
119 120	60A**	Hydraulic ABS
121 122	60A**	Hydromax Motor
201	—	Washer Pump Relay
202	—	Wiper Speed Relay
203	—	Wiper Run/Park Relay
204	—	Cummins VP44 Relay/7.3L Power Stroke Neutral Start Relay
205	—	Right Hand Stop/Turn Relay
206	—	Left Hand Stop/Turn Relay
207	—	Shift Modulator Relay
208	—	Backup Lamps Relay
209	—	Stop Lamps Relay
301	—	Fuel Heater Relay (CAT and Cummins only)/7.3L Power Stroke PCM Relay
302	—	Park Lamps Relay
303	—	Blower Motor Relay
304	—	Air ABS Relay
401	—	Not Used
501	—	Not Used
502	—	Not Used
503	Diode	7.3L Power Stroke PCM Diode
* Mini Fuses ** Maxi Fuses		

Roadside emergencies

JUMP STARTING YOUR VEHICLE



The gases around the battery can explode if exposed to flames, sparks, or lit cigarettes. An explosion could result in injury or vehicle damage.



Do not push start your vehicle. You could damage the catalytic converter.



Batteries contain sulfuric acid which burns skin, eyes, and clothing.

Preparing your vehicle

Also see the label on the battery.

1. Use only a 12-volt supply to start your vehicle. If you connect your battery to a 24-volt power supply you can damage your starter, ignition system and other electrical components. Do not attach the jumper cables to the glow plug relay as this could severely damage the glow plugs, injector driver module and PCM.
2. Do not disconnect the battery of the disabled vehicle as this could damage the vehicle's electrical system.
3. Park the booster vehicle close to the disabled vehicle making sure they **do not** touch. Set the parking brake on both vehicles and stay clear of the engine cooling fan and other moving parts.
4. Check all battery terminals and remove any excessive corrosion before you attach the battery cables.
5. Turn the heater fan on in both vehicles to protect any electrical surges. Turn all other accessories off.

Roadside emergencies

Connecting the jumper cables

1. Position the vehicles so that they do not touch one another.
2. Apply the parking brakes.
3. Switch off the engine and any unnecessary electrical equipment.
4. Find the positive (+) terminal of the discharged battery.
5. Using the jumper cables, connect the positive (+) terminal of the discharged battery to the positive (+) terminal of the booster battery.

Note: In the illustration, lightning bolts are used to designate the assisting (boosting) battery.

6. Connect one end of the cable to the negative (-) terminal of the booster battery and the other end to a ground at least 12 inches from the battery of the discharged vehicle. The vehicle frame is usually a good ground.

7. Ensure that the jump leads are clear of moving parts of the engine, and that the clamps from one cable do not touch the clamps on the other cable.

8. Do not lean over the batteries when making the connections.

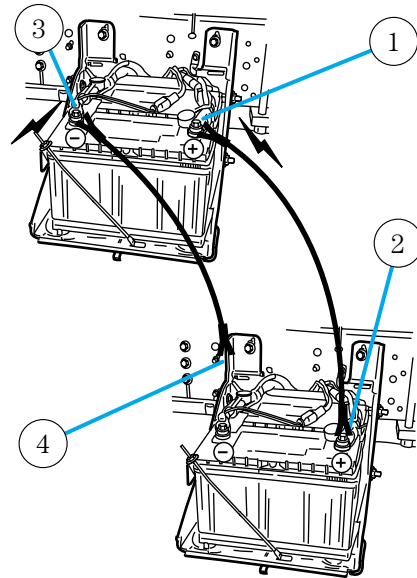

Do not connect the end of the second cable to the negative (-) terminal of the battery to be jumped. A spark may cause an explosion of the gases that surround the battery.

Jump starting

1. Start the booster vehicle and run the engine at moderately increased speed.
2. After a few minutes, start the engine of the vehicle with the discharged battery.
3. After starting, run the engine at about 1,000 RPM for 3–5 minutes.

Roadside emergencies

Do not operate the starter longer than 30 seconds. Wait at least two minutes between starting attempts to allow the starter to cool. If the engine does not start after several attempts, call for road service.

Removing the jumper cables

1. Remove the ground connection from the disabled vehicle first, followed by the cable on the negative (-) battery terminal of the booster vehicle.
2. Remove the cable from the positive (+) terminal of the discharged battery and then from the positive (+) terminal of the booster battery.
3. After the disabled vehicle has been started, allow it to idle for a while so the engine can “relearn” its idle conditions.

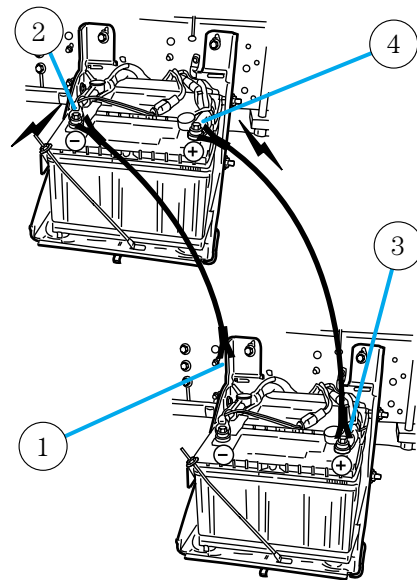

Roadside emergencies

WRECKER TOWING

Always unload your vehicle before towing it. The recommended method of towing is with the drive wheels off the ground.

Before towing, make sure:

- the parking brake is released.
- if air pressure has been lost, to release the brakes manually.

Improper towing of the vehicle will not allow sufficient lubrication of the transmission which may cause serious damage to internal transmission components. Always follow the outlined towing procedures.

- **To tow a vehicle on the front wheels**, the steering wheel must be in the straight ahead position. Secure the steering wheel with a holding device (such as provided by a towing company).
- **To tow a vehicle on the rear wheels**, it will be necessary to remove the drive axles or disconnect the driveshaft. If the drive axles are removed, the ends of the axle housing must be sealed to prevent the loss of axle lubricant during towing.
- **To tow a vehicle with an inoperative rear axle**, the rear wheels must be raised onto a dolly or tow the vehicle on the front wheels.
- **If your vehicle is equipped with tow hooks**, chains must be fastened directly to the tow hooks on the vehicle.
- **If your vehicle is not equipped with tow hooks**, chains must be routed under the bottom edge of the bumper with a protection bar to protect the bumper, and attached to the vehicle chassis. Under no circumstances is the vehicle to be lifted or towed by attaching chains directly to the bumper.

RAISING THE VEHICLE

Never lift the vehicle by the bumper. When raising the vehicle, attach chains to or place the jack(s) directly beneath the main structural members of the vehicle.

PUSH-STARTING YOUR VEHICLE

Avoid attempting to start a vehicle by pushing. Instead, use jumper cables as described under *Jump starting your vehicle* in the *Roadside emergencies* chapter. Vehicles with an automatic transmission cannot be started by pushing.

Maintenance and care

CHECKING UNDER THE HOOD

Opening the hood

The hood and fenders are held in position by a latch located on each fender.



The parking brake must be fully set before opening the hood or possible personal injury may occur.



If you must leave the engine running while checking under the hood, do not allow any loose clothing, jewelry, hair or other items to get near moving engine components or possible personal injury may occur.

To open the hood:

1. Set the parking brake, shift into N (Neutral) (automatic transmission) or 1 (First) (manual transmission) and turn the engine off.
2. Lift upward on the bottom of each latch.

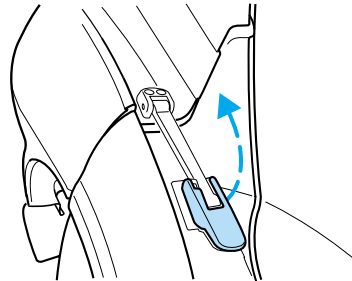

3. Pull the bottom of each latch away from the fender.

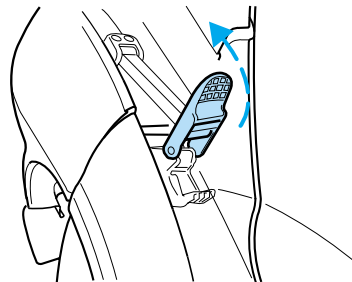

Maintenance and care

4. Tilt the hood forward until stopped by the retaining cables.

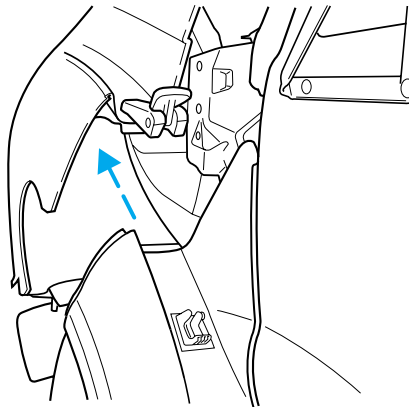

To lower the hood:

1. Push the hood rearward at the top center of the hood above the grille until closed.
2. Engage the latch on each fender.
3. Push down on the bottom of each latch until locked.



To avoid the possibility of personal injury, never stand beneath the hood when it is being raised or lowered.

ENGINE OIL

Checking engine oil level—Cummins B and Caterpillar 3126 B engines

Refer to the appropriate engine operator's manual for information on the engine oil.

Checking engine oil level—7.3L Power Stroke engine

Refer to the Scheduled Maintenance Guide for the appropriate intervals for checking the engine oil.

Check the engine oil level consistently and accurately. The following procedure is recommended:

Maintenance and care

1. Start the engine and let it run until it reaches normal operating temperature (the engine coolant temperature gauge indicator will be near the center of the normal area between H and C).
2. Park the vehicle on level ground.
3. Set the parking brake and shift into N (Neutral) (automatic transmission) or 1 (First) (manual transmission).
4. Turn off the engine and wait a few minutes for the oil to drain completely into the oil pan.
5. Open the hood. Protect yourself from engine heat.
6. Locate and carefully remove the engine oil level indicator (dipstick).

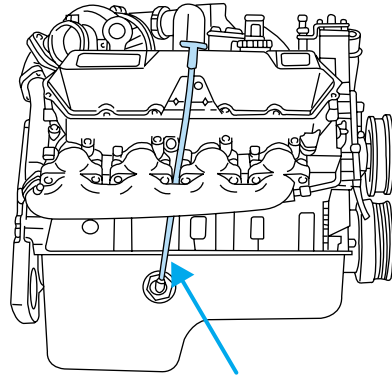

7. Wipe the indicator clean. Insert the indicator fully, then remove it again.
 - If the oil level is **between FULL and OPERATING RANGE**, the oil level is acceptable. **DO NOT ADD OIL.**
 - Maintain the oil level between ADD and OPERATING RANGE on the dipstick by adding oil as required.
 - The distance from ADD to OPERATING RANGE on the dipstick represents 1.9L (2 quarts).
 - Oil levels above OPERATING RANGE may cause engine damage. Some oil must be removed from the engine by a qualified service technician.
8. Put the indicator back into the engine and ensure it is fully seated.

Maintenance and care

Engine oil and filter recommendations—Cummins B and Caterpillar 3126 B engines

Refer to the appropriate engine operator's manual for information on the engine oil.

Engine oil and filter recommendations—7.3L Power Stroke engine

To help achieve proper engine performance and durability, it is important that you:

- Use only engine lubricating oils and oil filters of the proper quality.
- Change the engine oil and filter **no later** than the recommended service interval. Refer to the Scheduled Maintenance Guide for the appropriate intervals for changing the engine oil and filter.
- Change your engine oil and filter more frequently if your vehicle operation includes extended periods of idling or low-speed operation, driving for a long time in cold temperatures or short driving distances.

Diesel engines require specially formulated oil to resist contamination. Proper quality oils also provide maximum efficiency of the crankcase ventilation system which reduces air pollution.

Use Motorcraft motor oil or an equivalent oil meeting Ford specification WSS-M2C171-B or API service category designation CH-4/SJ. Do not use oils labeled with only one of the category designations SG, SH, SJ, CE, CF-4, CH-4 or CG-4, as they could cause engine damage.

Diesel engine oils with improved fuel economy properties (energy conserving) are currently available. If you use an energy conserving oil, be sure it meets Ford specification WSS-M2C171-B or API service category designation CH-4/SJ and is of the proper viscosity grade for the temperature range in which you expect to operate your vehicle. Some energy conserving oils do not meet the requirements necessary for your diesel engine.

Maintenance and care

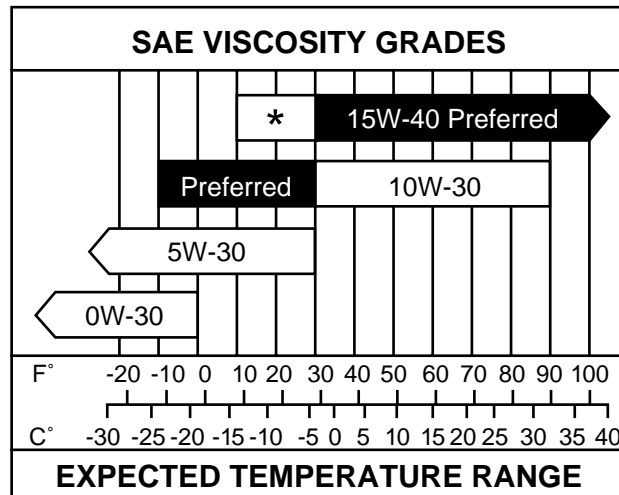

Using the chart, determine which SAE viscosity grade best suits the temperature range in which you expect to operate your vehicle. The use of the correct oil viscosity grade for diesel engines is important for satisfactory engine operation.

A symbol has been developed by the American Petroleum Institute (API) to help you select the proper engine oil. The symbol will be included on the oil container you purchase.

The top section of the symbol shows the API service category designation. This should be CH-4/SJ.

The center section of the API symbol shows the SAE viscosity grade.



The lower section of the API symbol will state *energy conserving* if the engine oil has been proven to have fuel savings capabilities.

Use a Ford engine oil filter, part number FL-1995 or equivalent. This filter protects your engine by filtering harmful, abrasive or sludge particles.

Maintenance and care

BRAKE FLUID (⚠)

Checking and adding brake fluid

Check and refill the Hydromax brake fluid reservoir using the following procedure. Refer to the Scheduled Maintenance Guide for the service interval.

1. Clean the reservoir caps before removal to prevent dirt or water from entering the reservoir.
2. Visually inspect the fluid level.
3. If necessary, add brake fluid from a clean un-opened container until the level reaches MAX. Do not fill above this line.
4. Use only a DOT 3 brake fluid certified to meet Ford specifications. Refer to *Lubricant specifications* in the *Capacities and specifications* chapter.

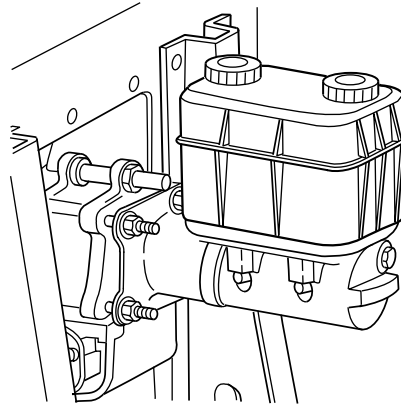

 Brake fluid is toxic. If brake fluid contacts the eyes, flush eyes with running water for 15 minutes. Seek medical attention if irritation persists. If taken internally, drink water and induce vomiting. Seek medical attention immediately.

 If you use a brake fluid that is not DOT 3, you will cause permanent damage to your brakes.

 Do not let the reservoir for the master cylinder run dry. This may cause the brakes to fail.

Brake system fluid should be replaced on a regular basis to maintain optimum braking performance, especially under heavy-duty driving conditions such as frequent steep grades or heavy loads. Refer to the Scheduled Maintenance Guide for the service interval.

Maintenance and care

AVOID MIXING LUBRICANTS

In some cases, different brands of lubricants are not compatible with each other and deteriorate when mixed. It is best to stick with one brand during a maintenance interval.

CLUTCH (IF EQUIPPED)—LINKAGE LUBRICATION

Lubricate the clutch linkage using the following procedure. Refer to the Scheduled Maintenance Guide for the service interval schedules.

Use a grease which meets Ford specifications. Refer to *Capacities and specifications*.

1. Set the parking brake, shift into 1 (First) and turn the engine off.
2. Remove the inspection cover from the clutch housing.

- **Transmission and clutch removed for clarity.**

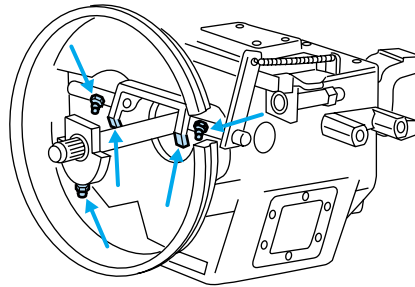

3. With a grease gun, lubricate the clutch release bearing (at one location) and the clutch release shaft (at two locations) using the grease fittings provided.
4. Lubricate clutch release wear pads at the two locations where they contact the clutch release bearing using a brush or similar tool.
5. Install the inspection cover onto the clutch housing.

CLUTCH FLUID (IF EQUIPPED)

Check the clutch fluid level. Refer to the Scheduled Maintenance Guide for the service interval schedules.

During normal operation, the fluid level in the clutch reservoir should remain constant. If the fluid level drops, maintain the fluid level at the step in the reservoir.

Maintenance and care

Use only a DOT 3 brake fluid designed to meet Ford specifications. Refer to *Capacities and specifications*.

1. Set the parking brake, shift into 1 (First) and turn the engine off.
2. Open the hood.
3. Clean the reservoir cap before removal to prevent dirt and water from entering the reservoir.
4. Remove cap and rubber diaphragm from reservoir.
5. Add fluid until the level reaches the step in the reservoir.
6. Reinstall rubber diaphragm and cap onto reservoir.

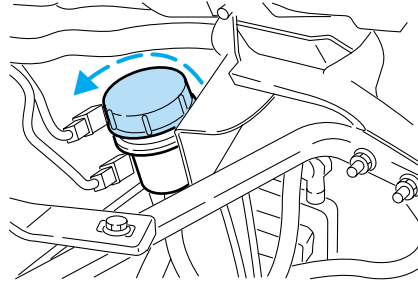

WINDSHIELD WASHER FLUID

Checking and adding washer fluid

Inspect the solution level in the washer reservoir when insufficient solution is sprayed.

Use 3.8L (4.0 quarts) of Ultra—Clear Windshield Washer Concentrate or a washer fluid that meets the Ford specification listed. Refer to *Lubricant specifications* in the *Capacities and specifications* chapter.

State or local regulations on volatile organic compounds may restrict the use of methanol, a common windshield washer antifreeze additive. Washer fluids containing non-methanol antifreeze agents should be used only if they provide cold weather protection without damaging the vehicle's paint finish, wiper blades or washer system.

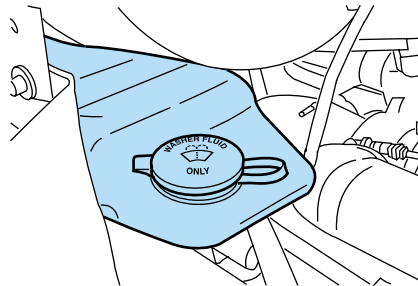

Do not put engine coolant or antifreeze in the washer fluid reservoir. Engine coolant or antifreeze can severely reduce visibility if sprayed on the windshield.

Maintenance and care

ENGINE COOLANT

Checking coolant level

Refer to the Scheduled Maintenance Guide for the appropriate intervals for checking the engine coolant level. Check the engine coolant level in the coolant reservoir when the engine is cold.

If the coolant level has not been checked at the recommended interval, the coolant reservoir may become empty. If this occurs, a STOP ENGINE warning lamp will illuminate (if equipped).

If necessary, add a mixture of 50% engine coolant concentrate and 50% water (50/50 ratio) to the coolant reservoir to bring the engine coolant level to within the cold fill range on the reservoir. For more information on engine coolant, refer to *Adding and replacing engine coolant* in this chapter.

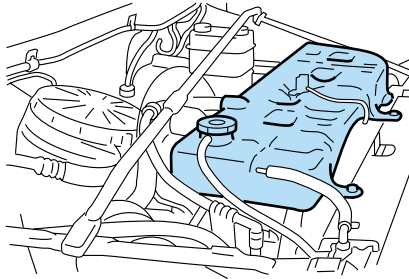

Never remove the coolant reservoir cap while the engine is running or hot or personal injury may occur.

If you must remove the coolant reservoir cap, follow these steps to avoid personal injury:

1. Before you remove the cap, turn the engine off and let the engine cool.
2. When the engine is cool, wrap a thick cloth around the cap. Slowly turn the cap counterclockwise until pressure begins to release.
3. Step back while the pressure releases.
4. Once you are sure that all the pressure has been released, use the cloth to turn the cap counterclockwise and remove it.

Automotive fluids are not interchangeable; do not use engine coolant, antifreeze or windshield washer fluid outside of its specified function and vehicle location.

Maintenance and care

Adding and replacing engine coolant-7.3L Power Stroke and Cummins B engines

Refer to the Scheduled Maintenance Guide for service intervals of the engine cooling system.

Use Ford Premium Engine Coolant E2FZ-19549-AA (in Canada, Motorcraft CXC-8-B) or a premium engine coolant that meets Ford specification ESE-M97B44-A. Do not use alcohol or methanol antifreeze.

The use of an improper coolant may cause cooling system and/or engine damage and may void the warranty of your vehicle's engine cooling system.

A mixture of 50% engine coolant concentrate and 50% water (50/50 ratio) is recommended to maintain best overall cooling system performance. A 60/40 antifreeze to water ratio is acceptable for extremely cold climates, but the coolant and water mixture must be returned to a 50/50 ratio at the end of the winter season. To avoid damaging the cooling system and engine, the coolant and water mixture should never exceed a 60/40 antifreeze to water ratio.

Operating the engine with insufficient coolant can cause severe cooling system and engine damage.

When refilling the engine cooling system as part of regular maintenance or due to service, adhere to the following instructions:

1. Drain and flush the cooling system to remove dirt deposits, oil and rust particles. Always dispose of used automotive fluids following your community's standards.
2. Fill the coolant reservoir with the specified coolant and water mixture until the level stabilizes within the cold fill range.
3. Reinstall the coolant reservoir cap.
4. Start and idle the engine until the upper radiator hose is warm (approximately 10–15 minutes). If the hose does not get warm, repeat this step at a higher engine speed.
5. Once the hose is warm, shut the engine off.
6. Cautiously remove the coolant reservoir cap as previously described, and add the specified coolant and water mixture until the level stabilizes within the cold fill range of the coolant reservoir.
7. Reinstall the engine coolant reservoir cap.

Maintenance and care

Adding and replacing engine coolant-Caterpillar 3126 B engine

Refer to the engine operator's manual for engine cooling system information.

FAN CLUTCHES

Your vehicle's cooling system is equipped with a viscous variable speed fan clutch.

- The fan clutch helps control cooling, increase performance, improve fuel economy and reduce noise.
- The fan clutch is controlled by bimetallic spring sensors. Do not tamper with these sensors as this may change their calibration or keep the fan clutch from operating at all.



Stay clear of the fan/fan area while the engine is running or possible personal injury may occur.

CHECKING AND ADDING POWER STEERING FLUID

Checking power steering fluid level

Check the power steering fluid level using the following procedure. Refer to the Scheduled Maintenance Guide for the recommended service intervals. If adding fluid is necessary, use only MERCON® ATF.

1. Set the parking brake, shift into N (Neutral) (automatic transmission) or 1 (First) (manual transmission) and turn the engine off.
2. Open the hood.
3. Clean the top of the power steering fluid reservoir.
4. Remove the dipstick from the reservoir and wipe the dipstick clean.
5. Reinstall the dipstick. Remove it again and check the fluid level.

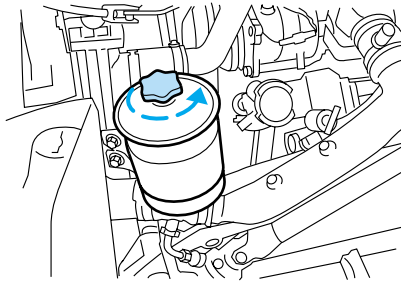

Maintenance and care

- If the fluid temperature is at approximately 20°C - 49°C (68°F - 120°F) (**fluid cool or warm to the touch**), check the COLD side of the dipstick. The fluid level should be within the FULL range

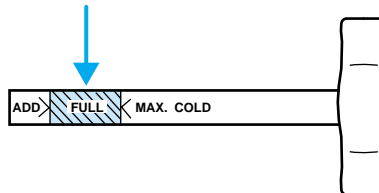

- If the fluid level is below the ADD line, add fluid in small amounts, continuously checking the level until it reaches the proper level.
- If the fluid temperature is at approximately 80°C - 110°C (176°F - 230°F) (**fluid too hot to touch**), check the HOT side of the dipstick. The fluid level should be within the FULL range.

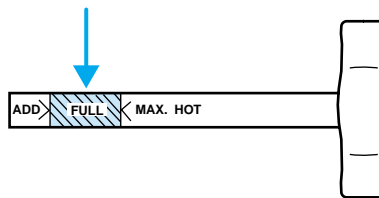

- If the fluid level is below the ADD line, add fluid in small amounts, continuously checking the level until it reaches the proper level.

A low fluid level may indicate a leak in the power steering system. Inspect the power steering system and repair the leak. If necessary, see your dealer or a qualified service technician.

To avoid damage to the power steering system, **do not** operate the vehicle with a low power steering fluid level.

Whenever the dipstick is installed, make sure it is properly seated and tightened securely.

TRANSMISSION FLUID



Always dispose of used automotive fluids in a responsible manner. Follow your community's standards for disposing of these types of fluids. Call your recycling center to find out about recycling automotive fluids.

Automatic transmission fluid

Refer to your Allison Automatic Transmission Operator's Manual for scheduled intervals for transmission fluid checks and changes. Your transmission does not consume fluid. However, the fluid level should be checked if the transmission is not working properly, i.e., if the transmission slips or shifts slowly or if you notice some sign of fluid leakage.

Maintenance and care

Transmission fluid level should be checked by your dealer or a qualified service technician.

If you must add transmission fluid, make sure the correct type of fluid is being used. The type of fluid used is indicated in your Allison Automatic Transmission Operator's Manual.

Use of a non-approved automatic transmission fluid may cause internal transmission component damage.

Manual transmission fluid

Refer to your Scheduled Maintenance Guide for transmission fluid level checks and fluid change intervals.

Your manual transmission may be filled with an optional synthetic fluid which allows the use of extended service intervals. A tag on the filler plug will identify the use of the synthetic fluid.

Use only fluid that meets Ford specifications (refer to *Lubricant specifications* in the *Capacities and specification* chapter).

Use of a non-approved transmission fluid may cause internal transmission component damage.

For location of the transmission filler plug, refer to your transmission operator's manual or *Transmission Refill Capacities* in the *Capacities and specifications* chapter.

Check your transmission fluid level using the following procedure:

1. Park the vehicle on level ground.
2. Set the parking brake and shift into 1 (First) and turn the engine off.
3. Clean any dirt from around the filler plug.
4. Remove the filler plug and inspect the fluid level.
5. The fluid level should be up to the bottom of the filler plug opening.
6. If necessary, add enough fluid through the filler plug opening so that the fluid level is at the bottom of the opening.
7. Clean and install the filler plug securely.

Drain and refill your transmission fluid using the following procedure:

1. Drain the transmission while the fluid is warm.
2. Park the vehicle on level ground.
3. Set the parking brake and shift into 1 (First) and turn the engine off.

Maintenance and care

4. Clean any dirt from around the filler and drain plugs.
5. Remove the filler and drain plugs and drain the fluid into a suitable container. Dispose all used automotive fluids in a responsible manner following your local authorized standards.
6. Clean and install the drain plug securely.
7. Add enough fluid through the filler plug opening so that the fluid level is up to the bottom of the opening.
8. Clean and install the filler plug securely.

REAR AXLE LUBRICANT

Refer to your Scheduled Maintenance Guide for rear axle lubricant level checks and lubricant change intervals.

Your rear axle may be filled with an optional synthetic lubricant which allows the use of extended service intervals. A tag on the filler plug will identify the use of the synthetic lubricant.

Use only a lubricant that meets Ford specifications (refer to *Lubricant specifications* in the *Capacities and specification* chapter).

Use of a non-approved rear axle lubricant may cause internal axle component damage.

Check your rear axle lubricant level using the following procedure:

1. Park the vehicle on level ground.
2. Set the parking brake and shift into N (Neutral) (automatic transmission) or 1 (First) (manual transmission) and turn the engine off.
3. Clean any dirt from around the rear axle filler plug.
4. Remove the filler plug and inspect the lubricant level.
5. The lubricant level should be up to the bottom of the filler plug opening.
6. If necessary, add enough lubricant through the filler plug opening so that the lubricant level is at the bottom of the opening.
7. Clean and install the filler plug securely.

Drain and refill your rear axle lubricant using the following procedure:

1. Drain the rear axle while the lubricant is warm.
2. Park the vehicle on level ground.

Maintenance and care

3. Set the parking brake and shift into N (Neutral) (automatic transmission) or 1 (First) (manual transmission) and turn the engine off.
4. Clean any dirt from around the rear axle filler and drain plugs.
5. Remove the filler and drain plugs and drain the lubricant into a suitable container. Dispose all used automotive fluids in a responsible manner following your local authorized standards.
6. Clean and install the drain plug securely.
7. Add enough lubricant through the filler plug opening so that the lubricant level is up to the bottom of the opening.
8. Clean and install the filler plug securely.

BATTERY

Your vehicle is equipped with two Motorcraft maintenance-free batteries which are mounted in a covered tray and located on the left frame rail. The covered battery tray, depending upon application, may also have one or two steps attached.

- Covered battery tray shown.
Battery tray with steps similar.

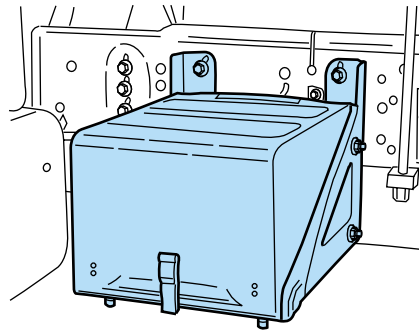

Maintenance and care

- Battery tray with cover removed.

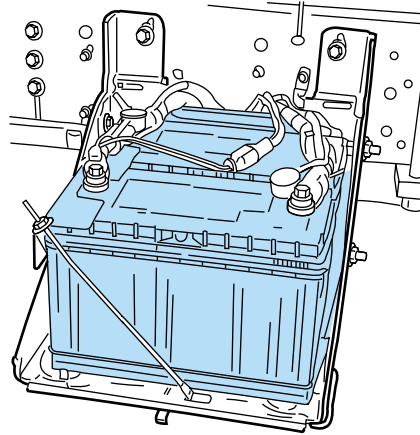

Motorcraft maintenance-free batteries do not normally require adding additional water. However, for severe usage or in high temperature climates, check the battery electrolyte levels. Refer to the Scheduled Maintenance Guide for the service interval schedules.

Keep the electrolyte level in each cell up to the “level indicator”. Do not overfill the battery cells.

If the electrolyte level in the battery is low, you can add plain tap water to the battery, as long as you do not use hard water (water with a high mineral or alkali content). If possible, however, try to only fill the battery cells with distilled water. If the battery needs water often, have the charging system checked.

Make sure the battery cover/shield is reinstalled after the battery has been cleaned or replaced.

For longer, trouble-free operation, keep the top of the batteries clean and dry. Also, make certain the battery cables are always tightly fastened to the battery terminals.

If you see any corrosion on the battery or terminals, remove the cables from the terminals and clean with a wire brush. You can neutralize the acid with a solution of baking soda and water.

Maintenance and care

 Batteries normally produce explosive gases which can cause personal injury. Therefore, do not allow flames, sparks or lighted substances to come near the battery. When working near the battery, always shield your face and protect your eyes. Always provide proper ventilation.

 When lifting a plastic-cased battery, excessive pressure on the end walls could cause acid to flow through the vent caps, resulting in personal injury and/or damage to the vehicle or battery. Lift the battery with a battery carrier or with your hands on opposite corners.

 Keep batteries out of reach of children. Batteries contain sulfuric acid. Avoid contact with skin, eyes or clothing. Shield your eyes when working near the battery to protect against possible splashing of acid solution. In case of acid contact with skin or eyes, flush immediately with water for a minimum of 15 minutes and get prompt medical attention. If acid is swallowed, call a physician immediately.

AIR FILTER

When to service

Your vehicle is equipped with an air filter restriction gauge to determine when to replace the air filter element. It is not possible to determine the need for service by visually inspecting the air filter.

When the yellow indicator on the air filter restriction indicator reaches the red line, the air filter element should be replaced.

Each time the air filter element is replaced, reset the air filter restriction indicator by pressing the red button.

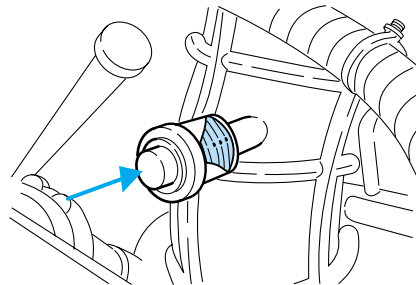

Maintenance and care

Servicing the air filter

Your vehicle is equipped with a dry-type air cleaner element. When the yellow indicator on the air filter restriction indicator reaches the red line the air filter element should be replaced.

- 7.3L Power Stroke engine

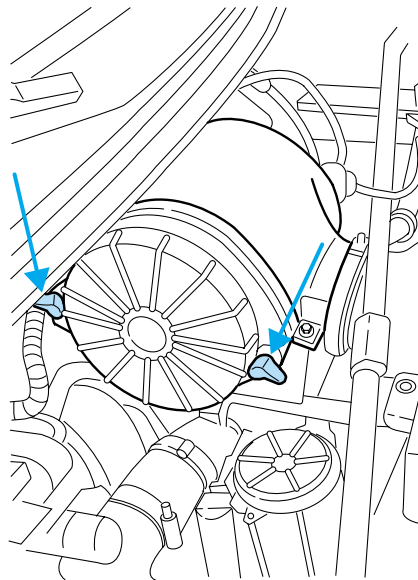

- Cummins B engine

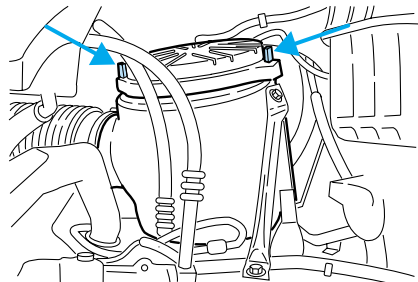

Maintenance and care

- Caterpillar 3126 B engine

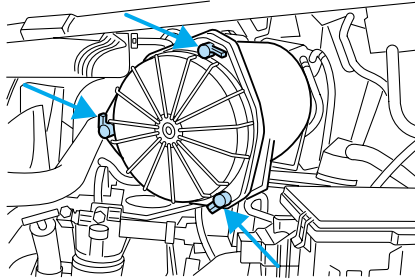

Replace the air filter element using the following procedure:

1. Set the parking brake and shift into N (Neutral) (automatic transmission) or 1 (First) (manual transmission) and turn the engine off.
2. Open the hood. Protect yourself from engine heat.
3. Push in and turn the latches that retain the air filter housing cover counterclockwise 90 degrees, then carefully remove the cover.
4. Carefully remove the air filter element. **Use caution to keep dirt and debris from falling into the engine.** A twisting rocking motion may be needed to break the seal between the filter element and the filter housing.

Maintenance and care

- **If your vehicle is equipped with the 7.3L Power Stroke engine,** it will be necessary to remove the air filter element from the filter housing by moving the exposed end of the filter element down and to the rear of the vehicle, then lifting the other end of the filter element up and out of the engine compartment.

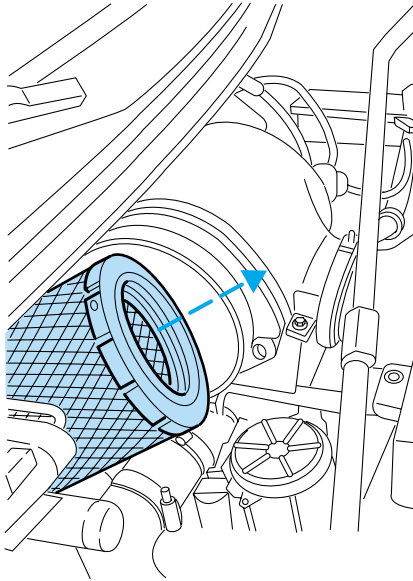

- **If your vehicle is equipped with the Cummins B engine,** a secondary air filter is located the bottom of the air filter housing to keep dirt and debris from falling into the engine when the air filter element is being removed. This secondary filter needs to be replaced only after the primary air filter element has been replaced several times. If necessary replace the secondary air filter.
5. Reach inside the air filter housing and clean the outlet tube where it extends into the housing. Be sure not to damage the tube because the air filter element seals around this surface.
 6. Check to be sure that the drain hole in the air filter housing is open and clear of any dirt and debris.
 7. Check to be sure the new air filter element is not damaged, then install it. Make sure there is a tight seal (apply pressure at the outer rim of the element, not the flexible center).
 8. Align the air filter cover latches with the holes in the air filter housing and install the cover.
 9. Push in on the cover latches, then turn the latches clockwise 90 degrees. Make sure that all air filter cover latches are fully engaged.

Maintenance and care

10. Reset the air filter restriction indicator.
11. Inspect the air induction system for loose fitting, damaged or missing components and repair as necessary.

WINDSHIELD WIPER BLADES

Check the wiper blades at least twice a year or when they seem less effective. Substances such as tree sap and some hot wax treatments used by commercial car washes reduce the effectiveness of wiper blades.

Checking the wiper blades

If the wiper blades do not wipe properly, clean both the windshield and wiper blades using undiluted windshield wiper solution or a mild detergent. Rinse thoroughly with clean water. To avoid damaging the blades, do not use fuel, kerosene, paint thinner or other solvents.

Changing the wiper blades

To replace the wiper blades:

1. Pull the wiper arm away from the windshield and lock into the service position.
2. Turn the blade at an angle from the wiper arm. Push the lock pin manually to release the blade and pull the wiper blade down toward the windshield to remove it from the arm.
3. Attach the new wiper to the wiper arm and press it into place until a click is heard.

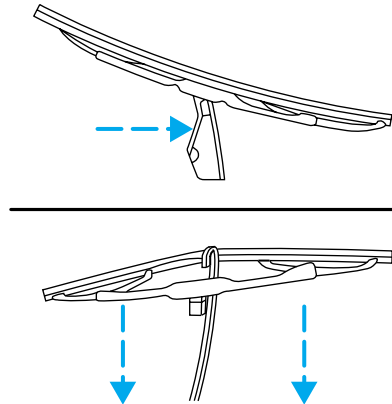

Maintenance and care

SERVICING YOUR WHEELS AND TIRES

Wheel assembly

Your vehicle is fitted with hub piloted wheels and two-element swiveling lug nuts (20 & 22 mm). Do not use taper type wheels or ball seat wheel nuts.

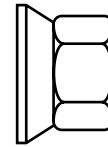
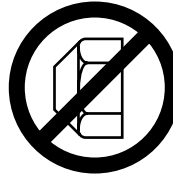

- Do not paint the mating face of the hub/drum.
- Do not paint the two-element swiveling lug nuts or wheel stud.
- Do not allow an excessive thickness of paint to build between the disc wheel mounting surfaces.
- Do not install disc wheels where the paint has not fully cured.
- At wheel changes, ensure mounting faces are clean and free of rust, dirt and excess paint.

If fasteners are needed, use only Ford recommended replacement parts.

- To maintain the desired torque/tension relation between nut body and flange, it is necessary to use clean engine oil meeting Ford specification

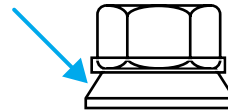

WSS-M2C153-G between nut body and flange. Lubricate the nut body and flange any time a wheel is removed.

The M20 & M22 wheel nuts are right-hand threads. Refer to the following chart for approved wheel lug nut torque.

Wheel type	Bolt size	Wheel nut torque
10-hole disc 285.75 mm bolt circle	M22 (22 by 1.5 mm)	610-677 Nm (450-500 lb-ft)
8-hole disc 19.5x6.75 mm bolt circle	M20 (20 by 1.5 mm)	610-677 Nm (450-500 lb-ft)

The disc wheel nuts on your vehicle were tightened before delivery. Recheck torque of nuts at 160 km (100 miles) and 800 km (500 miles) of new vehicle operation or any time a wheel is removed. Reset to recommended torque levels.

Maintenance and care



Tires are one of the weaker weight carrying components of the vehicle. Do not overload the vehicle beyond safe load carrying capacity.



Avoid hammering rim with steel hammers.



Never run the engine with one wheel off the ground.



Failure to retighten wheel lug nuts as required could allow the wheel to come off while the vehicle is in motion, possibly causing loss of vehicle control and collision. Loose wheel studs may also cause shimmy and vibration.



Use of aftermarket wheel assemblies is not recommended; they may be incompatible with your vehicle and may result in equipment failure and possible injury. Replacement with used wheels is not advised; they may have been treated harshly or have high mileage and could fail without warning.



A wheel or tire of the wrong size or type may adversely affect such things as load carrying capacity, wheel and bearing life, brake cooling, speedometer/odometer calibration, stopping ability, headlight aim, bumper height, vehicle ground clearance and tire or tire chain clearance to the body and chassis.

- 10-hole disc

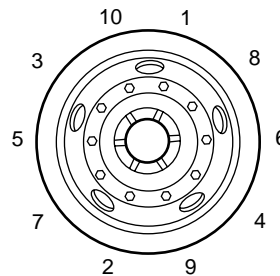

Maintenance and care

- 8-hole disc

Always tighten wheel lug nuts alternately in the sequence shown. Make sure the wheel is drawn evenly against the hub or drum.

Check for damage that would affect the runout of the wheels. Wobble or shimmy caused by a damaged wheel will eventually damage the wheel bearings. Stones or lumps of mud wedged between a wheel and drum or between dual wheels can unbalance a wheel and tire.

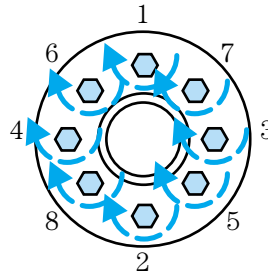

Servicing your tires

Inspect the tire treads and remove stones, nails, glass or other objects that may be wedged in the tread grooves. Check for holes or cuts that may permit air leakage from the tire and make the necessary repairs.

Inspect the tire sidewalls for cuts, bruises and other damage. If internal damage to the tire is suspected, have the tire removed from wheel and inspected.

Check the pressure regularly. Maintain the recommended air pressure for your vehicle, load, tires and rims or wheels. Check the tire valve for air leaks and replace the valve if necessary. If the valve cap is missing, install a new cap.



An inflated tire and rim can be very dangerous if improperly used, serviced or maintained. To avoid serious injury, never attempt to re-inflate a tire which has been run flat or seriously under-inflated without first removing the tire from the wheel assembly for inspection. Do not attempt to add air to tires or replace tires or wheels without first taking precautions to protect persons and property.

Refer to the Ford Service Manual or the regulations of the Occupational Safety and Health Administration (OSHA) for appropriate procedures and cautions.

Maintenance and care



Tire inflation pressure must not exceed the recommendations of the axle, tire and/or wheel rim manufacturer for the specific load, speed and application. The inflation pressures on the tire sidewall do not take the wheel rim capabilities into consideration.



Never use a rim of different manufacture or any different size or type than original rims.

Try to replace tires in pairs on the same axle shaft. Tires larger or smaller than originally installed may affect the accuracy of the speedometer. Consult your dealer about the need to change the switch setting on the back of the speedometer.

Front wheel alignment

If abnormal tire wear or ride and handling characteristics such as vehicle lead or wander are experienced with properly inflated tires, the front end alignment should be checked.

Wheel bearing care

Front and rear wheel bearings are adjustable to correct for bearing and spindle wear. Long bearing life depends upon proper adjustment and correct lubrication. If bearings are adjusted too tightly (preloaded) they will overheat and wear rapidly. Loose adjustment will cause pounding and will contribute to uneven tire wear, steering difficulties and inefficient brake operation.

Refer to the Ford Service Manual applicable to your vehicle for proper tightening procedures and torque specifications.

Periodically check the oil level on oil filled front bearing hubs. If necessary, add oil through the filler plug so the oil level is between the ADD and FULL marks indicated on the hub. Do not overfill. Overfilling can result in oil on brake linings.

Refer to your Scheduled Maintenance Guide for fluid level checks and change intervals for the front hubs.

Your front hubs may be filled with an optional synthetic fluid which allows use of the extended service intervals. A blue colored filler plug identifies use of the synthetic fluid.

Maintenance and care

Tire/wheel rim selection and inflation pressures

Tire Size, Load Range (PR)	Wheel Width (in.) and Type	Single Rear Axle: Max. Tire and Wheel Capacity kg. (lb.) kPa @ (psi) (cold) by Axle	
		Front	Rear
	Tubeless Type Radial Ply		
10R22.5 F (12)	7.50 10H (I.S.O.)	10 300 (4 671) 698 100	19 280 (8 745) 698 100
10R22.5 G (14)	7.50 10H (I.S.O.)	10 300 (4 671) 698 100	21 000 (9 525) 711 115
11R22.5 G (14)	8.25 10H (I.S.O.)	12 080 (5 478) 703 105	22 520 (10 213) 703 105
245/70R19.5	6.75 8H (I.S.O.)	10 300 (4 671) 698 100	19 280 (8 745) 698 100
11X20 (16)	7.50 10H (I.S.O.)	12 080 (5 478) 703 105	22 520 (10 213) 703 105

FUEL INFORMATION

Important safety precautions



Do not overfill the fuel tank. The pressure in an overfilled tank may cause leakage and lead to fuel spray and fire.



The fuel system may be under pressure. If the fuel cap is venting vapor or if you hear a hissing sound, wait until it stops before completely removing the cap.



Automotive fuels can cause serious injury or death if misused or mishandled.

Maintenance and care

Observe the following guidelines when handling fuel:

- Extinguish all smoking materials and any open flames before fueling your vehicle.
- Always turn off the vehicle before fueling.
- Automotive fuels can be harmful or fatal if swallowed. If fuel is swallowed, call a physician immediately, even if no symptoms are immediately apparent. The toxic effects of fuel may not be visible for hours.
- Avoid inhaling fuel vapors. Inhaling too much fuel vapor of any kind can lead to eye and respiratory tract irritation. In severe cases, excessive or prolonged breathing of fuel vapor can cause serious illness and permanent injury.
- Avoid getting fuel liquid in your eyes. If fuel is splashed in the eyes, remove contact lenses (if worn), flush with water for 15 minutes and seek medical attention. Failure to seek proper medical attention could lead to permanent injury.
- Fuels can also be harmful if absorbed through the skin. If fuel is splashed on the skin and/or clothing, promptly remove contaminated clothing and wash skin thoroughly with soap and water. Repeated or prolonged skin contact with fuel liquid or vapor causes skin irritation.



If you must replace the fuel filler cap, replace it with a genuine Ford or Motorcraft part. The customer warranty may be void for any damage to the fuel tank or fuel system if a genuine Ford or Motorcraft fuel filler cap is not used.



If you do not use the proper fuel filler cap, excessive pressure or vacuum in the fuel tank may damage the fuel system or cause the fuel system to work improperly in a collision, which may result in possible personal injury.

Choosing the right fuel

At operating temperatures below 0°C (32°F), use a blend of No. 1D and No. 2D Diesel fuels, also known as winterized No. 2D.

Maintenance and care

Do not use diesel fuel blended with waste oil in engines equipped with a catalytic converter-muffler. Blending waste oil in with the fuel will plug the catalytic converter-muffler, resulting in a significant loss of engine power. Your emissions warranty will be voided if blending waste oil with diesel fuel is practiced.

Use low sulfur (less than 0.05% by weight) fuel as required by the EPA for emission compliance.



Do not mix diesel fuel with gasoline, gasohol or alcohol. This could cause an explosion resulting in personal injury.



Do not use starting fluid such as ether or gasoline. Such fluids can cause immediate explosive damage to the engine and possible personal injury.

Running out of fuel

Avoid running out of fuel as this will allow air to enter the fuel system, which will make restarting the vehicle difficult.

If you have run out of fuel:

- **If your vehicle is equipped with dual fuel tanks**, add at least 15–19 liters (4–5 gallons) of fuel to each tank before attempting to restart the engine.
- **If your vehicle is equipped with the Caterpillar 3126 B engine**, the fuel system must be primed before attempting to restart the engine. Refer to the engine operator's manual for instructions on priming the engine.
- **Use caution not to overheat and damage the starter** by cranking the engine for an excessive period of time. You may need to crank the engine for a longer time than normal. If the engine fails to start in 30 seconds, turn the ignition to the OFF position and wait for two minutes before cranking the engine again.
- Any remaining trapped air will self-purge from the fuel system once the engine starts running.
- The engine may run rough and produce white smoke while air is in the fuel system. This is normal and should stop after a short period of time.

Maintenance and care

Fuel filter/water separator

The fuel filter/water separator removes any contaminated particles and/or water from the fuel before the fuel enters the engine.

The fuel filter/water separator should be drained as recommended in the Scheduled Maintenance Guide.

Draining the fuel filter/water separator—Caterpillar 3126 B engine

1. With the engine off, open the drain valve located at the bottom of the fuel filter/water separator by turning it counterclockwise.

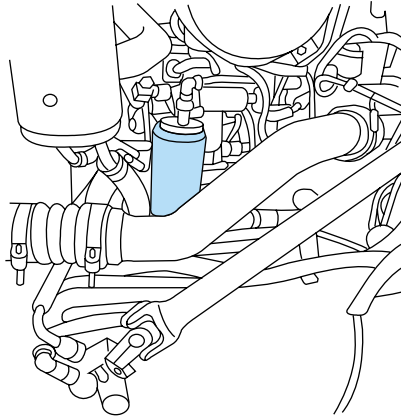

2. Drain the filter until clear fuel is visible.
3. Turn the drain valve clockwise to close the valve. Do not overtighten the drain valve as this could cause damage to the fuel filter/water separator.

Draining the fuel filter/water separator—7.3L Power Stroke engine

1. With the engine off, open the drain valve located on the side of the fuel filter/water separator using your hand.

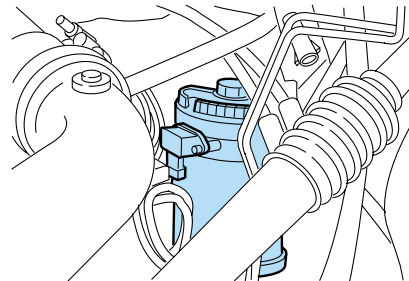

2. Drain the filter until clear fuel is visible.
3. Close the drain valve completely.

Maintenance and care

Draining the fuel filter/water separator—Cummins B engine

Refer to your engine operator's manual for service procedures.

Fuel filter replacement—Caterpillar 3126 B engine

The fuel filter/water separator is located on the left side of the engine. Replace the fuel filter/water separator as recommended in the Scheduled Maintenance Guide, or sooner if it becomes plugged. Vehicles operated on fuel with more than average impurities may require replacement of the fuel filter more frequently. The spin-on filter has a water drain valve built into the bottom of the filter canister.

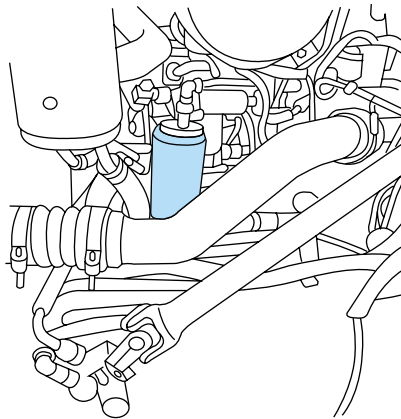

Removal

1. Using an oil filter wrench, remove the filter.
2. Carefully clean the mating surfaces.

Installation

1. Fill the filter with clean, fresh diesel fuel.
2. Coat the filter seal with clean, fresh diesel fuel.
3. Hand-tighten the filter until it seats firmly against the mount, then tighten (by hand) an additional $\frac{1}{3}$ to $\frac{1}{2}$ turn.
4. Start the engine and check for fuel leaks.

Maintenance and care

Fuel filter replacement—7.3L Power Stroke engine

The fuel filter/water separator is located on the right side of the engine. Replace the fuel filter/water separator as recommended in the Scheduled Maintenance Guide, or sooner if it becomes plugged.

Vehicles operated on fuel with more than average impurities may require replacement of the fuel filter more frequently. The filter has a water drain valve built into the bottom of the filter housing.

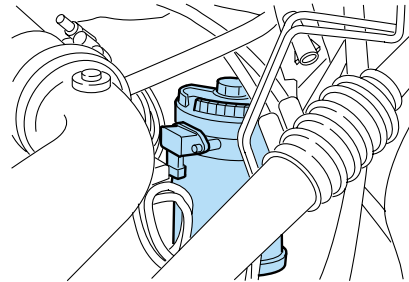

Removal

1. Remove the fuel filter cap by turning counterclockwise. The fuel filter element will come out with the cap.

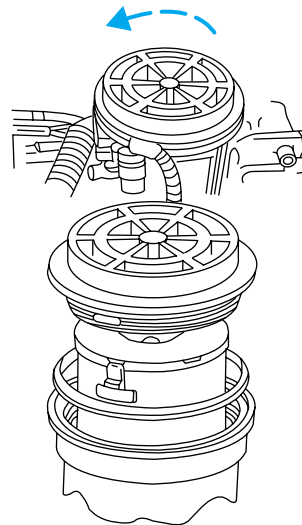

2. Remove and discard the bevel gasket. Carefully clean the mating surfaces.

3. Press in on the fuel filter element locking tabs to separate the element from the cap.

Maintenance and care

Installation



The engine will not run properly if the fuel filter is not installed in housing.

1. Apply a coating of clean diesel fuel to the new bevel gasket and install it onto the fuel filter housing.
2. Install the new fuel filter element onto the cap. Place the new fuel filter element and cap into the fuel filter housing. Allow fuel to soak into the fuel filter element.
3. Tighten cap onto the fuel filter housing until cap contacts the housing.
4. Start the engine and check for fuel leaks.

After changing the fuel filter, the engine will purge the trapped air as it runs. Engine may run roughly and smoke until the air is completely eliminated.

Fuel filter replacement—Cummins B engine

Refer to your engine operator's manual for service intervals and procedures.

ESSENTIALS OF GOOD FUEL ECONOMY

Measuring techniques

Your best source of information about actual fuel economy is you, the driver. You must gather information as accurately and consistently as possible. Fuel expense, frequency of fillups or fuel gauge readings are NOT accurate as a measure of fuel economy. We do not recommend taking fuel economy measurements during the first 1 600 km (1 000 miles) of driving (engine break-in period). You will get a more accurate measurement after 3 000 km–5 000 km (2 000 miles–3 000 miles).

The advertised fuel capacity of the fuel tank(s) on your vehicle is equal to the rated refill capacity of the fuel tank(s) as listed in *Fuel Tank Capacities* in the *Capacities and Specifications* chapter. The advertised capacity is the amount of the Indicated Capacity and the Empty Reserve combined. Indicated Capacity is the difference in the amount of fuel in a full tank and a tank when the fuel gauge indicates empty. Empty Reserve is the small amount of usable fuel remaining in the fuel tank after the fuel gauge indicates empty.

Maintenance and care

The amount of Empty Reserve varies and should not be relied upon to increase driving range. When refueling your vehicle after the fuel gauge indicates empty, you might not be able to refuel the full amount of the advertised capacity of the fuel tank due to the empty reserve still present in the tank.

Filling the tank

For consistent results:

- Use the same fill rate setting (low — medium — high) each time during filling.
- Allow three automatic click-offs when filling.
- Always use fuel of a known quality, preferably a national brand.
- Have the vehicle loading and distribution the same every time.
- When refueling a vehicle equipped with dual fuel tanks, if the two tanks are not filled equally, the fuel gauge reading may fluctuate slightly until the fuel level between the two tanks balance out and become equal.

Your results will be most accurate if your filling method is consistent.

Calculating fuel economy

1. Fill the fuel tank(s) completely and record the initial odometer reading (in kilometers or miles).
2. Each time you fill the tank(s), record the amount of fuel added (in liters or gallons).
3. After at least three to five tank fill-ups, fill the fuel tank(s) and record the current odometer reading.
4. Subtract your initial odometer reading from the current odometer reading.
5. Follow one of the simple calculations in order to determine fuel economy:

Multiply liters used by 100, then divide by total kilometers traveled.

Divide total miles traveled by total gallons used.

Keep a record for at least one month and record the type of driving (city or highway). This will provide an accurate estimate of the vehicle's fuel economy under current driving conditions. Additionally, keeping records during summer and winter will show how temperature impacts fuel economy. In general, lower temperatures give lower fuel economy.

Maintenance and care

Driving style — good driving and fuel economy habits

Give consideration to the lists that follow and you may be able to change a number of variables and improve your fuel economy.

Habits

- Smooth, moderate operation can yield up to 10% savings in fuel.
- Steady speeds without stopping will usually give the best fuel economy.
- Anticipate stopping; slowing down may eliminate the need to stop.
- Sudden or hard accelerations may reduce fuel economy.
- Slow down gradually.
- Driving at reasonable speeds (traveling at 88 km/h [55 mph] uses 15% less fuel than traveling at 105 km/h [65 mph]).
- Using the air conditioner or defroster may reduce fuel economy.
- Resting your foot on the brake pedal while driving may reduce fuel economy.

Conditions

- Carrying unnecessary weight may reduce fuel economy.
- Fuel economy may decrease with lower temperatures during the first 12–16 km (8–10 miles) of driving.
- Flat terrain driving improves fuel economy over hilly roads.
- Transmissions give their best fuel economy when operated in the top cruise gear and with steady pressure on the accelerator.
- Close windows for highway driving.

EXTERIOR BULBS

Check operation of lamps, safety equipment and warning signals

It is a good safety practice to check operation of headlamps, parking lamps, turn signals, clearance and marker lamps, instrument panel and control lamps each day.

Replacing headlamp bulbs

To remove the headlamp bulbs:

1. Make sure headlamp switch is in OFF position.

Maintenance and care

2. Open the hood.
3. Remove four screws and move the parking lamp assembly away from the headlamp bulb.

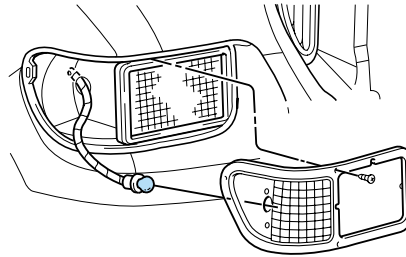

4. Remove four screws and the retaining bracket from the headlamp bulb.
5. Pull headlamp bulb out of the housing, disconnect the electrical connector and remove the headlamp bulb.
6. To complete installation, follow the removal procedure in reverse order.

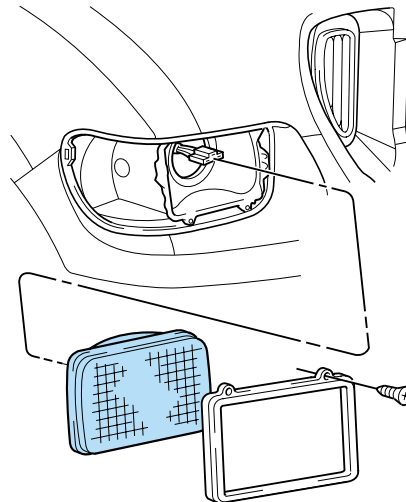

Replacing front parking lamp/turn signal bulbs

To remove the parking/turn signal bulbs:

1. Make sure the headlamp control is in the OFF position.
2. Open the hood.

Maintenance and care

3. Remove four screws from the lamp assembly.
4. Carefully lower lamp assembly and pull the bulb socket straight out of the lamp assembly.
5. Carefully pull the bulb straight out of the socket and push in the new bulb.
6. To complete installation, follow the removal procedure in reverse order.

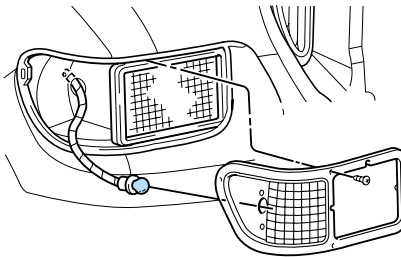

Replacing cab marker bulbs

To change the cab marker bulbs:

1. Remove the screw and lens from the lamp assembly.
2. Carefully pull the bulb straight out of the socket and push in the new bulb.
3. Install lens on lamp assembly with screw.

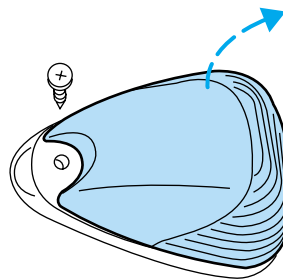

Maintenance and care

Replacing brake/tail/backup lamp bulbs

The brake/tail/backup lamp bulbs are located in the same portion of the tail lamp assembly. Follow the same steps to replace either bulb:

1. Remove the four screws and the lamp lens from lamp assembly.
2. Carefully pull the bulb straight out of the socket and push in the new bulb.
3. Install the lens on the lamp assembly with the four screws.

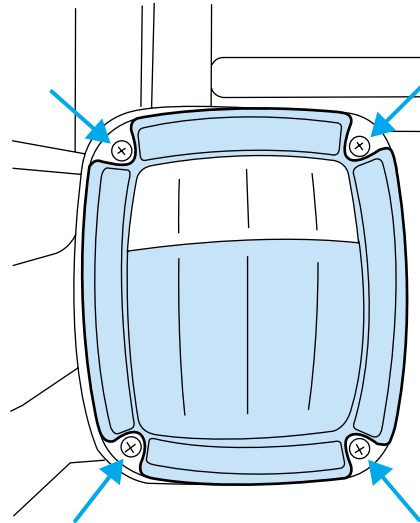

Using the right bulbs

Function	Number of bulbs	Trade number
Headlamps	2	4652
Park/turn signal	2	1157
Sidemarkers	4	1895
Brake/tail	2	3157
Backup	4	1156
Cabmarker	5	168
Rear fender clearance	4	^(a)
Rear identification	3	194
Dome lamp	1	105
To replace all instrument panel lights - see your dealer		
^(a) Replace entire lamp assembly; bulb is not serviceable.		

Maintenance and care

AIMING THE HEADLAMPS

The headlamps on your vehicle are properly aimed at the assembly plant. If your vehicle has been in an accident the alignment of your headlamps should be checked by a qualified service technician.

MINOR TROUBLESHOOTING GUIDE

Diesel engine

For troubleshooting information, refer to the diesel engine operator's manual.

If engine won't crank

For troubleshooting information, refer to the engine operator's manual.

If engine cranks but won't start

For troubleshooting information, refer to the engine operator's manual.

If engine runs hot

For troubleshooting information, refer to the engine operator's manual.

If fuses burn out

Burned-out or "blown-out" fuses or circuit breaker tripping (if equipped) usually indicate an electrical short circuit, although a fuse may occasionally fail from vibration. Insert a second fuse or reset the breaker (if equipped). If this fuse immediately burns out or the breaker (if equipped) trips and you cannot locate the fuse, return your vehicle to your dealer for a circuit check.

If lamp bulbs burn out

Repeated lamp burn-out usually indicates a loose connection, either at the lamp socket, the system ground or a malfunctioning voltage regulator. If examination does not indicate the cause of the trouble, return your vehicle to your dealer for inspection.

If headlamps flash on and off

If headlamps flash on and off at regular intervals, the system circuit breaker (if equipped) is operating, indicating a short circuit or overload. Take your vehicle to your dealer for a circuit check.

Maintenance and care

CLEANING AND CARING FOR YOUR VEHICLE

Refer to the Customer Assistance chapter for a list of Ford-approved cleaners, polishes and waxes.

Washing your vehicle

Wash your vehicle regularly with cold or lukewarm water. Never use strong detergents or soap. If your vehicle is particularly dirty, use a quality car wash detergent. Always use a clean sponge, washing glove or similar device and plenty of water for best results. To avoid spots, avoid washing when the hood is still warm, immediately after or during exposure to strong sunlight.

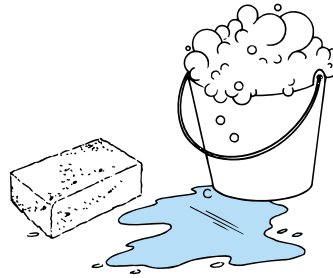

During winter months, it is especially important to wash the vehicle on a regular basis. Large quantities of dirt and road salt are difficult to remove and also cause damage to the vehicle.

Any gasoline spilled on the vehicle or deposits such as bird droppings should be washed and sponged off as soon as possible. Deposits not removed promptly can cause damage to the vehicle's paintwork.

Remove any exterior accessories, such as antennas, before entering a car wash. If you have wax applied to the vehicle at a commercial car wash, it is recommended that you clean the wiper blades and windshield as described in *Cleaning the wiper blades and windshield*.

After washing, apply the brakes several times to dry them.

Waxing your vehicle

Waxing your vehicle on a regular basis will reduce minor scratches and paint damage.

Wax when water stops beading on the surface. This could be every three or four months, depending on operating conditions.

Use only carnauba or synthetic-based waxes. Use a cleaning fluid with a clean cloth to remove any bugs before waxing your vehicle. Use tar remover to remove any tar spots.

Avoid getting wax on the windshield, or on any surfaces which appear coarse or bumpy. If you have wax applied at a commercial car wash, it is

Maintenance and care

recommended that you clean the wiper blades and windshield as described in *Cleaning the wiper blades and windshield*.

Repairing paint chips

Minor scratches or paint damage from road debris may be repaired with the Ultra Touch Prep and Finishing Kit (#F7AZ-19K507-BA), Lacquer Touch-up Paint (#ALBZ-19500-XXXXA), or Exterior Acrylic Spray Lacquer (#ALAZ-19500-XXXXA) from the Ford Car Care Chemicals line. Please note that the part numbers (shown as XXXX above) will vary with your vehicle's specific coloring. Observe the application instructions on the products.

Remove particles such as bird droppings, tree sap, insect remains, tar spots, road salt and industrial fallout immediately.

Cleaning the wheels

Wash with the same detergent as the body of your vehicle. Do not use acid-based or alcohol-based wheel cleaners, steel wool, fuel or strong detergents. Never use abrasives that will damage the finish of special wheel surfaces. Use a tar remover to remove grease and tar.

The brushes used in some automatic car washes may damage the finish on your wheels. Before going to a car wash, find out if the brushes are abrasive.

Cleaning the engine

Cover the underhood electrical connections and terminals of your vehicle when cleaning the engine compartment. Avoid spraying or splashing cleaning solvents or detergent solutions on the terminals and connections. After the cleaning is completed and with the engine not running, remove the protective cleaning coverings. Exposing electrical connections and terminals to cleaning solvents and detergent solutions over a period of time can corrode them and result in electrical system damage and malfunctions.

Underbody

Flush the complete underside of vehicle frequently. Keep body drain holes unplugged. Inspect for road damage.

Maintenance and care

Cleaning non-painted plastic exterior parts

Use vinyl cleaner for routine cleaning. Clean with a tar remover if necessary. Do not clean plastic parts with thinners, solvents or petroleum-based cleaners.

Cleaning the exterior lamps

Wash with the same detergent as the exterior of your vehicle. If necessary, use a tar remover such as Ford Extra Strength Tar and Road Oil Remover (B7A-19520-AA).

To avoid scratching the lamps, do not use a dry paper towel, chemical solvents or abrasive cleaners.

Cleaning the wiper blades, windshield and rear window

If the wiper blades do not wipe properly, clean the wiper blade rubber element with undiluted windshield washer solution or a mild detergent. To avoid damaging the blades, do not use fuel, kerosene, paint thinner or other solvents.

If the wiper still does not wipe properly, this could be caused by substances on the windshield or rear window such as tree sap and some hot wax treatments used by commercial car washes. Clean the outside of the windshield or rear window with a non-abrasive cleaner such as Ford Ultra-Clear Spray Glass Cleaner, (E4AZ-19C507-AA), available from your Ford Dealer. **Do not** use abrasive cleansers on glass as they may cause scratches. The windshield or rear window is clean if beads do not form when you rinse it with water. The windshield, rear window and wiper blades should be cleaned on a regular basis, and blades or rubber elements replaced when worn.

Cleaning the instrument panel

Clean with a damp cloth, then dry with a dry cloth.

Avoid cleaner or polish that increases the gloss of the upper portion of the instrument panel. The dull finish in this area helps protect the driver from undesirable windshield reflection.



Do not use chemical solvents or strong detergents when cleaning the steering wheel or instrument panel to avoid contamination of the air bag system.

Maintenance and care

Cleaning the instrument cluster lens

Clean with a damp cloth, then dry with a dry cloth.

Do not use household or glass cleaners as these may damage the lens.

Cleaning the interior fabric

Remove dust and loose dirt with a whisk broom or a vacuum cleaner.

Remove fresh spots immediately. Do not use household or glass cleaners.

These agents can stain and discolor the fabric. Use a mild soap and water solution if necessary.

Cleaning and maintaining the safety belts

Clean the safety belts with a mild soap solution recommended for cleaning upholstery or carpets. Do not bleach or dye the belts, because these actions may weaken the belt webbing.

Check the safety belt system periodically to make sure there are no nicks, wear or cuts. If your vehicle has been involved in an accident, refer to the *Safety belt maintenance* section in the *Seating and safety restraints* chapter.

Capacities and specifications

ENGINE COOLANT AND OIL REFILL CAPACITIES

Engine	Engine coolant (approximate capacity)	Engine oil (approximate capacity)
Caterpillar 3126 B	26.9L (28.4 quarts)	¹
Cummins B 5.9L	23.1L (24.4 quarts)	¹
Power Stroke 7.3L	25.1L (26.5 quarts)	18.0L (19.0 quarts) ²

¹ Refer to the engine operator's manual for engine oil refill capacities.

² Engine oil and filter change.

POWER STEERING FLUID CAPACITIES

GVWR	Axle application	System capacity
11 794/13 608 kg (26 000/30 000 lb.)	3 856/4 082 kg (8 000/9 000 lb.)	4.3L (4.5 quarts)
14 969 kg (33 000 lb.)	5 443 kg (12 000 lb.)	4.5L (4.7 quarts)

TRANSMISSION REFILL CAPACITIES

Type and make	Approximate capacity
5-speed (Eaton FS-4205A) ^{1, 2}	5.4L (5.75 quarts)
5-speed (Eaton FS-5205A) ^{1, 2}	5.9L (6.25 quarts)
6-speed (Eaton FS-5306A and FS-6306A) ^{1, 2}	9.2L (9.75 quarts)
7-speed (Spicer ES52-7B and ES066-7B) ^{1, 2}	10.4L (11.0 quarts)
Allison AT-545 ³	18.9L (20.0 quarts)
2000/2400 Series-Standard sump	10.0L (10.6 quarts) ⁴
2000/2400 Series-Shallow sump	7.0L (7.4 quarts) ⁵
MD series ³	27.4L (29.0 quarts)

¹ Quantity shown is nominal; fluid level should be at lower edge of fill hole.

² Fill plug is located on the right side of the transmission and the drain plug on the rear of the transmission.

³ Fluid level should be checked by your dealer or a qualified service technician.

Capacities and specifications

⁴ Approximate quantities only, does not include external lines and cooler hoses.

⁵ Approximate quantities only, does not include external lines and cooler hoses.

REAR AXLE REFILL CAPACITIES

Make and model	Approximate capacity
Rockwell RS-17-144 ¹	16.6L (35 pints)
Rockwell RS-17-145 ^{1, 2}	16.6L (35 pints)
Rockwell RS-21-145 ^{1, 2}	16.6L (35 pints)
Rockwell RS-23-160 ^{1, 2}	18.9L (40 pints)

¹ Quantities listed are approximate. Fill axle until the lubricant level is at bottom of filler hole, with vehicle on level ground.

² If hubs have been removed, add an additional 0.75 liter (1.6 pints) of axle lubricant. Add lubricant through the axle vent.

FUEL TANK CAPACITIES

Type	Approximate capacity
Single tank	189.0L (50 gallons)
Dual tank	378.6L (100 gallons)

LUBRICANT SPECIFICATIONS

Item	Ford Part Name	Ford Part Number	Ford Specification
Brake and clutch fluid (if equipped)	High Performance DOT 3 Motor Vehicle Brake Fluid	C6AZ-19542-AB	ESA-M6C25-A and DOT 3
Body hinges, hood hinges and latches.	Multi-Purpose Grease	D0AZ-19584-AA or F5AZ-19G209-AA	ESB-M1C93-B or ESR-M1C159-A
Lock cylinders	Penetrating Lubricant	E8AZ-19A501-B	N/A

Capacities and specifications

Item	Ford Part Name	Ford Part Number	Ford Specification
Front axle spindle pins, steering linkage, front and rear spring shackle pins, steering column U-joints, steering shaft slip yoke and universal joint, steering shaft pillow block bearing, clutch linkage fittings.	Premium Long Life Grease	XG-1-C or XG-1-K	ESA-M1C75-B
Bushings, front wheel bearings (grease packed type) and seals, fuel shut-off solenoid linkage, air brake control valve, linkage, treadle hinge and roller, transmission and transmission cables, clutch release bearing hub, transmission shift lever pivot.	Premium Long Life Grease	XG-1-C or XG-1-K	ESA-M1C75-B
Door weatherstrips	Silicone Lubricant	F7AZ-19G208-BA and F5AZ-19553-AA	ESR-M13P4-A
Driveshaft U-joints and slip splines, power steering gear output shaft.	High Temperature 4 x 4 Front Axle and Wheel Bearing Grease	E8TZ-19590-A	ESA-M1C198-A

Capacities and specifications

Item	Ford Part Name	Ford Part Number	Ford Specification
Spring leaves, transmission linkage pivots, brake and clutch pedal pivots and clevises, transmatic detent stop, starter motor.	Motorcraft SAE 10W30 Super Duty Motor Oil	XO-10W30-QSD	WSS-M2C171-B
Automatic transmission	Refer to the Allison Automatic Transmission Operator's manual.		
Rear axle and front wheel bearings (oil filled) ¹	SAE 80W-90 Premium Rear Axle Lubricant	XY-80W90-QL	WSP-M2C197-A
	SAE 75W-140 High Performance Rear Axle Lubricant (synthetic)	F1TZ-19580-B	WSL-M2C192-A
Manual transmission ¹	Motor oil SAE 50 (above -18°C [0°F])	²	N/A
	Motorcraft SAE 30 Super Duty Motor oil (below -18°C [0°F])	XO-30-QSD ³	WSS-M2C171-B
Engine oil- 7.3L Power Stroke engine ^{1, 4}	Motorcraft Super Duty Motor oil	XO-15W40-QSD ³ XO-10W30-QSD ³	WSS-M2C171-B
	Motorcraft SAE 0W-30 Super All Season Motor oil (synthetic)	XO-0W30-LAS	
Engine oil- Cummins B and Caterpillar 3126 B engines	Refer to the appropriate engine operator's manual.		

Capacities and specifications

Item	Ford Part Name	Ford Part Number	Ford Specification
Engine coolant- 7.3L Power Stroke	Ford Premium Engine Coolant	E2FZ-19549-AA (in Canada, Motorcraft CXC-8-B)	ESE-M97B44-A
Engine coolant- Caterpillar 3126 B engine and Cummins B engine	Refer to the engine operator's manual.		
Power steering	Motorcraft MERCON® ATF	XT-2-QDX	MERCON®
Windshield washer fluid	Ultra-Clear Windshield Washer Concentrate	C9AZ-19550-AC	ESR-M17P5-A

¹ Refer to your Scheduled Maintenance Guide to determine the correct service interval for the lubricant which you are using.

² Ford Motor Company currently does not offer a SAE 50 Motor oil.

³ Ford Motor Company currently does not offer a synthetic based lubricant for this viscosity grade. Select the correct SAE viscosity grade lubricant and API service category for your vehicle's operating conditions.

⁴ Refer to *Engine oil and filter recommendations—7.3L Power Stroke engine* in the *Maintenance and care* chapter to select the correct SAE viscosity grade and API service category for your vehicle's operating conditions.

Capacities and specifications

VEHICLE IDENTIFICATION NUMBER (VIN/SERIAL NUMBER)

The Vehicle Identification Number (VIN) is printed on the Vehicle Rating Decal attached to the vehicle. The VIN also serves as the warranty number. The rating decal is attached to the front door latch pillar (B-pillar) on the driver's side.

If you ever find it necessary to communicate with Ford Motor Company about your vehicle, always include the VIN in your communication.

CERTIFICATION LABEL

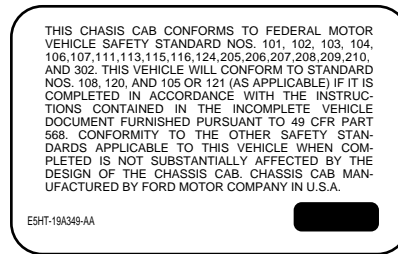

Incomplete Vehicle Label

**INCOMPLETE VEHICLE MANUFACTURED BY
FORD MOTOR COMPANY**
MADE IN U.S.A.

GVWR: XXXXX LB/XXXXX KG
VEHICLE IDENTIFICATION NUMBER

YG		71		0064	
EXTERIOR PAINT COLORS		DISTRICT		DSO	
WB	TYPE-GVW	BODY	TRANS	AXLE	
XXX	XXXXXX	XXX	XX	XX	
FGAWR			RGAWR		

Capacities and specifications

Vehicle Rating Decal - Sample

MFD. BY FORD MOTOR CO. IN U.S.A.						
DATE: XXXXX GVWR: XXXXX LB/ XXXXX KG						
FGAWR: XXXXXXXXXX			RGAWR: XXXXXXXXXX			
XXXXXXXXXX W/TIRES			XXXXXXXXXX W/TIRES			
XXXXXXXXXX RIMS		XXXXXXXXXX RIMS				
AT XXX PSI COLD			AT XXX PSI COLD			
THIS VEHICLE CONFORMS TO ALL APPLICABLE FEDERAL MOTOR VEHICLE SAFETY STANDARDS IN EFFECT ON THE DATE OF MANUFACTURE SHOWN ABOVE.						
VIN: XXXXXXXXXXXXXXXX			REAR REAR GAWR			
TYPE: XXXXXXXXXXXXXXXX			XXXXXXXXXXXXXX			
						
WB	TYPE/GVV	BODY	TRANS	AXLE	EXT PNT	DSO
XXX	XXXXXX	XXX	XXX	XXX	XXXX	XXXXXX
VFOHT-15294A10-GA						

The National Highway Traffic Safety Administration Regulations require that a Certification Label be affixed to a vehicle and prescribe where the Certification Label may be located. Where Ford Motor Company is the sole manufacturer of the vehicle, the Certification Label is located on the front door latch pillar on the driver's side. In many instances, the vehicle is sold by Ford Motor Company to an intermediate or final stage manufacturer who is required to affix the Compliance Label. In these cases, the completed vehicle is manufactured in two (or more) stages by two (or more) separate manufacturers, with the manufacture of the completed vehicle occurring at a later date than the manufacture of the chassis or incomplete vehicle. Consequently, the model year of the completed vehicle may be later than the model year of the incomplete vehicle or chassis.

General maintenance information

GENERAL MAINTENANCE INFORMATION

The Scheduled Maintenance Services listed in this section are required because they are considered essential to the life and performance of your vehicle.

Ford Motor Company recommends you perform the Owner Maintenance Services listed in this section. These services are matters of day-to-day care that are important to the proper operation of your vehicle. In addition to the conditions described in the Owner Maintenance Checklist, be alert for any unusual noise, vibration or other indication that your vehicle may need service and attend to it promptly.

Use only recommended fuels, lubricants, fluids and service parts conforming to Ford specifications. Motorcraft parts are designed and built for best performance in your vehicle. Using these parts for replacement is your assurance that Ford-Built quality stays in your vehicle.

SCHEDULED MAINTENANCE

The maintenance or replacement of the emission control devices (or systems) in your new Ford Motor Company vehicle (or engine) may be performed at your expense. These services may be performed by any automotive repair establishment or individual using automotive parts equivalent to those with which your vehicle or engine was originally equipped. If any parts other than Ford, Motorcraft, or Ford authorized, remanufactured parts are used for maintenance replacements (or for the service) of components effecting the emission control, the owner should be assured that such parts are warranted by their manufacturer to be equivalent to genuine Ford Motor Company Parts in performance and durability. Please consult your warranty information booklet for complete warranty information.

Authorized dealer maintenance

Your authorized dealer specializes in knowing all about Ford Motor Company vehicles rather than knowing a little about all makes.

There are Ford or Ford of Canada dealer service shops ready to serve you wherever you drive in the U.S. or Canada. They stock Ford and Motorcraft parts, and Ford Chemicals and lubricants. You can be confident that these meet the same exacting design and quality standards as those used to build the vehicle originally. Dealer Service Technicians have available training in the latest product developments and service techniques.

General maintenance information

OWNER MAINTENANCE

You can do much of the maintenance your vehicle requires yourself, if you have the time and a reasonable amount of mechanical ability. If you prefer to have this work done professionally, your authorized dealer stands ready to help you.

All mechanical components and attachments are important in that they could affect the performance of vital components and systems. If replacement becomes necessary, they must be replaced with parts having the same part number or with equivalent parts. Torque values of the attaching parts must be used as specified during any reassembly procedure to assure proper retention.

EMISSIONS CONTROL SYSTEM

To assure the emissions control systems operate effectively, you should have the services listed in the maintenance schedule performed at the specified time and km/mileage intervals. You should avoid running out of fuel or turning off the ignition while the vehicle is in motion, especially at high speeds.



Because of high engine compartment and exhaust system temperatures resulting from emissions equipment, do not park, idle or operate your vehicle in dry grass or other dry ground cover where the possibility of ground fire exists.

Do not make unauthorized modifications to the engine or vehicle. Modifications causing increased amounts of unburned fuel to reach the exhaust system can significantly increase the temperature of the engine compartment and/or the exhaust system.

Avoid driving your vehicle if it does not operate properly. If the engine diesels (more than five seconds of engine run-on after shut-off), misfires, surges, stalls or backfires, see your dealer. Be alert for fluid leakage, odor, smoke, loss of oil pressure, or charge indicator or over temperature warning.

Do NOT use diesel fuel blended with waste oil in engines equipped with a CATALYTIC CONVERTER-MUFFLER. Waste lube oil blending in fuel will plug the CATALYTIC CONVERTER-MUFFLER, resulting in a significant loss of engine power.

General maintenance information

Emissions control system(s) laws

Federal law prohibits vehicle manufacturers, dealers and other persons engaged in the business of repairing, servicing, selling, leasing or trading motor vehicles, as well as fleet operators from knowingly removing or rendering an emissions control device or system inoperative. Further, modifications of the emissions control system(s) could create liability on the part of individual owners under the laws of some states. In Canada, modification of the emissions control system could create liability under applicable Federal or Provincial laws.

NOISE EMISSIONS WARRANTY, PROHIBITED TAMPERING ACTS AND MAINTENANCE

On January 1, 1978, Federal regulations became effective governing the noise emissions on trucks over 4 535 kgs. (10 000 lbs.) GVWR. The following statements concerning prohibited tampering acts and maintenance and the noise warranty are found in the Warranty Guide, and are applicable to completed trucks.

Tampering with noise control system prohibited

Federal law prohibits the following acts or the causing thereof: (1) The removal or rendering inoperative, by any person other than for purposes of maintenance, repair or replacement, of any device or element of design incorporated into any new vehicle for the purpose of noise control prior to its sale or delivery to the ultimate purchaser or while it is in use, or (2) the use of the vehicle after such device or element of design has been removed or rendered inoperative by any person.

Among those acts presumed to constitute tampering are the following acts listed:

Vehicle System	Acts
Acoustical Shielding	Removal of noise shields, hood blanket, tunnel liner or acoustical absorptive material.
Engine	Removal or rendering inoperative the engine speed governor so as to allow engine speed to exceed manufacturer specifications. Removal of engine mounted noise shield or oil pan enclosure.

General maintenance information

Vehicle System	Acts
Engine Air Induction System	Removal of the air duct, silencer, air cleaner, and/or air cleaner element and baffle in air cleaner; re-indexing of air cleaner.
Exhaust System	Removal or rendering inoperative exhaust system components including the catalytic converter - muffler assembly, inlet pipe, outlet pipe, resonator and flexpipe. Rotation of horizontal exhaust system directional outlet pipe to cause the exhaust to be emitted in a direction other than downward.
Engine Cooling System	Removal or rendering inoperative the fan clutch. Removal or modification of the fan shroud. Replacing a fixed fan with a fan of increased diameter, different number of blades or different pitch width.

MAINTENANCE

Instructions for maintenance and service of the noise control system have been included in the Required Maintenance Services and in the General Maintenance Checklist. To further help minimize noise emissions degradation throughout the life of the vehicle, Ford Motor Company recommends that this vehicle should be operated in the manner described within the Owner Guide. Caution should be exercised by the owner when installing replacement parts to be sure that a tampering act (as outlined above) is not committed. Note any inspection and service performed in the Maintenance Record.

EMISSIONS INFORMATION LABEL

Emissions information appears on the Important Engine Information Decal located on or near the engine.

General maintenance information

SCHEDULED MAINTENANCE SERVICES

Maintenance service adjustments must conform to specifications contained in this manual, and those shown on the Important Engine Information Decal. The following services are to be performed at scheduled intervals because they are considered essential to the life and performance of your vehicle. Ford recommends that you perform maintenance on all designated items to achieve best vehicle operation.

Scheduled maintenance beyond 160 930 km (100 000 miles) should be continued as before 160 930 km (100 000 miles).

SPECIAL OPERATING CONDITIONS

If your driving habits **frequently** include one or more the following conditions:

- Short trips of **less** than 16 km (ten miles) when outside temperatures remain below freezing.
- Operating during **hot weather** in stop-and-go “rush hour” traffic.
- Operating in severe dust conditions.
- Extensive idling, or low speed operation such as door-to-door delivery service.
- High speed operation with a fully loaded vehicle (max. GVW).
- Snowplowing.

Perform the following:

- Change engine oil and oil filter every three months, 8 000 km (5 000 miles) or 125 hours of engine service.
- If operating in severe dust conditions, replace the air cleaner filter more often than regular intervals as determined by the air filter restriction indicator. Make sure that the air filter restriction indicator is in good working order.
- Lube the manual transmission and the rear axle every 48 279 km (30 000 miles) or 6 months, whichever comes first.
- See the Allison, Cummins and Caterpillar Operator’s Manual.

General maintenance information

AIR BRAKE ADJUSTMENT



Failure to maintain proper air brake adjustment can result in reduction or loss of braking ability.

Air brake inspection and adjustment should be performed by a qualified service technician in accordance with the instructions in the Ford Truck Service Manual.

Cam brakes - automatic slack adjusters

Inspect standard air brakes equipped with automatic slack adjusters for proper brake adjustment every four months or 32 000 km (20 000 miles) whichever occurs first.

However, more frequent inspection is required if your vehicle's brakes are subjected to heavy use or adverse operating conditions such as:

- Frequent brake applications while fully loaded.
- Operation on hilly or mountainous terrain.
- Frequent operation on dirt, gravel or mud.

Some aftermarket brake linings also require more frequent inspections.

General maintenance information

SCHEDULED MAINTENANCE GUIDE

MAINTENANCE SERVICES AND RECORD RETENTION

The maintenance record form which follows is for your convenience. In addition to recording the services performed, you should retain copies of your receipts for the services. You also should keep records of any emission control systems maintenance services performed on your vehicle.

Maintenance Record

Warranty _____
Start Date _____ Engine Displacement _____
Vehicle Identification Number _____ Owner Name _____

IMPORTANT — This document should remain with the vehicle at all times.

General maintenance information

Daily Owner Checks	Engine system
	Check the air filter restriction indicator
	Check the engine oil
	Inspect the coolant level - for Powerstroke engine (for Caterpillar and Cummins engines, refer to the Owner's Manual)
	Brake system
	Drain the air brake system reservoir - manual valve
	Check the air brake system reservoir automatic drain valve operation
	Transmission system
	Visually check the automatic transmission for fluid leakage
	Steering system
	Check the power steering pump fluid level and check the system for leaks
	Check the entire vehicle for evidence of fluid leaks
	U.S. Department of Transportation, Federal Highway Administration requirements (ensure that the entire system is functioning properly)
	Check the service brakes
	Check the parking brake
	Check the steering mechanism
	Check the lighting devices and reflectors
	Check the tires
	Check the horn
	Check the windshield wipers
Check the rear vision mirrors	
Check the wheels and rims	
Check the emergency equipment	

General maintenance information

<p>Check every oil change Oil change intervals are as follows: Powerstroke - 10 000 ; Caterpillar - 10 000 ; Cummins - 15 000 (refer to the Caterpillar and Cummins service manuals for further instructions and information)</p>	<p>Engine system</p>
	<p>Check the engine cooling system - hoses, clamps and protection</p>
	<p>Inspect the drive belts</p>
	<p>Exhaust system</p>
	<p>Inspect the entire exhaust system (including the inlet pipe(s), muffler(s), outlet pipe(s), clamps and fasteners) for holes, leakage, breakage, corrosive damage and separation from other components. Adjust, service or replace with the same or the equivalent part. (Also a noise emission control service)</p>
	<p>Suspension system</p>
	<p>Lubricate the front and rear spring pins</p>
	<p>Tighten the front and rear spring U-bolts to the specified torque</p>
	<p>Driveline and rear axle system</p>
	<p>Lubricate the U-joints and the slip yoke</p>
	<p>Brake system</p>
	<p>Lube the air brake foot control valve, hinge and roller</p>
	<p>Inspect the drum brake linings through the inspection holes</p>
	<p>Lubricate the brake camshafts (air brakes)</p>
	<p>Lubricate the brake slack adjuster (air brakes)</p>
	<p>Inspect the disc brake pads and the piston boots (hydraulic brakes)</p>
	<p>Clutch system</p>
	<p>Lubricate the clutch release cross shaft and all linkages</p>
	<p>Check the clutch fluid</p>
	<p>Fuel system</p>
<p>Drain the accumulated water or sediment from the fuel tank(s)</p>	

General maintenance information

Check every oil change Oil change intervals are as follows: Powerstroke - 10 000 ; Caterpillar - 10 000 ; Cummins - 15 000 (refer to the Caterpillar and Cummins service manuals for further instructions and information)	Steering system
	Lubricate the steering shaft(s), U-joints and splines when equipped with grease fittings
	Lubricate the front axle spindle pins
	Lubricate the steering linkage when equipped with grease fittings
Grease the power steering gear output shaft	
<p>* Coolant protection checks should be made just prior to the onset of freezing weather, where applicable. If coolant is dirty or rusty in appearance, the system should be drained, flushed and refilled with the prescribed solution of cooling system fluid and water. Use only permanent type coolant that meets Ford specifications ESE-M97B18-C. See the engine manufacturer's operating guide for supplemental corrosion inhibitor specifications.</p>	

In addition to the items to be performed daily or at each oil change, the following need to be completed as specified:

5 000 MILES

- Initial change — change the lubricant in the manual shift transmission – 5 speed and 6 speed Eaton manual transmission. (Not required when equipped with optional synthetic lubricant.)

20 000 MILES

- Replace the fuel filter.*

30 000 MILES

- Replace the engine spin-on coolant filter.*
- Repack and adjust the front wheel bearings — grease-filled hubs.

40 000 MILES

- Replace the fuel filter.*

General maintenance information

50 000 MILES

- Disassemble the single check valve (SC-2) and the automatic drain valve (DB-2) — clean and inspect the valve for wear and deterioration.

60 000 MILES

- Replace the engine spin-on coolant filter.*
- Oil filled front hubs— drain oil, adjust bearings and refill the front hubs with oil. (Not required when equipped with optional synthetic lubricant.)
- Drain the oil, adjust the bearings and refill with axle lubricant — oil filled hubs.
- Replace the fuel filter.*
- Change the manual transmission oil — Eaton 5 and 6 speeds only. (Not required when equipped with optional synthetic lubricant.)

70 000 MILES

- Replace the engine spin-on coolant filter.*
- Replace the engine coolant.* See the engine manufacturer's operating guide for supplemental corrosion inhibitor specifications.

80 000 MILES

- Replace the fuel filter.*

90 000 MILES

- Replace the engine spin-on coolant filter*.
- Repack and adjust the front wheel bearings — grease-filled hubs.
- Change the lubricant in the manual shift transmission – 7 speed Spicer. (Not required when equipped with optional synthetic lubricant.)
- Change the power steering fluid and filter.

General maintenance information

100 000 MILES

- Disassemble the single check valve (SC-2) and the automatic drain valve (DB-2) — clean and inspect the valves for wear and deterioration.
- Lube the clutch release and the cross shaft lever.
- Replace the fuel filter.*
- Change the rear axle lubricant. (Not required when equipped with optional synthetic lubricant.)

250 000 MILES

- Change the rear axle lubricant when equipped with optional synthetic lubricant.

300 000 MILES

- Disassemble the air dryer, replace the desiccant and check the mounting of the dryer to the vehicle (if equipped).

Please continue with these scheduled maintenance intervals for your vehicle.

* Shown intervals are for Powerstroke engine only. Refer to Caterpillar and Cummins Owner Manuals for intervals for their respective engines.

500 000 MILES

- Change the lubricant in the manual shift transmission (all applications) when equipped with optional synthetic lubricant.

General maintenance information

GENERAL MAINTENANCE SERVICES

Listed below are vehicle checks that should be made periodically either by the owner or a qualified technician. It is recommended that deficiencies be brought to the attention of your dealer or another qualified service outlet as soon as possible in order that advice regarding the need for service or replacement can be obtained.

Maintenance Operation	Frequency — Observation
Clean body/door drain holes.	At least twice annually.
Clean windshield wiper blades.	As required.
Replace windshield wiper blades.	If wiping the blades with a clean cloth and mild detergent and washing the windshield with a cleaner does not restore a clean wipe.
Lubricate body lock cylinders, door and hood hinges.	Difficult to operate or noisy.
Check headlamp alignment.	Lamp beams in wrong position when vehicle operating loaded.
Check windshield washer fluid level. Add fluid if required.	If washers do not spray fluid when operated.

General maintenance information

Maintenance Operation	Frequency - Observation
Inspect the automatic slack adjuster function	Insufficient power shown in loaded practice stop
Check the operation of the brakes, the clutch, and the steering (*b,a)	Vehicle handling qualities not up to par
Inspect the vehicle for missing, damaged, or mislocated noise shields	Excessive noise emanates from under the cab or engine compartment
Check the engine performance and the engine governor	Excessive engine noise
Inspect the fan, the fan shroud, and the fan clutch	Engine overheats, fans runs at high speed constantly, excessive fan noise, or fan wobble due to worn bearings
Check for operation of ABS warning lamp	At each engine start up
Inspect the entire exhaust system (including inlet pipe, muffler, outlet pipe and all exhaust clamps and fasteners) for holes, leakage, breakage, looseness and corrosive damage	Excessive noise or the smell of fumes is experienced
Inspect the engine air induction system (including the air ducts, the air cleaner, and the air cleaner element) for loose fitting, damaged or missing components	Excessive noise emanates from the engine compartment
Inspect the tires and check the air pressure (*c)	Poor steering, wandering or excessive tire wear
Balance the wheels and the tires	Vibration or abnormal tire wear indicates imbalance
Check the front end alignment (*c)	Poor steering, wandering or excessive tire wear

General maintenance information

Maintenance Operation	Frequency - Observation
Check the transmission and engine mountings (*b)	Hard shifting or excessive vibration
Check and adjust transmission controls (*b)	High effort to shift or noisy transmission
Check fuel pump pressure	Insufficient full-throttle power or backfiring
Clean radiator cap seal. Clean and inspect the cap surface on the radiator	When the cap does not hold pressure
Check the battery terminals for corrosion	Whenever electrical power supply has diminished
Tighten the wheel mounting nuts to the specified torque. Refer to <i>Servicing your wheels and tires</i>	Required initially at 804 and 1 609 km (500 and 1 000 miles). Perform again at 804 and 1 609 km (500 and 1 000 mile) intervals after each tire removal/replacement.
*a During maintenance and repair, protect the fuel tube and the hose assemblies, the power steering lines, and the air brake lines from the external heat, the acids and the abrasion that could damage the lines.	
*b Check for (free) linkage action and ensure that (return) spring force is adequate to maintain pedal free play.	
*c Adjust, repair or replace as required with the same or equivalent parts.	

General maintenance information

Maintenance Intervals/ Service Performed	Date Service Performed	Mileage	Service Shop Name and Address

General maintenance information

Maintenance Record

Maintenance Intervals/ Service Performed	Date Service Performed	Mileage	Service Shop Name and Address

General maintenance information

Maintenance Record

Maintenance Intervals/ Service Performed	Date Service Performed	Mileage	Service Shop Name and Address

General maintenance information

Maintenance Record

Maintenance Intervals/ Service Performed	Date Service Performed	Mileage	Service Shop Name and Address

Customer assistance

Ford Extended Service Plan

You can get more protection for your new car or light truck by purchasing Ford Extended Service Plan (Ford ESP) coverage. Ford ESP is an optional service contract which is backed by Ford Motor Company or Ford Motor Service Company (in the U.S.) and Ford of Canada (in Canada). It provides the following:

- benefits during the warranty period depending on the plan you purchase (such as: reimbursement for rentals; coverage for certain maintenance and wear items)
- protection against repair costs after your Bumper to Bumper Warranty expires

You may purchase Ford ESP from any participating Ford and Lincoln/Mercury and Ford of Canada dealer. There are several plans available in various time, distance and deductible combinations which can be tailored to fit your own driving needs. Ford ESP also offers reimbursement benefits for towing and rental coverage. (In Hawaii, rules vary. See your dealer for details.)

When you buy Ford ESP, you receive Peace-of-Mind protection throughout the United States and Canada, provided by a network of more than 5,000 participating Ford or Lincoln/Mercury and Ford of Canada dealers.

If you did not take advantage of the Ford Extended Service Plan at the time of purchasing your vehicle, you may still be eligible. Please contact your dealer for further information. Since this information is subject to change, please ask your dealer for complete details about Ford Extended Service Plan coverage options.

Getting the service you need

At home

Ford Motor Company and Ford of Canada have authorized dealerships to service your vehicle. When you need warranty repairs your selling dealer would like you to return to it for that service, but you may also take your vehicle to another Ford Motor Company or Ford of Canada dealership authorized for warranty repairs. Certain warranty repairs require special training though, so not all dealers are authorized to perform all warranty repairs. That means that depending on the warranty repair needed, the vehicle may need to be taken to another dealer. If a particular dealership can not assist you, then contact the Customer Assistance Center.

Customer assistance

If you have questions or concerns, or are unsatisfied with the service you are receiving, follow these steps:

1. Contact your Sales Representative or Service Advisor at your selling/servicing dealership.
2. If your inquiry or concern remains unresolved, contact the Sales Manager or Service Manager at the dealership.
3. If the inquiry or concern cannot be resolved at the dealership level, please contact the Ford Customer Assistance Center.

Ford Motor Company and Ford of Canada dealerships also carry quality parts and accessories, providing you with equipment reliability.

Away from home

If you own a Ford or Mercury vehicle and are away from home when your vehicle needs service, or if you need more help than the dealership could provide, after following the steps described above, contact the Ford Customer Assistance Center to find an authorized dealership to help you. In the United States:

Ford Motor Company
Customer Assistance Center
16800 Executive Plaza Drive
P.O. Box 6248
Dearborn, Michigan 48121
1-800-392-3673 (FORD)
(TDD for the hearing impaired: 1-800-232-5952)

In Canada:
Customer Assistance Centre
Ford Motor Company of Canada, Limited
P.O. Box 2000
Oakville, Ontario L6J 5E4
1-800-565-3673 (FORD)

Customer assistance

If you own a Lincoln vehicle and are away from home when your vehicle needs service, or if you need more help than the dealership could provide, after following the steps described above, contact the Ford Customer Assistance Center to find an authorized dealership to help you. In the United States:

Ford Motor Company
Customer Assistance Center
16800 Executive Plaza Drive
P.O. Box 6248
Dearborn, Michigan 48121
1-800-521-4140
(TDD for the hearing impaired: 1-800-232-5952)

In Canada:
Customer Assistance Centre
Ford Motor Company of Canada, Limited
P.O. Box 2000
Oakville, Ontario L6J 5E4
1-800-565-3673 (FORD)

In order to help you service your Ford or Lincoln Mercury vehicle, please have the following information available when contacting a Customer Assistance Center:

- Your telephone number (home and business)
- The name of the dealer and the city where the dealership is located
- The year and make of your vehicle
- The date of vehicle purchase
- The current odometer reading
- The vehicle identification number (VIN)

If you still have a complaint involving a warranty dispute, you may wish to contact the Dispute Settlement Board (U.S.) or the Mediation/Arbitration Program (Canada).

In some states (in the U.S.) you must directly notify Ford in writing before pursuing remedies under your state's warranty laws. Ford is also allowed a final repair attempt in some states.

In the United States, a warranty dispute must be submitted to the Dispute Settlement Board before taking action under the Magnuson-Moss Warranty Act, or to the extent allowed by state law, before pursuing replacement or repurchase remedies provided by certain state laws. This

Customer assistance

dispute handling procedure is not required prior to enforcing state created rights or other rights which are independent of the Magnuson-Moss Warranty Act or state replacement or repurchase laws.

THE DISPUTE SETTLEMENT BOARD (U.S. only)

The Dispute Settlement Board is:

- an independent, third-party arbitration program for warranty disputes
- available free to owners and lessees of qualifying Ford Motor Company vehicles

The Dispute Settlement Board may not be available in all states. Ford Motor Company reserves the right to change eligibility limitations, modify procedures and/or to discontinue this service without notice and without incurring obligations per applicable state law.

What kinds of cases does the Board review?

Unresolved warranty repair concerns or vehicle performance as designed concerns on Ford and Lincoln Mercury cars and Ford and Lincoln Mercury light trucks which are within the terms of any applicable written new vehicle warranty are eligible for review, except those involving:

- a non-Ford product
- a non-Ford dealership
- sales disputes between customer and dealer except those associated with warranty repairs or concerns with the vehicle's performance as designed
- a request for reimbursement of consequential expenses unless a service or product concern is being reviewed
- items not covered by the New Vehicle Limited Warranty (including maintenance and wear items)
- alleged personal injury/property damage claims
- cases currently in litigation
- vehicles not used primarily for family, personal or household purposes (except in states where the Dispute Settlement Board is required to review commercial vehicles)
- vehicles with non-U.S. warranties

Customer assistance

Concerns are ineligible for review if the New Vehicle Limited Warranty has expired at receipt of your application and, in certain states eligibility is dependent upon the customer's possession of the vehicle.

Eligibility may differ according to state law. For example, see the unique brochures for California, West Virginia, Georgia and Wisconsin purchasers/lessees.

Board membership

The Board consists of:

- three consumer representatives
- a Ford or Lincoln Mercury dealership representative

Consumer candidates for Board membership are recruited and trained by an independent consulting firm. The dealership Board member is chosen from Ford and Lincoln Mercury dealership management, recognized for their business leadership qualities.

What the Board needs

To have your case reviewed you must complete the application in the DSB brochure and mail it to the address provided on the application form. Some states will require you to use certified mail, with return receipt requested.

Your application is reviewed and, if it is determined to be eligible, you will receive an acknowledgment indicating:

- the file number assigned to your application
- the toll-free phone number of the DSB's independent administrator

Your dealership and a Ford Motor Company representative will then be asked to submit statements.

To properly review your case, the Board needs the following information:

- legible copies of all documents and maintenance or repair orders relevant to the case
- the year, make, model, and Vehicle Identification Number (VIN) listed on your vehicle ownership license
- the date of repair(s) and mileage at the time of occurrence(s)
- the current mileage
- the name of the dealer(s) who sold or serviced the vehicle
- a brief description of your unresolved concern

Customer assistance

- a brief summary of the action taken by the dealer(s) and Ford Motor Company
- the names (if known) of all the people you contacted at the dealership(s)
- a description of the action you expect to resolve your concern

You will receive a letter of explanation if your application does not qualify for Board review.

Oral presentations

If you would like to make an oral presentation, indicate YES to question #6 on the application. While it is your right to make an oral presentation before the Board, this is not a requirement and the Board will decide the case whether or not an oral presentation is made. Oral presentation may be requested by the Board as well.

Making a decision

Board members review all available information related to each complaint, including oral presentations, and arrive at a fair and impartial decision. Board review may be terminated at any time by either party.

Every effort is made to decide the case within 40 days of the date that all requested information is received by the Board. Since the Board generally meets once a month, it may take longer for the Board to consider some cases.

After a case is reviewed, the Board mails you a decision letter and a form on which to accept or reject the Board's decision. The decisions of the Board are binding on Ford (and, in some cases, on the dealer) but not on consumers who are free to pursue other remedies available to them under state or federal law.

To Request a DSB Brochure/Application

For a brochure/application, speak to your dealer or write/call to the Board at the following address/phone number:

Dispute Settlement Board
P.O. Box 5120
Southfield, MI 48086-5120
1-800-428-3718

Customer assistance

You may also contact the North American Customer Assistance Center at 1-800-392-3673 (Ford), TDD for the hearing impaired: 1-800-232-5952 or by writing to the Center at the following address:

Ford Motor Company
Customer Assistance Center
16800 Executive Plaza Drive
P.O. Box 6248
Dearborn, Michigan 48121

UTILIZING THE MEDIATION/ARBITRATION PROGRAM (CANADA ONLY)

In those cases where you continue to feel that the efforts by Ford and the dealer to resolve a factory-related vehicle service concern have been unsatisfactory, Ford of Canada participates in an impartial third party mediation/arbitration program administered by the Canadian Motor Vehicle Arbitration Plan (CAMVAP).

The CAMVAP program is a straight-forward and relatively speedy alternative to resolve a disagreement when all other efforts to produce a settlement have failed. This procedure is without cost to you and is designed to eliminate the need for lengthy and expensive legal proceedings.

In the CAMVAP program, impartial third-party arbitrators conduct hearings at mutually convenient times and places in an informal environment. These impartial arbitrators review the positions of the parties, make decisions and, when appropriate, render awards to resolve disputes. CAMVAP decisions are fast, fair, and final; the arbitrator's award is binding both to you and Ford of Canada.

CAMVAP services are available in all territories and provinces, except Quebec. For more information, without charge or obligation, call your CAMVAP Provincial Administrator directly at 1-800-207-0685.

GETTING ASSISTANCE OUTSIDE THE U.S. AND CANADA

Before exporting your vehicle to a foreign country, contact the appropriate foreign embassy or consulate. These officials can inform you of local vehicle registration regulations and where to find unleaded fuel.

If you cannot find unleaded fuel or can only get fuel with an anti-knock index lower than is recommended for your vehicle, contact a district or owner relations/customer assistance office.

Customer assistance

The use of leaded fuel in your vehicle without proper conversion may damage the effectiveness of your emission control system and may cause engine knocking or serious engine damage. Ford Motor Company/Ford of Canada is not responsible for any damage caused by use of improper fuel.

In the United States, using leaded fuel may also result in difficulty importing your vehicle back into the U.S.

If your vehicle must be serviced while you are traveling or living in Central or South America, the Caribbean, or the Middle East, contact the nearest Ford dealership. If the dealership cannot help you, write or call:

FORD MOTOR COMPANY
WORLDWIDE DIRECT MARKET OPERATIONS
1555 Fairlane Drive
Fairlane Business Park #3
Allen Park, Michigan 48101
U.S.A.
Telephone: (313) 594-4857
FAX: (313) 390-0804

If you are in another foreign country, contact the nearest Ford dealership. If the dealership employees cannot help you, they can direct you to the nearest Ford affiliate office.

If you buy your vehicle in North America and then relocate outside of the U.S. or Canada, register your vehicle identification number (VIN) and new address with Ford Motor Company Worldwide Direct Market Operations.

FORD CAR CARE PRODUCTS FOR YOUR VEHICLE

Ford has many quality products available from your dealer to clean your vehicle and protect its finishes. These quality products have been specifically engineered to fulfill your automotive needs; they are custom designed to complement the style and appearance of your vehicle. Each product is made from high quality materials and that meet or exceed Ford's rigid specifications. For best results, use the following or products of equivalent quality:

Ford Custom Clearcoat Polish*

Ford Custom Silicone Gloss Polish

Ford Custom Vinyl Protectant* (not available in Canada)

Motorcraft Vinyl Conditioner (Canada only)

Customer assistance

Ford Deluxe Leather and Vinyl Cleaner (not available in Canada)

Motorcraft Vinyl Cleaner (Canada only)

Ford Extra Strength Tar and Road Oil Remover* (not available in Canada)

Ford Extra Strength Upholstery Cleaner (Canada only)

Ford Extra Strength Upholstery Cleaner (not available in Canada)

Ford Metal Surface Cleaner

Ford Multi-Purpose Cleaner*

Motorcraft Car Wash Concentrate

Motorcraft Carlite Glass Cleaner

Ford Spot and Stain Remover*

Ford Super Premium Tire and Trim Dressing

Ford Triple Clean

Ford Ultra-Clear Spray Glass Cleaner (not available in Canada)

* May be sold with the Motorcraft name

FORD ACCESSORIES FOR YOUR VEHICLE

A wide selection of Ford accessories are available for your vehicle through your local authorized Ford, Lincoln Mercury or Ford of Canada dealer. These quality accessories have been specifically engineered to fulfill your automotive needs; they are custom designed to complement the style and aerodynamic appearance of your vehicle. In addition, each accessory is made from high quality materials and meets or exceeds Ford's rigid engineering and safety specifications. Ford accessories are warranted for up to 12 months or 20 000 km (12 000 miles) on all cars and light trucks and 12 months with unlimited distance on medium/heavy duty trucks unless the accessory is installed on a new vehicle, then the warranty becomes the balance of the new vehicle's warranty or the accessories warranty, whichever is greater. See your dealer for complete warranty information and availability.

Not all accessories are available for all models.

Customer assistance

ORDERING ADDITIONAL OWNER'S LITERATURE

To order the publications in this portfolio:

Make checks payable to:

HELM, INCORPORATED

P.O. Box 07150

Detroit, Michigan 48207

For a free publication catalog, order toll free: 1-800-782-4356

Monday-Friday 8:00 a.m. - 6:00 p.m. EST,

for credit card holders only

Obtaining a French owner's guide

French Owner's Guides can be obtained from your dealer or by writing to Ford Motor Company of Canada, Limited, Service Publications, P.O. Box 1580, Station B, Mississauga, Ontario L4Y 4G3.

Reporting safety defects

REPORTING SAFETY DEFECTS (U.S. ONLY)

If you believe that your vehicle has a defect that could cause a crash, or could cause injury or death, you should immediately inform the National Highway Traffic Safety Administration (NHTSA) in addition to notifying Ford Motor Company.



If NHTSA receives similar complaints, it may open an investigation, and if it finds that a safety defect exists in a group of vehicles, it may order a recall and remedy campaign. However, NHTSA cannot become involved in individual problems between you, your dealer or Ford Motor Company.

To contact NHTSA, you may either call the Auto Safety Hotline toll-free at 1-800-424-9393 (202-366-0123 in the Washington D.C. area) or write to:

NHTSA
U.S. Department of Transportation
400 Seventh Street
Washington D.C. 20590

You can also obtain other information about motor vehicle safety from the Hotline.

Index

- Air cleaner filter142
- Air conditioning21
- Audio system (see Radio)26
- Automatic transmission102
- Auxiliary power point21
- Battery140
 - jumping a disabled battery125
 - voltage gauge18
- Belt minder67
- Brakes82,84,87
 - anti-lock82,83,84,90
 - anti-lock brake system (ABS) warning light12,83
 - brake warning light10,11
 - fluid, checking and adding131
 - parking85,87,90
 - trailer93
- Child safety restraints71
 - child safety belts71
- Child safety seats72,73
 - attaching with tether straps75
 - in front seat74
 - in rear seat74
 - tether anchorage hardware76
- Cleaning your vehicle164
 - engine compartment165
 - exterior165
 - exterior lamps166
 - instrument panel166
 - instrument panel lens167
 - interior167
 - plastic parts166
 - safety belts167
 - washing164
 - waxing164
 - wheels165
 - wiper blades166
- Climate control (see Air conditioning or Heating)21
- Clock29,36,45
- Clutch132
 - fluid132
- Coolant134
 - checking and adding134
- Cruise control (see Speed control)51
- Customer Assistance114
 - Ford accessories for your vehicle201
 - Ford Extended Service Plan194
 - Getting assistance outside the U.S. and Canada200
 - Getting roadside assistance ...114
 - Getting the service you need194
 - Ordering additional owner's literature203
 - The Dispute Settlement Board197
 - Utilizing the Mediation/Arbitration Program200
- Daytime running lamps (see Lamps)20
- Driving under special conditions
 - through water112
- Emergencies, roadside
 - jump-starting125
- Emission control system176
- Engine
 - check engine/service engine soon light14
 - cleaning165
 - coolant134
- Engine block heater80
- Engine fan136
- Engine oil127
 - checking and adding127
 - oil pressure gauge19
 - recommendations129
- Exhaust fumes81
- Fuel151

Index

- calculating
 - fuel economy112,157
 - choosing the right fuel152
 - filling your vehicle with fuel ..151
 - filter, specifications154,155
 - gauge16
 - improving
 - fuel economy112,157
 - safety information relating to automotive fuels151
- Fuses115,116
- Gas mileage
(see Fuel economy)112,157
- Gauges16
 - battery voltage gauge18
 - engine coolant temperature gauge16
 - engine oil pressure gauge19
 - fuel gauge16
 - odometer17
 - speedometer17
 - tachometer18
 - trip odometer18
- Hazard flashers115
- Headlamps20
 - aiming163
 - daytime running lights20
 - flash to pass50
 - high beam12,50
 - turning on and off20
 - warning chime15
- Heating21
 - heater only system21
 - heating and air conditioning system23
- Hood126
- Ignition
 - positions of the ignition49
 - removing the key101
- Infant seats
(see Safety seats)72,73
- Instrument panel
 - cleaning166
 - cluster167
 - lighting up
 - panel and interior20
 - location of components10
- Jump-starting your vehicle125
- Keys
 - key in ignition chime15
 - positions of the ignition49
 - removing from the ignition101
- Lamps
 - cargo lamps20
 - daytime running light20
 - headlamps20
 - headlamps, flash to pass50
 - instrument panel, dimming20
 - replacing bulbs ..159,160,161,162
- Lane change indicator
(see Turn signal)49
- Lights, warning and indicator10
 - anti-lock brakes (ABS)12,83
 - brake10,11
 - charging system10
 - check coolant14
 - high beam12
 - safety belt14
 - service engine soon14
 - turn signal indicator12
- Lubricant specifications169
- Maintenance and Care179
- Manual transmission97
- Mirrors57
- Odometer17
- Parking brake85,87,90
- Power distribution box
(see Fuses)119
- Power door locks56
- Power steering95,96
 - fluid, checking and adding136
- Radio26
- Refill capacities for fluids168

Index

- Relays115
- Safety belts
 - (see Safety restraints)61,62,63
- Safety defects, reporting204
- Safety restraints61,62,63
 - belt minder67
 - cleaning the safety belts ...70,167
 - extension assembly66
 - for adults62,63
 - for children71
 - lap belt65
 - warning light
 - and chime14,15,66
- Safety seats for children72,73
- Seat belts
 - (see Safety restraints)61
- Seats58
 - child safety seats72,73
- Servicing your vehicle179
- Speed control51
- Speedometer17
- Starting your vehicle77
 - jump starting125
 - preparing to start your
 - vehicle77
- Tachometer18
- Tires
 - checking the pressure151
- Towing
 - wrecker125
- Transmission
 - fluid, checking and adding
 - (automatic)137
 - fluid, checking and adding
 - (manual)137
 - manual operation97
- Trip odometer18
- Turn signal12,49
- Vehicle Identification Number (VIN)173
- Vehicle loading111
- Warning chimes10,15
- Warning lights (see Lights)10
- Washer fluid133
 - reservoir133
- Water, Driving through112
- Wheels147
- Windows
 - power55
- Windshield washer
 - fluid and wipers
 - checking and cleaning146
 - operation50
 - replacing wiper blades146
- Wrecker towing125

