

Before driving

Introduction	2
Instrumentation	4
Controls and features	14
Seating and safety restraints	44

Starting and driving

Starting	76
Driving	84
Roadside emergencies	107

Servicing

Maintenance and care	125
Capacities and specifications	183
Reporting safety defects (U. S. only)	189
Index	190

Introduction

ICONS

Indicates a warning. Read the following section on *Warnings* for a full explanation.



Indicates that vehicle information related to recycling and other environmental concerns will follow.



We must all play our part in protecting the environment. Correct vehicle usage and the authorized disposal of waste cleaning and lubrication materials are significant steps toward this aim.

WARNINGS

How can you reduce the risk of personal injury and prevent possible damage to others, your vehicle and its equipment?

In this owner's guide, answers to such questions are contained in comments highlighted by the warning triangle symbol.

BREAKING IN YOUR VEHICLE

There are no particular breaking-in rules for your vehicle. Simply avoid driving too fast during the first 1 600 km (1 000 miles). Vary speeds frequently. This is necessary to give the moving parts a chance to break in.

If possible, you should avoid hard braking for the first 1 600 km (1 000 miles).

From 1 600 km (1 000 miles) onwards you can gradually increase the performance of your vehicle up to the permitted maximum speeds.

INFORMATION ABOUT THIS GUIDE

The information found in this guide was in effect at the time of printing. Ford may change the contents without notice and without incurring obligation.

Instrumentation

Page 17
Power mirrors

Page 27
Turn signal/high beam

Page 26
Hazard flasher control

Page 6
Instrument cluster

Page 28
Windshield wiper/washer control

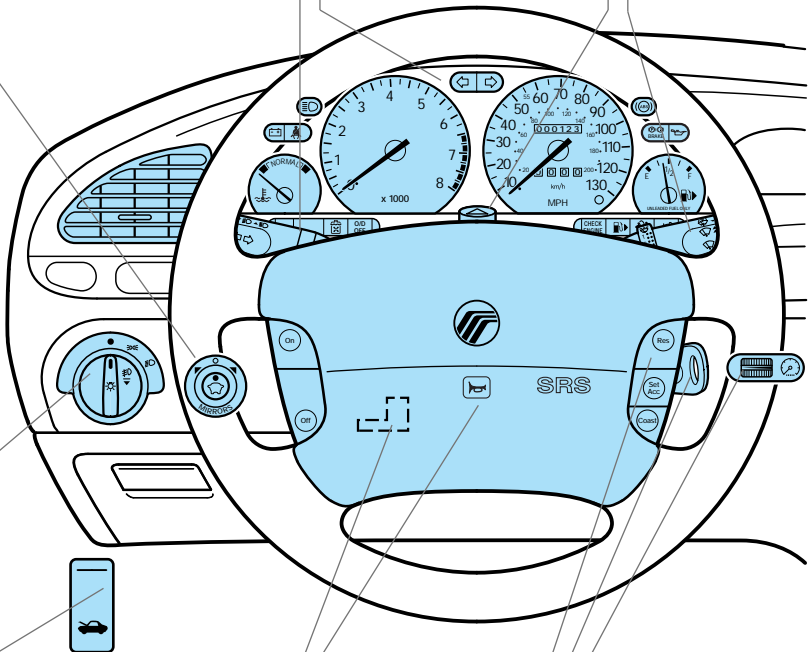

Page 129
Hood release

Page 26
Horn

Page 16
Instrument panel dimmer switch

Page 14
Headlamp control/
Foglamp control*

Page 25
Tilt steering wheel lever

Page 24
Ignition switch

Page 29
Speed control*

Instrumentation

Page 16
Rear window
defroster control*

On various models the appearance and location of some items may differ from those shown here. However, the page references given still apply.

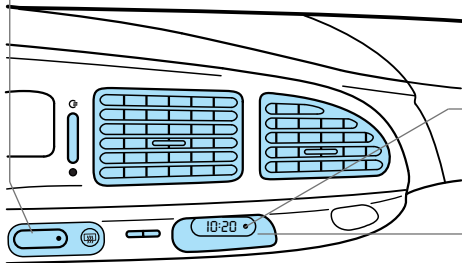

Page 42
Anti-theft system status
indicator*

Page 18
Clock

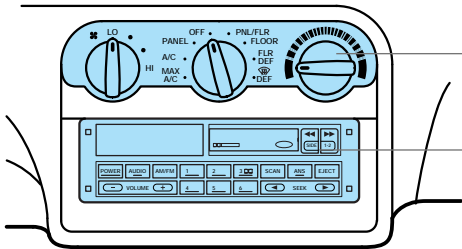

Page 19
Climate control system

Electronic sound system;
refer to "Audio Guide"

* if equipped

Instrumentation

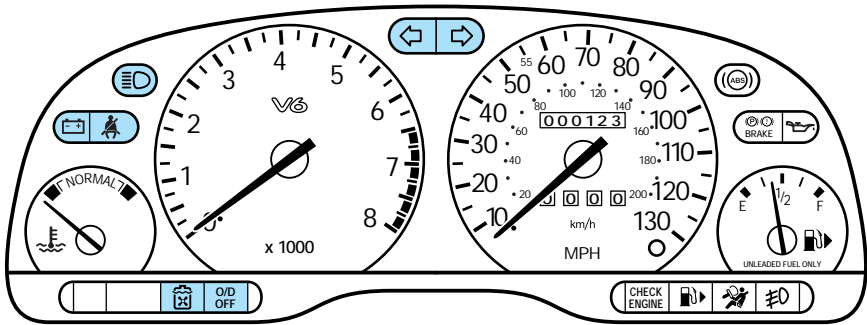

INSTRUMENT CLUSTER LIGHTS AND CHIMES

Turn signal

Flashes when the left or right turn signal or hazard lights are activated.

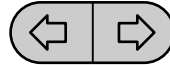

High beams

Illuminates when the headlamp high beams are on.



Charging system

Briefly illuminates when the ignition is turned on and the engine is off. The light also illuminates when the battery is not charging properly and the vehicle may require electrical system service.



Safety belt

Illuminates when the ignition is switched on as a reminder to fasten the safety belts. For more information, refer to *Safety belt indicator light and warning chime* in the *Seating and safety restraints* chapter.



Low coolant (if equipped)

Briefly illuminates when the ignition is turned on and the engine is off. Illuminates when the engine coolant level is low. Refer to the *Maintenance and care* chapter to check the engine coolant level.

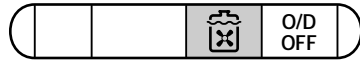

O/D Off indicator (Automatic transaxle only)

Illuminates and remains illuminated when the transaxle control switch (TCS) on the end of the gearshift lever is pressed and overdrive is turned off.

Indicates the status of the transaxle and will flash steadily if a malfunction is detected. If the flashing persists, have your transaxle serviced by your dealer or a qualified service technician as soon as possible.

If the condition persists, your transaxle may be damaged.

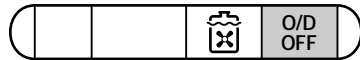

Instrumentation

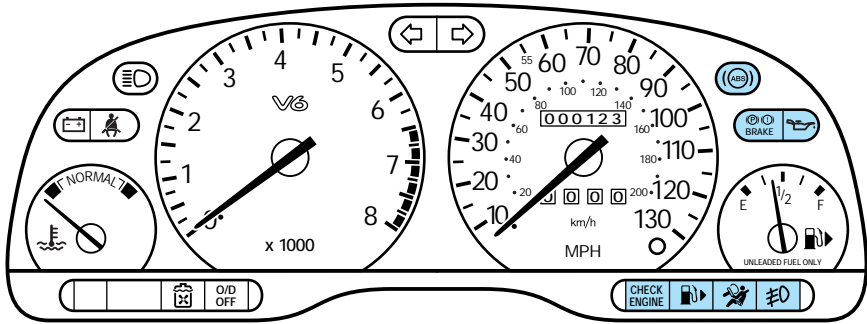

Check engine

Illuminates when the ignition is turned on and the engine is off. Also illuminates when the engine's emission control system requires service or if the fuel filler cap is not fitted correctly.

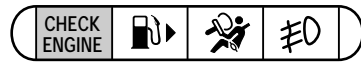

Low fuel

Illuminates when the fuel level is low.



Air bag readiness

Briefly illuminates when the ignition is turned on. If the light fails to illuminate, continues to flash or remains on, have the system serviced immediately.



Front foglamps

Illuminates when foglamps are switched on.

Refer to *Foglamps control* in the *Controls and features* chapter for notes on use.

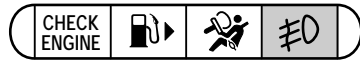

Brake system warning light

Extinguishes when the parking brake is released. Illuminates after releasing the parking brake to indicate low brake fluid level.



Engine oil pressure

Briefly illuminates when the ignition is turned on and the engine is off. The light also illuminates when engine oil pressure has been lost. Refer to the *Maintenance and care* chapter to check the engine oil level as soon as possible. If the engine oil level is correct and the light stays on, see your dealer or qualified service technician.



Anti-lock brake system (ABS) (if equipped)

Momentarily illuminates when the ignition is turned on and the engine is off. If the light stays on or continues to flash, the ABS needs to be serviced.



Instrumentation

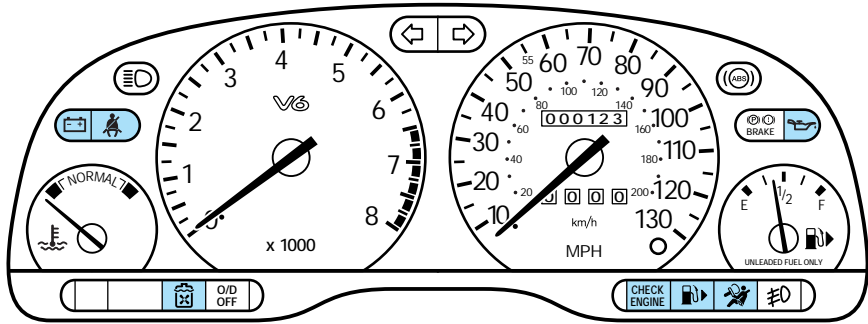

Testing the warning and indicator lights and chimes

Turn the ignition key to the on position without starting the engine. The following warning and indicator lights will illuminate briefly: charging system, safety belt (does not illuminate, if the driver's safety belt is fastened), low coolant, low fuel, engine oil pressure, check engine and air bag readiness.

If any of these lights do not illuminate, see your dealer or qualified service technician.

Headlamps on warning chime

Sounds when the headlamps are on, the ignition is off (and the key is not in the ignition) and the driver's door is open.

Key-in-ignition warning chime

Sounds when the key is left in the off/lock or accessory position and the driver's door is open.

Safety belt warning chime

For information on the safety belt warning chime, refer to the *Seating and safety restraints* chapter.

Air bag supplemental restraint system (SRS) warning chime

For information on the SRS warning chime, refer to the *Seating and safety restraints* chapter.

Instrumentation

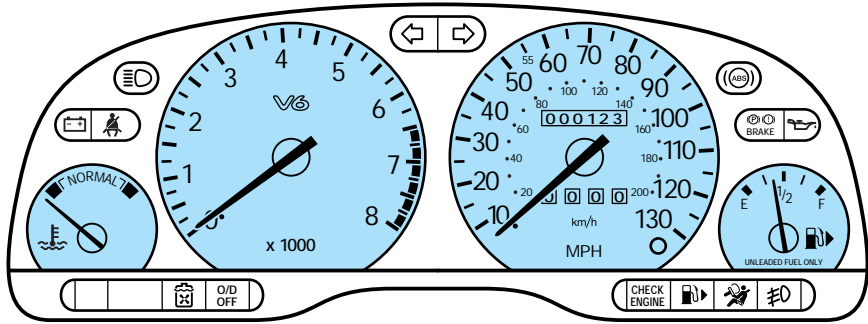

INSTRUMENT CLUSTER GAUGES

Engine coolant temperature gauge

Indicates the temperature of the engine coolant. At normal operating temperature, the needle remains within the NORMAL area. If it enters the red section, the engine is overheating. Switch off the ignition and determine the source of the problem. Refer to *Checking and adding engine coolant* in the *Maintenance and care* chapter.

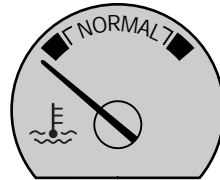

Instrumentation

Tachometer

Indicates the engine speed in revolutions per minute (rpm).

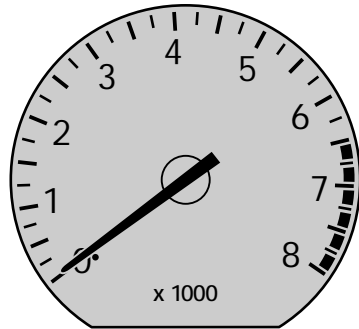

Speedometer

Indicates the current vehicle speed.

Odometer

Registers the total mileage of the vehicle.

Trip odometer

The trip odometer can register the mileage of individual journeys. To reset, depress the button.

Speedometer

Odometer

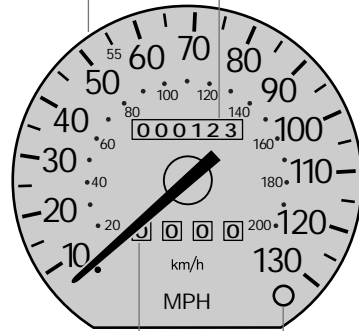

Trip odometer

Reset button

Fuel gauge

The fuel gauge displays the approximate level of usable fuel left in the fuel reservoir.

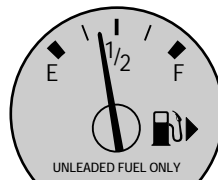

Controls and features

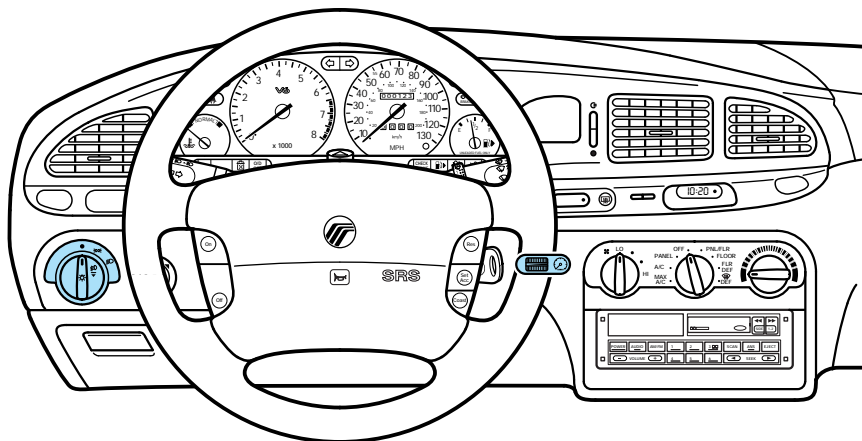

INSTRUMENT PANEL CONTROLS

Headlamp control

- Lamps off.

☰ Turn one position clockwise:
Parking lamps, instrument panel
lamps, license plate lamps and tail
lamps on

☰☰ Turn two positions clockwise:
Headlamps on.

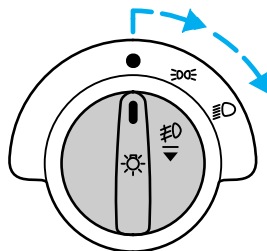

Controls and features

Foglamp control (if equipped)

Pull out the control while the headlamps are on to turn the foglamps on.

Push the control in to deactivate the foglamps.

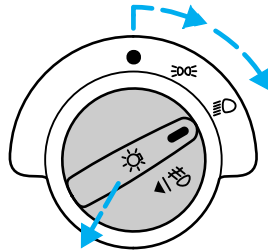

Daytime running light (DRL) (Canadian vehicles only)

The DRL system turns on the highbeam headlamps, with a reduced light output, when:

- the vehicle is running and the ignition is in the on position,
- the vehicle has a fully released parking brake, and
- the headlamp system is in the off position.

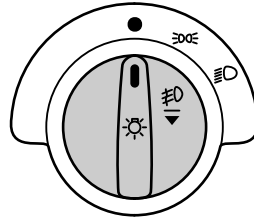

The daytime running light (DRL) system will not illuminate the tail lamps and parking lamps. Turn on your headlamps at dusk. Failure to do so may result in a collision.

Controls and features

Rear window defroster (if equipped)

Press the defroster control to clear the rear window of thin ice and fog.

The ignition must be in the on position to operate the rear window defroster.

The defroster turns off automatically after 10 minutes or when the ignition is turned to the off position. To manually turn off the defroster, push the control again.

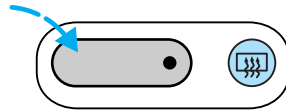

Panel dimmer control

Adjust the control to vary the intensity of the panel lighting. Operates only when the exterior lights are switched on.

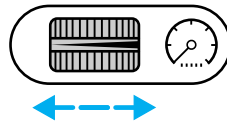

Controls and features

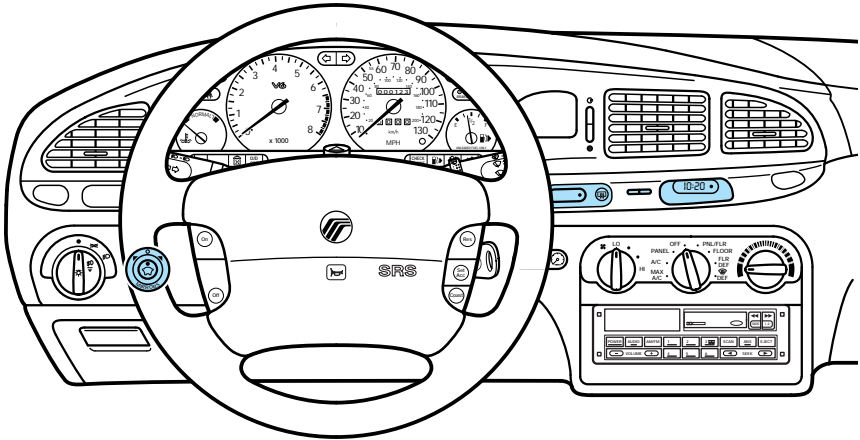

Power mirrors

The control can be swivelled and turned.

Turn the control counterclockwise to adjust the driver's side mirror, clockwise to adjust the passenger's side mirror. Adjust the selected mirror by moving the center control in the desired direction. Then turn the control back to the center position.

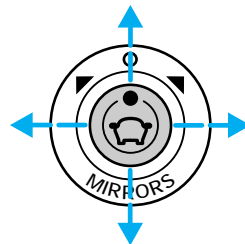
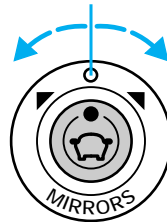

Controls and features

Digital clock

Switch the ignition on: The clock can be set to either 12 or 24 hour format.

To toggle between 12 or 24 hour format, depress the H button and the M button simultaneously and then release them.

To advance the hours, press the H button; to advance the minutes press the M button. To advance rapidly, depress and hold the corresponding button.

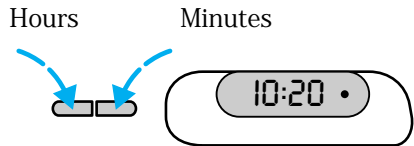

Audio system

For information on the audio system, refer to the “Audio Guide”.

Controls and features

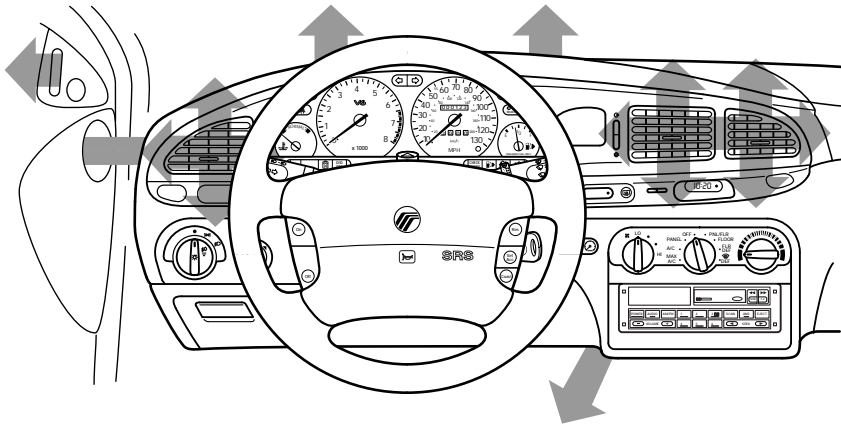

Climate controls

Your vehicle has one of the following climate control systems:

- Manual heating system
- Manual heating and air conditioning system

In some modes, the two systems function similarly. In modes where the systems do not function similarly, the different functions are noted.

Vents

Airflow from the vents may be adjusted by moving the horizontal control or vertically adjusting the vent according to your airflow preference.

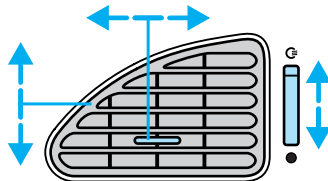

Controls and features

Temperature

Turn the temperature control to the desired mix of warm or cool air (left for cooler and right for warmer).

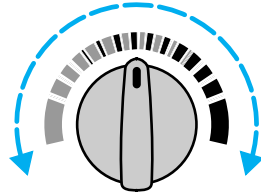

Fan speed

Turn the fan speed control to the desired speed.

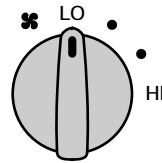

Controlling airflow

Turn the mode control to the desired airflow position.

The A/C compressor (if equipped) operates in the positions marked *.

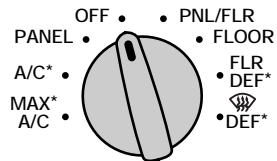

Controls and features

Using MAX A/C mode (if equipped)

The MAX A/C mode recirculates the air and directs it to flow through the instrument panel vents.

This mode is noisier, but provides quicker cooling than the A/C mode. The A/C compressor only functions if the outside temperature is above 10°C (50°F).

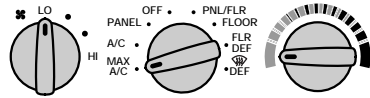

Using A/C mode (if equipped)

The A/C mode directs outside conditioned air to flow through the instrument panel vents. The A/C mode can be used for heating, ventilating and air conditioning. The A/C compressor only functions in the A/C mode if the outside temperature is above 10°C (50°F).

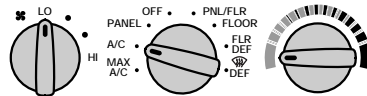

Controls and features

Using the **PANEL** mode

The panel mode directs outside air to the panel vents.

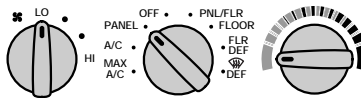

OFF mode

Select the off position for all climate control functions to cease. The outside inlet door will close and the fan will shut off.

Drive with the climate control system on (either in heating or A/C mode) to reduce humidity in your vehicle.

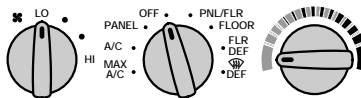

Using the **PNL/FLR** mode

The panel/floor mode directs outside air to flow through both the panel and floor vents.

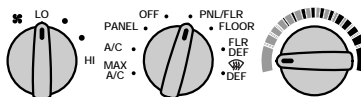

Using the **FLOOR** mode

The floor mode directs outside air to the floor vents.

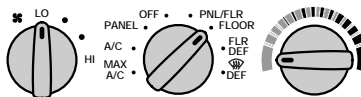

Controls and features

Using the FLR/DEF mode

The floor/defrost mode directs outside air to flow through the floor vents and windshield defroster vents. The A/C compressor (if equipped) will function to dehumidify the windows provided the outside temperature is above 10°C (50°F).

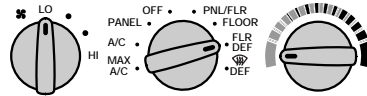

Using the DEF mode

In addition to defogging and demisting the front windshield, the defrost mode of your vehicle also has the capability to demist the front side windows. The A/C compressor (if equipped) will function to dehumidify the windows provided the outside temperature is above 10°C (50°F).

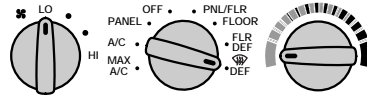

Passenger compartment air filter

Your vehicle is equipped with an air filter that removes pollen and road dust from outside air before it is directed to the interior of the vehicle. Refer to the *Maintenance and care* chapter for maintenance of this filter.

Controls and features

STEERING COLUMN CONTROLS

Ignition

1. Ignition off, steering wheel locked.

On vehicles with automatic transaxles, the ignition key can return to this position only if the gearshift lever is in P (Park).

2. The accessory position. Steering unlocked, radio operational. Ignition and all main electrical circuits are disabled.

The ignition key should not be left in this position for too long to avoid discharging the battery unnecessarily.

3. Ignition switched on, all electrical circuits operational. Warning and indicator lights illuminate. This key position is for normal driving.

4. Starter motor activated. Release the key as soon as the engine starts.

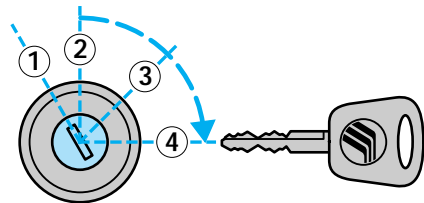
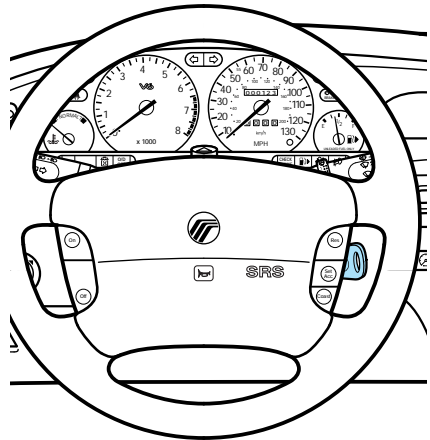

Controls and features

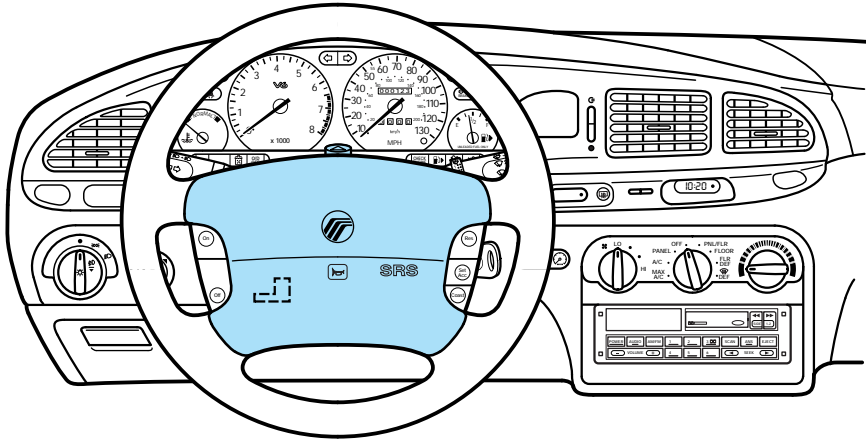

Tilt steering

Pull the locking lever on the steering column cover up to adjust the steering column position. Secure the wheel by pushing the locking lever down.



Never adjust the steering wheel while the vehicle is moving.

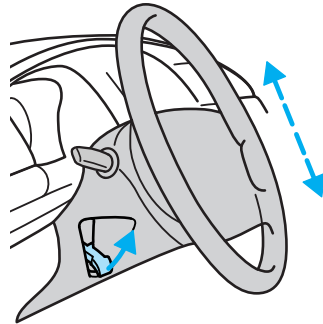

Controls and features

Hazard flasher control

Use only in an emergency to warn traffic of vehicle breakdown or approaching danger. Depress to activate. Depress again to switch off. The hazard lights can be operated when the ignition is off.

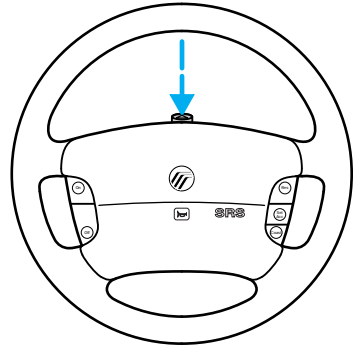

Horn

Press the pad. The horn can be operated when the ignition is off.

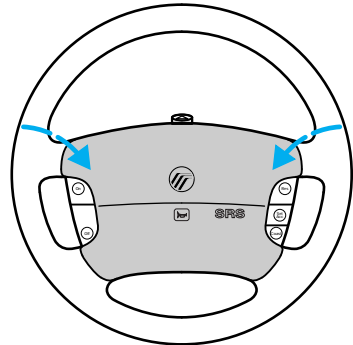

Controls and features

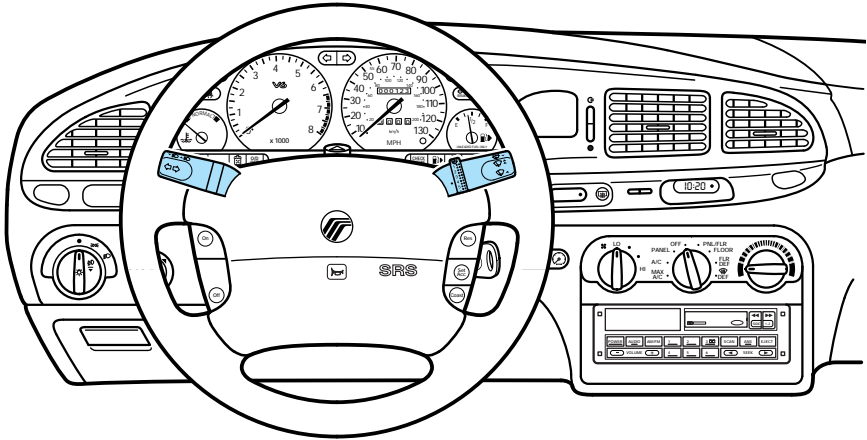

Multi-function switch

The turn signal functions are available only with the ignition switch on.

Right turn signal

Move the lever up.

Left turn signal

Move the lever down.

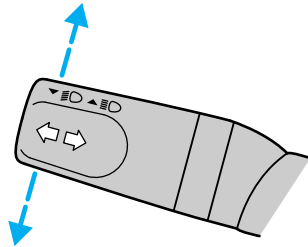

Flash-to-pass

Pull the lever toward you and release quickly for “flash-to-pass” operation.

High beam Headlamps

Push the lever toward the instrument panel.

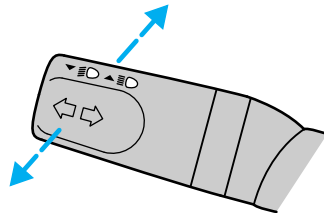

Controls and features

Windshield wipers and washer

Wipers

Lift the windshield wiper lever to the desired speed interval.

- Intermittent: push lever up to the first position.
- Low: push lever up to the second position.
- High: push lever up to the third position.

For a single wipe, push the lever downward.

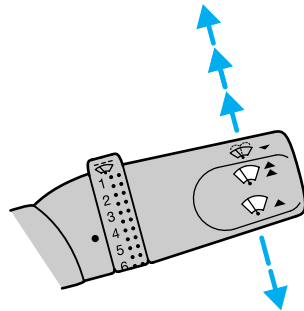

Intermittent wiper control (if equipped)

Rotate the variable intermittent wiper control to the desired speed.

1 = Short time interval

6 = Extended time interval

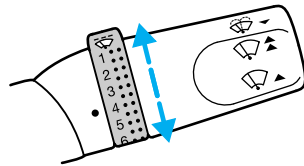

Washer

Pull the lever toward the steering wheel. The washer operates in conjunction with the windshield wipers.

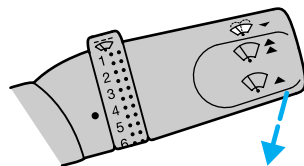

Controls and features

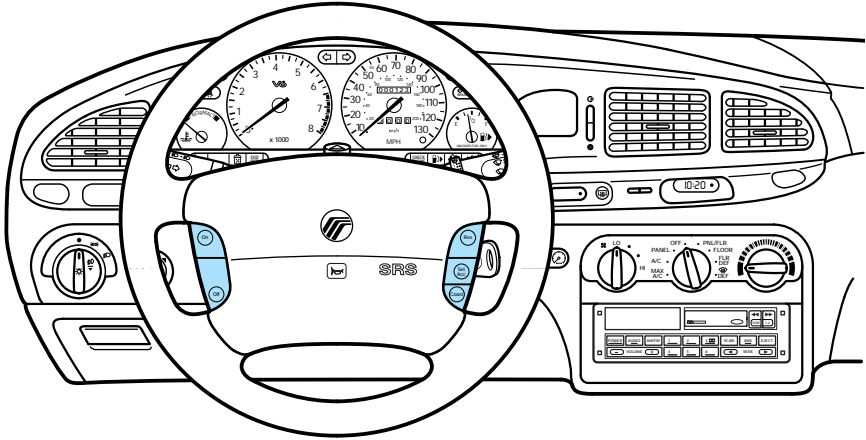

Speed control (if equipped)



Do not use the speed control in heavy traffic or on roads that are winding, slippery, or unpaved.

To turn speed control off

- Press Off or
- turn off the vehicle ignition.

Once speed control is switched off, the previously programmed set speed will be erased.

To turn speed control on

- Press On.

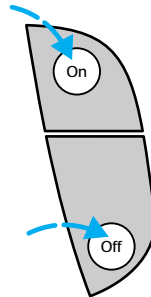

Controls and features

To set a speed

Press Set Acc. For speed control to operate, the speed control must be on and the vehicle speed must be greater than 48 km/h (30 mph).

If you drive up or down a steep hill, your vehicle speed may vary momentarily slower or faster than the set speed. This is normal.

Speed control cannot reduce the vehicle speed if it increases above the set speed on a downhill. If your vehicle speed is faster than the set speed while driving on a downhill in overdrive, you may want to shift to the next lower gear to reduce your vehicle speed.

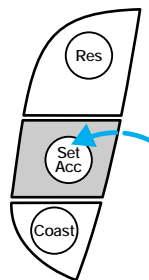

If your vehicle slows down more than 16 km/h (10 mph) below your set speed on an uphill, your speed control will disengage. This is normal. Press Res to re-engage it.

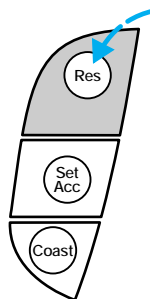

Controls and features

To set a higher speed

- Press and hold Set Acc. Release when the desired set speed is reached, or
- press and release Set Acc. Each press will increase the set speed by 1.6 km/h (1 mph) or
- accelerate with your accelerator pedal, then press Set Acc.

You may accelerate with the accelerator pedal at any time during speed control usage. Releasing the accelerator pedal will return your vehicle speed to the previously set speed.

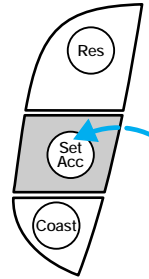

To set a lower speed

- Press and hold Coast. Release the control when the desired vehicle speed is reached, or
- press and release Coast. Each press will decrease the set speed by 1.6 km/h (1 mph), or
- depress the brake pedal. When the desired vehicle speed is reached, press Set Acc.

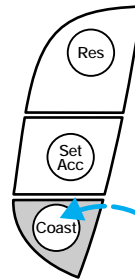

Controls and features

To return to a set speed

- Press Res. For Res to operate, the vehicle speed must be faster than 48 km/h (30 mph).

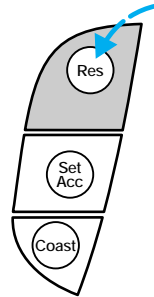

To disengage speed control

- Depress the brake pedal.

Disengaging the speed control will not erase the previously programmed set speed.

Controls and features

OVERHEAD CONTROLS

Interior lamps

The interior lamps have three switch positions: door delay, off and on.

When the control is switched to door delay (12 SEC), the interior light stays on for 12 seconds after the doors are closed with the ignition off.

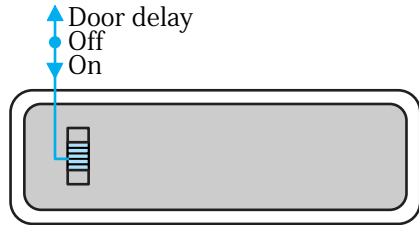

Reading lamps (if equipped)

The reading lamps are operated by separate on/off switches and can be adjusted to point in the desired direction.

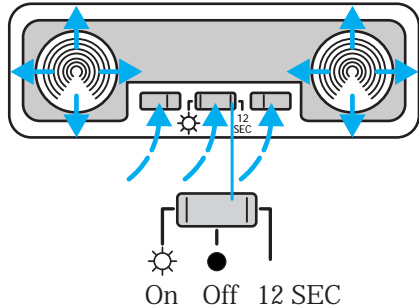

Sunroof (if equipped)

The electric sunroof can be operated only when the ignition is switched on.

To open and close the sunroof

Press the rear part of the control on the rocker switch in the roof console to open the sunroof. Press the front control to close it.

To lift the rear of the sunroof

Close the sunroof and press the front part of the control again. Press the rear control to lower the sunroof.

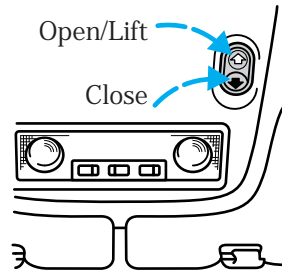

Controls and features

DOOR MOUNTED CONTROLS

Power door locks (if equipped)

Push to lock or unlock all doors.

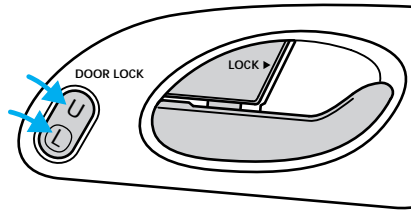

Power windows (if equipped)

The windows will only operate when the ignition is switched on. Press the appropriate control to operate the power windows at each door position. All of the windows can be controlled from the control on the driver's door. The passenger's door window and the rear windows can be operated individually with separate door controls on the respective door.

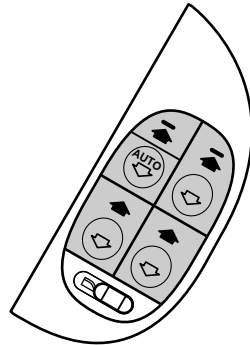

One-touch down feature (driver only)

Briefly press the control to the second action point: the window opens automatically.

Press again to stop the window while it is in motion.

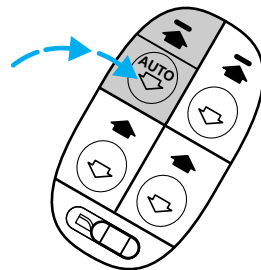

Controls and features

Safety switch

Move the switch to the right to prevent passengers from operating the windows.

Move the switch to the left to allow passengers to operate the windows.

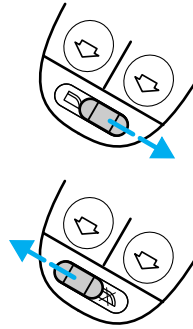

Rear door childproof safety locks

When the lever in the rear door lock is pushed inwards, the door can be opened only from the outside of the vehicle.

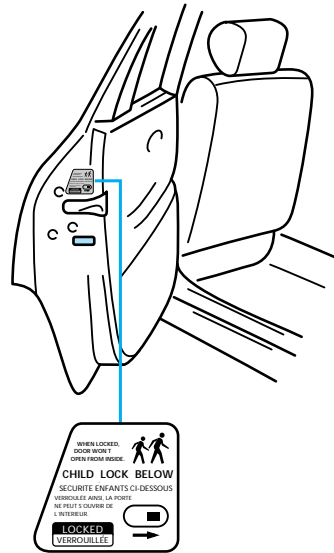

Controls and features

FLOOR MOUNTED CONTROLS

Parking brake

For information on the parking brake, refer to *Preparing to start the vehicle* in the *Starting* chapter.

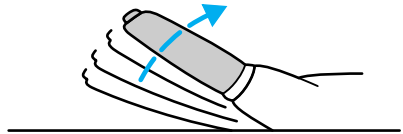

Remote luggage compartment control

Pull the control located on the left of the driver's seat to open the luggage compartment.

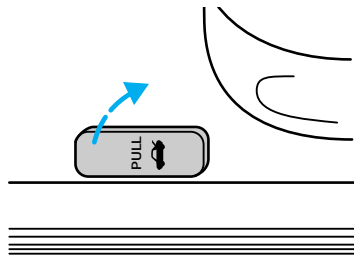

To disable the remote luggage compartment release, depress the control on the luggage compartment latch that is marked in orange before closing the luggage compartment.

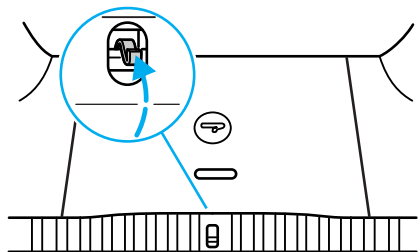

Fuel pump shut-off switch

For information on the fuel pump shut-off switch, refer to *Fuel pump shut-off switch* in the *Roadside emergencies* chapter.

Positive retention floor mat (if equipped) (Standard in Canada)

Position the floor mat in the footwell. Place the mat eyelet over the pointed end of the retention post from the rear and rotate forward to install. Adjust the floor mat position to allow proper operation of accelerator pedal, brake pedal and clutch pedal (if equipped).

To remove, lift the floor mat just forward of the retention post and rotate it rearward to disengage it from the retention post.

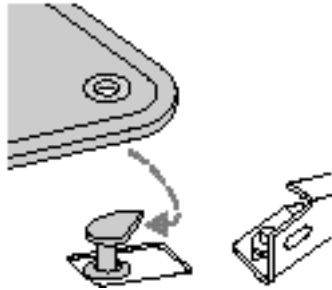

Controls and features

REMOTE KEYLESS ENTRY SYSTEM (if equipped)

If your vehicle has a remote entry system, you can lock and unlock the vehicle doors and open the luggage compartment without using a key. The remote also has a personal alarm feature.

The remote entry feature only operates with the ignition in the off position.

Locking the doors

Press the LOCK control.

To signal that the doors are locked, press the LOCK control again within five seconds. The doors will lock again and the horn will sound.

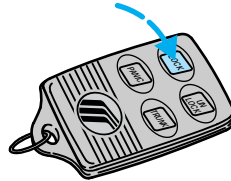

Unlocking the doors

Press the UNLOCK control to open the driver's door.

To unlock the other doors, press the UNLOCK control a second time within five seconds.

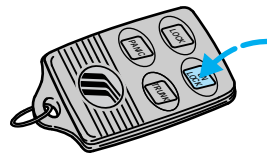

Controls and features

Opening the luggage compartment

Press the TRUNK control.

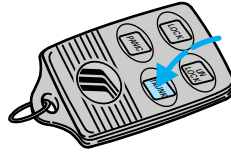

Sounding the panic alarm

Press the PANIC control. The horn will sound and the headlamps and tail lamps will flash for approximately two minutes and forty-five seconds.

To deactivate the alarm, press the PANIC control again or turn the ignition key to the on position.

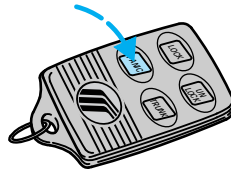

Replacing the batteries

The transmitter is powered by two coin-type, three-volt lithium batteries. A decrease in operating range can be caused by:

- battery failure,
- weather conditions, or
- structures around the vehicle.

Replacement batteries for the remote entry system transmitters may be purchased at pharmacies, watch stores or at authorized dealers.

Controls and features

To replace the batteries:

1. Twist a thin coin between the two halves of the transmitter. Do not take the front part of the transmitter apart.
2. Remove the old batteries.
3. Place the positive (+) side of the new batteries down.
4. Snap the two halves of the transmitter back together.

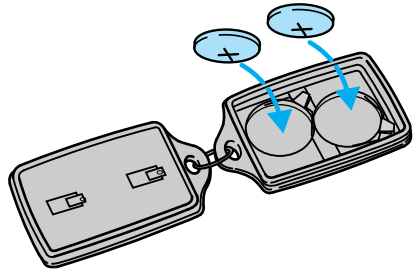

Replacing lost transmitters

Take your transmitters to the dealer for reprogramming if:

- a transmitter is lost or
- you want to purchase additional transmitters.

This device complies with part 15 of the FCC rules. Operation is subject to the two following conditions: (1) The device may not cause harmful interference, and (2) This device must accept any interference received, including interference that may cause undesired operation.

Controls and features

PASSIVE ANTI-THEFT SYSTEM (if equipped)

The Passive Anti-Theft system (PATS) is an engine immobilization system. It is an additional theft protection feature which prevents the engine from being started unless a coded key is used..

This system is only available with 2.5 l engines.

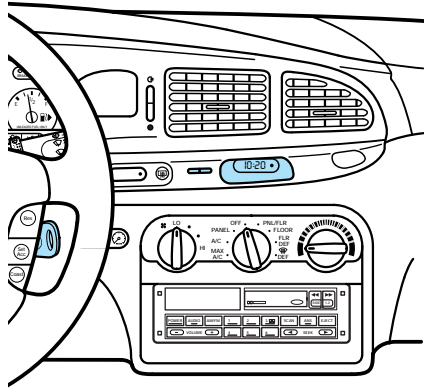

Automatic arming

The system is armed five seconds after switching off the ignition.

The armed status is indicated when the control light flashes every two seconds.

Automatic disarming

Switching on the ignition disarms the system if the correct code is recognized.

Keys

Your vehicle is supplied with two coded keys.

Only these keys can be used to start your vehicle.

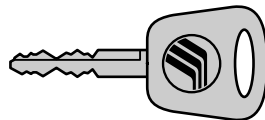

Controls and features

Functional check

When the ignition is switched on, the control light in the digital clock will illuminate for approximately three seconds to indicate that the system is operating correctly.

If the control light flashes rapidly for approximately one minute and then repeatedly at irregular intervals, the system did not recognize the key code. Remove the key and try again.

If the control light illuminates continuously for approximately one minute and then flashes repeatedly at irregular intervals, a system malfunction has occurred.

Have the malfunction repaired by your dealer or a qualified technician as soon as possible.

To ensure a trouble-free exchange between vehicle and key, do not shield the keys with any metal objects.

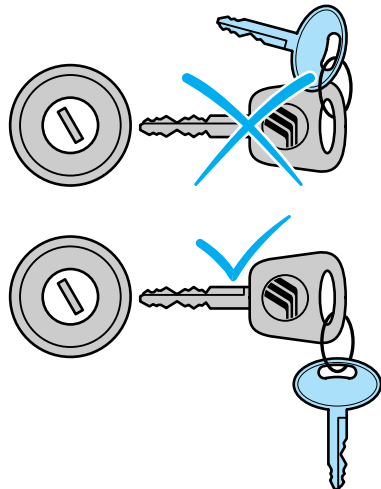
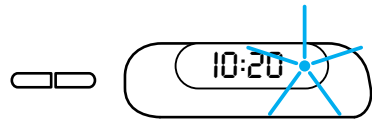

Key coding

Replacement keys or a maximum of 15 duplicate keys can be coded.

To program a key, cycle ignition switch from (3) to (1) with a programmed key. Within five seconds of this cycle, insert a new PATS key into ignition and turn to (3) or (4). If successful, the theft warning indicator will glow for two seconds, and the vehicle can be started. Repeat until all chosen keys have been programmed.

The control light illuminates to indicate a successful programming operation.

Repeat the procedure to program additional keys.

Your dealer can also delete keys already programmed.

The system is maintenance free.

If keys become lost, you must have your dealer clear and reprogram the code for security reasons.

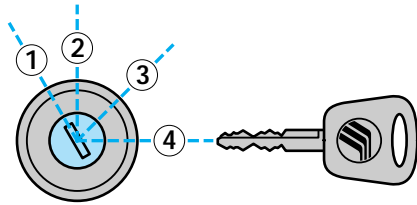

Seating and safety restraints

HEAD RESTRAINTS

Adjusting the head restraints

Push or pull the head restraint to the desired height.

Swivel the head restraint forward or backward to the desired angle.

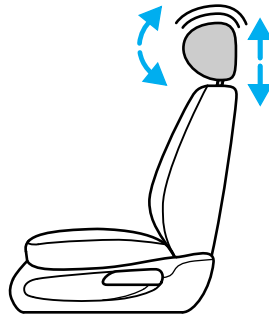

SEATING

Manually adjusting the seats

Pull the lever located inside the front edge of the seat to move the seat forward or backward.

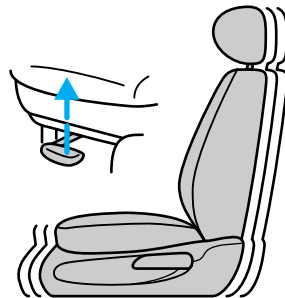

Pull the lever on the outside of the seat to recline the seat.

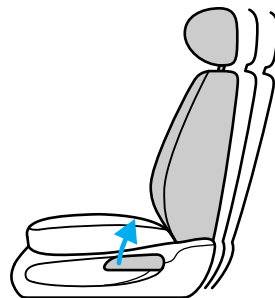

Never adjust the driver's seat or seatback when the vehicle is moving.

Seating and safety restraints

Adjusting the power seats (if equipped)

Move the relevant control in the respective direction to adjust the seat, seatback and lumbar as follows:



Seat

- (1) Forward and backward
- (2) Height of the entire seat
- (3) Height of the front of the seat
- (4) Height of the rear of the seat

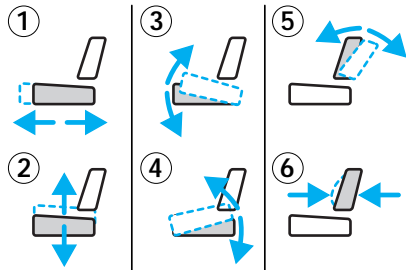

Seatback

- (5) Seatback inclination

Lumbar support

- (6) Lumbar support

Seating and safety restraints

Folding rear seats (if equipped)

Pull the release knob located in the luggage compartment. Fold down the seat. The seatback cannot be released while the built-in childseat (if equipped) is open.

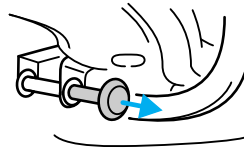

If you are carrying objects that might damage the center rear three-point safety belt, you can unbuckle the end of the belt from the small buckle on the seat cushion and let the retractor reel it up. Reconnect the belt tongue to the buckle when you fold the seat back up.

To raise the rear seatback, push the seatback upward until it locks in place. Make sure it is firmly latched by pushing forward and back on it.



Check to see that the seat and seatback are latched securely in position. Keep luggage area free of objects that would prevent proper engagement.

Seating and safety restraints

SAFETY RESTRAINTS

Important safety restraints precautions

The use of safety belts helps to restrain both driver and passenger in case of a collision. In most states and Canada, the law requires the use of safety belts.

⚠ Front and rear seat occupants including pregnant women, should wear safety belts for optimum protection in an accident.

⚠ Always drive and ride with your seatback upright and the lap belt snug and low across the hips.

⚠ Lock the doors of your vehicle before driving to lessen the risk of the door coming open in a collision.

⚠ Cargo should always be secured to prevent it from shifting and causing damage to the vehicle or harm to passengers.

⚠ To prevent the risk of injury, make sure children sit where they can be properly restrained.

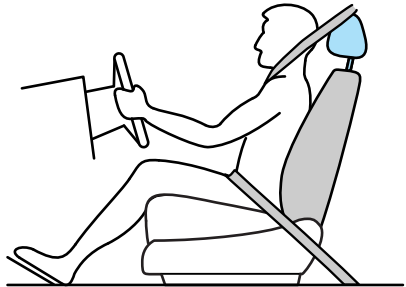

Seating and safety restraints

Using safety restraints properly

Combination lap and shoulder belt

Insert the tongue into the slot in the buckle to fasten.

Push the red release button and remove the tongue from the slot to unfasten.

The passenger safety restraints in the vehicle are combination lap and shoulder belts. The front and rear seat passenger safety belts have two types of locking modes.

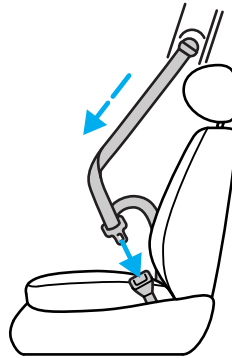

Each seating position in your vehicle has a specific safety belt assembly which is made up of one buckle and one tongue that are designed to be used as a pair.

Use the shoulder belt on the outside shoulder only. Never wear the shoulder belt under the arm.

Never swing it around your neck over the inside shoulder.

Never use a single belt for more than one person.

Seating and safety restraints

Vehicle sensitive (emergency) locking mode

The vehicle sensitive mode is the normal retractor mode which locks the belts in response to vehicle movement. For example, if the driver brakes suddenly, turns a corner sharply or your vehicle receives an impact of 8 km/h (5 mph) or more the combination safety belts will lock to help reduce the forward movement of the driver and passengers.

The retractor can be made to lock by pulling sharply on the belt.

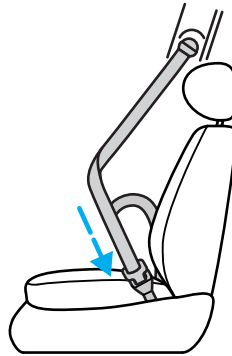

Automatic locking mode

In this mode, the shoulder belt is automatically prelocked; however, the belt will react to remove any slack in the shoulder belt.

The automatic locking mode is not available on the driver's safety belt.

When to use the automatic locking mode

- When a tight lap and shoulder belt fit is desired.
- Any time a child safety seat is installed in the vehicle. For information on the proper use of a child safety seat, refer to *Child safety seats* later in this chapter.

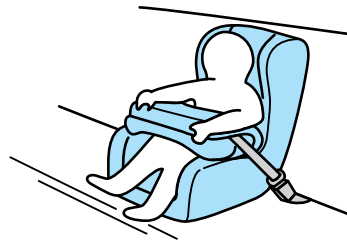

Seating and safety restraints

Using automatic locking mode

The automatic locking mode must be used when installing a child safety seat in any passenger seat.

1. Buckle the combination lap and shoulder belt.
2. Grasp the shoulder belt portion and pull downward until the entire belt is extracted.
3. Allow the belt to retract. As the belt retracts, you will hear a clicking sound. This indicates that the safety belt is now in the automatic locking mode.

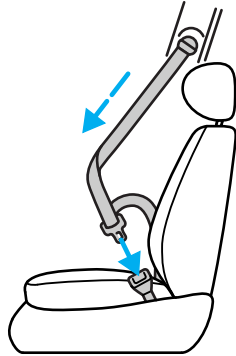

Canceling automatic locking mode

Disconnect the combination lap and shoulder belt and allow it to completely retract. This will cancel the automatic locking mode and activate the vehicle sensitive (emergency) locking mode.

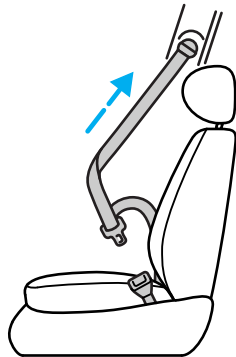

Seating and safety restraints

Front seat safety belt height adjustment



Position the shoulder belt height adjuster so that the belt rests across the middle of your shoulder. Be sure the shoulder belt is properly positioned on your shoulder each time you use the belt. If the shoulder belt is off your shoulder, on your upper arm or neck, there is a greater risk of severe injury in a collision.

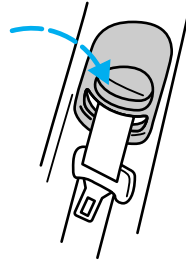

To lower the height of the shoulder belt:

1. Push the control down.
2. Slide down.

To raise the height of the shoulder belt:

1. Slide up.
2. Pull down on the height adjuster to make sure that it is locked in place.

Seating and safety restraints

Center position three-point safety belts

If the lower end of the belt has been unbuckled, pull the belt steadily from the reel and insert the small tongue into the small buckle until a distinct “click” is heard.

This buckle should be left buckled except when the seatback is folded down and cargo that might damage the seatbelt or get it dirty is being hauled.

Pull the seat belt across the hips and insert the big (sliding) tongue into the appropriate buckle until a distinct “click” is heard.

Should the center rear belt need to be unlatched from its anchorage, a thin probe is required to be inserted into the hole located on the underside of the floor mounted buckle. If the buckle and tongue are not reconnected, then the belt is not safe to be used.

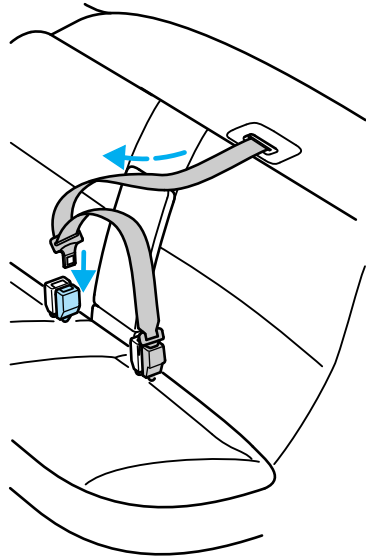

Safety belt indicator light and warning chime

Illuminates in the instrument cluster and a chime sounds to remind the occupants to fasten their safety belts.



Seating and safety restraints

Conditions of operation

If the driver's safety belt is not buckled before the ignition key is turned to on, the safety belt indicator illuminates for 1-2 minutes and the warning chime sounds for 4-8 seconds.

If the driver's safety belt is buckled while the indicator light is illuminated and the reminder chime is sounding, the safety belt indicator light and reminder turn off.

Safety belt extension assembly

The safety belt may be too short even when fully extended. Approximately 20 cm (8 inches) may be added to the length of the belt with a safety belt extension (part number 611C22). Safety belt extensions are available at no cost from your dealer.

Only use extensions manufactured by the same supplier as the safety belt. Manufacturer identification is on the label located at the end of the webbing.

Do not use the extension to change the fit of the shoulder belt across the torso.

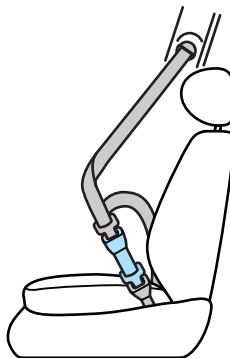

Seating and safety restraints

Care of safety belts

Periodically check the belts for damage or fraying. Check the security of the anchorage points and the locking action of the inertia reels by giving each belt a sharp tug.

Belts subjected to strain, as in the result of an accident, should be replaced and the anchorages checked by your dealer or a qualified technician.



Failure to follow these instructions will affect the performance of the safety belts and increase the risk of personal injury.

Safety belt warning label

A warning label has been placed on the buckle of each of your vehicle's front seat safety belts.

In a collision of sufficient severity while the safety belt is in use, the safety belt buckle will pull out of the sleeve so that all or part of the orange portion of the label is visible.



Whenever the orange portion of the label is visible, the safety belt must be replaced.

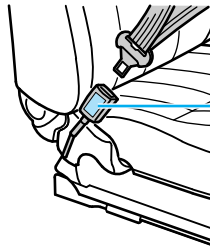

Seating and safety restraints

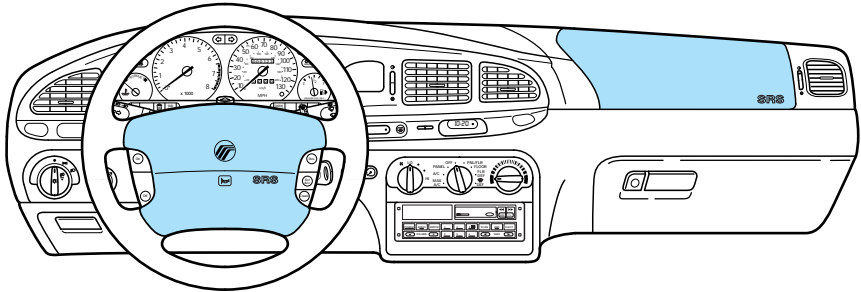

AIR BAG SUPPLEMENTAL RESTRAINT SYSTEM (SRS)

Important supplemental restraint system (SRS) precautions

The supplemental restraint system is designed to:

- work with the safety belt to protect the driver and right front passenger.
- reduce certain upper body injuries.

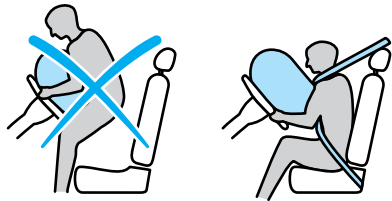

Seating and safety restraints

 Do not place objects or mount equipment on or near the air bag covers that may come into contact with an inflating air bag.

 Do not attempt to service, repair, or modify the air bag Supplemental Restraint System or its fuses. See your Ford or Lincoln-Mercury dealer.

Children and air bags

For additional important safety information, read all information on safety restraints in this guide.

Children should always wear safety belts. Failure to follow these instructions may increase the risk of injury in a collision.

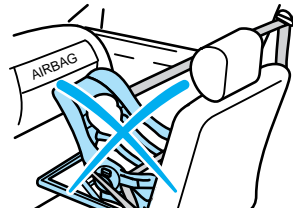

 When installing forward-facing child seats in the front seat always move the passenger seat as far back from the instrument panel as possible. Never install rear-facing child seats or rear-facing infant seats in the front seat.



Seating and safety restraints

How does the air bag supplemental restraint system (SRS) work?

The SRS is designed to activate when the vehicle is in a collision, similar to hitting a fixed barrier head on at 12-24 km/h (8-14 mph).

The fact that the air bags did not inflate in a collision does not mean that something is wrong with the system. Rather, it means the forces were not of the type sufficient to cause activation.

The air bags inflate and deflate rapidly upon activation.

After air bag deployment, it is normal to notice a smoke-like, powdery residue or smell the burned propellant. This may consist of cornstarch, talcum powder (to lubricate the bag) or sodium compounds (e.g., baking soda) that result from the combustion process that inflates the air bag. Small amounts of sodium hydroxide may be present which may irritate the skin and eyes, but none of the residue is toxic.

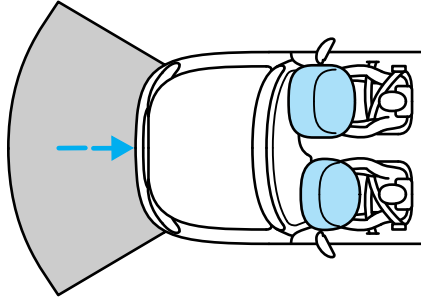

Seating and safety restraints

⚠ Several air bag system components get hot after inflation. Do not touch them after inflation.

⚠ If the air bag is inflated, **the air bag will not function again and must be replaced immediately.** If the air bag is not replaced, the unrepaired area will increase the risk of injury in a collision.

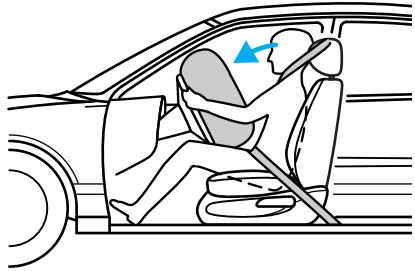

The SRS consists of the following:

- driver and passenger air bag modules (which include the inflators and air bags),
- one or more impact and safing sensors,
- a readiness light and tone,
- and the electrical wiring and components.

The diagnostic module monitors its own internal circuits and the supplemental air bag electrical system readiness (including the impact sensors), the system wiring, the air bag system readiness light, the air bag back up power and the air bag ignitors.

Seating and safety restraints

Determining if the system is operational

The SRS uses a readiness light in the instrument cluster or a chime to indicate the condition of the system. Refer to the *Air bag readiness* section in the *Instrumentation* chapter. Routine maintenance of the air bag is not required.

A difficulty with the system is indicated by one or more of the following:

- The readiness light will either flash or stay lit.
- The readiness light will not illuminate after ignition is turned on.
- A group of five beeps will be heard. The tone pattern will repeat periodically until the problem and light are repaired.

If any of these things happen, even intermittently, have the SRS serviced at your dealership or by a qualified technician immediately. Unless serviced, the system may not function properly in the event of a collision.

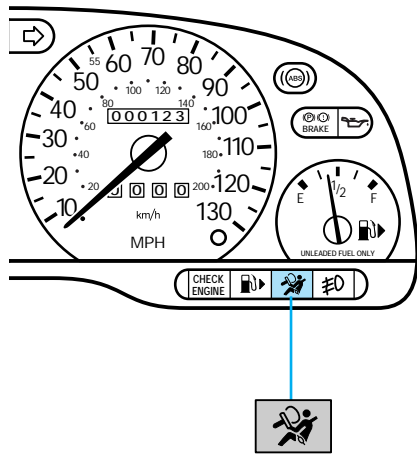

Seating and safety restraints

Disposal of air bags and air bag equipped vehicles

For disposal of air bags or air bag equipped vehicles, see your local dealership or a qualified technician. Air bags **MUST BE** disposed of by qualified personnel.



Seating and safety restraints

CHILDREN AND SAFETY RESTRAINTS



To prevent the risk of injury, make sure children sit where they can be properly restrained.



Whenever possible, put children in one of the rear seats in your vehicle. Accident statistics indicate that children are safer when properly restrained in the rear seats than in the front seats.



Do not leave children, unreliable adults, or pets unattended in your vehicle.



Safety belts and seats can become hot in a vehicle that has been closed up in sunny weather; they could burn a small child. Check seat covers and buckles before you place a child anywhere near them.



It is extremely dangerous to ride in a cargo area, inside or outside of a vehicle. In a collision, people riding in these areas are more likely to be seriously injured or killed. Do not allow people to ride in any area of your vehicle that is not equipped with seats and safety belts. Be sure everyone in your vehicle is in a seat and using a safety belt properly.

Seating and safety restraints

Important child restraint precautions

You are required by law to use safety restraints for children in the U.S. and Canada. If small children ride in your vehicle (generally children who are four years old or younger and who weigh 18 kg [40 lbs] or less), you must put them in safety seats made especially for children. Check your local and state or provincial laws for specific requirements regarding the safety of children in your vehicle.



Never let a passenger hold a child on his or her lap while the vehicle is moving. The passenger cannot protect the child from injury in a collision.

Always follow the instructions and warnings that come with any infant or child restraint you might use.

When possible, place children in the rear seat of your vehicle.

Accident statistics suggest that children are safer when properly restrained in the rear seating positions than in the front seating position.

Seating and safety restraints

Children and safety belts

Children who are too large for child safety seats (as specified by the child safety seat manufacturer) should always wear safety belts.

Follow all the important safety restraints and air bag precautions that apply to adult passengers in your vehicle.

If the shoulder belt portion of a combination lap and shoulder belt can be positioned so it does not cross or rest in front of the child's face or neck, the child should wear the lap and shoulder belt. Moving the child closer to the center of the vehicle may help provide a good shoulder belt fit.

If the shoulder belt cannot be properly positioned:

- move the child to one of the seats with a lap belt only (if equipped).

OR

- if the child is the appropriate size, restrain the child in a safety seat.

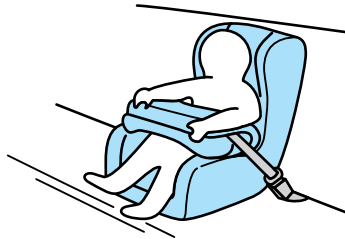

Seating and safety restraints

To improve the fit of lap and shoulder belts on children who have outgrown child safety seats, Ford recommends use of a belt-positioning booster seat that is labelled as conforming to all federal motor vehicle safety standards. Belt-positioning booster seats raise the child and provide a shorter, firmer seating posture and better fit of lap and shoulder belts on the child. A belt-positioning booster seat should be used if the shoulder belt rests in front of the child's face or neck, or if the lap belt does not fit snugly on both thighs, or if the thighs are too short to let the child sit all the way back on the seat cushion when the lower legs hang over the edge of the seat cushion. You may wish to discuss the special needs of your child with your pediatrician.

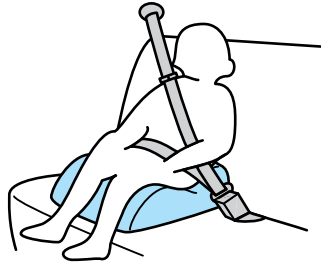

Seating and safety restraints

Built-in child seat

Built-in child safety seat (if equipped)

The rear seat may include a built-in child seat. This child seat conforms to all Federal and local motor vehicle safety standards. Read the labels located on the child seat cushion and shoulder belt for information on the built-in child seat.

Use the built-in child seat only if the child is at least one year old, weighs 10-27 kg (22-60 lbs) and the child's shoulders fit below the shoulder harness slots on the built-in child seat.

Children not meeting these requirements should be secured in an aftermarket seat. Refer to *Child safety seats* in this chapter.

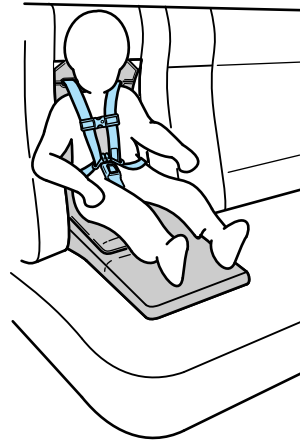

All built-in child restraints, including seats, buckles, retractors, seat latches, interlocks, and attaching hardware should be inspected by a qualified dealer technician after any collision.

Seating and safety restraints

Child seat interlock safety feature

The interlock ensures that a child is not placed in the integrated child seat when the folding seatback is not securely latched.

It prevents the seatback from being unlatched while the child seat is in use. When the child seat is deployed, the seatback cannot be released.

Built-in child seat retractors

The belts on built-in child seats are equipped with a retractor. The retractor will automatically snug the belts around the child. If the belts do not remain snug, take the vehicle to your dealer or a qualified technician for child seat repair. The belts will not remain snug during a collision if the retractor is not functioning properly.

Seating and safety restraints

Placing your child in the built-in child seat



Failure to follow all of the instructions on the use of this child restraint system can result in your child striking the vehicle's interior during a sudden stop or crash.



Never use the built-in child seat as a booster cushion with the adult safety belts. A child using the adult belts could slide forward and out from under the safety belts.



The rear seatback must be fully locked before operating the child safety restraint system.

1. Make sure that the seatback is securely latched in place.
2. Grasp the child seat cushion and pull the top forward to release the latch. Continue to unfold the child seat until it rests on the seat in the fully open position.

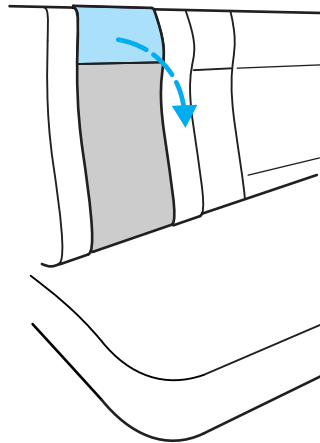

Seating and safety restraints

3. Read all the information and warnings on the child seat cushion and shoulder safety belt. Make sure the child is not too large for the child seat.

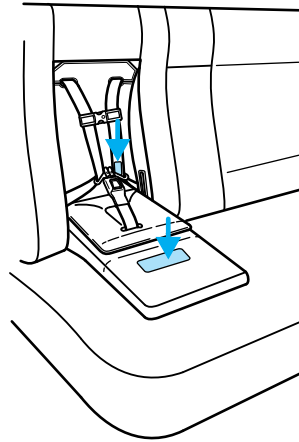

4. If connected, squeeze the tabs on the top and bottom of the chest clip and pull the halves apart to open the chest clip. Then release the lower half of belt by pressing the red button.

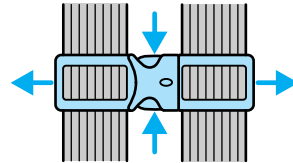

5. Place the child on the child seat and position the shoulder belts over each shoulder.

Seating and safety restraints

6. Insert either the left or the right safety belt tongue into the single opening of the crotch safety belt buckle (it doesn't matter which tongue is inserted first). Insert the other tongue. The color green must appear in the indicator window on each tongue when buckled. Allow belts to retract and fit snugly.

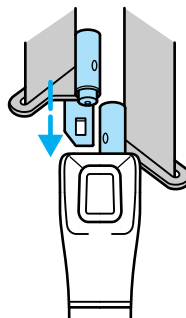

If both tongues do not latch in the buckle, do not use the child seat. See your dealer for repairs.

7. Fasten both halves of the chest clip below the child's shoulders and adjust it to comfortably hold the shoulder belts in place on the child's chest. The color green must appear in the indicator window when fastened.

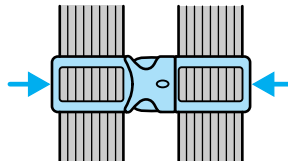

8. Pull the lap portion of the belts toward you to make sure the crotch safety belt buckle is properly fastened and the retractor is locked.

9. If the belts become too tight, unbuckle the crotch safety belt buckle to unlock the retractors, then reinsert both belt tongues.

Seating and safety restraints

Removing your child from the built-in child seat

1. Squeeze the tabs on the top and the bottom of the chest clip and pull the halves apart to open the chest clip.
2. Press the release button on the crotch safety belt buckle.
3. Slide the shoulder belts off the child's shoulders and remove the child.

To stow the built-in child seat

Return the child seat cushion to the upright position, then press firmly in the center and top of the child seat.

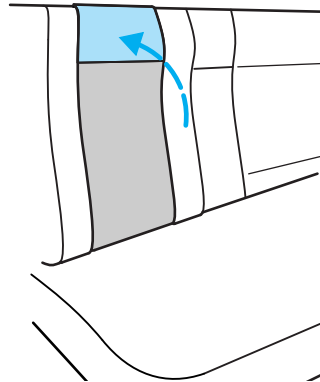

Inspecting the built-in child seat after a collision

All built-in child restraints, including seats, buckles, retractors, seat latches, interlocks and attaching hardware should be inspected by your dealer or a qualified technician after any collision. If the child seat was in use during a collision, Ford recommends replacing it. Built-in child restraints not in use during a collision should be inspected and replaced if either damage or improper operation is noted.

Seating and safety restraints

Child safety seats



Carefully follow all of the manufacturer's instructions included with the safety seat you put in your vehicle. If you do not install and use the safety seat properly, the child may be injured in a sudden stop or collision.

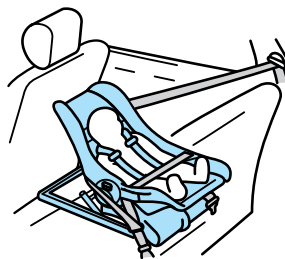

Ford recommends the use of a child safety seat having a top tether strap. Install the child safety seat in a seating position which is capable of providing a tether anchorage. For more information on top tether straps see *Attaching safety seats with tether straps* in this chapter.

When installing a child safety seat:

- Use the correct safety belt buckle for that seating position.
- Make sure the tongue is securely fastened in the buckle.
- Keep the buckle release button pointing up and away from the safety seat, with the tongue between the child seat and the release button, to prevent accidental unbuckling.
- Put the safety belt in the automatic locking mode. Refer to *Using automatic locking mode* in this chapter.

Seating and safety restraints

Installing child safety seats in combination lap and shoulder belt seat positions

1. Position the child safety seat in a seat with a combination lap and shoulder belt.



When using forward-facing child seats move the passenger seat as far back from the instrument panel as possible. Never secure rear-facing infant seats in the front seat.



2. Pull down on the shoulder belt and then grasp the shoulder belt and lap belt together.

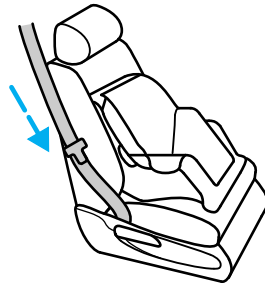

3. While holding the shoulder and lap belt portions together, route the tongue through the child seat according to the child seat manufacturer's instructions. Be sure the belt webbing is not twisted.

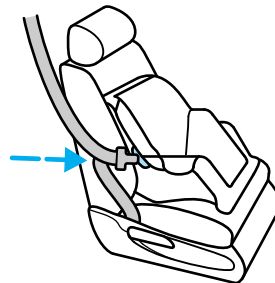

Seating and safety restraints

4. Insert the belt tongue into the proper buckle for that seating position until you hear and feel the latch engage. Make sure the tongue is latched securely by pulling on it.

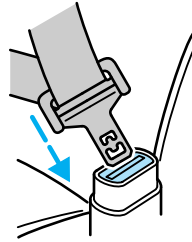

5. To put the retractor in the automatic locking mode, grasp the shoulder portion of the belt and pull downward until all of the belt is extracted and a click is heard.

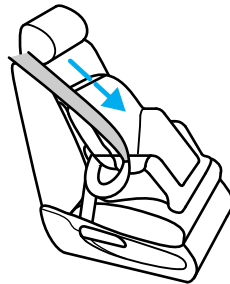

6. Allow the belt to retract. The belt will click as it retracts to indicate it is in the automatic locking mode.

7. Pull the lap belt portion across the child seat toward the buckle and pull up on the shoulder belt while pushing down with your knee on the child seat.

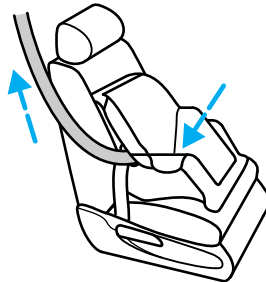

Seating and safety restraints

8. Allow the safety belt to retract to remove any slack in the belt.

9. Before placing the child in the seat, forcibly tilt the seat forward and back to make sure the seat is securely held in place.

10. Try to pull the belt out of the retractor to make sure the retractor is in automatic locking mode (you should not be able to pull more belt out). If the retractor is not locked, unbuckle the belt and repeat steps two through nine.

Check to make sure the child seat is properly secured before each use.

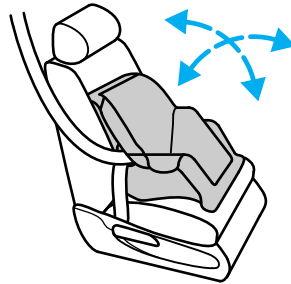

Attaching safety seats with tether straps

Some manufacturers make safety seats that include a tether strap that goes over the back of the vehicle seat and attaches to an anchoring point. Other manufacturers offer their tether strap as an accessory. Contact the manufacturer of your child safety seat for information about ordering a tether strap.

Seating and safety restraints

To install a tether from a child safety seat in the front seat, route the tether strap under the vehicle seat head restraint and hook the tether hook into the hole in the tongue of the center rear lap belt. After the hook is in the hole, pull on the loose end of the lap belt webbing to shorten the belt and tighten the tether strap.

To install a tethered child safety seat in the rear seat, you will need tether anchor hardware.



Tighten the anchor according to specifications. Otherwise, the safety seat may not be properly secured and the child may be injured in a sudden stop or collision.

Tether anchor hardware

Tether anchor hardware kits (part number 613D74), including instructions, may be obtained at no charge from any Ford or Lincoln-Mercury dealer. All vehicles built for sale in Canada include a tether anchor hardware kit.

Starting

IMPORTANT SAFETY PRECAUTIONS

A computer system controls the engine's idle revolutions per minute (rpm). When the engine starts, the idle rpm runs faster to warm the engine. If the engine idle speed does not slow down automatically, have the vehicle checked by your dealer or a qualified service technician. Do not allow the vehicle to idle for more than ten minutes.

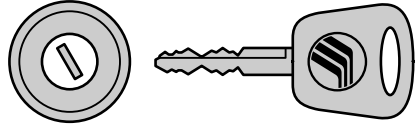

Extended idling at high engine speeds can produce very high temperatures in the engine and exhaust system, creating the risk of fire or other damage.



Do not park, idle, or drive your vehicle in dry grass or other dry ground cover. The emission system heats up the engine compartment and exhaust system, which can start a fire.

 Do not start your vehicle in a closed garage or in other enclosed areas. Exhaust fumes can be toxic. Always open the garage door before you start the engine. See *Guarding against exhaust fumes* in this chapter for more instructions.

IMPORTANT VENTILATION INFORMATION

If the engine is idling while the vehicle is stopped in an open area for long periods of time, open the windows at least 2.5 cm (1 inch).

Adjust the heating or air conditioning to bring in fresh air.

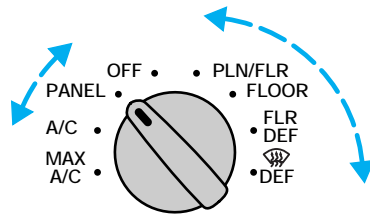
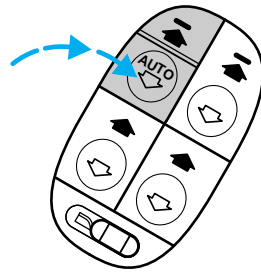

Starting

Improve vehicle ventilation by keeping all air inlet vents clear of snow, leaves and other debris.

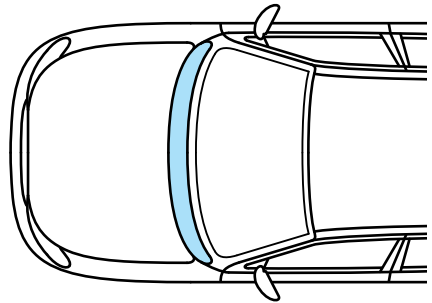

Guarding against exhaust fumes

Although odorless and colorless, carbon monoxide is present in exhaust fumes. Take precautions to avoid its dangerous effects.



If you ever smell exhaust fumes of any kind inside your vehicle, have your dealer inspect and fix your vehicle immediately. Do not drive if you smell exhaust fumes. These fumes are harmful and could kill you.

Have the exhaust and body ventilation system checked whenever:

- the vehicle is raised for service.
- the sound of the exhaust system changes.
- the vehicle has been damaged in a collision.

PREPARING TO START THE VEHICLE

Engine starting is controlled by the spark ignition system. This system meets all Canadian Interference-Causing Equipment standard requirements regulating the impulse electrical field strength of radio noise.

When starting a fuel-injected engine, avoid pressing the accelerator pedal before or during starting. Only use the accelerator pedal when you have difficulty starting the engine. For more information on starting the vehicle, refer to *Starting the engine* in this chapter.

Before starting the vehicle:

1. Make sure all vehicle occupants have buckled their safety belts. For more information on safety belts and their proper usage, refer to the *Seating and safety restraints* chapter.
2. Make sure the headlamps and vehicle accessories are off.

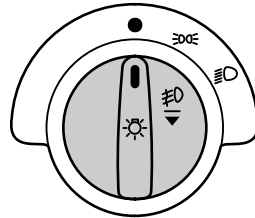

Starting

If starting a vehicle with an automatic transaxle:

- Make sure the parking brake is set.
- Make sure the gearshift is in P (Park).

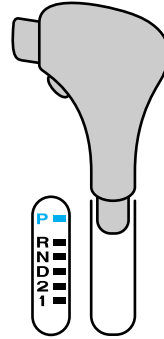

If starting a vehicle with a manual transaxle:

- Make sure the parking brake is set.
- Push the clutch pedal to the floor. Otherwise, the engine will not crank (turn over).
- Put the gearshift into neutral.

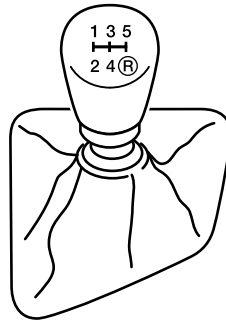

Starting

3. Turn the key to the on position (without turning the key to start).

Make sure the following lights illuminate briefly. If a light fails to illuminate, have the vehicle serviced by your dealer or a qualified service technician.

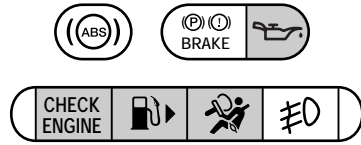

- If the driver's safety belt is fastened the warning light does not illuminate.



Starting

STARTING THE ENGINE

1. Turn the key to the start position (4) without pressing the accelerator pedal and release as soon as the engine starts. The key will return to the on (3) position.

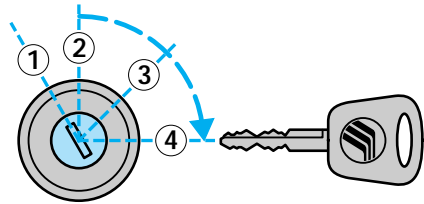

2. If the engine does not start within five seconds, wait ten seconds and try again.

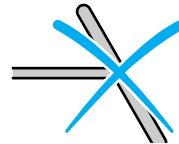

3. If the engine does not start in two attempts OR the temperature is below -12°C (10°F), depress the accelerator pedal and start the engine while holding the accelerator pedal down. Release accelerator pedal when the engine starts.

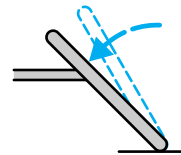

Vehicles equipped with the 2.0 l engine: If the engine fails to start, continue to crank with the accelerator depressed about 1/4 of the way down and hold that position until the engine starts.

DO NOT crank for more than 30 seconds or you could damage the starter.

4. After idling the engine for a few seconds, apply the brake and release the parking brake

USING THE ENGINE BLOCK HEATER (if equipped)

An engine block heater warms the engine coolant, which improves starting, warms up the engine faster and allows the heater-defroster system to respond quickly. It is strongly recommended if you live in a region where temperatures reach -23°C (-10°F) or below.

For best results, plug the heater in at least three hours before starting the vehicle. Using the heater for more than three hours will not harm the engine, so the heater can be plugged in the night before starting the vehicle.



To prevent electrical shock, do not use your heater with ungrounded electrical systems or two-pronged (cheater) adapters.

Driving

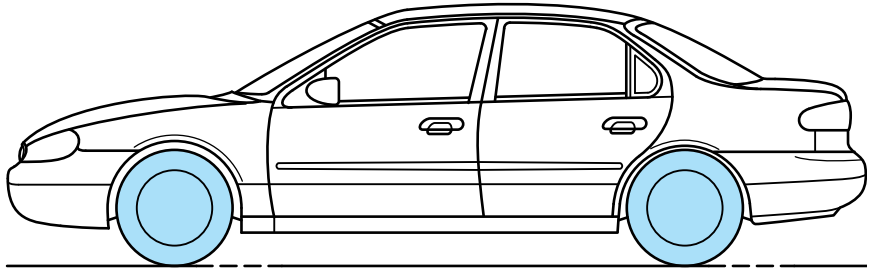

BRAKES

Your brakes are self-adjusting. Refer to the “Service Guide” for maintenance intervals.

Anti-lock braking system (ABS) (if equipped)

The ABS operates by detecting the onset of wheel lock up during brake applications and compensating for this tendency. The wheels are prevented from locking even when the brakes are firmly applied, helping to ensure that the vehicle can be steered and the driver can avoid obstacles.

Operation of the anti-lock braking system

The anti-lock braking system is not employed during normal braking. It becomes operational only when it senses differences in the rotational speed of the road wheels, indicating that they are about to lock up. Its operation is indicated by a pulsing of the brake pedal.

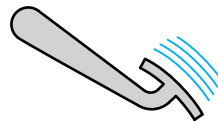

Braking with ABS

- In an emergency, apply full force on the brake pedal. In vehicles with manual transaxles, you must also depress the clutch pedal. The anti-lock braking system will be activated immediately, allowing you to retain full steering control of your vehicle and, providing there is sufficient space, will enable you to avoid obstacles.
- We recommend that you familiarize yourself with this braking technique. However, avoid taking any unnecessary risks.

Two important rules when braking in emergencies with ABS:

1. Apply full force on both brake and clutch pedal (if equipped).

2. Steer around the obstacle. No matter how hard you brake, steering control is maintained.



Driving

Parking brake

To engage the parking brake:
Pull the handle upward.

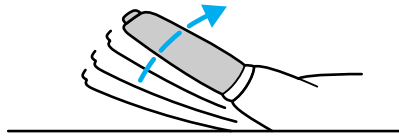

To release the parking brake:

1. Press and hold the release button.
2. Pull the handle upward to disengage the brake.
3. Push handle downward to the off position.

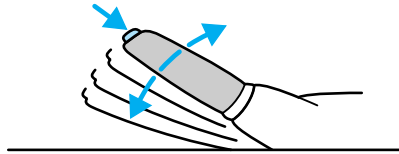

Always set the parking brake fully and make sure that the gearshift is securely latched in P (Park) (automatic transaxle) or in 1 (first) (manual transaxle).



To prevent personal injury, do not release the parking brake while outside the vehicle.

TRANSAXLE OPERATION

Automatic transaxle (if equipped)

Vehicles equipped with an automatic transaxle are equipped with a brake-shift interlock feature that prevents the gearshift lever from being moved from the P (Park) position unless the brake pedal is depressed.

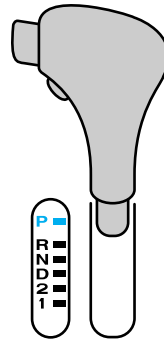

Putting your vehicle in gear

You must push the thumb button to move the gearshift to the position you choose.

To operate:

1. Start the engine.
2. Depress and hold the brake pedal.
3. Move the gearshift lever out of P (Park).

Driving

Overriding the brake-shift interlock feature

If it is necessary to use this procedure to move the gearshift lever, it is possible that a fuse has blown and the vehicle's brakelamps may not be working. Refer to *Fuses and relays* in the *Roadside emergencies* chapter.

If you cannot move the gearshift lever from P (Park) with the brake pedal depressed:

1. Turn the ignition off and remove the ignition key.
2. Apply the parking brake and the brake pedal.
3. Insert a screwdriver or similar item about 5 cm (2 inches) into the square opening to the right of the gearshift at the base of the console.
4. Rotate the screwdriver point rearward.
5. Push and hold the thumb button and move the gearshift.
6. Remove the screwdriver when the gearshift moves from the P (Park) position.

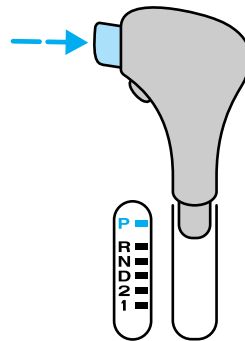
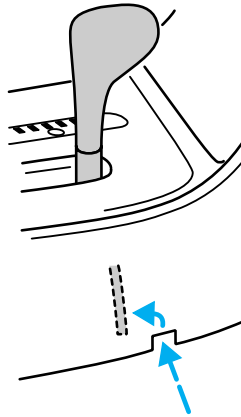

The console-mounted gearshift will lock when you turn the key to the lock position. When the gearshift is in any position except P (Park), the ignition key cannot be turned to lock or removed from the steering column. To remove the key, the gearshift lever must be in P (Park).

Once the gearshift is secure in the desired position, release the brake pedal and use the accelerator as necessary.

Driving



Never leave a vehicle unattended while it is running.

- **P** (Park)

Always come to a complete stop before shifting into P (Park). This locks the transaxle and prevents the front wheels from rotating.

- **R** (Reverse)

The vehicle only moves backward. Always come to a complete stop before shifting in or out of R (Reverse).

P = Park **P** 

R = Reverse **R** 

N = Neutral. **N** 

D = Drive: Gear 1 to 4
with overdrive **D** 

Gear 1 to 3
with overdrive
cancelled

2 = Gear 2 **2** 

1 = Gear 1 **1** 

Driving

- **N** (Neutral)

The wheels of the transaxle are not locked. Your vehicle will roll freely, even on the slightest incline, unless the parking brake or brakes are on.

- **D** (Overdrive)

Note that the vehicle's gearshift is console-mounted on the floor. The transaxle control switch (TCS) is located on the gearshift handle. The transaxle control indicator light (O/D light) is located on the instrument panel.

Overdrive is not shown on the display, but is the default mode for the D gearshift position. This is the normal driving mode for the best fuel economy. The transaxle operates in gears one through four. The O/D light is off (not illuminated) during normal vehicle operation.

Overdrive can be deactivated by pressing the transaxle control switch (TCS) located on the gearshift handle. The O/D OFF indicator light will illuminate in the instrument cluster.

- **D (Drive)**

D (Drive) provides more engine braking than overdrive and is useful when driving through hilly terrain or if your vehicle requires additional power for climbing hills. Activate by pressing the transaxle control switch (TCS) located on the gearshift handle. The O/D OFF indicator light will illuminate in the instrument cluster. Transaxle operates in gears one through three.

To return to overdrive mode, press the transaxle control switch. The O/D OFF indicator light will extinguish.

When starting your vehicle, the transaxle will automatically return to normal overdrive mode when the D (Drive) gearshift position is selected.

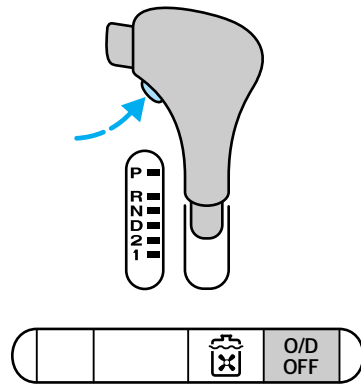

Driving

- **2 (Second)**

Use the 2 (Second) position to start up on slippery roads or to provide additional braking on downgrades. When your vehicle is in 2 (Second), it automatically starts off in second gear. Do not go faster than 90 km/h (55 mph) in this gear.

- **1 (First)**

Use the 1 (First) position to provide maximum engine braking on steep downgrades. Upshifts will not occur while the gearshift lever remains in the 1 (First) position. Upshifts may be made by shifting to the 2 (second) position or to D (Drive). Selecting the 1 (First) position at high speeds causes the transaxle to downshift through the gears and will shift to 1 (First) after the vehicle decelerates to the transaxle first gear designed speed. Do not go faster than 60 km/h (38 mph) in this gear.

Manual transaxle (if equipped)

Vehicles equipped with a manual transaxle have a starter interlock that prevents cranking the engine unless the clutch pedal is fully depressed.

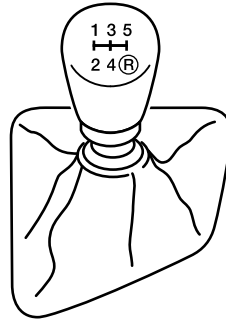

Using the clutch

When starting a vehicle with a manual transaxle:

1. Hold down the brake pedal.
2. Depress the clutch pedal.
3. Put the gearshift lever in neutral.
4. Start the vehicle.
5. Put the gearshift in 1 (First) or R (Reverse).
6. Release the clutch slowly while pressing gradually down on the accelerator pedal.

Do not drive with your foot resting on the clutch pedal. Do not use the clutch to hold your vehicle at a standstill while waiting on a hill. These actions may reduce the clutch life.

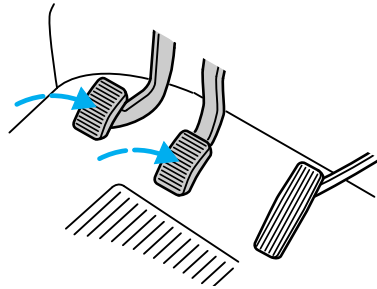

Driving

Recommended shift speeds

2.0 litre engine 5-speed transaxle shift speed schedules				
Recommended upshifts:	During acceleration:		During cruise*:	
	km/h	mph	km/h	mph
Shift from				
First to second	22	14	19	12
Second to third	40	25	32	20
Third to fourth	53	33	46	29
Fourth to fifth	77	48	64	40

2.5 litre engine 5-speed transaxle shift speed schedules				
Recommended upshifts:	During acceleration:		During cruise*:	
	km/h	mph	km/h	mph
Shift from				
First to second	22	14	16	10
Second to third	40	25	32	20
Third to fourth	53	33	50	31
Fourth to fifth	73	45	64	40

*The vehicle can be shifted at lower speeds to improve fuel economy.

Parking

1. Apply the brake and the clutch and shift into neutral.
2. Engage the parking brake.
3. Shift into 1 (First) or R (Reverse).
4. Turn the ignition off.



Do not park your vehicle in Neutral, it may move unexpectedly and injure someone. Use 1 (first) gear and set the parking brake.

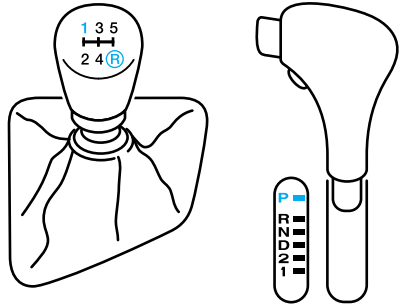
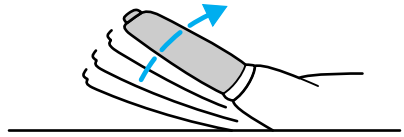

Reverse

To shift into R (Reverse):

1. Completely stop your vehicle.
2. Depress the clutch pedal to the floor and place the gearshift lever in the neutral position. Do not release the clutch pedal.
3. If the following direction is not followed, a grinding noise may occur.

Wait a minimum of three seconds before attempting to shift into R (Reverse) gear.

4. Push the gearshift lever completely to the right, pull up the ring on the stalk of the gearshift lever, and then pull rearward on the gearshift lever to engage the R (Reverse) gear.

5. If the R (Reverse) gear is engaged, slowly release the clutch pedal from the floor.

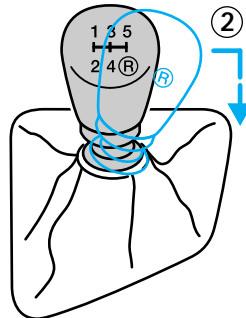
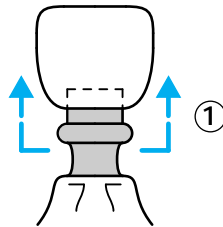

Driving

LOADING YOUR VEHICLE

Before loading your vehicle, familiarize yourself with these terms.

Base curb weight

Weight of the vehicle including any standard equipment, fluids and lubricants. It does not include passengers or aftermarket equipment.

Payload

Combined maximum allowable weight of passengers, cargo and optional equipment.

GVW (Gross Vehicle Weight)

Base curb weight plus the payload weight. The GVW is not a limit or a specification.

GVWR (Gross Vehicle Weight Rating)

Maximum total weight of the base vehicle, passengers, optional equipment and cargo. The GVWR is specific to each vehicle and is listed on the Safety Compliance Certification Label on the driver's door pillar.

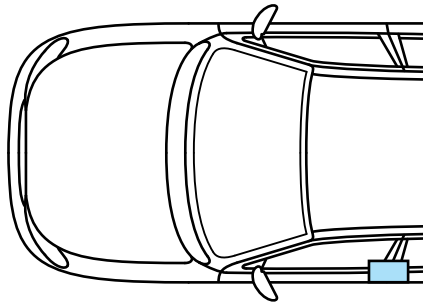

GAWR (Gross Axle Weight Rating)

Carrying capacity for each axle system (front and rear). The GAWR is specific to each vehicle and is listed on the Safety Compliance Certification Label on the driver's door pillar.

GCW (Gross Combined Weight)

The GCW is the maximum combined weight of the towing vehicle (including passengers and cargo) and the loaded trailer. The GCW is specified by the manufacturer to indicate the combined maximum loaded weight that the vehicle is designed to tow.

Driving

Payload = GVWR minus Base curb weight

To obtain the correct weight for your vehicle, try taking your vehicle to a shipping company or an inspection station for trucks.

Do not use replacement tires with lower weight capacities than the originals because they might lower the vehicle's GVWR and GAWR. (Replacement tires with a higher weight limit than the originals do not increase the GVWR and GAWR limitations.)

In high altitudes, engines will lose power at a rate of 3% power per 300 m (1 000 ft) increase in elevation. A reduction in GVW and GCW is recommended for maximum vehicle performance.

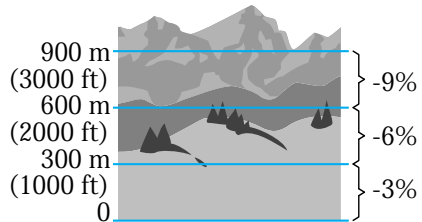

Do not exceed the GVWR or the GAWR specified on the Safety Compliance Certification Label.



It is extremely dangerous to ride in a cargo area, inside or outside of a vehicle. In a collision, people riding in these areas are more likely to be seriously injured or killed. Do not allow people to ride in any area of your vehicle that is not equipped with seats and safety belts. Be sure everyone in your vehicle is in a seat and using a safety belt properly.

Driving with a heavy load

The total weight of the vehicle plus the total weight of passengers and cargo should never exceed the GVWR.

The weight that the vehicle carries over the front and rear axles should never exceed the GAWR for the respective axle.

The weight limits of your vehicle's tires affect the GVWR and GAWR limitations. Using tires with higher weight limits than the original tires will not increase the GVWR or GAWR of your vehicle; using tires with lower weight limits may lower the GVWR or GAWR of your vehicle.

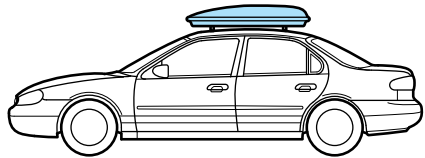

Driving

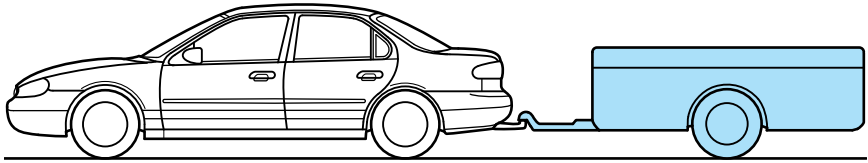

TRAILER TOWING

Your vehicle is capable of towing a trailer of up to a maximum of 454 kg (1 000 lbs) gross trailer weight with a maximum tongue load of 45 kg (100 lbs). It should also have 2.3 sq. meters (25 sq. feet) or less frontal area. Do not drive faster than 72 km/h (45 mph) while towing a 454 kg (1 000 lb) trailer.

Your vehicle does not come from the factory fully equipped to tow. No towing packages are available through Ford or Lincoln/Mercury dealers.

Trailer towing puts additional loads on your vehicle's engine, transaxle, axle, brakes, tires, and suspension. For your safety and to maximize vehicle performance, be sure to use the proper equipment while towing.

Follow these guidelines to ensure safe towing procedure:

- Stay within your vehicle's load limits.
- Thoroughly prepare your vehicle for towing. Refer to *Preparing to tow* in this chapter.
- Use extra caution when driving while trailer towing. Refer to *Driving while towing a trailer* in this chapter.
- Service your vehicle more frequently if you tow a trailer. Refer to the severe duty schedule in the "Service Guide".
- Do not tow a trailer until your vehicle has been driven at least 800 km (500 miles).
- Refer to the instructions included with towing accessories for the proper installation and adjustment specifications.

Driving

Do not exceed the maximum loads listed on the Safety Compliance Certification Label. For load specification terms found on the label, refer to *Loading your vehicle* in this chapter. Remember to figure in the tongue load of your loaded vehicle when figuring the total weight.

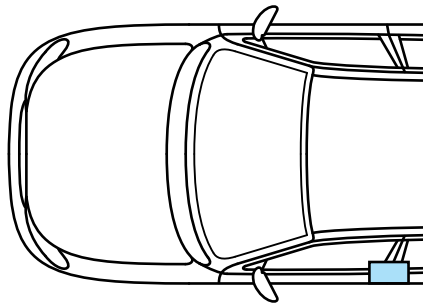

Towing trailers beyond the maximum recommended gross trailer weight exceeds the limit of the vehicle and could result in engine damage, transaxle damage, structural damage, loss of control, and personal injury.

Preparing to tow

Use the proper equipment for towing a trailer and make sure that it is properly attached to your vehicle. See your dealer or a reliable trailer retailer if you require assistance.

Auxiliary coolers are recommended for the power steering system and automatic transaxle system if you are planning on:

- Traveling farther than 80 km (50 miles).
- Towing in hilly terrain.
- Towing frequently.

Using a hitch

Do not use hitches that:

- Clamp onto the vehicle bumper.
- Attach to the axle.

Distribute the load so that only 10 to 15% of the total weight of the trailer is on the tongue. Tie down the load so that it does not shift and change weight on the hitch. Follow the instructions of a reputable rental agency.

Using trailer lamps

See your local trailer retailer or rental agency for proper instructions and equipment for hooking up trailer lamps.

Do not hook the trailer lamps directly into the vehicle's wiring system. If the trailer lamps are not working properly, the warning lights in the instrument cluster may not work properly.

Driving

Using trailer brakes

Use electric brakes or manual, automatic or surge type hydraulic brakes that meet Federal and local regulations. Install and adjust brakes according to the manufacturer's instructions.



Do not connect a trailer's hydraulic brake system directly to your vehicle's brake system. Your vehicle may not have enough braking power and your chances of having a collision greatly increase.

Using safety chains

Always connect the trailer's safety chains to the vehicle. To connect the chains, cross the chains under the trailer tongue and attach to the vehicle frame or hook retainers (not the bumper). Make sure there is enough slack to allow the vehicle to turn corners.

Driving while towing a trailer

Do not drive faster than 72 km/h (45 mph) while towing a 454 kg (1 000 lb) trailer. Do not drive faster than 72 km/h (45 mph) with any weight trailer while towing in hilly terrain or on hot days.

Speed control (if equipped) may not work properly while towing on long, steep grades.

If driving with an automatic transaxle:

- Use D (Drive) or a low gear rather than D (Overdrive) while towing up or down steep inclines.
- Anticipate stops and brake gradually.

If driving with a manual transaxle:

- Select a gear that avoids jerking or excessive engine speed.
- Avoid driving excessively in first or second gear. If you need to drive excessively in first or second gear, the trailer may be too big or too heavily loaded for the vehicle drivetrain.
- Shift to a lower gear while towing up or down steep hills.
- Anticipate stops and brake gradually.

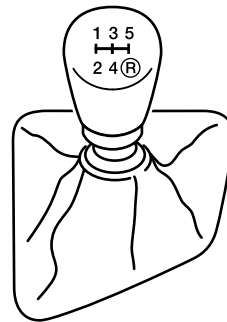
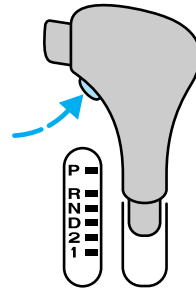

Driving

FUEL CONSUMPTION

Fuel economy can be improved by avoiding:

- lack of regular, scheduled maintenance,
- excessive speed,
- rapid acceleration,
- driving with the brake pedal depressed,
- sudden stops,
- extended engine idling,
- use of speed control in hilly terrain,
- extended use of the air conditioner, defroster, rear window defroster and other accessories,
- underinflated tires,
- heavy loads,
- aftermarket add-ons such as bike, ski or luggage racks, bug deflectors, etc.

Roadside emergencies

HAZARD FLASHER CONTROL

Use only in an emergency to warn traffic of vehicle breakdown or approaching danger. Depress to activate. Depress again to switch off. The hazard lights can be operated when the ignition is off.

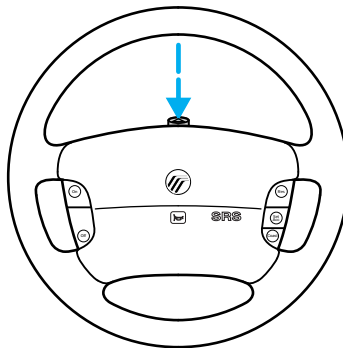

FUEL PUMP SHUT-OFF SWITCH

If the engine cranks, but does not start or does not start after a collision, the fuel pump shut-off switch may have been activated. The shut-off switch is a device intended to stop the electric fuel pump when your vehicle has been involved in a substantial jolt.

Once the shut-off switch is activated, you must reset the switch by hand before you can start your vehicle. The switch is located on the side panel in front of the driver's side door.

Roadside emergencies

 If you see or smell fuel, do not reset the switch or try to start your vehicle. Have all the passengers get out of the vehicle and call the local fire department or a towing service.

If your engine cranks but does not start after a collision or substantial jolt:

1. Turn the ignition key to the off position.
2. Check under the vehicle for leaking fuel.
3. If you do not see or smell fuel, push the red reset button down. If the button is already set, you may have a different mechanical problem.
4. Turn the ignition key to the on position for a few seconds, then turn it to the off position.
5. Check under the vehicle again for leaking fuel. If you see or smell fuel, do not start your vehicle again. If you do not see or smell fuel, you can try to start your vehicle again.

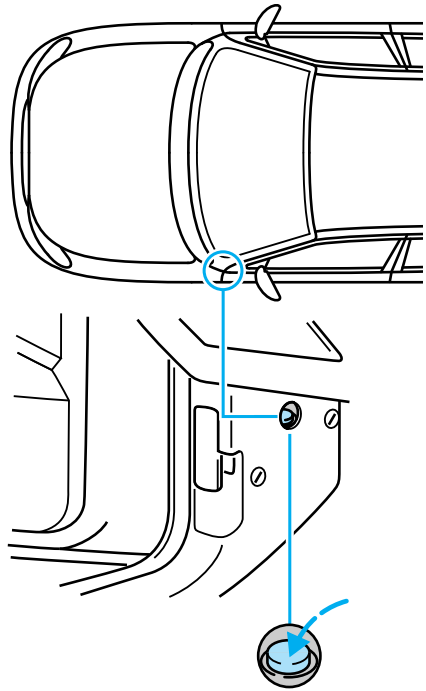

Roadside emergencies

FUSES AND RELAYS

If electrical components in the vehicle are not working, a fuse may have blown. Blown fuses are identified by a broken wire. Check the appropriate fuses before replacing any electrical components.

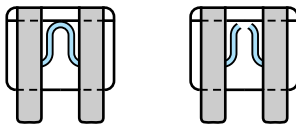

Always replace a fuse with one that has the specified amperage rating. Using a fuse with higher amperage rating can cause severe wire damage and could start a fire.

Even after a fuse is replaced, it will continue to blow if the cause of the overload is not identified and corrected. If the fuse continues to blow, have the vehicle's electrical system checked by your dealer or a qualified service technician.

The passenger compartment fuse panel is located on the driver's side under the instrument panel. The power distribution box is located on the driver's side of the engine compartment.

They contain the main fuses and the main relays. The circuits protected are identified by numbers on the passenger compartment fuse panel and inside the cover on the power distribution box.

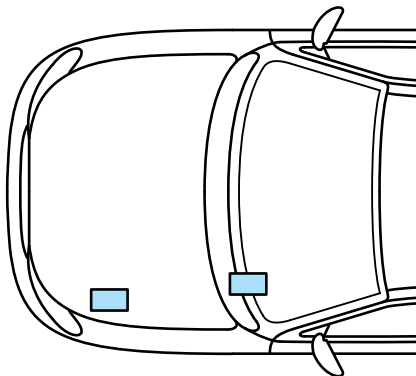

Roadside emergencies

Power distribution box

To check or replace a fuse or a relay, remove the cover of the fuse box in the engine compartment by releasing the latch (1) and lifting up.

A blown fuse can be identified by a break in the wire. Use the fuse puller (2) attached to the cover of the power distribution box to change a fuse.

All fuses are a push fit.

Five reserve fuses with different current ratings are attached to the inside cover of the power distribution box in case of emergency fuse replacement.

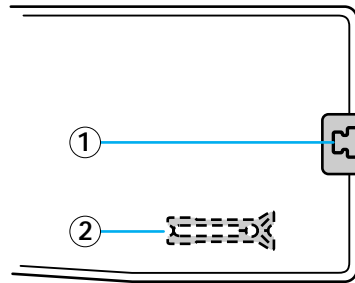

Always replace the cover to the Power Distribution Box before reconnecting the battery or refilling fluid reservoirs.

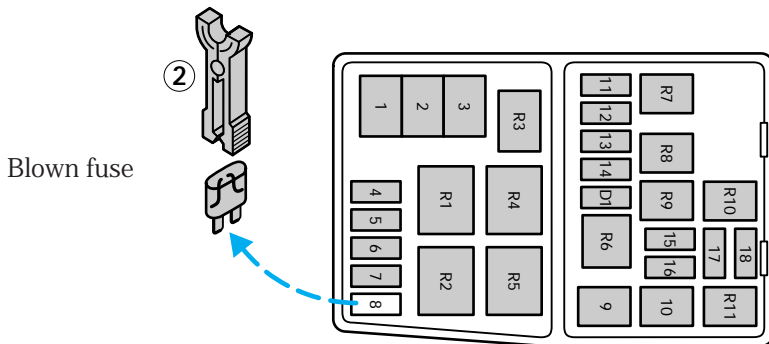

Roadside emergencies

Power distribution box (engine compartment)			
Fuse	Ampere rating	Color	Circuits protected
1*	80	black	Main power supply to vehicle electrical system
2*	60	yellow	Engine cooling fan
3*	60	yellow	ABS braking system, heater blower
4	20	yellow	Ignition and EEC module
5	15	light blue	Foglamp
6	—	—	Not used
7	20	yellow	ABS system
8	—	—	not used
9	20	light blue	Electronic Engine Control (EEC)
10	20	light blue	Ignition switch
11	3	violet	EEC ignition module (memory)
12	15	light blue	Horn and hazard flasher warning system
13	20	yellow	HEGO sensor
14	15	light blue	Electrically operated fuel pump
15	10	red	Low beam headlamp – (passenger's side)
16	10	red	Low beam headlamp – (driver's side)
17	10	red	High beam headlamp – (passenger's side)
18	10	red	High beam headlamp – (driver's side)

* Have these fuses replaced by your dealer or qualified technician.

Roadside emergencies

Power distribution box (engine compartment)	
Relay	Circuits switched
R 1	Daytime running lights
R 2	Radiator fan relay (high speed)
R 3	Air conditioning
R 4	Air conditioning clutch relay
R 5	Radiator fan relay (low speed)
R 6	Starter solenoid
R 7	Horn
R 8	Electrically operated fuel pump
R 9	Low beam headlamps
R 10	High beam headlamps
R 11	EEC module
D1	Reverse voltage protection

Passenger compartment fuse panel

To check or change a fuse or a relay, open the fuse box by pulling down the lock release lever (1).

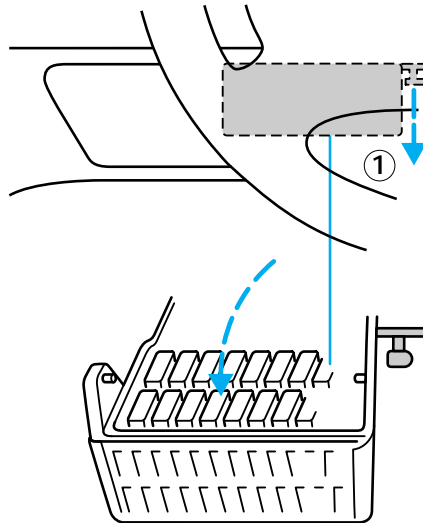

Roadside emergencies

A blown fuse can be identified by a break in the wire. Use the fuse puller (2) attached to the cover of the power distribution box to change a fuse.

All fuses are a push fit.

Five reserve fuses with different current ratings are attached to the inside cover of the power distribution box in case of emergency fuse replacement.

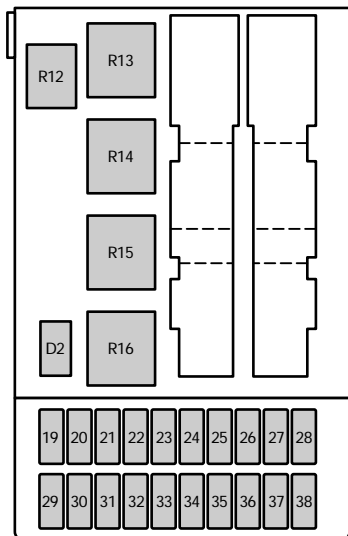

Passenger compartment fuse panel (below instrument panel)

Relay	Circuit switched
R 12	Interior lighting
R 13	Rear window defrost
R 14	Heater blower motor
R 15	Wiper motor
R 16	Ignition
D 2	Reverse voltage protection

Roadside emergencies

Passenger compartment fuse panel (below instrument panel)			
Fuse	Ampere rating	Color	Circuits protected
19	—	—	Not used
20	C10	black	Wiper motors (circuit breaker)
21	40	orange	Power windows
22	7.5	brown	ABS module
23	15	light blue	Backup lamps
24	15	light blue	Brake lamps
25	20	yellow	Door locks
26	7.5	brown	Main light
27	15	light blue	Cigar lighter
28	30	light green	Electric seats
29	30	light green	Rear window defrost
30	7.5	brown	Engine management system
31	7.5	brown	Instrument panel illumination
32	7.5	brown	Radio
33	7.5	brown	Parking lamps - driver's side
34	7.5	brown	Interior lighting/electric mirror adjustment/clock
35	7.5	brown	Parking lamps - passenger's side
36	10	red	Air bag
37	30	light green	Heater blower motor
38	—	—	Not used

Roadside emergencies

Standard fuse amperage ratings and colors

Fuse rating	Color
3 amp	violet
7.5 amp	brown
10 amp	red
15 amp	blue
20 amp	yellow
30 amp	light green
30 amp fuse link	pink
40 amp	green
60 amp fuse link	yellow
80 amp fuse link	black
100 amp fuse link	blue

Auxiliary relays (outside of fuse boxes)

Relay	Circuits switched	Location
R 18	"One touch" switch (driver's window)	Driver's door
R 20	Not used	—
R 21	Not used	—
R 22	Foglamps	Module bracket
R 23	Turn signals	Steering column
R 24	Panic alarm – driver's side	Door lock module bracket
R 25	Panic alarm – right-hand side	Door lock module bracket
R 26	Not used	—

Roadside emergencies

CHANGING TIRES

Park your vehicle in such a position that neither the traffic nor you are hindered or endangered when changing the tire. Ensure that the vehicle is on firm, level ground. If necessary, secure your vehicle further by blocking the wheels with chocks.

Activate the hazard lights.

Apply the parking brake and engage first or reverse gear or, if the vehicle has an automatic transaxle, select the P (Park) position.

If parking on a slope is unavoidable, secure the wheels with suitable chocks.

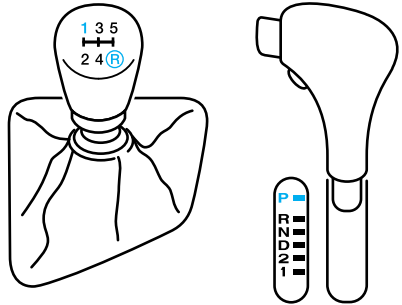
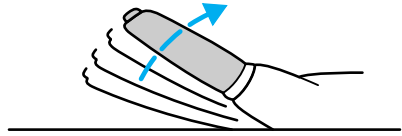

The temporary spare tire

The vehicle may have a high pressure temporary spare tire. This spare is smaller than a regular tire and is designed for emergency use only. This tire should be replaced as soon as possible.



If you use the temporary spare tire continuously or do not follow these precautions, the tire could fail, causing you to lose control of the vehicle, possibly injuring yourself or others.

When driving with a temporary spare tire:

- Do not exceed the maximum speed of 80 km/h (50 mph) and only drive the shortest possible distance.
- Do not exceed the permissible gross weight of the vehicle.
- Do not install more than one spare wheel on your vehicle at any one time.
- Do not use snow chains on this type of wheel.
- Do not drive through an automatic car wash.



Roadside emergencies

Spare tire location

The spare tire and tools are located under the floor cover in the luggage compartment.

Removing the spare tire and tools

1. Raise the rear of the floor cover in the luggage compartment and fold it forward.
2. Completely unscrew the bolt and remove the wheel cover panel with the holder.
3. Remove the wheel cover panel.
4. Lift out the spare wheel.
5. Remove the jack which is located in the tool pack.

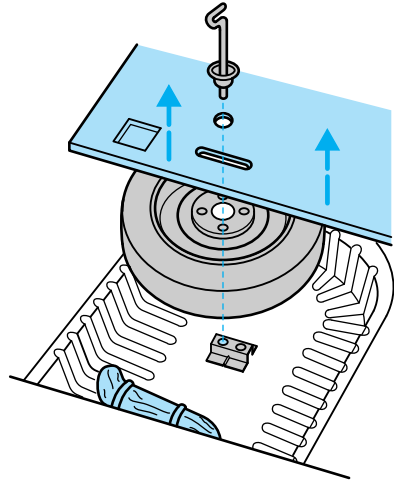

Tire changing procedure

Removing a tire

1. Apply the parking brake and 1 (first) gear (manual transaxle) or the P (Park) position (automatic transaxle).
2. Activate the hazard flashers.
3. The driver and all passengers must leave the vehicle.
4. Secure the vehicle against rolling or sliding.
5. Insert the tapered end of the jack handle between the rim and hub cover and push in. Twist off to remove the cover.
6. Loosen the wheel nuts slightly.

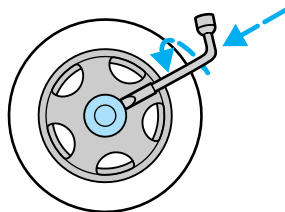
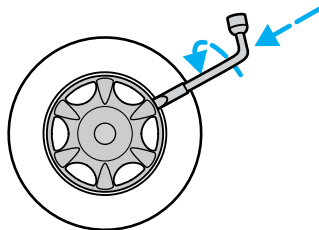

7. Place jack with complete support surface on the ground.
8. The jack must be applied exactly vertical to the jacking point of the vehicle.
9. Jack up the vehicle until the tire is clear of the ground. Unscrew and remove the wheel nuts and remove the wheel.

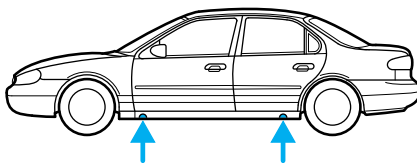

Roadside emergencies

Replacing a tire

1. Push the spare tire onto the wheel studs.
2. Screw on the wheel nuts, ensuring the tapered end of the wheel nuts are facing the wheel, and secure in a clockwise direction.
3. Lower the vehicle and remove the jack by turning the handle counterclockwise.
4. Fully tighten the wheel nuts in a crosswise pattern.
5. Align the hub cap with the valve and push firmly into position with the ball of the hand.
6. Stow the jack and damaged tire in the luggage compartment by reversing the spare tire removal instructions.

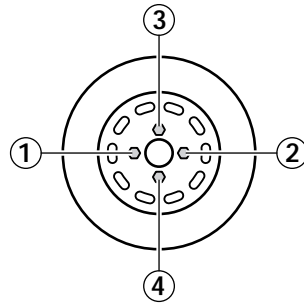
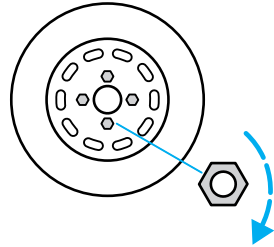

Roadside emergencies

JUMP STARTING YOUR VEHICLE

 The gases around the battery can explode if exposed to flames, sparks, or lit cigarettes. An explosion could result in injury or vehicle damage.

 Do not push start your vehicle. You could damage the catalytic converter. For further information, see *Jumper cables* in the index.

 Batteries contain sulfuric acid which burns skin, eyes, and clothing.

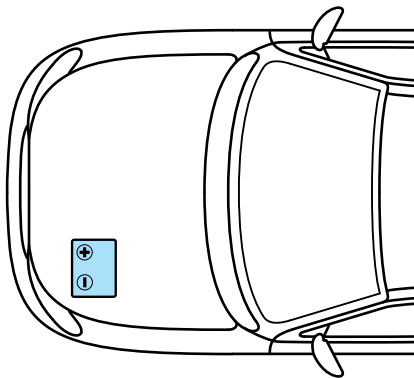

Roadside emergencies

Connecting jumper cables

1. Position the vehicles so that they do not touch one another.
2. Switch off the engine. Switch off any unnecessary electrical equipment.
3. Connect the positive (+) terminal of the discharged battery to the positive (+) terminal of the booster battery (1).
4. Connect one end of the second lead to the negative (-) terminal of the booster battery and the other end to a metal part of the engine to be started (2).
5. Make sure that the jumper cables are clear of moving parts of the engine.

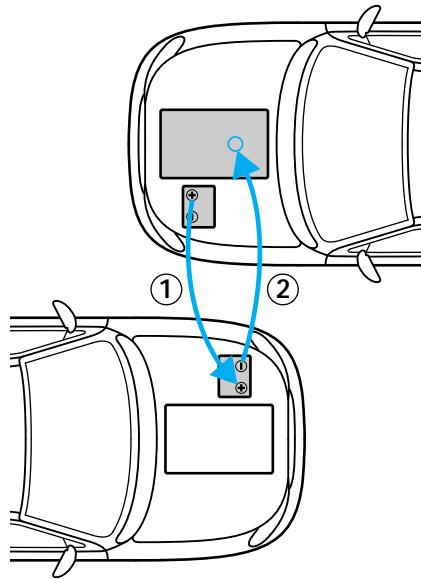

Do not connect the end of the second cable to the negative (-) terminal of the battery to be jumped. A spark may cause an explosion of the gases that surround the battery.

Roadside emergencies

Jump starting

1. Start the booster vehicle and run the engine at moderately increased speed.
2. Start the engine of the vehicle with the discharged battery.
3. Once the engine has been started, run both vehicles for an additional three minutes before disconnecting the cable leads.

Removing jumper cables

1. Remove the jumper cables in reverse order. Take the cable off the metallic surface first (1), then the cable on the negative (-) booster battery terminal (2).
2. Remove the cable from the positive (+) terminal of the booster battery (3) and then the discharged battery (4).
3. After the disabled vehicle has been started, allow it to idle for a while so the engine can “relearn” its idle conditions.

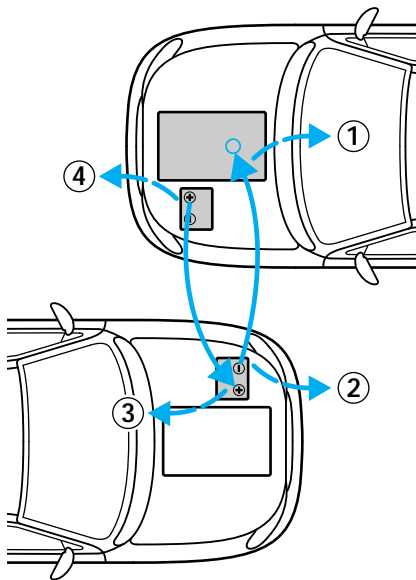

Roadside emergencies

WRECKER TOWING

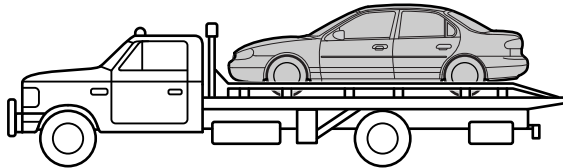
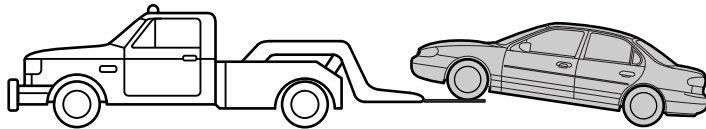

If towing is necessary, it is recommended that your vehicle be towed with a wheel lift or flatbed equipment. Do not tow with slingbelt equipment. Ford Motor Company has not developed or approved a T-hook or slingbelt towing procedure.

TOWING YOUR VEHICLE BEHIND ANOTHER VEHICLE

Before you have your vehicle towed:

- release the parking brake,
- move the gearshift to N (Neutral),
- turn the ignition to the off position and
- unlock the steering wheel.

Do not tow your vehicle at a speed faster than 55 km/h (35 mph) or for a distance greater than 80 km (55 miles) unless the drive wheels are placed on dollies.

SERVICE RECOMMENDATIONS

- We highlight do-it-yourself items in the engine compartment for easy location.
- As possible, we design parts that can be replaced without tools.
- We provide you with a “Service Guide” which makes tracking routine service for your vehicle easy.

If your vehicle requires professional service, your Ford dealership can provide necessary parts and service. Check your “Warranty Guide” to find out which parts and services are covered.

Use only recommended fuels, lubricants, fluids and service parts conforming to specifications. Motorcraft parts are designed and built to provide the best performance in your vehicle.

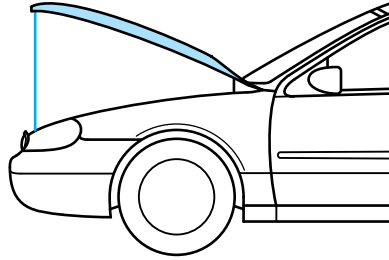

Maintenance and care

Precautions when servicing your vehicle

Be especially careful when inspecting or servicing your vehicle. Here are some general precautions for your safety:

- Do not work on a hot engine.



The cooling fan is automatic and may come on at any time. Always disconnect the negative terminal of the battery before working near the fan.

- If you must work with the engine running, avoid wearing loose clothing or jewelry that could get caught in moving parts. Take precautions with long hair.
- Do not work on a vehicle with the engine running in an enclosed space, unless you are sure you have enough ventilation.
- Keep all lit cigarettes, open flames and other lit material away from the battery and all fuel related parts.

If you disconnect the battery, the engine must “relearn” its idle conditions before your vehicle will drive properly, as explained under *Battery* in this chapter.

Working with engine off (automatic transaxle)

1. Set the parking brake fully and ensure the gearshift is securely latched in P (Park).
2. Turn off the engine and remove the key.
3. Block the wheels to prevent the vehicle from moving unexpectedly.

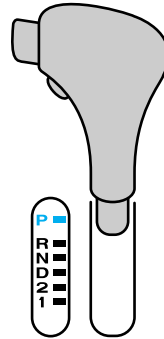

Working with engine off (manual transaxle)

1. Set the parking brake, depress the clutch and place the gearshift in 1 (first) or R (Reverse).
2. Turn off the engine and remove the key.
3. Block the wheels to prevent the vehicle from moving unexpectedly.

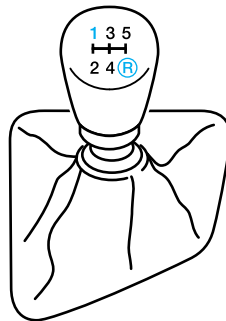

Maintenance and care

Working with engine on (automatic transaxle)

1. Set the parking brake fully and ensure the gearshift is securely latched in P (Park).
2. Block the wheels to prevent the vehicle from moving unexpectedly.



Do not start your engine with the air cleaner removed and do not remove it while the engine is running.

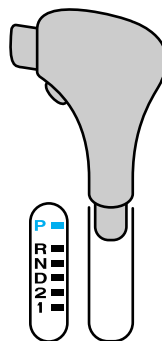

Working with engine on (manual transaxle)

1. Set the parking brake, depress the clutch and place the gearshift in neutral.
2. Block the wheels to prevent the vehicle from moving unexpectedly.

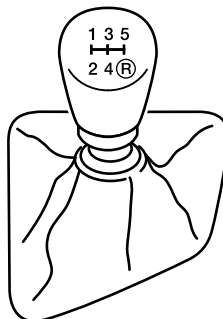

Maintenance and care

Opening the hood

- Pull the handle (1) located under the instrument panel.
- Release the safety catch by reaching under the hood (2) (adjacent to the Mercury emblem) and pushing it up.
- Raise the hood and support it with the strut (3) in the yellow colored retainer, ensuring it is secure. Hold the support at the yellow colored insulation section.

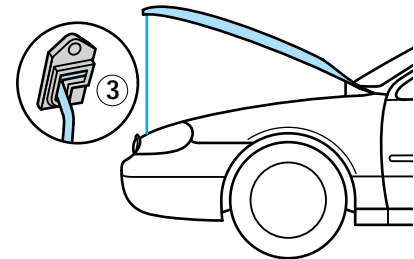
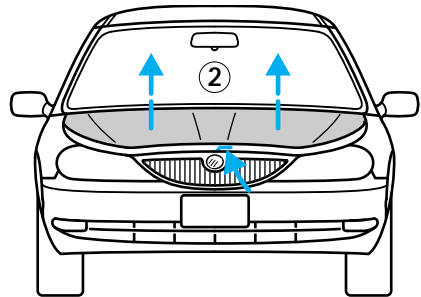
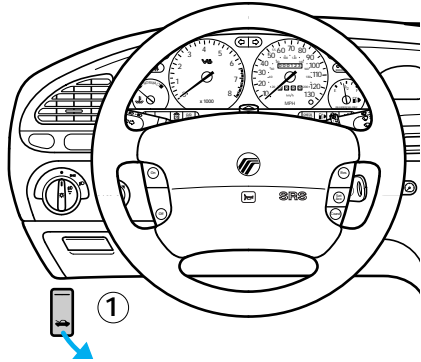

To close, replace the support strut in its retaining clip, lower the hood and allow it to drop into the catch for the last 20 – 30 cm (8 – 12 inches).

Always check to ensure that the hood lock is fully engaged.

Maintenance and care

2.0 litre EFI-engine compartment

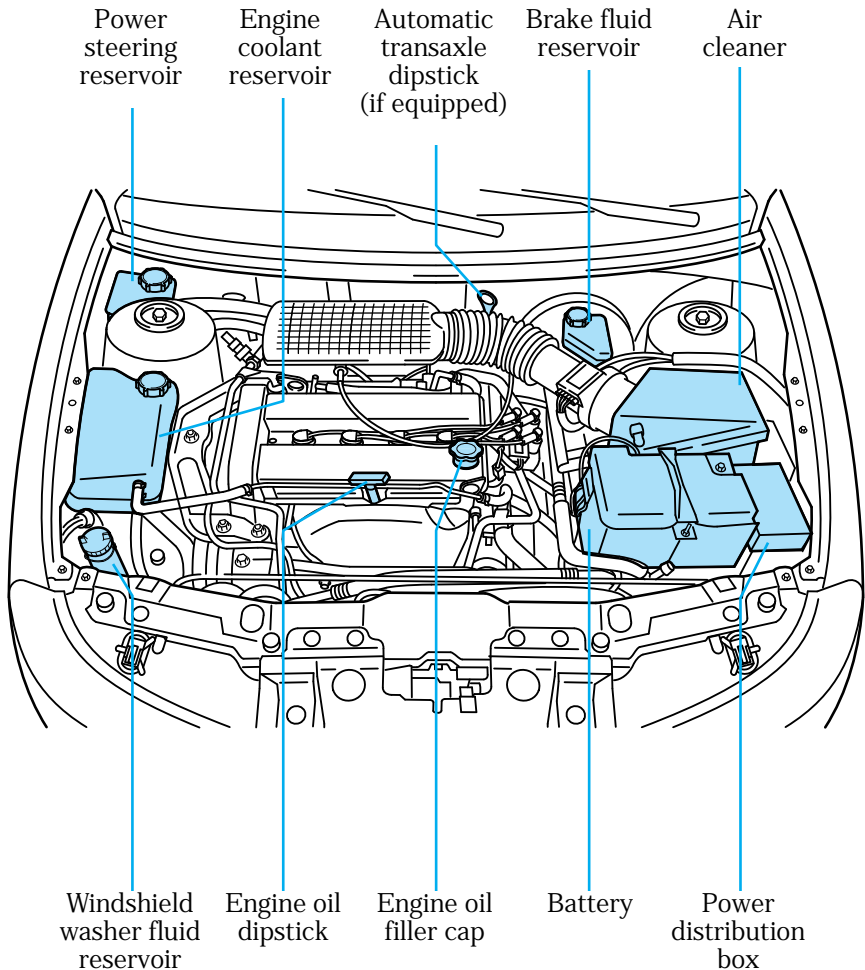

For ease of identification, all filler caps and the engine oil dipstick are marked yellow/black.

Maintenance and care

2.5 litre EFI-engine compartment

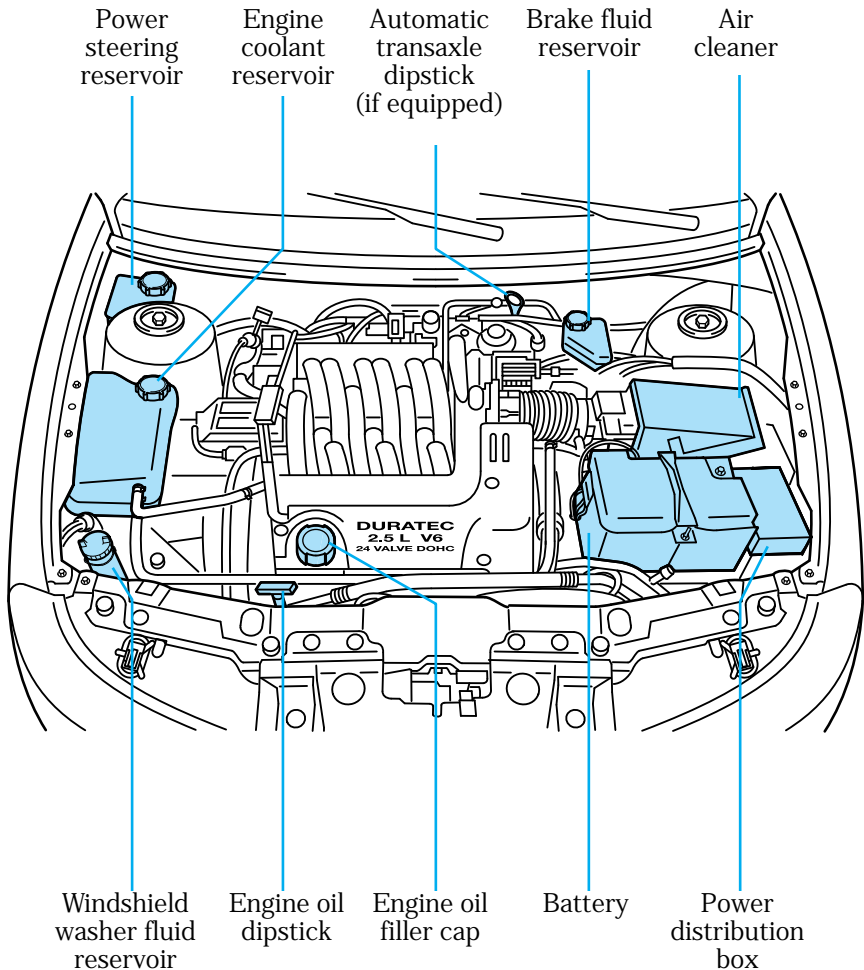

For ease of identification, all filler caps and the engine oil dipstick are marked yellow/black.

Maintenance and care

Engine oil

Use SAE 5W-30 motor oil CERTIFIED FOR GASOLINE ENGINES by the American Petroleum Institute.

Do not use supplemental engine oil additives, oil treatments or engine treatments. They are unnecessary and could, under certain conditions, lead to engine damage which is not covered by Ford Warranty.

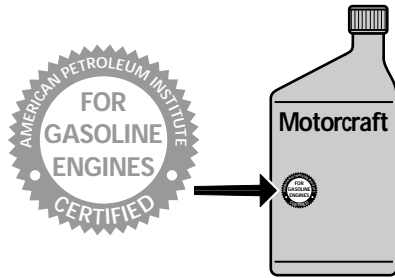

Checking the engine oil

Check the engine oil each time you fuel your vehicle.

To check the oil:

1. Make sure the vehicle is on level ground. If the engine is warm, turn the engine off and wait a few minutes for the oil to drain into the oil pan.
2. Set the parking brake and ensure the gearshift is securely latched in P (Park).
3. Open the hood. Protect yourself from engine heat.
4. Locate and carefully remove the engine oil dipstick.
5. Wipe the dipstick clean. Insert the dipstick fully, then remove it again. The oil level should be in the range shown on the dipstick.

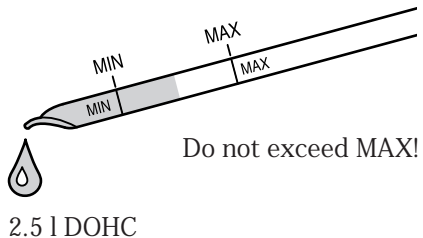
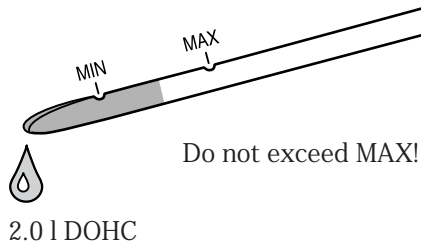

6. If the oil level is below the minimum line, add engine oil as necessary. If the oil level is beyond the maximum line, engine damage or high oil consumption may occur and some oil must be removed from the engine by a service technician.

7. Put the dipstick back in and ensure it is fully seated.



Continuous contact with used motor oil has caused cancer in laboratory mice.

Adding engine oil

1. Check the engine oil. For instructions, refer to *Checking the engine oil* in this chapter.

2. If the fluid level is not within the normal range, add only certified engine oil of the preferred viscosity. Add engine oil through the oil filler cap. Remove the filler cap and use a funnel to pour oil in the opening.

3. Recheck the oil level. **Make sure the oil level is not above the MAX mark on the dipstick.**

Change your engine oil and oil filter according to these mileage and time requirements, whichever occurs first.

5 000 miles (8 000 km) or 6 months Normal schedule
3 000 miles (5 000 km) or 3 months Severe duty schedule:
<ul style="list-style-type: none">• Extensive idling• Trailer towing• Driving in severe dust• Police, taxi, or delivery service

Maintenance and care

Refer to the "Maintenance Schedule" booklet for additional information.

It is recommended you use the appropriate Motorcraft oil filter (or another brand meeting Ford specifications) for your engine application.

 Always dispose of used automotive fluids in a responsible manner. Follow your community's standards for disposing of these types of fluids. Call your local recycling center to find out more about recycling automotive fluids.

Engine oil filler cap

The design of the filler cap varies by engine. To open, turn in the direction of the arrow and pull. Do not open the cap while the engine is running.

 Empty and used oil containers must be disposed of at an authorized waste disposal facility.

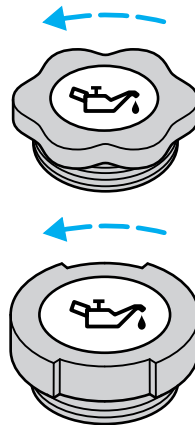

Maintenance and care

Brake/clutch fluid reservoir

Brake and clutch fluid systems are supplied from the same reservoir.

The level of the fluid must lie between the MIN and MAX marks on the side of the reservoir. If the level falls below the MIN mark, the brake fluid level warning light on the instrument panel will illuminate. Add only brake fluid that meets the Ford specification (see the chapter *Capacities and specifications*).

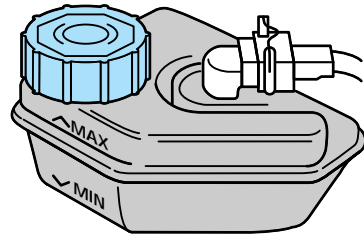

Brake fluid is toxic.



If you use a brake fluid that is not DOT 3, you will cause permanent damage to your brakes.



Do not let the reservoir for the master cylinder run dry. This may cause the brakes to fail.

Windshield washer system

If necessary, add enough washer fluid to fill the reservoir. Follow the instructions on the washer fluid label.



Do not put engine coolant in the container for the windshield washer fluid.

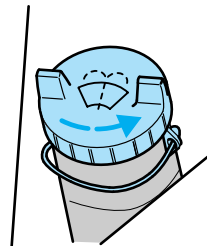

Maintenance and care

Engine coolant maintenance

Checking and adding engine coolant

Check the level of the coolant in the reservoir at least once a month. Be sure to read and understand *Precautions when servicing your vehicle* in this chapter.

If the engine coolant has not been checked for a long period of time, the engine coolant reservoir may eventually empty. If this occurs, add engine coolant to the coolant reservoir. For more information refer to *Adding engine coolant* in this chapter.

Automotive fluids are not interchangeable; do not use engine coolant, antifreeze or windshield washer fluid outside its specified function and vehicle location.

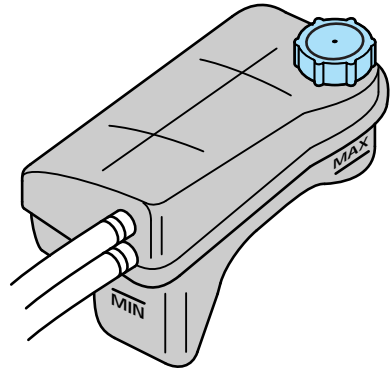

Do not put windshield washer fluid in the container for engine coolant.

When adding engine coolant

Ford recommends Ford Premium Cooling System Fluid, which is an optimized formula that will protect all metals and rubber elastomers used in Ford engines for four years or 80 000 km (50 000 miles).

It is neither necessary nor recommended to use supplemental coolant additives in your gasoline-powered vehicle. These additives may harm your engine coolant system.

When you change or add engine coolant, it is important to maintain engine coolant concentration between 40% (-24°C [-11°F]) and 60% (-52°C [-62°F]), depending on your local climate conditions.

A coolant concentration below 40% will result in a loss of freeze protection. A concentration above 60% may cause the engine to overheat on a warm day.

Refer to *Lubricant specifications* in the *Capacities and specifications* chapter. Use only a premium nationally-recognized brand name engine coolant or equivalent.

Maintenance and care

Recycled engine coolant

Ford Motor Company recommends that Ford and Lincoln-Mercury dealers use recycled engine coolant produced by Ford-approved processes. Not all coolant recycling processes produce coolant which meets Ford specifications ESE-M97B44-A, and use of such coolant may harm engine and cooling system components.



Always dispose of used automotive fluids in a responsible manner. Follow your community's standards for recycling and disposing of automotive fluids.

Adding engine coolant

1. Before removing the engine coolant recovery cap, turn the engine off and allow it to cool.
2. When the engine is cool, turn and remove the cap.

 Never remove the coolant recovery cap while the engine is running or hot.

- Step back for a moment while the pressure in the reservoir is released.
 - Stand away from the reservoir opening. Hot steam or coolant spray may be released.
3. Add engine coolant until the fluid level in the reservoir is between the MAX and MIN lines on the reservoir.

Follow the recommended service interval for changing engine coolant as outlined in the “Service Guide”. Refer to *Capacities and specifications* for more information on engine coolant specifications.

Have your dealer or a qualified service technician check the engine coolant system for leaks if you have to add more than a litre (quart) of engine coolant per month.

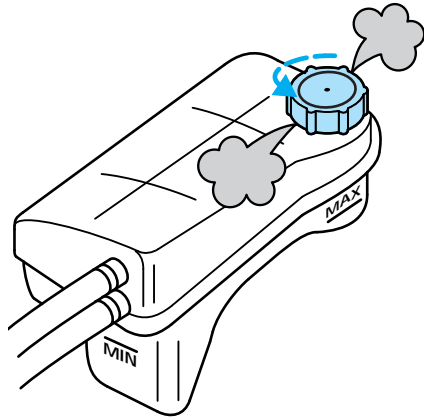

Maintenance and care

Severe winter climate

If you drive in extremely cold climates (less than -36°C [-34°F]), it may be necessary to increase the coolant concentration above 50%. Refer to the chart on the coolant container to ensure the coolant concentration in your vehicle is such that the coolant will not freeze at the temperature level in which you drive during the winter months. Never increase the engine coolant concentration above 60%. Leave a 50/50 mixture of engine coolant and water in your vehicle year-round in non-extreme climates.

Checking and adding power steering fluid

Switch off the engine. With the steering system at normal operating temperature, the fluid level should come up to the MAX mark.

If the fluid level drops below the MIN mark, add the specified fluid. Refer to the *Capacities and specifications* chapter.

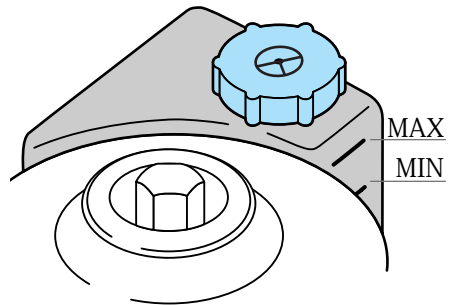

Automatic transaxle fluid

Check the automatic transaxle fluid according to the scheduled intervals in the “Service Guide”. However, if the transaxle is not working properly (slipping, shifting slowly or fluid leakage) the fluid level should be checked.

Adding automatic transaxle fluid

Before adding any fluid, make sure the correct type will be used. This information is stamped on the dipstick.

Check the fluid after your vehicle has reached normal operating temperature, which is reached after driving approximately 32 km (20 miles).

Add fluid in 0.25 litre (0.5 pint) increments through the filler tube until the fluid is at the correct level on the dipstick. If an overfill occurs, excess fluid should be removed by your dealer or a qualified service technician.

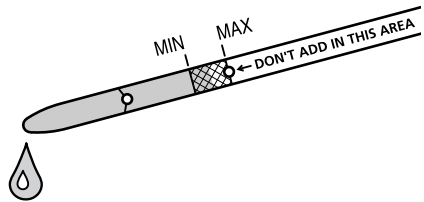

Maintenance and care

Checking the automatic transaxle fluid

With the vehicle on a level surface and the brake fully applied, start the engine and move the gearshift lever through all of the gears. Securely latch the lever in P (Park). Set parking brake and leave the engine running.

Wipe off the dipstick cap and pull the dipstick out. Wipe indicator clean. Put dipstick back into filler tube and make sure it is fully seated. Pull the dipstick out and read the fluid level.

Note that your vehicle should not be driven until some fluid has been added if the fluid level is below the bottom dimple on the dipstick and the outside temperature is above 10°C (50°F). Add only enough fluid to bring the level above the bottom hole.

If the vehicle has not been driven and the fluid level is above the bottom dimple on the dipstick, don't add fluid. Recheck the level after driving your vehicle approximately 30 km (20 miles) when the engine has reached normal operating temperature. The fluid level should be within the crosshatched area on the dipstick.

Battery

Your vehicle may be equipped with a Motorcraft maintenance-free battery. The Motorcraft maintenance-free battery normally does not require additional water during its life of service. However, for severe service usage or in high temperature climates, check your battery electrolyte level, at least every 24 months or 40 000 km (24 000 miles). Keep the electrolyte in each cell up to the “level” indicator. Do not overfill the battery cell.

For longer, trouble-free operation, keep the top of the battery clean and dry. Also, make certain the battery cables are always tightly fastened to the battery terminals.

If you see any corrosion on the battery cables or terminals, remove the cables from the terminal(s) and clean with a wire brush. You can neutralize the acid with a solution of baking soda and water. Reinstall the cables when you are done cleaning them, and apply a small quantity of grease to the top of each battery terminal to help prevent corrosion.

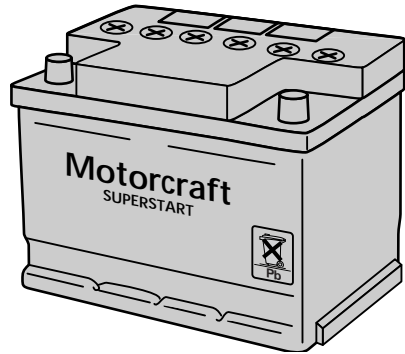

Maintenance and care

Battery replacement

If your original equipment battery requires replacement while under warranty, it will be replaced with a Motorcraft service battery, identical in design technology. Like the original equipment battery, it should not require water addition during its normal life of service; however, for severe service usage or in high temperature climates, check your battery electrolyte level, at least every 24 months or 40 000 km (24 000 miles). Do not overfill the battery cell.

If the electrolyte level in your battery gets low, you can add plain tap water to the battery, as long as you do not use hard water (water with a high mineral or alkali content). If possible, however, try to only fill the battery cell with distilled water. If the battery needs water often, have the charging system checked.

Maintenance and care

 Applying too much pressure on the ends when lifting a battery could cause acid to spill. Lift the battery with a carrier or with your hands on the opposite corners.

 Batteries normally produce explosive gases which can cause personal injury. Do not allow flames, sparks or lit tobacco to come near the battery. Always cover your face and protect your eyes and also provide ventilation.

 Follow these steps to minimize risk of personal injury.

 Always dispose of automotive batteries in a responsible manner. Follow your community's local standards for disposal. Call your local recycling center to find out more about recycling automotive batteries.

Maintenance and care

Relearning the idle function

Because your vehicle's engine is electronically controlled, some control conditions are maintained by power from the battery. When the battery is disconnected or a new battery is installed, the computer must "relearn" its idle conditions before your vehicle can drive properly. To begin this process:

1. Put the automatic transaxle gearshift in P (Park). Put the manual transaxle gearshift in neutral.
 2. Turn off all accessories and start the vehicle.
 3. Let the engine idle for at least one minute.
 4. The "relearning" process will automatically complete as you drive the vehicle.
- If you do not allow the engine to "relearn" its idle, the idle quality of your vehicle may be adversely affected until the idle is eventually "relearned".
 - If the battery has been disconnected or if a new battery has been installed, the clock and preset radio stations must be reset once the battery is reconnected.

Checking wiper blades

Check the wiper blades on your vehicle for roughness by running the tips of your fingers over the edge of the blade.

Traces of grease, silicone and fuel prevent wiper blades from functioning properly. We recommend Ford cleaning solutions or equivalent to clean wiper blades.

Change the wiper blades on your vehicle at least once a year.

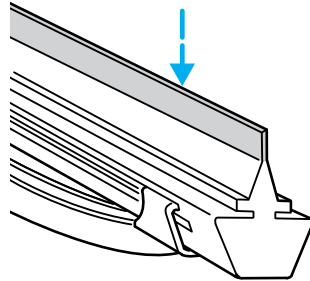

Cabin air filter replacement

In your climate control system, you have a filter that cleans the air before it enters the interior of the vehicle. This filter should be replaced at the intervals in the "Maintenance Schedule" booklet.

To replace the cabin air filter:

1. Remove both windshield wiper arms. With the wiper arm in the horizontal position, lift the arm away from the windshield while pulling the retaining clip at the base toward the windshield. Release the wiper arm, then lift it off the base.

Maintenance and care

2. Remove the plastic caps from the screws on the grille. Remove the screws.

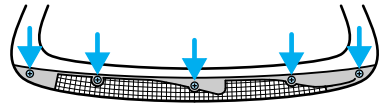

3. Open the hood. Pull off the rubber weatherstrip at the back of the engine compartment. Remove the screws that hold the grille, separate the two halves and remove the grille.

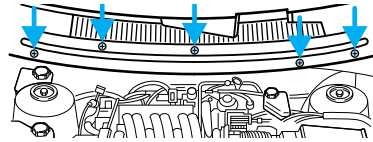

4. The filter is in a housing at the back of the engine compartment, on the left side. Pull off the two clips on the sides of the housing. Slide out the housing and filter.

5. Slide the filter out of the housing, replace with the new filter and slide the housing and cabin air filter back into place. Reinstall the clips on the housing.

6. Replace the grille and wiper arms.

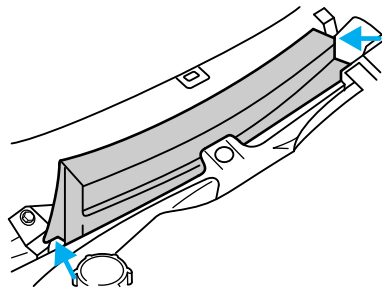

IMPORTANT TIRE MAINTENANCE INFORMATION

Information about tire quality grades

New vehicles are fitted with tires that have their Tire Quality Grade (described below) molded into the tire's sidewall. These Tire Quality Grades are determined by standards that the United States Department of Transportation has set.

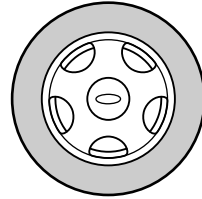

Tire Quality Grades apply to new pneumatic tires for use on passenger cars. They do not apply to deep tread, winter-type snow tires, space-saver or temporary use spare tires, tires with nominal rim diameters of 25 to 30 cm (10 to 12 inches) or limited production tires as defined in Title 49 Code of Federal Regulation Part 575.104(c) (2).

U.S. Department of Transportation – Tire quality grades:

The U.S. Department of Transportation requires Ford to give you the following information about tire grades exactly as the government has written it.

Maintenance and care

Treadwear

The treadwear grade is a comparative rating based on the wear rate of the tire when tested under controlled conditions on a specified government test course. For example, a tire grade of 150 would wear one and one-half (1 1/2) times as well on the government course as a tire grade 100. The relative performance of tires depends upon the actual conditions of their use, however, and may depart significantly from the norm due to variations in driving habits, service practices, and differences in road characteristics and climate.

Traction A B C

The traction grades, from highest to lowest are A, B, and C, and they represent the tire's ability to stop on wet pavement as measured under test surfaces of asphalt and concrete. A tire marked C may have poor traction performance. Warning: The traction grade assigned to this tire is based on braking (straightahead) traction tests and does not include cornering (turning) traction.

Temperature A B C

The temperature grades are A (the highest), B, and C, representing the tire's resistance to the generation of heat when tested under controlled conditions on a specified indoor laboratory test wheel. Sustained high temperature can cause the material of the tire to degenerate and reduce tire life, and excess temperature can lead to sudden tire failure. The grade C corresponds to a level of performance which all passenger cars tires must meet under the Federal Motor Vehicle Safety Standard No. 109. Grades B and A represent higher levels of performance on the laboratory test wheel than the minimum required by law.



The temperature grade for this tire is established for a tire that is properly inflated and not overloaded.



Excessive speed, underinflation, or excessive loading can cause heat buildup and possible tire failure.

Maintenance and care

Checking tire pressure

Check the tire pressure periodically and inflate the tires as necessary. To check the tire pressure, insert the tire pressure gauge into the valve.

The cold pressure amount is listed on the Safety Compliance Certification label.



Improperly inflated tires can affect vehicle handling and can fail suddenly, possibly resulting in loss of vehicle control.

Rotating tires

Rotate your tires at regular intervals for even wear. Rotation intervals are listed in the “Service Guide”.

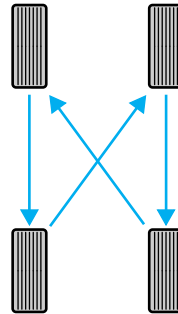

Replacing tires

Replace tires when the wear band is visible through the tire treads.



When replacing full size tires, never mix radial, bias-belted, or bias-type tires. Use only the tire sizes that are listed on the tire pressure decal. Make sure that all tires are the same size, speed rating, and load-carrying capacity. Use only the tire combinations recommended on the decal. If you do not follow these precautions, your vehicle may not drive properly and safely.



Do not replace your tires with “high performance” tires or larger size tires.



Failure to follow these precautions may adversely affect the handling of the vehicle and make it easier to lose control and roll over.

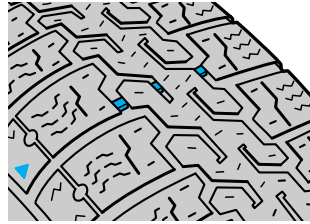

Maintenance and care



Dispose of worn tires in accordance with local environmental regulations.

Refer to the Safety Compliance Certification label to determine the specific size tire and wheel Ford Motor Company recommends for use on this vehicle.

When purchasing replacement tires for your vehicle, consult your dealer or a qualified service technician to ensure that the correct tire type is used.

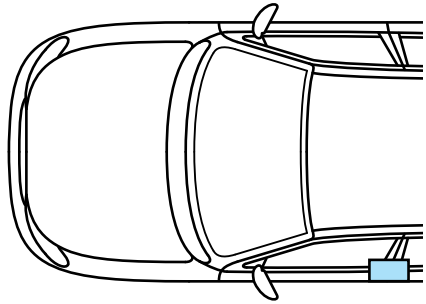

Using snow tires and chains



Snow tires must be the same size and grade as the tires you currently have on your vehicle.

The tires on your vehicle have all-weather treads to provide traction in rain and snow. However, in some climates, using snow tires and chains may be necessary. Ford offers snow chains as a Ford approved accessory and recommends use of these or their equivalents on approved tires. See your dealer or a qualified service technician for more information on tire chains for your vehicle. Follow these guidelines when using snow tires and chains:

- Install chains securely, verifying that the chains do not touch any wiring, brake lines or fuel lines.
- Install the chains on the front tires only.
- Do not use tire chains 205/60 tires and 205/55R16 Z rated tires. Steering, suspension and body components may be damaged by use of chains.

Maintenance and care

- Drive cautiously. If you hear the chains rub or bang against the vehicle, stop and retighten them. If this does not work, remove the chains to prevent vehicle damage.
- Local regulations may prohibit or restrict the use of tire chains. Investigate the laws and regulations in your area before installing chains.
- Avoid overloading your vehicle.
- Do not use tire chains on temporary spare tires.
- Remove the tire chains when they are no longer needed. Do not use chains on dry roads.
- The suspension insulation and bumpers will help prevent vehicle damage. Do not remove these components from the vehicle when using snow tires and chains.



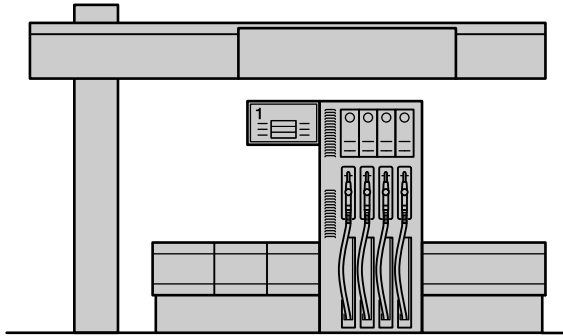

Change over from winter to summer tires as soon as road conditions allow, this will reduce fuel consumption and noise in the vehicle's interior.





IMPORTANT FUEL INFORMATON

Important safety precautions

 Do not overfill the fuel tank. The pressure in an overfilled tank may cause leakage and lead to fuel spray and fire.

 If you do not use the proper fuel cap, the pressure in the fuel tank can damage the fuel system or cause it to work improperly in a collision.

 The fuel system may be under pressure. If the fuel cap is venting vapor or if you hear a hissing sound, wait until it stops before completely removing the cap.

 Automotive fuels can cause serious injury or death if misused or mishandled.

Maintenance and care

Observe the following guidelines when handling automotive fuel:

- Extinguish all smoking materials and any open flames before fueling your vehicle.
- Always turn off the vehicle before fueling.
- Make sure the fuel cap is correctly fitted after fueling. Failure to do so may cause the on board diagnostic system to illuminate the CHECK ENGINE light.
- Automotive fuels can be harmful or fatal if swallowed. If fuel is swallowed, call a physician immediately, even if no symptoms are immediately apparent. The toxic effects of fuel may not be visible for hours.
- Fuels can also be harmful if absorbed through the skin. If fuel is splashed on the skin, promptly remove contaminated clothing and wash skin thoroughly with soap and water.
- If fuel is splashed in the eyes, remove contact lenses (if worn), flush with water for 15 minutes and seek medical attention.
- Be particularly careful if you are taking "Antabuse" or other forms of disulfiram for the treatment of alcoholism. Breathing gasoline vapors or skin contact could cause an adverse reaction. Consult a physician immediately.

Choosing the right fuel

Use only UNLEADED FUEL. The use of leaded fuel is prohibited by law and could damage your vehicle. The damage may not be covered by your warranty.

Your vehicle was not designed to use fuel containing manganese-based additives such as MMT. Additionally, vehicles certified to California emission standards (indicated on the underhood Vehicle Emission Control Information label) are designed to operate on California reformulated gasolines. If California reformulated gasoline is not available when you refuel, your vehicle can be operated on non-California fuels. However, even though your engine will perform adequately on other gasolines, the performance of the emission control devices and systems may be adversely affected. Repair of damage caused by a fuel that your vehicle was not designed for may not be covered by your warranty.

Maintenance and care

Octane recommendations

Your vehicle is designed to use regular gasoline with an (R+M)/2 octane rating of 87. We do not recommend gasolines labeled as “regular” in high altitude areas that are sold with octane ratings of 86 or even less.

Do not be concerned if your vehicle sometimes knocks lightly. However, if it knocks heavily under most driving conditions on the recommended octane, see your dealer or a qualified service technician to prevent any engine damage.

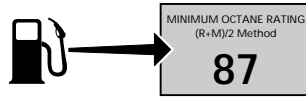

Fuel quality

If you are experiencing starting, rough idle or hesitation problems try a different brand of fuel. If the condition persists, see your dealer or qualified service technician.

The American Automobile Manufacturers Association (AAMA) issued a gasoline specification to provide information on high quality fuels that optimize the performance of your vehicle. We recommend the use of gasolines that meet the AAMA specification if they are available.

It should not be necessary to add any aftermarket products to your fuel tank if you continue to use a high-quality fuel.

Cleaner air

Ford approves the use of gasolines to improve air quality, including reformulated gasolines that contain oxygenates such as a maximum of 10% ethanol or 15% MTBE. There should be no more than 5% methanol with cosolvents and additives to protect the fuel system.

Maintenance and care

Calculating fuel economy

To accurately calculate your vehicle's fuel economy:

1. Fill the tank completely and record the initial odometer reading.
2. Each time you fill the tank, record the amount of fuel added (in litres or gallons)
3. After at least three to five fill-ups, fill the fuel tank and record the current mileage reading.
4. Use one of the following equations to calculate fuel economy.

$\text{Litres used} \times 100 / \text{Total kilometres traveled}$

$\text{Total miles traveled} / \text{Total gallons used}$

Keep a record for at least one month. This will provide an accurate estimate of the vehicle's fuel economy.

WHAT YOU SHOULD KNOW ABOUT THE EMISSION CONTROL SYSTEM

For more information about your vehicle's emission control system, refer to the Vehicle Emission Control Information Decal located on the inside, left of the engine compartment.

The catalytic converter enables the vehicle's emission control system to operate properly.

Follow these guidelines to ensure proper emission system operation:

- Use unleaded fuel only.
- Avoid running out of fuel.

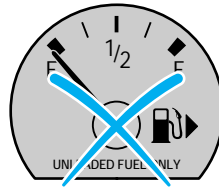

- Do not turn off the ignition while your vehicle is in motion.
- Have maintenance performed according to intervals in the "Service Guide".



Exhaust leaks may result in the entry of harmful and potentially lethal fumes into the passenger compartment. Under extreme conditions excessive exhaust temperatures could damage the fuel system, the interior floor covering, or other vehicle components, possibly causing a fire.

Maintenance and care

If you notice one or more of the following, the emission system may not be functioning properly; have the vehicle serviced as soon as possible:

- Fluid leaks.
- The charging system, engine oil pressure or low coolant warning lights illuminate in the instrument cluster and remain lit.

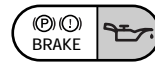

- Strange odors.
- Engine runs for more than five seconds after shut off or engine misfires, surges, stalls or backfires.
- Loss of oil pressure.

Important emission control information

By law, anyone who manufactures, repairs, services, leases, trades vehicles or supervises a fleet of vehicles is not permitted to intentionally remove an emission control device or prevent it from working. Do not make any unauthorized changes to the vehicle or engine. Changes that cause more unburned fuel to reach the exhaust system can increase the temperature of the engine or exhaust system.

When your vehicle is serviced, never use a metal exhaust collector. The use of a metal collector may melt or deform plastic parts.



Do not park, idle or drive your vehicle in dry grass or other dry ground cover. The emission system heats up the engine compartment and exhaust system, which can start a fire.

Maintenance and care

Preparing your vehicle for inspection/maintenance (I/M) testing

In some localities it may be a legal requirement to pass an I/M test of the on-board diagnostic (OBD) II system. If your vehicle's powertrain system or battery has just been serviced, the OBD II system is reset to a condition unready for I/M testing. To ready the OBD II system for I/M testing, the law specifies that additional city and highway driving is necessary to complete the check of the OBD II system.

The driving mode required to reach the ready condition consists of a minimum of 30 minutes of city and highway driving:

- At least 20 minutes driving in stop and go city-type traffic with at least four idle periods.
- At least 10 minutes of driving on an expressway or highway.

Before completing the above driving modes, the engine must be warmed up and at operating temperature. Once started, the vehicle must not be turned off during these modes.

BULB REPLACEMENT

Removing the headlamps assembly

 Handle a halogen headlamp bulb carefully and keep out of children's reach. Grasp the bulb only by its plastic base and do not touch the glass. The oil from your hand could cause the bulb to break the next time the headlamps are operated.

The bulbs for the low beam, high beam, turn signals and side lamps are housed in the lamp assembly. To replace a bulb, the complete lamp assembly has to be removed as follows:

1. Switch off the lamps.
2. Open the hood.
3. Remove the lower screw (2) from the headlamp housing.
4. Remove the two upper screws (1) from the headlamp housing.
5. Gently pull the headlamp housing outward.
6. Replace the headlamp bulbs.

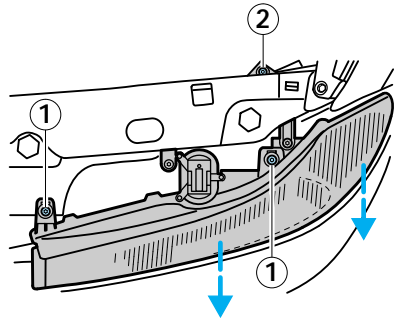

Maintenance and care

Reinstalling the headlamp assembly

The gasket lining must be seated properly around the lamp assembly when reinstalling.

All bulb connectors must be correctly connected.

Install in the reverse order.

Headlamp – low beam

Pull off the connector, release the wire clip and replace the bulb.

Pay attention to the tab guides when replacing.

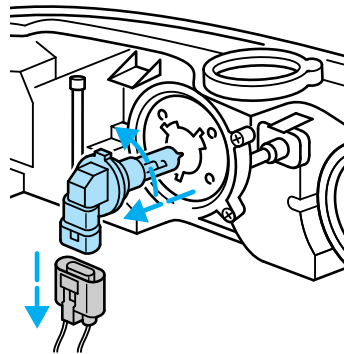

Headlamps – high beam

Replacement instructions are the same as for the low beam headlamp.

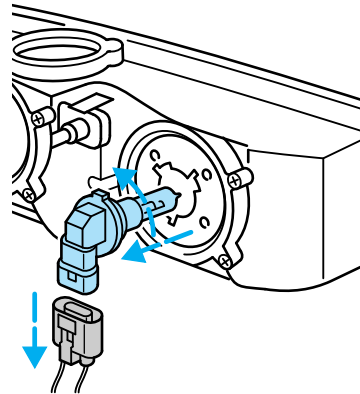

Headlamp alignment

Check the headlamp alignment after each replacement of a bulb. Refer to *Aiming the headlamps*.

Maintenance and care

Front turn signal/side lamps

Pull the socket out. Pull the bulb out and replace it.

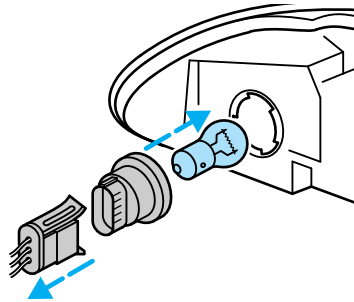

Foglamps (if equipped)

1. Detach the cover (access at bottom of front bumper).
2. Turn the bulb counterclockwise and pull it out of the light assembly.
3. Remove the electrical connector.
4. Fit the new bulb in reverse order (do not touch the glass part of the bulb).

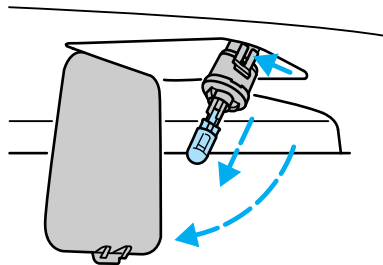

Maintenance and care

Brake/turn signal/tail lamps

1. Disconnect the electrical connector.
2. Turn the socket counterclockwise and pull it out.
3. Turn the bulb counterclockwise and pull it out.
4. To install, fit the new bulb in reverse order.

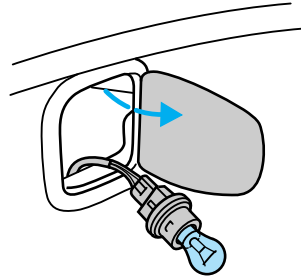

Backup lamps

The backup lamps are located in the trunk lid. Replacement instructions are the same as for the brake/turn signal/tail lamps.

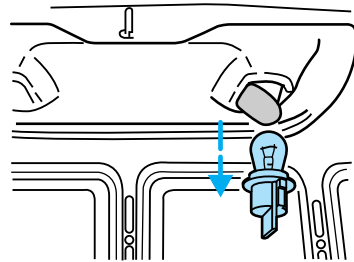

License plate lamp

Unscrew the bulb holder with a screwdriver. Remove the bulb from the clip holder.

Replace the new bulb in reverse sequence.

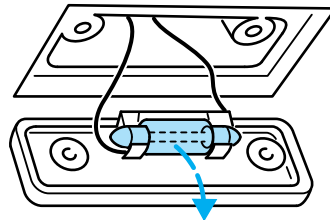

Maintenance and care

High-mounted brake lamp

Enter the rear seat compartment. Unscrew both screws and remove the complete lamp assembly. Bend the housing outwards to unclip the lamp module. Press the reflector fitting from the four locking points and pull it off. Pull out the wedge base bulb and replace.

To install, fit the new bulb in reverse sequence.

On vehicles equipped with a rear spoiler, the high-mounted brake lamp is included in the spoiler.

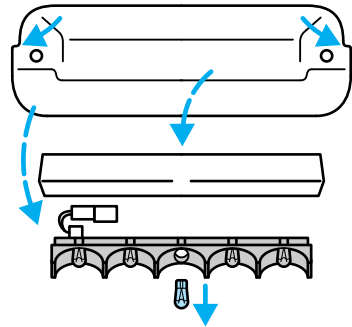

Luggage compartment lamp

Pry out the light assembly from the holder with a flat screwdriver. Turn the spherical bulb under slight pressure counterclockwise and remove.

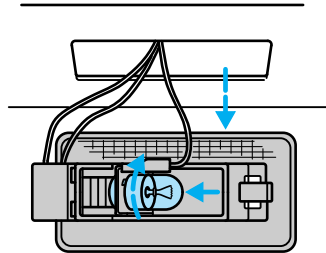

Maintenance and care

Interior lamps

Switch off the interior lamps (middle switch position). Pry out the lamp assembly with a flat screwdriver, release the reflector at the side and replace the festoon bulb.

To install, fit the new bulb in reverse sequence.

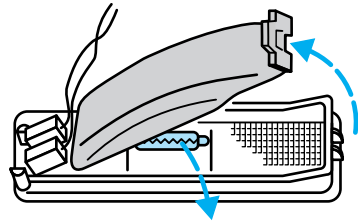

Reading lamps (if equipped)

Open the lamp assembly.

The bulbs can be replaced after the contact plate has been hinged back.

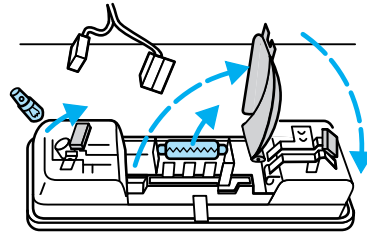

Bulb specifications

Function	Trade number
Front /turn lamp	3457 NA
Headlamp (high)	9005
Headlamp (low)	9006
Fog lamp	893
Rear tail/turn/brake lamp	1157
Backup lamp	1156
High-mounted brake lamp	2723
License plate lamp	C5W

AIMING THE HEADLAMPS

The alignment of your headlamps should be checked if:

- Oncoming motorists frequently signal you to deactivate your high beams, and your high beams are not activated.
- The headlamps do not seem to provide enough light for clear night vision.
- The headlamp beams are pointed substantially away from a slightly down and to the right position.

Aiming the headlamps

Your vehicle is equipped with a Vehicle Headlamp Aim Device (VHAD) on each headlamp body. Each headlamp may be properly aimed in the horizontal direction (left/right) and the vertical position (up/down).

A non-zero bubble reading does not necessarily indicate out-of-aim headlamps. If your vehicle is not positioned **on a level surface**, the slope will be included in the level indicator. Therefore, vertical headlamp adjustment should be performed only when beam direction appears to be incorrect and a level surface can be verified.

Maintenance and care

The horizontal aim must be adjusted first. You will need one 7 mm box wrench, open end wrench or T-15 Torx drive.

The following procedures assumes that the vehicle's front structure is properly aligned. If the vehicle has been in an accident requiring the front end of the vehicle to be repaired, the horizontal indicator should be recalibrated by your dealer or a qualified service technician.

Adjusting the horizontal aim

1. Make sure the vehicle is **on a level surface**.
2. With the hood open, locate the horizontal indicator and adjusting screw.
3. Turn the horizontal adjusting screw until the reference mark on the reflector extension aligns with the "0" reference mark on the horizontal indicator when viewed directly from above.
4. When the horizontal aim has been adjusted, close the headlamp access panel.

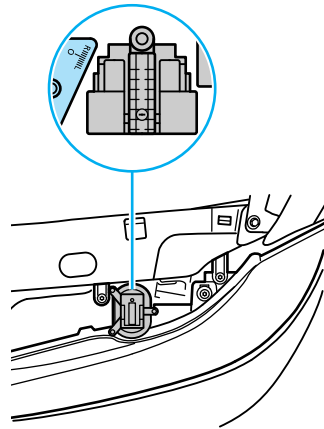

Adjusting the vertical aim

The numbers shown on the vial indicate beam direction in degrees up or down.

1. Do not adjust the vertical aim until after adjusting the horizontal aim.
2. With the hood open, locate the bubble level vertical aim indicator. It is visible when viewed from the above rear of the headlamp.
3. Turn the vertical adjusting screw until the reference mark on the reflector extension aligns with the "0" reference mark on the vertical indicator when viewed from directly above.
4. Close the hood.

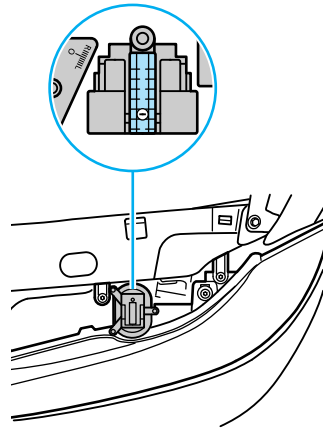

Maintenance and care

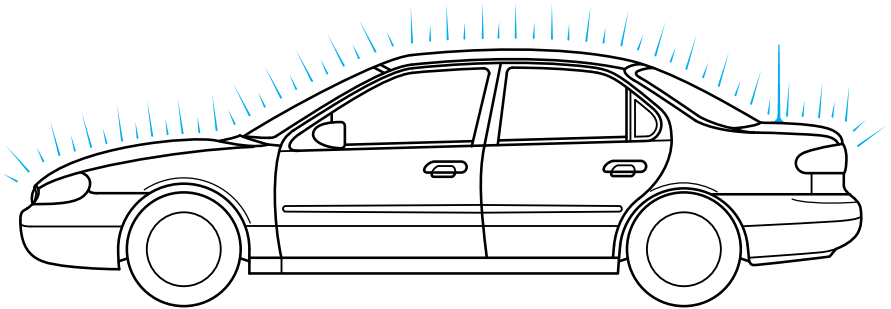

VEHICLE CARE

Washing your vehicle



Only use car washing areas that have environmentally friendly drainage systems.

Wash your vehicle regularly with cold or lukewarm water. Never use strong detergents or soap. If your vehicle is particularly dirty, use a quality car wash detergent. Always use a clean sponge, washing glove or similar device and plenty of water for best results. To avoid spots, avoid washing when the hood is still warm, immediately after or during exposure to strong sunlight.

Maintenance and care

During winter months, it is especially important to wash the vehicle on a regular basis. Large quantities of dirt and road salt are difficult to remove, and they also cause damage to the vehicle. Remove or lower any exterior accessories, such as antennas, before entering a car wash.

Remove particles such as bird droppings, tree sap, insect remains, tar spots, road salt and industrial fallout immediately.

After washing, apply the brakes several times to dry them.

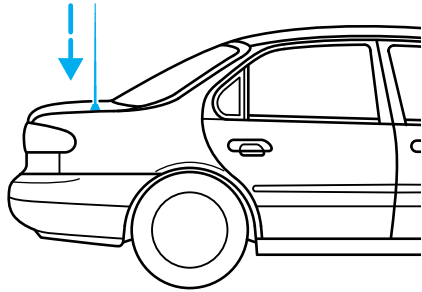

Waxing your vehicle

The best way to determine when the paintwork needs waxing is by noting when water stops beading on the surface. This could be every three or four months depending on operating conditions.

Use only carnauba or synthetic-based waxes. Remove any bugs and tar before waxing the vehicle. Use cleaning fluid or alcohol with a clean cloth to remove bugs. Use tar remover to remove any tar spots.

Maintenance and care

Repairing paint chips

Minor scratches or paint damage from road debris may be repaired with touch-up paint, paint repair foil or aerosol spray from the Ford accessories line. Observe the application instructions on the products.

Cleaning the wheels

Wash the wheels with the same detergent you use to clean the body of your vehicle. Do not use acid-based wheel cleaners, steel wool, fuel or strong detergents. Never use abrasives that will damage the finish of special wheel surfaces. Use a tar remover to remove grease and tar.

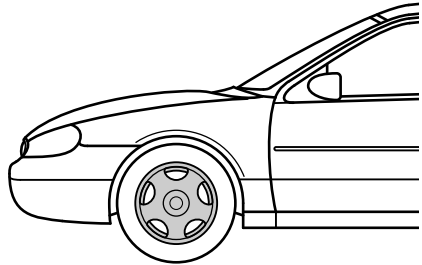

Cleaning the engine

Engines are more efficient when they are clean because grease and dirt buildup act as insulators and keep the engine warmer than normal. Follow these guidelines to clean your engine:

- Take care when using a power washer to clean the engine. The high pressure fluid could penetrate the sealed parts and cause damage.
- Do not spray with cold water, to avoid cracking the engine block.
- Cover the alternator to prevent water damage when cleaning the engine.
- Never wash or rinse the engine while it is running; water in the running engine may cause internal damage.

Maintenance and care

Cleaning plastic exterior parts

Use a vinyl cleaner for routine cleaning of plastic. Clean with a tar remover if necessary. Do not clean plastic parts with thinners, solvents or petroleum-based cleaners.

Cleaning the exterior lamps

Wash the exterior lamps with the same detergent you use to wash the exterior of your vehicle. Use glass cleaner or tar remover if necessary.

To avoid scratching the lamps, do not use a dry paper towel, chemical solvents or abrasive cleaners to clean the lamps.

Cleaning the wiper blades

If the wiper blades do not wipe properly, clean both the windshield and wiper blades using undiluted windshield wiper solution or a mild detergent. Rinse thoroughly with clean water. To avoid damaging the blades, do not use fuel, kerosene, paint thinner or other solvents.

Maintenance and care

Cleaning the instrument panel

Clean the instrument panel with a damp cloth, then dry with a dry cloth.

Any cleaner or polish that increases the gloss of the upper portion of the instrument panel should be avoided. The dull finish in this area is to help protect the driver from undesirable windshield reflection.

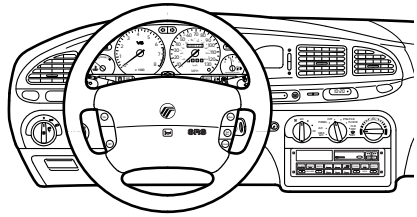

Cleaning the interior fabric

Remove dust and loose dirt with a whisk broom or a vacuum cleaner. Remove fresh spots immediately. Follow the directions that come with the cleaner.

Cleaning leather seats (if equipped)

For routine cleaning, wipe the surface with a soft, damp cloth. For more thorough cleaning, wipe the surface with a leather and vinyl cleaner or a mild soap.



Maintenance and care

Cleaning and maintaining the safety belts

Clean the safety belts with a mild soap solution recommended for cleaning upholstery or carpets and warm water. Do not bleach or dye the belts, because these actions may weaken the belt webbing.

Check the safety belt system periodically to make sure there are no nicks, wear or cuts.

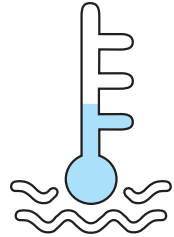
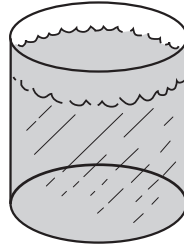

Ford recommends that all safety belt assemblies and attaching hardware should be inspected by a qualified technician after any collision. Safety belt assemblies not in use during a collision should also be inspected and replaced if either damage or improper operation is noted.

Cleaning and caring for your vehicle

Refer to the “Customer Assistance Guide” for a list of Ford-approved cleaners, polishes and waxes.

Capacities and specifications

Motorcraft parts

Component	Part number	
	2.0 litre engine	2.5 litre engine
Spark plug*	AZFS-22F # 1+2** AZFS-22FE# 3+4	AWSF-32F
Air filter	FA-1612	FA-1613
Passenger compartment air filter	FP4	FP4
Fuel filter	FG-800A	FG-800A
Oil filter	FL-2005	FL-820
Battery	BXT-40R	BXT-40R
PCV valve	EV-224	EV-152
Crankcase ventilation filter	FA-1621	—

*Refer to Vehicle Emission Control Information (VECI) decal for spark plug and gap specifications.

**If a spark plug is removed for examination, it must be reinstalled in the same cylinder. If a spark plug needs to be replaced, use only spark plugs with the service part number suffix letter "FE" as shown on the engine decal.

Capacities and specifications

Capacities	2.0 litre engine	2.5 litre engine
Engine oil - with filter - without	4.25 l (4.5 qts) 3.75 l (4.0 qts)	5.5 l (5.8 qts) 5.0 l (5.3 qts)
Manual transaxle	2.6 l (2.7 qts)	
Automatic transaxle with oil cooler	8.5 l (9.0 qts.)	9.6 l (10.2 qts)
Power steering	Fill to MAX mark	
Cooling system with heating	6.6 l (7.0 qts)* 7.1 l (7.5 qts)**	9.5 l (10.0 qts)* 9.7 l (10.2 qts)**
Windshield washer fluid	Fill to top of reservoir	
Fuel tank	61.5 l (16.2 gallons)	
Braking system	Fill to MAX mark	

* Total capacity

** with automatic transaxle

Capacities and specifications

Lubricant Specifications

Item	Ford part name or equivalent	Ford part number	Ford specification
Brake fluid	High performance DOT 3 brake fluid	C6AZ-19542-AB	ESA-M6C25-A
Engine coolant	Premium engine coolant	E2FZ-19549-AA CXC-8-B*	WSE-97B44-A
Engine oil	Motorcraft motor oil 5W-30 super premium	XO-5W30-QSP	American Petroleum Institute Certification Mark and WSS-M2C153-G
Power steering fluid	MERCON [®] power steering fluid	E6AZ-19582-AA	MERCON [®]
Transaxle fluid automatic/ 5-speed manual	Motorcraft MERCON [®] ATF	XT-2-QDX	MERCON [®]
Windshield washer fluid	Ultra-clear windshield washer concentrate	C9AZ-19550-AA or C9AZ-19550-BA	ESR-M17P5-A

Capacities and specifications

Engine data

Engine			2.0 litre Engine	2.5 litre Engine
Capacity	cm ³		1988	2544
Power output	kW (HP) at rpm		96 (125) 5500	125 (170) 6250
Max. torque	Nm (lb-ft) at rpm		176 (130) 4000	220 (162) 4250
Fuel required	87 Octane			
Continuous engine speed	rpm		6150	6700
Max. intermittent engine speed	rpm		6375	6925
Idle speed (manual transaxle)	rpm		800±50 (880±50)	725±50 (725±50)
Mixture preparation	Injection system			
Firing order			1-3-4-2	1-4-2-5-3-6
Spark plug gap	mm		1.3	
Ignition system	Electronically controlled			
Valve clearances	Inlet	0.14 mm	0.11-0.18*	Hydraulic valve adjusters
	Exhaust	0.30 mm	0.27-0.34*	

* Mechanical valve adjuster

Capacities and specifications

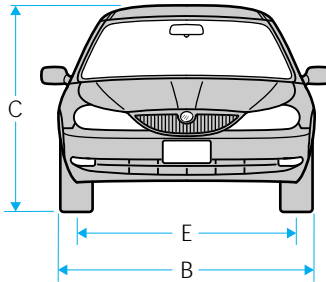
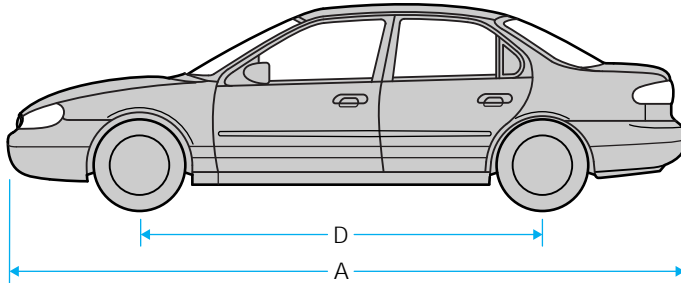

Dimensions		mm (inches)
A = Maximum length		4556 (179.4)
B = Overall width (without mirrors)		1751 (68.9)
C = Overall height (curb weight)		1380 - 1427 (54.3 - 56.2)
D = Wheelbase		2704 (106.5)
E = Track	Front	1499 - 1518* (59.0 - 59.8)
	Rear	1483 - 1502* (58.4 - 59.1)

* Dependent on tyre size

Capacities and specifications

VEHICLE IDENTIFICATION NUMBER

The vehicle identification number (VIN) is attached to a metal tag and is located on the front driver's side of the instrument panel. The VIN tag may be seen by looking through the windshield from the outside of the vehicle.

REPORTING SAFETY DEFECTS (U.S. ONLY)

If you believe that your vehicle has a defect that could cause a crash, or could cause injury or death, you should immediately inform the National Highway Traffic Safety Administration (NHTSA) in addition to Ford Motor Company.

If NHTSA receives similar complaints, it may open an investigation, and if it finds that a safety defect exists in a group of vehicles, it may order a recall and remedy campaign. However, NHTSA cannot become involved in individual problems between you, your dealer or Ford Motor Company.

To contact NHTSA, you may either call the Auto Safety Hotline toll-free at 1-800-424-9393 (202-366-0123 in the Washington D.C. area) or write to

NHTSA
U.S. Department of Transportation
400 Seventh Street
Washington D.C. 20590

You can also obtain other information about motor vehicle safety from the hotline.

Index

A	Page	B	Page
Accessory position on the ignition	24	Brake fluid	
Additives, engine oil	132	checking and adding	135
Air bag supplemental restraint system		specifications	185
and child safety seats	56	Brake-shift interlock	88
description	55	Brakelamps	
disposal	60	(see Bulb replacement)	
indicator light	8, 59	Brakes	
operation	57	anti-lock brake system (ABS) .84	
wearing safety belts	55	brake warning light	9
Air conditioning		fluid, checking and adding . . .135	
(see Climate control system)		fluid, refill capacities	184
Alarm, activating panic	39	fluid, specification	185
Antenna, radio		parking	86
(see Audio system)	18	Built-in child seat	
Anti-lock brake system (ABS) . .84		folding up the seat	70
Anti-theft system (see Passive Anti-Theft System)	41	inspection after a collision . . .70	
Antifreeze (see Engine coolant)		interlock safety feature	66
Audio system	18	operation	65
Automatic transaxle		retractors	69
driving with	89	Break-in period	2
fluid, adding	141	Bulbs, replacing	
fluid, checking	142	foglamps	169
fluid, refill capacities	184	headlamps	168
fluid, specification	185	high-mounted brake lamp . . .171	
B		license plate lamp	170
Backing up	89, 95	rear lamps	170
Battery		specifications	172
charging system warning light . .6		C	
jumping a disabled battery . . .121		Cabin air filter	147
proper disposal, recycling . . .145		Capacities for refilling fluids . . .184	
replacement, specifications . .183		Carbon monoxide in exhaust . .163	
servicing	143	Catalytic converter	163
		Chains, tires	155
		Changing a tire	116
		Charging system warning light . . .6	

C	Page	D	Page
Child safety restraints		Daytime running lights	15
built-in child seat	65	Defects, reporting	189
child safety seats	71	Defrost	
children and safety belts . . .	61, 63	rear window	16
Child safety seats		windshield	23
and air bags	56	Dipstick, engine oil	130
attaching with tether straps . .	74	Door mounted controls	34
automatic locking mode	49	Driving under special conditions	
Childproof safety locks	35	heavy load	99
Chimes	10	towing a trailer	100
Circuit breakers	109	E	
Cleaning your vehicle		Electrical system	
engine compartment	179	fuses	109
exterior lamps	180	Emergencies, roadside	
fabric	181	fuel pump shut-off switch . . .	107
instrument panel	181	jump starting	121
plastic exterior parts	180	towing	124
safety belts	182	Emergency brake (see Parking	
wheels	178	brake)	
wiper blades	180	Emission control system	163
Climate control system		Engine	
air conditioning	21	check engine warning light	8
controlling airflow	20	fuel pump shut-off switch . . .	107
defrosting	23	lubricant specifications	185
temperature	20	preparing to start	79
vents	19	refill capacities	184
Clock	18	starting	82
Clutch		Engine block heater	83
operation	93	Engine coolant	
recommended shift speeds . . .	94	checking and adding	136
Cold engine starting	82	disposal	138
Controls		low coolant warning light	7
instrument panel	14	refill capacities	184
mirrors	17	specifications	185
power seats	45	Engine fan	126
steering column	24		

Index

E	Page	F	Page
Engine oil		Fuses	
changing oil and filter	133	charts	111, 114
checking and adding	132	checking and replacing	109
dipstick	130	G	
disposal	134	Gas mileage (see Fuel economy)	
engine oil pressure		Gauges	
warning light	9	engine coolant temperature . . .	12
filter specifications	183	fuel	13
refill capacities	184	odometer	13
specifications	185	speedometer	13
Exhaust fumes	78, 163	trip odometer	13
F		GAWR	
Fan (see Engine fan)		(Gross Axle Weight Rating)	97
Flasher, hazard	26, 107	Gearshift	87, 93
Flashing the lights	27	GVWR	
Floor mats	37	(Gross Vehicle Weight Rating) . .	97
Fluid refill capacities	184	H	
Foglamps	15, 169	Hazard flashers	26, 107
Fuel		Head restraints	44
calculating fuel economy	162	Headlamps	
capacity	184	aiming	173
choosing the right fuel	159	bulb specifications	172
consumption	106	daytime running light	15
fuel gauge	13	flashing	27
low fuel warning light	8	high beam	27
octane rating	160	replacing bulbs	167
quality	161	turning on and off	14
running out of fuel	163	warning chime	11
safety information relating		High beams	
to automotive fuels	157	indicator light	6
Fuel pump shut-off switch	107	operation	27
Fuse panels			
engine compartment	110		
instrument panel	113		

H	Page	L	Page
High-mount brakelamp	171	Lamps	
Hood		bulb replacement specification	
latch location	129	chart	172
release lever	129	daytime running light system . .	15
Horn	26	flashing the lamps	27
I		foglamps	15, 169
Identification Number, Vehicle		hazard flashers	26, 107
(VIN)	188	headlamps	14
Idle, relearning	146	high beams	27
Idle, speed	146, 186	high-mounted brake lamp . . .	171
Ignition		instrument panel, dimming . .	16
chime	11	interior lamps	33
positions on the ignition	24	reading lamps	33
Instrument cluster	6	replacing bulbs	167
Instrument panel		rear lamps	170
cleaning	181	Lights, warning and indicator	
lighting up the panel	16	air bag	8
Integrated child seat (see Built-in		anti-lock brakes (ABS)	9
child seat)		brake	9
Intermittent wipers	28	charging system	6
Introduction	2	check engine	8
J		engine oil pressure	9
Jack		high beam	6
positioning	119	low coolant	7
storage	118	low fuel	8
Jump starting your vehicle		overdrive off	7
attaching cables	122	safety belt	7
disconnecting cables	123	testing the warning lights . . .	10
K		turn signal indicator	6
Keys		Load limits	96
key in ignition warning chime .	11	Lubricant specifications	187
positions of the ignition	24	Luggage compartment	36

Index

M	Page	P	Page
Maintenance (see Servicing)		Power distribution box (see Fuses)	
Manual transaxle		Power door locks	34
backing up (reverse)	95	Power features	
clutch	93	mirrors	17
fluid, capacity	184	seats	45
fluid, checking and adding . . .	141	sunroof	33
shift speeds	94	windows	34
Mileage, calculating fuel		Power steering	
economy	162	fluid, checking and adding . . .	140
Mirrors		fluid, refill capacity	184
side view mirrors (power)	17	fluid, specification	185
Motorcraft parts	183		
N		R	
National Highway Traffic Safety		Radio (see Audio system)	18
Administration	189	Rear window defroster	16
O		Refill capacities for fluids	184
Octane rating	160	Relays	109
Odometer	13	Remote control	
Oil (see Engine oil)		luggage compartment	36
Oil filter	133, 183	Remote entry system	
On-board diagnostic (OBD II)		locking/unlocking doors	38
system	166	opening the trunk	39
Overdrive	7, 90	panic alarm	39
Overhead controls	33	replacing the batteries	39
P		replacement/additional	
Panel dimmer control	16	transmitters	40
Panic alarm, remote entry system	39	Repairing paint chips	178
Parking brake	86	Reporting safety defects	189
Parts (see Motorcraft parts)	138	Restraints, safety	47
Passenger compartment		Rotating the tires	152
air filter (see Cabin air filter) . .	147		
Passive Anti-Theft			
System (PATS)	41		

S	Page
Safety belts	
(see Safety restraints)	
Safety chains, when towing	
a trailer	104
Safety Compliance Certification	
Label	102
Safety defects, reporting	189
Safety restraints	
adjusting the safety belts . . .	47, 51
automatic locking mode	
(retractors)	49
cleaning the safety belts	182
extention assembly	53
for children	61
head restraints	44
lap and shoulder belts	48
maintenance	54, 182
vehicle sensitive locking mode .	49
warning light and chime	7, 11
Safety seats for children	
and air bags	56, 72
attaching with tether straps . . .	74
automatic locking mode	
(retractors)	49, 71
built-in child seat	65
in front seat	56, 72
tether anchorage hardware	75
Seats	
adjusting the seats, manual	44
adjusting the seats, power	45
folding rear seats	46
head restraints	44
Servicing your vehicle	125
Shift-lock system	88
Shift positions (see Gearshift)	
Snow tires and chains	155

S	Page
Spare tire	
changing the tire	116
removing the spare tire	118
temporary spare tire	117
Spark plugs, certifications	183
Specification charts, lubricants . .	185
Speed control	
disengaging speed control	32
return to a set speed	32
set a speed	30
set a higher speed	31
set a lower speed	31
turn speed control off	29
turn speed control on	29
Speedometer	13
Starting your vehicle	
preparing to start the vehicle . .	79
starting the engine	82
Steering column controls	24
Steering wheel	
horn	26
speed control	29
tilting	25
Sunroof	33
Supplemental restraint	
system	11, 53
T	
Tachometer	13
Tail lamps (see Rear lamps)	
Temperature control	
(see Climate control)	
Testing the warning lights	10
Tether anchor installation	
(see Child safety restraints)	
Tilt steering wheel	25

Index

T	Page	V	Page
Tires		Variable interval wipers	28
changing	116	Vehicle care	176
checking tire pressure	152	Vehicle Identification Number (VIN)	188
cleaning	178	Vehicle Emission Control Information (VECI)	163
inspection and maintenance	152	Vehicle loading	96
replacing	120	Ventilating your vehicle	77
rotating	152	Viscosity (see Engine oil)	
snow tires and chains	155	W	
spare tire	117	Warning chimes	
tire grades	149	headlamps on	11
treadwear	150, 153	key in ignition	11
wearbands	153	safety belt	11
Towing your vehicle	124	Warning lights (see Lights)	
Trailer towing	100	Washer fluid reservoir	130
Transaxle		Weight limits (GAWR, GVWR)	96
automatic, operation	87	Wheels	
fluid, checking and adding (automatic)	141	cleaning	178
fluid, refill capacities	184	inspection and maintenance	152
lubricant specifications	185	Windows	
manual, operation	93	one-touch down	34
Transmitter (see Remote entry)		power windows, operating	34
Trip odometer	13	rear, defrosting	16
Trunk (see Luggage compartment)		Windshield washer fluid and wipers	
remote release lever	36	checking and adding fluid	135
using the remote entry system	39	checking and replacing wiper blades	147
Turn signal		operation	28
indicator lights	6	fluid, specification	185
lever	27	variable interval wipers	28
U		Wrecker towing	124
Used engine oil, disposal	134		