

CHRYSLER



2008

300 SRT8

OWNER'S MANUAL

VEHICLES SOLD IN CANADA

With respect to any Vehicles Sold in Canada, the name Chrysler LLC shall be deemed to be deleted and the name Chrysler Canada Inc. used in substitution therefor.

DRIVING AND ALCOHOL

Drunken driving is one of the most frequent causes of accidents.

Your driving ability can be seriously impaired with blood alcohol levels far below the legal minimum. If you are drinking, don't drive. Ride with a designated non-drinking driver, call a cab, a friend, or use public transportation.

WARNING!

Driving after drinking can lead to an accident. Your perceptions are less sharp, your reflexes are slower, and your judgment is impaired when you have been drinking. Never drink and then drive.

This manual illustrates and describes the operation of features and equipment that are either standard or optional on this vehicle. This manual may also include a description of features and equipment that are no longer available or were not ordered on this vehicle. Please disregard any features and equipment described in this manual that are not on this vehicle.

Chrysler LLC reserves the right to make changes in design and specifications, and/or make additions to or improvements to its products without imposing any obligation upon itself to install them on products previously manufactured.



TABLE OF CONTENTS

SECTION		PAGE	
1	INTRODUCTION	3	1
2	THINGS TO KNOW BEFORE STARTING YOUR VEHICLE	9	2
3	UNDERSTANDING THE FEATURES OF YOUR VEHICLE	79	3
4	UNDERSTANDING YOUR INSTRUMENT PANEL	193	4
5	STARTING AND OPERATING	293	5
6	WHAT TO DO IN EMERGENCIES	369	6
7	MAINTAINING YOUR VEHICLE	383	7
8	MAINTENANCE SCHEDULES	439	8
9	IF YOU NEED CONSUMER ASSISTANCE	447	9
10	INDEX	457	10

INTRODUCTION

CONTENTS

■ Introduction	4	■ Vehicle Identification Number	6
■ How To Use This Manual	4	■ Vehicle Modifications / Alterations	7
■ Warnings And Cautions	6		

INTRODUCTION

This manual has been prepared with the assistance of service and engineering specialists to acquaint you with the operation and maintenance of your new vehicle. It is supplemented by a Warranty Information Booklet and various customer-oriented documents. You are urged to read these publications carefully. Following the instructions and recommendations in this manual will help assure safe and enjoyable operation of your vehicle.

NOTE: After you read the manual, it should be stored in the vehicle for convenient reference and remain with the vehicle when sold so that the new owner will be aware of all safety warnings.















When it comes to service, remember that your authorized dealer knows your vehicle best, has the factory-trained technicians and genuine Mopar® parts, and is interested in your satisfaction.

HOW TO USE THIS MANUAL

Consult the Table of Contents to determine which section contains the information you desire.

The detailed Index at the back of this manual contains a complete listing of all subjects.

Consult the following table for a description of the symbols that may be used on your vehicle or throughout this Owner's Manual.

											ESP BAS ELECTRONIC STABILITY PROGRAM / BRAKE ASSIST SYSTEM
											BRAKE BRAKE SYSTEM WARNING PARKING BRAKE
										AWD!	 FAILURE OF ANTI-LOCK BRAKING SYSTEM
										4WD!	BRAKE BRAKE SYSTEM WARNING PARKING BRAKE
											TOW/HAUL TOW / HAUL
											4 LOW FOUR WHEEL DRIVE LOW
			SRS AIRBAG SUPPLEMENTAL RESTRAINT SYSTEM								8191e970

WARNINGS AND CAUTIONS

This manual contains **WARNINGS** against operating procedures that could result in an accident or bodily injury. It also contains **CAUTIONS** against procedures that could result in damage to your vehicle. If you do not read this entire manual, you may miss important information. Observe all Warnings and Cautions.

VEHICLE IDENTIFICATION NUMBER

The Vehicle Identification Number (VIN) is on the left front corner of the instrument panel. The VIN is visible from outside of the vehicle through the windshield. This number also appears on the Automobile Information Disclosure Label affixed to a window on your vehicle, the vehicle registration, and the title.

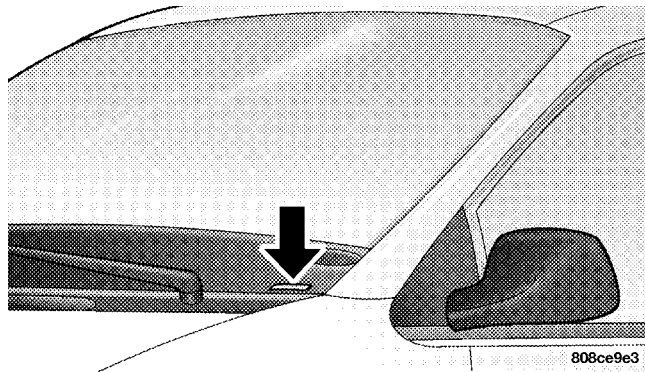

VIN Location

NOTE: It is illegal to remove the VIN.

VEHICLE MODIFICATIONS / ALTERATIONS**WARNING!**

Any modifications or alterations to this vehicle could seriously affect its roadworthiness and safety and may lead to an accident resulting in serious injury or death.

THINGS TO KNOW BEFORE STARTING YOUR VEHICLE

CONTENTS

■ A Word About Your Keys	12	□ General Information	18
□ Wireless Ignition Node (WIN)	12	■ Security Alarm System — If Equipped	18
□ FOB With Integrated Key	13	□ Rearming Of The System	18
□ Tip Start Feature	14	□ To Arm The System	19
□ Ignition Key Removal	14	□ To Disarm The System	19
□ Key-In-Ignition Reminder	15	■ Illuminated Entry System	20
■ Sentry Key® Immobilizer System	15	■ Remote Keyless Entry (RKE)	20
□ Replacement Keys	16	□ To Unlock The Doors	21
□ Customer Sentry Key® (FOB) Programming	17	□ To Lock The Doors	22

10 THINGS TO KNOW BEFORE STARTING YOUR VEHICLE

□ To Unlatch The Trunk22	□ Wind Buffeting36
□ Using The Panic Alarm22	■ Trunk Lock And Release37
□ Programming Additional Transmitters23	■ Trunk Safety Warning38
□ Transmitter Battery Service23	□ Trunk Emergency Release38
□ General Information24	■ Occupant Restraints39
■ Remote Starting System — If Equipped25	□ Lap/Shoulder Belts40
□ How To Use Remote Start25	□ Lap/Shoulder Belt Untwisting Procedure45
■ Door Locks27	□ Seat Belt Pretensioners46
□ Manual Door Locks27	□ Enhanced Seat Belt Reminder System (BeltAlert®)46
□ Power Door Locks28	□ Automatic Locking Mode — If Equipped47
□ Child Protection Door Lock30	□ Seat Belts And Pregnant Women48
■ Windows33	□ Seat Belt Extender48
□ Power Windows33		

□ Driver And Front Passenger Supplemental Restraint System (SRS) - Airbag49
□ Event Data Recorder (EDR)62
□ Child Restraint64
■ Break-In Recommendations73
■ Safety Tips74
□ Transporting Passengers74

THINGS TO KNOW BEFORE STARTING YOUR VEHICLE 11

□ Lock Your Vehicle75
□ Exhaust Gas75
□ Safety Checks You Should Make Inside The Vehicle76
□ Periodic Safety Checks You Should Make Outside The Vehicle77

A WORD ABOUT YOUR KEYS

Your vehicle uses a keyless ignition system. This system consists of a Fob with Integrated Key and a Wireless Ignition Node (WIN) with integral ignition switch. You can insert the double-sided integrated key into the ignition switch with either side up.

Wireless Ignition Node (WIN)

The Wireless Ignition Node (WIN) operates similarly to an ignition switch. It has four operating positions, three of which are detented and one spring-loaded. The detented positions are LOCK, ACC, and ON. The START position is a spring-loaded momentary contact position. When released from the START position, the switch automatically returns to the detented ON position.

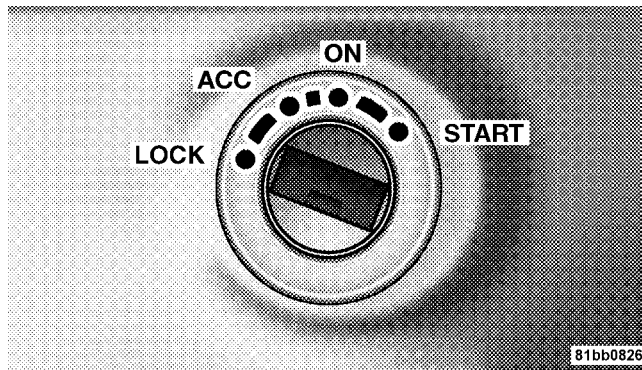

Wireless Ignition Node (WIN)

Fob with Integrated Key

The Fob with Integrated Key operates the ignition switch. It also contains the Remote Keyless Entry (RKE) transmitter and a valet key, which stores in the rear of the Fob.

The valet key allows for entry into the vehicle should the battery in the vehicle or the Fob go dead. The valet key is also for locking the glove box. You can keep the valet key with you when valet parking.

To remove the valet key from the Fob, slide the mechanical latch at the top of the Fob sideways with your thumb and then pull the key out of the Fob with your other hand.

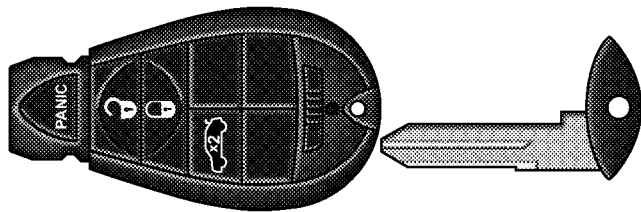

2

81c67821

Valet Key Removal

NOTE: You can insert the double-sided valet key into the lock cylinders with either side up.

Tip Start Feature

Do not press the accelerator. Use the Fob with Integrated Key to briefly turn the ignition switch to the START position and release it as soon as the starter engages. The starter motor will continue to run, and it will disengage automatically when the engine is running.

Ignition Key Removal

Place the shift lever in PARK. Turn the key to the LOCK position and then remove the key.

NOTE: The power window switches, radio, power sunroof (if equipped), and power outlets will remain active for up to 60 minutes after the ignition switch is turned to the LOCK position. Opening either front door will cancel this feature. The time for this feature is programmable. Refer to “Delay Power Off to Accessories Until Exit,” under “Personal Settings (Customer Programmable Features),” under “Electronic Vehicle Information Center (EVIC)” in Section 4.

WARNING!

Never leave children alone in a vehicle. Leaving unattended children in a vehicle is dangerous for a number of reasons. A child or others could be seriously or fatally injured. Don't leave the key in the ignition. A child could operate power windows, other controls, or move the vehicle.

CAUTION!

An unlocked car is an invitation to thieves. Always remove key from the ignition and lock all doors when leaving the vehicle unattended.

Key-In-Ignition Reminder

If you open the driver's door and the key is in the ignition, a chime will sound to remind you to remove the key.

NOTE: The Key-In-Ignition reminder only sounds when the ignition key is placed in the LOCK or ACC position.

SENTRY KEY® IMMOBILIZER SYSTEM

The Sentry Key® prevents unauthorized vehicle operation by disabling the engine. The system does not need to be armed or activated. Operation is automatic, regardless of whether the vehicle is locked or unlocked.

The system uses the factory-mated Fob with Integrated Key and Wireless Ignition Node (WIN) to prevent unauthorized vehicle operation. Therefore, only fobs that are programmed to the vehicle can be used to start and

operate the vehicle. The system will shut the engine off in two seconds if an invalid fob is used to start the engine.

After turning the ignition switch to the ON position, the Vehicle Security Alarm Indicator Light will turn on for three seconds for a bulb check. If the light remains on after the bulb check, it indicates that there is a problem with the electronics. In addition, if the light begins to flash after the bulb check, it indicates that someone used an invalid fob to start the engine. Either of these conditions will result in the engine being shut off after two seconds.

If the Vehicle Security Alarm Indicator Light turns on during normal vehicle operation (vehicle running for longer than 10 seconds), it indicates that there is a fault in the electronics. Should this occur, have the vehicle serviced as soon as possible.

NOTE:

- The Sentry Key® Immobilizer System is not compatible with aftermarket remote starting systems. Use of these systems may result in vehicle starting problems and loss of security protection.
- Exxon/Mobil SpeedPass™, additional fobs, or any other transponder-equipped components on the same key chain **will not** cause a fault unless the additional part is **physically held against the fob** being used to start the vehicle. Cell phones, pagers, or other RF electronics will not cause interference with this system.

All of the fobs provided with your new vehicle have been programmed to the vehicle electronics.

Replacement Keys

NOTE: Only fobs that are programmed to the vehicle electronics can be used to start and operate the vehicle. Once a fob is programmed to a vehicle, it cannot be programmed to any other vehicle.

CAUTION!

Always remove the Sentry Key® from the vehicle and lock all doors when leaving the vehicle unattended.

At the time of purchase, the original owner is provided with a four-digit Personal Identification Number (PIN). Keep the PIN in a secure location. This number is required for authorized dealer replacement of fobs. Duplication of fobs may be performed at an authorized dealer or by using the Customer Key Programming

procedure. This procedure consists of programming a blank fob to the vehicle electronics. A blank fob is one that has never been programmed.

NOTE: When having the Sentry Key® Immobilizer System serviced, bring all vehicle fobs with you to the authorized dealer.

Customer Sentry Key® (Fob) Programming

If you have two valid Sentry Keys®, you can program new Sentry Keys® to the system by performing the following steps:

1. Insert the first valid key into the ignition switch and turn the ignition switch to the ON position for at least three seconds, but no longer than 15 seconds. Turn the ignition switch to the OFF position and remove the first key.

2. Insert the second valid key and turn the ignition switch to the ON position within 15 seconds. After 10 seconds, a chime will sound and the Vehicle Security Alarm Indicator Light will begin to flash. Turn the ignition switch OFF and remove the second key.

3. Insert a blank Sentry Key® into the ignition switch and turn the ignition switch to the ON position within 60 seconds. After 10 seconds, a single chime will sound and the Vehicle Security Alarm Indicator Light will stop flashing, turn on again for three seconds, and then turn off.

The new Sentry Key® is programmed. **The Keyless Entry Transmitter will also be programmed during this procedure.**

Repeat this procedure to program up to eight keys. If you do not have a programmed Sentry Key®, contact your authorized dealer for details.

NOTE: If a programmed key is lost, see your authorized dealer to have all remaining keys erased from the system's memory. This will prevent the lost key from starting your vehicle. The remaining keys must then be reprogrammed. All vehicle keys must be taken to an authorized dealer at the time of service to be reprogrammed.

General Information

The Sentry Key® System complies with FCC rules Part 15 and with RSS-210 of Industry Canada. Operation is subject to the following conditions:

- This device may not cause harmful interference.
- This device must accept any interference that may be received, including interference that may cause undesired operation.

SECURITY ALARM SYSTEM — IF EQUIPPED

The Vehicle Security Alarm system monitors the vehicle doors for unauthorized entry and the ignition switch for unauthorized operation. If something triggers the alarm, the system will prevent the vehicle from starting and provide the following audible and visible signals: the horn will pulse; the headlights will flash; the park lights will flash; and the Vehicle Security Alarm Indicator Light in the instrument cluster will flash.

Rearming of the System

If something triggers the alarm, and no action is taken to disarm it, the system will turn the horn off after three minutes, turn all of the visual signals off after 15 minutes, and then the system will rearm itself.

To Arm the System

Remove the key from the ignition switch and either press a power door LOCK switch while the driver or passenger door is open or press the LOCK button on the Remote Keyless Entry (RKE) transmitter. After the last door is closed, or if all doors are closed, the system will arm itself in about 16 seconds. During that time, the Vehicle Security Alarm Indicator Light will flash. If it does not illuminate, the system is not arming. In addition, if you open a door during the arming period, the system will cancel the arming process. If you wish to rearm the system after closing the door, you must repeat one of the previously-described arming sequences.

To Disarm the System

Either press the UNLOCK button on the RKE transmitter or insert a valid ignition key into the ignition switch and turn the key to the ON position.

NOTE:

- The driver's door key cylinder and the TRUNK button on the RKE transmitter cannot arm or disarm the system.
- The system remains armed during trunk entry. Pressing the TRUNK button will not disarm the system. If someone enters the vehicle through the trunk, and opens any door, the alarm will sound.
- When the system is armed, the interior power door LOCK switches will not unlock the doors.

The Vehicle Security Alarm system is designed to protect your vehicle; however, you can create conditions where the system will give you a false alarm. If one of the previously-described arming sequences has occurred, the system will arm regardless of whether you are in the vehicle or not. If you remain in the vehicle and open a door, the alarm will sound. If this occurs, disarm the system.

If the alarm system is armed and the battery becomes disconnected the system will remain armed when the battery is reconnected. The exterior lights will flash, the horn will sound, and the ignition will not start the vehicle. If this occurs, disarm the system.

Tamper Alert

If something has triggered the system in your absence, the horn will sound three times when you disarm the system. Check the vehicle for tampering.

ILLUMINATED ENTRY SYSTEM

The courtesy lights will turn on when you use the Remote Keyless Entry (RKE) transmitter or open any door.

The lights will fade to off after about 30 seconds or they will immediately fade to off once the ignition switch is turned ON from the LOCK position.

NOTE:

- None of the courtesy lights will operate if the dimmer control is in the “defeat” position (extreme downward position), unless the overhead map/reading lights are turned on manually.

REMOTE KEYLESS ENTRY (RKE)

This system allows you to lock or unlock the doors, open the trunk, or activate the Panic Alarm from distances up to about 35 ft (11 m) using a hand-held radio transmitter. The transmitter need not be pointed at the vehicle to activate the system.

NOTE: Inserting the Fob with Integrated Key into the ignition switch disables all buttons on that transmitter; however, the buttons on the remaining transmitters will continue to work. Driving at speeds 5 mph (8 km/h) and above disables all transmitter buttons for all fobs.

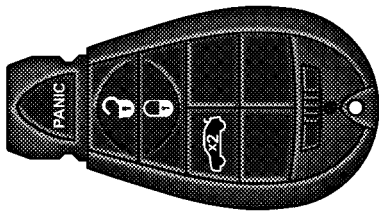

81c6782c

Remote Keyless Entry (RKE) Transmitter

To unlock the doors:

Press and release the UNLOCK button on the transmitter once to unlock the driver's door, or twice within five seconds to unlock all doors. The turn signal lights will flash to acknowledge the unlock signal. The illuminated entry system will also turn on.

Remote Key Unlock, Driver Door/All Doors First

This feature lets you program the system to unlock either the driver's door or all doors on the first press of the UNLOCK button on the transmitter. For details, refer to "Remote Key Unlock," under "Personal Settings (Customer Programmable Features)," under "Electronic Vehicle Information Center (EVIC)" in Section 4.

Flash Lights with Remote Key Lock

This feature will cause the turn signal lights to flash when the doors are locked or unlocked with the transmitter. This feature can be turned on or turned off. For details, refer to "Flash Lights with Remote Key Lock," under "Personal Settings (Customer Programmable Features)," under "Electronic Vehicle Information Center (EVIC)" in Section 4.

Turn Headlights On with Remote Key Unlock

This feature activates the headlights for up to 90 seconds when the doors are unlocked with the transmitter. The time for this feature is programmable. For details, refer to “Turn Headlights On with Remote Key Unlock,” under “Personal Settings (Customer Programmable Features),” under “Electronic Vehicle Information Center (EVIC)” in Section 4.

To lock the doors:

Press and release the LOCK button on the transmitter to lock all doors. The turn signal lights will flash and the horn will chirp to acknowledge the signal.

Sound Horn with Remote Key Lock

This feature will cause the horn to chirp when the doors are locked with the transmitter. This feature can be turned on or turned off. For details, refer to “Sound Horn

with Remote Key Lock,” under “Personal Settings (Customer Programmable Features),” under “Electronic Vehicle Information Center (EVIC)” in Section 4.

To unlatch the trunk:

Press the TRUNK button on the transmitter two times within five seconds to unlatch the trunk.

Using The Panic Alarm:

To turn the Panic Alarm feature ON or OFF, press and hold the PANIC button on the transmitter for at least one second and release. When the Panic Alarm is on, the headlights and park lights will flash, the horn will pulse on and off, and the interior lights will turn on.

The Panic Alarm will stay on for three minutes unless you turn it off by either pressing the PANIC button a second time or drive the vehicle at a speed of 15 mph (24 km/h) or greater.

NOTE:

- The interior lights will turn off if you turn the ignition switch to the ACC or ON position while the Panic Alarm is activated. However, the exterior lights and horn will remain on.
- You may need to be less than 35 ft (11 m) from the vehicle when using the transmitter to turn off the Panic Alarm due to the radio frequency noises emitted by the system.

Programming Additional Transmitters

Refer to Sentry Key[®], “Customer Sentry Key[®] (Fob) Programming.” (See page 17 for more information.)

If you do not have a programmed transmitter, contact your authorized dealer for details.

Transmitter Battery Service

The recommended replacement battery is one CR2032 battery.

NOTE:

- Perchlorate Material — special handling may apply. See www.dtsc.ca.gov/hazardouswaste/perchlorate
 - Do not touch the battery terminals that are on the back housing or the printed circuit board.
1. Battery access is through a door located on the rear of the fob. Insert a small, flat blade screwdriver into the slot and gently pry open the access door.

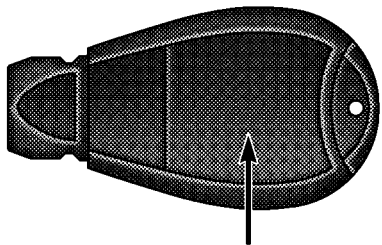
**BATTERY ACCESS DOOR**

81bb1827

Battery Replacement

2. Remove and replace the batteries. Avoid touching the new batteries with your fingers. Skin oils may cause battery deterioration. If you touch a battery, clean it with rubbing alcohol.
3. Reposition the access door panel over the battery opening and snap into place.

General Information

This device complies with Part 15 of the FCC rules and RSS 210 of Industry Canada. Operation is subject to the following conditions:

- This device may not cause harmful interference.
- This device must accept any interference received, including interference that may cause undesired operation.

NOTE: Changes or modifications not expressly approved by the party responsible for compliance could void the user's authority to operate the equipment.

If your Remote Keyless Entry (RKE) transmitter fails to operate from a normal distance, check for these two conditions:

1. A weak battery in the transmitter. The expected life of the battery is a minimum of three years.

2. Closeness to a radio transmitter such as a radio station tower, airport transmitter, and some mobile or CB radios.

REMOTE STARTING SYSTEM — IF EQUIPPED

This system uses the Remote Keyless Entry (RKE) transmitter to start the engine conveniently from outside the vehicle while still maintaining security. The system has a targeted range of 328 ft (100 m).

NOTE: The vehicle must be equipped with an automatic transmission to be equipped with Remote Start.

How To Use Remote Start

All of the following conditions must be met before the engine will remote start:

- Shift lever in PARK
- Doors closed
- Hood closed
- Trunk closed

- HAZARD switch off
- BRAKE switch inactive (brake pedal not pressed)
- Ignition key removed from ignition switch
- Battery at an acceptable charge level, and
- RKE PANIC button not pressed.

To Enter REMOTE START Mode



Press and release the REMOTE START button on the RKE transmitter twice, within five seconds. The parking lights will flash and the horn will honk twice (if programmed). Then, the engine will start and the vehicle will remain in the REMOTE START mode for a 15 minute cycle.

NOTE:

- The park lamps will turn on and remain on during REMOTE START mode.

- For security, power window and power sunroof operation (if so equipped) are disabled when the vehicle is in the REMOTE START mode.
- The engine can be started two consecutive times (two 15 minute cycles) with the RKE transmitter. However, the ignition switch must be cycled to the ON position before you can repeat the start sequence for a third cycle.

To Exit REMOTE START Mode without Driving the Vehicle

Allow the engine to run for the entire 15 minute cycle.

To Exit REMOTE START Mode and Drive the Vehicle

Before the end of the 15 minute cycle, press and release the UNLOCK button on the RKE transmitter to unlock the doors and disarm the Vehicle Security Alarm (if

equipped). Then, prior to the end of the 15 minute cycle, insert the key into the ignition switch and turn the switch to the ON position.

NOTE:

- The ignition switch must be in the ON position in order to drive the vehicle.
- For vehicles equipped with the Electronic Vehicle Information Center (EVIC), the message “Insert Key/ Turn To Run” will flash in the EVIC until you insert the key. Once inserted, the message “Turn To Run” will flash in the EVIC until you turn the key to run.

To Turn Off the Engine While in REMOTE START Mode

Press and release the REMOTE START button one time.

NOTE: To avoid inadvertent shut downs, the system will disable the one time press of the REMOTE START button for two seconds after receiving a valid REMOTE START request.

DOOR LOCKS

Manual Door Locks

To lock each door, push the door LOCK plunger on each door trim panel downward. To unlock each door, pull the door LOCK plunger on each door trim panel upward.

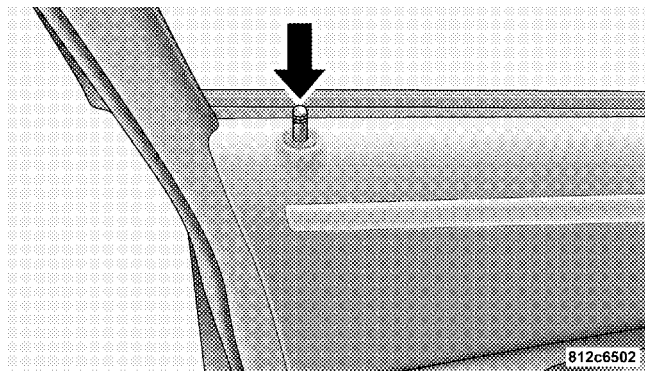

2

Door LOCK Plunger

If the door LOCK plunger is down when you shut the door, the door will lock. Therefore, make sure the key is not inside the vehicle before closing the door.

WARNING!

- For personal security and safety in the event of an accident, lock the vehicle doors before you drive as well as when you park and leave the vehicle.
- When leaving the vehicle, always remove the key from the ignition and lock your vehicle. Unsupervised use of vehicle equipment may cause severe personal injuries and death.
- Never leave children alone in a vehicle. Leaving unattended children in a vehicle is dangerous for a number of reasons. A child or others could be seriously or fatally injured. Don't leave the keys in the ignition. A child could operate power windows, other controls, or move the vehicle.

Power Door Locks

A power door LOCK switch is on each front door trim panel. Use this switch to lock or unlock the doors.

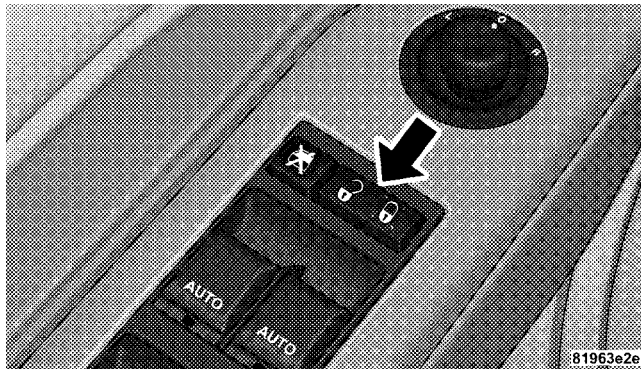

Power Door LOCK Switch

If you press the power door LOCK switch while the key is in the ignition, and any front door is open, the power locks will not operate. This prevents you from accidentally locking the key in the vehicle. Removing the key or closing the door will allow the locks to operate. If a door is open, the key is in the ignition, and the ignition is in the LOCK or ACC position, a chime will sound as a reminder to remove the key.

Automatic Door Locks

The doors will lock automatically on vehicles with power door locks if all of the following conditions are met:

1. The Automatic Door Locks feature is enabled
2. The transmission is in gear
3. All doors are closed

4. The throttle is pressed
5. The vehicle speed is above 15 mph (24 km/h), and
6. The doors were not previously locked using the power door LOCK switch or Remote Keyless Entry (RKE) transmitter.

Automatic Door Locks Programming

The Automatic Door Locks feature can be enabled or disabled. Refer to “Lock Doors Automatically at 15 mph (24 km/h),” under “Personal Settings (Customer Programmable Features),” under “Electronic Vehicle Information Center (EVIC)” in Section 4.

NOTE: Use the Automatic Door Locks feature in accordance with local laws.

Automatic Unlock Doors on Exit

The doors will unlock automatically on vehicles with power door locks if:

1. The Automatic Unlock Doors On Exit feature is enabled
2. The transmission was in gear and the vehicle speed returned to 0 mph (0 km/h)
3. The transmission is in NEUTRAL or PARK
4. The driver door is opened
5. The doors were not previously unlocked, and
6. The vehicle speed is 0 mph (0 km/h).

Automatic Unlock Doors on Exit Programming

The Automatic Unlock Doors On Exit feature can be enabled or disabled. Refer to “Unlock Doors Automatically on Exit,” under “Personal Settings (Customer Programmable Features),” under “Electronic Vehicle Information Center (EVIC)” in Section 4.

NOTE: Use the Automatic Unlock Doors On Exit feature in accordance with local laws.

Child Protection Door Lock

To provide a safer environment for small children riding in the rear seats, the rear doors are equipped with a Child Protection Door Lock system.

To Engage the Child Protection Door Lock System

1. Open the rear door.
2. Insert the tip of the valet key (or alike) into the child lock control and pull it upward.

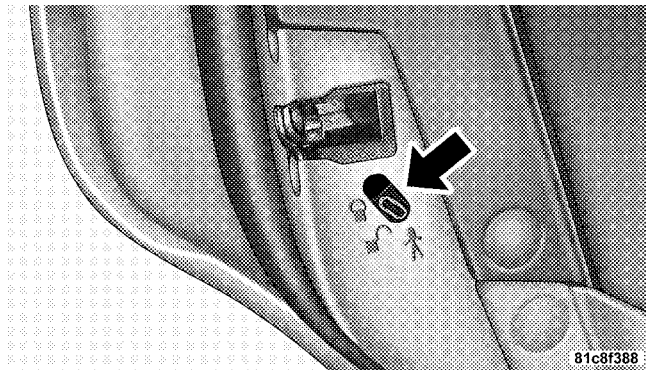

Child Lock Control

3. Repeat Steps 1 and 2 for the opposite rear door.

NOTE: When the Child Protection Door Lock system is engaged, the door can be opened only by using the outside door handle even though the inside door lock is in the unlocked position.

WARNING!

Avoid trapping anyone in a vehicle in a collision. Remember that the rear doors can only be opened from the outside when the child protection locks are engaged.

NOTE:

- After engaging the Child Protection Door Lock system, always test the door from the inside to make certain it is in the desired position.

32 THINGS TO KNOW BEFORE STARTING YOUR VEHICLE

- For emergency exit with the system engaged, move the door LOCK switch to the UNLOCK position, roll down the window and open the door with the outside door handle.

To Disengage the Child Protection Door Lock System

1. Open the rear door.
2. Insert the tip of the valet key (or alike) into the child lock control and pull it downward.

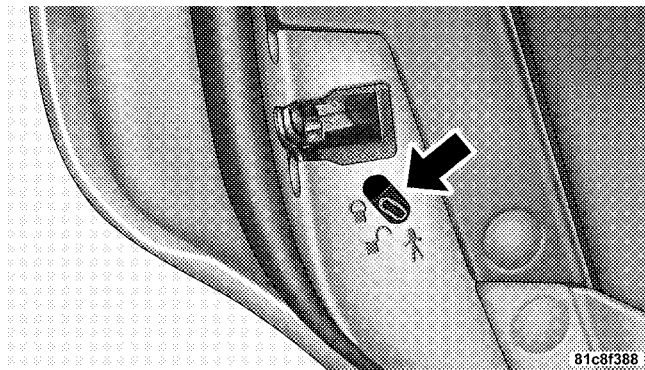

81c8f388

Child Lock Control

3. Repeat Steps 1 and 2 for the opposite rear door.

NOTE: After disengaging the Child Protection Door Lock system, always test the door from the inside to make certain it is in the desired position.

WINDOWS

Power Windows

The window controls on the driver's door control all the door windows.

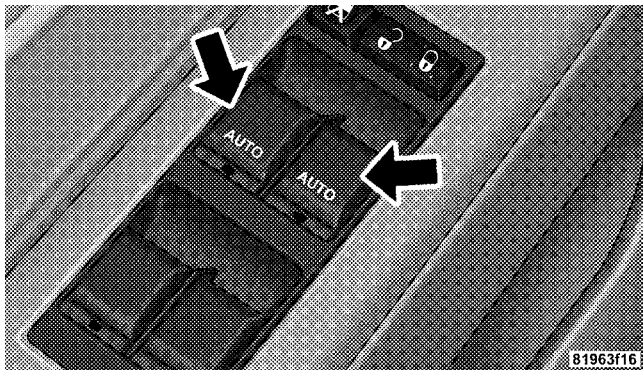

Power WINDOW Switches

There are single window controls on each passenger door trim panel, which operate the passenger door windows. The window controls will operate only when the ignition switch is in the ON or ACC position.

WARNING!

Never leave children in a vehicle with the key in the ignition switch. Occupants, particularly unattended children, can become entrapped by the windows while operating the power WINDOW switches. Such entrapment may result in serious injury or death.

AUTO-Down Feature

The driver door power WINDOW switch and some model passenger door power WINDOW switches have an AUTO-down feature. Press the WINDOW switch to the second detent, release, and the window will go down automatically.

To open the window part way, press the WINDOW switch to the first detent and release it when you want the window to stop.

To stop the window from going all the way down during the AUTO-down operation, pull up on the switch briefly.

The power WINDOW switches will remain active for up to 60 minutes after the ignition switch is turned off. Opening either front door will cancel this feature. The

time for this feature is programmable. Refer to “Delay Power Off to Accessories Until Exit,” under “Personal Settings (Customer Programmable Features),” under “Electronic Vehicle Information Center (EVIC)” in Section 4.

AUTO-Up Feature with Anti-Pinch Protection — If Equipped

Lift the WINDOW switch to the second detent, release, and the window will go up automatically.

To stop the window from going all the way up during the AUTO-up operation, push down on the switch briefly.

To close the window part way, lift the WINDOW switch to the first detent and release it when you want the window to stop.

The power WINDOW switches will remain active for up to 60 minutes after the ignition switch is turned off. Opening either front door will cancel this feature. The time for this feature is programmable. Refer to "Delay Power Off to Accessories Until Exit," under "Personal Settings (Customer Programmable Features)," under "Electronic Vehicle Information Center (EVIC)" in Section 4.

NOTE:

- If the window runs into any obstacle during auto-closure, it will reverse direction and then stop. Remove the obstacle and use the WINDOW switch again to close the window.
- Any impact due to rough road conditions may trigger the auto-reverse function unexpectedly during auto-closure. If this happens, pull the switch lightly to the first detent and hold to close the window manually.

WARNING!

There is no anti-pinch protection when the window is almost closed. Be sure to clear all objects from the window before closing.

2**Window LOCKOUT Switch**

The window LOCKOUT switch on the driver's door trim panel allows you to disable the window controls on the passenger doors. To disable the window controls, press and release the window LOCKOUT button (setting it in the down position). To enable the window controls, press and release the window LOCKOUT button again (setting it in the up position).

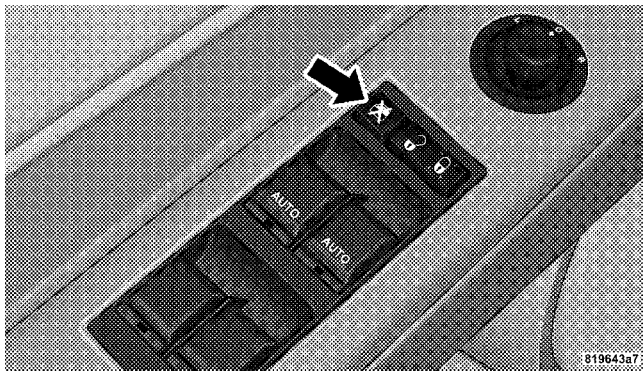

Window LOCKOUT Switch

Reset

Anytime the vehicle battery is disconnected or goes dead, the AUTO-up function will be disabled. To reactivate the auto-up feature, perform the following steps after vehicle power is restored:

1. Pull the WINDOW switch up to close window completely and continue to hold the switch up for an additional two seconds after the window is closed.
2. Push the WINDOW switch down firmly to the second detent to open the window completely and continue to hold the switch down for an additional two seconds after the window is fully open.

Wind Buffeting

Wind buffeting can be described as the perception of pressure on the ears or a helicopter type sound in the ears. Your vehicle may exhibit wind buffeting with the windows down, or the sunroof (if equipped) in certain open or partially open positions. This is a normal occurrence and can be minimized. If the buffeting occurs with the rear windows open, then open the front and rear windows together to minimize the buffeting. If the buffeting occurs with the sunroof open, then adjust the sunroof opening to minimize the buffeting.

TRUNK LOCK AND RELEASE

The trunk lid can be released from inside the vehicle by pressing the TRUNK RELEASE Button located on the instrument panel to the left of the steering wheel.

NOTE: The transmission must be in PARK before the switch will operate.

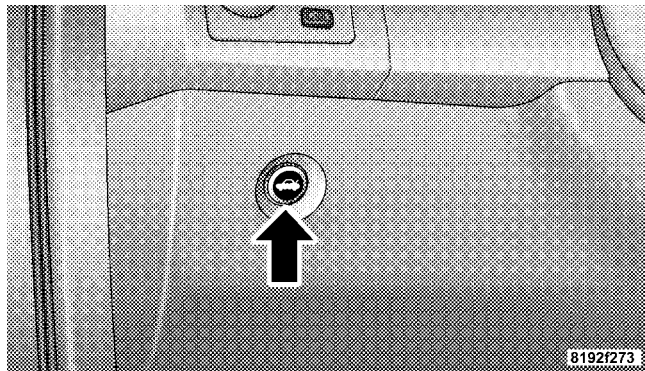

TRUNK RELEASE Button

The trunk lid can be released from outside the vehicle by pressing the TRUNK button on the Remote Keyless Entry (RKE) transmitter twice within five seconds.

With the ignition switch in the ON position, the Trunk Open symbol will display in the instrument cluster indicating that the trunk is open. The odometer display will reappear once the trunk is closed.

With the ignition switch in the LOCK position or the key removed from the ignition switch, the Trunk Open symbol will display until the trunk is closed.

TRUNK SAFETY WARNING**WARNING!**

Do not allow children to have access to the trunk, either by climbing into the trunk from outside, or through the inside of the vehicle. Always close the trunk lid when your vehicle is unattended. Once in the trunk, young children may not be able to escape, even if they entered through the rear seat. If trapped in the trunk, children can die from suffocation or heat stroke.

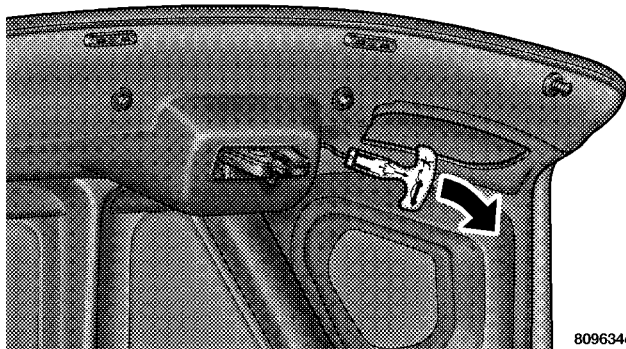
Trunk Emergency Release

809634cd

Emergency Release

The trunk of your vehicle is equipped with an emergency release handle. It is located on the inside of the trunk lid, near the latch, and is coated so that it glows in a darkened trunk. Pull on the handle to open the trunk.

OCCUPANT RESTRAINTS

Some of the most important safety features in your vehicle are the restraint systems. These include the front and rear seat belts for the driver and all passengers, the front airbags for both the driver and front passenger, the optional supplemental side curtain airbags for the driver and passengers seated next to a window, and the optional supplemental front seat mounted side airbags. If you will be carrying children too small for adult-size belts, your seat belts also can be used to hold infant and child restraint systems.

Please pay close attention to the information in this section. It tells you how to use your restraint system properly to keep you and your passengers as safe as possible.

WARNING!

In a collision, you and your passengers can suffer much greater injuries if you are not properly buckled up. You can strike the interior of your vehicle or other passengers or you can be thrown out of the vehicle. Always be sure you and others in your vehicle are buckled up properly.

Buckle up even though you are an excellent driver, even on short trips. Someone on the road may be a poor driver and cause a collision that includes you. This can happen far away from home or on your own street.

Research has shown that seat belts save lives, and they can reduce the seriousness of injuries in a collision. Some of the worst injuries happen when people are thrown from the vehicle. Seat belts reduce the possibility of ejection and the risk of injury caused by striking the inside of the vehicle. **Everyone** in a motor vehicle should be belted at all times.

Lap/Shoulder Belts

All seating positions in your vehicle are equipped with lap/shoulder belts.

The belt webbing retractor is designed to lock during very sudden stops or impacts. This feature allows the shoulder part of the belt to move freely with you under normal conditions. However, in a collision, the belt will lock and reduce your risk of striking the inside of the vehicle or being thrown out.

WARNING!

- It is extremely dangerous to ride in a cargo area, inside or outside of a vehicle. In a collision, people riding in these areas are more likely to be seriously injured or killed.
- Do not allow people to ride in any area of your vehicle that is not equipped with seats and seat belts.
- Be sure everyone in your vehicle is in a seat and using a seat belt properly.
- Wearing a seat belt incorrectly is dangerous. Seat belts are designed to go around the large bones of your body. These are the strongest parts of your body and can take the forces of a collision best.
- Wearing your belt in the wrong place could make your injuries in a collision much worse. You might suffer internal injuries, or you could even slide out of part of the belt. Follow these instructions to wear your seat belt safely and to keep your passengers safe, too.
- Two people should never be belted into a single seat belt. People belted together can crash into one another in an accident, hurting one another badly. Never use a lap/shoulder belt or a lap belt for more than one person, no matter what their size.

Lap/Shoulder Belt Operating Instructions

1. Enter the vehicle and close the door. Sit back and adjust the front seat.
2. The seat belt latch plate is above the back of your seat. Grasp the latch plate and pull out the belt. Slide the latch plate up the webbing as far as necessary to make the belt go around your lap.

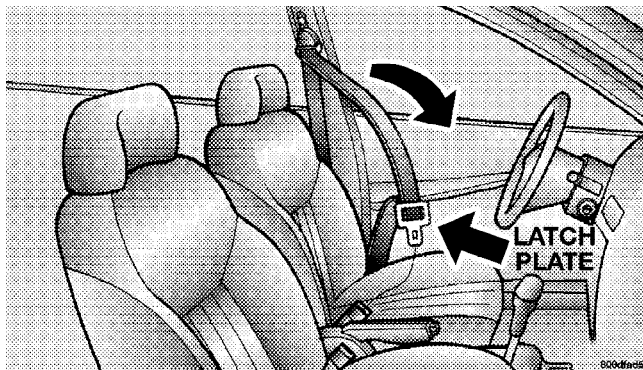

Pulling Out Lap/Shoulder Belt

3. When the belt is long enough to fit, insert the latch plate into the buckle until you hear a “click.”

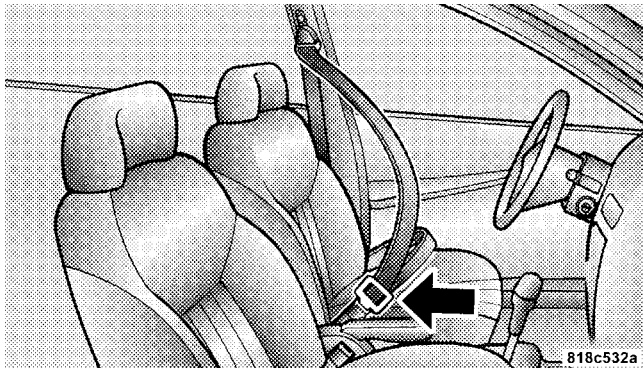

Connecting Latch Plate To Buckle

WARNING!

- A belt that is buckled into the wrong buckle will not protect you properly. The lap portion could ride too high on your body, possibly causing internal injuries. Always buckle your belt into the buckle nearest you.
- A belt that is too loose will not protect you as well. In a sudden stop, you could move too far forward, increasing the possibility of injury. Wear your seat belt snugly.
- A belt that is worn under your arm is very dangerous. Your body could strike the inside surfaces of the vehicle in a collision, increasing head and neck injury. A belt worn under the arm can cause internal injuries. Ribs aren't as strong as shoulder bones. Wear the belt over your shoulder so that your strongest bones will take the force in a collision.
- A shoulder belt placed behind you will not protect you from injury during a collision. You are more likely to hit your head in a collision if you do not wear your shoulder belt. The lap and shoulder belt are meant to be used together.

4. Position the lap belt across your thighs, below your abdomen. To remove slack in the lap belt portion, pull up a bit on the shoulder belt. To loosen the lap belt if it is too tight, tilt the latch plate and pull on the lap belt. A snug belt reduces the risk of sliding under the belt in a collision.

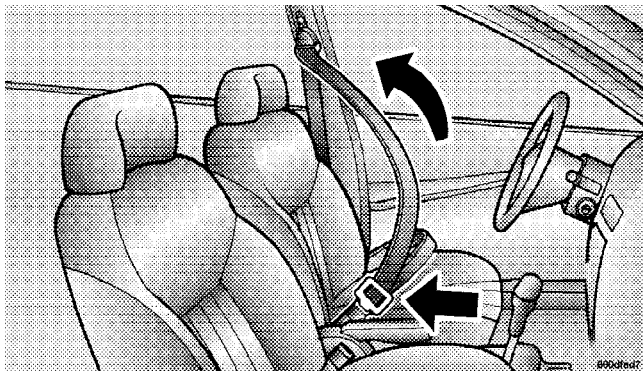

Removing Slack From Belt

WARNING!

- A lap belt worn too high can increase the risk of internal injury in a collision. The belt forces won't be at the strong hip and pelvic bones, but across your abdomen. Always wear the lap belt as low as possible and keep it snug.
- A twisted belt can't do its job as well. In a collision, it could even cut into you. Be sure the belt is straight. If you can't straighten a belt in your vehicle, take it to your authorized dealer and have it fixed.

5. Position the shoulder belt on your chest so that it is comfortable and not resting on your neck. The retractor will withdraw any slack in the belt.

6. To release the belt, push the red button on the buckle. The belt will automatically retract to its stowed position. If necessary, slide the latch plate down the webbing to allow the belt to retract fully.

WARNING!

A frayed or torn belt could rip apart in a collision and leave you with no protection. Inspect the belt system periodically, checking for cuts, frays, or loose parts. Damaged parts must be replaced immediately. Do not disassemble or modify the system. Seat belt assemblies must be replaced after a collision if they have been damaged (bent retractor, torn webbing, etc.).

Adjustable Upper Shoulder Belt Anchorage

In the driver and front passenger seats, the shoulder belt can be adjusted upward or downward to position the belt away from your neck. Push and fully depress the button above the webbing to release the anchorage, then move it up or down to the position that fits you best.

NOTE: When the shoulder belt is adjusted to the full downward position, it will not be at the bottom of the slot in the Trim Panel. This is normal and the intended lowest position.

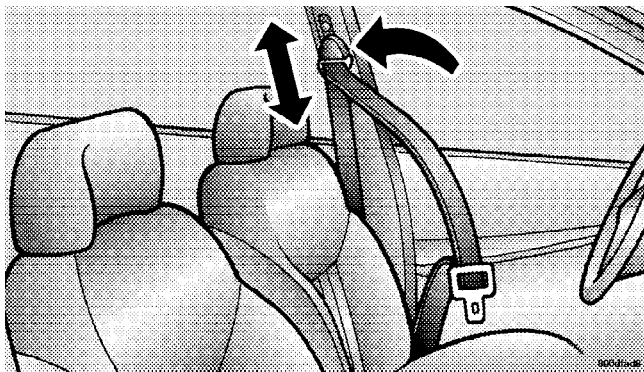

Adjusting Upper Shoulder Belt

As a guide, if you are shorter than average you will prefer a lower position, and if you are taller than average you will prefer a higher position. When you release the anchorage try to move it up and down to make sure that it is locked in position.

In the rear seat, move toward the center of the seat to position the belt away from your neck.

Lap/Shoulder Belt Untwisting Procedure

Use the following procedure to untwist a twisted lap/shoulder belt.

2

1. Position the latch plate as close as possible to the anchor point.
2. At about 6 to 12 in (15 to 30 cm) above the latch plate, grasp and twist the belt webbing 180 degrees to create a fold that begins immediately above the latch plate.
3. Slide the latch plate upward over the folded webbing. The folded webbing must enter the slot at the top of the latch plate.
4. Continue to slide the latch plate up until it clears the folded webbing.

Seat Belt Pretensioners

The seat belts for both front seating positions are equipped with pretensioning devices that are designed to remove any slack from the seat belts in the event of a collision. These devices improve the performance of the seat belt system by assuring that the belt is tight around the occupant in a collision. Pretensioners work for all size occupants, including those in child restraints.

NOTE: These devices are not a substitute for proper seat belt placement by the occupant. The seat belt still must be worn snugly and positioned properly.

The pretensioners are triggered by the Occupant Restraint Controller (ORC). (Refer to information on Airbags in this section). Like the front airbags, the pretensioners are single use items. After a collision that is severe enough to deploy the airbags and pretensioners, both must be replaced.

Enhanced Seat Belt Reminder System (BeltAlert®)

If the driver's seat belt has not been buckled within 60 seconds of starting the vehicle and if the vehicle speed is greater than 5 mph (8 km/h), the Enhanced Warning System (BeltAlert®) will alert the driver to buckle the seat belt. The driver should also instruct all other occupants to buckle their seat belts. Once the warning is triggered, the BeltAlert® will continue to chime and flash the Seat Belt Reminder Light for 96 seconds or until the driver's seat belt is buckled. The BeltAlert® will be reactivated if the driver's seat belt is unbuckled for more than 10 seconds and the vehicle speed is greater than 5 mph (8 km/h).

BeltAlert® Programming

The BeltAlert® can be enabled or disabled by your authorized dealer or by performing the following steps:

NOTE: DaimlerChrysler does not recommend deactivating the BeltAlert®.

1. With all doors closed, and the ignition switch in any position except ON or START, buckle the driver's seat belt.

2. Turn the ignition switch to the ON position, but do not start the engine. Wait for the Seat Belt Reminder Light to turn off and then proceed to the next step.

NOTE: You must perform the following steps within 60 seconds of turning the ignition switch to the ON position.

3. Within 60 seconds of turning the ignition switch to the ON position, unbuckle and then re-buckle the driver's seat belt at least three times within 10 seconds, ending with the seat belt buckled.

NOTE: Watch for the Seat Belt Reminder Light to turn on while unbuckling the seat belt and turn off while re-buckling the seat belt. It may be necessary to retract the seat belt.

4. Turn the ignition switch to the LOCK position. A single chime will sound to signify that you have successfully completed the programming.

The BeltAlert® can be reactivated by repeating this procedure.

NOTE: When the BeltAlert® is deactivated, the Seat Belt Reminder Light will continue to illuminate as long as the driver's seat belt is unbuckled.

Automatic Locking Mode — If Equipped

In this mode, the shoulder belt is automatically pre-locked. However, the belt will still retract to remove slack in the shoulder belt. Use The Automatic Locking mode any time a child safety seat is installed in a seating position that has a seat belt with this feature. Seat belts that have the Automatic Locking mode feature have a distinctive label on the webbing. Children 12 years old and younger should be properly restrained in the rear seat whenever possible.

How To Engage The Automatic Locking Mode

1. Buckle the combination lap and shoulder belt.
2. Grasp the shoulder portion and pull downward until the entire belt is extracted.
3. Allow the belt to retract. As the belt retracts, you will here a clicking sound. This indicates the safety belt is now in the Automatic Locking mode.

How To Disengage The Automatic Locking Mode

Unbuckle the combination lap and shoulder belt and allow it to retract completely to disengage the Automatic Locking mode and activate the vehicle sensitive (emergency) locking mode.

Seat Belts and Pregnant Women

We recommend that pregnant women use the seat belts throughout their pregnancy. Keeping the mother safe is the best way to keep the baby safe.

Pregnant women should wear the lap part of the belt across the thighs and as snug across the hips as possible. Keep the belt low so that it does not come across the abdomen. That way the strong bones of the hips will take the force if there is a collision.

Seat Belt Extender

If a seat belt is too short even when fully extended and when the adjustable upper shoulder belt anchorage (if so equipped) is in its lowest position, your authorized dealer can provide you with a seat belt extender. This extender should be used only if the existing belt is not long enough. When it is not required, remove the extender and store it.

WARNING!

Using a seat belt extender when not needed can increase the risk of injury in a collision. Only use when the seat belt is not long enough when it is worn low and snug and in the recommended seating positions. Remove and store the extender when not needed.

Driver and Front Passenger Supplemental Restraint System (SRS) - Airbag

This vehicle has front airbags for both the driver and front passenger as a supplement to the seat belt restraint systems. The driver's airbag is mounted in the center of the steering wheel. The passenger's front airbag is

mounted in the instrument panel, above the glove compartment. The words SRS AIRBAG are embossed on the airbag covers.

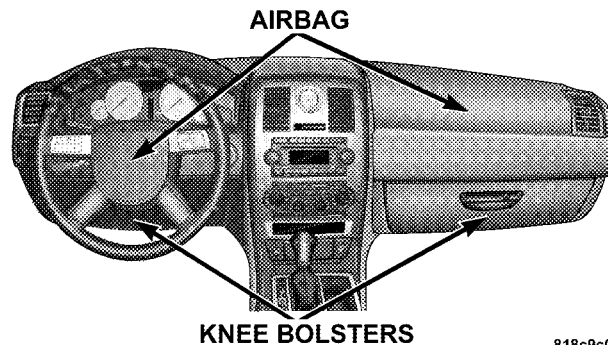

Front Airbag Components

NOTE: The front airbags are certified to the Federal regulations that allow less forceful deployment.

818c9c09

The front airbags have a multistage inflator design. This may allow the airbag to have different rates of inflation that are based on collision severity.

WARNING!

- **Do not put anything on or around the front airbag covers or attempt to open them. You may damage the airbags and you could be injured because the airbags are no longer functional. These protective covers for the airbag cushions are designed to open only when the airbags are inflating.**
- **Do not drill, cut or tamper with the knee bolster in any way.**
- **Do not mount any accessories to the knee bolster such as alarm lights, stereos, citizens band radios etc.**

This vehicle may also be equipped with supplemental side curtain airbags to protect the driver and passengers sitting next to a window and/or supplemental front seat mounted side airbags.

If the vehicle is equipped with supplemental side curtain airbags, they are located above the side windows. Their covers are also labeled SRS AIRBAG.

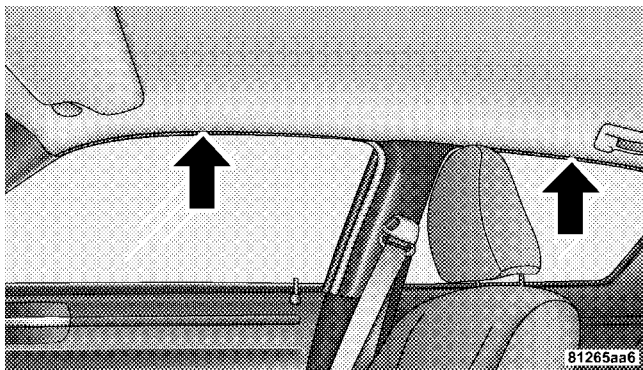

Window Airbag

NOTE: Airbag covers may not be obvious in the interior trim, but they will open to allow airbag deployment.

If the vehicle is equipped with supplemental front seat mounted side airbags, they are marked with an SRS label sewn into the outboard side of the seat.

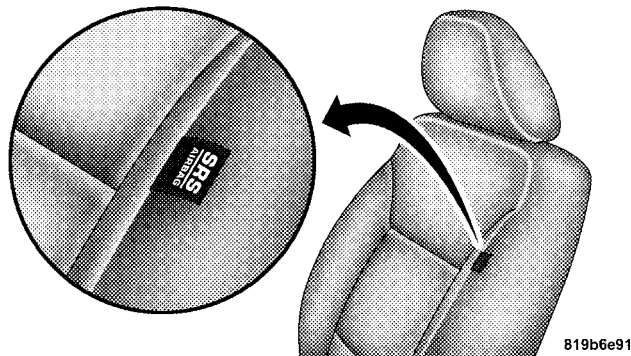

WARNING!

- If your vehicle is equipped with supplemental front seat mounted side airbags, do not use accessory seat covers or place objects between you and the seat airbags; the performance could be adversely affected and/or objects could be pushed into you, causing serious injury.
- If your vehicle is equipped with supplemental front seat mounted side airbags, do not attach cupholders or any other objects on or around the door. The inflating seat airbag could drive the object into occupants, causing serious injury.
- If your vehicle is equipped with supplemental side curtain airbags, do not stack luggage or other cargo up high enough to block the location of the side curtain airbag. The area where the side curtain airbag is located should remain free from any obstructions.
- If your vehicle is equipped with supplemental side curtain airbags, do not have any accessory items installed which will alter the roof, including adding a sunroof to your vehicle. Do not add roof racks that require permanent attachments (bolts or screws) for installation on the vehicle roof. Do not drill into the roof of the vehicle for any reason.

NOTE: Do not use a clothing bar mounted to the coat hooks in this vehicle. A clothing bar will impede the proper performance of the curtain airbags.

Along with the seat belts, front airbags work with the instrument panel knee bolsters to provide improved protection for the driver and front passenger. Side curtain and seat airbags also work with seat belts to improve occupant protection.

While the seat belts are designed to protect you in many types of collisions, the front airbags will deploy in moderate to severe frontal collisions. For vehicles so equipped, the supplemental side curtain airbag and front seat mounted side airbag on the crash side of the vehicle will also trigger in moderate to severe side collisions. However, even in collisions where the airbags deploy, you need the seat belts to keep you in the correct position for the airbags to protect you properly.

Here are some simple steps you can take to minimize the risk of harm from a deploying airbag.

1. Children 12 years old and younger should ride buckled up in the rear seat.

WARNING!

Infants in rear-facing child restraints should NEVER ride in the front seat of a vehicle with a passenger front airbag. An airbag deployment could cause severe injury or death to infants in that position.

2. Children who are not big enough to wear the vehicle seat belt properly should be secured in the rear seat in child restraints or belt-positioning booster seats. (Refer to information on Child Restraint in this section.)

3. Older children who do not use child restraints or belt-positioning booster seats should ride properly buckled up in the rear seat. Never allow children to slide the shoulder belt behind them or under their arm.

4. If a child from 1 to 12 years old must ride in the front passenger seat because the vehicle is crowded, move the seat as far back as possible and use the proper child restraint. (Refer to information on Child Restraint in this section.)

5. You should read the instructions provided with your child restraint to make sure that you are using it properly.

6. All occupants should use their seat belts properly.

7. The driver and front passenger seats should be moved back as far as practical to allow the airbags time to inflate.

8. If your vehicle has supplemental side curtain airbags and/or supplemental front seat mounted side airbags, do not lean against the door, as the airbags will inflate forcefully into the space between you and the door.

9. If the airbag system in this vehicle needs to be modified to accommodate a disabled person, contact the Customer Center. Phone numbers are provided in the "If You Need Customer Assistance" section.

WARNING!

- **Relying on the airbags alone could lead to more severe injuries in a collision. The airbags work with your seat belt to restrain you properly. In some collisions, the airbags won't deploy at all. Always wear your seat belts even though you have airbags.**
- **Being too close to the steering wheel or instrument panel during airbag deployment could cause serious injury. Airbags need room to inflate. Sit back, comfortably extending your arms to reach the steering wheel or instrument panel.**
- **If the vehicle has supplemental side curtain airbags and/or supplemental front seat mounted side airbags, they also need room to inflate. Do not lean against the door or window. Sit upright in the center of the seat.**

Airbag System Components

The airbag system consists of the following:

- Occupant Restraint Controller (ORC)
- Side Remote Acceleration Sensors (if equipped)
- Airbag Warning Light
- Driver Airbag
- Front Passenger Airbag
- Supplemental Side Curtain Airbags above side windows (if equipped)
- Supplemental Front Seat Mounted Side Airbags (if equipped)
- Steering Wheel and Column
- Instrument Panel
- Interconnecting Wiring

- Seat Belt Reminder Light
- Knee Impact Bolsters
- Front Acceleration Sensors
- Driver and Front Passenger Seat Belt Pretensioners

How the Airbag System Works

- The **Occupant Restraint Controller (ORC)** determines if a frontal collision is severe enough to require the airbags to inflate. The front airbag inflators are designed to provide different rates of airbag inflation from direction provided by the ORC. The ORC will not detect rollover.
- For vehicles so equipped, the ORC also determines if a side impact is severe enough to deploy the supplemental side curtain airbag and/or supplemental front seat mounted side airbag as required for each type of impact.

- The ORC also monitors the readiness of the electronic parts of the system whenever the ignition switch is in the START or ON positions. These include all of the items listed above except the knee bolster, the instrument panel, and the steering wheel and column. If the key is in the LOCK position, in the ACC position, or not in the ignition, the airbags are not on and they will not inflate.



- The ORC also turns on the Airbag Warning Light in the instrument panel for six to eight seconds as a self-check when the ignition is first turned on. After the self-check, the Airbag Warning Light will turn off. If the ORC detects a malfunction in any part of the system, it turns on the Airbag Warning Light either momentarily or continuously. A single chime will sound if the light comes on again after initial start-up.

WARNING!

Ignoring the AIRBAG Warning Light in your instrument panel could mean you won't have the airbags to protect you in a collision. If the light does not come on, stays on after you start the vehicle, or if it comes on as you drive, have the airbag system checked right away.

- The **Driver and Front Passenger Airbag/Inflator Units** are located in the center of the steering wheel and the passenger side of the instrument panel. When the ORC detects a collision requiring the airbags, it signals the inflator units. A large quantity of nontoxic gas is generated to inflate the front airbags. Different airbag inflation rates may be possible based on collision severity. The steering wheel hub trim cover, and the upper passenger side of the instrument panel

separate and fold out of the way as the bags inflate to their full size. The bags fully inflate in about 50 to 70 ms. This is about half of the time that it takes to blink your eyes. The bags then quickly deflate while helping to restrain the driver and front passenger. The driver's front airbag gas is vented through vent holes in the sides of the airbag. The passenger's front airbag gas is vented through vent holes in the sides of the airbag. In this way, the airbags do not interfere with your control of the vehicle.

- The **Knee Impact Bolsters** help protect the knees of the driver and the front passenger and position everyone for the best interaction with the front airbag.
- The **Supplemental Side Impact SRS Side Curtain Airbags** are designed to activate only in certain side collisions. When the ORC (with side impact option) detects a collision requiring the side curtain airbag to inflate, it signals the inflators on the crash side of the

vehicle. A quantity of nontoxic gas is generated to inflate the side curtain airbag. The inflating side curtain airbag pushes the outside edge of the headliner out of the way and covers the window. The airbag inflates in about 30 ms (about one-quarter of the time that it takes to blink your eyes) with enough force to injure you if you are not belted and seated properly, or if items are positioned in the area where the side curtain airbag inflates. This especially applies to children. The side curtain airbag is only about 3-1/2 in (9 cm) thick when it is inflated.

- The **Supplemental Front Seat Mounted Side Airbags** are designed to activate only in certain side collisions. When the ORC (with side impact option) detects a collision requiring the front seat mounted side airbag to inflate, it signals the inflators on the crash side of the vehicle. A quantity of nontoxic gas is generated to inflate the front seat mounted side airbag. The inflating front seat mounted side airbag pushes through the

seam in the seat's trim cover and opens into the space between the occupant and the door. The airbag inflates at a very high speed and with enough force to injure you if you are not belted and seated properly, or if items are positioned in the area where the front seat mounted side airbag inflates. This especially applies to children.

The following requirements must be strictly adhered to:

- Do not make any modifications to the front seat components, assembly, or to the seat cover in any way.
- Do not use prior or future model year seat covers not designated for the specific model being repaired. Always use the correct seat cover specified for the vehicle.

- Do not replace the seat cover with an aftermarket seat cover.
- Do not add a secondary seat cover other than those approved by DaimlerChrysler/Mopar®.
- At no time should any supplemental restraint system (SRS) component or SRS related component or fastener be modified or replaced with any part except those which are approved by DaimlerChrysler/Mopar®.

WARNING!

Unapproved modifications or service procedures to the front seat assembly, its related components, or seat cover may inadvertently change the airbag deployment in case of a frontal crash. This could result in death or serious injury to the driver or front seat passenger if the vehicle is involved in an accident. A modified vehicle may not comply with required Federal Motor Vehicle Safety Standards (FMVSS).

If a Deployment Occurs

The airbag system is designed to deploy when the ORC detects a moderate to severe collision to help restrain the driver and front passenger and then to immediately deflate.

NOTE: A frontal collision that is not severe enough to need airbag protection will not activate the system. This does not mean something is wrong with the airbag system.

If you do have a collision that deploys the airbags, any or all of the following may occur:

- The nylon airbag material may sometimes cause abrasions and/or skin reddening to the driver and front passenger as the airbags deploy and unfold. The abrasions are similar to friction rope burns or those you might get sliding along a carpet or gymnasium floor. They are not caused by contact with chemicals. They are not permanent and normally heal quickly. However, if you haven't healed significantly within a few days or if you have any blistering, see your doctor immediately.

- As the airbags deflate, you may see some smoke-like particles. The particles are a normal by-product of the process that generates the nontoxic gas used for airbag inflation. These airborne particles may irritate the skin, eyes, nose, or throat. If you have skin or eye irritation, rinse the area with cool water. For nose or throat irritation, move to fresh air. If the irritation continues, see your doctor. If these particles settle on your clothing, follow the garment manufacturer's instructions for cleaning.
- It is not advisable to drive your vehicle after the airbags have been deployed. If you are involved in another collision, the airbags will not be in place to protect you.

WARNING!

Deployed airbags can't protect you in another collision. Have the airbags replaced by an authorized dealer as soon as possible.

Enhanced Accident Response System

In the event of an impact that causes airbag deployment, with the vehicle stopped, and the vehicle communication network intact, and the power intact, the Enhanced Accident Response System performs the following functions:

- Cuts off fuel to the engine.
- Flashes hazard lights.
- Turns on the interior lights, which remain on as long as the battery has power or until the ignition key is removed.
- Unlocks the doors automatically.

NOTE: The interior lights can only be deactivated if the key is removed from the ignition switch or the vehicle is driven.

Maintaining Your Airbag System

WARNING!

- **Modifications to any part of the airbag system could cause it to fail when you need it. You could be injured because the airbags are not there to protect you. Do not modify the components or wiring, including adding any kind of badges or stickers to the steering wheel hub trim cover or the upper passenger side of the instrument panel. Do not modify the front bumper, vehicle body structure, or frame.**
- **You need proper knee impact protection in a collision. Do not mount or locate any aftermarket equipment on or behind the knee impact bolster.**
- **It is dangerous to try to repair any part of the airbag system yourself. Be sure to tell anyone who works on your vehicle that it has airbags.**

NOTE: Perchlorate Material — special handling may apply. See www.dtsc.ca.gov/hazardouswaste/perchlorate.

Airbag Warning Light



You will want to have the airbags ready to inflate for your protection in an impact. While the airbag system is designed to be maintenance free, if any of the following occurs, have an authorized dealer service the system promptly:

- The Airbag Warning Light does not come on or flickers during the six to eight seconds when the ignition switch is first turned ON.
- The light remains on or flickers after the six to eight second interval.
- The light flickers or comes on and remains on while driving.

Event Data Recorder (EDR)

In the event of an accident, your vehicle is designed to record up to five seconds of specific vehicle data parameters (see the following list) in an event data recorder prior to the moment of airbag deployment, or near deployment, and up to a quarter second of high-speed deceleration data during and/or after airbag deployment. EDR data are ONLY recorded if an airbag deploys, or nearly deploys, and are otherwise unavailable.

NOTE:

1. A near-deployment event occurs when the airbag sensor detects severe vehicle deceleration usually indicative of a crash, but not severe enough to warrant airbag deployment.
2. Under certain circumstances, EDR data may not be recorded (e.g., loss of battery power).

In conjunction with other data gathered during a complete accident investigation, the electronic data may be

used by DaimlerChrysler Corporation and others to learn more about the possible causes of crashes and associated injuries in order to assess and improve vehicle performance. In addition to crash investigations initiated by DaimlerChrysler Corporation, such investigations may be requested by customers, insurance carriers, government officials, and professional crash researchers, such as those associated with universities, and with hospital and insurance organizations.

In the event that an investigation is undertaken by DaimlerChrysler Corporation (regardless of initiative), the company or its designated representative will first obtain permission of the appropriate custodial entity for the vehicle (usually the vehicle owner or lessee) before accessing the electronic data stored, unless ordered to download data by a court with legal jurisdiction (i.e., pursuant to a warrant). A copy of the data will be provided to the custodial entity upon request. General data that does not identify particular vehicles or crashes

may be released for incorporation in aggregate crash databases, such as those maintained by the US government and various states. Data of a potentially sensitive nature, such as would identify a particular driver, vehicle, or crash, will be treated confidentially. Confidential data will not be disclosed by DaimlerChrysler Corporation to any third party except when:

1. Used for research purposes, such as to match data with a particular crash record in an aggregate database, provided confidentiality of personal data is thereafter preserved
2. Used in defense of litigation involving a DaimlerChrysler Corporation product
3. Requested by police under a legal warrant
4. Otherwise required by law

Data Parameters that May Be Recorded:

- Diagnostic trouble code(s) and warning light status for electronically-controlled safety systems, including the airbag system
- Airbag disable light status (if equipped)
- "Time" of airbag deployment (in terms of ignition cycles and vehicle mileage)
- Airbag deployment level (if applicable)
- Impact acceleration and angle
- Seat belt status
- Brake status (service and parking brakes)
- Accelerator status (including vehicle speed)
- Engine control status (including engine speed)
- Transmission gear selection
- Cruise control status

- Traction/stability control status
- Tire Pressure Monitoring System status (if equipped)

Child Restraint

Everyone in your vehicle needs to be buckled up all the time, including babies and children. Every state in the United States and all Canadian provinces require that small children ride in proper restraint systems. This is the law, and you can be prosecuted for ignoring it.

Children 12 years and younger should ride properly buckled up in a rear seat, if available. According to crash statistics, children are safer when properly restrained in the rear seats rather than in the front.

WARNING!

In a collision, an unrestrained child, even a tiny baby, can become a missile inside the vehicle. The force required to hold even an infant on your lap could become so great that you could not hold the child, no matter how strong you are. The child and others could be badly injured. Any child riding in your vehicle should be in a proper restraint for the child's size.

There are different sizes and types of restraints for children from newborn size to the child almost large enough for an adult safety belt. Always check the child seat Owner's Manual to ensure you have the correct seat for your child. Use the restraint that is correct for your child.

Infants and Child Restraints

- Safety experts recommend that children ride rearward-facing in the vehicle until they are at least one year old **and** weigh at least 20 lbs (9 kg). Two types of child restraints can be used rearward-facing, infant carriers and convertible child seats.
- The infant carrier is only used rearward-facing in the vehicle. It is recommended for children who weigh up to about 20 lbs (9 kg). Convertible child seats can be used either rearward-facing or forward-facing in the vehicle. Convertible child seats often have a higher weight limit in the rearward-facing direction than infant carriers do, so they can be used rearward-facing by children who weigh more than 20 lbs (9 kg) but are less than one year old. Both types of child restraints are held in the vehicle by the lap/shoulder belt or the LATCH child restraint anchorage system. Refer to

“LATCH — Child Seat Anchorage System (Lower Anchors and Tether for Children)” in this section.

- Rearward-facing child seats must **NEVER** be used in the front seat of a vehicle with the front passenger airbag unless the airbag is turned off. An airbag deployment could cause severe injury or death to infants in this position.

Older Children and Child Restraints

Children who weigh more than 20 lbs (9 kg) and who are older than one year can ride forward-facing in the vehicle. Forward-facing child seats and convertible child seats used in the forward-facing direction are for children who weigh 20 to 40 lbs (9 to 18 kg) and who are older than one year. These child seats are also held in the vehicle by the lap/shoulder belt or the LATCH child restraint anchorage system. Refer to “LATCH — Child Seat Anchorage System (Lower Anchors and Tether for Children)” in this section.

The belt-positioning booster seat is for children weighing more than 40 lbs (18 kg), but who are still too small to fit the vehicle's seat belts properly. If the child cannot sit with knees bent over the vehicle's seat cushion while the child's back is against the seatback, they should use a belt-positioning booster seat. The child and belt-positioning booster seat are held in the vehicle by the lap/shoulder belt.

Children too Large for Booster Seats

Children who are large enough to wear the shoulder belt comfortably and whose legs are long enough to bend over the front of the seat when their back is against the seatback should use the lap/shoulder belt in a rear seat.

- Make sure that the child is upright in the seat.
- The lap portion should be low on the hips and as snug as possible.

- Check belt fit periodically. A child's squirming or slouching can move the belt out of position.
- If the shoulder belt contacts the face or neck, move the child closer to the center of the vehicle. Never allow a child to put the shoulder belt under an arm or behind their back.

NOTE: For additional information, refer to www.seatcheck.org or call 1-866-SEATCHECK.

WARNING!

- Improper installation can lead to failure of an infant or child restraint. It could come loose in a collision. The child could be badly injured or killed. Follow the manufacturer's directions exactly when installing an infant or child restraint.
- A rearward-facing child restraint should only be used in a rear seat. A rearward-facing child restraint in the front seat may be struck by a deploying passenger airbag, which may cause severe or fatal injury to the infant.

Here are some tips on getting the most out of your child restraint:

- Before buying any restraint system, make sure that it has a label certifying that it meets all applicable Safety

Standards. We also recommend that you make sure that you can install the child restraint in the vehicle where you will use it before you buy it.

- The restraint must be appropriate for your child's weight and height. Check the label on the restraint for weight and height limits.
- Carefully follow the instructions that come with the restraint. If you install the restraint improperly, it may not work when you need it.
- Buckle the child into the seat according to the child restraint manufacturer's directions.
- When your child restraint is not in use, secure it in the vehicle with the seat belt or remove it from the vehicle. Do not leave it loose in the vehicle. In a sudden stop or collision, it could strike the occupants or seatbacks and cause serious personal injury.

LATCH — Child Seat Anchorage System (Lower Anchors and Tether for Children)

Your vehicle's rear seat is equipped with the child restraint anchorage system called LATCH. The LATCH system provides for the installation of the child restraint without using the vehicle's seat belts, instead securing the child restraint using lower anchorages and upper tether straps from the child restraint to the vehicle structure.

LATCH-compatible child restraint systems are now available. However, because the lower anchorages are to be introduced over a period of years, child restraint systems having attachments for those anchorages will continue to have features for installation using the vehicle's seat belts. Child restraints having tether straps and hooks for

connection to the top tether anchorages have been available for some time. For some older child restraints, many child restraint manufacturers offer add-on tether strap kits or retrofit kits. You are urged to take advantage of all the available attachments provided with your child restraint in any vehicle.

All three rear-seating positions have lower anchorages that are capable of accommodating LATCH-compatible child seats. You should **NEVER** install LATCH-compatible child seats so that two seats share a common lower anchorage. If installing child seats in adjacent rear-seating positions, or if your child restraints are not LATCH-compatible, install the restraints using the vehicle's seat belts.

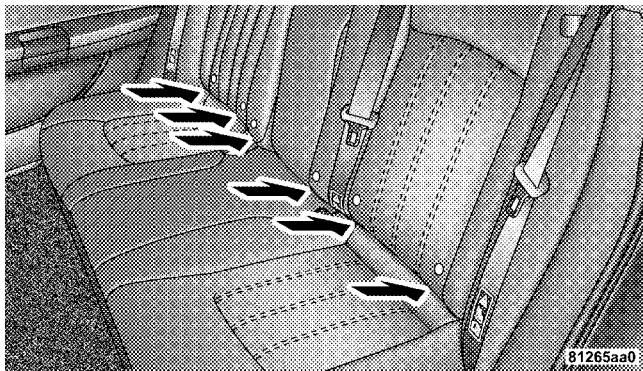

LATCH Anchorages

Installing the LATCH-Compatible Child Restraint System

We urge you to follow the manufacturer's directions carefully when installing your child restraint. Not all child restraint systems will be installed as described here.

Again, carefully follow the installation instructions that are provided with the child restraint system.



The rear seat lower anchorages are round bars located at the rear of the seat cushion where it meets the seatback and are just visible when you lean into the rear seat to install the child restraint. You will easily feel them if you run your finger along the intersection of the seatback and seat cushion surfaces.



In addition, there are tether strap anchorages behind each rear seating position located in the panel between the rear seatback and the rear window. These tether strap anchorages are under a plastic cover with this symbol on it.

Many, but not all restraint systems will be equipped with separate straps on each side, with each having a hook or connector for attachment to the lower anchorage and a

means of adjusting the tension in the strap. Forward-facing toddler restraints and some rear-facing infant restraints will also be equipped with a tether strap, a hook for attachment to the tether strap anchorage and a means of adjusting the tension of the strap.

You will first loosen the adjusters on the lower straps and on the tether strap so that you can more easily attach the hooks or connectors to the vehicle anchorages. Next, attach the lower hooks or connectors over the top of the seatcover material. Then rotate the tether anchorage cover directly behind the seat where you are placing the child restraint and attach the tether strap to the anchorage, being careful to route the tether strap to provide the most direct path between the anchor and the child restraint. Finally, tighten all three straps as you push the child restraint rearward and downward into the seat, removing slack in the straps according to the child restraint manufacturer's instructions.

NOTE:

- Ensure that the tether strap does not slip into the opening between the seatbacks as you remove slack in the strap.
- When using the LATCH attaching system to install a child restraint, please ensure that all seat belts not being used for occupant restraints are stowed and out of reach of children. It is recommended that before installing the child restraint, buckle the seat belt so the seat belt is tucked behind the child restraint and out of reach. If the buckled seat belt interferes with the child restraint installation, instead of tucking the seat belt behind the child restraint, route the seat belt through the child restraint belt path and then buckle it. This should stow the seat belt out of the reach of an inquisitive child. Remind all children in the vehicle that the seat belts are not toys and should not be played with, and never leave your child unattended in the vehicle.

WARNING!

Improper installation of a child restraint to the LATCH anchorages can lead to failure of an infant or child restraint. The child could be badly injured or killed. Follow the manufacturer's directions exactly when installing an infant or child restraint.

Installing Child Restraints Using the Vehicle Seat Belt

The passenger seat belts are equipped with either cinching latch plates or automatic locking retractors, which are designed to keep the lap portion tight around the child restraint so that it is not necessary to use a locking clip. Pulling up on the shoulder portion of the lap/shoulder belt will tighten the belt. The cinching latch plate will

keep the belt tight; however, any seat belt system will loosen with time, so check the belt occasionally and pull it tight if necessary.

Seat belts with an automatic locking retractor have a distinctive label on the seat belt webbing. The seat belt must be in the Automatic Locking mode in order to enable a child restraint to be tightly installed. Refer to "Automatic Locking Mode" in this section. A locking clip should not be necessary once the automatic locking feature is enabled. Position the shoulder and lap belt on the child restraint. The automatic locking retractor is activated by first attaching the child seat, then pulling all of the webbing out of the retractor, then allowing the webbing to retract back into the retractor. Tighten webbing. To release, simply unbuckle the seat belt by depressing the button, allowing the webbing to retract into the retractor.

In the rear seat, you may have trouble tightening the lap/shoulder belt on the child restraint because the buckle or latch plate is too close to the belt path opening on the restraint. Disconnect the latch plate from the buckle and twist the short buckle end belt several times to shorten it. Insert the latch plate into the buckle with the release button facing out.

If the belt still can't be tightened, or if pulling and pushing on the restraint loosens the belt, you may need to do something more. Disconnect the latch plate from the buckle, turn the buckle around, and insert the latch plate into the buckle again. If you still can't make the child restraint secure, try a different seating position.

To attach a child restraint tether strap:

1. Rotate the cover over the anchor directly behind the seat where you are placing the child restraint.

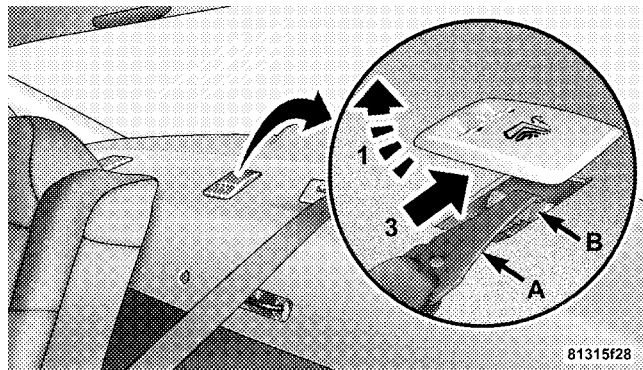

81315f28

Tether Strap Mounting

2. Route the tether strap to provide the most direct path for the strap between the anchor and the child seat.
3. Attach the tether strap hook (A) of the child restraint to the anchor (B) and remove slack in the tether strap according to the child restraint manufacturer's instructions.

NOTE: Ensure that the tether strap does not slip into the opening between the seatbacks as you remove slack in the strap.

WARNING!

An incorrectly anchored tether strap could lead to increased head motion and possible injury to the child. Use only the anchor positions directly behind the child seat to secure a child restraint top tether strap.

Transporting Pets

Airbags deploying in the front seat could harm your pet. An unrestrained pet will be thrown about and possibly injured, or injure a passenger during panic braking or in a collision.

Pets should be restrained in the rear seat in pet harnesses or pet carriers that are secured by seat belts.

BREAK-IN RECOMMENDATIONS

A long break-in period is not required for the drivetrain (engine, transmission, and rear axle) in your new vehicle.

Drive moderately during the first 500 mi (800 km). After the initial 60 mi (100 km), speeds up to 50 or 55 mph (80 or 90 km/h) are desirable.

While cruising, brief full-throttle acceleration within the limits of local traffic laws contributes to a good break-in. However, wide-open throttle acceleration in low gear can be detrimental and should be avoided.

The engine oil, transmission fluid, and axle lubricant installed at the factory is high-quality and energy-conserving. Oil, fluid, and lubricant changes should be consistent with anticipated climate and conditions under which vehicle operations will occur. The recommended viscosity and quality grades is shown in Section 7.

CAUTION!

Never use Non-Detergent Oil or Straight Mineral Oil in the engine or damage may result.

NOTE: A new engine may consume some oil during its first few thousand miles (kilometers) of operation. This should be considered as a normal part of the break-in and not interpreted as an indication of difficulty.

SAFETY TIPS**Transporting Passengers**

NEVER TRANSPORT PASSENGERS IN THE CARGO AREA.

WARNING!

It is extremely dangerous to ride in a cargo area, inside or outside of a vehicle. In a collision, people riding in these areas are more likely to be seriously injured or killed.

Do not allow people to ride in any area of your vehicle that is not equipped with seats and seat belts.

Be sure everyone in your vehicle is in a seat and using a seat belt properly.

Lock Your Vehicle

Always remove the key from the ignition and lock all doors when leaving the vehicle unattended, even in your own driveway or garage. Try to park your vehicle in a well-lit area and never invite theft by leaving articles of value exposed.

Exhaust Gas

Do not run the engine in a closed garage or in confined areas any longer than needed to move your vehicle in or out of the area.

If it is necessary to sit in a parked vehicle with the engine running, adjust your heating or cooling controls to force outside air into the vehicle. Set the blower at high speed.

The best protection against carbon monoxide entry into the vehicle body is a properly maintained engine exhaust system.

Whenever a change is noticed in the sound of the exhaust system, when exhaust fumes can be detected inside the vehicle, or when the underside or rear of the vehicle is damaged, have a competent mechanic inspect the complete exhaust system and adjacent body areas for broken, damaged, deteriorated, or mispositioned parts. Open seams or loose connections could permit exhaust fumes to seep into the passenger compartment. In addition, inspect the exhaust system each time the vehicle is raised for lubrication or oil change. Replace as required.

WARNING!

- Exhaust gases can injure or kill. They contain carbon monoxide (CO) which is colorless and odorless. Breathing it can make you unconscious and can eventually poison you. To avoid breathing (CO), follow the safety tips below.
- If you are required to drive with the trunk open, make sure that all windows are closed and the climate control BLOWER switch is set at high speed. DO NOT use the recirculation mode.

Safety Checks You Should Make Inside The Vehicle**Seat Belts**

Inspect the belt system periodically, checking for cuts, frays, and loose parts. Damaged parts must be replaced immediately. Do not disassemble or modify the system.

Front seat belt assemblies must be replaced after a collision. Rear seat belt assemblies must be replaced after a collision if they have been damaged (bent retractor, torn webbing, etc. If there is any question regarding belt or retractor condition, replace the belt.

Airbag Warning Light

The light should come on and remain on for six to eight seconds as a bulb check when the ignition switch is first turned ON. If the light is not lit during starting, see your authorized dealer. If the light stays on, flickers, or comes on while driving, have the system checked by an authorized dealer.

Defroster

Check operation by selecting the defrost mode and place the blower control on high speed. You should be able to feel the air directed against the windshield. See your authorized dealer for service if your defroster is inoperable.

Periodic Safety Checks You Should Make Outside The Vehicle

Tires

Examine tires for excessive tread wear and uneven wear patterns. Check for stones, nails, glass, or other objects lodged in the tread. Inspect the tread and sidewall for cuts and cracks. Check the wheel nuts for tightness. Check the tires (including spare) for proper pressure.

Lights

Have someone observe the operation of exterior lights while you work the controls. Check turn signal and high beam indicator lights on the instrument panel.

Door Latches

Check for positive closing, latching, and locking.

Fluid Leaks

Check area under vehicle after overnight parking for fuel, engine coolant, oil, or other fluid leaks. Also, if gasoline fumes are detected or if fuel, power steering fluid, or brake fluid leaks are suspected, the cause should be located and corrected immediately.

UNDERSTANDING THE FEATURES OF YOUR VEHICLE

CONTENTS

■ Mirrors84	□ Illuminated Vanity Mirrors88
□ Automatic Dimming Inside Mirror84	■ Hands-Free Communication (UConnect®) —	
□ Outside Mirrors85	If Equipped88
□ Exterior Mirrors Folding Feature —		□ Operation90
If Equipped85	□ Phone Call Features97
□ Driver's-Side Outside Mirror Auto Dimmer86	□ UConnect® System Features	100
□ Tilt In Reverse Feature86	□ Advanced Phone Connectivity	105
□ Power Remote Control Mirrors86	□ Things You Should Know About	
□ Heated Remote Control Mirrors87	Your UConnect® System	106
		□ General Information	115

- Voice Recognition System (VR) — If Equipped . . . 115
 - Voice Recognition System (VR) Operation 115
 - Commands 116
 - Voice Training 119
- Seats 120
 - Power Seats 120
 - Power Reclining Seats 121
 - Lumbar Support 122
 - Head Restraints 123
 - Heated Seats 124
 - Folding Rear Seat 125
- Driver Memory Seat — If Equipped 126
 - Programming The Memory Feature 127
 - Linking And Unlinking The Remote Keyless Entry (RKE) Transmitter To The Memory Feature 128
 - Memory Position Recall 129
 - Easy Entry/Exit Seat (Available With Memory Seat Only) 129
- To Open And Close The Hood 131
- Lights 132
 - Headlight Switch 132
 - Automatic Headlights 133
 - Headlights On With Wipers 134
 - SmartBeams — If Equipped 134
 - Headlight Time Delay 136
 - Daytime Running Lights — If Equipped 136

- Lights-On Reminder136
- Fog Lights137
- Multifunction Lever137
- Overhead Console Map/Reading Lights138
- Interior Lights139
- Windshield Wipers And Washers140
 - Intermittent Wiper System141
 - Mist Feature141
 - Windshield Washers142
 - Headlights On With Wipers142
 - Rain Sensing Wipers142
 - Adding Washer Fluid144
- Headlight Washers — If Equipped145
 - Adding Washer Fluid146
- Power Tilt/Telescoping Steering Column147
- Adjustable Pedals148
- Electronic Speed Control150
 - Electronic Speed Control Operation150
 - To Activate151
 - To Set At A Desired Speed151
 - To Deactivate152
 - To Resume Speed152
 - To Vary The Speed Setting152
 - To Accelerate For Passing153

- Adaptive Cruise Control (ACC) — If Equipped153
 - Adaptive Cruise Control (ACC) Operation . . .155
 - Activating Adaptive Cruise Control (ACC) . . .156
 - To Activate156
 - To Set a Desired Speed157
 - To Cancel158
 - To Turn Off159
 - To Resume Speed159
 - To Vary The Speed Setting160
 - Setting The Following Distance In ACC161
 - Adaptive Cruise Control (ACC) Menu162
 - Display Warnings And Maintenance165
 - Precautions While Driving With ACC168
 - General Information172
- Rear Park Assist System172
- Overhead Console176
 - Courtesy/Reading Lights176
 - Sunglasses Storage177
- Garage Door Opener — If Equipped177
 - Programming HomeLink®178
 - Gate Operator/Canadian Programming181
 - Using HomeLink®182
 - Reprogramming A Single HomeLink® Button182
 - Security182

		UNDERSTANDING THE FEATURES OF YOUR VEHICLE 83	
□ Troubleshooting Tips	183	□ Ignition Off Operation	186
□ General Information	183	□ Sunroof Fully Closed	186
■ Power Sunroof — If Equipped	184	■ Electrical Power Outlets	187
□ Opening Sunroof - Express	185	□ Electrical Outlet Use With Engine Off	188
□ Closing Sunroof - Express	185	■ Cupholders	189
□ Pinch Protect Feature	185	□ Front Seat Cupholders	189
□ Pinch Protect Override	185	□ Rear Seat Cupholders	189
□ Venting Sunroof - Express	185	■ Storage	190
□ Sunshade Operation	186	□ Console Features	190
□ Wind Buffeting	186	□ Cargo Area	191
□ Sunroof Maintenance	186		

MIRRORS

Automatic Dimming Inside Mirror

This mirror automatically adjusts for annoying headlight glare from vehicles behind you. You can turn the feature on or off by pressing the button at the base of the mirror. A light next to the button will illuminate to indicate when the dimming feature is activated.

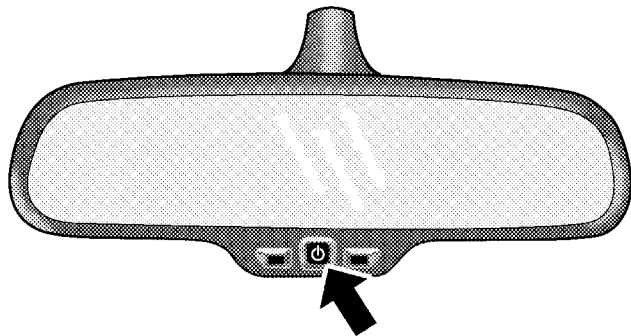

817892c4

Automatic Dimming Mirror

CAUTION!

To avoid damage to the mirror during cleaning, never spray any cleaning solution directly onto the mirror. Apply the solution onto a clean cloth and wipe the mirror clean.

Outside Mirrors

To receive maximum benefit, adjust the outside mirror(s) to center on the adjacent lane of traffic and a slight overlap of the view obtained from the inside mirror.

NOTE: The passenger-side convex outside mirror will give a much wider view to the rear, and especially of the lane next to your vehicle.

WARNING!

Vehicles and other objects seen in the passenger-side convex mirror will look smaller and farther away than they really are. Relying too much on your passenger-side convex mirror could cause you to collide with another vehicle or other object. Use your inside mirror when judging the size or distance of a vehicle seen in the passenger-side convex mirror.

Exterior Mirrors Folding Feature — If Equipped

Some models have exterior mirrors that are hinged. The hinge allows the mirror to pivot forward and rearward to resist damage. The hinge has three detent positions, full forward, full rearward, and normal.

Driver's-Side Outside Mirror Auto Dimmer

This mirror automatically adjusts for annoying headlight glare from vehicles behind you. You can turn this feature on or off by pressing the button at the base of the inside rearview mirror.

Tilt In Reverse Feature

The "Tilt in Reverse" feature tilts the outside rearview mirrors downward when the ignition switch is in the ON position and the transmission is in the REVERSE position. This feature provides the driver with a better view of the ground and vehicle in the area of the rear tires when backing up. The mirrors will move back to their previous position when the transmission is shifted out of REVERSE.

The "Tilt in Reverse" feature can be enabled or disabled. Refer to "Tilt Mirrors Down in Reverse," under "Personal Settings (Customer Programmable Features)," under "Electronic Vehicle Information Center (EVIC)" in Section 4.

Power Remote Control Mirrors

The power MIRROR switch is located on the driver's door trim panel next to the power door LOCK switch. A rotary knob selects the left mirror, right mirror, or off position.

After selecting a mirror, move the knob in the same direction you want the mirror to move. Use the center off position to guard against accidentally moving a mirror position.

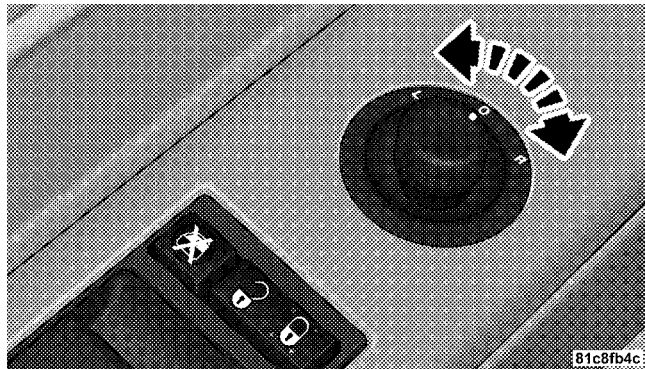

Power Mirror Control

NOTE: For vehicles equipped with Driver Memory Seat, you can use your Remote Keyless Entry (RKE) Transmitter or the MEMORY switch on the driver's door trim panel to return the power mirrors to pre-programmed positions. Refer to "Driver Memory Seat" in this section.

Heated Remote Control Mirrors

These mirrors are heated to melt frost or ice. This feature is activated whenever you turn on the Electric Rear Window Defroster.

Illuminated Vanity Mirrors

An illuminated vanity mirror is on the sun visor. To use the mirror, rotate the sun visor downward and swing the mirror cover upward. The light turns on automatically. Closing the mirror cover turns off the light.

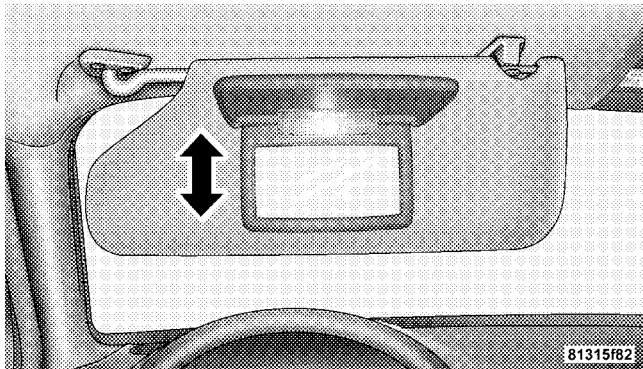

Illuminated Vanity Mirror

HANDS-FREE COMMUNICATION (UConnect®) — IF EQUIPPED

NOTE: The sales code RER radio contains an integrated Hands-Free Communication (UConnect®) system. Refer to your "Navigation User's Manual" for UConnect® system operating instructions for this radio.

UConnect® is a voice-activated, hands-free, in-vehicle communications system. UConnect® allows you to dial a phone number with your cellular phone using simple voice commands (e.g., "Call" ... "Mike" ... "Work" or "Dial" ... "248-555-1212"). Your cellular phone's audio is transmitted through your vehicle's audio system; the system will automatically mute your radio when using the UConnect® system.

NOTE: The UConnect® system requires a cellular phone equipped with the Bluetooth® "Hands-Free Profile," Version 0.96 or higher. See the UConnect® website for supported phones.

NOTE: For UConnect® customer support, visit the following websites:

- www.chrysler.com/uconnect
- www.dodge.com/uconnect
- www.jeep.com/uconnect
- or call 1-877-855-8400

UConnect® allows you to transfer calls between the system and your cellular phone as you enter or exit your vehicle and enables you to mute the system's microphone for private conversation.

The UConnect® phonebook enables you to store up to 32 names, with four numbers per name. Each language has a separate 32-name phonebook accessible only in that language. This system is driven through your Bluetooth® "Hands-Free profile" cellular phone. UConnect® features Bluetooth® technology - the global standard that enables

different electronic devices to connect to each other without wires or a docking station, so UConnect® works no matter where you stow your cellular phone (be it your purse, pocket, or briefcase), as long as your phone is turned on and has been paired to the vehicle's UConnect® system. The UConnect® system allows up to seven cellular phones to be linked to the system. Only one linked (or paired) cellular phone can be used with the system at a time. The system is available in English, Spanish, or French languages (as equipped).

PHONE Button



The rearview mirror contains the microphone for the system (depending on the type of mirror and radio equipped), and either the radio or the mirror has the two control buttons (PHONE Button and VOICE RECOGNITION button) that will enable you to access the system.

Voice Recognition Button



Actual button location may vary with radio. The individual buttons are described in the "Operation" section.

The UConnect® system can be used with any Hands-Free Profile certified Bluetooth® cellular phone. See the UConnect® website for supported phones. If your cellular phone supports a different profile (e.g., Headset Profile) you may not be able to use any UConnect® features. Refer to your cellular service provider or the phone manufacturer for details.

The UConnect® system is fully integrated with the vehicle's audio system. The volume of the UConnect® system can be adjusted either from the radio volume control knob or from the steering wheel radio control (right switch), if so equipped.

The radio display will be used for visual prompts from the UConnect® system such as "CELL" or caller ID on certain radios.

Operation

Voice commands can be used to operate the UConnect® system and to navigate through the UConnect® menu structure. Voice commands are required after most UConnect® system prompts. You will be prompted for a specific command and then guided through the available options.

- Prior to giving a voice command, one must wait for the beep, which follows the "Ready" prompt or another prompt.
- For certain operations, compound commands can be used. For example, instead of saying "Setup" and then "Phone Pairing," the following compound command can be said: "Setup Phone Pairing."

- For each feature explanation in this section, only the combined form of the voice command is given. You can also break the commands into parts and say each part of the command when you are asked for it. For example, you can use the combined form voice command "Phonebook New Entry," or you can break the combined form command into two voice commands: "Phonebook" and "New Entry." Please remember, the UConnect® system works best when you talk in a normal conversational tone, as if speaking to someone sitting a few feet/meters away from you.

Voice Command Tree

Refer to "Voice Tree" in this section.

Help Command

If you need assistance at any prompt, or if you want to know your options at any prompt, say "Help" following the beep. The UConnect® system will play all the options at any prompt if you ask for help.

To activate the UConnect® system from idle, simply press the PHONE button and follow the audible prompts for directions. All UConnect® system sessions begin with a press of the PHONE button on the radio control head.

Cancel Command

At any prompt, after the beep, you can say "Cancel" and you will be returned to the main menu. However, in a few instances the system will take you back to the previous menu.

Pair (Link) UConnect® System to a Cellular Phone

To begin using your UConnect® system, you must pair your compatible Bluetooth® enabled cellular phone.

To complete the pairing process, you will need to reference your cellular phone owner's manual. The UConnect® website may also provide detailed instructions for pairing.

The following are general phone to UConnect® system pairing instructions:

- Press the PHONE button to begin.
- After the "Ready" prompt and the following beep, say "Setup Phone Pairing."
- When prompted, after the beep, say "Pair a Phone" and follow the audible prompts.
- You will be asked to say a four-digit Personal Identification Number (PIN), which you will later need to enter into your cellular phone. You can enter any four-digit PIN number. You will not need to remember this PIN number after the initial pairing process.
- For identification purposes, you will be prompted to give the UConnect® system a name for your cellular phone. Each cellular phone that is paired should be given a unique phone name.
- You will then be asked to give your cellular phone a priority level between 1 and 7, with 1 being the highest priority. You can pair up to seven cellular phones to your UConnect® system. However, at any given time, only one cellular phone can be in use, connected to your UConnect® system. The priority allows the UConnect® system to know which cellular phone to use if multiple cellular phones are in the vehicle at the same time. For example, if priority 3 and priority 5 phones are present in the vehicle, the UConnect® system will use the priority 3 cellular phone when you make a call. You can select to use a lower priority cellular phone at any time (refer to "Advanced Phone Connectivity" in this section).

Dial by Saying a Number

- Press the PHONE button to begin.
- After the "Ready" prompt and the following beep, say "Dial."
- The system will prompt you to say the number you want to call.
- For example, you can say "234-567-8901." The phone number that you enter must be of valid length and combination. Based on the country in which the vehicle was purchased, the UConnect® system limits the user from dialing an invalid combination of numbers. For example, in the U.S., 234-567-890 is nine digits long, which is not a valid U.S. phone number - the closest valid phone number has 10 digits.
- The UConnect® system will confirm the phone number and then dial. The number will appear in the display of certain radios.

Call by Saying a Name

- Press the PHONE button to begin.
- After the "Ready" prompt and the following beep, say "Call."
- The system will prompt you to say the name of the person you want to call.
- After the "Ready" prompt and the following beep, say the name of the person you want to call. For example, you can say "John Doe," where John Doe is a previously stored name entry in the UConnect® phonebook. To learn how to store a name in the phonebook, refer to "Add Names to Your UConnect® Phonebook," in this section.
- The UConnect® system will confirm the name and then dial the corresponding phone number, which may appear in the display of certain radios.

Add Names to Your UConnect® Phonebook

NOTE: Adding names to the phonebook is recommended when the vehicle is not in motion.

- Press the PHONE button to begin.
- After the "Ready" prompt and the following beep, say "Phonebook New Entry."
- When prompted, say the name of the new entry. Use of long names helps the voice recognition and it is recommended. For example, say "Robert Smith" or "Robert" instead of "Bob."
- When prompted, enter the number designation (e.g., "Home," "Work," "Mobile," or "Pager"). This will allow you to store multiple numbers for each phonebook entry, if desired.
- When prompted, recite the phone number for the phonebook entry that you are adding.

After you are finished adding an entry into the phonebook, you will be given the opportunity to add more phone numbers to the current entry or to return to the main menu.

The UConnect® system will allow you to enter up to 32 names in the phonebook with each name having up to four associated phone numbers and designations. Each language has a separate 32-name phonebook accessible only in that language.

Phonebook Download

UConnect® allows the user to download entries from their phone via Bluetooth®. To use this feature, press the PHONE button and say "Phonebook Download." The system prompts, "Ready to accept "V" card entry via Bluetooth®..." The system is now ready to accept phonebook entries from your phone using the Bluetooth®

Object Exchange Profile (OBEX). Please see your phone Owner's Manual for specific instructions on how to send these entries from your phone.

NOTE:

- The phone handset must support Bluetooth® OBEX transfers of phonebook entries to use this feature.
- Some phones cannot send phonebook entries if they are already connected to any system via Bluetooth®, and you may see a message on the phone display that the Bluetooth® link is busy. In this case, the user must first disconnect or drop the Bluetooth® connection to the UConnect® system, and then send the address book entry via Bluetooth®. Please see your phone owner's manual for specific instructions on how to drop the Bluetooth® connection.
- If the phonebook entry is longer than 24 characters, it will only use the first 24 characters.

Edit Entries in the UConnect® Phonebook

NOTE: Editing names in the phonebook is recommended when the vehicle is not in motion.

- Press the PHONE button to begin.
- After the "Ready" prompt and the following beep, say "Phonebook Edit."
- You will then be asked for the name of the phonebook entry that you wish to edit.
- Next, choose the number designation (home, work, mobile, or pager) that you wish to edit.
- When prompted, recite the new phone number for the phonebook entry that you are editing.

After you are finished editing an entry in the phonebook, you will be given the opportunity to edit another entry in the phonebook, call the number you just edited, or return to the main menu.

"Phonebook Edit" can be used to add another phone number to a name entry that already exists in the phonebook. For example, the entry John Doe may have a mobile and a home number, but you can add "John Doe's" work number later using the "Phonebook Edit" feature.

Delete Entries in the UConnect® Phonebook

NOTE: Editing phonebook entries is recommended when the vehicle is not in motion.

- Press the PHONE button to begin.
- After the "Ready" prompt and the following beep, say "Phonebook Delete."
- After you enter the Phonebook Delete menu, you will then be asked for the name of the entry that you wish to delete. You can either say the name of a phonebook entry that you wish to delete or you can say "List Names" to hear a list of the entries in the phonebook

from which you choose. To select one of the entries from the list, press the "Voice Recognition" button while the UConnect® system is playing the desired entry and say "Delete."

- After you enter the name, the UConnect® system will ask you which designation you wish to delete: home, work, mobile, pager, or all. Say the designation you wish to delete.
- Note that only the phonebook entry in the current language is deleted.

Delete All Entries in the UConnect® Phonebook

- Press the PHONE button to begin.
- After the "Ready" prompt and the following beep, say "Phonebook Erase All."
- The UConnect® system will ask you to verify that you wish to delete all the entries from the phonebook.

- After confirmation, the phonebook entries will be deleted.
- Note that only the phonebook in the current language is deleted.

List All Names in the UConnect® Phonebook

- Press the PHONE button to begin.
- After the "Ready" prompt and the following beep, say "Phonebook List Names."
- The UConnect® system will play the names of all the phonebook entries.
- To call one of the names in the list, press the "Voice Recognition" button during the playing of the desired name, and say "Call."

NOTE: The user can also exercise "Edit" or "Delete" operations at this point.

- The UConnect® system will then prompt you as to the number designation you wish to call.
- The selected number will be dialed.

Phone Call Features

The following features can be accessed through the UConnect® system if the feature(s) are available on your cellular service plan. For example, if your cellular service plan provides three-way calling, this feature can be accessed through the UConnect® system. Check with your cellular service provider for the features that you have.

Answer or Reject an Incoming Call - No Call Currently in Progress

When you receive a call on your cellular phone, the UConnect® system will interrupt the vehicle audio system, if on, and will ask if you would like to answer the call. Press the PHONE button to accept the call. To reject

the call, press and hold the PHONE button until you hear a single beep, indicating that the incoming call was rejected.

Answer or Reject an Incoming Call - Call Currently in Progress

If a call is currently in progress and you have another incoming call, you will hear the same network tones for call waiting that you normally hear when using your cell phone. Press the PHONE button to place the current call on hold and answer the incoming call.

NOTE: The UConnect® system compatible phones in the market today do not support rejecting an incoming call when another call is in progress. Therefore, the user can only answer an incoming call or ignore it.

Making a Second Call While Current Call in Progress

To make a second call while you are currently on a call, press the "Voice Recognition" button and say "Dial" or

"Call" followed by the phone number or phonebook entry you wish to call. The first call will be on hold while the second call is in progress. To go back to the first call, refer to "Toggling Between Calls" in this section. To combine two calls, refer to "Conference Call" in this section.

Place/Retrieve a Call From Hold

To put a call on hold, press the PHONE button until you hear a single beep. This indicates that the call is on hold. To bring the call back from hold, press and hold the PHONE button until you hear a single beep.

Toggling Between Calls

If two calls are in progress (one active and one on hold), press the PHONE button until you hear a single beep, indicating that the active and hold status of the two calls have switched. Only one call can be placed on hold at one time.

Conference Call

When two calls are in progress (one active and one on hold), press and hold the PHONE button until you hear a double beep indicating that the two calls have been joined into one conference call.

Three-Way Calling

To initiate three-way calling, press the "Voice Recognition" button while a call is in progress, and make a second phone call, as described under "Making a Second Call While Current Call in Progress." After the second call has established, press and hold the PHONE button until you hear a double beep, indicating that the two calls have been joined into one conference call.

Call Termination

To end a call in progress, momentarily press the PHONE button. Only the active call(s) will be terminated and if

there is a call on hold, it will become the new active call. If the active call is terminated by the far end, a call on hold may not become active automatically. This is cell phone-dependent. To bring the call back from hold, press and hold the PHONE button until you hear a single beep.

Redial

- Press the PHONE button to begin.
- After the "Ready" prompt and the following beep, say "Redial."
- The UConnect® system will call the last number that was dialed from your cellular phone.

NOTE: This may not be the last number dialed from the UConnect® system.

Call Continuation

Call continuation is the progression of a phone call on the UConnect® system after the vehicle ignition key has been switched to OFF. Call continuation functionality available on the vehicle can be any one of three types:

- After the ignition key is switched to OFF, a call can continue on the UConnect® system either until the call ends, or until the vehicle battery condition dictates cessation of the call on the UConnect® system and transfer of the call to the mobile phone.
- After the ignition key is switched to OFF, a call can continue on the UConnect® system for a certain duration, after which the call is automatically transferred from the UConnect® system to the mobile phone.
- An active call is automatically transferred to the mobile phone after the ignition key is switched to OFF.

UConnect® System Features

Language Selection

To change the language that the UConnect® system is using:

- Press the PHONE button to begin.
- After the "Ready" prompt and the following beep, say the name of the language you wish to switch to (English, Espanol, or Francais, if so equipped).
- Continue to follow the system prompts to complete language selection.

After selecting one of the languages, all prompts and voice commands will be in that language.

NOTE: After every UConnect® language change operation, only the language-specific 32-name phonebook is usable. The paired phone name is not language-specific and usable across all languages.

Emergency Assistance

If you are in an emergency and the mobile phone is reachable:

- Pick up the phone and manually dial the emergency number for your area.

If the phone is not reachable and the UConnect® system is operational, you may reach the emergency number as follows:

- Press the PHONE button to begin.
- After the "Ready" prompt and the following beep, say "Emergency" and the UConnect® system will instruct the paired cellular phone to call the emergency number. This feature is only supported in the U.S.

NOTE: The emergency number dialed is based on the country where the vehicle is purchased (911 for the U.S.

and Canada and 060 for Mexico). The number dialed may not be applicable with the available cellular service and area.

The UConnect® system does slightly lower your chances of successfully making a phone call as to that for the cell phone directly.

Your phone must be turned on and paired to the UConnect® system to allow use of this vehicle feature in emergency situations, when the cell phone has network coverage and stays paired to the UConnect® system.

Towing Assistance

If you need towing assistance:

- Press the PHONE button to begin.
- After the "Ready" prompt and the following beep, say "Towing Assistance."

NOTE: The Towing Assistance number dialed is based on the country where the vehicle is purchased (1-800-528-2069 for the U.S., 1-877-213-4525 for Canada, 55-14-3454 for Mexico City and 1-800-712-3040 for outside Mexico City in Mexico).

Please refer to the 24-Hour "Towing Assistance" coverage details in the Warranty Information Booklet and on the 24-Hour Towing Assistance Card.

Paging

To learn how to page, refer to "Working with Automated Systems." Paging works properly except for pagers of certain companies, which time out a little too soon to work properly with the UConnect® system.

Voice Mail Calling

To learn how to access your voice mail, refer to "Working with Automated Systems."

Working with Automated Systems

This method is used in instances where one generally has to press numbers on the cellular phone keypad while navigating through an automated telephone system.

You can use your UConnect® system to access a voice mail system or an automated service, such as a paging service or automated customer service line. Some services require immediate response selection. In some instances, that may be too quick for use of the UConnect® system.

When calling a number with your UConnect® system that normally requires you to enter in a touch-tone sequence on your cellular phone keypad, you can press the "Voice Recognition" button and say the sequence you wish to enter, followed by the word "Send." For example, if required to enter your PIN number followed with a pound, (3 7 4 6 #), you can press the "Voice Recognition" button and say, "3 7 4 6 # Send." Saying a number, or

sequence of numbers, followed by "Send," is also to be used for navigating through an automated customer service center menu structure, and to leave a number on a pager.

You can also send stored UConnect® phonebook entries as tones for fast and easy access to voice mail and pager entries. To use this feature, dial the number you wish to call and then press the "Voice Recognition" button and say, "Send." The system will prompt you to enter the name or number and say the name of the phonebook entry you wish to send. The UConnect® system will then send the corresponding phone number associated with the phonebook entry, as tones over the phone.

NOTE:

- You may not hear all of the tones due to cellular phone network configurations; this is normal.

- Some paging and voice mail systems have system time out settings that are too short and may not allow the use of this feature.

Barge In - Overriding Prompts

The "Voice Recognition" button can be used when you wish to skip part of a prompt and issue your voice recognition command immediately. For example, if a prompt is asking "Would you like to pair a phone, clear a...," you could press the "Voice Recognition" button and say, "Pair a Phone" to select that option without having to listen to the rest of the voice prompt.

Turning Confirmation Prompts On/Off

Turning confirmation prompts off will stop the system from confirming your choices (e.g., the UConnect® system will not repeat a phone number before you dial it).

- Press the PHONE button to begin.

- After the "Ready" prompt and the following beep, say "Setup Confirmations." The UConnect® system will play the current confirmation prompt status and you will be given the choice to change it.

Phone and Network Status Indicators

If available on the radio and/or on a premium display such as the instrument panel cluster, and supported by your cell phone, the UConnect® system will provide notification to inform you of your phone and network status when you are attempting to make a phone call using UConnect®. The status is given for roaming, network signal strength, phone battery strength, etc.

Dialing Using the Cellular Phone Keypad

You can dial a phone number with your cellular phone keypad and still use the UConnect® system (while dialing via the cell phone keypad, the user must exercise caution and take precautionary safety measures). By dialing a number with your paired Bluetooth® cellular

phone, the audio will be played through your vehicle's audio system. The UConnect® system will work the same as if you dial the number using voice recognition.

NOTE: Certain brands of mobile phones do not send the dial ring to the UConnect® system to play it on the vehicle audio system, so you will not hear it. Under this situation, after successfully dialing a number the user may feel that the call did not go through even though the call is in progress. Once your call is answered, you will hear the audio.

Mute/Un-Mute (Mute Off)

When you mute the UConnect® system, you will still be able to hear the conversation coming from the other party, but the other party will not be able to hear you. In order to mute the UConnect® system:

- Press the "Voice Recognition" button.
- Following the beep, say "Mute."

In order to un-mute the UConnect® system:

- Press the “Voice Recognition” button.
- Following the beep, say “Mute off.”

Advanced Phone Connectivity

Transfer Call to and from Cellular Phone

The UConnect® system allows ongoing calls to be transferred from your cellular phone to the UConnect® system without terminating the call. To transfer an ongoing call from your UConnect® paired cellular phone to the UConnect® system or vice versa, press the “Voice Recognition” button and say “Transfer Call.”

Connect or Disconnect Link Between the UConnect® System and Cellular Phone

Your cellular phone can be paired with many different electronic devices, but can only be actively “connected” with one electronic device at a time.

If you would like to connect or disconnect the Bluetooth® connection between a UConnect® paired cellular phone and the UConnect® system, follow the instructions described in your cellular phone User’s Manual.

List Paired Cellular Phone Names

- Press the PHONE button to begin.
- After the “Ready” prompt and the following beep, say “Setup Phone Pairing.”
- When prompted, say “List Phones.”
- The UConnect® system will play the phone names of all paired cellular phones in order from the highest to the lowest priority. To “select” or “delete” a paired phone being announced, press the “Voice Recognition” button and say “Select” or “Delete.” Also, see the next two sections for an alternate way to “select” or “delete” a paired phone.

Select Another Cellular Phone

This feature allows you to select and start using another phone paired with the UConnect® system.

- Press the PHONE button to begin.
- After the "Ready" prompt and the following beep, say "Setup Select Phone" and follow the prompts.
- You can also press the "Voice Recognition" button at any time while the list is being played, and then choose the phone that you wish to select.
- The selected phone will be used for the next phone call. If the selected phone is not available, the UConnect® system will return to using the highest priority phone present in or near (approximately within 30 ft (9 m) the vehicle.

Delete UConnect® Paired Cellular Phones

- Press the PHONE button to begin.

- After the "Ready" prompt and the following beep, say "Setup Phone Pairing."
- At the next prompt, say "Delete" and follow the prompts.
- You can also press the "Voice Recognition" button at any time while the list is being played, and then choose the phone you wish to delete.

Things You Should Know About Your UConnect® System

UConnect® Tutorial

To hear a brief tutorial of the system features, press the PHONE button and say "UConnect® Tutorial."

Voice Training

For users experiencing difficulty with the system recognizing their voice commands or numbers, the UConnect®

system Voice Training feature may be used. To enter this training mode, follow one of the two following procedures:

From outside the UConnect® mode (e.g., from radio mode):

- Press and hold the “Voice Recognition” button for five seconds until the session begins, or,
- Press the “Voice Recognition” button and say the “Setup, Voice Training” command.

Repeat the words and phrases when prompted by the UConnect® system. For best results, the Voice Training session should be completed when the vehicle is parked with the engine running, all windows closed, and the blower fan switched off.

This procedure may be repeated with a new user. The system will adapt to the last trained voice only.

To restore the voice recognition system to factory default settings, enter the Voice Training session via the above procedure and follow the prompts.

Voice Recognition (VR)

- For best performance, adjust the rear view mirror to provide at least ½ in (1 cm) gap between the overhead console (if equipped) and the mirror.
- Always wait for the beep before speaking.
- Speak normally, without pausing, just as you would speak to a person sitting a few feet/meters away from you.
- Make sure that no one other than you is speaking during a voice recognition period.
- Performance is maximized under:
 - low-to-medium blower setting,

- low-to-medium vehicle speed,
- low road noise,
- smooth road surface,
- fully closed windows,
- dry weather condition.
- Even though the system is designed for users speaking in North American English, French, and Spanish accents, the system may not always work for some.
- When navigating through an automated system such as voice mail, or when sending a page, at the end of speaking the digit string, make sure to say "Send."
- Storing names in the phonebook when the vehicle is not in motion is recommended.
- It is not recommended to store similar sounding names in the UConnect® phonebook.

- The UConnect® phonebook nametag recognition rate is optimized for the person who stored the name in the phonebook.
- You can say "O" (letter "O") for "0" (zero). "800" must be spoken "eight-zero-zero."
- Even though international dialing for most number combinations is supported, some shortcut dialing number combinations may not be supported.
- In a convertible vehicle, system performance may be compromised with the convertible top down.

Far End Audio Performance

- Audio quality is maximized under:
 - low-to-medium blower setting,
 - low-to-medium vehicle speed,
 - low road noise,

- smooth road surface,
- fully closed windows,
- dry weather conditions, and
- operation from the drivers seat.
- Performance, such as audio clarity, echo, and loudness to a large degree rely on the phone and network, and not the UConnect® system.
- Echo at the far end can sometimes be reduced by lowering the in-vehicle audio volume.
- In a convertible vehicle, system performance may be compromised with the convertible top down.

Bluetooth® Communication Link

Cellular phones have been found to lose connection to the UConnect® system. When this happens, the connection can generally be re-established by switching the phone off/on. Your cell phone is recommended to remain in Bluetooth® ON mode.

Power-Up

After switching the ignition key from OFF to either ON or ACC position, or after a language change, you must wait at least five seconds prior to using the system.

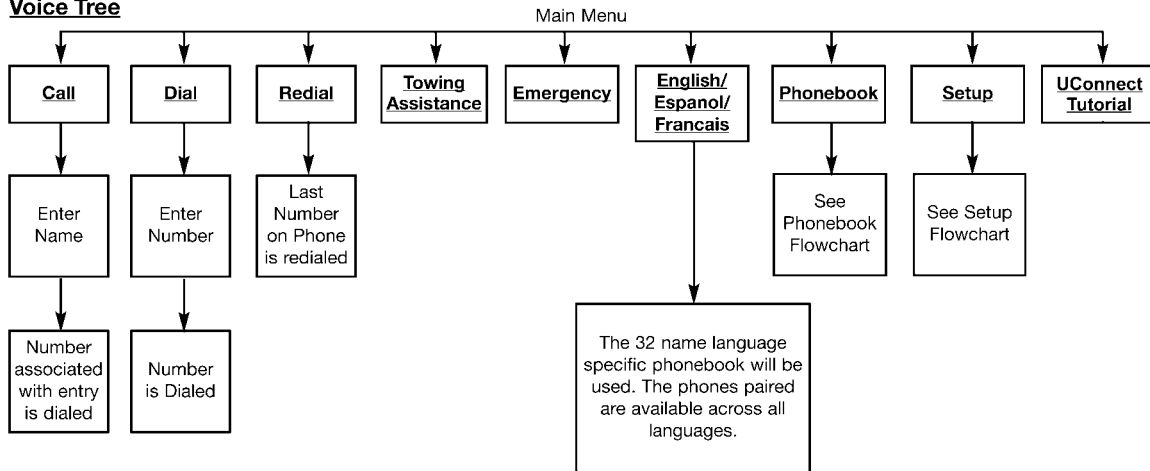
Voice Tree

Note: Available Voice commands are shown in bold face and are underlined.

Voice Tree – Phonebook

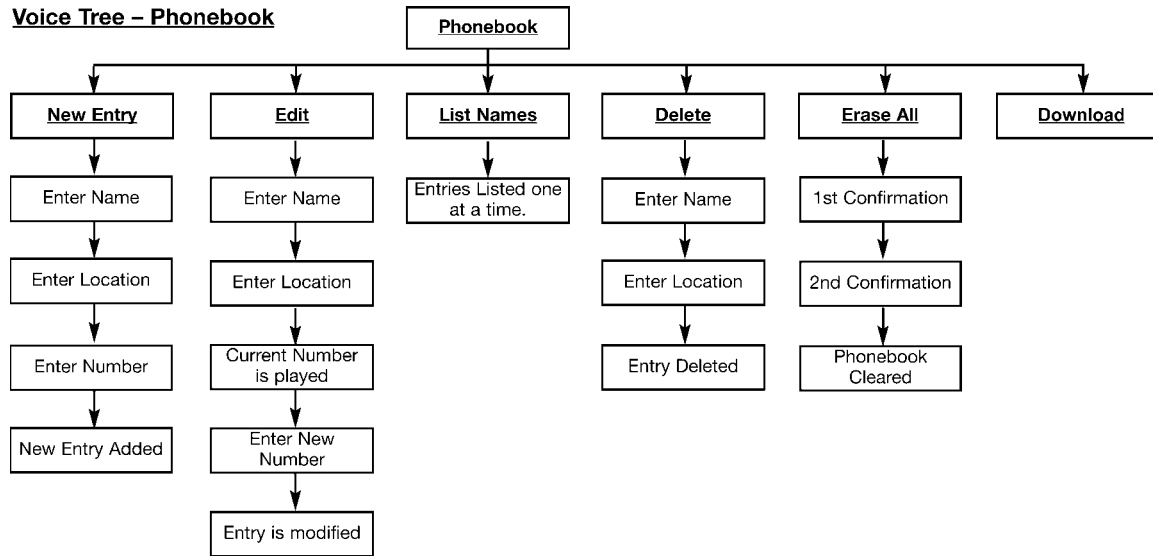

Note: Available Voice commands are shown in bold face and are underlined.

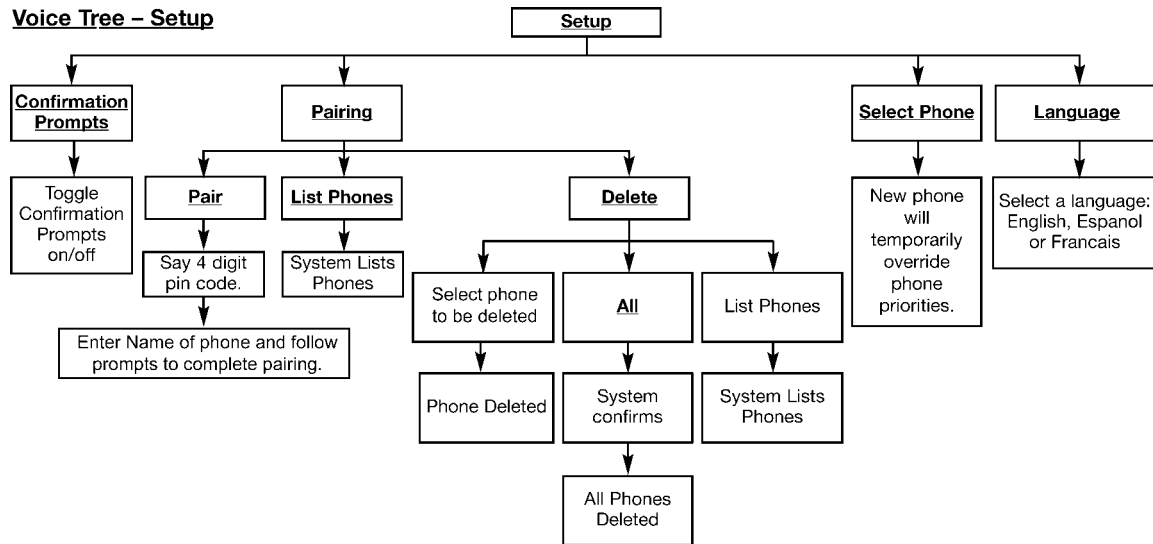
Voice Tree – Setup

Note: Available Voice commands are shown in bold face and are underlined.

819402e4

Voice Commands	
Primary	Alternate(s)
zero	
one	
two	
three	
four	
five	
six	
seven	
eight	
nine	
star (*)	
plus (+)	
pound (#)	
add location	
all	

Voice Commands	
Primary	Alternate(s)
call	
cancel	
confirmation prompts	
continue	
delete	
dial	
download	
edit	
emergency	
English	
erase all	
Espanol	
Francais	
help	
home	

Voice Commands	
Primary	Alternate(s)
language	
list names	
list phones	
mobile	
mute	
mute off	
new entry	
no	
pager	
pair a phone	
phone pairing	pairing
phonebook	phone book
previous	
record again	
redial	

Voice Commands	
Primary	Alternate(s)
return to main menu	return or main menu
select phone	select
send	
set up	phone settings or phone set up
towing assistance	
transfer call	
UConnect® Tutorial	
try again	
voice training	
work	
yes	

General Information

This device complies with part 15 of the FCC rules and RSS 210 of Industry Canada. Operation is subject to the following conditions:

- This device may not cause harmful interference.
- This device must accept any interference received, including interference that may cause undesired operation.

VOICE RECOGNITION SYSTEM (VR) — IF EQUIPPED

Voice Recognition System (VR) Operation



This Voice Recognition System allows you to control your AM, FM radio, satellite radio, disc player, and a memo recorder.

NOTE: In a stressful situation, take care to speak into the Voice Interface System as calmly and normally as

possible. The ability of the Voice Interface System to recognize user voice commands may be negatively affected by rapid speaking or a raised voice level.

WARNING!

Any voice commanded system should be used only in safe driving conditions and all attention should be kept on the roadway ahead. Failure to do so may result in an accident causing serious injury or death.

When you press the VR hard-key, you will hear a beep. The beep is your signal to give a command.

NOTE: If you do not say a command within a few seconds, the system will present you with a list of options.

If you ever wish to interrupt the system while it lists options, press the VR hard-key, listen for the beep, and say your command.

Pressing the VR hard-key while the system is speaking is known as “barging in.” The system will be interrupted and you can add or change commands. This will become helpful once you start to learn the options.

NOTE: At any time, you can say the words CANCEL, HELP, or MAIN MENU.

These commands are universal and can be used from any menu. All other commands can be used depending upon the active application.

For example, if you are in the disc menu and you are listening to FM radio, you can speak commands from the disc menu or from the FM radio menu.

When using this system, you should speak clearly and at a normal speaking volume.

The system will best recognize your speech if the windows are closed, and the heater/air-conditioning fan is set to low.

At any point, if the system does not recognize one of your commands, you will be prompted to repeat it.

To hear the first available Menu, press the VR hard-key and say HELP or MAIN MENU.

Commands

The Voice Recognition System understands two types of commands. Global commands are available at all times. Local commands are available if the supported radio mode is active.

Changing the Volume

1. Start a dialogue by pressing the VR hard-key.
2. Say a command (e.g., HELP).

3. Use the ON/OFF VOLUME rotary knob to adjust the volume to a comfortable level while the voice recognition system is speaking. Please note the volume setting for VR is different than the audio system.

Main Menu

Start a dialogue by pressing the VR hard-key. You may say MAIN MENU to switch to the main menu.

In this mode, you can say the following commands:

- RADIO (to switch to the radio mode)
- DISC (to switch to the disc mode)
- MEMO (to switch to the memo recorder)

Radio AM (or Radio Long Wave or Radio Medium Wave - if equipped)

To switch to the AM band say AM or RADIO AM. In this mode, you may say the following commands:

- FREQUENCY (to change the frequency)

- NEXT STATION (to select the next station)
- PREVIOUS STATION (to select the previous station)
- RADIO MENU (to switch to the radio menu)
- MAIN MENU (to switch to the main menu)

Radio FM

To switch to the FM band say FM or RADIO FM. In this mode, you may say the following commands:

- FREQUENCY (to change the frequency)
- NEXT STATION (to select the next station)
- PREVIOUS STATION (to select the previous station)
- RADIO MENU (to switch to the radio menu)
- MAIN MENU (to switch to the main menu)

Satellite Radio

To switch to satellite radio mode say SAT or SATELLITE RADIO. In this mode, you may say the following commands:

- CHANNEL NUMBER (to change the channel by its spoken number)
- NEXT CHANNEL (to select the next channel)
- PREVIOUS CHANNEL (to select the previous channel)
- LIST CHANNEL (to hear a list of available channels)
- SELECT NAME (to say the name of a channel)
- RADIO MENU (to switch to the radio menu)
- MAIN MENU (to switch to the main menu)

Disc

To switch to the disc mode say DISC. In this mode, you may say the following commands:

- TRACK (#) (to change the track)
- NEXT TRACK (to play the next track)
- PREVIOUS TRACK (to play the previous track)
- MAIN MENU (to switch to the main menu)

Memo

To switch to the voice recorder mode say MEMO. In this mode, you may say the following commands:

- NEW MEMO (to record a new memo) — During the recording you may press the VR hard-key to stop recording. You continue by saying one of the following commands:
 - SAVE (to save the memo)

- CONTINUE (to continue recording)
- DELETE (to delete the recording)
- PLAY MEMOS (to play previously recorded memos)
 - During the playback you may press the VR hard-key to stop playing memos. You continue by saying one of the following commands:
 - REPEAT (to repeat a memo)
 - NEXT (to play the next memo)
 - PREVIOUS (to play the previous memo)
 - DELETE (to delete a memo)
- DELETE ALL (to delete all memos)

NOTE: Keep in mind that you have to press the VR hard-key first and wait for the beep, before speaking the “barge in” commands.

Voice Training

For users experiencing difficulty with the system recognizing their voice commands or numbers, the UConnect® system Voice Training feature may be used.

1. Press the VR hard-key, speak “System Setup” and once you are in that menu then speak “Voice Training.” This will train your own voice to the system and will improve recognition.
2. Repeat the words and phrases when prompted by the UConnect® System. For best results, the Voice Training session should be completed when the vehicle is parked, engine running, all windows closed, and the blower fan switched off. This procedure may be repeated with a new user. The system will adapt to the last trained voice only.

SEATS

Power Seats

The power SEAT switch is on the outboard side of the seat near the floor. Use this switch to move the driver's seat up or down, forward or rearward, or to tilt the seat. The passenger's seat will move up or down, forward or rearward.

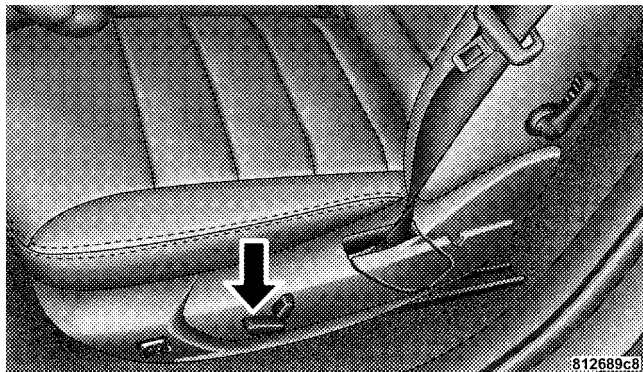

Power SEAT Switch

WARNING!

Adjusting a seat while the vehicle is moving is dangerous. The sudden movement of the seat could cause you to lose control. The seat belt might not be properly adjusted and you could be injured. Adjust the seat only while the vehicle is parked.

CAUTION!

Do not place any article under a power seat as it may cause damage to the seat controls.

Power Reclining Seats

The recliner control is located on the outboard side of the seat.

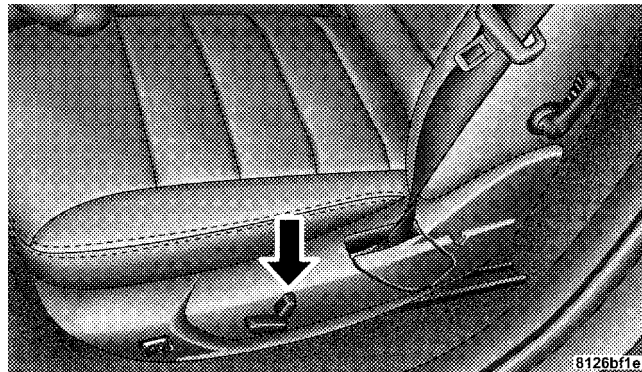

Power Seat RECLINE Switch

WARNING!

Do not ride with the seatback reclined so that the shoulder belt is no longer resting against your chest. In a collision you could slide under the seat belt and be seriously or even fatally injured. Use the recliner only when the vehicle is parked.

Lumbar Support

This feature allows you to increase or decrease the amount of lumbar support. Turn the control lever forward to increase and rearward to decrease the desired amount of lumbar support.

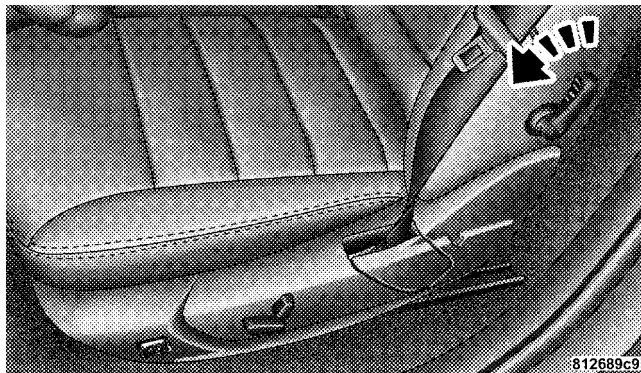

Lumbar Support Control Lever

Head Restraints

Head restraints can reduce the risk of whiplash injury in the event of impact from the rear. Adjust the restraint so that the upper edge is as high as practical. To raise it, pull upward on the head restraint. To lower it, depress the button on the post guide and push downward on the head restraint.

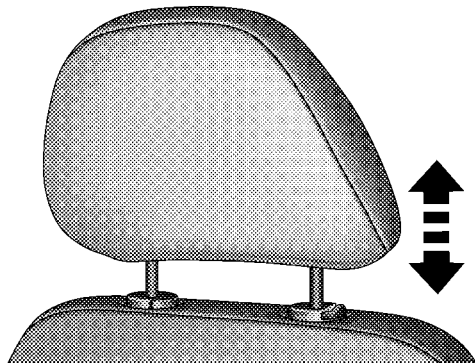

Adjustable Head Restraint

81b7959a

Heated Seats

Heated seats provide comfort and warmth on cold days and can help soothe sore muscles and backs. The heaters provide the same heat level for both cushion and back. The driver seat and front passenger seat are heated.

The controls for each heater are located near the bottom center of the instrument panel. After turning on the ignition, you can choose from High, Off, or Low heat settings. Amber LEDs in the top portion of each switch indicate the level of heat in use. Two LEDs will illuminate for high, one for low, and none for off.

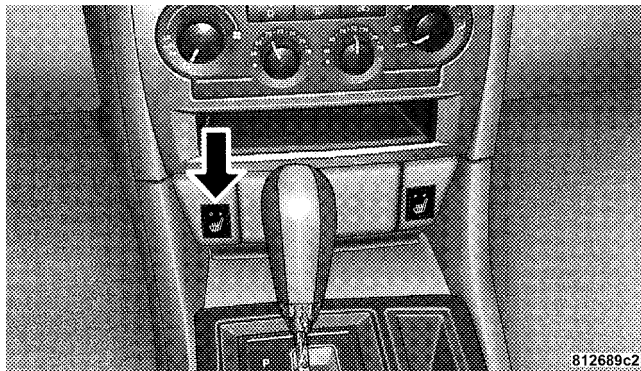

Front HEATED SEAT Switch

Press the switch once to select high level heating. Press the switch a second time to select low level heating. Press the switch a third time to shut OFF the heating elements.

If high level heating is selected, the system will automatically switch to the low level after 30 minutes of continuous operation. At that time, the number of illuminated

LEDs changes from two to one, indicating the change. Operation on the low setting also turns off automatically after 30 minutes.

NOTE: Once a heat setting is selected, heat will be felt within two to five minutes.

WARNING!

Persons who are unable to feel pain to the skin because of advanced age, chronic illness, diabetes, spinal cord injury, medication, alcohol use, exhaustion, or other physical conditions must exercise care when using the seat heater. It may cause burns even at low temperatures, especially if used for long periods.

Do not place anything on the seat that insulates against heat, such as a blanket or cushion. This may cause the seat heater to overheat.

Folding Rear Seat

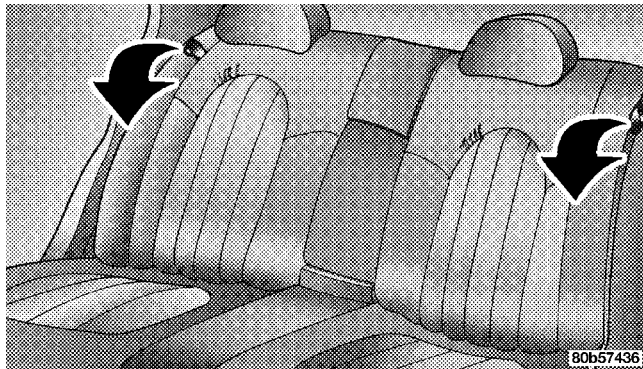

3

Folding Rear Seats

The rear seatbacks can be folded forward to provide an additional storage area. Pull on the loops shown in the illustration to fold down either or both seatbacks. These loops can be tucked away when not in use.

When the seatback is folded to the upright position, make sure it is latched by strongly pulling on the top of the seatback above the seat strap.

WARNING!

- **Be certain that the seatback is securely locked into position. If the seatback is not securely locked into position, the seat will not provide the proper stability for child seats and/or passengers. An improperly latched seat could cause serious injury.**
- **The cargo area in the rear of the vehicle (with the rear seatbacks in the locked-up or folded down position) should not be used as a play area by children when the vehicle is in motion. They could be seriously injured in an accident. Children should be seated and using the proper restraint system.**

DRIVER MEMORY SEAT — IF EQUIPPED

This feature allows the driver to store up to two different memory profiles for easy recall through a MEMORY switch. Each memory profile contains desired position settings for the driver seat, side mirror, adjustable pedals, and power tilt and telescopic steering column, and a set of desired radio station presets.

The memory switch is located on the driver's door trim panel. The switch contains an (S) button to activate the memory save function. It also contains a rocker switch labeled with the number (1) and the number (2). The rocker switch allows the driver to recall either of two pre-programmed memory profiles by pressing the appropriate side of the switch.

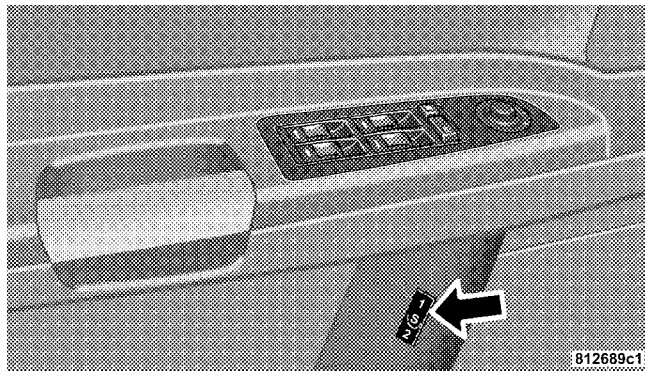

Memory Switch

Programming The Memory Feature

To create a new memory profile, perform the following:

NOTE: Saving a new memory profile will erase an existing profile from memory.

1. Adjust all memory profile settings to desired preferences (i.e., seat, side mirror, adjustable pedals, power tilt and telescopic steering column, and radio station presets).

2. Press and release the SET (S) button on the MEMORY switch, then press the side of the rocker switch labeled (1) within five seconds. The Electronic Vehicle Information Center (EVIC) will display which memory position is being set.

If desired, a second memory profile can be stored into memory as follows:

1. Adjust all memory profile settings to desired preferences (i.e., seat, side mirror, adjustable pedals, power tilt and telescopic steering column, and radio station presets).

2. Press and release the SET (S) button on the MEMORY switch, then press the side of the rocker switch labeled (2) within five seconds. The EVIC will display which memory position is being set.

NOTE: Memory profiles can be set without the vehicle in PARK, but the vehicle must be in PARK to recall a memory profile.

NOTE: The Recall Memory with Remote Key Unlock feature can be enabled or disabled. Refer to “Recall Memory with Remote Key Unlock,” under “Personal Settings (Customer Programmable Features),” under “Electronic Vehicle Information Center (EVIC)” in Section 4.

Linking and Unlinking the Remote Keyless Entry (RKE) Transmitter to the Memory Feature

Your Remote Keyless Entry (RKE) Transmitters can be programmed to recall one of two pre-programmed memory profiles by pressing the UNLOCK button on the RKE transmitter.

To program your transmitters, perform the following:

1. Remove key from ignition.
2. Select desired memory profile 1 or 2.
3. Press and release the SET (S) button on the MEMORY switch, then press and release the side of the rocker switch labeled 1 or 2 accordingly. “Memory Profile Set” (1 or 2) will display in the EVIC.
4. Press and release the LOCK button on the transmitter within 10 seconds.

NOTE: Your transmitters can be unlinked to your memory settings by pressing the SET (S) button followed by the UNLOCK button on the transmitter in Step 4 above.

Memory Position Recall

NOTE: The vehicle must be in PARK to recall memory positions. If a recall is attempted when the vehicle is not in PARK, a message will display in the EVIC.

To recall the memory settings for driver one, press MEMORY button number 1 on the driver's door or the UNLOCK button on the RKE transmitter linked to memory position 1.

To recall the memory setting for driver two, press MEMORY button number 2 on the driver's door or the UNLOCK button on the RKE transmitter linked to memory position 2.

A recall can be cancelled by pressing any of the MEMORY buttons (S, 1, or 2) on the driver's door during a recall. When a recall is cancelled, the driver seat, side mirror, adjustable pedals, and power tilt and telescopic steering column stop moving. A delay of one second will occur before another recall can be selected.

Easy Entry/Exit Seat (Available with Memory Seat Only)

This feature provides automatic driver seat positioning to enhance driver mobility when entering and exiting the vehicle.

The distance the driver seat moves depends on where you have the driver seat positioned when you remove the key from the ignition switch.

- When you remove the key from the ignition switch, the driver seat will move about 2.4 in (60 mm) rearward if the driver seat position is greater than or equal to 2.7 in (67.7 mm) forward of the rear stop. The seat will return to its previously set position when you insert the key into the ignition switch and turn it out of the LOCK position.
- When you remove the key from the ignition switch, the driver seat will move to a position 0.3 in (7.7 mm) forward of the rear stop if the driver seat position is between 0.9 in and 2.7 in (22.7 mm and 67.7 mm) forward of the rear stop. The seat will return to its previously set position when you insert the key into the ignition switch and turn it out of the LOCK position.

- The Easy Entry/Easy Exit feature is disabled when the driver seat position is less than 0.9 in (22.7 mm) forward of the rear stop. At this position, there is no benefit to the driver by moving the seat for Easy Exit or Easy Entry.

Each stored memory setting will have an associated Easy Entry and Easy Exit position.

NOTE: The Easy Entry/Easy Exit feature can be enabled or disabled. Refer to “Automatically Move Seat Back on Exit,” under “Personal Settings (Customer Programmable Features),” under “Electronic Vehicle Information Center (EVIC)” in Section 4.

TO OPEN AND CLOSE THE HOOD

Two latches must be released to open the hood. First, pull the hood release lever located under the left side of the instrument panel.

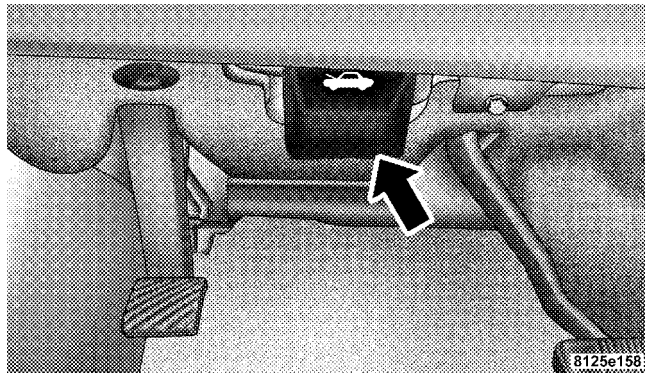

Hood Release Lever

Next, move to the outside of the vehicle and push the safety catch to the left. The safety catch is located under the center front edge of the hood.

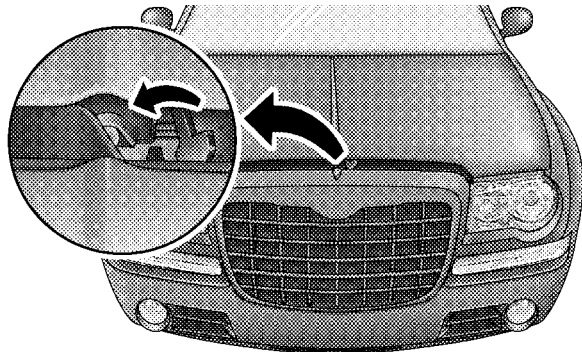

Hood Safety Catch

Use the hood prop rod (if equipped) to secure the hood in the open position.

To prevent possible damage, do not slam the hood to close it. Lower the hood, until it is open approximately 6 in (15 cm), and then drop it. This should secure both latches. Never drive your vehicle unless the hood is fully closed, with both latches engaged.

WARNING!

If the hood is not fully latched, it could fly up when the vehicle is moving and block your forward vision. You could have a collision. Be sure all hood latches are fully latched before driving.

LIGHTS

Headlight Switch



The HEADLIGHT switch is located on the left side of the instrument panel. This switch controls the operation of the headlights, parking lights, instrument panel lights, instrument panel light dimming, interior lights, and fog lights.

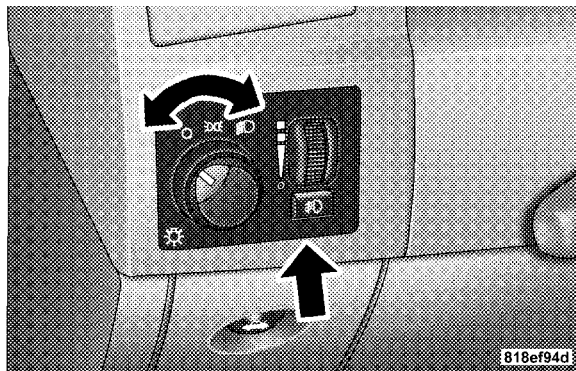

HEADLIGHT Switch

Rotate the HEADLIGHT switch clockwise to the first detent for parking light and instrument panel light operation. Turn it to the second detent for headlight, parking light, and instrument panel light operation.

Automatic Headlights

This system automatically turns the headlights ON or OFF according to ambient light levels. To turn the system ON, rotate the HEADLIGHT switch counterclockwise to the AUTO (A) position. When the system is on, the headlight time delay feature is also on. This means the headlights will stay on for up to 90 seconds after you turn the ignition switch OFF. To turn the automatic system OFF, move the HEADLIGHT switch out of the AUTO (A) position.

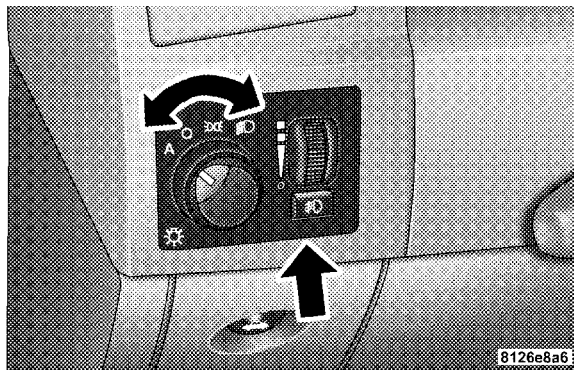

HEADLIGHT Switch

NOTE: The engine must be running before the headlights will come on in the automatic mode.

Headlights On with Wipers

When this feature is active, the headlights will turn on approximately 10 seconds after the wipers are turned ON if the HEADLIGHT switch is placed in the AUTO position. In addition, the headlights will turn off when the wipers are turned OFF if they were turned ON by this feature.

The Headlights On with Wipers feature can be enabled or disabled. Refer to "Headlights On with Wipers," under "Personal Settings (Customer Programmable Features)," under "Electronic Vehicle Information Center" in Section 4.

SmartBeams — If Equipped

The SmartBeam system provides increased forward lighting at night by automating high beam control through the use of a digital camera mounted on the inside rearview mirror. This camera detects vehicle specific light

and automatically switches from high beams to low beams until the approaching vehicle is out of view.

To Activate

1. Select “Automatic High Beams — ON” through the Electronic Vehicle Information Center (EVIC). Refer to “Automatic High Beams,” under “Personal Settings (Customer Programmable Features),” under “Electronic Vehicle Information Center” in Section 4.
2. Rotate the HEADLIGHT switch counterclockwise to the AUTO (A) position.
3. Push the multifunction lever away from you to switch the headlights to the HIGH BEAM position.

NOTE: This system will not activate until the vehicle is at or above 25 mph (40 km/h).

To Deactivate

Perform either of the following steps to deactivate the SmartBeam system.

1. Pull the multifunction lever toward you to switch the headlights from the HIGH BEAM to the LOW BEAM position.
2. Rotate the headlight switch clockwise from the AUTO (A) to the ON position.

NOTE: Broken, muddy, or obstructed headlights and taillights of vehicles in the field of view will cause headlights to remain on longer (closer to the vehicle). Also, dirt, film, and other obstructions on the windshield or camera lens will cause the system to function improperly.

Headlight Time Delay

This feature provides the safety of headlight illumination for up to 90 seconds (programmable) when leaving your vehicle in an unlit area.

To activate the delay feature, turn OFF the ignition switch while the headlights are still on. Then, turn OFF the headlights within 45 seconds. The delay interval begins when the HEADLIGHT switch is turned OFF.

If you turn the headlights, park lights, or ignition switch ON again, the system will cancel the delay.

If you turn the headlights OFF before the ignition, they will turn off in the normal manner.

NOTE: The lights must be turned OFF within 45 seconds of turning the ignition OFF to activate this feature.

The Headlight delay time is programmable. Refer to “Delay Turning Headlights Off,” under “Personal Settings (Customer Programmable Features),” under “Electronic Vehicle Information Center (EVIC)” in Section 4.

Daytime Running Lights — If Equipped

The high beam headlights will come on as Daytime Running Lights whenever the ignition switch is ON, the headlights are off, and the parking brake is off. The HEADLIGHT switch must be used for normal nighttime driving.

Lights-On Reminder

If the headlights or parking lights are on after the ignition is turned OFF, a chime will sound to alert the driver when the driver’s door is opened.

Fog Lights

#D The front FOG LIGHT switch is on the HEADLIGHT switch below the dimmer control. To activate the front fog lights, turn ON the parking lights or the low beam headlights and press the FOG LIGHT switch.

An indicator light in the instrument cluster illuminates when the fog lights are turned ON.

NOTE: The fog lights will operate with the low beam headlights or parking lights on. However, selecting the high beam headlights will turn off the fog lights.

Multifunction Lever

The multifunction lever controls the operation of the turn signals, headlight beam selection, and passing lights. The lever is located on the left side of the steering column.

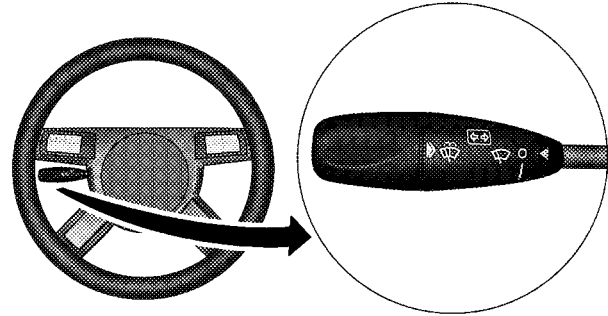

818c9c32

Multifunction Lever

Turn Signals

Move the multifunction lever up or down and the corresponding turn signal indicator in the instrument cluster flashes to show proper operation of the front and rear turn signal lights. You can also signal a lane change by moving the lever partially up or down without moving beyond the detent. Releasing the lever at the detent will provide three flashes.

If either indicator has a very fast flash rate, check for a defective outside light bulb. If an indicator fails to light when the lever is moved, see your authorized dealer for service.

NOTE: A “Turn Signal On” message will appear in the EVIC and a continuous chime will sound if the vehicle is driven more than 1 mi (1.6 km) with either turn signal on.

Highbeam/Lowbeam Select Switch

Push the multifunction lever away from you to switch the headlights to HIGH beam. Pull the lever toward you to switch the headlights back to LOW beam.

Flash to Pass

You can signal another vehicle with your headlights by lightly pulling the multifunction lever toward you. This will cause the headlights to turn on at high beam and remain on until the lever is released.

Overhead Console Map/Reading Lights

These lights are mounted between the sun visors on the overhead console. Each light is turned ON by pressing the lens. Press the lens a second time to turn OFF the light. These lights also turn on when a door is opened, or when the UNLOCK button on the Remote Keyless Entry (RKE) transmitter is pressed, or when the dimmer control is turned fully upward, past the second detent.

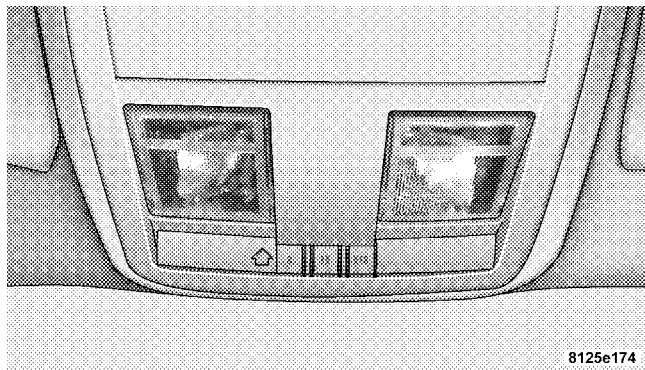

Overhead Console

Interior Lights

The interior lights come on when a door is opened.

To protect the battery, the interior lights will turn off automatically 10 minutes after the ignition switch is moved to the LOCK position. This will occur if the interior lights were switched ON manually or are on

because a door is open. This includes the glove box light, but not the trunk light. To restore interior light operation, either turn the ignition switch ON or cycle the light switch.

Dimmer Control

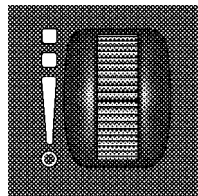

The dimmer control is part of the HEADLIGHT switch and is located on the left side of the instrument panel. With the parking lights or headlights on, rotating the dimmer control upward will increase the brightness of the instrument panel lights and, if so equipped, the lighting in the door map pockets and cupholders.

Dome Light Position

Rotate the dimmer control completely upward to the second detent to turn on the interior lights. The interior lights will remain on when the dimmer control is in this position.

Interior Light Defeat (OFF)

Rotate the dimmer control to the extreme bottom OFF position. The interior lights will remain off when the doors are open.

Parade Mode (Daytime Brightness Feature)

Rotate the dimmer control upward to the first detent. This feature brightens all text displays such as the odometer, EVIC, and radio when the parking lights or headlights are on.

WINDSHIELD WIPERS AND WASHERS



The multifunction lever operates the windshield wipers and washer when the ignition switch is in the ON position. The lever is located on the left side of the steering column.

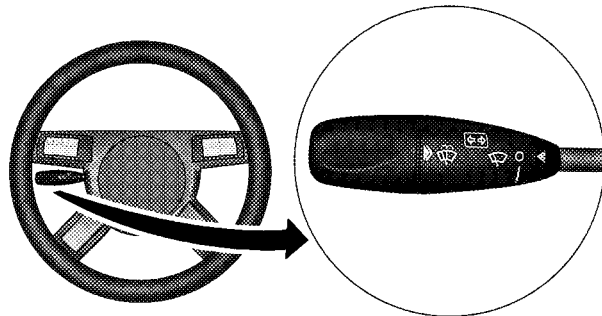

818c9c32

Windshield Wiper/Washer Control

Rotate the end of the multifunction lever to the first detent past the intermittent settings for low speed wiper operation, or to the second detent past the intermittent settings for high speed wiper operation.

CAUTION!

Turn the windshield wipers off when driving through an automatic car wash. Damage to the windshield wipers may result if the WIPER switch is left in any position other than OFF.

Intermittent Wiper System

Use the intermittent wiper when weather conditions make a single wiping cycle with a variable pause between cycles desirable. Rotate the end of the multifunction lever to the first detent position, and then turn the end of the lever to select the desired delay interval. There are six delay settings, which allow you to regulate the

wipe interval from a minimum of one cycle every second to a maximum of approximately 23 seconds between cycles.

WARNING!

Sudden loss of visibility through the windshield could lead to an accident. You might not see other vehicles or other obstacles. To avoid sudden icing of the windshield during freezing weather, warm the windshield with the defroster before and during windshield washer use.

Mist Feature

Push the multifunction lever inward (toward the steering column) to the first detent to activate a single wipe cycle to clear off road mist or spray from a passing vehicle. The wipers will continue to operate until you release the lever.

Windshield Washers

To use the washer, push the multifunction lever inward (toward the steering column) to the second detent and hold it for as long as washer spray is desired.

If you activate the washer while the windshield wiper control is in the delay range, the wipers will operate for two wipe cycles after releasing the lever and then resume the intermittent interval previously selected.

If you activate the washer while the windshield wiper is turned OFF, the wipers will operate for three wipe cycles and then turn OFF.

Headlights On with Wipers

When this feature is active, the headlights will turn on approximately 10 seconds after the wipers are turned ON if the HEADLIGHT switch is placed in the AUTO position. In addition, the headlights will turn off when the wipers are turned OFF if they were turned ON by this feature.

The Headlights On with Wipers feature can be enabled or disabled. Refer to "Headlights On with Wipers," under "Personal Settings (Customer Programmable Features)," under "Electronic Vehicle Information Center" in Section 4.

Rain Sensing Wipers

This feature senses moisture on the windshield and automatically activates the wipers for the driver. This feature is especially useful for road splash or over spray from the windshield washers of the vehicle ahead. Rotate the end of the multifunction lever to one of the six intermittent wiper settings to activate this feature.

The sensitivity of the system is adjustable from the multifunction lever. Wiper delay position 1 is the least sensitive and wiper delay position 6 is the most sensitive. Choose setting 3 or 4 for normal rain conditions. Choose setting 2 or 1 if you desire less wiper sensitivity. Choose

setting 5 or 6 if you desire more sensitivity. Place the lever in the OFF position when not using the system.

NOTE:

- The rain sensing feature will not operate when the wiper speed is in the LOW or HIGH position.
- The rain sensing feature may not function properly when ice or dried salt water is present on the windshield.
- Use of Rain-X® or products containing wax or silicone may reduce rain sensor performance.
- The rain sense feature can be enabled or disabled. Refer to “Rain Sensing Intermittent Wipers,” under “Personal Settings (Customer Programmable Features),” under “Electronic Vehicle Information Center (EVIC)” in Section 4.

The rain sensing system has protective features for the wiper blades and arms. It will not operate under the following conditions:

- **Low Temperature Wipe Inhibit** — The rain sensing feature will not operate when the ignition is first switched ON, and the vehicle is stationary, and the outside temperature is below 32°F (0°C), unless the wiper control on the multifunction lever is moved, or the vehicle speed becomes greater than 0 mph (0 km/h), or the outside temperature rises above freezing.
- **Neutral Wipe Inhibit** — The rain sensing feature will not operate when the ignition is ON, and the transmission shift lever is in the NEUTRAL position, and the vehicle speed is less than 5 mph (8 km/h), unless the wiper control on the multifunction lever is moved or the shift lever is moved out of the NEUTRAL position.

Adding Washer Fluid

The windshield washer fluid reservoir is located in the front of the engine compartment. Be sure to check the fluid level in the reservoir at regular intervals. Fill the reservoir with windshield washer solvent (not radiator antifreeze) and operate the system for a few seconds to flush out the residual water.

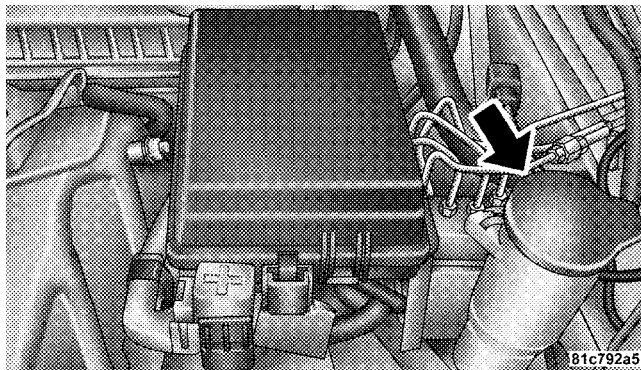

Washer Fluid Reservoir

The fluid reservoir will hold nearly 1 gal (4 l) of washer fluid when the message “Low Washer Fluid” appears in the EVIC.

WARNING!

Commercially available windshield washer solvents are flammable. They could ignite and burn you. Care must be exercised when filling or working around the washer solution.

HEADLIGHT WASHERS — IF EQUIPPED

The multifunction lever operates the headlight washers when the ignition switch is in the ON position and the headlights are ON. The multifunction lever is located on the left side of the steering column.

To use the headlight washers, push the multifunction lever inward (toward the steering column) to the second detent and release it. The headlight washers will spray a timed high-pressure spray of washer fluid onto each

headlight lens. In addition, the windshield washers will spray the windshield and the windshield wipers will cycle.

NOTE: The headlight washers will operate on the first spray of the windshield washer and then every fourth spray after that.

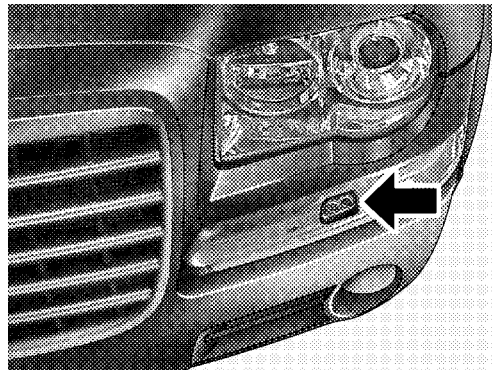

818c9c1b

Headlight Washer

Adding Washer Fluid

The headlight washer and windshield washer share the same fluid reservoir. The reservoir is located in the front of the engine compartment. Be sure to check the fluid level in the reservoir at regular intervals. Fill the reservoir with windshield washer solvent (not radiator antifreeze) and operate the system for a few seconds to flush out the residual water.

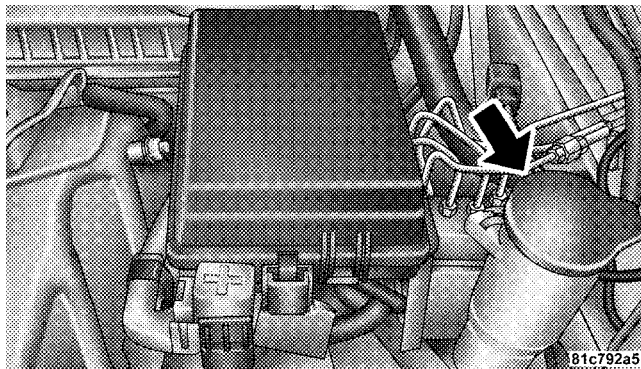

Washer Fluid Reservoir

WARNING!

Commercially available windshield washer solvents are flammable. They could ignite and burn you. Care must be exercised when filling or working around the washer solution.

POWER TILT/TELESCOPING STEERING COLUMN

This feature allows you to tilt the steering column upward or downward. It also allows you to lengthen or shorten the steering column. The power tilt/telescoping steering column lever is located below the multifunction lever on the steering column.

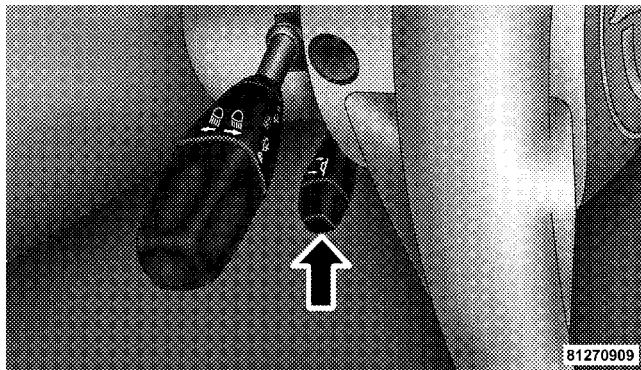
**Power Tilt/Telescoping Steering**

To tilt the steering column, move the lever up or down as desired. To lengthen or shorten the steering column, pull the lever toward you or push the lever away from you as desired.

NOTE: For vehicles equipped with Driver Memory Seat, you can use your Remote Keyless Entry (RKE) transmitter or the MEMORY switch on the driver's door trim panel to return the tilt/telescopic steering column to pre-programmed positions. Refer to "Driver Memory Seat" in this section.

WARNING!

Moving the steering column while the vehicle is moving is dangerous. Without a stable steering column, you could lose control of the vehicle and have an accident. Adjust the column only while the vehicle is stopped.

ADJUSTABLE PEDALS

The adjustable pedals system is designed to allow a greater range of driver comfort for steering wheel tilt and seat position. This feature allows both the brake and accelerator pedal to move toward or away from the driver to provide improved position with the steering wheel. The switch is located on the front side of the driver's seat cushion side shield.

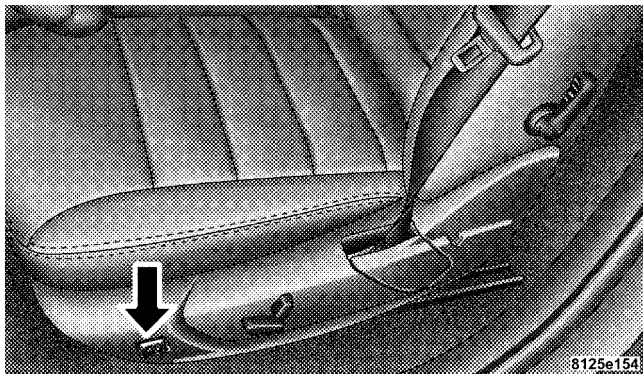

ADJUSTABLE PEDALS Switch

Press the switch forward to move the pedals forward (toward the front of the vehicle).

Press the switch rearward to move the pedals rearward (toward the driver).

- The pedals can be adjusted with the ignition OFF.

- The pedals can be adjusted while driving.
- The pedals **cannot** be adjusted when the vehicle is in REVERSE or when the Speed Control is ON. One of the following messages will display in the Electronic Vehicle Information Center (EVIC) if a pedal adjustment is attempted when the system is locked out: “Adjustable Pedal Disabled — Cruise Control Engaged” or “Adjustable Pedal Disabled — Vehicle In Reverse.”

NOTE: For vehicles equipped with Driver Memory Seat, you can use your Remote Keyless Entry (RKE) Transmitter or the MEMORY switch on the driver's door trim panel to return the adjustable pedals to pre-programmed positions. Refer to “Driver Memory Seat” in this section.

CAUTION!

Do not place any article under the adjustable pedals or impede its ability to move as it may cause damage to the pedal controls. Pedal travel may become limited if movement is stopped by an obstruction in the adjustable pedal's path.

ELECTRONIC SPEED CONTROL

When engaged, this device takes over the accelerator operation at speeds greater than 25 mph (40 km/h).

Electronic Speed Control Operation

The speed control lever located on the right side of the steering wheel operates the system.

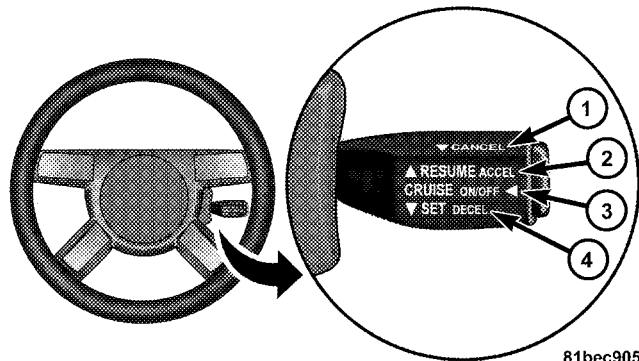

81bec905

- 1 — CANCEL
- 2 — RESUME ACCEL
- 3 — ON/OFF
- 4 — SET DECEL

To Activate



Push and release the ON/OFF button located on the end of the speed control lever. The indicator light in the instrument cluster will illuminate to show that the speed control system is ON. To turn the system OFF, push and release the ON/OFF button again. The system and the indicator light will turn off.

WARNING!

Leaving the electronic speed control system on when not in use is dangerous. You could accidentally set the system or cause it to go faster than you want. You could lose control and have an accident. Always leave the system OFF when you aren't using it.

To Set At A Desired Speed

When the vehicle reaches the speed desired, push the lever downward to SET DECEL and release. Remove your foot from the accelerator pedal and the vehicle will operate at the selected speed.

NOTE:

- Speed control will only function in 3rd, 4th, or 5th gear when in the Autostick® mode (if equipped).
- The speed control may not engage if a different size tire is installed on one wheel, such as the compact spare tire.

To Deactivate

The system will disable electronic speed control without erasing the memory if you:

- Softly tap the brake pedal,
- Depress the brake pedal, or
- Pull the speed control lever toward you to CANCEL.

Pushing and releasing the ON/OFF button or turning off the ignition erases the set speed from memory.

To Resume Speed

If you deactivated the speed control without erasing the set speed from memory and your vehicle speed is above 20 mph (32 km/h) you can resume the previous set speed. To do so, push the lever upward to RESUME ACCEL and release. Then remove your foot from the accelerator pedal.

To Vary the Speed Setting

When the speed control is set, you can increase speed by pushing upward and holding the lever in RESUME ACCEL. When the lever is released, a new set speed will be established.

Tapping the lever to RESUME ACCEL once will result in a 1 mph (1.6 km/h) speed increase. Each time the lever is tapped speed increases, so tapping the lever three times will increase speed by 3 mph (4.8 km/h), etc.

To decrease speed while speed control is set, push downward and hold the lever in SET DECEL. Release the lever when the desired speed is reached, and a new set speed will be established.

Tapping the lever to SET DECEL once will result in a 1 mph (1.6 km/h) speed decrease. Each time the lever is tapped, speed decreases.

To Accelerate For Passing

Depress the accelerator as you would normally. When the pedal is released, the vehicle will return to the set speed.

Using Speed Control on Hills

NOTE: The speed control system maintains speed up and down hills. A slight speed change on moderate hills is normal.

The automatic transmission will downshift while climbing uphill or descending downhill. This downshift is necessary to maintain vehicle set speed.

On steep hills, a greater speed loss or gain may occur, so it may be preferable to drive without speed control.

WARNING!

Speed control can be dangerous where the system can't maintain a constant speed. Your vehicle could go too fast for the conditions and you could lose control. An accident could be the result. Don't use speed control in heavy traffic or on roads that are winding, icy, snow-covered, or slippery.

ADAPTIVE CRUISE CONTROL (ACC) — IF EQUIPPED

Adaptive Cruise Control (ACC) increases the driving convenience provided by cruise control while traveling on highways and major roadways. However, it is not a safety system and not designed to prevent collisions.

ACC will allow you to keep cruise control engaged in light to moderate traffic conditions without the constant need to reset your cruise control. ACC utilizes an infrared sensor designed to detect a vehicle directly ahead in your path.

NOTE:

- If the sensor does not detect a vehicle directly ahead of you, ACC will function in the same way as a standard cruise control system. For additional information, refer to “Electronic Speed Control” in this section.
- If the ACC sensor detects a vehicle ahead, ACC will apply limited braking or acceleration automatically so that your vehicle maintains a preset following distance.

WARNING!

- Adaptive Cruise Control (ACC) is a convenience system. It is not a substitute for active driving involvement. It is always the driver’s responsibility to be attentive of road, traffic, and weather conditions, vehicle speed, distance to the vehicle ahead; and, most importantly, brake operation to ensure safe operation of the vehicle under all road conditions. Your complete attention is always required while driving to maintain safe control of your vehicle. Failure to follow these warnings can result in an accident or serious personal injury.
- The ACC system:
 - Does not react to pedestrians, oncoming vehicles, and stationary objects (i.e., a stopped vehicle in a traffic jam or a disabled vehicle).
 - Does not predict the lane curvature or the movement of preceding vehicles and will not compensate for such changes.
 - Cannot take street, traffic, and weather conditions into account, and may be limited upon adverse sight distance conditions.
 - Does not always fully recognize complex driving conditions, which can result in wrong or missing distance warnings.
 - May not detect a vehicle ahead when strong light (for example, sunrise or sunset) is directly shining on the front of the vehicle.
 - Can only apply a maximum of 25% of the vehicle’s braking capability, and will not bring the vehicle to a complete stop.

WARNING!

You should switch off the ACC system:

- When driving in fog; heavy rain; heavy snow; sleet; heavy traffic; and complex driving situations (i.e., in highway construction zones).
- When entering a turn lane or highway off ramp; when driving on roads that are winding, icy, snow-covered, slippery, or have steep uphill or downhill slopes; and when towing a trailer.
- When circumstances do not allow safe driving at a constant speed.

Failure to follow these warnings can result in an accident or serious personal injury.

Adaptive Cruise Control (ACC) Operation

The speed control lever (located on the right side of the steering wheel) operates the ACC system.

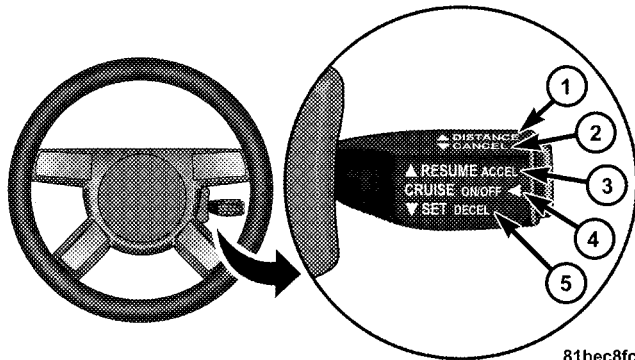

- 1 — DISTANCE SETTING
- 2 — CANCEL
- 3 — RESUME/ACCEL
- 4 — ON/OFF
- 5 — SET/DECEL

Activating Adaptive Cruise Control (ACC)

You can only activate ACC if the vehicle speed is above 25 mph (40 km/h).

When the system is turned on and in the READY state, the Electronic Vehicle Information Center (EVIC) displays “ACC READY.”

When the system is OFF, the EVIC displays “ACC OFF.”

NOTE: You cannot enable ACC under the following conditions:

- When you apply the brakes.
- When the parking brake is set.
- When the automatic transmission is in PARK, REVERSE, or NEUTRAL.
- When the Electronic Stability Program (ESP) is switched off.

- When pushing the RESUME ACCEL switch without a previously set speed in memory.

To Activate

Push and release the ON/OFF button located on the end of the speed control lever. The ACC menu in the EVIC displays “ACC READY.”

EXAMPLE ONLY

ACC READY



1148 MI

To turn the system OFF, push and release the ON/OFF button again. At this time, the system will turn off and the EVIC will display “ACC OFF.”

WARNING!

Leaving the Adaptive Cruise Control (ACC) system on when not in use is dangerous. You could accidentally set the system or cause it to go faster than you want. You could lose control and have an accident. Always leave the system OFF when you aren't using it.

To Set a Desired Speed

When the vehicle reaches the speed desired, push the lever down to SET DECEL and release. The EVIC will display the set speed.

EXAMPLE ONLY

ACC SET: 60 MPH



1148 MI

818e9511

Remove your foot from the accelerator pedal. If you do not, the vehicle may continue to accelerate beyond the set speed. If this occurs:

- The message “DRIVER OVERRIDE” will display in the EVIC.

- The system will not be controlling the distance between your vehicle and the vehicle ahead. The vehicle speed will only be determined by the position of the accelerator pedal.

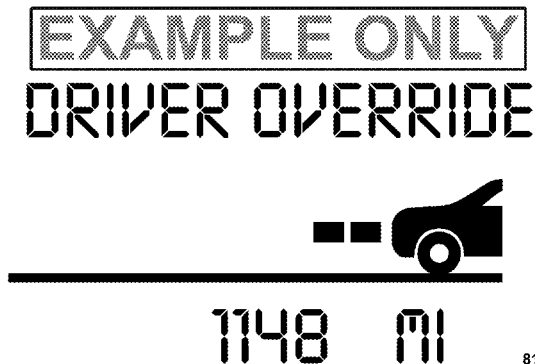

818e9515

To Cancel

The system will disable ACC without erasing the memory if:

- You softly tap the brake pedal.
- You depress the brake pedal.
- You pull the speed control lever toward you to CANCEL.
- The Electronic Stability Program / Traction Control System (ESP/TCS) activates.

EXAMPLE ONLY

ACC CANCELLED



1148 MI

819725e0

To Turn Off

The system will turn off and erase the set speed in memory if:

- You push and release the ON/OFF button.
- You turn off the ignition.
- You switch off ESP.

To Resume Speed

Push the lever up to RESUME ACCEL and release. Then remove your foot from the accelerator pedal. The EVIC will display the last set speed.

WARNING!

The Resume function should only be used if traffic and road conditions permit. Resuming a set speed that is too high or too low for prevailing traffic and road conditions could cause the vehicle to accelerate or decelerate too sharply for safe operation. This could cause an accident and/or serious injury.

To Vary the Speed Setting

While ACC is set, you can increase the set speed by lifting and holding the lever in RESUME ACCEL. If the lever is continually held, the set speed will continue to increase in 5 mph (Canada 10 km/h) increments until the lever is released. The increase in set speed is reflected in the EVIC display.

Tapping the lever up once will result in a 1 mph (Canada 1 km/h) increase in set speed. Each subsequent tap of the lever results in an increase of 1 mph (Canada 1 km/h).

While ACC is set, the set speed can be decreased by pushing and holding the lever down in SET DECEL. If the lever is continually held, the set speed will continue to decrease in 5 mph (Canada 10 km/h) increments until the lever is released. The decrease in set speed is reflected in the EVIC display.

Tapping the lever down once will result in a 1 mph (Canada 1 km/h) decrease in set speed. Each subsequent tap of the lever results in a decrease of 1 mph (Canada 1 km/h).

NOTE:

- When you use the lever to decelerate, if the engine's braking power does not slow the vehicle sufficiently to reach the set speed, the brake system will automatically slow the vehicle.
- The ACC system maintains set speed when driving up hill and down hill. However, a slight speed change on moderate hills is normal. In addition, downshifting may occur while climbing uphill or descending downhill. This is normal operation and necessary to maintain set speed.

Setting the Following Distance in ACC

The specified following distance for ACC can be set by varying the distance setting between long, medium, and short. Using this distance setting and the vehicle speed, ACC calculates and sets the distance to the vehicle ahead. This distance setting displays in the EVIC.

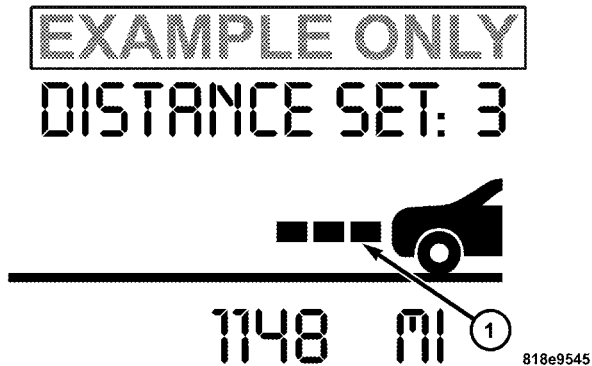

1 — Sensor Bars. Default Distance Setting is Three Bars = Long.

To can change the distance setting, push the lever away from you to DISTANCE and release. Each time this is done, the distance setting toggles between long, medium, and short.

If there is no vehicle ahead, the vehicle will maintain the set speed. If a slower moving vehicle is detected in the same lane, the EVIC displays the “Sensed Vehicle Indicator” icon, and the system adjusts vehicle speed automatically to maintain the distance setting, regardless of the set speed.

The vehicle will then maintain the set distance until:

- The vehicle ahead accelerates to a speed above the set speed.
- The vehicle ahead moves out of your lane or view of the sensor.
- The vehicle ahead slows to a speed below 15 mph (24 km/h) and the system automatically disables itself.

- The distance setting is changed.
- The system disengages. (Refer to the information on ACC Activation).

The maximum braking applied by ACC is limited; however, the driver can always apply the brakes manually, if necessary.

NOTE: The brake lights will illuminate whenever the ACC system applies the brakes.

A Proximity Warning will alert the driver if ACC predicts that its maximum braking level is not sufficient to maintain the set distance. If this occurs, a visual alert “ATTENTION” will flash in the EVIC and a chime will sound while ACC continues to apply its maximum braking capacity. When this occurs, you should immediately apply the brakes as needed to maintain a safe distance from the vehicle ahead.

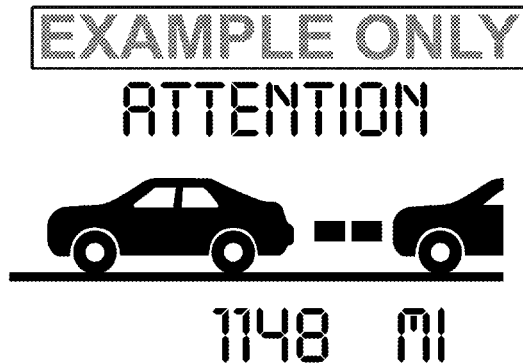

818e9519

Adaptive Cruise Control (ACC) Menu

The EVIC displays the current ACC system settings. The EVIC is located in the upper part of the instrument cluster between the speedometer and the tachometer. The information it displays depends on ACC system status.



Press the MENU button (located on the steering wheel) repeatedly until one of the following displays in the EVIC:

**Menu
Button**

ACC OFF

- When ACC is deactivated, the display will read "ACC OFF."

EXAMPLE ONLY

ACC OFF



1148 MI

818e94e1

ACC READY

- When ACC is activated, the display will read “ACC READY.”

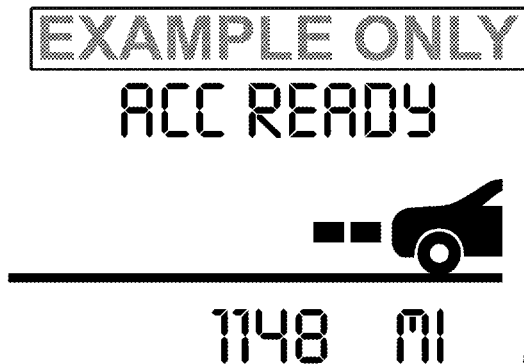
*ACC SET*

- When ACC is set, the set speed will display.

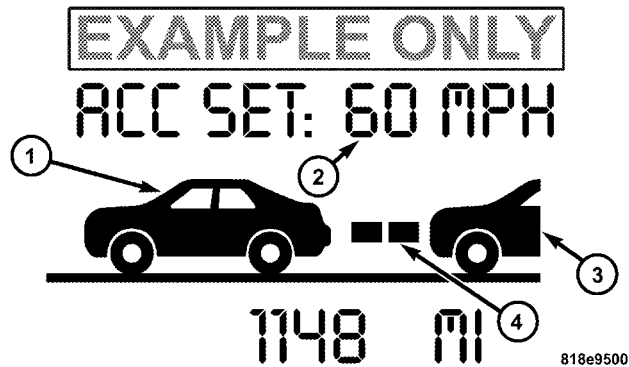

- 1 — Sensed Vehicle Indicator
- 2 — Set Speed
- 3 — Your Vehicle
- 4 — Following Distance Setting: Three Bars = Long; Two Bars = Medium; One Bar = Short.

The set speed will continue to display in place of the odometer reading when changing the EVIC display while ACC is set.

EXAMPLE ONLY

W 10°F
103.5 FM
SET: 55 MPH

8197267d

The ACC SET screen will display once again if any ACC activity occurs, which may include any of the following:

- Set speed change
- Distance setting change
- System cancel

- Acquisition/loss of Target
- Driver override
- System off
- Proximity warning
- ACC warning

The EVIC will return to the last display selected after five seconds of no ACC activity.

Display Warnings and Maintenance

ACC Blinded Warning

The ACC Blinded Warning will display when conditions temporarily limit system performance. This most often occurs at times of poor visibility, such as in snow, fog, heavy rain, or when driving into direct sunlight (sunrise or sunset). The ACC system may also become temporarily blinded due to obstructions, such as dirt or ice. In these cases, the EVIC will display “ACC Blinded.”

EXAMPLE ONLY

ACC Blinded



1148 MI

81becab7

If weather conditions are not a factor, the driver should examine the sensor. It may require cleaning or removal of an obstruction. The sensor is located behind the grille, slightly offset from the center of the grille.

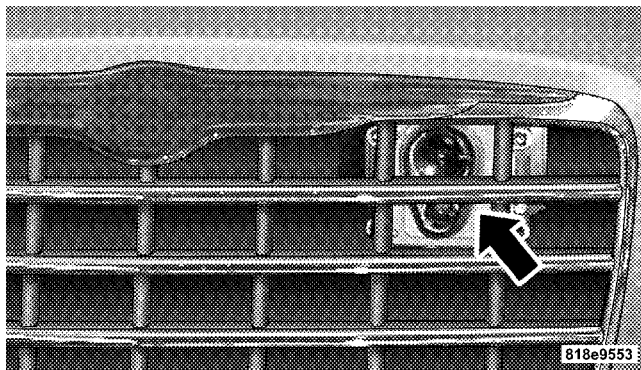

ACC Sensor Location

To keep the ACC System operating properly, it is important to note the following maintenance items:

- Always keep the sensor clean. Carefully wipe the sensor lens with a soft cloth. Be cautious not to damage the sensor lens.

- Do not remove any screws from the sensor or the sensor mount. Doing so could cause an ACC system malfunction or failure and require a sensor re-alignment.
- If the sensor is damaged due to an accident, see your authorized dealer for service.
- Do not attach or install any accessories near the sensor, including transparent material or aftermarket grilles. Doing so could cause an ACC system failure or malfunction.

When the condition that deactivated the system is no longer present, the system will return to the "ACC Off" state and will resume function by simply reactivating it.

NOTE: Installing a vehicle front-end protector or an aftermarket grille or modifying the grille is not recommended. Doing so may block the sensor and inhibit ACC operation.

ACC Unavailable Warning

If the system turns off, and the EVIC displays "ACC UNAVAILABLE," there may be a temporary malfunction that limits ACC functionality. In this case, ACC will be temporarily unavailable. If this occurs, try activating ACC again later, following a key cycle. If the problem persists, see your authorized dealer.

EXAMPLE ONLY
ACC UNAVAILABLE



1148 MI

Service ACC Warning

If the system turns off, and the EVIC displays “SERVICE ACC,” it indicates there is an internal system fault that requires service from an authorized dealer.

Precautions While Driving with ACC

In certain driving situations, ACC may have detection issues. In these cases, ACC may brake late or unexpectedly. The driver needs to stay alert and may need to intervene.

Adding a Trailer Hitch

The weight of a trailer hitch may affect the performance of ACC. If there is a noticeable change in performance following the installation of a hitch, such as reduced detection range, please see your authorized dealer for service.

Offset Driving

ACC may not detect a vehicle in the same lane that is offset from your direct line of travel. There will not be sufficient distance to the vehicle ahead. The offset vehicle may move in and out of the line of travel, which can cause your vehicle to brake or accelerate unexpectedly.

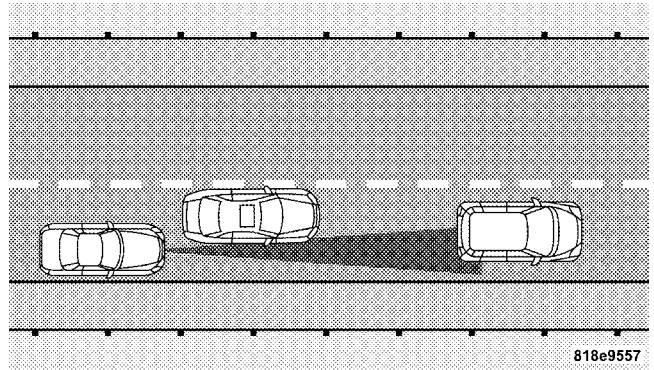

818e9557

Turns and Bends

In turns or bends, ACC may detect a vehicle ahead too late or too early. This may cause your vehicle to brake late or unexpectedly. Give extra attention in curves and be ready to apply the brakes if necessary. Be sure to select an appropriate speed while driving in curves.

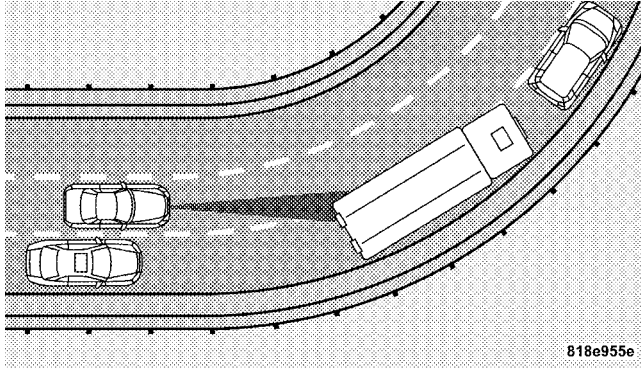

ACC may occasionally provide braking and/or a driver alert that you consider unnecessary. This may be the system's response to signs, guardrails, and other stationary objects in a curve. This may also occur at the base of dramatic hills. This is normal operation and your vehicle does not require service.

Using ACC on Hills

When driving on hills, ACC may not detect a vehicle in your lane. Depending on the speed, vehicle load, traffic conditions, and the steepness of the hills, ACC performance may be limited.

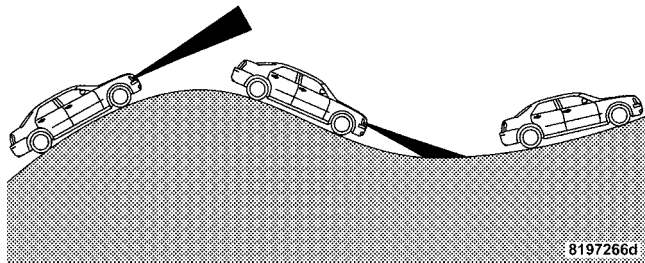

Lane Changing

ACC will not detect a vehicle until it is completely in the lane in which you are traveling. In the illustration shown, ACC has not yet detected the vehicle changing lanes and it will not until it may be too late to take action. ACC will not detect a vehicle until it is completely in the lane.

There will not be sufficient distance to the lane-changing vehicle. Always be attentive and ready to apply the brakes if necessary.

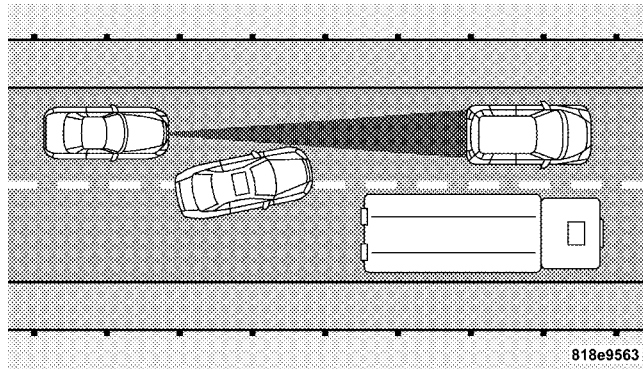

Narrow Vehicles

Some narrow vehicles traveling near the outer edges of the lane or edging into the lane are not detected until they have moved fully into the lane. There will not be sufficient distance to the vehicle ahead.

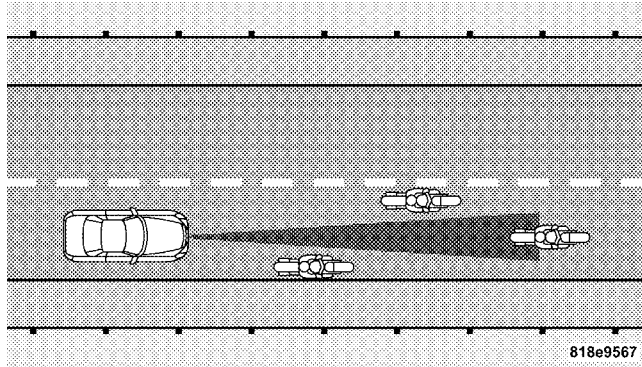

Stationary Objects and Vehicles

ACC does not react to stationary objects and stationary vehicles. For example, ACC will not react in situations where the vehicle you are following exits your lane and the vehicle ahead is stopped in your lane. Always be attentive and ready to apply the brakes if necessary.

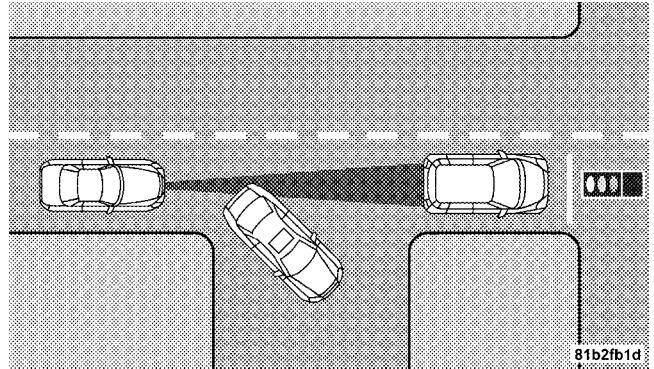

General Information

CLASS 1 LASER PRODUCT

Classification Specifications:
21 C.F.R part 1040.10 & 1040.11
DIN EN 60825-1:2003
IEC 60825-1:2001

REAR PARK ASSIST SYSTEM

The Rear Park Assist System is a driver aid that senses for obstacles behind the vehicle. Refer to the Warnings, Cautions, and Notes in this section for system limitations and usage recommendations.

The Rear Park Assist System is active when the driver shifts the transmission into the REVERSE position, and the parking brake is not applied, and the vehicle speed is less than 10 mph (16 km/h).

The system can be turned on or off through the Electronic Vehicle Information Center (EVIC) when the vehicle is in PARK. Refer to “Personal Settings (Customer Programmable Features)” under “Electronic Vehicle Information Center (EVIC)” in Section 4.

The system uses four sensors located in the rear bumper to scan for obstacles up to 59 in (150 cm) away from the rear bumper fascia. The warning display located above the rear window provides both visible and audible warnings to indicate the range of the object.

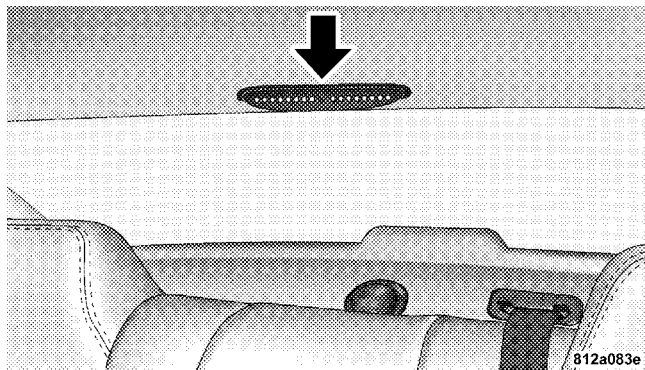

Rear Park Assist Indicator

The warning display contains two sets of yellow and red LEDs, one set to warn of obstacles behind the left rear of the vehicle and the other set to warn of obstacles behind the right rear of the vehicle. The driver can view the LEDs either through the rear view mirror or by looking at the display above the rear window.

3

The system dimly illuminates the two outer most yellow LEDs when it is ON and detecting no obstacles. The following chart shows the warning display operation when the system is detecting an obstacle:

WARNING DISPLAY DISTANCES

DISPLAY LED	OBSTACLE DISTANCE FROM:		LED COLOR	AUDIBLE SIGNAL
	REAR CORNERS	REAR CENTER		
1st LED		59 in (150 cm)	Yellow	None
2nd LED		47 in (120 cm)	Yellow	None
3rd LED		39 in (100 cm)	Yellow	None
4th LED	31.5 in (80 cm)	31.5 in (80 cm)	Yellow	None
5th LED	25.5 in (65 cm)	25.5 in (65 cm)	Yellow	None
6th LED	20 in (50 cm)	20 in (50 cm)	Yellow	None
7th LED	16 in (40 cm)	16 in (40 cm)	Red	at 12 in (30 cm) Intermittent
8th LED	6 in (15 cm)	12 in (30 cm)	Red	at 8 in (20 cm) Continuous

NOTE: The Rear Park Assist system will MUTE the radio, if on, when the system is sounding an audio tone.

WARNING!

- Drivers must be careful when backing up even when using the Rear Park Assist System. Always check carefully behind your vehicle, look behind you, and be sure to check for pedestrians, animals, other vehicles, obstructions, and blind spots before backing up. You are responsible for safety and must continue to pay attention to your surroundings. Failure to do so can result in serious injury or death.
- Before using the Rear Park Assist System, it is strongly recommended that the ball mount and hitch ball assembly is disconnected from the vehicle when the vehicle is not used for towing. Failure to do so can result in injury or damage to vehicles or obstacles because the hitch ball will be much closer to the obstacle than the rear fascia when the warning display turns the red LEDs ON. Also, the sensors could detect the ball mount and hitch ball assembly, depending on its size and shape, giving a false indication that an obstacle is behind the vehicle.

CAUTION!

- The Rear Park Assist System is only a parking aid and it is unable to recognize every obstacle, including small obstacles. Parking curbs might be temporarily detected or not detected at all. Obstacles located above or below the sensors will not be detected when they are in close proximity.
- The vehicle must be driven slowly when using the Rear Park Assist System to be able to stop in time when the obstacle is detected. It is recommended that the driver looks over his/her shoulder when using the Rear Park Assist System.

NOTE:

- Ensure that the rear bumper is free of dirt and debris to keep the system operating properly.
- Jackhammers, large trucks, and other vibrations could affect the performance of the system.

If “Service Park Assist System” appears in the EVIC after making sure the rear bumper is clean please see your authorized dealer.

OVERHEAD CONSOLE

The overhead console contains courtesy/reading lights, an optional universal garage door opener (HomeLink®), storage for sunglasses, and an optional power SUNROOF switch.

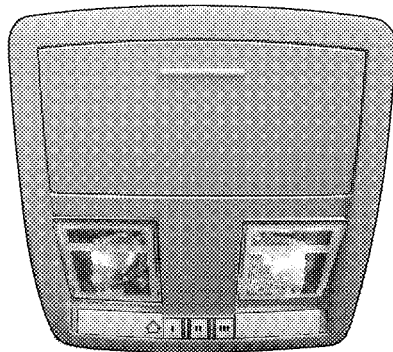

8125e191

**Overhead Console
Courtesy/Reading Lights**

At the forward end of the console are two courtesy/reading lights.

Press the lens to turn on the light. Press it a second time to turn off the light.

These lights also turn on when a door is opened, or when the UNLOCK button on the Remote Keyless Entry (RKE) transmitter is pressed, or when the dimmer control is turned fully upward, past the second detent.

Sunglasses Storage

At the rear of the console, a compartment is provided for the storage of a pair of sunglasses.

The storage compartment access is a "push/push" design. Push on the raised bar on the compartment door to open. Push on the raised bar to close.

GARAGE DOOR OPENER — IF EQUIPPED

HomeLink® replaces up to three remote controls (hand-held transmitters) that operate devices such as garage door openers, motorized gates, lighting, or home security systems. The HomeLink® unit operates off your vehicle's battery.

The HomeLink® buttons are located in the overhead console, and contain one, two, or three dots/lines designating the different HomeLink® channels.

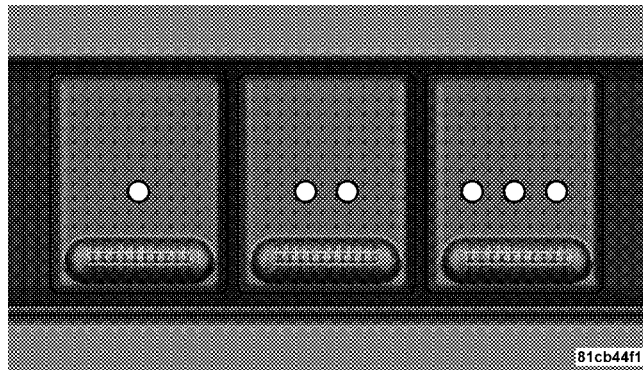

HomeLink® Buttons

NOTE: HomeLink® is disabled when the Vehicle Security Alarm is active.

WARNING!

Your motorized door or gate will open and close while you are training the Universal Transceiver. Do not train the transceiver if people or pets are in the path of the door or gate. Only use this transceiver with a garage door opener that has a "stop and reverse" feature as required by federal safety standards. This includes most garage door opener models manufactured after 1982. Do not use a garage door opener without these safety features. Call toll-free 1-800-355-3515 or, on the Internet at www.HomeLink.com for safety information or assistance.

WARNING!

Vehicle exhaust contains carbon monoxide, a dangerous gas. Do not run your vehicle in the garage while training the transceiver. Exhaust gas can cause serious injury or death.

Programming HomeLink®**Before You Begin**

If you have not trained any of the HomeLink® buttons, erase all channels before you begin training.

To do this, press and hold the two outside buttons for 20 seconds. The EVIC will display "CLEARING CHANNELS." Release the buttons when the EVIC message states "CHANNELS CLEARED."

It is recommended that a new battery be placed in the hand-held transmitter of the device being programmed to HomeLink® for more efficient training and accurate transmission of the radio-frequency signal.

Your vehicle should be parked outside of the garage while training.

1. Turn the ignition switch to the ON/RUN position.
2. Place the hand-held transmitter 1 to 3 in (3 to 8 cm) from the HomeLink® buttons while keeping the EVIC display in view.

For optimal training, point the battery end of the hand-held transmitter away from the HomeLink®.

3. Simultaneously, press and hold both the chosen HomeLink® button and the hand-held transmitter button until the EVIC display changes from “CHANNEL # TRAINING” to “CHANNEL # TRAINED.”

Then release both the HomeLink® and hand-held transmitter buttons.

If the EVIC display states “DID NOT TRAIN” repeat Step 3. If the signal is too weak, replace the battery in the original hand-held transmitter.

It may take up to 30 seconds, or longer, in rare cases. The garage door may open and close while you train.

NOTE: Some gate operators and garage door openers may require you to replace Step 3 with procedures noted in the “Gate Operator/Canadian Programming” section.

4. Press and hold the just-trained HomeLink® button. If the channel has been trained, the EVIC display will now state “CHANNEL # TRANSMIT.”

If the EVIC display still states “CHANNEL # TRAINING” repeat Step 3.

NOTE: After training a HomeLink® channel, if the garage door does not operate with HomeLink® and the garage door opener was manufactured after 1995, the garage door opener may have rolling code. If so, proceed to the heading “Programming A Rolling Code System.”

5. PROGRAMMING A ROLLING CODE SYSTEM

At the garage door opener motor (in the garage), locate the “learn” or “training” button.

This can usually be found where the hanging antenna wire is attached to the garage door opener motor (it is NOT the button normally used to open and close the door).

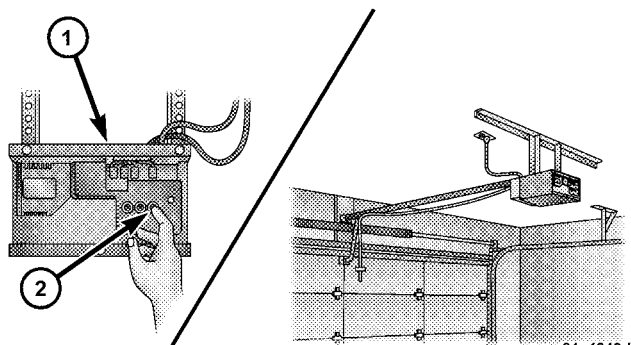

- 1 — Garage Door Opener
2 — Training Button

6. Firmly press and release the “learn” or “training” button. The name and color of the button may vary by manufacturer.

NOTE: There are 30 seconds in which to initiate the next step after the “Learn” button has been pressed.

7. Return to the vehicle and press the programmed HomeLink® button twice (holding the button for two seconds each time). If the device is plugged in and activates, programming is complete.

If the device does not activate, press the button a third time (for two seconds) to complete the training.

If you have any problems, or require assistance, please call toll-free 1-800-355-3515 or, on the Internet at www.HomeLink.com for information or assistance.

To program the remaining two HomeLink® buttons, repeat each step for each remaining button. DO NOT erase the channels.

Gate Operator/Canadian Programming

Canadian radio-frequency laws require transmitter signals to “time-out” (or quit) after several seconds of transmission – which may not be long enough for HomeLink® to pick up the signal during programming.

Similar to this Canadian law, some U.S. gate operators are designed to “time-out” in the same manner.

It may be helpful to unplug the device during the cycling process to prevent possible overheating of the garage door or gate motor.

If you are having difficulties programming a garage door opener or a gate operator, replace “Programming HomeLink” Step 3 with the following:

3. Continue to press and hold the HomeLink® button while you press and release - every two seconds (“cycle”) your hand-held transmitter until HomeLink® has successfully accepted the frequency signal. The EVIC display will change from “CHANNEL # TRAINING” to “CHANNEL # TRAINED.”

If you unplugged the device for training, plug it back in at this time.

Then proceed with Step 4 under “Programming HomeLink®” earlier in this section.

Using HomeLink®

To operate, simply press and release the programmed HomeLink® button. Activation will now occur for the trained device (i.e., garage door opener, gate operator, security system, entry door lock, home/office lighting, etc.) The hand-held transmitter of the device may also be used at any time.

Reprogramming A Single HomeLink® Button

To reprogram a channel that has been previously trained, follow these steps:

1. Turn the ignition switch to the ON/RUN position.
2. Press and hold the desired HomeLink® button for 20 seconds until the EVIC display states “CHANNEL # TRAINING.” **Do not release the button.**

3. **Without releasing the button**, proceed with Programming HomeLink® Step 2 and follow all remaining steps.

Security

It is advised to erase all channels before you sell or turn in your vehicle.

To do this, press and hold the two outside buttons for 20 seconds until the EVIC message states “CHANNELS CLEARED.” Note that all channels will be erased. Individual channels cannot be erased.

The HomeLink® Universal Transceiver is disabled when the Vehicle Security Alarm is active.

Troubleshooting Tips

If you are having trouble programming HomeLink®, here are some of the most common solutions:

- Replace the battery in the original transmitter.
- Press the learn button on the garage door opener to complete the training for rolling code.
- Did you unplug the device for training, and remember to plug it back in?

If you are having any problems or require assistance, please call toll-free 1-800-355-3515 or, on the Internet at www.HomeLink.com for information or assistance.

General Information

This device complies with FCC rules Part 15 and Industry Canada RSS-210. Operation is subject to the following two conditions:

1. This device may not cause harmful interference

2. This device must accept any interference that may be received including interference that may cause undesired operation

NOTE: The transmitter has been tested and it complies with FCC and IC rules. Changes or modifications not expressly approved by the party responsible for compliance could void the user's authority to operate the device.

The term "IC:" before the certification/registration number only signifies that Industry Canada technical specifications were met.

POWER SUNROOF — IF EQUIPPED

The power SUNROOF switch is located between the sun visors on the overhead console.

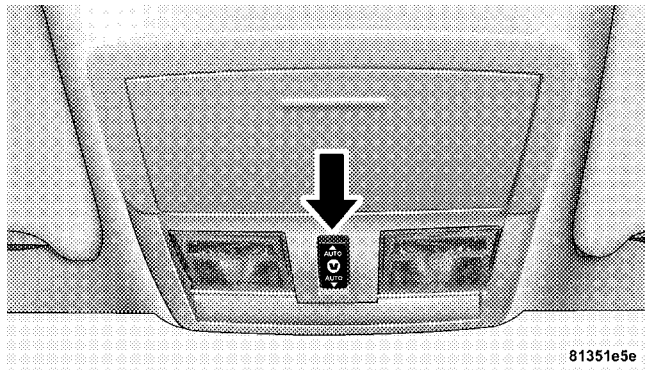

Power Sunroof Controls

81351e5e

WARNING!

- Never leave children in a vehicle with the key in the ignition switch. Occupants, particularly unattended children, can become entrapped by the power sunroof while operating the power SUNROOF switch. Such entrapment may result in serious injury or death.
- In an accident, there is a greater risk of being thrown from a vehicle with an open sunroof. You could also be seriously injured or killed. Always fasten your seat belt properly and make sure all passengers are also properly secured.
- Do not allow small children to operate the sunroof. Never allow fingers or other body parts, or any object, to project through the sunroof opening. Injury may result.

Opening Sunroof - Express

Press the switch rearward and release, and the sunroof will open automatically from any position. The sunroof will open fully and then stop automatically. This is called Express Open. During Express Open operation, any movement of the SUNROOF switch will stop the sunroof.

Closing Sunroof - Express

Press the switch forward and release, and the sunroof will close automatically from any position. The sunroof will close fully and stop automatically. This is called Express Close. During Express Close operation, any movement of the SUNROOF switch will stop the sunroof.

Pinch Protect Feature

This feature will detect an obstruction in the opening of the sunroof during Express Close operation. If an obstruction in the path of the sunroof is detected, the

sunroof will automatically retract. Remove the obstruction if this occurs. Next, press the switch forward and release to Express Close.

Pinch Protect Override

If a known obstruction (ice, debris, etc.) prevents closing, press the switch forward and hold for two seconds after the reversal occurs. This allows the sunroof to move towards the closed position.

NOTE: Pinch protection is disabled while the switch is pressed.

Venting Sunroof - Express

Press and release the "V" button in the center of the switch, and the sunroof will open to the vent position. This is called Express Vent, which operates regardless of sunroof position. During Express Vent operation, any movement of the SUNROOF switch will stop the sunroof.

Sunshade Operation

The sunshade can be opened manually. However, the sunshade will open automatically as the sunroof opens.

NOTE: The sunshade cannot be closed if the sunroof is open.

Wind Buffeting

Wind buffeting can be described as the perception of pressure on the ears or a helicopter-type sound in the ears. Your vehicle may exhibit wind buffeting with the windows down, or the sunroof (if equipped) in certain open or partially open positions. This is a normal occurrence and can be minimized. If the buffeting occurs with the rear windows open, then open the front and rear windows together to minimize the buffeting. If the buffeting occurs with the sunroof open, then adjust the sunroof opening to minimize the buffeting or open any window.

Sunroof Maintenance

Use only a non-abrasive cleaner and a soft cloth to clean the glass panel.

Ignition Off Operation

The power SUNROOF switch will remain active for up to 60 minutes after the ignition switch is turned OFF. Opening either front door will cancel this feature. The time for this feature is programmable. Refer to “Delay Power Off to Accessories Until Exit,” under “Personal Settings (Customer Programmable Features),” under “Electronic Vehicle Information Center (EVIC)” in Section 4.

Sunroof Fully Closed

Press the switch forward and release to ensure that the sunroof is fully closed.

ELECTRICAL POWER OUTLETS

There are two 12-volt electrical outlets on this vehicle. Both of the outlets are protected by a fuse.

The 12-volt power outlet next to the ash receiver tray (if equipped with an optional Smoker's Package) has power available only when the ignition is ON. This outlet will also operate a conventional cigar lighter unit.

WARNING!

Do not place ashes inside the cubby bin located on the center console on vehicles not equipped with the ash receiver tray. A fire leading to bodily injury could result.

NOTE: If desired, the power outlet next to the ash receiver tray (if equipped) can be converted by your authorized dealer to provide power with the ignition switch in the LOCK position.

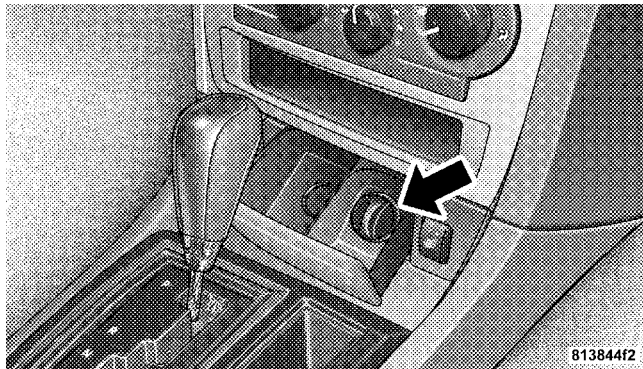

Front Power Outlet

The center console outlet is powered directly from the battery (power available at all times). Items plugged into this outlet may discharge the battery and/or prevent engine starting.

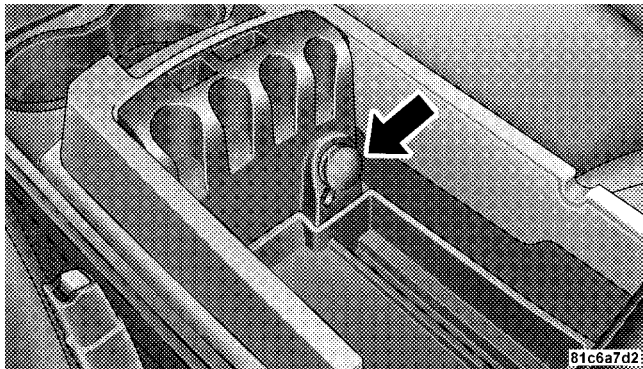

Center Console Power Outlet

Electrical Outlet Use With Engine Off

CAUTION!

- Many accessories that can be plugged in draw power from the vehicle's battery even when not in use (i.e., cellular phones, etc.). Eventually, if plugged in long enough, the vehicle's battery will discharge sufficiently to degrade battery life and/or prevent engine starting.
- Accessories that draw higher power (i.e., coolers, vacuum cleaners, lights, etc.) will degrade the battery even more quickly. Only use these intermittently and with greater caution.
- After the use of high power draw accessories or long periods of the vehicle not being started (with accessories still plugged in), the vehicle must be driven a sufficient length of time to allow the alternator to recharge the vehicle's battery.
- Power outlets are designed for accessory plugs only. Do not hang any type of accessory or accessory bracket from the plug. Improper use of the power outlet can cause damage.

CUPHOLDERS

Front Seat Cupholders

The cupholders are located in the forward edge of the center console.

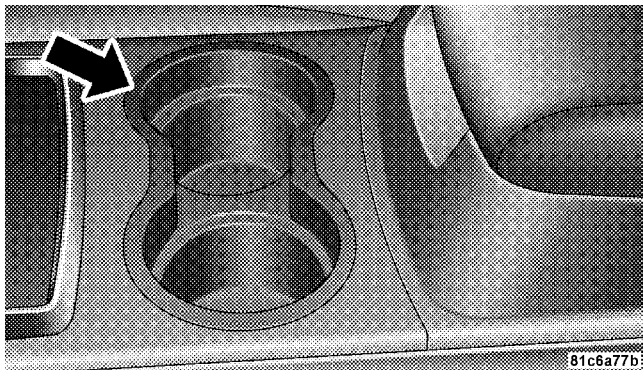

Front Seat Cupholders

Rear Seat Cupholders

The rear seat cupholders are located in the center armrest between the rear seats. The cupholders are positioned forward in the armrest and side-by-side to provide convenient access to beverage cans or bottles while maintaining a resting place for the rear occupants' elbows.

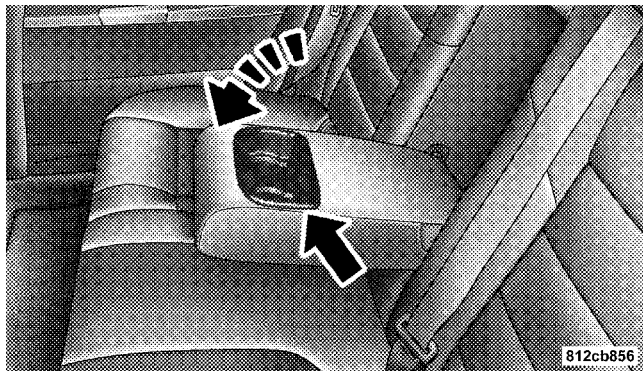

Rear Seat Cupholders

STORAGE

Console Features

The center console contains two shift bezel cubby bins with rubber mats for holding small items. For vehicles not equipped with navigation radio, the console also contains an extra storage bin located below the climate control, which holds up to four CD jewel cases.

Without Vehicle Entertainment System (VES)[®]

Two separate storage compartments are also located underneath the armrest.

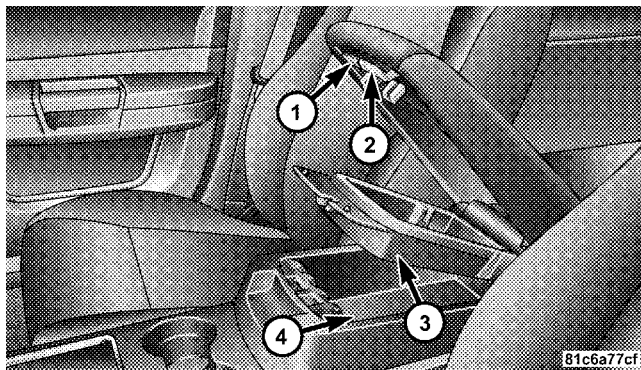

- 1 — Release button for bottom compartment
- 2 — Release button for top compartment
- 3 — Top Compartment
- 4 — Bottom Compartment. You can access this compartment directly, without first exposing the upper compartment, by operating the Release Button for the bottom compartment with the armrest down.

The top compartment holds small items, such as a pen and note pad, while the larger bottom compartment will hold CDs and alike. The bottom compartment also contains a 12-volt power outlet and a molded-in coin holder (designed to hold various size coins). A slot in the left and right side of the top compartment provides clearance for power cords to pass conveniently out of the bin with the lid closed. This feature is ideal for games, laptops, cell phones, or other electrical equipment. The console's front opening lid allows for easy access to these compartments.

With Vehicle Entertainment System (VES)[®]

The center console contains a large storage compartment. The storage compartment contains a 12-volt power outlet and a molded-in coin holder (designed to hold various size coins). A slot in the top left and right side of the storage compartment provides clearance for power cords

to pass conveniently out of the compartment with the lid closed. This feature is ideal for games, laptops, cell phones, or other electrical equipment. The console's front-opening lid allows for easy access to the storage compartment for both the driver and the front passenger.

Cargo Area

The 60/40 split-folding rear seat provides cargo-carrying versatility. The seatbacks fold down easily by pulling nylon tabs between the seatbacks and the bolsters. When the seats are folded down, they provide a continuous, nearly-flat extension of the load floor.

When the seatback is folded to the upright position, make sure it is latched by strongly pulling on the top of the seatback above the seat strap.

WARNING!

- Be certain that the seatback is securely locked into position. If the seatback is not securely locked into position, the seat will not provide the proper stability for child seats and/or passengers. An improperly latched seat could cause serious injury.
- The cargo area in the rear of the vehicle (with the rear seatbacks in the locked-up or folded down position) should not be used as a play area by children when the vehicle is in motion. They could be seriously injured in an accident. Children should be seated and using the proper restraint system.
- To help protect against personal injury, passengers should not be seated in the rear cargo area. The rear cargo space is intended for load carrying purposes only, not for passengers, who should sit in seats and use seat belts.

WARNING!

- The weight and position of cargo and passengers can change the vehicle center of gravity and vehicle handling. To avoid loss of control resulting in personal injury, follow these guidelines for loading your vehicle:
 - Always place cargo evenly on the cargo floor. Put heavier objects as low and as far forward as possible.
 - Place as much cargo as possible in front of the rear axle. Too much weight or improperly placed weight over or behind the rear axle can cause the rear of the vehicle to sway.
 - Do not pile luggage or cargo higher than the top of the seatback. This could impair visibility or become a dangerous projectile in a sudden stop or collision.

UNDERSTANDING YOUR INSTRUMENT PANEL

CONTENTS

■ Instrument Panel And Controls	197	□ Telephone — If Equipped	222
■ Premium Instrument Cluster	198	□ Navigation — If Equipped	224
■ Instrument Cluster Descriptions	199	□ Driver-Selectable Surround Sound (DSS) – If Equipped	225
■ Electronic Vehicle Information Center (EVIC)	209	□ System Warnings (Customer Information Features)	225
□ Electronic Vehicle Information Center (EVIC) Displays	211	□ Personal Settings (Customer Programmable Features)	226
□ Trip Functions	215	■ Setting The Analog Clock	231
□ Performance Pages — If Equipped	217	■ Radio General Information	231
□ Compass Display	220		

194 UNDERSTANDING YOUR INSTRUMENT PANEL

- Radio Broadcast Signals 231
- Two Types Of Signals 231
- Electrical Disturbances 232
- AM Reception 232
- FM Reception 232
- Sales Code REN — Multimedia System —
If Equipped 232
 - Operating Instructions — Satellite Radio
(If Equipped) 233
 - Operating Instructions — Voice Recognition
System (VR) (If Equipped) 233
 - Operating Instructions — Hands-Free
Communication (UConnect®) (If Equipped) . . . 233
 - Clock Setting Procedure 234
- Sales Code REQ — AM/FM Stereo Radio And
6-Disc CD/DVD Changer
(MP3/WMA AUX Jack) 236
 - Operating Instructions - Radio Mode 236
 - Operation Instructions - (Disc Mode For CD And
MP3/WMA Audio Play, DVD-Video) 244
 - Notes On Playing MP3/WMA Files 246
 - List Button (Disc Mode For
MP3/WMA Play) 249
 - Info Button (Disc Mode For
MP3/WMA Play) 249
- Sales Code RER — Multimedia System —
If Equipped 251
 - Operating Instructions — Satellite Radio 253

- Operating Instructions — Hands-Free Communication (UConnect®) (If Equipped)253
- Clock Setting Procedure253
- Sales Code RES — AM/FM Stereo Radio With CD Player (MP3 AUX Jack)256
- Operating Instructions - Radio Mode256
- Operation Instructions - CD Mode For CD And MP3 Audio Play262
- Notes On Playing MP3 Files264
- List Button (CD Mode For MP3 Play)267
- Info Button (CD Mode For MP3 Play)267
- Satellite Radio (RSC) — If Equipped (RER/REQ/REN Radios Only)268
 - System Activation268
- Electronic Serial Number/Sirius Identification Number (ENS/SID)269
- Selecting Satellite Mode269
- Satellite Antenna270
- Reception Quality270
- Operating Instructions - Satellite Mode270
- Operating Instructions - Hands-Free Phone (If Equipped)273
- Operating Instructions - Video Entertainment System (VES™) (If Equipped)273
- Sirius Backseat TV™ — If Equipped273
- Video Entertainment System (VES)® — If Equipped273

- Kicker® 13-Speaker High Performance Sound System With Driver-Selectable Surround (DSS) – If Equipped276
 - Kicker® Mobile Surround (KMS1)® – If Equipped276
- Universal Consumer Interface (UCI) — If Equipped277
 - Connecting The iPod® Device277
 - Controlling The iPod® Using Radio Buttons . . .278
 - Play Mode278
 - List Or Browse Mode280
- Remote Sound System Controls — If Equipped281
- CD/DVD Disc Maintenance283
- Radio Operation And Cellular Phones283
- Climate Controls283
 - Automatic Temperature Control284
 - Operating Tips289
- Rear Window Features292
 - Electric Rear Window Defroster292

INSTRUMENT PANEL AND CONTROLS

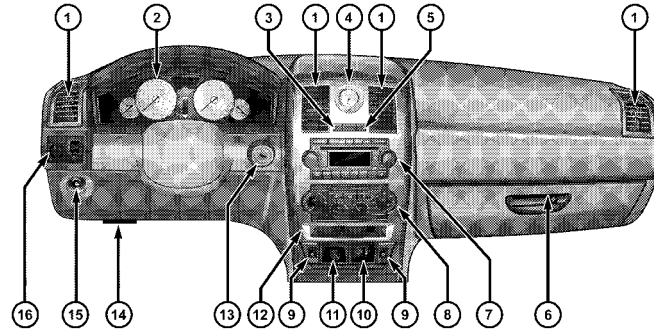

818f7219

- | | | |
|--|---------------------------|---------------------------|
| 1 — Air Outlet | 7 — Radio | 13 — Ignition Switch |
| 2 — Instrument Cluster | 8 — Climate Control | 14 — Hood Release |
| 3 — HAZARD Switch | 9 — HEATED SEAT Switch* | 15 — TRUNK RELEASE Switch |
| 4 — Analog Clock | 10 — Power Outlet | 16 — HEADLIGHT Switch |
| 5 — Electronic Stability Program OFF Button* | 11 — Ash Tray* | |
| 6 — Glove Box | 12 — Storage Compartment* | |

* If Equipped

PREMIUM INSTRUMENT CLUSTER

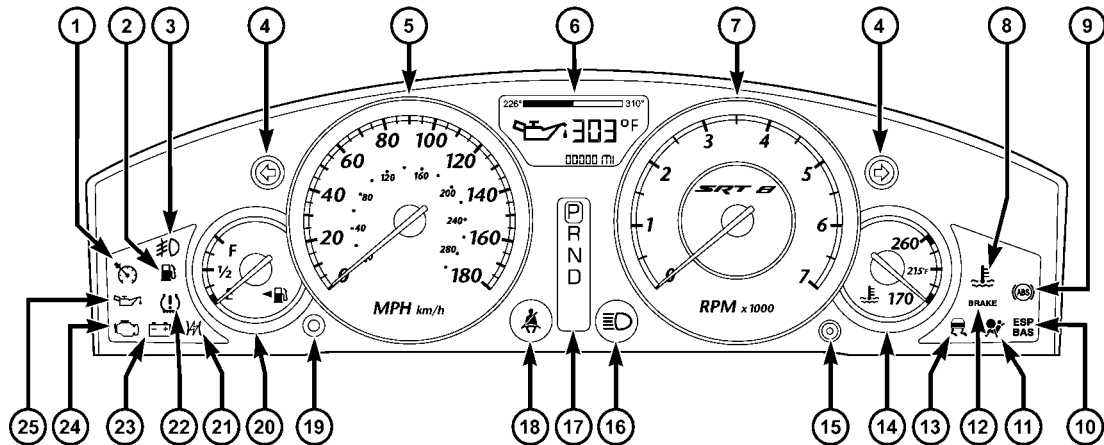

INSTRUMENT CLUSTER DESCRIPTIONS

1. *Electronic Speed Control/Adaptive Cruise Control Indicator Light — If Equipped*



This light will turn on when the electronic speed control or ACC is ON. (See page 150 for more information.) (See page 153 for more information.)

2. *Low Fuel Indicator Light*



This light will turn on and a single chime will sound when the fuel level drops to 1/8 tank. (See page 361 for more information.)

3. *Front Fog Light Indicator*



This light will turn on when the front fog lights are ON. (See page 137 for more information.)

4. *Turn Signal Indicators*



The arrow will flash with the exterior turn signal when the turn signal lever is operated. (See page 138 for more information.)

NOTE: A continuous chime will sound if the vehicle is driven more than 1 mi (1.6 km) with either turn signal on.

NOTE: Check for a defective outside light bulb if either indicator flashes at a rapid rate.

5. *Speedometer*

Indicates vehicle speed.

6. *Electronic Vehicle Information Center Display*

This display shows the Electronic Vehicle Information Center (EVIC) messages when the appropriate conditions exist. (See page 209 for more information.)

Loose Fuel Filler Cap

If the vehicle diagnostic system determines that the fuel filler cap is loose, improperly installed, or damaged, a “Check Gascap” message will display in the EVIC. Tighten the fuel filler cap properly and press the TRIP ODOMETER button to turn off the message. If the problem continues, the message will appear the next time the vehicle is started.

A loose, improperly installed, or damaged fuel filler cap may also turn on the Malfunction Indicator Light (MIL). (See page 387 for more information.)

7. Tachometer

The red segments indicate the maximum permissible engine revolutions per minute (RPM x 1000) for each gear range. Ease up on the accelerator before reaching the red area.

8. Engine Temperature Warning Light



This light will turn on and a single chime will sound to warn of an overheated engine condition.

When this light turns on, the engine temperature is critically hot. The vehicle should be turned OFF immediately and serviced as soon as possible. (See page 371 for more information.)

9. Anti-Lock Brake Light



This light monitors the Anti-Lock Brake System (ABS). The light will turn on when the ignition switch is turned to the ON position and may stay on for as long as four seconds.

If the ABS light remains on or turns on while driving, then the Anti-Lock portion of the brake system is not functioning and service is required. However, the conventional brake system will continue to operate normally if the BRAKE warning light is not on.

If the ABS light is on, the brake system should be serviced as soon as possible to restore the benefits of Anti-Lock brakes. If the ABS light does not turn on when the Ignition switch is turned to the ON position, have the light inspected by an authorized dealer. (See page 317 for more information.)

10. *Electronic Stability Program (ESP) / Brake Assist System (BAS) Malfunction Indicator Light*

**ESP
BAS** The yellow ESP/BAS Malfunction Indicator Light will turn on when the key in the ignition switch is turned to the ON position. The light should go out with the engine running. If the light remains on after several ignition cycles, and the vehicle has been driven several miles (kilometers) at speeds greater than 30 mph (48 km/h), see your authorized dealer as soon as possible to have the problem diagnosed and corrected. (See page 320 for more information.)

11. *Airbag Warning Light*



This light will turn on for six to eight seconds as a bulb check when the ignition switch is first turned ON. If the light is either not on during starting, or stays on, or turns on while driving, then have the system inspected at your authorized dealer as soon as possible. (See page 61 for more information.)

12. *Brake System Warning Light*

BRAKE This light monitors various brake functions, including brake fluid level and parking brake application. If the brake light turns on, it may indicate that the parking brake is applied, that the brake fluid level is low, or that there is a problem with the ABS.

The dual brake system provides a reserve braking capacity to a portion of the hydraulic system in the event of a failure. Failure of either half of the dual brake system is indicated by the Brake Warning Light, which will turn on when the brake fluid level in the master cylinder drops below a specified level.

The light will remain on until the cause is corrected.

NOTE: The light may flash momentarily during sharp cornering maneuvers due to a change in fluid level. If so, the vehicle should have service performed and the brake fluid level checked.

Immediate repair is necessary if brake failure is indicated.

WARNING!

Driving a vehicle with the brake light on is dangerous. Part of the brake system may have failed. It will take longer to stop the vehicle. You could have an accident. Have the vehicle checked immediately.

Vehicles equipped with ABS are also equipped with Electronic Brake Force Distribution (EBD). Both the Brake Warning Light and the ABS Light will turn on in the event of an EBD failure. Immediate repair of the ABS is required in the event of an EBD failure.

The operation of the Brake Warning Light can be checked by turning the ignition switch from the LOCK position to the ON position. The light should turn on for approximately two seconds and then turn off. The light will remain on if the parking brake is applied or if a brake fault is detected. If the parking brake is not applied and

the light remains on, or if the light does not turn on, have the light inspected by an authorized dealer.

NOTE: The light will turn on when the ignition switch is in the ON position and the parking brake is applied. This light shows only that the parking brake is applied. It does not show the degree of brake application. (See page 317 for more information.)

13. Electronic Stability Program (ESP)/Traction Control System (TCS) Indicator Light



If this indicator light flashes during acceleration, ease up on the accelerator and apply as little throttle as possible. Adapt your speed and driving to the prevailing road conditions, and do not switch off the ESP. (See page 320 for more information.)

14. Temperature Gauge

The temperature gauge shows engine coolant temperature. Any reading within the normal range indicates that the engine cooling system is operating satisfactorily.

The gauge pointer will likely indicate a higher temperature when driving in hot weather, up mountain grades, or when towing a trailer. It should not be allowed to exceed the upper limits of the normal operating range.

CAUTION!

Driving with a hot cooling system could damage your vehicle. If the temperature gauge reads 240°F (116°C) or greater, pull over and stop the vehicle. Idle the vehicle with the air conditioner turned off until the pointer drops back into the normal range 200–230°F (93–110°C). If the pointer remains at 240°F (116°C) or greater and you hear a chime, turn the engine OFF immediately, and call for service.

WARNING!

A hot engine cooling system is dangerous. You or others could be badly burned by steam or boiling coolant. You may want to call a service center if your vehicle overheats. If you decide to look under the hood yourself, refer to Section 7 and follow the warnings under the Cooling System Pressure Cap paragraph.

15. Trip Odometer Button

Press this button to change the display from odometer to either of two trip odometer settings. The letter “A” or “B” will appear when in the trip odometer mode. Push in and hold the button for two seconds to reset the trip odometer to 0 mi (km). The odometer must be in TRIP mode to reset it.

16. High Beam Light

 This light will turn on when the high beam headlights are ON. Push the multifunction lever away from the steering wheel to switch the headlights to high beam. (See page 137 for more information.)

17. Transmission Range Indicator

This display indicator shows the automatic transmission gear selection.

18. Seat Belt Reminder Light

 This light will turn on for five to eight seconds as a bulb check when the ignition switch is first turned ON. A chime will sound if the driver's seat belt is unbuckled during the bulb check. The Seat Belt Warning Light will flash, or remain on continuously, if the driver's seat belt remains unbuckled after the bulb check or when driving. (See page 46 for more information.)

19. Vehicle Security Alarm (VSA) Indicator Light — If Equipped

The VSA Indicator Light flashes rapidly when the VSA is arming, and slowly when the VSA is armed. (See page 18 for more information.)

20. Fuel Gauge

The pointer shows the level of fuel in the fuel tank when the ignition switch is in the ON position.

21. Electronic Throttle Control (ETC) Light

 This light will turn on briefly, as a bulb check, when the ignition switch is turned ON. This light will also turn on while the engine is running if there is a problem with the Electronic Throttle Control system.

If the light comes on while the engine is running, safely bring the vehicle to a complete stop as soon as possible, place the shift lever in PARK, and cycle the ignition key. The light should turn off. If the light remains lit with the

engine running, your vehicle will usually be drivable. However, see your authorized dealer for service as soon as possible.

If the light is flashing when the engine is running, immediate service is required. In this case, you may experience reduced performance, an elevated/rough idle or engine stall, and your vehicle may require towing.

Also, have the system checked by an authorized dealer if the light does not come on during starting.

22. Tire Pressure Monitoring Telltale Light — If Equipped



Each tire, including the spare (if provided), should be checked monthly when cold and inflated to the inflation pressure recommended by the vehicle manufacturer on the vehicle placard or tire inflation pressure label. (If your vehicle has tires of a different size than the size indicated on the

vehicle placard or tire inflation pressure label, you should determine the proper tire inflation pressure for those tires.)

As an added safety feature, your vehicle has been equipped with a tire pressure monitoring system (TPMS) that illuminates a low pressure telltale when one or more of your tires is significantly under-inflated. Accordingly, when the low tire pressure telltale illuminates, you should stop and check your tires as soon as possible, and inflate them to the proper pressure. Driving on a significantly under-inflated tire causes the tire to overheat and can lead to tire failure. Under-inflation also reduces fuel efficiency and tire tread life, and may affect the vehicle's handling and stopping ability.

Please note that the TPMS is not a substitute for proper tire maintenance, and it is the driver's responsibility to maintain correct tire pressure, even if under-inflation has not reached the level to trigger illumination of the TPMS low tire pressure telltale.

Your vehicle has also been equipped with a TPMS malfunction indicator to indicate when the system is not operating properly. The TPMS malfunction indicator is combined with the low tire pressure telltale. When the system detects a malfunction, the telltale will flash for approximately one minute and then remain continuously illuminated. This sequence will continue upon subsequent vehicle start-ups as long as the malfunction exists. When the malfunction indicator is illuminated, the system may not be able to detect or signal low tire pressure as intended. TPMS malfunctions may occur for a variety of reasons, including the installation of replacement or alternate tires or wheels on the vehicle that prevent the TPMS from functioning properly. Always check the TPMS malfunction telltale after replacing one or more tires or wheels on your vehicle to ensure that the replacement or alternate tires and wheels allow the TPMS to continue to function properly. (See page 347 for more information.)

CAUTION!

The TPMS has been optimized for the original equipment tires and wheels. TPMS pressures and warning have been established for the tire size equipped on your vehicle. Undesirable system operation or sensor damage may result when using replacement equipment that is not of the same size, type, and/or style. Aftermarket wheels can cause sensor damage. Do not use aftermarket tire sealants or balance beads if your vehicle is equipped with a TPMS, as damage to the sensors may result.

23. *Charging System Light*



This light shows the status of the electrical charging system. The light should turn on when the ignition switch is first turned ON and remain on briefly as a bulb check. If the light stays on, or turns on while driving, turn off some of the vehicle's non-essential electrical devices (i.e., radio) or slightly increase engine speed (if at idle). If the light remains on, it means that the charging system is experiencing a problem. See your local authorized dealer to obtain service immediately.

24. *Malfunction Indicator Light (MIL)*



This light is part of an onboard diagnostic system called OBD. The OBD system monitors engine and automatic transmission control systems. The MIL will turn on when the key is in the ON position before engine start. If the MIL does not come on when turning the key from OFF to ON, have the condition checked promptly.

Certain conditions such as a loose or missing gas cap, poor fuel quality, etc., may illuminate the MIL after engine start. The vehicle should be serviced if the MIL stays on through several of your typical driving cycles. In most situations, the vehicle will drive normally and will not require towing.

The MIL flashes to alert you to serious conditions that could lead to immediate loss of power or severe catalytic converter damage. The vehicle should be serviced as soon as possible if this occurs. (See page 387 for more information.)

25. *Oil Pressure Warning Light*



This light shows low engine oil pressure. The light should turn on momentarily when the engine is started. If the light turns on while driving, stop the vehicle, and shut OFF the engine as soon as possible. A single chime will sound when this light turns on.

Do not operate the vehicle until the cause is corrected. This light does not show how much oil is in the engine. The engine oil level must be checked using the procedure shown in Section 7. (See page 391 for more information.)

ELECTRONIC VEHICLE INFORMATION CENTER (EVIC)

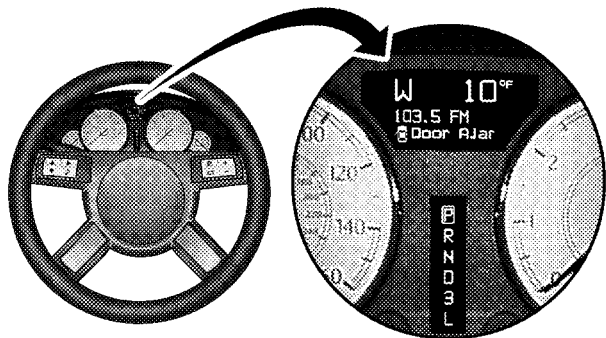

818c9c36

Electronic Vehicle Information Center

The Electronic Vehicle Information Center (EVIC) features a driver-interactive display. It is located in the upper part of the cluster between the speedometer and tachometer. Vehicles equipped with steering wheel-mounted buttons (described in this section) are also equipped with the EVIC. The EVIC consists of the following:

- System status,
- Vehicle information warning message displays,
- Tire Pressure Monitor System (if equipped),
- Personal settings (customer programmable features),
- Compass display,
- Outside temperature display,
- Trip computer functions,

- UConnect® hands-free communication system displays (if equipped),
- Navigation system screens (if equipped),
- Audio mode display,
- Surround Sound modes (if equipped with Driver-Selectable Surround [DSS]), and
- Performance Pages (if equipped).

The system allows the driver to select information by pressing the following buttons mounted on the steering wheel.



**MENU
Button**

Press and release the MENU button and the mode displayed will change between Trip Functions, Performance Pages (if equipped), Navigation (if equipped), System Warnings, System Status, Personal Settings, Telephone (if equipped), and Surround Sound (if equipped).



**FUNC-
TION
SELECT
Button**

Press the FUNCTION SELECT button to accept a selection. The FUNCTION SELECT button also functions as a remote sound system control. Refer to “Remote Sound System Controls” in this section.



**SCROLL
Button**

Press the SCROLL button to scroll through Trip Functions, Performance Pages (if equipped), Navigation (if equipped), System Status Messages, and Personal Settings (Customer Programmable Features). The SCROLL button also functions as a remote sound system control.

Refer to “Remote Sound System Controls” in this section.

**AUDIO
MODE
Button**

Press the AUDIO MODE button to select the Compass/Temp/Audio screen. Along with compass reading and outside temperature, this screen will display radio and media mode information depending on which radio is in the vehicle. Refer to “Remote Sound System Controls” in this section.

Electronic Vehicle Information Center (EVIC)**Displays**

When the appropriate conditions exist, the EVIC displays the following messages:

- Turn Signal On (with a continuous warning chime if the vehicle is driven more than 1 mi [1.6 km] with either turn signal on)
- Left Front Turn Signal Light Out (with a single chime)
- Left Rear Turn Signal Light Out (with a single chime)
- Right Front Turn Signal Light Out (with a single chime)
- Right Rear Turn Signal Light Out (with a single chime)
- RKE Battery Low (with a single chime)
- Memory #1/#2 Profile Set
- Memory #1/#2 Profile Recall
- Memory System Disabled – Vehicle Not In PARK (with a single chime)
- Memory System Disabled – Seat Belt Buckled (with a single chime)
- Personal Settings Not Available – Vehicle Not in PARK
- Left/Right Front Door Ajar (one or more, with a single chime if speed is above 1 mph [1.6 km/h])
- Left/Right Rear Door Ajar (one or more, with a single chime if speed is above 1 mph [1.6 km/h])

- Door(s) Ajar (with a single chime if vehicle is in motion)
- Trunk Ajar (with a single chime)
- Low Washer Fluid (with a single chime)
- Oil Pressure
- ACC Off — When the Adaptive Cruise Control (ACC) system is turned off. Refer to “Adaptive Cruise Control (ACC)” in Section 3 (if so equipped).
- ACC Ready — When the Adaptive Cruise Control (ACC) system is activated. Refer to “Adaptive Cruise Control (ACC)” in Section 3 (if so equipped).
- ACC Set — After setting the desired speed in the Adaptive Cruise Control (ACC) system. Refer to “Adaptive Cruise Control (ACC)” in Section 3 (if so equipped).
- Driver Override — If you apply the accelerator after setting the desired speed in the Adaptive Cruise Control (ACC) system. Refer to “Adaptive Cruise Control (ACC)” in Section 3 (if so equipped).
- Distance Set — After changing the desired following distance in the Adaptive Cruise Control (ACC) system, this message will display momentarily. Refer to “Adaptive Cruise Control (ACC)” in Section 3 (if so equipped).
- Attention — If the Adaptive Cruise Control (ACC) system predicts that its maximum braking level is not sufficient to maintain the set distance, this message will flash and a chime will sound while ACC continues to apply its maximum braking capacity. When this occurs, you should immediately apply the brakes as needed to maintain a safe distance from the vehicle ahead. Refer to “Adaptive Cruise Control (ACC)” in Section 3 (if so equipped).

- ACC Blinded — If the Adaptive Cruise Control (ACC) system deactivates due to performance limiting conditions. Refer to “Adaptive Cruise Control (ACC)” in Section 3 (if so equipped).
- ACC Unavailable — If the Adaptive Cruise Control (ACC) system turns off due to a temporary malfunction that limits functionality. Refer to “Adaptive Cruise Control (ACC)” in Section 3 (if so equipped).
- Service ACC — If the Adaptive Cruise Control (ACC) system turns off due to an internal system fault that requires service from an authorized dealer. Refer to “Adaptive Cruise Control (ACC)” in Section 3 (if so equipped).
- Adjustable Pedals Disabled – Cruise Engaged (with a single chime) — only available on vehicles equipped with memory seats.
- Adjustable Pedals Disabled – Vehicle In REVERSE (with a single chime) — only available on vehicles equipped with memory seats.
- Channel # Transmit
- Channel # Training
- Channel # Trained
- Clearing Channels
- Channels Cleared
- Did Not Train
- Left Front Low Pressure (with a single chime). Refer to information on “Tire Pressure” and “Tire Pressure Monitor” under “Starting And Operating.”
- Left Rear Low Pressure (with a single chime). Refer to information on “Tire Pressure” and “Tire Pressure Monitor” under “Starting And Operating.”

- Right Front Low Pressure (with a single chime). Refer to information on “Tire Pressure” and “Tire Pressure Monitor” under “Starting And Operating.”
- Right Rear Low Pressure (with a single chime). Refer to information on “Tire Pressure” and “Tire Pressure Monitor” under “Starting And Operating.”
- Check TPM System (with a single chime). Refer to information on “Tire Pressure” and “Tire Pressure Monitor” under “Starting And Operating.”
- Check GasCap (refer to “Adding Fuel” in Section 5)
- Service Park Assist System (with a single chime)
- Insert Key/Turn To Run (refer to “Remote Starting System” in Section 2)
- Upshift
- Stereo (if equipped with Driver-Selectable Surround Sound [DSS])
- Video Surround (if equipped with Driver-Selectable Surround Sound [DSS])
- Audio Surround (if equipped with Driver-Selectable Surround Sound [DSS])
- 0-60 mph (0-100 km/h) (if equipped with Performance Pages)
- Braking Distance (if equipped with Performance Pages)
- 1/8 Mile (if equipped with Performance Pages)
- 1/4 Mile (if equipped with Performance Pages)
- Instantaneous G-Force (if equipped with Performance Pages)
- Peak G-Force (if equipped with Performance Pages)
- Digital Speedometer (if equipped with Performance Pages)

Trip Functions

Press and release the MENU button until one of the following Trip Functions displays in the EVIC:

- Average Fuel Economy
- Distance To Empty
- Trip A
- Trip B
- Elapsed Time
- Display Units of Measure in

Press the SCROLL button to cycle through all the Trip Computer functions.

The Trip Functions mode displays the following information.

- *Average Fuel Economy*

Shows the average fuel economy since the last reset. When the fuel economy is reset, the display will read “RESET” or show dashes for two seconds. Then, the history information will be erased, and the averaging will continue from the last fuel average reading before the reset.

- *Distance To Empty (DTE)*

Shows the estimated distance that can be traveled with the fuel remaining in the tank. This estimated distance is determined by a weighted average of the instantaneous and average fuel economy, according to the current fuel tank level. DTE cannot be reset through the FUNCTION SELECT button.

NOTE: Significant changes in driving style or vehicle loading will greatly affect the actual drivable distance of the vehicle, regardless of the DTE displayed value.

- When the DTE value is less than 30 mi (48 km) estimated driving distance, the DTE display will change to a text display of "LOW FUEL." This display will continue until the vehicle runs out of fuel. Adding a significant amount of fuel to the vehicle will turn off the "LOW FUEL" text and a new DTE value will display.

- ***Trip A***

Shows the total distance traveled for Trip A since the last reset.

- ***Trip B***

Shows the total distance traveled for Trip B since the last reset.

- ***Elapsed Time***

Shows the total elapsed time of travel since the last reset when the ignition switch is in the ACC position. Elapsed time will increment when the ignition switch is in the ON or START position.

- ***Display Units of Measure in***

To make your selection, press and release the FUNCTION SELECT button until "US" or "METRIC" appears.

To Reset The Display

Reset will only occur while a resettable function is being displayed. Press and release the FUNCTION SELECT button once to clear the resettable function being displayed. To reset all resettable functions, press and release the FUNCTION SELECT button a second time within three seconds of resetting the currently-displayed function (>Reset ALL will display during this three-second window).

Performance Pages — If Equipped

WARNING!

Measurement of vehicle statistics with the Performance Pages is intended for off-highway or off-road use only and should not be done on any public roadways. It is recommended that these features be used in a controlled environment and within the limits of the law. The capabilities of the vehicle as measured by the performance pages must never be exploited in a reckless or dangerous manner, which can jeopardize the user's safety or the safety of others. Only a safe, attentive, and skillful driver can prevent accidents.

The Performance Pages include the following features:

- 0-60 mph (0-100 km/h)

- Braking Distance
- 1/8 Mile
- 1/4 Mile
- Instantaneous G-Force
- Peak G-Force
- Digital Speedometer

To access, press and release the MENU button until Performance Pages displays in the EVIC. Press the SCROLL button to cycle through the features. Press the FUNCTION SELECT button to select a feature.

The following describes each feature and its operation:

0-60 mph (0-100 km/h)

When selected, this screen displays the time it takes for the vehicle to go from 0 to 60 mph (0 to 100 km/h) within 10 seconds.

- The feature will “ready” when the vehicle speed is at 0 mph (0 km/h). The word “READY” will flash when conditions are met for the event to begin.
 - Dashes will display if the vehicle fails to reach 60 mph (100 km/h) in less than 10 seconds.
 - The time will continue to display until the FUNCTION SELECT button is pressed.
 - Pressing the FUNCTION SELECT button will clear the current run time and display the vehicle’s best 0-60 mph (0-100 km/h) time.
 - To clear the vehicle’s best 0-60 mph (0-100 km/h) time, press and hold the FUNCTION SELECT button for five seconds.
- Braking Distance**
- When selected, this screen displays the vehicle’s braking distance and the speed at which the brake pedal was depressed.
- This feature will only function when applying the brakes at speeds above 30 mph (48 km/h).
 - Engaging the parking brake will disable this feature.
 - The word “READY” will flash when conditions are met for the event to begin.
 - The distance and speed measurements display while the event is taking place.
 - The distance measurement will be aborted if the brake pedal is released before the vehicle comes to a complete stop.
 - The distance and speed measurements will continue to display until the FUNCTION SELECT button is pressed.
 - Pressing the FUNCTION SELECT button will clear the current run and prepare the cluster to record a new run.

1/8 Mile, 1/4 Mile

When selected, this screen displays the time it takes the vehicle to travel 1/8 mile (1/4 mile) within 30 seconds and the vehicle's speed when it reaches 1/8 mile (1/4 mile).

- The feature will "ready" when the vehicle is at 0 mph (0 km/h). The word "READY" will flash when conditions are met for the event to begin.
- Dashes will display if the vehicle fails to reach 1/8 mile (1/4 mile) in less than 30 seconds.
- The time and speed will continue to display until the FUNCTION SELECT button is pressed.
- Pressing the FUNCTION SELECT button will clear the current run and display the vehicle's best 1/8 mile (1/4 mile) run.
- To clear the vehicle's best 1/8 mile (1/4 mile) run, press and hold the FUNCTION SELECT button for five seconds.

Instantaneous G-Force

When selected, this screen displays the current G-Force (longitude and latitude) along with a friction circle that displays the directions of the forces.

Peak G-Force

When selected, this screen displays all four G-force values (two longitude and two latitude).

- When a force greater than zero is measured, the display will update the value as it climbs. As the G-Force falls, the peak forces will continue to display.
- Pressing the FUNCTION SELECT button will clear the peak force values.

Digital Speedometer

When selected, this screen displays vehicle speed and records top speed.

- Press and hold the FUNCTION SELECT button for three seconds to toggle between current speed and top speed.
- To reset top speed, quickly press and release the FUNCTION SELECT button when top speed is displayed.

Compass Display



COM-
PASS
Button

The compass readings indicate the direction the vehicle is facing. Press and release the COMPASS button to display one of eight compass readings and the outside temperature.

Automatic Compass Calibration

This compass is self-calibrating, which eliminates the need to set the compass manually. When the vehicle is new, the compass may appear erratic and the EVIC will display “CAL” until the compass is calibrated. You may

also calibrate the compass by completing one or more 360 degree turns (in an area free from large metal or metallic objects) until the “CAL” message displayed in the EVIC turns off. The compass will now function normally.

Manual Compass Calibration

If the compass appears erratic and the “CAL” message does not appear in the EVIC display, you must put the compass into the Calibration Mode manually as follows:

1. Turn the ignition switch ON.
2. Press and hold the COMPASS button for approximately two seconds.
3. Press the SCROLL button until “Calibrate Compass” displays in the EVIC.
4. Press and release the FUNCTION SELECT button to start the calibration. The message “CAL” will display in the EVIC.

5. Complete one or more 360 degree turns (in an area free from large metal or metallic objects) until the “CAL” message turns off. The compass will now function normally.

Compass Variance

Compass Variance is the difference between magnetic North and geographic North. In some areas of the country, the difference between magnetic and geographic North is great enough to cause the compass to give false readings. If this occurs, the compass variance must be set using the following procedure:

NOTE: Magnetic materials should be kept away from the overhead console. This is where the compass sensor is located.

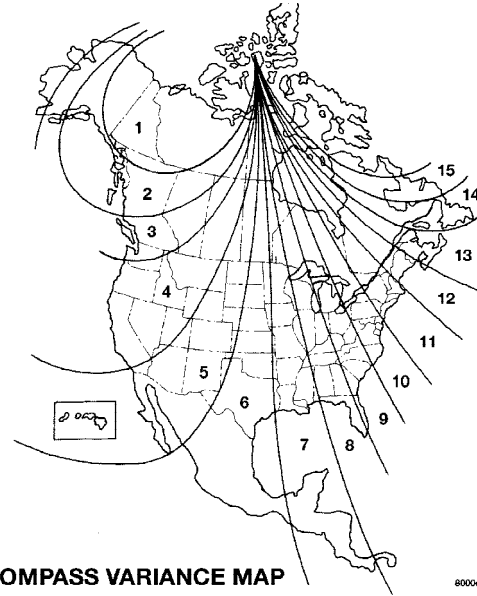

1. Turn the ignition switch ON.
2. Press and hold the COMPASS button for approximately two seconds.
3. Press the SCROLL button until “Compass Variance” message and the last variance zone number displays in the EVIC.
4. Press and release FUNCTION SELECT button until the proper variance zone is selected according to the map.
5. Press and release the COMPASS button to exit.

Telephone — If Equipped

Press and release the MENU button until “Telephone” displays in the EVIC.

When the appropriate conditions exist, the EVIC provides the following telephone information:

- Phone status: idle, voice mail, roaming, battery strength, and signal strength in increments of 20 percent.
- Call status: Incoming call, connecting, connected, air time in minutes and seconds, call ended, call failed, roaming, and no phone connection.
- UConnect® active.
- Caller ID phone number display.

When the appropriate conditions exist, and if supported by the cell phone, the EVIC will display the following telephone symbols:



**Signal
Strength**

The EVIC displays this symbol to indicate the signal strength of the UConnect® phone. The number of horizontal bars increases as the strength of the UConnect® phone signal increases.

**Incom-
ing Call**

The EVIC displays this symbol to indicate an incoming call.

**Analog**

The EVIC displays this symbol to indicate that the UConnect® phone is currently in analog mode.

**Roam-
ing**

The EVIC displays this symbol to indicate that the UConnect® phone is currently roaming.

**Voice
Mail**

The EVIC displays this symbol to indicate that you have voice mail.

**Text
Message**

The EVIC displays this symbol to indicate a text message.

**Battery
Strength**

The EVIC displays this symbol to indicate the battery strength of the UConnect® phone.



Call in Progress

The EVIC displays this symbol to indicate that a phone connection has been made.



Phone Not Available

The EVIC displays this symbol to indicate that the UConnect® phone is currently not available.

Navigation — If Equipped

Navigation Display Control

Press and release the MENU button until Navigation displays in the EVIC. When the Navigation System is On, the steering wheel buttons can be used to select the Map or Menu display on the Navigation Unit. When the Menu

display is active, the SCROLL button can be used to scroll through the list, the FUNCTION SELECT button can be used to select an item, and the AUDIO MODE button can be used to return to the previous menu. When the Map display is active, pressing the FUNCTION SELECT button will change the Navigation Unit Display to the Menu.

Turn-by-Turn Directions

The EVIC displays turn-by-turn directions to a programmed destination when Turn-by-Turn Navigation is enabled through Personal Settings. When enabled, the EVIC displays the name of the approaching road at the top of the screen, followed by an arrow to indicate the direction to turn the vehicle, and a count down to indicate the distance to the turn.

NOTE: Refer to your “Navigation User’s Manual” for detailed operating instructions.

Driver-Selectable Surround Sound (DSS) – If Equipped

Press and release the MENU button until “Surround Sound” displays in the EVIC. The EVIC provides information on the current surround mode.

- Stereo
- Video Surround
- Audio Surround

While in the Surround Sound menu, press the FUNCTION SELECT button to change surround modes. The Video Surround Mode will only be available for video media sources (DVDs, Video CDs, or other video media supported by the radio).

System Warnings (Customer Information Features)

Press and release the MENU button until “SYSTEM WARNINGS” displays in the EVIC. Then, press the SCROLL button to display anyone of the following choices.

- *Oil Temperature*

Shows the actual oil temperature.

- *Oil Pressure*

Shows the actual oil pressure.

- *Tire Pressure*

Shows the actual tire pressure for each tire (EXCLUDING THE SPARE TIRE).

Personal Settings (Customer Programmable Features)

Personal Settings allows the driver to set and recall features when the transmission is in PARK.

Press and release the MENU button until Personal Settings displays in the EVIC.

Use the SCROLL button to display one of the following choices:

“Language”

When in this display you may select one of five languages for all display nomenclature, including the trip functions and the navigation system (if equipped). Press the FUNCTION SELECT button while in this display to select English, Espanol, Deutsch, Italiano, or Francais. Then, as you continue, the information will display in the selected language.

NOTE: The EVIC will not change the UConnect® language selection. Refer to “Language Selection” under “Hands-Free Communication (UConnect®)” in Section 3.

“Lock Doors Automatically at 15 mph (24 km/h)”

When ON is selected, all doors will lock automatically when the vehicle reaches a speed of 15 mph (24 km/h). To make your selection, press and release the FUNCTION SELECT button until “ON” or “OFF” appears.

“Unlock Doors Automatically on Exit”

When ON is selected, all doors will unlock when the vehicle is stopped and the transmission is in the PARK or NEUTRAL position and the driver’s door is opened. To make your selection, press and release the FUNCTION SELECT button until “ON” or “OFF” appears.

“Remote Key Unlock”

When **Driver Door 1st Press** is selected, only the driver’s door will unlock on the first press of the Remote Keyless Entry (RKE) UNLOCK button. When Driver Door 1st

Press is selected, you must press the RKE UNLOCK button twice to unlock the passenger's doors. When **All Doors 1st Press** is selected, all of the doors will unlock on the first press of the RKE UNLOCK button. To make your selection, press and release the FUNCTION SELECT button until "Driver Door 1st Press" or "All Doors 1st Press" appears.

"Recall Memory with Remote Key Unlock" — If Equipped

When ON is selected, you can use your RKE transmitter to recall one of two pre-programmed memory profiles. Each memory profile contains desired position settings for the driver seat, side mirror, adjustable pedals (if equipped), and power tilt and telescopic steering column (if equipped), and a set of desired radio station presets. When OFF is selected, only the memory switch on the driver's door panel will recall memory profiles. To make

your selection, press and release the FUNCTION SELECT button until "ON" or "OFF" appears. Refer to "Driver Memory Seat" in Section 3.

"Sound Horn with Remote Key Lock"

When ON is selected, a short horn sound will occur when the RKE LOCK button is pressed. This feature may be selected with or without the flash lights on lock/unlock feature. To make your selection, press and release the FUNCTION SELECT button until "ON" or "OFF" appears.

"Rain Sensing Intermittent Wipers"

When ON is selected, the system will automatically activate the windshield wipers if it senses moisture on the windshield. To make your selection, press and release the FUNCTION SELECT button until "ON" or "OFF" appears. When OFF is selected, the system reverts to the standard intermittent wiper operation.

“Automatically Move Seat Back on Exit” — If Equipped

This feature provides automatic driver seat positioning to enhance driver mobility when entering and exiting the vehicle. To make your selection, press and release the FUNCTION SELECT button until “ON” or “OFF” appears.

NOTE: The seat will return to the memorized seat location (if Recall Memory with Remote Key Unlock is set to ON) when the RKE transmitter is used to unlock the door. Refer to “Easy Entry/Exit Seat” under “Driver Memory Seat” in Section 3.

“Flash Lights with Remote Key Lock”

When ON is selected, the front and rear turn signals will flash when the doors are locked or unlocked with the RKE transmitter. This feature may be selected with or without the sound horn on lock feature selected. To make

your selection, press and release the FUNCTION SELECT button until “ON” or “OFF” appears.

“Headlights On with Wipers”

When ON is selected, and the HEADLIGHT switch is in the AUTO position, the headlights will turn on approximately 10 seconds after the wipers are turned on. The headlights will also turn off when the wipers are turned off if they were turned on by this feature. To make your selection, press and release the FUNCTION SELECT button until “ON” or “OFF” appears.

NOTE: Turning the headlights on during the daytime causes the instrument panel lights to dim. To increase the brightness, refer to “Lights” in Section 3.

“Delay Turning Headlights Off”

When this feature is selected, the driver can choose to have the headlights remain on for 0, 30, 60, or 90 seconds

when exiting the vehicle. To make your selection, press and release the FUNCTION SELECT button until “0,” “30,” “60,” or “90” appears.

“Tilt Mirrors Down in Reverse”

When ON is selected, the outside rearview mirrors will tilt downward when the ignition switch is in the ON position and the transmission is in the REVERSE position. The mirrors will move back to their previous position when the transmission is shifted out of REVERSE. To make your selection, press and release the FUNCTION SELECT button until “ON” or “OFF” appears.

“Turn Headlights On with Remote Key Unlock”

When this feature is selected, the headlights will activate and remain on for up to 90 seconds when the doors are unlocked with the RKE transmitter. To make your selection, press and release the FUNCTION SELECT button until “OFF,” “30 sec.,” “60 sec.,” or “90 sec.” appears.

“Delay Power Off to Accessories Until Exit”

When this feature is selected, the power WINDOW switches, radio, hands-free system (if equipped), DVD video system (if equipped), power sunroof (if equipped), and power outlets will remain active for up to 60 minutes after the ignition switch is turned OFF. Opening a vehicle door will cancel this feature. To make your selection, press and release the FUNCTION SELECT button until “Off,” “45 sec.,” “5 min.,” “10 min.,” “30 min.,” or “60 min.” appears.

“Confirmation of Voice Commands” — If Equipped

When ON is selected, all voice commands from the UConnect® system are confirmed. To make your selection, press and release the FUNCTION SELECT button until “ON” or “OFF” appears.

“Park Assist System”

When ON is selected, the system will scan for objects behind the vehicle when the transmission is in the REVERSE or NEUTRAL position. To make your selection, press and release the FUNCTION SELECT button until “ON” or “OFF” appears.

“Turn-by-Turn Navigation” — If Equipped

When ON is selected, the turn-by-turn directions will appear in the display as the vehicle approaches a designated turn within a programmed route. To make your selection, press and release the FUNCTION SELECT button until “ON” or “OFF” appears.

“Display Units of Measure in”

The EVIC, odometer, and navigation system (if equipped) can be changed between English and Metric units of measure. To make your selection, press and release the FUNCTION SELECT button until “US” or “METRIC” appears.

“Automatic High Beams” — If Equipped

When this feature is selected, the high beam headlights will deactivate automatically under certain conditions. To make your selection, press and release the FUNCTION SELECT button until “ON” or “OFF” appears. Refer to “SmartBeams” in Section 3.

SETTING THE ANALOG CLOCK

To set the analog clock at the top center of the instrument panel, press and hold the button until the setting is correct.

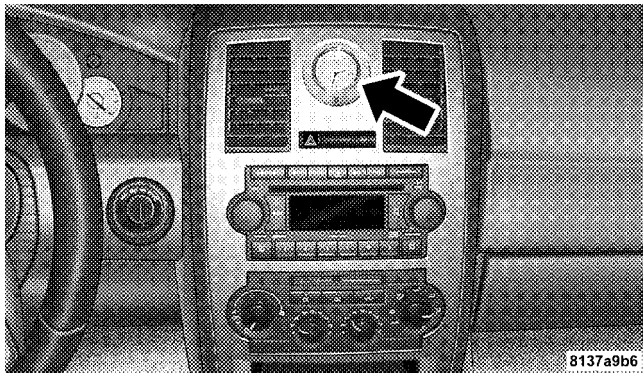

Analog Clock

RADIO GENERAL INFORMATION

Radio Broadcast Signals

Your new radio will provide excellent reception under most operating conditions. Like any system, however, car radios have performance limitations, due to mobile operation and natural phenomena, which might lead you to believe your sound system is malfunctioning. To help you understand and save you concern about these “apparent” malfunctions, you must understand a point or two about the transmission and reception of radio signals.

Two Types of Signals

There are two basic types of radio signals: AM or Amplitude Modulation, in which the transmitted sound causes the amplitude, or height, of the radio waves to vary; and FM or Frequency Modulation, in which the frequency of the wave is varied to carry the sound.

Electrical Disturbances

Radio waves may pick up electrical disturbances during transmission. They mainly affect the wave amplitude, and thus remain a part of the AM reception. They interfere very little with the frequency variations that carry the FM signal.

AM Reception

AM sound is based on wave amplitude, so AM reception can be disrupted by such things as lightning, power lines and neon signs.

FM Reception

Because FM transmission is based on frequency variations, interference that consists of amplitude variations can be filtered out, leaving the reception relatively clear, which is the major feature of FM radio.

NOTE: The radio, steering wheel radio controls, and 6-disc CD/DVD changer (if equipped) will remain active for up to 60 minutes after the ignition switch is turned

OFF. Opening either front door will cancel this feature. The time is programmable. Refer to “Delay Power Off to Accessories Until Exit,” under “Personal Settings (Customer Programmable Features),” under “Electronic Vehicle Information Center (EVIC)” in Section 4.

SALES CODE REN — MULTIMEDIA SYSTEM — IF EQUIPPED

NOTE: The sales code is located on the lower right side of the unit’s faceplate.

The REN Multimedia system contains a radio, CD/DVD player, USB port, a 20-gigabyte hard drive (HDD), and a “JukeBox” (virtual CD changer). Sirius Satellite Radio is optional. The 6.5-in (16.5 cm) touch screen allows for easy menu selection.

A 20-gigabyte HDD allows uploads of music and photos from CDs or through the USB port. The Gracenote database finds the artist, track, and title for the music.

An auxiliary input jack permits passengers to listen to a portable MP3 player through the vehicle's speakers. For vehicles equipped with the Vehicle Entertainment System (VES)[®], separate audio outputs allow passengers to listen to the vehicle speakers while different audio tracks play through the system's wireless headphones. This means rear-seat passengers can watch a DVD on the optional rear seat entertainment system, while the driver and front-seat passenger listen to the radio.

Other special features include direct tune, music type selections, easy store presets, backup camera display for vehicles equipped with a backup camera, and on some models, a dual display screen operation. Refer to your Radio-specific user's manual for detailed operating instructions.

Operating Instructions — Satellite Radio (If Equipped)

Refer to your Radio-specific user's manual for detailed operating instructions.

Operating Instructions — Voice Recognition System (VR) (If Equipped)

For the radio, refer to "Voice Recognition System (VR)" in Section 3.

For Hands Free Phone Communication (UConnect[®]) "Voice Recognition System (VR)," refer to "Hands-Free Communication (UConnect[®])" in Section 3.

Operating Instructions — Hands-Free Communication (UConnect[®]) (If Equipped)

Refer to "Hands-Free Communication (UConnect[®])" in Section 3.

Clock Setting Procedure

Setting the Clock

1. Turn on the multimedia system.
2. Touch the screen where the time is displayed. The clock setting menu will appear on the screen.
3. To move the hour forward, touch the screen where the word "Hour" with the arrow pointing upward is displayed. To move the hour backward, touch the screen where the word "Hour" with the arrow pointing downward is displayed.
4. To move the minute forward, touch the screen where the word "Min" with the arrow pointing upward is displayed. To move the minute backward, touch the screen where the word "Min" with the arrow pointing downward is displayed.

5. To save the new time setting, touch the screen where the word "Save" is displayed.

Changing Daylight Savings Time

When selected, this feature will display the time of day in daylight savings time. Proceed as follows to change the current setting:

1. Turn on the multimedia system.
2. Touch the screen where the time is displayed. The clock setting menu will appear on the screen.
3. When this feature is on, a check mark will appear in the box next to the words "Daylight Savings." Touch the screen where the words "Daylight Savings" are displayed to change the current setting.

Show Time if Radio is Off

When selected, this feature will display the time of day on the touch screen when the multimedia system is turned off. Proceed as follows to change the current setting:

1. Turn on the multimedia system.
2. Touch the screen where the time is displayed. The clock setting menu will appear on the screen.
3. When this feature is on, a check mark will appear in the box next to the words "Show Time if Radio is Off." Touch the screen where the words "Show Time if Radio is Off" are displayed to change the current setting.

Changing the Time Zone

1. Turn on the multimedia system.
2. Touch the screen where the time is displayed. The clock setting menu will appear on the screen.
3. Touch the screen where the words "Set Time Zone" are displayed. The time zone selection menu will appear on the screen.
4. Select a time zone by touching the screen where your selection appears. If you do not see a time zone that you want to select, touch the screen where the word "Page" is displayed to view additional time zones in the menu.
5. Touch the screen where the word "Save" is displayed.

SALES CODE REQ — AM/FM STEREO RADIO AND 6-DISC CD/DVD CHANGER (MP3/WMA AUX JACK)

NOTE: The radio sales code is located on the lower right side of your radio faceplate.

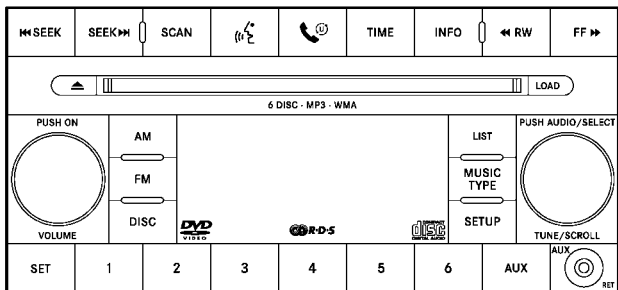

8189f8f9

REQ Radio

Operating Instructions - Radio Mode

NOTE: The ignition switch must be in the ON or ACC position to operate the radio.

Power Switch/Volume Control (Rotary)

Push the ON/VOLUME control knob to turn on the radio. Press the ON/VOLUME control knob a second time to turn off the radio.

Electronic Volume Control

The electronic volume control turns continuously (360 degrees) in either direction without stopping. Turning the ON/VOLUME control knob to the right increases the volume and to the left decreases it.

When the audio system is turned ON, the sound will be set at the same volume level as last played.

SEEK Buttons

Press and release the SEEK buttons to search for the next listenable station in AM/FM mode. Press the right switch

to seek up and the left switch to seek down. The radio will remain tuned to the new station until you make another selection. Holding either button will bypass stations without stopping until you release it.

SCAN Button

Pressing the SCAN button causes the tuner to search for the next listenable station, in AM, FM or Satellite (if equipped) frequencies, pausing for five seconds at each listenable station before continuing to the next. To stop the search, press the SCAN button a second time.

Voice Recognition Button (UConnect® Hands-Free Phone) — If Equipped

Press this button to operate the Hands-Free Phone (UConnect®) feature (if equipped). Refer to “Hands-Free Communication (UConnect®)” in Section 3.

If your vehicle is not equipped with or this feature is not available on your vehicle, a “UConnect® System Not Available” message will display on the radio screen.

Phone Button (UConnect® Hands-Free Phone) — If Equipped

Press this button to operate the Hands-Free Phone (UConnect®) feature (if equipped). Refer to “Hands-Free Communication (UConnect®)” in Section 3.

If your vehicle is not equipped with or this feature is not available on your vehicle, a “UConnect® System Not Available” message will display on the radio screen.

TIME Button

Press the TIME button and the time of day will display. In AM or FM mode, pressing the TIME button will switch between the time and frequency displays.

Clock Setting Procedure

1. Press and hold the TIME button until the hours blink.
2. Adjust the hours by turning the right side TUNE/SCROLL control knob.

3. After adjusting the hours, press the right side TUNE/SCROLL control knob to set the minutes. The minutes will begin to blink.

4. Adjust the minutes using the right side TUNE/SCROLL control knob. Press the TUNE/SCROLL control knob to save the time change.

5. To exit, press any button/knob or wait five seconds.

The clock can also be set by pressing the SETUP button and selecting the "SET HOME CLOCK" entry. Once in this display follow the above procedure, starting at step 2.

INFO Button

Press the INFO button for an RDS station (one with call letters displayed). The radio will return a Radio Text message broadcast from an FM station (FM mode only).

RW/FF

Pressing the RW (Rewind) or FF (Fast Forward) buttons causes the tuner to search for the next frequency in the direction of the arrows. This feature operates in AM, FM or Satellite (if equipped) frequencies.

TUNE Control

Turn the rotary TUNE/SCROLL control knob clockwise to increase or counterclockwise to decrease the frequency.

Setting the Tone, Balance, and Fade

Push the rotary TUNE/SCROLL control knob and BASS will display. Turn the TUNE/SCROLL control knob to the right or left to increase or decrease the bass tones.

Push the rotary TUNE/SCROLL control knob a second time and MID will display. Turn the TUNE/SCROLL control knob to the right or left to increase or decrease the mid range tones.

Push the rotary TUNE/SCROLL control knob a third time and TREBLE will display. Turn the TUNE/SCROLL control knob to the right or left to increase or decrease the treble tones.

Push the rotary TUNE/SCROLL control knob a fourth time and BALANCE will display. Turn the TUNE/SCROLL control knob to the right or left to adjust the sound level from the right or left side speakers.

Push the rotary TUNE/SCROLL control knob a fifth time and FADE will display. Turn the TUNE/SCROLL control knob to the left or right to adjust the sound level between the front and rear speakers.

Push the rotary TUNE/SCROLL control knob again to exit setting tone, balance, and fade.

MUSIC TYPE Button

Pressing this button once will turn on the Music Type mode for five seconds. Pressing the MUSIC TYPE button

or turning the TUNE/SCROLL control knob within five seconds will allow the program format type to be selected. Many radio stations do not currently broadcast Music Type information.

Toggle the MUSIC TYPE button to select the following format types:

Program Type	16-Digit Character Display
No program type or undefined	None
Adult Hits	Adlt Hit
Classical	Classicl
Classic Rock	Cls Rock
College	College
Country	Country
Foreign Language	Language
Information	Inform

Program Type	16-Digit Character Display
Jazz	Jazz
News	News
Nostalgia	Nostalgia
Oldies	Oldies
Personality	Persnlty
Public	Public
Rhythm and Blues	R & B
Religious Music	Rel Musc
Religious Talk	Rel Talk
Rock	Rock
Soft	Soft
Soft Rock	Soft Rck
Soft Rhythm and Blues	Soft R&B
Sports	Sports
Talk	Talk

Program Type	16-Digit Character Display
Top 40	Top 40
Weather	Weather

By pressing the SEEK button when the Music Type icon is displayed, the radio will be tuned to the next frequency station with the same selected Music Type name. The Music Type function only operates when in the FM mode.

If a preset button is activated while in the Music Type (Program Type) mode, the Music Type mode will be exited and the radio will tune to the preset station.

SETUP Button

Pressing the SETUP button allows you to select between the following items:

NOTE: Turn the TUNE/SCROLL control knob to scroll through the entries. Push the AUDIO/SELECT button to select an entry and make changes.

- **DVD Enter** - When the disc is in DVD Menu mode, selecting DVD Enter will allow you to play the current highlighted selection. Use the remote control to scroll up and down the menu (if equipped).



- **DISC Play/Pause** - You can toggle between playing the DVD and pausing the DVD by pushing the SELECT button (if equipped).
- **DVD Play Options** - Selecting the DVD Play Options will display the following:
 - **Subtitle** – Repeatedly pressing SELECT will switch subtitles to different subtitle languages that are available on the disc (if equipped).

- **Audio Stream** – Repeatedly pressing SELECT will switch to different audio languages (if supported on the disc) (if equipped).
- **Angle** – Repeatedly pressing SELECT will change the viewing angle if supported by the DVD disc (if equipped).

NOTE: The available selections for each of the above entries varies depending upon the disc.

NOTE: These selections can only be made while playing a DVD.

- **VES™ Power** - Allows you to turn VES™ ON and OFF (if equipped).
- **VES™ Lock** - Locks out rear VES™ remote controls (if equipped).

- **VES™ CH1/CH2** - Allows the user to change the mode of either the IR1 or IR2, wireless headphones by pressing the AUDIO/SELECT button (if equipped).
- **Set Home Clock** - Pressing the SELECT button allows you to set the clock. Turn the TUNE/SCROLL control knob to adjust the hours and then press and turn the TUNE/SCROLL control knob to adjust the minutes. Press the TUNE/SCROLL control knob again to save changes.
- **Player Defaults** - Selecting this item will allow the user to scroll through the following items, and set defaults according to customer preference.

Menu Language — If Equipped

Selecting this item will allow the user to choose the default startup DVD menu language (effective only if language supported by disc). If you want to select a language not listed, then scroll down and select "other."

Enter the four-digit country code using the TUNE/SCROLL control knob to scroll up and down to select the number and then push to select.

Audio Language — If Equipped

Selecting this item allows you to choose a default audio language (effective only if the language is supported by the disc). You can select a language not listed by scrolling down and selecting "other." Enter the country code using the TUNE/SCROLL control knob to scroll up and down to select the number and then push to select.

Subtitle Language — If Equipped

Selecting this item allows you to choose a default subtitle language (effective only if the language is supported by the disc). You can select a language not listed by scrolling down and selecting "other." Enter the country code using the TUNE/SCROLL control knob to scroll up and down to select the number and then push to select.

Subtitles — If Equipped

Selecting this item allows you to choose between subtitle Off or On.

Audio DRC — If Equipped

Selecting this item allows you to limit maximum audio dynamic range. The default is set to "High," and under this setting, dialogues will play at 11 db higher than if the setting is "Normal."

Aspect Ratio — If Equipped

Selecting this item allows you to choose between wide screen, pan scan, and letter box.

AutoPlay — If Equipped

When this is set to On and a DVD video is inserted, it will bypass the DVD menu screen and automatically play the movie. In some rare cases, the DVD player may not

auto-play the main title. In such cases, use the MENU button on the remote control to select desired title to play.

NOTE: The user will have to set these defaults before loading a disc. If changes are made to these settings after a disc is loaded, changes will not be effective. Also, the defaults are effective only if the disc supports the customer-preferred settings.

AM and FM Buttons

Press the buttons to select AM or FM Modes.

SET Button — To Set the Pushbutton Memory

When you are receiving a station that you wish to commit to pushbutton memory, press the SET button. The symbol SET 1 will now show in the display window. Select the button (1-6) you wish to lock onto this station and press and release that button. If a button is not selected within five seconds after pressing the SET button, the station will continue to play but will not be stored into pushbutton memory.

You may add a second station to each pushbutton by repeating the above procedure with this exception: Press the SET button twice and SET 2 will show in the display window. Each button can be set for SET 1 and SET 2 in both AM and FM. This allows a total of 12 AM, 12 FM, and 12 Satellite (if equipped) stations to be stored into pushbutton memory. The stations stored in SET 2 memory can be selected by pressing the pushbutton twice.

Every time a preset button is used, a corresponding button number will display.

Buttons 1 - 6

These buttons tune the radio to the stations that you commit to pushbutton memory {12 AM, 12 FM, and 12 Satellite (if equipped) stations}.

DISC Button

Pressing the DISC button will allow you to switch from AM/FM modes to Disc modes.

Operation Instructions - (DISC MODE for CD and MP3/WMA Audio Play, DVD-VIDEO)

The radio DVD player and many DVD discs are coded by geographic region. These region codes must match in order for the disc to play. If the region code for the DVD disc does not match the region code for the radio DVD player, it will not play the disc. Customers may take their vehicle to an authorized dealer to change the region code of the player a maximum of five times.

CAUTION!

The radio may shut down during extremely hot conditions. When this occurs, the radio will indicate "Disc Hot" and shut off until a safe temperature is reached. This shutdown is necessary to protect the optics of the DVD player and other radio internal components.

NOTE: The ignition switch must be in the ON or ACC position to operate the radio.

LOAD Button — Loading Compact Disc(s)

Press the LOAD button and the pushbutton with the corresponding number (1-6) where the CD is being loaded. The radio will display PLEASE WAIT and prompt when to INSERT DISC. After the radio displays "INSERT DISC," insert the CD into the player.

Radio display will show "LOADING DISC" when the disc is loading and "READING DISC" when the radio is reading the disc.

CAUTION!

This CD player will accept 4-3/4 in (12 cm) discs only. The use of other sized discs may damage the CD player mechanism.

Eject Button — Ejecting Compact Disc(s)



Press the eject button and the pushbutton with the corresponding number (1-6) where the CD was loaded and the disc will unload and move to the entrance for easy removal. Radio display will show "EJECTING DISC" when the disc is being ejected and prompt the user to remove the disc.

Press and hold the eject button for five seconds and all CDs will be ejected from the radio.

The disc can be ejected with the radio and ignition OFF.

SEEK Button (CD MODE)

Press the right SEEK button for the next selection on the CD. Press the left SEEK button to return to the beginning of the current selection, or return to the beginning of the previous selection if the CD is within the first second of the current selection. Pressing and holding the SEEK button will allow you to scroll through the tracks faster in CD, MP3/MWA modes.

SCAN Button (CD MODE)

Press the SCAN button to scan through each track on the CD currently playing.

TIME Button (CD MODE)

Press this button to change the display from a large CD playing time display to a small CD playing time display.

RW/FF (CD MODE)

Press and hold FF (Fast Forward) and the CD player will begin to fast forward until FF is released, or RW or another CD button is pressed. The RW (Rewind) button works in a similar manner.

AM or FM Button (CD MODE)

Switches the radio to the Radio mode.

Notes On Playing MP3/WMA Files

The radio can play MP3/WMA files; however, acceptable MP3/WMA file recording media and formats are limited. When writing MP3/WMA files, pay attention to the following restrictions.

Supported Media (Disc Types)

The MP3/WMA file recording media supported by the radio are CDDA, CD-R, CD-RW, MP3, WMA, DVD Video, DVD-R, DVD-RW, DVD+R, DVD+RW, and CDDA+MP3.

Supported Medium Formats (File Systems)

The medium formats supported by the radio are ISO 9660 Level 1 and Level 2 and includes the Joliet extension. When reading discs recorded using formats other than ISO 9660 Level 1 and Level 2, the radio may fail to read files properly and may be unable to play the file normally. UDF and Apple HFS formats are not supported.

The radio uses the following limits for file systems:

- Maximum number of directory levels: 8
- Maximum number of files: 255
- Maximum number of folders: 100
- Maximum number of characters in file/folder names:
 - Level 1: 12 (including a separator "." and a three-character extension)
 - Level 2: 31 (including a separator "." and a three-character extension)

Multisession disc formats are supported by the radio. Multisession discs may contain combinations of normal CD audio tracks and computer files (including MP3/WMA files). Discs created with an option such as "keep disc open after writing" are most likely multisession discs. The use of multisession for CD audio or MP3/WMA playback may result in longer disc loading times.

If a disc contains multi-formats, such as CD audio and MP3/WMA tracks, the radio will only play the MP3/WMA tracks on that disc.

Supported MP3/WMA File Formats

The radio will recognize only files with the *.MP3/WMA extension as MP3/WMA files. Non-MP3/WMA files named with the *.MP3/WMA extension may cause playback problems. The radio is designed to recognize the file as an invalid MP3/WMA and will not play the file.

When using the MP3/WMA encoder to compress audio data to an MP3/WMA file, the bit rate and sampling frequencies in the following table are supported. In addition, variable bit rates (VBR) are also supported. The majority of MP3/WMA files use a 44.1 kHz sampling rate and a 192, 160, 128, 96 or VBR bit rates.

MPEG Specification	Sampling Frequency (kHz)	Bit Rate (kbps)
MPEG-1 Audio Layer 3	48, 44.1, 32	320, 256, 224, 192, 160, 128, 112, 96, 80, 64, 56, 48
MPEG-2 Audio Layer 3	24, 22.05, 16	160, 128, 144, 112, 96, 80, 64, 56, 48

WMA Specification	Sampling Frequency (kHz)	Bit Rate (kbps)
WMA	44.1 and 48	48, 64, 96, 128, 160, 192 VBR

ID3 Tag information for artist, song title, and album title are supported for ID3 version 1 tags. ID3 version 2 is not supported by the radios.

Playlist files are not supported. MP3 Pro files are not supported.

Playback of MP3/WMA Files

When a medium containing MP3/WMA data is loaded, the radio checks all files on the medium. If the medium contains a lot of folders or files, the radio will take more time to start playing the MP3/WMA files.

Loading times for playback of MP3/WMA files may be affected by the following:

- Media - CD-RW media may take longer to load than CD-R media
- Medium formats - Multisession discs may take longer to load than non-multisession discs
- Number of files and folders - Loading times will increase with more files and folders

To increase the speed of disc loading, it is recommended to use CD-R media and single-session discs. To create a single-session disc, enable the "Disc at Once" option before writing to the disc.

LIST Button (DISC Mode for MP3/WMA Play)

Pressing the LIST button will bring up a list of all folders on the disc. Scrolling up or down the list is done by turning the TUNE/SCROLL control knob. Selecting a folder by pressing the TUNE/SCROLL control knob will begin playing the files contained in that folder (or the next folder in sequence if the selection does not contain playable files).

The folder list will time out after five seconds.

INFO Button (DISC Mode for MP3/WMA Play)

Pressing the INFO button repeatedly will scroll through the following TAG information: Song Title, Artist, File Name, and Folder Name (if available).

Press the INFO button once more to return to "elapsed time" priority mode.

Press and hold the INFO button for three seconds or more and radio will display song titles for each file.

Press and hold the INFO button again for three seconds to return to "elapsed time" display.

Operation Instructions - Auxiliary Mode

The auxiliary (AUX) jack is an audio input jack, which allows the user to plug in a portable device such as an MP3/WMA player, cassette player, or microphone and utilize the vehicle's audio system to amplify the source and play through the vehicle speakers.

Pressing the AUX button will change the mode to auxiliary device if the AUX jack is connected.

NOTE: The AUX device must be turned on and the device's volume set to the proper level. If the AUX audio is not loud enough, turn the device's volume up. If the AUX audio sounds distorted, turn the device's volume down.

SEEK Button (Auxiliary Mode)

No function.

SCAN Button (Auxiliary Mode)

No function.

EJECT Button (Auxiliary Mode)

No function.



TIME Button (Auxiliary Mode)

Press the TIME button to change the display from elapsed playing time to time of day. The time of day will display for five seconds.

RW/FF (Auxiliary Mode)

No function.

SET Button (Auxiliary Mode)

No function.

Operating Instructions — Voice Recognition System (VR) (If Equipped)

For the radio, refer to “Voice Recognition System (VR)” in Section 3.

For UConnect® “Voice Recognition System (VR),” refer to “Hands-Free Communication (UConnect®)” in Section 3.

Operating Instructions - Hands-Free Phone (UConnect®) (If Equipped)

Refer to “Hands-Free Communication (UConnect®)” in Section 3.

Operating Instructions - Satellite Radio Mode (If Equipped)

Refer to “Satellite Radio” in this section.

Operating Instructions - Video Entertainment System (VES™) (If Equipped)

Refer to separate “Video Entertainment System (VES™) Guide.”

Dolby®

Manufactured under license from Dolby Laboratories. “Dolby” and the double-D symbol are trademarks of Dolby Laboratories.

Macrovision

This product incorporates copyright protection technology that is protected by U.S. patents and other intellectual property rights. Use of this copyright protection technology must be authorized by Macrovision, and is intended for home and other limited viewing uses only, unless otherwise authorized by Macrovision. Reverse engineering or disassembly is prohibited

DTS™

“DTS” and “DTS 2.0” are trademarks of Digital Theater Systems, Inc.

SALES CODE RER — MULTIMEDIA SYSTEM — IF EQUIPPED

NOTE: The sales code is located on the lower right side of the unit’s faceplate.

The RER Multimedia system contains a radio, Sirius Satellite Radio player, navigation system, CD/DVD player, USB port, 20-gigabyte hard drive (HDD), and the UConnect® Hands-Free Bluetooth® cellular system.

NOTE: If your vehicle is not equipped with UConnect®, the unit will respond with a “Feature Not Available” message when selecting controls related to this feature.

A 6.5-in (16.5 cm) touch screen allows easy menu selection, while the Advanced Voice Dialog System recognizes more than 1,000 words for audio, navigation, entertainment, and hands-free mobile phone use.

The satellite navigation capability combines a Global-Positioning System (GPS)-based navigation system with an integrated color screen to provide maps, turn identification, selection menus, and instructions for selecting a variety of destinations and routes.

A shared HDD for the navigation system, the database, and other radio features allows uploads of music and photos from CDs or through the USB port. The Gracenote database finds the artist, track, and title for the music.

An auxiliary input jack permits passengers to listen to a portable MP3 player through the vehicle’s speakers. For vehicles equipped with the Vehicle Entertainment System (VES)®, separate audio outputs allow passengers to listen to the vehicle speakers while different audio tracks play through the system’s wireless headphones. This means rear-seat passengers can watch a DVD on the optional rear-seat entertainment system while the driver and front-seat passenger listen to the radio.

Other special features include direct tune, music type selections, traffic messaging (optional), easy store presets, parental lockout for VES™ (if equipped), backup camera display for vehicles equipped with a backup camera, and on some models, a dual display screen operation. Refer to your “Navigation User’s Manual” for detailed operating instructions.

Operating Instructions — Satellite Radio

Refer to your “Navigation User’s Manual” for detailed operating instructions.

Operating Instructions — Hands-Free Communication (UConnect®) (If Equipped)

Refer to your “Navigation User’s Manual” for detailed operating instructions.

Clock Setting Procedure

The GPS receiver in this system is synchronized to the time data being transmitted by the GPS satellites. The satellites’ clock is Greenwich Mean Time (GMT). This is the worldwide standard for time. This makes the system’s clock very accurate once the appropriate time zone and daylight savings information is set.

Changing the Time Zone

1. Turn on the multimedia system.
2. Touch the screen where the time is displayed. The clock setting menu will appear on the screen. If the words “Time: GPS Time” are displayed at the top of the screen, proceed to Step 4. Otherwise, proceed to Step 3.
3. If the words “Time: User Clock” are displayed at the top of the screen, touch the bottom of the screen where the words “User Clock” are displayed. The GPS time setting menu will appear on the screen.

4. Touch the screen where the words “Set Time Zone” are displayed. The time zone selection menu will appear on the screen.

5. Select a time zone by touching the screen where your selection appears. If you do not see a time zone that you want to select, touch the screen where the word “Page” is displayed to view additional time zones in the menu.

Changing Daylight Savings Time

When selected, this feature will display the time of day in daylight savings time. Proceed as follows to change the current setting:

1. Turn on the multimedia system.
2. Touch the screen where the time is displayed. The clock setting menu will appear on the screen.

3. When this feature is on, a check mark will appear in the box next to the words “Daylight Savings.” Touch the screen where the words “Daylight Savings” are displayed to change the current setting.

Setting the User Clock

If you wish to set the clock to a time different from the system clock, you can manually adjust the time by performing the following:

1. Turn on the multimedia system.
2. Touch the screen where the time is displayed. The clock setting menu will appear on the screen. If the words “Time: User Clock” are displayed at the top of the screen, proceed to Step 4. Otherwise, proceed to Step 3.

3. If the words “Time: GPS Time” are displayed at the top of the screen, touch the bottom of the screen where the words “GPS Time” are displayed. The user clock time setting menu will appear on the screen.
4. To move the hour forward, touch the screen where the word “Hour” with the arrow pointing upward is displayed. To move the hour backward, touch the screen where the word “Hour” with the arrow pointing downward is displayed.
5. To move the minute forward, touch the screen where the word “Min” with the arrow pointing upward is displayed. To move the minute backward, touch the screen where the word “Min” with the arrow pointing downward is displayed.
6. To save the new time setting, touch the screen where the word “Save” is displayed.

Show Time if Radio is Off

When selected, this feature will display the time of day on the touch screen when the system is turned off. Proceed as follows to change the current setting:

1. Turn on the multimedia system.
2. Touch the screen where the time is displayed. The clock setting menu will appear on the screen.
3. When this feature is on, a check mark will appear in the box next to the words “Show Time if Radio is Off.” Touch the screen where the words “Show Time if Radio is Off” are displayed to change the current setting.

SALES CODE RES — AM/FM STEREO RADIO WITH CD PLAYER (MP3 AUX JACK)

NOTE: The radio sales code is located on the lower right side of your radio faceplate.

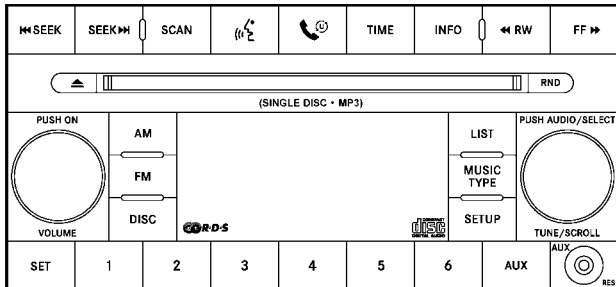

81c7c564

RES Radio (Non-Satellite Model Shown - With Satellite Similar)

Operating Instructions - Radio Mode

NOTE: The ignition switch must be in the ON or ACC position to operate the radio.

Power Switch/Volume Control (Rotary)

Push the ON/VOLUME control knob to turn on the radio. Push the ON/VOLUME control knob a second time to turn off the radio.

Electronic Volume Control

The electronic volume control turns continuously (360 degrees) in either direction without stopping. Turning the ON/VOLUME control knob to the right increases the volume and to the left decreases it.

When the audio system is turned on, the sound will be set at the same volume level as last played.

SEEK Buttons

Press and release the SEEK buttons to search for the next listenable station in AM/FM mode. Press the right switch to seek up and the left switch to seek down. The radio will remain tuned to the new station until you make another selection. Holding either button will bypass stations without stopping until you release it.

SCAN Button

Pressing the SCAN button causes the tuner to search for the next listenable station in AM or FM frequencies, pausing for five seconds at each listenable station before continuing to the next. To stop the search, press the SCAN button a second time.

Voice Recognition System (Radio) — If Equipped

Refer to “Voice Recognition System (VR)” in Section 3.

Voice Recognition Button (UConnect® Hands-Free Phone) — If Equipped

Press this button to operate the Hands-Free Phone (UConnect®) feature (if equipped). Refer to “Hands-Free Communication (UConnect®)” in Section 3.

If your vehicle is not equipped with this or this feature is not available on your vehicle, a “Not Equipped With UConnect” message will display on the radio screen.

PHONE Button (UConnect® Hands-Free Phone) — If Equipped

Press this button to operate the Hands-Free Phone (UConnect®) feature (if equipped). Refer to “Hands-Free Communication (UConnect®)” in Section 3.

If your vehicle is not equipped with this or this feature is not available on your vehicle, a “Not Equipped With UConnect®” message will display on the radio screen.

TIME Button

Press the TIME button and the time of day will display. In AM or FM mode, pressing the TIME button will switch between the time and frequency displays.

Clock Setting Procedure

1. Press and hold the TIME button, until the hours blink.
2. Adjust the hours by turning the right side TUNE/SCROLL control knob.
3. After adjusting the hours, press the right side TUNE/SCROLL control knob to set the minutes. The minutes will begin to blink.
4. Adjust the minutes using the right side TUNE/SCROLL control knob. Press the TUNE/SCROLL control knob to save time change.
5. To exit, press any button/knob or wait five seconds.

The clock can also be set by pressing the SETUP button. For vehicles equipped with satellite radio, press the SETUP button, use the TUNE/SCROLL control to select SET CLOCK, and then follow the above procedure, starting at Step 2. For vehicles not equipped with satellite radio, press the SETUP button and then follow the above procedure, starting at Step 2.

INFO Button

Press the INFO button for an RDS station (one with call letters displayed). The radio will return a Radio Text message broadcast from an FM station (FM mode only).

RW/FF

Pressing the RW (Rewind) or FF (Fast Forward) buttons causes the tuner to search for the next frequency in the direction of the arrows. This feature operates in either AM or FM frequencies.

TUNE Control

Turn the rotary TUNE/SCROLL control knob clockwise to increase or counterclockwise to decrease the frequency.

Setting the Tone, Balance, and Fade

Push the rotary TUNE/SCROLL control knob and BASS will display. Turn the TUNE/SCROLL control knob to the right or left to increase or decrease the bass tones.

Push the rotary TUNE/SCROLL control knob a second time and MID will display. Turn the TUNE/SCROLL control knob to the right or left to increase or decrease the mid range tones.

Push the rotary TUNE/SCROLL control knob a third time and TREBLE will display. Turn the TUNE/SCROLL control knob to the right or left to increase or decrease the treble tones.

Push the rotary TUNE/SCROLL control knob a fourth time and BALANCE will display. Turn the TUNE/

SCROLL control knob to the right or left to adjust the sound level from the right or left side speakers.

Push the rotary TUNE/SCROLL control knob a fifth time and FADE will display. Turn the TUNE/SCROLL control knob to the left or right to adjust the sound level between the front and rear speakers.

Push the rotary TUNE/SCROLL control knob again to exit setting tone, balance, and fade.

MUSIC TYPE Button

Pressing this button once will turn on the Music Type mode for five seconds. Pressing the MUSIC TYPE button or turning the TUNE/SCROLL control knob within five seconds will allow the program format type to be selected. Many radio stations do not currently broadcast Music Type information.

Toggle the MUSIC TYPE button to select the following format types:

Program Type	16-Digit Character Display
No program type or undefined	None
Adult Hits	Adlt Hit
Classical	Classicl
Classic Rock	Cls Rock
College	College
Country	Country
Foreign Language	Language
Information	Inform
Jazz	Jazz
News	News
Nostalgia	Nostalga
Oldies	Oldies

Program Type	16-Digit Character Display
Personality	Persnlty
Public	Public
Rhythm and Blues	R & B
Religious Music	Rel Musc
Religious Talk	Rel Talk
Rock	Rock
Soft	Soft
Soft Rock	Soft Rck
Soft Rhythm and Blues	Soft R&B
Sports	Sports
Talk	Talk
Top 40	Top 40
Weather	Weather

By pressing the SEEK button when the Music Type icon is displayed, the radio will be tuned to the next frequency station with the same selected Music Type name. The Music Type function only operates when in the FM mode.

If a preset button is activated while in the Music Type (Program Type) mode, the Music Type mode will be exited and the radio will tune to the preset station.

SETUP Button

Pressing the SETUP button allows you to select between the following items:

- **Set Clock** — Pressing the SELECT button will allow you to set the clock. Turn the TUNE/SCROLL control knob to adjust the hours and then press and turn the TUNE/SCROLL control knob to adjust the minutes. Press the TUNE/SCROLL control knob again to save changes.

AM and FM Buttons

Press the buttons to select AM or FM modes.

SET Button — To Set the Pushbutton Memory

When you are receiving a station that you wish to commit to pushbutton memory, press the SET button. The symbol SET 1 will now show in the display window. Select the button (1 to 6) you wish to lock onto this station and press and release that button. If a button is not selected within five seconds after pressing the SET button, the station will continue to play but will not be stored into pushbutton memory.

You may add a second station to each pushbutton by repeating the above procedure with this exception: Press the SET button twice and SET 2 will show in the display window. Each button can be set for SET 1 and SET 2 in both AM and FM. This allows a total of 12 AM and 12 FM

stations to be stored into pushbutton memory. The stations stored in SET 2 memory can be selected by pressing the pushbutton twice.

Every time a preset button is used, a corresponding button number will display.

Buttons 1 - 6

These buttons tune the radio to the stations that you commit to pushbutton memory (12 AM and 12 FM stations).

DISC Button

Pressing the DISC button will allow you to switch from AM/FM modes to Disc modes.

Operation Instructions - CD MODE for CD and MP3 Audio Play

NOTE: The ignition switch must be in the ON or ACC position to operate the radio.

NOTE: This radio is capable of playing compact discs (CD), recordable compact discs (CD-R), rewritable compact discs (CD-RW), compact discs with MP3 tracks and multisession compact discs with CD and MP3 tracks.

Inserting Compact Disc(s)

Gently insert one CD into the CD player with the CD label facing up. The CD will automatically be pulled into the CD player and the CD icon will illuminate on the radio display. If a CD does not go into the slot more than an inch (2.5 cm), a disc may already be loaded and must be ejected before a new disc can be loaded.

If you insert a disc with the ignition ON and the radio ON, the unit will switch from radio to CD mode and begin to play when you insert the disc. The display will show the disc number, the track number, and index time in minutes and seconds. Play will begin at the start of track 1.

CAUTION!

- This CD player will accept 4-3/4 in (12 cm) discs only. The use of other sized discs may damage the CD player mechanism.
- Do not use adhesive labels. These labels can peel away and jam the player mechanism.
- RES is a single CD player. Do not attempt to insert a second CD if one is already loaded.
- Dual-media disc types (one side is a DVD, the other side is a CD) should not be used, and they can cause damage to the player.

EJECT Button - Ejecting a CD

Press the EJECT button to eject the CD.



If you have ejected a disc and have not removed it within 10 seconds, it will be reloaded. If the CD is not removed, the radio will reinsert the CD but will not play it.

A disc can be ejected with the radio and ignition OFF.

NOTE: Ejecting with ignition OFF is not allowed on convertible or soft-top models (if equipped).

SEEK Button

Press the right SEEK button for the next selection on the CD. Press the left SEEK button to return to the beginning of the current selection, or return to the beginning of the previous selection if the CD is within the first second of the current selection. Pressing and holding the SEEK button will allow faster scrolling through the tracks in CD, MP3 modes.

SCAN Button

Press the SCAN button to scan through each track on the CD currently playing.

TIME Button

Press this button to change the display from a large CD playing time display to a small CD playing time display.

RW/FF

Press the RW button to stop the CD at the beginning of the current CD track/title.

Press and hold FF (Fast Forward) and the CD player will begin to fast forward until FF is released or RW or another CD button is pressed. The RW (Reverse) button works in a similar manner.

AM or FM Button

Switches the AM or FM radio to the opposite radio mode.

RND Button (Random Play Button)

Press this button while the CD is playing to activate Random Play. This feature plays the selections on the compact disc in random order to provide an interesting change of pace.

Press the right SEEK button to move to the next randomly selected track.

Press the RND button a second time to stop Random Play.

Notes On Playing MP3 Files

The radio can play MP3 files; however, acceptable MP3 file recording media and formats are limited. When writing MP3 files, pay attention to the following restrictions.

Supported Media (Disc Types)

The MP3 file recording media supported by the radio are CDDA, CD-R, CD-RW, MP3, and CDDA+MP3.

Supported Medium Formats (File Systems)

The medium formats supported by the radio are ISO 9660 Level 1 and Level 2 and includes the Joliet extension. When reading discs recorded using formats other than ISO 9660 Level 1 and Level 2, the radio may fail to read

files properly and may be unable to play the file normally. UDF and Apple HFS formats are not supported.

The radio uses the following limits for file systems:

- Maximum number of folder levels: 8
- Maximum number of files: 255
- Maximum number of folders. (The radio display of file names and folder names is limited. For large numbers of files and/or folders, the radio may be unable to display the file name and folder name and will assign a number instead. With a maximum number of files, exceeding 20 folders will result in this display. With 200 files, exceeding 50 folders will result in this display.)
- Maximum number of characters in file/folder names:
 - Level 1: 12 (including a separator "." and a three-character extension)
 - Level 2: 31 (including a separator "." and a three-character extension)

Multisession disc formats are supported by the radio. Multisession discs may contain combinations of normal CD audio tracks and computer files (including MP3 files). Discs created with an option such as "keep disc open after writing" are most likely multisession discs. The use of multisession for CD audio or MP3 playback may result in longer disc loading times.

Supported MP3 File Formats

The radio will recognize only files with the *.MP3 extension as MP3 files. Non-MP3 files named with the *.MP3 extension may cause playback problems. The radio is designed to recognize the file as an invalid MP3 and will not play the file.

When using the MP3 encoder to compress audio data to an MP3 file, the bit rate and sampling frequencies in the following table are supported. In addition, variable bit

rates (VBR) are also supported. The majority of MP3 files use a 44.1 kHz sampling rate and a 192, 160, 128, 96 or VBR bit rates.

MPEG Specification	Sampling Frequency (kHz)	Bit Rate (kbps)
MPEG-1 Audio Layer 3	48, 44.1, 32	320, 256, 224, 192, 160, 128, 112, 96, 80, 64, 56, 48, 40, 32
MPEG-2 Audio Layer 3	24, 22.05, 16	160, 128, 144, 112, 96, 80, 64, 56, 48, 40, 32, 24, 16, 8

ID3 Tag information for artist, song title, and album title are supported for version 1 ID3 tags. ID3 version 2 is not supported by the radios.

Playlist files are not supported. MP3 Pro files are not supported.

Playback of MP3 Files

When a medium containing MP3 data is loaded, the radio checks all files on the medium. If the medium contains a lot of folders or files, the radio will take more time to start playing the MP3 files.

Loading times for playback of MP3 files may be affected by the following:

- Media - CD-RW media may take longer to load than CD-R media
- Medium formats - Multisession discs may take longer to load than non-multisession discs
- Number of files and folders - Loading times will increase with more files and folders

To increase the speed of disc loading, it is recommended to use CD-R media and single-session discs. To create a single-session disc, enable the “Disc at Once” option before writing to the disc.

LIST Button (CD Mode for MP3 Play)

Pressing the LIST button will bring up a list of all folders on the disc. Scrolling up or down the list is done by turning the TUNE/SCROLL control knob. Selecting a folder by pressing the TUNE/SCROLL control knob will begin playing the files contained in that folder (or the next folder in sequence if the selection does not contain playable files).

The folder list will time out after five seconds.

INFO Button (CD Mode for MP3 Play)

Pressing the INFO button repeatedly will scroll through the following TAG information: Song Title, Artist, File Name, and Folder Name (if available).

Press the INFO button once more to return to "elapsed time" priority mode.

Press and hold the INFO button for three seconds or more and the radio will display song titles for each file.

Press and hold the INFO button again for three seconds to return to "elapsed time" display.

Operation Instructions - Auxiliary Mode

The auxiliary (AUX) jack is an audio input jack, which allows the user to plug in a portable device such as an MP3 player, or cassette player, and utilize the vehicle's audio system to amplify the source and play through the vehicle speakers.

Pressing the AUX button will change the mode to auxiliary device if the AUX jack is connected.

NOTE: The AUX device must be turned on and the device's volume set to proper level. If the AUX audio is not loud enough, turn the device's volume up. If the AUX audio sounds distorted, turn the device's volume down.

TIME Button (Auxiliary Mode)

Press this button to change the display to time of day. The time of day will display for five seconds (when ignition is OFF).

Operating Instructions - Hands-Free Phone (UConnect®) (If Equipped)

Refer to “Hands-Free Communication (UConnect®)” in Section 3.

Operating Instructions - Satellite Radio Mode (If Equipped)

Refer to “Satellite Radio” in this section.

Operating Instructions - Video Entertainment System™ (VES™) (If Equipped)

Refer to separate “Video Entertainment System™ (VES™) Guide.”

SATELLITE RADIO (RSC) — IF EQUIPPED (RER/REQ/REN RADIOS ONLY)

Satellite radio uses direct satellite-to-receiver broadcasting technology to provide clear digital sound, coast to coast. The subscription service provider is Sirius Satellite Radio. This service offers over 130 channels of music, sports, news, entertainment, and programming for children, directly from its satellites and broadcasting studios.

NOTE: Sirius service is not available in Hawaii and has limited coverage in Alaska.

System Activation

Sirius Satellite Radio service is pre-activated, and you may begin listening immediately to the one year of audio service that is included with the factory-installed satellite radio system in your vehicle. Sirius will contact you to supply a welcome kit and to confirm subscription information, including the setup of your on-line listening account at no additional charge. For further information,

call the toll-free number 888-539-7474, or visit the Sirius web site at www.sirius.com, or at www.siriuscanada.ca for Canadian residents. Please have the following information available when calling:

1. The Electronic Serial Number/Sirius Identification Number (ESN/SID).
2. Your Vehicle Identification Number.

Electronic Serial Number/Sirius Identification Number (ENS/SID)

The Electronic Serial Number/Sirius Identification Number is needed to activate your Sirius Satellite Radio system. To access the ESN/SID, refer to the following steps:

ESN/SID Access With REQ Radios

With the ignition switch in the ON/RUN or ACC position and the radio ON, press the SETUP button and scroll using the TUNE/SCROLL control knob until Sirius ID is

selected. Press the TUNE/SCROLL control knob and the Sirius ID number will display. The Sirius ID number display will time out in two minutes. Press any button on the radio to exit this screen.

ESN/SID Access With RER/REN Radios

While in SAT mode, press the MENU button on the radio faceplate.

Next touch the SUBSCRIPTION tab on the touch screen. All the ESNs that apply to your vehicle will be displayed.

Selecting Satellite Mode

Press the SAT button until "SAT" appears in the display. A CD may remain in the radio while in the Satellite radio mode.

Satellite Antenna

To ensure optimum reception, do not place items on the roof around the rooftop antenna location or strap items to the trunk lid around the trunk lid antenna (if equipped). Metal objects placed within the line of sight of the antenna will cause decreased performance. Larger luggage items such as bikes should be placed as far rearward as possible, within the loading design of the rack. Do not place items directly on or above the antenna.

Reception Quality

Satellite reception may be interrupted due to one of the following reasons:

- The vehicle is parked in an underground parking structure or under a physical obstacle.
- Dense tree coverage may interrupt reception in the form of short audio mutes.

- Driving under wide bridges or along tall buildings can cause intermittent reception.
- Placing objects over or too close to the antenna can cause signal blockage.

Operating Instructions - Satellite Mode

NOTE: The ignition switch must be in the ON or ACC position to operate the radio.

SEEK Buttons

Press and release the SEEK buttons to search for the next channel in Satellite mode. Press the right switch to seek up and the left switch to seek down. The radio will remain tuned to the new channel until you make another selection. Holding either button will bypass channels without stopping until you release it.

SCAN Button

Pressing the SCAN button causes the tuner to search for the next channel, pausing for eight seconds before continuing to the next. To stop the search, press the SCAN button a second time.

INFO Button

Pressing the INFO button will cycle between Artist, Song Title, and Composer (if available) information. Also, pressing and holding the INFO button for an additional three seconds will make the radio display the Song Title all of the time (press and hold again to return to normal display).

RW/FF

Pressing the RW (Rewind) or FF (Fast Forward) buttons causes the tuner to search for the next channel in the direction of the arrows.

TUNE Control (Rotary)

Turn the rotary TUNE/SCROLL control knob clockwise to increase or counterclockwise to decrease the channel.

MUSIC TYPE Button

Pressing this button once will turn on the Music Type mode for five seconds. Pressing the MUSIC TYPE button or turning the TUNE/SCROLL control knob within five seconds will allow the program format type to be selected.

Toggle the MUSIC TYPE button again to select the music type.

By pressing the SEEK button when the Music Type function is active, the radio will be tuned to the next channel with the same selected Music Type name.

If a preset button is activated while in the Music Type (Program Type) mode, the Music Type mode will be exited and the radio will tune to the preset channel.

SETUP Button

Pressing the SETUP button allows you to select the following items:

- Display Sirius ID number — Press the AUDIO/SELECT button to display the Sirius ID number. This number is used to activate, deactivate, or change the Sirius subscription.

SET Button – To Set the Pushbutton Memory

When you are receiving a channel that you wish to commit to pushbutton memory, press the SET button. The symbol SET 1 will now show in the display window. Select the button (1-6) you wish to lock onto this channel and press and release that button. If a button is not selected within five seconds after pressing the SET button, the channel will continue to play but will not be stored into pushbutton memory.

You may add a second channel to each pushbutton by repeating the above procedure with this exception: Press the SET button twice and SET 2 will show in the display window. Each button can be set for SET 1 and SET 2. This allows a total of 12 Satellite channels to be stored into pushbutton memory. The channels stored in SET 2 memory can be selected by pressing the pushbutton twice.

Every time a preset button is used, a corresponding button number will display.

Buttons 1 - 6

These buttons tune the radio to the channels that you commit to pushbutton memory (12 Satellite stations).

Operating Instructions - Hands-Free Phone (If Equipped)

Refer to “Hands-Free Communication (UConnect®)” in Section 3.

Operating Instructions - Video Entertainment System (VES™) (If Equipped)

Refer to separate “Video Entertainment System (VES™) Guide.”

SIRIUS BACKSEAT TV™ — IF EQUIPPED

Satellite video uses direct satellite receiver broadcasting technology to provide streaming video coast to coast. The subscription service provider is SIRIUS Satellite Radio. SIRIUS Backseat TV™ offers three video channels for family entertainment, directly from its satellites and broadcasting studios.

NOTE: SIRIUS service is not available in Hawaii and has limited coverage in Alaska.

Refer to your Video Entertainment System (VES), RER Navigation or REN Multimedia User Manuals for detailed operating instructions.

VIDEO ENTERTAINMENT SYSTEM (VES)® — IF EQUIPPED

The optional Video Entertainment System (VES)® includes the following components for rear seat entertainment:

- A diagonal 7 in (17.8 cm) Liquid Crystal Display (LCD) screen integrated into the center console armrest. The screen features brightness control for optimum daytime and nighttime viewing.

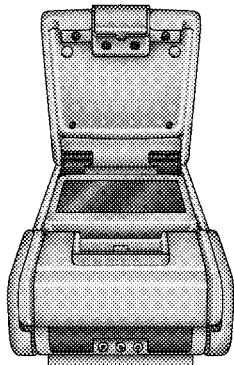

8199815e

Opening the Rear Seat VES®

- The LCD Screen swings up from the rear of the armrest to allow the rear seat passenger(s) to view the display.

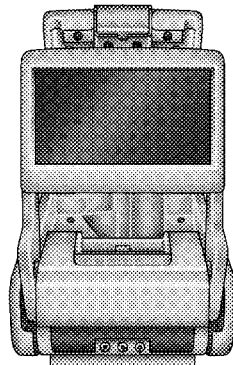

8199818b

VES® Video Screen

- NOTE:** Close the armrest after the LCD screen has been raised to its viewing position.
- The touch screen radio and DVD player controls allow front seat operation for easy setup in the case of younger rear seat passengers.

- A battery-powered infrared remote control snaps into a molded compartment in the center console armrest upper storage bin.

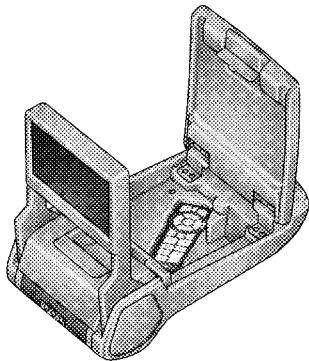

VES® Remote Control

81abfb61

- Two wireless infrared headsets allow rear seat passengers to listen to the same or individual audio sources.

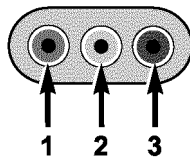

Audio/Video RCA Jacks (AUX Jacks) on the rear of the center console enable the monitor to display video directly from a video camera, connect video games for display on the screen, or play music directly from an MP3 player.

1. Video in (yellow)
2. Left audio in (white)
3. Right audio in (red)

NOTE: Refer to your “Vehicle Entertainment System (VES®) Users Manual” for detailed operating instructions.

Kicker® 13-speaker High Performance Sound System with Driver-Selectable Surround (DSS) – If Equipped

Your vehicle is equipped with a state of the art audio amplifier that provides 5.1-channel surround sound from any stereo audio source. A new feature of the Kicker® audio system offers the ability to choose surround sound for any audio source or video source.

“Video Surround” is optimized for rear-seat passengers watching a video, and “Audio Surround” is optimized for front-seat passengers for any audio source. This surround effect is available for audio from any source – AM/FM/CD/ Satellite Radio or Video / Video / AUX – and is activated through the Electronic Vehicle Information Center (EVIC). Refer to “Driver-Selectable Surround Sound (DSS)” under “Electronic Vehicle Information Center (EVIC)” in Section 4.

DSS modes for audio sources are “Stereo” and “Audio Surround,” which is surround sound equalized for the front seat occupants. The “Video Surround” mode is described under “Kicker® Mobile Surround (KMS1).®” Please note that DSS effects are dependent on the mix of the original recording. Some audio will sound better in DSS modes, others in Stereo mode.

When in “Audio Surround” mode, balance is set automatically. Fader control is available to add more surround audio if desired.

Kicker® Mobile Surround (KMS1)® – If Equipped

The VES® for this vehicle comes equipped with Kicker Mobile Surround (KMS1).® This feature offers the ultimate movie experience by providing surround sound uniquely equalized for the interior space of your vehicle.

The KMS1® Video Surround mode activates whenever a video source is selected, unless the system is already in “Audio Surround” mode. DSS modes for video sources are “Stereo,” “Audio Surround,” and “Video Surround.” When in Video Surround mode, balance and fade are set automatically by the KMS1® system to provide the ultimate surround sound experience.

UNIVERSAL CONSUMER INTERFACE (UCI) — IF EQUIPPED

NOTE: This section is for sales code RES and REQ radios only with UConnect®. For sales code REN touch screen radio, refer to the separate User’s Manual.

This feature allows you to plug an iPod® mobile digital device into the vehicle’s sound system through a connector (UCI connector) using an optional connection cable (available through MOPAR®). See your authorized dealer for details.

Using this feature,

- the iPod® audio can be played on the vehicle’s sound system, providing metadata (Track Title, Artist, Album, etc.) information display on radio.
- the iPod® can be controlled using the radio buttons to Play, Browse and List the iPod® contents.
- the iPod® battery charges when plugged into the UCI connector.

Connecting The iPod® Device

Use the optional connection cable to connect an iPod® to the vehicle’s UCI connector (which is located in the glove box on some vehicles. This location may vary with vehicle). Once the iPod® is connected and synchronized to the vehicle system (this may take a few seconds to connect), the vehicle brand logo appears on the iPod® display, and it starts charging and is ready for use by pressing radio switches as described below.

Controlling The iPod® Using Radio Buttons

To get into the UCI (iPod®) mode and access a connected iPod®, press the AUX button on the radio faceplate. Once in the UCI (iPod®) mode, the iPod® audio track (if available from iPod®) will start playing over the vehicle audio system.

Play Mode

When switched to UCI mode the iPod® will be in Play mode. In Play mode, you may use the following buttons on the radio faceplate to control the iPod® and display data:

TUNE/SCROLL Knob

Use the TUNE/SCROLL knob to go to the next or previous track.

The TUNE/SCROLL knob functions similar to the scroll wheel on the iPod® mobile digital device.

Turning it clockwise (forward) by one click while playing a track skips to the next track.

Turning it counterclockwise (backward) by one click during the first two seconds of the track will jump to the previous track in the list and turning this button at any other time in the track will jump to the beginning of the current track.

RW (Rewind) Button

Press and hold the RW button to move backward in the current track. Holding the RW button long enough will take you back to the beginning of the current track.

Pressing and releasing the RW button will go back five seconds of the current track.

FF (Fast Forward) Button

Press and hold the FF button to move forward in the current track.

Pressing and releasing the FF button will go forward five seconds of the current track.

SEEK Buttons

Use the SEEK buttons to move to the previous or the next track.

If the left (down) button is pressed during the first two seconds of the current track, it will go back to the previous track in the list; if you press this button at any other time in the current track it will go back to the beginning of the track.

If the right (up) button is pressed during Play mode, it will go to the next track in the list.

INFO Button

Press the INFO button while a track is playing to see the information (Track Title, Artist, Album, etc.) for that track. Each press of the INFO button will take you to the next screen of data for that track. Once you have seen all

of the screens, the last press of the INFO button will take you back to the Play mode screen on the radio.

REPEAT Button

Press the REPEAT button to repeat the current playing track.

SCAN Button

Pressing the SCAN button will play the first five seconds of each track in the current list and then forward to the next song. To stop the SCAN mode and start playing the desired track, press the SCAN button again.

During the SCAN mode, you can also press the SEEK button to the left or right to go to the previous or next tracks.

RND (Random) Button (RES Radios Only)

Pressing the RND button will switch between the shuffle on and shuffle off modes of the iPod®. If the RND icon is showing on the radio display then the shuffle mode is on.

List or Browse Mode

During Play mode, pressing any of the following buttons will take you to List mode. List mode enables you to scroll through the list of menus and tracks on the iPod® device.

TUNE/SCROLL Knob

In the List mode, the TUNE/SCROLL knob functions in a similar manner as the scroll wheel on the iPod®.

Turning the TUNE/SCROLL knob clockwise (forward) and counterclockwise (backward) scrolls through lists, displaying the track detail on the radio display. Once you have the track to be played highlighted on the radio display, press the TUNE/SCROLL knob to select and start playing the track. By turning the TUNE/SCROLL knob fast, you can jump through the list faster. During fast scroll, you may notice a slight delay in updating the information on the radio display.

During all List modes, the iPod® will display all lists in “wrap-around” mode. So if the track you wish to select is at the bottom of the list, you just turn the TUNE/SCROLL knob backward (counterclockwise) to get to the track faster.

Radio Preset Buttons

In the List mode, the radio preset buttons are used as shortcuts to the following lists on the iPod® device.

- 1 – Playlists
- 2 – Artists
- 3 – Albums
- 4 – Genres
- 5 - Audiobooks
- 6 – Podcasts

After pressing a preset button, you will see the list you are in on the top line and the first item in that list on the second line.

To exit the List mode without selecting a track, press the same preset button again to go back to Play mode.

LIST Button

Pressing the LIST button will take to the top level menu of the iPod®. This takes you to the same top level menu as on your iPod®. Turn the TUNE/SCROLL knob to list the top menu item you wish to select and then press the TUNE/SCROLL knob. This will take you to the next sub menu list item of the iPod® and you can follow the same steps to go to the desired track in that list. Not all iPod® sub menu levels are available on this system.

MUSIC TYPE Button

The MUSIC TYPE button is another shortcut button to the genre listing on your iPod®.

REMOTE SOUND SYSTEM CONTROLS — IF EQUIPPED

The remote sound system controls are located on the surface of the steering wheel at the 3 and 9 o'clock positions.

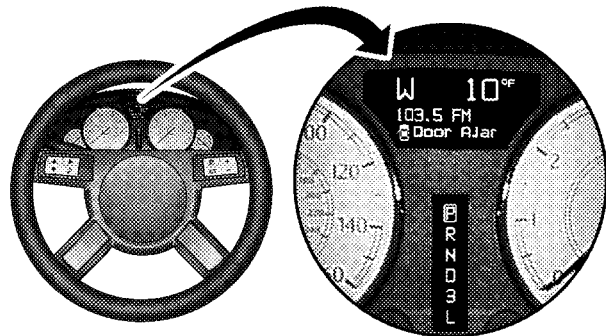

818c9c36

Electronic Vehicle Information Center

Vehicles equipped with steering wheel-mounted buttons are also equipped with the Electronic Vehicle Information Center (EVIC). The EVIC features a driver-interactive display. This is located in the upper part of the instrument cluster between the speedometer and tachometer.



**VOLUME
Button**

The VOLUME button controls the sound level of the sound system. Press the top of the VOLUME button to increase the sound level. Press the bottom of the VOLUME button to decrease the sound level.



**AUDIO
MODE
Button**

Press the AUDIO MODE button to select the Compass/Temp/Audio screen. This screen displays radio and media mode information depending on which radio is in the vehicle.

If the Compass/Temp/Audio screen is already displayed when the AUDIO MODE button is pressed, then the mode will change (i.e. from AM to FM, to Media mode, etc., depending on which radio is in the vehicle).



**FUNCTION
SELECT
Button**

When the EVIC is in the Compass/Temp/Audio screen, press the FUNCTION SELECT button to operate various radio, media, and Universal Customer Interface (UCI) functions (i.e., advance presets, select next folder, jump to or start playing songs in playlists, etc., depending on which radio is in the vehicle and if equipped with UCI).



**SCROLL
Button**

When the EVIC is in the Compass/Temp/Audio screen, press the SCROLL button to seek up and down radio stations, tracks, chapters, files, etc., depending on which radio is in the vehicle.

CD/DVD DISC MAINTENANCE

To keep the CD/DVD discs in good condition, take the following precautions:

1. Handle the disc by its edge; avoid touching the surface.
2. If the disc is stained, clean the surface with a soft cloth, wiping from center to edge.
3. Do not apply paper, paper CD labels, or tape to the disc; avoid scratching the disc.
4. Do not use solvents such as benzine, thinner, cleaners, or antistatic sprays.
5. Store the disc in its case after playing.
6. Do not expose the disc to direct sunlight.
7. Do not store the disc where temperatures may become too high.

RADIO OPERATION AND CELLULAR PHONES

Under certain conditions, the cellular phone being on in your vehicle can cause erratic or noisy performance from your radio. This condition may be lessened or eliminated by relocating the cellular phone antenna. This condition is not harmful to the radio. If your radio performance does not satisfactorily “clear” by the repositioning of the antenna, it is recommended that the radio volume be turned down or off during cellular phone operation.

CLIMATE CONTROLS

The Air Conditioning and Heating System is designed to make you comfortable in all types of weather.

Automatic Temperature Control

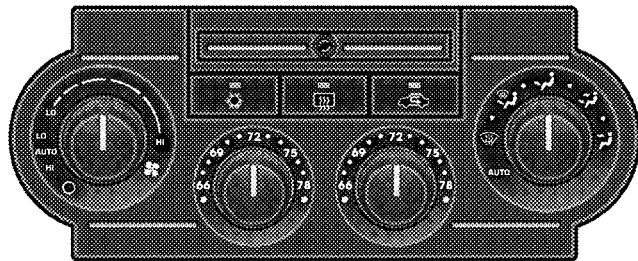

8135020a

Automatic Temperature Controls

Automatic Operation

The Infrared Dual-Zone Climate Control System automatically maintains the climate in the cabin of the vehicle at the comfort levels desired by the driver and passenger. To accomplish this, the system gathers information from

the controls on the climate control, from a dual sun-sensor located in the top of the instrument panel, from an infrared sensor located in the face of the climate control, and from various sensors located throughout the vehicle.

The controls on the climate control provide the system with operator input. The dual sun-sensor monitors sun load coming through the windshield. The infrared sensor independently measures the surface temperature of the driver and passenger. Other sensors take account of vehicle-speed, A/C pressure, outside temperature, and engine cooling temperature. Using all of these inputs, the system automatically adjusts airflow temperature, airflow distribution, airflow volume, and the amount of outside air recirculation. This maintains a comfortable temperature even under changing conditions.

Operation of the system is quite simple. Begin by turning the Mode Control knob (on the right) to AUTO, and place the Blower Control knob (on the left) to either LO AUTO

or HI AUTO. The LO AUTO position should be used for front seat occupants only. The HI AUTO position should be used when more airflow is desired, or when rear seat occupants are present. Then, dial in the temperature you would like the system to maintain by rotating the driver or passenger Temperature Control knob. Once the comfort level is selected, the system will maintain that level automatically using the heating system. Should the desired comfort level require air conditioning, the system will automatically make the adjustment.

You will experience the greatest efficiency by simply allowing the system to function automatically. Selecting the OFF position on the fan control stops the system completely and closes the outside air intake.

72°F (22°C) is the recommended setting for maximum comfort for the average person; however, this may vary.

NOTE: The temperature setting can be adjusted at any time without affecting automatic operation.



Air conditioning in this system is automatic. Pressing the Air Conditioning Control button while in AUTO mode will cause the LED in the control button to flash three times and then turn off. This indicates that the system is in AUTO mode and requesting the air conditioning is not necessary.



The system will automatically control recirculation. However, pressing the Recirculation Control button will temporarily put the system in recirculation mode (10 minutes). This can be used when outside conditions such as smoke, odors, dust, or high humidity are present. Activating recirculation will cause the LED in the control button to illuminate. After 10 minutes, the system will return to normal AUTO mode function and the LED will turn off.

NOTE:

- The surface of the climate control panel and the top center of the instrument panel should be kept free of debris due to the location of the climate control sensors. Mud on the windshield may also cause poor operation of this system.
- Extended use of recirculation may cause the windows to fog. If the interior of the windows begins to fog, press the Recirculation button to return to outside air. Some temp/humidity conditions will cause captured interior air to condense on windows and hamper visibility. For this reason, the system will not allow Recirculation to be selected while in defrost or defrost/floor mode. Attempting to use the recirculation while in these modes will cause the LED in the control button to blink and then turn off.

Manual Operation

This system offers a full complement of manual override features, which consist of Blower Preferred Automatic, Mode Preferred Automatic, or Blower and Mode Preferred Automatic. This means the operator can override the blower, the mode, or both. There is a manual blower range for times when the AUTO setting is not desired. The blower can be set to any fixed blower speed by rotating the Blower Control knob (on the left).

NOTE: Please read the Automatic Temperature Control Operation Chart that follows for details.

Automatic Temperature Control Operation		The system will...				
Operation	How	Blower Control	Mode Control	Air Temperature Control	Air Recirculation Control	A/C Operation
Full Automatic Operation	Set blower knob to either Hi or Lo Auto. Set mode knob to Auto. Set temperature knobs for comfort.	Automatic	Automatic	Automatic	Automatic but can be overridden for 10 minutes at a time.	Automatic
Blower Preferred Automatic	Set blower knob to any desired airflow level other than Hi or Lo Auto. Set mode knob to Auto. Set temperature knobs for comfort.	User selectable to any speed.	Automatic	Automatic	Automatic but can be overridden for 10 minutes at a time.	Automatic
Mode Preferred Automatic	Set mode knob to any desired air delivery point other than Auto. Set blower knob to either Hi or Lo Auto. Set temperature knobs for comfort.	Automatic	User selectable to any air delivery point.	Automatic	User selectable outside or recirculated.	User selectable A/C on or off.
Blower and Mode Preferred Automatic	Set blower knob to any desired airflow level other than Hi or Lo Auto. Set mode knob to any desired air delivery point other than Auto. Set temperature knobs for comfort.	User selectable to any speed.	User selectable to any air delivery point.	Automatic	User selectable outside or recirculated.	User selectable A/C on or off.

The operator can override the AUTO mode setting to change airflow distribution by rotating the Mode Control knob (on the right) to one of the following positions.

- *Defrost*



Air is directed to the windshield through the outlets at the base of the windshield. Air is also directed to the front door windows through the side window demister grilles.

- *Defrost/Floor*



Air flows through the front and rear floor outlets and the outlets at the base of the windshield. Air is also directed to the front door windows through the side window demister grilles.

- *Floor*



Air flows through the floor outlets located under the instrument panel and into the rear seating area through vents under the front seats.

- *Bi-Level*



Air flows through the outlets located in the instrument panel and through the outlets located on the floor. Air flows through the registers in the back of the center console to the rear seat passengers. These registers can be closed to block airflow.

- *Panel*



Air flows through the outlets located in the instrument panel. Air flows through the registers in the back of the center console to the rear seat passengers. These registers can be closed to block airflow.

- *Air Conditioning Control*



Press this button to turn on the air conditioning during manual operation only. When the air conditioning is turned on, cool dehumidified air will flow through the outlets selected with the Mode control dial. Press this button a second time to

turn off the air conditioning. An LED in the button illuminates when manual compressor operation is selected.

NOTE: To control the air conditioning manually, the mode selector must be moved out of the AUTO position.

- **Recirculation Control**



This button can be used to block out smoke, odors, dust, high humidity, or if rapid cooling is desired. The recirculation mode should only be used temporarily. An LED in the button illuminates when the recirculation mode is active. You may use this feature separately.

NOTE: Extended use of recirculation may cause the windows to fog. If the interior of the windows begins to fog, press the Recirculation button to return to outside air. Some temp/humidity conditions will cause captured

interior air to condense on windows and hamper visibility. For this reason, the system will not allow Recirculation to be selected while in defrost or defrost/floor mode. Attempting to use the recirculation while in these modes will cause the LED in the control button to blink and then turn off.

Operating Tips

NOTE: Refer to the chart at the end of this section for suggested control settings for various weather conditions.

Summer Operation

The engine cooling system in air-conditioned vehicles must be protected with a high-quality antifreeze coolant to provide proper corrosion protection and to protect against engine overheating. A 50% solution of ethylene glycol antifreeze coolant in water is recommended. Refer to “Maintenance Procedures” in Section 7 of this manual for proper coolant selection.

Winter Operation

Use of the air Recirculation mode during winter months is not recommended because it may cause window fogging.

Vacation Storage

Anytime you store your vehicle, or keep it out of service (i.e., vacation) for two weeks or more, run the air conditioning system at idle for about five minutes in the fresh air and high blower setting. This will insure adequate system lubrication to minimize the possibility of compressor damage when the system is started again.

Window Fogging

Interior fogging on the windshield can be quickly removed by turning the mode selector to Defrost. The Defrost/Floor mode can be used to maintain a clear

windshield and provide sufficient heating. If side window fogging becomes a problem, increase blower speed. Vehicle windows tend to fog on the inside in mild but rainy or humid weather.

NOTE: Recirculate without A/C should not be used for long periods as fogging may occur.











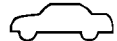





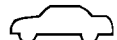

Outside Air Intake

Make sure the air intake, located directly in front of the windshield, is free of obstructions such as leaves. Leaves collected in the air intake may reduce airflow, and if they enter the plenum, they could plug the water drains. In winter months, make sure the air intake is clear of ice, slush, and snow.

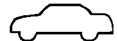
A/C Air Filter — If Equipped

The climate control system filters outside air containing dust, pollen and some odors. Strong odors cannot be totally filtered out. Refer to “Maintenance Procedures” in Section 7 for filter replacement instructions.

Control Setting Suggestions for Various Weather Conditions

WEATHER	CONTROL SETTINGS
<p>HOT WEATHER AND VEHICLE INTERIOR IS VERY HOT</p>  	<p>Open the windows, start the vehicle, set the Mode control to Panel  or Bi-Level , and turn on A/C. Set the Fan control to the High position (full clockwise). Set the temperature control to full cool. After the hot air is flushed from the vehicle, set the Mode control to Recirculate  with A/C on and roll up the windows. Once you are comfortable, set the Mode control to Panel  or Bi-Level  with A/C on.</p>
<p>WARM WEATHER</p>  	<p>If it's sunny, set the Mode control to Panel  and turn on A/C. If it's cloudy or dark, set the Mode control to Bi-Level  with A/C on. Adjust Temperature control for comfort.</p>
<p>COOL OR COLD HUMID CONDITIONS</p>  	<p>Set the Mode control to Defrost/Floor  or Defrost .</p> <p>Set the Fan Control to the High position (full clockwise). Adjust Fan and Temperature control for comfort if windows are clear.</p>
<p>COLD DRY CONDITIONS</p>  	<p>Set the Mode control to Floor . If it's sunny, you may want more upper air. In this case, set the Mode control to Bi-Level . In very cold weather, if you need extra heat at the windshield, set the Mode control to Defrost/Floor  or Defrost  as needed. Adjust Fan and Temperature control for comfort.</p>

81352266

REAR WINDOW FEATURES

Electric Rear Window Defroster



The Electric Rear Window Defroster control is located on the climate control. Press this button to turn ON the rear window defroster and the heated outside rearview mirrors (if equipped). An LED in the button will illuminate when the rear window defroster is ON. The defroster automatically turns off after approximately 10 minutes. For five more minutes of operation, press of the button again.

CAUTION!

To avoid damaging the electrical conductors of the rear window defroster, do not use scrapers, sharp instruments, or abrasive window cleaners on the interior surface of the window.

Labels can be peeled off after soaking with warm water.

STARTING AND OPERATING

CONTENTS

■ Starting Procedures	297	□ Automatic Transmission — General Information	302
□ Automatic Transmission	298	□ Brake/Transmission Shift Interlock System	304
□ Normal Starting (Tip Start)	299	□ 5-Speed Automatic Transmission	305
□ Extremely Cold Weather (Below -20°F Or -29°C)	299	■ AutoStick®	310
□ If Engine Fails To Start	300	□ AutoStick® Operation	310
□ After Starting	301	□ AutoStick® General Information	311
■ Engine Block Heater — If Equipped	301	■ Driving On Slippery Surfaces	312
■ Automatic Transmission	301	□ Acceleration	312

- Traction 312
- Driving Through Water 313
 - Flowing/Rising Water 313
 - Shallow Standing Water 313
- Parking Brake 315
- Brake System 317
 - Anti-Lock Brake System 317
- Power Steering 319
- Electronic Brake Control System 320
 - ABS (Anti-Lock Brake System) 321
 - TCS (Traction Control System) 322
 - BAS (Brake Assist System) 322
 - ESP (Electronic Stability Program) 323
- Synchronizing ESP 326
- ESP/BAS Malfunction Indicator Light And
ESP/TCS Indicator Light 327
- Tire Safety Information 328
 - Tire Markings 328
 - Tire Identification Number (TIN) 331
 - Tire Loading And Tire Pressure 332
- Tires — General Information 336
 - Tire Pressure 336
 - Tire Inflation Pressures 337
 - Radial-Ply Tires 339
 - Tire Spinning 340
 - Tread Wear Indicators 340

- Life Of Tire341
- Replacement Tires342
- Alignment And Balance343
- Tire Chains343
- Snow Tires344
- Tire Rotation Recommendations345
 - Tire Rotation — Standard Tires345
 - Tire Rotation — All Season Tires346
- Tire Pressure Monitor System (TPMS) —
If Equipped347
 - Base System — If Equipped349
 - Premium System — If Equipped352
 - General Information357
- Fuel Requirements357
 - 6.1L Engine357
 - Reformulated Gasoline358
 - Gasoline/Oxygenate Blends358
 - MMT In Gasoline359
 - Materials Added To Fuel359
 - Fuel System Cautions359
 - Carbon Monoxide Warnings360
- Adding Fuel361
 - Fuel Filler Cap (Gas Cap)361
 - Loose Fuel Filler Cap Message363
- Vehicle Loading364
 - Vehicle Certification Label364

296 STARTING AND OPERATING

- Gross Vehicle Weight Rating (GVWR)364
- Gross Axle Weight Rating (GAWR)364
- Overloading365
- Loading365
- Trailer Towing367
 - Recreational Towing (Behind Motorhome, Etc.) . .367
 - Towing This Vehicle Behind Another Vehicle (Flat Towing With All Four Wheels On The Ground)367
 - Ground Clearance367

STARTING PROCEDURES

Before starting your vehicle, adjust your seat, adjust the inside and outside mirrors, fasten your seat belt, and if present, instruct all other occupants to buckle their seat belts.

WARNING!

- **Never leave children alone in a vehicle. Leaving unattended children in a vehicle is dangerous for a number of reasons. A child or others could be seriously or fatally injured. Don't leave the keys in the ignition. A child could operate power windows, other controls, or move the vehicle.**
- **Do not leave animals or children inside parked vehicles in hot weather; interior heat buildup may cause serious injury or death.**
- **Be sure to turn OFF the engine and remove the key from the ignition switch if you want to rest or sleep in your car. Accidents can be caused by inadvertently moving the shift lever. Accidents can also be caused by pressing the accelerator pedal. This may cause excessive heat in the exhaust system, resulting in overheating and vehicle fire, which may cause serious or fatal injuries.**

Automatic Transmission

The shift lever must be in the NEUTRAL or PARK position before you can start the engine. Apply the brakes before shifting into any driving gear.

CAUTION!

Damage to the transmission may occur if the following precautions are not observed:

- Shift into PARK only after the vehicle has come to a complete stop.
- Shift into or out of REVERSE only after the vehicle has come to a complete stop and the engine is at idle speed.
- Do not shift from REVERSE, PARK, or NEUTRAL into any forward gear when the engine is above idle speed.
- Before shifting into any gear, make sure your foot is firmly on the brake pedal.

Normal Starting (Tip Start)

NOTE: Normal Starting of either a cold or a warm engine is obtained without pumping or depressing the accelerator pedal.

Do not press the accelerator. Use the Fob with Integrated Key to briefly turn the ignition switch to the START position and release it as soon as the starter engages. The starter motor will continue to run, and it will disengage automatically when the engine is running. If the engine fails to start, the starter will disengage automatically in 10 seconds. If this occurs, turn the ignition switch to the LOCK position, wait 10 to 15 seconds, then repeat the normal starting procedure.

Extremely Cold Weather (Below -20°F or -29°C)

To ensure reliable starting at these temperatures, use of an externally powered electric engine block heater (available from your authorized dealer) is recommended.

If Engine Fails To Start

WARNING!

- **Never pour fuel or other flammable liquids into the throttle body air inlet opening in an attempt to start the vehicle. This could result in a flash fire causing serious personal injury.**
- **Do not attempt to push or tow your vehicle to get it started. Vehicles equipped with an automatic transmission cannot be started this way. Unburned fuel could enter the catalytic converter and once the engine has started, ignite and damage the converter and vehicle. If the vehicle has a discharged battery, booster cables may be used to obtain a start from a booster battery or the battery in another vehicle. This type of start can be dangerous if done improperly. Refer to Section 6 for proper jump-starting procedures and follow them carefully.**

If the engine fails to start after you have followed the “Normal Starting” or “Extreme Cold Weather” procedures, it may be flooded. To clear any excess fuel, push the accelerator pedal all the way to the floor and hold it. Then, turn the ignition switch to the START position and release it as soon as the starter engages. The starter motor will disengage automatically in 10 seconds. Once this occurs, release the accelerator pedal, turn the ignition switch to the LOCK position, wait 10 to 15 seconds, then repeat the normal starting procedure.

CAUTION!

To prevent damage to the starter, wait 10 to 15 seconds before trying again.

After Starting

The idle speed is controlled automatically and it will decrease as the engine warms up.

ENGINE BLOCK HEATER — IF EQUIPPED

The engine block heater warms engine coolant and permits quicker starts in cold weather. Connect the cord to a standard 110-115 Volt AC electrical outlet with a grounded, three-wire extension cord.

The engine block heater cord is routed under the hood on the driver side of the vehicle. It has a removable cap that is located on the driver side of the Integrated Power Module.

WARNING!

Remember to disconnect the cord before driving. Damage to the 110-115 Volt electrical cord could cause electrocution.

AUTOMATIC TRANSMISSION**CAUTION!**

Damage to the transmission may occur if the following precautions are not observed:

- Shift into **PARK** only after the vehicle has come to a complete stop.
- Shift into or out of **REVERSE** only after the vehicle has come to a complete stop and the engine is at idle speed.
- Do not shift from **REVERSE, PARK, or NEUTRAL** into any forward gear when the engine is above idle speed.
- Before shifting into any gear, make sure your foot is firmly on the brake pedal.

WARNING!

It is dangerous to move the shift lever out of PARK or NEUTRAL if the engine speed is higher than idle speed. If your foot is not firmly on the brake pedal, the vehicle could accelerate quickly forward or in reverse. You could lose control of the vehicle and hit someone or something. Only shift into gear when the engine is idling normally and when your right foot is firmly on the brake pedal.

Automatic Transmission — General Information

The automatic transmission selects individual gears automatically, dependent upon:

- Altitude
- Vehicle loading
- Driving style

- Shift lever position
- Accelerator position
- Vehicle speed

The gear shifting process is continuously adapted, dependent on the driving style, the driving situation, and the road characteristics.

NOTE:

- After selecting any driving position, wait a moment to allow the gear to engage fully before accelerating, especially when the engine is cold.
- If there is a need to restart the engine, be sure to cycle the key to the LOCK position before restarting. Transmission engagement may be delayed up to 10 seconds after restart if the key is not cycled to the LOCK position first.

- The electronically-controlled transmission provides a precise shift schedule. The transmission electronics are self-calibrating. Therefore, the first few shifts on a new vehicle may be somewhat abrupt or soft until after the break-in period. This is a normal condition, and precision shifts will develop within a few shift cycles.

The shift lever is automatically locked while in the PARK position. To move the shift lever out of the PARK position, the brake pedal must be firmly depressed before the shift lock will release.

Move the shift lever to the desired position only when the engine is idling normally and the brake pedal is applied. Do not release the brake pedal until ready to drive. The vehicle may otherwise accelerate quickly when the shift lever is in DRIVE or REVERSE position.

WARNING!

Unintended movement of a vehicle could injure those in and near the vehicle. As with all vehicles, you should never exit a vehicle while the engine is running. Before exiting a vehicle, you should always shift the transmission into PARK, remove the key from the ignition, and apply the parking brake. Once the key is removed from the ignition, the transmission shift lever is locked in the PARK position, securing the vehicle against unwanted movement. Furthermore, you should never leave unattended children inside a vehicle.

Over-Temperature Mode

The transmission electronics constantly monitor the transmission oil temperature. If the transmission exceeds normal operating temperature, the transmission will change the way it shifts to help control the condition. This may result in a slightly different feeling or response during normal operation in DRIVE position. After the transmission cools down, it will return to normal operation.

Brake/Transmission Shift Interlock System

This vehicle is equipped with a Brake Transmission Shift Interlock System (BTSI) that holds the shift lever in the PARK position when the ignition switch is in the LOCK position. To move the shift lever out of the PARK position, the ignition switch must be turned to the ON position, and the brake pedal must be depressed.

BTSI Override

There is an override for the BTSI that allows you to move the shift lever out of the PARK position if an electrical

system malfunction occurs (i.e., dead battery). To access the override, remove the rubber tray from the storage bin located to the right of the shift lever. The override access port is at the top of the bin to the right of the shift lever gate.

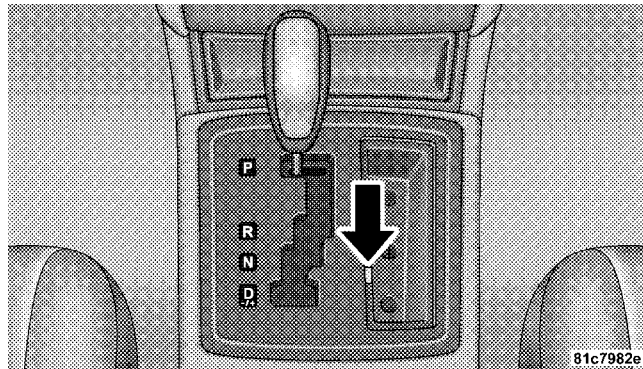

Brake Interlock Override

To activate the override, first insert the key into the ignition switch and turn it to the ACC or ON position. Then, press the pink-colored tab through the access pot with a small flat blade screwdriver or alike. While pressing the override, move the shift lever out of the PARK position. When complete, return the rubber tray to its original position.

5-Speed Automatic Transmission

Shifting from DRIVE to PARK or REVERSE should be done only after the accelerator pedal is released and the vehicle is stopped. Be sure to keep your foot on the brake pedal when moving the shift lever between these gears.

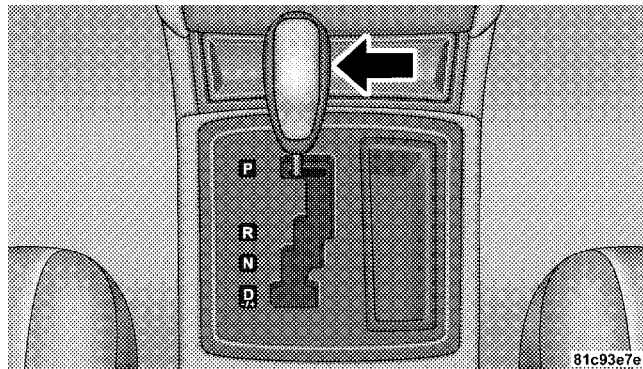

Shift Lever

Gear Ranges

PARK

PARK supplements the parking brake by locking the transmission. The engine can be started in this range. Never use PARK while the vehicle is in motion. Apply the parking brake when leaving the vehicle in this range.

When parking on a flat surface, place the shift lever in the PARK position first, and then apply the parking brake.

When parking on a hill, it is important to set the parking brake before placing the shift lever in PARK, otherwise the load on the transmission locking mechanism may make it difficult to move the shift lever out of PARK. As an added precaution, turn the front wheels toward the curb on a downhill grade and away from the curb on an uphill grade.

WARNING!

Never use PARK position on an automatic transmission as a substitute for the parking brake. Always apply parking brake fully when parked to guard against vehicle movement and possible injury or damage.

The following indicators should be used to ensure that you have engaged the shift lever in the PARK position:

- When shifting into PARK, move the shift lever all the way forward until it stops and is fully seated.
- Look at the shift indicator display on the instrument panel to ensure it is in the P position.

CAUTION!

Damage to the shifter could result if the shift lever is moved out of PARK before the ignition is turned from the LOCK to ON position.

REVERSE

Shift into REVERSE gear only when the vehicle is completely stopped.

NEUTRAL

In NEUTRAL, no power is transmitted from the engine to the drive axle. When the brakes are released, the vehicle can be moved freely (pushed or towed). Do not engage NEUTRAL position while driving except to coast when the vehicle is in danger of skidding (e.g., on icy roads).

The engine may be started in this range. Use this range for starting your vehicle if it is moving or being towed.

CAUTION!

Coasting the vehicle or driving for any other reason with the shift lever in NEUTRAL can result in transmission damage.

WARNING!

Do not coast in NEUTRAL and never turn off the ignition to coast down a hill. These are unsafe practices that limit your response to changing traffic or road conditions. You might lose control of the vehicle and have an accident.

DRIVE

This range should be used for most city and highway driving. It provides the smoothest upshifts and downshifts and the best fuel economy.

The transmission automatically upshifts through 5th gear. The DRIVE position provides optimum driving characteristics under all normal operating conditions.

When frequent transmission shifting occurs when using the Overdrive range, such as when operating the vehicle under heavy loading conditions (in hilly terrain, traveling into strong head winds, or while towing heavy trailers, use the AutoStick® mode and select the “3” range.

AutoStick® Gear Selection

The AutoStick® feature can be selected by pressing the shift lever to the right or the left with the lever in the DRIVE position. The gear currently selected is indicated in the instrument cluster display. Briefly, press the shift lever in the “D -” direction and the transmission will shift from the current gear to the next lower gear.

Press and hold the shift lever in the “D -” direction and the transmission will shift from the current gear directly to the next lowest gear for best acceleration.

NOTE: To avoid overrevving the engine when the shift lever is moved in “D -” direction, the transmission will

not shift to a lower gear if the engine’s revolutions per minute (RPM) limit would be exceeded.

Briefly press the shift lever in the “D +” direction and the transmission will shift from the current gear to the next higher gear.

Press and hold the shift lever in the “D +” direction and the transmission will shift from the current gear directly to gear “D.”

WARNING!

On slippery road surfaces never downshift in order to obtain braking action. This could result in drive wheel slip and reduced vehicle control. Your vehicle’s ABS will not prevent this type of loss of control. You could lose control of your vehicle and have an accident.

Delayed Shifts in Cold Temperatures

During cold temperature operation, you may notice delayed upshifts depending on engine and transmission temperature as well as vehicle speed. This feature improves warm up time of the engine and transmission to achieve maximum efficiency.

Temporary Transmission Limp Home Mode

The transmission is monitored for abnormal conditions. If a condition is detected that could result in transmission damage, the transmission will engage Limp Home Mode. If vehicle acceleration worsens, or the transmission no longer shifts, the transmission is most likely operating in the Limp Home Mode. In this mode, the transmission will remain in the current gear until the vehicle is brought to a stop. After the vehicle has stopped, PARK, REVERSE, and NEUTRAL will continue to operate. Second gear will operate in the DRIVE position. The Malfunction Indicator Light (MIL) may be illuminated.

A reset feature is available to allow the vehicle to be driven to an authorized dealer for service. To reset the transmission, use the following procedure:

1. Stop the vehicle.
2. Move the shift lever to the PARK position.
3. Turn OFF the engine.
4. Wait approximately 10 seconds.
5. Restart the engine.
6. Move the shift lever to the desired range. If the problem is no longer detected, the transmission will return to normal operation.

NOTE: Even if the transmission can be reset, we recommend that you visit your authorized dealer at your earliest possible convenience. Your authorized dealer has diagnostic equipment to determine if the problem could recur.

Have the transmission checked at your authorized dealer as soon as possible.

If the problem has been momentary, the transmission can be reset to regain all forward gears.

Permanent Transmission Limp Home Mode

Permanent Limp Home Mode will be activated if the transmission enters temporary Limp Home Mode three times. Follow the reset procedure described under “Temporary Transmission Limp Home Mode” in this section. In Permanent Limp Home Mode, PARK, REVERSE, and NEUTRAL will continue to operate. Second gear will operate in the DRIVE position. The Malfunction Indicator Light (MIL) may illuminate.

AUTOSTICK®

Autostick® is a driver-interactive transmission that offers manual gear shifting to provide you with more control of the vehicle. Autostick® allows you to maximize engine braking, eliminate undesirable upshifts and downshifts, and improve overall vehicle performance. This system can also provide you with more control during passing, city driving, cold slippery conditions, mountain driving, trailer towing, and many other situations.

Autostick® Operation

By placing the shift lever in the DRIVE position, it can be moved from side to side. This allows the driver to select a higher or lower range of gears. Moving the shift lever to the Left (-) triggers a downshift and to the Right (+) an upshift. The gear position will display in the instrument cluster on the transmission range indicator.

NOTE:

- In Autostick® mode, the transmission will only shift up and down when the driver manually moves the shift lever Right (D+) or Left (D-).
- An UPSHIFT message will appear in the Electronic Vehicle Information Center (EVIC) portion of the instrument cluster when using Autostick®. This message appears in order to alert the driver to upshift to the next gear. The UPSHIFT message will display while operating the vehicle at higher engine revolutions per minute (RPM).

You can shift in or out of the Autostick® mode at any time without taking your foot off the accelerator pedal. When you wish to engage Autostick®, simply move the shift lever to the Right (D+) or Left (D-) while in the DRIVE position. The transmission will remain in the current gear until an upshift or downshift is chosen. When you wish to disengage Autostick®, hold the shift lever to the right

for at least one second. The transmission will now operate automatically, shifting between the five available gears.

Autostick® General Information

- You can start out in 1st or 2nd gear. The system will ignore attempts to upshift at too low of a vehicle speed.
- The transmission will automatically downshift to 1st gear when coming to a stop.
- Starting out in 2nd gear is helpful in snowy or icy conditions.
- Avoid using speed control when Autostick® is engaged.
- The transmission will not automatically shift up when maximum engine speed is reached while Autostick® is engaged.

- Transmission shifting will be more noticeable when Autostick® is engaged.

DRIVING ON SLIPPERY SURFACES

Acceleration

Rapid acceleration on snow covered, wet, or other slippery surfaces may cause the rear wheels to pull erratically to the right or left. This phenomenon occurs when there is a difference in the surface traction under the rear (driving) wheels.

WARNING!

Rapid acceleration on slippery surfaces is dangerous. Unequal traction can cause sudden pulling of the rear wheels. You could lose control of the vehicle and possibly have an accident. Accelerate slowly and carefully whenever there is likely to be poor traction (ice, snow, wet mud, loose sand, etc.).

Traction

When driving on wet or slushy roads, it is possible for a wedge of water to build up between the tire and road surface. This is known as hydroplaning and may cause partial or complete loss of vehicle control and stopping ability. To reduce this possibility, the following precautions should be observed:

1. Slow down during rainstorms or when the roads are slushy.
2. Slow down if the road has standing water or puddles.
3. Replace tires when tread wear indicators first become visible.
4. Keep tires properly inflated.
5. Maintain sufficient distance between your vehicle and the vehicle in front of you to avoid a collision in a sudden stop.

DRIVING THROUGH WATER

Driving through water more than a few inches/millimeters deep will require extra caution to ensure safety and prevent damage to your vehicle.

Flowing/Rising Water

WARNING!

Do not drive on, or cross, a road or a path where water is flowing and/or rising (as in storm run-off). Flowing water can wear away the road or path's surface and cause your vehicle to sink into deeper water. Furthermore, flowing and/or rising water can carry your vehicle away swiftly. Failure to follow this warning may result in injuries that are serious or fatal to you, your passengers, and others around you.

Shallow Standing Water

Although your vehicle is capable of driving through shallow standing water, consider the following Caution and Warning before doing so.

CAUTION!

- Always check the depth of the standing water before driving through it. Never drive through standing water that is deeper than the bottom of the tire rims mounted on the vehicle.
- Determine the condition of the road or the path that is under water, and if there are any obstacles in the way, before driving through the standing water.
- Do not exceed 5 mph (8 km/h) when driving through standing water. This will minimize wave effects.

CAUTION!

- Driving through standing water may cause damage to your vehicle's drivetrain components. Always inspect your vehicle's fluids (i.e., engine oil, transmission, axle, etc.) for signs of contamination (i.e., fluid that is milky or foamy in appearance) after driving through standing water. Do not continue to operate the vehicle if any fluid appears contaminated, as this may result in further damage. Such damage is not covered by the New Vehicle Limited Warranty.
- Getting water inside your vehicle's engine can cause it to lock up and stall out, and cause serious internal damage to the engine. Such damage is not covered by the New Vehicle Limited Warranty.

WARNING!

- Driving through standing water limits your vehicle's traction capabilities. Do not exceed 5 mph (8 km/h) when driving through standing water.
- Driving through standing water limits your vehicle's braking capabilities, which increases stopping distances. Therefore, after driving through standing water, drive slowly and lightly press on the brake pedal several times to dry the brakes.
- Getting water inside your vehicle's engine can cause it to lock up and stall out, and leave you stranded.
- Failure to follow these warnings may result in injuries that are serious or fatal to you, your passengers, and others around you.

PARKING BRAKE

The parking brake should always be applied when the driver is not in the vehicle.

WARNING!

Never use PARK position on an automatic transmission as a substitute for the parking brake. Always apply the parking brake fully when parked to guard against vehicle movement and possible injury or damage.

When parking on a flat surface, place the shift lever in the PARK position first and then apply the parking brake.

When parking on a hill, it is important to apply the parking brake before placing the shift lever in PARK, otherwise the load on the transmission locking mechanism may make it difficult to move the shift lever out of PARK. As an added precaution, turn the front wheels toward the curb on a downhill grade and away from the curb on an uphill grade.

The foot operated parking brake is positioned below the lower left corner of the instrument panel. To apply the parking brake, push the parking brake pedal down and then remove your foot from the pedal. To release the parking brake, push down on the parking brake pedal and then release.

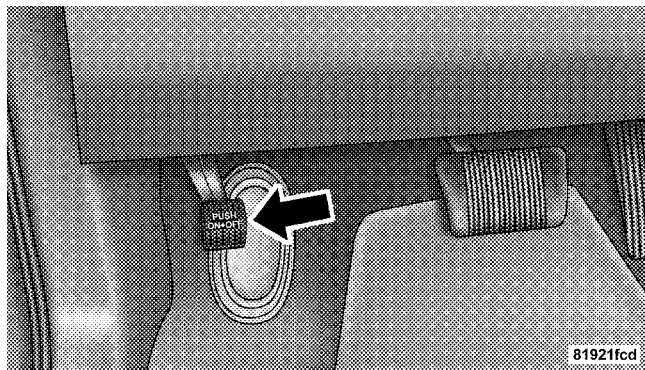

Parking Brake

The brake light in the instrument cluster will turn on when the parking brake is applied and the ignition switch is ON.

NOTE: This light only shows that the parking brake is applied. It does not show the degree of brake application.

WARNING!

- Never leave children alone in a vehicle. Leaving unattended children in a vehicle is dangerous for a number of reasons. A child or others could be seriously or fatally injured. Don't leave the keys in the ignition. A child could operate power windows, other controls, or move the vehicle.
- Be sure the parking brake is fully disengaged before driving; failure to do so can lead to brake failure and an accident.

BRAKE SYSTEM

Your vehicle is equipped with dual hydraulic brake systems. If either of the two hydraulic systems loses normal capability, the remaining system will still function. There will be some loss of overall braking effectiveness. This may be evident by increased pedal travel during application, greater pedal force required to slow or stop, and potential activation of the Brake Warning Light.

In the event power assist is lost for any reason (for example, repeated brake applications with the engine off) the brakes will still function. The effort required to brake the vehicle will be much greater than that required with the power system operating.

Anti-Lock Brake System

The Anti-Lock Brake System provides increased vehicle stability and brake performance under most braking conditions. The system automatically “pumps” the brakes during severe braking conditions to prevent wheel lock-up.

The electronic brake force distribution (EBD) prevents the rear wheels from over-braking and provides greater control of available braking forces applied to the rear axle.

When the vehicle is driven over 7 mph (11 km/h), you may also hear a slight clicking sound as well as some related motor noises. These noises are the system performing its self check cycle to ensure that the ABS system is working properly. This self check occurs each time the vehicle is started and accelerated past 7 mph (11 km/h).

ABS is activated during braking under certain road or stopping conditions. ABS-inducing conditions can include ice, snow, gravel, bumps, railroad tracks, loose debris, or panic stops.

You also may experience the following when the brake system goes into Anti-lock:

- The ABS motor running (it may continue to run for a short time after the stop),
- The clicking sound of solenoid valves,
- Brake pedal pulsations, and
- A slight drop or fall away of the brake pedal at the end of the stop.

These are all normal characteristics of ABS.

WARNING!

- The Anti-Lock Brake System contains sophisticated electronic equipment that may be susceptible to interference caused by improperly installed or high output radio transmitting equipment. This interference can cause possible loss of anti-lock braking capability. Installation of such equipment should be performed by qualified professionals.
- Pumping of the Anti-Lock Brakes will diminish their effectiveness and may lead to an accident. Pumping makes the stopping distance longer. Just press firmly on your brake pedal when you need to slow down or stop.
- Anti-lock system (ABS) cannot prevent the natural laws of physics from acting on the vehicle, nor can it increase braking or steering efficiency beyond that afforded by the condition of the vehicle brakes and tires or the traction afforded.
- The ABS cannot prevent accidents, including those resulting from excessive speed in turns, following another vehicle too closely, or hydroplaning. Only a safe, attentive, and skillful driver can prevent accidents.
- The capabilities of an ABS equipped vehicle must never be exploited in a reckless or dangerous manner, which could jeopardize the user's safety or the safety of others.

All vehicle wheels and tires must be the same size and type and tires must be properly inflated to produce accurate signals for the computer.

Anti-Lock Brake Light

 The ABS light monitors the Anti-Lock Brake System. The light will come on when the ignition switch is turned to the ON position and may stay on for as long as four seconds.

If the ABS light remains on or comes on while driving, it indicates that the Anti-Lock portion of the brake system is not functioning and that service is required. However, the conventional brake system will continue to operate normally if the BRAKE warning light is not on.

If the ABS light is on, the brake system should be serviced as soon as possible to restore the benefits of Anti-Lock brakes. If the ABS light does not come on when the Ignition switch is turned to the ON position, have the bulb repaired as soon as possible.

If both the Brake Warning Light and the ABS Light remain on, the Anti-Lock brakes (ABS) and Electronic Brake Force Distribution (EBD) systems are not functioning. Immediate repair to the ABS system is required.

POWER STEERING

The standard power steering system will give you good vehicle response and increased ease of maneuverability in tight spaces. The system will provide mechanical steering capability if power assist is lost.

If for some reason the power assist is interrupted, it will still be possible to steer your vehicle. Under these conditions, you will observe a substantial increase in steering effort, especially at very low vehicle speeds and during parking maneuvers.

NOTE: Increased noise levels at the end of the steering wheel travel are considered normal and do not indicate that there is a problem with the power steering system.

Upon initial start-up in cold weather, the power steering pump may make noise for a short amount of time. This is due to the cold, thick fluid in the steering system. This noise should be considered normal, and it does not in any way damage the steering system.

WARNING!

Continued operation with reduced power steering assist could pose a safety risk to yourself and others. Service should be obtained as soon as possible.

CAUTION!

Prolonged operation of the steering system at the end of the steering wheel travel will increase the steering fluid temperature and it should be avoided when possible. Damage to the power steering pump may occur.

ELECTRONIC BRAKE CONTROL SYSTEM

Your vehicle is equipped with an advanced electronic brake control system commonly referred to as ESP. This system includes the ABS (Anti-Lock Brake System), the TCS (Traction Control System), the BAS (Brake Assist System), and the ESP (Electronic Stability Program). These systems work together to enhance both vehicle stability and control in various driving conditions.

ABS (Anti-Lock Brake System)

This system aids the driver in maintaining vehicle control under adverse braking conditions by controlling hydraulic brake pressure. This prevents wheel lock-up to help avoid skidding on slippery surfaces during braking. For more information about ABS, refer to “Anti-Lock Brake System” in Section 5.

WARNING!

The ABS (Anti-Lock Brake System) cannot prevent the natural laws of physics from acting on the vehicle, nor can it increase the traction afforded by prevailing road conditions. The ABS cannot prevent accidents, including those resulting from excessive speed in turns, driving on very slippery surfaces, or hydroplaning. Only a safe, attentive, and skillful driver can prevent accidents. The capabilities of an ABS-equipped vehicle must never be exploited in a reckless or dangerous manner that could jeopardize the user’s safety or the safety of others.

TCS (Traction Control System)

This system monitors the amount of wheel spin of each driven wheel. If wheel spin is detected, brake pressure is applied to the slipping wheel(s) and engine power is reduced to provide enhanced acceleration and stability.

BAS (Brake Assist System)

This system complements the Anti-Lock Brake System (ABS) by optimizing the vehicle braking capability during emergency braking maneuvers. This system detects an emergency braking situation by sensing the rate and amount of brake application and then applies optimum pressure to the brakes. This can help reduce braking distances.

Applying the brakes very quickly results in the best BAS assistance. To receive the benefits of this system, you must apply continuous brake pedal pressure during the

stopping sequence. Do not reduce brake pedal pressure unless braking is no longer desired. Once the brake pedal is released, the BAS is deactivated.

WARNING!

The BAS (Brake Assist System) cannot prevent the natural laws of physics from acting on the vehicle, nor can it increase the traction afforded by prevailing road conditions. The BAS cannot prevent accidents, including those resulting from excessive speed in turns, driving on very slippery surfaces, or hydroplaning. Only a safe, attentive, and skillful driver can prevent accidents. The capabilities of a BAS-equipped vehicle must never be exploited in a reckless or dangerous manner that could jeopardize the user's safety or the safety of others.

ESP (Electronic Stability Program)

This system enhances directional control and stability of the vehicle under various driving conditions. The ESP corrects for oversteering and understeering the vehicle by applying the brake of the appropriate wheel. Engine power may also be reduced to assist in counteracting the condition of oversteer or understeer and help the vehicle maintain the desired path.

The ESP uses sensors in the vehicle to determine the path that the driver intends to steer the vehicle and compares it to the actual path of the vehicle. When the actual path does not match the intended path, the ESP applies the brake of the appropriate wheel to assist in counteracting the condition of oversteer or understeer.

- Oversteer - when the vehicle is turning more than appropriate for the steering wheel position.
- Understeer - when the vehicle is turning less than appropriate for the steering wheel position.



The "ESP/TCS Indicator Light," located in the instrument cluster, starts to flash as soon as the tires lose traction and the ESP system becomes active. The "ESP/TCS Indicator Light" also flashes when TCS is active. If the "ESP/TCS Indicator Light" begins to flash during acceleration, ease up on the accelerator and apply as little throttle as possible. Be sure to adapt your speed and driving to the prevailing road conditions.

WARNING!

The ESP (Electronic Stability Program) cannot prevent the natural laws of physics from acting on the vehicle, nor can it increase the traction afforded by prevailing road conditions. The ESP cannot prevent accidents, including those resulting from excessive speed in turns, driving on very slippery surfaces, or hydroplaning. Only a safe, attentive, and skillful driver can prevent accidents. The capabilities of an ESP-equipped vehicle must never be exploited in a reckless or dangerous manner that could jeopardize the user's safety or the safety of others.

The ESP system has 3 available operating modes:

ESP On

This is the normal operating mode for the ESP. Whenever the vehicle is started, the ESP system will be in this mode.

This mode should be used for most all driving situations. The ESP should only be turned off for specific reasons as noted in the following paragraphs.

Partial Off

The "Partial Off" mode is intended for times when a more spirited driving experience is desired. It is also intended for driving in deep snow, sand, or gravel. This mode disables the TCS portion of the ESP and raises the threshold for ESP activation, which allows for more wheel spin than what ESP normally allows.

ESP OFF

The "ESP OFF" button is located in the switch bank near the top center of the instrument panel. To enter the "Partial Off" mode, momentarily depress the "ESP OFF" button and the "ESP/TCS Indicator Light" will illuminate. To turn the ESP ON again, momentarily depress the "ESP OFF" button and the "ESP/TCS Indicator Light" will turn off.

NOTE: To improve the vehicle's traction when driving with snow chains, or when starting-off in deep snow, sand, or gravel, it may be desirable to switch to the "Partial Off" mode by momentarily depressing the "ESP OFF" button. Once the situation requiring "Partial Off" mode is overcome, turn the ESP ON again by momentarily depressing the "ESP OFF" button. This may be done while the vehicle is in motion.

Full Off

This mode is intended for off-highway or off-road use only and should not be used on any public roadways. In this mode, all TCS and ESP stability features are turned off. To enter the "Full Off" mode, depress and hold the "ESP OFF" button for five seconds while the vehicle is stopped with the engine running. After five seconds, a chime will sound, the "ESP/TCS Indicator Light" will illuminate, and the "ESP OFF" message will display in the vehicle odometer. Press and release the TRIP ODOMETER button located on the instrument cluster to clear

this message. The "ESP OFF" message may appear in the Electronic Vehicle Information Center (EVIC). Refer to "Electronic Vehicle Information Center (EVIC)" in Section 4. To turn ESP ON again, momentarily depress the "ESP OFF Button."

NOTE: The "ESP OFF," or "ESP System Deactivated" message will display and the audible chime will sound when the gear selector is moved into the PARK position from any position other than PARK and then moved out of the PARK position. This will occur when the message was previously cleared.

WARNING!

In the ESP Full Off mode, the engine torque reduction and stability features are cancelled. Therefore, the enhanced vehicle stability offered by ESP is unavailable.

NOTE: When the ESP is switched off a feature of the system remains active. This feature controls wheel spin across an axle quite similarly to a limited slip differential. If one wheel on an axle is spinning faster than the other, the system will apply the brake of the spinning wheel and allow more engine torque to be applied to the wheel that is not spinning. To improve the vehicle's traction when driving with tire chains, or when starting-off in deep snow, sand, or gravel, it may be desirable to switch to the "Partial Off" mode by momentarily depressing the "ESP OFF" button.

WARNING!

With the ESP switched off, the enhanced vehicle stability offered by ESP is unavailable. In an emergency evasive maneuver, the ESP system will not engage to assist in maintaining stability. The "Full Off" ESP mode is intended for off-highway or off-road only.

Synchronizing ESP

ESP BAS

The Malfunction Indicator Light for the ESP is combined with BAS indicator. If the power supply is interrupted (battery disconnected or discharged), the ESP/BAS Malfunction Indicator Light may illuminate with the engine running. If this should occur, turn the steering wheel completely to the left and then to the right. The ESP/BAS Malfunction

Indicator Light should go out. However, if the light remains on, have the ESP and BAS checked at your authorized dealer as soon as possible.

ESP/BAS Malfunction Indicator Light and ESP/TCS Indicator Light

ESP BAS

The Malfunction Indicator Light for the ESP is combined with the BAS indicator. The yellow “ESP/BAS Malfunction Indicator Light” and the yellow “ESP/TCS Indicator Light” in the instrument cluster both come on when the ignition switch is turned to the ON position. They should go out with the engine running.

The system will turn the “ESP/BAS Malfunction Indicator Light” on continuously while the engine running if it detects a malfunction in either the ESP or the BAS or both. If the light remains on after several ignition cycles and you have driven the vehicle several miles (kilometers) at speeds greater than 30 mph (48 km/h), and the

ESP is synchronized (refer to Synchronizing ESP), see your authorized dealer as soon as possible to have the problem diagnosed and corrected.

NOTE:

- The “ESP/TCS Indicator Light” and the “ESP/BAS Malfunction Indicator Light” will turn on momentarily each time the ignition switch is turned ON.
- Each time the ignition is turned ON, the ESP System will be on even if it was turned off previously.
- The ESP Control System will make buzzing or clicking sounds when it is active. This is normal; the sounds will stop when ESP becomes inactive following the maneuver that caused the ESP activation.

TIRE SAFETY INFORMATION

Tire Markings

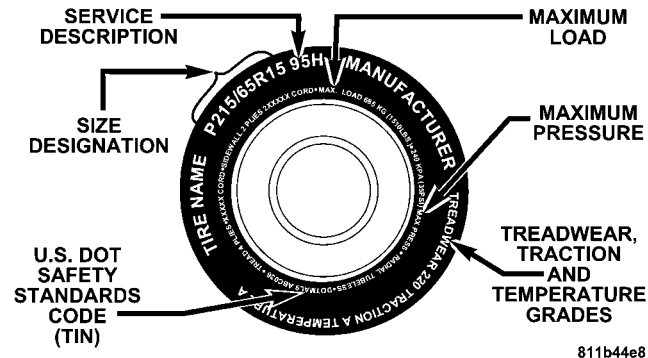

NOTE:

- P (Passenger)-Metric tire sizing is based on U.S. design standards. P-Metric tires have the letter "P" molded into the sidewall preceding the size designation. Example: P215/65R15 95H.

- European Metric tire sizing is based on European design standards. Tires designed to this standard have the tire size molded into the sidewall beginning with the section width. The letter "P" is absent from this tire size designation. Example: 215/65R15 96H
- LT (Light Truck)-Metric tire sizing is based on U.S. design standards. The size designation for LT-Metric tires is the same as for P-Metric tires except for the letters "LT" that are molded into the sidewall preceding the size designation. Example: LT235/85R16.
- Temporary spare tires are high-pressure compact spares designed for temporary emergency use only. Tires designed to this standard have the letter "T" molded into the sidewall preceding the size designation. Example: T145/80D18 103M.
- High flotation tire sizing is based on U.S. design standards, and it begins with the tire diameter molded into the sidewall. Example: 31x10.5 R15 LT.

Tire Sizing Chart

EXAMPLE:

Size Designation:

P = Passenger car tire size based on U.S. design standards

"...**blank**..." = Passenger car tire based on European design standards

LT = Light truck tire based on U.S. design standards

T = Temporary spare tire

31 = Overall diameter in inches (in)

215 = Section width in millimeters (mm)

65 = Aspect ratio in percent (%).

—Ratio of section height to section width of tire

10.5 = Section width in inches (in)

R = Construction code

—"R" means radial construction

—"D" means diagonal or bias construction

15 = Rim diameter in inches (in)

EXAMPLE:	
Service Description:	
95 = Load Index	—A numerical code associated with the maximum load a tire can carry
H = Speed Symbol	—A symbol indicating the range of speeds at which a tire can carry a load corresponding to its load index under certain operating conditions —The maximum speed corresponding to the speed symbol should only be achieved under specified operating conditions (i.e., tire pressure, vehicle loading, road conditions, and posted speed limits)
Load Identification:	
"....blank...." = Absence of any text on the sidewall of the tire indicates a Standard Load (SL) Tire	
Extra Load (XL) = Extra load (or reinforced) tire	
Light Load = Light load tire	
C,D,E = Load range associated with the maximum load a tire can carry at a specified pressure	
Maximum Load — Maximum load indicates the maximum load this tire is designed to carry	
Maximum Pressure — Maximum pressure indicates the maximum permissible cold tire inflation pressure for this tire	

Tire Identification Number (TIN)

The TIN may be found on one or both sides of the tire, however, the date code may only be on one side. Tires with white sidewalls will have the full TIN, including the date code,

located on the white sidewall side of the tire. Look for the TIN on the outboard side of black sidewall tires as mounted on the vehicle. If the TIN is not found on the outboard side, then you will find it on the inboard side of the tire.

EXAMPLE:**DOT MA L9 ABCD 0301****DOT** = Department of Transportation

—This symbol certifies that the tire is in compliance with the U.S. Department of Transportation tire safety standards, and is approved for highway use

MA = Code representing the tire manufacturing location (two digits)**L9** = Code representing the tire size (two digits)**ABCD** = Code used by the tire manufacturer (one to four digits)**03** = Number representing the week in which the tire was manufactured (two digits)

—03 means the 3rd week.

01 = Number representing the year in which the tire was manufactured (two digits)

—01 means the year 2001

—Prior to July 2000, tire manufacturers were only required to have one number to represent the year in which the tire was manufactured. Example: 031 could represent the 3rd week of 1981 or 1991

Tire Loading and Tire Pressure

Tire Placard Location

NOTE: The proper cold tire inflation pressure is listed on either the face of the driver's door or the driver's side B-pillar.

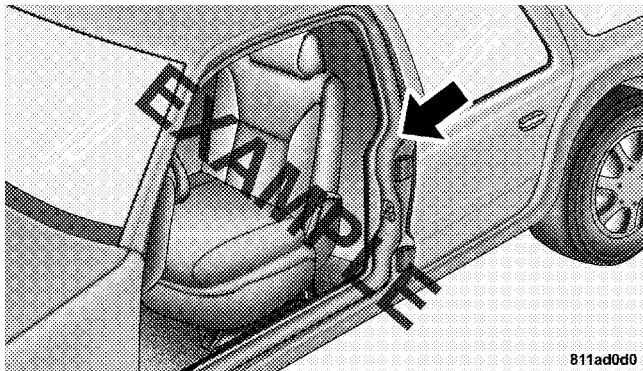

Tire Placard Location

Tire and Loading Information Placard

TIRE AND LOADING INFORMATION			
SEATING CAPACITY - TOTAL 5 FRONT 2 REAR 3			
THE COMBINED WEIGHT OF OCCUPANTS AND CARGO SHOULD NEVER EXCEED XXX KG OR XXX LBS.			
TIRE	FRONT	REAR	SPARE
ORIGINAL TIRE SIZE	P195/70R14	P195/70R14	T125/70D15
COLD TIRE INFLATION PRESSURE	200kPa, 29PSI	200kPa, 29PSI	420kPa, 60PSI
SEE OWNER'S MANUAL FOR ADDITIONAL INFORMATION			4N109268

811b5a9a

Tire And Loading Information Placard

This placard tells you important information about:

- 1) number of people that can be carried in the vehicle
- 2) total weight your vehicle can carry
- 3) tire size designed for your vehicle
- 4) cold tire inflation pressures for the front, rear, and spare tires.

Loading

The vehicle maximum load on the tire must not exceed the load carrying capacity of the tire on your vehicle. You will not exceed the tire's load carrying capacity if you adhere to the loading conditions, tire size, and cold tire inflation pressures specified on the Tire and Loading Information placard and in the "Vehicle Loading" section of this manual.

NOTE: Under a maximum loaded vehicle condition, gross axle weight ratings (GAWRs) for the front and rear axles must not be exceeded. For further information on GAWRs, vehicle loading, and trailer towing, refer to "Vehicle Loading" in this section.

To determine the maximum loading conditions of your vehicle, locate the statement "The combined weight of

occupants and cargo should never exceed XXX kg or XXX lbs." on the Tire and Loading Information placard. The combined weight of occupants, cargo/luggage and trailer tongue weight (if applicable) should never exceed the weight referenced here.

Steps for Determining Correct Load Limit

1. Locate the statement "The combined weight of occupants and cargo should never exceed XXX lbs or XXX kg" on your vehicle's placard.
2. Determine the combined weight of the driver and passengers that will be riding in your vehicle.
3. Subtract the combined weight of the driver and passengers from XXX kg or XXX lbs.

4. The resulting figure equals the available amount of cargo and luggage load capacity. For example, if “XXX” amount equals 1,400 lbs (635 kg) and there will be five 150 lb (68 kg) passengers in your vehicle, the amount of available cargo and luggage load capacity is 650 lbs (295 kg) {(since $5 \times 150 = 750$, and $1400 - 750 = 650$ lbs (295 kg)}.

5. Determine the combined weight of luggage and cargo being loaded on the vehicle. That weight may not safely exceed the available cargo and luggage load capacity calculated in Step 4.

6. If your vehicle will be towing a trailer, load from your trailer will be transferred to your vehicle. Consult this

manual to determine how this reduces the available cargo and luggage load capacity of your vehicle.

NOTE: The following table shows examples on how to calculate total load, cargo/luggage, and towing capacities of your vehicle with varying seating configurations and number and size of occupants. This table is for illustration purposes only and may not be accurate for the seating and load carry capacity of your vehicle.

NOTE: For the following example, the combined weight of occupants and cargo should never exceed 865 lbs (392 kg).

Occupants			Combined weight of occupants and cargo from Tire Placard	MINUS	Combined Occupant's weight	=	AVAILABLE Cargo/Luggage and Trailer Tongue Weight
TOTAL	FRONT	REAR					
EXAMPLE 1							
5	2	3	865 lbs	minus	670 lbs	=	195 lbs
Occupant 1: 200 lbs Occupant 2: 130 lbs Occupant 3: 160 lbs Occupant 4: 100 lbs Occupant 5: 80 lbs TOTAL WEIGHT: 670 lbs							
EXAMPLE 2							
3	2	1	865 lbs	minus	540 lbs	=	325 lbs
Occupant 1: 210 lbs Occupant 2: 180 lbs Occupant 3: 150 lbs TOTAL WEIGHT: 540 lbs							
EXAMPLE 3							
2	2	0	865 lbs	minus	400 lbs	=	465 lbs
Occupant 1: 200 lbs Occupant 2: 200 lbs TOTAL WEIGHT: 400 lbs							

811a4d11

WARNING!

Overloading of your tires is dangerous. Overloading can cause tire failure, affect vehicle handling, and increase your stopping distance. Use tires of the recommended load capacity for your vehicle. Never overload them.

TIRES — GENERAL INFORMATION**Tire Pressure**

Proper tire inflation pressure is essential to the safe and satisfactory operation of your vehicle. Three primary areas are affected by improper tire pressure:

1. Safety—**WARNING!**

- Improperly inflated tires are dangerous and can cause accidents.
- Under-inflation increases tire flexing and can result in tire failure.
- Over-inflation reduces a tire's ability to cushion shock. Objects on the road and chuckholes can cause damage that result in tire failure.
- Unequal tire pressures can cause steering problems. You could lose control of your vehicle.
- Over-inflated or under-inflated tires can affect vehicle handling and can fail suddenly, resulting in loss of vehicle control.
- Unequal tire pressures from one side of the vehicle to the other can cause the vehicle to drift to the right or left.
- Always drive with each tire inflated to the recommended cold tire inflation pressure.

2. *Economy*—

Improper inflation pressures can cause uneven wear patterns to develop across the tire tread. These abnormal wear patterns will reduce tread life resulting in a need for earlier tire replacement. Under-inflation, also increases tire rolling resistance and results in higher fuel consumption.

3. *Ride Comfort and Vehicle Stability*—

Proper tire inflation contributes to a comfortable ride. Over-inflation produces a jarring and uncomfortable ride.

Tire Inflation Pressures

The proper cold tire inflation pressure is listed either on the face of the driver's door or on the driver's side B-pillar.

Some vehicles may have supplemental tire pressure information for vehicle loads that are less than the

maximum loaded vehicle condition. These pressure conditions will be found in the "Supplemental Tire Pressure Information" section of this manual.

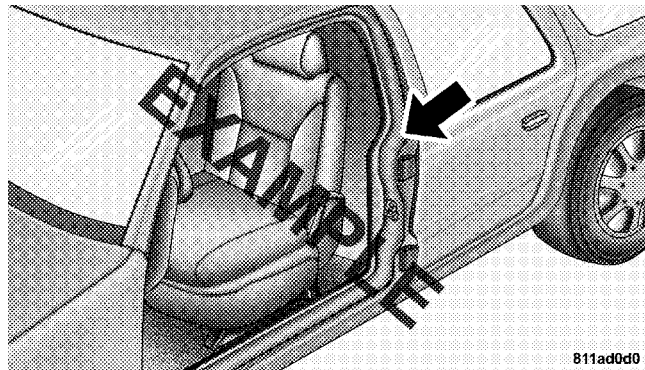

Tire Placard Location

The pressure should be checked and adjusted as well as inspecting for signs of tire wear or visible damage at least once a month. Use a good quality pocket-type gauge to

check tire pressure. Do not make a visual judgement when determining proper inflation. Radial tires may look properly inflated even when they are under-inflated.

CAUTION!

After inspecting or adjusting the tire pressure, always reinstall the valve stem cap (if equipped). This will prevent moisture and dirt from entering the valve stem, which could damage the valve stem.

Inflation pressures specified on the placard are always "cold tire inflation pressure." Cold tire inflation pressure is defined as the tire pressure after the vehicle has not been driven for at least three hours, or driven less than 1 mi (1 km) after a three hour period. The cold tire inflation pressure must not exceed the maximum inflation pressure molded into the tire sidewall.

Check tire pressures more often if subject to a wide range of outdoor temperatures, as tire pressures vary with temperature changes.

Tire pressures change by approximately 1 psi (7 kPa) per 12° F (7° C) of air temperature change. Keep this in mind when checking tire pressure inside a garage, especially in the Winter.

Example: If garage temperature = 68°F (20°C) and the outside temperature = 32°F (0°C) then the cold tire inflation pressure should be increased by 3 psi (21 kPa), which equals 1 psi (7 kPa) for every 12°F (7°C) for this outside temperature condition.

Tire pressure may increase from 2 to 6 psi (13 to 40 kPa) during operation. DO NOT reduce this normal pressure build up or your tire pressure will be too low.

Tire Pressures for High Speed Operation

The manufacturer advocates driving at safe speeds within posted speed limits. Where speed limits or conditions are such that the vehicle can be driven at high speeds, maintaining correct tire inflation pressure is very important. Increased tire pressure and reduced vehicle loading may be required for high-speed vehicle operation. Refer to original equipment or an authorized tire dealer for recommended safe operating speeds, loading and cold tire inflation pressures.

WARNING!

High speed driving with your vehicle under maximum load is dangerous. The added strain on your tires could cause them to fail. You could have a serious accident. Don't drive a vehicle loaded to the maximum capacity at continuous speeds above 75 mph (120 km/h).

Radial-Ply Tires

WARNING!

Combining radial ply tires with other types of tires on your vehicle will cause your vehicle to handle poorly. The instability could cause an accident. Always use radial ply tires in sets of four (or six, in case of trucks with dual rear wheels). Never combine them with other types of tires.

Cuts and punctures in radial tires are repairable only in the tread area because of sidewall flexing. Consult your authorized tire dealer for radial tire repairs.

Tire Spinning

When stuck in mud, sand, snow, or ice conditions, do not spin your vehicle's wheels above 35 mph (55 km/h).

Refer to the paragraph on "Freeing A Stuck Vehicle" in Section 6.

WARNING!

Fast spinning tires can be dangerous. Forces generated by excessive wheel speeds may cause tire damage or failure. A tire could explode and injure someone. Do not spin your vehicle's wheels faster than 30 mph (48 km/h) for more than 30 seconds continuously when you are stuck, and don't let anyone near a spinning wheel, no matter what the speed.

Tread Wear Indicators

Tread wear indicators are in the original equipment tires to help you in determining when your tires should be replaced.

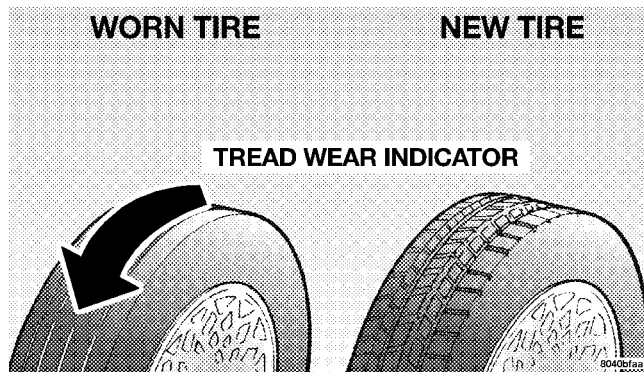

These indicators are molded into the bottom of the tread grooves. They will appear as bands when the tread depth becomes 1/16 in (2 mm). When the tread is worn to the tread wear indicators, the tire should be replaced.

Many states have laws requiring tire replacement at this point.

Life of Tire

The service life of a tire is dependent upon varying factors including, but not limited to:

- Driving style
- Tire pressure
- Distance driven

WARNING!

Tires and the spare tire should be replaced after six years, regardless of the remaining tread. Failure to follow this warning can result in sudden tire failure. You could lose control and have an accident resulting in serious injury or death.

Keep dismounted tires in a cool, dry place with as little exposure to light as possible. Protect tires from contact with oil, grease, and gasoline.

Replacement Tires

The tires on your new vehicle provide a balance of many characteristics. They should be inspected regularly for wear and correct cold tire inflation pressure. The manufacturer strongly recommends that you use tires equivalent to the originals in size, quality and performance when replacement is needed. (Refer to the paragraph on “Tread Wear Indicators”). Refer to the “Tire and Loading Information” placard for the size designation of your tire. The service description and load identification will be found on the original equipment tire. Failure to use equivalent replacement tires may adversely affect the safety, handling, and ride of your vehicle. We recommend that you contact your original equipment or an authorized tire dealer with any questions you may have on tire specifications or capability.

WARNING!

- **Do not use a tire, wheel size or rating other than that specified for your vehicle. Some combinations of unapproved tires and wheels may change suspension dimensions and performance characteristics, resulting in changes to steering, handling, and braking of your vehicle. This can cause unpredictable handling and stress to steering and suspension components. You could lose control and have an accident resulting in serious injury or death. Use only the tire and wheel sizes with load ratings approved for your vehicle.**
- **Never use a tire with a smaller load index or capacity than what was originally equipped on your vehicle. Using a tire with a smaller load index could result in tire overloading and failure. You could lose control and have an accident.**
- **Failure to equip your vehicle with tires having adequate speed capability can result in sudden tire failure and loss of vehicle control.**

CAUTION!

Replacing original tires with tires of a different size may result in false speedometer and odometer readings.

Alignment And Balance

Poor suspension alignment may result in:

- Fast tire wear.
- Uneven tire wear, such as feathering and one-sided wear.
- Vehicle pull to right or left.

Tires may also cause the vehicle to pull to the left or right. Alignment will not correct this condition. See your authorized dealer for proper diagnosis.

Improper alignment will not cause vehicle vibration. Vibration may be a result of tire and wheel out-of-balance. Proper balancing will reduce vibration and avoid tire cupping and spotty wear.

TIRE CHAINS

If driving conditions require tire chains for your vehicle, use only chains that meet SAE type “Class S” specifications. In addition, only install tire chains on 245/45ZR20 size tires. Contact your local dealership or tire dealer for these size tires.

CAUTION!

To avoid damage to your vehicle or tires, observe the following precautions:

- Because of restricted chain clearance between tires and other suspension components, it is important that only chains in good condition are used. Broken chains can cause serious damage. Stop the vehicle immediately if noise occurs that could indicate chain breakage. Remove the damaged parts of the chain before further use.
- Install chains on the rear wheels as tightly as possible and then retighten after driving about ½ mi (0.8 km).
- Do not exceed 30 mph (48 km/h).
- Drive cautiously and avoid severe turns and large bumps, especially with a loaded vehicle.
- Use on rear wheels only.
- Do not drive for prolonged period on dry pavement.
- Observe the tire chain manufacturer's instructions on the method of installation, operating speed, and conditions for use. Always use the lower suggested operating speed of the chain manufacturer if different from the speed recommended by the manufacturer.

NOTE: In order to avoid damage to tires, chains, and your vehicle do not drive for a prolonged period on dry pavement. Observe the tire chain manufacturer's instructions on method of installation, operating speed, and conditions for usage.

Always use the lower suggested operating speed if both the chain manufacturer and vehicle manufacturer suggest a maximum speed. This notice applies to all chain traction devices, including link and cable (radial) chains.

SNOW TIRES

Some areas of the country require the use of snow tires during the winter. Standard tires are of the all season type and satisfy this requirement as indicated by the M+S designation on the tire sidewall.

If you need snow tires, select tires equivalent in size and type to the original equipment tires. Use snow tires only in sets of four. Failure to do so may adversely affect the safety and handling of your vehicle.

Snow tires generally have lower speed ratings than what was originally equipped with your vehicle and should not be operated at sustained speeds over 75 mph (120 km/h).

TIRE ROTATION RECOMMENDATIONS

Tires on the front and rear axles of vehicles operate at different loads and perform different steering, driving, and braking functions. For these reasons, they wear at unequal rates and tend to develop irregular wear patterns. These effects can be reduced by timely rotation of tires. The benefits of rotation are especially worthwhile with aggressive tread designs such as those on all season

type tires. Rotation will increase tread life, help to maintain mud, snow, and wet traction levels, and contribute to a smooth, quiet ride.

Follow the Maintenance Schedule in Section 8 for the recommended tire rotation frequency. Remember, more frequent rotation is permissible if desired. Also, correct for anything causing rapid or unusual wear prior to performing the tire rotation.

Tire Rotation — Standard Tires

The suggested rotation method is the “side-to-side” as shown in the following diagram.

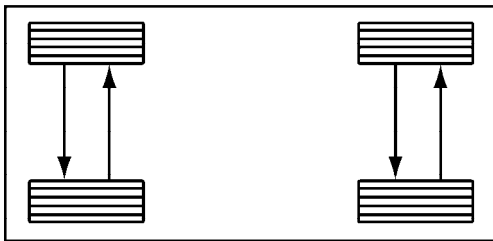
TIRE ROTATION PATTERN← **FRONT OF VEHICLE****4 TIRE ROTATION****Tire Rotation — All Season Tires**

The suggested rotation method for vehicles equipped with all season tires is the “forward-cross” as shown in the following diagram.

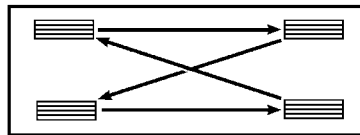
TIRE ROTATION PATTERN← **FRONT OF VEHICLE****4 TIRE ROTATION**

80ba79fe

TIRE PRESSURE MONITOR SYSTEM (TPMS) — IF EQUIPPED

- The Tire Pressure Monitor System (TPMS) will warn the driver of a low tire pressure based on the vehicle recommended cold placard pressure.
- The tire pressure will vary with temperature by about 1 psi (6.9 kPa) for every 12°F (6.5°C). This means that when the outside temperature decreases, the tire pressure will decrease. Tire pressure should always be set based on cold inflation tire pressure. This is defined as the tire pressure after the vehicle has not been driven for at least three hours, or driven less than 1 mi (1 km) after a three hour period. The cold tire inflation pressure must not exceed the maximum inflation pressure molded into the tire sidewall. Refer to the “Tires – General Information” in this section for information on how to properly inflate the vehicle’s tires.
- The tire pressure will also increase as the vehicle is driven - this is normal and there should be no adjustment for this increased pressure.
- The TPMS will warn the driver of a low tire pressure if the tire pressure falls below the low-pressure warning limit for any reason, including low temperature effects and natural pressure loss through the tire.
- The TPMS will continue to warn the driver of low tire pressure as long as the condition exists, and will not turn off until the tire pressure is at or above the recommended cold placard pressure. Once the low tire pressure warning (Tire Pressure Monitoring Telltale Light) illuminates, you must increase the tire pressure to the recommended cold placard pressure in order for the Tire Pressure Monitoring Telltale Light to turn off. The system will automatically update and the Tire Pressure Monitoring Telltale Light will turn off once the system receives the updated tire pressures. The

vehicle may need to be driven for up to 10 minutes above 15 mph (25 km/h) in order for the TPMS to receive this information.

- For example, your vehicle may have a recommended cold (parked for more than three hours) placard pressure of 30 psi (207 kPa). If the ambient temperature is 68°F (20°C) and the measured tire pressure is 27 psi (186 kPa), a temperature drop to 20°F (-7°C) will decrease the tire pressure to approximately 26 psi (179 kPa). This tire pressure is sufficiently low enough to turn ON the Tire Pressure Monitoring Telltale Light. Driving the vehicle may cause the tire pressure to rise to approximately 27 psi (186 kPa), but the Tire Pressure Monitoring Telltale Light will still be ON. In this situation, the Tire Pressure Monitoring Telltale Light will turn OFF only after the tires are inflated to the vehicle's recommended cold placard pressure value.

CAUTION!

- The TPMS has been optimized for the original equipment tires and wheels. TPMS pressures and warning have been established for the tire size equipped on your vehicle. Undesirable system operation or sensor damage may result when using replacement equipment that is not of the same size, type, and/or style. Aftermarket wheels can cause sensor damage. Do not use aftermarket tire sealants or balance beads if your vehicle is equipped with a TPMS, as damage to the sensors may result.
- After inspecting or adjusting the tire pressure, always reinstall the valve stem cap. This will prevent moisture and dirt from entering the valve stem, which could damage the Tire Pressure Monitoring Sensor.

NOTE:

- The TPMS is not intended to replace normal tire care and maintenance or to provide warning of a tire failure or condition.
- The TPMS should not be used as a tire pressure gauge while adjusting your tire pressure.
- Driving on a significantly under-inflated tire causes the tire to overheat and can lead to tire failure. Under-inflation also reduces fuel efficiency and tire tread life, and may affect the vehicle's handling and stopping ability.
- The TPMS is not a substitute for proper tire maintenance, and it is the driver's responsibility to maintain correct tire pressure using an accurate tire pressure gauge, even if under-inflation has not reached the level to trigger illumination of the Tire Pressure Monitoring Telltale Light.

- Seasonal temperature changes will affect tire pressure, and the TPMS will monitor the actual tire pressure in the tire.

Base System — If Equipped

The Tire Pressure Monitor System (TPMS) uses wireless technology with wheel rim mounted electronic sensors to monitor tire pressure levels. Sensors mounted to each wheel as part of the valve stem transmit tire pressure readings to the receiver module.

NOTE: It is particularly important for you to check the tire pressure in all of the tires on your vehicle monthly and to maintain the proper pressure.

The TPMS consists of the following components:

- Receiver Module
- Four Tire Pressure Monitoring Sensors
- Tire Pressure Monitoring Telltale Light

The matching full size spare wheel and tire assembly (if equipped) has a tire pressure monitoring sensor. The matching full size spare can be used in place of any of the four road tires. The TPMS will only monitor the pressure in the full size spare when it is used in place of a road tire. Otherwise, a spare with a pressure below the low-pressure limit will not cause the Tire Pressure Monitoring Telltale Light to illuminate or the chime to sound.

Tire Pressure Monitoring Low Pressure Warnings



The Tire Pressure Monitoring Telltale Light will illuminate in the instrument cluster and a chime will sound when tire pressure is low in one or more of the four active road tires. Should this occur, you should stop as soon as possible, check the inflation pressure of each tire on your vehicle, and inflate each tire to the vehicle's recommended cold placard pressure value. Once the system receives the updated tire pressures, the system will automatically update and the Tire Pressure Monitoring Telltale Light will turn off. The

vehicle may need to be driven for up to 10 minutes above 15 mph (25 km/h) in order for the TPMS to receive this information.

Check TPMS Warning

If a system fault is detected, the Tire Pressure Monitoring Telltale Light will flash on and off for 75 seconds and then remain on solid. The system fault will also sound a chime. If the ignition key is cycled, this sequence will repeat, providing the system fault still exists. The Tire Pressure Monitoring Telltale Light will turn off when the fault condition no longer exists. A system fault can occur due to any of the following:

1. Signal interference due to electronic devices or driving next to facilities emitting the same radio frequencies as the TPM sensors.
2. Installing aftermarket window tinting that contains materials that may block radio wave signals.

3. Accumulation of snow or ice around the wheels or wheel housings.
4. Using tire chains on the vehicle.
5. Using wheels/tires not equipped with TPM sensors.

NOTE:*Vehicles with Full Size Spare*

1. The matching full size spare wheel and tire assembly has a tire pressure monitoring sensor that can be monitored by the TPMS.
2. If you install the full size spare in place of a road tire that has a pressure below the low-pressure warning limit, upon the next ignition key cycle, a chime will sound and the TPM Telltale Light will turn ON.
3. Driving the vehicle for up to 10 minutes above 15 mph (25 km/h) will turn off the TPM Telltale Light, as long as no tire pressure is below the low-pressure warning limit in any of the four active road tires.

NOTE:*Vehicles with Compact Spare*

1. The compact spare tire does not have a tire pressure monitoring sensor. Therefore, the TPMS will not monitor the pressure in the compact spare tire.
2. If you install the compact spare tire in place of a road tire that has a pressure below the low-pressure warning limit, upon the next ignition key cycle, a chime will sound and the TPM Telltale Light will turn ON.
3. After driving the vehicle for up to 10 minutes above 15 mph (25 km/h), the TPM Telltale Light will flash on and off for 75 seconds and then remain on solid.
4. For each subsequent ignition key cycle, a chime will sound and the TPM Telltale Light will flash on and off for 75 seconds and then remain on solid.

5. Once you repair or replace the original road tire, and reinstall it on the vehicle in place of the compact spare, the TPMS will update automatically and the TPM Telltale Light will turn OFF, as long as no tire pressure is below the low-pressure warning limit in any of the four active road tires. The vehicle may need to be driven for up to 10 minutes above 15 mph (25 km/h) in order for the TPMS to receive this information.

Premium System — If Equipped

The Tire Pressure Monitor System (TPMS) uses wireless technology with wheel rim mounted electronic sensors to monitor tire pressure levels. Sensors mounted to each wheel as part of the valve stem transmit tire pressure readings to the receiver module.

NOTE: It is particularly important for you to check the tire pressure in all of the tires on your vehicle monthly and to maintain the proper pressure.

The TPMS consists of the following components:

- Receiver Module
- Four Tire Pressure Monitoring Sensors
- Three Trigger Modules (mounted in three of the four wheel-wells)
- Various tire pressure monitoring system messages, which display in the Electronic Vehicle Information Center (EVIC)
- Tire Pressure Monitoring Telltale Light

The matching full size spare wheel and tire assembly (if equipped) has a tire pressure monitoring sensor. The full size spare can be used in place of any of the four road tires. A spare with a pressure below the low-pressure limit will not cause the Tire Pressure Monitoring Telltale Light to illuminate or the chime to sound.

Tire Pressure Monitoring Low Pressure Warnings

 The Tire Pressure Monitoring Telltale Light will illuminate in the instrument cluster and a chime will sound when tire pressure is low in one or more of the four active road tires. In addition, the EVIC will display one or more low pressure messages (Left Front, Left Rear, Right Front, Right Rear) for three seconds and a graphic showing the pressure values of each tire with the low tire pressure values flashing.

EXAMPLE ONLY

Low Tire PSI

27  30
27  21

2345 mi

Should this occur, you should stop as soon as possible and inflate the tires with low pressure (those flashing in the EVIC graphic) to the vehicle's recommended cold placard pressure value. Once the system receives the updated tire pressures, the system will automatically update, the graphic display in the EVIC will stop flashing, and the Tire Pressure Monitoring Telltale Light will turn off. The vehicle may need to be driven for up to 10 minutes above 15 mph (25 km/h) in order for the TPMS to receive this information.

Check TPMS Warning

If a system fault is detected, the Tire Pressure Monitoring Telltale Light will flash on and off for 75 seconds and then remain on solid. The system fault will also sound a chime. In addition, the EVIC will display a "CHECK TPM SYSTEM" message for three seconds and then display dashes (- -) in place of the pressure value to indicate which sensor is not being received.

EXAMPLE ONLY

Tire	PSI
30	33
30	--

If the ignition key is cycled, this sequence will repeat, providing the system fault still exists. If the system fault no longer exists, the Tire Pressure Monitoring Telltale Light will no longer flash, and the "CHECK TPM SYSTEM" message will no longer display, and a pressure value will display in place of the dashes. A system fault can occur due to any of the following:

1. Signal interference due to electronic devices or driving next to facilities emitting the same radio frequencies as the TPM sensors.
2. Installing aftermarket window tinting that contains materials that may block radio wave signals.
3. Accumulation of snow or ice around the wheels or wheel housings.
4. Using tire chains on the vehicle.
5. Using wheels/tires not equipped with TPM sensors.

NOTE:*Vehicles with Full Size Spare*

1. The matching full size spare wheel and tire assembly has a tire pressure monitoring sensor that can be monitored by the TPMS.
2. If you install the full size spare in place of a road tire that has a pressure below the low-pressure warning limit, upon the next ignition key cycle, a chime will sound and the TPM Telltale Light will turn ON. In addition, the EVIC will display a low pressure message and a graphic showing the low tire pressure value flashing.
3. After driving the vehicle for up to 10 minutes above 15 mph (25 km/h) the TPM Telltale Light will turn OFF, as long as no tire pressure is below the low-pressure warning limit in any of the four active road tires.

NOTE:*Vehicles with Compact Spare*

1. The compact spare tire does not have a tire pressure monitoring sensor. Therefore, the TPMS will not monitor the pressure in the compact spare tire.
2. If you install the compact spare tire in place of a road tire that has a pressure below the low-pressure warning limit, upon the next ignition key cycle, the TPM Telltale Light will remain ON and a chime will sound. In addition, the graphic in the EVIC will still display a flashing pressure value.
3. After driving the vehicle for up to 10 minutes above 15 mph (25 km/h), the TPM Telltale Light will flash on and off for 75 seconds and then remain on solid. In addition, the EVIC will display a "CHECK TPM SYSTEM" message for three seconds and then display dashes (- -) in place of the pressure value.
4. For each subsequent ignition key cycle, a chime will sound, the TPM Telltale Light will flash on and off for 75

seconds and then remain on solid, and the EVIC will display a "CHECK TPM SYSTEM" message for three seconds and then display dashes (- -) in place of the pressure value.

5. Once you repair or replace the original road tire and reinstall it on the vehicle in place of the compact spare, the TPMS will update automatically. In addition, the TPM Telltale Light will turn OFF and the graphic in the EVIC will display a new pressure value instead of dashes (- -), as long as no tire pressure is below the low-pressure warning limit in any of the four active road tires. The vehicle may need to be driven for up to 10 minutes above 15 mph (25 km/h) in order for the TPMS to receive this information.

General Information

This device complies with Part 15 of the FCC rules and RSS 210 of Industry Canada. Operation is subject to the following conditions:

- This device may not cause harmful interference.
- This device must accept any interference received, including interference that may cause undesired operation.

The tire pressure sensors are covered under one of the following licenses:

United States	KR5S120123
Canada	2671-S120123

FUEL REQUIREMENTS

6.1L Engine



The 6.1L Engine is designed to meet all emissions regulations and provide excellent fuel economy and performance when using high-quality premium unleaded gasoline with an octane rating of 91 or higher.

Light spark knock at low engine speeds is not harmful to your engine. However, continued heavy spark knock at high speeds can cause damage and immediate service is required. Poor quality gasoline can cause problems such as hard starting, stalling, and hesitations. If you experience these symptoms, try another brand of gasoline before considering service for the vehicle.

Over 40 auto manufacturers worldwide have issued and endorsed consistent gasoline specifications (the Worldwide Fuel Charter, WWFC) which define fuel properties

necessary to deliver enhanced emissions, performance, and durability for your vehicle. The manufacturer recommends the use of gasolines that meet the WWFC specifications, if they are available.

Reformulated Gasoline

Many areas of the country require the use of cleaner burning gasoline referred to as reformulated gasoline. Reformulated gasolines contain oxygenates and are specifically blended to reduce vehicle emissions and improve air quality.

The manufacturer supports the use of reformulated gasolines. Properly blended reformulated gasolines will provide excellent performance and durability of engine and fuel system components.

Gasoline/Oxygenate Blends

Some fuel suppliers blend unleaded gasoline with oxygenates such as 10% ethanol, MTBE, and ETBE. Oxygenates are required in some areas of the country during the winter months to reduce carbon monoxide emissions. Fuels blended with these oxygenates may be used in your vehicle.

CAUTION!

DO NOT use gasolines containing Methanol or E85 Ethanol. Use of these blends may result in starting and driveability problems and may damage critical fuel system components.

Problems that result from using methanol/gasoline or E85 ethanol blends are not the responsibility of the manufacturer. While MTBE is an oxygenate made from methanol, it does not have the negative effects of methanol.

MMT In Gasoline

MMT is a manganese-containing metallic additive that is blended into some gasoline to increase octane. Gasoline blended with MMT provides no performance advantage beyond gasoline of the same octane number without MMT. Gasoline blended with MMT reduces spark plug life and reduces emissions system performance in some vehicles. The manufacturer recommends that gasoline without MMT be used in your vehicle. The MMT content of gasoline may not be indicated on the gasoline pump, therefore, you should ask your gasoline retailer whether the gasoline contains MMT. It is even more important to look for gasoline without MMT in Canada, because MMT

can be used at levels higher than those allowed in the United States. MMT is prohibited in Federal and California reformulated gasoline.

Materials Added to Fuel

All gasoline sold in the United States is required to contain effective detergent additives. Use of additional detergents or other additives is not needed under normal conditions and they would result in additional cost. Therefore, you should not have to add anything to the fuel.

Fuel System Cautions

CAUTION!

Follow these guidelines to maintain your vehicle's performance:

- The use of leaded gas is prohibited by Federal law. Using leaded gasoline can impair engine performance and damage the emissions control system.
- An out-of-tune engine or certain fuel or ignition malfunctions can cause the catalytic converter to overheat. If you notice a pungent burning odor or some light smoke, your engine may be out of tune or malfunctioning and may require immediate service. Contact your authorized dealer for service assistance.
- The use of fuel additives, which are now being sold as octane enhancers, is not recommended. Most of these products contain high concentrations of methanol. Fuel system damage or vehicle performance problems resulting from the use of such fuels or additives is not the responsibility of the manufacturer.

NOTE: Intentional tampering with the emissions control system can result in civil penalties being assessed against you.

Carbon Monoxide Warnings

WARNING!

Carbon monoxide (CO) in exhaust gases is deadly. Follow the precautions below to prevent carbon monoxide poisoning:

- Do not inhale exhaust gases. They contain carbon monoxide, a colorless and odorless gas, which can kill. Never run the engine in a closed area, such as a garage, and never sit in a parked vehicle with the engine running for an extended period. If the vehicle is stopped in an open area with the engine running for more than a short period, adjust the ventilation system to force fresh, outside air into the vehicle.

- Guard against carbon monoxide with proper maintenance. Have the exhaust system inspected every time the vehicle is raised. Have any abnormal conditions repaired promptly. Until repaired, drive with all side windows fully open.
- Keep the trunk/liftgate closed when driving your vehicle to prevent carbon monoxide and other poisonous exhaust gases from entering the vehicle.

ADDING FUEL

Fuel Filler Cap (Gas Cap)

The gas cap is located behind the fuel filler door on the left side of the vehicle. Push in on the left side (near the edge) of the fuel filler door to access the fuel filler cap. If the gas cap is lost or damaged, be sure the replacement cap is for use with this vehicle.

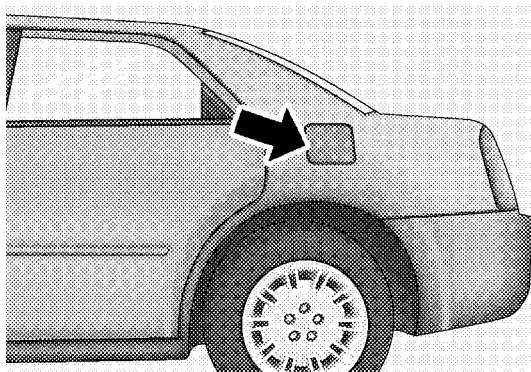

Fuel Filler Door

81368080

NOTE: When removing the fuel filler cap, lay the cap tether in the hook, located on the fuel filler cap door reinforcement.

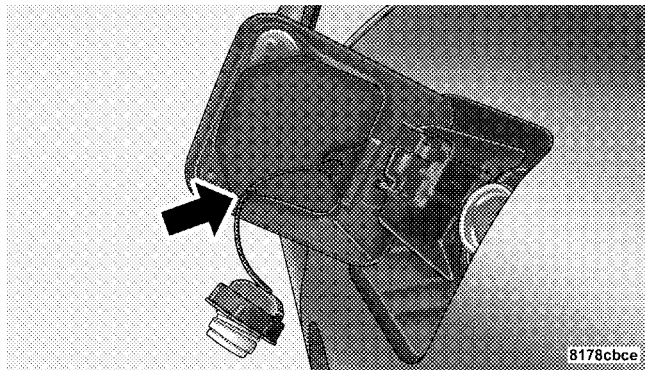

Gas Cap Tether Hook

CAUTION!

- Damage to the fuel system or emissions control system could result from using an improper fuel tank filler tube cap (gas cap).
- A poorly fitting gas cap could let impurities into the fuel system.
- A poorly fitting gas cap may cause the Malfunction Indicator Light (MIL) to turn on.
- To avoid fuel spillage and overfilling, do not “top off” the fuel tank after filling. When the fuel nozzle “clicks” or shuts off, the fuel tank is full.

WARNING!

- Never have any smoking materials lit in or near the vehicle when the gas cap is removed or the tank filled.
- Never add fuel to the vehicle when the engine is running.
- A fire may result if gasoline is pumped into a portable container that is inside of a vehicle. You could be burned. Always place gas containers on the ground while filling.

NOTE:

- Tighten the gas cap until you hear a “clicking” sound. This is an indication that the gas cap is tightened properly. The MIL in the instrument cluster may turn

on if the gas cap is not secured properly. Make sure that the gas cap is tightened each time the vehicle is refueled.

- When the fuel nozzle “clicks” or shuts off, the fuel tank is full.

Loose Fuel Filler Cap Message

If the vehicle diagnostic system determines that the fuel filler cap is loose, improperly installed, or damaged, a “Check Gascap” message will display in the Electronic Vehicle Information Center (EVIC). If this occurs, tighten the fuel filler cap properly and press the TRIP ODOMETER button to turn off the message. If the problem continues, the message will appear the next time the vehicle is started.

A loose, improperly installed, or damaged fuel filler cap may also turn on the MIL. Refer to “Onboard Diagnostic System” in Section 7.

VEHICLE LOADING

The load carrying capacity of your vehicle is shown on the “Vehicle Certification Label.” This information should be used for passenger and luggage loading as indicated.

Do not exceed the specified Gross Vehicle Weight Rating (GVWR) or the Gross Axle Weight Rating (GAWR).

Vehicle Certification Label

Your vehicle has a Vehicle Certification Label affixed to the rear of the driver’s door.

The label contains the following information:

- Name of manufacturer
- Month and year of manufacture
- Gross Vehicle Weight Rating (GVWR)
- Gross Axle Weight Rating (GAWR) front

- Gross Axle Weight Rating (GAWR) rear
- Vehicle Identification Number (VIN)
- Type of Vehicle
- Month Day and Hour of Manufacture (MDH)

The bar code allows a computer scanner to read the VIN.

Gross Vehicle Weight Rating (GVWR)

The GVWR is the total allowable weight of your vehicle. This includes driver, passengers, and cargo. The total load must be limited so that you do not exceed the GVWR.

Gross Axle Weight Rating (GAWR)

The GAWR is the maximum capacity of the front and rear axles. Distribute the load over the front and rear axles evenly. Make sure that you do not exceed either front or rear GAWR.

WARNING!

Because the front wheels steer the vehicle, it is important that you do not exceed the maximum front or rear GAWR. A dangerous driving condition can result if either rating is exceeded. You could lose control of the vehicle and have an accident.

Overloading

The load carrying components (axle, springs, tires, wheels, etc.) of your vehicle will provide satisfactory service as long as you do not exceed the GVWR and the front and rear GAWR.

The best way to figure out the total weight of your vehicle is to weigh it when it is fully loaded and ready for operation. Weigh it on a commercial scale to ensure that it is not over the GVWR.

Figure out the weight on the front and rear of the vehicle separately. It is important that you distribute the load evenly over the front and rear axles.

Overloading can cause potential safety hazards and shorten useful service life. Heavier axles or suspension components do not necessarily increase the vehicle's GVWR.

Loading

To load your vehicle properly, first figure out its empty weight, axle-by-axle and side-by-side. Store heavier items down low and be sure you distribute their weight as evenly as possible. Stow all loose items securely before driving. If weighing the loaded vehicle shows that you have exceeded either GAWR, but the total load is within the specified GVWR, you must redistribute the weight. Improper weight distribution can have an adverse effect on the way your vehicle steers and handles and the way the brakes operate.

A loaded vehicle is shown in the illustration. Note that neither the GVWR nor the GAWR capacities have been exceeded.

GROSS VEHICLE WEIGHT RATING (GVWR) 2177 KG (4800 LBS)
(Example Only)

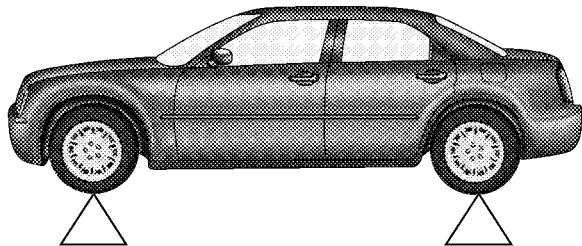

812cb8da

EXAMPLE ONLY	Front Axle	Rear Axle
Empty Weight	2054 lbs (932 kg)	1805 lbs (819 kg)
Load (including driver, passengers, and cargo)	271 lbs (123 kg)	579 lbs (263 kg)
Total	2325 lbs (1055 kg)	2384 lbs (1081 kg)
GAWR	2546 lbs (1155 kg)	2708 lbs (1228 kg)

NOTE: Refer to the “Vehicle Certification Label” affixed to the rear of the driver’s door for your vehicle’s GVWR and GAWRs. This table is only an example.

TRAILER TOWING

Trailer towing with this vehicle is not recommended.

RECREATIONAL TOWING (BEHIND MOTORHOME, ETC.)

TOWING THIS VEHICLE BEHIND ANOTHER VEHICLE (Flat Towing With All Four Wheels On The Ground)

Recreational towing for this vehicle is not recommended.

NOTE: If the vehicle requires towing, make sure all four wheels are off the ground.

GROUND CLEARANCE

CAUTION!

Damage to the front and rear fascias can occur if you disregard the low ground clearance in the front and rear of this vehicle. Pay close attention when parking to avoid running into parking curbs. Exercise caution when entering or exiting steep driveways or when pulling off the road onto soft shoulders.

WHAT TO DO IN EMERGENCIES

CONTENTS

- Hazard Warning Flasher370
- If Your Engine Overheats371
- TIREFIT Tire Repair372
- Jump-Starting Procedures377
- Freeing A Stuck Vehicle380
- Towing A Disabled Vehicle381
 - Without The Ignition Key381
 - Towing This Vehicle Behind Another Vehicle (Flat Towing With All Four Wheels On The Ground)381
 - Towing This Vehicle Behind Another Vehicle With A Tow Dolly382

HAZARD WARNING FLASHER

The HAZARD switch is located in the center of the instrument panel between the center air outlets.

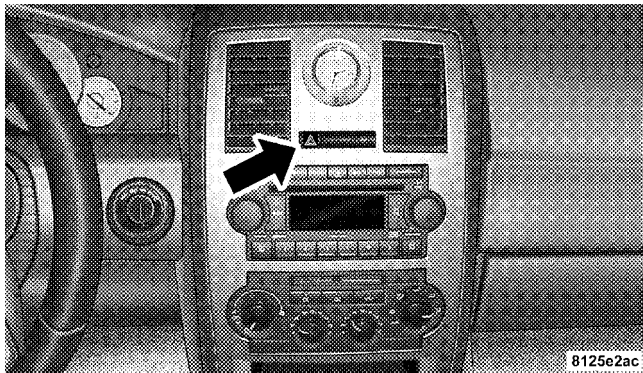

Hazard Flasher Switch

Depress the switch to activate the flashers. When activated, all directional turn signals will flash on and off to warn oncoming traffic of an emergency. Push the switch a second time to turn off the flashers.

This is an emergency warning system and it should not be used when the vehicle is in motion. Use it when your vehicle is disabled and it is creating a safety hazard for other motorists.

When you must leave the vehicle to seek assistance, the hazard warning flashers will continue to operate even though the ignition switch is in the LOCK position.

NOTE: With extended use, the hazard warning flashers may wear down your battery.

IF YOUR ENGINE OVERHEATS

In any of the following situations, you can reduce the potential for overheating by taking the appropriate action.

- On the highways — Slow down.
- In city traffic — While stopped, put transmission in NEUTRAL, but do not increase engine idle speed.

NOTE: There are steps that you can take to slow down an impending overheat condition. If your air conditioner is on, turn it off. The air conditioning system adds heat to the engine cooling system and turning off the A/C removes this heat. You can also turn the temperature control to maximum heat, the mode control to floor, and the Fan control to HI. This allows the heater core to act as a supplement to the radiator and aids in removing heat from the engine cooling system.

CAUTION!

Driving with a hot cooling system could damage your vehicle. If the temperature gauge reads 240°F (116°C) or greater pull over and stop the vehicle. Idle the vehicle with the air conditioner turned off until the pointer drops back into the normal range 200–230°F (93–110°C). If the pointer remains at 240°F (116°C) or greater and you hear a chime, turn the engine off immediately and call for service.

WARNING!

A hot engine cooling system is dangerous. You or others could be badly burned by steam or boiling coolant. You may want to call a service center if your vehicle overheats. If you decide to look under the hood yourself, refer to Section 7 and follow the warnings under the Cooling System Pressure Cap paragraph.

TIREFIT TIRE REPAIR

Small punctures, particularly those in the tread, can be sealed with TIREFIT. Foreign objects (e.g., screws or nails) should not be removed from the tire. TIREFIT can be used in outside temperatures down to approximately -4°F (-20°C).

The TIREFIT system is located under an access panel in the trunk.

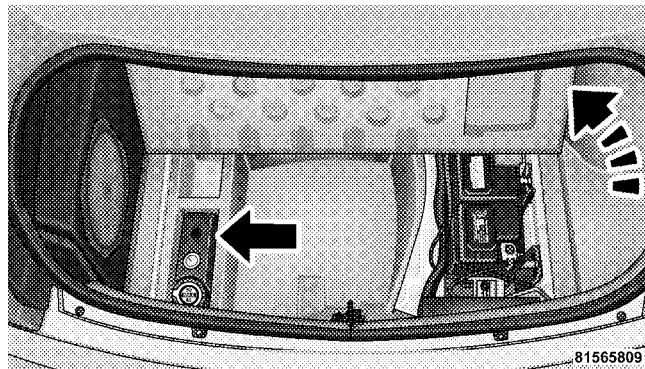

TIREFIT Location

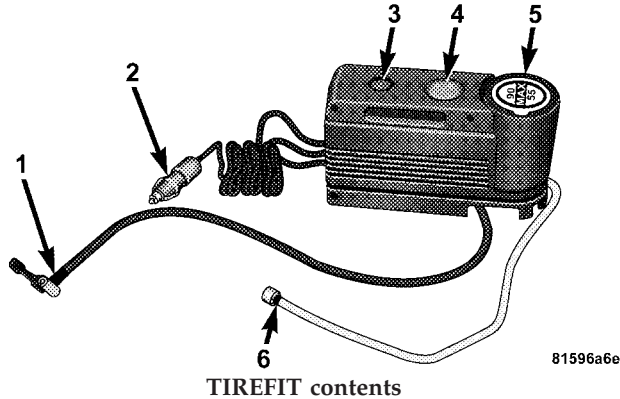

1. Air pump hose
2. Power plug and cable
3. AIR PUMP switch
4. Pressure gauge
5. TIREFIT sealant bottle
6. TIREFIT sealant hose

WARNING!

- Do not attempt to repair a tire on the side of the vehicle close to traffic. Pull far enough off the road to avoid the danger of being hit when operating the jack or repairing a tire.
- Cuts or punctures larger than approximately 0.16 in. (4 mm), tire damage caused by driving with extremely low tire pressure or on a flat tire, or a damaged wheel can pose a hazard while driving. TIREFIT should not be used in such circumstances. Do not drive the vehicle under such circumstances. Contact your nearest authorized dealer for assistance.
- Take care not to allow the contents of TIREFIT to come in contact with hair, eyes or clothing. TIREFIT is harmful if inhaled, swallowed, or absorbed through the skin: It causes skin, eye, and respiratory irritation. Any contact with eyes or skin should be flushed immediately with plenty of water. If clothing comes in contact with TIREFIT, change clothing as soon as possible.
- In case of allergic reaction or rash, consult a physician immediately. Keep TIREFIT out of reach of children. If swallowed, rinse mouth immediately with plenty of water and drink plenty of water. Do not induce vomiting! Consult a physician immediately.
- Keep away from open flame or heat source.

Sealing tire with TIREFIT



Turn on the hazard warning flashers.

1. Move the shift lever to the PARK position, turn off the engine, and set the parking brake.
2. Remove the TIREFIT kit from the trunk.
3. Pull the power plug (2) and the TIREFIT sealant hose (6) out from the TIREFIT kit.
4. Unscrew the valve cap from the valve on the deflated tire.
5. Screw the fitting at the end of TIREFIT sealant hose (6) coming from the sealant bottle (5) onto the tire valve.
6. Insert the power plug (2) into the power point on the instrument panel.
7. Leave the parking brake set and the shift lever in PARK and start the engine.

8. Press the switch (3) on the air pump to I (ON). The air pump should start to inflate the tire and the tire sealant (white fluid) will flow from the sealant bottle (5) through the TIREFIT sealant hose (6) and into the tire.

9. Allow the air pump to run for five minutes and then read the pressure gauge (4). If the tire inflates to 26 psi (1.8 bar) or greater, proceed to Step 19 of this procedure. If not, proceed to the following step.

10. Press the AIR PUMP switch (3) to 0 (OFF). Then, disconnect the TIREFIT system from the tire and place it back in the vehicle.

11. Release the parking brake and drive the vehicle back and forth approximately 30 ft (9.1 m) to distribute the sealant more evenly within the tire.

12. Turn on the hazard warning flashers.

13. Move the shift lever to the PARK position, turn off the engine, and set the parking brake.

14. Disconnect the air pump hose (1) from the underside of the sealant bottle (5) by flipping the hose valve open.
15. Connect the air pump hose valve to the tire valve and flip the hose valve closed.
16. Leave the parking brake set and the shift lever in PARK and start the engine.
17. Press the switch (3) on the air pump to I (ON). The air pump should inflate the tire to at least 26 psi (1.8 bar) within five minutes. If the tire inflates to this level, proceed to the following step. **NOTE:** If a tire pressure of 26 psi (1.8 bar) is not obtained within five minutes, the tire is too badly damaged. Do not attempt to drive the vehicle further. Call for assistance.
18. With a tire pressure of no less than 26 psi (1.8 bar) press the AIR PUMP switch (3) to 0 (OFF) and turn off the engine. Then, disconnect the TIREFIT system from the tire and place it back in the vehicle.
19. Release the parking brake and drive the vehicle for approximately 10 minutes to ensure optimum distribution of the tire sealant within the tire.
20. Turn on the hazard warning flashers.
21. Move the shift lever to the PARK position, turn off the engine, and set the parking brake.
22. Disconnect the air pump hose (1) from the underside of the sealant bottle (5) by flipping the hose valve open.
23. Connect the air pump hose valve to the tire valve and flip the hose valve closed.
24. Check the pressure in the tire by reading the pressure gauge (4). If the pressure is 19 psi (1.3 bar) or greater, proceed to the following step. **NOTE:** If the pressure is less than 19 psi (1.3 bar), the tire is too badly damaged. Do not attempt to drive the vehicle further. Call for assistance.

25. Leave the parking brake set and the shift lever in PARK and start the engine.

26. Inflate the tire to the pressure indicated on the tire pressure label on the driver-side latch pillar by pressing the switch (3) on the air pump to I (ON) and watching the pressure gauge. When the tire pressure is set to the pressure indicated on the tire pressure label, press the AIR PUMP switch (3) to 0 (OFF) and turn off the engine.

27. Disconnect the TIREFIT system from the tire and reinstall the valve cap.

28. Place the sealant kit back in the trunk of the vehicle. Replace the sealant bottle at your nearest authorized MOPAR® parts dealership.

29. Have the tire inspected at the earliest opportunity at an authorized dealer or tire service center.

NOTE:

- If a pressure of at least 19 psi (1.3 bar) cannot be maintained in the tire, the tire is too badly damaged. Do not attempt to drive the vehicle further. Call for assistance.
- Do not operate the electric air pump for more than eight minutes to avoid overheating. The air pump may be used again once it has cooled down.
- Replace the TIREFIT sealant bottle (5) once every four years to assure optimum operation of the system.
- If TIREFIT is liquid, clean water and a damp cloth will remove the material from the vehicle or tire and wheel components. Once TIREFIT sealing material has dried, it can easily be peeled off and properly discarded.
- Do not exceed 55 mph (90 km/h) until the tire has been inspected.

JUMP-STARTING PROCEDURES

WARNING!

- Take care to avoid the radiator cooling fan whenever the hood is raised. It can start anytime the ignition switch is ON. You can be hurt by the fan.
- Do not attempt to push or tow your vehicle to get it started. Vehicles equipped with an automatic transmission cannot be started this way. Unburned fuel could enter the catalytic converter and once the engine has started, ignite and damage the converter and vehicle. If the vehicle has a discharged battery, booster cables may be used to obtain a start from another vehicle. This type of start can be dangerous if done improperly, so follow this procedure carefully.
- Battery fluid is a corrosive acid solution; do not allow battery fluid to contact eyes, skin, or clothing. Don't lean over battery when attaching clamps or allow the clamps to touch each other. If acid splashes in eyes or on skin, flush contaminated area immediately with large quantities of water.
- A battery generates hydrogen gas, which is flammable and explosive. Keep flame or spark away from the vent holes.
- Do not use a booster battery or any other booster source with an output that exceeds 12 Volts.
- The battery in this vehicle has a vent hose that should not be disconnected and should only be replaced with a battery of the same type (vented).

NOTE: The battery is stored under an access cover in the trunk. Remote battery terminals are located in the engine compartment for jump-starting.

1. Wear eye protection and remove any metal jewelry such as watchbands or bracelets that might make an inadvertent electrical contact.
2. When boost is provided by a battery in another vehicle, park that vehicle within booster cable reach, but do not allow the vehicles to touch one another.

WARNING!

Do not permit vehicles to touch each other as this could establish a ground connection and personal injury could result.

3. Set the parking brake, place the automatic transmission in PARK, and turn the ignition switch to the LOCK position on both vehicles.
4. Turn off the heater, radio, and all unnecessary electrical loads.
5. Connect one end of the jumper cable to the remote jump-start positive battery post (+) in the engine compartment. Connect the other end of the same cable to the positive terminal of the booster battery. Refer to the following illustration for jump-starting connections.
6. Connect the other cable, first to the negative terminal of the booster battery and **then to the engine ground (-) of the vehicle with the discharged battery.** Make sure you have a good contact on the engine ground. Refer to the following illustration for jump-starting connections.

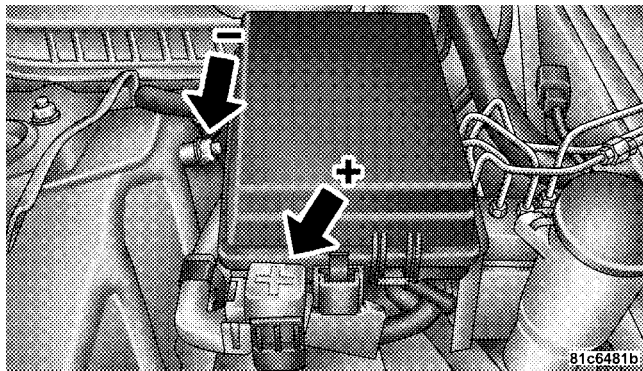

Jump-Starting

WARNING!

- You should not try to start your vehicle by pushing or towing.
- Do not connect the cable to the negative post of the discharged battery. The resulting electrical spark could cause the battery to explode.
- During cold weather when temperatures are below the freezing point, electrolyte in a discharged battery may freeze. Do not attempt jump-starting because the battery could rupture or explode. The battery temperature must be brought above the freezing point before attempting jump-start.

7. Start the engine in the vehicle that has the booster battery. Let the engine idle a few minutes. Then, start the engine in the vehicle with the discharged battery.

NOTE: Refer to "Synchronizing ESP" under "Electronic Stability Program" in Section 5 if the ESP/BAS light (in the instrument cluster) remains on continuously after starting the engine of the vehicle with the discharged battery.

8. When removing the jumper cables, reverse the above sequence exactly. Be careful of the moving belts and fan.

WARNING!

Any procedure other than above could result in:

- Personal injury caused by electrolyte squirting out the battery vent
- Personal injury or property damage due to battery explosion
- Damage to charging system of booster vehicle or of immobilized vehicle

FREEING A STUCK VEHICLE

If your vehicle becomes stuck in mud, sand, or snow, it can often be moved by a rocking motion. Turn your steering wheel right and left to clear the area around the front wheels. Then shift back and forth between REVERSE and DRIVE. Usually, the least accelerator pedal pressure to maintain the rocking motion without spinning the wheels is most effective.

NOTE: Turn off the Electronic Stability Program (ESP) before rocking the vehicle. Refer to “Electronic Stability Program,” or “Traction Control” in Section 5.

CAUTION!

- When “rocking” a stuck vehicle by moving between “1st” and REVERSE, do not spin the wheels faster than 15 mph (24 km/h), or drivetrain damage may result.
- Racing the engine or spinning the wheels too fast may lead to transmission overheating and failure. It can also damage the tires. Do not spin the wheels above 35 mph (55 km/h).

WARNING!

Fast spinning tires can be dangerous. Forces generated by excessive wheel speeds may cause tire damage or failure. A tire could explode and injure someone. Do not spin your vehicle's wheels faster than 35 mph (55 km/h) when you are stuck, and don't let anyone near a spinning wheel, no matter what the speed.

TOWING A DISABLED VEHICLE**Without The Ignition Key**

Special care must be taken when the vehicle is towed with the ignition in the LOCK position. The only approved method of towing without the ignition key is with a flat-bed truck. Proper towing equipment is necessary to prevent damage to the vehicle.

Towing This Vehicle Behind Another Vehicle (Flat Towing With All Four Wheels On The Ground)

Flat towing of vehicles equipped with an automatic transmission, is only permitted within the following limitations

With The Ignition Key

Your vehicle may be towed under the following conditions: The shift lever must be in NEUTRAL, the distance to be traveled must not exceed 30 mi (48 km), and the towing speed must not exceed 30 mph (48 km/h). Exceeding these towing limits may cause a transmission geartrain failure. If the transmission is not operative or if the vehicle is to be towed more than 30 mi (48 km), the vehicle must be transported using a flat-bed truck.

CAUTION!

- Do not attempt to tow this vehicle from the front with sling type towing equipment. Damage to the front fascia will result.
- If the transmission is not operative or if the vehicle is to be towed more than 30 mi (48 km), then the only approved method of towing is with a flat-bed truck. Damage to the transmission may result.
- Do not tow the vehicle from the rear. Damage to the rear sheet metal and fascia will occur.
- Do not push or tow this vehicle with another vehicle as damage to the bumper fascia and transmission may result.

If you must use the accessories (wipers, defrosters, etc.) while being towed, the key must be in the ON position, not the ACC position. Make certain the transmission remains in NEUTRAL.

Towing This Vehicle Behind Another Vehicle With A Tow Dolly

The manufacturer **does not recommend** that you tow this vehicle on a tow dolly. Vehicle damage may occur.

MAINTAINING YOUR VEHICLE

CONTENTS

■ 6.1L Engine Compartment	386	□ Engine Oil Filter	393
■ Onboard Diagnostic System — OBD II	387	□ Drive Belts — Check Condition And Tension . .	393
□ Loose Fuel Filler Cap	387	□ Spark Plugs	394
■ Emissions Inspection And Maintenance Programs	388	□ Engine Air Cleaner Filter	394
■ Replacement Parts	389	□ Fuel Filter	395
■ Authorized Dealer Service	390	□ Catalytic Converter	395
■ Maintenance Procedures	390	□ Maintenance-Free Battery	397
□ Engine Oil	391	□ Air Conditioner Maintenance	399
		□ A/C Air Filter — If Equipped	400

- Power Steering — Fluid Check 400
- Front And Rear Suspension Ball Joints 401
- Steering Linkage 401
- Body Lubrication 401
- Windshield Wiper Blades 402
- Windshield Washers/Headlight Washers 402
- Exhaust System 403
- Cooling System 404
- Hoses And Vacuum/Vapor Harnesses 409
- Fuel System 409
- Brake System 410
- Automatic Transmission 413
- Front And Rear Wheel Bearings 414
- Appearance Care And Protection From Corrosion 414
- Cleaning The Center Console Cupholders 419
- Fuses (Power Distribution Centers) 419
 - Fuses (Front Power Distribution Center) 419
 - Fuses (Rear Power Distribution Center) 422
- Vehicle Storage 427
- Replacement Bulbs 427
- Bulb Replacement 428
 - Low Beam Headlight, High Beam Headlight, And Park/Turn Light 428
 - Tail/Stop, Tail, Turn Signal Light, And Backup Light 431
 - License Light 434

■ Fluids And Capacities	435	□ Engine	436
■ Fluids, Lubricants, And Genuine Parts	436	□ Chassis	437

6.1L ENGINE COMPARTMENT

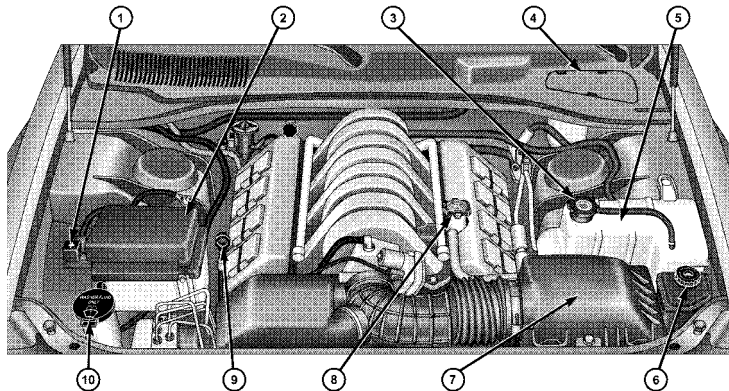

81c6cd8e

- 1 — Remote Jump-Start Positive Battery Post
- 2 — Fuses (Front Power Distribution Center)
- 3 — Coolant Pressure Cap
- 4 — Brake Fluid Reservoir Access Cover
- 5 — Coolant Bottle

- 6 — Power Steering Fluid
- 7 — Air Cleaner Filter
- 8 — Engine Oil Fill
- 9 — Engine Oil Dipstick
- 10 — Washer Fluid Bottle

ONBOARD DIAGNOSTIC SYSTEM — OBD II

Your vehicle is equipped with a sophisticated onboard diagnostic system called OBD II. This system monitors the performance of the emissions, engine, and automatic transmission control systems. When these systems are operating properly, your vehicle will provide excellent performance and fuel economy, as well as engine emissions well within current government regulations.

If any of these systems require service, the OBD II system will turn on the Malfunction Indicator Light (MIL). It will also store diagnostic codes and other information to assist your service technician in making repairs. Although your vehicle will usually be drivable and not need towing, see your authorized dealer for service as soon as possible.

CAUTION!

Prolonged driving with the “MIL” on could cause further damage to the emissions control system. It could also affect fuel economy and driveability. The vehicle must be serviced before any emissions tests can be performed.

If the “MIL” is flashing while the engine is running, severe catalytic converter damage and power loss will soon occur. Immediate service is required.

Loose Fuel Filler Cap

If the vehicle diagnostic system determines that the fuel filler cap is loose, improperly installed, or damaged, a “Check Gas cap” message will display in the Electronic Vehicle Information Center (EVIC) (if equipped). If this occurs, tighten the fuel filler cap properly and press the

TRIP ODOMETER button to turn off the message. If the problem continues, the message will appear the next time the vehicle is started.

A loose, improperly installed, or damaged fuel filler cap may also turn on the MIL.

EMISSIONS INSPECTION AND MAINTENANCE PROGRAMS

In some localities, it may be a legal requirement to pass an inspection of your vehicle's emissions control system. Failure to pass could prevent vehicle registration.



For states that require an I/M (Inspection and Maintenance), this check verifies the MIL is functioning and is not on when the engine is running, and that the OBD II system is ready for testing.

Normally, the OBD system will be ready. The OBD II system may **not** be ready if your vehicle was recently serviced or recently had a dead battery or had a battery

replacement. If the OBD II system should be determined not ready for the I/M test, your vehicle may fail the test.

Your vehicle has a simple ignition key-actuated test, which you can use prior to going to the test station. To check if your vehicle's OBD II system is ready, you must do the following:

1. Insert your ignition key into the ignition switch.
2. Turn the ignition to the ON position, but do not crank or start the engine.
3. If you crank or start the engine, you will have to start this test over.
4. As soon as you turn your key to the ON position, you will see the MIL symbol come on as part of a normal bulb check.

5. Approximately 15 seconds later, one of two things will happen:

- a. The MIL will flash for about 10 seconds and then return to being fully illuminated until you turn OFF the ignition key or start the engine. This means that your vehicle's OBD II system is **not ready** and you should **not** proceed to the I/M station.
- b. The MIL will not flash at all and will remain fully illuminated until you turn OFF the ignition key or start the engine. This means that your vehicle's OBD II system is **ready** , and you can proceed to the I/M station.

If your OBD II system is **not ready**, you should see your authorized dealer or repair facility. If your vehicle was recently serviced or had a battery failure or replacement, you may need to do nothing more than drive your vehicle as you normally would in order for your OBD II

system to update. A recheck with the above test routine may then indicate that the system is now ready.

Regardless of whether your vehicle's OBD II system is ready or not ready, if the MIL is illuminated during normal vehicle operation, you should have your vehicle serviced before going to the I/M station. The I/M station can fail your vehicle because the MIL is on with the engine running.

REPLACEMENT PARTS

Use of genuine MOPAR® parts for normal/scheduled maintenance and repairs is highly recommended to ensure the designed performance. Damage or failures caused by the use of non-MOPAR® parts for maintenance and repairs will not be covered by the manufacturer's warranty.

AUTHORIZED DEALER SERVICE

Your authorized dealer has the qualified service personnel, special tools, and equipment to perform all service operations in an expert manner. Service manuals are available which include detailed service information for your vehicle. Refer to these manuals before attempting any procedure yourself.

NOTE: Intentional tampering with emissions control systems can result in civil penalties being assessed against you.

WARNING!

You can be badly injured working on or around a motor vehicle. Only do service work for which you have the knowledge and the proper equipment. If you have any doubt about your ability to perform a service job, take your vehicle to a competent mechanic.

MAINTENANCE PROCEDURES

The pages that follow contain the **required** maintenance services determined by the engineers who designed your vehicle.

Besides the maintenance items for which there are fixed maintenance intervals, there are other items that should operate satisfactorily without periodic maintenance. However, if a malfunction of these items does occur, it could adversely affect the engine or vehicle performance. These items should be inspected if a malfunction is observed or suspected.

Engine Oil

Checking Oil Level

To assure proper engine lubrication, the engine oil must be maintained at the correct level. Check the oil level at regular intervals, such as every fuel stop.

The best time to check the engine oil level is about five minutes after a fully warmed engine is shut off or before starting the engine after it has sat overnight.

Checking the oil while the vehicle is on level ground will improve the accuracy of the oil level readings. Maintain the oil level in the "SAFE" range. Adding 1.0 qt (1.0L) of oil when the reading is at the bottom of the "SAFE" range will result in an oil level at the top of the "SAFE" range on these engines.

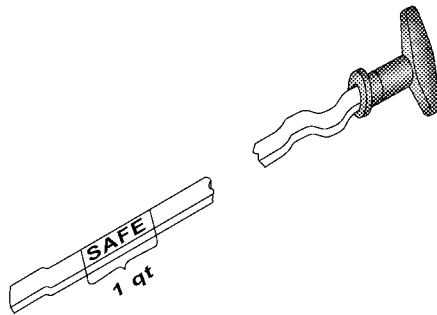

8131ee6a

Engine Oil Dipstick

CAUTION!

Overfilling or underfilling will cause oil aeration or loss of oil pressure. This could damage your engine.

Change Engine Oil

Refer to the Maintenance Schedule in Section 8.

NOTE: Under no circumstances should oil change intervals exceed 6,000 mi (10 000 km) or six months, whichever occurs first.

Engine Oil Selection

For best performance and maximum protection under all types of operating conditions, the manufacturer only recommends full synthetic engine oils that meet the American Petroleum Institute (API) categories of SM or SM/CF, and meet the requirements of DaimlerChrysler Material Standard MS-10725.

The manufacturer recommends the use of a full synthetic engine oil, such as Mobil 1[®] SAE 0W-40 or equivalent.

Engine Oil Viscosity (SAE Grade)

SAE 0W-40 engine oil is preferred for use in 6.1L Engines within the operating temperatures shown in the engine

oil viscosity chart. SAE 5W-40 Engine Oil is also allowed for use in 6.1L Engines. The proper SAE viscosity grade of engine oil should be selected based on the following recommendation and be within the operating temperature shown in the engine oil viscosity chart.

ENGINE OIL VISCOSITY CHART								
°F	-20°	0°	10°	20°	32°	60°	80°	100°
°C	-29°	-18°	-12°	-7°	0°	16°	27°	38°
Temperature range anticipated before next oil change								
813eda54								

The engine oil filler cap also shows the recommended engine oil viscosity for your engine. For information on engine oil filler cap location, refer to the “Engine Compartment” illustration in this section.

Materials Added to Engine Oil

The manufacturer strongly recommends against the addition of any additives (other than leak detection dyes) to the engine oil. Engine oil is an engineered product and its performance may be impaired by supplemental additives.

Disposing of Used Engine Oil and Oil Filters

Care should be taken in disposing of used engine oil and oil filters from your vehicle. Used oil and oil filters, indiscriminately discarded, can present a problem to the environment. Contact your authorized dealer, service station, or governmental agency for advice on how and where used oil and oil filters can be safely discarded in your area.

Engine Oil Filter

The engine oil filter should be replaced at every engine oil change.

Engine Oil Filter Selection

This manufacturer’s engines have a full-flow type oil filter. Use a filter of this type for replacement. The quality of replacement filters varies considerably. Only high quality filters should be used to assure most efficient service. Mopar® Engine Oil Filters are a high quality oil filter and are recommended.

Drive Belts — Check Condition and Tension

Belt tension is controlled by means of an automatic tensioner. Therefore, no belt tension adjustments are required. However, belt and belt tensioner condition should be inspected periodically and replaced if required. Improper belt tension can cause belt slippage and failure. Low generator belt tension can cause battery failure.

Inspect belts for evidence of cuts, cracks, glazing, or frayed cords and replace if there is indication of damage that could result in belt failure. Also, check belt routing to make sure there is no interference between the belts and other engine components. See your authorized dealer for service.

Spark Plugs

Spark plugs must fire properly to assure engine performance and emissions control. New plugs should be installed at the specified mileage. The entire set should be replaced if there is any malfunction due to a faulty spark plug. Malfunctioning spark plugs can damage the catalytic converter. Refer to “Fluids, Lubricants, and Genuine Parts” in this section for the proper type of spark plug for use in your vehicle.

Engine Air Cleaner Filter

Refer to the Maintenance Schedule in Section 8 for engine air cleaner filter maintenance intervals.

NOTE: Be sure to follow the “dusty or off-road conditions” maintenance interval if applicable.

WARNING!

The air induction system (air cleaner, hoses, etc) can provide a measure of protection in the case of engine backfire. Do not remove the air induction system (air cleaner, hoses, etc) unless such removal is necessary for repair or maintenance. Make sure that no one is near the engine compartment before starting the vehicle with the air induction system (air cleaner, hoses, etc) removed. Failure to do so can result in serious personal injury.

Fuel Filter

A plugged fuel filter can cause stalling, limit the speed at which a vehicle can be driven or cause hard starting. Should an excessive amount of dirt accumulate in the fuel tank, filter replacement may be necessary. See your authorized dealer for service.

Catalytic Converter

The catalytic converter requires the use of unleaded fuel only. Leaded gasoline will destroy the effectiveness of the catalyst as an emissions control device.

Under normal operating conditions, the catalytic converter will not require maintenance. However, it is important to keep the engine properly tuned to assure proper catalyst operation and prevent possible catalyst damage.

CAUTION!

Damage to the catalytic converter can result if your vehicle is not kept in proper operating condition. In the event of engine malfunction, particularly involving engine misfire or other apparent loss of performance, have your vehicle serviced promptly. Continued operation of your vehicle with a severe malfunction could cause the converter to overheat, resulting in possible damage to the converter and the vehicle.

NOTE: Intentional tampering with emissions control systems can result in civil penalties being assessed against you.

WARNING!

A hot exhaust system can start a fire if you park over materials that can burn. Such materials might be grass or leaves coming into contact with your exhaust system. Do not park or operate your vehicle in areas where your exhaust system can contact anything that can burn.

In unusual situations involving grossly malfunctioning engine operation, a scorching odor may indicate severe and abnormal catalyst overheating. If this should occur, safely bring the vehicle to a complete stop, shut the engine OFF, and allow the vehicle to cool. Thereafter, obtain service, including a tune-up to manufacturer's specifications immediately.

To minimize the possibility of catalyst damage:

- Do not shut off the engine or interrupt the ignition when the transmission is in gear and the vehicle is in motion.
- Do not try to start the engine by pushing or towing the vehicle.
- Do not idle the engine with any spark plug wires disconnected or removed, such as when diagnostic testing, or for prolonged periods during very rough idling or malfunctioning operating conditions.

Maintenance-Free Battery

The top of the maintenance-free battery is permanently sealed. You will never have to add water, nor is periodic maintenance required.

NOTE: The battery is stored under an access cover in the trunk. Remote battery terminals are located in the engine compartment for jump-starting.

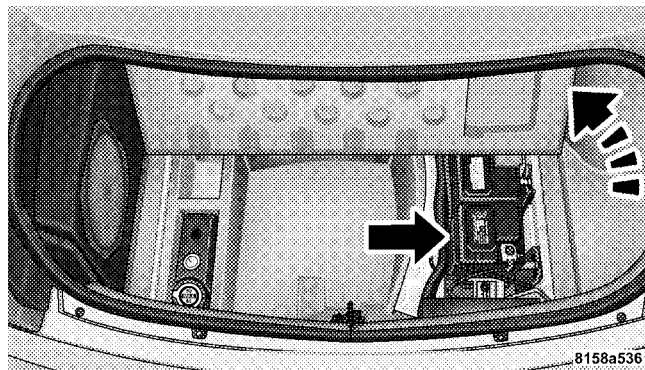

Battery Location

WARNING!

- Battery fluid is a corrosive acid solution and can burn or even blind you. Don't allow battery fluid to contact your eyes, skin, or clothing. Don't lean over a battery when attaching clamps. If acid splashes in eyes or on skin, flush the area immediately with large amounts of water.
- Battery gas is flammable and explosive. Keep flame or sparks away from the battery. Don't use a booster battery or any other booster source with an output greater than 12 Volts. Don't allow cable clamps to touch each other.
- Battery posts, terminals, and related accessories contain lead and lead compounds. Wash hands after handling.
- The battery in this vehicle has a vent hose that should not be disconnected and should only be replaced with a battery of the same type (vented).

CAUTION!

- It is essential when replacing the cables on the battery that the positive cable is attached to the positive post and the negative cable is attached to the negative post. Battery posts are marked positive (+) and negative (-) and identified on the battery case. Cable clamps should be tight on the terminal posts and free of corrosion.
- If a "fast charger" is used while the battery is in the vehicle, disconnect both vehicle battery cables before connecting the charger to the battery. Do not use a "fast charger" to provide starting voltage.

Air Conditioner Maintenance

For best possible performance, your air conditioner should be checked and serviced by an authorized dealer at the start of each warm season. This service should include cleaning of the condenser fins and a performance test. Drive belt tension should also be checked at this time.

WARNING!

- Use only refrigerants and compressor lubricants approved by the manufacturer for your air conditioning system. Some unapproved refrigerants are flammable and can explode, injuring you. Other unapproved refrigerants or lubricants can cause the system to fail, requiring costly repairs. Refer to Section 3 of the Warranty Information book for further warranty information.
- The air conditioning system contains refrigerant under high pressure. To avoid risk of personal injury or damage to the system, adding refrigerant or any repair requiring lines to be disconnected should be done by an experienced technician.

Refrigerant Recovery and Recycling

R-134a Air Conditioning Refrigerant is a hydrofluorocarbon (HFC) that is endorsed by the Environmental Protection Agency and is an ozone-saving product. However, the manufacturer recommends that air conditioning service be performed by authorized dealers or other service facilities using recovery and recycling equipment.

NOTE: Use only manufacturer approved A/C system sealers, stop leak products, seal conditioners, compressor oil, and refrigerants.

A/C Air Filter — If Equipped

The filter is located in the fresh air inlet under the hood, behind a removable panel in the cowl on the passenger side of the vehicle, next to the windshield wipers. When installing a new filter, ensure its proper orientation. To replace the filter, remove the access door in the cowl screen by pressing the retaining clips. Slide the lid on the filter adapter forward and down and remove the used

filter. Install the new filter with arrows pointing in the direction of airflow, which is toward the rear of the vehicle (text and arrows on the filter indicate this).

Refer to the Maintenance Schedule in Section 8 for the recommended air conditioning filter replacement intervals.

Power Steering — Fluid Check

Checking the power steering fluid level at a defined service interval is not required. The fluid should only be checked if a leak is suspected, abnormal noises are apparent, and/or the system is not functioning as anticipated. Coordinate inspection efforts through an authorized dealer. No chemical flushes should be used in any power steering system; only the approved lubricant may be used.

WARNING!

Fluid level should be checked on a level surface and with the engine OFF to prevent injury from moving parts and to ensure accurate fluid level reading. Do not overfill. Use only manufacturer's recommended power steering fluid.

If necessary, add fluid to restore to the proper indicated level. With a clean cloth, wipe any spilled fluid from all surfaces. Refer to "Fluids, Lubricants, and Genuine Parts" in this section for the correct fluid type.

Front and Rear Suspension Ball Joints

The suspension ball joints should be inspected for external leakage or damage when other maintenance is performed.

Steering Linkage

The tie rod end ball joints should be inspected for external leakage or damage when other maintenance is performed.

Body Lubrication

Locks and all body pivot points, including seat tracks, door hinges, trunk hinges, and hood hinges, should be lubricated periodically to assure quiet, easy operation and to protect against rust and wear. Prior to the application of any lubricant, the parts concerned should be wiped clean to remove dust and grit; after lubricating, excess oil and grease should be removed. Particular attention should also be given to hood latching components to ensure proper function. When performing other underhood services, the hood latch, release mechanism, and safety catch should be cleaned and lubricated.

The external lock cylinders should be lubricated twice a year, preferably in the Fall and Spring. Apply a small amount of a high quality lubricant such as Mopar® Lock Cylinder Lubricant or equivalent directly into the lock cylinder.

Windshield Wiper Blades

The rubber edges of the wiper blades and the windshield should be cleaned periodically with a sponge or soft cloth and a mild nonabrasive cleaner. This will remove accumulations of salt or road film.

Operation of the wipers on dry glass for long periods may cause deterioration of the wiper blades. Always use washer fluid when using the wipers to remove salt or dirt from a dry windshield.

Avoid using the wiper blades to remove frost or ice from the windshield. Keep the blade rubber out of contact with petroleum products such as engine oil, gasoline, etc.

Windshield Washers/Headlight Washers

The windshield washer and the headlight washer share the same fluid reservoir. The fluid reservoir is located in the front of the engine compartment. Be sure to check the fluid level in the reservoir at regular intervals. Fill the reservoir with windshield washer solvent (not radiator antifreeze) and operate the system for a few seconds to flush out the residual water.

When refilling the washer fluid reservoir, apply some washer fluid to a cloth or towel and wipe the wiper blades clean. This will help blade performance.

To prevent freeze-up of your windshield washer system in cold weather, select a solution or mixture that meets or exceeds the temperature range of your climate. This rating information can be found on most washer fluid containers.

The fluid reservoir will hold nearly 1 gal (4 l) of washer fluid when the message “Low Washer Fluid” appears in the Electronic Vehicle Information Center (EVIC).

WARNING!

Commercially available windshield washer solvents are flammable. They could ignite and burn you. Care must be exercised when filling or working around the washer solution.

Exhaust System

The best protection against carbon monoxide entry into the vehicle body is a properly maintained engine exhaust system.

Whenever a change is noticed in the sound of the exhaust system, when exhaust fumes can be detected inside the vehicle, or when the underside or rear of the vehicle is

damaged, have a competent mechanic inspect the complete exhaust system and adjacent body areas for broken, damaged, deteriorated, or mispositioned parts. Open seams or loose connections could permit exhaust fumes to seep into the passenger compartment. In addition, inspect the exhaust system each time the vehicle is raised for lubrication or oil change. Replace as required.

WARNING!

Exhaust gases can injure or kill. They contain carbon monoxide (CO), which is colorless and odorless. Breathing it can make you unconscious and can eventually poison you. To avoid breathing CO, refer to “Exhaust Gas” under “Safety Tips” in Section 2.

Cooling System

WARNING!

- When working near the radiator cooling fan, disconnect the fan motor lead or turn the ignition switch to the LOCK position. The fan is temperature controlled and can start at any time the ignition switch is in the ON position.
- You or others can be badly burned by hot coolant or steam from your radiator. If you see or hear steam coming from under the hood, don't open the hood until the radiator has had time to cool. Never try to open a cooling system pressure cap when the radiator is hot.

Coolant Checks

Check engine coolant (antifreeze) protection every 12 months (before the onset of freezing weather, where applicable). If coolant is dirty or rusty in appearance, the system should be drained, flushed, and refilled with fresh coolant. Check the front of the A/C condenser for any accumulation of bugs, leaves, etc. If dirty, clean by gently spraying water from a garden hose vertically down the face of the condenser.

Check the coolant recovery bottle tubing for brittle rubber, cracking, tears, cuts, and tightness of the connection at the bottle and radiator. Inspect the entire system for leaks.

With the engine at normal operating temperature (but not running), check the cooling system pressure cap for proper vacuum sealing by draining a small amount of coolant from the radiator drain cock. If the cap is sealing properly, the engine coolant (antifreeze) will begin to

drain from the coolant recovery bottle. **DO NOT REMOVE THE COOLANT PRESSURE CAP WHEN THE COOLING SYSTEM IS HOT.**

Cooling System — Drain, Flush, and Refill

The system should be drained, flushed, and refilled at the intervals shown in the “Maintenance Schedule” in Section 8.

If the solution is dirty or contains a considerable amount of sediment, clean and flush with a reliable cooling system cleaner. Follow with a thorough rinsing to remove all deposits and chemicals. Properly dispose of old antifreeze solution.

Selection of Coolant

Use only the manufacturer’s recommended coolant. Refer to “Fluids, Lubricants, and Genuine Parts” in this section for the correct coolant type.

CAUTION!

- **Mixing of coolants other than specified HOAT engine coolants, may result in engine damage and may decrease corrosion protection. If a non-HOAT coolant is introduced into the cooling system in an emergency, it should be replaced with the specified coolant as soon as possible.**
- **Do not use plain water alone or alcohol-based engine coolant (antifreeze) products. Do not use additional rust inhibitors or antirust products, as they may not be compatible with the radiator engine coolant and may plug the radiator.**
- **This vehicle has not been designed for use with propylene glycol-based coolants. Use of propylene glycol-based coolants is not recommended.**

Adding Coolant

Your vehicle has been built with an improved engine coolant that allows extended maintenance intervals. This coolant can be used up to five years or 100,000 mi (160 000 km) before replacement. To prevent reducing this extended maintenance period, it is important that you use the same coolant throughout the life of your vehicle. Please review these recommendations for using Hybrid Organic Additive Technology (HOAT) coolant.

When adding coolant:

- The manufacturer recommends using Mopar® Antifreeze/Coolant 5 Year/100,000 Mile Formula HOAT (Hybrid Organic Additive Technology).
- Mix a minimum solution of 50% HOAT engine coolant and distilled water. Use higher concentrations (not to exceed 70%) if temperatures below -34°F (-37°C) are anticipated.

- Use only high purity water such as distilled or deionized water when mixing the water/engine coolant solution. The use of lower quality water will reduce the amount of corrosion protection in the engine cooling system.

Please note that it is the owner's responsibility to maintain the proper level of protection against freezing according to the temperatures occurring in the area where the vehicle is operated.

NOTE: Mixing coolant types will decrease the life of the engine coolant and will require more frequent coolant changes.

Cooling System Pressure Cap

The cap must be fully tightened to prevent loss of coolant and to ensure that coolant will return to the radiator from the coolant recovery bottle.

The cap should be inspected and cleaned if there is any accumulation of foreign material on the sealing surfaces.

WARNING!

- The warning words **“DO NOT OPEN HOT”** on the cooling system pressure cap are a safety precaution. Never add coolant when the engine is overheated. Do not loosen or remove the cap to cool an overheated engine. Heat causes pressure to build up in the cooling system. To prevent scalding or injury, do not remove the pressure cap while the system is hot or under pressure.
- Do not use a pressure cap other than the one specified for your vehicle. Personal injury or engine damage may result.

Disposal of Used Coolant

Used ethylene glycol-based engine coolant is a regulated substance requiring proper disposal. Check with your local authorities to determine the disposal rules for your community. To prevent ingestion by animals or children, do not store ethylene glycol-based engine coolant in open containers or allow it to remain in puddles on the ground. If ingested by a child, contact a physician immediately. Clean up any ground spills immediately.

Coolant Level

The coolant bottle provides a quick visual method for determining that the coolant level is adequate. With the engine OFF and cold, the level of the coolant in the bottle should be between the ranges indicated on the bottle.

The radiator normally remains completely full, so there is no need to remove the radiator cap unless checking for coolant freeze point or replacing coolant. Advise your service attendant of this. As long as the engine operating temperature is satisfactory, the coolant bottle need only be checked once a month.

When additional coolant is needed to maintain the proper level, it should be added to the coolant bottle. Do not overfill.

Points to Remember

NOTE: When the vehicle is stopped after a few miles (kilometers) of operation, you may observe vapor coming from the front of the engine compartment. This is normally a result of moisture from rain, snow, or high humidity accumulating on the radiator and being vaporized when the thermostat opens, allowing hot coolant to enter the radiator.

If an examination of your engine compartment shows no evidence of radiator or hose leaks, the vehicle may be safely driven. The vapor will soon dissipate.

- Do not overfill the coolant recovery bottle.
- Check coolant freeze point in the radiator and in the coolant recovery bottle. If antifreeze needs to be added, contents of coolant recovery bottle must also be protected against freezing.
- If frequent coolant additions are required, or if the level in the coolant recovery bottle does not drop when the engine cools, the cooling system should be pressure tested for leaks.
- Maintain coolant concentration at 50% HOAT engine coolant (minimum) and distilled water for proper corrosion protection of your engine, which contains aluminum components.

- Make sure that the radiator and coolant recovery bottle overflow hoses are not kinked or obstructed.
- Keep the front of the radiator clean. If your vehicle is equipped with air conditioning, keep the front of the condenser clean, also.
- Do not change the thermostat for Summer or Winter operation. If replacement is ever necessary, install **ONLY** the correct type thermostat. Other designs may result in unsatisfactory coolant performance, poor gas mileage, and increased emissions.

Hoses and Vacuum/Vapor Harnesses

Inspect surfaces of hoses and nylon tubing for evidence of heat and mechanical damage. Hard or soft spots, brittle rubber, cracking, tears, cuts, abrasions, and excessive swelling indicate deterioration of the rubber.

Pay particular attention to those hoses nearest to high heat sources such as the exhaust manifold. Inspect hose

routing to be sure hoses do not come in contact with any heat source or moving component, which may cause heat damage or mechanical wear.

Ensure nylon tubing in these areas has not melted or collapsed.

Inspect all hose connections such as clamps and couplings to make sure they are secure and no leaks are present.

Components should be replaced immediately if there is any evidence of wear or damage that could cause failure.

Fuel System

The Electronic Fuel Injection high-pressure fuel system's hoses and quick connect fittings have unique material characteristics that provide adequate sealing and resist attack by deteriorated gasoline.

You are urged to use only the manufacturer's specified hoses with quick connect fittings, or their equivalent in material and specification, in any fuel system servicing. It is mandatory to replace any damaged hoses or quick connect fittings that have been removed during service. Care should be taken with installing quick connect fittings to ensure they are properly installed and fully connected. See your authorized dealer for service.

Brake System

In order to assure brake system performance, all brake system components should be inspected periodically. Suggested service intervals can be found in the "Maintenance Schedule" in Section 8.

WARNING!

Riding the brakes can lead to brake failure and possibly an accident. Driving with your foot resting or riding on the brake pedal can result in abnormally high brake temperatures, excessive lining wear, and possible brake damage. You wouldn't have your full braking capacity in an emergency.

Brake and Power Steering Hoses

When the vehicle is serviced for scheduled maintenance, inspect surface of hoses and nylon tubing for evidence of heat and mechanical damage. Hard and brittle rubber, cracking, tears, cuts, abrasion, and excessive swelling indicate deterioration of the rubber. Particular attention should be made to examining those hose surfaces nearest to high heat sources, such as the exhaust manifold.

Ensure nylon tubing in these areas has not melted or collapsed.

Inspect all hose connections such as clamps and couplings to make sure they are secure and no leaks are present.

NOTE:

- Often, fluid such as oil, power steering fluid, and brake fluid are used during assembly plant operations to facilitate the assembly of hoses to couplings. Therefore, oil wetness at the hose-coupling area is not necessarily an indication of leakage. Actual dripping of hot fluid when systems are under pressure (during vehicle operation), should be noted before a hose is replaced based on leakage.
- Inspect the brake hoses whenever the brake system is serviced and at every engine oil change. Inspect hydraulic brake hoses for surface cracking, scuffing, or worn spots. If there is any evidence of cracking,

scuffing, or worn spots, the hose should be replaced immediately. Eventual deterioration of the hose can take place, resulting in a possibility of a burst failure.

WARNING!

Worn brake hoses can burst and cause brake failure. You could have an accident. If you see any signs of cracking, scuffing, or worn spots, have the brake hoses replaced immediately.

Master Cylinder - Brake Fluid Level Check

Check the fluid level in the master cylinder immediately if the brake system warning light indicates system failure.

Check the fluid level in the master cylinder when performing underhood services.

Clean the top of the master cylinder area before removing the cap. Add fluid to bring the level up to the top of the "FULL" mark on the side of the master cylinder reservoir.

Overfilling of fluid is not recommended because it may cause leaking in the system.

Add enough fluid to bring the level up to the requirements described on the brake fluid reservoir. With disc brakes, fluid level can be expected to fall as the brake pads wear. However, low fluid level may be caused by a leak and a checkup may be needed.

Use only manufacturer's recommended brake fluid. Refer to "Fluids, Lubricants, and Genuine Parts" in this section for the correct fluid type.

WARNING!

- **Overfilling the brake fluid reservoir can result in spilling brake fluid on hot engine parts and the brake fluid catching fire.**
- **Use of a brake fluid that may have a lower initial boiling point, or is unidentified as to specification, may result in sudden brake failure during hard prolonged braking. You could have an accident.**

Use only brake fluid that has been in a tightly closed container to avoid contamination from foreign matter or moisture.

CAUTION!

Do not allow petroleum-based fluid to contaminate the brake fluid. Seal damage may result.

Automatic Transmission**Fluid Level Check**

Regular automatic transmission fluid level checks are not required. For this reason, the dipstick is omitted.

If you notice fluid loss or gear shift malfunction, have your authorized dealer check the transmission fluid level.

CAUTION!

- Using a transmission fluid other than the manufacturer's recommended fluid may cause deterioration in transmission shift quality and/or torque converter shudder. Using a transmission fluid other than that recommended by the manufacturer will result in more frequent fluid and filter changes. Refer to "Fluids, Lubricants, and Genuine Parts" in this section for the correct fluid type.
- The fluid level is preset at the factory and it does not require adjustment under normal operating conditions. If a transmission fluid leak occurs, visit your authorized dealer immediately. Severe damage to the transmission may occur. Your authorized dealer has the proper tools to adjust the fluid level accurately.

Fluid and Filter Changes

Refer to the Maintenance Schedule in Section 8 for the recommended transmission fluid and filter change intervals.

If the transmission is disassembled for any reason, the fluid and filter should be changed.

Selection of Lubricant

It is important that the proper lubricant is used in the transmission to assure optimum transmission performance. Use only manufacturer's recommended transmission fluid. Refer to "Fluids, Lubricants, and Genuine Parts" in this section for the correct fluid type. It is important that the transmission fluid be maintained at the prescribed level using the recommended fluid. No chemical flushes should be used in any transmission; only the approved lubricant may be used.

Special Additives

Automatic Transmission Fluid (ATF) is an engineered product and its performance may be impaired by supplemental additives. Therefore, do not add any fluid additives to the transmission. The only exception to this policy is the use of special dyes to aid in detecting fluid leaks. In addition, avoid using transmission sealers as they may adversely affect seals.

Front and Rear Wheel Bearings

Front and rear wheel bearings are permanently sealed. No regular maintenance is required for these components.

Appearance Care and Protection from Corrosion

Protection of Body and Paint from Corrosion

Vehicle body care requirements vary according to geographic locations and usage. Chemicals that make roads passable in snow and ice, and chemicals that are sprayed on trees and road surfaces during other seasons, are

highly corrosive to the metal in your vehicle. Outside parking, which exposes your vehicle to airborne contaminants, road surfaces on which the vehicle is operated, extreme hot or cold weather and other extreme conditions will have an adverse effect on paint, metal trim, and underbody protection.

The following maintenance recommendations will enable you to obtain maximum benefit from the corrosion resistance built into your vehicle.

What Causes Corrosion?

Corrosion is the result of deterioration or removal of paint and protective coatings from your vehicle.

The most common causes are:

- Road salt, dirt, and moisture accumulation.
- Stone and gravel impact.
- Insects, tree sap, and tar.

- Salt in the air near seacoast localities.
- Atmospheric fallout/industrial pollutants.

Washing

- Wash your vehicle regularly. Always wash your vehicle in the shade using Mopar® Car Wash or a mild car wash soap, and rinse the panels completely with clear water.
- If insects, tar, or other similar deposits have accumulated on your vehicle, use Mopar® Super Kleen Bug and Tar Remover to remove.
- Use Mopar® Cleaner Wax to remove road film, stains and to protect your paint finish. Take care never to scratch the paint.
- Avoid using abrasive compounds and power buffing that may diminish the gloss or thin out the paint finish.

CAUTION!

Do not use abrasive or strong cleaning materials such as steel wool or scouring powder that will scratch metal and painted surfaces.

Special Care

- If you drive on salted or dusty roads or if you drive near the ocean, hose off the undercarriage at least once a month.
- It is important that the drain holes in the lower edges of the doors, rocker panels, and trunk be kept clear and open.
- If you detect any stone chips or scratches in the paint, touch them up immediately. The cost of such repairs is considered the responsibility of the owner.

- If your vehicle is damaged due to an accident or similar cause that destroys the paint and protective coating, have your vehicle repaired as soon as possible. The cost of such repairs is considered the responsibility of the owner.
- If you carry special cargo such as chemicals, fertilizers, de-icer salt, etc., be sure that such materials are well packaged and sealed.
- If a lot of driving is done on gravel roads, consider mud or stone shields behind each wheel.
- Use Mopar® touch up paint or equivalent on scratches as soon as possible. Your authorized dealer has touch up paint to match the color of your vehicle.

Wheel and Wheel Trim Care

All wheels and wheel trim, especially aluminum and chrome plated wheels should be cleaned regularly with a mild soap and water to prevent corrosion. To remove

heavy soil and/or excessive brake dust, use Mopar® Wheel Cleaner (05066247AB) or equivalent or select a nonabrasive, non-acidic cleaner. Do not use scouring pads, steel wool, a bristle brush, or metal polishes. Only Mopar® or equivalent is recommended. Do not use oven cleaner. Avoid automatic car washes that use acidic solutions or harsh brushes that may damage the wheels' protective finish.

Interior Care

Use Mopar® Fabric Cleaner or equivalent to clean fabric upholstery and Mopar® Carpet Cleaner for carpeting.

Interior Trim should be cleaned starting with a damp cloth, or Mopar® Satin Select. Do not use harsh cleaners or Armorall. Use Mopar® Total Clean to clean vinyl upholstery.

Mopar® Total Clean is specifically recommended for leather upholstery.

Your leather upholstery can be best preserved by regular cleaning with a damp soft cloth. Small particles of dirt can act as an abrasive and damage the leather upholstery and should be removed promptly with a damp cloth. Stubborn soils can be removed easily with a soft cloth and Mopar® Total Clean or equivalent. Care should be taken to avoid soaking your leather upholstery with any liquid. Please do not use polishes, oils, cleaning fluids, solvents, detergents, or ammonia-based cleaners to clean your leather upholstery. Application of a leather conditioner is not required to maintain the original condition.

WARNING!

Do not use volatile solvents for cleaning purposes. Many are potentially flammable, and if used in closed areas they may cause respiratory harm.

Cleaning Headlights

Your vehicle has plastic headlights that are lighter and less susceptible to stone breakage than glass headlights.

Plastic is not as scratch resistant as glass and therefore different lens cleaning procedures must be followed.

To minimize the possibility of scratching the lenses and reducing light output, avoid wiping with a dry cloth. To remove road dirt, wash with a mild soap solution followed by rinsing.

Do not use abrasive cleaning components, solvents, steel wool or other aggressive material to clean the lenses.

Glass Surfaces

All glass surfaces should be cleaned on a regular basis with Mopar® Glass Cleaner or any commercial household-type glass cleaner. Never use an abrasive type cleaner. Use caution when cleaning the inside rear window equipped with electric defrosters or the right rear

quarter window equipped with the radio antenna. Do not use scrapers or other sharp instrument that may scratch the elements.

When cleaning the rear view mirror, spray cleaner on the towel or rag that you are using. Do not spray cleaner directly on the mirror.

Cleaning Plastic Instrument Cluster Lenses

The lenses in front of the instruments in this vehicle are molded in clear plastic. When cleaning the lenses, care must be taken to avoid scratching the plastic.

1. Clean with a wet soft rag or micro-fiber towel. A mild soap solution may be used, but do not use high alcohol content or abrasive cleaners. If soap is used, wipe clean with a clean damp rag.
2. Dry with a soft tissue.

Seat Belt Maintenance

Do not bleach, dye, or clean the belts with chemical solvents or abrasive cleaners. This will weaken the fabric. Sun damage can also weaken the fabric.

If the belts need cleaning, use Mopar® Total Clean, a mild soap solution, or lukewarm water. Do not remove the belts from the vehicle to wash them.

Replace the belts if they appear frayed or worn or if the buckles do not work properly.

Cleaning the Center Console Cupholders

Clean with a damp cloth or towel using a mild detergent with the cupholder in the center console.

NOTE: The cupholder cannot be removed.

FUSES (POWER DISTRIBUTION CENTERS)

Fuses (Front Power Distribution Center)

A power distribution center is located in the engine compartment. This center contains fuses and relays.

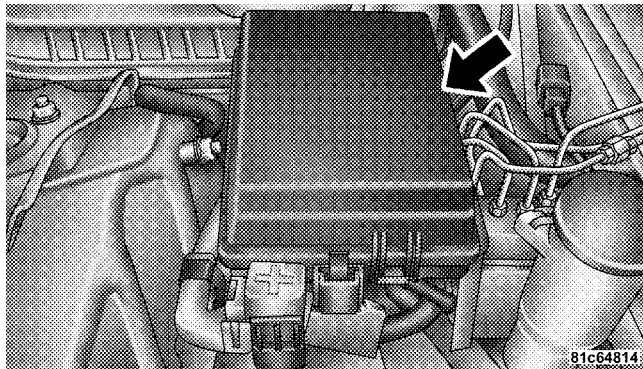

Front Power Distribution Center

CAUTION!

- When installing the power distribution center cover, it is important to ensure the cover is properly positioned and fully latched. Failure to do so may allow water to get into the power distribution center and possibly result in an electrical system failure.
- When replacing a blown fuse, it is important to use only a fuse having the correct amperage rating. The use of a fuse with a rating other than indicated may result in a dangerous electrical system overload. If a properly rated fuse continues to blow, it indicates a problem in the circuit that must be corrected.

Cavity	Cartridge Fuse	Mini-Fuse	Description
1	—	15 Amp Blue	Washer Motor
2	—	25 Amp Neutral	Powertrain Control Module (PCM)
3	—	25 Amp Neutral	Ignition Run/Start
4	—	25 Amp Neutral	Alternator
5	—	—	—
6	—	25 Amp Neutral	Ignition Coils/Injectors
7	—	—	—
8	—	25 Amp Neutral	Starter
9	—	—	—

Cavity	Cartridge Fuse	Mini-Fuse	Description
10	30 Amp Pink	—	Windshield Wiper
11	30 Amp Pink	—	Anti-lock Brake System (ABS) Valves
12	40 Amp Green	—	Radiator Fan
13	50 Amp Red	—	Anti-lock Brake System (ABS) Pump Motor
14	—	—	—
15	50 Amp Red	—	Radiator Fan

Cavity	Cartridge Fuse	Mini-Fuse	Description
16	—	—	—
17	—	—	—
18	—	—	—
19	—	—	—
20	—	—	—
21	—	—	—
22	—	—	—

Fuses (Rear Power Distribution Center)

There is also a power distribution center located in the trunk under the spare tire access panel. This center contains fuses and relays.

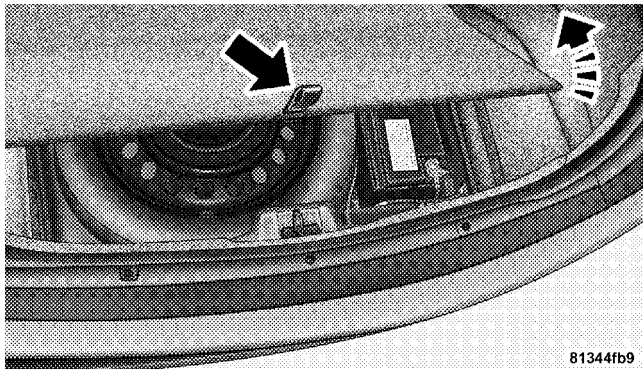

Opening The Access Panel

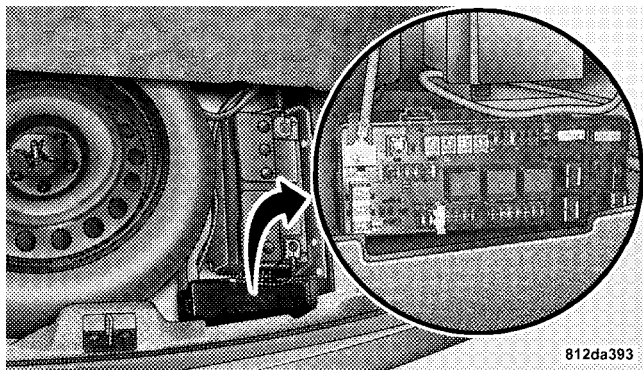

Rear Power Distribution Center

CAUTION!

- When installing the power distribution center cover, it is important to ensure the cover is properly positioned and fully latched. Failure to do so may allow water to get into the power distribution center and possibly result in an electrical system failure.
- When replacing a blown fuse, it is important to use only a fuse having the correct amperage rating. The use of a fuse with a rating other than indicated may result in a dangerous electrical system overload. If a properly rated fuse continues to blow, it indicates a problem in the circuit that must be corrected.

Cavity	Cartridge Fuse	Mini-Fuse	Description
1	60 Amp Yellow	—	Ignition Off Draw (IOD)
2	40 Amp Green	—	Integrated Power Module (IPM)
3	—	—	—
4	40 Amp Green	—	Integrated Power Module (IPM)
5	30 Amp Pink	—	Heated Seats - if equipped
6	—	20 Amp Yellow	Fuel Pump
7	—	20 Amp Yellow	Sub Amp - if equipped

Cavity	Cartridge Fuse	Mini-Fuse	Description
8	—	15 Amp Blue	Diagnostic Link Connector (DLC)/Wireless Control Module (WCM)/Wireless Ignition Node (WIN)
9	—	20 Amp Yellow	Power Outlet
10	—	—	—
11 *	—	—	—
12 *	—	—	—
13 *	—	—	—
14	—	10 Amp Red	AC Heater Control/Cluster/Security Module - if equipped
15	—	—	—
16	—	—	—

Cavity	Cartridge Fuse	Mini-Fuse	Description
17	—	20 Amp Yellow	Cluster
18	—	20 Amp Yellow	Selectable Power Outlet
19	—	10 Amp Red	Stop Lights
20	—	—	—
21	—	—	—
22	—	—	—
23	—	—	—
24	—	—	—
25	—	—	—
26	—	—	—
27	—	10 Amp Red	Occupant Restraint Controller (ORC)

Cavity	Cartridge Fuse	Mini-Fuse	Description
28	—	10 Amp Red	Ignition Run
29	—	5 Amp Orange	Adaptive Cruise Control (ACC) - if equipped/Cluster/Electronic Stability Program (ESP)/Powertrain Control Module (PCM)/STOP LIGHT Switch
30	—	10 Amp Red	Door Modules/Power Mirrors/Steering Control Module (SCM)
31	—	—	—
32	—	—	—
33	—	—	—
34	—	—	—

Cavity	Cartridge Fuse	Mini-Fuse	Description
35	—	5 Amp Orange	Antenna Module - if equipped/Power Mirrors/Rain Sensor - if equipped
36	—	20 Amp Yellow	Hands-Free Phone - if equipped/Video Monitor - if equipped/Radio
37	—	15 Amp Blue	Transmission
38	—	10 Amp Red	Analog Clock/Cargo Light/Satellite Receiver (SDARS) Video - if equipped/Vehicle Information Module - if equipped

Cavity	Cartridge Fuse	Mini-Fuse	Description
39	—	10 Amp Red	Heated Mirrors - if equipped
40	—	5 Amp Orange	Auto Inside Rearview Mirror/Heated Seats - if equipped/Switch Bank
41	—	10 Amp Red	AC Heater Control/Headlights/Park Assist - if equipped/Tire Pressure Monitoring - if equipped/Occupant Restraint Controller (ORC)
42	30 Amp Pink	—	Front Blower Motor
43	30 Amp Pink	—	Rear Window Defroster

Cavity	Cartridge Fuse	Mini-Fuse	Description
44	20 Amp Blue	—	Amplifier - if equipped/Sunroof - if equipped

* Cavities 11, 12, and 13 contain self-resetting fuses (circuit breakers) that are only serviceable by an authorized dealer. The cluster, driver SEAT switch, and memory module (if equipped) are fused by the 25-amp circuit breaker in cavity 11. The passenger SEAT Switch is fused by the 25-amp circuit breaker in cavity 12. The door modules, the driver power WINDOW switch, and the passenger power WINDOW switch are fused by the 25-amp circuit breaker in cavity 13. If you experience temporary or permanent loss of these systems, see your authorized dealer for service.

VEHICLE STORAGE

If you are leaving your vehicle dormant for more than 21 days, you may want to take these steps to protect your battery.

- Disconnect the negative cable from the battery.
- Anytime you store your vehicle, or keep it out of service (i.e., vacation) for two weeks or more, run the air conditioning system at idle for about five minutes in the fresh air and high blower setting. This will ensure adequate system lubrication to minimize the possibility of compressor damage when the system is started again.

REPLACEMENT BULBS

LIGHT BULBS — Interior	Bulb Number
Rear Courtesy/Reading Lights	W5W
Rear Compartment (Trunk) Light	579
Overhead Console Reading Lights	578
Visor Vanity Lights	A6220
Glove Box Light	194
Door Courtesy	562
Shift Indicator Light	JKLE14140
Optional Door Map Pocket / Cupholder Lighting	LED (Serviced at Authorized Dealer)

NOTE: For lighted switches, see your authorized dealer for replacement instructions.

All of the interior bulbs are glass wedge base or glass cartridge types. Aluminum base bulbs are not approved and should not be used for replacement.

LIGHT BULBS — Exterior	Bulb Number
Low Beam Headlight – High Intensity Discharge (HID)	D1S (Serviced at Authorized Dealer)
High Beam Headlight.	9005
Front Park/Turn Light	3157AK
Front Fog Light.	9145/H10 (Serviced at Authorized Dealer)
Front Side Marker	W5W (Serviced at Authorized Dealer)
Tail/Stop Light	3057
Tail Light	3057
Turn Signal Light.	3757A
Backup Light.	3057
Center High Mount Stop Light (CHMSL)	LED
License	W5W

BULB REPLACEMENT

Low Beam Headlight, High Beam Headlight, and Park/Turn Light

High Intensity Discharge Headlights (HID)

The headlights are a type of high voltage discharge tube. High voltage can remain in the circuit even with the headlight switch off and the key removed. **Because of this, you should not attempt to service a headlight bulb yourself. If a headlight bulb fails, take your vehicle to an authorized dealer for service.**

WARNING!

A transient high tension occurs at the bulb sockets of High Intensity Discharge (HID) headlights when the headlight switch is turned ON. It may cause serious electrical shock or electrocution if not serviced properly. See your authorized dealer for service.

NOTE: When HID headlights are turned on, there is a blue hue to the lights. This diminishes and becomes more white after approximately 10 seconds, as the system charges.

1. Open the hood.

NOTE: Removal of the air cleaner filter housing may be necessary prior to replacing bulbs in the headlight assembly on the driver side of the vehicle.

2. Twist the appropriate bulb and socket assembly counterclockwise, and then pull it out of the headlight assembly.
3. Disconnect the bulb from the socket assembly and install the replacement bulb.
4. Reinstall the bulb and socket assembly into the headlight assembly, and then turn it clockwise.

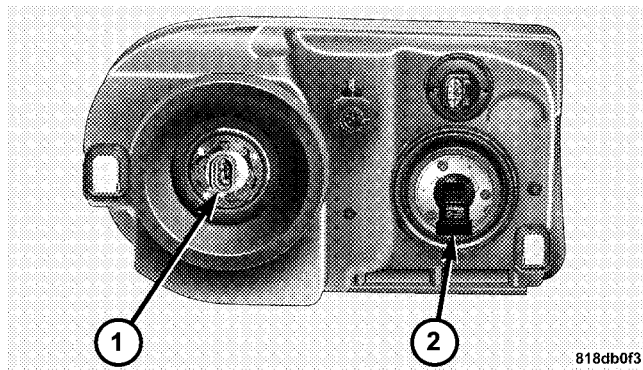

- 1 — Low Beam Headlight Bulb
2 — High Beam Headlight Bulb

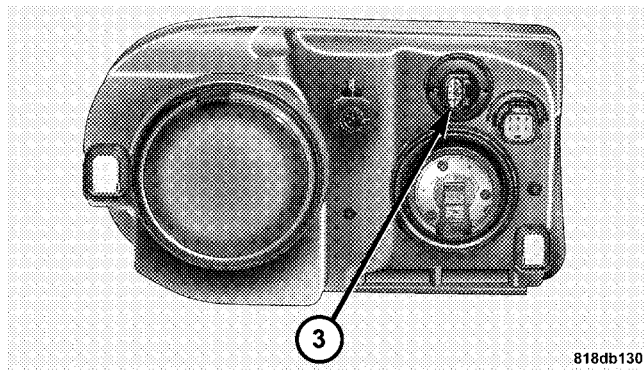

3 — Park/Turn Light Bulb

CAUTION!

Do not touch the new bulb with your fingers. Oil contamination will severely shorten bulb life. If the bulb comes in contact with an oily surface, clean the bulb with rubbing alcohol.

Tail/Stop, Tail, Turn Signal Light, and Backup Light

1. Open the Trunk.
2. Remove two fasteners from the back of the tail light assembly.

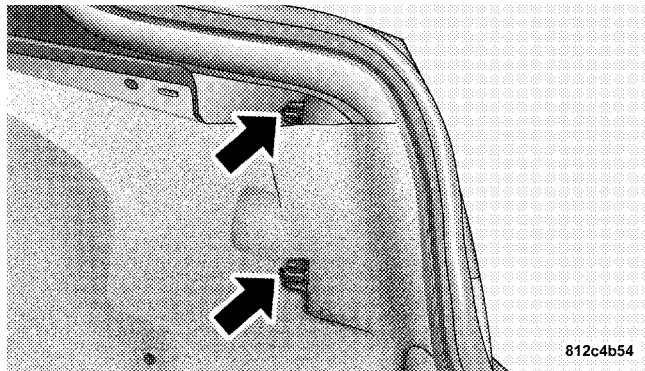

3. Pull back the trunk liner.

4. Remove the remaining fastener from the back of the tail light assembly.
5. Push the electrical connector locking tab to the side.
6. Disconnect the electrical connector.

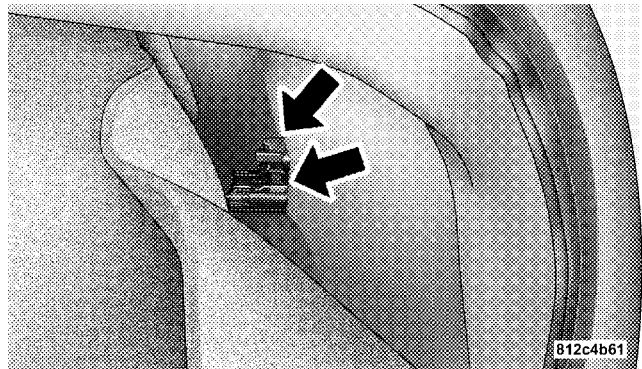

7. Pull the tail light assembly clear from the vehicle to access the bulbs. Turn bulb sockets counterclockwise to remove.

8. Turn the appropriate bulb and socket assembly counterclockwise to remove it from the tail light assembly.

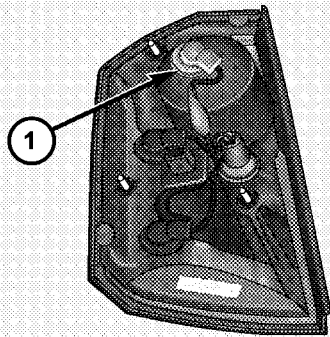

818db1af

1 — Tail/Stop Light Bulb

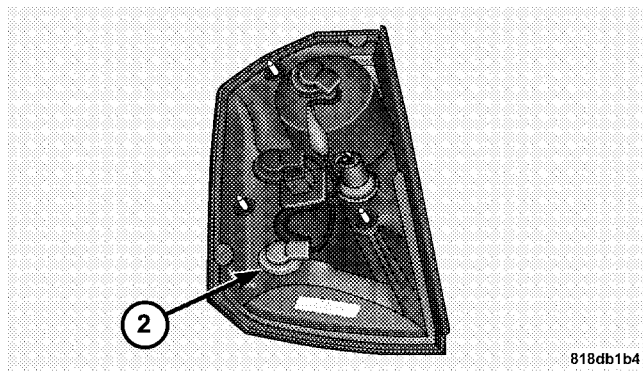

818db1b4

2 — Tail Light Bulb

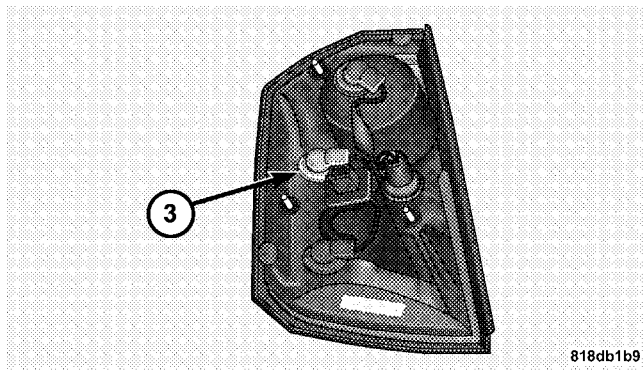

818db1b9

3 — Turn Signal Light Bulb

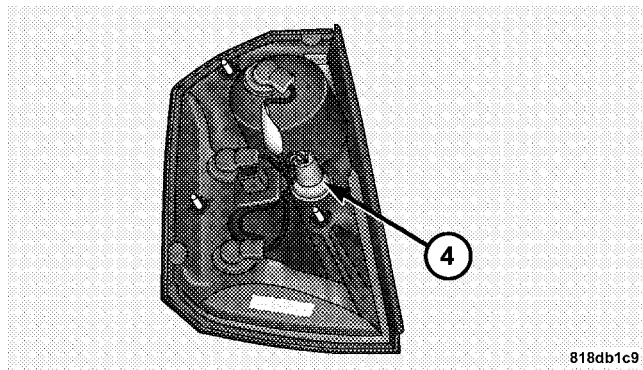

818db1c9

4 — Backup Light Bulb

9. Disconnect the bulb from the socket assembly and install the replacement bulb.

10. Reinstall the bulb and socket assembly into the tail light assembly, and then turn it clockwise.

11. Reinstall the tail light assembly, fasteners, electrical connector, and trunk liner.
12. Close the trunk.

License Light

1. Remove the screws securing the light to the rear fascia.
2. Remove the bulb and socket assembly.
3. Disconnect the bulb from the socket assembly and install the replacement bulb.

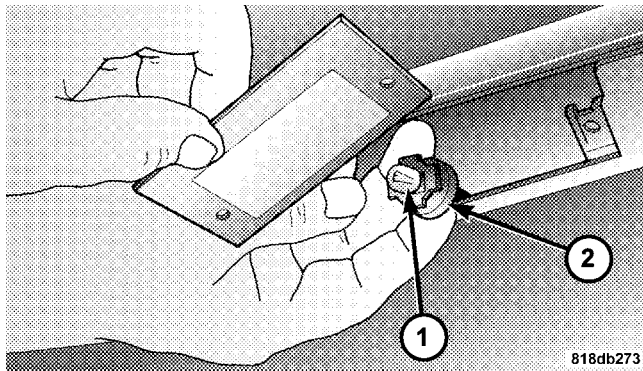

818db273

- 1 — License Light Bulb
2 — Socket

4. Reinstall the bulb and socket assembly.
5. Reattach the light to the rear fascia, and then install the screws.

FLUIDS AND CAPACITIES

	U.S.	Metric
Fuel (approximate)		
6.1 Liter Engine	19 gal	72 l
Engine Oil with Filter		
6.1 Liter Engine (SAE 0W-40)	7 qts	6.6 liters
Cooling System *		
6.1 Liter Engine (Mopar® Antifreeze/Coolant 5 Year/ 100,000 Mile Formula) or equivalent	15.2 qts	14.4 l

* Includes heater and coolant recovery bottle filled to MAX level.

FLUIDS, LUBRICANTS, AND GENUINE PARTS

Engine

Component	Fluids, Lubricants, and Genuine Parts
Engine Coolant	Mopar® Antifreeze/Coolant 5 Year/100,000 Mile Formula HOAT (Hybrid Organic Additive Technology) or equivalent
Engine Oil (6.1L)	For best performance and maximum protection under all types of operating conditions, the manufacturer only recommends full synthetic engine oils that meet the American Petroleum Institute (API) categories of SM or SM/CF, and meet the requirements of DaimlerChrysler Material Standard MS-10725. The manufacturer recommends the use of a full synthetic engine oil, such as Mobil 1® SAE 0W-40 or equivalent. For additional information, refer to the “Engine Oil Selection” and “Engine Oil Viscosity (SAE Grade)” in the “Maintenance Procedures” section of this manual.
Oil Filter (6.1L)	Mopar® 05281090 or equivalent
Spark Plugs (6.1L)	PLZTR5A-13 (Gap.050 in [1.27 mm])
Fuel Selection (6.1L)	Premium Unleaded 91 Octane Only or higher

Chassis

Component	Fluids, Lubricants, and Genuine Parts
Automatic Transmission	Mopar® ATF+4 Automatic Transmission Fluid
Brake Master Cylinder	Mopar® DOT 3, SAE J1703 should be used. If DOT 3, SAE J1703 brake fluid is not available, then DOT 4 is acceptable. Use only recommended brake fluids.
Power Steering Reservoir	Mopar® Power Steering Fluid + 4, Mopar® ATF+4 Automatic Transmission Fluid
Rear Axle	API GL-5 SAE 75W140 Synthetic Gear Lubricant or equivalent

MAINTENANCE SCHEDULES

CONTENTS

■ Emissions Control System Maintenance	440	□ Severe Duty	442
■ Maintenance Schedule	440	□ Required Maintenance Intervals	443

EMISSIONS CONTROL SYSTEM MAINTENANCE

The Scheduled Maintenance services, listed in **bold type**, must be done at the times or mileages specified to ensure the continued proper functioning of the emission control system. These, and all other maintenance services included in this manual, should be done to provide best vehicle performance and reliability. More frequent maintenance may be needed for vehicles in severe operating conditions, such as dusty areas and very short trip driving.

Inspection and service should also be done any time a malfunction is suspected.

NOTE: Maintenance, replacement, or repair of the emission control devices and systems on your vehicle may be performed by any automotive repair establishment or individual using any automotive part that has been certified pursuant to U.S. EPA or, in the State of California, California Air Resources Board regulations.

MAINTENANCE SCHEDULE

To help you have the best driving experience possible, the manufacturer has identified the specific vehicle maintenance service intervals that are required to keep your vehicle operating properly and safely.

Chrysler recommends that these maintenance intervals be performed at your selling dealer. The technicians at your dealership know your vehicle best, and have access to factory-trained information, genuine Mopar® parts, and specially designed electronic and mechanical tools that can help prevent future costly repairs.

The maintenance intervals shown should be performed as indicated in this section.

NOTE: Under no circumstances should oil change intervals exceed **6,000 mi (10,000 km) or six months, whichever comes first.**

At Each Stop for Fuel

- Check the engine oil level. Refer to “Engine Oil” under “Maintenance Procedures” in Section 7.
- Check the windshield washer solvent and add if required.

Once a Month

- Check tire pressure and look for unusual wear or damage.
- Inspect the battery, and clean and tighten the terminals as required.
- Check the fluid levels of coolant reservoir and brake master cylinder, and add as needed.

- Check all lights and other electrical items for correct operation.

At Each Oil Change

- Change the engine oil filter.
- Inspect the brake hoses and lines.

CAUTION!

Failure to perform the required maintenance items may result in damage to the vehicle.

Severe Duty

If your vehicle is operated under the Severe Duty conditions listed below change your engine oil and filter every 3,000 mi (5 000 km) or three months as indicated in the Maintenance Schedule.

- Stop and go driving.
- Driving in dusty conditions.
- Short trips of less than 10 mi (16 km).
- Trailer towing.
- Taxi, police, or delivery service (commercial service).
- Off-road or desert operation.

Required Maintenance Intervals

Maintenance Items	Perform Maintenance Every (Where time and mileage are listed, follow the interval that occurs first.)		
	Miles	Kilometers	or Months
Change the engine oil and engine oil filter if using your vehicle under any of these severe duty conditions: Short trips, stop and go driving, dusty or off-road conditions, police, taxi, fleet, or frequent trailer towing.	3,000	5 000	3
	or	or	or
Change the engine oil and engine oil filter if your vehicle is NOT operated under any of the conditions listed under Severe Duty.	6,000	10 000	6
Rotate the tires.	6,000	10 000	6
If using your vehicle in dusty or off-road conditions, inspect the engine air cleaner filter, and replace if necessary.	12,000	20 000	12
Inspect the brake linings, and replace if necessary.	12,000	20 000	12

444 MAINTENANCE SCHEDULES

Maintenance Items	Perform Maintenance Every (Where time and mileage are listed, follow the interval that occurs first.)		
	Miles	Kilometers	or Months
Replace the air conditioning filter (if equipped).	12,000	20 000	12
Inspect the rear axle fluid.	18,000	30 000	18
Inspect the CV joints. Perform the first inspection at 12,000 mi (20 000 km) or 12 months.	24,000	40 000	24
Inspect the exhaust system. Perform the first inspection at 12,000 mi (20 000 km) or 12 months.	24,000	40 000	24
Inspect the front suspension, tie rod ends and boot seals, and replace if necessary.	24,000	40 000	24
Replace the engine air cleaner filter.	30,000	50 000	30
Change the rear axle fluid if using your vehicle for any of the following: police, taxi, fleet, off-road, or frequent trailer towing.	48,000	80 000	48
Change the automatic transmission fluid and filter if using your vehicle for any of the following: police, taxi, fleet, or frequent trailer towing.	60,000	100 000	60

Maintenance Items	Perform Maintenance Every (Where time and mileage are listed, follow the interval that occurs first.)		
	Miles	Kilometers	or Months
Inspect and replace PCV valve if necessary.	90,000	150 000	90
Flush and replace the engine coolant.	102,000	170 000	60
Replace the spark plugs.	102,000	170 000	102
Change the automatic transmission fluid and filter.	120,000	200 000	120

WARNING!

You can be badly injured working on or around a motor vehicle. Do only that service work for which you have the knowledge and the right equipment. If you have any doubt about your ability to perform a service job, take your vehicle to a competent mechanic.

IF YOU NEED CONSUMER ASSISTANCE

CONTENTS

- Suggestions For Obtaining Service For Your Vehicle449
 - Prepare For The Appointment449
 - Prepare A List449
 - Be Reasonable With Requests449
- If You Need Assistance450
 - DaimlerChrysler Motors Corporation Customer Center450
 - DaimlerChrysler Canada Inc. Customer Center451
 - In Mexico Contact451
 - Customer Assistance For The Hearing Or Speech Impaired (TDD/TTY)451
 - Service Contract451
- Warranty Information (U.S. Vehicles Only)452
- Mopar® Parts453
- Reporting Safety Defects453
 - In The 50 United States And Washington, D.C.453
 - In Canada453

■ Publication Order Forms454

■ Department Of Transportation Uniform Tire
Quality Grades455

□ Treadwear455

□ Traction Grades456

□ Temperature Grades456

SUGGESTIONS FOR OBTAINING SERVICE FOR YOUR VEHICLE

Prepare For The Appointment

If you're having warranty work done, be sure to have the right papers with you. Take your warranty folder. All work to be performed may not be covered by the warranty. Discuss additional charges with the service manager. Keep a maintenance log of your vehicle's service history. This can often provide a clue to the current problem.

Prepare A List

Make a written list of your vehicle's problems or the specific work you want done. If you've had an accident or work done that is not on your maintenance log, let the service advisor know.

Be Reasonable With Requests

If you list a number of items and you must have your vehicle by the end of the day, discuss the situation with the service advisor and list the items in order of priority. At many authorized dealers, you may obtain a rental vehicle at a minimal daily charge. If you need a rental, it is advisable to make these arrangements when you call for an appointment.

IF YOU NEED ASSISTANCE

The manufacturer and its authorized dealers are vitally interested in your satisfaction. We want you to be happy with our products and services.

Warranty service must be done by an authorized dealer. We strongly recommend that you take your vehicle to your authorized selling dealer. They know you and your vehicle best, and are most concerned that you get prompt and high quality service. The manufacturer's authorized dealers have the facilities, factory-trained technicians, special tools, and the latest information to ensure your vehicle is fixed correctly and in a timely manner.

This is why you should always talk to your authorized dealer's service manager first. Most matters can be resolved with this process.

- If for some reason you are still not satisfied, talk to the general manager or owner of the authorized dealership. They want to know if you need assistance.

- If your authorized dealership is unable to resolve the concern, you may contact the Manufacturer's Customer Center.

Any communication to the Manufacturer's Customer Center should include the following information:

- Owner's name and address
- Owner's telephone number (home and office)
- Authorized dealership name
- Vehicle Identification Number (VIN)
- Vehicle delivery date and mileage

DaimlerChrysler Motors Corporation Customer Center

P.O. Box 21-8004

Auburn Hills, MI 48321-8004

Phone: (800) 992-1997

DaimlerChrysler Canada Inc. Customer Center

P.O. Box 1621

Windsor, Ontario N9A 4H6

Phone: (800) 465-2001

In Mexico contact:

Av. Prolongacion Paseo de la Reforma, 1240

Sante Fe C.P. 05109

Mexico, D. F.

In Mexico: (915) 729-1248 or 729-1240

Outside Mexico: (525) 729-1248 or 729-1240

Customer Assistance for the Hearing or Speech Impaired (TDD/TTY)

To assist customers who have hearing difficulties, the manufacturer has installed special TDD (Telecommunication Devices for the Deaf) equipment at its Customer Center. Any hearing or speech impaired customer, who has access to a TDD or a conventional teletypewriter

(TTY) in the United States, can communicate with the manufacturer by dialing 1-800-380-CHRY.

Service Contract

You may have purchased a service contract for your vehicle to help protect you from the high cost of unexpected repairs after your manufacturer's New Vehicle Limited Warranty expires. The manufacturer stands behind only the manufacturer's Service Contracts. If you purchased a manufacturer's Service Contract, you will receive Plan Provisions and an Owner Identification Card in the mail within three weeks of your vehicle delivery date. If you have any questions about your service contract, call the manufacturer's Service Contract National Customer Hotline at 1-800-521-9922.

The manufacturer will not stand behind any service contract that is not the manufacturer's Service Contract. It is not responsible for any service contract other than the manufacturer's Service Contract. If you purchased a service contract that is not a manufacturer's Service Contract, and you require service after your manufacturer's New Vehicle Limited Warranty expires, please refer to your contract documents, and contact the person listed in those documents.

We appreciate that you have made a major investment when you purchased your vehicle. Your authorized dealer has also made a major investment in facilities, tools, and training to assure that you are absolutely delighted with your ownership experience. You'll be pleased with their sincere efforts to resolve any warranty issues or related concerns.

WARNING!

Engine exhaust, some of its constituents, and certain vehicle components contain, or emit, chemicals known to the State of California to cause cancer and birth defects or other reproductive harm. In addition, certain fluids contained in vehicles and certain products of component wear contain, or emit, chemicals known to the State of California to cause cancer and birth defects or other reproductive harm.

WARRANTY INFORMATION (U.S. Vehicles Only)

See the Warranty Information Booklet for the terms and provisions of DaimlerChrysler's warranties applicable to this vehicle.

MOPAR® PARTS

MOPAR® fluids, lubricants, parts, and accessories are available from your authorized dealer. They will help you keep your vehicle operating at its best.

REPORTING SAFETY DEFECTS

In the 50 United States and Washington, D.C.

If you believe that your vehicle has a defect which could cause a crash or cause injury or death, you should immediately inform the National Highway Traffic Safety Administration (NHTSA) in addition to notifying the manufacturer.

If NHTSA receives similar complaints, it may open an investigation, and if it finds that a safety defect exists in a group of vehicles, it may order a recall and remedy campaign. However, NHTSA cannot become involved in individual problems between you, your authorized dealer, and the manufacturer.

To contact NHTSA, you may either call the Auto Safety Hotline toll free at 1-888-327-4236 (TTY: 1-800-424-9153), or go to <http://www.safercar.gov>; or write to: Administrator, NHTSA, 400 Seventh Street, SW., Washington, D.C. 20590. You can also obtain other information about motor vehicle safety from <http://www.safercar.gov>.

In Canada

If you believe that your vehicle has a safety defect, you should contact the Customer Service Department immediately. Canadian customers who wish to report a safety defect to the Canadian government should write to: Transport Canada, Motor Vehicle Defect Investigations and Recalls, 2780 Sheffield Road, Ottawa, Ontario K1B 3V9.

PUBLICATION ORDER FORMS

To order the following manuals, you may use either the website or the phone numbers listed below. Visa, Mastercard, American Express, and Discover orders are accepted. If you prefer mailing your payment, please call for an order form.

NOTE: A street address is required when ordering manuals (no P.O. Boxes).

- *Service Manuals*

These comprehensive Service Manuals provide the information that students and professional technicians need in diagnosing/troubleshooting, problem solving, maintaining, servicing, and repairing DaimlerChrysler Corporation vehicles. A complete working knowledge of the vehicle, system, and/or components is written in straightforward language with illustrations, diagrams, and charts.

- *Diagnostic Procedure Manuals*

Diagnostic Procedure Manuals are filled with diagrams, charts and detailed illustrations. These practical manuals make it easy for students and technicians to find and fix problems on computer-controlled vehicle systems and features. They show exactly how to find and correct problems the first time, using step-by-step troubleshooting and drivability procedures, proven diagnostic tests and a complete list of all tools and equipment.

- *Owner's Manuals*

These Owner's Manuals have been prepared with the assistance of service and engineering specialists to acquaint you with specific DaimlerChrysler Corporation vehicles. Included are starting, operating, emergency and maintenance procedures as well as specifications, capabilities and safety tips.

Call toll free at:

- 1-800-890-4038 (U.S.)
- 1-800-387-1143 (Canada)

Or

Visit us on the Worldwide Web at:

- www.techauthority.daimlerchrysler.com
- www.daimlerchrysler.ca/manuals

DEPARTMENT OF TRANSPORTATION UNIFORM TIRE QUALITY GRADES

The following tire grading categories were established by the National Highway Traffic Safety Administration. The specific grade rating assigned by the tire's manufacturer in each category is shown on the sidewall of the tires on your vehicle.

All passenger car tires must conform to Federal safety requirements in addition to these grades.

Treadwear

The treadwear grade is a comparative rating, based on the wear rate of the tire when tested under controlled conditions on a specified government test course. For example, a tire graded 150 would wear 1-1/2 times as well on the government course as a tire graded 100. The relative performance of tires depends upon the actual conditions of their use, however, and may depart significantly from the norm due to variations in driving habits, service practices, and differences in road characteristics and climate.

Traction Grades

The traction grades, from highest to lowest, are AA, A, B, and C. These grades represent the tire's ability to stop on wet pavement, as measured under controlled conditions on specified government test surfaces of asphalt and concrete. A tire marked C may have poor traction performance.

WARNING!

The traction grade assigned to this tire is based on straight-ahead braking traction tests, and does not include acceleration, cornering, hydroplaning, or peak traction characteristics.

Temperature Grades

The temperature grades are A (the highest), B, and C, representing the tire's resistance to the generation of heat and its ability to dissipate heat, when tested under controlled conditions on a specified indoor laboratory

test wheel. Sustained high temperature can cause the material of the tire to degenerate and reduce tire life, and excessive temperature can lead to sudden tire failure. The grade C corresponds to a level of performance, which all passenger car tires must meet under the Federal Motor Vehicle Safety Standard No. 109. Grades B and A represent higher levels of performance on the laboratory test wheel, than the minimum required by law.

WARNING!

The temperature grade for this tire is established for a tire that is properly inflated and not overloaded. Excessive speed, under-inflation, or excessive loading, either separately or in combination, can cause heat buildup and possible tire failure.

INDEX

- About Your Brakes 315,317
 ABS (Anti-Lock Brake System) 317,321
 Adaptive Cruise Control (ACC) (Cruise Control) . . 153
 Adding Engine Coolant (Antifreeze) 406
 Adding Fuel 361
 Adding Washer Fluid 144,146,402
 Additives, Fuel 359
 Adjustable Pedals 148
 Air Cleaner, Engine (Engine Air Cleaner Filter) . . . 394
 Air Conditioner Maintenance 399
 Air Conditioning Filter 290,400
 Air Conditioning, Operating Tips 291
 Air Conditioning Refrigerant 399,400
 Air Conditioning System 284,399
 Air Pressure, Tires 206,337
 Airbag 49
 Airbag Deployment 55,59
 Airbag Light 56,61,76,201
 Airbag Maintenance 61
 Airbag, Side 50,57
 Airbag, Window (Side Curtain) 50,57
 Alarm, Panic 22
 Alarm (Security Alarm) 18,205
 Alarm System (Security Alarm) 18
 Alignment and Balance 343
 Alterations/Modifications, Vehicle 7
 Antenna, Satellite Radio 270
 Antifreeze (Engine Coolant) 405,406,435
 Disposal 407
 Anti-Lock Brake System (ABS) 317,321
 Anti-Lock Warning Light 200,319
 Anti-Theft Security Alarm (Theft Alarm) 18
 Anti-Theft System 205
 Appearance Care 414
 Arming Theft System (Security Alarm) 18
 Assistance Towing 101
 Audio Systems (Radio) 232,251
 Auto Down Power Windows 34

Auto Unlock, Doors	30	Axle Fluid	437
Auto Up Power Windows	34	Axle Lubrication (Axle Fluid)	437
Automatic Dimming Mirror	84	Ball Joints	401
Automatic Door Locks	29,30	Battery	397
Automatic Headlights	133	Emergency Starting	377
Automatic Temperature Control (ATC)	284	Jump Starting	377
Automatic Transaxle		Keyless Transmitter Replacement (RKE)	23
Special Additives	414	Location	377,397
Automatic Transmission	305,413,414	Bearings	414
Adding Fluid	414,437	Belts, Drive	393
Autostick	308,310	Belts, Seat	40,76
Fluid and Filter Changes	414	Body Mechanism Lubrication	401
Fluid Change	414	B-Pillar Location	332
Fluid Level Check	413	Brake Assist System	322
Fluid Type	437	Brake Control System, Electronic	320
Shifting	305	Brake Fluid	437
Special Additives	414	Brake, Parking	315
Automatic Transmission Limp Home Mode	309,310	Brake System	317,410
Autostick	308,310		

- Anti-Lock (ABS) 317,321
 Fluid Check 411,437
 Hoses 410
 Master Cylinder 411
 Parking 315
 Warning Light 201,317
 Brakes 317,410
 Brake/Transmission Interlock 304
 Break-In Recommendations, New Vehicle 73
 Brightness, Interior Lights 139
 Bulb Replacement 427,428
 Bulbs, Light 77,427
 Calibration, Compass 220
 Capacities, Fluid 435
 Caps, Filler
 Fuel 361
 Oil (Engine) 392
 Radiator (Coolant Pressure) 406
 Car Washes 415
 Carbon Monoxide Warning 75,360
 Cargo (Vehicle Loading) 364
 Catalytic Converter 395
 CD (Compact Disc) Player 232,251
 Cellular Phone 88,251,253
 Certification Label 364
 Chains, Tire 343
 Chart, Tire Sizing 329
 Check Engine Light (Malfunction Indicator Light) 388
 Checking Your Vehicle For Safety 74
 Checks, Safety 74
 Child Restraint 64,65,66,69,71
 Child Restraint Tether Anchors 68,69
 Child Safety Locks 30
 Clean Air Gasoline 358
 Cleaning
 Wheels 416
 Windshield Wiper Blades 402

- Climate Control 283
- Clock 231,234,237,253,258
- Coin Holder 190
- Cold Weather Operation 299
- Compact Disc (CD) Maintenance 283
- Compass 220
- Compass Calibration 220
- Compass Variance 221
- Computer, Trip/Travel 215
- Connector
 UCI 277
 Universal Consumer Interface (UCI) 277
- Console, Floor 190
- Console, Overhead 176
- Contract, Service 451
- Converter, Catalytic 395
- Coolant Pressure Cap (Radiator Cap) 406
- Cooling System 404
 Adding Coolant (Antifreeze) 406
- Coolant Capacity 435
- Coolant Level 404,407
- Disposal of Used Coolant 407
- Drain, Flush, and Refill 405
- Inspection 407
- Points to Remember 408
- Pressure Cap 406
- Radiator Cap 406
- Selection of Coolant (Antifreeze) 405,435,436
- Corrosion Protection 414
- Cruise Control (Speed Control) 150,153
- Cruise Light 199
- Cup Holder 189,419
- Customer Assistance 450
- Customer Programmable Features 226
- Data Recorder, Event 62
- Daytime Brightness, Interior Lights 140
- Daytime Running Lights 136

- Dealer Service 390
- Deck Lid, Emergency Release 38
- Deck Lid, Power Release 37
- Defroster, Rear Window 292
- Defroster, Windshield 77,288
- Delay (Intermittent) Wipers 141
- Diagnostic System, Onboard 387
- Digital Video Disc (DVD) Player 232,251
- Dimmer Switch, Headlight 138
- Dipsticks
- Oil (Engine) 391
- Disabled Vehicle Towing 381
- Disposal
- Antifreeze (Engine Coolant) 407
- Engine Oil 393
- Door Locks 27
- Door Locks, Automatic 29
- Door Opener, Garage 177
- Drive Belts 393
- Driving
- On Slippery Surfaces 312
- Through Flowing, Rising, or Shallow
standing Water 313
- DVD Player (Video Entertainment System) 273
- Electric Rear Window Defrost 292
- Electric Remote Mirrors 86
- Electrical Power Outlets 187
- Electronic Brake Control System 320
- Electronic Power Distribution Center (Fuses) 419
- Electronic Speed Control (Cruise Control) 150,153
- Electronic Stability Program (ESP) 323
- Electronic Throttle Control Warning Light 205
- Electronic Vehicle Information Center (EVIC) 209
- Emergency Deck Lid Release 38
- Emergency, In Case of
- Freeing Vehicle When Stuck 380
- Hazard Warning Flasher 370

Jump Starting	377	Oil Change Interval	392
Overheating	371	Oil Filler Cap	392
Towing	381	Oil Filter	393
Emergency Trunk Release	38	Oil Filter Disposal	393
Emission Control System Maintenance	388,440	Oil Selection	392,435
Engine	386	Overheating	371
Air Cleaner	394	Starting	297
Block Heater	301	Temperature Gauge	203
Break-In Recommendations	73	Engine Oil Viscosity	392
Checking Oil Level	391	Enhanced Accident Response Feature	60
Compartment	386	Entry System, Illuminated	20
Coolant (Antifreeze)	404,436	Ethanol	358
Cooling	404	Event Data Recorder	62
Exhaust Gas Caution	75,360	Exhaust Gas Caution	75,76,360,403
Fails to Start	300	Exhaust System	75,403
Flooded, Starting	300	Exterior Folding Mirrors	85
Fuel Requirements	357	Exterior Lighting	132
Jump Starting	377	Exterior Lights	77
Oil	391,435,436		

Filters

Air Cleaner	394
Air Conditioning	290,400
Engine Fuel	395
Engine Oil	393,436
Engine Oil Disposal	393

Flashers

Hazard Warning	370
Turn Signal	77,138,199

Flash-To-Pass	138
-------------------------	-----

Flooded Engine Starting	300
-----------------------------------	-----

Floor Console	190
-------------------------	-----

Fluid, Brake	437
------------------------	-----

Fluid Capacities	435
----------------------------	-----

Fluid Leaks	77
-----------------------	----

Fluid Level Checks

Automatic Transmission	413
Brake	411
Cooling System	404

Engine Oil	391
----------------------	-----

Power Steering	400
--------------------------	-----

Fluids	436
------------------	-----

Fluids, Lubricants and Genuine Parts	436
--	-----

Fog Lights	137,199
----------------------	---------

Folding Rear Seat	125
-----------------------------	-----

Freeing A Stuck Vehicle	380
-----------------------------------	-----

Front Suspension Ball Joints	401
--	-----

Front Wheel Bearings	414
--------------------------------	-----

Fuel	357
----------------	-----

Adding	361
------------------	-----

Additives	359
---------------------	-----

Clean Air	358
---------------------	-----

Ethanol	358
-------------------	-----

Filler Cap (Gas Cap)	361
--------------------------------	-----

Filter	395
------------------	-----

Gasoline	357
--------------------	-----

Gauge	205
-----------------	-----

Hoses	409
-----------------	-----

Materials Added	359	Tachometer	200
Methanol	358	General Information	18,24,115,172,311,357
Octane Rating	357,436	General Maintenance	390
Requirements	357	Glass Cleaning	418
Specifications	436	Gross Axle Weight Rating	364
Tank Capacity	435	Gross Vehicle Weight Rating	364
Fuel System Caution	362	Ground Clearance	367
Fueling	361	GVWR	364
Fuses	419		
		Hands-Free Phone (UConnect™)	88,251,253
Garage Door Opener (HomeLink®)	177	Hard Drive (HDD)	232,251
Gas Cap (Fuel Filler Cap)	361,387	Hazard	
Gasoline, Clean Air	358	Driving Through Flowing, Rising, or Shallow	
Gasoline (Fuel)	357	Standing Water	313
Gasoline, Reformulated	358	Hazard Warning Flasher	370
Gauges		Head Restraints	123
Coolant Temperature	203	Headlight Washers	145,402
Fuel	205	Headlights	428
Speedometer	199	Automatic	133

Bulb Replacement	428	Hoses	409
Cleaning	418	Ignition	14
Delay	136	Key	12,14
High Beam	138	Ignition Key Removal	14
High Beam/Low Beam Select Switch	138	Illuminated Entry	20
Lights On Reminder	136	Immobilizer (Sentry Key)	15
On With Wipers	134,142	Infant Restraint	64,65
Passing	138	Inflation Pressure Tires	206
Switch	132	Information Center, Vehicle	209
Time Delay	136	Instrument Cluster	198,199
Washers	145,402	Instrument Panel and Controls	197
Heated Mirrors	87	Instrument Panel Lens Cleaning	418
Heated Seats	124	Interior Appearance Care	417
Heater, Engine Block	301	Interior Fuses	419
High Beam/Low Beam Select (Dimmer) Switch	138	Interior Lights	139
Holder, Coin	190	Intermittent Wipers (Delay Wipers)	141
Holder, Cup	189	Introduction	4
HomeLink® (Garage Door Opener) Transmitter	177		
Hood Release	131		

- Jump Starting 377
 Key, Programming 17
 Key, Replacement 16
 Key, Sentry (Immobilizer) 15
 Key-In Reminder 15
 Keyless Entry System 20
 Keys 12
 Knee Bolster 49

 Lane Change and Turn Signals 138
 Lap/Shoulder Belts 40
 LATCH (Lower Anchors and Tether for
 CHildren) 68,69
 Latch Plate 41
 Latches 77
 Hood 131
 Lead Free Gasoline 357
 Leaks, Fluid 77

 Life of Tires 341
 Light Bulbs 77,427
 Lights 77,132
 Airbag 56,61,76,201
 Anti-Lock 200,319
 Automatic Headlights 133
 Brake Assist Warning 327
 Brake Warning 201,317
 Bulb Replacement 427,428
 Courtesy/Reading 138,176
 Cruise 199
 Daytime Running 136
 Dimmer Switch, Headlight 137,138
 Electronic Stability Program (ESP) Indicator 327
 Electronic Throttle Control Warning 205
 Engine Temperature Warning 200
 Exterior 77
 Fog 137,199
 Hazard Warning Flasher 370

Headlight Switch	132	Reading	138,176
Headlights	132,428	Seat Belt Reminder	205
Headlights On Reminder	136	Service	427,428
Headlights On With Wipers	134,142	Service Engine Soon (Malfunction Indicator) . . .	208
High Beam	138,205	SmartBeams	134
High Beam Indicator	205	Tire Pressure Monitoring (TPMS)	206,347
Illuminated Entry	20	Traction Control	327
Instrument Cluster	132,199	Turn Signal	77,137,138,199
Intensity Control	139	Vanity Mirror	88
Interior	139,176	Voltage	208
License	434	Warning (Instrument Cluster Description)	199
Lights On Reminder	136	Loading Vehicle	364,365
Low Fuel	199	Capacities	365
Low Tire	206	Tires	332
Malfunction Indicator (Check Engine)	208	Locks	27
Map Reading	138,176	Auto Unlock	30
Oil Pressure	208	Automatic Door	29
Parade Mode (Daytime Brightness)	140	Child Protection	30
Passing	138	Door	27

Power Door	28	Methanol	358
Low Tire Pressure System	347	Mini-Trip Computer	215
Lower Anchors and Tether for CHildren (LATCH)	68,69	Mirrors	84
Lubrication, Body	401	Automatic Dimming	84
Lumbar Support	122	Electric Powered	86
		Electric Remote	86
Maintenance Free Battery	397	Exterior Folding	85
Maintenance, General	390	Heated	87
Maintenance Procedures	390	Outside	85
Maintenance Schedule	440	Vanity	88
Maintenance, Sunroof	186	Modifications/Alterations, Vehicle	7
Malfunction Indicator Light (Check Engine)	208,388	Monitor, Tire Pressure System	347
Manual, Service	454	Mopar Parts	389,453
Map/Reading Lights	138,176	MP3 Player	232,251
Master Cylinder (Brakes)	411	MTBE/ETBE	358
Memory Feature (Memory Seat)	126	Multi-Function Control Lever	137
Memory Seat	126		
Memory Seats and Radio	126	Navigation Radio	251
		Navigation System	251

New Vehicle Break-In Period	73	Onboard Diagnostic System	387,388
Occupant Restraints	39	Opener, Garage Door (HomeLink®)	177
Octane Rating, Gasoline (Fuel)	357,436	Operating Precautions	387
Odometer	204	Outside Rearview Mirrors	85
Trip	204	Overhead Console	176
Oil, Engine	391,436	Overheating, Engine	371
Capacity	435	Owner's Manual (Operator Manual)	454
Change Interval	392	Paint Care	414
Checking	391	Panic Alarm	22
Dipstick	391	Park Sense System, Rear	172
Disposal	393	Parking Brake	315
Filter	393,436	Parking On Hill	315
Filter Disposal	393	Passing Light	138
Materials Added to	393	Pedals, Adjustable	148
Recommendation	392,435	Personal Settings	226
Viscosity	392,435	Pets	73
Oil Filter, Change	393	Phone, Cellular	88,251,253
Oil Filter, Selection	393	Phone, Hands-Free (UConnect™)	88,251,253

- Placard, Tire and Loading Information 332
- Port
- Universal Serial Bus (USB) 232,251
 - USB 232,251
- Power
- Brakes 317
 - Deck Lid Release 37
 - Distribution Center (Fuses) 419
 - Door Locks 28
 - Mirrors 86
 - Outlet (Auxiliary Electrical Outlet) 187
 - Seats 120
 - Steering 319
 - Steering, Checking 400
 - Sunroof 184
 - Tilt/Telescoping Steering Column 147
 - Windows 33
- Power Steering Fluid 400,437
- Pregnant Women and Seat Belts 48
- Pretensioners
- Seat Belts 46
- Programmable Electronic Features 226
- Programming Transmitters
(Remote Keyless Entry) 20
- Radial Ply Tires 339
- Radiator Cap (Coolant Pressure Cap) 406
- Radio Broadcast Signals 231
- Radio, Navigation 251
- Radio Operation 233,253,283
- Radio Remote Controls 281
- Radio, Satellite 232,233,251,253,268,273
- Radio (Sound Systems) 232,251
- Rain Sensitive Wiper System 142
- Rear Cup Holder 189
- Rear Park Sense System 172
- Rear Seat, Folding 125
- Rear Wheel Bearings 414

Rear Window Defroster	292	Replacement Parts	389
Rear Window Features	292	Replacement Tires	342
Reception, Radio	231	Reporting Safety Defects	453
Reclining Front Seats	121	Restraint, Head	123
Recorder, Event Data	62	Restraints, Child	64
Recreational Towing	367	Restraints, Occupant	39
Reformulated Gasoline	358	Rocking Vehicle When Stuck	380
Refrigerant	400	Rotation, Tires	345
Release, Hood	131		
Reminder, Lights On	136	Safety Checks Inside Vehicle	76
Reminder, Seat Belt	46	Safety Checks Outside Vehicle	77
Remote Control		Safety Defects, Reporting	453
Starting System	25	Safety, Exhaust Gas	75
Remote Keyless Entry (RKE)	20	Safety Information, Tire	328
Remote Sound System (Radio) Controls	281	Safety Tips	74
Remote Starting System	25	Satellite Radio	232,233,251,253,268,273
Remote Trunk Release	37	Satellite Radio Antenna	270
Replacement Bulbs	427	Schedule, Maintenance	440
Replacement Keys	16	Seat Belt Maintenance	419

Seat Belt Reminder	46	Lumbar Support	122
Seat Belts	39,40,76	Memory	126
Adjustable Upper Shoulder Anchorage	44	Power	120
And Pregnant Women	48	Rear Folding	125
Child Restraint	64,65,66,71	Reclining	121
Extender	48	Seatback Release	125
Front Seat	40,41	Tilting	120
Inspection	76	Security Alarm (Theft Alarm)	18,205
Operating Instructions	41	Selection of Coolant (Antifreeze)	405,436
Pretensioners	46	Selection of Oil	392
Rear Seat	40	Sentry Key (Immobilizer)	15
Reminder	205	Sentry Key Programming	17
Untwisting Procedure	45	Sentry Key Replacement	16
Seats	120	Service Assistance	449,450
Adjustment	120	Service Contract	451
Easy Entry	129	Service Engine Soon Light (Malfunction Indicator)	208
Head Restraints	123	Service Manuals	454
Heated	124	Setting the Clock	231,234,237,253,258
Height Adjustment	120		

- Settings, Personal 226
- Shifting 301
- Automatic Transmission 301,305
- Shoulder Belt Upper Anchorage 44
- Shoulder Belts 40
- Side Airbag 50,57
- Side Curtain (Window Airbag) 50
- Side View Mirror Adjustment 85
- Signals, Turn 77,138,199
- Slippery Surfaces, Driving On 312
- SmartBeams 134
- Snow Chains (Tire Chains) 343
- Snow Tires 344
- Sound Systems (Radio) 232,251
- Spark Plugs 394,436
- Specifications
- Fuel (Gasoline) 436
- Oil 436
- Speed Control (Cruise Control) 150,153
- Speedometer 199
- Starting 25,297
- Automatic Transmission 298
- Cold Weather 299
- Emergency (Jump Starting) 377
- Engine Fails to Start 300
- Remote 25
- Starting and Operating 297
- Starting Procedures 297
- Steering
- Column Controls 137
- Linkage 401
- Power 319,400
- Tilt Column 147
- Wheel, Tilt 147
- Steering Wheel Mounted Sound System
- Controls 281
- Storage 190,427
- Storage, Vehicle 290,427

Storing Your Vehicle	427	Tire and Loading Information Placard	332
Stuck, Freeing	380	Tire Identification Number (TIN)	331
Sun Roof	184	Tire Markings	328
Sunglasses Storage	177	Tire Safety Information	328
Sunroof Maintenance	186	TIREFIT	372
Supplemental Restraint System - Airbag	49	Tires	77,336,455
System, Navigation	251	Aging (Life of Tires)	341
System, Remote Starting	25	Air Pressure	336
		Alignment	343
Tachometer	200	Chains	343
Telescoping Steering Column	147	General Information	336
Temperature Control, Automatic (ATC)	284	High Speed	339
Temperature Gauge, Engine Coolant	203,204,371	Inflation Pressures	337
Tether Anchor, Child Restraint	68	Life of Tires	341
Theft Alarm (Security Alarm)	18	Load Capacity	332,333
Theft System (Security Alarm)	18	Pressure Monitor System (TPMS)	347
Tilt Steering Column	147	Quality Grading	455
Time Delay, Headlight	136	Radial	339
Tip Start	14	Replacement	342

- Rotation 345
- Safety 328,336
- Sizes 329
- Snow Tires 344
- Spinning 340
- Tread Wear Indicators 340
- To Open Hood 131
- Towing 367
- 24-Hour Towing Assistance 101
- Behind a Motor Home 367
- Disabled Vehicle 381
- Recreational 367
- Towing Assistance 101
- Towing Vehicle Behind a Motor Home 367
- Traction Control 322
- Trailer Towing 367
- Transmission 413
- Automatic 301,305,413
- Fluid 437
- Shifting 301
- Transmitter Battery Service
(Remote Keyless Entry) 23
- Transmitter, Garage Door Opener (HomeLink®) . . 177
- Transmitter Programming
(Remote Keyless Entry) 20
- Transmitter, Remote Keyless Entry (RKE) 20
- Transporting Pets 73
- Tread Wear Indicators 340
- Trip Odometer 204
- Trunk Lid (Deck Lid) 37,38
- Trunk Release, Emergency 38
- Trunk Release Remote Control 37
- Turn Signals 138,199
- UCI Connector 277
- UConnect™ (Hands-Free Phone) 88,251
- Uniform Tire Quality Grades 455
- Universal Consumer Interface (UCI) Connector . . . 277

- Universal Serial Bus (USB) Port 232,251
 Universal Transmitter 177
 Unleaded Gasoline 357
 Untwisting Procedure, Seat Belt 45
 USB Port 232,251

 Vacuum/Vapor Harnesses 409
 Vanity Mirrors 88
 Variance, Compass 221
 Vehicle Certification Label 364
 Vehicle Identification Number (VIN) 6
 Vehicle Loading 333,364,365
 Vehicle Modifications/Alterations 7
 Vehicle Storage 290,427
 Vehicle Theft Alarm (Security Alarm) 18
 Video Entertainment System
 (Rear Seat Video System) 273
 Viscosity, Engine Oil 392
 Voice Recognition System (VR) 115

 Warning Flasher, Hazard 370
 Warning Lights (Instrument Cluster
 Description) 199
 Warnings and Cautions 6
 Warranty Information 452
 Washer, Adding Fluid 144,146,402
 Washers, Headlight 145
 Washers, Windshield 140,142,402
 Washing Vehicle 415
 Water
 Driving Through 313
 Wheel Alignment and Balance 343
 Wheel and Wheel Trim 416
 Wheel and Wheel Trim Care 416
 Wheel Bearings 414
 Wind Buffeting 36,186
 Window Airbag (Side Curtain) 50,57
 Window Fogging 290
 Windows 33

Power	33	Windshield Wipers	140
Windshield Defroster	77,288	Wiper Blade Replacement	402
Windshield Washers	140,142,402	Wiper, Delay	141
Fluid	402	Wipers, Intermittent	141
Windshield Wiper Blades	402	Wipers, Rain Sensitive	142

INSTALLATION OF RADIO TRANSMITTING EQUIPMENT

Special design considerations are incorporated into this vehicle's electronic system to provide immunity to radio frequency signals. Mobile two-way radios and telephone equipment must be installed properly by trained personnel. The following must be observed during installation.

The positive power connection should be made directly to the battery and fused as close to the battery as possible. The negative power connection should be made to body sheet metal adjacent to the negative battery connection. This connection should not be fused.

Antennas for two-way radios should be mounted on the roof or the rear area of the vehicle. Care should be used in mounting antennas with magnet bases. Magnets may affect the accuracy or operation of the compass on vehicles so equipped.

The antenna cable should be as short as practical and routed away from the vehicle wiring when possible. Use only fully shielded coaxial cable.

Carefully match the antenna and cable to the radio to ensure a low Standing Wave Ratio (SWR).

Mobile radio equipment with output power greater than normal may require special precautions.

All installations should be checked for possible interference between the communications equipment and the vehicle's electronic systems.



Stick with the Specialists™

DaimlerChrysler Corporation

81-026-0848



First Edition

Printed in U.S.A.