

# 2004 Buick Century Owner Manual

---

<b>Seats and Restraint Systems</b> .....	1-1	<b>Driving Your Vehicle</b> .....	4-1
Front Seats .....	1-2	Your Driving, the Road, and Your Vehicle .....	4-2
Rear Seats .....	1-5	Towing .....	4-31
Safety Belts .....	1-6	<b>Service and Appearance Care</b> .....	5-1
Child Restraints .....	1-28	Service .....	5-3
Air Bag Systems .....	1-49	Fuel .....	5-4
Restraint System Check .....	1-58	Checking Things Under the Hood .....	5-10
<b>Features and Controls</b> .....	2-1	Headlamp Aiming .....	5-49
Keys .....	2-2	Bulb Replacement .....	5-51
Doors and Locks .....	2-10	Windshield Wiper Blade Replacement .....	5-56
Windows .....	2-15	Tires .....	5-57
Theft-Deterrent Systems .....	2-17	Appearance Care .....	5-88
Starting and Operating Your Vehicle .....	2-18	Vehicle Identification .....	5-96
Mirrors .....	2-31	Electrical System .....	5-97
OnStar® System .....	2-33	Capacities and Specifications .....	5-103
Storage Areas .....	2-34	<b>Maintenance Schedule</b> .....	6-1
Sunroof .....	2-36	Maintenance Schedule .....	6-2
<b>Instrument Panel</b> .....	3-1	<b>Customer Assistance and Information</b> .....	7-1
Instrument Panel Overview .....	3-2	Customer Assistance and Information .....	7-2
Climate Controls .....	3-18	Reporting Safety Defects .....	7-10
Warning Lights, Gages and Indicators .....	3-27	<b>Index</b> .....	1
Audio System(s) .....	3-44		

---



GENERAL MOTORS, GM, the GM Emblem, BUICK, the BUICK Emblem and the name CENTURY are registered trademarks of General Motors Corporation.

This manual includes the latest information at the time it was printed. We reserve the right to make changes after that time without further notice. For vehicles first sold in Canada, substitute the name "General Motors of Canada Limited" for Buick Motor Division whenever it appears in this manual.

Please keep this manual in your vehicle, so it will be there if you ever need it when you're on the road. If you sell the vehicle, please leave this manual in it so the new owner can use it.

## Canadian Owners

You can obtain a French copy of this manual from your dealer or from:

Helm, Incorporated  
P.O. Box 07130  
Detroit, MI 48207

## How to Use This Manual

Many people read their owner's manual from beginning to end when they first receive their new vehicle. If you do this, it will help you learn about the features and controls for your vehicle. In this manual, you will find that pictures and words work together to explain things.

## Index

A good place to look for what you need is the Index in back of the manual. It is an alphabetical list of what is in the manual, and the page number where you will find it.

## Safety Warnings and Symbols

You will find a number of safety cautions in this book. We use a box and the word CAUTION to tell you about things that could hurt you if you were to ignore the warning.

 **CAUTION:**

**These mean there is something that could hurt you or other people.**

In the caution area, we tell you what the hazard is. Then we tell you what to do to help avoid or reduce the hazard. Please read these cautions. If you don't, you or others could be hurt.



You will also find a circle with a slash through it in this book. This safety symbol means “Don’t,” “Don’t do this” or “Don’t let this happen.”

## Vehicle Damage Warnings

Also, in this book you will find these notices:

**Notice:** These mean there is something that could damage your vehicle.

A notice will tell you about something that can damage your vehicle. Many times, this damage would not be covered by your warranty, and it could be costly. But the notice will tell you what to do to help avoid the damage.

When you read other manuals, you might see CAUTION and NOTICE warnings in different colors or in different words.

You'll also see warning labels on your vehicle. They use the same words, CAUTION or NOTICE.

































## Vehicle Symbols

Your vehicle has components and labels that use symbols instead of text. Symbols, used on your vehicle, are shown along with the text describing the operation or information relating to a specific component, control, message, gage or indicator.

If you need help figuring out a specific name of a component, gage or indicator, reference the following topics:

- Seats and Restraint Systems in Section 1
- Features and Controls in Section 2
- Instrument Panel Overview in Section 3
- Climate Controls in Section 3
- Warning Lights, Gages and Indicators in Section 3
- Audio System(s) in Section 3
- Engine Compartment Overview in Section 5

These are some examples of vehicle symbols you may find on your vehicle:

CAUTION POSSIBLE INJURY		LATCH BOTH LAP AND SHOULDER BELTS TO PROTECT OCCUPANT DO NOT TWIST SAFETY BELT WHEN ATTACHING	 	MASTER LIGHTING SWITCH		ENGINE COOLANT TEMP		FUSE BOX ACCESS			
PROTECT EYES BY SHIELDING		FASTEN SEAT BELTS		AIR BAG		TURN SIGNALS		BATTERY CHARGING SYSTEM		ENGINE COOLANT FAN	
CAUSTIC BATTERY ACID COULD CAUSE BURNS		MOVE SEAT FULLY REARWARD SECURE CHILD SEAT		DO NOT INSTALL A REAR-FACING CHILD RESTRAINT IN THIS SEATING POSITION		PARKING LAMPS		BRAKE		FUEL	
AVOID SPARKS OR FLAMES		PULL BELT OUT COMPLETELY THEN SECURE CHILD SEAT		DO NOT INSTALL A FORWARD-FACING CHILD RESTRAINT IN THIS SEATING POSITION		HAZARD WARNING FLASHER		COOLANT		OWNER'S MANUAL	
SPARK OR FLAME COULD EXPLODE BATTERY		POWER WINDOW		DOOR LOCK UNLOCK		DAYTIME RUNNING LAMPS		ENGINE OIL PRESSURE		SERVICE	
						FOG LAMPS		ANTI-LOCK BRAKES		SERVICE MANUAL	



## NOTES

---

---

---

---

---

---

---

---

---

---

---

---

---

---

---

---

---

---

---

---

---

---

---

---



# Section 1 Seats and Restraint Systems

---

<b>Front Seats</b> .....	1-2	Top Strap .....	1-38
Manual Seats .....	1-2	Top Strap Anchor Location .....	1-39
Six-Way Power Seats .....	1-3	Lower Anchorages and Top Tethers for Children (LATCH System) .....	1-40
Reclining Seatbacks .....	1-3	Securing a Child Restraint Designed for the LATCH System (Rear) .....	1-42
Head Restraints .....	1-5	Securing a Child Restraint in a Rear Outside Seat Position .....	1-42
<b>Rear Seats</b> .....	1-5	Securing a Child Restraint in a Center Rear Seat Position .....	1-44
Split Folding Rear Seat .....	1-5	Securing a Child Restraint in the Right Front Seat Position .....	1-47
<b>Safety Belts</b> .....	1-6	<b>Air Bag Systems</b> .....	1-49
Safety Belts: They Are for Everyone .....	1-6	Where Are the Air Bags? .....	1-52
Questions and Answers About Safety Belts .....	1-10	When Should an Air Bag Inflate? .....	1-54
How to Wear Safety Belts Properly .....	1-11	What Makes an Air Bag Inflate? .....	1-55
Driver Position .....	1-12	How Does an Air Bag Restrain? .....	1-55
Safety Belt Use During Pregnancy .....	1-19	What Will You See After an Air Bag Inflates? .....	1-56
Right Front Passenger Position .....	1-20	Servicing Your Air Bag-Equipped Vehicle .....	1-58
Center Passenger Position .....	1-20	<b>Restraint System Check</b> .....	1-58
Rear Seat Passengers .....	1-22	Checking Your Restraint Systems .....	1-58
Rear Safety Belt Comfort Guides for Children and Small Adults .....	1-25	Replacing Restraint System Parts After a Crash .....	1-59
Safety Belt Extender .....	1-27		
<b>Child Restraints</b> .....	1-28		
Older Children .....	1-28		
Infants and Young Children .....	1-30		
Child Restraint Systems .....	1-34		
Where to Put the Restraint .....	1-37		

## Front Seats

### Manual Seats

#### CAUTION:

You can lose control of the vehicle if you try to adjust a manual driver's seat while the vehicle is moving. The sudden movement could startle and confuse you, or make you push a pedal when you don't want to. Adjust the driver's seat only when the vehicle is not moving.



Lift the bar located under the front of the passenger's seat to unlock the seat. Slide the seat to the desired position and release the bar. Try to move the seat to be sure it is locked into place.



## Six-Way Power Seats

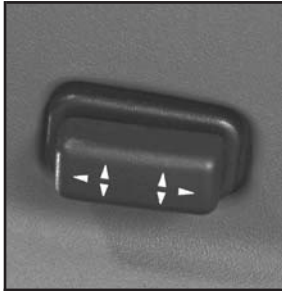

If the vehicle has a driver's side power seat, the control for it is located on the outboard side of the seat cushion.

- To move the seat forward or rearward, push the control forward or rearward.
- To raise or lower the entire seat, push the control up or down.
- To raise or lower the front of the seat, push the front of the control up or down.
- To raise or lower the rear of the seat, push the rear of the control up or down.

## Reclining Seatbacks

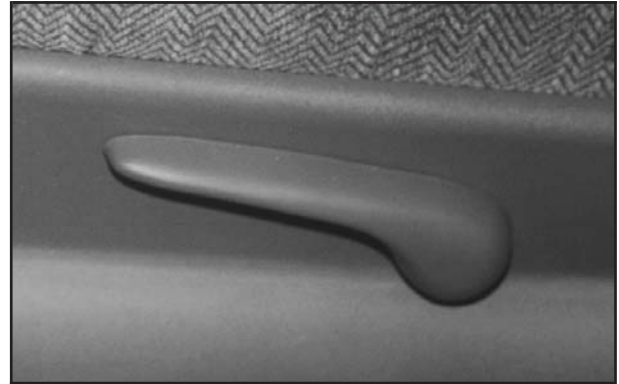

Lift the lever located on the outboard side of the seat to release the seatback, then move the seatback to the desired position. Release the lever to lock the seatback in place. Pull up on the lever without pushing on the seatback and the seatback will move forward.



But don't have a seatback reclined if your vehicle is moving.

## **⚠ CAUTION:**

Sitting in a reclined position when your vehicle is in motion can be dangerous. Even if you buckle up, your safety belts can't do their job when you're reclined like this.

The shoulder belt can't do its job because it won't be against your body. Instead, it will be in front of you. In a crash you could go into it, receiving neck or other injuries.

The lap belt can't do its job either. In a crash the belt could go up over your abdomen. The belt forces would be there, not at your pelvic bones. This could cause serious internal injuries.

For proper protection when the vehicle is in motion, have the seatback upright. Then sit well back in the seat and wear your safety belt properly.

## Head Restraints



Adjust your head restraint so that the top of the restraint is closest to the top of your head. This position reduces the chance of a neck injury in a crash.

## Rear Seats

### Split Folding Rear Seat

If the vehicle has a split folding seat, you can gain access to the interior of the vehicle through the trunk.



To do this, pull forward on the seat tab, located on the side of the rear seat, to move the rear seatback down.

To return the seatback to its original position, push it back up, making sure the seat latch locks it in place.

# Safety Belts

## Safety Belts: They Are for Everyone

This part of the manual tells you how to use safety belts properly. It also tells you some things you should not do with safety belts.

### CAUTION:

Don't let anyone ride where he or she can't wear a safety belt properly. If you are in a crash and you're not wearing a safety belt, your injuries can be much worse. You can hit things inside the vehicle or be ejected from it. You can be seriously injured or killed. In the same crash, you might not be, if you are buckled up. Always fasten your safety belt, and check that your passengers' belts are fastened properly too.

### CAUTION:

It is extremely dangerous to ride in a cargo area, inside or outside of a vehicle. In a collision, people riding in these areas are more likely to be seriously injured or killed. Do not allow people to ride in any area of your vehicle that is not equipped with seats and safety belts. Be sure everyone in your vehicle is in a seat and using a safety belt properly.



Your vehicle has a light that comes on as a reminder to buckle up. See *Safety Belt Reminder Light* on page 3-30.

In most states and in all Canadian provinces, the law says to wear safety belts. Here's why: *They work.*

You never know if you'll be in a crash. If you do have a crash, you don't know if it will be a bad one.

A few crashes are mild, and some crashes can be so serious that even buckled up, a person wouldn't survive. But most crashes are in between. In many of them, people who buckle up can survive and sometimes walk away. Without belts they could have been badly hurt or killed.

After more than 30 years of safety belts in vehicles, the facts are clear. In most crashes buckling up does matter... a lot!

## Why Safety Belts Work

When you ride in or on anything, you go as fast as it goes.

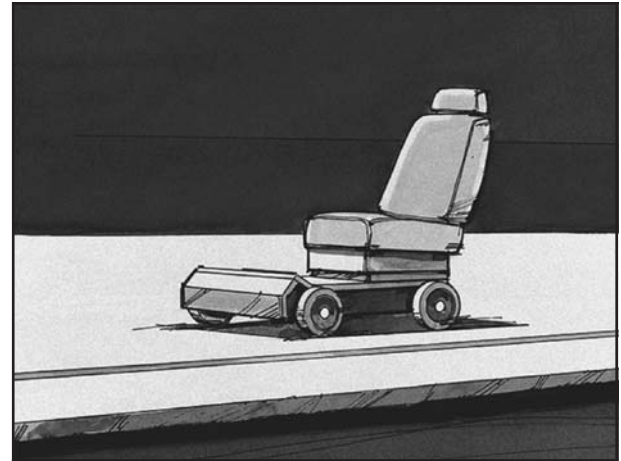

Take the simplest vehicle. Suppose it's just a seat on wheels.



Put someone on it.

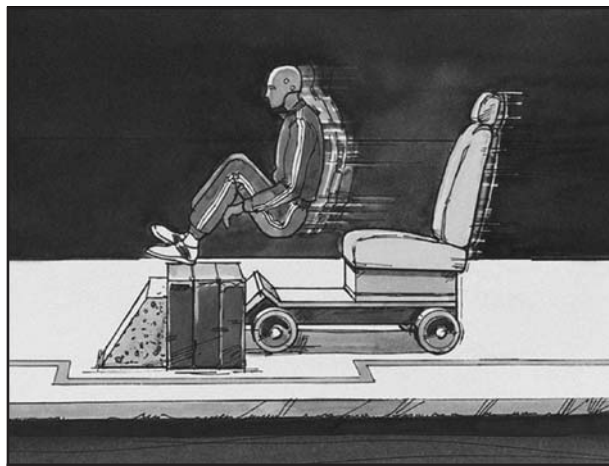

Get it up to speed. Then stop the vehicle. The rider doesn't stop.



The person keeps going until stopped by something. In a real vehicle, it could be the windshield...

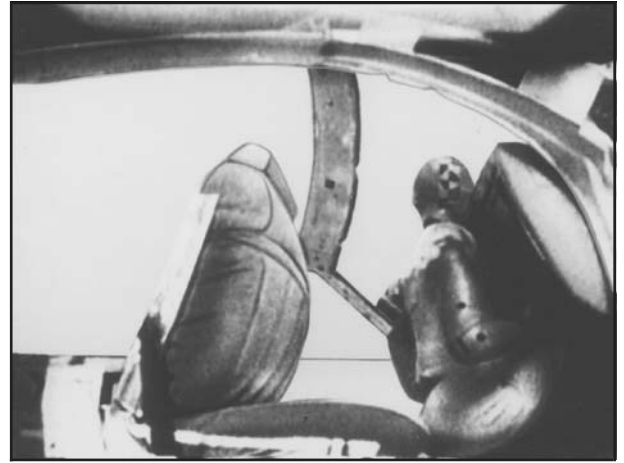

or the instrument panel...

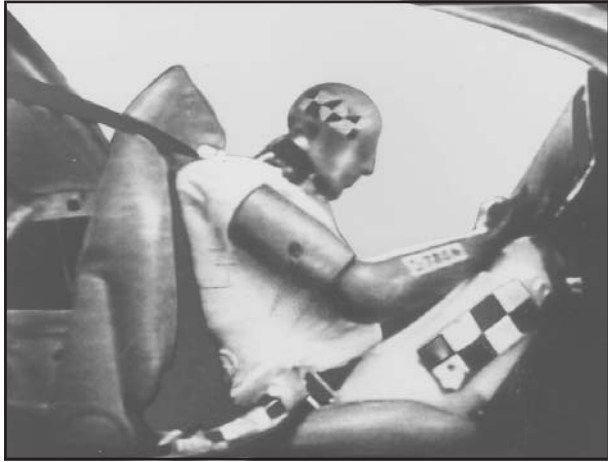

or the safety belts!

With safety belts, you slow down as the vehicle does. You get more time to stop. You stop over more distance, and your strongest bones take the forces. That's why safety belts make such good sense.

## Questions and Answers About Safety Belts

**Q:** Won't I be trapped in the vehicle after an accident if I'm wearing a safety belt?

**A:** You *could* be – whether you're wearing a safety belt or not. But you can unbuckle a safety belt, even if you're upside down. And your chance of being conscious during and after an accident, so you *can* unbuckle and get out, is *much* greater if you are belted.

**Q:** If my vehicle has air bags, why should I have to wear safety belts?

**A:** Air bags are in many vehicles today and will be in most of them in the future. But they are supplemental systems only; so they work *with* safety belts – not instead of them. Every air bag system ever offered for sale has required the use of safety belts. Even if you're in a vehicle that has air bags, you still have to buckle up to get the most protection. That's true not only in frontal collisions, but especially in side and other collisions.



**Q:** If I'm a good driver, and I never drive far from home, why should I wear safety belts?

**A:** You may be an excellent driver, but if you're in an accident – even one that isn't your fault – you and your passengers can be hurt. Being a good driver doesn't protect you from things beyond your control, such as bad drivers.

Most accidents occur within 25 miles (40 km) of home. And the greatest number of serious injuries and deaths occur at speeds of less than 40 mph (65 km/h).

Safety belts are for everyone.

## How to Wear Safety Belts Properly

This part is only for people of adult size.

Be aware that there are special things to know about safety belts and children. And there are different rules for smaller children and babies. If a child will be riding in your vehicle, see *Older Children on page 1-28* or *Infants and Young Children on page 1-30*. Follow those rules for everyone's protection.

First, you'll want to know which restraint systems your vehicle has.

We'll start with the driver position.

## Driver Position

This part describes the driver's restraint system.

### Lap-Shoulder Belt

The driver has a lap-shoulder belt. Here's how to wear it properly.

1. Close and lock the door.
2. Adjust the seat so you can sit up straight. To see how, see "Seats" in the Index.



3. Pick up the latch plate and pull the belt across you. Don't let it get twisted.

The shoulder belt may lock if you pull the belt across you very quickly. If this happens, let the belt go back slightly to unlock it. Then pull the belt across you more slowly.

4. Push the latch plate into the buckle until it clicks. Pull up on the latch plate to make sure it is secure. If the belt isn't long enough, see *Safety Belt Extender on page 1-27*.

Make sure the release button on the buckle is positioned so you would be able to unbuckle the safety belt quickly if you ever had to.



5. To make the lap part tight, pull down on the buckle end of the belt as you pull up on the shoulder belt.

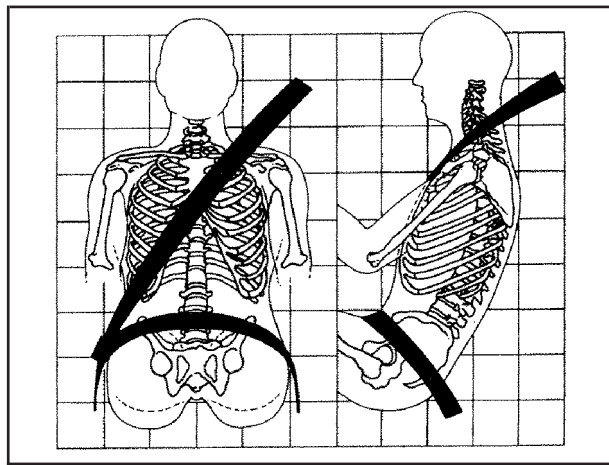

The lap part of the belt should be worn low and snug on the hips, just touching the thighs. In a crash, this applies force to the strong pelvic bones. And you'd be less likely to slide under the lap belt. If you slid under it, the belt would apply force at your abdomen. This could cause serious or even fatal injuries. The shoulder belt should go over the shoulder and across the chest. These parts of the body are best able to take belt restraining forces.

The safety belt locks if there's a sudden stop or crash, or if you pull the belt very quickly out of the retractor.

## Shoulder Belt Height Adjuster

Before you begin to drive, move the shoulder belt adjuster to the height that is right for you.

Adjust the height so that the shoulder portion of the belt is centered on your shoulder. The belt should be away from your face and neck, but not falling off your shoulder.



To move it down, squeeze the release lever and the shoulder belt guide as shown and move the height adjuster to the desired position. You can move the adjuster up just by pushing up on the shoulder belt guide. After you move the adjuster to where you want it, try to move it down without squeezing the release lever to make sure it has locked into position.

**Q:** What's wrong with this?

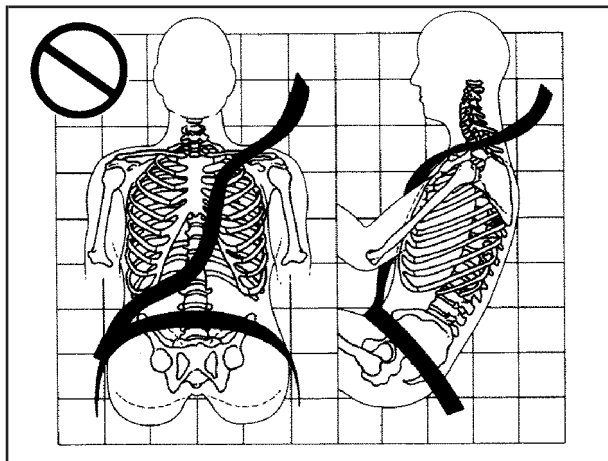

**A:** The shoulder belt is too loose. It won't give nearly as much protection this way.

**⚠ CAUTION:**

You can be seriously hurt if your shoulder belt is too loose. In a crash, you would move forward too much, which could increase injury. The shoulder belt should fit against your body.

**Q:** What's wrong with this?

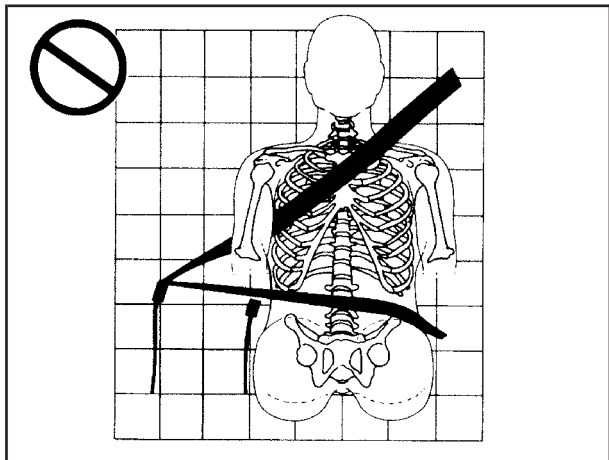

**A:** The belt is buckled in the wrong place.

**⚠ CAUTION:**

You can be seriously injured if your belt is buckled in the wrong place like this. In a crash, the belt would go up over your abdomen. The belt forces would be there, not at the pelvic bones. This could cause serious internal injuries. Always buckle your belt into the buckle nearest you.

**Q:** What's wrong with this?

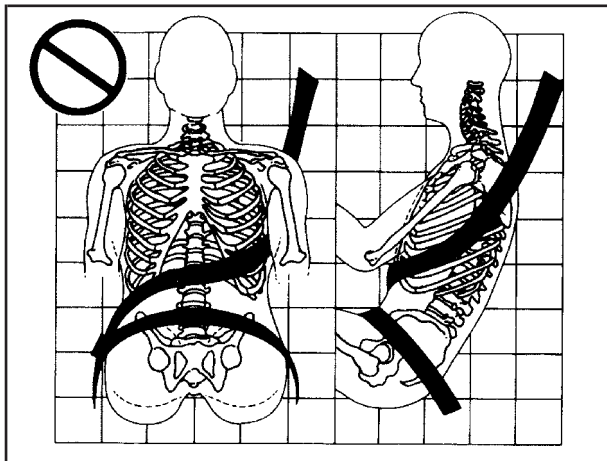

**A:** The shoulder belt is worn under the arm. It should be worn over the shoulder at all times.

**⚠ CAUTION:**

You can be seriously injured if you wear the shoulder belt under your arm. In a crash, your body would move too far forward, which would increase the chance of head and neck injury. Also, the belt would apply too much force to the ribs, which aren't as strong as shoulder bones. You could also severely injure internal organs like your liver or spleen.

**Q:** What's wrong with this?

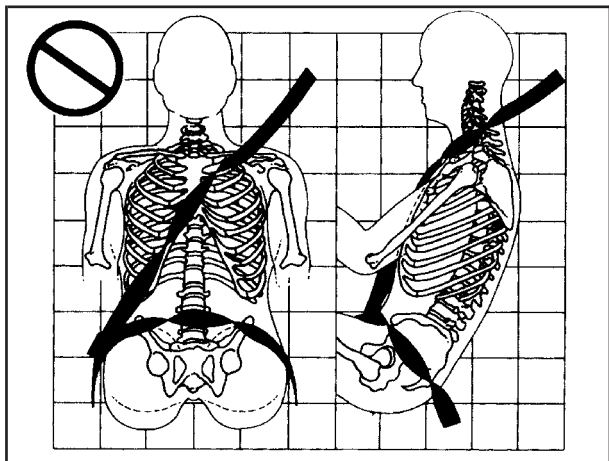

**A:** The belt is twisted across the body.

**⚠ CAUTION:**

You can be seriously injured by a twisted belt. In a crash, you wouldn't have the full width of the belt to spread impact forces. If a belt is twisted, make it straight so it can work properly, or ask your dealer to fix it.





To unlatch the belt, just push the button on the buckle. The belt should go back out of the way.

Before you close the door, be sure the belt is out of the way. If you slam the door on it, you can damage both the belt and your vehicle.

## Safety Belt Use During Pregnancy

Safety belts work for everyone, including pregnant women. Like all occupants, they are more likely to be seriously injured if they don't wear safety belts.

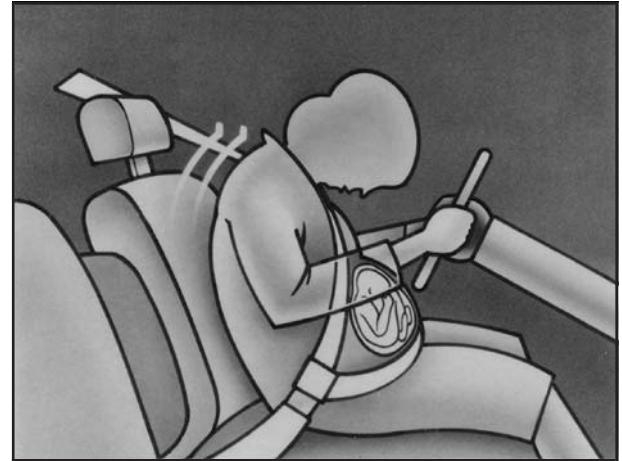

A pregnant woman should wear a lap-shoulder belt, and the lap portion should be worn as low as possible, below the rounding, throughout the pregnancy.

The best way to protect the fetus is to protect the mother. When a safety belt is worn properly, it's more likely that the fetus won't be hurt in a crash. For pregnant women, as for anyone, the key to making safety belts effective is wearing them properly.

## Right Front Passenger Position

To learn how to wear the right front passenger's safety belt properly, see *Driver Position on page 1-12*.

The right front passenger's safety belt works the same way as the driver's safety belt — except for one thing. If you ever pull the shoulder portion of the belt out all the way, you will engage the child restraint locking feature. If this happens, just let the belt go back all the way and start again.

## Center Passenger Position

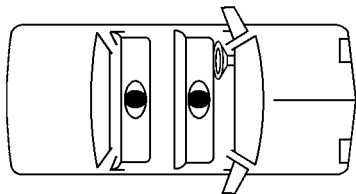

## Lap Belt

If your vehicle has front and rear bench seats, someone can sit in the center positions.



When you sit in the center seating position, you have a lap safety belt, which has no retractor. To make the belt longer, tilt the latch plate and pull it along the belt.



To make the belt shorter, pull its free end as shown until the belt is snug.

Buckle, position and release it the same way as the lap part of a lap-shoulder belt. If the belt isn't long enough, see *Safety Belt Extender* on page 1-27.

Make sure the release button on the buckle is positioned so you would be able to unbuckle the safety belt quickly if you ever had to.

## Rear Seat Passengers

It is very important for rear seat passengers to buckle up! Accident statistics show that unbelted people in the rear seat are hurt more often in crashes than those who are wearing safety belts.

Rear passengers who are not safety belted can be thrown out of the vehicle in a crash. And they can strike others in the vehicle who are wearing safety belts.

## Rear Seat Outside Passenger Positions

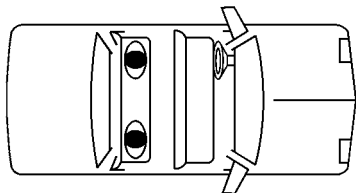

## Lap-Shoulder Belt

The positions next to the windows have lap-shoulder belts. Here is how to wear one properly.



1. Pick up the latch plate and pull the belt across you. Do not let it get twisted.

The shoulder belt may lock if you pull the belt across you very quickly. If this happens, let the belt go back slightly to unlock it. Then pull the belt across you more slowly.

2. Push the latch plate into the buckle until it clicks.

If the belt stops before it reaches the buckle, tilt the latch plate and keep pulling until you can buckle it.

Pull up on the latch plate to make sure it is secure.

When the shoulder belt is pulled out all the way, it will lock. If it does, let it go back all the way and start again. If the belt is not long enough, see *Safety Belt Extender on page 1-27*.

Make sure the release button on the buckle is positioned so you would be able to unbuckle the safety belt quickly if you ever had to.



3. To make the lap part tight, pull down on the buckle end of the belt as you pull up on the shoulder part.

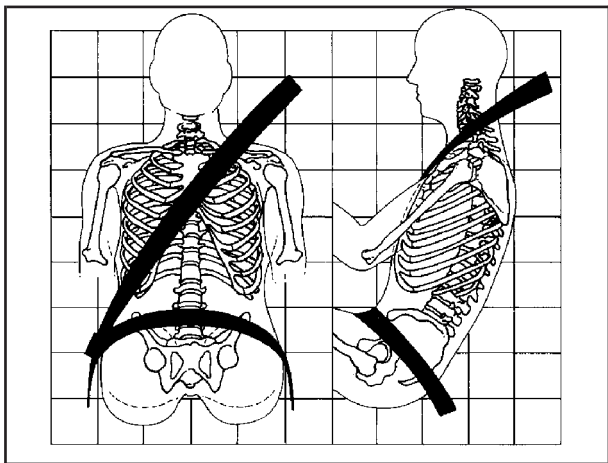

The lap part of the belt should be worn low and snug on the hips, just touching the thighs. In a crash this applies force to the strong pelvic bones. And you would be less likely to slide under the lap belt. If you slid under it, the belt would apply force at your abdomen. This could cause serious or even fatal injuries. The shoulder belt should go over the shoulder and across the chest. These parts of the body are best able to take belt restraining forces.

The safety belt locks if there is a sudden stop or a crash, or if you pull the belt very quickly out of the retractor.

## CAUTION:

You can be seriously hurt if your shoulder belt is too loose. In a crash, you would move forward too much, which could increase injury. The shoulder belt should fit against your body.



To unclatch the belt, just push the button on the buckle.

## Rear Safety Belt Comfort Guides for Children and Small Adults

Rear shoulder belt comfort guides will provide added safety belt comfort for older children who have outgrown booster seats and for small adults. When installed on a shoulder belt, the comfort guide better positions the belt away from the neck and head.

There is one guide for each outside passenger position in the rear seat. To provide added safety belt comfort for children who have outgrown child restraints and booster seats and for smaller adults, the comfort guides may be installed on the shoulder belts. Here's how to install a comfort guide and use the safety belt:



1. Pull the elastic cord out from between the edge of the seatback and the interior body to remove the guide from its storage clip.



2. Slide the guide under and past the belt. The elastic cord must be under the belt. Then, place the guide over the belt, and insert the two edges of the belt into the slots of the guide.

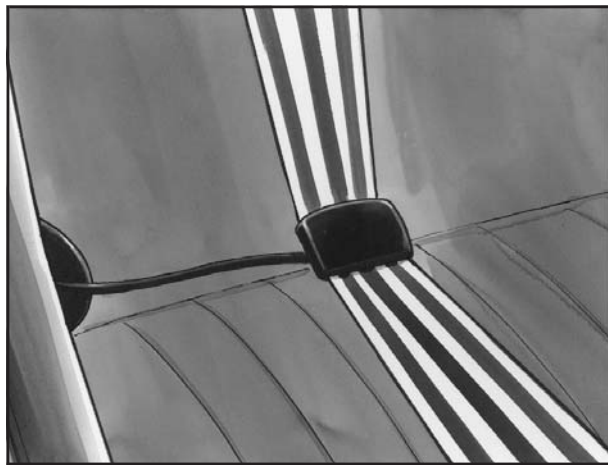

3. Be sure that the belt is not twisted and it lies flat. The elastic cord must be under the belt and the guide on top.





## Safety Belt Extender

If the vehicle's safety belt will fasten around you, you should use it.

But if a safety belt isn't long enough to fasten, your dealer will order you an extender. It's free. When you go in to order it, take the heaviest coat you will wear, so the extender will be long enough for you. The extender will be just for you, and just for the seat in your vehicle that you choose. Don't let someone else use it, and use it only for the seat it is made to fit. To wear it, just attach it to the regular safety belt.

4. Buckle, position and release the safety belt as described in *Rear Seat Passengers on page 1-22*. Make sure that the shoulder belt crosses the shoulder.

To remove and store the comfort guides, squeeze the belt edges together so that you can take them out of the guides. Pull the guide upward to expose its storage clip, and then slide the guide onto the clip. Turn the guide and clip inward and in between the seatback and the interior body, leaving only the loop of the elastic cord exposed.

# Child Restraints

## Older Children



Older children who have outgrown booster seats should wear the vehicle's safety belts.

If you have the choice, a child should sit next to a window so the child can wear a lap-shoulder belt and get the additional restraint a shoulder belt can provide.

**Q:** What is the proper way to wear safety belts?

**A:** If possible, an older child should wear a lap-shoulder belt and get the additional restraint a shoulder belt can provide. The shoulder belt should not cross the face or neck. The lap belt should fit snugly below the hips, just touching the top of the thighs. It should never be worn over the abdomen, which could cause severe or even fatal internal injuries in a crash.

Accident statistics show that children are safer if they are restrained in the rear seat.

In a crash, children who are not buckled up can strike other people who are buckled up, or can be thrown out of the vehicle. Older children need to use safety belts properly.



**⚠ CAUTION:**

**Never do this.**

**Here two children are wearing the same belt. The belt can't properly spread the impact forces. In a crash, the two children can be crushed together and seriously injured. A belt must be used by only one person at a time.**

**Q:** What if a child is wearing a lap-shoulder belt, but the child is so small that the shoulder belt is very close to the child's face or neck?

**A:** Move the child toward the center of the vehicle, but be sure that the shoulder belt still is on the child's shoulder, so that in a crash the child's upper body would have the restraint that belts provide. If the child is sitting in a rear seat outside position, see *Rear Safety Belt Comfort Guides for Children and Small Adults* on page 1-25. If the child is so small that the shoulder belt is still very close to the child's face or neck, you might want to place the child in the center seat position, the one that has only a lap belt.



**⚠ CAUTION:**

**Never do this.**

**Here a child is sitting in a seat that has a lap-shoulder belt, but the shoulder part is behind the child. If the child wears the belt in**

**CAUTION: (Continued)**

**CAUTION: (Continued)**

**this way, in a crash the child might slide under the belt. The belt's force would then be applied right on the child's abdomen. That could cause serious or fatal injuries.**

Wherever the child sits, the lap portion of the belt should be worn low and snug on the hips, just touching the child's thighs. This applies belt force to the child's pelvic bones in a crash.

## Infants and Young Children

Everyone in a vehicle needs protection! This includes infants and all other children. Neither the distance traveled nor the age and size of the traveler changes the need, for everyone, to use safety restraints. In fact, the law in every state in the United States and in every Canadian province says children up to some age must be restrained while in a vehicle.

Every time infants and young children ride in vehicles, they should have the protection provided by appropriate restraints. Young children should not use the vehicle's adult safety belts alone, unless there is no other choice. Instead, they need to use a child restraint.



**⚠ CAUTION:**

People should never hold a baby in their arms while riding in a vehicle. A baby doesn't weigh much -- until a crash. During a crash a baby will become so heavy it is not possible to hold it. For example, in a crash at only 25 mph (40 km/h), a 12-lb. (5.5 kg) baby will suddenly become a 240-lb. (110 kg) force on a person's arms. A baby should be secured in an appropriate restraint.



**⚠ CAUTION:**

Children who are up against, or very close to, any air bag when it inflates can be seriously injured or killed. Air bags plus lap-shoulder belts offer outstanding protection for adults

**CAUTION: (Continued)**

**CAUTION: (Continued)**

and older children, but not for young children and infants. Neither the vehicle's safety belt system nor its air bag system is designed for them. Young children and infants need the protection that a child restraint system can provide.

**Q:** What are the different types of add-on child restraints?

**A:** Add-on child restraints, which are purchased by the vehicle's owner, are available in four basic types. Selection of a particular restraint should take into consideration not only the child's weight, height, and age but also whether or not the restraint will be compatible with the motor vehicle in which it will be used.

For most basic types of child restraints, there are many different models available. When purchasing a child restraint, be sure it is designed to be used in a motor vehicle. If it is, the restraint will have a label saying that it meets federal motor vehicle safety standards.

The restraint manufacturer's instructions that come with the restraint state the weight and height limitations for a particular child restraint. In addition, there are many kinds of restraints available for children with special needs.

 **CAUTION:**

**Newborn infants need complete support, including support for the head and neck. This is necessary because a newborn infant's neck is weak and its head weighs so much compared with the rest of its body. In a crash, an infant in a rear-facing seat settles into the restraint, so the crash forces can be distributed across the strongest part of an infant's body, the back and shoulders. Infants always should be secured in appropriate infant restraints.**

 **CAUTION:**

**The body structure of a young child is quite unlike that of an adult or older child, for whom the safety belts are designed. A young child's hip bones are still so small that the vehicle's regular safety belt may not remain low on the hip bones, as it should. Instead, it may settle up around the child's abdomen. In a crash, the belt would apply force on a body area that's unprotected by any bony structure. This alone could cause serious or fatal injuries. Young children always should be secured in appropriate child restraints.**

## Child Restraint Systems

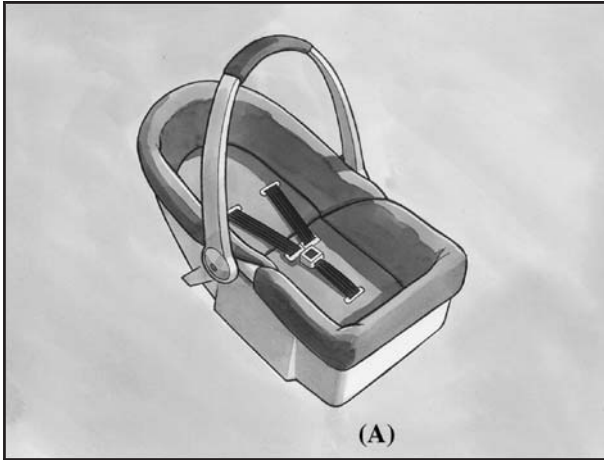

An infant car bed (A), a special bed made for use in a motor vehicle, is an infant restraint system designed to restrain or position a child on a continuous flat surface. Make sure that the infant's head rests toward the center of the vehicle.

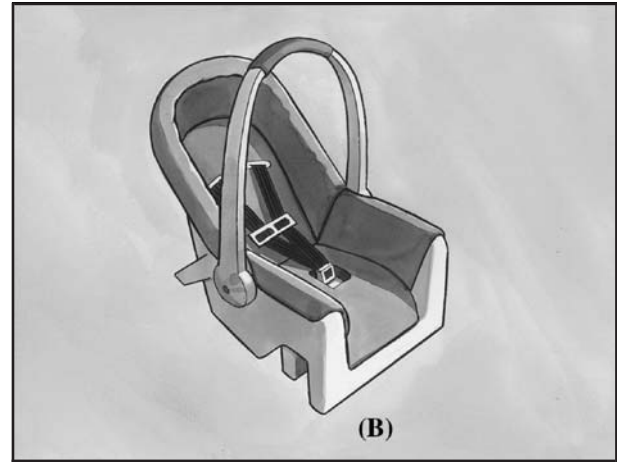

A rear-facing infant seat (B) provides restraint with the seating surface against the back of the infant. The harness system holds the infant in place and, in a crash, acts to keep the infant positioned in the restraint.



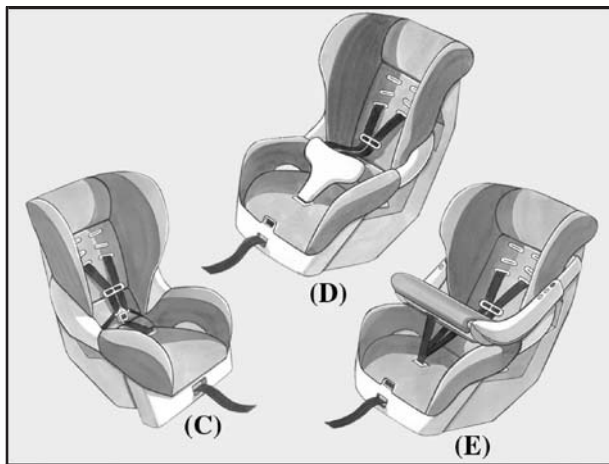

A forward-facing child seat (C-E) provides restraint for the child's body with the harness and also sometimes with surfaces such as T-shaped or shelf-like shields.

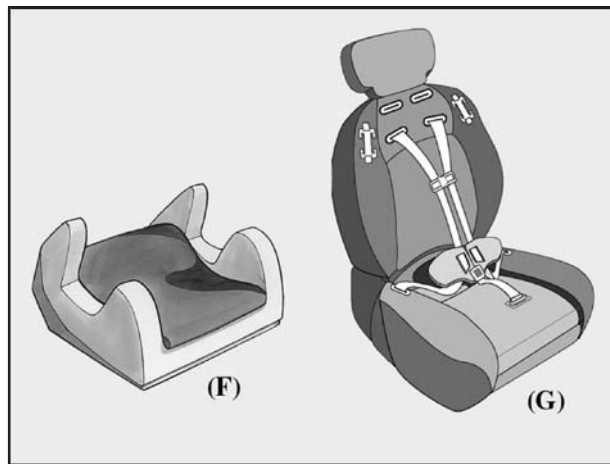

A booster seat (F-G) is a child restraint designed to improve the fit of the vehicle's safety belt system. Some booster seats have a shoulder belt positioner, and some high-back booster seats have a five-point harness. A booster seat can also help a child to see out the window.

**Q: How do child restraints work?**

**A:** A child restraint system is any device designed for use in a motor vehicle to restrain, seat, or position children. A built-in child restraint system is a permanent part of the motor vehicle. An add-on child restraint system is a portable one, which is purchased by the vehicle's owner.

For many years, add-on child restraints have used the adult belt system in the vehicle. To help reduce the chance of injury, the child also has to be secured within the restraint. The vehicle's belt system secures the add-on child restraint in the vehicle, and the add-on child restraint's harness system holds the child in place within the restraint.

One system, the three-point harness, has straps that come down over each of the infant's shoulders and buckle together at the crotch. The five-point harness system has two shoulder straps, two hip straps and a crotch strap. A shield may take the place of hip straps.

A T-shaped shield has shoulder straps that are attached to a flat pad which rests low against the child's body. A shelf- or armrest-type shield has straps that are attached to a wide, shelf-like shield that swings up or to the side.

When choosing a child restraint, be sure the child restraint is designed to be used in a vehicle. If it is, it will have a label saying that it meets federal motor vehicle safety standards.

Then follow the instructions for the restraint. You may find these instructions on the restraint itself or in a booklet, or both. These restraints use the belt system or the LATCH system in your vehicle, but the child also has to be secured within the restraint to help reduce the chance of personal injury. When securing an add-on child restraint, refer to the instructions that come with the restraint which may be on the restraint itself or in a booklet, or both, and to this manual. The child restraint instructions are important, so if they are not available, obtain a replacement copy from the manufacturer.

## Where to Put the Restraint

Accident statistics show that children are safer if they are restrained in the rear rather than the front seat. We, therefore, recommend that child restraints be secured in a rear seat, including an infant riding in a rear-facing infant seat, a child riding in a forward-facing child seat and an older child riding in a booster seat. *Never* put a rear-facing child restraint in the front passenger seat. Here is why:

### CAUTION:

**A child in a rear-facing child restraint can be seriously injured or killed if the right front passenger's air bag inflates. This is because the back of the rear-facing child restraint would be very close to the inflating air bag. Always secure a rear-facing child restraint in a rear seat.**

**If you secure a forward-facing child restraint in the right front seat, always move the front passenger seat as far back as it will go. It is better to secure the child restraint in a rear seat.**

### CAUTION:

**A child in a child restraint in the center front seat can be badly injured or killed by the right front passenger's air bag if it inflates. Never secure a child restraint in the center front seat. It is always better to secure a child restraint in the rear seat.**

**If you secure a forward-facing child restraint in the right front passenger seat, always move the front passenger seat as far back as it will go. It is better to secure the child restraint in a rear seat.**

Wherever you install it, be sure to secure the child restraint properly.

Keep in mind that an unsecured child restraint can move around in a collision or sudden stop and injure people in the vehicle. Be sure to properly secure any child restraint in your vehicle – even when no child is in it.

## Top Strap

Some child restraints have a top strap, or “top tether.” It can help restrain the child restraint during a collision. For it to work, a top strap must be properly anchored to the vehicle. Some top strap-equipped child restraints are designed for use with or without the top strap being anchored. Others require the top strap always to be anchored. Be sure to read and follow the instructions for your child restraint. If yours requires that the top strap be anchored, don’t use the restraint unless it is anchored properly.

If the child restraint does not have a top strap, one can be obtained, in kit form, for many child restraints. Ask the child restraint manufacturer whether or not a kit is available.

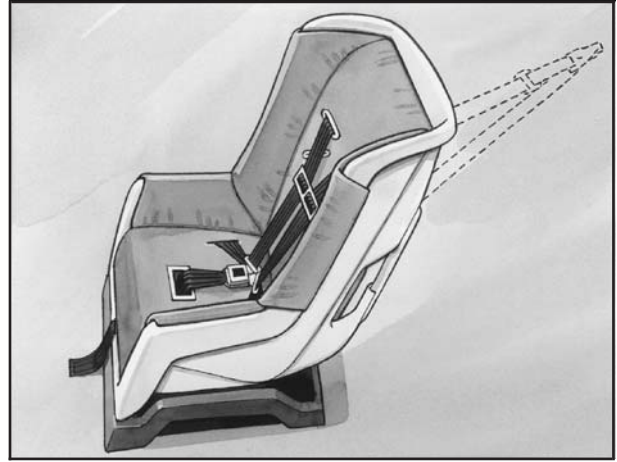

In Canada, the law requires that forward-facing child restraints have a top strap, and that the strap be anchored. In the United States, some child restraints also have a top strap. If your child restraint has a top strap, it should be anchored.

Anchor the top strap to an anchor point specified in *Top Strap Anchor Location* on page 1-39. Be sure to use an anchor point located on the same side of the vehicle as the seating position where the child restraint will be placed.

**⚠ CAUTION:**

Each top tether bracket is designed to anchor only one child restraint. Attaching more than one child restraint to a single bracket could cause the anchor to come loose or even break during a crash. A child or others could be injured if this happens. To help prevent injury to people and damage to your vehicle, attach only one child restraint per bracket.

Once you have the top strap anchored, you'll be ready to secure the child restraint itself. Tighten the top strap when and as the child restraint manufacturer's instructions say.

## Top Strap Anchor Location

The vehicle has top strap anchors installed for the rear seating positions.

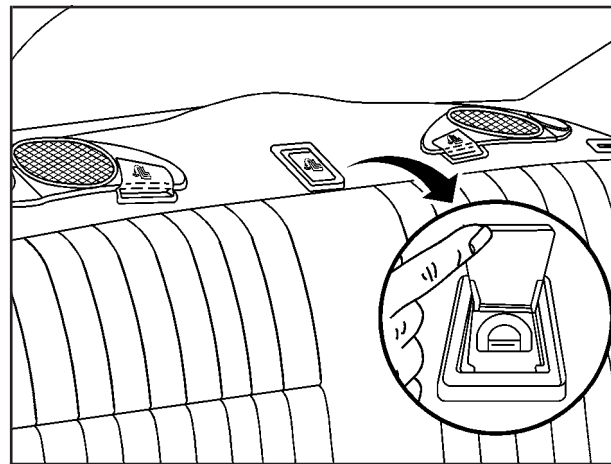

They are located under trim covers on the rear seatback filler panel.

Do not use a child restraint with a top strap in the right front passenger's position because there is no place to anchor the top strap.

If your child restraint is equipped with the LATCH system, see "Lower Anchorages and Top Tethers for Children (LATCH System)" following.

## Lower Anchorages and Top Tethers for Children (LATCH System)

The vehicle has the LATCH system. You will find anchors (A) in all three rear seating positions.

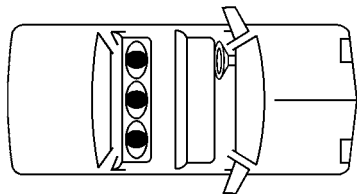

This system, designed to make installation of child restraints easier, does not use the vehicle's safety belts. Instead it uses vehicles anchors (A, B) and child restraint attachments to secure the restraints. Some restraints also use another vehicle anchor to secure a top tether strap (C).

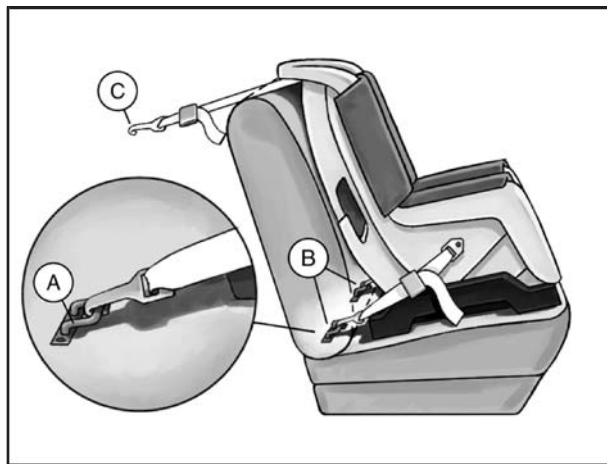

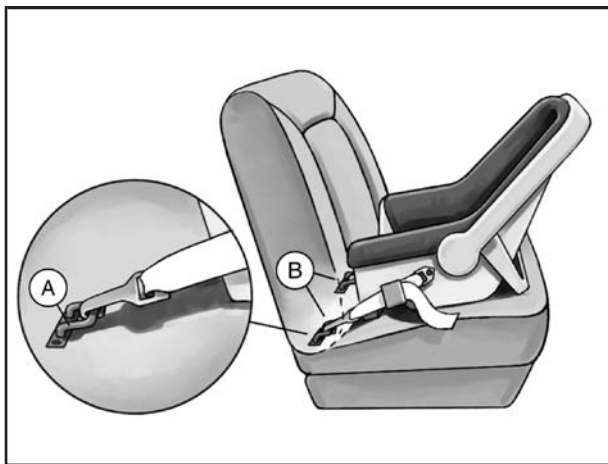

In order to use the LATCH system in your vehicle, you need a child restraint designed for that system.



To assist you in locating the lower anchors for this child restraint system, each seating position with the LATCH system has a label on the seatback at each lower anchor position.

The labels are located near the base of all three rear seating positions.

**⚠ CAUTION:**

If a LATCH-type child restraint isn't attached to its anchorage points, the restraint won't be able to protect the child correctly. In a crash, the child could be seriously injured or killed. Make sure that a LATCH-type child restraint is properly installed using the anchorage points, or use the vehicle's safety belts to secure the restraint. See "Securing a Child Restraint Designed for the LATCH System" or "Securing a Child Restraint in a Rear Seat Position" in the Index for information on how to secure a child restraint in your vehicle.

## Securing a Child Restraint Designed for the LATCH System (Rear)

1. Find the LATCH anchorages for the seating position you want to use, where the bottom of the seatback meets the back of the seat cushion.
2. Put the child restraint on the seat.
3. Attach and tighten the LATCH attachments on the child restraint to the LATCH anchorages in the vehicle. The child restraint instructions will show you how.
4. If the child restraint is forward-facing, attach and tighten the top tether to the top tether anchorage. The child restraint instructions will show you how. Also see *Top Strap on page 1-38*.
5. Push and pull the child restraint in different directions to be sure it is secure.

To remove the child restraint, simply unhook the top tether from the top tether anchorage and then disconnect the LATCH attachments from the LATCH anchorages.

## Securing a Child Restraint in a Rear Outside Seat Position

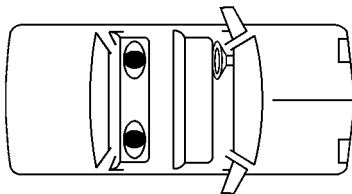

If your child restraint is equipped with the LATCH system, see *Lower Anchorages and Top Tethers for Children (LATCH System) on page 1-40*. See *Top Strap on page 1-38* if the child restraint has one.

If your child restraint does not have the LATCH system, you will be using the lap-shoulder belt to secure the child restraint in this position. Be sure to follow the instructions that came with the child restraint. Secure the child in the child restraint when and as the instructions say.

1. Put the restraint on the seat.
2. Pick up the latch plate, and run the lap and shoulder portions of the vehicle's safety belt through or around the restraint. The child restraint instructions will show you how.  
Tilt the latch plate to adjust the belt if needed.





3. Buckle the belt. Make sure the release button is positioned so you would be able to unbuckle the safety belt quickly if you ever had to.



4. Pull the rest of the shoulder belt all the way out of the retractor to set the lock.



To remove the child restraint, just unbuckle the vehicle's safety belt and let it go back all the way. The safety belt will move freely again and be ready to work for an adult or larger child passenger.

## Securing a Child Restraint in a Center Rear Seat Position

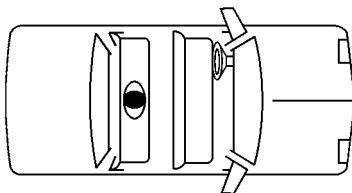

If your child restraint is equipped with the latch system, see *Lower Anchorages and Top Tethers for Children (LATCH System)* on page 1-40. See *Top Strap* on page 1-38 if the child restraint has one.

If your child restraint does not have the LATCH system, you'll be using the lap belt to secure the child restraint in this position.

Be sure to follow the instructions that came with the child restraint. Secure the child restraint when and as the instructions say.

5. To tighten the belt, feed the shoulder belt back into the retractor while you push down on the child restraint. If you are using a forward-facing child restraint, you may find it helpful to use your knee to push down on the child restraint as you tighten the belt.
6. Push and pull the child restraint in different directions to be sure it is secure.

**⚠ CAUTION:**

A child in a child restraint in the center front seat can be badly injured or killed by the right front passenger's air bag if it inflates. **Never secure a child restraint in the center front seat. It is always better to secure a child restraint in the rear seat.**

**If you secure a forward-facing child restraint in the right front passenger seat, always move the front passenger seat as far back as it will go. It is better to secure the child restraint in a rear seat.**



1. Make the belt as long as possible by tilting the latch plate and pulling it along the belt.
2. Put the restraint on the seat.
3. Run the vehicle's safety belt through or around the restraint. The child restraint instructions will show you how.



4. Buckle the belt. Make sure the release button is positioned so you would be able to unbuckle the safety belt quickly if you ever had to.
5. To tighten the belt, pull its free end while you push down on the child restraint. If you're using a forward-facing child restraint, you may find it helpful to use your knee to push the child restraint as you tighten the belt.
6. Push and pull the child restraint in different directions to be sure it is secure.

To remove the child restraint, just unbuckle the vehicle's safety belt. It will be ready to work for an adult or larger child passenger.

## Securing a Child Restraint in the Right Front Seat Position

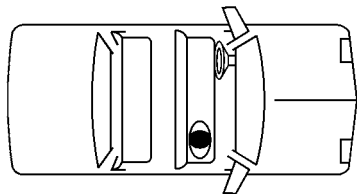

If your child restraint is equipped with the LATCH system, see *Lower Anchorages and Top Tethers for Children (LATCH System)* on page 1-40. See *Top Strap* on page 1-38 if the child restraint has one.

Your vehicle has a right front passenger air bag. *Never* put a rear-facing child restraint in this seat. Here is why:

### CAUTION:

A child in a rear-facing child restraint can be seriously injured or killed if the right front passenger's air bag inflates. This is because the back of the rear-facing child restraint would be very close to the inflating air bag. Always secure a rear-facing child restraint in a rear seat.

A rear seat is a safer place to secure a forward-facing child restraint. If you need to secure a forward-facing child restraint in the right front seat, you will be using the lap-shoulder belt to secure the child restraint. Be sure to follow the instructions that came with the child restraint. Secure the child in the child restraint when and as the instructions say.

1. Because your vehicle has a right front passenger air bag, always move the seat as far back as it will go before securing a forward-facing child restraint. See "Seats" in the Index.
2. Put the restraint on the seat.

3. Pick up the latch plate, and run the lap and shoulder portions of the vehicle's safety belt through or around the restraint. The child restraint instructions will show you how.

Tilt the latch plate to adjust the belt if needed.



4. Buckle the belt. Make sure the release button is positioned so you would be able to unbuckle the safety belt quickly if you ever had to.



5. Pull the rest of the shoulder belt all the way out of the retractor to set the lock.



6. To tighten the belt, feed the shoulder belt back into the retractor while you push down on the child restraint. You may find it helpful to use your knee to push down on the child restraint as you tighten the belt.
7. Push and pull the child restraint in different directions to be sure it is secure.

To remove the child restraint, just unbuckle the vehicle's safety belt and let it go back all the way. The safety belt will move freely again and be ready to work for an adult or larger child passenger.

## Air Bag Systems

This part explains the frontal and side impact air bag systems.

Your vehicle has air bags – a frontal air bag for the driver and another frontal air bag for the right front passenger. Your vehicle may also have a side impact air bag for the driver.



If your vehicle has a side impact air bag for the driver it will say AIR BAG on the air bag covering on the side of the driver's seatback closest to the door.

Frontal air bags are designed to help reduce the risk of injury from the force of an inflating frontal air bag. But these air bags must inflate very quickly to do their job and comply with federal regulations.

Here are the most important things to know about the air bag systems:

 **CAUTION:**

You can be severely injured or killed in a crash if you aren't wearing your safety belt, even if you have air bags. Wearing your safety belt during a crash helps reduce your chance of hitting things inside the vehicle or being ejected from it. Air bags are designed to work with safety belts but don't replace them.

Frontal air bags for the driver and right front passenger are designed to deploy only in moderate to severe frontal and near frontal crashes. They aren't designed to inflate at all in rollover, rear or low-speed frontal crashes, or in many side crashes. And, for some unrestrained occupants, frontal air bags may provide less protection in frontal crashes than more forceful air bags have provided in the past.

**CAUTION: (Continued)**

**CAUTION: (Continued)**

The side impact air bag for the driver is designed to inflate only in moderate to severe crashes where something hits the driver's side of your vehicle. It isn't designed to inflate in frontal, in rollover or in rear crashes.

Everyone in your vehicle should wear a safety belt properly, whether or not there's an air bag for that person.

 **CAUTION:**

Both frontal and side impact air bags inflate with great force, faster than the blink of an eye. If you're too close to an inflating air bag, as you would be if you were leaning forward, it could seriously injure you. Safety belts help keep you in position for air bag inflation before and during a crash.

**CAUTION: (Continued)**



**CAUTION: (Continued)**

Always wear your safety belt, even with frontal air bags. The driver should sit as far back as possible while still maintaining control of the vehicle, and should not lean on the door.

**⚠ CAUTION:**

Anyone who is up against, or very close to, any air bag when it inflates can be seriously injured or killed. Air bags plus lap-shoulder belts offer the best protection for adults, but not for young children and infants. Neither the vehicle's safety belt system nor its air bag system is designed for them.

**CAUTION: (Continued)**

**CAUTION: (Continued)**

Young children and infants need the protection that a child restraint system can provide. Always secure children properly in your vehicle. To read how, see the part of this manual called "Older Children" or "Infants and Young Children."

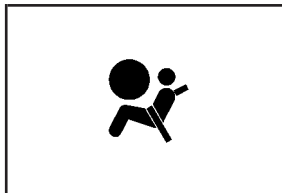

There is an air bag readiness light on the instrument panel, which shows the air bag symbol.

The system checks the air bag electrical system for malfunctions. The light tells you if there is an electrical problem. See *Air Bag Readiness Light* on page 3-30 for more information.

## Where Are the Air Bags?



The driver's frontal air bag is in the middle of the steering wheel.



The right front passenger's frontal air bag is in the instrument panel on the passenger's side.



If your vehicle has one, the driver's side impact air bag is in the side of the driver's seatback closest to the door.

**⚠ CAUTION:**

If something is between an occupant and an air bag, the bag might not inflate properly or it might force the object into that person causing severe injury or even death. The path of an inflating air bag must be kept clear. Don't put anything between an occupant and an air bag, and don't attach or put anything on the steering wheel hub or on or near any other air bag covering. Don't let seat covers block the inflation path of a side impact air bag.

## When Should an Air Bag Inflate?

The driver's and right front passenger's frontal air bags are designed to inflate in moderate to severe frontal or near-frontal crashes. But they are designed to inflate only if the impact speed is above the system's designed "threshold level."

If the front of your vehicle goes straight into a wall that does not move or deform, the threshold level is about 12 to 18 mph (19 to 29 km/h). The threshold level can vary, however, with specific vehicle design, so that it can be somewhat above or below this range.

If your vehicle strikes something that will move or deform, such as a parked car, the threshold level will be higher. The driver's and right front passenger's frontal air bags are not designed to inflate in rollovers, rear impacts, or in many side impacts because inflation would not help the occupant.

Your vehicle may or may not have a driver's side impact air bag. See *Air Bag Systems on page 1-49*. A driver's side impact air bag is designed to inflate in moderate to severe side crashes involving the driver's door. A side impact air bag will inflate if the crash severity is above the system's designed "threshold level." The threshold level can vary with specific vehicle design. A driver's side impact air bag is not designed to inflate in frontal or near-frontal impacts, rollovers or rear impacts, because inflation would not help the occupant.

In any particular crash, no one can say whether an air bag should have inflated simply because of the damage to a vehicle or because of what the repair costs were. For frontal air bags, inflation is determined by the angle of the impact and how quickly the vehicle slows down in frontal and near-frontal impacts. For side impact air bags, inflation is determined by the location and severity of the impact.

## What Makes an Air Bag Inflate?

In an impact of sufficient severity, the air bag sensing system detects that the vehicle is in a crash. For both the frontal and side impact air bags, the sensing system triggers a release of gas from the inflator, which inflates the air bag. The inflator, air bag and related hardware are all part of the air bag modules. Frontal air bag modules are located inside the steering wheel and instrument panel. For vehicles with a driver's side impact air bag, the air bag modules are located in the seatback closest to the driver's door.

## How Does an Air Bag Restrain?

In moderate to severe frontal or near frontal collisions, even belted occupants can contact the steering wheel or the instrument panel. In moderate to severe side collisions, even belted occupants can contact the inside of the vehicle. The air bag supplements the protection provided by safety belts. Air bags distribute the force of the impact more evenly over the occupant's upper body, stopping the occupant more gradually. But the frontal air bags would not help you in many types of collisions, including rollovers, rear impacts, and many side impacts, primarily because an occupant's motion is not toward the air bag. A side impact air bag would not help you in many types of collisions, including frontal or near frontal collisions, rollovers, and rear impacts, primarily because an occupant's motion is not toward that air bag. Air bags should never be regarded as anything more than a supplement to safety belts, and then only in moderate to severe frontal or near-frontal collisions for the driver's and right front passenger's frontal air bags, and only in moderate to severe side collisions for vehicles with a driver's side impact air bag.

## What Will You See After an Air Bag Inflates?

After the air bag inflates, it quickly deflates, so quickly that some people may not even realize the air bag inflated. Some components of the air bag module – the steering wheel hub for the driver's air bag, the instrument panel for the right front passenger's bag, the side of the seatback closest to the door for the driver's side impact air bag – will be hot for a short time. The parts of the bag that come into contact with you may be warm, but not too hot to touch. There will be some smoke and dust coming from the vents in the deflated air bags. Air bag inflation does not prevent the driver from seeing or being able to steer the vehicle, nor does it stop people from leaving the vehicle.

### CAUTION:

**When an air bag inflates, there is dust in the air. This dust could cause breathing problems for people with a history of asthma or other breathing trouble. To avoid this, everyone in the vehicle should get out as soon as it is safe to do so. If you have breathing problems but can't get out of the vehicle after an air bag inflates, then get fresh air by opening a window or a door. If you experience breathing problems following an air bag deployment, you should seek medical attention.**

In many crashes severe enough to inflate an air bag, windshields are broken by vehicle deformation. Additional windshield breakage may also occur from the right front passenger air bag.

- Air bags are designed to inflate only once. After an air bag inflates, you will need some new parts for your air bag system. If you do not get them, the air bag system will not be there to help protect you in another crash. A new system will include air bag modules and possibly other parts. The service manual for your vehicle covers the need to replace other parts.
- Your vehicle is equipped with a crash sensing and diagnostic module, which records information about the frontal air bag system. The module records information about the readiness of the system, when the system commands air bag inflation and driver's safety belt usage at deployment. The module also records speed, engine rpm, brake and throttle data.

- Let only qualified technicians work on your air bag systems. Improper service can mean that an air bag system will not work properly. See your dealer for service.

***Notice:*** If you damage the covering for the driver's or the right front passenger's air bag, or the air bag covering on the driver's seatback, the bag may not work properly. You may have to replace the air bag module in the steering wheel, both the air bag module and the instrument panel for the right front passenger's air bag, or the air bag module and seatback for the driver's side impact air bag. Do not open or break the air bag coverings.

## Servicing Your Air Bag-Equipped Vehicle

Air bags affect how your vehicle should be serviced. There are parts of the air bag systems in several places around your vehicle. Your dealer and the service manual have information about servicing your vehicle and the air bag systems. To purchase a service manual, see *Service Publications Ordering Information on page 7-11*.

### CAUTION:

**For up to 10 seconds after the ignition key is turned off and the battery is disconnected, an air bag can still inflate during improper service. You can be injured if you are close to an air bag when it inflates. Avoid yellow connectors. They are probably part of the air bag system. Be sure to follow proper service procedures, and make sure the person performing work for you is qualified to do so.**

The air bag systems do not need regular maintenance.

## Restraint System Check

### Checking Your Restraint Systems

Now and then, make sure the safety belt reminder light and all your belts, buckles, latch plates, retractors and anchorages are working properly. Look for any other loose or damaged safety belt system parts. If you see anything that might keep a safety belt system from doing its job, have it repaired.

Torn or frayed safety belts may not protect you in a crash. They can rip apart under impact forces. If a belt is torn or frayed, get a new one right away.

Also look for any opened or broken air bag covers, and have them repaired or replaced. (The air bag system does not need regular maintenance.)



## Replacing Restraint System Parts After a Crash

### CAUTION:

**A crash can damage the restraint systems in your vehicle. A damaged restraint system may not properly protect the person using it, resulting in serious injury or even death in a crash. To help make sure your restraint systems are working properly after a crash, have them inspected and any necessary replacements made as soon as possible.**

If you've had a crash, do you need new belts or LATCH system parts?

After a very minor collision, nothing may be necessary. But if the belts were stretched, as they would be if worn during a more severe crash, then you need new parts.

If the LATCH system was being used during a more severe crash, you may need new LATCH system parts.

If belts are cut or damaged, replace them. Collision damage also may mean you will need to have LATCH system, safety belt or seat parts repaired or replaced. New parts and repairs may be necessary even if the belt or LATCH system wasn't being used at the time of the collision.

If an air bag inflates, you'll need to replace air bag system parts. See the part on the air bag system earlier in this section.



# NOTES

---

---

---

---

---

---

---

---

---

---

---

---

---

---

---

---

---

---

---

---

---

---

---

---

## Section 2 Features and Controls

---

<b>Keys</b> .....	2-2	Automatic Transaxle Operation .....	2-22
Remote Keyless Entry System .....	2-4	Parking Brake .....	2-25
Remote Keyless Entry System Operation .....	2-5	Shifting Into Park (P) .....	2-26
<b>Doors and Locks</b> .....	2-10	Shifting Out of Park (P) .....	2-28
Door Locks .....	2-10	Parking Over Things That Burn .....	2-29
Power Door Locks .....	2-11	Engine Exhaust .....	2-29
Programmable Automatic Door Locks .....	2-11	Running Your Engine While You Are Parked .....	2-30
Lockout Protection .....	2-12	<b>Mirrors</b> .....	2-31
Leaving Your Vehicle .....	2-12	Manual Rearview Mirror .....	2-31
Trunk .....	2-13	Manual Rearview Mirror with OnStar® .....	2-31
<b>Windows</b> .....	2-15	Outside Power Mirrors .....	2-32
Power Windows .....	2-16	Outside Convex Mirror .....	2-32
Sun Visors .....	2-17	<b>OnStar® System</b> .....	2-33
<b>Theft-Deterrent Systems</b> .....	2-17	<b>Storage Areas</b> .....	2-34
PASS-Key® II .....	2-17	Glove Box .....	2-34
<b>Starting and Operating Your Vehicle</b> .....	2-18	Front Storage Area .....	2-34
New Vehicle Break-In .....	2-18	Center Console Storage Area .....	2-35
Ignition Positions .....	2-19	Convenience Net .....	2-35
Starting Your Engine .....	2-20	<b>Sunroof</b> .....	2-36
Engine Coolant Heater .....	2-21		

## Keys

### CAUTION:

Leaving children in a vehicle with the ignition key is dangerous for many reasons. They could operate the power windows or other controls or even make the vehicle move. The children or others could be badly injured or even killed. Do not leave the keys in a vehicle with children.



The vehicle has two keys that are used for separate functions.

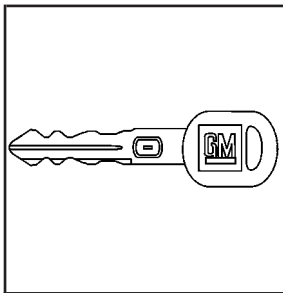

The ignition key is for the ignition only.

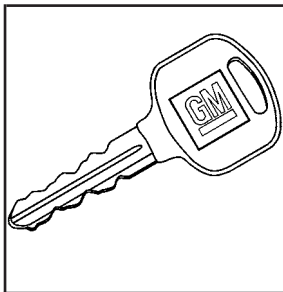

The door key is for the driver door and all other locks.

The keys have unique codes embedded in them to help prevent theft. See *PASS-Key<sup>®</sup> II* on page 2-17 for more information.

Your dealer or Buick Roadside Assistance can provide the correct codes for the keys. Contact your dealer or see *Roadside Assistance Program* on page 7-5 for more information.

**Notice:** If you ever lock your keys in your vehicle, you may have to damage the vehicle to get in. Be sure you have spare keys.

If the vehicle has the OnStar<sup>®</sup> system with an active subscription, and the keys were locked inside, a command could be sent by the OnStar<sup>®</sup> system to unlock the vehicle. See *OnStar<sup>®</sup> System* on page 2-33 for more information.

## Remote Keyless Entry System

Your keyless entry system operates on a radio frequency subject to Federal Communications Commission (FCC) Rules and with Industry Canada.

This device complies with Part 15 of the FCC Rules. Operation is subject to the following two conditions:

1. This device may not cause interference, and
2. This device must accept any interference received, including interference that may cause undesired operation of the device.

This device complies with RSS-210 of Industry Canada. Operation is subject to the following two conditions:

1. This device may not cause interference, and
2. This device must accept any interference received, including interference that may cause undesired operation of the device.

Changes or modifications to this system by other than an authorized service facility could void authorization to use this equipment.

At times you may notice a decrease in range. This is normal for any remote keyless entry system. If the transmitter does not work or if you have to stand closer to your vehicle for the transmitter to work, try this:

- Check the distance. You may be too far from your vehicle. You may need to stand closer during rainy or snowy weather.
- Check the location. Other vehicles or objects may be blocking the signal. Take a few steps to the left or right, hold the transmitter higher, and try again.
- Check to determine if battery replacement is necessary. See “Battery Replacement” under *Remote Keyless Entry System Operation on page 2-5*.
- If you are still having trouble, see your dealer or a qualified technician for service.

## Remote Keyless Entry System Operation

The remote keyless entry transmitter lets you lock and unlock the vehicle's doors or release its trunk lid from about 3 feet (1 m) and up to 30 feet (9 m) away.

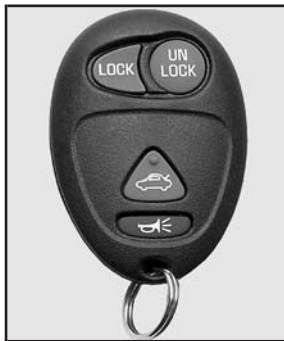

**LOCK:** Press the LOCK button to lock all the doors.

**UNLOCK:** Press the UNLOCK button to unlock the driver door and turn on the interior lamps. See "Illumination on Remote Activation" later in this section for more details. Press UNLOCK again to unlock the passenger doors.

 **(Trunk Release):** To release the trunk lid, press this button. The trunk will only unlock if the transaxle is in PARK (P).

 **(Remote Alarm):** Press this button to activate an alarm. The ignition must be in OFF or ACCESSORY for the remote alarm to work. When the remote alarm button is pressed, the headlamps will flash, the horn will sound repeatedly, and the interior lamps will turn on. The alarms will turn off when one of the following occurs:

- The remote alarm button on the remote keyless entry transmitter is pressed a second time.
- The ignition is moved to RUN.
- The alarms have been on for about two minutes.

## Security Feedback

The remote keyless entry transmitter can be programmed so that when the LOCK or UNLOCK button is pressed, the vehicle gives visual or audible feedback confirmation. Each lock or unlock command verification must be programmed individually. The ignition must be OFF for this feature to work.

### Programming the LOCK Command

One of four modes can be selected to confirm a LOCK command.

**Mode 1 (One Chime):** No Verification

**Mode 2 (Two Chimes):** Horn Chirp

**Mode 3 (Three Chimes):** Headlamps Flash

**Mode 4 (Four Chimes):** Horn Chirp and Headlamps Flash

The vehicle was originally programmed to Mode 3. The mode may have been changed since then. To determine the current lock mode mode, or to change the lock mode, do the following:

1. Close all doors and turn the ignition key to RUN.
2. Press and hold the power door lock switch in the LOCK position.

3. While holding the power door lock switch in the LOCK position, press and release the remote keyless entry transmitter LOCK button.

A series of one to four chimes will sound, corresponding to the current lock mode.

4. Press the remote keyless entry transmitter LOCK button to advance to the next lock mode.

If cycled beyond Mode 4, the vehicle will enter Mode 1.

5. To set a mode, release the power door LOCK switch after the chime sequence of the desired mode is heard.

Disconnecting the vehicle's battery for up to a year will not affect the programmed mode.

### Programming the UNLOCK Command

One of four modes can be selected to confirm an UNLOCK command.

**Mode 1 (One Chime):** No Verification

**Mode 2 (Two Chimes):** Horn Chirp

**Mode 3 (Three Chimes):** Headlamps Flash

**Mode 4 (Four Chimes):** Horn Chirp and Headlamps Flash



The vehicle was originally programmed to Mode 3. The mode may have been changed since then. To determine the current unlock mode mode, or to change the unlock mode, do the following:

1. Close all doors and turn the ignition key to RUN.
2. Press and hold the power door lock switch in the unlock position.
3. While holding the power door lock switch in the unlock position, press and release the remote keyless entry transmitter UNLOCK button.  
A series of one to four chimes will sound, corresponding to the current unlock mode.
4. Press the remote keyless entry transmitter UNLOCK button to advance to the next unlock mode.  
If cycled beyond Mode 4, the vehicle will enter Mode 1.
5. To set a mode, release the power door unlock switch after the chime sequence of the desired mode is heard.

Disconnecting the vehicle's battery for up to a year will not affect the programmed mode.

## Delayed Locking

This feature can be turned on or off. It delays the locking of the doors for five seconds after the power door LOCK position or the LOCK button on the remote keyless entry transmitter is pressed and the last door is closed.

If a door is opened before five seconds, the delayed lock is cancelled. When all doors are closed again, delayed locking begins again.

Three chimes will sound to indicate that this feature is on. The chime will sound only when the key is not in the ignition and a door is open.

To cancel delay locking, do any of the following:

- Press the unlock portion of the power door lock switch.
- Press the UNLOCK button on the remote keyless entry transmitter.
- Press the LOCK portion of the power door lock switch a second time.
- Press the LOCK button on the remote keyless entry transmitter a second time or.
- Insert the ignition key into the ignition.

## Programming Delayed Locking

Delayed locking has two modes.

**Mode One (One Chime):** Delayed locking is turned off.

**Mode Two (Two Chimes):** Delayed locking is turned on.

1. Close the doors.
2. Move the ignition key to the RUN position.
3. Apply the regular brakes.
4. Press and hold the power door unlock switch. While holding the power door unlock switch, move the shift lever out of and back into PARK (P).

One or two chimes will sound indicating what mode the delayed locking is in.

5. Release the power door unlock switch, after one of the chime mode sequences, to set the desired mode

Disconnecting the vehicle's battery for up to one year will not affect the programmed mode.

## Illumination on Remote Activation

This feature provides interior lighting when a remote keyless entry door unlock command is received by the vehicle. The ignition must be off for this feature to work. The interior lamps will stay on until either the ignition is turned to RUN or until 40 seconds has elapsed. If a door is opened during this time, the timed lighting will be canceled, and the interior lamps will remain on. Also see "Entry Lighting" under *Interior Lamps on page 3-15* for more information.

## Matching Transmitter(s) to Your Vehicle

Each remote keyless entry transmitter is uniquely coded to prevent another transmitter from unlocking your vehicle. If a transmitter is lost or stolen, a replacement can be purchased through your dealer. Remember to bring any additional transmitters with you so they also can be re-coded to match the new transmitter. Once your dealer has coded the new transmitter, the lost transmitter cannot unlock the vehicle. The vehicle can have a maximum of four transmitters coded to it.

## Battery Replacement

The battery in the remote keyless entry transmitter should last about three years.

If the battery is weak the transmitter will not work within its normal range. It is probably time to change the battery if you have to be very close to the vehicle before the transmitter works.

**Notice:** When replacing the battery, use care not to touch any of the circuitry. Static from your body transferred to these surfaces may damage the transmitter.



To replace the battery do the following:

1. Insert a flat object like a thin coin into the slot on the back of the transmitter and pry apart the front and back.
2. Remove the old battery, but do not use a metal object to do this. Make sure the new battery is a type CR2032 or equivalent, and that the positive (+) side of the battery is facing down.
3. Snap the front and back of the transmitter together.
4. Resynchronize and test the operation of the transmitter with the vehicle.

## Resynchronization

After the battery has been changed in the remote keyless transmitter, it will need to be resynchronized. To do this, press and hold both the LOCK and UNLOCK buttons until you hear one horn chirp.

# Doors and Locks

## Door Locks

### CAUTION:

Unlocked doors can be dangerous.

- Passengers — especially children — can easily open the doors and fall out of a moving vehicle. When a door is locked, the handle will not open it. You increase the chance of being thrown out of the vehicle in a crash if the doors are not locked. So, wear safety belts properly and lock the doors whenever you drive.
- Young children who get into unlocked vehicles may be unable to get out. A child can be overcome by extreme heat and can suffer permanent injuries or even death from heat stroke. Always lock your vehicle whenever you leave it.
- Outsiders can easily enter through an unlocked door when you slow down or stop your vehicle. Locking your doors can help prevent this from happening.

There are several ways to lock and unlock the vehicle.

From the outside, use the door key or remote keyless entry transmitter. From the inside use the manual or power door locks.

To manually lock or unlock the driver's door from the outside, insert the key and turn it clockwise or counterclockwise.



To lock or unlock the doors from the inside, push the manual lock lever forward or rearward.

## Power Door Locks



The vehicle has front power door lock switches. Press the top portion of a door lock switch to unlock or the bottom portion to lock all doors.

The rear doors do not have power door lock switches.

## Programmable Automatic Door Locks

Programmable power door locks are intended to provide enhanced security and convenience by automatically locking and unlocking doors under certain conditions. The doors can be set to one of four operating modes.

**Mode 1:** Doors do not lock or unlock automatically when the transaxle is shifted out of or into PARK (P).

**Mode 2:** All doors automatically lock when the transaxle is shifted out of PARK (P), but do not unlock automatically when the transaxle is shifted into PARK (P).

**Mode 3:** All doors automatically lock when the transaxle is shifted out of PARK (P) and automatically unlock when the transaxle is shifted into PARK (P).

**Mode 4:** All doors automatically lock when the transaxle is shifted out of PARK (P) but only the driver's door automatically unlocks when the transaxle is shifted into PARK (P).

The vehicle was originally programmed to Mode 3. The mode may have been changed since then. To determine the current mode, or to change the mode, do the following:

1. Turn the ignition key to RUN.
2. Close all of the doors.
3. Apply the brakes.
4. Press and hold the power door lock switch in the lock position.
5. Move the shift lever out of and back into PARK (P) while holding the door lock switch in the LOCK position.
6. Release the door lock switch to set the desired mode.

After initially moving the shift lever out of and back into PARK (P), each additional shift cycle will advance the programming from the current mode to the next operating mode. If cycled beyond Mode 4, the vehicle will enter operating Mode 1.

Disconnecting the vehicle's battery for up to a year will not affect the programmed mode.

## Lockout Protection

This feature helps to prevent a driver from locking the keys inside of the vehicle by disabling the power door locks when the following occurs:

- A door is opened.
- The key is left in the ignition.
- A power door lock is pressed.

The lockout protection feature can be overridden by holding the power door lock switch in the lock position for more than three seconds while the key is in the ignition and any door is open.

This feature cannot guarantee that you will never be locked out of the vehicle. If the manual door lock is used or if the key is left in the vehicle, but not in the ignition, you could still be locked out of the vehicle. Always remember to take the keys with you.

## Leaving Your Vehicle

Before leaving the vehicle, take the keys, open the door, and set the locks from inside. Then get out and close the door. See "Delayed Locking" in this section for more information.

## Trunk

### CAUTION:

It can be dangerous to drive with the trunk lid open because carbon monoxide (CO) gas can come into your vehicle. You can not see or smell CO. It can cause unconsciousness and even death. If you must drive with the trunk lid open or if electrical wiring or other cable connections must pass through the seal between the body and the trunk lid:

- Make sure all other windows are shut.
- Turn the fan on your heating or cooling system to its highest speed and select the control setting that will force outside air into your vehicle. See Climate Control System in the Index.
- If you have air outlets on or under the instrument panel, open them all the way.

See *Engine Exhaust on page 2-29*.

## Trunk Lock

To unlock the trunk lid from the outside, insert the door key into the trunk lock and turn it counterclockwise. Or, with the vehicle in PARK (P), press the open trunk symbol on the remote keyless entry transmitter.

## Remote Trunk Release



Press the remote trunk release button located behind the glove box door to release the trunk lid from inside the vehicle.

The shift lever must be in PARK (P), but the key does not have to be in the ignition for the remote trunk lid release button to work.

## Trunk Assist Handle

**Notice:** Using the trunk assist handle as a tie-down or anchor point when securing items in the trunk may damage it. Use the trunk assist handle only to help you close the trunk lid.



The vehicle may have an assist handle located on the inside of the trunk lid toward the driver's side of the vehicle.

Pull down on the handle to lower the trunk lid and close the trunk. If the trunk is not properly closed, the DOOR/TRUNK ajar warning light will appear in the message center of the instrument panel cluster. See *Door/Trunk Ajar Warning Light* on page 3-42 for more information.

## Emergency Trunk Release Handle

**Notice:** Using the emergency trunk release handle as a tie-down or anchor point when securing items in the trunk may damage it. Use the emergency trunk release handle only to help you open the trunk lid.

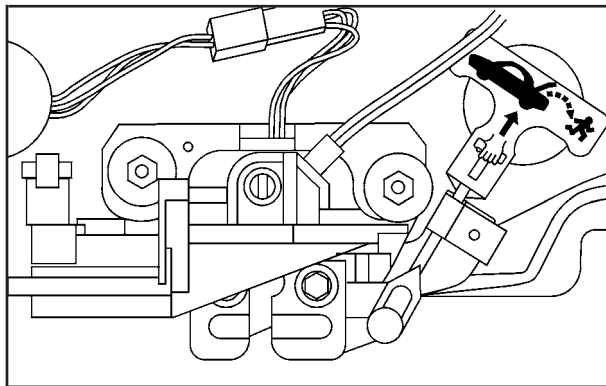

The vehicle has a glow-in-the-dark emergency trunk release handle located inside the trunk on the latch. This handle will glow following exposure to light. Pull the release handle to open the trunk from the inside.



## Windows

### CAUTION:

Leaving children in a vehicle with the windows closed is dangerous. A child can be overcome by the extreme heat and can suffer permanent injuries or even death from heat stroke. Never leave a child alone in a vehicle, especially with the windows closed in warm or hot weather.



## Power Windows

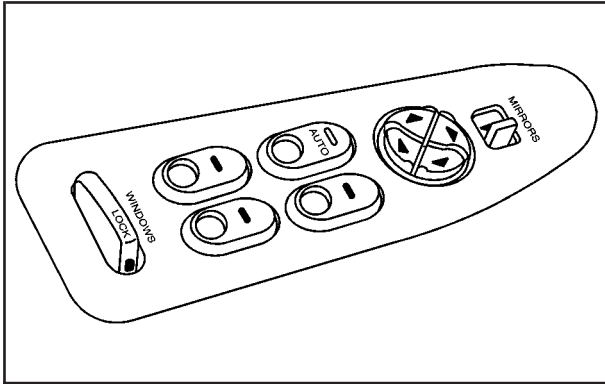

The switches on the driver's door armrest are used to control each of the windows when the ignition is in the ON position. Each passenger door has its own window switch.

## Express-Down Window

The driver's window switch has an express-down feature. This switch is labeled AUTO. Tap the switch rearward and the driver's window will open without stopping.

To stop the window while it is lowering, press forward on the switch. To raise the window, press and hold the switch forward.

## Window Lock-Out

The driver's window controls also include a lock-out switch. Press LOCK on this control to prevent passengers from using their window switches. The driver can still control all the windows with the lock on. Press the other side of the window lock-out switch to allow passengers individual control of their windows.

## Sun Visors

To block out glare, swing down the sun visors. They can also be moved to the side windows. The sun visors also have extenders that can be pulled out for added coverage.

## Visor Vanity Mirror

Open the cover on the sun visor to expose the vanity mirror.

## Lighted Visor Vanity Mirrors

If the vehicle has the lighted vanity mirrors, the lamps come on when the cover is opened.

## Theft-Deterrent Systems

Vehicle theft is big business, especially in some cities. Although your vehicle has a number of theft-deterrent features, we know that nothing we put on it can make it impossible to steal. However, there are ways you can help.

## PASS-Key® II

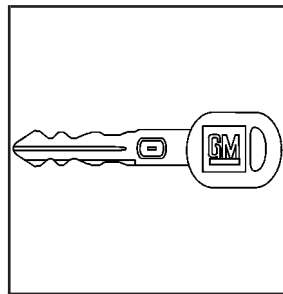

The vehicle is equipped with the PASS-Key® II (Personalized Automotive Security System) theft-deterrent system. PASS-Key® II is a passive theft-deterrent system. It works when the ignition key is inserted or removed from the ignition.

PASS-Key® II uses a resistor pellet in the ignition key that matches a decoder in the vehicle.

When the PASS-Key® II system senses that the wrong key has been inserted into the ignition, it shuts down the vehicle's starter and fuel systems. The starter will not work and fuel will not go to the engine for about three minutes. If someone tries to start the vehicle again with the wrong key, or uses another incorrect key during this time, the vehicle will not start. This discourages someone from randomly trying keys with different resistor pellets in an attempt to make a match.

The ignition key must be clean and dry before it is inserted in the ignition or the engine may not start. If the engine does not start and the SECURITY warning light on the instrument panel is flashing, the key may be dirty or wet. Turn the ignition off.

Clean and dry the key. Wait about three minutes and try again. If the vehicle still does not start, the ignition key may be faulty. Wait about three more minutes and try a spare ignition key. At this time, you may also want to check the fuse. See *Fuses and Circuit Breakers on page 5-97* for information on fuse location. If the starter will not work with the spare key, the vehicle needs service. See your dealer or a locksmith who can service the PASS-Key® II.

If a key is accidentally used that has a damaged or missing resistor pellet, the starter will not work. The SECURITY warning light on the instrument panel will then come on. But you do not have to wait three minutes before trying another ignition key.

See your dealer or a locksmith who can service the PASS-Key® II to have a new key made.

If the SECURITY warning light comes on the instrument panel while the vehicle is being driven, the engine will still be able to be started after it is turned off. The PASS-Key® II system, however, is not working properly and must be serviced by your dealer. The vehicle is not protected by the PASS-Key® II system when this happens.

If a PASS-Key® II ignition key is lost or damaged, see your dealer or a locksmith who can service PASS-Key® II to have a new key made. Also, see *Roadside Assistance Program on page 7-5* for more information.

## Starting and Operating Your Vehicle

### New Vehicle Break-In

**Notice:** Your vehicle does not need an elaborate “break-in.” But it will perform better in the long run if you follow these guidelines:

- Do not drive at any one speed — fast or slow — for the first 500 miles (805 km). Do not make full-throttle starts.
- Avoid making hard stops for the first 200 miles (322 km) or so. During this time your new brake linings are not yet broken in. Hard stops with new linings can mean premature wear and earlier replacement. Follow this breaking-in guideline every time you get new brake linings.
- Do not tow a trailer during break-in. See *Towing a Trailer on page 4-39* for more information.

## Ignition Positions

With the ignition key in the ignition, the key can be turned to five different positions:

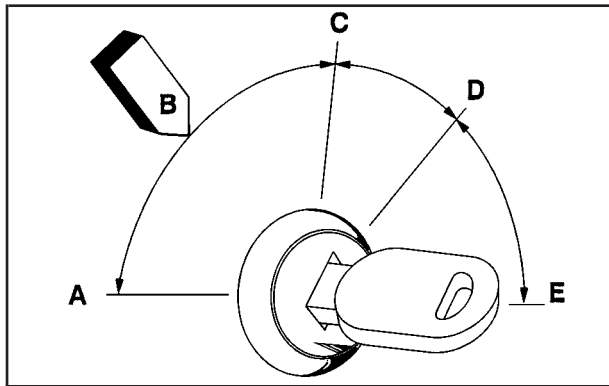

**A (ACCESSORY):** This position lets the radio and windshield wipers operate when the engine is off. To use ACCESSORY, push in the key and turn it counterclockwise. The steering wheel will stay locked.

**B (LOCK):** This is the only position in which the ignition key can be inserted or removed. This position locks the ignition, steering wheel and transaxle. It is a theft-deterrent feature.

**Notice:** If your key seems stuck in LOCK and you can not turn it, be sure you are using the correct key; if so, is it all the way in? If it is, then turn the steering wheel left and right while you turn the key hard. Turn the key only with your hand. Using a tool to force it could break the key or the ignition switch. If none of these works, then your vehicle needs service.

**C (OFF):** In this position the engine is off but the steering wheel is not locked and can still be turned. Use the OFF position if the vehicle must be pushed or towed.

**D (RUN):** This position is where the key returns to after the vehicle is started. This position displays some of the warning and indicator lights.

**E. (START):** This position starts the engine.

A warning chime will sound when the driver's door is opened if the ignition is in OFF, LOCK or ACCESSORY and the key is in the ignition.

## Retained Accessory Power (RAP)

If the vehicle has Retained Accessory Power (RAP), the power windows and audio system can continue to operate for up to 10 minutes after the ignition key is turned to OFF and before any of the doors are opened.

## Starting Your Engine

Move the shift lever to PARK (P) or NEUTRAL (N). The engine will not start in any other position – that is a safety feature. To restart the vehicle when it is already moving, use NEUTRAL (N) only.

**Notice:** Shifting into PARK (P) with the vehicle moving could damage the transaxle. Shift into PARK (P) only when your vehicle is stopped.

1. With your foot off the accelerator pedal, turn the ignition key to START. When the engine starts, let go of the key. The idle speed will go down as the engine gets warm.

**Notice:** Holding your key in START for longer than 15 seconds at a time will cause your battery to be drained much sooner. And the excessive heat can damage your starter motor. Wait about 15 seconds between each try to help avoid draining your battery or damaging your starter.

2. If the engine will not start, or starts but then stops, it could be flooded with too much gasoline. Try pushing the accelerator pedal all the way to the floor and holding it there as the key is held in START for not more than 15 seconds at a time. This clears the extra gasoline from the engine.

**Notice:** Your engine is designed to work with the electronics in your vehicle. If you add electrical parts or accessories, you could change the way the engine operates. Before adding electrical equipment, check with your dealer. If you do not, your engine might not perform properly.

## Engine Coolant Heater

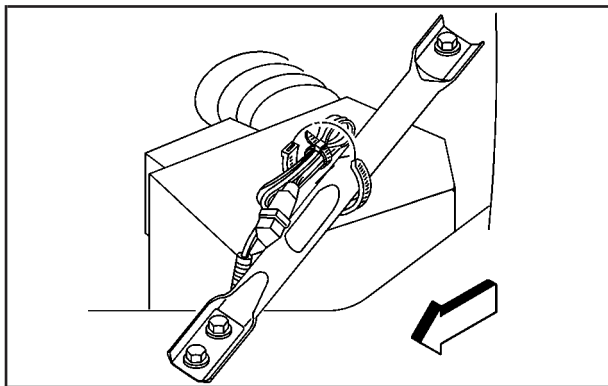

The vehicle may have this feature. In very cold weather, 0°F (-18°C) or colder, the engine coolant heater can help. The vehicle will start easier and get better fuel economy during engine warm-up. Usually, the coolant heater should be plugged in a minimum of four hours prior to starting your vehicle. At temperatures above 32°F (0°C), use of the coolant heater is not required.

## To Use the Engine Coolant Heater

1. Turn off the engine.
2. Open the hood and unwrap the electrical cord. The cord is attached to the underside of the vehicle's diagonal brace, which is located above the engine air cleaner/filter assembly.
3. Plug it into a normal, grounded 110-volt AC outlet.

### CAUTION:

**Plugging the cord into an ungrounded outlet could cause an electrical shock. Also, the wrong kind of extension cord could overheat and cause a fire. You could be seriously injured. Plug the cord into a properly grounded three-prong 110-volt AC outlet. If the cord will not reach, use a heavy-duty three-prong extension cord rated for at least 15 amps.**

4. Unplug and store the cord as it was before to keep it away from moving engine parts, before starting the engine. If this is not done, the cord could be damaged.

How long should the coolant heater be kept plugged in? The answer depends on the outside temperature, the kind of oil used in the vehicle, and some other things. Instead of trying to list everything here, contact your dealer in the area where the vehicle will be parking. The dealer can give you the best advice for that particular area.

## Automatic Transaxle Operation

The shift lever for the automatic transmission is on the steering column.



The ignition positions are displayed on the instrument panel cluster and will indicate the gear the vehicle is in.

Maximum engine speed is limited on the automatic transaxle when the vehicle is in PARK (P) or NEUTRAL (N) to protect driveline components from improper operation.

There are several different positions for the shift lever.

### CAUTION:

**It is dangerous to get out of your vehicle if the shift lever is not fully in PARK (P) with the parking brake firmly set. Your vehicle can roll.**

**Do not leave your vehicle when the engine is running unless you have to. If you have left the engine running, the vehicle can move suddenly. You or others could be injured. To be sure your vehicle will not move, even when you are on fairly level ground, always set your parking brake and move the shift lever to PARK (P). See *Shifting Into Park (P)* on page 2-26. If you are pulling a trailer, see *Towing a Trailer* on page 4-39.**



**PARK (P):** This position locks the vehicle's front wheels. It is the best position to use when the engine is started because the vehicle cannot move easily.

Make sure the shift lever is fully in PARK (P) before starting the engine. The vehicle has an automatic transaxle shift lock control system. The regular brakes must be fully applied before shifting from PARK (P) when the ignition is in RUN. If the vehicle cannot be shifted out of PARK (P), increase pressure on the shift lever by pushing it all the way into PARK (P) while keeping the brake pedal pushed down. Then move the shift lever out of PARK (P). See *Shifting Out of Park (P)* on page 2-28

**Notice:** Shifting to REVERSE (R) while your vehicle is moving forward could damage the transaxle. The repairs would not be covered by your warranty. Shift to REVERSE (R) only after your vehicle is stopped.

**REVERSE (R):** Use this gear to back up.

To rock the vehicle back and forth in order to get it out of snow, ice, or sand without damaging the transaxle, see *If You Are Stuck: In Sand, Mud, Ice or Snow* on page 4-30.

**NEUTRAL (N):** In this position, the engine does not connect with the wheels. To restart when the vehicle is already moving, use NEUTRAL (N) only. Also, use NEUTRAL (N) when the vehicle is being towed.

 **CAUTION:**

**Shifting into a drive gear while your engine is running at high speed is dangerous. Unless your foot is firmly on the brake pedal, your vehicle could move very rapidly. You could lose control and hit people or objects. Do not shift into a drive gear while your engine is running at high speed.**

**Notice:** Shifting out of PARK (P) or NEUTRAL (N) with the engine racing may damage the transaxle. The repairs would not be covered by your warranty. Be sure the engine is not racing when shifting your vehicle.

**Notice:** Driving your vehicle if you notice that it is moving slowly or not shifting gears as you increase speed may damage the transaxle. Have your vehicle serviced right away. You can drive in **SECOND (2)** when you are driving less than 35 mph (55 km/h) and **AUTOMATIC OVERDRIVE (D)** for higher speeds until then.

**AUTOMATIC OVERDRIVE (D):** This position is for normal driving. If more power is needed for passing, and the vehicle is:

- Going less than 35 mph (55 km/h), push the accelerator pedal about halfway down.
- Going about 35 mph (55 km/h) or more, push the accelerator pedal all the way down.

By doing this the vehicle will shift down to the next gear and have more power.

**THIRD (3):** This position is also used for normal driving, but it offers more power and lower fuel economy than **AUTOMATIC OVERDRIVE (D)**.

Here are some times you might choose **THIRD (3)** instead of **AUTOMATIC OVERDRIVE (D)**:

- When driving on hilly, winding roads.
- When towing a trailer, so there is less shifting between gears.

- When going down a steep hill.
- When driving in no-highway scenarios such as city streets.

**Notice:** Driving in **SECOND (2)** for more than 25 miles (40 km) or at speeds over 55 mph (90 km/h) may damage the transaxle. Also, shifting into **SECOND (2)** at speeds above 65 mph (105 km/h) can cause damage. Drive in **THIRD (3)** or **AUTOMATIC OVERDRIVE (D)** instead of **SECOND (2)**.

**SECOND (2):** This position gives the vehicle more power than **THIRD (3)** but lower fuel economy than **THIRD (3)**. You can use **SECOND (2)** on hills. It can help control the speed going down steep mountain roads, but then you would also want to use your brakes off and on.

**FIRST (1):** This position gives the vehicle even more power but lower fuel economy than **SECOND (2)**. It can be used on very steep hills, or in deep snow or mud. If the shift lever is put in **FIRST (1)**, the transaxle will not shift into first gear until the vehicle is going slowly enough.

**Notice:** Spinning the tires or holding the vehicle in one place on a hill using only the accelerator pedal may damage the transaxle. If you are stuck, do not spin the tires. When stopping on a hill, use the brakes to hold the vehicle in place.

## Parking Brake



To set the parking brake, hold the regular brake pedal down with your right foot. Push down the parking brake pedal with your left foot.

To release the parking brake, hold the regular brake pedal down with your right foot and push the parking brake pedal with your left foot. When you lift your left foot, the parking brake pedal will follow it to the released position.

A warning chime will sound if the parking brake is set, the ignition is on and the shift lever is not in PARK (P) or NEUTRAL (N).

**Notice:** Driving with the parking brake on can overheat the brake system and cause premature wear or damage to brake system parts. Verify that the parking brake is fully released and the brake warning light is off before driving.

If you are towing a trailer and parking on any hill, see *Towing a Trailer on page 4-39*. That section shows what to do first to keep the trailer from moving.

## Shifting Into Park (P)

### CAUTION:

It can be dangerous to get out of your vehicle if the shift lever is not fully in PARK (P) with the parking brake firmly set. Your vehicle can roll. If you have left the engine running, the vehicle can move suddenly. You or others could be injured. To be sure your vehicle will not move, even when you are on fairly level ground, use the steps that follow. If you are pulling a trailer, see *Towing a Trailer on page 4-39*.

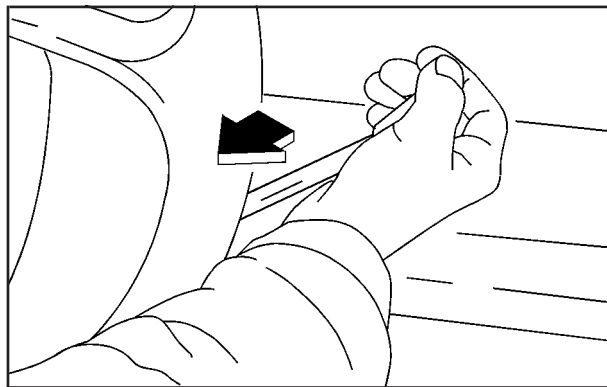

- Pull the shift lever toward you.

1. Hold the brake pedal down with your right foot and set the parking brake with your left foot.
2. Move the shift lever into PARK (P) like this:

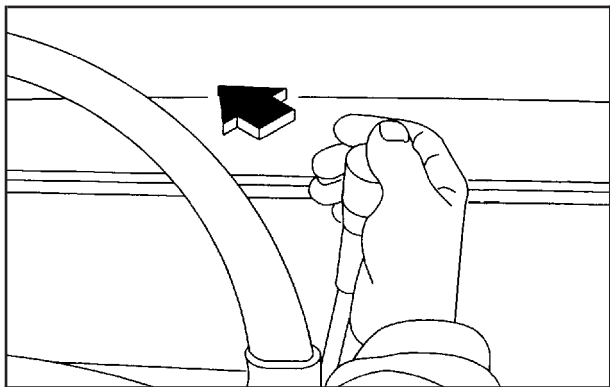

- Move the shift lever up as far as it will go.
3. Turn the ignition key to OFF.
  4. Remove the key and take it with you. If you can leave your vehicle with the ignition key in your hand, the vehicle is in PARK (P).

## Leaving Your Vehicle With the Engine Running

### **CAUTION:**

**It can be dangerous to leave your vehicle with the engine running. Your vehicle could move suddenly if the shift lever is not fully in PARK (P) with the parking brake firmly set. And, if you leave the vehicle with the engine running, it could overheat and even catch fire. You or others could be injured. Do not leave your vehicle with the engine running.**

If the vehicle is left with the engine running, be sure it is in PARK (P) and the parking brake is firmly set before you leave it. After you have moved the shift lever into PARK (P), hold the regular brake pedal down. Then, see if you can move the shift lever out of PARK (P). If you can, it means that the shift lever was not fully locked into PARK (P).

## Torque Lock

If parking the vehicle on a hill and the transaxle is not shifted into PARK (P) properly, the weight of the vehicle may put too much force on the parking pawl in the transaxle. It might be difficult to pull the shift lever out of PARK (P). This is called torque lock. To prevent torque lock, set the parking brake and then shift into PARK (P) properly before leaving the driver's seat. To find out how, see *Shifting Into Park (P)* on page 2-26.

When you are ready to drive, move the shift lever out of PARK (P) before releasing the parking brake.

If torque lock does occur, another vehicle might have to push yours a little uphill. This takes some of the pressure off the parking pawl in the transaxle, enabling the shift lever to be moved out of PARK (P).

## Shifting Out of Park (P)

The vehicle has an automatic transaxle shiftlock control system which locks the shift lever in PARK (P) when the ignition is in the OFF position. The regular brakes have to be fully applied before the vehicle can be shifted from PARK (P) when the ignition is in RUN. See *Automatic Transaxle Operation on page 2-22*.

If the vehicle cannot be shifted out of PARK (P), ease pressure on the shift lever and push the shift lever all the way up into PARK (P) as brake application is maintained. Then move the shift lever into the desired gear.

If the brake pedal is held down but still cannot be shifted out of PARK (P), try this:

1. Turn the ignition key to ACCESSORY. There is no shift interlock in this key position.
2. Apply and hold the brake until the end of Step 4.
3. Shift the transaxle to NEUTRAL (N).
4. Start the vehicle and then shift to the desired gear.
5. Have the system fixed as soon as possible.

## Parking Over Things That Burn

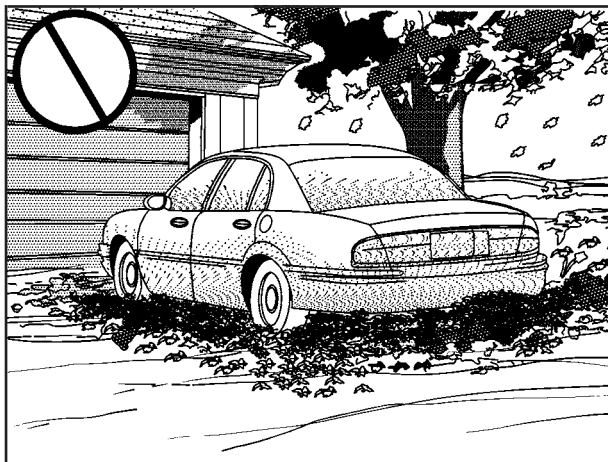

### CAUTION:

Things that can burn could touch hot exhaust parts under your vehicle and ignite. Do not park over papers, leaves, dry grass or other things that can burn.

## Engine Exhaust

### CAUTION:

Engine exhaust can kill. It contains the gas carbon monoxide (CO), which you can not see or smell. It can cause unconsciousness and death.

You might have exhaust coming in if:

- Your exhaust system sounds strange or different.
- Your vehicle gets rusty underneath.
- Your vehicle was damaged in a collision.
- Your vehicle was damaged when driving over high points on the road or over road debris.
- Repairs were not done correctly.
- Your vehicle or exhaust system had been modified improperly.

If you ever suspect exhaust is coming into your vehicle:

- Drive it only with all the windows down to blow out any CO; and
- Have your vehicle fixed immediately.

## Running Your Engine While You Are Parked

It is better not to park with the engine running. But if you ever have to, here are some things to know.

### CAUTION:

Idling the engine with the climate control system off could allow dangerous exhaust into your vehicle. See the earlier Caution under *Engine Exhaust on page 2-29*.

Also, idling in a closed-in place can let deadly carbon monoxide (CO) into your vehicle even if the climate control fan is at the highest setting. One place this can happen is a garage. Exhaust — with CO — can come in easily. NEVER park in a garage with the engine running.

Another closed-in place can be a blizzard. See *Winter Driving on page 4-26*.

### CAUTION:

It can be dangerous to get out of your vehicle if the shift lever is not fully in PARK (P) with the parking brake firmly set. Your vehicle can roll. Do not leave your vehicle when the engine is running unless you have to. If you have left the engine running, the vehicle can move suddenly. You or others could be injured. To be sure your vehicle will not move, even when you are on fairly level ground, always set your parking brake and move the shift lever to PARK (P).

Follow the proper steps to be sure your vehicle will not move. See *Shifting Into Park (P) on page 2-26*.

If you are parking on a hill and if you are pulling a trailer, also see *Towing a Trailer on page 4-39*.



## Mirrors

### Manual Rearview Mirror

Adjust all the mirrors so you can see clearly when sitting in a comfortable driving position.

To reduce glare from other vehicles' headlamps, pull the lever at the bottom of the mirror, to the night position.

To return the mirror to the day position, push the lever.

### Manual Rearview Mirror with OnStar<sup>®</sup>

The vehicle may have a mirror with OnStar<sup>®</sup>. It has a lever located at the bottom between the two lamps.

To reduce glare from other vehicles' headlamps, pull the lever to the night position. For the day position, push the lever to its original position.

There are two lamps located on the bottom of the mirror. Press the button located next to each lamp to turn it on or off.



There are also three OnStar<sup>®</sup> buttons located at the bottom of the mirror. See your dealer for more information on the system and how to subscribe to OnStar<sup>®</sup>. See *OnStar<sup>®</sup> System on page 2-33* for more information about the services OnStar<sup>®</sup> provides.

## Outside Power Mirrors



The power mirror controls are located on the driver's door armrest.

To choose either the left or right outside mirror, move the selector switch located above the control pad to the left or the right. Then use the four-way arrows located on the control pad to move the mirrors in the desired direction.

Adjust each mirror so you can see the side of your vehicle and the area behind your vehicle.

## Outside Convex Mirror

The passenger's side mirror is convex. A convex mirror's surface is curved so you can see more from the driver's seat.

### **CAUTION:**

**A convex mirror can make things (like other vehicles) look farther away than they really are. If you cut too sharply into the right lane, you could hit a vehicle on your right. Check your inside mirror or glance over your shoulder before changing lanes.**

## OnStar® System



OnStar® uses global positioning system (GPS) satellite technology, wireless communications, and call centers to provide you with a wide range of safety, security, information and convenience services.

A complete OnStar® user's guide and the terms and conditions of the OnStar® Subscription Service Agreement are included in your vehicle's glove box literature. For more information, visit [www.onstar.com](http://www.onstar.com), contact OnStar® at 1-888-4-ONSTAR (1-888-466-7827), or press the blue OnStar® button to speak to an OnStar® advisor 24 hours a day, 7 days a week.

A completed Subscription Service Agreement is required prior to delivery of OnStar® services and prepaid calling minutes are also required for OnStar® Personal Calling and OnStar® Virtual Advisor use. Terms and conditions of the Subscription Service Agreement can be found at [www.onstar.com](http://www.onstar.com).

## OnStar® Services

One of the following plans is normally included for a specific duration with each vehicle equipped with OnStar®. You can upgrade or extend your OnStar® service plan to meet your needs.

### Safe and Sound Plan

- Automatic Notification of Air Bag Deployment
- Emergency Services
- Roadside Assistance
- Stolen Vehicle Assistance
- AccidentAssist
- Remote Door Unlock
- Remote Diagnostics
- Online Concierge

### Directions and Connections Plan

- All Safe and Sound Plan services
- Route Support
- RideAssist
- Information and Convenience Services

## Luxury and Leisure Plan

- All Directions and Connections Plan services
- Personal Concierge

## OnStar® Personal Calling

With OnStar® Personal Calling, you have a safer way to stay connected while driving. It's a hands-free wireless phone that's integrated into your vehicle. You can place calls nationwide using voice-activated dialing with no contracts and no additional roaming charges. To find out more about OnStar® Personal Calling, refer to the OnStar® user's guide in your vehicle's glove box, or call OnStar® at 1-888-4-ONSTAR (1-888-466-7827).

## OnStar® Virtual Advisor

With OnStar® Virtual Advisor you can listen to the news, entertainment and informative topics, such as traffic and weather reports. You are able to listen and reply to your e-mail through your vehicle's speakers.

## Storage Areas

### Glove Box

Use the door key to lock and unlock the glove box. To open the glove box, lift the latch on its door.

### Front Storage Area



To use the storage area, fold down the armrest located in the center front seat. Press the latch on the front edge and pull up to access the storage area.

## Center Console Storage Area

If the vehicle has bucket seats it may have a center console. The console has cupholders, and storage areas for cassette tapes and compact discs.

To open the console's rear storage area, press the latch located toward the front of the console and pull up.

## Convenience Net

The vehicle may have a convenience net located on the back wall of the trunk.

Put small loads, like grocery bags, behind the net. It can help keep them from falling over.

The net is not for larger, heavier loads. Store those in the trunk as far forward as possible.

Unhook the net so that it will lie flat when not in use.

## Sunroof

The vehicle may have a sunroof. It includes a sliding glass panel and a sunshade.

The switch to open the sunroof is located overhead on the headliner.

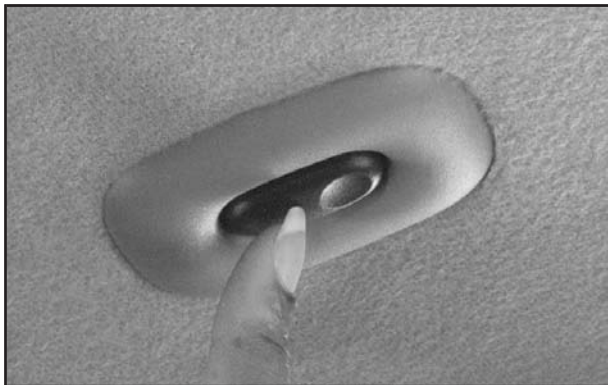

The switch works only when the ignition is on or when Retained Accessory Power (RAP) is active. See “Retained Accessory Power (RAP)” in *Ignition Positions on page 2-19*.

**VENT:** To raise the sunroof to the vent position, push and hold the front of the switch until the sunroof glass stops. The sunshade must be opened by hand. To close the sunroof from the vent position, push and hold the rear of the switch until the sunroof glass closes.

**Open/Express Open:** To open the sunroof, push the rear of the switch once. The sunroof and sunshade will open by themselves. To close the sunroof, push and hold the front of the switch until the sunroof motor stops. The sunshade must be closed by hand.

## Section 3 Instrument Panel

---

<b>Instrument Panel Overview</b> .....	3-2	Engine Coolant Temperature Warning Light .....	3-35
Hazard Warning Flashers .....	3-4	Engine Coolant Temperature Gage .....	3-35
Other Warning Devices .....	3-4	Tire Pressure Light .....	3-36
Horn .....	3-5	Malfunction Indicator Lamp .....	3-36
Tilt Wheel .....	3-5	Oil Pressure Light .....	3-40
Turn Signal/Multifunction Lever .....	3-5	Change Engine Oil Light .....	3-41
Exterior Lamps .....	3-12	Security Light .....	3-41
Interior Lamps .....	3-15	Cruise Control Light .....	3-42
Accessory Power Outlets .....	3-17	Low Washer Fluid Warning Light .....	3-42
Ashtrays and Cigarette Lighter .....	3-17	Door/Trunk Ajar Warning Light .....	3-42
<b>Climate Controls</b> .....	3-18	Service Vehicle Soon Light .....	3-42
Dual Climate Control System .....	3-18	Fuel Gage .....	3-43
Dual Automatic Climate Control System .....	3-21	Low Fuel Warning Light .....	3-44
Outlet Adjustment .....	3-25	<b>Audio System(s)</b> .....	3-44
Passenger Compartment Air Filter .....	3-26	Setting the Time .....	3-45
<b>Warning Lights, Gages and Indicators</b> .....	3-27	Radio with CD .....	3-45
Instrument Panel Cluster .....	3-28	Radio with Cassette and CD .....	3-53
Speedometer and Odometer .....	3-29	Theft-Deterrent Feature .....	3-62
Safety Belt Reminder Light .....	3-30	Audio Steering Wheel Controls .....	3-62
Air Bag Readiness Light .....	3-30	Understanding Radio Reception .....	3-63
Charging System Light .....	3-31	Care of Your Cassette Tape Player .....	3-63
Brake System Warning Light .....	3-32	Care of Your CDs .....	3-64
Anti-Lock Brake System Warning Light .....	3-33	Care of Your CD Player .....	3-64
Enhanced Traction System Warning Light .....	3-34	Fixed Mast Antenna .....	3-64
Low Traction Light .....	3-34		

# Instrument Panel Overview

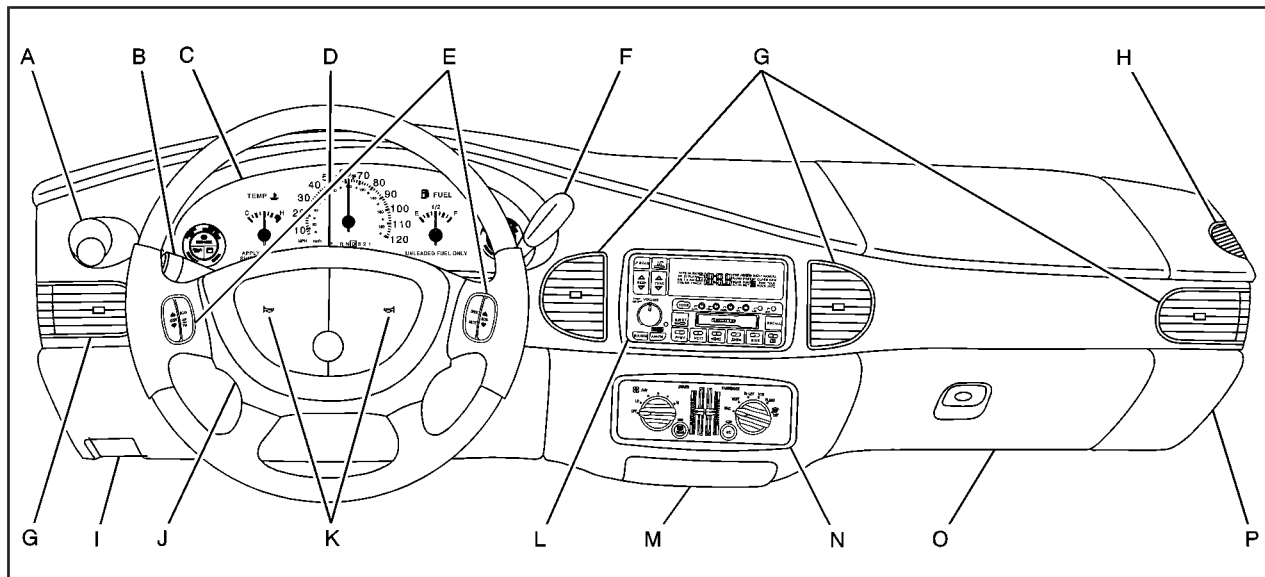



The main components of the instrument panel are the following:

- A. Exterior Lamps Control. See *Exterior Lamps on page 3-12.*
- B. Turn Signal/Multifunction Lever. See *Turn Signal/Multifunction Lever on page 3-5.*
- C. Instrument Panel Cluster. See *Instrument Panel Cluster on page 3-28.*
- D. Hazard Warning Flasher Button. See *Hazard Warning Flashers on page 3-4.*
- E. Audio Steering Wheel Controls. See *Audio Steering Wheel Controls on page 3-62.*
- F. Gear Shift Lever. See *Automatic Transaxle Operation on page 2-22.*
- G. Air Outlets. See *Outlet Adjustment on page 3-25.*
- H. Side Window Defogger Outlet.
- I. Hood Release. See *Hood Release on page 5-10.*
- J. Tilt Wheel Lever. See *Tilt Wheel on page 3-5.*
- K. Horn. See *Horn on page 3-5.*
- L. Audio System. See *Audio System(s) on page 3-44.*
- M. Ashtray. See *Ashtrays and Cigarette Lighter on page 3-17.*
- N. Climate Control. See *Dual Climate Control System on page 3-18.*
- O. Glove Box. See *Glove Box on page 2-34.*
- P. Instrument Panel Fuse Block. See *Fuses and Circuit Breakers on page 5-97.*

## Hazard Warning Flashers

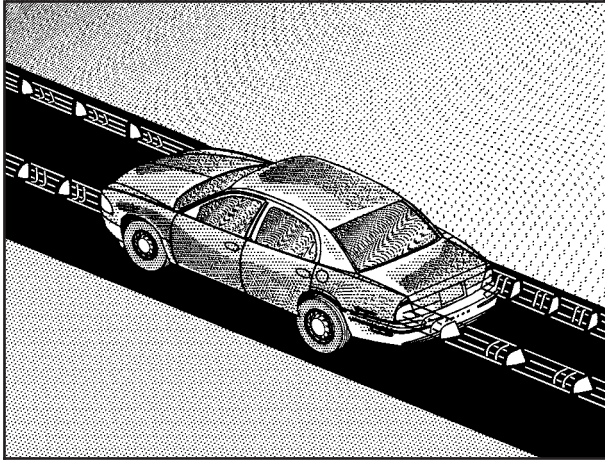

The hazard warning flashers let you warn others to use caution when approaching your vehicle. They also let police know you have a problem.



The hazard warning flasher button is located on the top of the steering column.

Press the button to activate the front and rear turn signals to flash on and off.

The hazard warning flashers work no matter what position the key is in, and even if it is not in the ignition. When the hazard warning flashers are on, the individual turn signals will not operate.

## Other Warning Devices

If you store reflective, safety triangles in the vehicle, put one at the side of the road, about 300 feet (100 m) behind the vehicle to warn oncoming traffic of an emergency situation.

## Horn

Press the horn symbols on the steering wheel pad to sound the horn.

## Tilt Wheel

A tilt wheel enables the position of the steering wheel to be adjusted.

The lever that lets the steering wheel tilt is located on the outboard side of the steering column.



To tilt the steering wheel, hold it and pull the lever. Move the steering wheel to a comfortable driving position and release the lever to lock it into place.

Tilt the steering wheel to the highest position to give more room when exiting and entering the vehicle.

## Turn Signal/Multifunction Lever



The lever located on the left side of the steering column includes the following:

- Turn and Lane-Change Signals
- Headlamp High/Low-Beam Changer
- Flash-to-Pass
- Windshield Wipers
- Windshield Washer
- Cruise Control

## Turn and Lane-Change Signals

To signal a turn, move the lever up or down. The lever returns to its original position when the turn is completed.

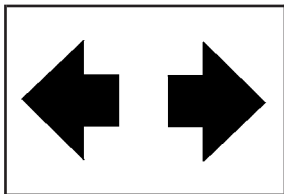

An arrow on the instrument panel cluster will flash in the direction of the turn or lane change.

To signal a lane change, raise or lower the lever until the arrow starts to flash. Hold it there until the lane change is completed. The lever will return to its original position when released.

Arrows that flash rapidly when signaling for a turn or lane change, or that fail to work, may indicate a burned-out signal bulb or fuse. Other drivers will not see the signal. See *Front Turn Signal and Parking Lamps on page 5-52* and *Taillamps, Turn Signal, and Stoplamps on page 5-54* for turn signal bulb replacement procedures. Also see *Fuses and Circuit Breakers on page 5-97* for location of fuses.

A chime will sound if the turn signal is left on for more than 3/4 mile (1.2 km).

## Headlamp High/Low-Beam Changer

To change the headlamps from low beams to high beams, or high to low, pull the multifunction lever until a click is heard, then release it.

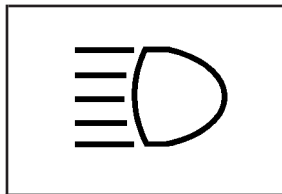

This indicator light on the instrument panel cluster will come on while the high-beam lamps are on.

## Flash-to-Pass

This feature lets you use your high-beam headlamps to signal the driver in front of you that you want to pass. It works even if the headlamps are off. Pull the turn signal lever toward you a little, but not so much that you hear a click.

If the headlamps are off or on low-beam, the high-beam headlamps will turn on. They will stay on as long as you hold the lever toward you. The high-beam indicator on the instrument panel cluster will come on.

## Windshield Wipers

To operate the windshield wipers turn the band located on the multifunction lever upward or downward.

**WIPER:** Turn this band to control the windshield wipers.

**OFF:** Turn the band to OFF to turn off the windshield wipers.

**LO (Low Speed):** Turn the band away from you to LO and past the delay settings for steady wiping at low speed.

**HI (High Speed):** Turn the band away from you, to HI, and past the delay settings for steady wiping at a high speed.

**(Delayed Wiping):** Turn the band away from you, just past OFF, to one of the five delayed settings, to choose the length of intervals between each wiping

cycle. The further the band is turned upward, toward LO, the shorter the delay will be. Select one of these settings for light rain or snow.

**MIST:** Turn the band to MIST for a single wiping cycle. Hold it until the windshield wipers start. Then let it go. The windshield wipers will stop after one wipe. If more wipes are needed, hold the band on MIST longer.

Be sure to clear ice and snow from the windshield wiper blades before using them. If they are frozen to the windshield, carefully loosen or thaw them. If the blades do become worn or damaged, get new blades or blade inserts. See *Windshield Wiper Blade Replacement on page 5-56*.

Heavy snow or ice can overload the wipers. A circuit breaker will stop them until the motor cools. Clear away snow or ice to prevent an overload.

## Windshield Washer

 **(Windshield Washer):** At the top of the multifunction lever, there is a paddle with the word PUSH on it. To spray washer fluid on the windshield, push on the paddle. The wipers will run for several sweeps and then either stop or return to the preset speed. See *Windshield Washer Fluid* on page 5-36.

### CAUTION:

**In freezing weather, do not use your washer until the windshield is warmed. Otherwise the washer fluid can form ice on the windshield, blocking your vision.**

**LOW WASH**

The LOW WASH light on the instrument panel cluster will come on when the fluid level is low.

## Cruise Control

If the vehicle has cruise control, a speed of about 25 mph (40 km/h) or more can be maintained without keeping your foot on the accelerator. This can really help on long trips. Cruise control does not work at speeds below about 25 mph (40 km/h).

When you apply your brakes, the cruise control shuts off.

### CAUTION:

- **Cruise control can be dangerous where you can not drive safely at a steady speed. So, do not use your cruise control on winding roads or in heavy traffic.**
- **Cruise control can be dangerous on slippery roads. On such roads, fast changes in tire traction can cause needless wheel spinning, and you could lose control. Do not use cruise control on slippery roads.**

The cruise control will automatically disengage when the enhanced traction system begins to limit wheel spin. See *Enhanced Traction System (ETS)* on page 4-9. When road conditions allow, the cruise control can be used again.

## Setting Cruise Control

### CAUTION:

If you leave your cruise control on when you are not using cruise, you might hit a button and go into cruise when you do not want to. You could be startled and even lose control. Keep the cruise control switch off until you want to use cruise control.



1. Move the cruise control switch to ON.
2. Accelerate to the speed you want.
3. Push in the SET button at the end of the lever and release it. The CRUISE light on the instrument panel cluster will come on.
4. Take your foot off the accelerator pedal.

## Resuming a Set Speed

Suppose you set the cruise control at a desired speed and then you apply the brake. This, of course, shuts off the cruise control. But you do not need to reset it.

Once you're going about 25 mph (40 km/h) or more, move the cruise control switch from ON to R/A (Resume/Accelerate) briefly. The vehicle will accelerate to the previous chosen speed and stay there.

## Increasing Speed While Using Cruise Control

There are two ways to go to a higher speed:

- Use the accelerator pedal to get to the higher speed. Push in the SET button, then release the button and the accelerator pedal. The vehicle will now cruise at the higher speed.

- Move the cruise switch from ON to R/A. Hold it there until you accelerate to the speed you want, and then release the switch. To increase the speed in very small amounts, move the switch to R/A briefly and then release it. Each time this is done, the vehicle will go about 1 mph (1.6 km/h) faster.

The accelerate feature will only work after the cruise control speed is set, by pushing the SET button.

## Reducing Speed While Using Cruise Control

There are two ways to reduce the vehicle's speed while using cruise control:

- Push in the SET button until the vehicle slows down to the desired, then release it.
- To slow the vehicle down in very small amounts, push the SET button briefly. Each time this is done, the vehicle will go about 1 mph (1.6 km/h) slower.



## **Passing Another Vehicle While Using Cruise Control**

Use the accelerator pedal to increase the vehicle's speed. When you take your foot off the pedal, your vehicle will slow down to the cruise control speed you set earlier.

## **Using Cruise Control on Hills**

How well the cruise control will work on hills depends upon the speed and load of the vehicle, and the steepness of the hills. When going up steep hills, you may have to step on the accelerator pedal to maintain the vehicle's speed. When going downhill, you may have to brake or shift to a lower gear to keep the vehicle's speed down. Of course, applying the brake takes the vehicle out of cruise control. Many drivers find this to be too much trouble and do not use cruise control on steep hills.

## **Ending Cruise Control**

There are two ways to turn off the cruise control:

- Step lightly on the brake pedal.
- Move the cruise switch to OFF.

## **Ending Speed Memory**

When the cruise control or the ignition is turned off, or the vehicle is shifted into PARK (P) or NEUTRAL (N), the cruise control set speed memory is erased.

## Exterior Lamps

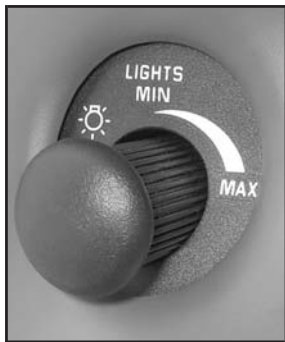

The exterior lamps control is located on the left side of the instrument panel.

The exterior lamps control has three positions:

**Off:** Push the control all the way in to turn off all lamps.

**Parking Lamps:** Pull the control out, to the first position, to turn on the parking lamps together with the following:

- Taillamps
- License Plate Lamps
- Sidemarkers Lamps
- Instrument Panel Lights

**Headlamps:** Pull the headlamp control to the second position, to turn on the headlamps together with the previously listed lamps and lights.

A warning chime will sound if the driver's door is opened when the ignition is turned to OFF, LOCK or ACCESSORY and the headlamps are on.

## Daytime Running Lamps/Automatic Headlamp System

Daytime Running Lamps (DRL) can make it easier for others to see the front of your vehicle during the day. DRL can be helpful in many different driving conditions, but they can be especially helpful in the short periods after dawn and before sunset. Daytime running lamps are required to function at all times on all vehicles first sold in Canada.

A light sensor on top of the instrument panel makes the DRL work, so be sure it is not covered.

The DRL system will make the front turn signal lamps come on when the following conditions are met:

- The ignition is on.
- The exterior lamps control is off.
- The parking brake is released.

While the DRL are on, the front turn signal lamps also will be on. The headlamps, taillamps, sidemarker and other lamps will not be on. The instrument panel will not be lit up either.

When it is dark enough outside, the front turn signal lamps will turn off and the vehicle's headlamps and parking lamps will turn on. The other lamps that come on with the headlamps will also come on.

When it is bright enough outside, the headlamps will go off and the front turn signal lamps will come on.

To idle the vehicle with the DRL and automatic headlamp control off, set the parking brake while the ignition is in OFF or LOCK. Then start the vehicle. The DRL, headlamps and parking lamps will stay off until the parking brake is released.

To turn off the automatic headlamp feature when it is dark outside, move the exterior lamps control to the parking lamp position. The parking lamps will remain illuminated and the headlamps will turn off.

As with any vehicle, the regular headlamp system should be turned on when needed.

## Delayed Headlamps

Delayed headlamp illumination provides a period of exterior lighting as you leave the vehicle's area. The feature is activated when the vehicle's ignition is turned off and the headlamps are on due to the automatic headlamp control feature described previously in this section. The headlamps will remain on until the exterior lamps control is moved from OFF to the parking lamp position or until a 90 second lighting period has ended.

If the ignition is turned off while the exterior lamps control is in the parking lamp or headlamp position, the delayed headlamp illumination cycle will not occur.

This feature can be turned on or off by doing the following:

1. Turn the ignition key to RUN.
2. Close all the doors.
3. Press and hold the LOCK position on the power door lock switch. While holding the LOCK position on the door lock switch, cycle the exterior lamps control on and off two times.

4. Release the power door LOCK switch. These steps must be carried out in a time period of less than 10 seconds, followed by a delay period of no more than 10 seconds.
5. Then, press and hold the unlock position on the power door switch. While holding the unlock position, turn the exterior lamps control on and off two times. Release the unlock position on the power door switch. These operations must be carried out in a time period of less than 10 seconds.

After releasing the unlock position on the power door switch, a single chime will be heard if the delayed headlamp illumination function has been turned off. Two chimes will be heard if the feature has been turned on. Disconnecting the vehicle's battery for up to a year will not change the programmed operation for this feature.

## Interior Lamps

### Instrument Panel Brightness

The instrument panel lights can be brightened or dimmed by turning the exterior lamps knob.

Turning the control all the way clockwise turns on the courtesy lamps.

### Courtesy Lamps

When any door is opened, several courtesy lamps come on to make it easier to enter and exit the vehicle. These lamps can also be turned on by turning the exterior lamps control all the way clockwise to MAX.

### Entry Lighting

The courtesy lamps will come on and stay on for a set time whenever you press UNLOCK on the remote keyless entry transmitter.

The lamps will stay on while a door is opened and then turn off automatically about 25 seconds after it is closed. If the UNLOCK button is pressed and a door is not open, the lamps will turn off after about 40 seconds.

Entry lighting includes a feature called theater dimming. With theater dimming, the lamps do not turn off at the end of the delay time. Instead, they slowly dim after the delay time and then turn off.

The courtesy lamps are canceled if the ignition key is turned to RUN or START and will not come on unless a door is opened.

### Delayed Entry Lighting

Delayed entry lighting lights the vehicle's interior for a period of time after all the doors have been closed.

The ignition must be off for delayed entry lighting to work. After all the doors have been closed, the delayed entry lighting feature will continue to work until one of the following occurs:

- The ignition is in RUN.
- The doors are locked.
- An illumination period of 25 seconds has elapsed.

If during the illumination period a door is opened, the timed illumination period will be canceled and the interior lamps will remain on.

## Delayed Exit Lighting

This feature illuminates the interior for a period of time after the ignition key is removed from the ignition.

The ignition must be off for delayed exit lighting to work. When the ignition key is removed, interior illumination will activate and remain on until one of the following occurs:

- The ignition is in RUN.
- The power door locks are activated.
- An illumination period of 25 seconds has elapsed.

If during the illumination period a door is opened, the timed illumination period will be canceled and the interior lamps will remain on.

## Reading Lamps

The reading lamps are located on the underside of the rearview mirror. Press the button next to each lamp to turn it on and off.

## Dome Lamp

The dome lamp will come on when you open a door.

## Battery Rundown Protection

This helps the vehicle's battery from draining the battery in case the interior courtesy lamps, reading lamps, visor vanity lamps, trunk lamp, underhood lamp or glove box lamps are left on. If any of these lamps are left on while the ignition is off, they will automatically turn off after 20 minutes. The lamps will not come back on again until you do one of the following:

- Turn the ignition on.
- Turn the exterior lamps control off, then on.
- Open a door.

If the vehicle has less than 15 miles (25 km) on the odometer, the battery saver will turn off the lamps after only three minutes.

## Accessory Power Outlets

The accessory power outlets enable power electrical equipment such as a cellular telephone or a CB radio to be used inside the vehicle.

The vehicle is equipped with a 12-volt outlet. It is located on the console, near the floor on the passenger's side. Open the cover to use the outlet. Be sure to close the cover when the outlet is not in use.

**Notice:** Adding any electrical equipment to your vehicle may damage it or keep other components from working as they should. The repairs would not be covered by your warranty. Check with your dealer before adding electrical equipment.

Certain power accessory plugs may not be compatible to the power accessory outlet and could result in blown vehicle or adapter fuses. If you experience a problem, see your dealer.

**Notice:** Improper use of the power outlet can cause damage not covered by your warranty. Do not hang any type of accessory or accessory bracket from the plug because the power outlets are designed for accessory power plugs only.

**Notice:** Leaving electrical equipment on for extended periods will drain the battery.

**Always turn off electrical equipment when not in use and do not plug in equipment that exceeds the maximum amperage rating.**

When adding electrical equipment, be sure to follow the proper installation instructions included with the equipment.

## Ashtrays and Cigarette Lighter

The center front ashtray is located below the instrument panel comfort controls.

To remove the ashtray, open the storage door. Then open the ashtray lid, lift up and pull it out.

**Notice:** Holding a cigarette lighter in while it is heating will not allow the lighter to back away from the heating element when it is hot. Damage from overheating may occur to the lighter or heating element, or a fuse could be blown. Do not hold a cigarette lighter in while it is heating.

Push the lighter to use it. When the heating element is hot, the lighter will pop back out by itself.

**Notice:** If you put papers or other flammable items in the ashtray, hot cigarettes or other smoking materials could ignite them and possibly damage your vehicle. Never put flammable items in the ashtray.

# Climate Controls

## Dual Climate Control System

The vehicle may have this climate control system.

The heating, cooling, and ventilation for the vehicle can be controlled with it.

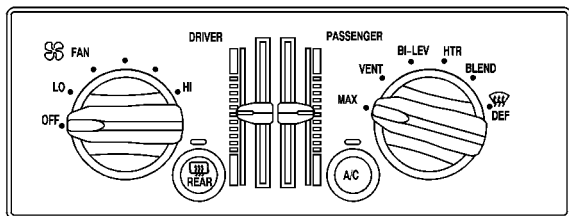

## Manual Operation

To change the current mode, select one of the following settings on the right knob.

**MAX (Maximum Air-Conditioning):** This mode recirculates much of the air inside the vehicle and sends it through the instrument panel outlets. The air-conditioning compressor will run automatically in this setting unless the outside temperature is below 40°F (4°C).

**VENT (Ventilation):** This mode brings in outside air and directs it through the instrument panel outlets.

**BI-LEV (Bi-Level):** This mode directs approximately half of the air to the instrument panel outlets, and then directs most of the remaining air to the floor outlets. Some air may be directed toward the windshield.

**HTR (Heater):** This mode directs most of the air to the floor outlets, with some air directed to the outboard outlets, for the side windows, and some air directed to the windshield.



**BLEND:** This mode directs half of the air to go to the floor outlets and half to the defroster and side window outlets. The air-conditioning compressor will run automatically in this setting unless the outside temperature is below 40°F (4°C).

The right knob can also be used for the defrost mode. Information on defrosting and defogging can be found later in this section.

 **FAN:** The left knob controls the fan speed.

**OFF:** Turn the knob all the way counterclockwise to turn off the fan.

**LO (Low Fan Speed):** This setting creates the lowest fan speed.

**HI (High Fan Speed):** This setting creates the highest fan speed.

**DRIVER (Driver's Side Temperature):** The lever on the left adjusts the air temperature for the driver's side outlets. Slide the lever up to raise the temperature and down to lower the temperature.

**PASSENGER (Passenger's Side Temperature):** The lever on the right adjusts the air temperature for the passenger's side outlets. Slide the lever up to raise the temperature and down to lower the temperature.

 **(Air Conditioning):** Press this button to turn the air-conditioning on and off. An indicator light above the button will come on when the air conditioning is on. During daylight hours the interior lighting control might need adjustment to the highest setting in order for the indicator light to be seen. The system will cool and dehumidify the air inside the vehicle when the A/C indicator light is on.

On very hot days, open the windows long enough to let hot, inside air escape. This reduces the time for the vehicle to cool down.

For a quick cool-down on a very hot day, use MAX with the temperature levers all the way in the blue area. If this setting is used for long periods of time, the air in the vehicle may become too dry.

For normal cooling on hot days, use VENT with the temperature levers in the blue area. The system will bring in outside air and cool it.

On cool, but sunny days, the sun may warm your upper body, but your lower body may not be warm enough. Select BI-LEV and set the temperature levers to a comfortable setting. The system will bring in outside air and direct it to your upper body, while sending slightly warmed air to your lower body. Push the A/C button for cooling.

## Defogging and Defrosting

Fog on the inside of the windows is a result of high humidity causing moisture to form and condense on the cool window glass. This can be minimized if the climate control system is used properly. There are two modes to clear fog or frost from the windshield and side windows. Use the blend mode to clear the windows of fog or moisture and warm the passengers. Use the defrost mode to remove frost or fog from the windshield more quickly. For best results, clear all snow and ice from the windshield before defrosting.

 **DEF (Defrost):** This setting, located on the right knob, directs most of the air through the defroster and the side window outlets. Some of the air is directed to the floor and side window outlets. The air-conditioning compressor will run automatically in this setting unless the outside temperature is below 40°F (4°C).

To defrost the window quickly, turn the mode knob to the defrost setting and turn the driver's and passenger's temperature levers all the way to the red area.

To warm passengers while keeping the windows clear, use BLEND.

Do not drive the vehicle until all the windows are clear.

## Rear Window Defogger

 **(Rear):** Press the button to turn the defogger on or off. The rear window defogger will initially run for about 15 minutes. If it is turned on again, the rear window defogger will only run for about seven and one half minutes before turning off.

Do not drive the vehicle until all the windows are clear.

**Notice:** Using a razor blade or sharp object to clear the inside rear window may damage the rear window defogger. Repairs would not be covered by your warranty. Do not clear the inside of the rear window with sharp objects.

## Dual Automatic Climate Control System

The vehicle may have this climate control system. The heating, cooling and ventilation can be controlled with it.

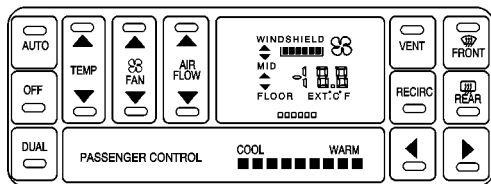

## Automatic Operation

**AUTO (Automatic):** Press the AUTO button for automatic control of the inside temperature, the air delivery mode and the fan speed. There might be a delay of two to three minutes before the fan comes on when the automatic operation is used in cold weather. For the automatic system to function, the temperature must be set between 61°F (16°C) and 89°F (31°C).

1. Adjust the temperature to a comfortable setting.
2. Press the AUTO button.

Choosing the coldest or warmest temperature setting will not cause the system to heat or cool any faster.

If the system is set at the warmest temperature setting, 90°F (32°C), hot air will be directed to the floor, the fan will increase to the highest speed, and the system will remain in manual mode at that temperature. The system will not return to automatic until the temperature setting is lowered.

If the system is set at the coldest temperature setting, 60°F (15°C), cold interior air will be recirculated through the air panel outlets, and the fan will increase to the highest speed. The system will not return to automatic until the temperature is raised.

In cold weather, the system will start at reduced fan speeds to avoid blowing cold air into the vehicle until warmer air is available. The system will start out blowing air at the floor but may change modes automatically as the vehicle warms up to maintain the chosen temperature setting. The length of time needed for warm up will depend on the outside temperature and the length of time that has elapsed since the vehicle was last driven.

3. Wait for the system to regulate. This may take from 10 to 30 minutes. Then, adjust the temperature, if necessary.

Do not cover the solar sensor located in the center of the instrument panel, near the windshield. For more information on the solar sensor, see "Solar Sensor" later in this section.

## Manual Operation

During daylight hours, the instrument panel brightness control might need to be adjusted to the highest setting, in order to see the indicator lights for the various climate control settings.

**OFF:** Pressing the OFF button cancels automatic operation and places the system in manual mode. Press the AUTO button to return to automatic operation.

**TEMP (Temperature):** To manually adjust the temperature inside the vehicle, press the up arrow on the TEMP control to raise the temperature and press the down arrow to lower the temperature. The display will show the selection for a few seconds, and then the outside temperature will be displayed.

When the DUAL light indicator is on, this means the TEMP control has set the temperature for the driver. When the DUAL light indicator light is not on, this means the TEMP control has set the temperature for the entire cabin.

 **FAN:** Press the up arrow on the FAN control to increase fan speed and the down arrow to decrease fan speed. Pressing the arrows cancels the automatic operation and places the system in manual mode. Press the AUTO button to return to automatic operation. If the airflow seems low when the fan is at the highest setting, the passenger compartment air filter, if equipped, may need to be replaced. For more information see *Passenger Compartment Air Filter on page 3-26* and *Scheduled Maintenance on page 6-4*.

**AIR FLOW:** This control has several settings to control the direction of airflow when the system is not in AUTO.

To access the various modes available, continue to press the AIR FLOW up or down arrows until the desired mode, listed below, appears in the display.

**WINDSHIELD/FLOOR:** This setting directs some of the air to the floor outlets and some to the defroster and side window outlets. The air-conditioning compressor will run automatically in this setting unless the outside temperature is below 40°F (4°C).

**MID/FLOOR:** This mode directs airflow through both the floor and the instrument panel outlets. A small amount of air is directed to the windshield and the side window outlets.

**MID (Instrument Panel):** This mode directs air through the instrument panel outlets.

**FLOOR:** This setting sends most of the air through the outlets near the floor. The rest comes out of the defroster and side window outlets.

**VENT:** Press this button to turn the air-conditioning compressor on or off. The indicator light on the VENT mode is lit when the compressor is turned off. The interior brightness control might have to be adjusted to the highest setting during the day in order to see the indicator lamp.

VENT does not operate in the FRONT defrost mode.

**RECIRC (Recirculation):** Press this button to turn this mode on or off. RECIRC limits the amount of outside air coming into the vehicle and recirculates most of the air inside your vehicle. It can be used to prevent

outside air and odors from entering the vehicle or to quickly heat or cool the air inside the vehicle. When this button is pressed an indicator light will come on. The interior brightness control might have to be adjusted to the highest setting during the day in order to see the indicator lamp.

This setting is not permitted in FRONT defrost mode and is only permitted in WINDSHIELD/FLOOR mode if the compressor is turned on.

On hot days, open the windows to let hot air inside escape; then close them. This helps to reduce the time it takes for the vehicle to cool down. It also helps the system to operate more efficiently.

For quick cool down on hot days, press the AUTO button. The system will automatically enter the recirculation mode where the temperature will be at the full cold position for maximum cooling.

The air-conditioning system removes moisture from the air, so a small amount of water dripping underneath the vehicle while it is idling or after the engine is turned off is normal.

Operating the climate control system in the RECIRC mode may cause fogging of the vehicle's windows when the weather is cold and damp. To clear the fog, select either WINDSHIELD/FLOOR or defrost mode and increase the speed.

## Sensors

The solar sensor on the vehicle monitors the solar heat and the air inside of the vehicle. This information is used to maintain the selected temperature by regulating adjustments to the temperature, the fan speed, and the air delivery system. The system may also supply cooler air to the side of the vehicle facing the sun. The recirculation mode will also be activated, as necessary. Do not cover the solar sensor located in the center of the instrument panel, near the windshield, or the system will not work properly.

## Passenger Control

The arrow buttons to control the temperature on the passenger side of the vehicle are located to the right of the PASSENGER CONTROL window. Press the DUAL button so that the indicator light is on. Press the right arrow to raise the temperature and press the left arrow to lower the temperature on the passenger side of the vehicle.

- If the indicator light below the arrows is amber this indicates that the passenger side temperature is set the same as the driver's side.
- If the indicator light below the arrows is red, this indicates that the passenger side temperature is set warmer than that of the driver's side.

- If the indicator light below the arrows is blue this indicates that the passenger side temperature is set cooler than that of the driver's side.

## Defogging and Defrosting

Fog on the outside of the windows is a result of high humidity causing moisture to form and condense on the cool window glass. This can be minimized if the climate control system is used properly. There are two modes to clear fog or frost from the windshield and side windows. Use the WINDSHIELD/FLOOR mode to clear the windows of fog or moisture and warm the passengers. Use the defrost mode to remove fog or frost from the windshield more quickly. For best results, clear all snow and ice from the windshield before defrosting.



**FRONT (Defrost):** This setting brings in outside air and directs most of the air through the defrost outlet. Some of the air also goes to the floor vents and the side window outlets. The indicator light on the button will come on and WINDSHIELD will be seen on the display.

To defrost the windows quickly, press the FRONT button, set the temperature to 90°F (32°C), select a high fan speed, and turn the DUAL button off.

To warm passengers while keeping the window clear, push the AIR FLOW button to select WINDSHIELD/FLOOR which will appear on the display. Select a fan speed.

The air-conditioning compressor will run automatically in this setting unless the outside temperature is below 40°F (4°C).

Do not drive the vehicle until all windows are clear.

## Rear Window Defogger

The rear window defogger uses a warming grid to remove fog or frost from the rear window.

 **REAR:** Press this button to turn the rear window defogger on or off. It will initially turn off after about 15 minutes. If it is turned on again, it will only run for about seven and one half minutes before turning off.

Do not drive the vehicle until all the windows are clear.

**Notice:** Using a razor blade or sharp object to clear the inside rear window may damage the rear window defogger. Repairs would not be covered by your warranty. Do not clear the inside of the rear window with sharp objects.

## Outlet Adjustment



Move the control in the center of each air outlet to open and close the louvers, or adjust the direction of the airflow.

## Operation Tips

- Clear away any ice, snow or leaves from the air inlets at the base of the windshield that may block the flow of air into the vehicle.
- Use of non-GM approved hood deflectors may adversely affect the performance of the system.
- Keep the path under the front seats clear of objects to help circulate the air inside of the vehicle more effectively.
- If the vehicle has a passenger compartment air filter and the airflow seems low when the fan is at the highest setting it may need to be replaced. For more information, see *Passenger Compartment Air Filter* on page 3-26.

## Passenger Compartment Air Filter

The passenger compartment air filter is located in the engine compartment below the air inlet grille, near the passenger's side windshield wiper arm.

The filter traps most of the pollen from the air entering the air conditioning module. Like the engine's air cleaner filter, it may need to be changed periodically. For information on how often to change the passenger compartment air filter, see *Scheduled Maintenance on page 6-4*.

To change the passenger compartment air filter, use the following steps:

1. Put the ignition in ACCESSORY and turn the windshield wipers on.
2. Turn the ignition to OFF when the windshield wipers are in the upright position.
3. Raise the hood.
4. Disconnect the windshield washer pump hose from the fender rail and air inlet grille.
5. Remove the hood weather-strip from the passenger's side of the vehicle and peel it back halfway to the center of the hood.
6. Remove the three air inlet grille retainers.

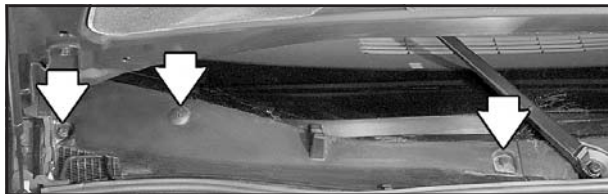

7. Remove the air inlet grille.





8. Replace the old air filter by pulling up on its tab.

9. Install a new passenger compartment air filter. See *Normal Maintenance Replacement Parts on page 6-13* for the type of filter to use. Make sure it slides under the compartment retainers.
10. Reverse Steps 1 through 6.

## Warning Lights, Gages and Indicators

This part describes the warning lights and gages that may be on the vehicle. The pictures will help you locate them.

Warning lights and gages can signal that something is wrong before it becomes serious enough to cause an expensive repair or replacement. Paying attention to the warning lights and gages could also save you or others from injury.

Warning lights come on when there may be or is a problem with one of the vehicle's functions. As you will see in the details on the next few pages, some warning lights come on briefly when you start the engine just to let you know they are working. If you are familiar with this section, you should not be alarmed when this happens.

Gages can indicate when there may be or is a problem with one of your vehicle's functions. Often gages and warning lights work together to let you know when there is a problem with your vehicle.

When one of the warning lights comes on and stays on when you are driving, or when one of the gages shows there may be a problem, check the section that tells you what to do about it. Please follow this manual's advice. Waiting to do repairs can be costly – and even dangerous. So please get to know the warning lights and gages. They are a big help.

# Instrument Panel Cluster

The instrument panel cluster is designed to let the driver know at a glance how the vehicle is running. It shows how fast the vehicle is going, about how much fuel is in the fuel tank and many other things needed to drive safely and economically.

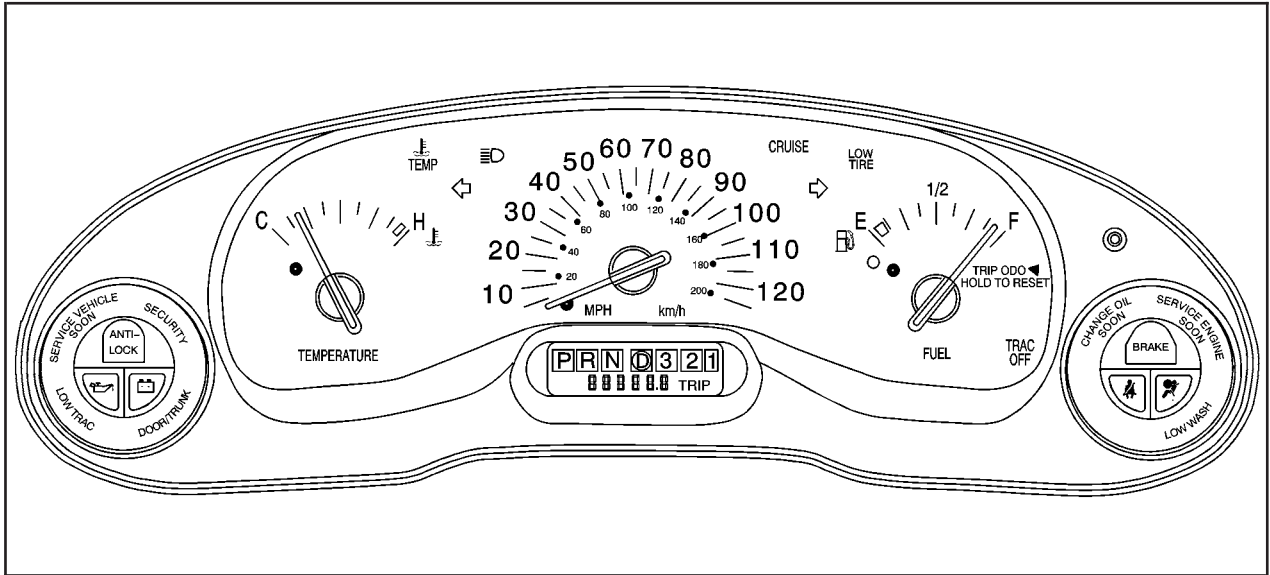

United States version with Enhanced Traction System and ABS shown; Canada Base Level similar

## Speedometer and Odometer

The speedometer shows the vehicle's speed in both miles per hour (mph) and kilometers per hour (km/h). The odometer shows how far the vehicle has been driven in either miles (used in the United States) or in kilometers (used in Canada).

The vehicle has a tamper-resistant odometer. If ERROR is displayed, this indicates someone has probably tampered with it and the numbers may not be accurate.

You may wonder what happens if the vehicle needs a new odometer installed. If the new one can be set to the mileage total of the old odometer, then that will be done. But if it cannot, then it will be set at zero and a label must be put on the driver's door to show the old mileage reading when the new odometer was installed.

## Trip Odometer

The trip odometer tells how far the vehicle has been driven since it was last reset. To set the trip odometer to zero, press the button on the right side of the instrument panel cluster.

The trip/select reset button will go back and forth between the odometer and the trip odometer if the button is pressed and released within 1.5 seconds.

If the button is pressed and held for longer than 1.5 seconds while in the trip odometer mode, it will be reset to zero. If the button is pressed and held for longer than 1.5 seconds while in the odometer mode, it will have no effect.

## Safety Belt Reminder Light

When the ignition key is turned to RUN or START, a chime will come on for several seconds to remind occupants to fasten their safety belts.



The safety belt light will also come on and stay on for several seconds, then it will flash for several more.

If the driver's belt is already buckled, neither the chime nor the light will come on.

## Air Bag Readiness Light

There is an air bag readiness light on the instrument panel, which shows the air bag symbol. The system checks the air bag's electrical system for malfunctions. The system check includes the air bag modules, the wiring and the crash sensing and diagnostic module. For more information on the air bag system, see *Air Bag Systems on page 1-49*.

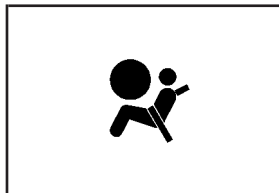

This light will come on when the vehicle is started, and it will flash for a few seconds. Then the light should go out. This means the system is functioning properly.

If the air bag readiness light stays on after the vehicle is started, or comes on as the vehicle is being driven, there may be an electrical problem and the air bag system may not work properly. Have the vehicle serviced right away.

**⚠ CAUTION:**

**If the air bag readiness light stays on after you start your vehicle, it means the air bag system may not be working properly. The air bags in your vehicle may not inflate in a crash, or they could even inflate without a crash. To help avoid injury to yourself or others, have your vehicle serviced right away if the air bag readiness light stays on after you start your vehicle.**

The air bag readiness light should flash for a few seconds when you turn the ignition key to RUN. If the light does not come on then, have it fixed so it will be ready to warn you if there is a problem.

## Charging System Light

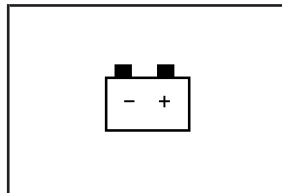

The charging system light will come on briefly when the ignition is turned on, as a check to show that it is working. Then it should go out.

If it stays on, or comes on while the vehicle is being driven, there may be a problem with the charging system. It could indicate that the vehicle has a loose accessory belt or another electrical problem. Have it checked right away. Driving while this light is on could drain the battery.

If the vehicle must be driven a short distance with the light on, be certain to turn off all the accessories, such as the radio and air conditioner.

## Brake System Warning Light

The vehicle's hydraulic brake system is divided into two parts. If one part is not working, the other part can still work and stop the vehicle. For good braking, though, you need both parts working well.

If the warning light comes on, there is a brake problem. Have the brake system inspected right away.

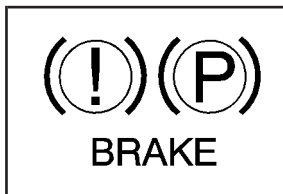

United States

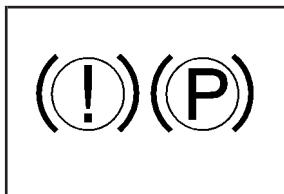

Canada

This light should come on briefly when the ignition key is turned to RUN. If it does not come on then, have it fixed so it will be ready to warn you if there is a problem.

When the ignition is on, the brake system warning light will also come on when the parking brake is set. The light will stay on if the parking brake does not release fully. If it stays on after the parking brake is fully released, it means there is a brake problem.

If the light comes on while the vehicle is being driven, pull off the road and stop carefully. The pedal may be harder to push, or it may go closer to the floor. It may take longer to stop. If the light is still on, have the vehicle towed for service. See *Towing Your Vehicle* on page 4-31.

### CAUTION:

**Your brake system may not be working properly if the brake system warning light is on. Driving with the brake system warning light on can lead to an accident. If the light is still on after you have pulled off the road and stopped carefully, have the vehicle towed for service.**

## Anti-Lock Brake System Warning Light

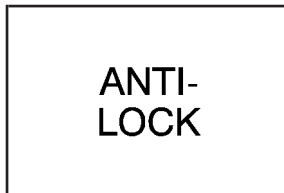

United States

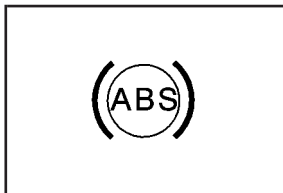

Canada

If the vehicle has anti-lock brakes, this warning light will come on for a few seconds when the ignition key is turned to RUN. If the anti-lock brake system warning light stays on longer than normal after the engine has been started, turn the ignition off. Or, if the light comes on and stays on while the vehicle is being driven, stop as soon as possible and turn the ignition off. Then start the engine again to reset the system. If the light still stays on, or comes on again while driving, the anti-lock brake system needs service. If the light is on and the regular brake system warning light is not on, the vehicle still has brakes, but it does not have anti-lock brakes.

The anti-lock brake system warning light will come on briefly when the ignition key is turned to RUN. This is normal. If the light does not come on then, have it fixed so it will be ready to warn you if there is a problem.

## Enhanced Traction System Warning Light

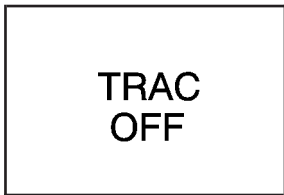

If the vehicle has the Enhanced Traction System, (ETS) the warning light may come on for the following reasons:

- When the vehicle is shifted to SECOND (2) or FIRST (1). To turn the system back on, shift to THIRD (3) or AUTOMATIC OVERDRIVE (Ⓧ). See *Enhanced Traction System (ETS) on page 4-9*.
- If the vehicle needs service. Adjust your driving accordingly.
- When the parking brake is set with the engine running, and the parking brake does not release fully.

After the parking brake is fully released and the transaxle shift lever is in any position other than FIRST (1) or SECOND (2). This means there is a problem with the system.

- If an engine-related problem affects the ETS and turns the system off.

When the ETS warning light is on, the system will not limit wheel spin. Adjust your driving accordingly.

## Low Traction Light



If the vehicle has the Enhanced Traction System (ETS), this light will come on when the system is limiting wheel spin.

You may feel or hear the system working, but this is normal. Slippery road conditions may exist if the low traction light comes on, so adjust your driving accordingly. The light will stay on for a few seconds after the ETS stops limiting wheel spin. See *Enhanced Traction System (ETS) on page 4-9*.

The low traction light also comes on briefly when the ignition key is turned to RUN. If the light does not come on then, have it fixed so it will function properly to indicate when the Enhanced Traction System is active.



## Engine Coolant Temperature Warning Light

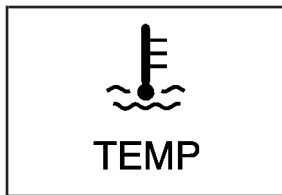

This light indicates that the engine coolant has overheated or the radiator cooling fan is not working.

The light will come on briefly when the ignition is turned on to show that it is working.

If the vehicle has been operating under normal driving conditions, pull off the road, stop the vehicle and turn off the engine as soon as possible. See *Engine Overheating on page 5-25*.

## Engine Coolant Temperature Gage

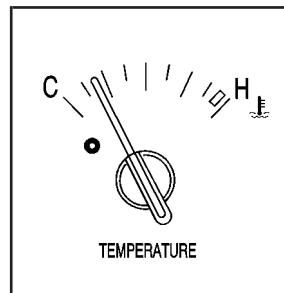

The vehicle has a gage that shows the engine coolant temperature. If the gage pointer moves into the red area, the engine is too hot.

This reading indicates the same thing as the warning light. It means that the engine coolant has overheated. If the vehicle has been operating under normal driving conditions, pull off the road, stop the vehicle and turn off the engine as soon as possible. See *Engine Overheating on page 5-25*.

## Tire Pressure Light



The vehicle may have a tire pressure monitor that indicates a large change in the pressure in one tire.

The system stores the tire pressures of the vehicle's properly inflated tires. The LOW TIRE light will come on if the pressure in one tire becomes 12 psi (83 kPa) lower than the other three tires. The LOW TIRE light will not come on if the pressure in more than one tire is low, if the system is not yet calibrated, or if the vehicle is moving faster than 70 mph (110 km/h).

When the LOW TIRE light comes on, stop as soon as possible and check all the tires for damage. If a tire is flat, see *If a Tire Goes Flat on page 5-74*. Also check the tire pressure in all four tires as soon as possible. See *Inflation - Tire Pressure on page 5-64*.

The light will stay on, while the ignition is on, until the system is reset. See *Tire Pressure Monitor System on page 5-65*.

## Malfunction Indicator Lamp

### Service Engine Soon Light



Your vehicle is equipped with a computer which monitors operation of the fuel, ignition and emission control systems.

This system is called OBD II (On-Board Diagnostics-Second Generation) and is intended to assure that emissions are at acceptable levels for the life of the vehicle, helping to produce a cleaner environment. The SERVICE ENGINE SOON light comes on and a chime will sound to indicate that there is a problem and service is required. Malfunctions often will be indicated by the system before any problem is apparent. This may prevent more serious damage to your vehicle. This system is also designed to assist your service technician in correctly diagnosing any malfunction.

**Notice:** If you keep driving your vehicle with this light on, after a while, your emission controls may not work as well, your fuel economy may not be as good and your engine may not run as smoothly. This could lead to costly repairs that may not be covered by your warranty.

**Notice:** Modifications made to the engine, transaxle, exhaust, intake or fuel system of your vehicle or the replacement of the original tires with other than those of the same Tire Performance Criteria (TPC) can affect your vehicle's emission controls and may cause this light to come on. Modifications to these systems could lead to costly repairs not covered by your warranty. This may also result in a failure to pass a required Emission Inspection/Maintenance test.

This light should come on, as a check to show you it is working, when the ignition is on and the engine is not running. If the light does not come on, have it repaired. This light will also come on during a malfunction in one of two ways:

- **Light Flashing** — A misfire condition has been detected. A misfire increases vehicle emissions and may damage the emission control system on your vehicle. Diagnosis and service may be required.

- **Light On Steady** — An emission control system malfunction has been detected on your vehicle. Diagnosis and service may be required.

## If the Light Is Flashing

The following may prevent more serious damage to your vehicle:

- Reducing vehicle speed.
- Avoiding hard accelerations.
- Avoiding steep uphill grades.
- If you are towing a trailer, reduce the amount of cargo being hauled as soon as it is possible.

If the light stops flashing and remains on steady, see “If the Light Is On Steady” following.

If the light continues to flash, when it is safe to do so, *stop the vehicle*. Find a safe place to park your vehicle. Turn the key off, wait at least 10 seconds and restart the engine. If the light remains on steady, see “If the Light Is On Steady” following. If the light is still flashing, follow the previous steps, and see your dealer for service as soon as possible.

## If the Light Is On Steady

You may be able to correct the emission system malfunction by considering the following:

Did you recently put fuel into your vehicle?

If so, reinstall the fuel cap, making sure to fully install the cap. See *Filling Your Tank on page 5-7*. The diagnostic system can determine if the fuel cap has been left off or improperly installed. A loose or missing fuel cap will allow fuel to evaporate into the atmosphere. A few driving trips with the cap properly installed should turn the light off.

Did you just drive through a deep puddle of water?

If so, your electrical system may be wet. The condition will usually be corrected when the electrical system dries out. A few driving trips should turn the light off.

Have you recently changed brands of fuel?

If so, be sure to fuel your vehicle with quality fuel. See *Gasoline Octane on page 5-4*. Poor fuel quality will cause your engine not to run as efficiently as designed. You may notice this as stalling after start-up, stalling when you put the vehicle into gear, misfiring, hesitation on acceleration or stumbling on acceleration. (These conditions may go away once the engine is warmed up.) This will be detected by the system and cause the light to turn on.

If you experience one or more of these conditions, change the fuel brand you use. It will require at least one full tank of the proper fuel to turn the light off.

If none of the above steps have made the light turn off, your dealer can check the vehicle. Your dealer has the proper test equipment and diagnostic tools to fix any mechanical or electrical problems that may have developed.

## **Emissions Inspection and Maintenance Programs**

Some state/provincial and local governments have or may begin programs to inspect the emission control equipment on your vehicle. Failure to pass this inspection could prevent you from getting a vehicle registration.

Here are some things you need to know to help your vehicle pass an inspection:

Your vehicle will not pass this inspection if the SERVICE ENGINE SOON light is on or not working properly.

Your vehicle will not pass this inspection if the OBD (on-board diagnostic) system determines that critical emission control systems have not been completely diagnosed by the system. The vehicle would be considered not ready for inspection. This can happen if you have recently replaced your battery or if your battery has run down. The diagnostic system is designed to evaluate critical emission control systems during normal driving. This may take several days of routine driving. If you have done this and your vehicle still does not pass the inspection for lack of OBD system readiness, your GM dealer can prepare the vehicle for inspection.

## Oil Pressure Light

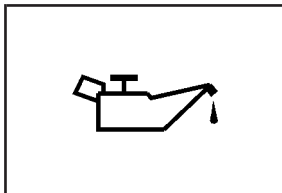

If the vehicle has an oil problem, this light may stay on after the engine is started, or come on while you are driving.

This light indicates that oil is not going through the engine quickly enough to keep it lubricated. The engine could be low on oil or could have some other oil problem. Have it fixed right away.

The oil light could also come on in the following situations:

- The light will come on briefly when the ignition is turned on to show that it is working properly. If it does not come on with the ignition on, there may be a problem with the fuse or bulb. Have it fixed right away.

- Sometimes when the engine is idling at a stop, the light may blink on and off. This is normal.

### **CAUTION:**

**Do not keep driving if the oil pressure is low. If you do, your engine can become so hot that it catches fire. You or others could be burned. Check your oil as soon as possible and have your vehicle serviced.**

**Notice:** Lack of proper engine oil maintenance may damage the engine. The repairs would not be covered by your warranty. Always follow the maintenance schedule in this manual for changing engine oil.

## Change Engine Oil Light



CHANGE OIL  
SOON

The CHANGE OIL SOON light should come on briefly as a bulb check when the engine is started. If the light does not come on, have it serviced.

If the CHANGE OIL SOON light comes on and stays on after the engine is started, have the oil changed.

For additional information, see “When to Change Engine Oil (GM Oil Life System)” under *Engine Oil on page 5-13*. To reset the CHANGE OIL SOON light, see “How to Reset the System” under *Engine Oil on page 5-13*.

## Security Light



SECURITY

The SECURITY light will come on when the key is turned to START, and will stay on until the vehicle starts.

It will also flash if the ignition key is too dirty or wet for the PASS-Key<sup>®</sup> II system to read the resistor pellet. See *PASS-Key<sup>®</sup> II on page 2-17*.

If the resistor pellet is damaged or missing, the light will come on.

## Cruise Control Light

CRUISE

The CRUISE light comes on whenever the cruise control is set. See "Cruise Control" under *Turn Signal/Multifunction Lever* on page 3-5.

## Door/Trunk Ajar Warning Light

DOOR/TRUNK

The DOOR/TRUNK light will come on if the trunk or any door is not completely closed.

## Low Washer Fluid Warning Light

LOW WASH

If the LOW WASH light comes on when the windshield washer paddle is used, this indicates that the fluid is low in the windshield washer reservoir.

## Service Vehicle Soon Light

SERVICE  
VEHICLE  
SOON

The SERVICE VEHICLE SOON light will come on if there are certain non-emission related vehicle problems.

The light will also come on briefly when the ignition is turned on to show that it is working properly.

These problems may not be obvious and may affect vehicle performance or durability. Consult your dealership for necessary repairs to maintain top vehicle performance. The light will come on briefly when ignition is turned on to show that it is working properly.



## Fuel Gage

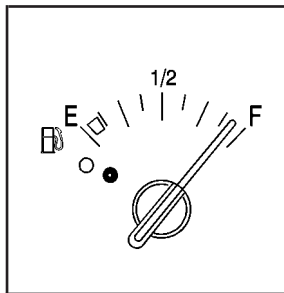

United States

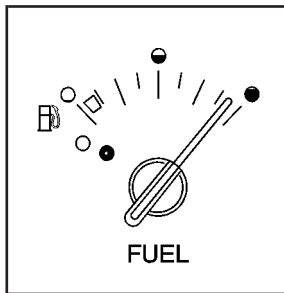

Canada

The fuel gage indicates about how much fuel is left in the fuel tank when the ignition is on. When the indicator nears empty, there is still a little fuel left, but you should get more fuel soon.

Here are four things that some owners ask about. All these things are normal and do not indicate that anything is wrong with the fuel gage:

- At the gas station, the pump shuts off before the gage reads full.
- It takes more, or less, fuel to fill up than the gage reads. For example, the gage reads half full, but it took more, or less, than half of the tank's capacity to fill it.
- The gage pointer may move while cornering, braking or accelerating.
- The gage may not indicate empty when the ignition is turned off.

## Low Fuel Warning Light

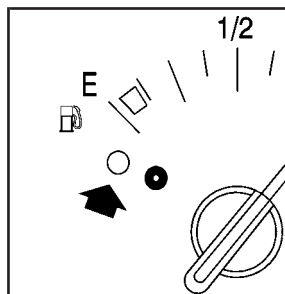

United States

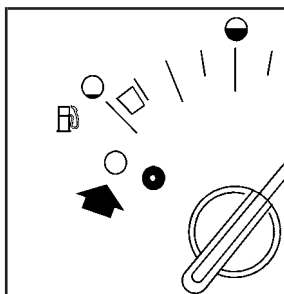

Canada

If the vehicle's fuel is low, a circular light on the instrument panel cluster will come on and a chime will sound periodically until fuel is added to the fuel tank.

It will also come on for a few seconds when the ignition is turned on as a check to indicate it is working. If it does not come on then, have it fixed.

## Audio System(s)

**Notice:** Before you add any sound equipment to your vehicle – like a tape player, CB radio, mobile telephone or two-way radio – be sure you can add what you want. If you can, it's very important to do it properly. Added sound equipment may interfere with the operation of your vehicle's engine, radio or other systems, and even damage them. Your vehicle's systems may interfere with the operation of sound equipment that has been added improperly.

**So, before adding sound equipment, check with your dealer and be sure to check federal rules covering mobile radio and telephone units.**

Your audio system has been designed to operate easily and to give years of listening pleasure. You will get the most enjoyment out of it if you acquaint yourself with it first. Figure out which radio you have in your vehicle, find out what your audio system can do and how to operate all of its controls to be sure you're getting the most out of the advanced engineering that went into it.

Your vehicle has a feature called Retained Accessory Power (RAP). With RAP, you can play your audio system even after the ignition is turned off. See "Retained Accessory Power (RAP)" under *Ignition Positions* on page 2-19.

## Setting the Time

Press and hold H until the correct hour appears on the display. AM will appear for morning hours. Press and hold M until the correct minute appears on the display. The time may be set with the ignition on or off.

To synchronize the time with an FM station broadcasting Radio Data System (RDS) information, press and hold H and M at the same time until TIME UPDATED appears on the display. If the time is not available from the station, NO UPDATE will appear on the display.

RDS time is broadcast once a minute. Once you have tuned to an RDS broadcast station, it may take a few minutes for your time to update.

## Radio with CD



## Playing the Radio

**PWR (Power):** Push this knob to turn the system on and off.

**VOL (Volume):** Turn this knob to increase or to decrease the volume.

**SCV (Speed-Compensated Volume):** With SCV, your audio system adjusts automatically to make up for road and wind noise as you drive. To get to SCV, push the TUNE/AUDIO button repeatedly until SPEED VOL is displayed. Turn the TUNE/AUDIO button to select OFF, MIN, MED, or MAX. Each higher setting allows for more volume compensation at faster vehicle speeds. Then, as you drive, SCV automatically increases the volume, as necessary, to overcome noise at any speed. The volume level should always sound the same to you as you drive. If you don't want to use SCV, select OFF.

**DISP (Display):** Press this button to switch the display between the radio station frequency and the time. The time can be displayed with the ignition on or off.

## Finding a Station

**BAND:** Press this button to switch between FM1, FM2, and AM. The display will show your selection.

**TUNE:** Turn this knob to select radio stations.

**◀ SEEK ▶ :** Press the right or the left arrow to go to the next or to the previous station and stay there.

To scan stations, press and hold either SEEK arrow for two seconds until SCAN appears on the display. The radio will go to a station, play for a few seconds, then go on to the next station. Press either SEEK arrow again to stop scanning.

To scan preset stations, press and hold either SEEK arrow for more than four seconds until PSCAN and the preset number appear on the display. You will hear a double beep. The radio will go to the first preset station stored on your pushbuttons, play for a few seconds, then go on to the next preset station. Press either SEEK arrow again to stop scanning presets.

The radio will seek and scan only to stations that are in the selected band and only to those with a strong signal.

## Setting Preset Stations

The six numbered pushbuttons let you return to your favorite stations. You can set up to 18 stations (six FM1, six FM2, and six AM) by performing the following steps:

1. Turn the radio on.
2. Press BAND to select FM1, FM2, or AM.
3. Tune in the desired station.
4. Press EQ to select the equalization.
5. Press and hold one of the six numbered pushbuttons until you hear a beep. Whenever you press that numbered pushbutton, the station you set will return and the equalization that you selected will be automatically stored for that pushbutton.
6. Repeat the steps for each pushbutton.

## Setting the Tone (Bass/Treble)

**AUDIO:** Push and release AUDIO until BASS, MID, or TREBLE appears on the display. Then turn the AUDIO knob to increase or to decrease. If a station is weak or noisy, you may want to decrease the treble.

To adjust bass, midrange, or treble to the middle position, select BASS, MID, or TREBLE. Then push and hold AUDIO for more than two seconds until you hear a beep. BASS and a zero, MID and a zero, or TREBLE and a zero will appear on the display.

To adjust both tone controls and both speaker controls to the middle position, end out of audio mode by waiting five seconds without making any changes. Then push and hold AUDIO for more than two seconds until you hear a beep. ALL CENTERED will appear on the display.

**EQ (Equalizer):** Press this button to select customized equalization settings designed for country/western, jazz, talk, pop, rock, and classical.

## Adjusting the Speakers (Balance/Fade)

**AUDIO:** To adjust the balance between the right and the left speakers, push and release AUDIO until BAL appears on the display. Then turn the AUDIO knob to move the sound toward the right or the left speakers. A bar graph with indicators will show how the sound is balanced.

To adjust the fade between the front and the rear speakers, push and release AUDIO until FADE appears on the display. Then turn the AUDIO knob to move the sound toward the front or the rear speakers. A bar graph with indicators will show how the sound is balanced.

To adjust balance or fade to the middle position, select BAL or FADE. Then push and hold AUDIO for more than two seconds until you hear a beep. The indicator will be centered on the display.

To adjust both tone controls and both speaker controls to the middle position, end out of audio mode by waiting five seconds without making any changes. Then push and hold AUDIO for more than two seconds until you hear a beep. ALL CENTERED will appear on the display.

## Radio Data System (RDS)

Your audio system is equipped with a Radio Data System (RDS). RDS features are available for use only on FM stations that broadcast RDS information.

With RDS, your radio can do the following:

- Seek to stations broadcasting the selected type of programming
- Receive announcements concerning local and national emergencies
- Display messages from radio stations
- Seek to stations with traffic announcements

This system relies upon receiving specific information from these stations and will only work when the information is available. In rare cases, a radio station may broadcast incorrect information that will cause the radio features to work improperly. If this happens, contact the radio station.

While you are tuned to an RDS station, the station name or the call letters will appear on the display, instead of the frequency. RDS stations may also provide the time of day, a program type (PTY) for current programming, and the name of the program being broadcast.

## Finding a Program Type (PTY) Station

To select and find a desired PTY perform the following:

1. Press P-TYP to activate program type select mode. The PTY symbol will appear on the display.
2. Turn the AUDIO knob to select a PTY.
3. Once the desired PTY is displayed, press either SEEK arrow to select the PTY and take you to the PTY's first station.
4. If you want to go to another station within that PTY and the PTY is displayed, press either SEEK arrow once. If the PTY is not displayed, press either SEEK arrow twice to display the PTY and then to go to another station.
5. Press P-TYP to exit program type select mode.  
If PTY times out and is no longer on the display, go back to Step 1.

If both PTY and TRAF are on, the radio will search for stations with the selected PTY and traffic announcements.

**SCAN:** You can scan the stations within a PTY by performing the following:

1. Press P-TYP to activate program type select mode. The PTY symbol will appear on the display.
2. Turn the AUDIO knob to select a PTY.
3. Once the desired PTY is displayed, press and hold either SEEK arrow, and the radio will begin scanning the stations in the PTY.
4. Press and hold either SEEK arrow to stop at a station.

If both PTY and TRAF are on, the radio will scan for stations with the selected PTY and traffic announcements.

**BAND (Alternate Frequency):** Alternate frequency allows the radio to switch to a stronger station with the same program type. To turn alternate frequency on, press and hold BAND for two seconds. AF ON will appear on the display. The radio may switch to stronger stations.

To turn alternate frequency off, press and hold BAND again for two seconds. AF OFF will appear on the display. The radio will not switch to other stations.

## RDS Messages

**ALERT!:** Alert warns of local or national emergencies. When an alert announcement comes on the current radio station, ALERT! will appear on the display. You will hear the announcement, even if the volume is muted or a CD is playing. If a CD is playing, play will stop during the announcement. You will not be able to turn off alert announcements.

ALERT! will not be affected by tests of the emergency broadcast system. This feature is not supported by all RDS stations.

**INFO (Information):** If the current station has a message, INFO will appear on the display. Press this button to see the message. The message may display the artist, song title, call in phone numbers, etc.

If the whole message is not displayed, parts of the message will appear every three seconds. To scroll through the message at your own speed, press the INFO button repeatedly. A new group of words will appear on the display with each press. Once the complete message has been displayed, INFO will disappear from the display until another new message is received. The old message can be displayed by pressing the INFO button. You can view an old message until a new message is received or a different station is tuned to.

**TRAF (Traffic):** If TRAF appears on the display, the tuned station broadcasts traffic announcements. To receive the traffic announcement from the tuned station, press this button. Brackets will be displayed around TRAF and when a traffic announcement comes on the tuned radio station you will hear it.

If the current tuned station does not broadcast traffic announcements, press the TRAF button and the radio will seek to a station that does. When the radio finds a station that broadcasts traffic announcements, the radio will stop and brackets will be displayed around TRAF. When a traffic announcement comes on the tuned radio station you will hear it. If no station is found, NO TRAFFIC will appear on the display.

If the brackets are on the display and TRAF is not, you can then press the TRAF button to remove the brackets or use the TUNE knob or the SEEK arrows to go to a station that supports traffic announcements. If no station is found, NO TRAFFIC will appear on the display.

Your radio will play the traffic announcements even if the volume is low. Your radio will interrupt the play of a cassette tape or CD if the last tuned station broadcasts traffic announcements.



## Radio Messages

**CAL (CALIBRATE):** Your audio system has been calibrated for your vehicle from the factory. If CAL appears on the display it means that your radio has not been configured properly for your vehicle and must be returned to the dealer for service.

### Playing a CD

Insert a CD partway into the slot, label side up. The player will pull it in. The CD should begin playing. If you want to insert a CD while the ignition or the radio is off, first press the eject or DISP button.

If you turn off the ignition or radio with a CD in the player, it will stay in the player. When you turn on the ignition or system, the CD will start playing where it stopped, if it was the last selected audio source.

As each new track starts to play, the track number will appear on the display.

The CD player can play the smaller 8 cm single CDs with an adapter ring. Full-size CDs and the smaller CDs are loaded in the same manner.

If playing a CD-R the sound quality may be reduced due to CD-R quality, the method of recording, the quality of the music that has been recorded, and the way the CD-R has been handled. You may experience an increase in skipping, difficulty in finding tracks, and/or difficulty in loading and ejecting. If these problems occur try a known good CD.

Do not add paper labels to CDs, they could get caught in the CD player.

Do not play 3 inch CDs without a standard adapter CD.

If an error appears on the display, see “CD Messages” later in this section.

**1◀◀ (Reverse):** Press and hold this pushbutton to reverse quickly within a track. You will hear sound at a reduced level. Release it to play the passage. The display will show the elapsed time of the track.

**2▶▶ (Forward):** Press and hold this pushbutton to advance quickly within a track. You will hear sound at a reduced level. Release it to play the passage. The display will show the elapsed time of the track.

**4 RDM (Random):** Press this pushbutton to hear the tracks in random, rather than sequential, order. Press RDM again to turn off random play.

**DISP (Display):** Press this button to see which track is playing. Press it again within five seconds to see how long it has been playing. To change the default on the display (track or elapsed time), press this button until you see the display you want, then hold the button until the display flashes. The selected display will now be the default.

◀ **SEEK** ▶ : Press the left arrow to go to the start of the current track if more than eight seconds have played. If you hold the button or press it more than once, the player will continue moving backward through the CD.

Press the right arrow to go to the next track. If you hold the button or press it more than once, the player will continue moving forward through the CD.

To scan tracks, press and hold either SEEK arrow for two seconds until SCAN appears on the display. You will hear a beep. The CD will go to the next track, play for a few seconds, then go on to the next track. The sound will mute and SCAN and the track number will appear on the display while scanning. The CD will only scan forward. Press either SEEK arrow again to stop scanning.

**BAND:** Press this button to listen to the radio when a CD is playing. The inactive CD will remain safely inside the radio for future listening.

**CD:** Press this button to play a CD when listening to the radio.

⏏ (**Eject**): Press this button to eject a CD. Eject may be activated with either the ignition or radio off. CDs may be loaded with the ignition or radio off, if this button is pressed first.

## CD Messages

**CHECK CD:** If this message appears on the radio display, it could be for one of the following reasons:

- It is very hot. When the temperature returns to normal, the CD should play.
- You are driving on a very rough road. When the road becomes smooth, the CD should play.
- The CD is dirty, scratched, wet, or upside down.
- The air is very humid. If so, wait about an hour and try again.
- There may have been a problem while burning the CD.
- The label may be caught in the CD player.

If the CD is not playing correctly, for any other reason, try a known good CD.

If any error occurs repeatedly or if an error cannot be corrected, contact your dealer. If your radio displays an error message, write it down and provide it to your dealer when reporting the problem.

## Radio with Cassette and CD



### Playing the Radio

**PWR (Power):** Push this knob to turn the system on and off.

**VOL (Volume):** Turn this knob to increase or to decrease the volume.

**SCV (Speed-Compensated Volume):** With SCV, your audio system adjusts automatically to make up for road and wind noise as you drive. To get to SCV, press the TUNE/AUDIO knob repeatedly until SPEED VOL is displayed. Turn the TUNE/AUDIO knob to select OFF, MIN, MED or MAX. Each higher setting allows for more volume compensation at faster vehicle speeds. Then, as you drive, SCV automatically increases the volume, as necessary, to overcome noise at any speed. The volume level should always sound the same to you as you drive. If you don't want to use SCV, select OFF.

**DISP (Display):** Press this button to switch the display between the radio station frequency and the time. The time can be displayed with the ignition on or off.

### Finding a Station

**BAND:** Press this button to switch between FM1, FM2, or AM. The display will show your selection.

**TUNE:** Turn this knob to select radio stations.

◀ **SEEK** ▶ : Press the right or the left arrow to go to the next or to the previous station and stay there.

To scan stations, press and hold either SEEK arrow for two seconds until SCAN appears on the display. The radio will go to a station, play for a few seconds, then go on to the next station. Press either SEEK arrow again to stop scanning.

To scan preset stations, press and hold either SEEK arrow for more than four seconds until SCAN and the preset number appear on the display. You will hear a double beep. The radio will go to the first preset station stored on your pushbuttons, play for a few seconds, then go on to the next preset station. Press either SEEK arrow again to stop scanning presets.

The radio will seek and scan only to the stations that are in the selected band and only to those with a strong signal.

## Setting Preset Stations

The six numbered pushbuttons let you return to your favorite stations. You can set up to 18 stations (six FM1, six FM2, and six AM), by performing the following steps:

1. Turn the radio on.
2. Press BAND to select FM1, FM2, or AM.
3. Tune in the desired station.

4. Press EQ to select the equalization.
5. Press and hold one of the six numbered pushbuttons until you hear a beep. Whenever you press that numbered pushbutton, the station you set will return and the equalization that you selected will be automatically stored for that pushbutton.
6. Repeat the steps for each pushbutton.

## Setting the Tone (Bass/Treble)

**AUDIO:** Push and release AUDIO until BASS, MID, or TREBLE appears on the display. Then turn the AUDIO knob to increase or to decrease. If a station is weak or noisy, you may want to decrease the treble.

To adjust bass, midrange, or treble to the middle position, select BASS, MID, or TREBLE. Then push and hold AUDIO for more than two seconds until you hear a beep. BASS and a zero, MID and a zero, or TREBLE and a zero will appear on the display.

To adjust both tone controls and both speaker controls to the middle position, end out of audio mode by waiting five seconds without making any changes. Then push and hold AUDIO for more than two seconds until you hear a beep. ALL CENTERED will appear on the display.

**EQ (Equalizer):** Press this button to select customized equalization settings designed for country/western, jazz, talk, pop, rock, and classical.

## Adjusting the Speakers (Balance/Fade)

**AUDIO:** To adjust the balance between the right and the left speakers, push and release AUDIO until BAL appears on the display. Then turn the AUDIO knob to move the sound toward the right or the left speakers. A bar graph with indicators will show how the sound is balanced.

To adjust the fade between the front and the rear speakers, push and release AUDIO until FADE appears on the display. Then turn the AUDIO knob to move the sound toward the front or the rear speakers. A bar graph with indicators will show how the sound is balanced.

To adjust balance or fade to the middle position, select BAL or FADE. Then push and hold AUDIO for more than two seconds until you hear a beep. The indicator will be centered on the display.

To adjust both tone controls and both speaker controls to the middle position, end out of audio mode by waiting five seconds without making any changes. Then push and hold AUDIO for more than two seconds until you hear a beep. ALL CENTERED will appear on the display.

## Radio Data System (RDS)

Your audio system is equipped with a Radio Data System (RDS). RDS features are available for use only on FM stations that broadcast RDS information.

With RDS, your radio can do the following:

- Seek to stations broadcasting the selected type of programming
- Receive announcements concerning local and national emergencies
- Display messages from radio stations
- Seek to stations with traffic announcements

This system relies upon receiving specific information from these stations and will only work when the information is available. In rare cases, a radio station may broadcast incorrect information that will cause the radio features to work improperly. If this happens, contact the radio station.

While you are tuned to an RDS station, the station name or the call letters will appear on the display, instead of the frequency. RDS stations may also provide the time of day, a program type (PTY) for current programming, and the name of the program being broadcast.

## Finding a Program Type (PTY) Station

To select and find a desired PTY perform the following:

1. Press P-TYP to activate program type select mode. The P-TYPE symbol will appear on the display.
2. Turn the AUDIO knob to select a PTY.
3. Once the desired PTY is displayed, press either SEEK arrow to select the PTY and take you to the PTY's first station.
4. If you want to go to another station within that PTY and the PTY is displayed, press either SEEK arrow once. If the PTY is not displayed, press either SEEK arrow twice to display the PTY and then to go to another station.
5. Press P-TYP to exit program type select mode.  
If PTY times out and is no longer on the display, go back to Step 1.

If both PTY and TRAF are on, the radio will search for station with the selected PTY and traffic announcements.

**SCAN:** You can scan the stations within a PTY by performing the following:

1. Press P-TYP to activate program type select mode. The P-TYPE symbol will appear on the display.
2. Turn the AUDIO knob to select a PTY.
3. Once the desired PTY is displayed, press and hold either SEEK arrow, and the radio will begin scanning the stations in the PTY.
4. Press and hold either SEEK arrow to stop at a station.

If both PTY and TRAF are on, the radio will scan for stations with the selected PTY and traffic announcements.

**BAND (Alternate Frequency):** Alternate frequency allows the radio to switch to a stronger station with the same program type. To turn alternate frequency on, press and hold BAND for two seconds. AF ON will appear on the display. The radio may switch to stronger stations.

To turn alternate frequency off, press and hold BAND again for two seconds. AF OFF will appear on the display. The radio will not switch to other stations. When you turn the ignition off and then on again, the alternate frequency feature will automatically be turned on.

## RDS Messages

**ALERT!:** Alert warns of local or national emergencies. When an alert announcement comes on the current radio station, ALERT! will appear on the display. You will hear the announcement, even if the volume is muted or a cassette tape or CD is playing. If a cassette tape or CD is playing, play will stop during the announcement. You will not be able to turn off alert announcements.

ALERT! will not be affected by tests of the emergency broadcast system. This feature is not supported by all RDS stations.

**INFO (Information):** If the current station has a message, INFO will appear on the display. Press this button to see the message. The message may display the artist, song title, call in phone numbers, etc.

If the whole message is not displayed, parts of the message will appear every three seconds. To scroll through the message at your own speed, press the INFO button repeatedly. A new group of words will appear on the display with each press. Once the complete message has been displayed, INFO will disappear from the display until another new message is received. The old message can be displayed by pressing the INFO button. You can view an old message until a new message is received or a different station is tuned to.

**TRAF (Traffic):** If TRAF appears on the display, the tuned station broadcasts traffic announcements. To receive the traffic announcement from the tuned station, press this button. Brackets will be displayed around TRAF and when a traffic announcement comes on the tuned radio station you will hear it.

If the current tuned station does not broadcast traffic announcements, press the TRAF button and the radio will seek to a station that does. When the radio finds a station that broadcasts traffic announcements, the radio will stop and brackets will be displayed around TRAF. When a traffic announcement comes on the tuned radio station you will hear it. If no station is found, NO TRAFFIC will appear on the display.

If the brackets are on the display and TRAF is not, you can then press the TRAF button to remove the brackets or use the TUNE knob or the SEEK arrows to go to a station that supports traffic announcements. If no station is found, NO TRAFFIC will appear on the display.

Your radio will play the traffic announcements even if the volume is low. Your radio will interrupt the play of a cassette tape or CD if the last tuned station broadcasts traffic announcements.

## Radio Messages

**CAL (CALIBRATE):** Your audio system has been calibrated for your vehicle from the factory. If CAL appears on the display it means that your radio has not been configured properly for your vehicle and must be returned to the dealer for service.

## Playing a Cassette Tape

You tape player is built to work best with tapes that are up to 30 to 45 minutes long on each side. Tapes longer than that are so thin they may not work well in this player. The longer side with the tape visible should face to the right. If the ignition and the radio are on, the tape can be inserted and will begin playing. If you hear nothing or hear a garbled sound, the tape may not be in squarely. Press the eject button to remove the tape and start over.

While the tape is playing, use the VOLUME and AUDIO controls just as you do for the radio. The display will show an arrow to show which side of the tape is playing. If you want to insert a tape while the ignition or radio is off, first press the eject or DISP button. Cassette tape adapter kits for portable CD players will work in your cassette tape player.

Your tape bias is set automatically when a metal or chrome tape is inserted.

If an error appears on the display, see "Cassette Tape Messages" later in this section.

**◀◀ (Reverse):** Press this pushbutton to reverse quickly within the tape. The radio will play while the tape reverses. Press it again to return to playing speed.

**▶▶ (Forward):** Press this pushbutton to advance quickly within the tape. The radio will play while the tape advances. Press this pushbutton again to return to playing speed.

**6 SIDE:** Press this pushbutton to play the other side of the tape.

**◀ SEEK ▶ :** Your tape must have at least three seconds of silence between each selection for seek to work. Press the left or the right arrow to go to the previous or to the next selection on the tape. SEEK and a negative or positive number will be displayed. Pressing the left or right arrow multiple times will increase the number of selections to be searched up to -5 or +5. If -5 or +5 is shown on the display the cassette tape player will fast forward or rewind through the four selections and stop at the fifth selection.

To scan cassette tape selections, press and hold either SEEK arrow for two seconds until SCN appears on the display. You will hear a beep. The tape will go to the next selection, play for a few seconds, then go on to the next selection. The cassette tape will only scan forward. Press either SEEK arrow again to stop scanning.



**BAND:** Press this button to listen to the radio when a cassette tape or CD is playing. The inactive cassette or CD will remain safely inside the radio for future listening.

**CD TAPE:** Press this button to play a cassette tape or a CD when listening to the radio.

 **(Eject):** Press this button to eject a tape. Eject may be activated with either the ignition or radio off. Cassettes may be loaded with the ignition or radio off if you press this button first.

## Cassette Tape Messages

If an error message appears on the display, it could be for one of the following reasons:

- **TIGHT TAPE:** The tape is tight and the player cannot turn the tape hubs. Remove the tape. Hold the tape with the open end down and try to turn the right hub counterclockwise with a pencil. Turn the tape over and repeat. If the hubs do not turn easily, your tape may be damaged and should not be used in the player. Try a new tape to make sure your player is working properly.
- **BROKEN TAPE:** The tape is broken. Try a new tape.

**CLEAN PLAYER:** If this message appears on the display, the cassette tape player needs to be cleaned. It will still play tapes, but you should clean it as soon as possible to prevent damage to the tapes and player. See *Care of Your Cassette Tape Player* on page 3-63.

If any error occurs repeatedly or if an error cannot be corrected, contact your dealer. If your radio displays an error number, write it down and provide it to your dealer when reporting the problem.

## CD Adapter Kits

It is possible to use a portable CD player with your cassette tape player after activating the bypass feature on your tape player.

To activate the bypass feature, use the following steps:

1. Turn the ignition on.
2. Turn the radio off.
3. Insert the adapter into the cassette slot.
4. Press and hold the CD TAPE button until READY appears on the display.

The override feature will remain active until the eject button is pressed.

## Playing a CD

Insert a CD partway into the slot, label side up. The player will pull it in. The CD should begin playing. If you want to insert a CD while the ignition or the radio is off, first press the eject button or DISP.

If you turn off the ignition or radio with a CD in the player, it will stay in the player. When you turn on the ignition or system, the CD will start playing where it stopped, if it was the last selected audio source.

As each new track start to play, the track number will appear on the display.

The CD player can play the smaller 8 cm single CDs with an adapter ring. Full-size CDs and the smaller CDs are loaded in the same manner.

If playing a CD-R the sound quality may be reduced due to CD-R quality, the method of recording, the quality of the music that has been recorded, and the way the CD-R has been handled. You may experience an increase in skipping, difficulty in finding tracks, and/or difficulty in loading and ejecting. If these problems occur try a known good CD.

Do not add paper labels to CDs, they could get caught in the CD player.

Do not play 3 inch CDs without a standard adapter CD.

If an error appears on the display, see "CD Messages" later in this section.

**⏮ (Reverse):** Press and hold this pushbutton to reverse quickly within a track. You will hear sound at a reduced volume. Release this pushbutton to play the passage.

**⏭ (Forward):** Press and hold this pushbutton to advance quickly within a track. You will hear sound at a reduced volume. Release this pushbutton to play the passage.

**4 RDM (Random):** Press this pushbutton to hear the tracks in random, rather than sequential, order. Press RDM again to turn off random play.

**DISP (Display):** Press this button to see which track is playing. Press it again within five seconds to see how long it has been playing. To change the default on the display (track or elapsed time), press this button until you see the display you want, then hold the button until the display flashes. The selected display will now be the default.

**⏪ SEEK ⏩ :** Press the left arrow to go to the start of the current track if more than eight seconds have played. If you hold the button or press it more than once, the player will continue moving backward through the CD.

Press the right arrow to go to the next track. If you hold the button or press it more than once, the player will continue moving forward through the CD.

To scan tracks, press and hold either SEEK arrow for two seconds until SCAN appears on the display. You will hear a beep. The CD will go to the next track, play for a few seconds, then go on to the next track. The sound will mute and SCAN and the track number will appear on the display. The CD will only scan forward. Press either SEEK arrow again to stop scanning.

**BAND:** Press this button to listen to the radio when a cassette tape or CD is playing. The inactive cassette or CD will remain safely inside the radio for future listening.

**CD TAPE:** Press this button to play a cassette tape or a CD when listening to the radio.

 **(Eject):** Press this button to eject a tape. Eject may be activated with either the ignition or radio off. CDs may be loaded with the ignition or radio off if you press this button first.

## CD Messages

**CHECK CD:** If this message appears on the radio display, it could be for one of the following reasons:

- It is very hot. When the temperature returns to normal, the CD should play.
- You are driving on a very rough road. When the road becomes smooth, the CD should play.
- The CD is dirty, scratched, wet, or upside down.
- The air is very humid. If so, wait about an hour and try again.
- There may have been a problem while burning the CD.
- The label may be caught in the CD player.

If the CD is not playing correctly, for any other reason, try a known good CD.

If any error occurs repeatedly or if an error cannot be corrected, contact your dealer. If your radio displays an error message, write it down and provide it to your dealer when reporting the problem.

## Theft-Deterrent Feature

THEFTLOCK<sup>®</sup> is designed to discourage theft of your radio. It works by using a secret code to disable all radio functions whenever battery power is removed and the radio is placed in a different vehicle. This feature requires no user input to be activated. It is automatically armed when it is put into the vehicle for the first time.

When the ignition is turned off, the blinking red light indicates that THEFTLOCK<sup>®</sup> is armed.

If THEFTLOCK<sup>®</sup> is activated, your radio will not operate if stolen. The radio will display LOCKED and a red LED indicator light will come on above the key symbol to indicate a locked condition. If this occurs, the radio will need to be returned to the dealer.

## Audio Steering Wheel Controls

If your vehicle has this feature, you can control certain radio functions using the buttons on your steering wheel.



△ **SEEK** ▽ : Press the up or the down arrow to seek to the next or to the previous radio station.

If a cassette tape or CD is playing, the player will advance to the next or the previous selection.

**SCAN:** Press this button and SCAN will appear on the display. The radio will go to the first preset station on your pushbuttons, play for a few seconds, then go to the next preset station. The radio will scan preset stations with a strong signal only. Press SCAN again to stop scanning.

**AM FM:** Press this button to choose FM1, FM2, or AM. If a cassette tape or CD is playing, press this button to listen to the radio. The inactive cassette or CD will remain safely inside the radio for future listening.

**SRCE (Source):** Press this button to play a cassette tape or CD when listening to the radio.

**MUTE:** Press this button to silence the audio system. Press it again to turn on the sound.

△ **VOL** ▽ (**Volume**): Press the up or the down arrow to increase or to decrease volume.

## Understanding Radio Reception

### AM

The range for most AM stations is greater than for FM, especially at night. The longer range, however, can cause stations to interfere with each other. AM can pick up noise from things like storms and power lines. Try reducing the treble to reduce this noise.

### FM

FM stereo will give you the best sound, but FM signals will reach only about 10 to 40 miles (16 to 65 km). Tall buildings or hills can interfere with FM signals, causing the sound to come and go.

## Care of Your Cassette Tape Player

A tape player that is not cleaned regularly can cause reduced sound quality, ruined cassettes, or a damaged mechanism. Cassette tapes should be stored in their cases away from contaminants, direct sunlight, and extreme heat. If they are not, they may not operate properly or they may cause failure of the tape player.

Your tape player should be cleaned regularly after every 50 hours of use. Your radio may display CLEAN PLAYER to indicate that you have used your tape player for 50 hours without resetting the tape clean timer. If this message appears on the display, your cassette tape player needs to be cleaned. It will still play tapes, but you should clean it as soon as possible to prevent damage to your tapes and player. If you notice a reduction in sound quality, try a known good cassette to see if the tape or the tape player is at fault. If this other cassette has no improvement in sound quality, clean the tape player.

For best results, use a scrubbing action, non-abrasive cleaning cassette with pads which scrub the tape head as the hubs of the cleaner cassette turn. The recommended cleaning cassette is available through your dealership.

The cut tape detection feature of your cassette tape player may identify the cleaning cassette tape as a damaged tape, in error. If the cleaning cassette ejects, insert the cassette at least three times to ensure thorough cleaning.

You may also choose a non-scrubbing action, wet-type cleaner which uses a cassette with a fabric belt to clean the tape head. This type of cleaning cassette will not eject on its own. A non-scrubbing action cleaner may not clean as thoroughly as the scrubbing type cleaner. The use of a non-scrubbing action, dry-type cleaning cassette is not recommended.

After you clean the player, press and hold the eject button for five seconds to reset the CLEAN PLAYER indicator. The radio will display --- to show the indicator was reset.

Cassettes are subject to wear and the sound quality may degrade over time. Always make sure the cassette tape is in good condition before you have your tape player serviced.

## Care of Your CDs

Handle CDs carefully. Store them in their original cases or other protective cases and away from direct sunlight and dust. If the surface of a CD is soiled, dampen a clean, soft cloth in a mild, neutral detergent solution and clean it, wiping from the center to the edge.

Be sure never to touch the side without writing when handling CDs. Pick up CDs by grasping the outer edges or the edge of the hole and the outer edge.

## Care of Your CD Player

The use of CD lens cleaners for CDs is not advised, due to the risk of contaminating the lens of the CD optics with lubricants internal to the CD mechanism.

## Fixed Mast Antenna

The fixed mast antenna can withstand most car washes without being damaged. If the mast should ever become slightly bent, you can straighten it out by hand. If the mast is badly bent, you should replace it.

Check occasionally to be sure the mast is still tightened to the fender. If tightening is required, tighten by hand, then with a wrench one quarter turn.

## Section 4 Driving Your Vehicle

---

<b>Your Driving, the Road, and Your Vehicle</b> .....	4-2	Freeway Driving .....	4-21
Defensive Driving .....	4-2	Before Leaving on a Long Trip .....	4-22
Drunken Driving .....	4-2	Highway Hypnosis .....	4-23
Control of a Vehicle .....	4-5	Hill and Mountain Roads .....	4-24
Braking .....	4-6	Winter Driving .....	4-26
Enhanced Traction System (ETS) .....	4-9	If You Are Stuck: In Sand, Mud, Ice or Snow .....	4-30
Steering .....	4-10	<b>Towing</b> .....	4-31
Off-Road Recovery .....	4-12	Towing Your Vehicle .....	4-31
Passing .....	4-13	Recreational Vehicle Towing .....	4-32
Loss of Control .....	4-14	Loading Your Vehicle .....	4-34
Driving at Night .....	4-16	Towing a Trailer .....	4-39
Driving in Rain and on Wet Roads .....	4-17		
City Driving .....	4-20		

# Your Driving, the Road, and Your Vehicle

## Defensive Driving

The best advice anyone can give about driving is: Drive defensively.

Please start with a very important safety device in your vehicle: Buckle up. See *Safety Belts: They Are for Everyone* on page 1-6.

Defensive driving really means “be ready for anything.” On city streets, rural roads or freeways, it means “always expect the unexpected.”

Assume that pedestrians or other drivers are going to be careless and make mistakes. Anticipate what they might do. Be ready for their mistakes.

Rear-end collisions are about the most preventable of accidents. Yet they are common. Allow enough following distance. It is the best defensive driving maneuver, in both city and rural driving. You never know when the vehicle in front of you is going to brake or turn suddenly.

Defensive driving requires that a driver concentrate on the driving task. Anything that distracts from the driving task — such as concentrating on a cellular telephone call, reading, or reaching for something on

the floor — makes proper defensive driving more difficult and can even cause a collision, with resulting injury. Ask a passenger to help do things like this, or pull off the road in a safe place to do them yourself. These simple defensive driving techniques could save your life.

## Drunken Driving

Death and injury associated with drinking and driving is a national tragedy. It is the number one contributor to the highway death toll, claiming thousands of victims every year.

Alcohol affects four things that anyone needs to drive a vehicle:

- Judgment
- Muscular Coordination
- Vision
- Attentiveness.

Police records show that almost half of all motor vehicle-related deaths involve alcohol. In most cases, these deaths are the result of someone who was drinking and driving. In recent years, more than 16,000 annual motor vehicle-related deaths have been associated with the use of alcohol, with more than 300,000 people injured.



Many adults — by some estimates, nearly half the adult population — choose never to drink alcohol, so they never drive after drinking. For persons under 21, it is against the law in every U.S. state to drink alcohol. There are good medical, psychological and developmental reasons for these laws.

The obvious way to eliminate the leading highway safety problem is for people never to drink alcohol and then drive. But what if people do? How much is “too much” if someone plans to drive? It is a lot less than many might think. Although it depends on each person and situation, here is some general information on the problem.

The Blood Alcohol Concentration (BAC) of someone who is drinking depends upon four things:

- The amount of alcohol consumed
- The drinker's body weight
- The amount of food that is consumed before and during drinking
- The length of time it has taken the drinker to consume the alcohol.

According to the American Medical Association, a 180 lb (82 kg) person who drinks three 12 ounce (355 ml) bottles of beer in an hour will end up with a BAC of about 0.06 percent. The person would reach the

same BAC by drinking three 4 ounce (120 ml) glasses of wine or three mixed drinks if each had 1-1/2 ounces (45 ml) of liquors like whiskey, gin or vodka.



It is the amount of alcohol that counts. For example, if the same person drank three double martinis (3 ounces or 90 ml of liquor each) within an hour, the person's BAC would be close to 0.12 percent. A person who consumes food just before or during drinking will have a somewhat lower BAC level.

There is a gender difference, too. Women generally have a lower relative percentage of body water than men. Since alcohol is carried in body water, this means that a woman generally will reach a higher BAC level than a man of her same body weight will when each has the same number of drinks.

The law in an increasing number of U.S. states, and throughout Canada, sets the legal limit at 0.08 percent. In some other countries, the limit is even lower. For example, it is 0.05 percent in both France and Germany. The BAC limit for all commercial drivers in the United States is 0.04 percent.

The BAC will be over 0.10 percent after three to six drinks (in one hour). Of course, as we have seen, it depends on how much alcohol is in the drinks, and how quickly the person drinks them.

But the ability to drive is affected well below a BAC of 0.10 percent. Research shows that the driving skills of many people are impaired at a BAC approaching 0.05 percent, and that the effects are worse at night. All drivers are impaired at BAC levels above 0.05 percent. Statistics show that the chance of being in a collision increases sharply for drivers who have a BAC of 0.05 percent or above. A driver with a BAC level of 0.06 percent has doubled his or her chance of having a collision. At a BAC level of 0.10 percent, the chance of this driver having a collision is 12 times greater; at a level of 0.15 percent, the chance is 25 times greater!

The body takes about an hour to rid itself of the alcohol in one drink. No amount of coffee or number of cold showers will speed that up. "I will be careful" is not the right answer. What if there is an emergency, a need to take sudden action, as when a child darts into the street? A person with even a moderate BAC might not be able to react quickly enough to avoid the collision.

There is something else about drinking and driving that many people do not know. Medical research shows that alcohol in a person's system can make crash injuries worse, especially injuries to the brain, spinal cord or heart. This means that when anyone who has been drinking — driver or passenger — is in a crash, that person's chance of being killed or permanently disabled is higher than if the person had not been drinking.

**⚠ CAUTION:**

**Drinking and then driving is very dangerous. Your reflexes, perceptions, attentiveness and judgment can be affected by even a small amount of alcohol. You can have a serious — or even fatal — collision if you drive after drinking. Please do not drink and drive or ride with a driver who has been drinking. Ride home in a cab; or if you are with a group, designate a driver who will not drink.**

## Control of a Vehicle

You have three systems that make your vehicle go where you want it to go. They are the brakes, the steering and the accelerator. All three systems have to do their work at the places where the tires meet the road.

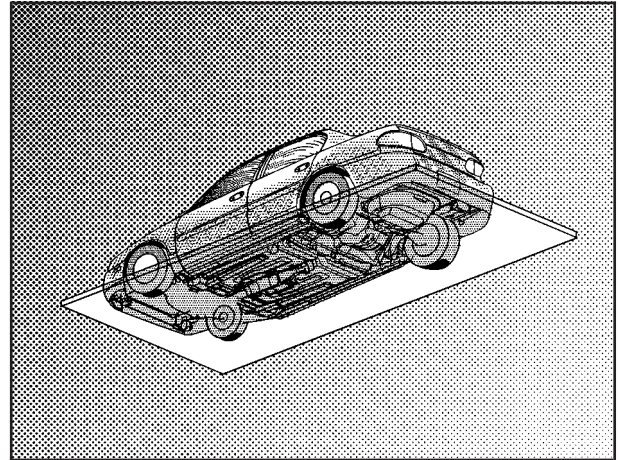

Sometimes, as when you are driving on snow or ice, it is easy to ask more of those control systems than the tires and road can provide. That means you can lose control of your vehicle. Also see *Enhanced Traction System (ETS)* on page 4-9.

## Braking

Braking action involves *perception time* and *reaction time*.

First, you have to decide to push on the brake pedal. That is *perception time*. Then you have to bring up your foot and do it. That is *reaction time*.

Average *reaction time* is about 3/4 of a second. But that is only an average. It might be less with one driver and as long as two or three seconds or more with another. Age, physical condition, alertness, coordination and eyesight all play a part. So do alcohol, drugs and frustration. But even in 3/4 of a second, a vehicle moving at 60 mph (100 km/h) travels 66 feet (20 m). That could be a lot of distance in an emergency, so keeping enough space between your vehicle and others is important.

And, of course, actual stopping distances vary greatly with the surface of the road (whether it is pavement or gravel); the condition of the road (wet, dry, icy); tire tread; the condition of your brakes; the weight of the vehicle and the amount of brake force applied.

Avoid needless heavy braking. Some people drive in spurts — heavy acceleration followed by heavy braking — rather than keeping pace with traffic. This is a mistake. Your brakes may not have time to cool between hard stops. Your brakes will wear out much faster if you do a lot of heavy braking.

If you keep pace with the traffic and allow realistic following distances, you will eliminate a lot of unnecessary braking. That means better braking and longer brake life.

If your engine ever stops while you are driving, brake normally but do not pump your brakes. If you do, the pedal may get harder to push down. If your engine stops, you will still have some power brake assist. But you will use it when you brake. Once the power assist is used up, it may take longer to stop and the brake pedal will be harder to push.

## Anti-lock Brake System (ABS)

Your vehicle may have anti-lock brakes. ABS is an advanced electronic braking system that will help prevent a braking skid.

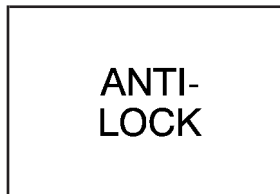

United States

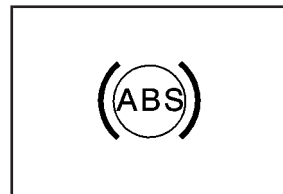

Canada

If your vehicle has anti-lock brakes, this warning light on the instrument panel will come on briefly when you start your vehicle.

When you start your engine, or when you begin to drive away, your anti-lock brake system will check itself. You may hear a momentary motor or clicking noise while this test is going on, and you may even notice that your brake pedal moves or pulses a little. This is normal.



Let us say the road is wet and you are driving safely. Suddenly, an animal jumps out in front of you. You slam on the brakes and continue braking. Here is what happens with ABS:

A computer senses that wheels are slowing down. If one of the wheels is about to stop rolling, the computer will separately work the brakes at each wheel.

The anti-lock system can change the brake pressure faster than any driver could. The computer is programmed to make the most of available tire and road conditions. This can help you steer around the obstacle while braking hard.



As you brake, your computer keeps receiving updates on wheel speed and controls braking pressure accordingly.

Remember: Anti-lock does not change the time you need to get your foot up to the brake pedal or always decrease stopping distance. If you get too close to the vehicle in front of you, you will not have time to apply your brakes if that vehicle suddenly slows or stops. Always leave enough room up ahead to stop, even though you have anti-lock brakes.

## Using Anti-Lock

Do not pump the brakes. Just hold the brake pedal down firmly and let anti-lock work for you. You may feel a slight brake pedal pulsation or notice some noise, but this is normal.

## Braking in Emergencies

At some time, nearly every driver gets into a situation that requires hard braking.

If you have anti-lock, you can steer and brake at the same time. However, if you do not have anti-lock, your first reaction — to hit the brake pedal hard and hold it down — may be the wrong thing to do. Your wheels

can stop rolling. Once they do, the vehicle can not respond to your steering. Momentum will carry it in whatever direction it was headed when the wheels stopped rolling. That could be off the road, into the very thing you were trying to avoid, or into traffic.

If you do not have anti-lock, use a “squeeze” braking technique. This will give you maximum braking while maintaining steering control. You can do this by pushing on the brake pedal with steadily increasing pressure.

In an emergency, you will probably want to squeeze the brakes hard without locking the wheels. If you hear or feel the wheels sliding, ease off the brake pedal. This will help you retain steering control. If you *do* have anti-lock, it is different. See “Anti-Lock Brake System” in this section.

In many emergencies, steering can help you more than even the very best braking.

## Enhanced Traction System (ETS)

If the vehicle has an Enhanced Traction System (ETS) it will limit wheel spin. This is especially useful in slippery road conditions. The system operates only if it senses that one or both of the front wheels are spinning or beginning to lose traction. When this happens, the system reduces engine power and may also upshift the transaxle to limit wheel spin.



**LOW TRAC**

This light will come on the instrument panel cluster while the ETS is limiting wheel spin. See *Enhanced Traction System Warning Light* on page 3-34.

You may feel or hear the system working, but this is normal.

If the vehicle is in cruise control when the enhanced traction system begins to limit wheel spin, the cruise control will automatically disengage. When road conditions allow safe use of it again, you can re-engage the cruise control. See “Cruise Control” under *Turn Signal/Multifunction Lever* on page 3-5.

The ETS operates in THIRD (3) and OVERDRIVE (D). If the vehicle is in THIRD (3), the system can upshift the transaxle to OVERDRIVE (D). The ETS is turned off in SECOND (2) or FIRST (1) gear, and when the parking brake is set. See *Automatic Transaxle Operation* on page 2-22.



**TRAC  
OFF**

While the ETS is on, this warning light will come on the instrument panel cluster to show that the system is not limiting wheel spin.

See *Enhanced Traction System Warning Light* on page 3-34. Adjust your driving accordingly.

To limit wheel spin, especially in slippery road conditions, the ETS should always be left on. But the system can be turned off. The ETS should be turned off if the vehicle ever gets stuck in sand, mud or snow and rocking the vehicle is required. See “Rocking Your Vehicle To Get It Out” under *If You Are Stuck: In Sand, Mud, Ice or Snow* on page 4-30.



To turn the system off, move the gear shift lever to FIRST (1) or SECOND (2) gear. See “Rocking Your Vehicle To Get It Out” under *If You Are Stuck: In Sand, Mud, Ice or Snow* on page 4-30. When the system is turned off, the TRAC OFF warning light will come on and stay on. If the ETS is limiting wheel spin when the system is turned off, the TRAC OFF light will come on – but the ETS will not turn off right away. It will continue to operate until there is no longer a need to limit wheel spin.

## Steering

### Power Steering

If you lose power steering assist because the engine stops or the system is not functioning, you can steer but it will take much more effort.

## Steering Tips Driving on Curves

It is important to take curves at a reasonable speed.

A lot of the “driver lost control” accidents mentioned on the news happen on curves. Here is why:

Experienced driver or beginner, each of us is subject to the same laws of physics when driving on curves. The traction of the tires against the road surface makes it possible for the vehicle to change its path when you turn the front wheels. If there is no traction, inertia will keep the vehicle going in the same direction. If you have ever tried to steer a vehicle on wet ice, you will understand this.

The traction you can get in a curve depends on the condition of your tires and the road surface, the angle at which the curve is banked, and your speed. While you are in a curve, speed is the one factor you can control.

Suppose you are steering through a sharp curve. Then you suddenly apply the brakes. Both control systems — steering and braking — have to do their work where the tires meet the road. Unless you have four-wheel anti-lock brakes, adding the hard braking can demand too much of those places. You can lose control.



The same thing can happen if you are steering through a sharp curve and you suddenly accelerate. Those two control systems — steering and acceleration — can overwhelm those places where the tires meet the road and make you lose control. See *Enhanced Traction System (ETS)* on page 4-9.

What should you do if this ever happens? Ease up on the brake or accelerator pedal, steer the vehicle the way you want it to go, and slow down.

Speed limit signs near curves warn that you should adjust your speed. Of course, the posted speeds are based on good weather and road conditions. Under less favorable conditions you will want to go slower.

If you need to reduce your speed as you approach a curve, do it before you enter the curve, while your front wheels are straight ahead.

Try to adjust your speed so you can “drive” through the curve. Maintain a reasonable, steady speed. Wait to accelerate until you are out of the curve, and then accelerate gently into the straightaway.

## Steering in Emergencies

There are times when steering can be more effective than braking. For example, you come over a hill and find a truck stopped in your lane, or a car suddenly pulls out from nowhere, or a child darts out from between parked cars and stops right in front of you. You can avoid these problems by braking — if you can stop in time. But sometimes you can not; there is not room. That is the time for evasive action — steering around the problem.

Your vehicle can perform very well in emergencies like these. First apply your brakes — but, unless you have anti-lock, not enough to lock your wheels. See *Braking* on page 4-6. It is better to remove as much speed as you can from a possible collision. Then steer around the problem, to the left or right depending on the space available.

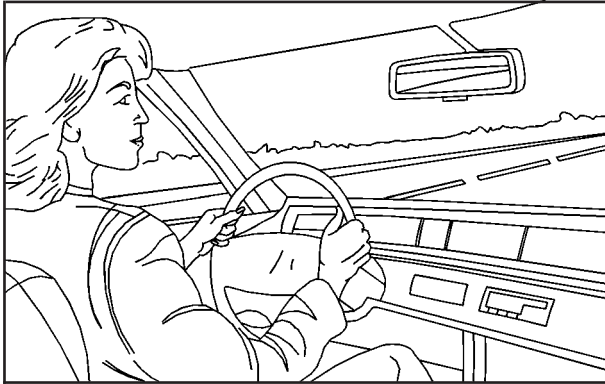

An emergency like this requires close attention and a quick decision. If you are holding the steering wheel at the recommended 9 and 3 o'clock positions, you can turn it a full 180 degrees very quickly without removing either hand. But you have to act fast, steer quickly, and just as quickly straighten the wheel once you have avoided the object.

The fact that such emergency situations are always possible is a good reason to practice defensive driving at all times and wear safety belts properly.

## Off-Road Recovery

You may find that your right wheels have dropped off the edge of a road onto the shoulder while you're driving.

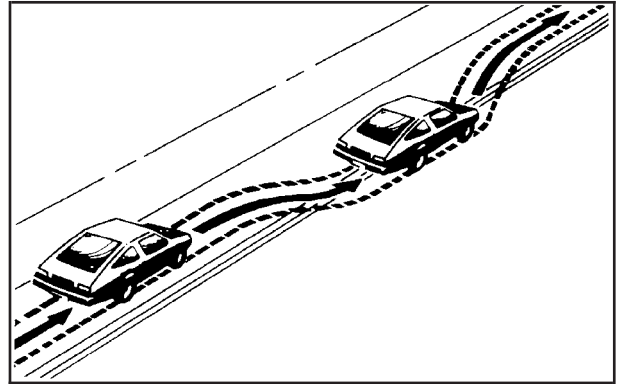

If the level of the shoulder is only slightly below the pavement, recovery should be fairly easy. Ease off the accelerator and then, if there is nothing in the way, steer so that your vehicle straddles the edge of the pavement. You can turn the steering wheel up to one-quarter turn until the right front tire contacts the pavement edge. Then turn your steering wheel to go straight down the roadway.

## Passing

The driver of a vehicle about to pass another on a two-lane highway waits for just the right moment, accelerates, moves around the vehicle ahead, then goes back into the right lane again. A simple maneuver?

Not necessarily! Passing another vehicle on a two-lane highway is a potentially dangerous move, since the passing vehicle occupies the same lane as oncoming traffic for several seconds. A miscalculation, an error in judgment, or a brief surrender to frustration or anger can suddenly put the passing driver face to face with the worst of all traffic accidents — the head-on collision.

So here are some tips for passing:

- “Drive ahead.” Look down the road, to the sides and to crossroads for situations that might affect your passing patterns. If you have any doubt whatsoever about making a successful pass, wait for a better time.
- Watch for traffic signs, pavement markings and lines. If you can see a sign up ahead that might indicate a turn or an intersection, delay your pass. A broken center line usually indicates it is all right to pass (providing the road ahead is clear). Never cross a solid line on your side of the lane or a double solid line, even if the road seems empty of approaching traffic.
- Do not get too close to the vehicle you want to pass while you are awaiting an opportunity. For one thing, following too closely reduces your area of vision, especially if you are following a larger vehicle. Also, you will not have adequate space if the vehicle ahead suddenly slows or stops. Keep back a reasonable distance.
- When it looks like a chance to pass is coming up, start to accelerate but stay in the right lane and do not get too close. Time your move so you will be increasing speed as the time comes to move into the other lane. If the way is clear to pass, you will have a “running start” that more than makes up for the distance you would lose by dropping back. And if something happens to cause you to cancel your pass, you need only slow down and drop back again and wait for another opportunity.

- If other vehicles are lined up to pass a slow vehicle, wait your turn. But take care that someone is not trying to pass you as you pull out to pass the slow vehicle. Remember to glance over your shoulder and check the blind spot.
- Check your mirrors, glance over your shoulder, and start your left lane change signal before moving out of the right lane to pass. When you are far enough ahead of the passed vehicle to see its front in your inside mirror, activate your right lane change signal and move back into the right lane. (Remember that your right outside mirror is convex. The vehicle you just passed may seem to be farther away from you than it really is.)
- Try not to pass more than one vehicle at a time on two-lane roads. Reconsider before passing the next vehicle.

- Do not overtake a slowly moving vehicle too rapidly. Even though the brake lamps are not flashing, it may be slowing down or starting to turn.
- If you are being passed, make it easy for the following driver to get ahead of you. Perhaps you can ease a little to the right.

## Loss of Control

Let us review what driving experts say about what happens when the three control systems (brakes, steering and acceleration) do not have enough friction where the tires meet the road to do what the driver has asked.

In any emergency, do not give up. Keep trying to steer and constantly seek an escape route or area of less danger.

## Skidding

In a skid, a driver can lose control of the vehicle. Defensive drivers avoid most skids by taking reasonable care suited to existing conditions, and by not “overdriving” those conditions. But skids are always possible.

The three types of skids correspond to your vehicle’s three control systems. In the braking skid, your wheels are not rolling. In the steering or cornering skid, too much speed or steering in a curve causes tires to slip and lose cornering force. And in the acceleration skid, too much throttle causes the driving wheels to spin.

A cornering skid and an acceleration skid are best handled by easing your foot off the accelerator pedal.

If your vehicle starts to slide, ease your foot off the accelerator pedal and quickly steer the way you want the vehicle to go. If you start steering quickly enough, your vehicle may straighten out. Always be ready for a second skid if it occurs.

Of course, traction is reduced when water, snow, ice, gravel or other material is on the road. For safety, you will want to slow down and adjust your driving to these conditions. It is important to slow down on slippery surfaces because stopping distance will be longer and vehicle control more limited.

While driving on a surface with reduced traction, try your best to avoid sudden steering, acceleration or braking (including engine braking by shifting to a lower gear). Any sudden changes could cause the tires to slide. You may not realize the surface is slippery until your vehicle is skidding. Learn to recognize warning clues — such as enough water, ice or packed snow on the road to make a “mirrored surface” — and slow down when you have any doubt.

If you have the anti-lock braking system, remember: It helps avoid only the braking skid. If you do not have anti-lock, then in a braking skid (where the wheels are no longer rolling), release enough pressure on the brakes to get the wheels rolling again. This restores steering control. Push the brake pedal down steadily when you have to stop suddenly. As long as the wheels are rolling, you will have steering control.

## Driving at Night

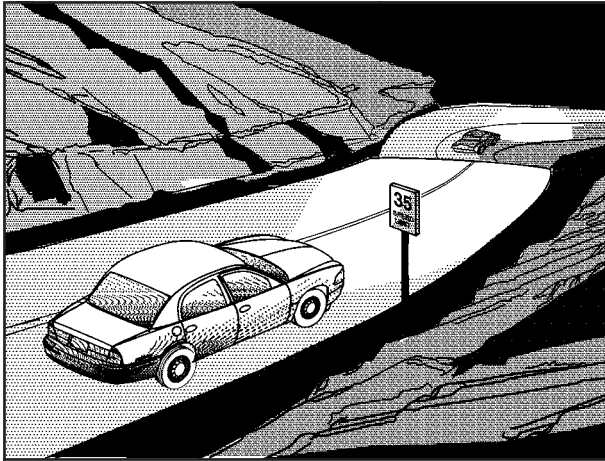

Night driving is more dangerous than day driving. One reason is that some drivers are likely to be impaired — by alcohol or drugs, with night vision problems, or by fatigue.

Here are some tips on night driving.

- Drive defensively.
- Do not drink and drive.
- Adjust your inside rearview mirror to reduce the glare from headlamps behind you.
- Since you can not see as well, you may need to slow down and keep more space between you and other vehicles.
- Slow down, especially on higher speed roads. Your headlamps can light up only so much road ahead.
- In remote areas, watch for animals.
- If you are tired, pull off the road in a safe place and rest.

No one can see as well at night as in the daytime.

But as we get older these differences increase.

A 50-year-old driver may require at least twice as much light to see the same thing at night as a 20-year-old.

What you do in the daytime can also affect your night vision. For example, if you spend the day in bright sunshine you are wise to wear sunglasses. Your eyes will have less trouble adjusting to night. But if you are driving, do not wear sunglasses at night. They may cut down on glare from headlamps, but they also make a lot of things invisible.

You can be temporarily blinded by approaching headlamps. It can take a second or two, or even several seconds, for your eyes to readjust to the dark. When you are faced with severe glare (as from a driver who does not lower the high beams, or a vehicle with misaimed headlamps), slow down a little. Avoid staring directly into the approaching headlamps.

Keep your windshield and all the glass on your vehicle clean — inside and out. Glare at night is made much worse by dirt on the glass. Even the inside of the glass can build up a film caused by dust. Dirty glass makes lights dazzle and flash more than clean glass would, making the pupils of your eyes contract repeatedly.

Remember that your headlamps light up far less of a roadway when you are in a turn or curve. Keep your eyes moving; that way, it is easier to pick out dimly lighted objects. Just as your headlamps should be checked regularly for proper aim, so should your eyes be examined regularly. Some drivers suffer from night blindness — the inability to see in dim light — and are not even aware of it.

## Driving in Rain and on Wet Roads

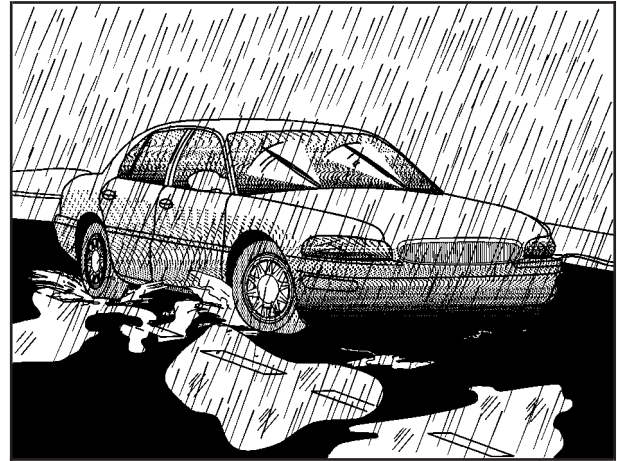

Rain and wet roads can mean driving trouble. On a wet road, you can not stop, accelerate or turn as well because your tire-to-road traction is not as good as on dry roads. And, if your tires do not have much tread left, you will get even less traction. It is always wise to go slower and be cautious if rain starts to fall while you are driving. The surface may get wet suddenly when your reflexes are tuned for driving on dry pavement.

The heavier the rain, the harder it is to see. Even if your windshield wiper blades are in good shape, a heavy rain can make it harder to see road signs and traffic signals, pavement markings, the edge of the road and even people walking.

It is wise to keep your windshield wiping equipment in good shape and keep your windshield washer tank filled with washer fluid. Replace your windshield wiper inserts when they show signs of streaking or missing areas on the windshield, or when strips of rubber start to separate from the inserts.

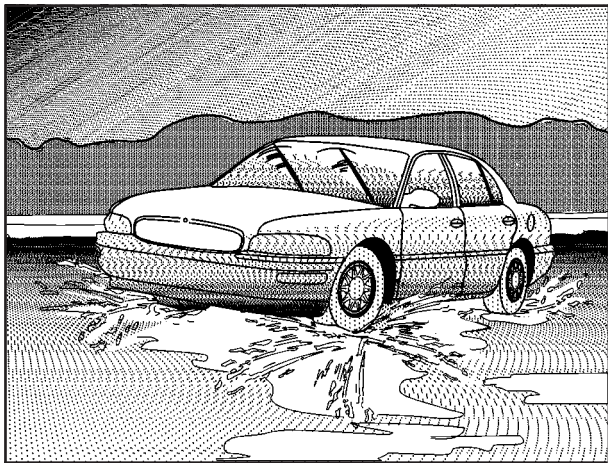

Driving too fast through large water puddles or even going through some car washes can cause problems, too. The water may affect your brakes. Try to avoid puddles. But if you can not, try to slow down before you hit them.

**⚠ CAUTION:**

**Wet brakes can cause accidents. They will not work as well in a quick stop and may cause pulling to one side. You could lose control of the vehicle.**

**After driving through a large puddle of water or a car wash, apply your brake pedal lightly until your brakes work normally.**



## Hydroplaning

Hydroplaning is dangerous. So much water can build up under your tires that they can actually ride on the water. This can happen if the road is wet enough and you are going fast enough. When your vehicle is hydroplaning, it has little or no contact with the road.

Hydroplaning does not happen often. But it can if your tires do not have much tread or if the pressure in one or more is low. It can happen if a lot of water is standing on the road. If you can see reflections from trees, telephone poles or other vehicles, and raindrops “dimple” the water’s surface, there could be hydroplaning.

Hydroplaning usually happens at higher speeds. There just is not a hard and fast rule about hydroplaning. The best advice is to slow down when it is raining.

## Driving Through Deep Standing Water

**Notice:** If you drive too quickly through deep puddles or standing water, water can come in through your engine’s air intake and badly damage your engine. Never drive through water that is slightly lower than the underbody of your vehicle. If you can not avoid deep puddles or standing water, drive through them very slowly.

## Driving Through Flowing Water

### CAUTION:

**Flowing or rushing water creates strong forces. If you try to drive through flowing water, as you might at a low water crossing, your vehicle can be carried away. As little as six inches of flowing water can carry away a smaller vehicle. If this happens, you and other vehicle occupants could drown. Do not ignore police warning signs, and otherwise be very cautious about trying to drive through flowing water.**

## Some Other Rainy Weather Tips

- Besides slowing down, allow some extra following distance. And be especially careful when you pass another vehicle. Allow yourself more clear room ahead, and be prepared to have your view restricted by road spray.
- Have good tires with proper tread depth. See *Tires* on page 5-57.

## City Driving



One of the biggest problems with city streets is the amount of traffic on them. You will want to watch out for what the other drivers are doing and pay attention to traffic signals.

Here are ways to increase your safety in city driving:

- Know the best way to get to where you are going. Get a city map and plan your trip into an unknown part of the city just as you would for a cross-country trip.
- Try to use the freeways that rim and crisscross most large cities. You will save time and energy. See *Freeway Driving on page 4-21*.
- Treat a green light as a warning signal. A traffic light is there because the corner is busy enough to need it. When a light turns green, and just before you start to move, check both ways for vehicles that have not cleared the intersection or may be running the red light.

## Freeway Driving

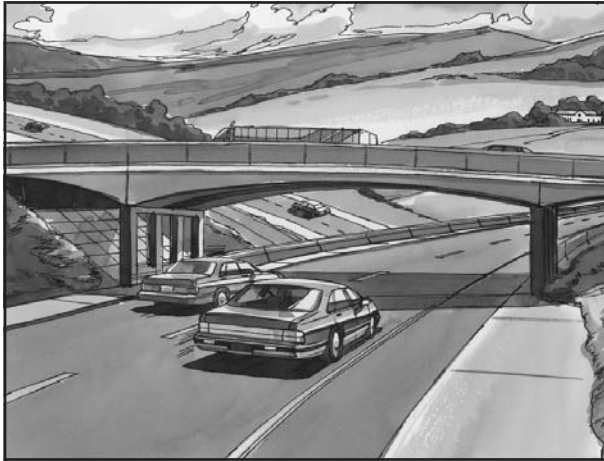

Mile for mile, freeways (also called thruways, parkways, expressways, turnpikes or superhighways) are the safest of all roads. But they have their own special rules.

The most important advice on freeway driving is: Keep up with traffic and keep to the right. Drive at the same speed most of the other drivers are driving. Too-fast or too-slow driving breaks a smooth traffic flow. Treat the left lane on a freeway as a passing lane.

At the entrance, there is usually a ramp that leads to the freeway. If you have a clear view of the freeway as you drive along the entrance ramp, you should begin to check traffic. Try to determine where you expect to blend with the flow. Try to merge into the gap at close to the prevailing speed. Switch on your turn signal, check your mirrors and glance over your shoulder as often as necessary. Try to blend smoothly with the traffic flow.

Once you are on the freeway, adjust your speed to the posted limit or to the prevailing rate if it is slower. Stay in the right lane unless you want to pass.

Before changing lanes, check your mirrors. Then use your turn signal.

Just before you leave the lane, glance quickly over your shoulder to make sure there is not another vehicle in your “blind” spot.

Once you are moving on the freeway, make certain you allow a reasonable following distance.

Expect to move slightly slower at night.

When you want to leave the freeway, move to the proper lane well in advance. If you miss your exit, do not, under any circumstances, stop and back up. Drive on to the next exit.

The exit ramp can be curved, sometimes quite sharply. The exit speed is usually posted. Reduce your speed according to your speedometer, not to your sense of motion. After driving for any distance at higher speeds, you may tend to think you are going slower than you actually are.

## Before Leaving on a Long Trip

Make sure you are ready. Try to be well rested. If you must start when you are not fresh — such as after a day's work — do not plan to make too many miles that first part of the journey. Wear comfortable clothing and shoes you can easily drive in.

Is your vehicle ready for a long trip? If you keep it serviced and maintained, it is ready to go. If it needs service, have it done before starting out. Of course, you will find experienced and able service experts in GM dealerships all across North America. They will be ready and willing to help if you need it.

Here are some things you can check before a trip:

- *Windshield Washer Fluid:* Is the reservoir full? Are all windows clean inside and outside?
- *Wiper Blades:* Are they in good shape?
- *Fuel, Engine Oil, Other Fluids:* Have you checked all levels?
- *Lamps:* Are they all working? Are the lenses clean?
- *Tires:* They are vitally important to a safe, trouble-free trip. Is the tread good enough for long-distance driving? Are the tires all inflated to the recommended pressure?
- *Weather Forecasts:* What is the weather outlook along your route? Should you delay your trip a short time to avoid a major storm system?
- *Maps:* Do you have up-to-date maps?

## Highway Hypnosis

Is there actually such a condition as “highway hypnosis”? Or is it just plain falling asleep at the wheel? Call it highway hypnosis, lack of awareness, or whatever.

There is something about an easy stretch of road with the same scenery, along with the hum of the tires on the road, the drone of the engine, and the rush of the wind against the vehicle that can make you sleepy. Do not let it happen to you! If it does, your vehicle can leave the road in *less than a second*, and you could crash and be injured.

What can you do about highway hypnosis? First, be aware that it can happen.

Then here are some tips:

- Make sure your vehicle is well ventilated, with a comfortably cool interior.
- Keep your eyes moving. Scan the road ahead and to the sides. Check your rearview mirrors and your instruments frequently.
- If you get sleepy, pull off the road into a rest, service or parking area and take a nap, get some exercise, or both. For safety, treat drowsiness on the highway as an emergency.

## Hill and Mountain Roads



Driving on steep hills or mountains is different from driving in flat or rolling terrain.

If you drive regularly in steep country, or if you are planning to visit there, here are some tips that can make your trips safer and more enjoyable.

- Keep your vehicle in good shape. Check all fluid levels and also the brakes, tires, cooling system and transaxle. These parts can work hard on mountain roads.
- Know how to go down hills. The most important thing to know is this: let your engine do some of the slowing down. Shift to a lower gear when you go down a steep or long hill.

### **CAUTION:**

**If you do not shift down, your brakes could get so hot that they would not work well. You would then have poor braking or even none going down a hill. You could crash. Shift down to let your engine assist your brakes on a steep downhill slope.**



## **CAUTION:**

**Coasting downhill in NEUTRAL (N) or with the ignition off is dangerous. Your brakes will have to do all the work of slowing down. They could get so hot that they would not work well. You would then have poor braking or even none going down a hill. You could crash. Always have your engine running and your vehicle in gear when you go downhill.**

- Know how to go uphill. You may want to shift down to a lower gear. The lower gears help cool your engine and transaxle, and you can climb the hill better.
- Stay in your own lane when driving on two-lane roads in hills or mountains. Do not swing wide or cut across the center of the road. Drive at speeds that let you stay in your own lane.
- As you go over the top of a hill, be alert. There could be something in your lane, like a stalled car or an accident.
- You may see highway signs on mountains that warn of special problems. Examples are long grades, passing or no-passing zones, a falling rocks area or winding roads. Be alert to these and take appropriate action.

## Winter Driving



Here are some tips for winter driving:

- Have your vehicle in good shape for winter.
- You may want to put winter emergency supplies in your trunk.



Include an ice scraper, a small brush or broom, a supply of windshield washer fluid, a rag, some winter outer clothing, a small shovel, a flashlight, a red cloth and a couple of reflective warning triangles. And, if you will be driving under severe conditions, include a small bag of sand, a piece of old carpet or a couple of burlap bags to help provide traction. Be sure you properly secure these items in your vehicle.



## Driving on Snow or Ice

Most of the time, those places where your tires meet the road probably have good traction.

However, if there is snow or ice between your tires and the road, you can have a very slippery situation. You will have a lot less traction or “grip” and will need to be very careful.



What is the worst time for this? “Wet ice.” Very cold snow or ice can be slick and hard to drive on. But wet ice can be even more trouble because it may offer the least traction of all. You can get wet ice when it is about freezing (32°F; 0°C) and freezing rain begins to fall. Try to avoid driving on wet ice until salt and sand crews can get there.

Whatever the condition — smooth ice, packed, blowing or loose snow — drive with caution.

If your vehicle has the Enhanced Traction System, keep the system on. It will improve your ability to accelerate when driving on a slippery road. Even though your vehicle has this system, you will want to slow down and adjust your driving to the road conditions. See *Enhanced Traction System (ETS) on page 4-9*.

Unless you have the anti-lock braking system, you will want to brake very gently, too. (If you do have anti-lock, see *Braking on page 4-6*. This system improves your vehicle’s stability when you make a hard stop on a slippery road.) Whether you have the anti-lock braking system or not, you will want to begin stopping sooner than you would on dry pavement. Without anti-lock brakes, if you feel your vehicle begin to slide, let up on the brakes a little. Push the brake pedal down steadily to get the most traction you can.

Remember, unless you have anti-lock, if you brake so hard that your wheels stop rolling, you will just slide. Brake so your wheels always keep rolling and you can still steer.

- Whatever your braking system, allow greater following distance on any slippery road.
- Watch for slippery spots. The road might be fine until you hit a spot that is covered with ice. On an otherwise clear road, ice patches may appear in shaded areas where the sun can not reach: around clumps of trees, behind buildings or under bridges. Sometimes the surface of a curve or an overpass may remain icy when the surrounding roads are clear. If you see a patch of ice ahead of you, brake before you are on it. Try not to brake while you are actually on the ice, and avoid sudden steering maneuvers.

## If You Are Caught in a Blizzard

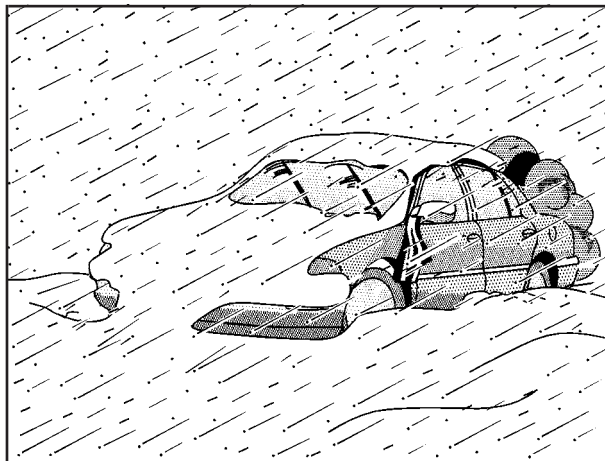

If you are stopped by heavy snow, you could be in a serious situation. You should probably stay with your vehicle unless you know for sure that you are near help and you can hike through the snow. Here are some things to do to summon help and keep yourself and your passengers safe:

- Turn on your hazard flashers.
- Tie a red cloth to your vehicle to alert police that you have been stopped by the snow.

- Put on extra clothing or wrap a blanket around you. If you have no blankets or extra clothing, make body insulators from newspapers, burlap bags, rags, floor mats — anything you can wrap around yourself or tuck under your clothing to keep warm.

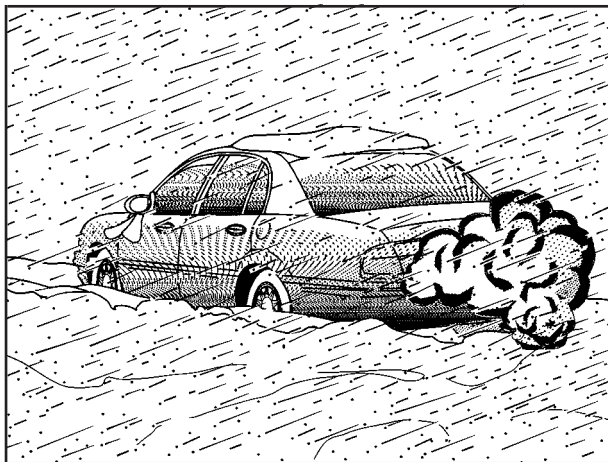

You can run the engine to keep warm, but be careful.

## **CAUTION:**

**Snow can trap exhaust gases under your vehicle. This can cause deadly CO (carbon monoxide) gas to get inside. CO could overcome you and kill you. You can not see it or smell it, so you might not know it is in your vehicle. Clear away snow from around the base of your vehicle, especially any that is blocking your exhaust pipe. And check around again from time to time to be sure snow does not collect there.**

**Open a window just a little on the side of the vehicle that is away from the wind. This will help keep CO out.**

Run your engine only as long as you must. This saves fuel. When you run the engine, make it go a little faster than just idle. That is, push the accelerator slightly. This uses less fuel for the heat that you get and it keeps the battery charged. You will need a well-charged battery to restart the vehicle, and possibly for signaling later on with your headlamps. Let the heater run for a while.

Then, shut the engine off and close the window almost all the way to preserve the heat. Start the engine again and repeat this only when you feel really uncomfortable from the cold. But do it as little as possible. Preserve the fuel as long as you can. To help keep warm, you can get out of the vehicle and do some fairly vigorous exercises every half hour or so until help comes.

## If You Are Stuck: In Sand, Mud, Ice or Snow

In order to free your vehicle when it is stuck, you will need to spin the wheels, but you do not want to spin your wheels too fast. The method known as “rocking” can help you get out when you are stuck, but you must use caution.

### CAUTION:

**If you let your tires spin at high speed, they can explode, and you or others could be injured. And, the transaxle or other parts of the vehicle can overheat. That could cause an engine compartment fire or other damage. When you are stuck, spin the wheels as little as possible. Do not spin the wheels above 35 mph (55 km/h) as shown on the speedometer.**

**Notice:** Spinning your wheels can destroy parts of your vehicle as well as the tires. If you spin the wheels too fast while shifting your transaxle back and forth, you can destroy your transaxle. See “Rocking Your Vehicle To Get It Out.”

For information about using tire chains on your vehicle, see *Tire Chains* on page 5-73.

## Rocking Your Vehicle To Get It Out

First, turn your steering wheel left and right. That will clear the area around your front wheels. If you have the Enhanced Traction System, you should turn the system off. See *Enhanced Traction System (ETS) on page 4-9*. Then shift back and forth between REVERSE (R) and FIRST (1) or SECOND (2) gear. The Enhanced Traction System will be turned off in FIRST (1) or SECOND (2) gear. Spin the wheels as little as possible. Release the accelerator pedal while you shift, and press lightly on the accelerator pedal when the transaxle is in gear. By slowly spinning your wheels in the forward and reverse directions, you will cause a rocking motion that may free your vehicle. If that does not get you out after a few tries, you may need to be towed out. If you do need to be towed out, see *Towing Your Vehicle on page 4-31*.

## Towing

### Towing Your Vehicle

Consult your dealer or a professional towing service if you need to have your disabled vehicle towed. See *Roadside Assistance Program on page 7-5*.

If you want to tow your vehicle behind another vehicle for recreational purposes (such as behind a motorhome), see “Recreational Vehicle Towing” following.

## Recreational Vehicle Towing

Recreational vehicle towing means towing your vehicle behind another vehicle – such as behind a motorhome. The two most common types of recreational vehicle towing are known as dinghy towing, towing the vehicle with all four wheels on the ground, and dolly towing, towing the vehicle with two wheels on the ground and two wheels up on a device known as a dolly.

With the proper preparation and equipment, many vehicles can be towed in these ways. See “Dinghy Towing” and “Dolly Towing,” following.

Here are some important things to consider before you do recreational vehicle towing:

- What is the towing capacity of the towing vehicle? Be sure you read the tow vehicle manufacturer's recommendations.
- How far will you tow? Some vehicles have restrictions on how far and how long they can tow.
- Do you have the proper towing equipment? See your dealer or trailering professional for additional advice and equipment recommendations.
- Is your vehicle ready to be towed? Just as you would prepare your vehicle for a long trip, you will want to make sure your vehicle is prepared to be towed. See *Before Leaving on a Long Trip* on page 4-22.

## Dinghy Towing

**Notice:** If you tow your vehicle with all four wheels on the ground, the drivetrain components could be damaged. The repairs would not be covered by your warranty. Do not tow your vehicle with all four wheels on the ground.

Your vehicle was not designed to be towed with all four wheels on the ground. If your vehicle must be towed, you should use a dolly. See “Dolly Towing” that follows for more information.

## Dolly Towing

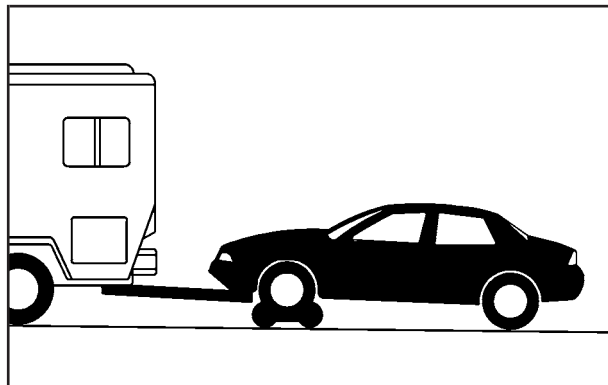

Your vehicle can be towed using a dolly. To tow your vehicle using a dolly, follow these steps:

1. Put the front wheels on a dolly.
2. Put the gear shift lever in PARK (P).
3. Set the parking brake and then remove the ignition key.
4. Clamp the steering wheel in a straight-ahead position.
5. Release the parking brake.

## Loading Your Vehicle

It is very important to know how much weight your vehicle can carry. This weight is called the vehicle capacity weight and includes the weight of all occupants, cargo and all nonfactory-installed options. Two labels on your vehicle show how much weight it may properly carry, the Tire and Loading Information label and the Certification label.

### CAUTION:

Do not load your vehicle any heavier than the GVWR, or either the maximum front or rear GAWR. If you do, parts on your vehicle can break, and it can change the way your vehicle handles. These could cause you to lose control and crash. Also, overloading can shorten the life of your vehicle.

## Tire and Loading Information Label

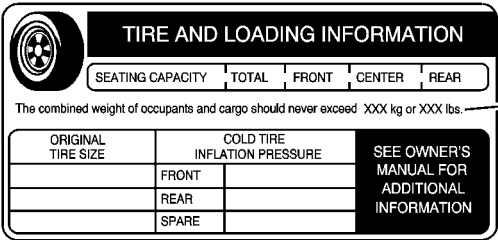

The combined weight of occupants and cargo should never exceed XXX kg or XXX lbs. A

ORIGINAL TIRE SIZE	COLD TIRE INFLATION PRESSURE		SEE OWNER'S MANUAL FOR ADDITIONAL INFORMATION
	FRONT	REAR	

The label features a tire icon on the left, a title bar, a row of five boxes for seating capacity, and a table for tire information. A line labeled 'A' points to the weight limit text.

Example 1

A. Vehicle Capacity Weight



TIRE-LOADING INFORMATION					
OCCUPANTS			VEHICLE CAP. WT.		
FRT.	CTR.	RR.	TOTAL	LBS.	KG.
□	□	□	□	□	□
MAX. LOADING & GVWR SAME AS VEHICLE					
CAPACITY WEIGHT			XXX	COLD TIRE	
TIRE SIZE			SPEED	PRESSURE	
			RTG	PSI/KPa	
FRT.					
RR.					
SPA.					
IF TIRES ARE HOT, ADD 4PSI/28KPa					
SEE OWNER'S MANUAL FOR ADDITIONAL INFORMATION					

**Example 2**

A. Vehicle Capacity Weight

The Tire and Loading Information label shows the seating capacity and the total weight your vehicle can properly carry. This weight is called the vehicle capacity weight. If your vehicle has the Tire and Loading Information label, Example 1, the label is attached to the center pillar, near the driver's door latch. If your vehicle has the Tire-Loading Information label, Example 2, the label is on the inside trunk lid.

The Tire and Loading Information label also gives you the size and recommended inflation pressure for the factory-installed, original equipment tires on your vehicle. For more information on tires and inflation see *Tires on page 5-57* and *Inflation - Tire Pressure on page 5-64*.

There is also important loading information on the Certification label. It tells you the Gross Vehicle Weight Rating (GVWR) and the Gross Axle Weight Rating (GAWR) for the front and rear axle; see "Certification Label" later in this section.

## Steps for Determining Correct Load Limit

1. Locate the statement “The combined weight of occupants and cargo should never exceed XXX pounds” on your vehicle placard.
2. Determine the combined weight of the driver and passengers that will be riding in your vehicle.
3. Subtract the combined weight of the driver and passengers from XXX kilograms or XXX pounds.
4. The resulting figure equals the available amount of cargo and luggage load capacity. For example, if the “XXX” amount equals 1400 lbs. and there will be five 150 lb. passengers in your vehicle, the amount of available cargo and luggage load capacity is 650 lbs. (1400 – 750 (5 x 150) = 650 lbs.).
5. Determine the combined weight of luggage and cargo being loaded on the vehicle. That weight may not safely exceed the available cargo and luggage load capacity calculated in Step 4.
6. If your vehicle will be towing a trailer, the load from your trailer will be transferred to your vehicle. Consult this manual to determine how this reduces the available cargo and luggage load capacity of your vehicle.

If your vehicle can tow a trailer, see *Towing a Trailer* on page 4-39 for important information on towing a trailer, towing safety rules and trailering tips.

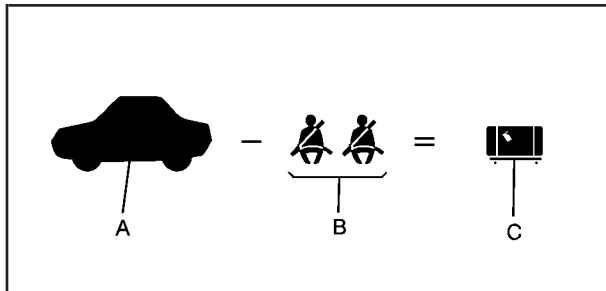

**Example 1**  
**Loading Your Vehicle**

Item	Description	Total
A	Vehicle Capacity Weight for Example 1 =	1,000 lbs (453 kg)
B	Subtract Occupant Weight @ 150 lbs (68 kg) x 2 =	300 lbs (136 kg)
C	Available Occupant and Cargo Weight =	700 lbs (317 kg)

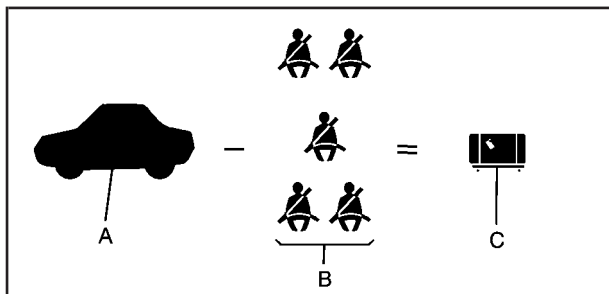

**Example 2**  
**Loading Your Vehicle**

Item	Description	Total
A	Vehicle Capacity Weight for Example 2 =	1,000 lbs (453 kg)
B	Subtract Occupant Weight @ 150 lbs (68 kg) x 5 =	750 lbs (340 kg)
C	Available Cargo Weight =	250 lbs (113 kg)

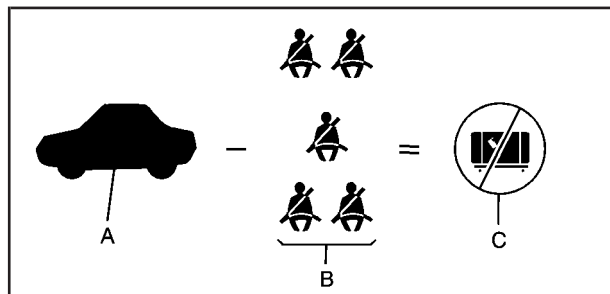

**Example 3**  
**Loading Your Vehicle**

Item	Description	Total
A	Vehicle Capacity Weight for Example 3 =	1,000 lbs (453 kg)
B	Subtract Occupant Weight @ 200 lbs (91 kg) x 5 =	1000 lbs (453 kg)
C	Available Cargo Weight	0 lbs (0 kg)

Refer to your vehicle's tire and loading information label for specific information about your vehicle's capacity weight and seating positions. The combined weight of the driver, passengers, and cargo should never exceed your vehicle's capacity weight.

## Certification Label

	MFD BY GENERAL MOTORS CORP			
DATE	GVWR	GAWR FRT	GAWR RB	
<input type="text"/>	<input type="text"/>	<input type="text"/>	<input type="text"/>	
THIS VEHICLE CONFORMS TO ALL APPLICABLE U.S. FEDERAL MOTOR VEHICLE SAFETY, BUMPER, AND THEFT PREVENTION STANDARDS IN EFFECT ON THE DATE OF MANUFACTURE SHOWN ABOVE.				
200	<input type="text"/>	<input type="text"/>	PASS CAR	

**EXAMPLE**

The Certification label, found on the rear edge of the driver's door tells the gross weight capacity of the vehicle, called the Gross Vehicle Weight Rating (GVWR). The GVWR includes the weight of the vehicle, all occupants, fuel and cargo. Never exceed the GVWR for the vehicle or the Gross Axle Weight Rating (GAWR) for either the front or rear axle.

If the vehicle is going to carry a heavy load, spread it out. Do not carry more than 167 lbs (75 kg) in your trunk.

### **CAUTION:**

**Do not load your vehicle any heavier than the GVWR, or either the maximum front or rear GAWR. If you do, parts on your vehicle can break, and it can change the way your vehicle handles. These could cause you to lose control and crash. Also, overloading can shorten the life of your vehicle.**

**Notice:** Overloading your vehicle may cause damage. Repairs would not be covered by your warranty. Do not overload your vehicle.

If things like suitcases, tools, packages or any thing else are put inside the vehicle, they will go as fast as the vehicle goes. If you have to stop or turn quickly, or if there is a crash, they will keep going.

### CAUTION:

Things you put inside your vehicle can strike and injure people in a sudden stop or turn, or in a crash.

- Put things in the trunk of your vehicle. In a trunk, put them as far forward as you can. Try to spread the weight evenly.
- Never stack heavier things, like suitcases, inside the vehicle so that some of them are above the tops of the seats.
- Do not leave an unsecured child restraint in your vehicle.
- When you carry something inside the vehicle, secure it whenever you can.
- Do not leave a seat folded down unless you need to.

## Towing a Trailer

### CAUTION:

If you do not use the correct equipment and drive properly, you can lose control when you pull a trailer. For example, if the trailer is too heavy, the brakes may not work well — or even at all. You and your passengers could be seriously injured. You may also damage your vehicle; the resulting repairs would not be covered by your warranty. Pull a trailer only if you have followed all the steps in this section. Ask your dealer for advice and information about towing a trailer with your vehicle.

The vehicle can tow a trailer if it is equipped with the proper trailer towing equipment. To identify what the vehicle trailering capacity is for the vehicle, read the information in “Weight of the Trailer” that appears later in this section. But trailering is different than just driving the vehicle by itself.

Trailer means changes in handling, acceleration, braking, durability, and fuel economy. Successful, safe trailering takes correct equipment, and it has to be used properly.

That is the reason for this part. In it are many time-tested, important trailering tips and safety rules. Many of these are important for your safety and that of your passengers. So please read this section carefully before pulling a trailer.

Load-pulling components such as the engine, transaxle, wheel assembly, and tires are forced to work harder against the drag of the added weight. The engine is required to operate at relatively higher speeds and under greater loads, generating extra heat. What is more, the trailer adds considerably to wind resistance, increasing the pulling requirements.

## If You Do Decide To Pull A Trailer

Here are some important points:

- There are many different laws, including speed limit restrictions, having to do with trailering. Make sure your rig will be legal, not only where you live but also where you will be driving. A good source for this information can be state or provincial police.
- Consider using a sway control. Ask a hitch dealer about sway controls.

- Do not tow a trailer at all during the first 1,000 miles (1 600 km) the vehicle is driven. The engine, axle or other parts could be damaged.
- Then, during the first 500 miles (800 km) that the vehicle tows a trailer, do not drive over 50 mph (80 km/h) and do not make starts at full throttle. This helps the engine and other parts of the vehicle wear in at the heavier loads.
- Obey speed limit restrictions when towing a trailer. Do not drive faster than the maximum posted speed for trailers, or no more than 55 mph (90 km/h), to save wear on the vehicle's parts.

There are three important considerations have to do with weight:

- The weight of the trailer.
- The weight of the trailer tongue.
- The total weight on the vehicle's tires.

## Weight of the Trailer

How heavy can a trailer safely be?

It should never weigh more than 1,000 lbs (450 kg). But even that can be too heavy.

It depends on how you plan to use your rig. For example, speed, altitude, road grades, outside temperature and how much the vehicle is used to pull a trailer are all important. And, it can also depend on any special equipment that is on the vehicle.

Ask your dealer for our trailering information or advice, or you can write us at:

Buick Customer Assistance Center  
P.O. Box 33136  
Detroit, MI 48232-5136

In Canada, write to:

General Motors of Canada Limited  
Customer Communication Centre, 163-005  
1908 Colonel Sam Drive  
Oshawa, Ontario L1H 8P7

## Weight of the Trailer Tongue

The tongue load (A) of any trailer is an important weight to measure because it affects the total or gross weight of the vehicle. The Gross Vehicle Weight (GVW) includes the curb weight of the vehicle, any cargo in it, and the people who will be riding in the vehicle. If there are a lot of options, equipment, passengers or cargo in the vehicle, it will reduce the tongue weight the vehicle can carry, which will also reduce the trailer weight the vehicle can tow. And if you tow a trailer, you

must add the tongue load to the GVW because the vehicle will be carrying that weight, too. See *Loading Your Vehicle* on page 4-34 for more information about the vehicle's maximum load capacity.

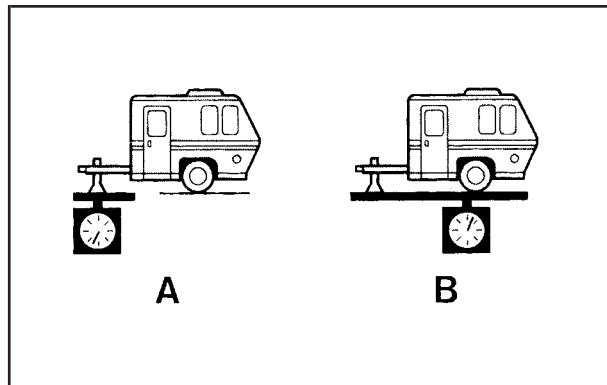

When using a weight-carrying hitch, the trailer tongue (A) should weigh 10 percent to 15 percent of the total loaded trailer weight (B).

After the trailer is loaded, weigh the trailer and the tongue, separately, to see if the weights are proper. The correct weight could be achieved simply by moving some items around in the trailer.

## Total Weight on Your Vehicle's Tires

Be sure the vehicle's tires are inflated to the upper limit for cold tires. These numbers can be found on the Tire-Loading Information label. See *Loading Your Vehicle on page 4-34*. Be sure not to go over the GVW limit for the vehicle, or the GAWR, including the weight of the trailer tongue. If a weight distribution hitch is used, make sure not to go over the rear axle limit before applying the weight distribution spring bars.

## Hitches

It is important to have the correct hitch equipment. Crosswinds, large trucks going by and rough roads are a few reasons why the right hitch is needed. Here are some rules to follow:

- The rear bumper on the vehicle is not intended for hitches. Do not attach rental hitches or other bumper-type hitches to it. Use only a frame-mounted hitch that does not attach to the bumper.
- If holes need to be made in the body of the vehicle to install a trailer hitch, then be sure to seal the holes later when the hitch is removed. If the holes are not sealed, deadly carbon monoxide (CO) from the exhaust can get into the vehicle. See *Engine Exhaust on page 2-29*. Dirt and water can, too.

## Safety Chains

Chains should always be attached between the vehicle and the trailer. Cross the safety chains under the tongue of the trailer so that the tongue will not drop to the road if it becomes separated from the hitch. Instructions about safety chains may be provided by the hitch manufacturer or by the trailer manufacturer. Follow the manufacturer's recommendation for attaching safety chains and do not attach them to the bumper. Always leave just enough slack so the rig can be turned. And, never allow safety chains to drag on the ground.

## Trailer Brakes

Because the vehicle has anti-lock brakes, do not try to tap into the vehicle's brake system. If that is done, both brake systems will not work well, or at all.

## Driving with a Trailer

Towing a trailer requires a certain amount of experience. Before setting out for the open road, get to know the rig. Acquaint yourself with the feel of handling and braking with the added weight of the trailer. And always keep in mind that the vehicle is now a good deal longer and not nearly as responsive as the vehicle is by itself.



Before starting, check all trailer hitch parts and attachments, safety chains, electrical connector, lamps, tires, and mirror adjustment. If the trailer has electric brakes, start the vehicle and trailer moving and then apply the trailer brake controller by hand to be sure the brakes are working. This lets you check the electrical connection at the same time.

During your trip, check occasionally to be sure that the load is secure, and that the lamps and any trailer brakes are still working.

## Following Distance

Stay at least twice as far behind the vehicle ahead as when driving the vehicle without a trailer. This can help avoid situations that require heavy braking and sudden turns.

## Passing

More passing distance is needed up ahead when towing a trailer. And, because the vehicle is a good deal longer with the trailer, you will need to go much farther beyond the vehicle you have passed before you can return to the proper lane.

## Backing Up

Hold the bottom of the steering wheel with one hand. Then, to move the trailer to the left, move that hand to the left. To move the trailer to the right, move your hand to the right. Always back up slowly and, if possible, have someone guide you.

## Making Turns

***Notice:*** Making very sharp turns while trailering could cause the trailer to come in contact with the vehicle. Your vehicle could be damaged. Avoid making very sharp turns while trailering.

When turning with a trailer, make wider turns than normal. Do this so the trailer will not strike soft shoulders, curbs, road signs, trees, or other objects. Avoid jerky or sudden maneuvers. Signal well in advance.

## Turn Signals When Towing a Trailer

When towing a trailer, the vehicle may need a different turn signal flasher and/or extra wiring. Check with your dealer. The arrows on the instrument panel will flash whenever signaling a turn or lane change. Properly hooked up, the trailer lamps will also flash, telling other drivers you are about to turn, change lanes or stop.

When towing a trailer, the arrows on the instrument panel will flash for turns even if the bulbs on the trailer are burned out. You may think drivers behind you are seeing your signal when they are not. It is important to check occasionally to be sure the trailer bulbs are still working.

## Driving On Grades

Reduce speed and shift to a lower gear *before* starting down a long hill or steep downgrade. If the vehicle is not shifted down, the brakes might have to be used so much that they would get hot and no longer work well.

On a long uphill grade, shift down and reduce the vehicle's speed to around 45 mph (70 km/h) to reduce the possibility of engine and transaxle overheating.

If towing a trailer, you may want to drive in THIRD (3) instead of AUTOMATIC OVERDRIVE (Ⓓ). Shift to a lower gear as needed.

## Parking on Hills

### CAUTION:

**You really should not park your vehicle, with a trailer attached, on a hill. If something goes wrong, your rig could start to move. People can be injured, and both your vehicle and the trailer can be damaged.**

But if the rig ever has to be parked on a hill, here is how to do it:

1. Apply the regular brakes, but do not shift into PARK (P) yet.
2. Have someone place chocks under the trailer's wheels.
3. When the wheel chocks are in place, release the regular brakes until the chocks absorb the load.
4. Reapply the regular brakes. Then apply the parking brake, and shift to PARK (P).
5. Release the regular brakes.

## When You Are Ready to Leave After Parking on a Hill

1. Apply the regular brakes and hold the pedal down while you:
  - Start the engine.
  - Shift into a gear.
  - Release the parking brake.
2. Let up on the brake pedal.
3. Drive slowly until the trailer is clear of the chocks.
4. Stop and have someone pick up and store the chocks.

## Maintenance When Trailer Towing

The vehicle will need service more often when it pulls a trailer. See *Scheduled Maintenance on page 6-4* for more information. Things that are especially important in trailer operation are automatic transaxle fluid; which should not be overfilled; engine oil, drive belt, cooling system, and brake system. Each of these is covered in this manual, and the Index will help you find them quickly. If trailering, it is a good idea to review this information before starting on a trip.

Check periodically to see that all hitch nuts and bolts are tight.

## Engine Cooling When Trailer Towing

The cooling system may temporarily overheat during severe operating conditions. See *Engine Overheating on page 5-25*.

 **NOTES**

---

---

---

---

---

---

---

---

---

---

---

---

---

---

---

---

---

---

---

---

---

---

---

## Section 5 Service and Appearance Care

---

<b>Service</b> .....	5-3	Battery .....	5-41
Doing Your Own Service Work .....	5-3	Jump Starting .....	5-42
Adding Equipment to the Outside of Your Vehicle .....	5-4	<b>Headlamp Aiming</b> .....	5-49
<b>Fuel</b> .....	5-4	<b>Bulb Replacement</b> .....	5-51
Gasoline Octane .....	5-4	Halogen Bulbs .....	5-51
Gasoline Specifications .....	5-5	Headlamps .....	5-51
California Fuel .....	5-5	Front Turn Signal and Parking Lamps .....	5-52
Additives .....	5-6	Center High-Mounted Stoplamp (CHMSL) .....	5-53
Fuels in Foreign Countries .....	5-6	Taillamps, Turn Signal, and Stoplamps .....	5-54
Filling Your Tank .....	5-7	Back-Up Lamps .....	5-55
Filling a Portable Fuel Container .....	5-9	<b>Windshield Wiper Blade Replacement</b> .....	5-56
<b>Checking Things Under the Hood</b> .....	5-10	<b>Tires</b> .....	5-57
Hood Release .....	5-10	Inflation - Tire Pressure .....	5-64
Engine Compartment Overview .....	5-12	Tire Pressure Monitor System .....	5-65
Engine Oil .....	5-13	Tire Inspection and Rotation .....	5-67
Engine Air Cleaner/Filter .....	5-18	When It Is Time for New Tires .....	5-68
Automatic Transaxle Fluid .....	5-19	Buying New Tires .....	5-69
Engine Coolant .....	5-22	Uniform Tire Quality Grading .....	5-70
Radiator Pressure Cap .....	5-25	Wheel Alignment and Tire Balance .....	5-71
Engine Overheating .....	5-25	Wheel Replacement .....	5-72
Cooling System .....	5-28	Tire Chains .....	5-73
Power Steering Fluid .....	5-35	If a Tire Goes Flat .....	5-74
Windshield Washer Fluid .....	5-36	Changing a Flat Tire .....	5-75
Brakes .....	5-38	Compact Spare Tire .....	5-87

## Section 5 Service and Appearance Care

---

<b>Appearance Care</b> .....	5-88	<b>Vehicle Identification</b> .....	5-96
Cleaning the Inside of Your Vehicle .....	5-88	Vehicle Identification Number (VIN) .....	5-96
Care of Safety Belts .....	5-91	Service Parts Identification Label .....	5-96
Weatherstrips .....	5-91	<b>Electrical System</b> .....	5-97
Cleaning the Outside of Your Vehicle .....	5-91	Add-On Electrical Equipment .....	5-97
Sheet Metal Damage .....	5-93	Headlamp Wiring .....	5-97
Finish Damage .....	5-93	Windshield Wiper Fuses .....	5-97
Underbody Maintenance .....	5-94	Power Windows and Other Power Options .....	5-97
Chemical Paint Spotting .....	5-94	Fuses and Circuit Breakers .....	5-97
Vehicle Care/Appearance Materials .....	5-95	<b>Capacities and Specifications</b> .....	5-103

## Service

Your dealer knows your vehicle best and wants you to be happy with it. We hope you will go to your dealer for all your service needs. You will get genuine GM parts and GM-trained and supported service people.

We hope you will want to keep your GM vehicle all GM. Genuine GM parts have one of these marks:

***ACDelco***

---

**GM** Parts

---

**GM**  
Goodwrench

---

**GM** Accessories

## Doing Your Own Service Work

If you want to do some of your own service work, you will want to use the proper service manual. It tells you much more about how to service your vehicle than this manual can. To order the proper service manual, see *Service Publications Ordering Information on page 7-11*.

Your vehicle has an air bag system. Before attempting to do your own service work, see *Servicing Your Air Bag-Equipped Vehicle on page 1-58*.

You should keep a record with all parts receipts and list the mileage and the date of any service work you perform. See *Maintenance Record on page 6-15*.

### CAUTION:

You can be injured and your vehicle could be damaged if you try to do service work on a vehicle without knowing enough about it.

- Be sure you have sufficient knowledge, experience, the proper replacement parts and tools before you attempt any vehicle maintenance task.

CAUTION: (Continued)

## **CAUTION: (Continued)**

- **Be sure to use the proper nuts, bolts and other fasteners. “English” and “metric” fasteners can be easily confused. If you use the wrong fasteners, parts can later break or fall off. You could be hurt.**

## **Adding Equipment to the Outside of Your Vehicle**

Things you might add to the outside of your vehicle can affect the airflow around it. This may cause wind noise and affect windshield washer performance. Check with your dealer before adding equipment to the outside of your vehicle.

## **Fuel**

Use of the recommended fuel is an important part of the proper maintenance of your vehicle.

### **Gasoline Octane**

Use regular unleaded gasoline with a posted octane of 87 or higher. If the octane is less than 87, you may get a heavy knocking noise when you drive. If this occurs, use a gasoline rated at 87 octane or higher as soon as possible. Otherwise, you might damage your engine. A little pinging noise when you accelerate or drive uphill is considered normal. This does not indicate a problem exists or that a higher-octane fuel is necessary. If you are using 87 octane or higher-octane fuel and hear heavy knocking, your engine needs service.



## Gasoline Specifications

It is recommended that gasoline meet specifications which were developed by automobile manufacturers around the world and contained in the World-Wide Fuel Charter which is available from the Alliance of Automobile Manufacturers at [www.autoalliance.org](http://www.autoalliance.org). Gasoline meeting these specifications could provide improved driveability and emission control system performance compared to other gasoline.



Canada Only

In Canada, look for the “Auto Makers’ Choice” label on the pump.

## California Fuel

If your vehicle is certified to meet California Emission Standards (see the underhood emission control label), it is designed to operate on fuels that meet California specifications. If this fuel is not available in states adopting California emissions standards, your vehicle will operate satisfactorily on fuels meeting federal specifications, but emission control system performance may be affected. The malfunction indicator lamp may turn on (see *Malfunction Indicator Lamp on page 3-36*) and your vehicle may fail a smog-check test. If this occurs, return to your authorized GM dealer for diagnosis. If it is determined that the condition is caused by the type of fuel used, repairs may not be covered by your warranty.

## Additives

To provide cleaner air, all gasolines in the United States are now required to contain additives that will help prevent engine and fuel system deposits from forming, allowing your emission control system to work properly. You should not have to add anything to your fuel. However, some gasolines contain only the minimum amount of additive required to meet U.S. Environmental Protection Agency regulations. General Motors recommends that you buy gasolines that are advertised to help keep fuel injectors and intake valves clean. If your vehicle experiences problems due to dirty injectors or valves, try a different brand of gasoline.

Gasolines containing oxygenates, such as ethers and ethanol, and reformulated gasolines may be available in your area to contribute to clean air. General Motors recommends that you use these gasolines, particularly if they comply with the specifications described earlier.

**Notice:** Your vehicle was not designed for fuel that contains methanol. Do not use fuel containing methanol. It can corrode metal parts in your fuel system and also damage the plastic and rubber parts. That damage would not be covered under your warranty.

Some gasolines that are not reformulated for low emissions may contain an octane-enhancing additive called methylcyclopentadienyl manganese tricarbonyl (MMT); ask the attendant where you buy gasoline whether the fuel contains MMT. General Motors does not recommend the use of such gasolines. Fuels containing MMT can reduce the life of spark plugs and the performance of the emission control system may be affected. The malfunction indicator lamp may turn on. If this occurs, return to your authorized GM dealer for service.

## Fuels in Foreign Countries

If you plan on driving in another country outside the United States or Canada, the proper fuel may be hard to find. Never use leaded gasoline or any other fuel not recommended in the previous text on fuel. Costly repairs caused by use of improper fuel would not be covered by your warranty.

To check the fuel availability, ask an auto club, or contact a major oil company that does business in the country where you will be driving.

## Filling Your Tank

### CAUTION:

Fuel vapor burns violently and a fuel fire can cause bad injuries. To help avoid injuries to you and others, read and follow all the instructions on the pump island. Turn off your engine when you are refueling. Do not smoke if you are near fuel or refueling your vehicle. Keep sparks, flames and smoking materials away from fuel. Do not leave the fuel pump unattended when refueling your vehicle — this is against the law in some places. Keep children away from the fuel pump; never let children pump fuel.

Turn the vehicle off to refuel.

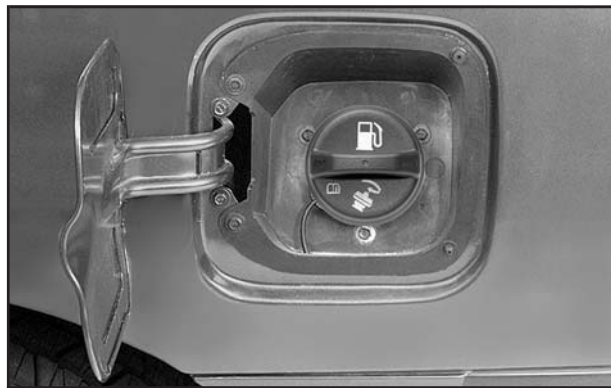

The tethered fuel cap is located behind a hinged door on the driver's side of the vehicle. To remove the fuel cap, turn it slowly counterclockwise. The fuel cap has a spring in it; so if it is released too soon, it will spring back.

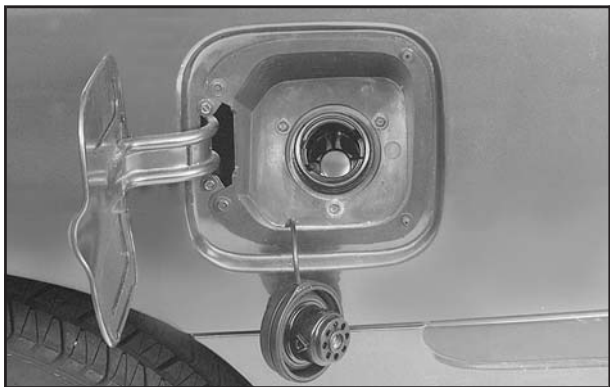

While refueling, let the fuel cap hang by the tether below the fuel fill opening.

**⚠ CAUTION:**

If you spill fuel and then something ignites it, you could be badly burned. Fuel can spray out on you if you open the fuel cap too quickly. This spray can happen if your tank is nearly full, and is more likely in hot weather. Open the fuel cap slowly and wait for any “hiss” noise to stop. Then unscrew the cap all the way.

Be careful not to spill fuel. Do not top off or overfill the fuel tank. Wait a few seconds after filling the fuel tank before removing the fuel pump nozzle. Clean fuel from painted surfaces as soon as possible. See *Cleaning the Outside of Your Vehicle* on page 5-91.

When putting the fuel cap back on, turn it clockwise until a click is heard. Make sure the cap is fully installed. The diagnostic system can determine if the fuel cap has been left off or improperly installed. This would allow fuel to evaporate into the atmosphere. See *Malfunction Indicator Lamp* on page 3-36.

 **CAUTION:**

If a fire starts while you are refueling, do not remove the nozzle. Shut off the flow of fuel by shutting off the pump or by notifying the station attendant. Leave the area immediately.

**Notice:** If you need a new fuel cap, be sure to get the right type. Your dealer can get one for you. If you get the wrong type, it may not fit properly. This may cause your malfunction indicator lamp to light and may damage your fuel tank and emissions system. See *Malfunction Indicator Lamp* on page 3-36.

## Filling a Portable Fuel Container

 **CAUTION:**

Never fill a portable fuel container while it is in your vehicle. Static electricity discharge from the container can ignite the gasoline vapor. You can be badly burned and your vehicle damaged if this occurs. To help avoid injury to you and others:

- Dispense gasoline only into approved containers.
- Do not fill a container while it is inside a vehicle, in a vehicle's trunk, pickup bed or on any surface other than the ground.
- Bring the fill nozzle in contact with the inside of the fill opening before operating the nozzle. Contact should be maintained until the filling is complete.
- Do not smoke while pumping gasoline.

## Checking Things Under the Hood

### CAUTION:

An electric fan under the hood can start up and injure you even when the engine is not running. Keep hands, clothing and tools away from any underhood electric fan.

### CAUTION:

Things that burn can get on hot engine parts and start a fire. These include liquids like fuel, oil, coolant, brake fluid, windshield washer and other fluids, and plastic or rubber. You or others could be burned. Be careful not to drop or spill things that will burn onto a hot engine.

## Hood Release

To open the hood, do the following:



1. Pull the interior hood release handle located below the instrument panel, to the left of the steering column.

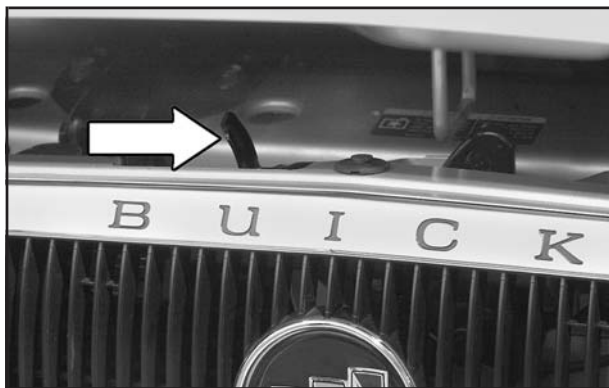

2. Push the secondary hood release, located under the hood, to the right to disengage it.
3. Lift the hood.

Before closing the hood, make sure all of the filler caps are properly secured. Pull the hood down and close it firmly.

## Engine Compartment Overview

When you open the hood, you will see:

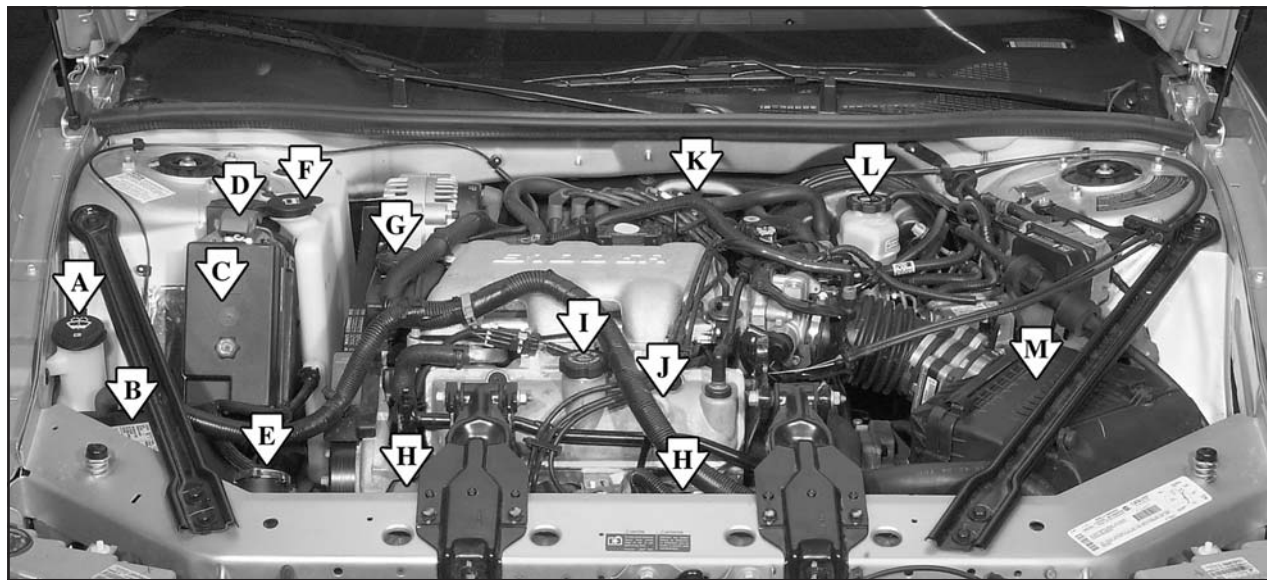



- A. Windshield Washer Fluid Reservoir. See *Windshield Washer Fluid* on page 5-36.
- B. Battery. See *Battery* on page 5-41.
- C. Underhood Fuse Block. See *Fuses and Circuit Breakers* on page 5-97.
- D. Remote Positive (+) Battery Terminal. See *Jump Starting* on page 5-42.
- E. Radiator Pressure Cap. See *Radiator Pressure Cap* on page 5-25.
- F. Engine Coolant Recovery Tank. See *Engine Coolant* on page 5-22.
- G. Power Steering Fluid Reservoir. See *Power Steering Fluid* on page 5-35.
- H. Electric Engine Cooling Fan. See *Jump Starting* on page 5-42.
  - I. Engine Oil Fill Cap. See *Engine Oil* on page 5-13.
  - J. Engine Oil Dipstick. See *Engine Oil* on page 5-13.
  - K. Automatic Transaxle Fluid Dipstick. See *Automatic Transaxle Fluid* on page 5-19.
  - L. Brake Fluid Reservoir. See *Brakes* on page 5-38.
- M. Engine Air Cleaner/Filter. See *Engine Air Cleaner/Filter* on page 5-18.

## Engine Oil

### Checking Engine Oil

It is a good idea to check your engine oil every time you get fuel. In order to get an accurate reading, the oil must be warm and the vehicle must be on level ground.

The engine oil dipstick handle is a yellow loop. See *Engine Compartment Overview* on page 5-12 for the location of the engine oil dipstick.

Turn off the engine and give the oil several minutes to drain back into the oil pan. If you don't, the oil dipstick might not show the actual level.

Pull out the dipstick and clean it with a paper towel or cloth, then push it back in all the way. Remove it again, keeping the tip down, and check the level.

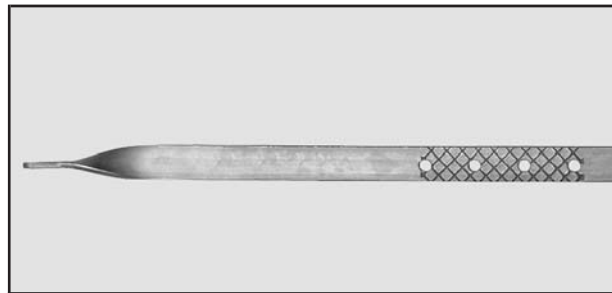

## When to Add Engine Oil

If the oil is at or below the cross-hatched area at the tip of the dipstick, then you will need to add at least one quart of oil. But you must use the right kind. This section explains what kind of oil to use. For engine oil crankcase capacity, see *Capacities and Specifications* on page 5-103.

**Notice:** Do not add too much oil. If your engine has so much oil that the oil level gets above the cross-hatched area that shows the proper operating range, your engine could be damaged.



See *Engine Compartment Overview* on page 5-12 for the location of the engine oil fill cap.

Be sure to add enough oil to put the level somewhere in the proper operating range in the cross-hatched area. Push the dipstick all the way back in when you are through.

## What Kind of Engine Oil to Use

Look for two things:

- GM6094M  
Your vehicle's engine requires oil meeting GM Standard GM6094M. You should look for and use only an oil that meets GM Standard GM6094M.

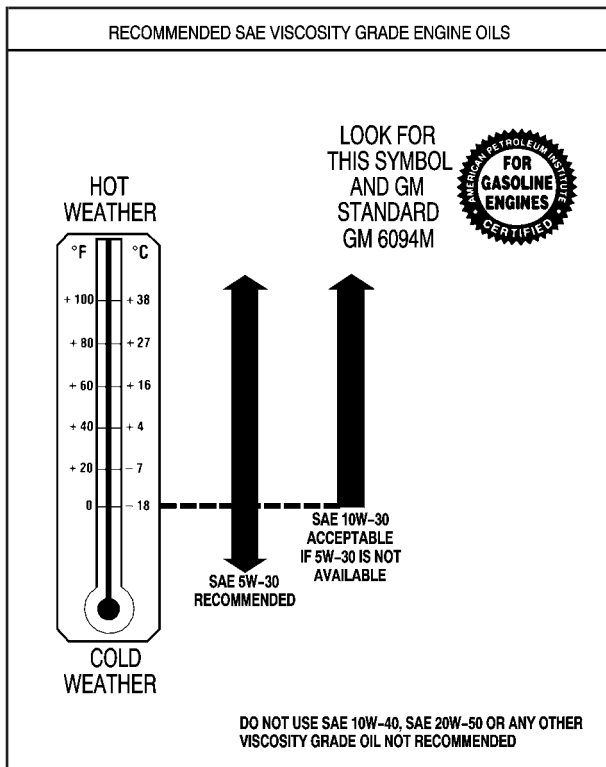

- SAE 5W-30

As shown in the viscosity chart, SAE 5W-30 is best for your vehicle. However, if it is going to be 0°F (-18°C) or above and SAE 5W-30 is not available, you may use SAE 10W-30.

These numbers on an oil container show its viscosity, or thickness. Do not use other viscosity oils such as SAE 20W-50.



Oils meeting these requirements should also have the starburst symbol on the container. This symbol indicates that the oil has been certified by the American Petroleum Institute (API).

You should look for this information on the oil container, and use *only* those oils that are identified as meeting GM Standard GM6094M and have the starburst symbol on the front of the oil container.

**Notice:** Use only engine oil identified as meeting GM Standard GM6094M and showing the American Petroleum Institute Certified For Gasoline Engines starburst symbol. Failure to use the recommended oil can result in engine damage not covered by your warranty.

GM Goodwrench® oil meets all the requirements for your vehicle.

If you are in an area of extreme cold, where the temperature falls below  $-20^{\circ}\text{F}$  ( $-29^{\circ}\text{C}$ ), it is recommended that you use either an SAE 5W-30 synthetic oil or an SAE 0W-30 oil. Both will provide easier cold starting and better protection for your engine at extremely low temperatures.

## Engine Oil Additives

Do not add anything to your oil. The recommended oils with the starburst symbol that meet GM Standard GM6094M are all you will need for good performance and engine protection.

## When to Change Engine Oil (GM Oil Life System)

Your vehicle has a computer system that lets you know when to change the engine oil and filter. This is based on engine revolutions and engine temperature, and not on mileage. Based on driving conditions, the mileage at which an oil change will be indicated can vary considerably. For the oil life system to work properly, you must reset the system every time the oil is changed.

When the system has calculated that oil life has been diminished, it will indicate that an oil change is necessary. A CHANGE OIL SOON light will come on. Change your oil as soon as possible within the next two times you stop for fuel. It is possible that, if you are driving under the best conditions, the oil life system may not indicate that an oil change is necessary for over a year. However, your engine oil and filter must be changed at least once a year and at this time the system must be reset. Your dealer has GM-trained service people who will perform this work using genuine GM parts and reset the system. It is also important to check your oil regularly and keep it at the proper level.

If the system is ever reset accidentally, you must change your oil at 3,000 miles (5 000 km) since your last oil change. Remember to reset the oil life system whenever the oil is changed.

## How to Reset the CHANGE OIL SOON Light

The GM Oil Life System calculates when to change your engine oil and filter based on vehicle use. Anytime your oil is changed, reset the system so it can calculate when the next oil change is required. If a situation occurs where you change your oil prior to a CHANGE OIL SOON light being turned on, reset the system.

After changing the engine oil, reset the system by performing the following steps:

1. With the engine off, turn the ignition key to RUN.
2. Fully press and release the accelerator pedal slowly three times within five seconds.

If the CHANGE OIL SOON light flashes, the system is resetting.

3. Turn the key to OFF, then start the vehicle. The oil life will change to 100 percent.

If the CHANGE OIL SOON light comes back on when you start your vehicle, the engine oil life system has not reset. Repeat the procedure.

## What to Do with Used Oil

Used engine oil contains certain elements that may be unhealthy for your skin and could even cause cancer. Do not let used oil stay on your skin for very long. Clean your skin and nails with soap and water, or a good hand cleaner. Wash or properly dispose of clothing or rags containing used engine oil. See the manufacturer's warnings about the use and disposal of oil products.

Used oil can be a threat to the environment. If you change your own oil, be sure to drain all the oil from the filter before disposal. Never dispose of oil by putting it in the trash, pouring it on the ground, into sewers, or into streams or bodies of water. Instead, recycle it by taking it to a place that collects used oil. If you have a problem properly disposing of your used oil, ask your dealer, a service station or a local recycling center for help.

## Engine Air Cleaner/Filter

See *Engine Compartment Overview* on page 5-12 for location of engine air cleaner/filter.

### When to Inspect the Engine Air Cleaner/Filter

Inspect the air cleaner/filter at every oil change and replace at the first oil change after 25,000 miles (40 000 km).

### How to Inspect the Engine Air Cleaner/Filter

To inspect the air cleaner/filter remove it from the vehicle and lightly shake the filter to release loose dust and dirt. If the filter remains caked with dirt, a new filter is required.

To check or replace the engine air cleaner/filter, do the following:

1. Loosen the screw and clamp on the air duct.

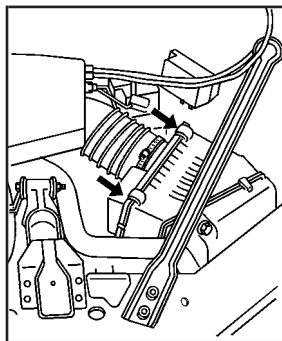

2. Lift the two clips located on the top of the filter assembly to unlock the cover.
3. Disconnect the duct and reposition it while removing the cover.
4. Pull out the filter.
5. Inspect or replace the filter if needed.
6. Reinstall the filter.
7. Push the two clips located on top of the filter assembly to lock the cover.

 **CAUTION:**

Operating the engine with the air cleaner/filter off can cause you or others to be burned. The air cleaner not only cleans the air, it helps to stop flame if the engine backfires. If it is not there and the engine backfires, you could be burned. Do not drive with it off, and be careful working on the engine with the air cleaner/filter off.

**Notice:** If the air cleaner/filter is off, a backfire can cause a damaging engine fire. And, dirt can easily get into your engine, which will damage it. Always have the air cleaner/filter in place when you are driving.

## Automatic Transaxle Fluid

### When to Check and Change

A good time to check the automatic transaxle fluid level is when the engine oil is changed.

Change both the fluid and filter every 50,000 miles (83 000 km) if the vehicle is mainly driven under one or more of these conditions:

- In heavy city traffic where the outside temperature regularly reaches 90°F (32°C) or higher.
- In hilly or mountainous terrain.
- When doing frequent trailer towing.
- Uses such as found in taxi, police or delivery service.

If the vehicle is not used under any of these conditions, change the fluid and filter at 100,000 miles (166 000 km).

See *Scheduled Maintenance* on page 6-4.

## How to Check

Because this operation can be a little difficult, you may choose to have this done at the dealership service department.

If you do it yourself, be sure to follow all the instructions here, or you could get a false reading on the dipstick.

**Notice:** Too much or too little fluid can damage the transaxle. Too much can mean that some of the fluid could come out and fall on hot engine or exhaust system parts, starting a fire. Too little fluid could cause the transaxle to overheat. Be sure to get an accurate reading if you check the transaxle fluid.

Wait at least 30 minutes before checking the transaxle fluid level if you have been driving:

- When outside temperatures are above 90°F (32°C).
- At high speed for quite a while.
- In heavy traffic – especially in hot weather.
- While pulling a trailer.

To get the right reading, the fluid should be at normal operating temperature, which is 180°F to 200°F (82°C to 93°C).

Get the vehicle warmed up by driving about 15 miles (24 km) when outside temperatures are above 50°F (10°C). If it is colder than 50°F (10°C), you may have to drive longer.

## Checking the Fluid Level

Prepare the vehicle as follows:

- Park the vehicle on a level place. Keep the engine running.
- With the parking brake applied, place the shift lever in PARK (P).
- With your foot on the brake pedal, move the shift lever through each gear range, pausing for about three seconds in each range. Then, position the shift lever in PARK (P).
- Let the engine run at idle for three to five minutes.

Then, without shutting off the engine, follow these steps:





The automatic transaxle fluid dipstick handle is the black loop located toward the rear of the engine. See *Engine Compartment Overview* on page 5-12 for more information on location.

1. Pull out the dipstick and wipe it with a clean rag or paper towel.
2. Push it back in all the way, wait three seconds and then pull it back out again.

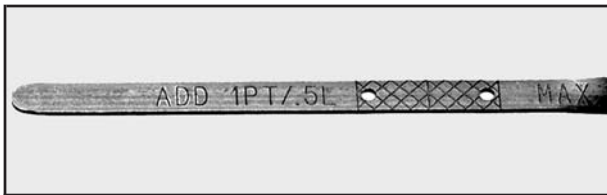

3. Check both sides of the dipstick, and read the lower level. The fluid level must be in the crosshatched area.

4. If the fluid level is in the acceptable range, push the dipstick back in all the way.

## How to Add Fluid

Refer to the Maintenance Schedule to determine what kind of transaxle fluid to use. See *Scheduled Maintenance* on page 6-4.

If the fluid level is low, add only enough of the proper fluid to bring the level into the crosshatched area on the dipstick.

1. Pull out the dipstick.
2. Using a long-neck funnel, add enough fluid at the dipstick hole to bring it to the proper level.

It does not take much fluid, generally less than one pint (0.5 L). *Don't overfill.*

**Notice:** Use of automatic transaxle fluid labeled other than DEXRON®-III may damage your vehicle, and the damages may not be covered by your warranty. Always use DEXRON®-III labeled automatic transaxle fluid.

3. After adding fluid, recheck the fluid level as described under "How to Check," earlier in this section.
4. When the correct fluid level is obtained, push the dipstick back in all the way.

## Engine Coolant

The cooling system in the vehicle is filled with DEX-COOL<sup>®</sup> engine coolant. This coolant is designed to remain in the vehicle for 5 years or 150,000 miles (240 000 km), whichever occurs first, if only DEX-COOL<sup>®</sup> extended life coolant is added.

The following explains the cooling system and how to add coolant when it is low. If there is a problem with engine overheating or if coolant needs to be added to the radiator, see *Engine Overheating on page 5-25*.

A 50/50 mixture of clean, drinkable water and DEX-COOL<sup>®</sup> coolant will:

- Give freezing protection down to -34°F (-37°C).
- Give boiling protection up to 265°F (129°C).
- Protect against rust and corrosion.
- Help keep the proper engine temperature.
- Let the warning lights and gages work as they should.

**Notice:** Using coolant other than DEX-COOL<sup>®</sup> may cause premature engine, heater core or radiator corrosion. In addition, the engine coolant may require changing sooner, at 30,000 miles (50 000 km) or 24 months, whichever occurs first. Any repairs would not be covered by your warranty. Always use DEX-COOL<sup>®</sup> (silicate-free) coolant in your vehicle.

## What to Use

Use a mixture of one-half clean, drinkable water and one-half DEX-COOL<sup>®</sup> coolant which will not damage aluminum parts. If this coolant mixture is used, nothing else needs to be added.

### CAUTION:

**Adding only plain water to your cooling system can be dangerous. Plain water, or some other liquid such as alcohol, can boil before the proper coolant mixture will. Your vehicle's coolant warning system is set for the proper coolant mixture. With plain water or the wrong mixture, your engine could get too hot but you would not get the overheat warning. Your engine could catch fire and you or others could be burned. Use a 50/50 mixture of clean, drinkable water and DEX-COOL<sup>®</sup> coolant.**

**Notice:** If you use an improper coolant mixture, your engine could overheat and be badly damaged. The repair cost would not be covered by your warranty. Too much water in the mixture can freeze and crack the engine, radiator, heater core and other parts.

If coolant has to be added more than four times a year, have your dealer check the cooling system.

**Notice:** If you use the proper coolant, you do not have to add extra inhibitors or additives which claim to improve the system. These can be harmful.

## Checking Coolant

The engine coolant recovery tank is located on the passenger's side of the vehicle at the rear of the engine compartment. See *Engine Compartment Overview on page 5-12* for more information on location.

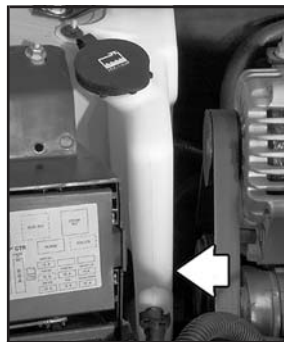

The vehicle must be on a level surface. When the engine is cold, the coolant level should be at the COLD mark or a little higher.

When the engine is warm, the level should be up to the HOT mark or a little higher.

## Adding Coolant

If more coolant is needed, add the proper DEX-COOL® coolant mixture at the coolant recovery tank, but be careful not to spill it.

If the coolant recovery tank is completely empty, add coolant to the radiator. See “How to Add Coolant to the Radiator” later in this section.

### CAUTION:

**Turning the radiator pressure cap when the engine and radiator are hot can allow steam and scalding liquids to blow out and burn you badly. With the coolant recovery tank, you will almost never have to add coolant at the radiator. Never turn the radiator pressure cap — even a little — when the engine and radiator are hot.**

### CAUTION:

**You can be burned if you spill coolant on hot engine parts. Coolant contains ethylene glycol, and it will burn if the engine parts are hot enough. Do not spill coolant on a hot engine.**

Occasionally check the coolant level in the radiator. For information on how to add coolant to the radiator, see *Cooling System* on page 5-28.

## Radiator Pressure Cap

**Notice:** The radiator cap on your vehicle is a pressure-type cap and must be tightly installed to prevent coolant loss and possible engine damage from overheating. Be sure the arrows on the cap line up with the overflow tube on the radiator filler neck.

The radiator pressure cap is located near the front of the engine compartment on the passenger's side of the vehicle. See *Engine Compartment Overview on page 5-12* for more information on location.

## Engine Overheating

The coolant temperature gage and the engine coolant temperature warning light on the instrument panel can indicate an overheated engine condition. See *Engine Coolant Temperature Gage on page 3-35* and *Engine Coolant Temperature Warning Light on page 3-35*.

## Overheated Engine Protection Operating Mode

The emergency engine protection operating mode allows the vehicle to be driven to a safe place in an emergency situation. If an overheated engine condition exists, this protection mode alternates firing groups of cylinders to help prevent engine damage. In this mode, there will be a significant loss in power and engine performance. The engine coolant temperature gage indicator will move to the red area, and, the engine coolant temperature warning light will come on, showing that an overheated engine condition exists. Driving extended miles (km) and/or towing a trailer in the overheated protection mode should be avoided.

**Notice:** After driving in the overheated engine protection operating mode, to avoid engine damage, allow the engine to cool before attempting any repair. The engine oil will be severely degraded. Repair the cause of coolant loss, change the oil and reset the oil life system. See *Engine Oil on page 5-13*.

## If Steam Is Coming From Your Engine



### CAUTION:

Steam from an overheated engine can burn you badly, even if you just open the hood. Stay away from the engine if you see or hear steam coming from it.

CAUTION: (Continued)

### CAUTION: (Continued)

Just turn it off and get everyone away from the vehicle until it cools down. Wait until there is no sign of steam or coolant before you open the hood.

If you keep driving when your engine is overheated, the liquids in it can catch fire. You or others could be badly burned. Stop your engine if it overheats, and get out of the vehicle until the engine is cool.

See “Overheated Engine Protection Operating Mode” under *Engine Overheating on page 5-25* for information on driving to a safe place in an emergency.

**Notice:** If your engine catches fire because you keep driving with no coolant, your vehicle can be badly damaged. The costly repairs would not be covered by your warranty. See “Overheated Engine Protection Operating Mode” under *Engine Overheating on page 5-25* for information on driving to a safe place in an emergency.

## If No Steam Is Coming From Your Engine

An overheated engine warning can indicate a serious problem.

If there is an overheated engine warning and you do not see or hear any steam, the problem may not be too serious. Sometimes the engine can get a little too hot when the vehicle:

- Climbs a long hill on a hot day.
- Stops after high-speed driving.
- Idles for long periods in traffic.
- Tows a trailer.

If an overheated engine warning appears with no sign of steam, try this for a minute or so:

1. In heavy traffic, let the engine idle in NEUTRAL (N) while stopped. If it is safe to do so, pull off the road, shift to PARK (P) or NEUTRAL (N) and let the engine idle.

2. Adjust the heater to the highest temperature and fan speed settings and open the window as necessary.

If the overheated engine warnings no longer exist, you can drive. Just to be safe, drive slower for about 10 minutes. If the warnings do not come back on, you can drive normally.

If the warning continues, and you have not stopped, pull over, stop, and park the vehicle right away.

If there is still no sign of steam, idle the engine for three minutes while you are parked. If the warning still exists, *turn off the engine and get everyone out of the vehicle* until it cools down. Also, see “Overheated Engine Protection Operating Mode” listed previously in this section.

You may decide not to lift the hood but to get service help right away.

## Cooling System

When it is safe to lift the hood, this is what will be seen:

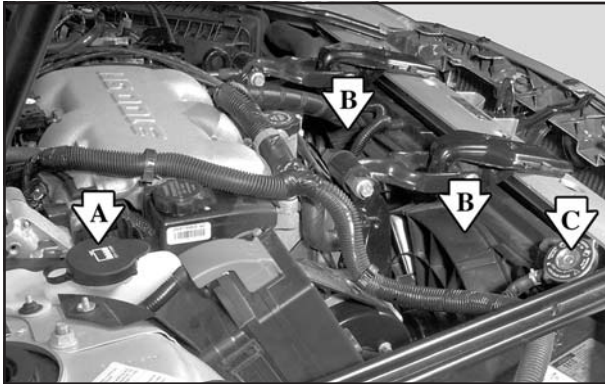

- A. Coolant Recovery Tank
- B. Electric Engine Cooling Fan
- C. Radiator Pressure Cap

### CAUTION:

An electric engine cooling fan under the hood can start up even when the engine is not running and can injure you. Keep hands, clothing and tools away from any underhood electric fan.

If the coolant inside the coolant recovery tank is boiling, do not do anything else until it cools down. The vehicle should be parked on a level surface.



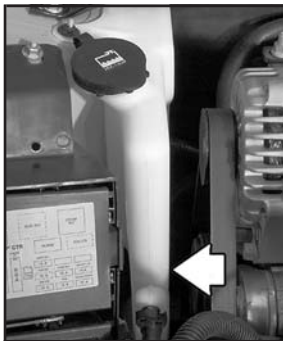

When the engine is cold, the coolant level should be at or above the COLD mark on the coolant recovery tank. If it is not, there may be a leak at the pressure cap or in the radiator hoses, heater hoses, radiator, water pump, or somewhere else in the cooling system.

**⚠ CAUTION:**

Heater and radiator hoses, and other engine parts, can be very hot. Do not touch them. If you do, you can be burned.

Do not run the engine if there is a leak. If you run the engine, it could lose all coolant. That could cause an engine fire, and you could be burned. Get any leak fixed before you drive the vehicle.

If there seems to be no leak, with the engine on, check to see if the electric engine cooling fans are running. If the engine is overheating, both fans should be running. If they are not the vehicle needs service.

**Notice:** Engine damage from running your engine without coolant is not covered by your warranty. See “Overheated Engine Protection Operating Mode” in the Index for information on driving to a safe place in an emergency.

**Notice:** Using coolant other than DEX-COOL<sup>®</sup> may cause premature engine, heater core or radiator corrosion. In addition, the engine coolant may require changing sooner, at 30,000 miles (50 000 km) or 24 months, whichever occurs first. Any repairs would not be covered by your warranty. Always use DEX-COOL<sup>®</sup>(silicate-free) coolant in your vehicle.

## How to Add Coolant to the Coolant Recovery Tank

If a problem has not been found yet, but the coolant level is not at the COLD mark, add a 50/50 mixture of clean, drinkable water and DEX-COOL® engine coolant at the coolant recovery tank. See *Engine Coolant* on page 5-22 for more information.

### CAUTION:

Adding only plain water to your cooling system can be dangerous. Plain water, or some other liquid such as alcohol, can boil before the proper coolant mixture will. Your vehicle's coolant warning system is set for the proper coolant mixture. With plain water or the wrong mixture, your engine could get too hot but you would not get the overheat warning. Your engine could catch fire and you or others could be burned. Use a 50/50 mixture of clean, drinkable water and DEX-COOL® coolant.

**Notice:** In cold weather, water can freeze and crack the engine, radiator, heater core and other parts. Use the recommended coolant and the proper coolant mixture.

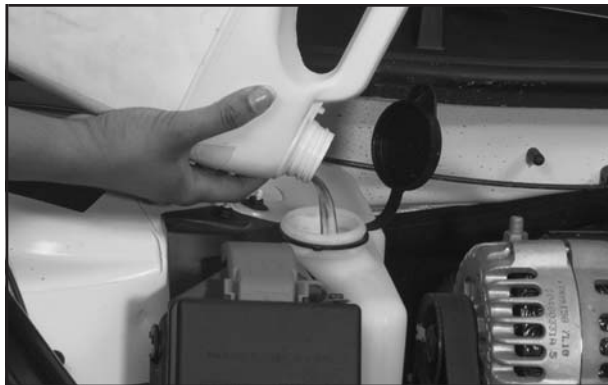

### CAUTION:

You can be burned if you spill coolant on hot engine parts. Coolant contains ethylene glycol and it will burn if the engine parts are hot enough. Do not spill coolant on a hot engine.

When the coolant in the coolant recovery tank is at the COLD mark, start the vehicle.

If the overheated engine warnings continue, there is one more thing that can be done. Add the proper coolant mixture directly to the radiator, but be sure the cooling system is cool before this is done.

**⚠ CAUTION:**

**Steam and scalding liquids from a hot cooling system can blow out and burn you badly. They are under pressure, and if you turn the radiator pressure cap — even a little — they can come out at high speed. Never turn the cap when the cooling system, including the radiator pressure cap, is hot. Wait for the cooling system and radiator pressure cap to cool if you ever have to turn the pressure cap.**

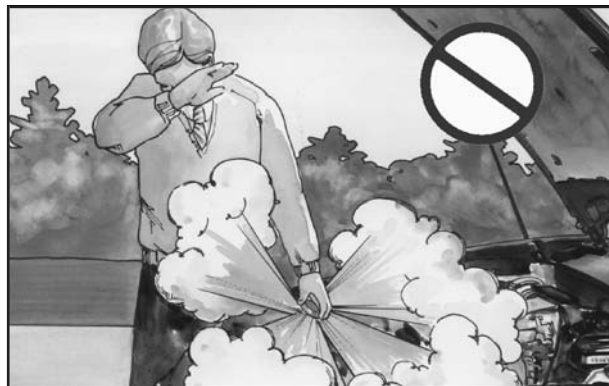

## How to Add Coolant to the Radiator

**Notice:** Your engine has a specific radiator fill procedure. Failure to follow this procedure could cause your engine to overheat and be severely damaged.

Remove the radiator pressure cap when the cooling system, including the radiator pressure cap and upper radiator hose, is no longer hot.



1. Turn the pressure cap slowly counterclockwise at its first stop. Do not press down while turning the pressure cap.

If a hiss is heard, wait for it to stop. A hiss means there is still some pressure left.



2. Keep turning the pressure cap, but now push down as you turn it. Remove the pressure cap.

### CAUTION:

**You can be burned if you spill coolant on hot engine parts. Coolant contains ethylene glycol and it will burn if the engine parts are hot enough. Do not spill coolant on a hot engine.**

3. After the engine cools, open the coolant air bleed valves. There are two bleed valves.

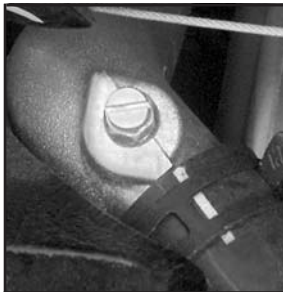

One is located on the thermostat housing.



The other is located on the thermostat bypass tube.



4. Fill the radiator with the proper DEX-COOL<sup>®</sup> coolant mixture, up to the base of the filler neck. See *Engine Coolant on page 5-22* for more information about the proper coolant mixture.

If a stream of coolant is coming from an air bleed valve, close the valve. Otherwise, close the valves after the radiator is filled.

5. Rinse or wipe any spilled coolant from the engine and the compartment.

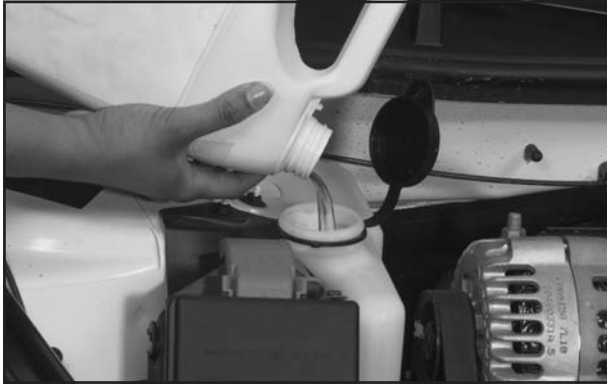

6. Then fill the coolant recovery tank to the COLD mark on the coolant recovery tank.
7. Put the cap back on the coolant recovery tank, but leave the radiator pressure cap off.

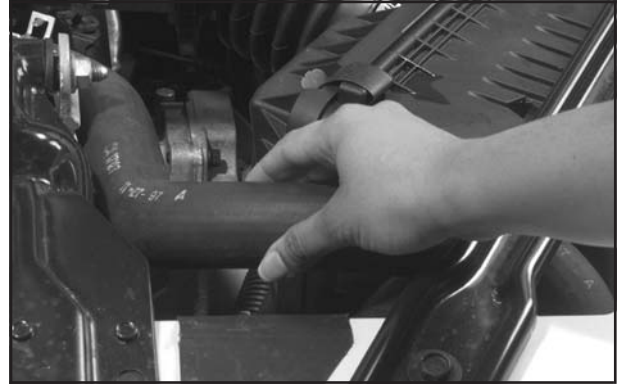

8. Start the engine and let it run until the upper radiator hose feels it is getting hot. Watch out for the engine cooling fans.
9. By this time, the coolant level inside the radiator filler neck may be lower. If the level is lower, add more of the proper DEX-COOL<sup>®</sup> coolant mixture through the filler neck until the level reaches the base of the filler neck.



10. Then replace the pressure cap. At any time during this procedure if coolant begins to flow out of the filler neck, reinstall the pressure cap. Be sure the arrow on the pressure cap lines up like this.
11. Check the coolant in the recovery tank. The level in the coolant recovery tank should be at the HOT mark when the engine is hot or at the COLD mark when the engine is cold.

## Power Steering Fluid

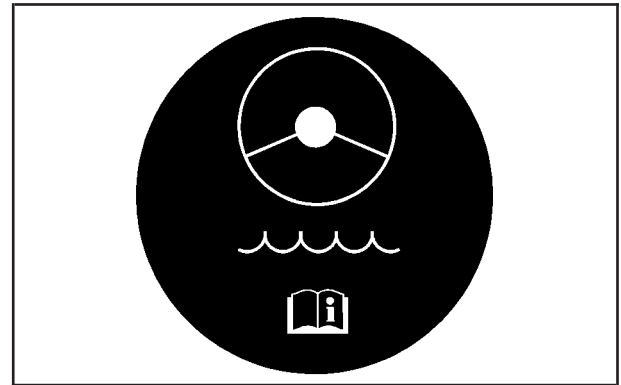

The power steering fluid reservoir is located at the back of the engine compartment, on the passenger's side of the vehicle.

See *Engine Compartment Overview* on page 5-12 for reservoir location.

## When to Check Power Steering Fluid

It is not necessary to regularly check power steering fluid unless there appears to be a leak in the system or an unusual noise is heard. A fluid loss in this system could indicate a problem. Have the system inspected and repaired.

## How to Check Power Steering Fluid

Turn the key off, let the engine compartment cool down, wipe the cap and the top of the reservoir clean, then unscrew the cap and wipe the dipstick with a clean rag. Replace the cap and completely tighten it. Then remove the cap again and look at the fluid level on the dipstick.

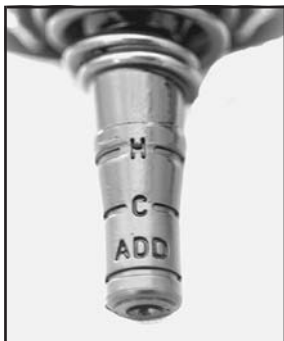

When the engine compartment is hot, the level should be at the H (hot) mark. When it is cold, the level should be at the C (cold) mark. If the fluid is at the ADD mark, fluid should be added.

## What to Use

To determine what kind of fluid to use, see *Recommended Fluids and Lubricants on page 6-12*. Always use the proper fluid. Failure to use the proper fluid can cause leaks and damage hoses and seals.

## Windshield Washer Fluid

### What to Use

When the vehicle needs windshield washer fluid, be sure to read the manufacturer's instructions before use. If the vehicle will be operating in an area where the temperature may fall below freezing, use a fluid that has sufficient protection against freezing.



## Adding Washer Fluid



Open the cap with the washer symbol on it. See *Engine Compartment Overview* on page 5-12 for reservoir location.

Add washer fluid until the windshield washer reservoir is full.

### **Notice:**

- **When using concentrated washer fluid, follow the manufacturer's instructions for adding water.**
- **Do not mix water with ready-to-use washer fluid. Water can cause the solution to freeze and damage your washer fluid tank and other parts of the washer system. Also, water does not clean as well as washer fluid.**
- **Fill your washer fluid tank only three-quarters full when it is very cold. This allows for expansion if freezing occurs, which could damage the tank if it is completely full.**
- **Do not use engine coolant (antifreeze) in your windshield washer. It can damage your washer system and paint.**

## Brakes

### Brake Fluid

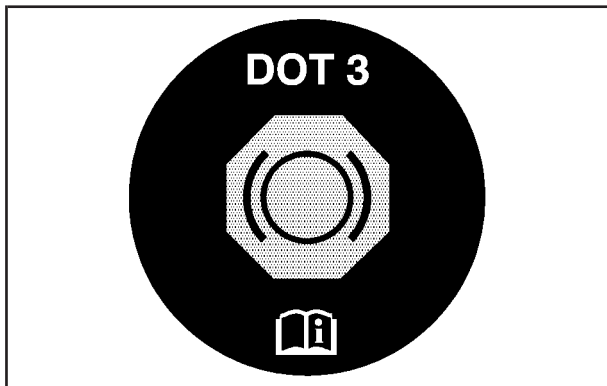

Your brake master cylinder reservoir is filled with DOT-3 brake fluid. See *Engine Compartment Overview* on page 5-12 for the location of the reservoir.

There are only two reasons why the brake fluid level in the reservoir might go down. The first is that the brake fluid goes down to an acceptable level during

normal brake lining wear. When new linings are put in, the fluid level goes back up. The other reason is that fluid is leaking out of the brake system. If it is, you should have your brake system fixed, since a leak means that sooner or later your brakes will not work well, or will not work at all.

So, it is not a good idea to “top off” your brake fluid. Adding brake fluid will not correct a leak. If you add fluid when your linings are worn, then you will have too much fluid when you get new brake linings. You should add (or remove) brake fluid, as necessary, only when work is done on the brake hydraulic system.

#### CAUTION:

**If you have too much brake fluid, it can spill on the engine. The fluid will burn if the engine is hot enough. You or others could be burned, and your vehicle could be damaged. Add brake fluid only when work is done on the brake hydraulic system.**



**United States**



**Canada**

When your brake fluid falls to a low level, your brake warning light will come on. See *Brake System Warning Light* on page 3-32.

### **What to Add**

When you do need brake fluid, use only DOT-3 brake fluid. Use new brake fluid from a sealed container only. See *Recommended Fluids and Lubricants* on page 6-12.

Always clean the brake fluid reservoir cap and the area around the cap before removing it. This will help keep dirt from entering the reservoir.

### **⚠ CAUTION:**

With the wrong kind of fluid in your brake system, your brakes may not work well, or they may not even work at all. This could cause a crash. Always use the proper brake fluid.

#### **Notice:**

- Using the wrong fluid can badly damage brake system parts. For example, just a few drops of mineral-based oil, such as engine oil, in your brake system can damage brake system parts so badly that they will have to be replaced. Do not let someone put in the wrong kind of fluid.
- If you spill brake fluid on your vehicle's painted surfaces, the paint finish can be damaged. Be careful not to spill brake fluid on your vehicle. If you do, wash it off immediately. See *Appearance Care* on page 5-88.

## Brake Wear

Your vehicle has four-wheel disc brakes.

Disc brake pads have built-in wear indicators that make a high-pitched warning sound when the brake pads are worn and new pads are needed. The sound may come and go or be heard all the time your vehicle is moving (except when you are pushing on the brake pedal firmly).

### CAUTION:

**The brake wear warning sound means that soon your brakes will not work well. That could lead to an accident. When you hear the brake wear warning sound, have your vehicle serviced.**

**Notice:** Continuing to drive with worn-out brake pads could result in costly brake repair.

Some driving conditions or climates may cause a brake squeal when the brakes are first applied or lightly applied. This does not mean something is wrong with your brakes.

Properly torqued wheel nuts are necessary to help prevent brake pulsation. When tires are rotated, inspect brake pads for wear and evenly tighten wheel nuts in the proper sequence to GM torque specifications.

Brake linings should always be replaced as complete axle sets.

## Brake Pedal Travel

See your dealer if the brake pedal does not return to normal height, or if there is a rapid increase in pedal travel. This could be a sign of brake trouble.

## Brake Adjustment

Every time you apply the brakes, with or without the vehicle moving, your brakes adjust for wear.

## Replacing Brake System Parts

The braking system on a vehicle is complex. Its many parts have to be of top quality and work well together if the vehicle is to have really good braking. Your vehicle was designed and tested with top-quality GM brake parts. When you replace parts of your braking system — for example, when your brake linings wear down and you need new ones put in — be sure you get new approved GM replacement parts. If you do not, your brakes may no longer work properly. For example, if someone puts in brake linings that are wrong for your vehicle, the balance between your front and rear brakes can change — for the worse. The braking performance you have come to expect can change in many other ways if someone puts in the wrong replacement brake parts.

## Battery

Your new vehicle comes with a maintenance free ACDelco® battery. When it is time for a new battery, get one that has the replacement number shown on the original battery's label. We recommend an ACDelco® battery. See *Engine Compartment Overview on page 5-12* for battery location.

**Warning:** Battery posts, terminals and related accessories contain lead and lead compounds, chemicals known to the State of California to cause cancer and reproductive harm. Wash hands after handling.

## Vehicle Storage

If you are not going to drive your vehicle for 25 days or more, remove the black, negative (-) cable from the battery. This will help keep your battery from running down.

### CAUTION:

**Batteries have acid that can burn you and gas that can explode. You can be badly hurt if you are not careful. See *Jump Starting on page 5-42* for tips on working around a battery without getting hurt.**

Contact your dealer to learn how to prepare your vehicle for longer storage periods.

Also, for your audio system, see *Theft-Deterrent Feature on page 3-62*.

## Jump Starting

If the battery has run down, you may want to use another vehicle and some jumper cables to start your vehicle. Be sure to follow the steps below to do it safely.

### **CAUTION:**

Batteries can hurt you. They can be dangerous because:

- They contain acid that can burn you.
- They contain gas that can explode or ignite.
- They contain enough electricity to burn you.

**If you do not follow these steps exactly, some or all of these things can hurt you.**

**Notice:** Ignoring these steps could result in costly damage to your vehicle that would not be covered by your warranty.

**Trying to start your vehicle by pushing or pulling it will not work, and it could damage your vehicle.**

1. Check the other vehicle. It must have a 12-volt battery with a negative ground system.

**Notice:** If the other vehicle's system is not a 12-volt system with a negative ground, both vehicles can be damaged. Only use vehicles with 12-volt systems with negative grounds to jump start your vehicle.

2. Get the vehicles close enough so the jumper cables can reach, but be sure the vehicles are not touching each other. If they are, it could cause a ground connection you do not want. You would not be able to start the vehicle, and the bad grounding could damage the electrical systems.

To avoid the possibility of the vehicles rolling, set the parking brake firmly on both vehicles involved in the jump start procedure. Put an automatic transaxle in PARK (P) or a manual transmission in NEUTRAL (N) before setting the parking brake.

**Notice:** If you leave your radio or other accessories on during the jump starting procedure, they could be damaged. The repairs would not be covered by your warranty. Always turn off your radio and other accessories when jump starting your vehicle.

3. Turn off the ignition on both vehicles. Unplug unnecessary accessories plugged into the cigarette lighter or in the auxiliary power outlet. Turn off the radio and all lamps that are not needed. This will avoid sparks and help save both batteries. And it could save the vehicle's radio!



4. Open the hoods and locate the batteries. Find the positive (+) and negative (-) terminal location on each vehicle. You will not need to access your battery for jump starting. Your vehicle has a remote positive (+) jump starting terminal for that purpose. The terminal is located on the same side of the engine compartment as your battery. See *Engine Compartment Overview* on page 5-12 for more information on location.

To uncover the remote positive (+) terminal, squeeze the sides of the red plastic cap and pull it upward. Always use the remote positive (+) terminal instead of the positive (+) terminal on the battery.

 **CAUTION:**

An electric fan can start up even when the engine is not running and can injure you. Keep hands, clothing and tools away from any underhood electric fan.

 **CAUTION:**

Using a match near a battery can cause battery gas to explode. People have been hurt doing this, and some have been blinded. Use a flashlight if you need more light.

Be sure the battery has enough water. You do not need to add water to the ACDelco<sup>®</sup> battery installed in your new vehicle. But if a battery

**CAUTION: (Continued)**

**CAUTION: (Continued)**

has filler caps, be sure the right amount of fluid is there. If it is low, add water to take care of that first. If you do not, explosive gas could be present.

Battery fluid contains acid that can burn you. Do not get it on you. If you accidentally get it in your eyes or on your skin, flush the place with water and get medical help immediately.

 **CAUTION:**

Fans or other moving engine parts can injure you badly. Keep your hands away from moving parts once the engine is running.



5. Check that the jumper cables do not have loose or missing insulation. If they do, you could get a shock. The vehicles could be damaged too.

Before you connect the cables, here are some basic things you should know. Positive (+) will go to positive (+) or to a remote positive (+) terminal if the vehicle has one. Negative (-) will go to a heavy, unpainted metal engine part or to a remote negative (-) terminal if the vehicle has one.

Do not connect positive (+) to negative (-) or you will get a short that would damage the battery and maybe other parts too. And do not connect the negative (-) cable to the negative (-) terminal on the dead battery because this can cause sparks.

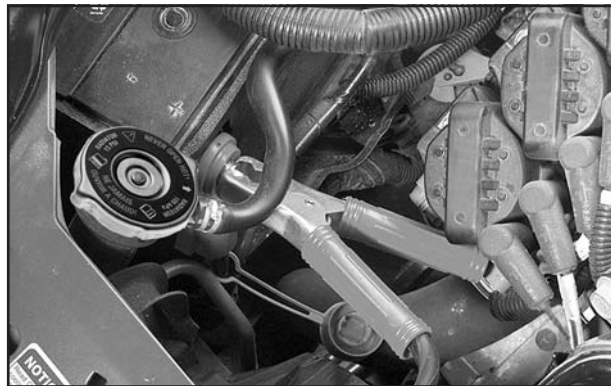

6. Connect the red positive (+) cable to the positive (+) terminal of the dead battery. Use a remote positive (+) terminal if the vehicle has one.



7. Do not let the other end touch metal. Connect it to the positive (+) terminal of the good battery. Use a remote positive (+) terminal if the vehicle has one.



8. Now connect the negative (-) cable to the negative (-) terminal of the good battery. Use a remote negative (-) terminal if the vehicle has one.

Do not let the other end touch anything until the next step. The other end of the negative (-) cable *does not* go to the dead battery. It goes to a heavy, unpainted metal part, or to the remote negative (-) terminal on the vehicle with the dead battery.

9. Connect the other end of the negative (-) cable at least 18 inches (45 cm) away from the dead battery, but not near engine parts that move. The electrical connection is just as good there, and the chance of sparks getting back to the battery is much less.

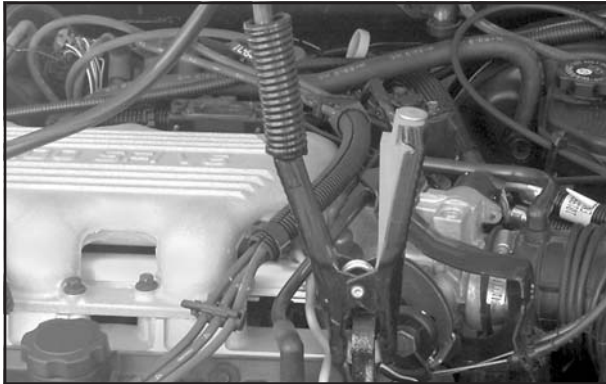

10. Now start the vehicle with the good battery and run the engine for a while.
11. Try to start the vehicle that had the dead battery. If it will not start after a few tries, it probably needs service.

**Notice:** If the jumper cables are removed in the wrong order, electrical shorting may occur and damage the vehicle. The repairs would not be covered by your warranty. Remove the jumper cables in the correct order, making sure that the cables do not touch each other or other metal.

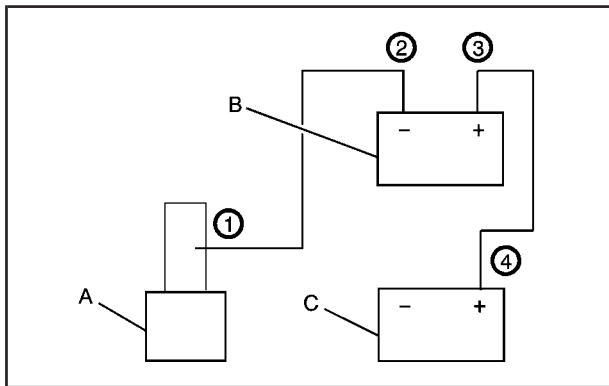

### Jumper Cable Removal

- A. Heavy, Unpainted Metal Engine Part or Remote Negative (-) Terminal
- B. Good Battery or Remote Positive (+) and Remote Negative (-) Terminals
- C. Dead Battery or Remote Positive (+) Terminal

To disconnect the jumper cables from both vehicles do the following:

1. Disconnect the black negative (-) cable from the vehicle that had the dead battery.
2. Disconnect the black negative (-) cable from the vehicle with the good battery.
3. Disconnect the red positive (+) cable from the vehicle with the good battery.
4. Disconnect the red positive (+) cable from the other vehicle.
5. Return the remote positive (+) terminal cover to its original position.

## Headlamp Aiming

The vehicle has a headlamp system equipped with horizontal and vertical aim indicators. The aim has been pre-set at the factory and should need no further adjustment. This is true even though the vertical and horizontal aim indicators may not fall exactly on the "0" (zero) marks on their scales.

If the vehicle is damaged in an accident, the headlamp aim may be affected. Aim adjustment may be necessary if it is difficult to see lane markers, for horizontal aim, or if oncoming drivers flash their high beams at you, for vertical aim. If you believe the headlamps need to be re-aimed, we recommend that you take it to your dealer for service; however, it is possible for you to re-aim the headlamps as described in the following procedure.

**Notice:** To make sure your headlamps are aimed properly, read all the instructions before beginning. Failure to follow these instructions could cause damage to headlamp parts.

To check the aim, the vehicle should be properly prepared as follows:

- The headlamps must be off for one hour prior to aiming and must remain off during this procedure.
- The vehicle must have all four tires on a perfectly level surface.
- If necessary, pads may be used on an uneven surface to help level the vehicle.
- The vehicle should not have any snow, ice or mud attached to it.
- The vehicle should be fully assembled and all other work stopped while headlamp aiming is being done.
- There should not be any cargo or loading of the vehicle. It should however, have a full fuel tank and one person or 160 lbs (75 kg) on the driver's seat.
- Close all doors.
- Tires should be properly inflated.
- Rock the vehicle to stabilize the suspension.

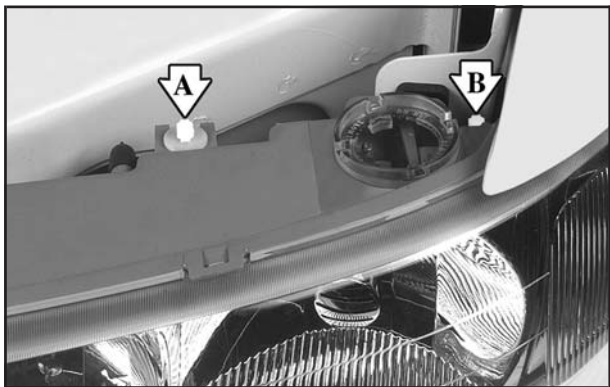

**Driver's Side Headlamp Shown**

- A. Vertical Aim Adjustment Screw
- B. Horizontal Aim Adjustment Screw

Open the hood and locate the vertical and horizontal aim indicators. The aiming screw for the vertical aim indicator (A) is at the center of the headlamp cover and the aiming screw for the horizontal aim indicator (B) is on the outboard side of the headlamp cover.

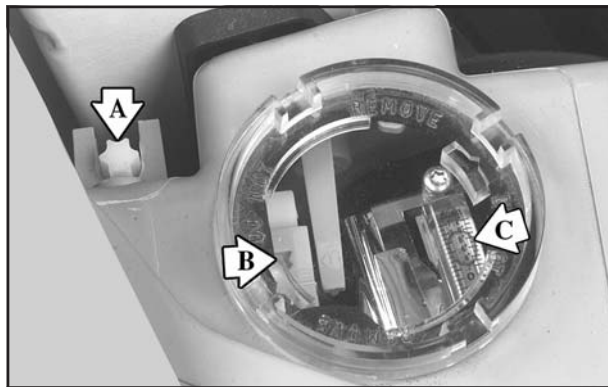

**Passenger's Side Headlamp Shown**

- A. Horizontal Aim Adjustment Screw
- B. Horizontal Block Index Plate
- C. Vertical Aiming Level

Start with the horizontal aim. The adjustment screws can be turned with an E8 Torx® socket.

Once the horizontal aim is adjusted, then adjust the vertical aim.

1. Turn the horizontal aiming screw until the indicator is lined up with zero.
2. Turn the vertical aiming screw until the level bubble is lined up with zero.

## Bulb Replacement

For any bulb changing procedure not listed in this section, contact your dealer. For the type of bulb, see *Replacement Bulbs on page 5-55*.

### Halogen Bulbs

#### CAUTION:

Halogen bulbs have pressurized gas inside and can burst if you drop or scratch the bulb. You or others could be injured. Be sure to read and follow the instructions on the bulb package.

## Headlamps

1. Open the hood.

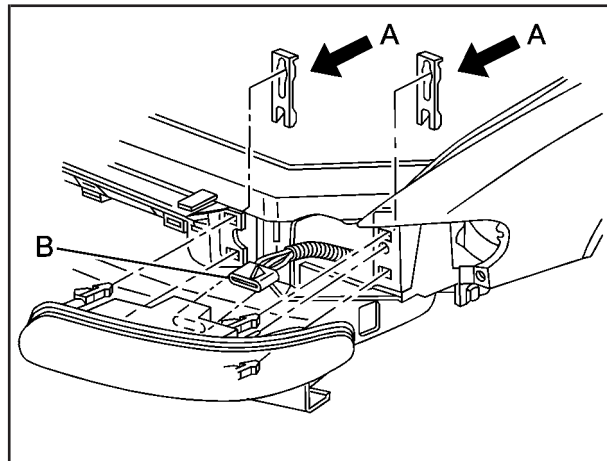

2. Pull up on the headlamp retainers (A) to release the assembly locator tabs.

3. Disconnect the electrical connector (B) from the headlamp assembly.
4. Slide the headlamp assembly out of the slots.

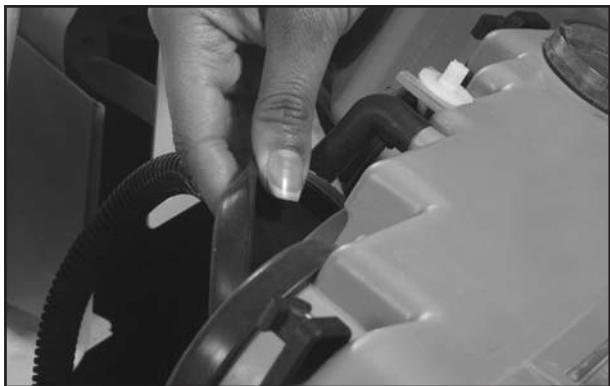

5. Remove the rubber access cover from behind the bulb being replaced.
6. Turn the bulb socket one-quarter turn and remove it from the headlamp assembly.
7. Lift the plastic locking tab on the electrical connector and pull the connector from the headlamp bulb socket.

8. Connect the new headlamp bulb to the electrical connector, making sure the connector tab snaps into place.
9. Insert the bulb socket into the headlamp assembly.
10. Reverse all steps to reassemble the headlamp assembly, then check the lamps.

## Front Turn Signal and Parking Lamps

1. Remove the headlamp assembly. Refer to the removal procedure earlier in this section.
2. Remove the rubber bulb access cover.
3. Twist the sidemarker lamp socket, located on the outboard side of the headlamp assembly, counterclockwise and pull it from the headlamp assembly.
4. Holding the base of the socket, pull the old bulb from the socket.
5. Push the new bulb into the socket.
6. Reverse Steps 1 through 3 to reinstall the lamp assembly.



## Center High-Mounted Stoplamp (CHMSL)

1. Open the trunk.



2. Reach through the access opening in the trunk lid.



3. Remove the old bulb by turning it counterclockwise one-quarter turn.
4. Push the new bulb into the bulb socket.
5. Turn the socket clockwise one-quarter turn to reinstall.

## Taillamps, Turn Signal, and Stoplamps

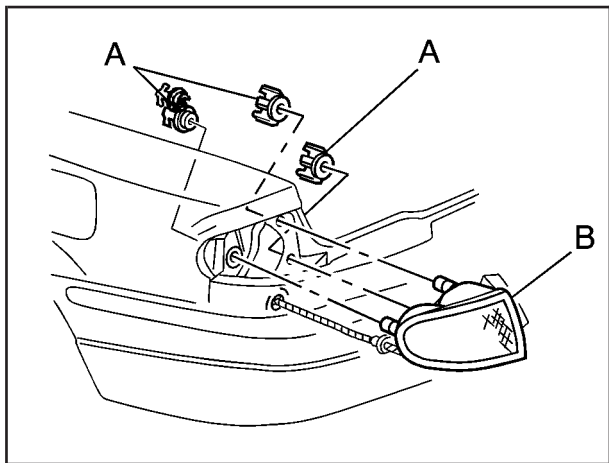

1. Open the trunk.
2. Remove the convenience net If the vehicle has one.
3. Remove the three plastic wing nuts (A).  
One wing nut is located on top of the carpet. The other two are located underneath the carpet.
4. Pull the taillamp housing (B) away from the body of the vehicle.
5. Squeeze the tab on the socket and turn the socket counterclockwise.
6. Pull out the socket.
7. Pull the old bulb out of the socket. There are two bulbs on each taillamp.
8. Push in a new bulb.
9. Reverse these steps to reinstall the lamp assembly.

## Back-Up Lamps

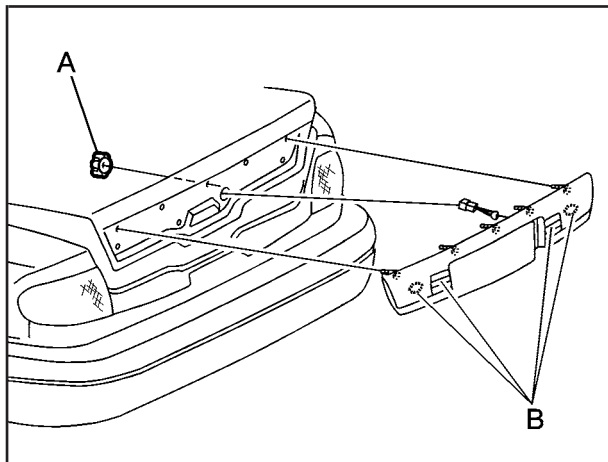

1. Open the trunk.
2. Remove the seven hex nuts (A) from the lamp covering.
3. Remove the lamp covering.

4. Twist and pull the bulb socket (B) from the trunk lid.
5. Twist and pull the old bulb from the bulb socket.
6. Twist and push the new bulb into the lamp socket.
7. Twist and push the lamp socket into the trunk lid covering.
8. Reverse Steps 2 and 3 to reinstall the lamp covering.

### Replacement Bulbs

Exterior Lamps	Bulb Number
Back-Up Lamps	1156
Center High-Mounted Stoplamp (CHMSL)	3155
Front Turn Signal and Parking Lamps	4157NAK
High-Beam Headlamps	9005
Low-Beam Headlamps	9006
Taillamps and Stoplamps/Turn Signal	3057
Taillamp	194
For any bulb not listed here contact your dealer.	

## Windshield Wiper Blade Replacement

Windshield wiper blades should be inspected for wear or cracking each time maintenance is performed. See *Scheduled Maintenance on page 6-4*.

1. Turn on the wipers to LO.
2. Turn off the ignition while the wipers are at the outer positions of the wiper pattern. The blades are more accessible for removal or replacement while in this position.
3. Pull the windshield wiper arm 3 to 4 inches (7.5 to 10 cm) away from the windshield.



4. While holding the wiper arm away from the glass, push the release clip from under the windshield wiper arm connecting point and slide the blade assembly down toward the glass to remove it from the wiper arm.
5. Slide the new wiper blade securely on the wiper arm until you hear the release clip click into place. See *Normal Maintenance Replacement Parts on page 6-13* for the type of windshield wiper blades to use.

## Tires

Your new vehicle comes with high-quality tires made by a leading tire manufacturer. If you ever have questions about your tire warranty and where to obtain service, see your GM Warranty booklet for details. For additional information refer to the tire manufacturer's booklet included with your vehicle's Owner's Manual.

### CAUTION:

**Poorly maintained and improperly used tires are dangerous.**

- **Overloading your tires can cause overheating as a result of too much friction. You could have an air-out and a serious accident. See “Loading Your Vehicle” in the Index.**
- **Underinflated tires pose the same danger as overloaded tires. The resulting accident could cause serious injury. Check all tires frequently to maintain the recommended pressure. Tire pressure should be checked when your tires are cold.**
- **Overinflated tires are more likely to be cut, punctured or broken by a sudden impact — such as when you hit a pothole. Keep tires at the recommended pressure.**
- **Worn, old tires can cause accidents. If your tread is badly worn, or if your tires have been damaged, replace them.**

## Tire Sidewall Labeling

Useful information about a tire is molded into its sidewall. The examples below show a typical passenger car tire and a compact spare tire sidewall.

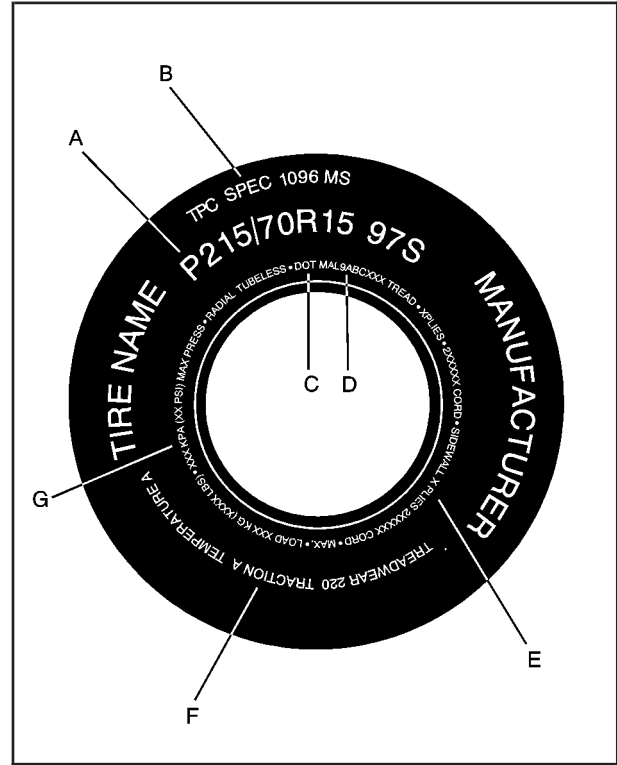

Passenger Car Tire Example

**(A) Tire Size:** The tire size code is a combination of letters and numbers used to define a particular tire's width, height, aspect ratio, construction type and service description. See the "Tire Size" illustration later in this section for more detail.

**(B) Tire Performance Criteria Specification (TPC Spec):** Original equipment tires designed to GM's specific tire performance criteria have a TPC specification code molded onto the sidewall. GM's TPC specifications meet or exceed all federal safety guidelines.

**(C) Department of Transportation (DOT):** The Department of Transportation (DOT) code indicates that the tire is in compliance with the U.S. Department of Transportation Motor Vehicle Safety Standards.

**(D) Tire Identification Number (TIN):** The letters and numbers following DOT code are the Tire Identification Number (TIN). The TIN shows the manufacturer and plant code, tire size, and date the tire was manufactured. The TIN is molded onto both sides of the tire, although only one side may have the date of manufacture.

**(E) Tire Ply Material:** The type of cord and number of plies in the sidewall and under the tread.

**(F) Uniform Tire Quality Grading (UTQG):** Tire manufacturers are required to grade tires based on three performance factors: treadwear, traction and temperature resistance. For more information see *Uniform Tire Quality Grading on page 5-70*.

**(G) Maximum Cold Inflation Load Limit:** Maximum load that can be carried and the maximum pressure needed to support that load. For more information on recommended tire pressure see *Inflation - Tire Pressure on page 5-64* and *Loading Your Vehicle on page 4-34*.

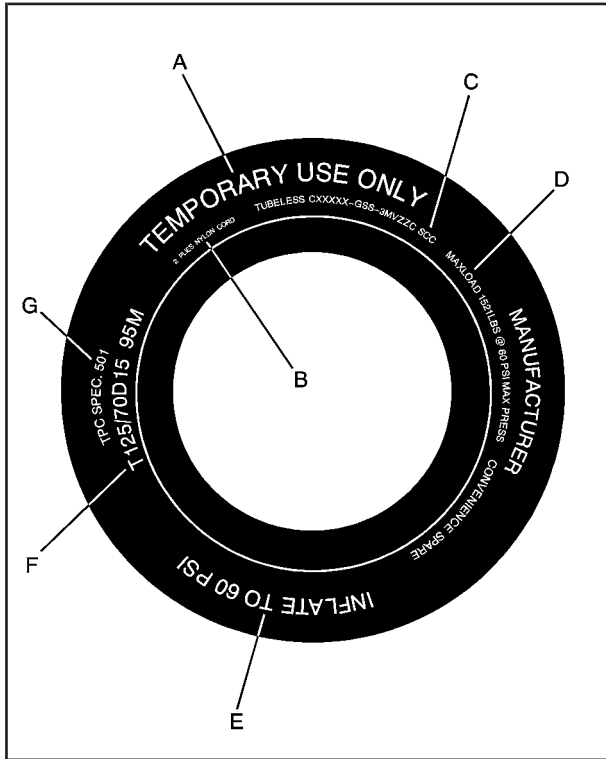

Compact Spare Tire Example

**(A) Temporary Use Only:** The compact spare tire or temporary use tire has a tread life of approximately 3,000 miles (5 000 km) and should not be driven at speeds over 65 mph (105 km/h). The compact spare tire is for emergency use when a regular road tire has lost air and gone flat. See *Compact Spare Tire on page 5-87* and *If a Tire Goes Flat on page 5-74*.

**(B) Tire Ply Material:** The type of cord and number of plies in the sidewall and under the tread.

**(C) Tire Identification Number (TIN):** The Tire Identification Number (TIN). The TIN shows the manufacturer and plant code, tire size, and date the tire was manufactured. The TIN is molded onto both sides of the tire, although only one side may have the date of manufacture.

**(D) Maximum Cold Inflation Load Limit:** Maximum load that can be carried and the maximum pressure needed to support that load. See *Compact Spare Tire on page 5-87* and *Loading Your Vehicle on page 4-34*.

**(E) Tire Inflation:** The temporary use tire or compact spare tire should be inflated to 60 psi (420 kPa). For more information on tire pressure and inflation see *Inflation - Tire Pressure on page 5-64*.



**(F) Tire Size:** A combination of letters and numbers define a tire's width, height, aspect ratio, construction type and service description. The letter "T" as the first character in the tire size means the tire is for temporary use only.

### **(G) Tire Performance Criteria Specification**

**(TPC Spec):** Original equipment tires designed to GM's specific tire performance criteria have a TPC specification code molded onto the sidewall. GM's TPC specifications meet or exceed all federal safety guidelines.

## **Tire Size**

The following illustration shows an example of a typical passenger car tire size.

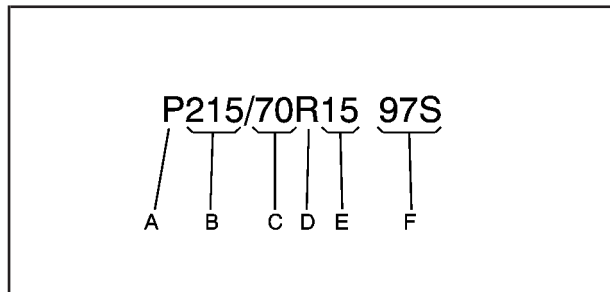

**(A) P-Metric Tire:** The United States version of a metric tire sizing system. The letter "P" as the first character in the tire size means a passenger vehicle tire engineered to standards set by the U. S. Tire and Rim Association.

**(B) Tire Width:** The three-digit number indicates the tire section width in millimeters from sidewall to sidewall.

**(C) Aspect Ratio:** A two-digit number that indicates the tire height-to-width measurements. For example, if the tire size aspect ratio is "70," as shown in item "C" of the illustration, it would mean that the tire's sidewall is 70% as high as it is wide.

**(D) Construction Code:** A letter code is used to indicate the type of ply construction in the tire. The letter "R" means radial ply construction; the letter "D" means diagonal or bias ply construction; and the letter "B" means belted-bias ply construction.

**(E) Rim Diameter:** Diameter of the wheel in inches.

**(F) Service Description:** These characters represent the load range and the speed rating of a tire. The load range represents the load carrying capacity a tire is certified to carry. The load index can range from 1 to 279. The speed rating is the maximum speed a tire is certified to carry a load. Speed ratings range from "A" to "Z".

## Tire Terminology and Definitions

**Air Pressure:** The amount of air inside the tire pressing outward on each square inch of the tire. Air pressure is expressed in pounds per square inch (psi) or kilopascal (kPa).

**Accessory Weight:** This means the combined weight of optional accessories. Some examples of optional accessories are, automatic transmission, power steering, power brakes, power windows, power seats, and air conditioning.

**Aspect Ratio:** The relationship of a tire's height to its width.

**Belt:** A rubber coated layer of cords that is located between the plies and the tread. Cords may be made from steel or other reinforcing materials.

**Bead:** The tire bead contains steel wires wrapped by steel cords that hold the tire onto the rim.

**Bias Ply Tire:** A pneumatic tire in which the plies are laid at alternate angles less than 90 degrees to the centerline of the tread.

**Cold Inflation Pressure:** The amount of air pressure in a tire, measured in pounds per square inch (psi) before a tire has built up heat from driving. See *Inflation - Tire Pressure on page 5-64*.

**Curb Weight:** This means the weight of a motor vehicle with standard and optional equipment including the maximum capacity of fuel, oil and coolant, but without passengers and cargo.

**DOT Markings:** A code molded into the sidewall of a tire signifying that the tire is in compliance with the U.S. Department of Transportation motor vehicle safety standards. The DOT code includes the Tire Identification Number (TIN), an alphanumeric designator which can also identify the tire manufacturer, production plant, brand and date of production.

**GVWR:** Gross Vehicle Weight Rating, see *Loading Your Vehicle on page 4-34*.

**GAWR FRT:** Gross Axle Weight Rating for the front axle, see *Loading Your Vehicle on page 4-34*.

**GAWR RR:** Gross Axle Weight Rating for the rear axle, see *Loading Your Vehicle on page 4-34*.

**Intended Outboard Sidewall:** The side of an asymmetrical tire that must always face outward when mounted on a vehicle.

**Kilopascal (kPa):** The metric unit for air pressure. There are 6.9 kPa's to one psi.

**Light Truck (LT-Metric) Tire:** A tire used on light duty trucks and some multipurpose passenger vehicles.

**Load Index:** An assigned number ranging from 1 to 279 that corresponds to the load carrying capacity of a tire.

**Maximum Inflation Pressure:** The maximum air pressure to which a cold tire may be inflated. The maximum air pressure is molded onto the sidewall.

**Maximum Load Rating:** The load rating for a tire at the maximum permissible inflation pressure for that tire.

**Maximum Loaded Vehicle Weight:** The sum of curb weight; accessory weight; vehicle capacity weight; and production options weight.

**Normal Occupant Weight:** The number of occupants a vehicle is designed to seat multiplied by 150 pounds (68 kg). See *Loading Your Vehicle on page 4-34*.

**Occupant Distribution:** Designated seating positions.

**Outward Facing Sidewall:** The side of a asymmetrical tire that has a particular side that faces outward when mounted on a vehicle. The side of the tire that contains a whitewall, bears white lettering or bears manufacturer, brand and or model name molding that is higher or deeper than the same moldings on the other sidewall of the tire.

**Passenger (P-Metric) Tire:** A tire used on passenger cars and some light duty trucks and multipurpose vehicles.

**Recommended Inflation Pressure:** Vehicle manufacturer's recommended tire inflation pressure and shown on the tire placard. See *Inflation - Tire Pressure on page 5-64* and *Loading Your Vehicle on page 4-34*.

**Radial Ply tire:** A pneumatic tire in which the ply cords that extend to the beads are laid at 90 degrees to the centerline of the tread.

**Rim:** A metal support for a tire and upon which the tire beads are seated.

**Sidewall:** The portion of a tire between the tread and the bead.

**Speed Rating:** An alphanumeric code assigned to a tire indicating the maximum speed at which a tire can operate.

**Traction:** The friction between the tire and the road surface. The amount of grip provided.

**Tread:** The portion of a tire that comes into contact with the road.

**Treadwear Indicators:** Narrow bands, sometimes called “wear bars,” that show across the tread of a tire when only 2/32 inch of tread remains. See *When It Is Time for New Tires on page 5-68*.

**UTQGS:** Uniform Tire Quality Grading Standards, a tire information system that provides consumers with ratings for a tire’s traction, temperature and treadwear. Ratings are determined by tire manufacturers using government testing procedures. The ratings are molded into the sidewall of the tire. See *Uniform Tire Quality Grading on page 5-70*.

**Vehicle Capacity Weight:** The number of designated seating positions multiplied by 150 lbs. (68 kg) plus the rated cargo load. See *Loading Your Vehicle on page 4-34*.

**Vehicle Maximum Load on the Tire:** Load on an individual tire due to curb weight, accessory weight, occupant weight and cargo weight.

**Vehicle Placard:** A label permanently attached to a vehicle showing the original equipment tire size and recommended inflation pressure. See *Loading Your Vehicle on page 4-34*.

## Inflation - Tire Pressure

The tire and loading information label, shows the correct inflation pressures for your tires when they’re cold. “Cold” means your vehicle has been sitting for at least three hours or driven no more than 1 mile (1.6 km). See *Loading Your Vehicle on page 4-34*, for the location of your vehicle’s tire and loading information label.

**Notice:** Don’t let anyone tell you that underinflation or overinflation is all right. It’s not. If your tires don’t have enough air (underinflation), you can get the following:

- Too much flexing
- Too much heat
- Tire overloading
- Bad wear
- Bad handling
- Bad fuel economy

If your tires have too much air (overinflation), you can get the following:

- Unusual wear
- Bad handling
- Rough ride
- Needless damage from road hazards

## When to Check

Check your tires once a month or more.

Don't forget your compact spare tire. It should be at 60 psi (420 kPa).

## How to Check

Use a good quality pocket-type gage to check tire pressure. You can't tell if your tires are properly inflated simply by looking at them. Radial tires may look properly inflated even when they're underinflated. Check the tire's inflation pressure when the tires are cold. Cold means your vehicle has been sitting for at least three hours or driven no more than 1 mile (1.6 km).

Remove the valve cap from the tire valve stem. Press the tire gage firmly onto the valve to get a pressure measurement. If the cold tire inflation pressure matches the recommended pressure on the Tire and Loading Information label, no further adjustment is necessary. If the inflation pressure is low, add air until you reach the recommended amount.

If you overfill the tire, release air by pushing on the metal stem in the center of the tire valve. Recheck the tire pressure with the tire gage.

Be sure to put the valve caps back on the valve stems. They help prevent leaks by keeping out dirt and moisture.

## Tire Pressure Monitor System

The tire inflation monitor system detects differences in tire rotation speeds that are caused by changes in tire pressure. The system can alert you if a tire is low – but it does not replace normal tire maintenance. See *Tires* on page 5-57.

When the LOW TIRE light comes on the instrument panel, stop as soon as you can and check all the tires for damage. If a tire is flat, see *If a Tire Goes Flat* on page 5-74. Also, check the tire pressure in all four tires as soon as possible. See *Inflation - Tire Pressure* on page 5-64.

In order for the tire inflation system to function properly, the vehicle must be driven between 45 and 90 minutes before the system determines the tire pressure in each tire. The driving time may be longer depending on an individual's driving habits. The data does not have to be accumulated during a single trip. Once determined, the system will store the tire pressures until the system is reset.

The system normally takes 15 to 20 minutes of driving time in each of three speed ranges to determine tire pressures. The speed ranges are 15 to 40 mph (25 to 65 km/h), 40 to 65 mph (65 to 105 km/h) and above 65 mph (105 km/h). When the storage of the tire inflation information is complete, the LOW TIRE light will come on the instrument panel after two to eight minutes if one tire is inflated 12 psi (83 kPa) less than the other three tires. Detection thresholds may be higher and detection times may be longer on rough roads, curves and at high speeds. The system is not capable of inflation differences at speeds greater than 70 mph (110 km/h).

The tire inflation monitor system will not alert you if the pressure in more than one tire is low, if the system is not properly calibrated, or if the vehicle is moving faster than 70 mph (110 km/h).

The LOW TIRE light will stay on while the ignition is on, until the system is reset

Do not reset the tire inflation monitor system without first correcting the cause of the problem and checking and adjusting the pressure in all four tires. If the system is reset when the tire pressures are incorrect, it will not function properly and may not alert you when a tire is low.

Any time a tire's pressure is adjusted, the tires are rotated, or one or more tires is repaired or replaced, the tire inflation monitor system will need to be reset. The system also needs to be reset when new tires are purchased and if the vehicle's battery has been disconnected.

To reset the system:

1. Turn the ignition to RUN.
2. Remove the passenger's side instrument panel cover to get to the fuse block.
3. Press and hold the RESET button in the fuse block for about five seconds.
4. The LOW TIRE light will come on and flash three times. Then it will go off. If the light does not go off, see your dealer for service.

## Tire Inspection and Rotation

Tires should be rotated every 5,000 to 8,000 miles (8 000 to 13 000 km).

Any time you notice unusual wear, rotate your tires as soon as possible and check wheel alignment. Also check for damaged tires or wheels. See *When It Is Time for New Tires on page 5-68* and *Wheel Replacement on page 5-72* for more information.

The purpose of regular rotation is to achieve more uniform wear for all tires on the vehicle. The first rotation is the most important. See *Scheduled Maintenance on page 6-4* for scheduled rotation intervals.

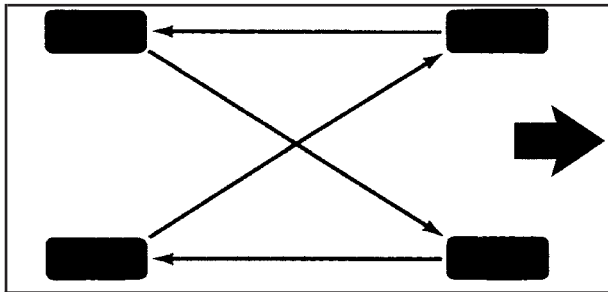

When rotating your tires, always use the correct rotation pattern shown here.

Don't include the compact spare tire in your tire rotation.

After the tires have been rotated, adjust the front and rear inflation pressures as shown on the Tire and Loading Information label.

Reset the Tire Inflation Monitor System. See *Tire Pressure Monitor System on page 5-65*.

Make certain that all wheel nuts are properly tightened. See "Wheel Nut Torque" under *Capacities and Specifications on page 5-103*.

### CAUTION:

Rust or dirt on a wheel, or on the parts to which it is fastened, can make wheel nuts become loose after a time. The wheel could come off and cause an accident. When you change a wheel, remove any rust or dirt from places where the wheel attaches to the vehicle. In an emergency, you can use a cloth or a paper towel to do this; but be sure to use a scraper or wire brush later, if you need to, to get all the rust or dirt off. See "Changing a Flat Tire" in the Index.

## When It Is Time for New Tires

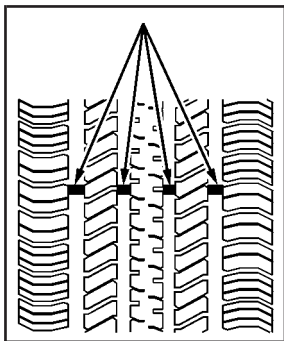

One way to tell when it's time for new tires is to check the treadwear indicators, which will appear when your tires have only 1/16 inch (1.6 mm) or less of tread remaining.

You need a new tire if any of the following statements are true:

- You can see the indicators at three or more places around the tire.
- You can see cord or fabric showing through the tire's rubber.
- The tread or sidewall is cracked, cut or snagged deep enough to show cord or fabric.
- The tire has a bump, bulge or split.
- The tire has a puncture, cut or other damage that can't be repaired well because of the size or location of the damage.



## Buying New Tires

To find out what kind and size of tires your vehicle needs, look at the tire and loading information label. For more information about this label and its location on your vehicle, see *Loading Your Vehicle on page 4-34*.

The tires installed on your vehicle when it was new had a Tire Performance Criteria Specification (TPC Spec) number on each tire's sidewall. When you get new tires, GM recommends that you get tires with that same TPC Spec number. That way your vehicle will continue to have tires that are designed to give proper endurance, handling, speed rating, load range, traction, ride and other things during normal service on your vehicle. If your tires have an all-season tread design, the TPC number will be followed by an "MS" (for mud and snow).

If you ever replace your tires with those not having a TPC Spec number, make sure they are the same size, load range, speed rating and construction type (bias, bias-belted or radial) as your original tires.

### CAUTION:

**Mixing tires could cause you to lose control while driving. If you mix tires of different sizes or types (radial and bias-belted tires), the vehicle may not handle properly, and you could have a crash. Using tires of different sizes may also cause damage to your vehicle. Be sure to use the same size and type tires on all wheels. It's all right to drive with your compact spare temporarily, it was developed for use on your vehicle. See "Compact Spare Tire" in the index.**

### CAUTION:

**If you use bias-ply tires on your vehicle, the wheel rim flanges could develop cracks after many miles of driving. A tire and/or wheel could fail suddenly, causing a crash. Use only radial-ply tires with the wheels on your vehicle.**

## Uniform Tire Quality Grading

Quality grades can be found where applicable on the tire sidewall between tread shoulder and maximum section width. For example:

### **Treadwear 200 Traction AA Temperature A**

The following information relates to the system developed by the United States National Highway Traffic Safety Administration, which grades tires by treadwear, traction and temperature performance. (This applies only to vehicles sold in the United States.)

The grades are molded on the sidewalls of most passenger car tires. The Uniform Tire Quality Grading system does not apply to deep tread, winter-type snow tires, space-saver or temporary use spare tires, tires with nominal rim diameters of 10 to 12 inches (25 to 30 cm), or to some limited-production tires.

While the tires available on General Motors passenger cars and light trucks may vary with respect to these grades, they must also conform to federal safety requirements and additional General Motors Tire Performance Criteria (TPC) standards.

## Treadwear

The treadwear grade is a comparative rating based on the wear rate of the tire when tested under controlled conditions on a specified government test course. For example, a tire graded 150 would wear one and a half (1.5) times as well on the government course as a tire graded 100. The relative performance of tires depends upon the actual conditions of their use, however, and may depart significantly from the norm due to variations in driving habits, service practices and differences in road characteristics and climate.

### **Traction – AA, A, B, C**

The traction grades, from highest to lowest, are AA, A, B, and C. Those grades represent the tire's ability to stop on wet pavement as measured under controlled conditions on specified government test surfaces of asphalt and concrete. A tire marked C may have poor traction performance. Warning: The traction grade assigned to this tire is based on straight-ahead braking traction tests, and does not include acceleration, cornering, hydroplaning, or peak traction characteristics.

## Temperature – A, B, C

The temperature grades are A (the highest), B, and C, representing the tire's resistance to the generation of heat and its ability to dissipate heat when tested under controlled conditions on a specified indoor laboratory test wheel. Sustained high temperature can cause the material of the tire to degenerate and reduce tire life, and excessive temperature can lead to sudden tire failure. The grade C corresponds to a level of performance which all passenger car tires must meet under the Federal Motor Vehicle Safety Standard No. 109. Grades B and A represent higher levels of performance on the laboratory test wheel than the minimum required by law.

Warning: The temperature grade for this tire is established for a tire that is properly inflated and not overloaded. Excessive speed, underinflation, or excessive loading, either separately or in combination, can cause heat buildup and possible tire failure.

## Wheel Alignment and Tire Balance

The wheels on your vehicle were aligned and balanced carefully at the factory to give you the longest tire life and best overall performance.

Scheduled wheel alignment and wheel balancing are not needed. However, if you notice unusual tire wear or your vehicle pulling one way or the other, the alignment may need to be reset. If you notice your vehicle vibrating when driving on a smooth road, your wheels may need to be rebalanced.

## Wheel Replacement

Replace any wheel that is bent, cracked or badly rusted or corroded. If wheel nuts keep coming loose, the wheel, wheel bolts and wheel nuts should be replaced. If the wheel leaks air, replace it (except some aluminum wheels, which can sometimes be repaired). See your dealer if any of these conditions exist.

Your dealer will know the kind of wheel you need.

Each new wheel should have the same load-carrying capacity, diameter, width, offset and be mounted the same way as the one it replaces.

If you need to replace any of your wheels, wheel bolts or wheel nuts, replace them only with new GM original equipment parts. This way, you will be sure to have the right wheel, wheel bolts and wheel nuts for your vehicle.

### CAUTION:

**Using the wrong replacement wheels, wheel bolts or wheel nuts on your vehicle can be dangerous. It could affect the braking and handling of your vehicle, make your tires lose air and make you lose control. You could have a collision in which you or others could be injured. Always use the correct wheel, wheel bolts and wheel nuts for replacement.**

**Notice:** The wrong wheel can also cause problems with bearing life, brake cooling, speedometer or odometer calibration, headlamp aim, bumper height, vehicle ground clearance and tire or tire chain clearance to the body and chassis.

See *Changing a Flat Tire* on page 5-75 for more information.

## Used Replacement Wheels

### **CAUTION:**

Putting a used wheel on your vehicle is dangerous. You can't know how it's been used or how far it's been driven. It could fail suddenly and cause a crash. If you have to replace a wheel, use a new GM original equipment wheel.

## Tire Chains

*Notice:* Use tire chains only where legal and only when you must. Use only SAE Class "S" type chains that are the proper size for your tires. Install them on the front tires and tighten them as tightly as possible with the ends securely fastened. Drive slowly and follow the chain manufacturer's instructions. If you can hear the chains contacting your vehicle, stop and retighten them. If the contact continues, slow down until it stops. Driving too fast or spinning the wheels with chains on will damage your vehicle.

## If a Tire Goes Flat

It's unusual for a tire to "blowout" while you're driving, especially if you maintain your tires properly. If air goes out of a tire, it's much more likely to leak out slowly. But if you should ever have a "blowout," here are a few tips about what to expect and what to do:

If a front tire fails, the flat tire will create a drag that pulls the vehicle toward that side. Take your foot off the accelerator pedal and grip the steering wheel firmly. Steer to maintain lane position, and then gently brake to a stop well out of the traffic lane.

A rear blowout, particularly on a curve, acts much like a skid and may require the same correction you'd use in a skid. In any rear blowout, remove your foot from the accelerator pedal. Get the vehicle under control by steering the way you want the vehicle to go. It may be very bumpy and noisy, but you can still steer. Gently brake to a stop, well off the road if possible.

### CAUTION:

**Lifting a vehicle and getting under it to do maintenance or repairs is dangerous without the appropriate safety equipment and training. The jack provided with your vehicle is designed only for changing a flat tire. If it is used for anything else, you or others could be badly injured or killed if the vehicle slips off the jack. Use the jack provided with your vehicle only for changing a flat tire.**

If a tire goes flat, the next part shows how to use your jacking equipment to change a flat tire safely.

## Changing a Flat Tire

If a tire goes flat, avoid further tire and wheel damage by driving slowly to a level place. Turn on the hazard warning flashers.

### CAUTION:

Changing a tire can cause an injury. The vehicle can slip off the jack and roll over you or other people. You and they could be badly injured. Find a level place to change your tire.

To help prevent the vehicle from moving:

1. Set the parking brake firmly.
2. Put the shift lever in PARK (P).
3. Turn off the engine.

To be even more certain the vehicle won't move, you can put blocks at the front and rear of the tire farthest away from the one being changed. That would be the tire on the other side of the vehicle, at the opposite end.

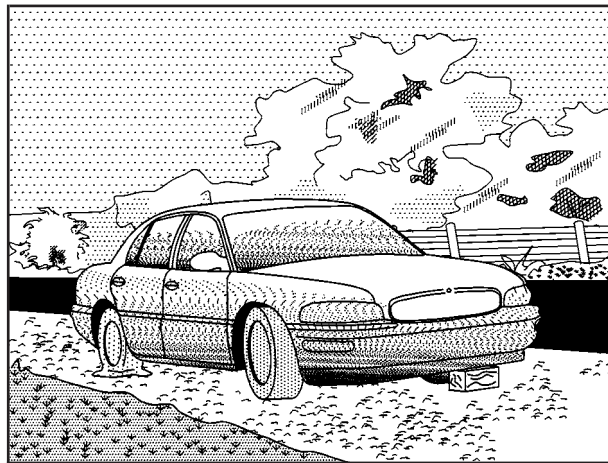

The following steps tell how to use the jack and change a tire.

## Removing the Spare Tire and Tools

The equipment you will need is in the trunk.



1. Turn the center nut on the compact spare tire cover counterclockwise to remove it. Then lift and remove the cover. See *Compact Spare Tire on page 5-87* for more information about the compact spare tire.



2. Remove the spare tire.



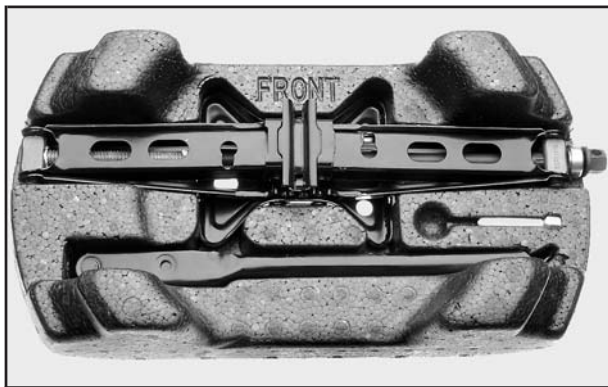

3. Turn the nut holding the jack counterclockwise and remove it. Then remove the jack and wrench.

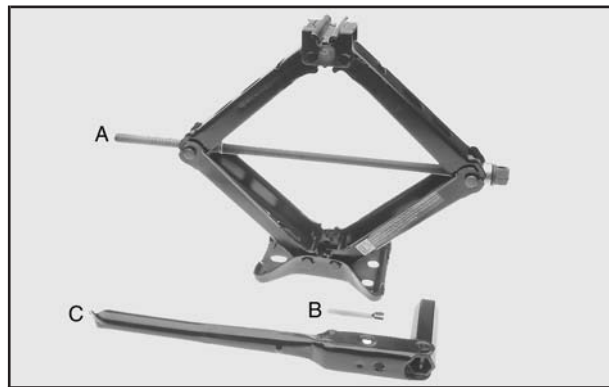

The tools you will be using include the jack (A), extension and protection guide (B) and wheel wrench (C).

## Removing the Wheel Covers

If the vehicle has wheel covers, be sure to use a wheel wrench to begin the process of loosening the plastic wheel nut caps.



Once the plastic nut caps have been loosened with the wheel wrench, finish loosening them with your fingers.

Then, using the flat end of the wheel wrench, pry along the edge of the wheel cover until it comes off. Be careful; the edge may be sharp. Do not try to remove the cover with your bare hands.

## Removing the Wheel Center Caps



To remove a center cap, use the wrench to pry gently at the notch. Do not use a tool that is narrower than the wrench to pry at this notch. Then pry off the cap.

## Removing the Flat Tire and Installing the Spare Tire

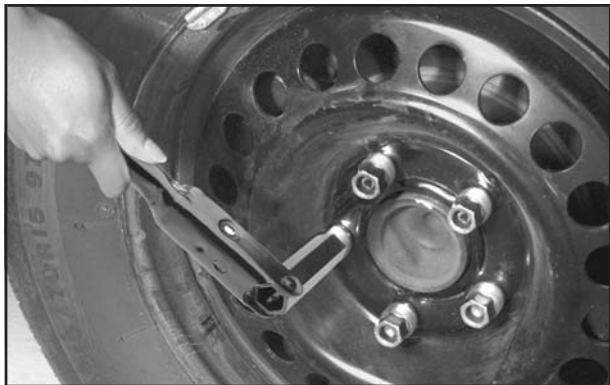

1. Using the wheel wrench, loosen all the wheel nuts, but do not remove them yet.
2. Turn the jack handle clockwise to raise the jack lift head.

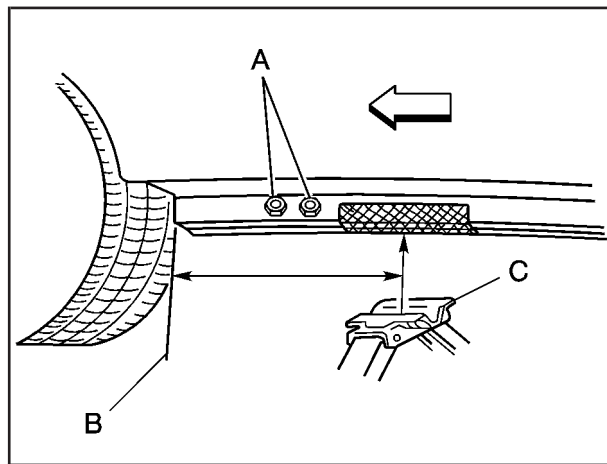

3. For jacking at the vehicle's front location, put the jack lift head (C) about 6 inches (15 cm) from the rear edge of the front wheel opening (B) or just behind the two bolts (A) as shown.

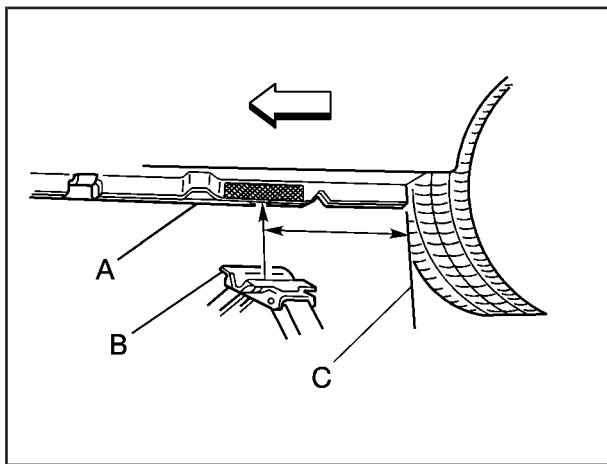

For jacking at the vehicle's rear location, put the jack lift head (B) about 5 inches (13 cm) from the front edge of the rear wheel opening (C) or just behind the off-set (A) as shown.

- Put the compact spare tire near you.

**⚠ CAUTION:**

Getting under a vehicle when it is jacked up is dangerous. If the vehicle slips off the jack you could be badly injured or killed. Never get under a vehicle when it is supported only by a jack.

**⚠ CAUTION:**

Raising your vehicle with the jack improperly positioned can damage the vehicle and even make the vehicle fall. To help avoid personal injury and vehicle damage, be sure to fit the jack lift head into the proper location before raising the vehicle.

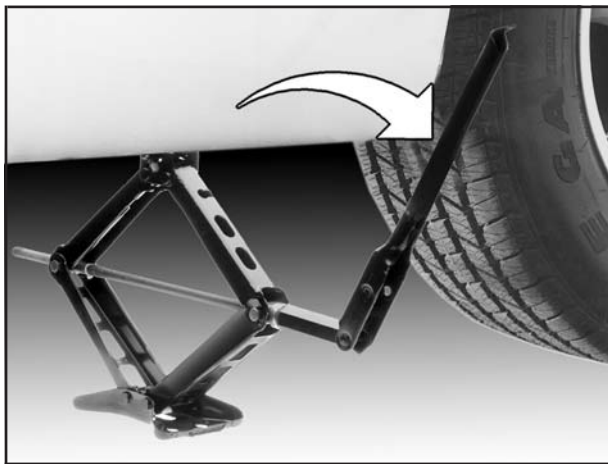

5. Raise the vehicle by turning the jack handle clockwise. Raise the vehicle far enough off the ground for the spare compact tire to fit underneath the wheel well.
6. Remove all wheel nuts and take off the flat tire.

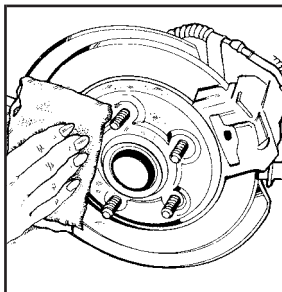

7. Remove any rust or dirt from the wheel bolts, mounting surfaces and spare wheel.

**⚠ CAUTION:**

Rust or dirt on the wheel, or on the parts to which it is fastened, can make the wheel nuts become loose after a time. The wheel could come off and cause an accident. When you change a wheel, remove any rust or dirt from the places where the wheel attaches to the vehicle. In an emergency, you can use a cloth or a paper towel to do this; but be sure to use a scraper or wire brush later, if you need to, to get all the rust or dirt off.

**⚠ CAUTION:**

Never use oil or grease on studs or nuts. If you do, the nuts might come loose. Your wheel could fall off, causing a serious accident.

8. Install the compact spare tire.



Put the wheel nuts back on with the rounded end of the nuts toward the wheel. Tighten each nut by hand until the wheel is held against the hub.

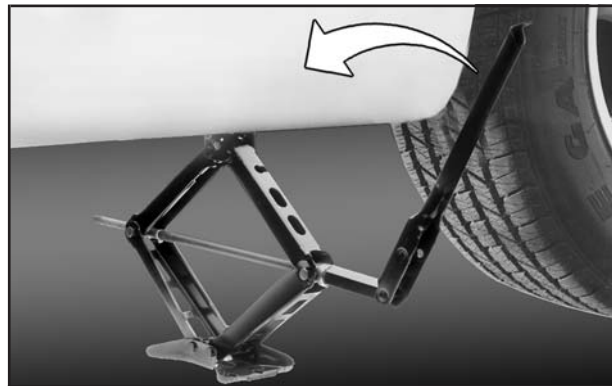

9. Lower the vehicle by turning the jack handle counterclockwise. Lower the jack completely.

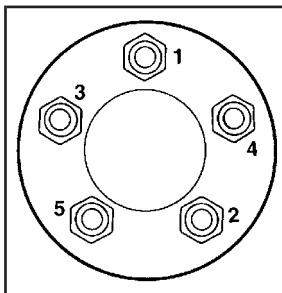

10. Tighten the wheel nuts firmly in a crisscross sequence as shown.

**⚠ CAUTION:**

Incorrect wheel nuts or improperly tightened wheel nuts can cause the wheel to come loose and even come off. This could lead to an accident. Be sure to use the correct wheel nuts. If you have to replace them, be sure to get new GM original equipment wheel nuts.

CAUTION: (Continued)

**CAUTION: (Continued)**

Stop somewhere as soon as you can and have the nuts tightened with a torque wrench to the proper torque specification. See “Capacities and Specifications” in the Index for wheel nut torque specification.

**Notice:** Improperly tightened wheel nuts can lead to brake pulsation and rotor damage. To avoid expensive brake repairs, evenly tighten the wheel nuts in the proper sequence and to the proper torque specification. See “Capacities and Specifications” in the index for the wheel nut torque specification.

Do not try to put the wheel cover on your compact spare tire. It will not fit. Store the wheel cover in the trunk until you have the flat tire repaired or replaced.

**Notice:** Wheel covers will not fit on your compact spare. If you try to put a wheel cover on the compact spare, you could damage the cover or the spare.



## Storing the Flat Tire and Tools

### CAUTION:

Storing a jack, a tire, or other equipment in the passenger compartment of the vehicle could cause injury. In a sudden stop or collision, loose equipment could strike someone. Store all these in the proper place.

After the compact spare tire is put on the vehicle, store the flat tire in the trunk. Use the following procedure to secure the flat tire in the trunk.



When storing a full-size tire, use the extension with the protector, located in the foam holder, to help avoid wheel surface damage. To store a full-size tire, place the tire valve stem facing down, and then remove the protector and attach the retainer securely. Store the cover as far forward as possible.

## Storing the Spare Tire and Tools

When storing a compact spare tire in the trunk, put the protector/guide back in the foam holder.

### CAUTION:

**Storing a jack, a tire, or other equipment in the passenger compartment of the vehicle could cause injury. In a sudden stop or collision, loose equipment could strike someone. Store all these in the proper place.**

The compact spare is for temporary use only. Replace the compact spare tire with a full-size tire as soon as you can. See *Compact Spare Tire* on page 5-87. See the storage instructions label to return the compact spare to the trunk properly.

Be sure to calibrate low tire inflation system after you replace the compact spare tire with a full-sized tire. See *Inflation - Tire Pressure* on page 5-64.

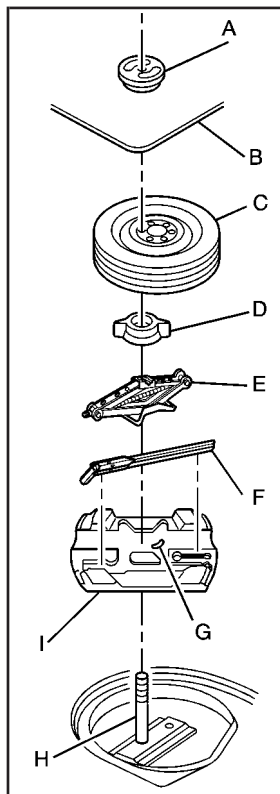

- A. Retainer
- B. Cover
- C. Compact Spare Tire
- D. Nut
- E. Jack
- F. Wheel Wrench
- G. Extension and Protector
- H. Bolt Screw
- I. Foam Holder

## Compact Spare Tire

Although the compact spare tire was fully inflated when the vehicle was new, it can lose air after a time. Check the inflation pressure regularly. It should be 60 psi (420 kPa).

After installing the compact spare on the vehicle, check to make sure it is correctly inflated. The compact spare is made to perform well at speeds up to 65 mph (105 km/h) for distances up to 3,000 miles (5 000 km). However, it is best to replace the compact spare with a full-size tire as soon as possible. The spare will last longer and be in good shape in case it is needed again. The tire inflation monitor system must be reset after installing or removing the compact spare. See *Tire Pressure Monitor System* on page 5-65.

**Notice:** When the compact spare is installed, don't take your vehicle through an automatic car wash with guide rails. The compact spare can get caught on the rails. That can damage the tire and wheel, and maybe other parts of your vehicle.

Do not use the compact spare on other vehicles.

Do not mix the compact spare tire or wheel with other wheels or tires. They will not fit. Keep the spare tire and its wheel together.

**Notice:** Tire chains won't fit your compact spare. Using them can damage your vehicle and can damage the chains too. Don't use tire chains on your compact spare.

## Appearance Care

Remember, cleaning products can be hazardous. Some are toxic. Others can burst into flames if you strike a match or get them on a hot part of the vehicle. Some are dangerous if you breathe their fumes in a closed space. When you use anything from a container to clean your vehicle, be sure to follow the manufacturer's warnings and instructions. And always open your doors or windows when you are cleaning the inside.

Never use these to clean your vehicle:

- Gasoline
- Benzene
- Naphtha
- Carbon Tetrachloride
- Acetone
- Paint Thinner
- Turpentine
- Lacquer Thinner
- Nail Polish Remover

They can all be hazardous — some more than others — and they can all damage your vehicle, too.

Do not use any of these unless this manual says you can. In many uses, these will damage your vehicle:

- Alcohol
- Laundry Soap
- Bleach
- Reducing Agents

## Cleaning the Inside of Your Vehicle

Use a vacuum cleaner often to get rid of dust and loose dirt. Wipe vinyl, leather, plastic and painted surfaces with a clean, damp cloth.

### Cleaning Fabric/Carpet

Your dealer has cleaners for the cleaning of fabric and carpet. They will clean normal spots and stains very well.

You can get GM-approved cleaning products from your dealer. See *Vehicle Care/Appearance Materials* on page 5-95.

Here are some cleaning tips:

- Always read the instructions on the cleaner label.
- Clean up stains as soon as you can — before they set.
- Carefully scrape off any excess stain.
- Use a clean cloth or sponge, and change to a clean area often. A soft brush may be used if stains are stubborn.
- If a ring forms on fabric after spot cleaning, clean the entire area immediately or it will set.

## Using Cleaner on Fabric

1. Vacuum and brush the area to remove any loose dirt.
2. Always clean a whole trim panel or section. Mask surrounding trim along stitch or welt lines.
3. Follow the directions on the container label.
4. Apply cleaner with a clean sponge. Do not saturate the material and do not rub it roughly.
5. As soon as you have cleaned the section, use a sponge to remove any excess cleaner.
6. Wipe cleaned area with a clean, water-dampened towel or cloth.
7. Wipe with a clean cloth and let dry.

## Special Fabric Cleaning Problems

Stains caused by such things as catsup, coffee (black), egg, fruit, fruit juice, milk, soft drinks, vomit, urine and blood can be removed as follows:

1. Carefully scrape off excess stain, then sponge the soiled area with cool water.
2. If a stain remains, follow the cleaning instructions described earlier.
3. If an odor lingers after cleaning vomit or urine, treat the area with a water and baking soda solution: 1 teaspoon (5 ml) of baking soda to 1 cup (250 ml) of lukewarm water.
4. Let dry.

Stains caused by candy, ice cream, mayonnaise, chili sauce and unknown stains can be removed as follows:

1. Carefully scrape off excess stain.
2. Clean with cool water and allow to dry completely.
3. If a stain remains, follow the cleaner instructions described earlier.

## Cleaning Vinyl

Use warm water and a clean cloth.

- Rub with a clean, damp cloth to remove dirt. You may have to do this more than once.
- Things like tar, asphalt and shoe polish will stain if you do not get them off quickly. Use a clean cloth and vinyl cleaner. See your dealer for this product.

## Cleaning Leather

Use a soft cloth with lukewarm water and a mild soap or saddle soap and wipe dry with a soft cloth. Then, let the leather dry naturally. Do not use heat to dry.

- For stubborn stains, use a leather cleaner.
- *Never* use oils, varnishes, solvent-based or abrasive cleaners, furniture polish or shoe polish on leather.
- Soiled or stained leather should be cleaned immediately. If dirt is allowed to work into the finish, it can harm the leather.

## Cleaning the Top of the Instrument Panel

Use only mild soap and water to clean the top surfaces of the instrument panel. Sprays containing silicones or waxes may cause annoying reflections in the windshield and even make it difficult to see through the windshield under certain conditions.

## Cleaning Interior Plastic Components

Use only a mild soap and water solution on a soft cloth or sponge. Commercial cleaners may affect the surface finish.

## Cleaning Glass Surfaces

Glass should be cleaned often. GM Glass Cleaner or a liquid household glass cleaner will remove normal tobacco smoke and dust films on interior glass. See *Vehicle Care/Appearance Materials on page 5-95*.

**Notice:** If you use abrasive cleaners when cleaning glass surfaces on your vehicle, you could scratch the glass and/or cause damage to the rear window defogger and the integrated radio antenna. When cleaning the glass on your vehicle, use only a soft cloth and glass cleaner.

## Care of Safety Belts

Keep belts clean and dry.

### CAUTION:

**Do not bleach or dye safety belts. If you do, it may severely weaken them. In a crash, they might not be able to provide adequate protection. Clean safety belts only with mild soap and lukewarm water.**

## Weatherstrips

Silicone grease on weatherstrips will make them last longer, seal better, and not stick or squeak. Apply silicone grease with a clean cloth at least every six months. During very cold, damp weather more frequent application may be required. See *Recommended Fluids and Lubricants* on page 6-12.

## Cleaning the Outside of Your Vehicle

The paint finish on your vehicle provides beauty, depth of color, gloss retention and durability.

### Washing Your Vehicle

The best way to preserve your vehicle's finish is to keep it clean by washing it often with lukewarm or cold water.

Do not wash your vehicle in the direct rays of the sun. Use a car washing soap. Do not use strong soaps or chemical detergents. Be sure to rinse the vehicle well, removing all soap residue completely. You can get GM-approved cleaning products from your dealer. See *Vehicle Care/Appearance Materials* on page 5-95. Do not use cleaning agents that are petroleum based, or that contain acid or abrasives. All cleaning agents should be flushed promptly and not allowed to dry on the surface, or they could stain. Dry the finish with a soft, clean chamois or an all-cotton towel to avoid surface scratches and water spotting.

High pressure car washes may cause water to enter your vehicle.

## Cleaning Exterior Lamps/Lenses

Use only lukewarm or cold water, a soft cloth and a car washing soap to clean exterior lamps and lenses. Follow instructions under “Washing Your Vehicle.”

## Finish Care

Occasional waxing or mild polishing of your vehicle by hand may be necessary to remove residue from the paint finish. You can get GM-approved cleaning products from your dealer. See *Vehicle Care/Appearance Materials* on page 5-95.

Your vehicle has a “basecoat/clearcoat” paint finish. The clearcoat gives more depth and gloss to the colored basecoat. Always use waxes and polishes that are non-abrasive and made for a basecoat/clearcoat paint finish.

**Notice: Machine compounding or aggressive polishing on a basecoat/clearcoat paint finish may damage it. Use only non-abrasive waxes and polishes that are made for a basecoat/clearcoat paint finish on your vehicle.**

Foreign materials such as calcium chloride and other salts, ice melting agents, road oil and tar, tree sap, bird droppings, chemicals from industrial chimneys, etc., can damage your vehicle’s finish if they remain

on painted surfaces. Wash the vehicle as soon as possible. If necessary, use non-abrasive cleaners that are marked safe for painted surfaces to remove foreign matter.

Exterior painted surfaces are subject to aging, weather and chemical fallout that can take their toll over a period of years. You can help to keep the paint finish looking new by keeping your vehicle garaged or covered whenever possible.

## Cleaning Windshield and Wiper Blades

If the windshield is not clear after using the windshield washer, or if the wiper blade chatters when running, wax, sap or other material may be on the blade or windshield.

Clean the outside of the windshield with a full-strength glass cleaning liquid. The windshield is clean if beads do not form when you rinse it with water.

Grime from the windshield will stick to the wiper blades and affect their performance. Clean the blade by wiping vigorously with a cloth soaked in full-strength windshield washer solvent. Then rinse the blade with water.

Check the wiper blades and clean them as necessary; replace blades that look worn.



## Cleaning Aluminum Wheels

Keep your wheels clean using a soft clean cloth with mild soap and water. Rinse with clean water. After rinsing thoroughly, dry with a soft clean towel. A wax may then be applied.

The surface of these wheels is similar to the painted surface of your vehicle. Do not use strong soaps, chemicals, abrasive polishes, abrasive cleaners, cleaners with acid, or abrasive cleaning brushes on them because you could damage the surface. Do not use chrome polish on aluminum wheels.

Do not take your vehicle through an automatic car wash that has silicone carbide tire cleaning brushes. These brushes can also damage the surface of these wheels.

## Cleaning Tires

To clean your tires, use a stiff brush with tire cleaner.

**Notice:** Using petroleum-based tire dressing products on your vehicle may damage the paint finish and/or tires. When applying a tire dressing, always wipe off any overspray from all painted surfaces on your vehicle.

## Sheet Metal Damage

If your vehicle is damaged and requires sheet metal repair or replacement, make sure the body repair shop applies anti-corrosion material to parts repaired or replaced to restore corrosion protection.

Original manufacturer replacement parts will provide the corrosion protection while maintaining the warranty.

## Finish Damage

Any stone chips, fractures or deep scratches in the finish should be repaired right away. Bare metal will corrode quickly and may develop into major repair expense.

Minor chips and scratches can be repaired with touch-up materials available from your dealer. Larger areas of finish damage can be corrected in your dealer's body and paint shop.

## Underbody Maintenance

Chemicals used for ice and snow removal and dust control can collect on the underbody. If these are not removed, corrosion and rust can develop on the underbody parts such as fuel lines, frame, floor pan and exhaust system even though they have corrosion protection.

At least every spring, flush these materials from the underbody with plain water. Clean any areas where mud and debris can collect. Dirt packed in close areas of the frame should be loosened before being flushed. Your dealer or an underbody car washing system can do this for you.

## Chemical Paint Spotting

Some weather and atmospheric conditions can create a chemical fallout. Airborne pollutants can fall upon and attack painted surfaces on your vehicle. This damage can take two forms: blotchy, ring-shaped discolorations, and small, irregular dark spots etched into the paint surface.

Although no defect in the paint job causes this, GM will repair, at no charge to the owner, the surfaces of new vehicles damaged by this fallout condition within 12 months or 12,000 miles (20 000 km) of purchase, whichever occurs first.

## Vehicle Care/Appearance Materials

See your GM dealer for more information on purchasing the following products.

### Vehicle Care/Appearance Materials

Description	Usage
Polishing Cloth Wax-Treated	Interior and exterior polishing cloth.
Tar and Road Oil Remover	Removes tar, road oil and asphalt.
Chrome Cleaner and Polish	Use on chrome or stainless steel.
White Sidewall Tire Cleaner	Removes soil and black marks from whitewalls.
Vinyl Cleaner	Cleans vinyl tops, upholstery and convertible tops.
Glass Cleaner	Removes dirt, grime, smoke and fingerprints.
Chrome and Wire Wheel Cleaner	Removes dirt and grime from chrome wheels and wire wheel covers.
Finish Enhancer	Removes dust, fingerprints, and surface contaminants. Spray on wipe off.

## Vehicle Care/Appearance Materials (cont'd)

Description	Usage
Swirl Remover Polish	Removes swirl marks, fine scratches and other light surface contamination.
Cleaner Wax	Removes light scratches and protects finish.
Foaming Tire Shine Low Gloss	Cleans, shines and protects in one easy step, no wiping necessary.
Wash Wax Concentrate	Medium foaming shampoo. Cleans and lightly waxes. Biodegradable and phosphate free.
Spot Lifter	Quickly and easily removes spots and stains from carpets, vinyl and cloth upholstery.
Odor Eliminator	Odorless spray odor eliminator used on fabrics, vinyl, leather and carpet.
See your General Motors parts department for these products. See <i>Recommended Fluids and Lubricants</i> on page 6-12.	

## Vehicle Identification

### Vehicle Identification Number (VIN)



This is the legal identifier for your vehicle. It appears on a plate in the front corner of the instrument panel, on the driver's side. You can see it if you look through the windshield from outside your vehicle. The VIN also appears on the Vehicle Certification and Service Parts labels and the certificates of title and registration.

### Engine Identification

The 8th character in your VIN is the engine code. This code will help you identify your engine, specifications and replacement parts.

### Service Parts Identification Label

This label is located on the inside of the trunk lid. It is very helpful if parts need to be ordered for the vehicle. It has the following information printed on it:

- The VIN
- The model designation
- Paint information
- A list of all production options and special equipment

Do not remove this label from the vehicle.

## Electrical System

### Add-On Electrical Equipment

**Notice:** Don't add anything electrical to your vehicle unless you check with your dealer first. Some electrical equipment can damage your vehicle and the damage wouldn't be covered by your warranty. Some add-on electrical equipment can keep other components from working as they should.

The vehicle has an air bag system. Before attempting to add anything electrical to the vehicle, see *Servicing Your Air Bag-Equipped Vehicle* on page 1-58.

### Headlamp Wiring

The headlamp wiring is protected by a circuit breaker in the underhood fuse block. An electrical overload will cause the headlamps to go on and off, or in some cases to remain off. If this happens, have the headlamp system checked right away.

## Windshield Wiper Fuses

The windshield wiper motor is protected by a circuit breaker and a fuse. If the motor overheats due to heavy snow, etc., the wiper will stop until the motor cools. If the overload is caused by some electrical problem, have it fixed.

## Power Windows and Other Power Options

Circuit breakers in the instrument panel fuse block protect the power windows and other power accessories. When the current load is too heavy, the circuit breaker opens and closes, protecting the circuit until the problem is fixed.

## Fuses and Circuit Breakers

The wiring circuits in the vehicle are protected from short circuits by a combination of fuses, circuit breakers and in the fuse block wiring itself. This greatly reduces the chance of fires caused by electrical problems.

Look at the silver-colored band inside the fuse. If the band is broken or melted, replace the fuse. Be sure a bad fuse is replaced with a new one of the identical size and rating.

## Instrument Panel Fuse Block



Some fuses are located in a fuse block on the passenger's side of the instrument panel. Pull off the cover labeled FUSES to expose the fuse block.

Circuit Breakers	PWR/WNDW PWR S/HOOF		INDEFOG		PWR/SEAT				
	Tire Reset								
10	PRK/LCK		PCM, BCM, UH	Radio Prem. Sound	PWR/MIR		INT/ILLUM		
9									
8	IGN D, CLSTR, PCM, & BCM			ACCY PWR BUS	DR/LCK		R/LAMPS		
7									
6		Cruise	CLSTR	LTR	Stop LAMPS	ONSTAR	PRK/LIGHT		
5									
4	CRNK SIG, BCM, CLSTR	HVAC	BTSI (REGAL)	AIRBAG	BCM PWR	HAZARD	LH HTD SEAT	BCM ACCY	
3									
2		LOW BLWR	ABS	TRN/SIG	RADIO HVAC, RFA, CLSTR ALDL	HI BLWR	RH HTD/SEAT	STR/WHL/CNTRL	
1								WPR	
	A	B	C	D	E	F	G	H	J



<b>Circuit Breakers</b>	<b>Usage</b>
TIRE RESET	Tire Inflation Monitor Reset Button
PWR/WNDW PWR S/ROOF	Power Windows, Power Sunroof
R/DEFOG	Rear Window Defogger
PWR/ SEAT	Power Seat
Blank	Not Used

<b>Fuses</b>	<b>Usage</b>
PRK/LCK	Ignition Key Solenoid
Blank	Not Used
Blank	Not Used
PCM, BCM, U/H	Ignition Signal: Hot in Run and Start, Powertrain Control Module, Body Control Module, Underhood Relay
RADIO PREM. SOUND	Remote Radio Premium Sound
PWR MIR	Power Mirrors
Blank	Not Used
INT/ILLUM	Panel Dimming
Blank	Not Used
IGN 0: CLSTR, PCM & BCM	Ignition Signal: Hot in Run, Unlock and Start; Cluster, Powertrain Control Module, Body Control Module

<b>Fuses</b>	<b>Usage</b>
Blank	Not Used
Blank	Not Used
Blank	Not Used
ACCY PWR BUS	Interior Lamps
DR/ LCK	Door Locks
Blank	Not Used
R/LAMPS	Taillamps, License Plate Lamps
Blank	Not Used
CRUISE	Cruise Control
Blank	Not Used
CLSTR	Instrument Panel Cluster
LTR	Cigarette Lighter
STOP LAMPS	Stoplamps
ONSTAR	OnStar <sup>®</sup>
PRK/LGHT	Parking Lamps
Blank	Not Used
CRNK SIG, BCM, CLSTR	Crank Signal, Body Control Module, Cluster, Powertrain Control Module
HVAC	Ignition Signal, Heating, Ventilation, and Air Conditioning Control Head
BTSI (REGAL)	Not Used
AIR BAG	Air Bag
BCM PWR	Body Control Module

Fuses	Usage
HAZRD	Hazard Warning Flashers
LH HTD SEAT	Not Used
Blank	Not Used
BCM ACCY	Ignition Signal: Hot in ACCESSORY and RUN, Body Control Module
Blank	Not Used
LOW BLWER	Low Blower
ABS	Anti-Lock Brakes
TRN SIG	Turn Signals, Cornering Lamps
RADIO, HVAC, RFA, CLSTR ALDL	Radio, Heating Ventilation and Air Conditioning Head; Remote Keyless Entry, Cluster
HI BLWR	High Blower
RH HTD SEAT	Not Used
STR/WHL CNTRL	Audio Steering Wheel Controls
WPR	Windshield Wipers

## Underhood Fuse Block

Some fuses and relays are located in the underhood fuse block on the passenger's side of the vehicle in the engine compartment. See *Engine Compartment Overview* on page 5-12 for more information on location.

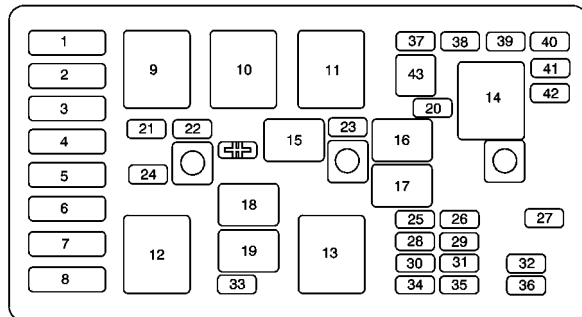



<b>Fuses</b>	<b>Usage</b>
1	Anti-Lock Brake System
2	Starter Solenoid
3	Power Seat, Rear Window Defogger
4	High Blower, Hazard Flasher, Stoplamps, Power Mirror, Door Locks
5	Ignition Switch, Stoplamps, Anti-Lock Brake System, Turn Signals, Cluster, Air Bag, Daytime Running Lamps Module
6	Cooling Fan
7	Retained Accessory Power, Remote Keyless Entry, Data Link, Heating, Ventilation, and Air Conditioning Head; Cluster, Radio, Cigarette Lighter
8	Ignition Switch, Wipers, Audio Steering Wheel Controls, Body Control Module, Power Windows, Sunroof, Heating, Ventilation, and Air Conditioning Controls; Daytime Running Lamps, Rear Window Defogger Relay

<b>Relays</b>	<b>Usage</b>
9	Cooling Fan 2
10	Cooling Fan 3
11	Starter Solenoid
12	Cooling Fan 1
13	Ignition Main
14	Air Pump (Optional)
15	Not Used
16	Horn
17	Fog Lamps
18	Not Used
19	Fuel Pump

Fuses	Usage
20	Not Used
21	Generator
22	Engine Control Module
23	Air Conditioner Compressor Clutch
24	Cooling Fan
25	Electronic Ignition
26	Transaxle
27	Horn
28	Fuel Injector
29	Oxygen Sensor
30	Engine Emissions
31	Fog Lamps
32	Right Headlamp

Fuses	Usage
33	Rear Compartment Release
34	Parking Lamps
35	Fuel Pump
36	Left Headlamp
37	Not Used
38	Not Used
39	Not Used
40	Not Used
41	Not Used
42	Not Used
43	Not Used
SYMBOL	Air Conditioner Compressor Clutch Diode

# Capacities and Specifications

## Capacities and Specifications

Application	Capacities	
	English	Metric
Air Conditioning Refrigerant R134a	2.4 lbs	1.1 kg
<b>Automatic Transaxle</b> Pan Removal and Replacement After Complete Overhaul When draining/replacing converter, more fluid will be needed.	7.4 quarts 10.0 quarts	7.0 L 9.5 L
Cooling System Including Reservoir	11.7 quarts	11.0 L
Engine Oil with Filter	4.0 quarts	3.8 L
Fuel Tank	17.0 gallons	64.0 L
Wheel Nut Torque	100 lb ft	140 N•m
All capacities are approximate. When adding, be sure to fill to the approximate level, as recommended in this manual.		

## Engine Specifications

Engine	VIN Code	Transmission	Displacement	Firing Order
3100 V6	J 1	Automatic	191 CID	1-2-3-4-5-6



# NOTES

---

---

---

---

---

---

---

---

---

---

---

---

---

---

---

---

---

---

---

---

---

---

## Section 6 Maintenance Schedule

---

<b>Maintenance Schedule</b> .....	6-2	Owner Checks and Services .....	6-8
Introduction .....	6-2	At Each Fuel Fill .....	6-8
Maintenance Requirements .....	6-2	At Least Once a Month .....	6-9
Your Vehicle and the Environment .....	6-2	At Least Once a Year .....	6-9
Using Your Maintenance Schedule .....	6-2	Recommended Fluids and Lubricants .....	6-12
Scheduled Maintenance .....	6-4	Normal Maintenance Replacement Parts .....	6-13
Additional Required Services .....	6-6	Engine Drive Belt Routing .....	6-14
Maintenance Footnotes .....	6-7	Maintenance Record .....	6-15

# Maintenance Schedule

## Introduction

**Important:** Keep engine oil at the proper level and change as recommended.



*Have you purchased the GM Protection Plan? The Plan supplements your new vehicle warranties. See your Warranty and Owner Assistance booklet or your dealer for details.*

## Maintenance Requirements

**Notice:** Maintenance intervals, checks, inspections, replacement parts and recommended fluids and lubricants as prescribed in this manual are necessary to keep your vehicle in good working condition. Any damage caused by failure to follow scheduled maintenance may not be covered by warranty.

## Your Vehicle and the Environment

Proper vehicle maintenance not only helps to keep your vehicle in good working condition, but also helps the environment. All recommended maintenance is important. Improper vehicle maintenance can even affect the quality of the air we breathe. Improper fluid levels or the wrong tire inflation can increase the level of emissions from your vehicle. To help protect our environment, and to keep your vehicle in good condition, be sure to maintain your vehicle properly.

## Using Your Maintenance Schedule

We at General Motors want to help you keep your vehicle in good working condition. But we do not know exactly how you will drive it. You may drive very short distances only a few times a week. Or you may drive long distances all the time in very hot, dusty weather. You may use your vehicle in making deliveries. Or you may drive it to work, to do errands or in many other ways.

Because of all the different ways people use their vehicles, maintenance needs vary. You may need more frequent checks and replacements. So please read the following and note how you drive. If you have any questions on how to keep your vehicle in good condition, see your GM Goodwrench dealer.

This schedule is for vehicles that:

- carry passengers and cargo within recommended limits. You will find these limits on the tire and loading information label. See *Loading Your Vehicle on page 4-34*.
- are driven on reasonable road surfaces within legal driving limits.
- use the recommended fuel. See *Gasoline Octane on page 5-4*.

The services in *Scheduled Maintenance on page 6-4* should be performed when indicated. See *Additional Required Services on page 6-6* and *Maintenance Footnotes on page 6-7* for further information.

 **CAUTION:**

**Performing maintenance work on a vehicle can be dangerous. In trying to do some jobs, you can be seriously injured. Do your own maintenance work only if you have the required know-how and the proper tools and equipment for the job. If you have any doubt, see your GM Goodwrench dealer to have a qualified technician do the work.**

Some maintenance services can be complex. So, unless you are technically qualified and have the necessary equipment, you should have your GM Goodwrench dealer do these jobs.

When you go to your GM Goodwrench dealer for your service needs, you will know that GM-trained and supported service technicians will perform the work using genuine GM parts.

If you want to get service information, see *Service Publications Ordering Information on page 7-11*.

*Owner Checks and Services on page 6-8* tells you what should be checked, when to check it and what you can easily do to help keep your vehicle in good condition.

The proper replacement parts, fluids and lubricants to use are listed in *Recommended Fluids and Lubricants on page 6-12* and *Normal Maintenance Replacement Parts on page 6-13*. When your vehicle is serviced, make sure these are used. All parts should be replaced and all necessary repairs done before you or anyone else drives the vehicle. We recommend the use of genuine GM parts.

## Scheduled Maintenance

When the CHANGE OIL SOON light comes on, it means that service is required for your vehicle. Have your vehicle serviced as soon as possible within the next 600 miles (1 000 km). It is possible that, if you are driving under the best conditions, the engine oil life system may not indicate that vehicle service is necessary for over a year. However, your engine oil and filter must be changed at least once a year and at this time the system must be reset. Your GM Goodwrench dealer has GM-trained service technicians who will perform this work using genuine GM parts and reset the system.

If the engine oil life system is ever reset accidentally, you must service your vehicle within 3,000 miles (5 000 km) since your last service. Remember to reset the oil life system whenever the oil is changed. See *Engine Oil on page 5-13* for information on the Engine Oil Life System and resetting the system.

When the CHANGE OIL SOON light appears, certain services, checks and inspections are required. Required services are described in the following for “Maintenance I” and “Maintenance II.” Generally, it is recommended that your first service be Maintenance I, your second service be Maintenance II and that you alternate Maintenance I and Maintenance II thereafter. However, in some cases, Maintenance II may be required more often.

**Maintenance I** — Use Maintenance I if the light comes on within ten months since vehicle was purchased or Maintenance II was performed.

**Maintenance II** — Use Maintenance II if the previous service performed was Maintenance I. Always use Maintenance II whenever the light comes on ten months or more since the last service or if the light has not come on at all for one year.



Service	Maintenance I	Maintenance II
Change engine oil and filter. Reset oil life system. See <i>Engine Oil on page 5-13. An Emission Control Service.</i>	•	•
Visually check for any leaks or damage. See <i>footnote (k).</i>	•	•
Inspect engine air cleaner filter. If necessary, replace filter. See <i>Engine Air Cleaner/Filter on page 5-18. An Emission Control Service. See footnote †.</i>	•	•
Rotate tires and check inflation pressures and wear. See <i>Tires on page 5-57.</i>	•	•
Inspect brake system. See <i>footnote (a).</i>	•	•
Check engine coolant and windshield washer fluid levels and add fluid as needed.	•	•
Perform any needed additional services. See “Additional Required Services” in this section.	•	•
Inspect suspension and steering components. See <i>footnote (b).</i>		•
Inspect engine cooling system. See <i>footnote (c).</i>		•
Inspect wiper blades. See <i>footnote (d).</i>		•
Inspect restraint system components. See <i>footnote (e).</i>		•
Lubricate body components. See <i>footnote (f).</i>		•
Check transaxle fluid level and add fluid as needed.		•
Replace passenger compartment air filter. See <i>footnote (g).</i>		•
Inspect throttle system. See <i>footnote (j).</i>		•

## Additional Required Services

The following services should be performed at the first maintenance service (I or II) after the indicated miles (kilometers) shown for each item.

Service	25,000 (41 500)	50,000 (83 000)	75,000 (125 000)	100,000 (166 000)	125,000 (207 500)	150,000 (240 000)
Inspect fuel system for damage or leaks.	•	•	•	•	•	•
Inspect exhaust system for loose or damaged components.	•	•	•	•	•	•
Replace engine air cleaner filter. See <i>Engine Air Cleaner/Filter on page 5-18. An Emission Control Service.</i>	•	•	•	•	•	•
Change automatic transaxle fluid and filter (severe service). See footnote (h).		•		•		•
Change automatic transaxle fluid and filter (normal service).				•		
Replace spark plugs and inspect spark plug wires. <i>An Emission Control Service.</i>				•		
Engine cooling system service (or every 5 years, whichever occurs first). <i>An Emission Control Service. See footnote (i).</i>						•
Inspect engine accessory drive belt. <i>An Emission Control Service.</i>						•

## Maintenance Footnotes

† The U.S. Environmental Protection Agency or the California Air Resources Board has determined that the failure to perform this maintenance item will not nullify the emission warranty or limit recall liability prior to the completion of the vehicle's useful life. We, however, urge that all recommended maintenance services be performed at the indicated intervals and the maintenance be recorded.

(a) Visually inspect brake lines and hoses for proper hook-up, binding, leaks, cracks, chafing, etc. Inspect disc brake pads for wear and rotors for surface condition. Inspect other brake parts, including calipers, parking brake, etc.

(b) Visually inspect front and rear suspension and steering system for damaged, loose or missing parts or signs of wear. Inspect power steering lines and hoses for proper hook-up, binding, leaks, cracks, chafing, etc.

(c) Visually inspect hoses and have them replaced if they are cracked, swollen or deteriorated. Inspect all pipes, fittings and clamps; replace with genuine GM parts as needed. To help ensure proper operation, a pressure test of the cooling system and pressure cap and cleaning the outside of the radiator and air conditioning condenser is recommended at least once a year.

(d) Visually inspect wiper blades for wear or cracking. Replace blade inserts that appear worn or damaged or that streak or miss areas of the windshield.

(e) Make sure the safety belt reminder light and all your belts, buckles, latch plates, retractors and anchorages are working properly. Look for any other loose or damaged safety belt system parts. If you see anything that might keep a safety belt system from doing its job, have it repaired. Have any torn or frayed safety belts replaced. Also look for any opened or broken air bag coverings, and have them repaired or replaced. (The air bag system does not need regular maintenance.)

(f) Lubricate all key lock cylinders. Lubricate all hinges and latches, including those for the body doors, hood, secondary latch, pivots, spring anchor, release pawl, rear compartment, glove box door and console door. More frequent lubrication may be required when exposed to a corrosive environment. Applying silicone grease on weatherstrips with a clean cloth will make them last longer, seal better and not stick or squeak.

(g) If you drive regularly under dusty conditions, the filter may require replacement more often.

(h) *Change automatic transaxle fluid and filter if the vehicle is mainly driven under one or more of these conditions:*

- *In heavy city traffic where the outside temperature regularly reaches 90°F (32°C) or higher.*
- *In hilly or mountainous terrain.*
- *When doing frequent trailer towing.*
- *Uses such as found in taxi, police or delivery service.*

(i) *Drain, flush and refill cooling system. See Engine Coolant on page 5-22 for what to use. Inspect hoses. Clean radiator, condenser, pressure cap and filler neck. Pressure test the cooling system and pressure cap.*

(j) *Check throttle system for interference or binding and for damaged or missing parts. Replace parts as needed. Replace any components that have high effort or excessive wear. Do not lubricate accelerator or cruise control cables.*

(k) *A fluid loss in any vehicle system could indicate a problem. Have the system inspected and repaired and the fluid level checked. Add fluid if needed.*

## Owner Checks and Services

These owner checks and services should be performed at the intervals specified to help ensure the safety, dependability and emission control performance of your vehicle. Your GM Goodwrench dealer can assist you with these checks and services.

Be sure any necessary repairs are completed at once. Whenever any fluids or lubricants are added to your vehicle, make sure they are the proper ones, as shown in *Recommended Fluids and Lubricants on page 6-12.*

### At Each Fuel Fill

*It is important to perform these underhood checks at each fuel fill.*

### Engine Oil Level Check

Check the engine oil level and add the proper oil if necessary. See *Engine Oil on page 5-13* for further details.

**Notice:** It is important to check your oil regularly and keep it at the proper level. Failure to keep your engine oil at the proper level can cause damage to your engine not covered by your warranty.

## Engine Coolant Level Check

Check the engine coolant level and add DEX-COOL® coolant mixture if necessary. See *Engine Coolant* on page 5-22 for further details.

## Windshield Washer Fluid Level Check

Check the windshield washer fluid level in the windshield washer tank and add the proper fluid if necessary.

## At Least Once a Month

### Tire Inflation Check

Visually inspect your tires and make sure tires are inflated to the correct pressures. Do not forget to check your spare tire. See *Tires* on page 5-57 for further details.

### Cassette Tape Player Service

Clean cassette tape player. Cleaning should be done every 50 hours of tape play. See *Audio System(s)* on page 3-44 for further details.

## At Least Once a Year

### Starter Switch Check

#### CAUTION:

**When you are doing this inspection, the vehicle could move suddenly. If the vehicle moves, you or others could be injured.**

1. Before you start, be sure you have enough room around the vehicle.
2. Firmly apply both the parking brake and the regular brake. See *Parking Brake* on page 2-25 if necessary.  
Do not use the accelerator pedal, and be ready to turn off the engine immediately if it starts.
3. Try to start the engine in each gear. The starter should work only in PARK (P) or NEUTRAL (N). If the starter works in any other position, contact your GM Goodwrench dealer for service.

## Automatic Transaxle Shift Lock Control System Check

### CAUTION:

When you are doing this inspection, the vehicle could move suddenly. If the vehicle moves, you or others could be injured.

1. Before you start, be sure you have enough room around the vehicle. It should be parked on a level surface.
2. Firmly apply the parking brake. See *Parking Brake on page 2-25* if necessary.

Be ready to apply the regular brake immediately if the vehicle begins to move.

3. With the engine off, turn the key to the RUN position, but don't start the engine. Without applying the regular brake, try to move the shift lever out of PARK (P) with normal effort. If the shift lever moves out of PARK (P), contact your GM Goodwrench dealer for service.

## Ignition Transaxle Lock Check

While parked, and with the parking brake set, try to turn the ignition key to LOCK in each shift lever position.

- The key should turn to LOCK only when the shift lever is in PARK (P).
- The key should come out only in LOCK.

Contact your GM Goodwrench dealer if service is required.

## Parking Brake and Automatic Transaxle Park (P) Mechanism Check

### CAUTION:

When you are doing this check, your vehicle could begin to move. You or others could be injured and property could be damaged. Make sure there is room in front of your vehicle in case it begins to roll. Be ready to apply the regular brake at once should the vehicle begin to move.

Park on a fairly steep hill, with the vehicle facing downhill. Keeping your foot on the regular brake, set the parking brake.

- To check the parking brake's holding ability: With the engine running and transaxle in NEUTRAL (N), slowly remove foot pressure from the regular brake pedal. Do this until the vehicle is held by the parking brake only.
- To check the PARK (P) mechanism's holding ability: With the engine running, shift to PARK (P). Then release the parking brake followed by the regular brake.

Contact your GM Goodwrench dealer if service is required.

## Underbody Flushing Service

At least every spring, use plain water to flush any corrosive materials from the underbody. Take care to clean thoroughly any areas where mud and other debris can collect.

## Recommended Fluids and Lubricants

Fluids and lubricants identified below by name, part number or specification may be obtained from your dealer.

Usage	Fluid/Lubricant
Engine Oil	Engine oil which meets GM Standard GM6094M and displays the American Petroleum Institute Certified for Gasoline Engines starburst symbol. To determine the proper viscosity for your vehicle's engine, see <i>Engine Oil</i> on page 5-13.
Engine Coolant	50/50 mixture of clean, drinkable water and use only DEX-COOL® Coolant. See <i>Engine Coolant</i> on page 5-22.
Hydraulic Brake System	Delco Supreme 11 Brake Fluid or equivalent DOT-3 brake fluid.
Windshield Washer Solvent	GM Optikleen® Washer Solvent.

Usage	Fluid/Lubricant
Power Steering System	GM Power Steering Fluid (GM Part No. U.S. 89021184, in Canada 89021186).
Automatic Transaxle	DEXRON®-III Automatic Transmission Fluid.
Key Lock Cylinders	Multi-Purpose Lubricant, Superlube (GM Part No. U.S. 12346241, in Canada 10953474).
Hood Latch Assembly, Secondary Latch, Pivots, Spring Anchor and Release Pawl	Lubriplate Lubricant Aerosol (GM Part No. U.S. 12346293, in Canada 992723) or lubricant meeting requirements of NLGI #2, Category LB or GC-LB.
Hood and Door Hinges	Multi-Purpose Lubricant, Superlube (GM Part No. U.S. 12346241, in Canada 109435474).
Weatherstrip Conditioning	Dielectric Silicone Grease (GM Part No. U.S. 12345579, in Canada 992887).



## Normal Maintenance Replacement Parts

Replacement parts identified below by name, part number, or specification can be obtained from your dealer.

### Normal Maintenance Replacement Parts

Part	GM Part Number	ACDelco® Part Number
Engine Air Cleaner/Filter	24508572	A1614C
Engine Oil Filter	25010792	PF-47
Passenger Compartment Air Filter	10406026	—
Spark Plugs Gap	12568387 .060 inches (56.0 cm)	41-101 .060 inches (56.0 cm)
Windshield Wiper Blades	22143943	—
Type	Shepherd's Hook Style	
Length	22.0 inches (56.0 cm)	

# Engine Drive Belt Routing

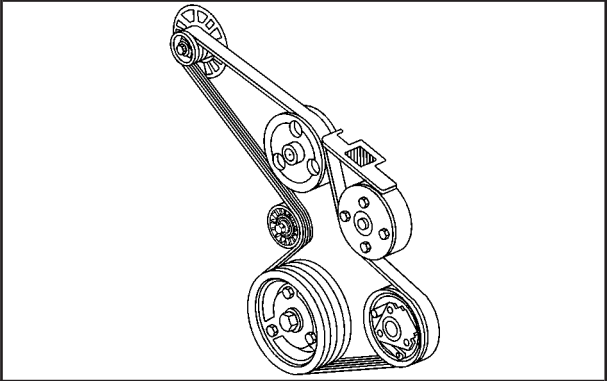

## Maintenance Record

After the scheduled services are performed, record the date, odometer reading, who performed the service and the type of services performed in the boxes provided. See *Maintenance Requirements on page 6-2* in this section. Any additional information from *Owner Checks and Services on page 6-8* can be added on the following record pages. Also, you should retain all maintenance receipts.

### Maintenance Record

Date	Odometer Reading	Serviced By	Maintenance I or Maintenance II	Services Performed

### Maintenance Record (cont'd)

Date	Odometer Reading	Serviced By	Maintenance I or Maintenance II	Services Performed

## Section 7 Customer Assistance and Information

---

<b>Customer Assistance and Information</b> .....	7-2	<b>Reporting Safety Defects</b> .....	7-10
Customer Satisfaction Procedure .....	7-2	Reporting Safety Defects to the United States	
Online Owner Center .....	7-3	Government .....	7-10
Customer Assistance for Text		Reporting Safety Defects to the Canadian	
Telephone (TTY) Users .....	7-4	Government .....	7-10
Customer Assistance Offices .....	7-4	Reporting Safety Defects to General Motors .....	7-11
GM Mobility Program for Persons		Service Publications Ordering Information .....	7-11
with Disabilities .....	7-5		
Roadside Assistance Program .....	7-5		
Courtesy Transportation .....	7-6		
Vehicle Data Collection and Event Data			
Records .....	7-9		

# Customer Assistance and Information

## Customer Satisfaction Procedure

Your satisfaction and goodwill are important to your dealer and to Buick. Normally, any concerns with the sales transaction or the operation of your vehicle will be resolved by your dealer's sales or service departments. Sometimes, however, despite the best intentions of all concerned, misunderstandings can occur. If your concern has not been resolved to your satisfaction, the following steps should be taken:

**STEP ONE:** Discuss your concern with a member of dealership management. Normally, concerns can be quickly resolved at that level. If the matter has already been reviewed with the sales, service or parts manager, contact the owner of the dealership or the general manager.

**STEP TWO:** If after contacting a member of dealership management, it appears your concern cannot be resolved by the dealership without further help, contact the Buick Customer Assistance Center by calling 1-800-521-7300. In Canada, contact GM of Canada Customer Communication Centre in Oshawa by calling 1-800-263-3777 (English) or 1-800-263-7854 (French).

We encourage you to call the toll-free number in order to give your inquiry prompt attention. Please have the following information available to give the Customer Assistance Representative:

- Vehicle Identification Number (This is available from the vehicle registration or title, or the plate at the top left of the instrument panel and visible through the windshield.)
- Dealership name and location
- Vehicle delivery date and present mileage

When contacting Buick, please remember that your concern will likely be resolved at a dealer's facility. That is why we suggest you follow Step One first if you have a concern.

**STEP THREE:** Both General Motors and your dealer are committed to making sure you are completely satisfied with your new vehicle. However, if you continue to remain unsatisfied after following the procedure outlined in Steps One and Two, you should file with the BBB Auto Line Program to enforce any additional rights you may have. Canadian owners refer to your Warranty and Owner Assistance Information booklet for information on the Canadian Motor Vehicle Arbitration Plan (CAMVAP).

The BBB Auto Line Program is an out of court program administered by the Council of Better Business Bureaus to settle automotive disputes regarding vehicle repairs or the interpretation of the New Vehicle Limited Warranty. Although you may be required to resort to this informal dispute resolution program prior to filing a court action, use of the program is free of charge and your case will generally be heard within 40 days. If you do not agree with the decision given in your case, you may reject it and proceed with any other venue for relief available to you.

You may contact the BBB Auto Line Program using the toll-free telephone number or write them at the following address:

BBB Auto Line Program  
Council of Better Business Bureaus, Inc.  
4200 Wilson Boulevard  
Suite 800  
Arlington, VA 22203-1804  
Telephone: 1-800-955-5100

This program is available in all 50 states and the District of Columbia. Eligibility is limited by vehicle age, mileage and other factors. General Motors reserves the right to change eligibility limitations and/or discontinue its participation in this program.

## Online Owner Center

The Owner Center is a resource for your GM ownership needs. You can find your specific vehicle information all in one place.

### The Owner Center allows you to:

- Get e-mail service reminders.
- Access information about your specific vehicle, including tips and videos and an electronic version of this owner's manual. (United States only)
- Keep track of your vehicle's service history and maintenance schedule.
- Find GM dealers for service nationwide.
- Receive special promotions and privileges only available to members. (United States only)

Refer to the web for updated information.

To register your vehicle, visit [www.MyGMLink.com](http://www.MyGMLink.com). (United States) or My GM Canada within [www.gmcanada.com](http://www.gmcanada.com) (Canada).

## **Customer Assistance for Text Telephone (TTY) Users**

To assist customers who are deaf, hard of hearing, or speech-impaired and who use Text Telephones (TTYs), Buick has TTY equipment available at its Customer Assistance Center. Any TTY user can communicate with Buick by dialing: 1-800-83-BUICK. (TTY users in Canada can dial 1-800-263-3830.)

## **Customer Assistance Offices**

Buick encourages customers to call the toll-free number for assistance. If a U.S. customer wishes to write to Buick, the letter should be addressed to Buick's Customer Assistance Center.

### **United States – Customer Assistance**

Buick Customer Assistance Center  
P.O. Box 33136  
Detroit, MI 48232-5136

1-800-521-7300  
1-800-832-8425 (For Text Telephone devices (TTYs))  
Roadside Assistance: 1-800-252-1112  
Fax Number: 313-381-0022

From Puerto Rico:

1-800-496-9992 (English)  
1-800-496-9993 (Spanish)  
Fax Number: 313-381-0022

From U.S. Virgin Islands  
1-800-496-9994  
Fax Number: 313-381-0022

### **Canada – Customer Assistance**

General Motors of Canada Limited  
Customer Communication Centre, 163-005  
1908 Colonel Sam Drive  
Oshawa, Ontario L1H 8P7

1-800-263-3777 (English)  
1-800-263-7854 (French)  
1-800-263-3830 (For Text Telephone devices (TTYs))  
Roadside Assistance: 1-800-268-6800

### **Overseas – Customer Assistance**

Please contact the local General Motors Business Unit.

### **Mexico, Central America and Caribbean Islands/Countries (Except Puerto Rico and U.S. Virgin Islands) – Customer Assistance**

General Motors de Mexico, S. de R.L. de C.V.  
Customer Assistance Center  
Paseo de la Reforma # 2740  
Col. Lomas de Bezares  
C.P. 11910, Mexico, D.F.  
01-800-508-0000  
Long Distance: 011-52-53 29 0 800



## GM Mobility Program for Persons with Disabilities

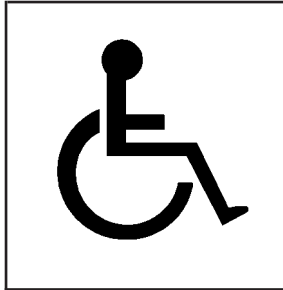

This program, available to qualified applicants, can reimburse you up to \$1,000 toward eligible aftermarket driver or passenger adaptive equipment you may require for your vehicle (hand controls, wheelchair/scooter lifts, etc.).

This program can also provide you with free resource information, such as area driver assessment centers and mobility equipment installers. The offer is available for a limited period of time from the date of vehicle purchase/lease. For more details, or to determine your vehicle's eligibility, see your GM dealer or call the GM Mobility Assistance Center at 1-800-323-9935. Text telephone (TTY) users, call 1-800-833-9935.

GM of Canada also has a Mobility Program. Call 1-800-GM-DRIVE (463-7483) for details. All TTY users call 1-800-263-3830.

## Roadside Assistance Program

Buick Motor Division is proud to offer Buick Premium Roadside Assistance to customers for vehicles covered under the 3 year/36,000 mile (60 000 km) new car warranty (whichever occurs first).

Our commitment to Buick owners has always included superior service through our network of Buick dealers. Buick Premium Roadside Assistance provides an extra measure of convenience and security.

Buick's Roadside Assistance toll-free number is staffed by a team of technically trained advisors, who are available 24 hours a day, 365 days a year.

We take anxiety out of uncertain situations by providing minor repair information over the phone or making arrangements to tow your vehicle to the nearest Buick dealer.

We will provide the following services for 3 years/36,000 miles (60 000 km), at no expense to you:

- Fuel delivery
- Lock-out service (identification required)
- Tow to nearest dealership for warranty service
- Change a flat tire
- Jump starts

We have quick, easy access to telephone numbers of the following additional services depending on your needs:

- Hotels
- Glass replacement
- Tire repair facilities
- Rental vehicle or taxis
- Airports or train stations
- Police, fire department or hospitals

In many instances, mechanical failures are covered under Buick's comprehensive warranty. However, when other services are utilized, our advisors will explain any payment obligations you might incur.

For prompt and efficient assistance when calling, please provide the following information to give the advisor:

- Location of vehicle
- Telephone number of your location
- Vehicle model, year and color
- Mileage of vehicle
- Vehicle Identification Number (VIN)
- Vehicle license plate number

Buick reserves the right to limit services or reimbursement to an owner or driver when, in Buick's judgement, the claims become excessive in frequency or type of occurrence.

While we hope you never have the occasion to use our service, it is added security while traveling for you and your family. Remember, we're only a phone call away. Buick Roadside Assistance: 1-800-252-1112, text telephone (TTY) users, call 1-888-889-2438.

## **Canadian Roadside Assistance**

Vehicles purchased in Canada have an extensive Roadside Assistance program accessible from anywhere in Canada or the United States. Please refer to the Warranty and Owner Assistance Information book.

## **Courtesy Transportation**

Buick has always exemplified quality and value in its offering of motor vehicles. To enhance your ownership experience, we and our participating dealers are proud to offer Courtesy Transportation, a customer support program for new vehicles.

The Courtesy Transportation program is offered to retail purchase/lease customers in conjunction with the Bumper-to-Bumper coverage provided by the New Vehicle Limited Warranty. Several transportation options are available when warranty repairs are required. This will reduce your inconvenience during warranty repairs.

## **Plan Ahead When Possible**

When your vehicle requires warranty service, you should contact your dealer and request an appointment. By scheduling a service appointment and advising your service consultant of your transportation needs, your dealer can help minimize your inconvenience.

If your vehicle cannot be scheduled into the service department immediately, keep driving it until it can be scheduled for service, unless, of course, the problem is safety-related. If it is, please call your dealership, let them know this, and ask for instructions.

If the dealer requests that you simply drop the vehicle off for service, you are urged to do so as early in the work day as possible to allow for same day repair.

## **Transportation Options**

Warranty service can generally be completed while you wait. However, if you are unable to wait Buick helps minimize your inconvenience by providing several transportation options. Depending on the circumstances, your dealer can offer you one of the following:

### **Shuttle Service**

Participating dealers can provide you with shuttle service to get to your destination with minimal interruption of your daily schedule. This includes a one way or round trip shuttle ride to a destination up to 10 miles from the dealership.

## Public Transportation or Fuel Reimbursement

If your vehicle requires overnight warranty repairs, reimbursement (five days maximum) may be available for the use of public transportation such as a taxi or bus. In addition, should you arrange transportation through a friend or relative, reimbursement for reasonable fuel expenses (five day maximum) may be available. Claim amounts should reflect actual costs and be supported by original receipts.

## Courtesy Rental Vehicle

Your dealer may arrange to provide you with a courtesy rental vehicle or reimburse you for a rental vehicle you obtained if your vehicle is kept for a warranty repair. Reimbursement will be limited to a maximum of \$30 a day and must be supported by receipts. This requires that you sign and complete a rental agreement and meet state, local and rental vehicle provider requirements. Requirements vary and may include minimum age requirements, insurance coverage, credit card, etc. You are responsible for taxes, levies, usage fees, excessive mileage or rental usage beyond the completion of the repair.

Generally it is not possible to provide a like-vehicle as a courtesy rental.

## Additional Program Information

Courtesy Transportation is available during the Bumper-to-Bumper warranty coverage period, but it *is not* part of the New Vehicle Limited Warranty. A separate booklet entitled Warranty and Owner Assistance Information furnished with each new vehicle provides detailed warranty coverage information.

Courtesy Transportation is available only at participating dealers and all program options, such as shuttle service, may not be available at every dealer. Please contact your dealer for specific information about availability. All Courtesy Transportation arrangements will be administered by appropriate dealer personnel.

**Canadian Vehicles:** For warranty repairs during the Complete Vehicle Coverage period of the General Motors of Canada New Vehicle Limited Warranty, alternative transportation may be available under the Courtesy Transportation Program. Please consult your dealer for details.

*General Motors reserves the right to unilaterally modify, change or discontinue Courtesy Transportation at any time and to resolve all questions of claim eligibility pursuant to the terms and conditions described herein at its sole discretion.*

## Vehicle Data Collection and Event Data Records

Your vehicle, like other modern motor vehicles, has a number of sophisticated computer systems that monitor and control several aspects of the vehicle's performance. Your vehicle uses on-board vehicle computers to monitor emission control components to optimize fuel economy, to monitor conditions for airbag deployment and, if so equipped, to provide anti-lock braking and to help the driver control the vehicle in difficult driving situations. Some information may be stored during regular operations to facilitate repair of detected malfunctions; other information is stored only in a crash or near crash event by computer systems commonly called event data recorders (EDR).

In a crash or near crash event, computer systems, such as the Airbag Sensing and Diagnostic Module (SDM) in your vehicle may record information about the condition of the vehicle and how it was operated, such as engine speed, brake applications, throttle position, vehicle speed, seat belt usage, airbag readiness, airbag performance data, and the severity of a collision. This information has been used to improve vehicle crash performance and may be used to improve crash performance of future vehicles and driving safety.

Unlike the data recorders on many airplanes, these on-board systems do not record sounds, such as conversation of vehicle occupants.

To read this information, special equipment is needed and access to the vehicle or the SDM is required. GM will not access information about a crash event or share it with others other than

- with the consent of the vehicle owner or, if the vehicle is leased, with the consent of the lessee,
- in response to an official request of police or similar government office,
- as part of GM's defense of litigation through the discovery process, or
- as required by law.

In addition, once GM collects or receives data, GM may

- use the data for GM research needs,
- make it available for research where appropriate confidentiality is to be maintained and need is shown, or
- share summary data which is not tied to a specific vehicle with non-GM organizations for research purposes.

Others, such as law enforcement, may have access to the special equipment that can read the information if they have access to the vehicle or SDM.

If your vehicle is equipped with OnStar, please check the OnStar subscription service agreement or manual for information on its operations and data collection.

## **Reporting Safety Defects**

### **Reporting Safety Defects to the United States Government**

If you believe that your vehicle has a defect which could cause a crash or could cause injury or death, you should immediately inform the National Highway Traffic Safety Administration (NHTSA), in addition to notifying General Motors.

If NHTSA receives similar complaints, it may open an investigation, and if it finds that a safety defect exists in a group of vehicles, it may order a recall and remedy campaign. However, NHTSA cannot become involved in individual problems between you, your dealer or General Motors.

To contact NHTSA, you may either call the Auto Safety Hotline toll-free at 1-800-424-9393 (or 366-0123 in the Washington, D.C. area) or write to:

NHTSA, U.S. Department of Transportation  
Washington, D.C. 20590

You can also obtain other information about motor vehicle safety from the hotline.

### **Reporting Safety Defects to the Canadian Government**

If you live in Canada, and you believe that your vehicle has a safety defect, you should immediately notify Transport Canada, in addition to notifying General Motors of Canada Limited. You may write to:

Transport Canada  
330 Sparks Street  
Tower C  
Ottawa, Ontario K1A 0N5

## Reporting Safety Defects to General Motors

In addition to notifying NHTSA (or Transport Canada) in a situation like this, we certainly hope you'll notify us.

Please call us at 1-800-521-7300, or write:

Buick Customer Assistance Center  
P.O. Box 33136  
Detroit, MI 48232-5136

In Canada, please call us at 1-800-263-3777 (English) or 1-800-263-7854 (French). Or, write:

General Motors of Canada Limited  
Customer Communication Centre, 163-005  
1908 Colonel Sam Drive  
Oshawa, Ontario L1H 8P7

## Service Publications Ordering Information

### Service Manuals

Service Manuals have the diagnosis and repair information on engines, transmission, axle, suspension, brakes, electrical, steering, body, etc.

RETAIL SELL PRICE: \$120.00

### Transmission, Transaxle, Transfer Case Unit Repair Manual

This manual provides information on unit repair service procedures, adjustments, and specifications for GM transmissions, transaxles, and transfer cases.

RETAIL SELL PRICE: \$50.00

## Service Bulletins

Service Bulletins give technical service information needed to knowledgeably service General Motors cars and trucks. Each bulletin contains instructions to assist in the diagnosis and service of your vehicle.

In Canada, information pertaining to Product Service Bulletins can be obtained by contacting your General Motors dealer or by calling 1-800-GM-DRIVE (1-800-463-7483).

## Owner's Information

Owner publications are written specifically for owners and intended to provide basic operational information about the vehicle. The owner's manual will include the Maintenance Schedule for all models.

In-Portfolio: Includes a Portfolio, Owner's Manual, and Warranty Booklet.

RETAIL SELL PRICE: \$35.00

Without Portfolio: Owner's Manual only.

RETAIL SELL PRICE: \$25.00

## Current and Past Model Order Forms

Service Publications are available for current and past model GM vehicles. To request an order form, please specify year and model name of the vehicle.

**ORDER TOLL FREE: 1-800-551-4123**  
**Monday-Friday 8:00 AM - 6:00 PM**  
**Eastern Time**

For Credit Card Orders Only  
(VISA-MasterCard-Discover), visit Helm, Inc.  
on the World Wide Web at: [www.helminc.com](http://www.helminc.com)

Or you can write to:

Helm, Incorporated  
P. O. Box 07130  
Detroit, MI 48207

Prices are subject to change without notice and without incurring obligation. Allow ample time for delivery.

Note to Canadian Customers: All listed prices are quoted in U.S. funds. Canadian residents are to make checks payable in U.S. funds.



# A

Accessory Power Outlets .....	3-17	Appearance Care .....	5-88
Adding Washer Fluid .....	5-37	Care of Safety Belts .....	5-91
Additional Program Information .....	7-8	Chemical Paint Spotting .....	5-94
Additives, Fuel .....	5-6	Cleaning the Inside of Your Vehicle .....	5-88
Add-On Electrical Equipment .....	5-97	Cleaning the Outside of Your Vehicle .....	5-91
Adjusting the Speakers (Balance/Fade) .....	3-48, 3-55	Finish Damage .....	5-93
Air Bag		Sheet Metal Damage .....	5-93
Readiness Light .....	3-30	Underbody Maintenance .....	5-94
Air Bag Systems .....	1-49	Vehicle Care/Appearance Materials .....	5-95
How Does an Air Bag Restrain? .....	1-55	Weatherstrips .....	5-91
Servicing Your Air Bag-Equipped Vehicle .....	1-58	Ashtrays .....	3-17
What Makes an Air Bag Inflate? .....	1-55	Audio System(s) .....	3-44
What Will You See After an Air Bag		Audio Steering Wheel Controls .....	3-62
Inflates? .....	1-56	Care of Your Cassette Tape Player .....	3-63
When Should an Air Bag Inflate? .....	1-54	Care of Your CD Player .....	3-64
Where Are the Air Bags? .....	1-52	Care of Your CDs .....	3-64
Air Cleaner/Filter, Engine .....	5-18	Fixed Mast Antenna .....	3-64
Airbag Sensing and Diagnostic Module (SDM) .....	7-9	Radio with Cassette and CD .....	3-53
AM .....	3-63	Radio with CD .....	3-45
Antenna, Fixed Mast .....	3-64	Setting the Time .....	3-45
Anti-lock Brake System (ABS) .....	4-6	Theft-Deterrent Feature .....	3-62
Anti-Lock Brake System Warning Light .....	3-33	Understanding Radio Reception .....	3-63
		Automatic Operation .....	3-21
		Automatic Transaxle	
		Fluid .....	5-19
		Operation .....	2-22

## B

Backing Up .....	4-43
Battery .....	5-41
Battery Replacement .....	2-9
Battery Rundown Protection .....	3-16
Before Leaving on a Long Trip .....	4-22
Brake	
Parking .....	2-25
System Warning Light .....	3-32
Brake Fluid .....	5-38
Brake Wear .....	5-40
Brakes .....	5-38
Braking .....	4-6
Braking in Emergencies .....	4-8
Break-In, New Vehicle .....	2-18
Bulb Replacement .....	5-51
Back-Up Lamps .....	5-55
Center High-Mounted Stoplamp (CHMSL) .....	5-53
Front Turn Signal and Parking Lamps .....	5-52
Halogen Bulbs .....	5-51
Headlamp Aiming .....	5-49
Headlamps .....	5-51
Replacement Bulbs .....	5-55
Taillamps, Turn Signal, and Stoplamps .....	5-54
Buying New Tires .....	5-69

## C

California Fuel .....	5-5
Canada – Customer Assistance .....	7-4
Canadian Owners .....	ii
Canadian Roadside Assistance .....	7-6
Capacities and Specifications .....	5-103
Carbon Monoxide .....	4-26, 4-39, 2-13, 2-29
Care of	
Safety Belts .....	5-91
Your Cassette Tape Player .....	3-63
Your CD Player .....	3-64
Your CDs .....	3-64
Cassette Tape Messages .....	3-59
Cassette Tape Player Service .....	6-9
CD Adapter Kits .....	3-59
CD Messages .....	3-52, 3-61
Center Console Storage Area .....	2-35
Center High-Mounted Stoplamp (CHMSL) .....	5-53
Center Passenger Position, Safety Belts .....	1-20
Chains, Tires .....	5-73
Charging System Light .....	3-31
Check	
Engine Light .....	3-36
Checking Coolant .....	5-23
Checking Engine Oil .....	5-13

Checking Things Under the Hood .....	5-10	Cleaning Exterior Lamps/Lenses .....	5-92
Checking Your Restraint Systems .....	1-58	Cleaning Fabric/Carpet .....	5-88
Chemical Paint Spotting .....	5-94	Cleaning Glass Surfaces .....	5-90
Child Restraints		Cleaning Interior Plastic Components .....	5-90
Child Restraint Systems .....	1-34	Cleaning Leather .....	5-90
Infants and Young Children .....	1-30	Cleaning the Top of the Instrument Panel .....	5-90
Lower Anchorages and Top Tethers for		Cleaning Tires .....	5-93
Children (LATCH System) .....	1-40	Cleaning Vinyl .....	5-90
Older Children .....	1-28	Cleaning Windshield and Wiper Blades .....	5-92
Securing a Child Restraint Designed for the		Climate Control System	
LATCH System .....	1-42	Air Filter, Passenger Compartment .....	3-26
Securing a Child Restraint in a Center Rear		Dual .....	3-18
Seat Position .....	1-44	Dual Automatic .....	3-21
Securing a Child Restraint in a Rear Outside		Outlet Adjustment .....	3-25
Seat Position .....	1-42	Compact Spare Tire .....	5-87
Securing a Child Restraint in the Right Front		Control of a Vehicle .....	4-5
Seat Position .....	1-47	Convenience Net .....	2-35
Top Strap .....	1-38	Coolant	
Top Strap Anchor Location .....	1-39	Engine Temperature Gage .....	3-35
Where to Put the Restraint .....	1-37	Engine Temperature Warning Light .....	3-35
Cigarette Lighter .....	3-17	Heater, Engine .....	2-21
Cleaning		Cooling System .....	5-28
Inside of Your Vehicle .....	5-88	Courtesy Lamps .....	3-15
Outside of Your Vehicle .....	5-91	Cruise Control .....	3-8
Underbody Maintenance .....	5-94	Cruise Control Light .....	3-42
Weatherstrips .....	5-91	Current and Past Model Order Forms .....	7-12
Cleaning Aluminum Wheels .....	5-93		

Customer Assistance Information	
Courtesy Transportation .....	7-6
Customer Assistance for Text Telephone (TTY)	
Users .....	7-4
Customer Assistance Offices .....	7-4
Customer Satisfaction Procedure .....	7-2
GM Mobility Program for Persons with	
Disabilities .....	7-5
Reporting Safety Defects to General Motors ....	7-11
Reporting Safety Defects to the Canadian	
Government .....	7-10
Reporting Safety Defects to the United States	
Government .....	7-10
Roadside Assistance Program .....	7-5
Service Publications Ordering Information .....	7-11

## D

Daytime Running Lamps/Automatic Headlamp	
System .....	3-13
Defensive Driving .....	4-2
Defogging and Defrosting .....	3-20, 3-24
Delayed Entry Lighting .....	3-15
Delayed Exit Lighting .....	3-16
Delayed Headlamps .....	3-14
Delayed Locking .....	2-7
Dinghy Towing .....	4-33

Doing Your Own Service Work .....	5-3
Dolly Towing .....	4-33
Dome Lamp .....	3-16
Door	
Locks .....	2-10
Power Door Locks .....	2-11
Programmable Automatic Door Locks .....	2-11
Trunk Ajar Warning Light .....	3-42
Driver	
Position, Safety Belt .....	1-12
Driving	
At Night .....	4-16
City .....	4-20
Defensive .....	4-2
Drunken .....	4-2
Freeway .....	4-21
Hill and Mountain Roads .....	4-24
In Rain and on Wet Roads .....	4-17
Winter .....	4-26
Driving On Grades .....	4-44
Driving on Snow or Ice .....	4-27
Driving Through Deep Standing Water .....	4-19
Driving Through Flowing Water .....	4-19
Driving with a Trailer .....	4-42
Dual Automatic Climate Control System .....	3-21
Dual Climate Control System .....	3-18

## E

Electrical System	
Add-On Equipment .....	5-97
Fuses and Circuit Breakers .....	5-97
Headlamp Wiring .....	5-97
Power Windows and Other Power Options .....	5-97
Windshield Wiper Fuses .....	5-97
Emergency Trunk Release Handle .....	2-14
Emissions Inspection and Maintenance Programs .....	3-39
Engine	
Air Cleaner/Filter .....	5-18
Battery .....	5-41
Change Engine Oil Light .....	3-41
Check and Service Engine Soon Light .....	3-36
Coolant .....	5-22
Coolant Heater .....	2-21
Coolant Temperature Gage .....	3-35
Coolant Temperature Warning Light .....	3-35
Drive Belt Routing .....	6-14
Engine Compartment Overview .....	5-12
Exhaust .....	2-29
Oil .....	5-13
Overheating .....	5-25
Starting .....	2-20
Engine Cooling When Trailer Towing .....	4-45
Engine Oil Additives .....	5-16

Enhanced Traction System (ETS) .....	4-9
Warning Light .....	3-34
Entry Lighting .....	3-15
Event Data Records (EDR) .....	7-9
Express-Down Window .....	2-16
Extender, Safety Belt .....	1-27
Exterior Lamps .....	3-12

## F

Filter	
Engine Air Cleaner .....	5-18
Finding a Program Type (PTY) Station .....	3-49, 3-56
Finding a Station .....	3-46, 3-53
Finish Care .....	5-92
Finish Damage .....	5-93
Fixed Mast Antenna .....	3-64
Flash-to-Pass .....	3-6
Flat Tire .....	5-74
Flat Tire, Changing .....	5-75
Fluid	
Automatic Transaxle .....	5-19
Power Steering .....	5-35
Windshield Washer .....	5-36
FM .....	3-63
Folding Rear Seat .....	1-5
Following Distance .....	4-43

Front Storage Area .....	2-34
Fuel .....	5-4
Additives .....	5-6
California Fuel .....	5-5
Filling a Portable Fuel Container .....	5-9
Filling Your Tank .....	5-7
Fuels in Foreign Countries .....	5-6
Gage .....	3-43
Gasoline Octane .....	5-4
Gasoline Specifications .....	5-5
Low Warning Light .....	3-44
Fuses	
Fuses and Circuit Breakers .....	5-97
Windshield Wiper .....	5-97

## G

Gage	
Engine Coolant Temperature .....	3-35
Fuel .....	3-43
Speedometer .....	3-29
Gasoline	
Octane .....	5-4
Specifications .....	5-5
Glove Box .....	2-34
GM Mobility Program for Persons with Disabilities .....	7-5

## H

Hazard Warning Flashers .....	3-4
Head Restraints .....	1-5
Headlamp	
Aiming .....	5-49
Headlamp High/Low-Beam Changer .....	3-6
Headlamp Wiring .....	5-97
Headlamps .....	5-51
Bulb Replacement .....	5-51
Front Turn Signal and Parking Lamps .....	5-52
Halogen Bulbs .....	5-51
Highway Hypnosis .....	4-23
Hill and Mountain Roads .....	4-24
Hitches .....	4-42
Hood	
Checking Things Under .....	5-10
Release .....	5-10
Horn .....	3-5
How to Add Coolant to the Coolant Recovery Tank .....	5-30
How to Add Coolant to the Radiator .....	5-32
How to Add Fluid .....	5-21
How to Check .....	5-20, 5-65
How to Check Power Steering Fluid .....	5-36
How to Use This Manual .....	ii
How to Wear Safety Belts Properly .....	1-11
Hydroplaning .....	4-19

## I

If No Steam Is Coming From Your Engine .....	5-27
If Steam Is Coming From Your Engine .....	5-26
If the Light Is Flashing .....	3-37
If the Light Is On Steady .....	3-38
If You Are Caught in a Blizzard .....	4-28
If You Are Stuck in Sand, Mud, Ice or Snow .....	4-30
If You Do Decide To Pull A Trailer .....	4-40
Ignition Positions .....	2-19
Illumination on Remote Activation .....	2-8
Infants and Young Children, Restraints .....	1-30
Inflation - Tire Pressure .....	5-64
Instrument Panel	
Cluster .....	3-28
Overview .....	3-2
Instrument Panel Brightness .....	3-15
Instrument Panel Fuse Block .....	5-98
Interior Lamps .....	3-15

## J

Jump Starting .....	5-42
---------------------	------

## K

Keyless Entry System .....	2-4
Keys .....	2-2

## L

Lamps	
Exterior .....	3-12
Interior .....	3-15
Lap Belt .....	1-20
Lap-Shoulder Belt .....	1-12, 1-22
LATCH System	
Child Restraints .....	1-40
Securing a Child Restraint Designed for the LATCH System .....	1-42
Leaving Your Vehicle .....	2-12
Leaving Your Vehicle With the Engine Running .....	2-27
Light	
Air Bag Readiness .....	3-30
Anti-Lock Brake System Warning .....	3-33
Brake System Warning .....	3-32
Change Engine Oil .....	3-41
Charging System .....	3-31
Cruise Control .....	3-42
Door/Trunk Ajar Warning .....	3-42
Engine Coolant Temperature Warning .....	3-35
Enhanced Traction System (ETS) Warning Light .....	3-34
Low Fuel Warning .....	3-44
Low Traction .....	3-34
Low Washer Fluid Warning .....	3-42

Light (cont.)	
Malfunction Indicator .....	3-36
Oil Pressure .....	3-40
Safety Belt Reminder .....	3-30
Security .....	3-41
Service Vehicle Soon .....	3-42
Tire Pressure .....	3-36
Lighted Visor Vanity Mirrors .....	2-17
Loading Your Vehicle .....	4-34
Lockout Protection .....	2-12
Locks	
Door .....	2-10
Leaving Your Vehicle .....	2-12
Lockout Protection .....	2-12
Power Door .....	2-11
Programmable Automatic Door Locks .....	2-11
Loss of Control .....	4-14
Low Fuel Warning Light .....	3-44
Low Traction Light .....	3-34
Low Washer Fluid Warning Light .....	3-42

## M

Maintenance Schedule	
Additional Required Services .....	6-6
At Each Fuel Fill .....	6-8
At Least Once a Month .....	6-9
At Least Once a Year .....	6-9
Introduction .....	6-2
Maintenance Footnotes .....	6-7
Maintenance Record .....	6-15
Maintenance Requirements .....	6-2
Normal Maintenance Replacement Parts .....	6-13
Owner Checks and Services .....	6-8
Recommended Fluids and Lubricants .....	6-12
Scheduled Maintenance .....	6-4
Using Your .....	6-2
Your Vehicle and the Environment .....	6-2
Maintenance When Trailer Towing .....	4-45
Making Turns .....	4-43
Malfunction Indicator Light .....	3-36
Manual Operation .....	3-18, 3-22
Manual Seats .....	1-2
Matching Transmitter(s) to Your Vehicle .....	2-8
Mexico, Central America and Caribbean Islands/ Countries (Except Puerto Rico and U.S. Virgin Islands) – Customer Assistance .....	7-4



Mirrors	
Manual Rearview Mirror .....	2-31
Manual Rearview Mirror with OnStar® .....	2-31
Outside Convex Mirror .....	2-32
Outside Power Mirrors .....	2-32
MyGMLink.com .....	7-3

## N

New Vehicle Break-In .....	2-18
Normal Maintenance Replacement Parts .....	6-13

## O

Odometer .....	3-29
Off-Road Recovery .....	4-12
Oil	
Change Engine Oil Light .....	3-41
Engine .....	5-13
Pressure Light .....	3-40
Older Children, Restraints .....	1-28
Online Owner Center .....	7-3
OnStar® Personal Calling .....	2-34
OnStar® Services .....	2-33
OnStar® System .....	2-33
OnStar® Virtual Advisor .....	2-34
Operation Tips .....	3-26
Other Warning Devices .....	3-4

Outlet Adjustment .....	3-25
Outside	
Convex Mirror .....	2-32
Power Mirrors .....	2-32
Overheated Engine Protection	
Operating Mode .....	5-25
Overseas – Customer Assistance .....	7-4
Owner Checks and Services .....	6-8
Owners, Canadian .....	ii
Owner's Information .....	7-12

## P

Park (P)	
Shifting Into .....	2-26
Shifting Out of .....	2-28
Parking	
Brake .....	2-25
Over Things That Burn .....	2-29
Parking on Hills .....	4-44
Passenger Compartment Air Filter .....	3-26
Passenger Control .....	3-24
Passing .....	4-13, 4-43
PASS-Key® II .....	2-17
Plan Ahead When Possible .....	7-7
Playing a Cassette Tape .....	3-58
Playing a CD .....	3-51, 3-60
Playing the Radio .....	3-45, 3-53

Power	
Accessory Outlets .....	3-17
Door Locks .....	2-11
Electrical System .....	5-97
Six-Way Seats .....	1-3
Steering Fluid .....	5-35
Windows .....	2-16
Power Steering .....	4-10
Programmable Automatic Door Locks .....	2-11

## Q

Questions and Answers About Safety Belts .....	1-10
--	------

## R

Radiator Pressure Cap .....	5-25
Radio Data System (RDS) .....	3-48, 3-55
Radio Messages .....	3-51, 3-58
Radios .....	3-44
Care of Your Cassette Tape Player .....	3-63
Care of Your CD Player .....	3-64
Care of Your CDs .....	3-64
Radio with Cassette and CD .....	3-53
Radio with CD .....	3-45
Setting the Time .....	3-45
Theft-Deterrent .....	3-62
Understanding Reception .....	3-63

RDS Messages .....	3-50, 3-57
Reading Lamps .....	3-16
Rear Safety Belt Comfort Guides .....	1-25
Rear Seat Outside Passenger Positions .....	1-22
Rear Seat Passengers, Safety Belts .....	1-22
Rear Window Defogger .....	3-20, 3-25
Rearview Mirror with OnStar® .....	2-31
Rearview Mirrors .....	2-31
Reclining Seatbacks .....	1-3
Recommended Fluids and Lubricants .....	6-12
Recreational Vehicle Towing .....	4-32
Remote Keyless Entry System .....	2-4
Remote Keyless Entry System Operation .....	2-5
Remote Trunk Release .....	2-13
Removing the Flat Tire and Installing the Spare Tire .....	5-79
Removing the Spare Tire and Tools .....	5-76
Removing the Wheel Center Caps .....	5-78
Removing the Wheel Covers .....	5-78
Replacement Bulbs .....	5-55
Replacing Brake System Parts .....	5-41
Replacing Restraint System Parts After a Crash .....	1-59
Reporting Safety Defects	
Canadian Government .....	7-10
General Motors .....	7-11
United States Government .....	7-10
Restraint System Check	
Checking Your Restraint Systems .....	1-58

Restraint System Check (cont.)	
Replacing Restraint System Parts After a Crash .....	1-59
Restraint Systems	
Checking .....	1-58
Replacing Parts .....	1-59
Resynchronization .....	2-9
Retained Accessory Power (RAP) .....	2-20
Right Front Passenger Position, Safety Belts .....	1-20
Roadside	
Assistance Program .....	7-5
Rocking Your Vehicle To Get It Out .....	4-31
Routing, Engine Drive Belt .....	6-14
Running Your Engine While You Are Parked .....	2-30

## S

Safety Belt	
Reminder Light .....	3-30
Safety Belts	
Care of .....	5-91
Center Passenger Position .....	1-20
Driver Position .....	1-12
How to Wear Safety Belts Properly .....	1-11
Questions and Answers About Safety Belts .....	1-10
Rear Safety Belt Comfort Guides for Children and Small Adults .....	1-25
Rear Seat Passengers .....	1-22
Right Front Passenger Position .....	1-20

Safety Belts (cont.)	
Safety Belt Extender .....	1-27
Safety Belt Use During Pregnancy .....	1-19
Safety Belts Are for Everyone .....	1-6
Safety Chains .....	4-42
Safety Warnings and Symbols .....	iii
Scheduled Maintenance .....	6-4
Seats	
Head Restraints .....	1-5
Manual .....	1-2
Reclining Seatbacks .....	1-3
Six-Way Power Seats .....	1-3
Split Folding Rear Seat .....	1-5
Securing a Child Restraint	
Center Rear Seat Position .....	1-44
Designed for the LATCH System .....	1-42
Rear Outside Seat Position .....	1-42
Right Front Seat Position .....	1-47
Security Feedback .....	2-6
Security Light .....	3-41
Sensors .....	3-24
Service .....	5-3
Adding Equipment to the Outside of Your Vehicle .....	5-4
Doing Your Own Work .....	5-3
Engine Soon Light .....	3-36
Publications Ordering Information .....	7-11
Vehicle Soon Light .....	3-42
Service Bulletins .....	7-12
Service Engine Soon Light .....	3-36

Service Manuals .....	7-11
Setting Preset Stations .....	3-47, 3-54
Setting the Time .....	3-45
Setting the Tone (Bass/Treble) .....	3-47, 3-54
Sheet Metal Damage .....	5-93
Shifting Into Park (P) .....	2-26
Shifting Out of Park (P) .....	2-28
Shoulder Belt Height Adjuster .....	1-14
Skidding .....	4-15
Some Other Rainy Weather Tips .....	4-19
Special Fabric Cleaning Problems .....	5-89
Specifications, Capacities .....	5-103
Speedometer .....	3-29
Split Folding Rear Seat .....	1-5
Starting Your Engine .....	2-20
Steering .....	4-10
Steering in Emergencies .....	4-11
Steering Tips .....	4-10
Steering Wheel Controls, Audio .....	3-62
Storage Areas	
Center Console Storage Area .....	2-35
Convenience Net .....	2-35
Front Storage Area .....	2-34
Glove Box .....	2-34
Storing the Flat Tire and Tools .....	5-85
Storing the Spare Tire and Tools .....	5-86
Stuck in Sand, Mud, Ice or Snow .....	4-30
Sun Visors .....	2-17
Sunroof .....	2-36

## T

Taillamps	
Turn Signal, and Stoplamps .....	5-54
Theft-Deterrent, Radio .....	3-62
Theft-Deterrent Systems .....	2-17
PASS-Key® II .....	2-17
Tilt Wheel .....	3-5
Tire	
Pressure Light .....	3-36
Tire Inflation Check .....	6-9
Tire Sidewall Labeling .....	5-58
Tire Size .....	5-61
Tire Terminology and Definitions .....	5-62
Tires .....	5-57
Buying New Tires .....	5-69
Chains .....	5-73
Changing a Flat Tire .....	5-75
Compact Spare Tire .....	5-87
If a Tire Goes Flat .....	5-74
Inflation - Tire Pressure .....	5-64
Inspection and Rotation .....	5-67
Pressure Monitor System .....	5-65
Uniform Tire Quality Grading .....	5-70
Wheel Alignment and Tire Balance .....	5-71
Wheel Replacement .....	5-72
When It Is Time for New Tires .....	5-68
To Use the Engine Coolant Heater .....	2-21
Top Strap .....	1-38

Top Strap Anchor Location .....	1-39
Torque Lock .....	2-28
Total Weight on Your Vehicle's Tires .....	4-42
Towing	
Recreational Vehicle .....	4-32
Towing a Trailer .....	4-39
Your Vehicle .....	4-31
Traction	
Enhanced Traction System (ETS) .....	4-9
Enhanced Traction System (ETS)	
Warning Light .....	3-34
Low Light .....	3-34
Trailer Brakes .....	4-42
Transaxle	
Fluid, Automatic .....	5-19
Transaxle Operation, Automatic .....	2-22
Transmission, Transaxle, Transfer Case Unit	
Repair Manual .....	7-11
Transportation Options .....	7-7
Trip Odometer .....	3-29
Trunk .....	2-13
Trunk Assist Handle .....	2-14
Trunk Lock .....	2-13
Turn and Lane-Change Signals .....	3-6
Turn Signal/Multifunction Lever .....	3-5
Turn Signals When Towing a Trailer .....	4-44

## U

Underhood Fuse Block .....	5-100
Understanding Radio Reception .....	3-63
Uniform Tire Quality Grading .....	5-70
United States – Customer Assistance .....	7-4
Used Replacement Wheels .....	5-73
Using Cleaner on Fabric .....	5-89

## V

Vehicle	
Control .....	4-5
Damage Warnings .....	iv
Loading .....	4-34
Service Soon Light .....	3-42
Symbols .....	iv
Vehicle Data Collection and Event	
Data Records .....	7-9
Vehicle Identification	
Number (VIN) .....	5-96
Service Parts Identification Label .....	5-96
Vehicle Storage .....	5-41
Ventilation Adjustment .....	3-25
Visor Vanity Mirror .....	2-17
Visors .....	2-17

## W

Warning Lights, Gages and Indicators .....	3-27
Warnings	
Hazard Warning Flashers .....	3-4
Other Warning Devices .....	3-4
Safety and Symbols .....	iii
Vehicle Damage .....	iv
Washer Fluid, Low Warning Light .....	3-42
Washing Your Vehicle .....	5-91
Weight of the Trailer .....	4-40
Weight of the Trailer Tongue .....	4-41
What Kind of Engine Oil to Use .....	5-14
What to Do with Used Oil .....	5-17
What to Use .....	5-22, 5-36
Wheels	
Alignment and Tire Balance .....	5-71
Replacement .....	5-72
When to Add Engine Oil .....	5-14
When to Change Engine Oil (GM Oil Life System) .....	5-16

When to Check .....	5-65
When to Check and Change .....	5-19
When to Check Power Steering Fluid .....	5-36
When You Are Ready to Leave After Parking on a Hill .....	4-45
Where to Put the Restraint .....	1-37
Why Safety Belts Work .....	1-7
Window Lock-Out .....	2-16
Windows .....	2-15
Power .....	2-16
Windshield Washer .....	3-8
Fluid .....	5-36
Windshield Wiper	
Blade Replacement .....	5-56
Fuses .....	5-97
Windshield Wipers .....	3-7
Winter Driving .....	4-26

## Y

Your Vehicle and the Environment .....	6-2
--	-----