

Contents

Before driving

Introduction	2
Instrumentation	4
Controls and features	25
Seating and safety restraints	105

Starting and driving

Starting	147
Driving	151
Roadside emergencies	167

Servicing

Maintenance and care	188
Capacities and specifications	236
Reporting safety defects	242
Index	243

All rights reserved. Reproduction by any means, electronic or mechanical including photocopying, recording or by any information storage and retrieval system or translation in whole or part is not permitted without written authorization from Ford Motor Company.

Introduction

ICONS

Indicates a safety alert. Read the following section on *Warnings*.



Indicates vehicle information related to recycling and other environmental concerns will follow.



Correct vehicle usage and the authorized disposal of waste cleaning and lubrication materials are significant steps towards protecting the environment.

Indicates a message regarding child safety restraints. Refer to *Seating and safety restraints* for more information.



Indicates that this Owner Guide contains information on this subject. Please refer to the Index to locate the appropriate section which will provide you more information.



WARNINGS

Warnings provide information which may reduce the risk of personal injury and prevent possible damage to others, your vehicle and its equipment.

BREAKING-IN YOUR VEHICLE

There are no particular breaking-in rules for your vehicle. During the first 1 600 km (1 000 miles) of driving, vary speeds frequently. This is necessary to give the moving parts a chance to break in.

INFORMATION ABOUT THIS GUIDE

The information found in this guide was in effect at the time of printing. Ford may change the contents without notice and without incurring obligation.

Instrumentation

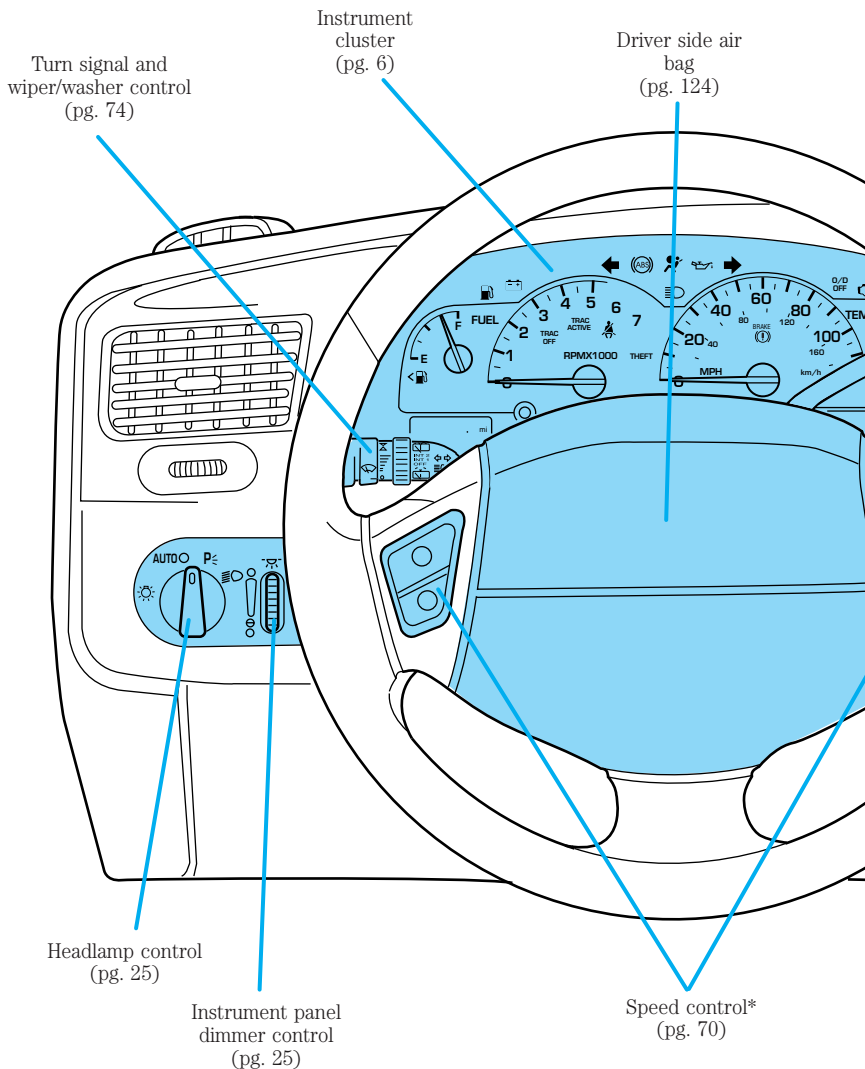

Instrumentation

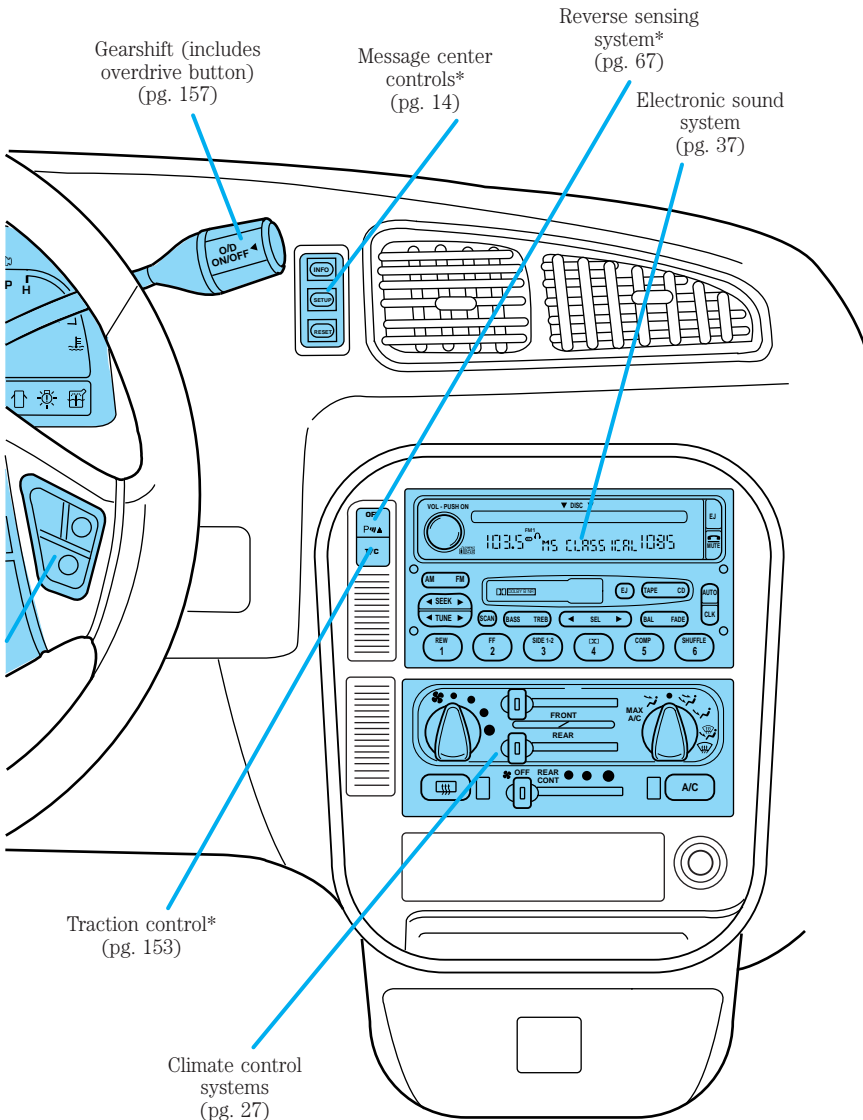

* if equipped

Instrumentation

WARNING LIGHTS AND CHIMES

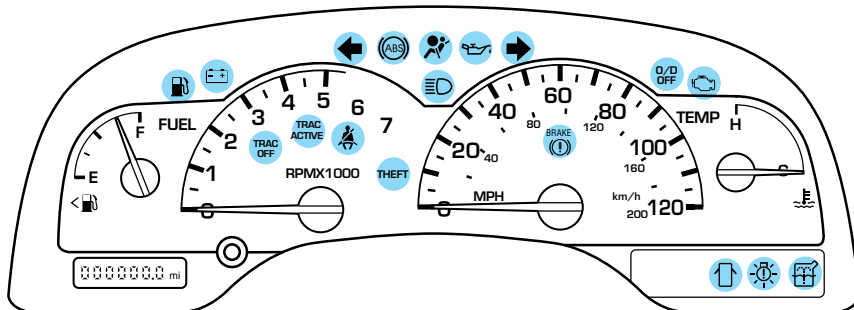

Low fuel

Illuminates as an early reminder of a low fuel condition indicated on the fuel gauge. The light comes on when there is approximately 1/16th of a tank indicated on the fuel gauge (refer to *Fuel gauge* in this chapter for more information). The ignition must be in the ON position for this lamp to illuminate. The lamp will also illuminate for several seconds after the ignition is turned to the ON position regardless of the fuel level.



Charging system

Illuminates when the ignition is turned to the ON position and the engine is off. The light also illuminates when the battery is not charging properly, requiring electrical system service.

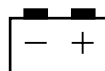

Traction Control™ active (if equipped)

This light momentarily illuminates when the ignition is turned to ON. It also illuminates when the Traction Control™ system begins applying and releasing the brakes and adjusting the engine characteristics to limit a wheelspin condition. It will be lit for a minimum of four seconds or for the duration of the Traction Control™ event.

**TRAC
ACTIVE**

For more information, refer to the *Driving* chapter.

Traction Control[™] off light (if equipped)

This light momentarily illuminates when the ignition is turned to ON position and illuminates when the Traction Control[™] system has been disabled (by the driver or as a result of a system failure). For more information, refer to the *Driving* chapter.

**TRAC
OFF**

Safety belt

Momentarily illuminates when the ignition is turned to the ON position to remind you to fasten your safety belts. For more information, refer to the *Seating and safety restraints* chapter.



Anti-theft system

Refer to *SecuriLock[™] passive anti-theft system* in the *Controls and features* chapter.

THEFT

Turn signal

Illuminates when the left or right turn signal or the hazard lights are turned on. If one or both of the indicators stay on continuously or flash faster, check for a burned-out turn signal bulb. Refer to *Exterior bulbs* in the *Maintenance and care* chapter.

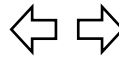

Instrumentation

Anti-lock brake system (ABS)

Momentarily illuminates when the ignition is turned to the ON position and the engine is off. If the light remains on or fails to illuminate, have the system serviced

immediately. With the ABS light on, the anti-lock brake system is disabled and normal braking is still effective unless the brake warning light also remains illuminated with parking brake released.



Air bag readiness

Momentarily illuminates when the ignition is turned ON. If the light fails to illuminate, continues to flash or remains on, have the system serviced immediately.



High beams

Illuminates when the high beam headlamps are turned on.



Engine oil pressure

Momentarily illuminates when the ignition is turned to the ON position and the engine is off. Illuminates when the oil pressure falls below the normal range. Stop the vehicle as

soon as safely possible and switch off the engine immediately. Check the oil level and add oil if needed. Refer to *Engine oil* in the *Maintenance and Care* chapter.

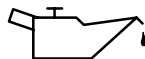

Brake system warning

Momentarily illuminates when the ignition is turned to the ON position, the engine is off and the parking brake is engaged. If the brake warning lamp does not illuminate at this time, seek service immediately. Illumination after releasing the parking brake indicates low brake fluid level and the brake system should be inspected immediately.



O/D off

Illuminates when the ignition is turned to the ON position and transmission control switch has been pushed. When the light is on, the transmission does not shift into overdrive. If the light does not come on when the transmission control switch is depressed or if the light flashes when you are driving, have your vehicle serviced.



Check engine

Your vehicle is equipped with a computer that monitors the engine's emission control system. This system is commonly known as the On Board Diagnostics System (OBD II). This OBD II system protects the environment by ensuring that your vehicle continues to meet government emission standards. The OBD II system also assists the service technician in properly servicing your vehicle.

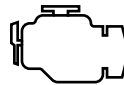

The *Check Engine* indicator light illuminates when the ignition is first turned to the ON position to check the bulb. If it comes on after the engine is started, one of the engine's emission control systems may be malfunctioning. The light may illuminate without a driveability concern being noted. The vehicle will usually be drivable and will not require towing.

Instrumentation

What you should do if the check engine light illuminates

Light turns on solid:

This means that the OBD II system has detected a malfunction.

Temporary malfunctions may cause your *Check Engine* light to illuminate. Examples are:

1. The vehicle has run out of fuel. (The engine may misfire or run poorly.)
2. Poor fuel quality or water in the fuel.
3. The fuel cap may not have been properly installed and securely tightened.

These temporary malfunctions can be corrected by filling the fuel tank with good quality fuel and/or properly installing and securely tightening the gas cap. After three driving cycles without these or any other temporary malfunctions present, the *Check Engine* light should turn off. (A driving cycle consists of a cold engine startup followed by mixed city/highway driving.) No additional vehicle service is required.

If the *Check Engine* light remains on, have your vehicle serviced at the first available opportunity.

Light is blinking:

Engine misfire is occurring which could damage your catalytic converter. You should drive in a moderate fashion (avoid heavy acceleration and deceleration) and have your vehicle serviced at the first available opportunity.



Under engine misfire conditions, excessive exhaust temperatures could damage the catalytic converter, the fuel system, interior floor coverings or other vehicle components, possibly causing a fire.

Door ajar

Illuminates when the ignition is in the ON or START position and any door is open.



Bulb Warning

Illuminates when the ignition is in the ON position and one of the exterior bulbs has burned out.



Low washer fluid

Illuminates when the ignition is turned to ON and when the windshield washer fluid is low.



Safety belt warning chime

Chimes to remind you to fasten your safety belts.

For information on the safety belt warning chime, refer to the *Seating and safety restraints* chapter.

Supplemental restraint system (SRS) warning chime

For information on the SRS warning chime, refer to the *Seating and safety restraints* chapter.

Key-in-ignition warning chime

Sounds when the key is left in the ignition in the OFF/LOCK or ACC position and the driver's door is opened.

Headlamps on warning chime (if equipped)

Sounds when the headlamps or parking lamps are on, the ignition is off (and the key is not in the ignition) and the driver's door is opened.

Turn signal chime (if equipped)

Sounds when the turn signal lever has been activated to signal a turn and not turned off after the vehicle is driven more than 0.8 km (1/2 mile).

Instrumentation

GAUGES

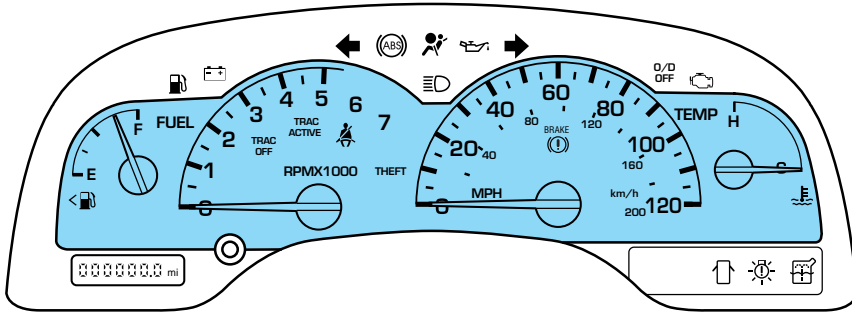

Fuel gauge

Displays approximately how much fuel is in the fuel tank (when the key is in the ON position). The fuel gauge may vary slightly when the vehicle is in motion. The ignition should be in the OFF position while the vehicle is being refueled. When the gauge first indicates empty, there is a small amount of reserve fuel in the tank. When refueling the vehicle from empty indication, the amount of fuel that can be added will be less than the advertised capacity due to the reserve fuel.

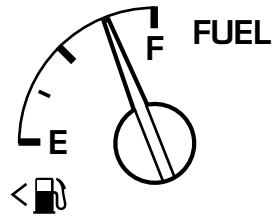

Tachometer

Indicates the engine speed in revolutions per minute.

Driving with your tachometer pointer continuously at the top of the scale may damage the engine.

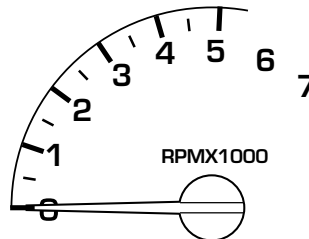

Instrumentation

Speedometer

Indicates the current vehicle speed.

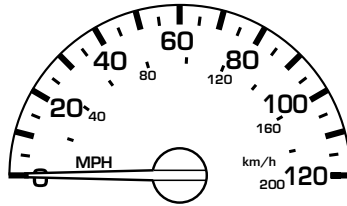

Engine coolant temperature gauge

Indicates the temperature of the engine coolant. At normal operating temperature, the needle remains within the normal area (the area between the “H” and “C”). If it enters the red section, the engine is overheating. Stop the vehicle as soon as safely possible, switch off the engine immediately and let the engine cool. Refer to *Engine coolant* in the *Maintenance and care* chapter.

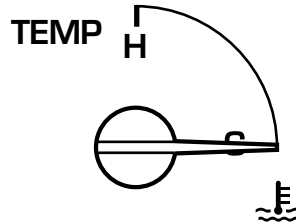

Never remove the coolant reservoir cap while the engine is running or hot.

This gauge indicates the temperature of the engine coolant, not the coolant level. If the coolant is not at its proper level the gauge indication will not be accurate.

Odometer

Registers the total kilometers (miles) of the vehicle.

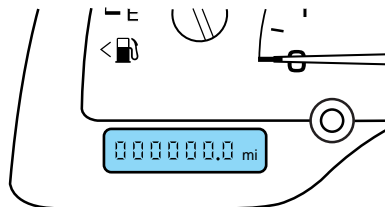

Instrumentation

Trip odometer

Registers the kilometers (miles) of individual journeys. To display, depress the control. To reset, depress and hold the control for 2 seconds.

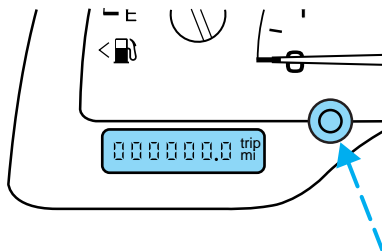

MESSAGE CENTER (IF EQUIPPED)

With the ignition in the ON position, the message center, located on your instrument cluster, displays important vehicle information through a constant monitor of vehicle systems. You may select display features on the message center for a display of status preceded by a brief indicator chime. The system will also notify you of potential vehicle problems with a display of system warnings followed by a long indicator chime.

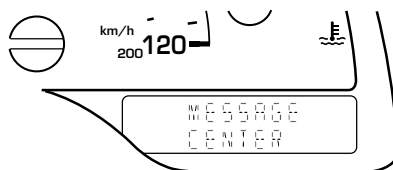

Selectable features

Info menu

This control displays the following control displays:

- Compass/Outside Temperature
- Distance to Empty
- Average Fuel Economy
- Instant Fuel Economy (if equipped)
- Trip Elapsed Drive Time
- Display On/Off

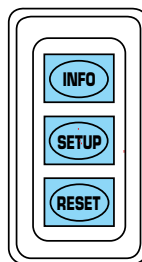

Setup menu

Press this control for the following displays:

- Language
- Units (English/Metric)
- System Check
- Single/Dual Display Mode

Reset

Press this control to select and reset functions shown in the INFO menu and SETUP menu.

System check

Selecting this function from the SETUP menu causes the message center to cycle through each of the systems being monitored. For each of the monitored systems, the message center will indicate either an OK message or a warning message for three seconds.

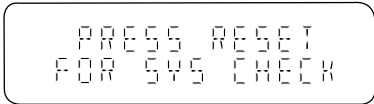

PRESS RESET
FOR SYS CHECK

Pressing the RESET control cycles the message center through each of the systems being monitored.

The sequence of the system check report is as follows:

1. oil life in XX%
2. charging system
3. washer fluid level
4. brake fluid level
5. doors closed (driver and passenger side). This message can only be reset by closing the door(s). If the RESET control is pressed, PLEASE CLOSE DOOR will be displayed.
6. rear liftgate status
7. exterior lamps (headlamps, front turn, brake, tail and cornering/side repeater lamp status)
8. traction control (if equipped)
9. fuel level
10. distance to empty

Instrumentation

Language

1. Select this function from the SETUP menu for the current language to be displayed.

ENGLISH
RESET FOR NEW

2. Pressing the RESET control cycles the message center through each of the language choices.

FOR ENGLISH
HOLD RESET

3. Press and hold the RESET control to set the language choice.

SET TO
ENGLISH

Units (English/Metric)

1. Select this function from the SETUP menu for the current units to be displayed.

UNITS
ENG > METRIC

2. Press the RESET control to change from English to Metric.

Single/Dual Display Mode

1. Select this function from the SETUP menu for the current display mode.

DISPLAY MODE
SINGLE > DUAL

2. Press the RESET control to change from the Single to the Dual display.

System warnings

System warnings alert you to possible problems or malfunctions in your vehicle's operating systems.

In the event of a multiple warning situation, the message center will cycle the display to show all warnings by displaying each one for 4 seconds.

Instrumentation

The message center will display the last selected feature if there are no more warning messages. This allows you to use the full functionality of the message center after you acknowledge the warning by pressing the RESET control and clearing the warning message.

Warning messages that have been reset are divided into two categories:

- They will reappear on the display ten minutes from the reset.
- They will not reappear until an ignition OFF-ON cycle has been completed.

This acts as a reminder that these warning conditions still exist within the vehicle.

Driver's door ajar	Warning cannot be reset
Passenger door ajar	
Driver rear door ajar	
Passenger rear door ajar	
Check charging system	Warning returns after 10 minutes
Transmission overheated	
Check transmission	
Low fuel level	
Liftgate ajar	Warning returns after the ignition key is turned from OFF to ON
Low brake fluid level	
Check tail lamps	
Check headlamps	
Check rear turn lamps	
Check front turn lamps	
Check cornering/side repeater lamps (if equipped)	
Change oil soon	
Oil change required	
Check traction control	
Low washer fluid	
Check turn signal on reminder	

Instrumentation

DRIVER'S DOOR AJAR. Displayed when the driver's door is not completely closed.

PASSENGER DOOR AJAR. Displayed when the passenger side door is not completely closed.

DRIVER'S REAR DOOR AJAR. Displayed when the driver's rear door is not completely closed.

PASSENGER REAR DOOR AJAR. Displayed when the passenger side rear door is not completely closed.

LIFTGATE AJAR. Displayed when the liftgate is not completely closed.

CHECK CHARGING SYSTEM. Displayed when the electrical system is not maintaining proper voltage. If you are operating electrical accessories when the engine is idling at a low speed, turn off as many of the electrical loads as soon as possible. If the warning stays on or comes on when the engine is operating at normal speeds, have the electrical system checked as soon as possible.

LOW FUEL LEVEL. Displayed when you have approximately 1/16th of a tank indicated on the fuel gauge.

CHECK TRANSMISSION. Indicates the transmission is not operating properly. If this warning stays on, contact your dealer as soon as possible.

TRANSMISSION OVERHEATED. Indicates the transmission is overheating. This warning may appear when towing heavy loads or when driving in a low gear at a high speed for an extended period of time. Stop the vehicle as soon as safely possible, turn off the engine and let it cool. Check the transmission fluid and level. Refer to *Transmission fluid* in the *Maintenance and care* chapter. If the warning stays on or continues to come on, contact your dealer for transmission service as soon as possible.

CHECK BRAKE LAMPS. Displayed when the brake lamps are activated and at least one is burned out. Check the lamps as soon as safely possible and have the burned out lamp replaced. The center high-mount brakelamp is not monitored.

CHECK HEADLAMPS. Displayed when the headlamps are activated and at least one is burned out. Check the lamps as soon as safely possible and have the burned out lamp replaced. Refer to *Replacing headlamp bulbs* in the *Maintenance and care* chapter.

Instrumentation

CHECK TAIL LAMPS. Displayed when the tail lamps are activated and at least one is burned out. Check the lamps as soon as safely possible and have the burned out lamp replaced.

CHECK FRT TURN LAMPS. Displayed when the turn signals are activated and at least one is burned out. Check the lamps as soon as safely possible and have the burned out lamp replaced.

CHECK REAR TURN LAMPS. Displayed when the turn signals are activated and at least one is burned out. Check the lamps as soon as safely possible and have the burned out lamp replaced.

CHECK REAR TURN LAMPS. Displayed when the turn signals are activated and at least one is burned out. Check the lamps as soon as safely possible and have the burned out lamp replaced.

CHECK SIDE REPEATER LAMPS (if equipped). Displayed when the turn signals are activated and at least one is burned out. Check the lamps as soon as safely possible and have the burned out lamp replaced.

TURN SIGNAL ON REMINDER. Displayed when the turn signal is activated and the vehicle is driven more that 0.8 km (1/2 mile).

LOW WASHER FLUID. Indicates the washer fluid reservoir is less than one quarter full. Check the washer fluid level. Refer to *Windshield washer fluid* in the *Maintenance and care* chapter.

CHECK TRACTION CONTROL (if equipped). Displayed when the Traction Control™ system is not operating properly. If this warning stays on, contact your dealer for service as soon as possible. For further information, refer to *Traction control™* in the *Driving* chapter.

CHANGE OIL SOON/OIL CHANGE REQUIRED. Displayed when the engine oil life remaining is 5 percent or less. When oil life left is between 5% and 0%, the CHANGE OIL SOON message will be displayed. When oil life left reaches 0%, the OIL CHANGE REQUIRED message will be displayed.

An oil change is required whenever indicated by the message center.
USE ONLY RECOMMENDED ENGINE OILS.

To reset the oil monitoring system to 100% approximately 8 000 km (5 000 miles or 180 days) (or your personalized oil reset percentage) after each oil change:

Press RESET and SETUP controls at the same time to activate a service mode which will display OIL LIFE % HOLD RESET NEW.

Instrumentation

- Press the SETUP control to access the System Check function. Press RESET to start the System Check.

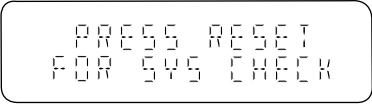

PRESS RESET
FOR SYS CHECK

- Press and hold the RESET control.

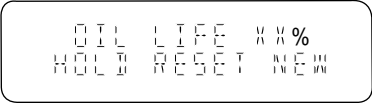

OIL LIFE XX%
HOLD RESET NEW

- Press RESET and SETUP controls for personalized setting.



OIL LIFE XX%
RESET TO ALTER

- After a successful reset, the message center will display OIL LIFE RESET TO 100%.

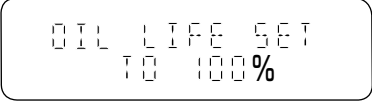

OIL LIFE SET
TO 100%

DATA ERR. These messages indicate improper operation of the vehicle network communication between electronic modules.

- Fuel Computer
- Oil life
- Charging system
- Door sensor
- Liftgate sensor
- Exterior lamps
- Traction control
- Washer fluid
- Brake Fluid
- Compass
- Outside temperature

Contact your dealer as soon as possible if these messages occur on a regular basis.

Compass display (if equipped)

The compass reading may be affected when you drive near large buildings, bridges, power lines and powerful broadcast antenna. Magnetic or metallic objects placed in, on or near the vehicle may also affect compass accuracy.

Usually, when something affects the compass readings, the compass will correct itself after a few days of operating your vehicle in normal conditions. If the compass still appears to be inaccurate, a manual calibration may be necessary. Refer to *Compass zone/calibration adjustment*.

Most geographic areas (zones) have a magnetic north compass point that varies slightly from the northerly direction on maps. This variation is four degrees between adjacent zones and will become noticeable as the vehicle crosses multiple zones. A correct zone setting will eliminate this error. Refer to *Compass zone/calibration adjustment*.

Instrumentation

Compass zone/calibration adjustment

Perform this adjustment in an open area free from steel structures and high voltage lines.

For optimum calibration, turn off all electrical accessories (heater/air conditioning, wipers, etc.) and make sure all vehicle doors are shut.

1. Turn ignition to the ON position.
2. Start the engine.
3. Determine your magnetic zone by referring to the zone map.
4. From Info menu, select the Compass/Outside Temperature function.

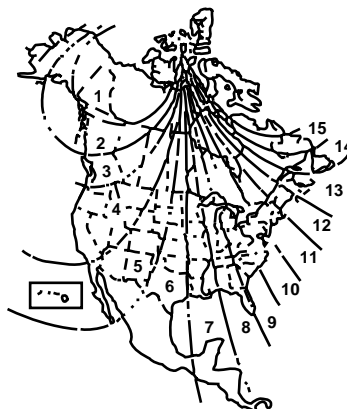

5. Press and hold the RESET control until the message center display changes to show the current zone setting.

```
RESET FOR ZONE  
INFO TO EXIT
```

6. Release the reset control, then slowly press down again.

```
SETUP ZONE XX  
RESET IF DONE
```

7. Press the SETUP control repeatedly until the correct zone setting for your geographic location is displayed on the message center. To exit the zone setting mode press and release the RESET control.

8. Press the RESET control to start the compass calibration function.

```
RESET FOR CAL  
INFO TO EXIT
```

Instrumentation

9. Slowly drive the vehicle in a circle (less than 5 km/h [3 mph]) until the CIRCLE SLOWLY TO CALIBRATE indicator changes to CALIBRATION COMPLETED. This will take up to three circles to complete calibration.

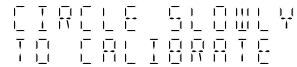

CIRCLE SLOWLY
TO CALIBRATE

10. The compass is now calibrated.

FUEL ECON AVG

Select this function from the INFO menu to display your average fuel economy in liters/100 km or miles/gallon.



XXX AVERAGE
L/100 KM

If you calculate your average fuel economy by dividing liters of fuel used by 100 kilometers traveled (miles traveled by gallons used), your figure may be different than displayed for the following reasons:

- your vehicle was not perfectly level during fill-up
- differences in the automatic shut-off points on the fuel pumps at service stations
- variations in top-off procedure from one fill-up to another
- rounding of the displayed values to the nearest 0.1 liter (gallon)

1. Drive the vehicle at least 8 km (5 miles) with the speed control system engaged to display a stabilized average.

2. Record the highway fuel economy for future reference.

It is important to press the RESET control after setting the speed control to get accurate highway fuel economy readings.

DIST TO EMPTY (DTE)

Selecting this function from the INFO menu will give you an estimate of how far you can drive with the fuel remaining in your tank under normal driving conditions.

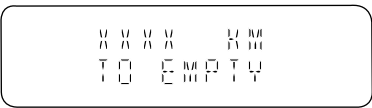

XXXX KM
TO EMPTY

Remember to turn the ignition OFF when refueling your vehicle. Otherwise, the display will not show the addition of fuel for a few kilometers (miles).

Instrumentation

The DTE function will display LOW FUEL LEVEL and sound a tone for 1 second when you have low fuel level indicated on the fuel gauge.

INST ECON (instantaneous fuel economy)(if equipped)

Select this function to calculate the instantaneous fuel economy of your running vehicle. For example, you can see what your fuel economy is in heavy traffic or on an open highway.



INSTANT
L / 100 KM

Your vehicle must be moving to calculate instantaneous fuel economy. When your vehicle is not moving, this function shows the approximate amount of fuel in the fuel tank in whole numbers (liters or gallons). If your tank is full or nearly full, the display will be “F”. If your tank is empty or nearly empty, the display will be “E”. Instantaneous fuel economy cannot be reset.

TRIP ELAPSED DRIVE TIME

Select this function from the INFO menu to display your trip elapsed drive time and will display and accumulate when the key is in the RUN position.

1. Press the INFO control until the message center display shows the TRIP ELAPSED TIME XXXX.
2. Hold the RESET control down for two seconds to clear display.

DISPLAY ON/OFF

Select this function from the INFO menu to turn your message center display OFF or ON.

Controls and features

PANEL DIMMER CONTROL

Use to adjust the brightness of the instrument panel lighting during headlamp and parklamp operation.

- Rotate control to full up position to turn on all interior lights.
- Rotate control to next position (adjustment dial) and move up and down to adjust the instrument panel lights.
- Rotate to the first or second lower detent position to turn on the instrument panel lights to full brightness.

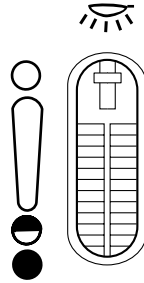

This control also has other features that are activated when **any door is opened**:

- Rotate to full up position or next position (adjustment dial) to turn on all interior lights.
- Rotate to first lower detent position to activate “sleeping baby mode”— dome lamps will remain off and only the lower lamps will illuminate.
- The second lower detent position (full down) will shut off all interior lights.

HEADLAMP CONTROL

Rotate the headlamp control to the first position to turn on the parking lamps. Rotate to the second position to also turn on the headlamps.

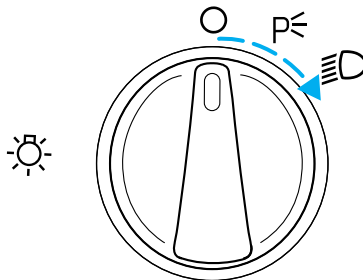

Controls and features

Battery saver

The battery saver will shut off the exterior lamps 10 minutes after the ignition switch has been turned off and the headlamp control is in the HEADLAMP position. The system will not turn off the parking lamps if the headlamp control is in the PARK position. For interior lights, refer to *Illuminated entry* in this chapter.

Daytime running lamps (DRL) (if equipped)

Turns the highbeam headlamps on with a reduced output. To activate:

- the key must be in the ON position,
- the headlamp control is in the OFF or Parking lamps position.



Always remember to turn on your headlamps at dusk or during inclement weather. The Daytime Running Light (DRL) System does not activate your tail lamps and generally may not provide adequate lighting during these conditions. Failure to activate your headlamps under these conditions may result in a collision.

High beams

Push forward to activate.

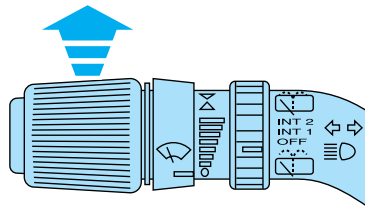

Flash to pass

Pull toward you to activate and release to deactivate.

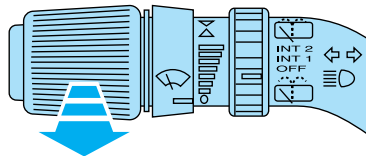

Controls and features

AUTOLAMP CONTROL (IF EQUIPPED)

The autolamp system provides light sensitive automatic on-off control of the exterior lights normally controlled by the headlamp control.

The autolamp system also keeps the lights on for a fixed period of time after the ignition switch is turned to OFF.

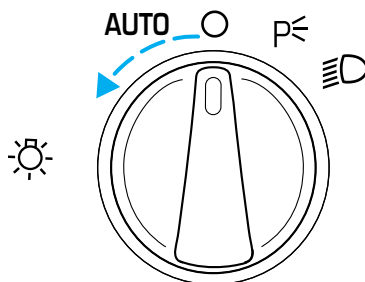

- To turn autolamps on, rotate the control counterclockwise.
- To turn autolamps off, rotate the control clockwise to OFF.

CLIMATE CONTROL SYSTEM

Manual heating system (if equipped)

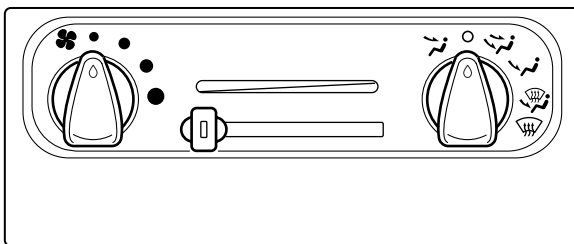

Fan speed control

Controls the volume of air circulated in the vehicle.



Controls and features

Temperature control

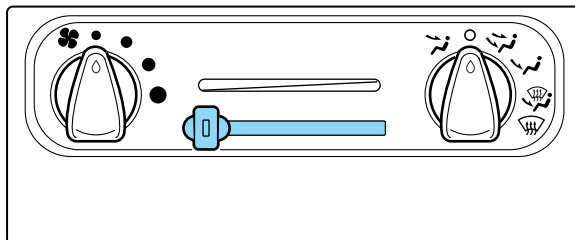





Controls the temperature of the airflow inside the vehicle.

Mode selector control

Controls the direction of the airflow to the inside of the vehicle.



Under normal conditions, your vehicle's climate control system should be left in any position other than OFF when the vehicle is parked. This allows the vehicle to “breathe” through the outside air inlet duct.

-  (Panel) — Distributes outside air through the instrument panel registers.
- OFF-Outside air is shut out and the fan will not operate. For short periods of time only, use this mode to prevent undesirable odors from entering the vehicle.
-  (Panel and floor) — Distributes outside air through the instrument panel registers and the floor ducts.
-  (Floor) — Allows for maximum heating by distributing outside air through the floor ducts.
-  (Floor and defrost) — Distributes outside air through the windshield defroster ducts and the floor ducts.
-  (Defrost) — Distributes outside air through the windshield defroster ducts. It can be used to clear ice or fog from the windshield.

Controls and features

Operating tips

- In humid weather, select  before driving. This will prevent your windshield from fogging. After a few minutes, select any desired position.
- To prevent humidity buildup inside the vehicle, don't drive with the climate control system in the OFF position.
- Don't put objects under the front seat that will interfere with the airflow to the back seats.
- Remove any snow, ice or leaves from the air intake area (at the bottom of the windshield under the hood).

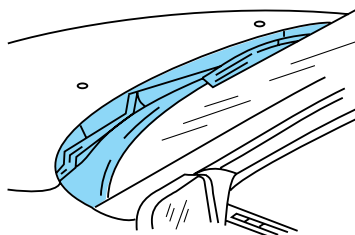

- When placing objects on top of your instrument panel, be careful to not place them over the defroster outlets. These objects can block airflow and reduce your ability to see through your windshield. Also, avoid placing small objects on top of your instrument panel. These objects can fall down into the defroster outlets and block airflow and possibly damage your climate control system.
- To get maximum heating performance from the second row floor vents (located under the front row seats), place the front mode selector control in the  (floor) position and set the fan speed to its highest setting.



Do not place objects on top of the instrument panel, as these objects may become projectiles in a collision or sudden stop.

Controls and features

Manual heating and air conditioning system (if equipped)

- Manual heating and air conditioning system without rear controls (if equipped)

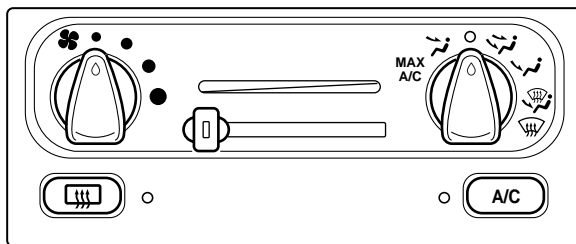

- Manual heating and air conditioning system with rear controls (if equipped)

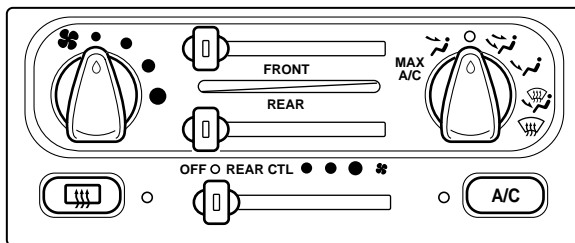

Fan speed control

Controls the volume of air circulated in the vehicle.



Controls and features

Temperature control

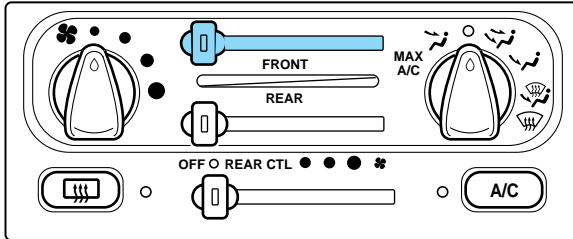

Controls the temperature of the airflow for the front part of the passenger compartment.

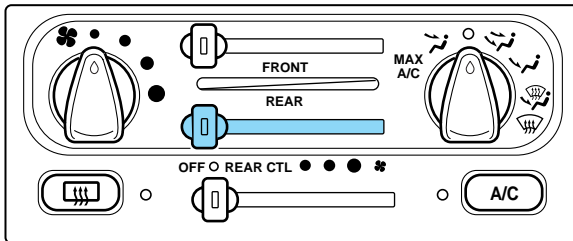

With the rear fan switch on the main control set to any fan speed (except OFF), the rear temperature control:

- regulates the temperature of the airflow for the rear passenger compartment.
- determines the air distribution to the rear registers.

The rear climate control distributes air in the following manner:

- Cool air is delivered from the overhead registers.
- Warm air is delivered from the lower (floor) register.
- Mid-temperature range air is delivered from both the overhead and floor registers.

Controls and features

Mode selector control

The mode selector control allows you to adjust the direction of the airflow to the front part of the passenger compartment.











The air conditioning can operate in all modes. However, the air conditioning will only function if the outside temperature is about 4°C (40°F) or above.

Since the air conditioner removes considerable moisture from the air during operation, it is normal if clear water drips on the ground under the air conditioner drain while the system is working and even after you have stopped the vehicle.

Under normal conditions, your vehicle's climate control system should be left in any position other than MAX A/C or OFF when the vehicle is parked. This allows the vehicle to “breathe” through the outside air inlet duct.

- MAX A/C - Uses recirculated air to cool the vehicle. MAX A/C is noisier than A/C, but more economical and will cool the inside of the vehicle faster. In this mode, the air conditioning will automatically engage if the outside temperature is about 4°C (40°F) or above. However, the indicator will not light unless the A/C control is selected. If the A/C control was previously selected before using MAX A/C, the indicator light will remain lit. Airflow will be from the instrument panel registers. This mode can also be used to prevent undesirable odors from entering the vehicle.
- (Panel) - Distributes outside air through the instrument panel registers. Heating and air conditioning capabilities are provided in this mode. Push the A/C control in order to cool the vehicle below the outside temperature.
- OFF - Outside air is shut out and the fan will not operate. For short periods of time only, use this mode to prevent undesirable odors from entering the vehicle.







Controls and features

-  (Panel and floor)-Distributes outside air through the instrument panel registers and the floor ducts. Heating and air conditioning capabilities are provided in this mode. Push the  (A/C) control in order to cool the vehicle below the outside temperature. For added customer comfort, when the temperature control knob is anywhere in between the full hot and full cold positions, the air distributed through the floor ducts will be slightly warmer than the air sent to the instrument panel registers.
-  (Floor)-Allows for maximum heating by distributing outside air through the floor ducts. Heating and air conditioning capabilities are provided in this mode. Push the  (A/C) control in order to cool the vehicle below the outside temperature.
-  (Floor and defrost)-Distributes outside air through the windshield defroster ducts and the floor ducts. Heating and air conditioning capabilities are provided in this mode. In this mode, the air conditioning will automatically engage if the outside temperature is about 4°C (40°F) or above. However, the indicator will not light unless the  (A/C) control is selected. If the A/C control was previously selected before using Floor/Defrost, the indicator light will remain lit. For added customer comfort, when the temperature control knob is anywhere in between the full hot and full cold positions, the air distributed through the floor ducts will be slightly warmer than the air sent to the instrument panel registers.
-  (Defrost)-Distributes outside air through the windshield defroster ducts. It can be used to clear ice or fog from the windshield. If the temperature is about 4°C (40°F) or higher, the air conditioner will automatically dehumidify the air to prevent fogging. However, the indicator will not light unless the  (A/C) control is selected.

Cooling your vehicle with outside air

Cooling your vehicle with air conditioned outside air is quieter but less economical than using recirculated air. It also has less cooling capacity.

In order to cool your vehicle using outside air:

1. Turn the mode selector to ,  (panel),  (panel and floor) or  (floor).
2. Press the  (A/C) control. The indicator light next to the  (A/C) control will illuminate.
3. Slide the temperature control knob to the left.
4. Turn the fan speed control to the position of your choice.

Controls and features

During periods of high humidity, vapor may be emitted from the air outlets when using the A/C system with outside air. This can be corrected by using MAX A/C to cool the vehicle.

Operating tips

- In humid weather, select  before driving. This will prevent your windshield from fogging. After a few minutes, select any desired position.
- To prevent humidity buildup inside the vehicle, don't drive with the climate control system in the OFF position.
- Don't put objects under the front seat that will interfere with the airflow to the back seats.
- Remove any snow, ice or leaves from the air intake area (at the bottom of the windshield under the hood).

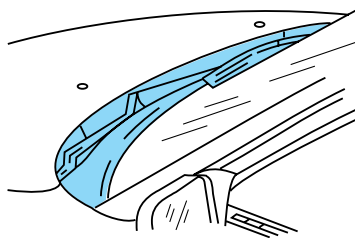

- If your vehicle has been parked with the windows closed during hot weather, the air conditioner will do a much faster job of cooling if you drive for two or three minutes with the windows open. This will force most of the hot, stale air out of the vehicle. Then operate your air conditioner as you would normally.
- When placing objects on top of your instrument panel, be careful to not place them over the defroster outlets. These objects can block airflow and reduce your ability to see through your windshield. Also, avoid placing small objects on top of your instrument panel. These objects can fall down into the defroster outlets and block airflow and possibly damage your climate control system.
- To get maximum heating performance from the second row floor vents (located under the front row seats), place the front mode selector control in the  (floor) position and set the fan speed to its highest setting.
- If the air conditioner works well in MAX A/C, but not in any other mode when the A/C control is selected, this may indicate that the passenger compartment air filter (if equipped) needs to be replaced.



Do not place objects on top of the instrument panel, as these objects may become projectiles in a collision or sudden stop.

Controls and features

Rear passenger compartment climate control system (if equipped)

This system allows the rear seat occupants to adjust their climate comfort level.

The rear seat climate control system is controlled from the main climate control system on the instrument panel:

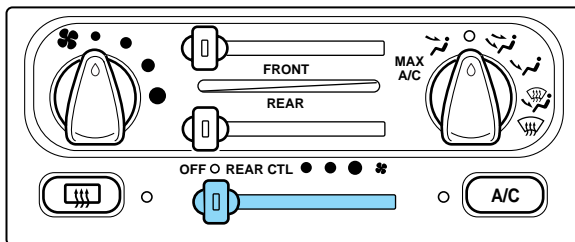

- If the main climate control system on the instrument panel is set to OFF, the rear climate control system will also be off.
- If the rear passenger compartment climate control lever is set to OFF, the rear climate controls will be off.
- If the rear fan control on the main climate control system is set in any of the fan speed positions, air will be distributed from the rear seat registers at the corresponding speed.
- If the rear fan control on the main climate control system is set to REAR CTL, rear seat passengers can control their own fan speed and temperature and upper or lower air distribution.

Controls and features

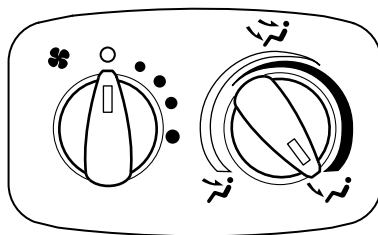



The rear climate system fan speed control allows rear passengers to control the volume of air that is distributed from the rear registers.



The temperature/mode selection control allows rear passengers to select the temperature, as well as whether the air is distributed from the overhead registers or the floor register, or a mix between the two.



The temperature/mode selection control allows you to select any temperature setting for your desired comfort level and gives you three choices for air distribution:

-  (Panel)
-  (Panel and floor)
-  (Floor)

It is important to note that whenever the temperature/mode selection control is set to a specific temperature setting, the system automatically determines the air distribution location:

- Cool temperature range settings allow the air to be distributed through the overhead registers.
- Mild (mid temperature range settings) allow the air to be distributed through both the overhead registers and the floor register.
- Warm temperature range settings allow the air to be distributed through the floor register.

Controls and features

REAR WINDOW DEFROSTER (IF EQUIPPED)

The rear defroster control is located on the instrument panel.

Press the defroster control to clear the rear window of thin ice and fog.

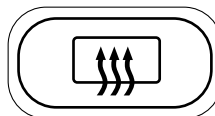

- The small LED will illuminate when the defroster is activated.

The engine must be running to operate the rear window defroster.

The defroster turns off automatically after 10 minutes or when the ignition is turned to the OFF position. To manually turn off the defroster before ten minutes have passed, push the control again.

USING YOUR AUDIO SYSTEM

AM/FM Stereo

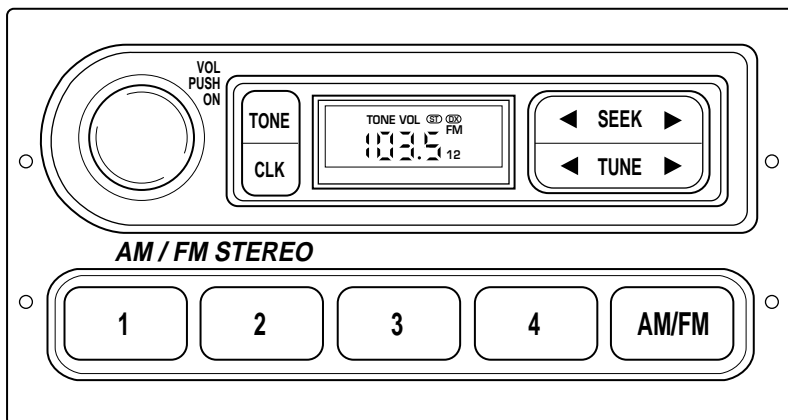

Your vehicle is equipped with a delayed accessory feature. This feature enables the audio playing media to continue playing up to 10 minutes after the ignition has been turned off, or until a door is opened.

Controls and features

Volume/power control

Press the control to turn the audio system on or off.

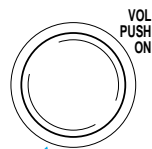

Turn the control to raise or lower volume.

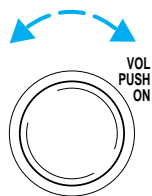

If the volume is set above a certain level and the ignition is turned off, the volume will come back on at a “nominal” listening level when the ignition switch is turned back on.

AM/FM select

The AM/FM select control works in radio mode.



AM/FM select in radio mode

This control allows you to select AM or FM frequency bands. Press the control to switch between AM, FM1 or FM2 memory preset stations.

Tune adjust

The tune control works in radio mode.

Controls and features

Tune adjust in radio mode

- Press ◀ to move to the next frequency down the band (whether or not a listenable station is located there). Hold the control to move through the frequencies quickly.



- Press ▶ to move to the next frequency up the band (whether or not a listenable station is located there). Hold for quick movement.

Seek function

The seek function control works in radio mode.

Seek function in radio mode

- Press ◀ to find the next listenable station down the frequency band.
- Press ▶ to find the next listenable station up the frequency band.

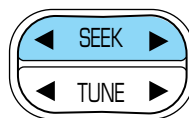

Radio station memory preset

The radio is equipped with four station memory preset controls. These controls can be used to select up to four preset AM stations and eight FM stations (four in FM1 and four in FM2).

Setting memory preset stations

1. Select the frequency band with the AM/FM select control.
2. Select a station. Refer to *Tune adjust* or *Seek function* for more information on selecting a station.
3. Press and hold a memory preset control until the sound returns, indicating the station is held in memory on the control you selected.

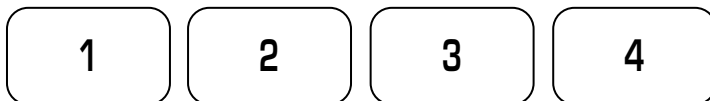

Controls and features

Bass adjust

The bass adjust control allows you to increase or decrease the audio system's bass output.

With the electronic AM/FM stereo, press the TONE control once, then use the volume knob to adjust the level.

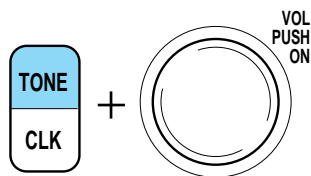

Treble adjust

The treble adjust control allows you to increase or decrease the audio system's treble output.

With the electronic AM/FM stereo, press the TONE control twice, then use the volume knob to adjust the level.

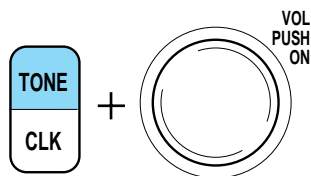

Speaker balance adjust

Speaker sound distribution can be adjusted between the right and left speakers.

With the electronic AM/FM stereo, press the TONE control three times, then use the volume knob to adjust the level.

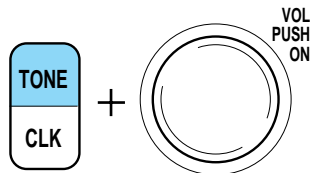

Speaker fade adjust (if equipped)

Speaker sound can be adjusted between the front and rear speakers.

With the electronic AM/FM stereo, press the TONE control four times, then use the volume knob to adjust the level.

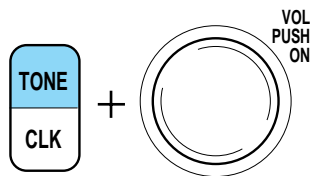

Controls and features

Setting the clock

Press CLK to toggle between listening frequencies and clock mode.

To set the hour, press and hold the CLK control and press:

- ◀ to decrease hours and
- ▶ to increase hours.

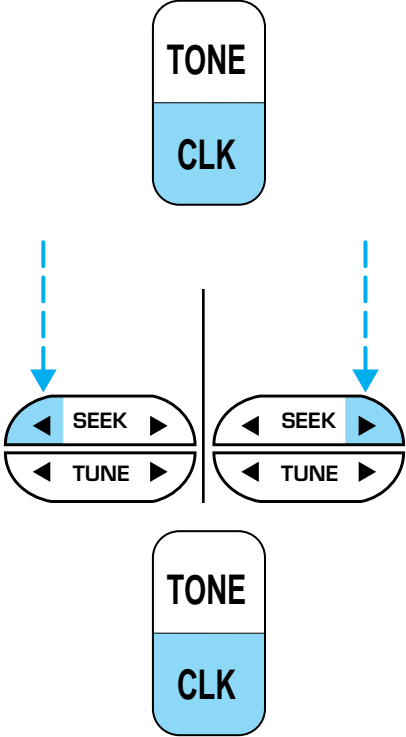

To set the minute, press and hold the CLK control and press:

Controls and features

- ◀ to decrease minutes and
- ▶ to increase minutes.

The CLK control will allow you to switch between media display mode (radio station, stereo information, etc.) and clock display mode (time).

When in clock mode, the media information will display for ten seconds, when the radio is turned on, and then revert to clock information. Anytime that the media is changed, (new radio station, etc.), the media information will again display for ten seconds before reverting back to the clock. In media mode, the media information will always be displayed.

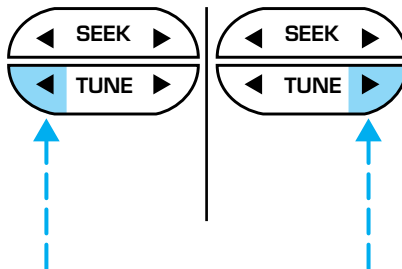

AM/FM Stereo/Cassette (CD changer compatible)

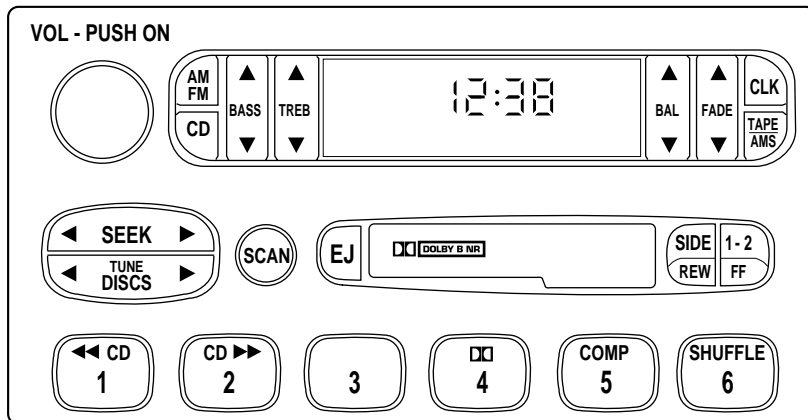

Your vehicle is equipped with a delayed accessory feature. This feature enables the audio playing media to continue playing up to 10 minutes after the ignition has been turned off, or until a door is opened.

Controls and features

Volume/power control

Press the control to turn the audio system on or off.

VOL - PUSH ON

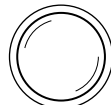

Turn the control to raise or lower volume.



VOL - PUSH ON

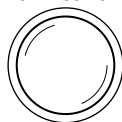

If the volume is set above a certain level and the ignition is turned off, the volume will come back on at a “nominal” listening level when the ignition switch is turned back on.

AM/FM select

The AM/FM select control works in radio, tape and CD changer modes (if equipped).



AM/FM select in radio mode

This control allows you to select AM or FM frequency bands. Press the control to switch between AM, FM1 or FM2 memory preset stations.

AM/FM select in tape mode

Press this control to stop tape play and begin radio play.

Controls and features

AM/FM select in CD changer mode (if equipped)

Press this control to stop CD play and begin radio play.

Tune adjust

The tune control works in radio and CD changer modes (if equipped).

Tune adjust in radio mode

- Press ◀ to move to the next frequency down the band (whether or not a listenable station is located there). Hold the control to move through the frequencies quickly.
- Press ▶ to move to the next frequency up the band (whether or not a listenable station is located there). Hold for quick movement.



Tune adjust for CD changer (if equipped)

- Press ◀ to select the previous disc in the CD changer. (Play will begin on the first track of the disc unless the CD changer is in shuffle mode. Refer to *Shuffle feature* for more information. Hold the control to continue reversing through the disc.
- Press ▶ to select the next disc in the CD changer. Hold the control to fast-forward through the remaining discs.

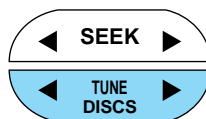

Seek function

The seek function control works in radio or CD changer mode.

Seek function in radio mode

- Press ◀ to find the next listenable station down the frequency band.
- Press ▶ to find the next listenable station up the frequency band.

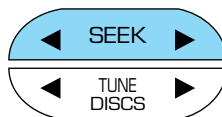

Controls and features

Seek function for CD changer (if equipped)

- Press ◀ to seek to the previous track of the current disc. If a selection has been playing for three seconds or more and you press ◀, the CD changer will replay that selection from the beginning.
- Press ▶ to seek forward to the next track of the current disc. After the last track has been completed, the first track of the current disc will automatically replay.

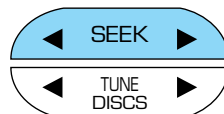

Scan function

The scan function works in radio or CD changer mode (if equipped).



Scan function in radio mode

Press the SCAN control to hear a brief sampling of all listenable stations on the frequency band. Press the SCAN control again to stop the scan mode.

Scan function in CD changer mode (if equipped)

Press the SCAN control to hear a brief sampling of all selections on the CD. (The CD scans in a forward direction, wrapping back to the first track at the end of the CD.) To stop on a particular selection, press the SCAN control again.

Radio station memory preset

The radio is equipped with six station memory preset controls. These controls can be used to select up to six preset AM stations and twelve FM stations (six in FM1 and six in FM2).

Setting memory preset stations

1. Select the frequency band with the AM/FM select control.
2. Select a station. Refer to *Tune adjust* or *Seek function* for more information on selecting a station.
3. Press and hold a memory preset control until the sound returns, indicating the station is held in memory on the control you selected.

Controls and features



Bass adjust

The bass adjust control allows you to increase or decrease the audio system's bass output.

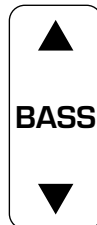

Treble adjust

The treble adjust control allows you to increase or decrease the audio system's treble output.



Speaker balance adjust

Speaker sound distribution can be adjusted between the right and left speakers.

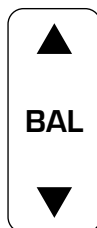

Controls and features

Speaker fade adjust

Speaker sound can be adjusted between the front and rear speakers.



Tape select

- To enter tape mode while in radio or CD changer mode, press the TAPE control.
- If no tape is found, NO TAPE appears in the display.



Automatic Music Search

The Automatic Music Search feature allows you to quickly locate the beginning of the tape selection being played or to skip to the next selection.

To activate the feature, momentarily depress the TAPE AMS button.

Then, press either REW (for the beginning of the current selection) or FF (to advance to the next selection). The tape deck stops and returns to play mode when the AMS circuit senses a blank section on the tape.

In order to ensure proper operation of the AMS feature, the tape **MUST** have a blank section of at least 4 seconds duration between programs.



Controls and features

CD changer select (if equipped)

- To enter CD changer mode while in radio or tape mode, press the CD control.

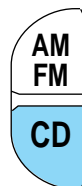

Rewind

The rewind control works in tape and CD changer (if equipped) modes.

To rewind in tape mode, press the SIDE/REW control.



Press the 1-2/FF control to stop rewinding the tape.

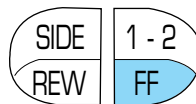

To rewind in CD changer mode, press the CD control (preset 1).

Press the control again to deactivate rewind mode.



Fast forward

The fast forward control works in tape and CD changer modes.

To fast forward in tape mode, press the 1-2/FF control.

Tape direction will automatically reverse when the end of the tape is reached.

Press the SIDE/REW control to stop the fast forward of the tape.

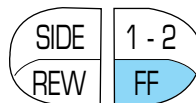

Controls and features

To fast forward in CD changer mode, press the CD control (preset 2).

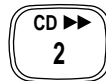

Press the control again to deactivate fast forward mode.

Compression feature (if equipped)

Compression adjust brings soft and loud CD passages together for a more consistent listening level.



Press the COMP control to activate and deactivate compression adjust.

Shuffle feature (if equipped)

The shuffle feature operates in CD changer mode and plays all tracks on the current disc in random order. The shuffle feature continues to the next disc after all tracks are played.



Press the SHUFFLE control to start this feature. Random order play will continue until the SHUFFLE control is pressed again.

Tape direction select

Press SIDE and 1-2 at the same time to play the alternate side of a tape.

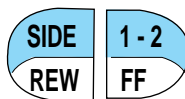

Eject function

Press the control to stop and eject a tape.



Controls and features

Dolby® noise reduction

Dolby® noise reduction operates only in tape mode. Dolby® reduces the amount of hiss and static during tape playback.

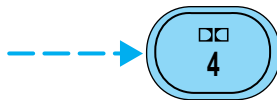

Press the  control to activate (and deactivate) Dolby® noise reduction.



The noise reduction system is manufactured under license from Dolby Laboratories Licensing Corporation.

Setting the clock

Press CLK to toggle between listening frequencies and clock mode while in radio mode.

To set the hour, press and hold the CLK control and press:



-  to decrease hours and
-  to increase hours.

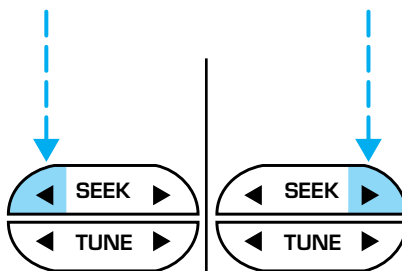

To set the minute, press and hold the CLK control and press:



Controls and features

- ◀ to decrease minutes and
- ▶ to increase minutes.

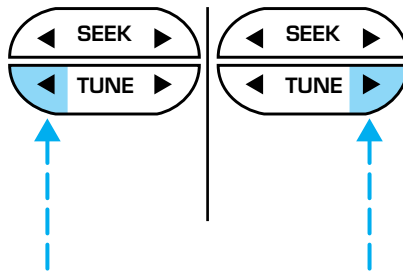

The CLK control will allow you to switch between media display mode (radio station, stereo information, etc.) and clock display mode (time). When in clock mode, the media information will display for ten seconds, when the radio is turned on, and then revert to clock information. Anytime that the media is changed, (new radio station, etc.), the media information will again display for ten seconds before reverting back to the clock. In media mode, the media information will always be displayed.

Premium AM/FM Stereo/Cassette/Single CD/Premium Sound

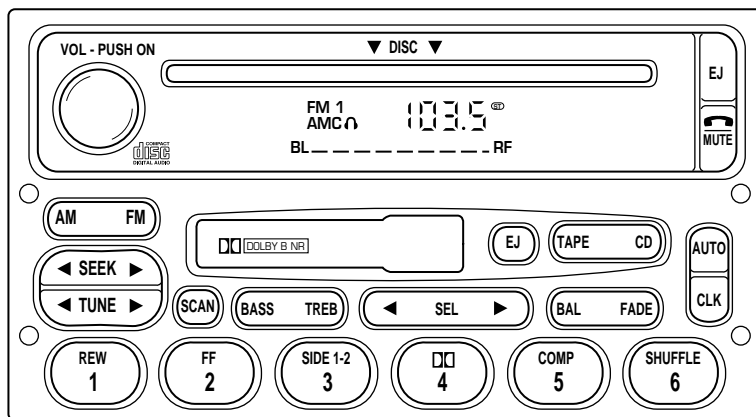

Your vehicle is equipped with a delayed accessory feature. This feature enables the audio playing media to continue playing up to 10 minutes after the ignition has been turned off, or until a door is opened.

Controls and features

Volume/power control

Press the control to turn the audio system on or off.

Audio power can also be turned on by pressing the AM/FM select control or the tape/CD select control. Audio power is turned off by using the volume/power control.

VOL - PUSH ON

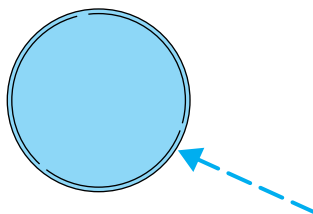

Turn control to raise or lower volume.

VOL - PUSH ON

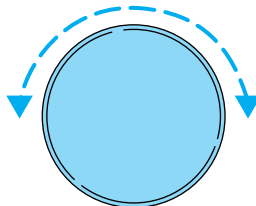

If the volume is set above a certain level and the ignition is turned off, the volume will come back on at a “nominal” listening level when the ignition switch is turned back on.

AM/FM select

The AM/FM select control works in radio, tape and CD modes.



AM/FM select in radio mode

This control allows you to select AM or FM frequency bands. Press the control to switch between AM, FM1 or FM2 memory preset stations.

AM/FM select in tape mode

Press this control to stop tape play and begin radio play.

AM/FM select in CD or CD changer mode (if equipped)

Press this control to stop CD play and begin radio play.

Controls and features

Tune adjust

The tune control works in radio or CD changer mode.

Tune adjust in radio mode

- Press ◀ to move to the next frequency down the band (whether or not a listenable station is located there). Hold the control to move through the frequencies quickly.
- Press ▶ to move to the next frequency up the band (whether or not a listenable station is located there). Hold for quick movement.

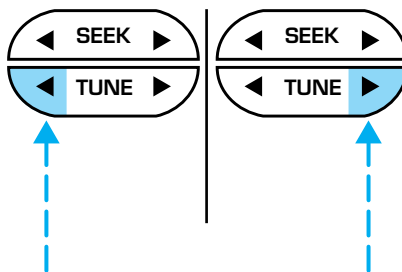

Tune adjust for CD changer (if equipped)

- Press ◀ to select the previous disc in the CD changer. (Play will begin on the first track of the disc unless the CD changer is in shuffle mode. Refer to *Shuffle feature* for more information. Hold the control to continue reversing through the remaining discs.
- Press ▶ to select the next disc in the CD changer. Hold the control to fast-forward through the remaining discs.

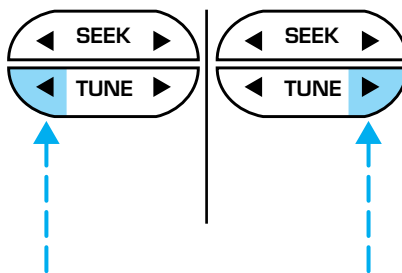

Seek function

The seek function control works in radio, tape or CD mode.

Controls and features

Seek function in radio mode

- Press ◀ to find the next listenable station down the frequency band.
- Press ▶ to find the next listenable station up the frequency band.

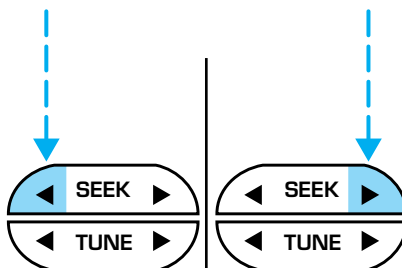

Seek function in tape mode

- Press ◀ to listen to the previous selection on the tape.
- Press ▶ to listen to the next selection on the tape.

Seek function for CD or CD changer (if equipped)

- Press ◀ to seek to the previous track of the current disc. If a selection has been playing for three seconds or more and you press ◀, the CD changer will replay that selection from the beginning.
- Press ▶ to seek forward to the next track of the current disc. After the last track has been completed, the first track of the current disc will automatically replay.

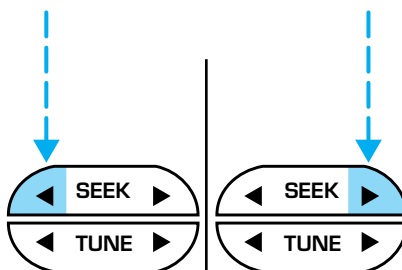

Scan function

The scan function works in radio, tape or CD mode.



Scan function in radio mode

Press the SCAN control to hear a brief sampling of all listenable stations on the frequency band. Press the control again to stop the scan mode.

Controls and features

Scan function in tape mode

Press the SCAN control to hear a short sampling of all selections on the tape. (The tape scans in a forward direction. At the end of the tape's first side, direction automatically reverses to the opposite side of the tape.) To stop on a particular selection, press the control again.

Scan function in CD or CD changer mode (if equipped)

Press the SCAN control to hear a short sampling of all selections on the CD. (The CD scans in a forward direction, wrapping back to the first track at the end of the CD.) To stop on a particular selection, press the control again.

Radio station memory preset

The radio is equipped with six station memory preset controls. These controls can be used to select up to six preset AM stations and twelve FM stations (six in FM1 and six in FM2).

Setting memory preset stations



1. Select the frequency band with the AM/FM select control.
2. Select a station. Refer to *Tune adjust* or *Seek function* for more information on selecting a station.

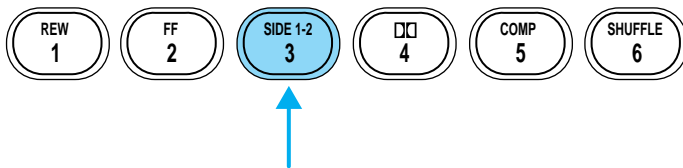

3. Press and hold a memory preset control until the sound returns, indicating the station is held in memory on the control you selected.

Autoset memory preset

Autoset allows you to set strong radio stations without losing your original manually set preset stations. This feature is helpful on trips when you travel between cities with different radio stations.

Controls and features

Starting autaset memory preset

1. Select a frequency using the AM/FM select controls.
2. Press the AUTO control.
3. When the first six strong stations are filled, the station stored in memory preset control 1 will start playing.

If there are less than six strong stations available on the frequency band, the remaining memory preset controls will all store the last strong station available.

These stations are temporarily stored in the memory preset controls (until deactivated) and are accessed in the same manner of your original presets.

To deactivate autaset and return to your audio system's manually set memory stations, press the AUTO control again.

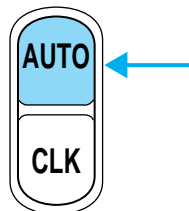

Bass adjust

The bass adjust control allows you to increase or decrease the audio system's bass output.

Press the BASS control then press:

- ◀ to decrease the bass output and
- ▶ to increase the bass output.

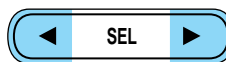
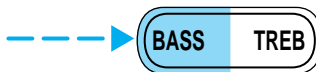

Treble adjust

The treble adjust control allows you to increase or decrease the audio system's treble output.



Controls and features

Press the TREB control then press:

- ◀ to decrease the treble output and
- ▶ to increase the treble output.

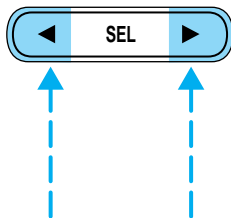

Speaker balance adjust

Speaker sound distribution can be adjusted between the right and left speakers.

Press the BAL control then press:

- ◀ to shift sound to the left and
- ▶ to shift sound to the right.

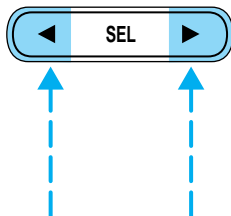

Speaker fade adjust

Speaker sound can be adjusted between the front and rear speakers.

Press the FADE control then press:

- ▶ to shift the sound to the front and
- ◀ to shift the sound to the rear.

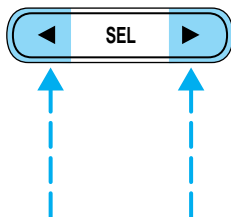

Controls and features

Tape/CD select

- To begin tape play (with a tape loaded into the audio system) while in the radio or CD mode, press the TAPE control. Press the button during rewind or fast forward to stop the rewind or fast forward function.
- To begin CD play (if CD(s) are loaded), press the CD control. The first track of the disc will begin playing. If returning from radio or tape mode, CD play will begin where it stopped last.



With the dual media audio system, press the CD control to toggle between single CD and CD changer play (if equipped).

Rewind

The rewind control works in tape and CD modes.

- In tape mode, radio play will continue until rewind is stopped (with the TAPE control) or the beginning of the tape is reached.
- In CD mode, pressing the REW control rewinds the CD within the current track.

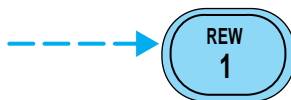

Fast forward

The fast forward control works in tape and CD modes.

- In the tape mode, tape direction will automatically reverse when the end of the tape is reached.
- In CD mode, pressing the control fast forwards the CD within the current track.

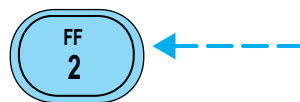

Tape direction select

Press SIDE 1-2 to play the alternate side of a tape.

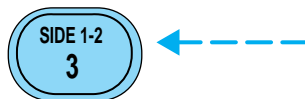

Controls and features

Eject function

Press the EJ control to stop and eject a tape.

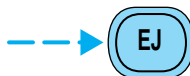

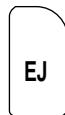

Press the EJ control to stop and eject a CD.

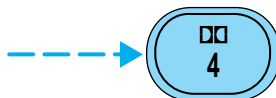

Dolby noise reduction

Dolby noise reduction reduces the amount of hiss and static during tape playback. Press the control to activate (and deactivate) the noise reduction.



Dolby noise reduction manufactured under license from Dolby Laboratories Licensing Corporation. "Dolby" and the double-D symbol  are trademarks of Dolby Laboratories Licensing Corporation.

Compression adjust

Compression adjust brings soft and loud CD passages together for a more consistent listening level.

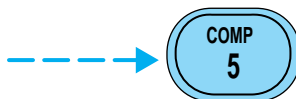

Press the COMP control to activate and deactivate compression adjust.

Shuffle feature

The shuffle feature operates in CD mode and plays all tracks on the current disc in random order. If equipped with the CD changer, the shuffle feature continues to the next disc after all tracks on the current disc are played.

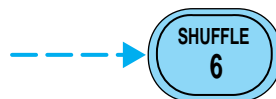

Press the SHUFFLE control to start this feature. Random order play will continue until the SHUFFLE control is pressed again.

Controls and features

Setting the clock

To set the hour, press and hold the CLK control and press SEEK:

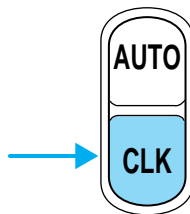

- ◀ to decrease hours and
- ▶ to increase hours.

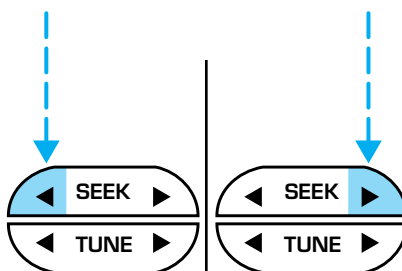

To set the minute, press and hold the CLK control and press TUNE:

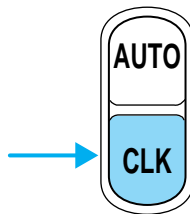

- ◀ to decrease minutes and
- ▶ to increase minutes.

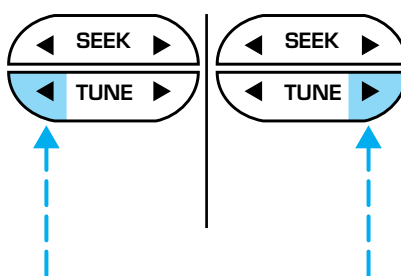

Controls and features

If your vehicle has a separate clock module, (other than the digital radio display), the CLK button will not function in the above manner.

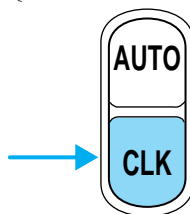

The CLK button will allow you to switch between media display mode (radio station, stereo information, etc.) and clock display mode (time). When in clock mode, the media information will display for ten seconds, when the radio is turned on, and then revert to clock information. Anytime that the media is changed, (new radio station, etc.), the media information will again display for ten seconds before reverting back to the clock. In media mode, the media information will always be displayed.

Mute mode

Press the control to mute the playing media. Press the control again to return to the playing media.

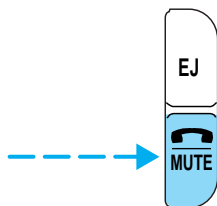

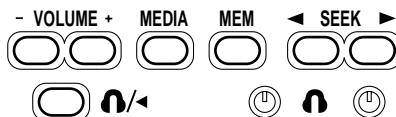

Rear seat controls (if equipped)

The Rear Seat Controls (RSC) allow the rear seat passengers to operate the radio, tape, CD, or CD changer (if equipped).

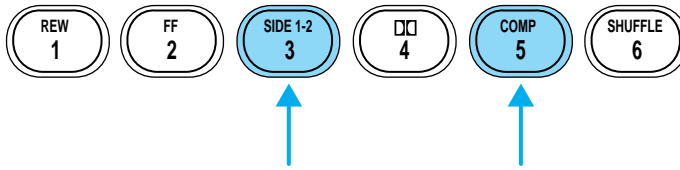

Controls and features



To turn on the rear seat controls, press the memory preset controls 3 and 5 at the same time. The  will appear in the radio display.

Pressing 3 and 5 at the same time again will turn the rear seat controls off.

If there is a discrepancy between the rear seat and the front audio controls, (i.e. both trying to listen to the same playing media), the front audio system will receive the desired selection.

Adjusting the volume

Press the + control to increase volume.

Press the — control to decrease volume.

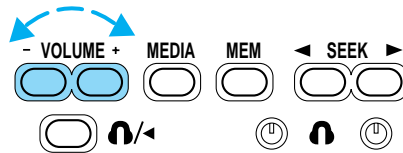

From the RSC controls, the speaker volume can not be set higher than the current volume radio setting. Once in headphone mode, the RSC volume controls will only change volume in the headphones to a desired level and will have no effect on the front speakers (muting the speakers will not mute the headphones).

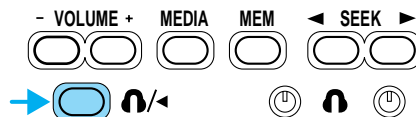

Using headphones/Personal Audio System

The Personal Audio System allows the rear seat passengers to listen to one media source (radio, tape, CD, or CD changer if equipped) while the front seat passengers listen to another. However, front and rear seat passengers can not listen to two different radio stations simultaneously.



Plug a 3.6 mm headphone (not included) into either one of the two  jacks. Press the  /  control to operate the headphones.

Controls and features

The rear speakers will cut out once the speaker on/off control is pressed. A soft audible sound may be heard from the rear speakers. The front speaker will remain playing for the front passengers. Press the  /  control again to deactivate headphones (Personal Audio System).

Media select

Push the MEDIA control to toggle between AM, FM1, FM2, tape, CD, or CD changer (if equipped).

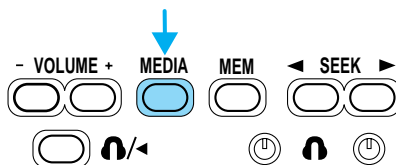



Memory preset control

Push the MEM control successively to allow rear seat passengers to scroll through the 6 memory presets in AM, FM1, or FM2.

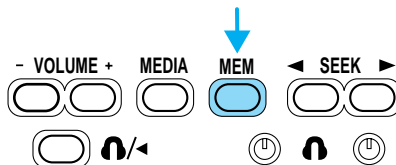

Push the MEM control in CD changer mode (if equipped) to advance to the next disc.

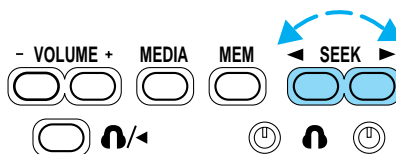

Seek function

- Press  to find the next listenable station down the frequency band.
- Press  to find the next listenable station up the frequency band.



In tape mode, use the SEEK function to access the next  or previous  selection.

In CD or CD changer mode (if equipped), use the SEEK function to access the next  or previous  selection.

Controls and features

CD changer (if equipped)

The CD changer is located in the center console of your vehicle.

Slide the door to access the CD changer magazine.

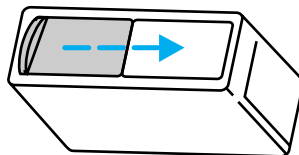

Press ▲ to eject the magazine.

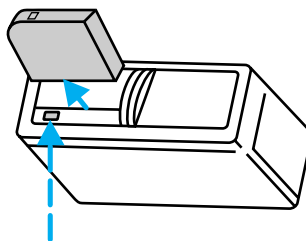

Make sure only one disc is inserted in each slot. Each disc must be inserted with the label surface upward. You may insert up to six CDs.

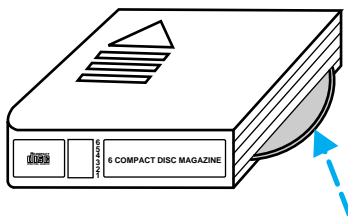

Controls and features

The magazine does not need to be full for the changer to operate.

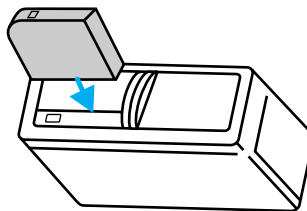

Radio power must be turned on to play the CDs in the changer. The magazine may be stored in the glove compartment when not being used. The CD magazine may be inserted or ejected with the radio power off.

Troubleshooting the CD changer (if equipped)



The laser beam used in the compact disc player is harmful to the eyes. Do not attempt to disassemble the case.

If sound skips:

- You may be traveling on a rough road, playing badly scratched discs or the disc may be dirty. Skipping will not scratch the discs or damage the player.

If your changer does not work, it may be that:

- A disc is already loaded where you want to insert a disc.
- The disc is inserted with the label surface downward.
- The disc is dusty or defective.
- The player's internal temperature is above 60°C (140°F). Allow the player to cool down before operating.
- A disc with format and dimensions not within industry standards is inserted.

Cleaning compact discs

Inspect all discs for contamination before playing. If necessary, clean discs only with an approved CD cleaner and wipe from the center out to the edge. Do not use circular motion.

Controls and features

CD and CD changer care

- Handle discs by their edges only. Never touch the playing surface.
- Do not expose discs to direct sunlight or heat sources for extended periods of time.
- Do not insert more than one disc into each slot of the CD changer magazine.

Cleaning cassette player (if equipped)

Clean the tape player head with a cassette cleaning cartridge after ten to twelve hours of play in order to maintain the best sound and operation.

Cassette and cassette player care

- Use only cassettes that are 90 minutes long or less.
- Do not expose tapes to direct sunlight, high humidity, extreme heat or extreme cold. Allow tapes that may have been exposed to extreme temperatures to reach a moderate temperature before playing.
- Tighten very loose tapes by inserting a finger or pencil into the hole and turning the hub.
- Remove loose labels before inserting tapes.
- Do not leave tapes in the cassette player for a long time when not being played.

Radio frequency information

The Federal Communications Commission (FCC) and the Canadian Radio and Telecommunications Communications (CRTC) establish the frequencies AM and FM stations may use for their broadcasts. Allowable frequencies are:

AM 530, 540–1600, 1610 kHz

FM 87.9, 88.1–107.1, 107.9 MHz

Not all frequencies are used in a given area.

Radio reception factors

Three factors can affect radio reception:

- **Distance/strength.** The further an FM signal travels, the weaker it is. The listenable range of the average FM station is approximately 40 km

Controls and features

(24 miles). This range can be affected by “signal modulation.” Signal modulation is a process radio stations use to increase their strength/volume relative to other stations.

- **Terrain.** Hills, mountains and tall buildings between your vehicle’s antenna and the radio station signal can cause FM reception problems. Static can be caused on AM stations by power lines, electric fences, traffic lights and thunderstorms. Moving away from an interfering structure (out of its “shadow”) returns your reception to normal.
- **Station overload.** Weak signals are sometimes captured by stronger signals when you pass a broadcast tower. A stronger signal may temporarily overtake a weaker signal and play while the weak station frequency is displayed.

The audio system automatically switches to single channel reception if it will improve the reception of a station normally received in stereo.

Audio system warranties and service

Refer to the “Warranty Guide” for audio system warranty information.

If service is necessary, see your dealer or a qualified technician.

REVERSE SENSING SYSTEM (IF EQUIPPED)

The reverse sensing system (RSS) sounds a tone to warn the driver of obstacles near the rear bumper when the reverse gear is selected.



To help avoid personal injury, please read and understand the limitations on the reverse sensing system described below. Reverse sensing is only an assist for some (generally large and fixed) objects when moving in reverse on a flat surface at “parking speeds” of approximately 6 km/h (4 mph) or less. It is the drivers responsibility for ensuring that their path is clear when operating the vehicle.



To help avoid personal injury, always use caution when in reverse and when using the reverse sensing system.

Controls and features

 This system is not designed to prevent contact with small or moving objects. The system is designed to provide a warning to assist the driver in detecting large stationary objects to avoid damaging the vehicle. The system may not detect smaller objects, particularly those close to the ground.

The RSS will assist the driver in detecting certain objects while the vehicle slowly moves in reverse at speeds less than 6 km/h (4 mph). The RSS is not effective at speeds greater than 6 km/h (4 mph) and may not detect certain angular or moving objects. The weather may also affect the function of RSS. RSS may have reduced performance, or be activated in inclement weather.

The reverse sensing system detects obstacles within approximately 1.8 meters (5.9 ft.) of the rear bumper with a decreased coverage area at the outer corners of the bumper, (refer to the figures for approximate zone coverage areas). As you move closer to the obstacle, the rate of the tone increases. When the distance to the obstacle is less than 25.0 cm (10 in.), the tone will sound continuously. If the system detects a stationary or receding object further than 25.0 cm (10 in.) from the side of the vehicle, the tone will sound for only 3 seconds. Once the system detects an object approaching, the tone will sound again.

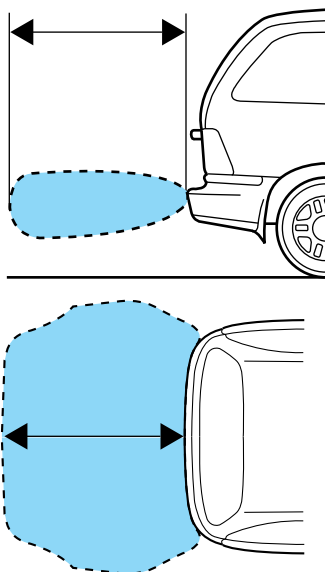

Controls and features

A reverse sensing control allows the driver to enable and disable the RSS when the ignition is ON. The reverse sensing control indicator momentarily illuminates when the ignition is turned ON.

The OFF indicator remains illuminated when the system is disabled. The system defaults to ON every time the reverse gear is selected. Press the control to disable or enable the system.

The indicator will remain illuminated to indicate a failure of the reverse sensing system.

Always keep the sensors (located on the rear bumper/fascia) free from dirt, snow and ice (do not clean the sensors with sharp objects). These elements may cause the system to operate inaccurately.

If the vehicle sustains damage to the rear bumper/fascia, leaving it misaligned or bent, the sensing zone may be altered causing inaccurate measurement of obstacles.

TRACTION CONTROL™ (IF EQUIPPED)

This control can be used to turn the Traction Control™ on or off. Refer to the *Traction Control™* section of the *Driving* chapter for more information.

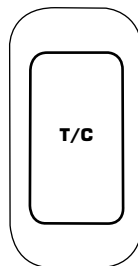

Controls and features

POSITIONS OF THE IGNITION

1. ACCESSORY, allows the electrical accessories such as the radio to operate while the engine is not running.

2. LOCK, locks the steering wheel, automatic transmission gearshift lever and allows key removal.

3. OFF, shuts off the engine and all accessories without locking the steering wheel.

4. ON, all electrical circuits operational. Warning lights illuminated. Key position when driving.

5. START, cranks the engine. Release the key as soon as the engine starts.

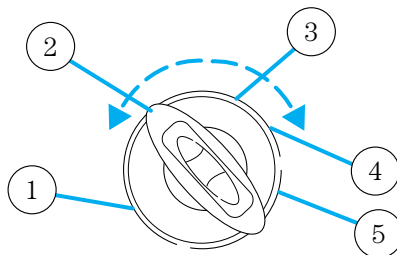

SPEED CONTROL (IF EQUIPPED)

To turn speed control on

- Press ON.

Vehicle speed cannot be controlled until the vehicle is traveling at or above 48 km/h (30 mph).

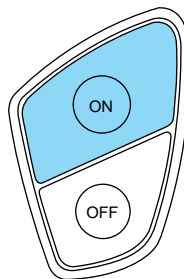

Do not use the speed control in heavy traffic or on roads that are winding, slippery, or unpaved.



Do not shift the gearshift lever into N (Neutral) with the speed control on.

Controls and features

To turn speed control off

- Press OFF or
- Turn off the vehicle ignition.

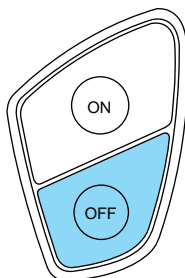

Once speed control is switched off, the previously programmed set speed will be erased.

To set a speed

- Press SET+ / SET-. For speed control to operate, the speed control must be ON and the vehicle speed must be greater than 48 km/h (30 mph).

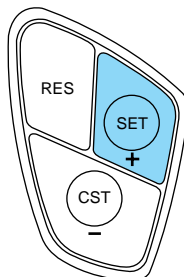

If you drive up or down a steep hill, your vehicle speed may vary momentarily slower or faster than the set speed. This is normal.

Speed control cannot reduce the vehicle speed if it increases above the set speed on a downhill. If your vehicle speed is faster than the set speed while driving on a downhill, you may want to shift to the next lower gear or apply the brakes to reduce your vehicle speed.

If your vehicle slows down more than 16 km/h (10 mph) below your set speed on an uphill, your speed control will disengage. This is normal. Pressing RES/RSM/RESUME will re-engage it.



Do not use the speed control in heavy traffic or on roads that are winding, slippery, or unpaved.

Controls and features

To set a higher set speed

- Press and hold SET/SET ACC/SET ACCEL. Release the control when the desired vehicle speed is reached or
- Press and release SET/SET ACC/SET ACCEL. Each press will increase the set speed by 1.6 km/h (1 mph) or
- Accelerate with your accelerator pedal. When the desired vehicle speed is reached, press and release SET/SET ACC/SET ACCEL.

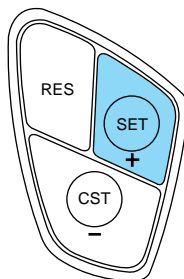

You can accelerate with the accelerator pedal at any time during speed control usage. Releasing the accelerator pedal will return your vehicle to the previously programmed set speed.

To set a lower set speed

- Press and hold CST/COAST. Release the control when the desired speed is reached or
- Press and release CST/COAST. Each press will decrease the set speed by 1.6 km/h (1 mph) or

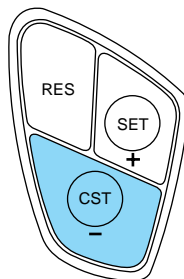

- Depress the brake pedal. When the desired vehicle speed is reached, press SET/SET ACC/SET ACCEL.

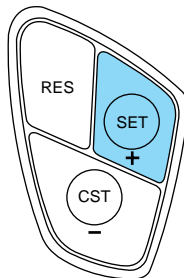

Controls and features

To disengage speed control

- Depress the brake pedal.

Disengaging the speed control will not erase the previously programmed set speed.

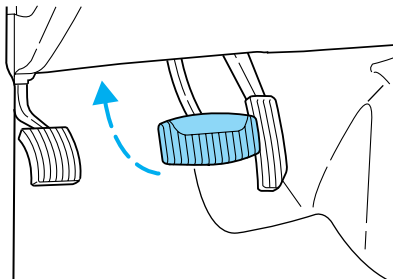

Pressing OFF will erase the previously programmed set speed.

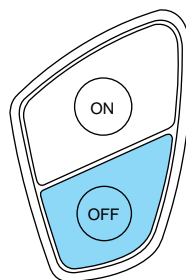

To return to a previously set speed

- Press RES/RSM/RESUME. For RES/RSM/RESUME to operate, the vehicle speed must be faster than 48 km/h (30 mph).

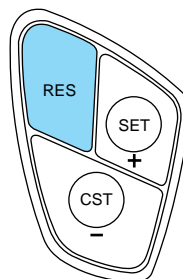

Controls and features

TURN SIGNAL CONTROL

- Push down to activate the left turn signal.
- Push up to activate the right turn signal.

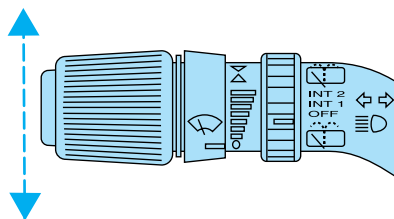

WINDSHIELD WIPER/WASHER CONTROLS

Rotate the windshield wiper control to the desired interval, low or high speed position.

The bars of varying length are for intermittent wipers. When in this position rotate the control upward for fast intervals and downward for slow intervals.

Push the control on the end of the stalk to activate washer. Push and hold for a longer wash cycle. The washer will automatically shut off after ten seconds of continuous use.

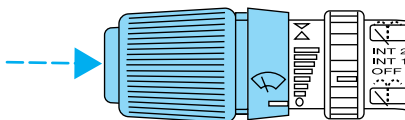
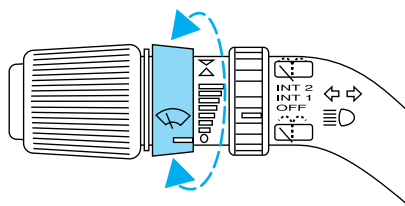

Mist Function

To operate the Mist function of the windshield wipers, push and release the windshield washer control quickly. The wipers will cycle one or two times.

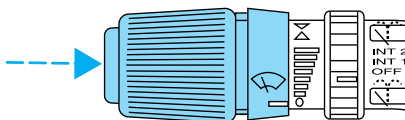

Controls and features

Rear window wiper/washer controls

For rear wiper operation, rotate the rear window wiper and washer control to the desired position.

Select:

INT 2 — One second interval rear wiper.

INT 1 — Ten second interval rear wiper.

OFF — Rear wiper and washer off.

For rear wash cycle, rotate (and hold as desired) the rear wiper/washer control to either  position.

From either position, the control will automatically return to the INT2 or OFF position.

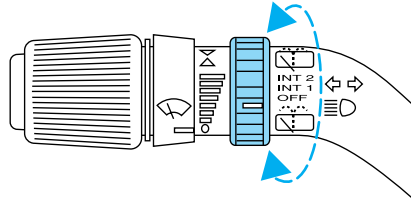

OVERDRIVE CONTROL

Activating overdrive

D (Overdrive) is the normal drive position for the best fuel economy.

The overdrive function allows automatic upshifts to second, third and fourth gear.

Deactivating overdrive

Press the Transmission Control Switch (TCS) located on the end of the gearshift lever. The O/D OFF indicator light will illuminate on the instrument cluster.

The transaxle will operate in gears one through three. To return to normal overdrive mode, press the Transmission Control Switch again. The O/D OFF indicator light will no longer be illuminated.

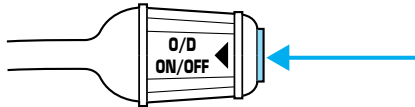
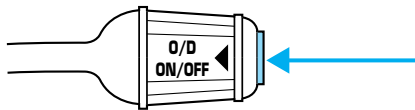

When you shut off and re-start your vehicle, the transaxle will automatically return to normal **D** (Overdrive) mode.

Controls and features

TILT STEERING WHEEL (IF EQUIPPED)

Pull the tilt steering control toward you to move the steering wheel up or down. Hold the control while adjusting the wheel to the desired position, then release the control to lock the steering wheel in position.

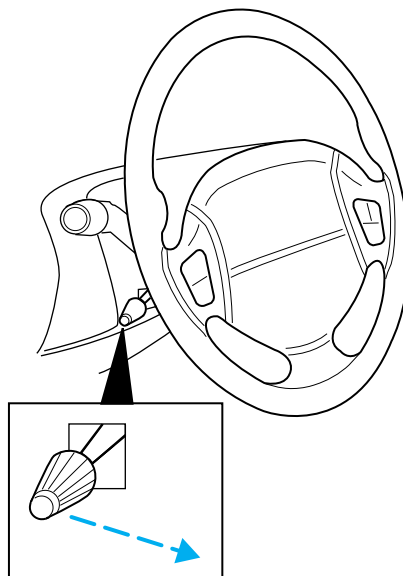

Never adjust the steering wheel when the vehicle is moving.

HAZARD FLASHER

For information on the hazard flasher control, refer to *Hazard flasher* in the *Roadside emergencies* chapter.

Controls and features

POWER WINDOWS (IF EQUIPPED)

Press and hold the rocker switches to open and close windows.

- Press the top portion of the rocker switch to close.

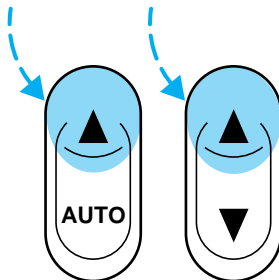

- Press the bottom portion of the rocker switch to open.

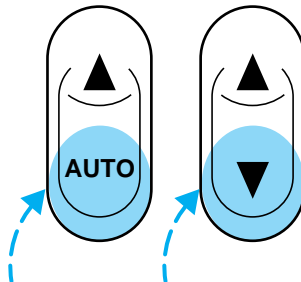

One touch down

- Press AUTO completely down and release quickly. The driver's window will open fully. Depress again to stop window operation.

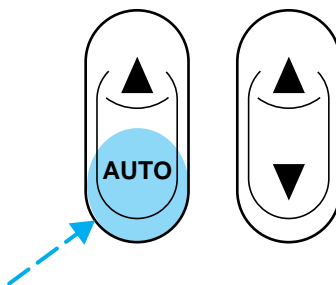

Controls and features

Accessory delay

With accessory delay, the window switches may be used for up to ten minutes after the ignition switch is turned to the OFF position or until any door is opened.

Power vent windows (if equipped)

Your vehicle may be equipped with rear power vent windows which are operated the same as the front power windows.

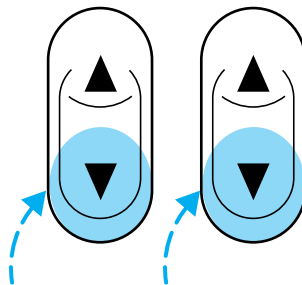

POWER SIDE VIEW MIRRORS (IF EQUIPPED)

To adjust your mirrors:

1. Select ◀ to adjust the left mirror or ▶ to adjust the right mirror.
2. Move the control in the direction you wish to tilt the mirror.

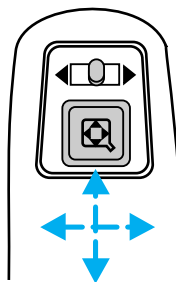

3. Return to the center position to lock mirrors in place.

Controls and features

Heated outside mirrors (if equipped)

Both mirrors are heated automatically to remove ice, mist and fog when the rear window defrost is activated.

Do not remove ice from the mirrors with a scraper or attempt to readjust the mirror glass if it is frozen in place. These actions could cause damage to the glass and mirrors.

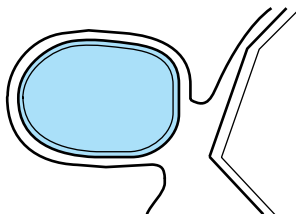

Fold-away mirrors

Pull the side mirrors in carefully when driving through a narrow space, like an automatic car wash.

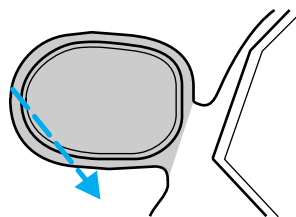

POWER DOOR LOCKS (IF EQUIPPED)

Press U to unlock all doors and L to lock all doors.

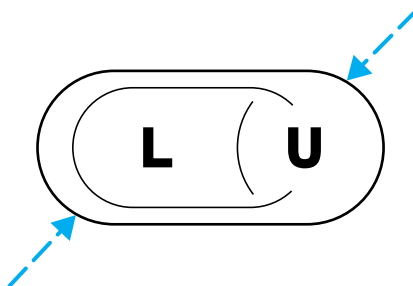

Controls and features

Memory lock

If you lock your doors with the power lock switch or the remote transmitter while the sliding door is open, the door will automatically lock after it is closed.

Smart locks

With the key in the ignition, in any switch position, and either the driver's or passenger's door open, the doors cannot be locked using the front door lock switches.

CHILDPROOF DOOR LOCKS

When these locks are set, the rear doors cannot be opened from the inside. The rear doors can be opened from the outside when the doors are unlocked.

The childproof locks are located on front edge of each rear door and must be set separately for each door. Setting the lock for one door will not automatically set the lock for both doors.

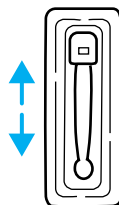

Move lock control up to engage the lock. Move control down to disengage childproof locks.

If your vehicle is equipped with Power Sliding Door(s), refer to the *Power Sliding Door* section of this chapter for more information on how the childproof locks operate with this system.

AUTOMATIC DIMMING INSIDE REAR VIEW MIRROR (IF EQUIPPED)

Your vehicle is equipped with an inside rear view mirror which has an auto-dimming function. The electronic day/night mirror will change from the normal state to the non-glare state when bright lights (glare) reach the mirror. When the mirror detects bright light from front or behind, it will automatically adjust (darken) to minimize glare.

Do not block the sensor on the backside of the mirror since this may impair proper mirror performance.

Controls and features

Press the control to turn the mirror OFF or AUTO.

The mirror will automatically return to the normal state whenever the vehicle is placed in R

(Reverse)(when the mirror is on) to ensure a bright clear view when backing up.

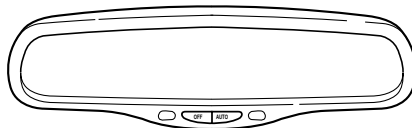

ILLUMINATED VISOR MIRROR (IF EQUIPPED)

To turn on the visor mirror lamps, lift the mirror cover.

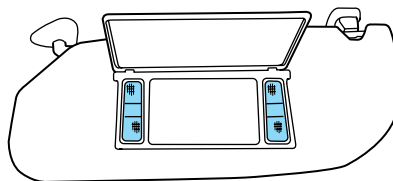

HOMELINK® UNIVERSAL TRANSCEIVER (IF EQUIPPED)

The HomeLink® Universal Transceiver, located on the driver's visor, provides a convenient way to replace up to three hand-held transmitters with a single built-in device. This feature will learn the radio frequency codes of most current transmitters to operate garage doors, entry gates, security systems, entry door locks, and home or office lighting.



When programming your HomeLink® Universal Transceiver, to a garage door or gate be sure that people and objects are out of the way to prevent potential harm or damage.

Do not use the HomeLink® Universal Transceiver with any garage door opener that lacks safety stop and reverse features as required by U.S. federal safety standards (this includes any garage door opener model manufactured before April 1, 1982). A garage door which cannot detect an object, signaling the door to stop and reverse, does not meet current U.S. federal safety standards. For more information on this matter, call toll-free: 1-800-355-3515 or on the Internet at **HomeLink.jci.com**.

Controls and features

Programming

1. Prepare for programming the HomeLink® Universal Transceiver by erasing the three factory default codes by holding down the two outside buttons until the red light begins to flash after 20 seconds. Release both buttons.

2. Hold the end of your hand-held transmitter 5–14 cm (2–5 inches) away from the HomeLink® Universal Transceiver surface (located on your visor) while keeping the red light in view.

3. Using both hands simultaneously press and hold the hand-held transmitter button and the desired HomeLink® button. Do not release the buttons until step 4 has been completed.

4. The red light will flash slowly and then rapidly. Release both buttons when the red light flashes rapidly.

5. Follow steps 2 through 4 to program the remaining two buttons.

If you do not successfully program the HomeLink® Universal Transceiver after repeated attempts, refer to *Rolling code programming* which follows, or call toll-free customer assistance: 1-800-355-3515 or on the Internet at **HomeLink.jci.com**.

Canadian Programming

During programming, your hand-held transmitter may automatically stop transmitting after two seconds which may not be long enough to program the HomeLink® Universal Transceiver.

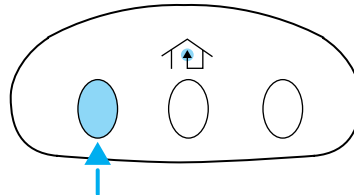
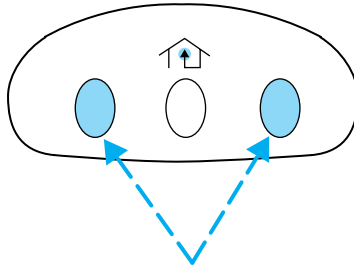

Controls and features

To program your hand-held transmitters:

- continue to hold the button on the HomeLink® Universal Transceiver.
- press and re-press the hand-held transmitter button every two seconds until the red light changes from a slow to a fast flash.

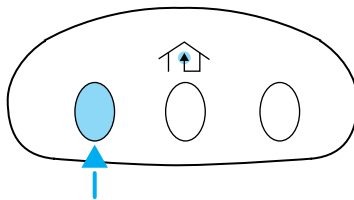

Operating the HomeLink® Universal Transceiver

Once programmed, the HomeLink® Universal Transceiver can be used in place of hand-held transmitters. To operate, simply press and release the appropriate HomeLink® button (the red light will illuminate, indicating the signal is being transmitted).

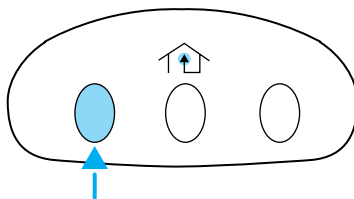

Rolling code programming

Rolling code garage door openers (or other rolling code devices) which are “code protected” and manufactured after 1996, may be determined by the following:

- Reference the device owner’s manual for verification
- The hand-held transmitter appears to program the HomeLink® Universal Transceiver but does not activate the device.
- Press and hold the trained HomeLink® button. The device has the rolling code feature if the indicator light flashes rapidly and then turns solid after 2 seconds.

After completing the “Programming” functions, follow these steps to train a garage door opener with the rolling code feature:

1. Locate the **training button** on the garage door motor head unit. Refer to the garage door opener manual or call 1-800-355-3515 or on the Internet at **HomeLink.jci.com**. if there is difficulty locating the training button.
2. Press the training button on the garage door motor head unit (which will activate the **“training” light.**)

Controls and features

3. Press and release the programmed HomeLink® button. Press and release the HomeLink® button a *second time* to complete the training process. (Some garage door openers may require this procedure to be done a third time to complete the training).

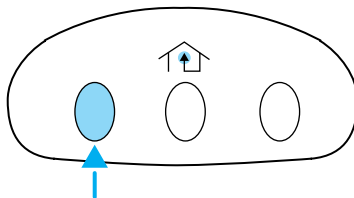

The 2nd or 3rd press from step 3 will activate the door. The HomeLink® Universal Transceiver has now been trained to the receiver. The remaining two buttons may now be programmed if this has not previously been done.

Erasing HomeLink® buttons

Individual buttons cannot be erased, however, to erase the three programmed buttons:

1. Hold down the two outside buttons until the red light begins to flash after 20 seconds.
2. Release both buttons.

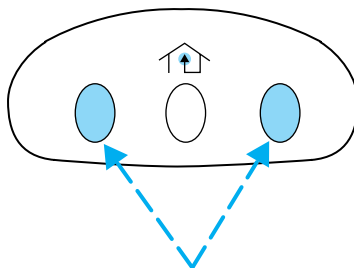

Reprogramming a single HomeLink® button

To program a device to HomeLink® using a HomeLink® button previously trained, follow these steps:

1. Press and hold the desired HomeLink® button. **Do NOT** release until **step 4** has been completed.
2. When the indicator light begins to flash slowly (after 20 seconds), position the hand-held transmitter 5–14 cm (2 to 5 inches) away from the HomeLink® surface.
3. Press and hold the hand-held transmitter button.
4. The HomeLink® indicator light will flash, first slowly and then rapidly. When the indicator light begins to flash rapidly, release both buttons.

The previous device has now been erased and the new device can be activated by pushing the HomeLink® button that has just been programmed.

Controls and features

INTERIOR LAMPS

Dome lamps (if equipped)

The front dome lamp is located overhead between the driver and passenger seats.

The dome lamp will stay on if the control is moved to the passenger side position. When the control is in the middle position, the lamp will only come on when a door is opened. If the control is moved to the driver's side position, the lamp will not come on at all.

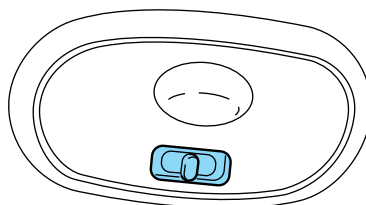

The dome lamp will illuminate whenever a front door is opened. If either front door has been opened from the outside, the lamp will remain on for 15 seconds after the door is shut. If any other door has been opened from the inside, the lamp will shut off immediately after the door is closed.

Rear courtesy/reading lamps (if equipped)

The courtesy lamp lights can be turned on with rocker switch at any time.

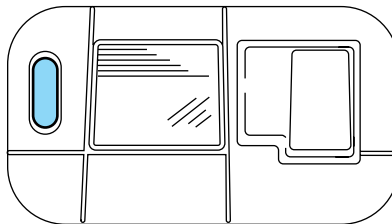

Rear dome lamp

The dome lamp lights when:

- any door is opened.
- the instrument panel dimmer switch is held up until the courtesy lamps come on.
- any of the remote entry controls are pressed and the ignition is OFF.

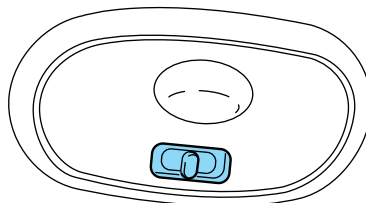

Controls and features

With the ignition key in the ACC or ON position, the rear dome lamp can be turned ON or OFF by sliding the control.

OVERHEAD CONSOLE (IF EQUIPPED)

The appearance of your vehicle's overhead console will vary according to your option package.

Forward storage bins and conversation mirror (if equipped)

The storage compartments may be used to store sunglasses or similar objects. The conversation mirror allows the driver to view the rear seating area. This does not replace your rear view mirror. Refer to *Power Sliding Doors (PSD)* (if equipped) in this chapter for operation of doors.

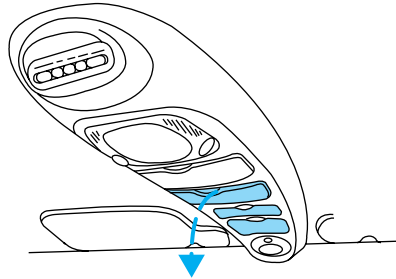

Installing a garage door opener (if equipped)

The storage compartment can be converted to accommodate a variety of aftermarket garage door openers:

- Remove the storage clip from the aftermarket transmitter.
- Place Velcro™ hook onto side of aftermarket transmitter opposite of actuator control.
- Place the transmitter into storage compartment, control down.

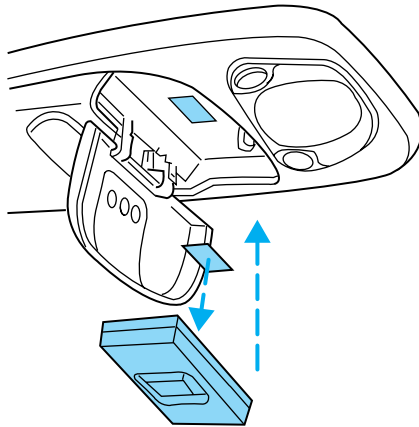

Controls and features

- Place the provided height adaptors onto the back of the GARAGE control as needed.
- Press the GARAGE control to activate the transmitter.

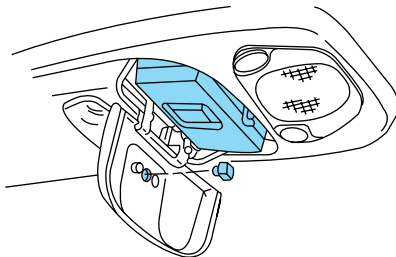

Map lamps (if equipped)

The map lamps and controls are located on the dome lamp. Press the controls on either side of each map lamp to activate the lamps.

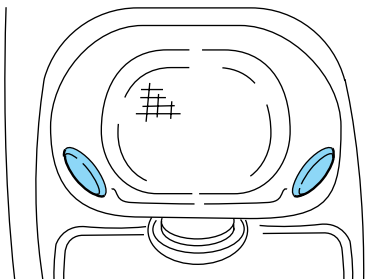

Power Sliding Door (if equipped)

The overhead console consists of the Power Sliding Door (PSD) ON/OFF control (with indicator light) and the right and left hand side PSD control(s).

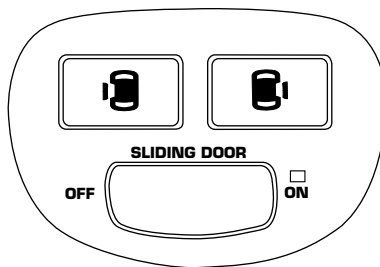

With this option, you can open and close the sliding door(s) with the controls inside your vehicle. With the remote keyless entry system, you can also operate the PSD with the remote transmitter. Refer to *Remote Entry System* in this chapter.

Controls and features

The PSD feature has control(s) accessible by passengers in the second row seating positions. The control(s) are located on the trim panel in front of the sliding door. Press and release the control to open the PSD on that side of the vehicle.

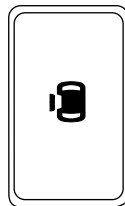

Press the left side of the ON/OFF control in the overhead console to turn off the PSD. This prevents opening the PSD using the rear seat control(s) or the handle; but the door(s) can be opened manually with the handle. The controls in the overhead console for right or left side and the Remote Entry System will remain functional with the system shut OFF

The sliding door must be unlocked for it to operate. The key does not have to be in the ignition. To help avoid accidental operation of the Power Sliding Door, disable the PSD second row passenger controls by pushing the overhead console control to OFF. When the key is in the ignition in RUN, the PSD will only open if the transaxle is in PARK (P). The transaxle does not have to be in PARK (P) to close the door.

Opening the PSD

With the ON/OFF control in the ON position, either sliding door can be opened by:

- operating the remote transmitter. Refer to *Remote Entry System* in this chapter.
- pushing and releasing the overhead console right hand or left hand control
- pushing and releasing the right hand or left hand second row passenger control
- manually pulling the inside or outside sliding door handle and release

The door will open fully using these options.

With the ON/OFF control in the OFF position, either sliding door can be opened by pulling the inside or outside handle and sliding the door all the way back manually.

The left hand PSD will not open (manually or power) if the fuel door is open regardless of the ON/OFF control position.

Controls and features

Closing the PSD

With the ON/OFF control in the ON position, either sliding door can be closed by:

- operating the remote transmitter. Refer to *Remote Entry System* in this chapter.
- pushing and releasing the overhead console right hand or left hand control
- pushing and releasing the right hand or left hand second row passenger control
- manually rolling the door several inches towards the closed position and release

The door will close completely and latch using these options.

With the ON/OFF control in the OFF position, either sliding door can be closed by pulling the inside or outside handle and sliding the door all the way forward to the latched position manually.

Safety/Obstructions

If anything obstructs the Power Sliding Door while it is closing, the door will automatically reverse to the open position, provided it meets sufficient resistance.

Resetting the PSD

The power sliding door may operate incorrectly or not at all because of the following condition:

- a low voltage or dead battery
- disconnecting the battery
- if the PSD fuse (fuse #6) is removed or blown. Refer to *Fuses and relays* in the *Roadside emergencies* chapter.

If any of these conditions occur, reset the PSD by:

1. Check to see if power sliding door is unlocked and securely closed.
2. Make sure vehicle is in (P) Park.
3. Push the power door control on the overhead console to open the door.
4. Wait five (5) seconds and close the door by pressing the power door control on the overhead console.
5. Wait five (5) seconds and repeat Steps 3 and 4 and go on to step 6.

Controls and features

6. Repeat steps 3–5 for opposite door.

If the door does not rest in the fully open position, repeat Steps 1–4 again. If the door still does not operate correctly:

7. Turn the ignition switch to OFF.

8. Remove the PSD fuse (fuse #6) from the passenger fuse panel and leave it out for thirty (30) seconds. Refer to *Fuses and relays* in the *Roadside emergencies* chapter.

9. Reinstall the fuse and wait ten (10) seconds.

10. Repeat steps 1–6 above.

If the door still does not operate correctly, see your dealer for service.

Sliding Door Child Safety Lock

Your vehicle is equipped with a sliding door child safety lock that helps prevent passengers from operating the sliding door by using the inside door handle. This lock is on both doors if equipped. The child safety lock lever is located in the inside of the sliding door, on the front edge of the door. Lift the control up to engage the child lock.

If you have the optional power sliding door, disable the power sliding door by pushing the ON/OFF control in the overhead console to the OFF position. The power sliding door cannot be opened from the rear seat when both this feature and the child lock are engaged.

If you want to open the sliding door when the child safety lock is on:

- Unlock the sliding door and open the door from the outside.
- If you have the optional power sliding door, press the right or left hand control on the overhead console to open the door.

CENTER CONSOLE (IF EQUIPPED)

Your vehicle may be equipped with a variety of console features. These include:

- utility compartment
- compact disc changer (if equipped)

Controls and features

POSITIVE RETENTION FLOOR MAT (IF EQUIPPED)

To install floor mats that have a retention post:

Position the floor mat so that the eyelet is over the pointed end of the retention post and rotate forward to lock in. Make sure that the mat does not interfere with the operation of the accelerator or the brake pedal. To remove the floor mat, reverse the installation procedure.

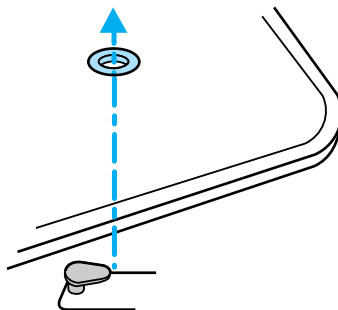

To install floor mats that have a screw in retainer:

1. Move the driver's seat to the most rearward position
2. Position the driver's side floor mat with the rear of the mat against left (outboard) front edge of seat track mounting bracket.
3. Use a screwdriver to screw locator post into vehicle carpeting. Exert pressure while turning to pierce the carpeting.

When installed properly, the locator will not screw down tightly, but will rotate freely.

Use only Ford original Equipment floor mats. Do not stack multiple floor mats over the Ford original equipment floor mats as they are not positively retained.

REMOTE ENTRY SYSTEM

The remote entry system allows you to:

- lock or unlock all vehicle doors and liftgate without a key.
- unlock/open a RH power sliding door and/or LH power sliding door (if equipped).
- activate the personal alarm.
- arm and disarm the perimeter anti-theft system (if equipped).

The lock/unlock and power sliding door features will operate with the vehicle in P (Park) or N (Neutral) and the ignition in the OFF, ACC or RUN positions. The panic control feature only operates with the ignition in the OFF position.

Controls and features

Unlocking the doors

- 3-button remote

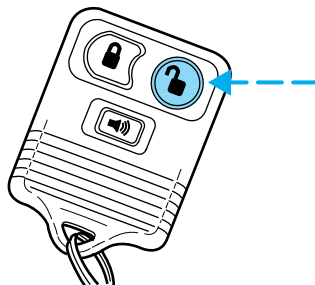

- 4-button remote

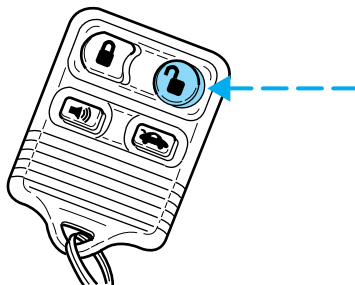

- 5-button remote

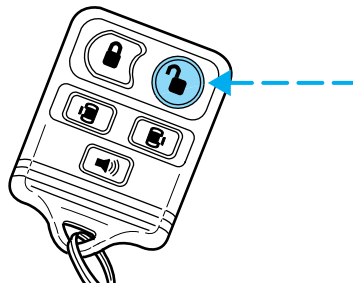

Press this control to unlock the driver door and disarm the anti-theft system (if equipped). The interior lamps will illuminate.

Press the control again within three seconds to unlock all doors and liftgate. If the control is pressed a third time within three seconds, the vehicle will chirp the horn once if all doors/hood are closed or twice if any door/hood is open.

Controls and features

Opening power sliding doors

- 4-button remote

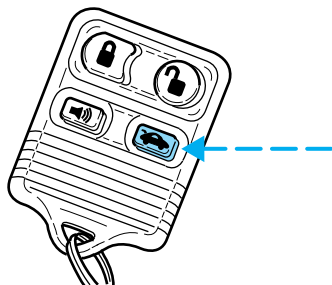

- 5-button remote

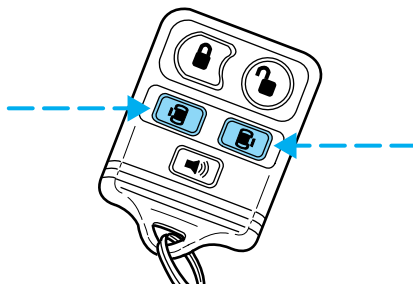

Press this control twice within three seconds to open the power sliding door (if equipped). The interior lamps will illuminate. Press this control another two times within three seconds to close the power sliding door and turn off the interior lights.

Controls and features

Locking the doors

- 3-button remote

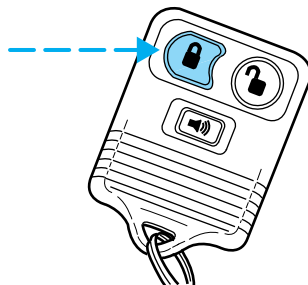

- 4-button remote

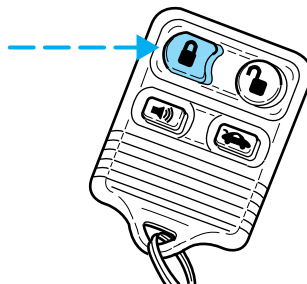

- 5-button remote

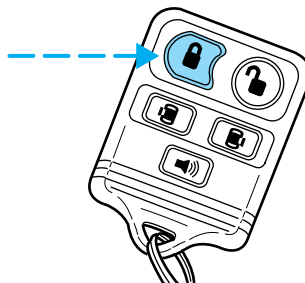

Press this control to lock all doors and liftgate, turn off the interior lights (if they were on) and arm the perimeter anti-theft system (if equipped).

To confirm doors/hood are closed and locked, press the control a second time within three seconds. The door(s) will lock again and the horn will chirp once.

If any of the doors are open or ajar, the horn will make two quick chirps, reminding you to properly close all doors/hood.

Controls and features

Sounding a panic alarm

- 3-button remote

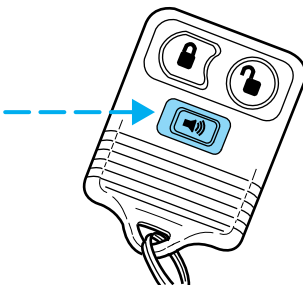

- 4-button remote

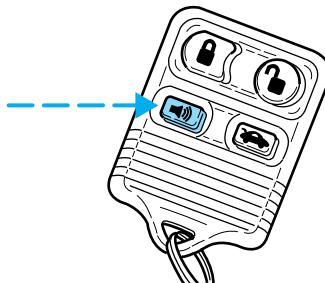

- 5-button remote

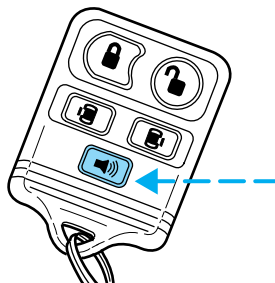

Press this control to activate the personal panic alarm.

The personal panic alarm will cycle the horn and turn signals on/off plus illuminate the interior lights.

To deactivate the alarm, press the control again or turn the ignition to RUN or ACC.

Controls and features

This device complies with part 15 of the FCC rules and with RS-210 of Industry Canada. Operation is subject to the following two conditions: (1) This device may not cause harmful interference, and (2) This device must accept any interference received, including interference that may cause undesired operation.

Changes or modifications not expressly approved by the party responsible for compliance could void the user's authority to operate the equipment.

Illuminated entry

The interior lights will illuminate when the remote entry Unlock or Panic control is pressed with the doors closed or when unlocking or opening a power sliding door (if equipped).

The system automatically turns off after 25 seconds or when the ignition is turned to the RUN position. The panel dimmer control must **not** be set to the OFF position for the illuminated entry to operate.

The inside lights will not turn off if:

- they have been turned on with the instrument panel dimmer control
or
- any door is open.

The battery saver will shut off the interior lamps 30 minutes after the last door is closed even if the panel dimmer control is left on.

Illuminated exit

The interior lights will illuminate when the key is removed from the ignition. When the headlamp control is on the “sleeping baby mode”, only the lower interior lights will illuminate.

The system automatically turns off after 25 seconds or when the driver's door is opened. The panel dimmer control must **not** be set to the OFF position for the illuminated entry to operate.

Controls and features

Replacing the battery

The transmitter is powered by one coin type three-volt lithium battery CR2032 or equivalent. Typical operating range will allow you to be up to 10 meters (33 feet) away from your vehicle. A decrease in operating range can be caused by:

- weather conditions
- nearby radio towers
- structures around the vehicle
- other vehicles parked next to the vehicle

To replace the battery:

1. Twist a thin coin between the two halves of the transmitter near the key ring. **DO NOT TAKE THE FRONT PART OF THE TRANSMITTER APART.**
2. Place the positive (+) side of new battery in the same orientation. Refer to the diagram inside the transmitter unit.
3. Snap the two halves back together.

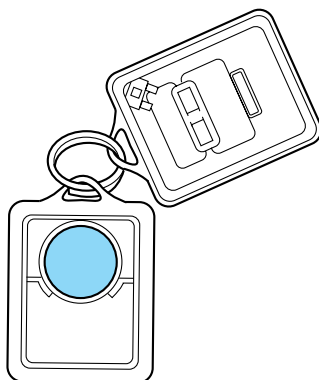

Replacement of the battery will **not** cause the remote transmitter to become deprogrammed from your vehicle. The remote transmitter should operate normally after battery replacement.

Controls and features

Replacing lost transmitters

- 3-button remote

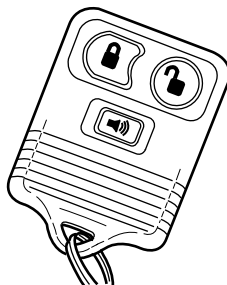

- 4-button remote

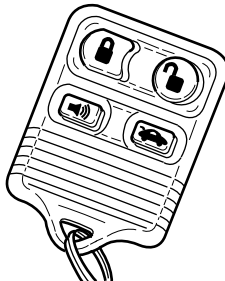

- 5-button remote

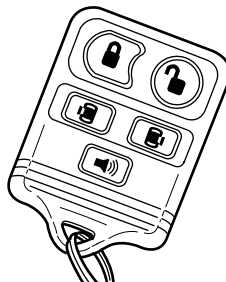

If a transmitter has been lost or if you would like to purchase additional transmitters for your vehicle (up to four may be programmed), take **all** your vehicle's transmitters to your dealer or perform the reprogramming procedure yourself. It will be necessary to reprogram **all** the transmitters to the vehicle at the same time while performing this procedure.

Controls and features

Reprogramming transmitters

To reprogram the transmitters yourself, place the key in the ignition and turn from OFF to ON eight times in rapid succession (within 10 seconds) ending in the ON position. After doors lock/unlock, press any control on all transmitters (up to four). With each control press of the transmitters, the door should cycle (lock/unlock) to confirm programming. When completed, turn the ignition to OFF. The door locks should cycle (lock/unlock) one last time to confirm completion of programming.

Autolock (if equipped)

This feature automatically locks all doors when:

- all vehicle doors are closed
- the ignition is in the RUN/START position
- you shift into or through R (Reverse)

Relock

The autolock feature repeats when:

- the ignition is in the RUN/START position
- the vehicle speed is below 5 km/h (3 mph) and any door is opened then closed
- the vehicle speed exceeds 5 km/h (3 mph)

Deactivating/activating the autolock feature

The autolock/relock feature can be turned off by your dealer.

Deactivating/activating the illuminated exit feature

The illuminated exit feature can be turned off by your dealer.

PERIMETER ALARM SYSTEM (IF EQUIPPED)

The perimeter anti-theft system will help prevent your vehicle from unauthorized entry.

Controls and features

Arming the system

When armed, this system will help protect your vehicle from unauthorized entry. When unauthorized entry occurs, the system will flash the turn signal lamps and side repeaters and honk the horn.

The system is ready to arm whenever the key is removed from the ignition. Any of the following actions will prearm the alarm system:

- Press the remote entry lock control
- Press the interior power door lock control while the door is open

Twenty seconds after one of the above events occurs, any door/hood that is closed is armed.

Any door/hood that still open is prearmed and waiting for the door/hood to be closed.

Once that input is closed, the input will arm in 20 seconds and the exterior lamps may flash.

Disarming the system

You can disarm the system by any of the following actions:

- Press the transmitter unlock control.
- Unlock the doors with a key.
- Turn a programmed SecuriLock key to RUN /START.

SECURILOCK™ PASSIVE ANTI-THEFT SYSTEM

Your vehicle is equipped with a coded-key anti-theft system. Only the correct key will be able to start your vehicle. If your keys are lost or stolen, you must take your vehicle to your dealership for key reprogramming.

The SecuriLock™ passive anti-theft system provides an advanced level of vehicle theft protection. Your vehicle's engine can only be started with the two special SecuriLock™ electronically coded keys provided with your vehicle. Each time you start your vehicle, the SecuriLock™ key is read by the SecuriLock™ passive anti-theft system. If the SecuriLock™ key identification code matches the code stored in the SecuriLock™ passive anti-theft system, the vehicle's engine is allowed to start. If the SecuriLock™ key identification code does not match the code stored in the system or if a SecuriLock™ key is not detected (vehicle theft situation), the vehicle's engine will not operate.

Controls and features

The SecuriLock™ passive anti-theft system is not compatible with aftermarket remote start systems. Use of these systems may result in vehicle starting problems and a loss of security protection. Large metallic objects or devices such as the Mobil Speedpass™ on the same key ring as your SecuriLock™ key may cause vehicle starting problems. These objects and devices cannot damage the SecuriLock™ key, but can cause a momentary problem if they are too close to the key when starting the engine. If a problem occurs, turn ignition off and restart the engine with all other objects on the key ring held away from the SecuriLock™ ignition key.

Spare SecuriLock™ keys can be purchased from your dealership and programmed to your SecuriLock™ passive anti-theft system. Refer to *Programming spare SecuriLock™ keys* for more information.

If one or both of your SecuriLock™ keys are lost or stolen and you want to ensure the lost or stolen key will not operate your vehicle, bring your vehicle and all available SecuriLock™ keys to your dealership for reinitialization.

Theft indicator

The theft indicator on top of the instrument panel will operate as follows:

- When the ignition is OFF, the theft indicator will flash briefly every 2 seconds to indicate the SecuriLock™ system is protecting your vehicle.
- When the ignition is turned to ON or START, the theft indicator will light for 3 seconds and then go out. If the theft indicator stays on for an extended period of time or flashes rapidly, have the system serviced by your dealership or a qualified technician.

Programming spare SecuriLock™ keys

Spare SecuriLock™ keys can be purchased from your dealership and programmed to your SecuriLock™ anti-theft system (up to a total of 8 keys). Your dealership can program your new SecuriLock™ key(s) to your vehicle or you can do it yourself using the following simple procedure. To program a new SecuriLock™ key yourself, you will need two previously programmed SecuriLock™ keys (keys that already operate your vehicle's engine). If two previously programmed SecuriLock™ keys are not available (one or both of your original keys were lost or stolen), you must bring your vehicle to your dealership to have the spare SecuriLock™ key(s) programmed.

Controls and features

Procedure to program spare SecuriLock™ keys to your vehicle

New SecuriLock™ keys must have the correct mechanical key cut for your vehicle.

Conventional (non-SecuriLock™) keys **cannot** be programmed to your vehicle.

You will need to have two previously programmed SecuriLock™ keys and the new unprogrammed SecuriLock™ key readily accessible for timely implementation of each step in the procedure. Please read and understand the entire procedure before you begin.

1. Insert the first previously programmed SecuriLock™ key into the ignition and turn the ignition from OFF to RUN (maintain ignition in RUN for at least one second).
2. Turn ignition to OFF and remove the first SecuriLock™ key from the ignition.
3. Within five seconds of turning the ignition to OFF, insert the second previously programmed SecuriLock™ key into the ignition and turn the ignition from OFF to RUN (maintain ignition in RUN for at least one second but no more than 5 seconds).
4. Turn the ignition to OFF and remove the second SecuriLock™ key from the ignition.
5. Within 10 seconds of turning the ignition to OFF, insert the unprogrammed SecuriLock™ key (new key) into the ignition and turn the ignition from OFF to RUN (maintain ignition in RUN for at least one second). This step will program your new SecuriLock™ key.
6. To program additional SecuriLock™ key(s), repeat this procedure from step 1.

If the programming procedure was successful, the new SecuriLock™ key(s) will start the vehicle's engine. The theft indicator (located on the instrument panel) will light for three seconds and then go out.

If the programming procedure was not successful, the new SecuriLock™ key(s) will not operate the vehicle's engine. The theft indicator will flash on and off. Wait at least one minute and then repeat the procedure from step 1. If failure repeats, bring your vehicle to your dealership to have the spare SecuriLock™ key(s) programmed.

Controls and features

AUXILIARY POWER POINT

The power point is an additional power source for electrical accessories. An additional power point is located in the rear cargo area.

LIFTGATE

To unlock the liftgate, insert door key into the lock and turn clockwise. You can also unlock the latch (but not release it) with the power door lock system and remote entry key fob.

To open the liftgate, squeeze the liftgate handle.

- Do not open the liftgate in a garage or other enclosed area with a low ceiling. If the liftgate is opened, the liftgate could be damaged against a low ceiling.
- Do not leave the liftgate open while driving. Doing so could cause serious damage to the liftgate and its components as well as allowing carbon monoxide to enter the vehicle.

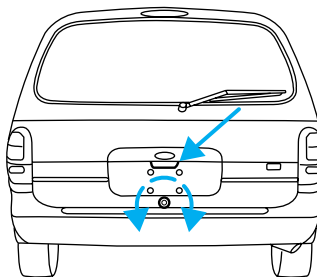

Make sure that the liftgate door is closed to prevent exhaust fumes from being drawn into the vehicle. This will also prevent passengers and cargo from falling out. If you must drive with the liftgate door open, keep the vents open so outside air comes into the vehicle.

Controls and features

CARGO AREA FEATURES

Cargo net (if equipped)

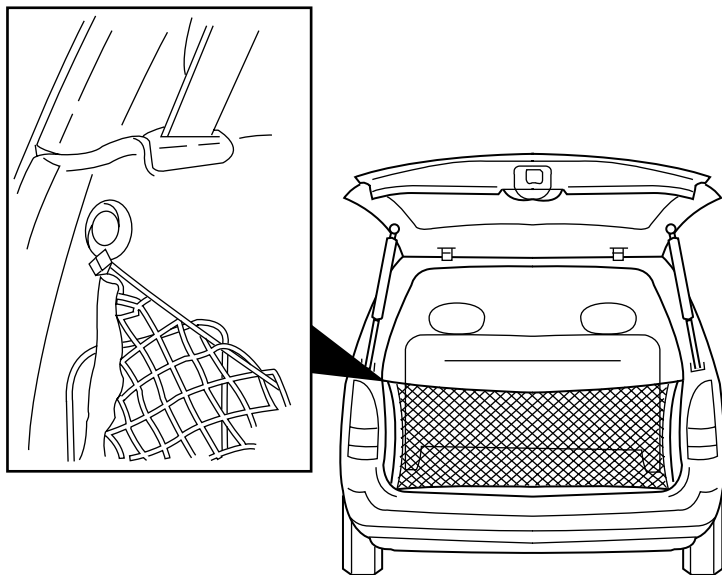

The cargo net secures lightweight objects in the cargo area. Attach the net to the anchors provided. Do not put more than 22 kg (50 lbs.) in the net. This net is not designed to restrain objects during a collision.

Seating and safety restraints

SEATING

Adjustable head restraints

Your vehicle's seats may be equipped with head restraints which are vertically adjustable. The purpose of these head restraints is to help limit head motion in the event of a rear collision. To properly adjust your head restraints, lift the head restraint so that it is located directly behind your head or as close to that position as possible. Refer to the following to raise and lower the head restraints.

The head restraints can be moved up and down.

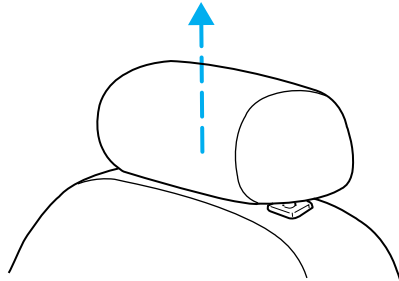

Push control to lower head restraint.

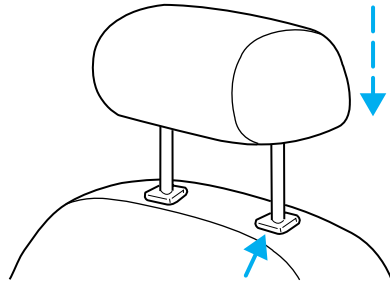

Adjusting the front manual seat



Never adjust the driver's seat or seatback when the vehicle is moving.



Do not pile cargo higher than the seatbacks to avoid injuring people in a collision or sudden stop.

Seating and safety restraints



Always drive and ride with your seatback upright and the lap belt snug and low across the hips.

Lift handle to move seat forward or backward.

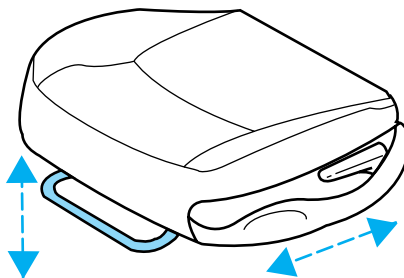

Pull lever up to adjust seatback.

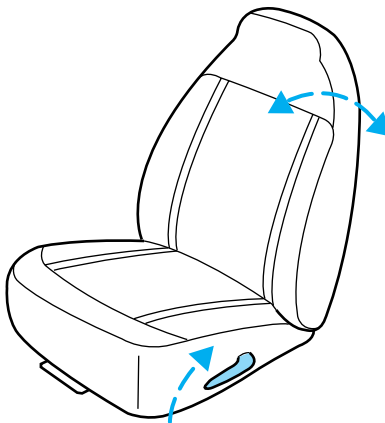

Tip slide seat (if equipped)

This feature allows convenient access into the second row seats through the driver's door and is only available on 3-door models.



Never adjust the driver's seat or seatback when the vehicle is moving.



Do not drive the vehicle with the tip slide seat unlatched.

Seating and safety restraints

To operate the tip slide seat:

1. Lift the tip slide release control located on the driver's seatback. The seatback will tilt forward.
2. Push on the seatback to move the seat assembly forward to gain access to the second row.

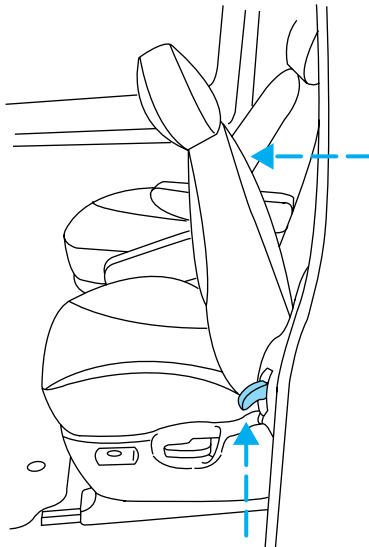

To return the driver's seat and seatback to their original position:

1. Push the seatback to move the seat assembly rearward, until it stops.
2. Continue pushing to return the seatback to its previously locked position.

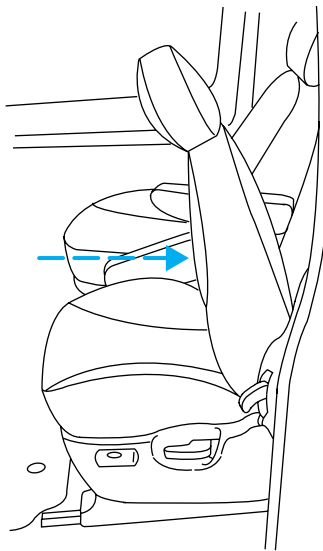

Seating and safety restraints

When returning the seatback to its original position, you may experience a slight hesitation. If so, stop pushing the seatback momentarily, then resume. The seatback will return to its original position after the seat is safely latched.

Your tip slide seat has been equipped with a lock-out feature which prevents the seatback from returning to its original position until the seat latches in the tracks. If the seat has not latched, check under the seat and in the tracks for possible obstructions.

Adjusting the power seats (if equipped)



Never adjust the driver's seat or seatback when the vehicle is moving.

Press control to move front or rear of seat up and down.

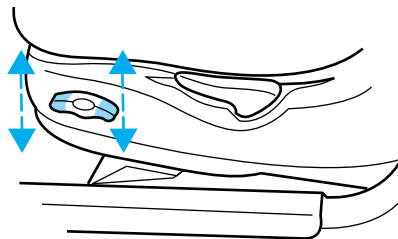

Press control to raise or lower the seat, or to move the seat forward or backward.

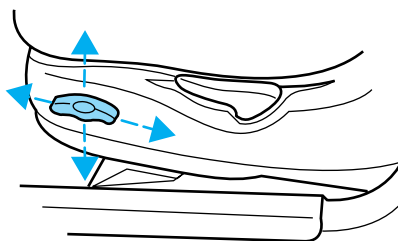

Using the power lumbar support (if equipped)

The power lumbar control is located on the inboard side of the seat.

Press one side of the control to adjust firmness.

Press the other side of the control to adjust softness.

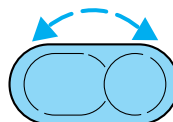

Seating and safety restraints

Rear seats

Head restraints

Your vehicle's seats may be equipped with head restraints which are vertically adjustable. The purpose of these head restraints is to help limit head motion in the event of a rear collision. To properly adjust your head restraints, lift the head restraint so that it is located directly behind your head or as close to that position as possible. Refer to the following to raise and lower the head restraints.

The head restraints can be moved up and down.

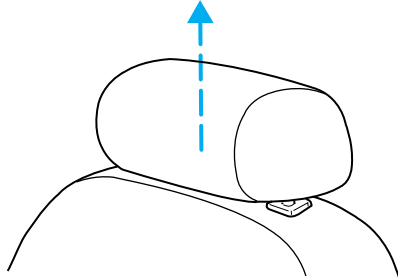

Push control to lower head restraint.

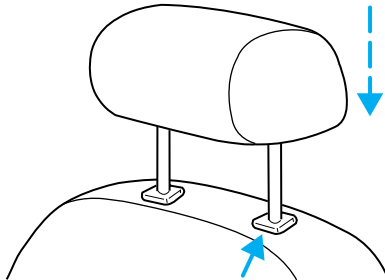

Seating and safety restraints

Integrated child seat head restraints

The Integrated Child Seat (ICS) head restraints can only be adjusted to two positions, full up or full down.

The ICS must be properly stowed and latched in order to adjust the head restraint.

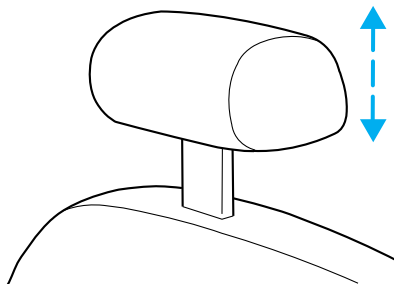

Seat mounted cup holders (if equipped)

Your vehicle may be equipped with cupholders mounted on the outboard sides of the second row seat(s). The cupholder is designed to detach from the seat when subjected to a heavy load. The cupholder can be reinstalled by lining up the arms with the side shield holes and pushing toward the seat.

Adjusting rear seats

Lift control to move seat forward or backward.

- 2nd row bucket seat

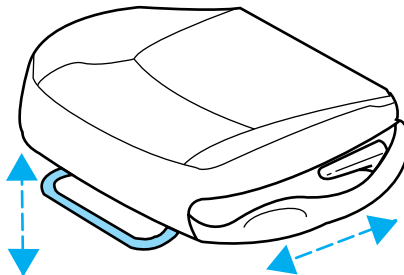

Seating and safety restraints

- 2nd / 3rd row bench seat

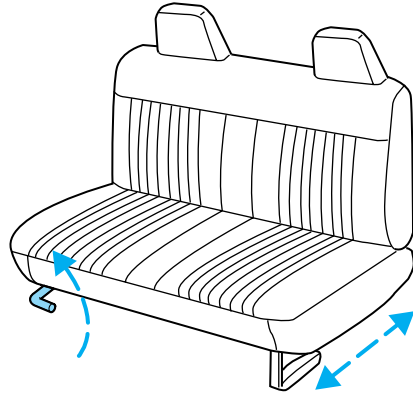

Pull control up to adjust seatback position.

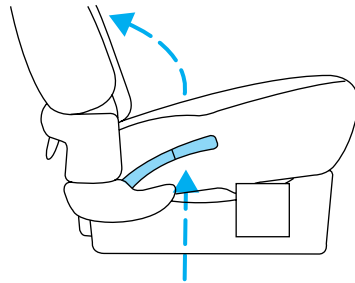

Pull control up to flip seatback to forward flat position.

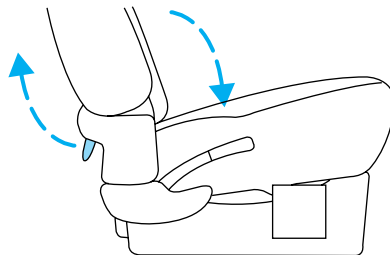

Seating and safety restraints

Accessing the 3rd row seat

If your vehicle has an adjustable 2nd row bench seat, it can be adjusted to allow easier access to the 3rd row seat by sliding the seat forward, folding the seatback to the forward flat position, or using the recline control to adjust seatback forward. The ICS (integrated child seat) bench seat does not have any adjustments.

If your vehicle has 2nd row bucket seats, it has an easy entry seat feature which allows ready access to the 3rd row seat.

To access the 3rd row seat with 2nd row buckets:

1. Pull the seatback recline control up and allow seatback to flip forward.
2. Push seatback toward front of vehicle. This releases the seat track automatically and the seat will move forward.
3. After entering the 3rd row seat, pull back the seatback until it latches. This will latch and lock the seatback and the seat track. The seatback and seat will not return to their original position.

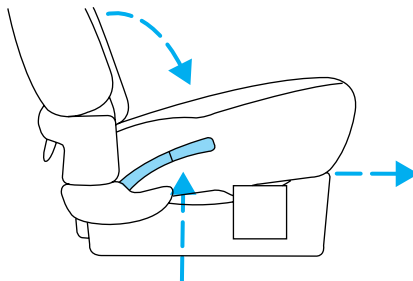

Do not attempt to use this feature when the seatback is folded in the forward flat position. The seatback must be in an upright position, as shown, for the system to work properly.



Check to see that the seat and seatback is latched securely in position. Keep floor area free of objects that would prevent proper seat engagement. Never attempt to adjust the seat while the vehicle is in motion.

Seating and safety restraints

Bench seat

To remove the seats:

1. (For 2nd row bench seat only.) Disengage the lap/shoulder belt from the side of the seat belt detach anchors (if equipped) by inserting the seatbelt tongue or a key into the slot in the detachable anchor and lifting upward.

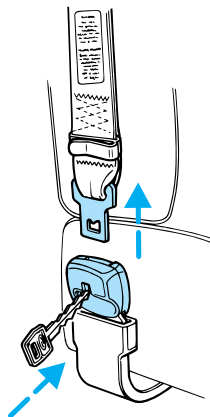
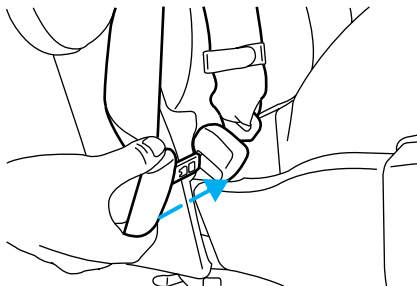

Seating and safety restraints

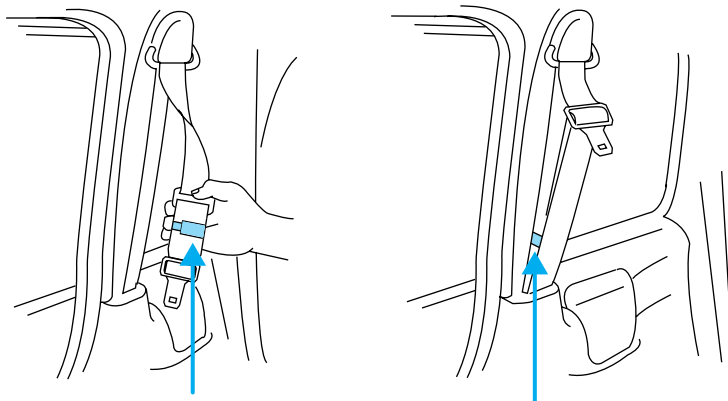

2. (For 2nd row bench seat only.) Using the clip attached to the end of the shoulder belt(s), clip the end of the belt to the stationary portion of the shoulder belt coming out of the trim panel. The end of the shoulder belt **must** be clipped in order to keep it from striking anything during vehicle operation.

If your bench seat is equipped with the forward fold down seatback, position the seatback in the full down position to make removing the seat easier.

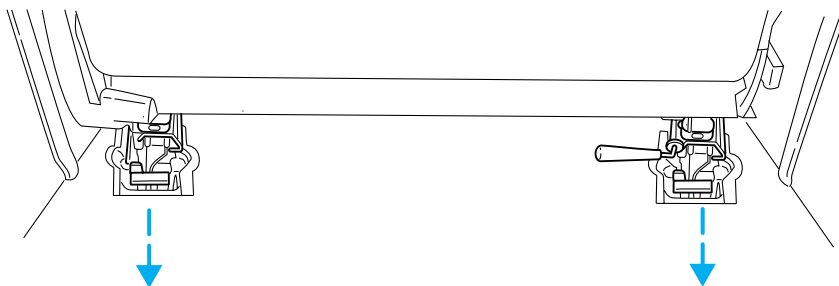

3. From behind the seat, pull straight back on the release controls located on each side of the seat, releasing the rear floor latches.

Seating and safety restraints

4. Lift up the back of the seat by the release controls to clear the floor latches and then pull the seat rearward until the front hooks have come out of the floor tubs.

5. Remove the seat.

To install the seat:

1. Remove (if necessary) tub covers from the floor to expose the seat mounts.

- To remove the tub cover(s), use a screwdriver to pry the tub cover (where indicated) upward and out of the floor tub.

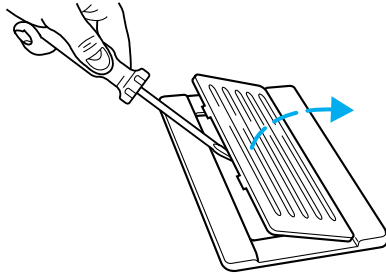

- To install the tub cover(s), first insert the tabs located on the opposite side of the pry location into the slots of the floor tub then press down on the other side of the cover until it snaps into place securely.

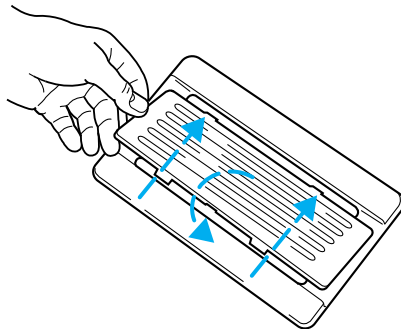

2. Position the seat in the vehicle.

The second row bench seat may be indexed to be positioned to either the far left or right hand side of the vehicle. **(4-door vehicles only)**. The left side of the figure is the front of the vehicle.

Seating and safety restraints

- Indexed to far left

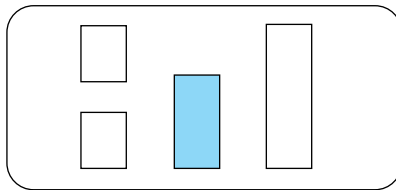

- Indexed to far right

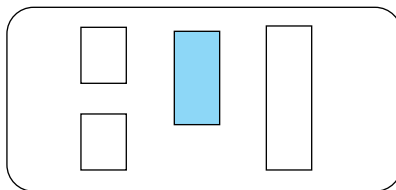

The 3rd row bench seat can be placed in the 2nd row position.

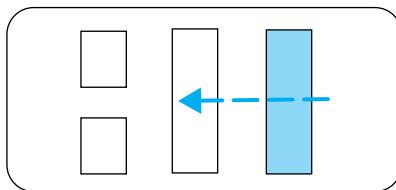

3. Align seat front hooks to front tub pins, lower back of seat into the rear tubs until both release controls latch into place. Be sure that the seat is locked in place both front and back.

4. Make sure the safety belt is not twisted, then insert the seat belt tongue into detachable anchor (if equipped) until you hear a “click” and feel the latch engage.



Always latch the vehicle seat to the floor, whether the seat is occupied or empty. If not latched, the seat may cause injury during a sudden stop.

Seating and safety restraints

Bucket seats

To remove the seat(s):

Position the seatback in the full down position to make removing the seat easier.

1. From behind the seat, pull straight back on the release controls located on each side of the seat, releasing the rear floor latches.

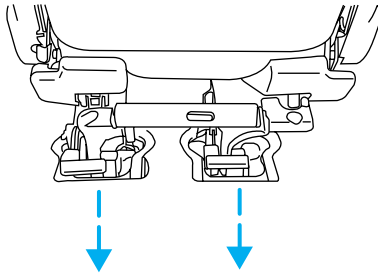

2. Lift up the back of the seat by the release controls to clear the floor latches and then pull the seat rearward until the front hooks have come out of the floor tubs.

3. Remove the seat.

4. Repeat steps 1–3 for other bucket seat.

To install the seat(s):

Before installing the bucket seats, be sure that the seats are on the correct side of the vehicle. They cannot be interchanged from one side to the other. Each seat base has a bracket on the outboard side that extends into a depression on the floor to ensure proper seat location. Always be sure that the seat is positioned so that the seat belt buckle is near the center aisle of the vehicle.

1. Position the seat in the vehicle.

2. Align seat front hooks to front tub pins, lower back of seat into the rear tubs until both release controls latch into place. Be sure that the seat is locked in place both front and back.



Always latch the vehicle seat to the floor, whether the seat is occupied or empty. If not latched, the seat may cause injury during a sudden stop.

Seating and safety restraints

SAFETY RESTRAINTS

Safety restraints precautions



Always drive and ride with your seatback upright and the lap belt snug and low across the hips.



To prevent the risk of injury, make sure children sit where they can be properly restrained.



Never let a passenger hold a child on his or her lap while the vehicle is moving. The passenger cannot protect the child from injury in a collision.



All occupants of the vehicle, including the driver, should always properly wear their safety belts, even when an air bag SRS is provided.



It is extremely dangerous to ride in a cargo area, inside or outside of a vehicle. In a collision, people riding in these areas are more likely to be seriously injured or killed. Do not allow people to ride in any area of your vehicle that is not equipped with seats and safety belts. Be sure everyone in your vehicle is in a seat and using a safety belt properly.



Each seating position in your vehicle has a specific safety belt assembly which is made up of one buckle and one tongue that are designed to be used as a pair. 1) Use the shoulder belt on the outside shoulder only. Never wear the shoulder belt under the arm. 2) Never swing the safety belt around your neck over the inside shoulder. 3) Never use a single belt for more than one person.

Seating and safety restraints

Combination lap and shoulder belts

1. Insert the belt tongue into the proper buckle (the buckle closest to the direction the tongue is coming from) until you hear a snap and feel it latch. Make sure the tongue is securely fastened in the buckle.

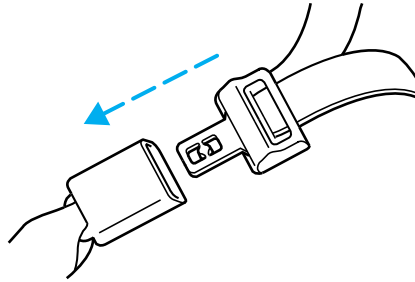

2. To unfasten, push the release button and remove the tongue from the buckle.

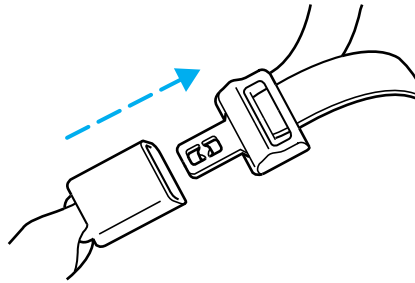

The front and rear outboard safety restraints in the vehicle are combination lap and shoulder belts. The front and rear seat passenger outboard safety belts have locking cinch tongues described below:

Safety belts with locking cinch tongue

The locking cinch tongue will slide up and down the belt webbing when the belt is in the stowed position or while putting seat belts on. When the locking cinch tongue of the lap/shoulder combination seat belt is latched into the buckle, the cinch tongue will allow the lap portion to become shorter, but locks the webbing in place to restrict it from becoming longer.

Before you can reach and latch a combination lap and shoulder belt having a cinch tongue into the buckle, you may have to lengthen the lap belt portion of it.

Seating and safety restraints

1. To lengthen the lap belt, pull some webbing out of the shoulder belt retractor.
2. While holding the webbing below the tongue, grasp the tip (metal portion) of the tongue so that it is parallel to the webbing and slide the tongue upward.

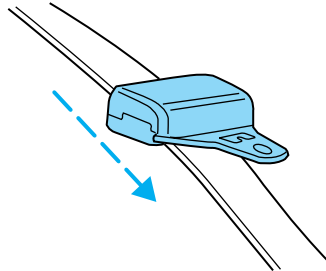

3. Provide enough lap belt length so that the tongue can reach the buckle.

If you grasp the tongue by the tongue cover to lengthen the belt, the tongue cover will grab the webbing, making it difficult to slide.

How to fasten the cinch tongue

1. Pull the combination lap and shoulder belt from the retractor so that the shoulder belt portion of the safety belt crosses your shoulder and chest.
2. Be sure the belt is not twisted. If the belt is twisted, remove the twist.
3. Insert the belt tongue into the proper buckle for your seating position until you hear a snap and feel it latch.
4. Make sure the tongue is securely fastened to the buckle by pulling on the tongue.



The lap belts should fit snugly and as low as possible around the hips, not around the waist.



Front and rear seat occupants, including pregnant women, should wear safety belts for optimum protection in an accident.



Each seating position in your vehicle has a specific safety belt assembly which is made up of one buckle and one tongue that are designed to be used as a pair. 1) Use the shoulder belt on the outside shoulder only. Never wear the shoulder belt under the arm. 2) Never swing the safety belt around your neck over the inside shoulder. 3) Never use a single belt for more than one person.

Seating and safety restraints

While you are fastened in the seat belt, the combination lap/shoulder belt with a cinch tongue adjusts to your movement. However, if you brake hard, turn hard, or if your vehicle receives an impact of 8 km/h (5 mph) or more, the safety belt will become locked and help reduce your forward movement.

Lap belts

Adjusting the lap belt

The lap belt does not adjust automatically.



The lap belts should fit snugly and as low as possible around the hips, not around the waist.

Insert the tongue into the correct buckle (the buckle closest to the direction the tongue is coming from). To lengthen the belt, turn the tongue at a right angle to the belt and pull across your lap until it reaches the buckle. To tighten the belt, pull the loose end of the belt through the tongue until it fits snugly across the hips.

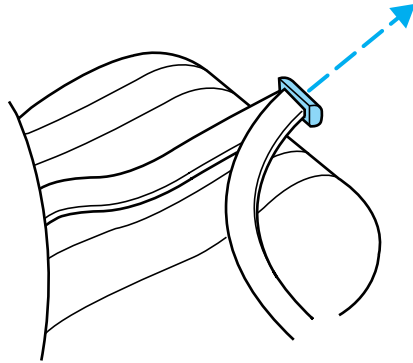

Shorten and fasten the belt when not in use.

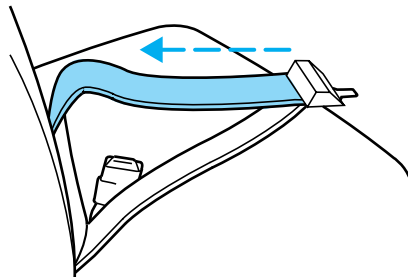

Seating and safety restraints

Safety belt height adjustment

Your vehicle has safety belt height adjustments for the driver, front passenger and second row passengers. Adjust the height of the shoulder belt so the belt rests across the middle of your shoulder.

To lower the shoulder belt height, push the button and slide the height control down. To raise the height of the shoulder belt, slide the height adjuster up. Pull down on the height adjustment assembly to make sure it is locked in place.

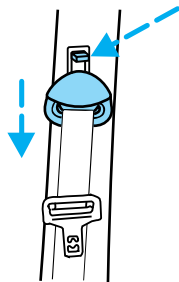

Position the shoulder belt height adjuster so that the belt rests across the middle of your shoulder. Failure to adjust the safety belt properly could reduce the effectiveness of the safety belt and increase the risk of injury in a collision.

Safety belt extension assembly

If the safety belt assembly is too short, even when fully extended, 20 cm (8 inches) can be added to the safety belt assembly by adding a safety belt extension assembly (part number 611C22). Safety belt extension assemblies can be obtained from your dealer at no cost.

Use only extensions manufactured by the same supplier as the safety belt. Manufacturer identification is located at the end of the webbing on the label. Also, use the safety belt extension only if the safety belt is too short for you when fully extended. Do not use extensions to change the fit of the shoulder belt across the torso.

Safety belt warning light and indicator chime

The seat belt warning light illuminates in the instrument cluster and a chime sounds to remind the occupants to fasten their safety belts.

Seating and safety restraints

Conditions of operation

If...	Then...
The driver's safety belt is not buckled before the ignition switch is turned to the ON position...	The safety belt warning light illuminates for one to two minutes and the warning chime sounds for four to eight seconds.
The driver's safety belt is buckled while the indicator light is illuminated and the warning chime is sounding...	The safety belt warning light and warning chime turn off.
The driver's safety belt is buckled before the ignition switch is turned to the ON position...	The safety belt warning light and indicator chime remain off.

Safety belt maintenance

Inspect the safety belt systems periodically to make sure they work properly and are not damaged. Inspect the safety belts to make sure there are no nicks, wears or cuts, replacing if necessary. All safety belt assemblies, including retractors, buckles, front seat belt buckle assemblies (slide bar)(if equipped), shoulder belt height adjusters (if equipped), child safety seat tether bracket assemblies (if equipped), and attaching hardware, should be inspected after a collision. Ford recommends that all safety belt assemblies used in vehicles involved in a collision be replaced. However, if the collision was minor and a qualified technician finds that the belts do not show damage and continue to operate properly, they do not need to be replaced, except as described in the *Replacing the second row bench seat belt assemblies after a collision* section of this chapter. Safety belt assemblies not in use during a collision should also be inspected and replaced if either damage or improper operation is noted.



Failure to inspect and if necessary replace the safety belt assembly under the above conditions could result in severe personal injuries in the event of a collision.

Refer to *Cleaning and maintaining the safety belts* in the *Maintenance and care* section.

Seating and safety restraints

Replacing the second row bench seat belt assemblies after a collision

All second row bench seat belt assemblies adjacent to a sliding door have special energy management retractors designed to further reduce the risk of injury in the event of a head-on collision. These retractors should be replaced if they were used in any accident in which the front airbags deploy. If the safety belt assemblies are not replaced, there may be increased risk of injury in the event of a subsequent collision.



Failure to inspect and if necessary replace the safety belt assembly under the above conditions could result in severe personal injuries in the event of a collision.

AIR BAG SUPPLEMENTAL RESTRAINT SYSTEM (SRS)

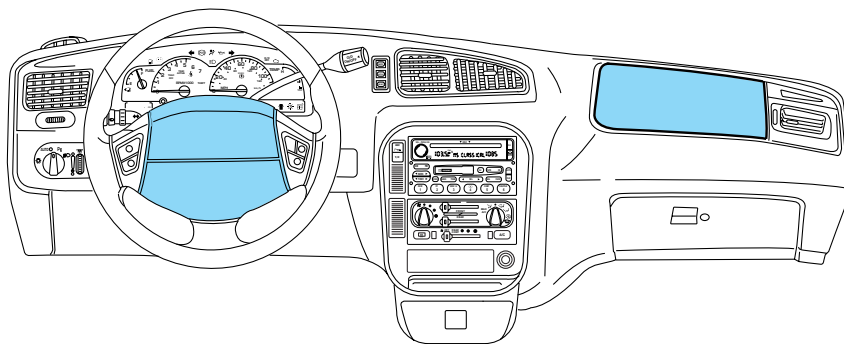

Seating and safety restraints

Important supplemental restraint system (SRS) precautions

The supplemental restraint system is designed to work with the safety belt to help protect the driver and right front passenger from certain upper body injuries.

Air bags DO NOT inflate slowly or gently and the risk of injury from a deploying air bag is greatest close to the trim covering the air bag module.

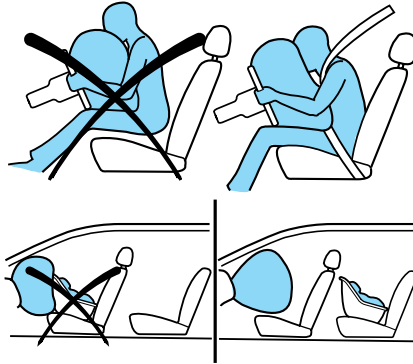

All occupants of the vehicle including the driver should always properly wear their safety belts even when air bag SRS is provided.



Always transport children 12 years old and under in the back seat and always use appropriate child restraints.



NHTSA recommends a minimum distance of at least 25 cm (ten [10] inches) between an occupant's chest and the air bag module.

Steps you can take to properly position yourself away from the airbag:

- Move your seat to the rear as far as you can while still reaching the pedals comfortably.
- Recline the seat slightly (one or two degrees) from the upright position.



Do not put anything on or over the air bag module. Placing objects on or over the air bag inflation area may cause those objects to be propelled by the air bag into your face and torso causing serious injury.

Seating and safety restraints



Do not attempt to service, repair, or modify the Air Bag Supplemental Restraint System or its fuses. See your Ford or Lincoln-Mercury dealer.

Children and air bags

For additional important safety information, read all information on safety restraints in this guide.

Children must always be properly restrained. Accident statistics suggest that children are safer when properly restrained in the rear seating positions than in the front seating position. Failure to follow these instructions may increase the risk of injury in a collision.



Air bags can kill or injure a child in a child seat. **NEVER** place a rear-facing child seat in front of an active air bag. If you must use a forward-facing child seat in the front seat, move the seat all the way back.

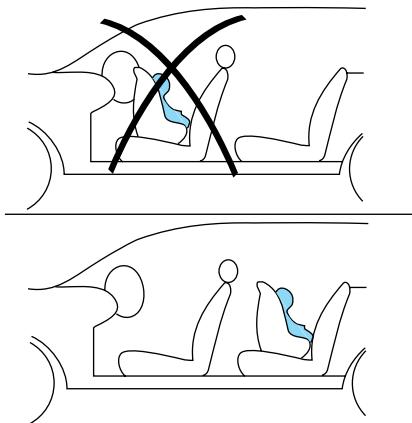

How does the air bag supplemental restraint system work?

The air bag SRS is designed to activate when the vehicle sustains sufficient longitudinal deceleration sufficient to cause the sensors to close an electrical circuit that initiates air bag inflation.

The fact that the air bags did not inflate in a collision does not mean that something is wrong with the system. Rather, it means the forces were not of the type sufficient to cause activation. Air bags are designed to inflate in frontal and near-frontal collisions, not rollover, side-impact, or rear-impacts.

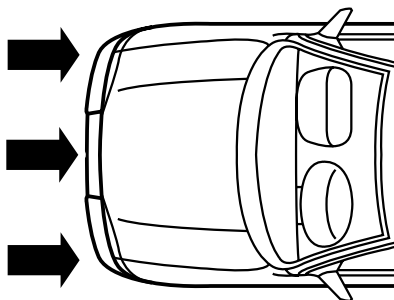

Seating and safety restraints

The air bags inflate and deflate rapidly upon activation. After air bag deployment, it is normal to notice a smoke-like, powdery residue or smell the burnt propellant. This may consist of cornstarch, talcum powder (to lubricate the bag) or sodium compounds (e.g., baking soda) that result from the combustion process that inflates the air bag. Small amounts of sodium hydroxide may be present which may irritate the skin and eyes, but none of the residue is toxic.



While the system is designed to help reduce serious injuries, it may also cause minor burns, abrasions, swelling or temporary hearing loss. Because air bags must inflate rapidly and with considerable force, there is the risk of death or serious injuries such as fractures, facial and eye injuries or internal injuries, particularly to occupants who are not properly restrained or are otherwise out of position at the time of air bag deployment. Thus, it is extremely important that occupants be properly restrained as far away from the air bag module as possible while maintaining vehicle control.



Several air bag system components get hot after inflation. Do not touch them after inflation.



If the air bag is deployed, **the air bag will not function again and must be replaced immediately.** If the air bag is not replaced, the unrepaired area will increase the risk of injury in a collision.

The SRS consists of:

- driver and passenger air bag modules (which include the inflators and air bags),
- one or more impact and safing sensors,
- a readiness light and tone
- and the electrical wiring which connects the components.

Seating and safety restraints

The diagnostic module monitors its own internal circuits and the supplemental air bag electrical system warning (including the impact sensors), the system wiring, the air bag system readiness light, the air bag back up power and the air bag ignitors.

Determining if the system is operational

The SRS uses a readiness light in the instrument cluster or a tone to indicate the condition of the system. Refer to the *Air bag readiness* section in the *Instrumentation* chapter. Routine maintenance of the air bag is not required.

A difficulty with the system is indicated by one or more of the following:

- The readiness light will either flash or stay lit.
- The readiness light will not illuminate immediately after ignition is turned on.
- A series of five beeps will be heard. The tone pattern will repeat periodically until the problem and light are repaired.



If any of these things happen, even intermittently, have the SRS serviced at your dealership or by a qualified technician immediately. Unless serviced, the system may not function properly in the event of a collision.

Side air bag system (if equipped)



Do not use accessory seat covers. The use of accessory seat covers may prevent the deployment of the side air bags and increase the risk of injury in an accident.



Do not lean your head on the door, the side air bag could injure you as it deploys from the side of the seatback.



Do not attempt to service, repair, or modify the air bag Supplemental Restraint System, its fuses or the seat cover on a seat containing an air bag. See your Ford or Lincoln Mercury dealer.

Seating and safety restraints



All occupants of the vehicle including the driver should always wear their safety belts even when an air bag SRS is provided.

How does the side air bag system work?

The side air bag system consists of the following:

- An inflatable nylon bag (air bag) with a gas generator concealed behind the outboard bolster of the driver and front passenger seatbacks.
- A special seat cover designed to allow airbag deployment.
- The same warning light, electronic control and diagnostic unit as used for the front air bags.
- Two crash sensors located under the outboard side of the front seats, attached to the floor.

Side air bags, in combination with seat belts, can help reduce the risk of severe injuries in the event of a significant side impact collision.

The side air bags are fitted on the outboard side of the seatbacks of the front seats. In certain lateral collisions, the air bag on the side affected by the collision will be inflated, even if the respective seat is not occupied. The air bag was designed to inflate between the door panel and occupant to further enhance the protection provided occupants in side impact collisions.

The air bag SRS is designed to activate when the vehicle sustains sufficient lateral deceleration sufficient to cause the sensors to close an electrical circuit that initiates air bag inflation.

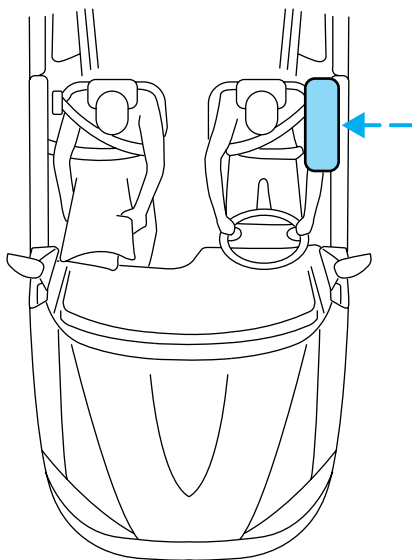

Seating and safety restraints

The fact that the air bags did not inflate in a collision does not mean that something is wrong with the system. Rather, it means the forces were not of the type sufficient to cause activation. Side air bags are designed to inflate in side-impact collisions, not roll-over, rear-impact, frontal or near-frontal collisions, unless the collision causes sufficient lateral deceleration.

 Several air bag system components get hot after inflation. Do not touch them after inflation.

 If the side air bag has deployed, **the air bag will not function again. The side air bag system (including the seat) must be inspected and serviced by a qualified technician in accordance with the vehicle service manual.** If the air bag is not replaced, the unrepaired area will increase the risk of injury in a collision.

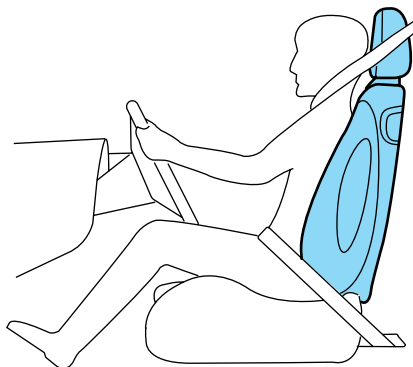

Determining if the system is operational

The SRS uses a readiness light in the instrument cluster or a tone to indicate the condition of the system. Refer to the *Air bag readiness* section in the *Instrumentation* chapter. Routine maintenance of the air bag is not required.

A difficulty with the system is indicated by one or more of the following:

- The readiness light will either flash or stay lit.
- The readiness light will not illuminate immediately after ignition is turned on.

If either of these indications occur, even intermittently, have the SRS serviced at your dealership or by a qualified technician immediately. Unless serviced, the system may not function properly in the event of a collision.

Seating and safety restraints

Disposal of air bags and air bag equipped vehicles

For disposal of air bags or air bag equipped vehicles, see your local dealership or qualified technician. Air bags **MUST BE** disposed of by qualified personnel.

SAFETY RESTRAINTS FOR CHILDREN

See the following sections for directions on how to properly use safety restraints for children. Also see *Air Bag Supplemental Restraint System (SRS)* in this chapter for special instructions about using air bags.

Important child restraint precautions

You are required by law to use safety restraints for children in the U.S. and Canada. If small children ride in your vehicle (generally children who are four years old or younger and who weigh 18 kg [40 lbs] or less), you must put them in safety seats made especially for children. Check your local and state or provincial laws for specific requirements regarding the safety of children in your vehicle.



Never let a passenger hold a child on his or her lap while the vehicle is moving. The passenger cannot protect the child from injury in a collision.

Always follow the instructions and warnings that come with any infant or child restraint you might use.

When possible, place children in the rear seat of your vehicle. Accident statistics suggest that children are safer when properly restrained in the rear seating positions than in the front seating position.

Children and safety belts

If the child is the proper size, restrain the child in a safety seat.

Children who are too large for child safety seats (as specified by your child safety seat manufacturer) should always wear safety belts.

Follow all the important safety restraint and air bag precautions that apply to adult passengers in your vehicle.

If the shoulder belt portion of a combination lap and shoulder belt can be positioned so it does not cross or rest in front of the child's face or neck, the child should wear the lap and shoulder belt. Moving the child

Seating and safety restraints

closer to the center of the vehicle may help provide a good shoulder belt fit.



Do not leave children, unreliable adults, or pets unattended in your vehicle.

To improve the fit of lap and shoulder belts on children who have outgrown child safety seats, Ford recommends use of a belt-positioning booster seat that is labelled as conforming to all Federal motor vehicle safety standards. Belt-positioning booster seats raise the child and provide a shorter, firmer seating cushion that encourages safer seating posture and better fit of lap and shoulder belts on the child.

A belt-positioning booster should be used if the shoulder belt rests in front of the child's face or neck, or if the lap belt does not fit snugly on both thighs, or if the thighs are too short to let the child sit all the way back on the seat cushion when the lower legs hang over the edge of the seat cushion. You may wish to discuss the special needs of your child with your pediatrician.

SAFETY SEATS FOR CHILDREN



Child and infant or child safety seats

Use a safety seat that is recommended for the size and weight of the child. Carefully follow all of the manufacturer's instructions with the safety seat you put in your vehicle. If you do not install and use the safety seat properly, the child may be injured in a sudden stop or collision.

Seating and safety restraints

When installing a child safety seat:

- Review and follow the information presented in the *Air Bag Supplemental Restraint System* section in this chapter.
- Use the correct safety belt buckle for that seating position.
- Insert the belt tongue into the proper buckle until you hear a snap and feel it latch. Make sure the tongue is securely fastened in the buckle.
- Keep the buckle release button pointing up and away from the safety seat, with the tongue between the child seat and the release button, to prevent accidental unbuckling.
- Place seat back in upright position.

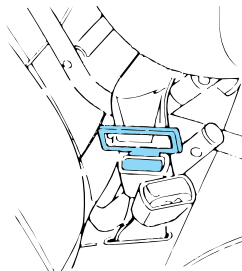

Ford recommends the use of a child safety seat having a top tether strap. Install the child safety seat in a seating position which is capable of providing a tether anchorage. For more information on top tether straps, refer to *Attaching safety seats with tether straps*.



Carefully follow all of the manufacturer's instructions included with the safety seat you put in your vehicle. If you do not install and use the safety seat properly, the child may be injured in a sudden stop or collision.

Installing child safety seats in cinch tongue combination lap and shoulder belt seating positions

The belt webbing below the tongue is the lap portion of the combination lap/shoulder belt, and the belt webbing above the tongue is the shoulder belt portion of the combination lap/shoulder belt.

Seating and safety restraints

1. Position the child safety seat in a seat with a combination lap and shoulder belt.

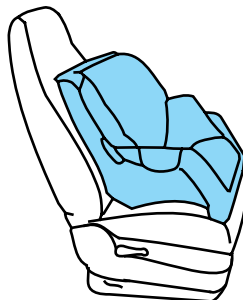

Air bags can kill or injure a child in a child seat. If you must use a forward-facing child seat in the front seat, move seat all the way back.



Rear facing seats should NEVER be placed in the front seats.

2. Grasp the belt webbing below the tongue and pull as much of the belt out of the retractor as possible. Hold the belt out.

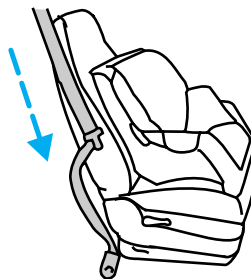

3. With your other hand, grasp the tip (metal portion) of the tongue (not the cover) and slide the tongue up the webbing as far as it will go. Release the tongue, but do not let go of the lap portion of the belt webbing.

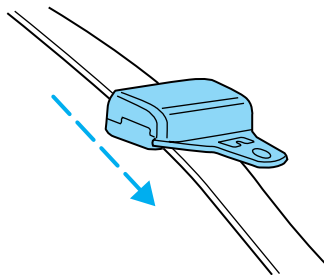

Seating and safety restraints

4. While holding the shoulder and lap portions together, route the tongue and webbing through the child seat according to the child seat manufacturer's instructions. Be sure that the belt webbing is not twisted.

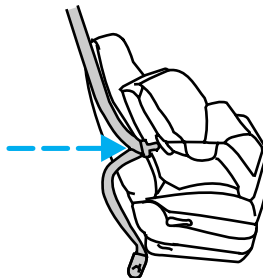

5. Insert the belt tongue into the proper buckle for that seating positions until you hear a snap and feel it latch. Make sure the tongue is securely latched to the buckle by pulling on the tongue.

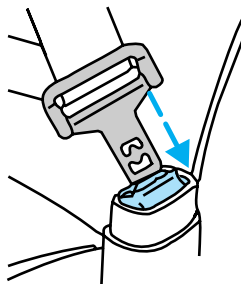

6. While pushing down with your knee on the child seat pull up on the shoulder belt portion to tighten the lap belt portion of the combination lap and shoulder belt.

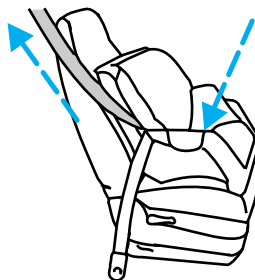

Seating and safety restraints

7. Allow the safety belt to retract and remove any slack in the belt to securely tighten the child safety seat in the vehicle.

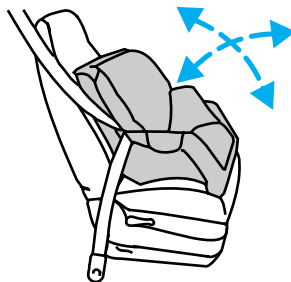

8. Before placing the child into the child seat, forcibly tilt the child seat forward and back to make sure that the seat is held securely in place.

9. Check from time to time to be sure that there is no slack in the lap/shoulder belt. The shoulder belt must be snug to keep the lap belt tight during a collision.

Installing child safety seats in the lap belt seating positions

1. Lengthen the lap belt. To lengthen the belt, hold the tongue so that its bottom is perpendicular to the direction of webbing while sliding the tongue up the webbing.

2. Place the child safety seat in the center seating position.

3. Route the tongue and webbing through the child seat according to the child seat manufacturer's instructions.

4. Insert the belt tongue into the proper buckle for the center seating position until you hear a snap and feel it latch. Make sure the tongue is securely fastened to the buckle by pulling on tongue.

5. Push down on the child seat while pulling on the loose end of the lap belt webbing to tighten the belt.

6. Before placing the child into the child seat, forcibly tilt the child seat from side to side and in forward direction to make sure that the seat is held securely in place. If the child seat moves excessively, repeat steps 5 through 6, or properly install the child seat in a different position.

Attaching safety seats with tether straps

Some manufacturers make safety seats that include a tether strap that goes over the back of the vehicle seat and attaches to an anchoring point. Other manufacturers offer the tether strap as an accessory.

Seating and safety restraints

Contact the manufacturer of your child safety seat for information about ordering a tether strap.

Tether anchorage hardware



Children should be placed in the rear in an appropriate child safety seat that is properly secured to the vehicle.



Rear-facing infant seats must always be secured in the rear seat. In vehicles without a rear seat, a rear-facing infant seat should be secured in the front seat only if your vehicle does not have a passenger side air bag or your vehicle is equipped with a passenger air bag deactivate switch and the switch is turned to “OFF.”



When using forward-facing child safety seats in vehicles with only two seating positions so the forward-facing child safety seat cannot be placed in the rear of the vehicle, move the passenger seat as far back from the instrument panel as possible.

Tether strap anchorage locations have been provided in your vehicle. The left side of the figure is the front of the vehicle.

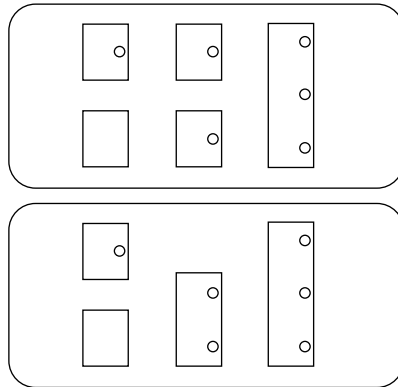

The tether can be attached directly to the rear of all passenger seating except the front passenger seat equipped with power adjustment. The front passenger seat with manual adjustment does have a tether anchor.

Seating and safety restraints

Front passenger seating position

1. Position the child safety seat on the passenger seat cushion.

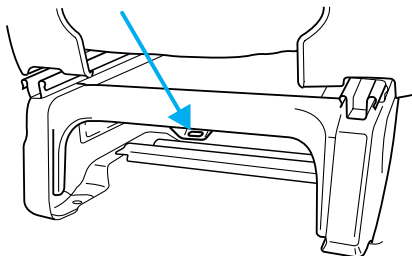

2. Route the child safety seat tether strap over the back of the seat.

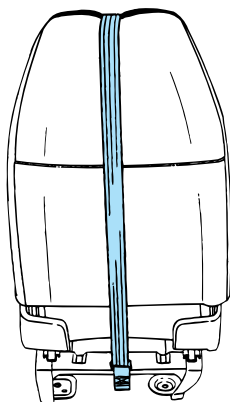

3. Grasp the tether strap and position it to the seat frame.

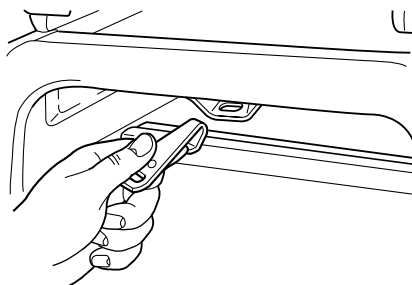

Seating and safety restraints

4. Rotate the tether strap.

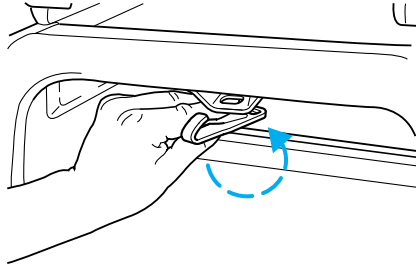

5. Clip the tether strap to the seat frame.

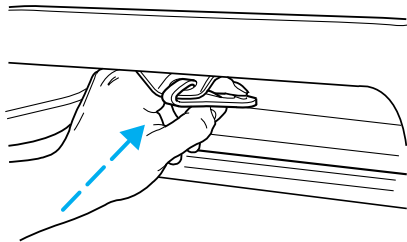

If the tether strap is clipped incorrectly (as shown) the child safety seat may not be retained properly in the event of a collision.

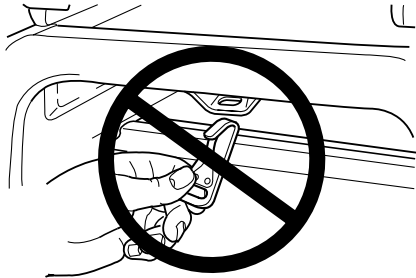

6. Rotate the tether strap clip.



7. Refer to the instructions in this section under *Installing child safety seats in cinch tongue combination lap and shoulder belt seating positions* to secure the child safety seat.

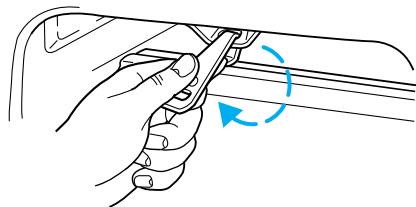

Seating and safety restraints

8. Tighten the child safety seat tether strap according to the manufacturer's instructions.

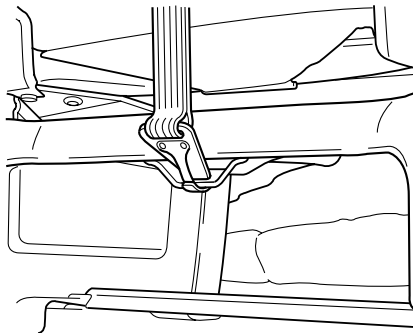

Rear seating positions

Follow steps 1–8 as described above for the following available seats:

- 2nd row bucket

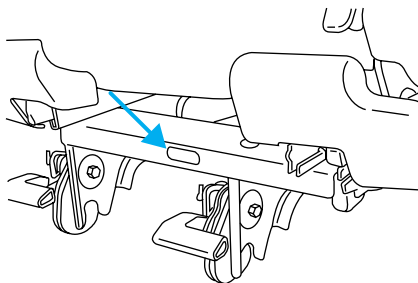

- 2nd row bench

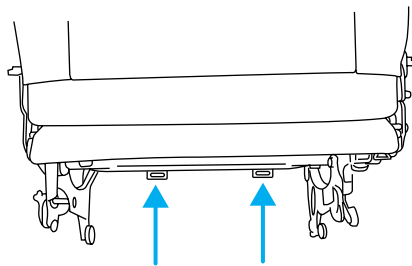

Seating and safety restraints

- 3rd row bench

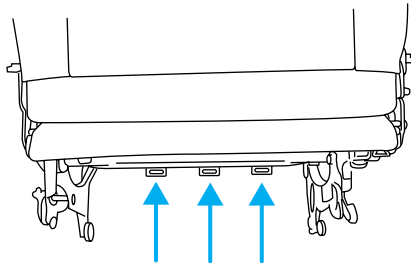

For additional important safety information on the proper use of seatbelts, child seats and infant seats, please read the entire *Seating and safety restraints* chapter in this owner's guide.

BUILT-IN CHILD SEATS

Built-in child safety seat (if equipped)

The rear seat may include a built-in child seat. This child seat conforms to all Federal and local motor vehicle safety standards. Read the labels located on the child seat cushion and shoulder belt for information on the built-in child seat.

Use the built-in child seat **only** if the child is at least 1 year old, weighs 10–27 kg (22–60 lb) and the child's shoulders (top) are below the shoulder harness slots in the built-in child seat.

Children not meeting these requirements should be secured in an approved aftermarket seat. Refer to *Child and infant or child safety seats* in this chapter.

Built-in child seat retractors

The belts on the built-in child seat are equipped with a retractor that has two types of locking modes.

Vehicle sensitive mode - the vehicle sensitive mode is the normal retractor mode, allowing some movement of the shoulder belts and locking in response to vehicle movement. For example, if the driver brakes suddenly or turns a corner sharply, or the vehicle receives an impact of 8 km/h (5 mph) or more, the combination safety belts will lock to help reduce forward movement of the child.

Seating and safety restraints

Automatic locking mode — in this mode, the shoulder belt is automatically pre-locked to limit the child's movement in the seat. The belt will still retract to remove any slack in the shoulder belts. The automatic locking mode should be used if the child is sleeping or attempting to get out of the seat.

The retractor will switch from the vehicle sensitive mode to the automatic locking mode when the left hand shoulder belt is pulled all the way out. The retractor will switch back to the vehicle sensitive mode when the belts are unbuckled and the shoulder belts retract completely.

Frequently check the child seat's lap and shoulder harness belts for correct placement and tightness. Use the child seat only if the harness belts will stay snug when belts are placed into the lock mode with a child in the seat. If belts do not remain snug, take the vehicle to the dealer for child seat repair.

Always adjust the lap and shoulder harness belts provided with this child seat snugly around your child.

Placing your child in the built-in child seat



Failure to follow all of the instructions on the use of this child restraint system can result in your child striking the vehicle's interior during a sudden stop or crash.



Never use the Built-In Child Seat as a booster cushion with the adult safety belts. A child using the adult belts could slide forward and out from under the safety belts.

Seating and safety restraints

1. Ensure head restraint is in the down position, then pull child seat down completely. The child seat can only be folded down when the head restraint is in the down position. The head restraint cannot be raised when the child seat is folded down.

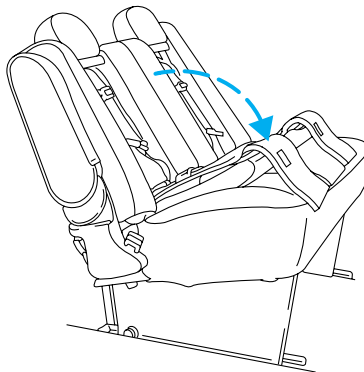

2. Read the information and warnings on both sides of the child seat cushion protector flap. Check the child's size, weight and age to be sure the child is not too small or too large for the child seat. Then fold the flap down onto the adult seat cushion.

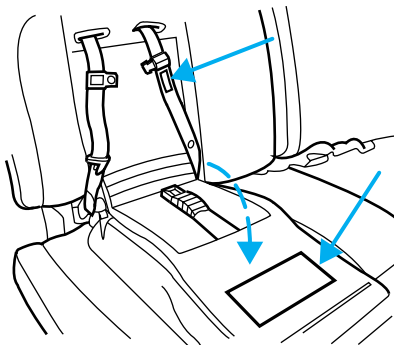

3. If connected, disconnect the chest clip and buckles.

4. Place the child on the child seat and position the shoulder belts over each shoulder.

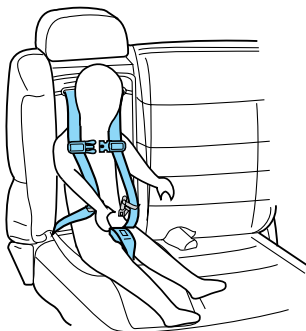

Seating and safety restraints

5. Insert the left and right safety belt tongues into the left and right slots of the crotch buckle. Verify that the indicator window on each tongue is green to ensure proper safety belt connections.

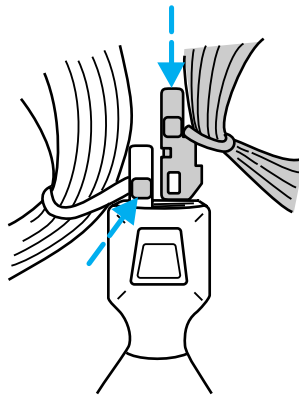

6. Fasten the right and left chest clip halves together and adjust the clip to comfortably hold the shoulder belts in place over the child's chest.

The chest clip is designed to easily pull apart in a collision. The clip helps to keep belts snug on a sleeping or squirming child.

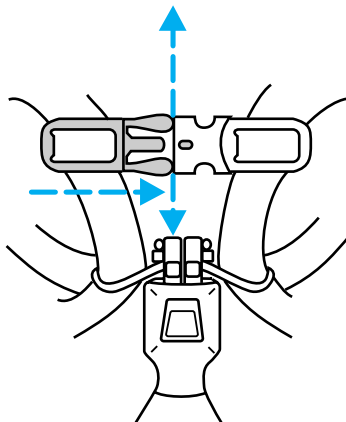

Seating and safety restraints

7. Pull on the safety belt tongues to ensure that they are both securely latched. If they are not properly latched, repeat steps five through seven.

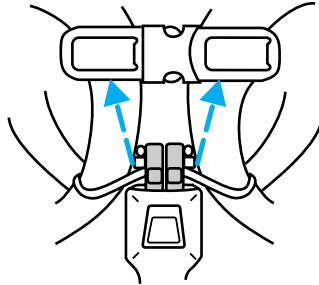

Activating the automatic locking mode on the built-in child safety seat

1. Fully extend the left shoulder belt.
2. Allow the belts to tighten snugly against the child's shoulders. As the belt retracts, you will hear a clicking sound which indicates the safety belt is now in the automatic locking mode.

Deactivating the automatic locking mode on the built-in child safety seat

1. Disconnect the chest clip and remove the left and right safety belt tongues from the crotch buckle.
2. Allow the shoulder belts to fully retract.

Removing your child from the built-in child seat

1. Disconnect the chest clip by squeezing the release tabs together and pulling the two sides apart.
2. Press the release button on the crotch buckle.
3. Slide the shoulder belts off the child's shoulders and remove the child from the seat.

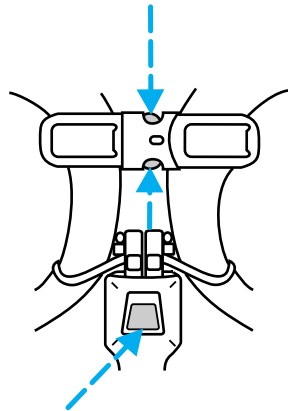

Seating and safety restraints

To fold up the child seat

1. Fold the protector flap onto the child seat cushion.
2. Push the built-in child seat up ensuring the wire handle on the bottom of the child seat engages into the slot under the head restraint.
3. Ensure that the child seat is fully engaged into the seatback. The head restraint will not operate if the child seat is not properly stowed.

Inspecting the built-in child seat after a collision

Inspect all built-in child restraints, including seats, buckles, retractors, and seat latches. Interlocks and attaching hardware should be inspected by a qualified technician after any collision. If the child seat was in use during a collision, Ford recommends replacing it. Built-in child restraints not in use during a collision should be inspected and replaced if either damage or improper operation is noted.

PREPARING TO START YOUR VEHICLE

Engine starting is controlled by the ignition system. This system meets all Canadian Interference-Causing Equipment standard requirements regulating the impulse electrical field strength of radio noise.

When starting a fuel-injected engine, avoid pressing the accelerator before or during starting. Only use the accelerator when you have difficulty starting the engine. For more information on starting the vehicle, refer to *Starting the engine* in this chapter.



Extended idling at high engine speeds can produce very high temperatures in the engine and exhaust system, creating the risk of fire or other damage.



Do not park, idle, or drive your vehicle in dry grass or other dry ground cover. The emission system heats up the engine compartment and exhaust system, which can start a fire.



Do not start your vehicle in a closed garage or in other enclosed areas. Exhaust fumes can be toxic. Always open the garage door before you start the engine. See *Guarding against exhaust fumes* in this chapter for more instructions.



If you smell exhaust fumes inside your vehicle, have your dealer inspect your vehicle immediately. Do not drive if you smell exhaust fumes.

Important safety precautions

A computer system controls the engine's idle revolutions per minute (RPM). When the engine starts, the idle RPM runs faster to warm the engine. If the engine idle speed does not slow down automatically, have the vehicle checked. Do not allow the vehicle to idle for more than ten minutes at the higher engine RPM.

Before starting the vehicle:

1. Make sure all vehicle occupants have buckled their safety belts. For more information on safety belts and their proper usage, refer to the *Seating and safety restraints* chapter.

Starting

2. Make sure the headlamps and vehicle accessories are off.
3. Make sure the parking brake is set.

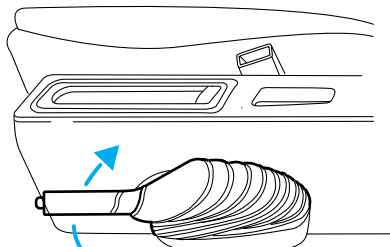

4. Make sure the gearshift is in P (Park).



5. Turn the key to 4 (ON) without turning the key to 5 (START).

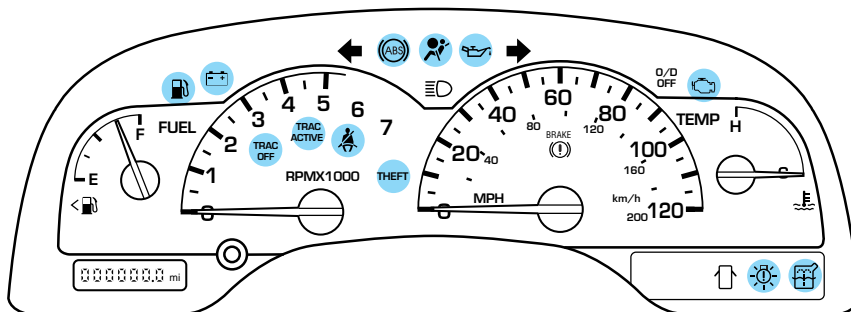
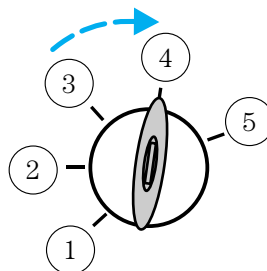

Make sure the corresponding lights illuminate briefly. If a light fails to illuminate, have the vehicle serviced.

Starting

- If the driver's safety belt is fastened, the  light may not illuminate.

STARTING THE ENGINE

1. Turn the key to 5 (START) without pressing the accelerator pedal and release as soon as the engine starts. The key will return to 4 (ON).

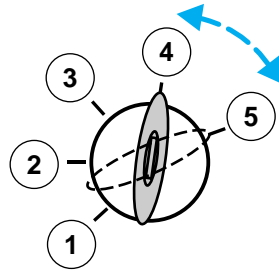

2. If the temperature is above -12°C (10°F) and the engine does not start within five seconds on the first try, turn the key to OFF, wait ten seconds and try again.
3. If the temperature is below -12°C (10°F) and the engine does not start in fifteen seconds on the first try, turn the key OFF and wait ten seconds and try again. If the engine does not start in two attempts, depress the accelerator and start the engine while holding the accelerator down to the floor. Release the accelerator when the engine starts.
4. After idling for a few seconds, apply the brake and release the parking brake.

Using the engine block heater (if equipped)

An engine block heater warms the engine coolant, which improves starting, warms up the engine faster and allows the heater-defroster system to respond quickly. Use of an engine block heater is strongly recommended if you live in a region where temperatures reach -23°C (-10°F) or below.

For best results, plug the heater in at least three hours before starting the vehicle. Using the heater for longer than three hours will not harm the engine, so the heater can be plugged in the night before starting the vehicle.

Starting



To prevent electrical shock, do not use your heater with ungrounded electrical systems or two-pronged (cheater) adapters.

Guarding against exhaust fumes

Although odorless and colorless, carbon monoxide is present in exhaust fumes. Take precautions to avoid its dangerous effects.



If you ever smell exhaust fumes of any kind inside your vehicle, have your dealer inspect and fix your vehicle immediately. Do not drive if you smell exhaust fumes. These fumes are harmful and could kill you.

Have the exhaust and body ventilation systems checked whenever:

- the vehicle is raised for service.
- the sound of the exhaust system changes.
- the vehicle has been damaged in a collision.



Engine exhaust, some of its constituents, and certain vehicle components contain or emit chemicals known to the State of California to cause cancer, and birth defects or other reproductive harm.

Important ventilating information

If the engine is idling while the vehicle is stopped in an open area for long periods of time, open the windows at least 2.5 cm (one inch).

Adjust the heating or air conditioning (if equipped) to bring in fresh air.

Improve vehicle ventilation by keeping all air inlet vents clear of snow, leaves and other debris.

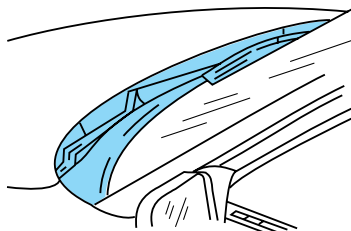

BRAKES

Your service brakes are self-adjusting. Refer to the scheduled maintenance guide for scheduled maintenance.

Occasional brake noise is normal and often does not indicate a performance concern with the vehicle's brake system. In normal operation, automotive brake systems may emit occasional or intermittent squeal or groan noises when the brakes are applied. Such noises are usually heard during the first few brake applications in the morning; however, they may be heard at any time while braking and can be aggravated by environmental conditions such as cold, heat, moisture, road dust, salt or mud. If a "metal-to-metal," "continuous grinding" or "continuous squeal" sound is present while braking, the brake linings may be worn-out and should be inspected by a qualified service technician.

Anti-lock brake system (ABS)

On vehicles equipped with an anti-lock braking system (ABS), a noise from the hydraulic pump motor and pulsation in the pedal may be observed during ABS braking events. Pedal pulsation coupled with noise while braking under panic conditions or on loose gravel, bumps, wet or snowy roads is normal and indicates proper functioning of the vehicle's anti-lock brake system. The ABS performs a self-check at 17 km/h (10 mph) after you start the engine and begin to drive away. A brief mechanical noise may be heard during this test. This is normal. If a malfunction is found, the ABS warning light will come on. If the vehicle has continuous vibration or shudder in the steering wheel while braking, the vehicle should be inspected by a qualified service technician.

The ABS operates by detecting the onset of wheel lockup during brake applications and compensating for this tendency. The wheels are prevented from locking even when the brakes are firmly applied. The accompanying illustration depicts the advantage of an ABS equipped vehicle (on bottom) to a non-ABS equipped vehicle (on top) during hard braking with loss of front braking traction.

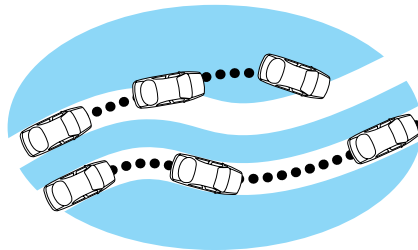

Driving

ABS warning lamp

The (ABS) warning lamp in the instrument cluster momentarily illuminates when the ignition is turned on and the engine is off. If the light does not illuminate momentarily at start up or remains on the ABS needs to be serviced.

With the ABS light on, the anti-lock brake system is disabled and normal braking is still effective unless the brake warning light also remains illuminated with parking brake released. (If your brake warning lamp illuminates, have your vehicle serviced immediately).

BRAKE



Using ABS

- In an emergency or when maximum efficiency from the ABS is required, apply continuous full force on the brake. The ABS will be activated immediately, thus allowing you to retain full steering control of your vehicle and, providing there is sufficient space, will enable you to avoid obstacles and bring the vehicle to a controlled stop.
- The Anti-Lock system does not decrease the time necessary to apply the brakes or always reduce stopping distance. Always leave enough room between your vehicle and the vehicle in front of you to stop.
- We recommend that you familiarize yourself with this braking technique. However, avoid taking any unnecessary risks.

Parking brake

Apply the parking brake whenever the vehicle is parked. To set the parking brake, pull the handle up as far as possible.

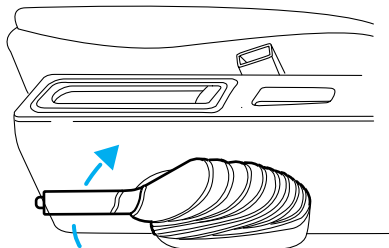

The BRAKE warning lamp in the instrument cluster illuminates and remains illuminated (when the ignition is turned ON) until the parking brake is released.

BRAKE (!)

The parking brake is not recommended to stop a moving vehicle. However, if the normal brakes fail, the parking brake can be used to stop your vehicle in an emergency. Since the parking brake applies only the rear brakes, the vehicle's stopping distance will increase greatly and the handling of your vehicle will be adversely affected.



Always set the parking brake fully and make sure that the gearshift is securely latched in P (Park) (automatic transaxle).

Push the button on the end of the parking brake and push the handle down as far as possible to release the brake. Driving with the parking brake on will cause the brakes to wear out quickly and reduce fuel economy.

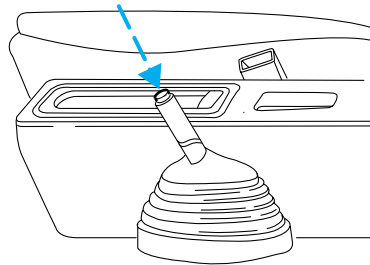

TRACTION CONTROL™ (IF EQUIPPED)

Traction Control™ helps the driver maintain the stability and steerability of the vehicle. It is especially useful on slippery and/or hilly road surfaces. The system operates by detecting and controlling wheel spin. The system borrows many of the electronic and mechanical elements already present in the anti-lock braking system (ABS).

Wheel-speed sensors allow excess front wheel spin to be detected by the Traction Control™ portion of the ABS computer. The system limits front wheel spin by automatically applying and releasing the front brakes in conjunction with engine torque reductions. Engine torque reduction is realized via the fully electronic spark and fuel injection systems. This process is very sensitive to driving conditions and very fast acting. The front wheels “search” for optimum traction several times a second and adjustments are made accordingly.

Driving

The Traction Control[™] system will assist you in making better use of available traction on slippery surfaces. The system is a driver aid which makes your vehicle easier to handle primarily on snow and ice covered roads.

During Traction Control[™] operation, TRACTION CONTROL OK is displayed on the message center (if equipped). You may hear an electric motor type of sound coming from the engine compartment and the engine will not “rev-up” when you push further on the accelerator. This is normal system behavior.

If you should become stuck in snow or on a very slippery road surface, try switching the Traction Control[™] system off with the traction control switch located on the left hand side of the radio. This may allow excess wheel spin to “dig” the vehicle out or enable a successful “rocking” maneuver.

If the Traction Control[™] system is cycled excessively, the brake portion of the system will shut down to prevent the front brakes from overheating. A limited Traction Control[™] function using only engine torque reduction will still control wheels from over-spinning. When the front brakes have cooled down, the system will again function normally. Anti-lock braking is not affected by this condition and will function normally during the cool down period.

If a system fault is detected, CHECK TRACTION CONTROL is displayed on the message center, the “TC OFF” warning indicator lamp is on and your vehicle should be serviced.

STEERING

Your vehicle is equipped with power steering. Power steering uses energy from the engine to help steer the vehicle.

To prevent damage to the power steering pump:

- Never hold the steering wheel to the extreme right or the extreme left for more than a few seconds when the engine is running.
- Do not operate the vehicle with a low power steering pump fluid level.

If the power steering system breaks down (or if the engine is turned off), you can steer the vehicle manually, but it takes more effort.

If the steering wanders or pulls, the condition could be caused by any of the following:

- underinflated tire(s) on any wheel(s)
- high crown in center of road
- high crosswinds
- wheels out of alignment
- loose or worn components in steering linkage

AUTOMATIC TRANSAXLE OPERATION

Brake-shift interlock

This vehicle is equipped with a brake-shift interlock feature that prevents the gearshift from being moved from P (Park) unless the brake pedal is pressed.

If the gearshift cannot be moved from P (Park) with the brake pedal pressed, it is possible that a fuse has blown or the vehicle's brakelamps are not operating properly. Refer to *Fuses and relays* in the *Roadside emergencies* chapter.



Do not drive your vehicle until you verify that the brakelamps are working.

If your vehicle gets stuck in mud or snow it may be rocked out by shifting from forward and reverse gears, stopping between shifts, in a steady pattern. Press lightly on the accelerator in each gear.

Do not rock the vehicle for more than a few minutes. The transaxle and tires may be damaged or the engine may overheat.



Always set the parking brake fully and make sure the gearshift is latched in P (Park). Turn off the ignition whenever you leave your vehicle.



If the parking brake is fully released, but the brake warning lamp remains illuminated, the brakes may not be working properly. See your dealer or a qualified service technician.

Driving

Driving with an automatic overdrive transaxle with column gearshift and O/D off switch

Your automatic transaxle electronically controls the shift feel by using an adaptive learning strategy. This feature is designed to optimize shift smoothness. It is normal for your transaxle to shift abruptly during the first few hundred kilometers (miles) of operation until the adaptive strategy has been learned. The adaptive learning strategy is maintained by power from the battery. When the battery is disconnected or a new battery is installed, the transaxle must relearn its adaptive strategy. Optimal shifting will resume within a few hundred kilometers (miles) of operation.

Your automatic overdrive transaxle provides fully automatic operation in either D (Overdrive) or with the O/D OFF switch depressed. Driving with the shift selector in D

(Overdrive) gives the best fuel economy for normal driving conditions. For manual control start in 1 (First) and then shift manually.

To put your vehicle in gear, start the engine, depress the brake pedal, then move gearshift out of P (Park).

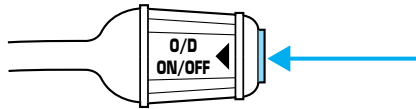

Understanding gearshift positions

To account for customer driving habits and conditions, your automatic transaxle electronically controls the shift feel by using an adaptive learning strategy. During the first few hundred kilometers (miles) of operation, it is normal for your transaxle to have abrupt shifts. The adaptive learning strategy is maintained by power from the battery. When the battery is disconnected or a new battery is installed, the transaxle must relearn its adaptive strategy. Optimal shifting will resume within a few hundred kilometers (miles) of operation.

P (Park)

Always come to a complete stop before shifting into P (Park). Make sure the gearshift is securely latched in P (Park). This locks the transaxle and prevent the front wheels from rotating.





Always set the parking brake fully and make sure the gearshift is securely latched in P (Park).



Never leave your vehicle unattended while it is running.

R (Reverse)

With the gearshift in R (Reverse), the vehicle will move backward. You should always come to a complete stop before shifting into and out of R (Reverse).



N (Neutral)

With the gearshift in the N (Neutral) position, the vehicle can be started and is free to roll. Hold the brake pedal down while in this position.



D Overdrive — column mounted gearshift with O/D off switch

The **D** Overdrive position with the O/D OFF switch **not** depressed is the normal driving position for this automatic overdrive transaxle. When your vehicle cruises at a constant speed for any length of time, this fourth gear will increase your fuel economy.



Overdrive may not be appropriate for certain terrains. If the transaxle shifts back and forth between third and fourth gears while you are driving hilly roads or if your vehicle

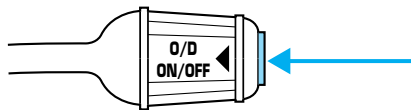

requires additional power for climbing hills, press the O/D OFF switch.

The transaxle will be in the “overdrive on” mode when the vehicle is started even if the O/D OFF mode was selected when the vehicle was last shut off.

Driving

If the O/D OFF indicator light is flashing on and off repeatedly when the vehicle is started or does not come on when the O/D OFF control is pressed, it means that there is a transaxle electronic system malfunction. You should contact your dealer as soon as possible or damage to the transaxle could occur.

When to use D (Drive) or press the O/D OFF switch

You will notice that there is only one drive position on your gearshift indicator (instead of Drive and Overdrive). However, you will find a control labeled O/D located on the

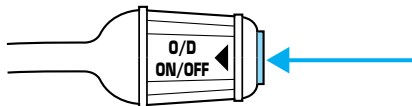

gearshift lever. Push in the switch and the O/D OFF light in the instrument cluster will illuminate. With the O/D OFF light illuminated, the transaxle will operate in first, second and third gears and will not shift into fourth gear. Operating in D (O/D OFF) provides more engine braking than **D** Overdrive for descending hills or city driving.

To return the transaxle to the normal Overdrive operation, press the O/D OFF control again. Use this control to select between Overdrive or D (O/D OFF) whenever you drive your vehicle.

If the O/D OFF indicator light is flashing on and off repeatedly when the vehicle is started or does not come on when the O/D OFF control is pressed, it means that there is a transaxle electronic system malfunction. You should contact your dealer as soon as possible or damage to the transaxle could occur.

2 (Second)

Use 2 (Second) to accelerate from a stop on slippery roads, or to give you more engine braking to slow your vehicle on downgrades.



1 (First)

Use 1 (First) when added engine braking is desired while descending steep hills.



The automatic transaxle will shift to the proper gear to ascend any grade without any need to shift to 1 (First).

Do not go faster than 61 km/h (38 mph) when in this gear. You can upshift from 1 (First) to overdrive at any time.



When parking, do not use the gearshift in place of the parking brake. Always set the parking brake fully and make sure that the gearshift is securely latched in Park (P). Turn off the ignition whenever you leave your vehicle. Never leave your vehicle unattended while it is running. If you do not take these precautions, your vehicle may move unexpectedly and injure someone.

DRIVING THROUGH WATER

Do not drive quickly through standing water, especially if the depth is unknown. Traction or brake capability may be limited and if the ignition system gets wet, your engine may stall. Water may also enter your engine's air intake and severely damage your engine.

If driving through deep or standing water is unavoidable, proceed very slowly. Never drive through water that is higher than the bottom of the hubs.

Once through the water, always try the brakes. Wet brakes do not stop the vehicle as effectively as dry brakes. Drying can be improved by moving your vehicle slowly while applying light pressure on the brake pedal.

Driving through deep water where the transmission is submerged may allow water into the transmission and cause internal transmission damage.

VEHICLE LOADING

Before loading a vehicle, familiarize yourself with the following terms:

- **Base Curb Weight:** Weight of the vehicle including any standard equipment, fluids, lubricants, etc. It does not include passengers or aftermarket equipment.
- **Payload:** Combined maximum allowable weight of cargo, passengers and optional equipment. The payload equals the gross vehicle weight rating minus base curb weight.
- **GVW (Gross Vehicle Weight):** Base curb weight plus payload weight. The GVW is not a limit or a specification.

Driving

- **GVWR (Gross Vehicle Weight Rating):** Maximum total weight of the base vehicle, passengers, optional equipment and cargo. The GVWR is specific to each vehicle and is listed on the Safety Compliance Label on the driver's door pillar.
- **GAWR (Gross Axle Weight Rating):** Carrying capacity for each axle system. The GAWR is specific to each vehicle and is listed on the Safety Compliance Label on the driver's door pillar.
- **GCW (Gross Combined Weight):** The combined weight of the towing vehicle (including passengers and cargo) and the trailer.
- **GCWR (Gross Combined Weight Rating):** Maximum combined weight of towing vehicle (including passengers and cargo) and the trailer. The GCWR indicates the maximum loaded weight that the vehicle is designed to tow.
- **Maximum Trailer Weight Rating:** Maximum weight of a trailer the vehicle is permitted to tow. The maximum trailer weight rating is determined by subtracting the vehicle curb weight for each engine/transmission combination, any required option weight for trailer towing and the weight of the driver from the GCWR for the towing vehicle.
- **Maximum Trailer Weight:** maximum weight of a trailer the loaded vehicle (including passengers and cargo) is permitted to tow. It is determined by subtracting the weight of the loaded trailer towing vehicle from the GCWR for the towing vehicle.
- **Trailer Weight Range:** Specified weight range that the trailer must fall within that ranges from zero to the maximum trailer weight rating.

Remember to figure in the tongue load of your loaded trailer when figuring the total weight.



Do not exceed the GVWR or the GAWR specified on the Safety Compliance Certification Label.

Do not use replacement tires with lower load carrying capacities than the originals because they may lower the vehicle's GVWR and GAWR limitations. Replacement tires with a higher limit than the originals do not increase the GVWR and GAWR limitations.

The Certification Label, found on the inside pillar of the driver's door, lists several important vehicle weight rating limitations. Before adding any additional equipment, refer to these limitations. If you are adding weight to the front of your vehicle, (potentially including weight added to the cab), the weight added should not exceed the Front Axle Reserve Capacity (FARC). Additional frontal weight may be added to the front axle reserve capacity provided you limit your payload in other ways (i.e. restrict the number of passengers or amount of cargo carried).

You may add equipment throughout your vehicle if the total weight added is equal to or less than the Total Axle Reserve Capacity (TARC) weight. You should NEVER exceed the Total Axle Reserve Capacity.

Always ensure that the weight of passengers, cargo and equipment being carried is within the weight limitations that have been established for your vehicle including both Gross Vehicle Weight and Front and Rear Gross Axle Weight Rating limits. Under no circumstance should these limitations be exceeded. Exceeding any vehicle weight rating limitation could result in serious damage to the vehicle and/or personal injury.

Calculating the load your vehicle can carry/tow

1. Use the appropriate maximum gross combined weight rating (GCWR) chart to find the maximum GCWR for your type engine and rear axle ratio.
2. Weigh your vehicle as you customarily operate the vehicle without cargo. To obtain correct weights, try taking your vehicle to a shipping company or an inspection station for trucks.
3. Subtract your loaded vehicle weight from the maximum GCWR on the following charts. This is the maximum trailer weight your vehicle can tow and must fall below the maximum shown under maximum trailer weight on the chart.

Driving

TRAILER TOWING

Trailer towing with your vehicle requires the optional trailer tow electrical package and may require the use of an additional medium duty trailer tow option package.

Trailer towing puts additional loads on your vehicle's engine, transmission, axle, brakes, tires, and suspension. For your safety and to maximize vehicle performance, be sure to use the proper equipment while towing.

Follow these guidelines to ensure safe towing procedure:

- Stay within your vehicle's load limits. If exceeded, cargo should be removed from the trailer and/or the vehicle until all weights are within specified limits.
- Thoroughly prepare your vehicle for towing. Refer to *Preparing to tow* in this chapter.
- Use extra caution when driving while trailer towing. Refer to *Driving while you tow* in this chapter.
- Service your vehicle more frequently if you tow a trailer. Refer to Special Operating Conditions in the Scheduled Maintenance Guide.
- Do not tow a trailer until your vehicle has been driven at least 800 km (500 miles).
- Refer to the instructions included with towing accessories for the proper installation and adjustment specifications.

If your vehicle is equipped with the optional heavy duty trailer tow wiring, it is pre-wired for trailer towing. An electrical connector is provided under the instrument panel for installing a customer-supplied electric brake controller. Another electrical connector is provided at the hitch. This connector provides power to the trailer for taillamps, stop and turn lamps, back up lamps, battery charge, electric brakes (when a customer provided controller is installed) and ground. The kit included with your vehicle provides you with adaptors to attach the brake controller and convert the hitch connector for Class I trailer usage.

TRAILER TOWING TABLE

Engine	Maximum GCWR	Trailer weight range (0 - maximum)
Van		
3.0L	2 971 kg (6 550 lbs.)	0-907 kg (0-2 000 lbs.)
3.8L	3 175 kg (7 000 lbs.)	0-907 kg (0-2 000 lbs.)
Wagon		
3.0L	2 971 kg (6 550 lbs.)	0-907 kg (0-2 000 lbs.)
3.8L	3 175 kg (7 000 lbs.)	0-907 kg (0-2 000 lbs.)
3.8L with Trailer Tow Option	3 856 kg (8 500 lbs.)	0-1 588 kg (0- 3 500 lbs.)

Do not exceed the maximum loads listed on the Safety Compliance Certification label. For load specification terms found on the label, refer to *Vehicle loading* in this chapter. Remember to figure in the tongue load of your loaded trailer when figuring the total weight.



Towing trailers beyond the maximum recommended gross trailer weight exceeds the limit of the vehicle and could result in engine damage, transmission damage, structural damage, loss of control and personal injury.

Preparing to tow

Use the proper equipment for towing a trailer, and make sure it is properly attached to your vehicle. See your dealer or a reliable trailer dealer if you require assistance.

Hitches

Do not use hitches that clamp onto the vehicle bumper. Use a load carrying hitch. You must distribute the load in your trailer so that 10% of the total weight of the trailer is on the tongue.

Driving

Safety chains

Always connect the trailer's safety chains to the vehicle. To connect the trailer's safety chains, cross the chains under the trailer tongue and allow slack for turning corners.

If you use a rental trailer, follow the instructions that the rental agency gives to you.

Do not attach safety chains to the bumper.

Trailer brakes

Electric brakes and manual, automatic or surge-type brakes are safe if installed properly and adjusted to the manufacturer's specifications. The trailer brakes must meet local and Federal regulations.



Do not connect a trailer's hydraulic brake system directly to your vehicle's brake system. Your vehicle may not have enough braking power and your chances of having a collision greatly increase.

The braking system of the tow vehicle is rated for operation at the GVWR not GCWR.

Trailer lamps

Trailer lamps are required on most towed vehicles. Ensure that your trailer lamps conform to local and Federal Regulations.

Do not splice or modify the vehicle electrical wiring or lamps for trailer towing.

Your vehicle uses an advanced electronic module with ground side switching to control and monitor your vehicle lamps. Splicing into the wiring or attaching wiring to the vehicle bulbs will DISABLE the rear vehicle lamps from functioning. Your lamp outage feature will also be disabled or provide incorrect information.

Your vehicle is ready to install a Trailer Tow module that will provide the proper communication with the vehicle electrical system so your trailer lamps will function properly. See your dealer or trailer rental agency for proper instructions and equipment for hooking up trailer lamps.

Driving while you tow

Do not drive faster than 88 km/h (55 mph) when towing a trailer. Speed control may shut off if you are towing on long, steep grades. When towing a trailer:

- Use a lower gear when towing up or down steep hills. This will eliminate excessive downshifting and upshifting for optimum fuel economy and transmission cooling.
- Anticipate stops and brake gradually.

Exceeding the GCWR rating may cause internal transmission damage and void your warranty coverage.

Servicing after towing

If you tow a trailer for long distances, your vehicle will require more frequent service intervals. Refer to your Scheduled Maintenance guide for more information.

Trailer towing tips

- Practice turning, stopping and backing up in an area before starting on a trip to get the feel of the vehicle trailer combination. When turning, make wider turns so the trailer wheels will clear curbs and other obstacles.
- Allow more distance for stopping with a trailer attached.
- The trailer tongue weight should be 10% of the loaded trailer weight.
- After you have traveled 80 km (50 miles), thoroughly check your hitch, electrical connections and trailer wheel lug nuts.
- When stopped in traffic for long periods of time in hot weather, place the gearshift in P (Park) and increase idle speed. This aids engine cooling and air conditioner efficiency.
- Vehicles with trailers should not be parked on a grade. If you must park on a grade, place wheel chocks under the trailer's wheels.

Driving

LUGGAGE RACK (IF EQUIPPED)

Maximum load is 75 kg (165 lbs) on the roof rack structure, or 45 kg (100 lbs) on the roof panel slats, evenly distributed. If it is not possible to distribute the load, position it as far rearward as possible. Use adjustable tie down loops to secure the load.

To adjust the cross-bar position:

1. Loosen the thumbwheel at both ends of the cross-bar (both cross-bars are adjustable).
2. Slide cross-bar to the desired location.
3. Tighten thumbwheel at both ends of the cross-bar.

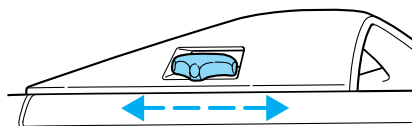

To remove the cross-bar assembly from the roof rack side rails:

1. Loosen the thumbwheel at both ends of the cross-bar (both cross-bars are adjustable).
2. Slide cross-bar to the end of the rail.
3. Use a long, flat object in order to depress the tabs on both ends of the cross-bar.
4. Slide the assemblies off the end.

To reinstall the cross-bar assembly to the roof rack side rails:

1. Slide the cross-bar assemblies over the tabs and into the side rails.
2. Tighten thumbwheel at both ends of the cross-bar.

Roadside emergencies

HAZARD FLASHER

Use only in an emergency to warn traffic of vehicle breakdown, approaching danger, etc. The hazard flashers can be operated when the ignition is off.

- The hazard lights control is located on top of the steering column.
- Depress hazard lights control to activate all hazard flashers simultaneously.
- Depress control again to turn the flashers off.

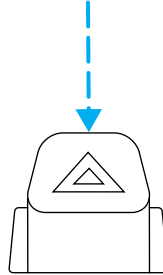

FUEL PUMP SHUT-OFF SWITCH

After a collision, if the engine cranks but does not start, the fuel pump shut-off switch may have been activated. The shut-off switch is a device intended to stop the electric fuel pump when your vehicle has been involved in a substantial jolt.

1. Turn the ignition to the OFF position.
2. Check the fuel system for leaks.
3. If no fuel leak is apparent, reset the fuel pump shut-off switch by pushing in the reset button.
4. Turn the ignition to the ON position. Pause for a few seconds and return the key to the OFF position.
5. Make a further check for leaks in the fuel system.

Roadside emergencies

The fuel pump shut-off switch is located behind the service panel on the right side of the cargo area.

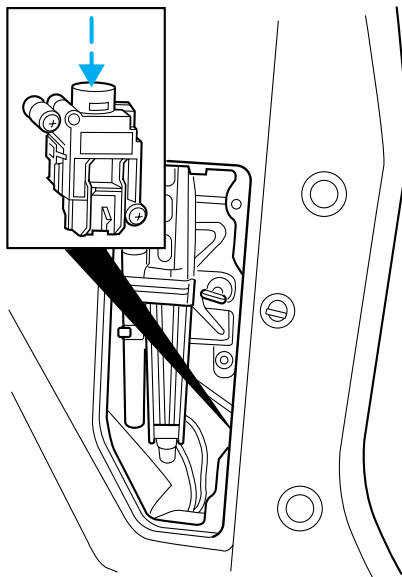

FUSES AND RELAYS

Fuses

If electrical components in the vehicle are not working, a fuse may have blown. Blown fuses are identified by a broken wire within the fuse. Check the appropriate fuses before replacing any electrical components.

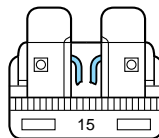

Always replace a fuse with one that has the specified amperage rating. Using a fuse with a higher amperage rating can cause severe wire damage and could start a fire.

Roadside emergencies

Standard fuse amperage rating and color

COLOR					
Fuse Rating	Mini Fuses	Standard Fuses	Maxi Fuses	Cartridge Maxi Fuses	Fuse Link Cartridge
2A	Grey	Grey	—	—	—
3A	Violet	Violet	—	—	—
4A	Pink	Pink	—	—	—
5A	Tan	Tan	—	—	—
7.5A	Brown	Brown	—	—	—
10A	Red	Red	—	—	—
15A	Blue	Blue	—	—	—
20A	Yellow	Yellow	Yellow	Blue	Blue
25A	Natural	Natural	—	—	—
30A	Green	Green	Green	Pink	Pink
40A	—	—	Orange	Green	Orange
50A	—	—	Red	Red	Red
60A	—	—	Blue	—	Yellow
70A	—	—	Tan	—	Brown
80A	—	—	Natural	—	Black

Passenger compartment fuse panel

The fuse panel is located below and to the left of the steering wheel by the brake pedal. Remove the panel cover to access the fuses.

To remove a fuse use the fuse puller tool provided on the fuse panel cover.

Your vehicle is equipped with a Pull Fuse feature that when used, can extend the duration of your battery life while your vehicle is parked for long periods of time. This time will be increased from 31 days to 45 – 55 days (based on option content). You should use this feature when your vehicle will be parked for long periods of times to ensure the vehicle starts upon your return.

The pull fuse is located under the instrument panel and is visible from the exterior of the fuse panel cover.

Roadside emergencies

The fuse holder is designed to allow you to pull the fuse (#6) from the fuse panel circuit without having to completely remove it from the fuse panel. The fuse and fuse holder will remain in the fuse panel.

If the fuse (#6) must be replaced, the fuse and fuse holder can be removed by pulling it completely out from the fuse panel cover.

With the fuse (#6) removed, the following systems will not be functional:

- radio
- power sliding door(s) – (if equipped)
- keyless entry system– (if equipped)

When the pull fuse is reinstalled, the following features will need to be reset.

- radio pre-sets
- power sliding door(s) – (if equipped)

Please refer to the *Using Your Audio System* and *Power Sliding Door* sections in the *Controls and Features* chapter for instructions to reset these features.

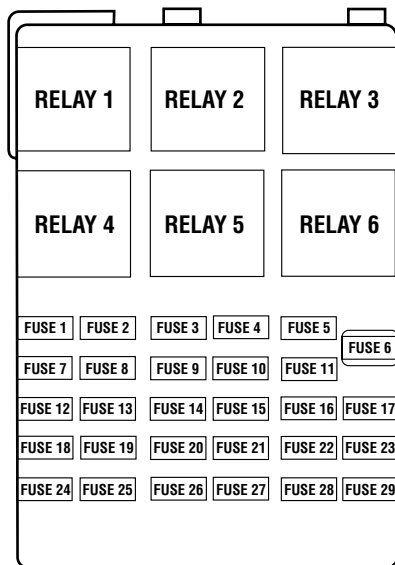

Roadside emergencies

The fuses are coded as follows:

Fuse/Relay Location	Fuse Amp Rating	Description
1	10A	Right Stepwell Lamp, Left Stepwell Lamp, Right Puddle Lamp, Left Puddle Lamp, Left 2nd Row Reading Lamp, Right 2nd Row Reading Lamp, Left 3rd Row Reading Lamp, Right 3rd Row Reading Lamp, Cargo Lamp, Dome Lamp, Map Lamp, LH Visor/Vanity Lamp, RH Visor/Vanity Lamp
2	25A	Glove Box Lamp, LH I/P Courtesy Lamp, RH I/P Courtesy Lamp, Trailer Tow Module
3	10A	LH Power Mirror Motor, RH Power Mirror Motor
4	—	Not Used
5	20A	I/P Power Point
6	15A	Radio, Compact Disc Changer, Remote Keyless Entry Module, PSD (Power Sliding Door) Module RH and LH, Rear Seat Radio Controller
7	15A	Left Rear Turn Lamp, Right Backup Lamp, Right Stop Lamp, Right Rear Park Lamp, Right License Lamp, Left License Lamp, LH Backup Lamp
8	20A	Rear Electronic Module, RHF/RH Sliding/LH Sliding/Liftgate Door Lock Motors, Aux. Air Blend Door Motor, Aux. Air Mode Door Motor
9	10A	Cluster, PATS Transceiver, Powertrain Control Module Relay (coil)
10	10A	Heated Backlite Relay (coil), Speed Control Module, ABS Module, Cluster, Front Temp Blend Door Actuator, Brake Shift Interlock Solenoid, Powertrain Control Module, Power Sliding Door Module RH and LH, Reverse Sensing System, Front A/C Control Head

Roadside emergencies

Fuse/Relay Location	Fuse Amp Rating	Description
11	10A	Electric Brake Controller, Brake Shift Interlock Solenoid, Rear Electronic Module
12	20A	Center High-Mount Stop Lamp, Trailer Tow Module
13	10A	Right Rear Turn Lamp, Left Stop Lamp, Left Rear Park Lamp
14	10A	Autolamp Sensor, Transmission Overdrive Cancel Switch, Front Electronic Module, Compass Module, Electrochromatic Mirror, Power Sliding Door Overhead Console Switch
15	—	Not Used
16	10A	Cluster, Rear Electronic Module
17	20A	Cigar Lighter/Powerpoint, Datalink Connector
18	10A	LH Quarter Window Motor, RH Quarter Window Motor, RH Window Switch Backlighting, RH Lock Switch Backlighting, Master Control Switch (LH) Backlighting, Radio
19	10A	Starter Interrupt Relay (coil)
20	—	Not Used
21	—	Not Used
22	10A	LH Heated Mirror, RH Heated Mirror
23	20A	Body Powerpoint, Auxiliary Blower Relay #1 and #2
24	—	Not Used
25	10A	Radio
26	10A	Airbag Module
27	—	Not Used
28	10A	Cluster
29	—	Not Used
Relay 1	—	Switched System Power Relay #4
Relay 2	—	Accessory Delay Relay

Roadside emergencies

Fuse/Relay Location	Fuse Amp Rating	Description
Relay 3	—	Front Blower Motor Relay
Relay 4	—	Switched System Power Relay #3
Relay 5	—	Rear Defrost Relay
Relay 6	—	Auxiliary Blower Motor Relay

Power distribution box

The power distribution box is located in the engine compartment. The power distribution box contains high-current fuses that protect your vehicle's main electrical systems from overloads.



Always disconnect the battery before servicing high current fuses.



Always replace the cover to the Power Distribution Box before reconnecting the battery or refilling fluid reservoirs.

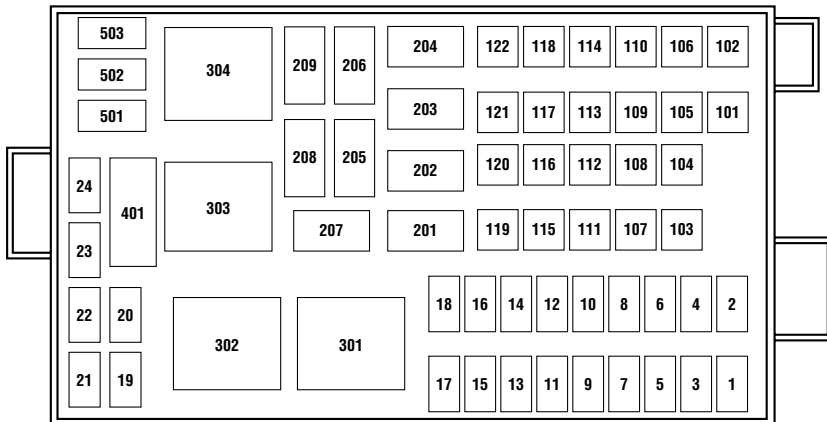

Roadside emergencies

The high-current fuses are coded as follows:

Fuse/Relay Location	Fuse Amp Rating	Description
1	30A*	Powertrain Control Module Relay
2	10A*	Powertrain Control Module, Front Electronic Module
3	10A*	A/C Compressor Clutch
4	25A*	Horns, Horn Relay (coil)
5	15A*	Fuel Pump Motor, Powertrain Control Module
6	30A*	Front Wiper Motor, Front Wiper Relay, Front Washer Pump, FEM
7	25A*	Rear Wiper Motor, Rear Washer Pump, Rear Wiper Relay (coil)
8	—	Not Used
9	—	Not Used
10	—	Not Used
11	—	Not Used
12	—	Not Used
13	—	Not Used
14	—	Not Used
15	15A*	Right Headlamp (Low and High Beam)
16	15A*	Left Headlamp (Low and High Beam)
17	—	Not Used
18	—	Not Used
19	15A*	AX4S Transaxle, Vapor Management Valve, A/C Clutch Relay Coil, EGR Control Solenoid, Engine Fuel Control HO2S #11 Sensor, Engine Fuel Control HO2S #21 Sensor, Catalyst Monitor HO2S #12 Sensor, Catalyst Monitor HO2S #22 Sensor, Canister Vent Solenoid

Roadside emergencies

Fuse/Relay Location	Fuse Amp Rating	Description
20	15A*	Ignition Coil, Intake Air Control Valve, Fuel Injectors #1, #2, #3, #4, #5, #6, Mass Air Flow Sensor, Fuel Pump Relay Coil, Intake Manifold Runner Control, HI-Speed Cooling Fan Relay Coil, LO-Speed Cooling Fan Relay Coil, Powertrain Control Module
21	10A*	Front Electronic Module (LH Door Lock Motor)
22	15A*	Right Front Park Lamp, Right Front Turn Lamp, Right Front Cornering Lamp
23	15A*	Left Front Park Lamp, Left Front Turn Lamp, Left Front Cornering Lamp
24	—	Not Used
101	40A**	ABS Module
102	40A**	ABS Module
103	40A**	SSP4 Relay, SSP4 Relay (coil)
104	40A**	LH Power Seat Motors, LH Power Lumbar Motor
105	30A**	Starter Motor Solenoid, Ignition Switch
106	30A**	Delayed Accessory Relay, Delayed Accessory Relay (coil), Front Electronic Module, RHF Window Motor
107	50A**	RH/LH Engine Cooling Fan Motors, Cooling Fan Dropping Resistor
108	40A**	SSP2 Relay, SSP2 Relay (coil)
109	40A**	SSP1 Relay, SSP1 Relay (coil)
110	50A**	RH Power Sliding Door Module
111	—	Not Used
112	30A**	Electric Brake Controller
113	30A**	Front Electronic Module (LH Window Motor)
114	40A**	SSP3 Relay, SSP3 Relay (coil)
115	50A**	Fuse Junction Box Bus #2

Roadside emergencies

Fuse/Relay Location	Fuse Amp Rating	Description
116	30A**	Heated Backlight Relay
117	40A**	Auxiliary Blower Relay (coil), Auxiliary Blower Motor
118	50A**	LH Power Sliding Door Module
119	30A**	Fuse Junction Box Bus #1
120	40A**	Front Blower Relay (coil), Front Blower Motor
121	20A**	Ignition Switch, Rear Defrost Relay (coil)
122	40A**	RH Power Seat Motors, RH Power Lumbar Motor
201	—	Not Used
202	—	Front Wiper ON/OFF Relay
203	—	Rear Wiper Relay
204	—	A/C Clutch Relay
205	—	Horn Relay
206	—	Not Used
207	—	Fuel Pump Relay
208	—	Not Used
209	—	Front Wiper Hi/Low Relay
301	—	SSP2 Relay
302	—	Start Interrupt Relay
303	—	SSP1 Relay
304	—	Powertrain Control Module Relay
401	—	Not Used
501	—	Powertrain Control Module Diode
502	—	A/C Clutch Diode
503	—	Not Used
* Mini Fuses ** Maxi Fuses		

Roadside emergencies

CHANGING THE TIRES

If you get a flat tire while driving, do not apply the brake heavily. Instead, gradually decrease your speed. Hold the steering wheel firmly and slowly move to a safe place on the side of the road.

Temporary spare tire information

Your vehicle may have a temporary or conventional spare tire. The temporary spare tire for your vehicle is labeled as such. It is smaller than a regular tire and is designed for emergency use only. Replace this tire with a conventional tire as soon as possible.



If you use the temporary spare tire continuously or do not follow these precautions, the tire could fail, causing you to lose control of the vehicle, possibly injuring yourself or others.

When driving with the temporary spare tire **do not:**

- exceed 80 km/h (50 mph) under any circumstances
- load the vehicle beyond maximum vehicle load rating listed on the Safety Compliance Label
- tow a trailer
- use tire chains
- drive through an automatic car wash, because of the vehicle's reduced ground clearance
- try to repair the temporary spare tire or remove it from its wheel
- use the wheel for any other type of vehicle

Spare tire information

Your vehicle is equipped with a spare tire that **must be used** for emergencies only. Vehicles equipped with 16" tires have a 15" spare tire. Vehicles equipped with self-sealing tires do not have a self-sealing spare.

Roadside emergencies

Location of the spare tire and tools

The spare tire and tools for your vehicle are stowed in the following locations:

Item	Location
Spare tire	Under the vehicle, just forward of the rear bumper
Jack, wheel nut wrench,	Behind the access panel located on the right rear quarter panel interior trim
Jack handle	Attached to jack with clip

Removing the jack and tools

1. Locate the access panel on the interior trim. Rotate the two panel retaining clips and remove the panel.
2. Remove the jack and lug nut wrench by turning the thumbscrew counterclockwise to remove clamp and relieve tension against the stowage bracket.

Removing the spare tire

1. Open the liftgate and open the plastic cover from the carpeting on cargo floor to expose the hex nut. On cargo van model, lift flap in mat to expose hex nut.
2. Insert the lug nut wrench on the hex nut in cargo floor.

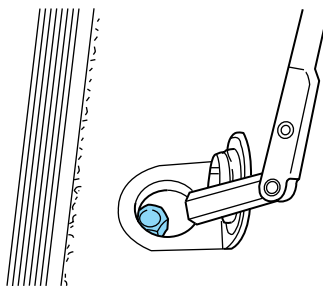

Roadside emergencies

3. Turn the wrench counterclockwise until tire is lowered to the ground and the cable is slightly slack.
4. Remove the retainer from the spare tire.

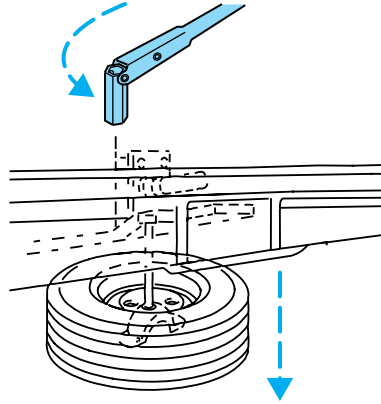

Stowing the spare

1. Lay the tire on the ground with the interior side facing up.
2. Install the retainer through the wheel center and slide the wheel under the vehicle.
3. Turn the lug nut wrench clockwise until the tire is raised to its original position underneath the vehicle. The hex nut ratchets when the tire is raised to the stowed position. It will not allow you to overtighten.
4. Check seating position of tire for looseness against the underbody supports and retighten if necessary.

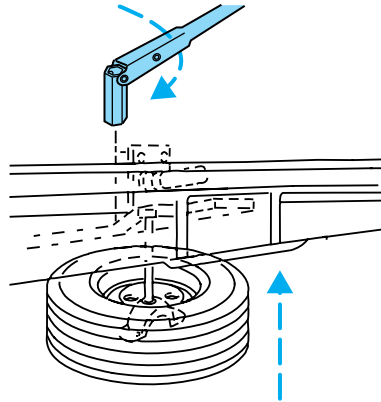



Ensure the position of the tire is not too far forward to avoid contact with the axle.

Roadside emergencies

Tire change procedure

 When one of the front wheels is off the ground, the transaxle alone will not prevent the vehicle from moving or slipping off the jack, even if the vehicle is in P (Park).

 To prevent the vehicle from moving when you change a tire, be sure the parking brake is set, then block (in both directions) the wheel that is diagonally opposite (other side and end of the vehicle) to the tire being changed.

 If the vehicle slips off the jack, you or someone else could be seriously injured.

1. Park on a level surface, activate hazard flashers and set parking brake.

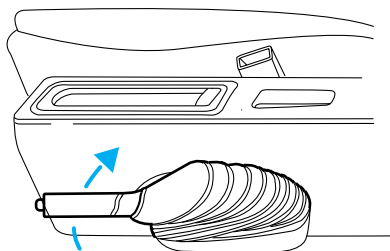

2. Place gearshift lever in P (Park), turn engine OFF, and block the diagonally opposite wheel.

3. Remove the spare tire, jack and lug wrench.

4. Remove the center ornament or wheel cover from the wheel with the tapered end of the wheel nut wrench that came with your vehicle. Insert and twist the handle, then pry against the wheel.

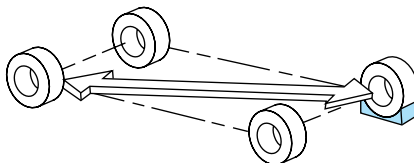

Roadside emergencies

5. Loosen each wheel lug nut one-half turn counterclockwise but do not remove them until the wheel is raised off the ground.

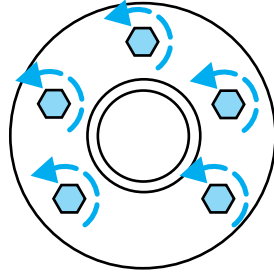

If Ford Accessory Running Boards have been installed, use the jack adapters supplied with the running boards as described on the inside of the jack storage area.

6. Locate the jack notch next to the door closest to the tire you are changing, then place the jack on the frame rail directly behind the notch.

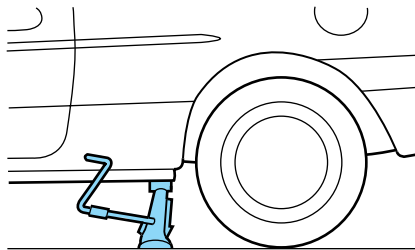

7. Turn the jack handle clockwise until the wheel is completely off the ground.

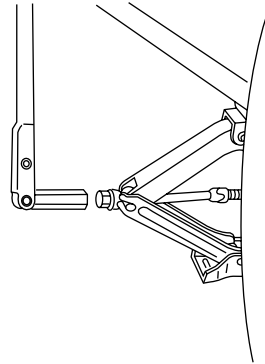

To lessen the risk of personal injury, do not put any part of your body under the vehicle while changing a tire. Do not start the engine when your vehicle is on the jack. The jack is only meant for changing the tire.

8. Remove the lug nuts with the lug wrench.

Roadside emergencies

9. Replace the flat tire with the spare tire, making sure the valve stem is facing outward. Reinstall lug nuts until the wheel is snug against the hub. Do not fully tighten the lug nuts until the wheel has been lowered.

10. Lower the wheel by turning the jack handle counterclockwise.

11. Remove the jack and fully tighten the lug nuts in the order shown.

12. Put flat tire, jack and lug wrench away in the proper stowage locations.

13. If using a mini-spare tire, turn off the traction control switch (if equipped) (located on the left hand side of the radio).

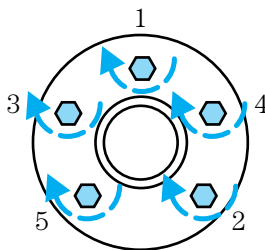

JUMP STARTING YOUR VEHICLE



The gases around the battery can explode if exposed to flames, sparks, or lit cigarettes. An explosion could result in injury or vehicle damage.



Do not push start your vehicle. You could damage the catalytic converter.



Batteries contain sulfuric acid which can burn skin, eyes, and clothing, if contacted.

Do not attempt to push start your vehicle. Automatic transmissions do not have push-start capability.

Preparing your vehicle

1. **Use only a 12-volt supply to start your vehicle.**

2. Do not disconnect the battery of the disabled vehicle as this could damage the vehicle's electrical system.

Roadside emergencies

3. Park the booster vehicle close to the hood of the disabled vehicle making sure the two vehicles **do not** touch. Set the parking brake on both vehicles and stay clear of the engine cooling fan and other moving parts.
4. Check all battery terminals and remove any excessive corrosion before you attach the battery cables. Ensure that vent caps are tight and level.
5. Turn the heater fan on in both vehicles to protect any electrical surges. Turn all other accessories off.

Connecting the jumper cables

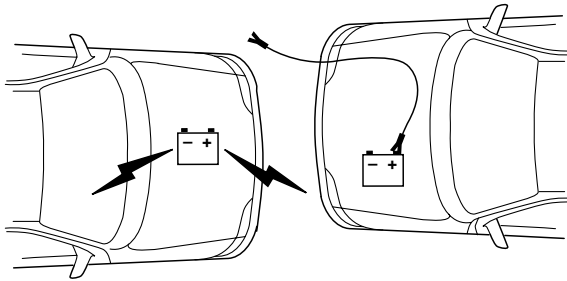

1. Connect the positive (+) booster cable to the positive (+) terminal of the discharged battery.

Note: In the illustrations, *lightning bolts* are used to designate the assisting (boosting) battery.

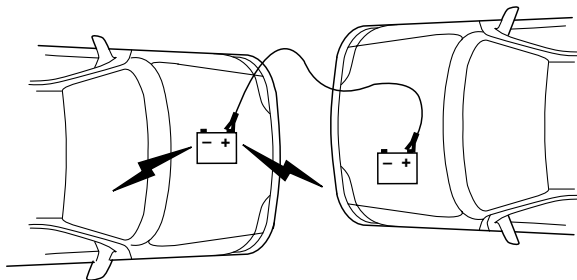

2. Connect the other end of the positive (+) cable to the positive (+) terminal of the assisting battery.

Roadside emergencies

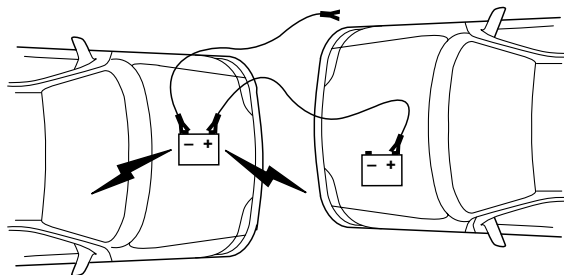

3. Connect the negative (-) cable to the negative (-) terminal of the assisting battery.

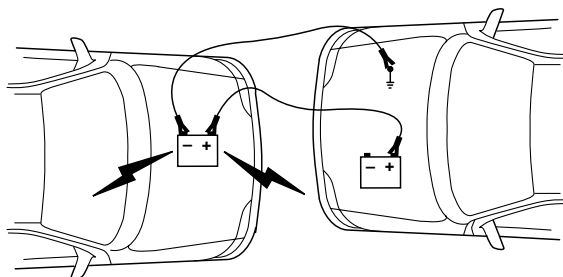

4. Make the final connection of the negative (-) cable to an exposed metal part of the stalled vehicle's engine, away from the battery and the carburetor.

The preferred locations of an exposed metal part (to *ground* the circuit) are the alternator mounting brackets or an engine lifting *eye*. **Do not** use fuel lines, engine rocker covers or the intake manifold as *grounding* points.



Do not connect the end of the second cable to the negative (-) terminal of the battery to be jumped. A spark may cause an explosion of the gases that surround the battery.

Roadside emergencies

5. Be sure that the cables are clear of fan blades, belts and other moving parts of both engines.

Jump starting

1. Start the engine of the booster vehicle and run the engine at moderately increased speed.
2. Start the engine of the disabled vehicle.
3. Once the disabled vehicle has been started, run both engines for a further three minutes before disconnecting the jumper cables.

Removing the jumper cables

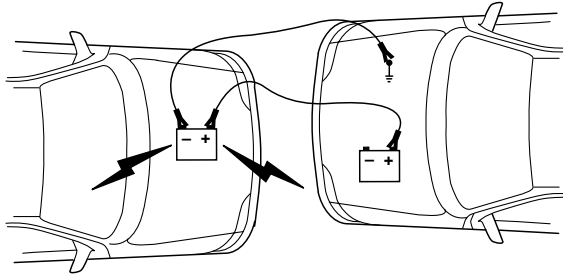

Remove the jumper cables in the reverse order that they were connected.

1. Remove the jumper cable from the *ground* metal surface.

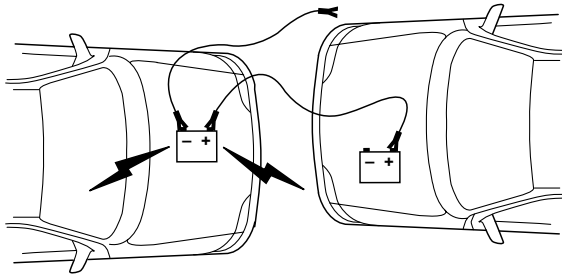

2. Remove the jumper cable on the negative (-) connection of the booster vehicle's battery.

Roadside emergencies

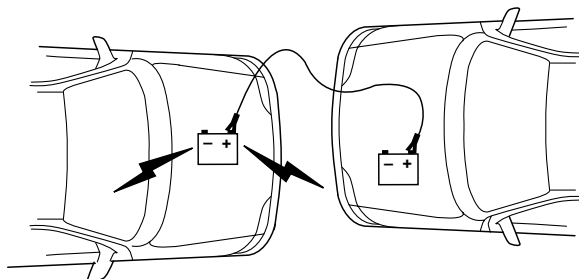

3. Remove the jumper cable from the positive (+) terminal of the booster vehicle's battery.

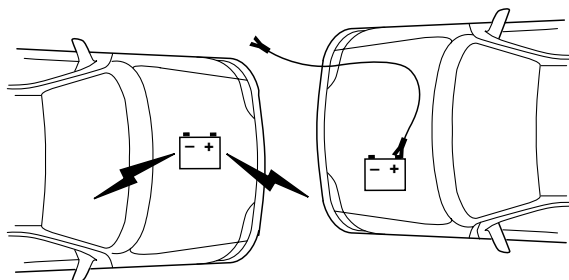

4. Remove the jumper cable from the positive (+) terminal of the disabled vehicle's battery.

After the disabled vehicle has been started and the jumper cables removed, allow it to idle for several minutes so the engine computer can *relearn* its idle conditions.

Roadside emergencies

WRECKER TOWING

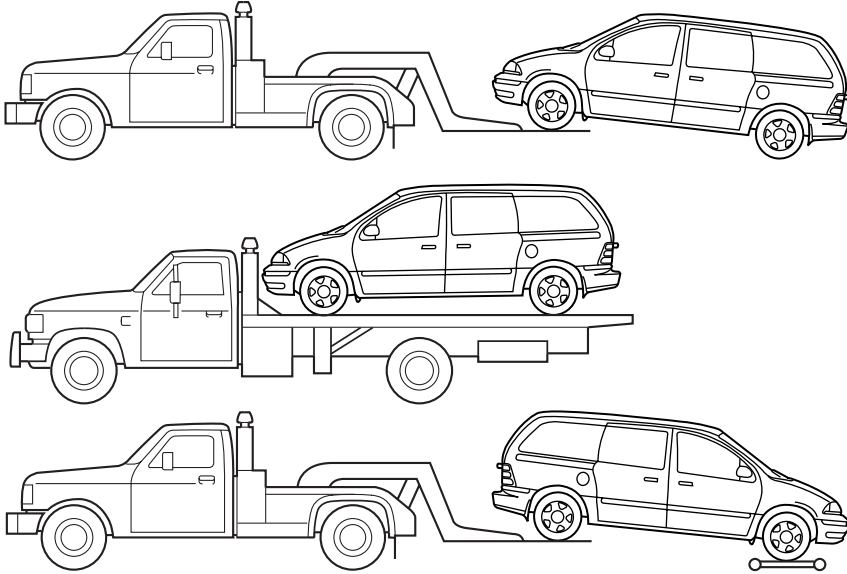

If you need to have your vehicle towed, contact a professional towing service or, if you are a member, your roadside assistance center.

It is recommended that your vehicle be towed by wheel lift or flatbed equipment. However, a slingbelt with T-hooks can also be used.

A towing manual is available from Ford Motor Company for all authorized tow truck operators. Have your tow truck driver refer to this manual for proper hook-up and towing procedures for your vehicle.

Maintenance and care

SERVICE RECOMMENDATIONS

To help you service your vehicle:

- We highlight do-it-yourself items in the engine compartment for easy location.
- We provide a Scheduled Maintenance Guide which makes tracking routine service easy.

If your vehicle requires professional service, your dealership can provide necessary parts and service. Check your “Warranty Guide” to find out which parts and services are covered.

Use only recommended fuels, lubricants, fluids and service parts conforming to specifications. Motorcraft parts are designed and built to provide the best performance in your vehicle.

PRECAUTIONS WHEN SERVICING YOUR VEHICLE

Be especially careful when inspecting or servicing your vehicle.

- Do not work on a hot engine.
- When the engine is running, make sure that loose clothing, jewelry or long hair does not get caught up in moving parts.
- Do not work on a vehicle with the engine running in an enclosed space, unless you are sure you have enough ventilation.
- Keep all lit cigarettes, open flames and other lit material away from the battery and all fuel related parts.

If you disconnect the battery, the engine must “relearn” its idle conditions before your vehicle will drive properly, as explained in *Battery* in this chapter.

Working with the engine off

1. Set the parking brake and ensure the gearshift is securely latched in P (Park).
2. Turn off the engine and remove the key.
3. Block the wheels to prevent the vehicle from moving unexpectedly.

Working with the engine on

1. Set the parking brake and ensure the gearshift is securely latched in P (Park).
2. Block the wheels to prevent the vehicle from moving unexpectedly.

Maintenance and care



Do not start your engine with the air cleaner removed and do not remove it while the engine is running.

OPENING THE HOOD

1. Inside the vehicle, pull the hood release handle located under the bottom left corner of the instrument panel.

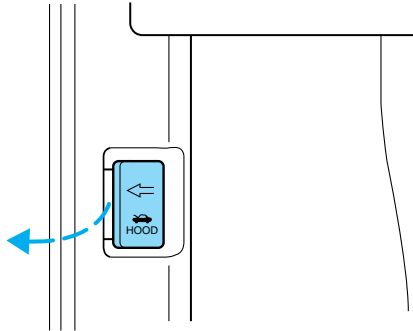

2. Go to the front of the vehicle and release the auxiliary latch that is located under the front center of the hood.

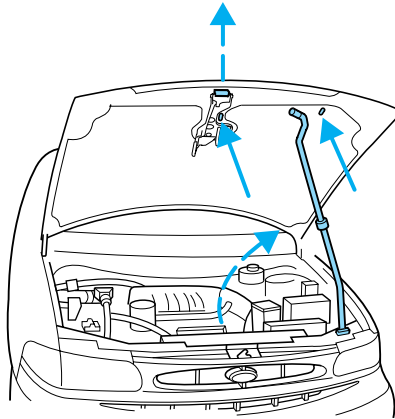

3. Lift the hood and secure it with the prop rod. Your vehicle's hood has two locations for the prop rod to be placed. These locations provide two different hood opening positions. Use the location which best suits your needs.

Maintenance and care

IDENTIFYING COMPONENTS IN THE ENGINE COMPARTMENT

3.0L V6 Vulcan engine

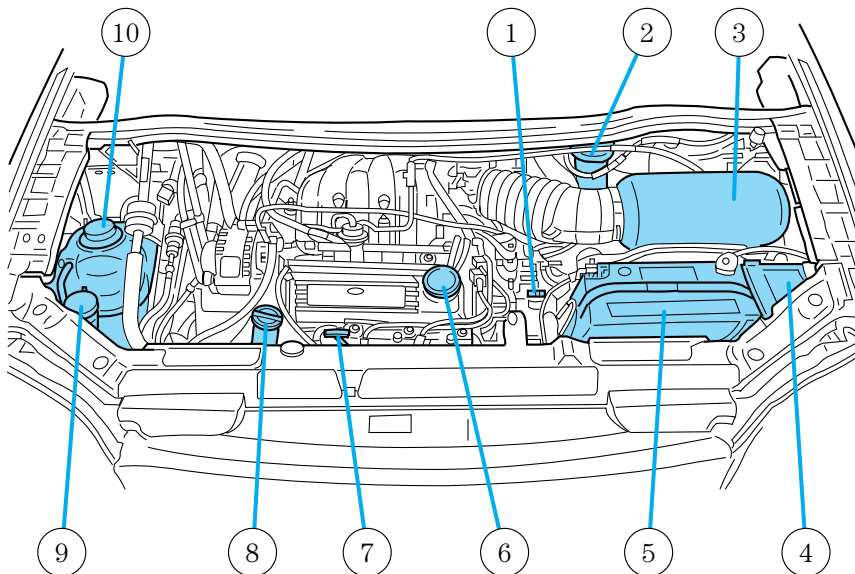

1. Automatic transmission fluid dipstick
2. Brake fluid reservoir
3. Air filter assembly
4. Power distribution box
5. Battery
6. Engine oil filler cap
7. Engine oil dipstick
8. Power steering fluid reservoir
9. Windshield washer fluid reservoir
10. Engine coolant reservoir

Maintenance and care

3.8L OHV V6 engine

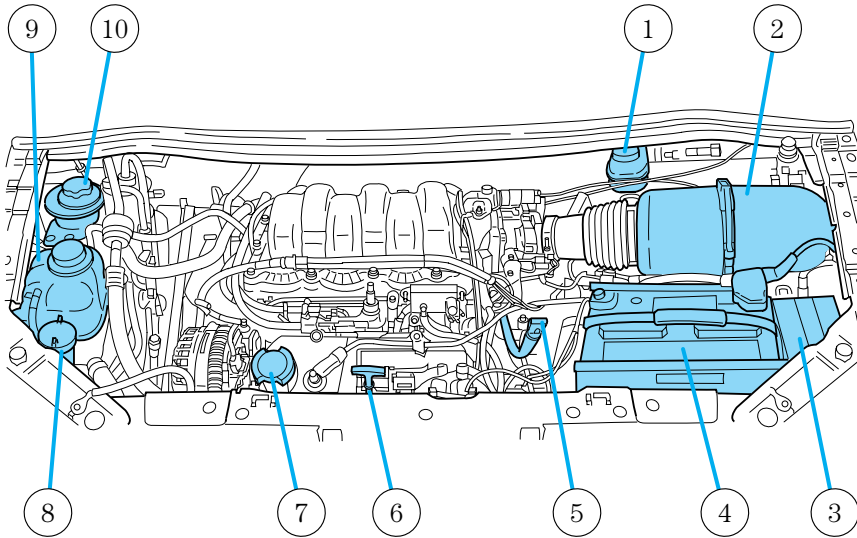

1. Brake fluid reservoir
2. Air filter assembly
3. Power distribution box
4. Battery
5. Automatic transmission fluid dipstick
6. Engine oil dipstick
7. Engine oil filler cap
8. Windshield washer fluid reservoir
9. Engine coolant reservoir
10. Power steering fluid reservoir

Maintenance and care

ENGINE OIL

Checking the engine oil

Refer to the Scheduled Maintenance Guide for the appropriate intervals for checking the engine oil.

1. Make sure the vehicle is on level ground.
2. Turn the engine off and wait a few minutes for the oil to drain into the oil pan.
3. Set the parking brake and ensure the gearshift is securely latched in P.
4. Open the hood. Protect yourself from engine heat.
5. Locate and carefully remove the engine oil indicator (dipstick).

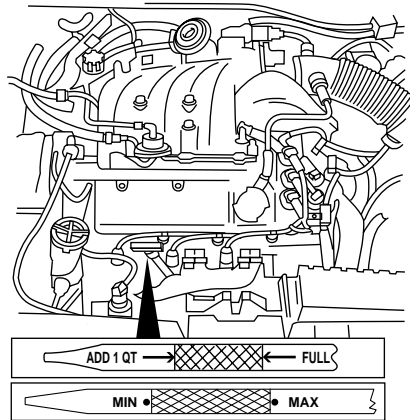

6. Wipe the indicator clean. Insert the indicator fully, then remove it again.

- If the oil level is **between the ADD and FULL marks or between the MIN and MAX marks (depending on application)**, the oil level is acceptable. **DO NOT ADD OIL.**

Maintenance and care

- If the oil level is below the ADD or MIN mark, add enough oil to raise the level within the ADD-FULL or within the MIN-MAX range.

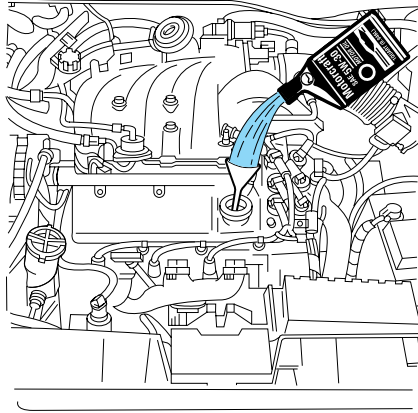

- Oil levels above the F in FULL or above the MAX mark, may cause engine damage. Some oil must be removed from the engine by a service technician.

7. Put the indicator back in and ensure it is fully seated.

Adding engine oil

1. Check the engine oil. For instructions, refer to *Checking the engine oil* in this chapter.
2. If the engine oil level is not within the normal range, add only certified engine oil of the recommended viscosity. Remove the engine oil filler cap and use a funnel to pour the engine oil into the opening.
3. Recheck the engine oil level. Make sure the oil level is not above the MAX mark or the letter F in FULL on the dipstick.

Maintenance and care

Engine oil and filter recommendations

Look for this certification mark.

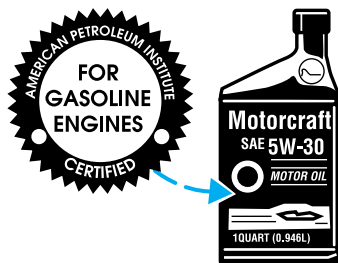

Ford oil specification is WSS-M2C153-G.

Use SAE 5W-30 motor oil certified for gasoline engines by the American Petroleum Institute.

Do not use supplemental engine oil additives, oil treatments or engine treatments. They are unnecessary and could, under certain conditions, lead to engine damage which is not covered by your warranty.

Change your engine oil and filter according to the appropriate schedule listed in the Scheduled Maintenance Guide.

Ford production and aftermarket (Motorcraft) oil filters are designed for added engine protection and long life. If a replacement oil filter is used that does not meet Ford material and design specifications, startup engine noises or knock may be experienced.

It is recommended you use the appropriate Motorcraft oil filter (or another brand meeting Ford specifications) for your engine application.

Maintenance and care

BRAKE FLUID

Checking and adding brake fluid

Brake fluid should be checked and refilled as needed. Refer to the Scheduled Maintenance Guide for the service interval schedules:

1. Clean the reservoir cap before removal to prevent dirt or water from entering the reservoir.
2. Visually inspect the fluid level.
3. If necessary, add brake fluid until the level reaches MAX. Do not fill above this line.
4. Use only brake fluids certified to meet Ford specifications. Refer to *Lubricant specifications* in the *Capacities and specifications* chapter. DOT 3 fluid is recommended. However, if DOT 3 is not available, DOT 4 fluid can be used.

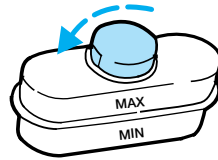
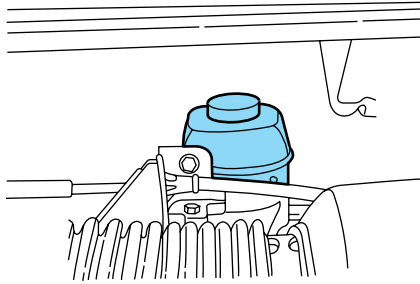

Brake fluid is toxic.



If you use DOT 5 or any other brake fluid that is not DOT 3 or DOT 4, you will cause permanent damage to your brakes.



Do not let the fluid level in the reservoir for the master cylinder fall below the MIN mark. If master cylinder runs dry, this may cause the brakes to fail.

Maintenance and care

WINDSHIELD WASHER FLUID

Checking and adding washer fluid

Check the washer fluid whenever you stop for fuel. The reservoir is highlighted with a  symbol.

If the level is low, add enough fluid to fill the reservoir. In very cold weather, do not fill the reservoir all the way.

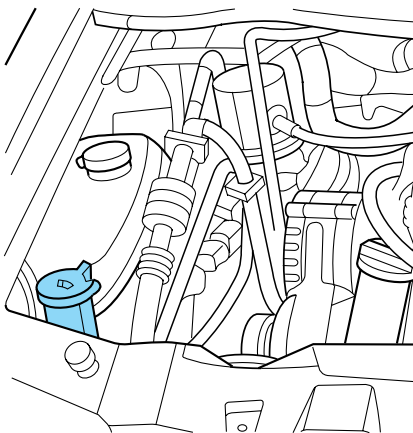

Do not put engine coolant in the container for the windshield washer fluid.

Checking and adding washer fluid for the liftgate

Washer fluid for the liftgate is supplied by the same reservoir as the windshield.

Maintenance and care

ENGINE COOLANT

Check the level of the engine coolant in the reservoir. Refer to the Scheduled Maintenance Guide for service interval schedules. Be sure to read and understand *Precautions when servicing your vehicle* in this chapter.

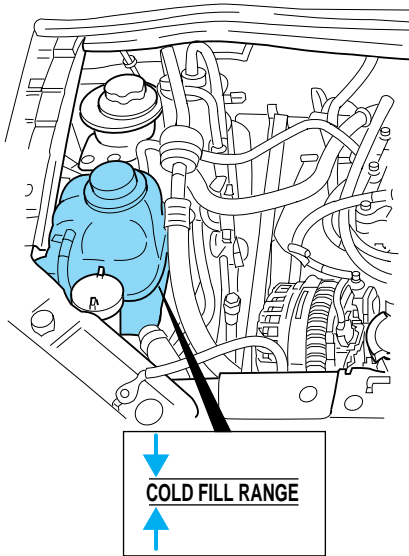

If the engine coolant has not been checked at the recommended interval, the engine coolant reservoir may become empty. If this occurs, add engine coolant to the reservoir. For more information on engine coolant maintenance, refer to *Adding engine coolant* in this chapter.

Automotive fluids are not interchangeable; do not use engine coolant, antifreeze or windshield washer fluid outside of its specified function and vehicle location.

Adding engine coolant



Do not put engine coolant in the container for the windshield washer fluid.

Do not mix conventional green coolant, orange coolant or recycled coolants together in your vehicle. Use only the type of coolant that your vehicle was originally equipped with. If you are unsure which type of coolant your vehicle requires, contact your local dealer.

Maintenance and care

If sprayed on the windshield, engine coolant could make it difficult to see through the windshield.

When the engine is cool, add a 50/50 mixture of engine coolant and water to the engine coolant reservoir-DO NOT ADD DIRECTLY TO THE RADIATOR. Add straight water only in an emergency, but you should replace it with a 50/50 mixture of coolant and distilled water as soon as possible.

Check the coolant level in the coolant reservoir the next few times you drive the vehicle. If necessary, add enough of a 50/50 mixture of coolant and water to bring the liquid level to the fill line on the reservoir.



Never remove the coolant reservoir cap while the engine is running or hot.

If you must remove the coolant reservoir cap, follow these steps to avoid personal injury:

1. Before you remove the cap, turn the engine off and let it cool.
2. When the engine is cool, wrap a thick cloth around the cap. Slowly turn cap counterclockwise until pressure begins to release.
3. Step back while the pressure releases.
4. When you are sure that all the pressure has been released, use the cloth to turn it counterclockwise and remove the cap.

Change your engine coolant according to the appropriate schedule listed in the Scheduled Maintenance Guide.

Before adding engine coolant, check the color of the coolant in your vehicle.

For vehicles with green coolant, use Ford Premium Cooling System Fluid E2FZ-19549-AA (in Canada, Motorcraft CXC-8-B) or an equivalent premium engine coolant that meets Ford specification ESE-M97B44-A.

Do not add orange coolant or recycled coolant to your vehicle originally equipped with conventional green coolant.

For vehicles with orange coolant, use Ford Extended Life Engine Coolant F6AZ-19544-AA or a DEX-COOL® equivalent that meets Ford specification WSS-M97B44-D.

Do not add conventional green coolant or recycled coolant to your vehicle originally equipped with orange coolant.

Maintenance and care

Do not use alcohol or methanol antifreeze or any engine coolants mixed with alcohol or methanol antifreeze. Do not use supplemental coolant additives in your vehicle. These additives may harm your engine cooling system. The use of an improper coolant may void your warranty of your vehicle's engine cooling system.

Recycled engine coolant

Ford Motor Company recommends that Ford and Lincoln-Mercury dealers use recycled engine coolant produced by Ford-approved processes.

For vehicles with green coolant, not all coolant recycling processes produce coolant which meets Ford specification ESE-M97B44-A, and use of such coolant may harm engine and cooling system components.

For vehicles with orange coolant, no recycling process has been approved at this time and use of such coolant may harm engine and cooling system components.



Always dispose of used automotive fluids in a responsible manner. Follow your community's regulations and standards for recycling and disposing of automotive fluids.

Coolant refill capacity

To find out how much fluid your vehicle's cooling system can hold, refer to *Refill capacities* in the *Capacities and specifications* chapter.

Have your dealer check the engine cooling system for leaks if you have to add more than 1.0 liter (1.0 quart) of engine coolant per month.

Severe winter climate

If you drive in extremely cold climates (less than -36°C [-34°F]), it may be necessary to increase the coolant concentration above 50%. Refer to the chart on the coolant container to ensure the coolant concentration in your vehicle is such that the coolant will not freeze at the temperature level in which you drive during winter months. Never increase the engine coolant concentration above 60%. Leave a 50/50 mixture of engine coolant and water in your vehicle year-round in non-extreme climates.

Maintenance and care

CHECKING AND ADDING POWER STEERING FLUID

- 3.0L V6 Vulcan engine

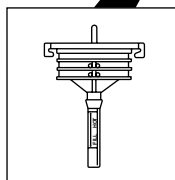
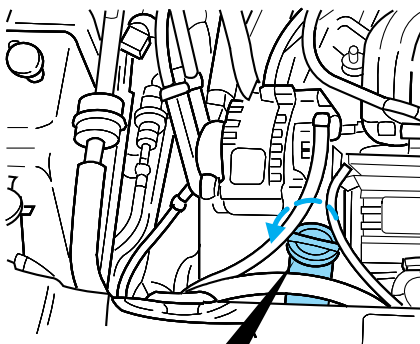

- 3.8L OHV V6 engine

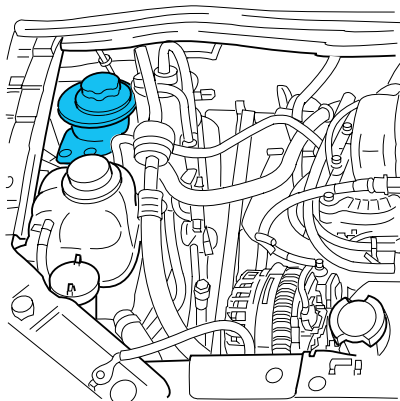

Check the power steering fluid. Refer to the Scheduled Maintenance Guide for the service interval schedules. If adding fluid is necessary, use only MERCON® ATF.

Maintenance and care

1. Start the engine and let it run until it reaches normal operating temperature (the engine coolant temperature gauge indicator will be near the center of the normal area between H and C).
2. While the engine idles, turn the steering wheel left and right several times.
3. Turn the engine off.
4. **If your vehicle is equipped with the 3.0L V6 Vulcan engine,** check the fluid level on the dipstick. It should be between the arrows in the FULL HOT range. Do not add fluid if the level is within this range.

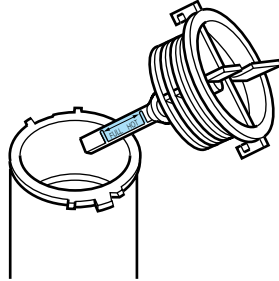

5. **If your vehicle is equipped with the 3.8L OHV V6 engine,** check the fluid level in the reservoir. It should be between the MIN and MAX lines. Do not add fluid if the level is within this range.
6. If the fluid is low, add fluid in small amounts, continuously checking the level until it reaches the correct operating range. Be sure to put the cap back on the reservoir.

TRANSMISSION FLUID

Checking automatic transmission fluid

Refer to your Scheduled Maintenance Guide for scheduled intervals for fluid checks and changes. Your transaxle does not consume fluid. However, the fluid level should be checked if the transaxle is not working properly, i.e., if the transaxle slips or shifts slowly or if you notice some sign of fluid leakage.

Automatic transmission fluid expands when warmed. To obtain an accurate fluid check, drive the vehicle until it is warmed up (approximately 30 km [20 miles]). If your vehicle has been operated for an extended period at high speeds, in city traffic during hot weather or pulling a trailer, the vehicle should be turned off for about 30 minutes to allow fluid to cool before checking.

Maintenance and care

1. Drive the vehicle 30 km (20 miles) or until it reaches normal operating temperature.
2. Park the vehicle on a level surface and engage the parking brake.
3. With the parking brake engaged and your foot on the brake pedal, start the engine and move the gearshift lever through all of the gear ranges. Allow sufficient time for each gear to engage.
4. Latch the gearshift lever in P (Park) and leave the engine running.
5. Remove the dipstick, wiping it clean with a clean, dry lint free rag.
6. Install the dipstick making sure it is fully seated in the filler tube.
7. Remove the dipstick and inspect the fluid level. The fluid should be in the designated areas for normal and room temperature.

Low fluid level

Do not drive the vehicle if the fluid level is at the bottom of the dipstick and the outside temperatures are above 10°C (50°F).



Correct fluid level

The transmission fluid should be checked at normal operating temperatures 66°C-77°C (150°F-170°F) on a level surface. The normal operating temperature can be reached after approximately 30 km (20 miles) of driving.

The transmission fluid should be in this range if at normal operating temperature (66°C-77°C [150°F-170°F]).



High fluid level

Fluid levels above the safe range may result in transaxle failure. An overfill condition of transmission fluid may cause shift and/or engagement concerns and/or possible damage.

High fluid levels can be caused by an overheating condition.



Maintenance and care

Adjusting automatic transmission fluid levels

Before adding any fluid, make sure the correct type is used. The type of fluid used is normally indicated on the dipstick and/or dipstick handle and also in the *Lubricant specifications* section in the *Capacities and specifications* chapter.

Use of a non-approved automatic transmission fluid may cause internal transaxle component damage.

If necessary, add fluid in 250 mL (1/2 pint) increments through the filler tube until the level is correct.

If an overfill occurs, excess fluid should be removed by a qualified technician.



An overfill condition of transmission fluid may cause shift and/or engagement concerns and/or possible damage.

CABIN AIR FILTER

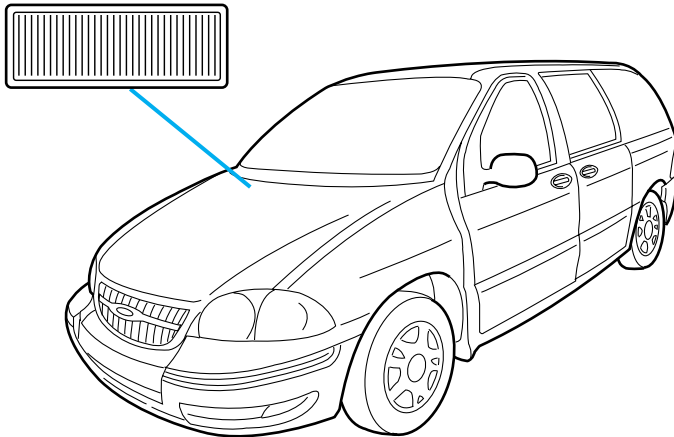

The cabin air filter restricts the entry of airborne dust and pollen particles. The filter is located just in front of the windshield under the cowl vent screen on the passenger side of the vehicle.

Maintenance and care

To replace the filter, perform the following procedure:

1. Release and open the hood.

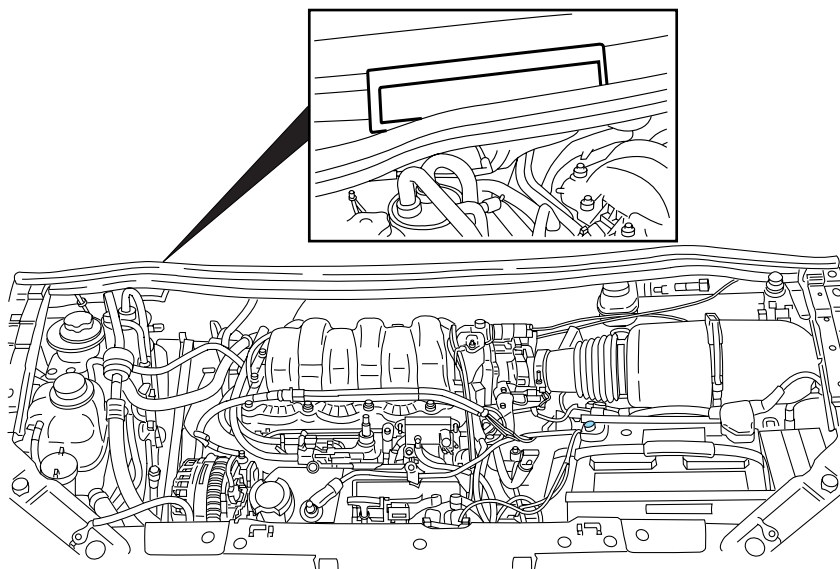
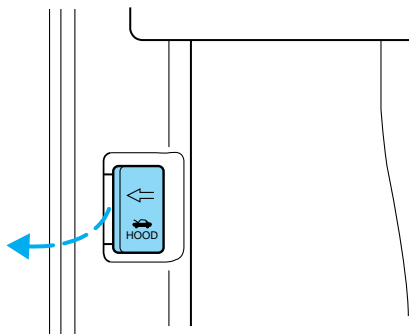

2. Locate the cabin air filter.

Maintenance and care

3. Remove the cabin air filter access cover.

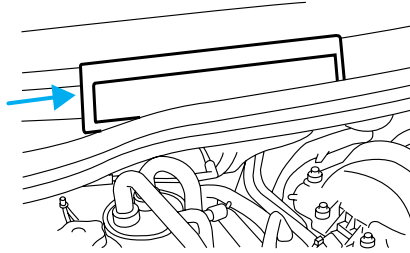

4. Lift and remove the cabin air filter.

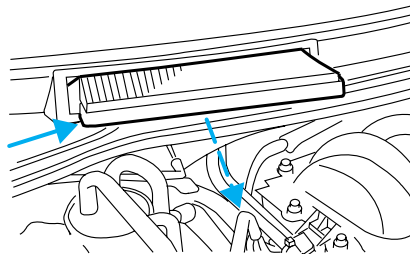

5. Slide the new filter into the filter opening, ensuring proper orientation of the filter. The black rubber seal around the filter perimeter should be closer to the bottom of the opening when installed.

6. With your fingertips, ensure that the filter is pushed down properly. The filter is seated when it fits snugly into the filter housing.

7. Reinstall the access cover.

Maintenance and care

BATTERY

Your vehicle is equipped with a Motorcraft maintenance-free battery which normally does not require additional water during its life of service.

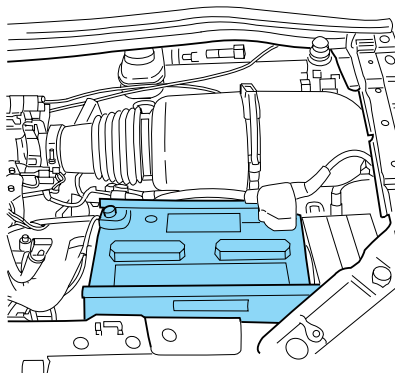

However, for severe usage or in high temperature climates, check the battery electrolyte level. Refer to the Scheduled Maintenance Guide for the service interval schedules.

Keep the electrolyte level in each cell up to the “level indicator”. Do not overfill the battery cells.

If the electrolyte level in the battery is low, you can add plain tap water to the battery, as long as you do not use hard water (water with a high mineral or alkali content). If possible, however, try to only fill the battery cells with distilled water. If the battery needs water often, have the charging system checked.

If your battery has a cover/shield, make sure it is reinstalled after the battery has been cleaned or replaced.

For longer, trouble-free operation, keep the top of the battery clean and dry. Also, make certain the battery cables are always tightly fastened to the battery terminals.

If you see any corrosion on the battery or terminals, remove the cables from the terminals and clean with a wire brush. You can neutralize the acid with a solution of baking soda and water.

Maintenance and care



Batteries normally produce explosive gases which can cause personal injury. Therefore, do not allow flames, sparks or lighted substances to come near the battery. When working near the battery, always shield your face and protect your eyes. Always provide proper ventilation.



When lifting a plastic-cased battery, excessive pressure on the end walls could cause acid to flow through the vent caps, resulting in personal injury and/or damage to the vehicle or battery. Lift the battery with a battery carrier or with your hands on opposite corners.



Keep batteries out of reach of children. Batteries contain sulfuric acid. Avoid contact with skin, eyes or clothing. Shield your eyes when working near the battery to protect against possible splashing of acid solution. In case of acid contact with skin or eyes, flush immediately with water for a minimum of 15 minutes and get prompt medical attention. If acid is swallowed, call a physician immediately.

To account for customer driving habits and conditions, your automatic transaxle electronically controls the shift feel by using an adaptive learning strategy. This feature is designed to optimize shift smoothness. It is normal for your transaxle to shift abruptly during the first few hundred kilometers (miles) of operation until the adaptive strategy has been learned. The adaptive learning strategy is maintained by power from the battery. When the battery is disconnected or a new battery is installed, the transaxle must relearn its adaptive strategy. Optimal shifting will resume within a few hundred kilometers (miles) of operation.

Because your vehicle's engine is electronically controlled by a computer, some control conditions are maintained by power from the battery. When the battery is disconnected or a new battery is installed, the engine must relearn its idle and fuel trim strategy for optimum driveability and performance. To begin this process:

1. Set your parking brake.
2. Put the gearshift in P (Park), turn off all accessories and start the engine.
3. Let the engine idle for at least one minute.

Maintenance and care

4. The relearning process will automatically complete as you drive the vehicle.
- The vehicle may need to be driven 16 km (10 miles) or more to relearn the idle and fuel trim strategy.
 - If you do not allow the engine to relearn its idle trim, the idle quality of your vehicle may be adversely affected until the idle trim is eventually relearned.

If the battery has been disconnected or a new battery has been installed, the clock and the preset radio stations must be reset once the battery is reconnected.

If the battery has been discharged, disconnected or a new battery has been installed, the power sliding door may need to be reset. Refer to *Power Sliding Door-Resetting the PSD* in the *Controls and Features* chapter.

- Always dispose of automotive batteries in a responsible manner. Follow your local authorized standards for disposal. Call your local authorized recycling center to find out more about recycling automotive batteries.

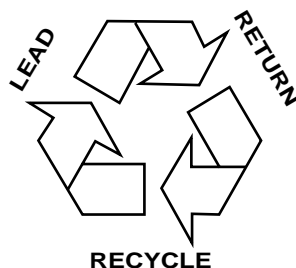

WINDSHIELD WIPER BLADES

Check the wiper blades at least twice a year or when they seem less effective. Substances such as tree sap and some hot wax treatments used by commercial car washes reduce the effectiveness of wiper blades.

Checking the wiper blades

If the wiper blades do not wipe properly, clean both the windshield and wiper blades using undiluted windshield wiper solution or a mild detergent. Rinse thoroughly with clean water. To avoid damaging the blades, do not use fuel, kerosene, paint thinner or other solvents.

Maintenance and care

Changing the wiper blades

To replace the wiper blades:

1. Pull the wiper arm away from the windshield and lock into the service position.
2. Turn the blade at an angle from the wiper arm. Push the lock pin manually to release the blade and pull the wiper blade down toward the windshield to remove it from the arm.
3. Attach the new wiper to the wiper arm and press it into place until a click is heard.

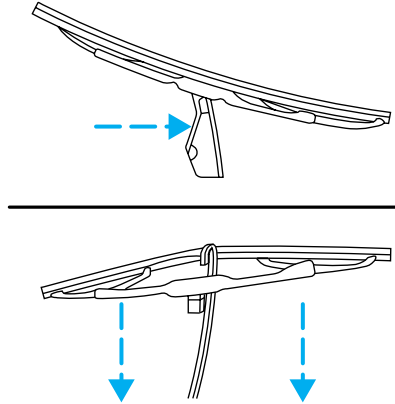

INFORMATION ABOUT TIRE QUALITY GRADES

New vehicles are fitted with tires that have their Tire Quality Grade (described below) molded into the tire's sidewall. These Tire Quality Grades are determined by standards that the United States Department of Transportation has set.

Tire Quality Grades apply to new pneumatic tires for use on passenger cars. They do not apply to deep tread, winter-type snow

tires, space-saver or temporary use spare tires, tires with nominal rim diameters of 10 to 12 inches or limited production tires as defined in Title 49 Code of Federal Regulations Part 575.104(c)(2).

U.S. Department of Transportation-Tire quality grades: The U.S. Department of Transportation requires Ford to give you the following information about tire grades exactly as the government has written it.

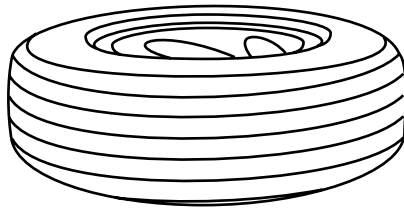

Maintenance and care

Treadwear

The treadwear grade is a comparative rating based on the wear rate of the tire when tested under controlled conditions on a specified government test course. For example, a tire graded 150 would wear one and one-half (1 1/2) times as well on the government course as a tire graded 100. The relative performance of tires depends upon the actual conditions of their use, however, and may depart significantly from the norm due to variations in driving habits, service practices, and differences in road characteristics and climate.

Traction AA A B C

The traction grades, from highest to lowest are AA, A, B, and C. Those grades represent the tire's ability to stop on wet pavement as measured under controlled conditions on specified government test surfaces of asphalt and concrete. A tire marked C may have poor traction performance.



The traction grade assigned to this tire is based on straight-ahead braking traction tests, and does not include acceleration, cornering, hydroplaning or peak traction characteristics.

Temperature A B C

The temperature grades are A (the highest), B, and C, representing the tire's resistance to the generation of heat and its ability to dissipate heat when tested under controlled conditions on a specified indoor laboratory test wheel. Sustained high temperature can cause the material of the tire to degenerate and reduce tire life, and excessive temperature can lead to sudden tire failure. The grade C corresponds to a level of performance which all passenger car tires must meet under the Federal Motor Vehicle Safety Standard No. 109. Grades B and A represent higher levels of performance on the laboratory test wheel than the minimum required by law.



The temperature grade for this tire is established for a tire that is properly inflated and not overloaded. Excessive speed, underinflation, or excessive loading, either separately or in combination, can cause heat buildup and possible tire failure.

Maintenance and care

SERVICING YOUR TIRES

Checking the tire pressure

- Use an accurate tire pressure gauge.
- Check the tire pressure when tires are cold, after the vehicle has been parked for at least one hour or has been driven less than 5 km (3 miles).
- Adjust tire pressure to recommended specifications found on the Safety Compliance Certification Label located on the B-pillar.



Improperly inflated tires can affect vehicle handling and can fail suddenly, possibly resulting in loss of vehicle control.

Tire rotation

Because your vehicle's tires perform different jobs, they often wear differently. To make sure your tires wear evenly and last longer, rotate them as indicated in the Schedule maintenance guide. If you notice that the tires wear unevenly, have them checked.

- Four tire rotation

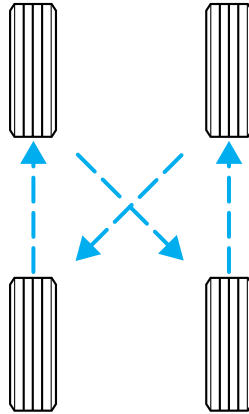



Maintenance and care

Replacing the tires

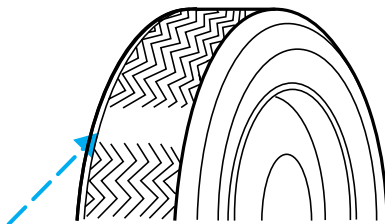
Replace the tires when the wear band is visible through the tire treads.



 When replacing full size tires, never mix radial, bias-belted, or bias-type tires. Use only the tire sizes that are listed on the tire pressure decal. Make sure that all tires are the same size, speed rating, and load-carrying capacity. Use only the tire combinations recommended on the decal. If you do not follow these precautions, your vehicle may not drive properly and safely.

 Make sure that all replacement tires are of the same size, type, load-carrying capacity and tread design (e.g., “All Terrain”, etc.), as originally offered by Ford.

 Do not replace your tires with “high performance” tires or larger size tires.

 Failure to follow these precautions may adversely affect the handling of the vehicle and make it easier for the driver to lose control and roll over.

Tires that are larger or smaller than your vehicle’s original tires may also affect the accuracy of your speedometer.

Maintenance and care

SNOW TIRES AND CHAINS



Driving too fast for conditions creates the possibility of loss of vehicle control. Driving at very high speeds for extended periods of time may result in damage to vehicle components.



Snow tires must be the same size and grade as the tires you currently have on your vehicle.

The tires on your vehicle have all weather treads to provide traction in rain and snow. However, in some climates, you may need to use snow tires and chains. If you need to use chains, it is recommended that steel wheels (of the same size and specifications) be used as chains may chip aluminum wheels.

Follow these guidelines when using snow tires and chains:

- Do not use tire chains with size P225/60R16 or P215/70R15 tires.
- Use only SAE Class S chains.
- Install chains securely, verifying that the chains do not touch any wiring, brake lines or fuel lines.
- Drive cautiously. If you hear the chains rub or bang against your vehicle, stop and re-tighten the chains. If this does not work, remove the chains to prevent damage to your vehicle.
- If possible, avoid fully loading your vehicle.
- Remove the tire chains when they are no longer needed. Do not use tire chains on dry roads.
- The suspension insulation and bumpers will help prevent vehicle damage. Do not remove these components from your vehicle when using snow tires and chains.

Maintenance and care

WHAT YOU SHOULD KNOW ABOUT AUTOMOTIVE FUELS

Important safety precautions



Do not overfill the fuel tank. The pressure in an overfilled tank may cause leakage and lead to fuel spray and fire.



If you do not use the proper fuel cap, the pressure in the fuel tank can damage the fuel system or cause it to work improperly in a collision.



The fuel system may be under pressure. If the fuel cap is venting vapor or if you hear a hissing sound, wait until it stops before completely removing the cap.



Automotive fuels can cause serious injury or death if misused or mishandled.

Observe the following guidelines when handling automotive fuel:

- Extinguish all smoking materials and any open flames before fueling your vehicle.
- Always turn off the vehicle before fueling.
- Automotive fuels can be harmful or fatal if swallowed. Fuel such as gasoline is highly toxic and if swallowed can cause death or permanent injury. If fuel is swallowed, call a physician immediately, even if no symptoms are immediately apparent. The toxic effects of fuel may not be visible for hours.
- Avoid inhaling fuel vapors. Inhaling too much fuel vapor of any kind can lead to eye and respiratory tract irritation. In severe cases, excessive or prolonged breathing of fuel vapor can cause serious illness and permanent injury.

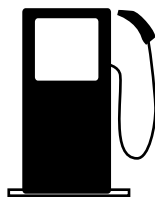

Maintenance and care

- Avoid getting fuel liquid in your eyes. If fuel is splashed in the eyes, remove contact lenses (if worn), flush with water for 15 minutes and seek medical attention. Failure to seek proper medical attention could lead to permanent injury.
- Fuels can also be harmful if absorbed through the skin. If fuel is splashed on the skin and/or clothing, promptly remove contaminated clothing and wash skin thoroughly with soap and water. Repeated or prolonged skin contact with fuel liquid or vapor causes skin irritation.
- Be particularly careful if you are taking “Antabuse” or other forms of disulfiram for the treatment of alcoholism. Breathing gasoline vapors, or skin contact could cause an adverse reaction. In sensitive individuals, serious personal injury or sickness may result. If fuel is splashed on the skin, promptly wash skin thoroughly with soap and water. Consult a physician immediately if you experience an adverse reaction.

Fuel Filler Cap

Your fuel tank filler cap has an indexed design with a one-eighth turn on/off feature.

When fueling your vehicle:

1. Turn the engine off.
2. Carefully turn the filler cap counterclockwise 1/8 of a turn until it stops.
3. Pull to remove the cap from the fuel filler pipe.
4. To install the cap, align the tabs on the cap with the notches on the filler pipe.
5. Turn the filler cap clockwise 1/8 of a turn until it stops.

If the “Service Engine Soon/Check Engine” indicator comes on and stays on when you start the engine, the fuel filler cap may not be properly installed. Turn off the engine, remove the fuel filler cap and reinstall it being careful to align the cap properly.

If you must replace the fuel filler cap, replace it with a genuine Ford or Motorcraft part. The customer warranty may be void for any damage to the fuel tank or fuel system if a genuine Ford or Motorcraft fuel filler cap is not used.

Maintenance and care



The fuel system may be under pressure. If the fuel filler cap is venting vapor or if you hear a hissing sound, wait until it stops before completely removing the fuel filler cap. Otherwise, fuel may spray out and injure you or others.



If you do not use the proper fuel filler cap, the pressure in the fuel tank can damage the fuel system or cause it to work improperly in a collision.

Choosing the right fuel

Use only UNLEADED FUEL. The use of leaded fuel is prohibited by law and could damage your vehicle.

Do not use gasolines containing methanol. It can damage critical fuel systems components.

Vehicles certified to meet California emission standards (indicated on the underhood Vehicle Emissions Control Information label) are designed to operate on California cleaner-burning, low-sulfur gasolines. If you have a California-certified vehicle and California cleaner-burning gasoline is not available when you refuel, your engine should perform adequately.

However, the performance of the emission control devices and systems may be adversely affected. In New York and Massachusetts, which have adopted California's emission standards without requiring the sale of California cleaner-burning gasoline, repairs to correct the effects of using non-California fuel may not be covered by the emissions warranty.

Your vehicle was not designed to use fuel or fuel additives with metallic compounds, including manganese-based compounds containing (MMT).

Repairs to correct the effects of using a fuel for which your vehicle was not designed may not be covered by your warranty.

Maintenance and care

Octane recommendations

Your vehicle is designed to use “Regular” unleaded gasoline with an (R+M)/2 octane rating of 87. We do not recommend the use of gasolines labeled as “Regular” that are sold with octane ratings of 86 or lower in high altitude areas.

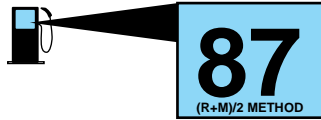

Do not be concerned if your engine sometimes knocks lightly. However, if it knocks heavily under most driving conditions while you are using fuel with the recommended octane rating, see your dealer or a qualified service technician to prevent any engine damage.

Fuel quality

If you are experiencing starting, rough idle or hesitation driveability problems during a cold start, try a different brand of “Regular” unleaded gasoline. “Premium” unleaded gasoline is not recommended (particularly in the United States) because it may cause these problems to become more pronounced. If the problems persist, see your dealer or a qualified service technician.

The American Automobile Manufacturers Association (AAMA) issued a fuel specification to provide information on high quality fuels that optimize the performance of your vehicle. We recommend the use of fuels that meet the AAMA specification if they are available.

It should not be necessary to add any aftermarket products to your fuel tank if you continue to use a high-quality fuel.

Cleaner air

Ford approves the use of gasolines to improve air quality, including reformulated gasolines that contain oxygenates up to 10% ethanol or 15% MTBE.

Maintenance and care

Running out of fuel

Avoid running out of fuel because this situation may have an adverse effect on powertrain components.

If you have run out of fuel:

- You may need to crank the engine several times before the system starts to pump fuel from the tank to the engine.
- Your “Check Engine” light may come on. For more information on the “Check Engine” light, refer to the *Instrumentation* chapter.

Fuel Filter

Your vehicle is equipped with a fuel filter that is mounted on the underbody.

For fuel filter replacement, see your dealer or a qualified service technician. Refer to the Scheduled Maintenance Guide for the appropriate intervals for changing the fuel filter.

If you replace the fuel filter, replace it with an authorized Motorcraft part. The customer warranty may be void for any damage to the fuel system if an authorized Motorcraft fuel filter is not used.

ESSENTIALS OF GOOD FUEL ECONOMY

Measuring techniques

Your best source of information about actual fuel economy is you, the driver. You must gather information as accurately and consistently as possible. Fuel expense, frequency of fillups or fuel gauge readings are NOT accurate as a measure of fuel economy. We do not recommend taking fuel economy measurements during the first 1 600 km (1 000 miles) of driving (engine break-in period). You will get a more accurate measurement after 3 000 km–5 000 km (2 000 miles–3 000 miles).

The advertised fuel capacity of the fuel tank on your vehicle is equal to the rated refill capacity of the fuel tank as listed in the Refill Capacities chart in this “Owner Guide.” The advertised capacity is the amount of the Indicated Capacity and the Empty Reserve combined. Indicated Capacity is the difference in the amount of fuel in a full tank and a tank when the fuel gauge indicates empty. Empty Reserve is the small amount of usable fuel remaining in the fuel tank after the fuel gauge indicates empty.

Maintenance and care

The amount of Empty Reserve varies and should not be relied upon to increase driving range. When refueling your vehicle after the fuel gauge indicates empty, you might not be able to refuel the full amount of the advertised capacity of the fuel tank due to the empty reserve still present in the tank.

Filling the tank

For consistent results:

- Use the same filling rate setting (low — medium — high) each time the tank is filled.
- Allow three automatic click-offs when filling.
- Always use the recommended octane rating of a known quality gasoline, preferably a national brand.
- Use the same side of the same pump and have the vehicle facing the same direction each time you fill up.
- Have the vehicle loading and distribution the same every time.

Your results will be most accurate if your filling method is consistent.

Calculating fuel economy

1. Fill the fuel tank completely and record the initial odometer reading.
2. Each time you fill the tank, record the amount of fuel added (in liters or gallons).
3. After at least three to five tank fill-ups, fill the fuel tank and record the current kilometer (mileage) reading.
4. Follow one of the simple calculations in order to determine fuel economy:

Multiply liters used by 100, then divide by total kilometers traveled.

Divide total miles traveled by total gallons used.

Keep a record for at least one month and record the type of driving (city or highway). This will provide an accurate estimate of the vehicle's fuel economy. Additionally, keeping records during summer and winter will show how temperature impacts fuel economy. In general, lower temperatures give lower fuel economy.

Maintenance and care

Driving style — good driving and fuel economy habits

Give consideration to the lists that follow and you may be able to change a number of variables and improve your fuel economy.

Habits

- Smooth, moderate operation can yield up to 10% savings in fuel.
- Steady speeds without stopping will usually give the best fuel economy.
- Idling for long periods of time (greater than one minute) may waste fuel.
- Anticipate stopping; slowing down may eliminate the need to stop.
- Sudden or hard accelerations may reduce fuel economy.
- Slow down gradually.
- Drive at reasonable speeds (traveling at 105 km /h [65 mph] uses 15% more fuel than traveling at 88 km/h [55 mph]).
- Revving the engine before turning it off may reduce fuel economy.
- Use of the air conditioner or defroster may reduce fuel economy.
- Use of speed control (if equipped) may improve fuel economy. Speed control can help maintain a constant speed and reduce speed changes. You may want to turn off the speed control in hilly terrain as unnecessary shifting between third and fourth gears may occur and could result in reduced fuel economy.
- Warming up a vehicle on cold mornings is not required and may reduce fuel economy.
- Resting your foot on the brake pedal while driving may reduce fuel economy.
- Combine errands and minimize stop-and-go driving.

Maintenance and care

Maintenance

- Keep tires properly inflated and use only recommended size.
- Operating a vehicle with the wheels out of alignment will reduce fuel economy.
- Use recommended engine oil. Refer to *Lubricant Specifications*.
- Perform all regularly scheduled maintenance items. Follow the recommended maintenance schedule and owner maintenance checks found in your vehicle Scheduled Maintenance Guide.

Conditions

- Heavily loading a vehicle or towing a trailer may reduce fuel economy at any speed.
- Carrying unnecessary weight may reduce fuel economy (approximately 2 km/h [1 mpg] is lost for every 180 kg [400 lb] of weight carried).
- Adding certain accessories to your vehicle (for example bug deflectors, rollover/light bars, running boards, ski/luggage racks) may reduce fuel economy.
- Use of fuel blended with alcohol may lower fuel economy.
- Fuel economy may decrease with lower temperatures during the first 12–16 km (8–10 miles) of driving.
- Flat terrain driving improves fuel economy over hilly roads.
- Transmissions give their best fuel economy when operated in the top cruise gear and with steady pressure on the gas pedal.
- Close windows for high speed driving.

EPA window sticker

Every new vehicle should have the EPA window sticker. Contact your dealer if the window sticker is not supplied with your vehicle. The EPA window sticker should be your guide for the fuel economy comparisons with other vehicles.

It is important to note the box in the lower left corner of the window sticker. These numbers represent the Range of Km/L (MPG) expected on the vehicle, depending upon the driver's method of operation and conditions.

Maintenance and care

EMISSION CONTROL SYSTEM

Your vehicle is equipped with various emission control components and a catalytic converter which will enable your vehicle to comply with applicable exhaust emission standards. To make sure that the catalytic converter and other emission control components continue to work properly:

- Use only unleaded fuel.
- Avoid running out of fuel.
- Do not turn off the ignition while your vehicle is moving, especially at high speeds.
- Have the items listed in your Scheduled Maintenance Guide performed according to the specified schedule.

The scheduled maintenance items listed in the Scheduled Maintenance Guide are essential to the life and performance of your vehicle and to its emissions system.

If other than Ford, Motorcraft or Ford-authorized parts are used for maintenance replacements or for service of components affecting emission control, such non-Ford parts should be equivalent to genuine Ford Motor Company parts in performance and durability.



Do not park, idle, or drive your vehicle in dry grass or other dry ground cover. The emission system heats up the engine compartment and exhaust system, which can start a fire.

Illumination of the charging system warning light, *Check Engine* indicator light or the temperature warning light, fluid leaks, strange odors, smoke or loss of oil pressure, could indicate that the emission control system is not working properly.



Exhaust leaks may result in entry of harmful and potentially lethal fumes into the passenger compartment.

Maintenance and care

Do not make any unauthorized changes to your vehicle or engine. By law, vehicle owners and anyone who manufactures, repairs, items, sells, leases, trades vehicles, or supervises a fleet of vehicles are not permitted to intentionally remove an emission control device or prevent it from working. Information about your vehicle's emission system is on the Vehicle Emission Control Information Decal located on or near the engine. This decal identifies engine displacement and gives some tune up specifications.

Please consult your “Warranty Guide” for complete emission warranty information.

Readiness for inspection/maintenance (I/M) testing

In some localities, it may be a legal requirement to pass an I/M test of the on-board diagnostic (OBD-II) system. If your “Check Engine/Service Engine Soon” light is on, refer to the description in the *Warning Lights and Chimes* section of the *Instrumentation* chapter. Your vehicle may not pass the I/M test with the “Check Engine/Service Engine Soon” light on.

If the vehicle's powertrain system or its battery has just been serviced, the OBD-II system is reset to a “not ready for I/M test” condition. To ready the OBD-II system for I/M testing, a minimum of 30 minutes of city and highway driving is necessary as described below:

- First, at least 10 minutes of driving on an expressway or highway.
- Next, at least 20 minutes driving in stop-and-go, city-type traffic with at least four idle periods.

Allow the vehicle to sit for at least eight hours without starting the engine. Then, start the engine and complete the above driving cycle. The engine must warm up to its normal operating temperature. Once started, do not turn off the engine until the above driving cycle is complete.

Maintenance and care

EXTERIOR BULBS

Replacing exterior bulbs

It is a good idea to check the operation of the following lights frequently:

- Headlamps
- Turn signals
- Cornering lamps
- High-mount brakelamp
- Tail lamps
- Brakelamps
- Backup lamps
- License plate lamps

Do not remove lamp bulbs unless they will be replaced immediately. If a bulb is removed for an extended period of time, contaminants may enter the lamp housings and affect performance.



Handle a halogen bulb carefully and keep out of children's reach. Grasp the bulb only by its plastic base and do not touch the glass; the oil from your hand could cause the bulb to break the next time that the headlamps are operated.

Replacing headlamp bulbs



Handle a halogen headlamp bulb carefully and keep out of children's reach. Grasp the bulb only by its plastic base and do not touch the glass. The oil from your hand could cause the bulb to break the next time the headlamps are operated.

To remove the headlamp bulb:

1. Make sure headlamp switch is in OFF position, then open the hood.

Maintenance and care

Note size and location of retainer pins for installation.

2. At the back of the headlamp, pull two retainer pins up to release the headlamp assembly.

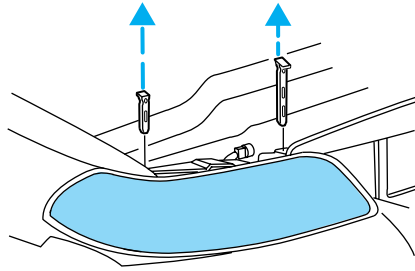

3. Pull headlamp assembly forward disengaging the lamp from the rear retainer to expose the back of the bulb.

4. Release clip and disconnect the electrical connector from the bulb.

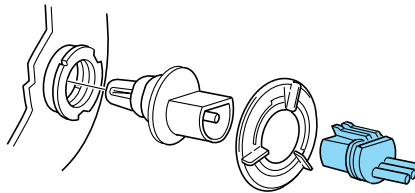

5. Remove the bulb retaining ring by rotating it counterclockwise (when viewed from the rear) about 1/8 turn to free it from the bulb socket, and slide the ring off the plastic base. Keep the ring to retain the new bulb.

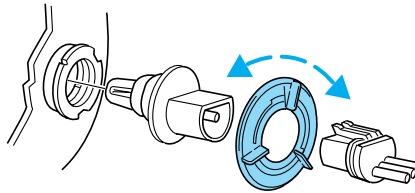

6. Without turning, remove the old bulb from its socket by gently pulling it straight back out of the lamp assembly.

To install the new bulb:

1. With the flat side of the new bulb's plastic base facing upward, insert the glass end of the bulb into the lamp assembly. Turn the bulb left or right to align the grooves in the plastic base with the tabs in the lamp assembly. When the grooves are aligned, push the bulb into the lamp assembly until the plastic base contacts the rear of the lamp assembly.

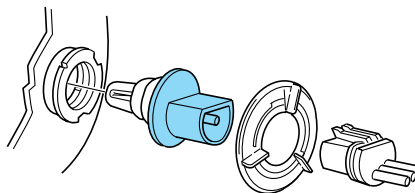

Maintenance and care

2. Install the bulb retaining ring over the plastic base until it contacts the rear of the socket by rotating clockwise until you feel a “stop.”
3. Connect the electrical connector into the rear of the plastic base until it snaps, locking it into position.
4. Install the headlamp on vehicle by aligning the lamp with the rear retainer, push rearward and secure with two retainer pins.
5. Turn the headlamps on and make sure they work properly. If the headlamp was correctly aligned before you changed the bulb, you should not need to align it again.

Replacing front parking/turn signal bulbs

Note size and location of retainer pins for installation.

1. At the back of the headlamp, pull two retainer pins up to release the headlamp assembly.
2. Pull headlamp assembly forward disengaging the lamp from the rear retainer to expose the back of the bulb.
3. Remove bulb socket by turning it counterclockwise about $\frac{1}{4}$ turn, then slide it out of the lamp assembly.
4. Carefully pull bulb straight out of the socket and push in the new bulb.
5. To complete installation, follow removal procedure in the reverse order.

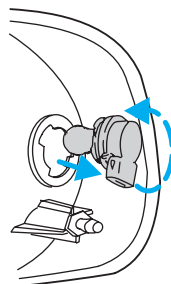
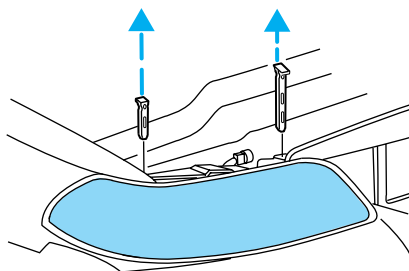

Maintenance and care

Replacing tail lamp/backup lamp bulbs

1. Open the liftgate to expose the tail lamp assemblies.
2. Remove the two screws from the lamp assembly.
3. Carefully remove the lamp assembly by pulling it rearward about 45 degrees.
4. Rotate bulb socket counterclockwise $\frac{1}{4}$ turn and remove from lamp assembly.
5. Pull bulb straight out of socket and push in new bulb.
6. To complete installation, follow the removal procedure in the reverse order.

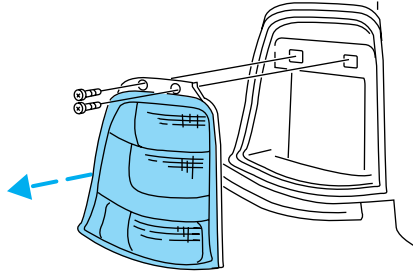

Replacing license plate lamp bulbs

To change the license plate bulbs:

1. Remove two screws and the license plate lamp assembly from the liftgate.
2. Remove bulb socket by pulling it straight out of the lamp assembly.
3. Carefully pull the bulb out from the socket and push in the new bulb.
4. Push bulb socket in to the lamp assembly.
5. Install the lamp assembly on liftgate with two screws.

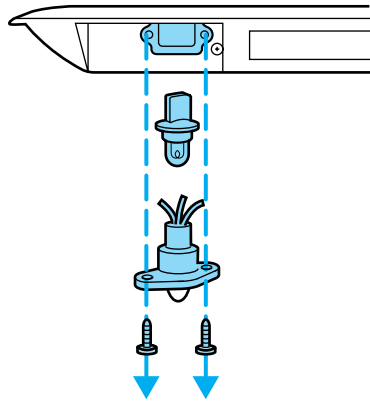

High-mount brakelamp bulbs

For bulb replacement, see a dealer or qualified technician.

Cornering lamp bulbs

For bulb replacement, see a dealer or qualified technician.

Maintenance and care

Using the right bulbs

Function	Trade Number
Front park/turn lamps	3157 NAK
Cornering lamps	3156K
Headlamps	9007
Rear license plate lamps	168
High-mount brake lamp	921
Rear turn lamps	3156K
Backup lamps	3156K
Brake/tail lamps	3157K
Dome lamp	921
Cargo liftgate lamp	T-562
Map lamps/dome	578 (opt)
Stepwell lamp	T-562
Front seat footwell	194
Front door mounted courtesy lamp	168
Second row reading lamp	578
To replace all instrument panel lights - see your dealer.	

AIMING THE HEADLAMPS

Your vehicle is equipped with a Vehicle Headlamp Aim Device (VHAD) on each headlamp body. Each headlamp may be properly aimed in the horizontal direction (left/right) and the vertical position (up/down).

A non-zero bubble reading does not necessarily indicate out-of-aim headlamps. If your vehicle is not positioned on a level surface, the slope will be included in the level indicator. Therefore, vertical headlamp adjustment should be performed only when beam direction appears to be incorrect.

You will need one E8 Torx socket to make the adjustments.

If the vehicle has been in an accident, the vehicle's front structure should be properly aligned before aiming the headlamps.

Maintenance and care

Horizontal aim adjustment

1. Park the vehicle on a level surface
2. With the hood open, locate the horizontal indicator and the adjusting screw on the inner top of the headlamp.

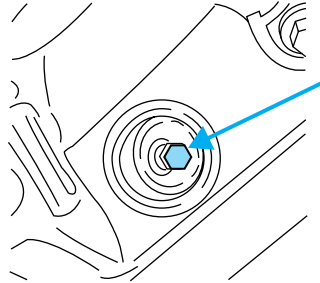

3. The “I” and “O” on the yellow ring refer to the directional change (inboard or outboard of vehicle) of the horizontal aim.

- For the left-hand (driver’s side) headlamp, turning the adjusting screw clockwise will change the aim outboard (left), and turning the adjusting screw counterclockwise will change the aim inboard (right).
- For the right-hand (passenger side) headlamp, turning the adjusting screw clockwise will change the aim outboard (right), and turning the adjusting screw counterclockwise will change the aim inboard (left).

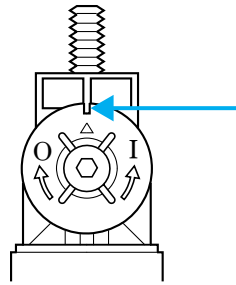

4. Use an E8 Torx socket to turn the horizontal adjusting screw until the “O” mark on the yellow dial lines up with the reference mark on the marker (as shown) when viewed directly from above.
5. When the horizontal aim has been adjusted, close the hood.

Maintenance and care

Vertical aim adjustment

The numbers shown on the vial indicate beam direction in degrees up or down.

1. Park the vehicle on a level surface
2. Locate the bubble level vertical aim indicator located on the bottom shelf of the headlamp reflector, visible through the headlamp lens.

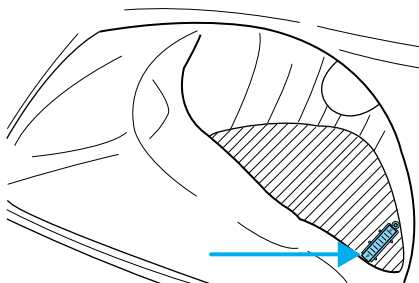

3. With the hood open, locate the vertical adjusting screw on the outer top of the headlamp.

4. Using an E8 Torx socket rotate the adjusting screw until the bubble in the vial is centered between the two white lines (which represent the “0” mark) when viewed from the front of the lens.

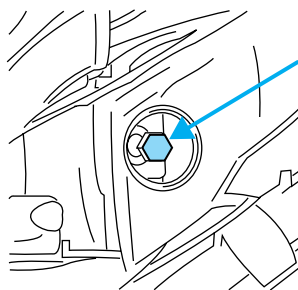

5. When the horizontal and vertical indicators are set to the “0” mark, the headlamp has been properly aimed.

6. Close the hood.

CLEANING AND CARING FOR YOUR VEHICLE

Refer to the “Customer Assistance Guide” for a list of Ford-approved cleaners, polishes and waxes.

Maintenance and care

Washing your vehicle

Wash your vehicle regularly with cold or lukewarm water. Never use strong detergents or soap. If your vehicle is particularly dirty, use a quality car wash detergent. Always use a clean sponge, washing glove or similar device and plenty of water for best results. To avoid spots, avoid washing when the hood is still warm, immediately after or during exposure to strong sunlight.

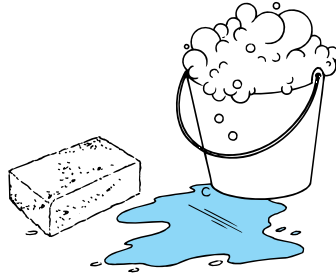

During winter months, it is especially important to wash the vehicle on a regular basis. Large quantities of dirt and road salt are difficult to remove and also cause damage to the vehicle.

Remove any exterior accessories, such as antennas, before entering a car wash. If you have wax applied to the vehicle at a commercial car wash, it is recommended that you clean the wiper blades and windshield as described in *Cleaning the wiper blades and windshield*.

After washing, apply the brakes several times to dry them.

Waxing your vehicle

Wax when water stops beading on the surface. This could be every three or four months, depending on operating conditions.

Use only carnauba or synthetic-based waxes. Use cleaning fluid or alcohol with a clean cloth to remove any bugs and tar before waxing vehicle. Use tar remover to remove any tar spots.

Avoid getting wax on the windshield. If you have wax applied at a commercial car wash, it is recommended that you clean the wiper blades and windshield as described in *Cleaning the wiper blades and windshield*.

Repairing paint chips

Minor scratches or paint damage from road debris may be repaired with touch-up paint, repair foil or aerosol paint spray from the Ford accessory line. Observe the application instructions on the products.

Remove particles such as bird droppings, tree sap, insect remains, tar spots, road salt and industrial fallout immediately.

Maintenance and care

Cleaning the wheels

Wash with the same detergent as the body of your vehicle. Do not use acid-based or alcohol-based wheel cleaners, steel wool, fuel or strong detergents. Never use abrasives that will damage the finish of special wheel surfaces. Use a tar remover to remove grease and tar.

Cleaning the engine

Engines are more efficient when they are clean because grease and dirt buildup keep the engine warmer than normal. When washing:

- Take care when using a power washer to clean the engine. The high pressure fluid could penetrate the sealed parts and cause damage.
- Do not spray with cold water to avoid cracking the engine block or other engine components.

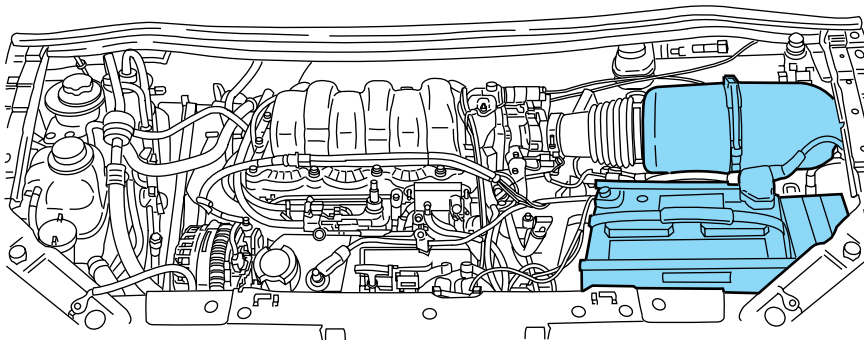

- Cover the highlighted areas to prevent water damage when cleaning the engine.
- Never wash or rinse the engine while it is running; water in the running engine may cause internal damage.

Cleaning plastic exterior parts

Use vinyl cleaner for routine cleaning. Clean with a tar remover if necessary. Do not clean plastic parts with thinners, solvents or petroleum-based cleaners.

Maintenance and care

Cleaning the exterior lamps

Wash with the same detergent as the exterior of your vehicle. Use glass cleaner or tar remover if necessary.

To avoid scratching the lamps, do not use a dry paper towel, chemical solvents or abrasive cleaners.

Cleaning the wiper blades and windshield

If the wiper blades do not wipe properly, clean the wiper blade rubber element with undiluted windshield washer solution or a mild detergent. To avoid damaging the blades, do not use fuel, kerosene, paint thinner or other solvents.

If the wiper still does not wipe properly, this could be caused by substances on the windshield such as tree sap and some hot wax treatments used by commercial car washes. Clean the outside of the windshield with a non-abrasive cleanser such as the non-abrasive Bon-Ami® powder. Rinse thoroughly with clean water. **Do not** use abrasive cleansers on glass as they may cause scratches. The windshield is clean if beads do not form when you rinse it with water. The windshield and wiper blades should be cleaned on a regular basis, and blades or rubber elements replaced when worn.

Cleaning seats equipped with side air bags

Remove dust and loose dirt with a whisk broom or a vacuum cleaner. Remove fresh spots immediately. Follow the directions that come with the cleaner. Do not saturate the seat cover with upholstery cleaner.



Do not use chemical solvents or strong detergents when cleaning the seat mounted side air bag. Such products could contaminate the side air bag system and affect performance of the side air bag in a collision.

Cleaning the instrument panel

Clean with a damp cloth, then dry with a dry cloth.

Avoid cleaner or polish that increases the gloss of the upper portion of the instrument panel. The dull finish in this area helps protect the driver from undesirable windshield reflection.

Maintenance and care

Cleaning the overhead console

Clean with a damp cloth, then wipe dry with a dry cloth.

Avoid cleaner or polish that increases the gloss of the console. The dull finish in this area helps protect the driver from undesirable windshield reflection.

Underbody

Flush the complete underside of vehicle frequently. Keep body drain holes unplugged. Inspect for road damage.

Cleaning the interior fabric

Remove dust and loose dirt with a whisk broom or a vacuum cleaner. Remove fresh spots immediately. Do not use household or glass cleaners. These agents can stain and discolor the fabric. Use a mild soap and water solution if necessary.

Cleaning leather seats (if equipped)

To clean, simply use a soft cloth dampened with water and a mild soap. Wipe the leather again with a damp cloth to remove soap residue. Dry with a soft cloth. For tougher soiling concerns, Ford recommends using the leather cleaning kit F8AJ-19G253-AA, which is available from your Ford Dealer. This mild cleaner and special pad, cleans the leather and maintains its natural beauty. Follow the instructions on the cleaner label. Regular cleaning of your leather upholstery helps maintain its resiliency and color.

Do not use household cleaning products, alcohol solutions, solvents or cleaners intended for rubber, vinyl or plastics.

Maintenance and care

Cleaning and maintaining the safety belts

Clean the safety belts with a mild soap solution recommended for cleaning upholstery or carpets. Do not bleach or dye the belts, because these actions may weaken the belt webbing.

Check the safety belt system periodically to make sure there are no nicks, wear or cuts. If your vehicle has been involved in an accident, refer to the *Safety belt maintenance* section in the *Seating and safety restraints* chapter.

Cleaning the built-in child seat (if equipped)

Clean with mild soap and water. Do not use household cleaning products because they may weaken the safety belt webbing or damage the vinyl parts of the seat.

The child seat liner is removable and may be machine-washed and air dried.

Inside windows

Use glass cleaner for the inside windows if they become fogged.

Cleaning mirrors

Do not clean your mirrors with a dry cloth or abrasive materials. Use a soft cloth and mild detergent and water. Be careful when removing ice from outside mirrors because you may damage the reflective surface.

Capacities and specifications

MOTORCRAFT PART NUMBERS

Component	3.0L Vulcan V6 engine	3.8L OHV V6 engine
Air filter	FA-1616	FA-1616
Fuel filter	FG-986B	FG-986B
Battery (standard)	BXT-59	BXT-65-650
Battery (optional)	BXT-65-650	BXT-65-750
Oil filter	FL-400S	FL-400S
PCV valve	EV-155	EV-152
Spark plugs*	AWSF-32PP**	AWSF-42EE***

* Refer to Vehicle Emissions Control Information (VECI) decal for spark plug gap information.

** If a spark plug is removed for inspection, it must be reinstalled in the same cylinder. Cylinders No. 1, 2 and 3 have a "PG" suffix. Cylinders No. 4, 5 and 6 have a "P" suffix. If a spark plug needs to be replaced, use only spark plugs with the service part number suffix letter "PP" as shown on the engine decal.

*** If a spark plug is removed for inspection, it must be reinstalled in the same cylinder. Cylinders No. 1, 2, and 3 have a "EG" suffix. Cylinders No. 4, 5, and 6 have a "E" suffix. If a spark plug needs to be replaced, use only spark plugs with the service part number suffix letter "EE" as shown on the engine decal.

Capacities and specifications

REFILL CAPACITIES

Fluid	Ford Part Name	Application	Capacity
Brake fluid	¹	All	Fill to MAX line on reservoir
Engine oil (includes filter change)	Motorcraft 5W30 Super Premium Motor Oil	3.0L engine	4.3L (4.5 quarts)
		3.8L engine	4.7L (5.0 quarts)
Engine coolant	²	Without rear heater	14.0L (14.8 quarts)
		With rear heater	15.0L (15.9 quarts)
Fuel tank	N/A	All	98.4L (26.0 gallons)
Automatic transaxle fluid	Motorcraft MERCON®V ATF	All	11.6L (12.25 quarts)
Windshield washer fluid	Ultra-Clear Windshield Washer Concentrate	All	Fill to line on reservoir

¹ Use only brake fluids certified to meet Ford specifications. Refer to *Lubricant Specifications* in this chapter. DOT 3 fluid is recommended. However, if DOT 3 is not available, DOT 4 fluid can be used.

² If your engine coolant is green in color, use Ford Premium Cooling System Fluid. If your coolant is orange in color, use Ford Extended Life Engine Coolant. Refer to *Adding engine coolant, in the Maintenance and Care chapter*.

Capacities and specifications

LUBRICANT SPECIFICATIONS

Item	Ford part name	Ford part number	Ford specification
Brake fluid	High Performance DOT 3 Motor Vehicle Brake Fluid ¹	C6AZ-19542-AB	ESA-M6C25-A and DOT 3
Door weatherstrips	Silicone Lubricant	F7AZ-19G208-BA and F5AZ-19553-AA	ESR-M13P4-A
Engine coolant	Ford Premium Engine Coolant (green in color)	E2FZ-19549-AA	ESE-M97B44-A
	Ford Extended Life Engine Coolant (orange in color)	F6AZ-19544-AA	WSS-M97B44-D or DEX-COOL [®] equivalent
Engine oil	Motorcraft 5W30 Super Premium Motor Oil	XO-5W30-QSP	WSS-M2C153-G with API Certification Mark
Door latch, hood latch, auxiliary hood latch, door and liftgate hinges, striker plates, seat tracks and fuel filler door hinge.	Multi-Purpose Grease	D0AZ-19584-AA or F5AZ-19G209-AA	ESB-M1C93-B or ESR-M1C159-A
Lock cylinders	Penetrating Lubricant	E8AZ-19501-B	none
Power steering fluid	Motorcraft MERCON [®] ATF	XT-2-QDX	MERCON [®]
Automatic transaxle (AX4S)	Motorcraft MERCON [®] V ATF	XT-5-QM	MERCON [®] V

Capacities and specifications

Item	Ford part name	Ford part number	Ford specification
Disc brake caliper rails	Silicone Brake Caliper and Dielectric compound	D7AZ-19A331-A (Motorcraft WA-10)	ESE-M1C171-A
Constant velocity joints	CV Joint Grease (High Temp.)	E43Z-19590-A	ESP-M1C207-A
Windshield washer fluid	Ultra-Clear Windshield Washer Concentrate	C9AZ-19550-AC	ESR-M17P5-A

¹ Use only brake fluids certified to meet Ford specifications. DOT 3 fluid is recommended. However, if DOT 3 is not available, DOT 4 fluid can be used.

ENGINE DATA

Engine	3.0L V6 Vulcan engine	3.8L OHV V6 engine
Cubic inches	182	232
Horsepower	150 @ 5000 rpm	200 @ 4900 rpm
Torque	186 lb.-ft. @ 3750 rpm	240 lb.-ft. @ 3600 rpm
Recommended fuel	87 octane	87 octane
Firing order	1-4-2-5-3-6	1-4-2-5-3-6
Spark plug gap	1.07-1.17 mm (0.042-0.046 inch)	1.07-1.17 mm (0.042-0.046 inch)
Ignition system	EDIS	EDIS
Compression ratio	9.3:1	9.3:1

VEHICLE DIMENSIONS

Vehicle dimensions	Wagon mm (in)	Van mm (in)
(1) Overall length	5 102.9 (200.9)	5 102.9 (200.9)
(2) Overall width	1 945.6 (76.6)	1 945.6 (76.6)

Capacities and specifications

Vehicle dimensions	Wagon mm (in)	Van mm (in)
(3) Overall height	1 727.2 (68.0)	1 678.9 (66.1)
(4) Wheelbase	3 065.8 (120.7)	3 065.8 (120.7)
(5) Track - Front	1 643.4 (64.7)	1 643.4 (64.7)
(5) Track - Rear	1 600.2 (63.0)	1 600.2 (63.0)

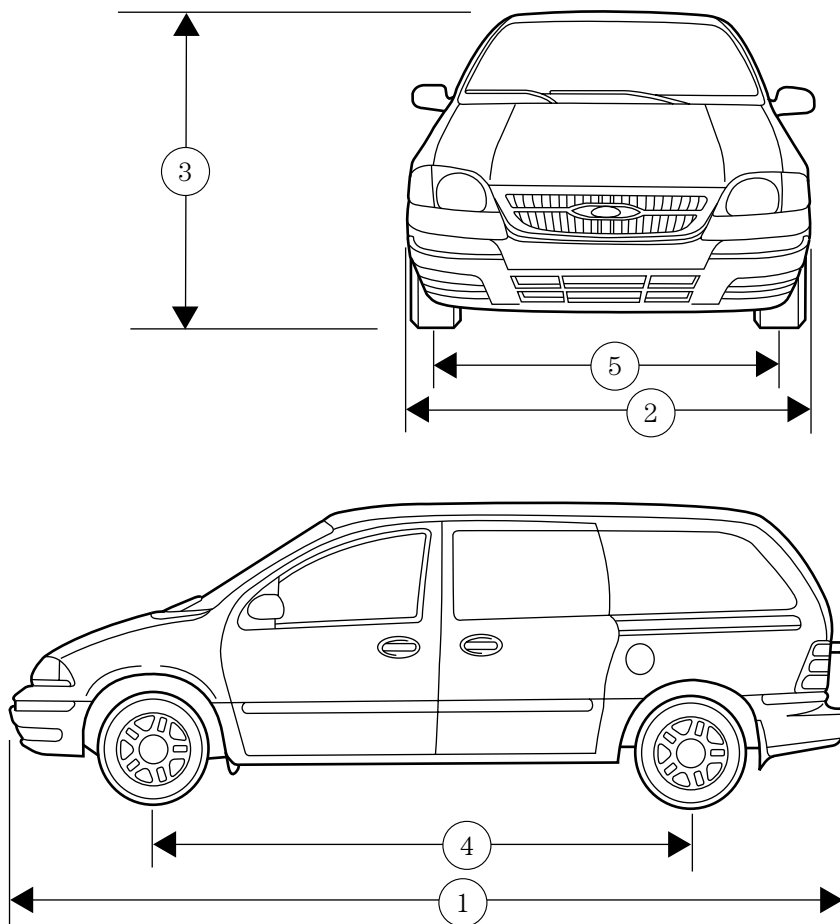

Capacities and specifications

IDENTIFYING YOUR VEHICLE

Safety compliance label

The National Highway Traffic Safety Administration Regulations require that a Safety Compliance Certification Label be affixed to a vehicle and prescribe where the Safety Compliance Certification Label may be located. The Safety Compliance Certification Label is located on the front door latch pillar on the driver's side.

MFD. BY FORD MOTOR CO. IN U.S.A.			
DATE: XXXXX	GVWR: XXXXX LB/ XXXXX KG		
FGAWR: XXXXXX/XXXXXXXX	RGAWR: XXXXXX/XXXXXXXX		
THIS VEHICLE CONFORMS TO ALL APPLICABLE FEDERAL MOTOR VEHICLE SAFETY STANDARDS IN EFFECT ON THE DATE OF MANUFACTURE SHOWN ABOVE.			
VIN: XXXXXXXXXXXXXXXXXXXX	TYPE: XXXXXXXXXXXXXXXXXXXX		
			
MAXIMUM LOAD=OCCUPANTS + LUGGAGE=XXXXG/XXXXLB			
OCCUPANTS: X TOTAL X FR X 2ND X RR OCCUPANTS LUGGAGE			
TIRE: XXXX/XXXXX XXX			
PRESSURE (FR) XXX kPa/33 PSI COLD			
PRESSURE (RR) XXX kPa/33 PSI COLD			
TRAILER TOWING - SEE OWNER GUIDE			
EXT PNT: XXXXXX XXXXXX		RC: XX	DSO: XXXX
BAR INT TR TP/PS R	AXLE TR SPR	F0000	
X XX XXX X XX X XXXX		T0000	
UTC VFOHT-15294A10-GA			

Vehicle identification number

The vehicle identification number is attached to a metal tag and is located on the driver side instrument panel.



Engine number

The engine number (the last eight numbers of the vehicle identification number) is stamped on the engine block, transmission, frame and transfer case (if equipped).

Reporting safety defects

REPORTING SAFETY DEFECTS (U.S. ONLY)

If you believe that your vehicle has a defect that could cause a crash, or could cause injury or death, you should immediately inform the National Highway Traffic Safety Administration (NHTSA) in addition to notifying Ford Motor Company.



If NHTSA receives similar complaints, it may open an investigation, and if it finds that a safety defect exists in a group of vehicles, it may order a recall and remedy campaign. However, NHTSA cannot become involved in individual problems between you, your dealer or Ford Motor Company.

To contact NHTSA, you may either call the Auto Safety Hotline toll-free at 1-800-424-9393 (202-366-0123 in the Washington D.C. area) or write to:

NHTSA
U.S. Department of Transportation
400 Seventh Street
Washington D.C. 20590

You can also obtain other information about motor vehicle safety from the Hotline.

- Accessory delay78
- Air bag supplemental restraint system124
 - and child safety seats126
 - description125,128
 - disposal131
 - indicator light128,130
 - passenger air bag126,129
- Air filter, cabin203
- Anti-theft system ...99,100,101,102,103
 - arming the system100
 - disarming a triggered system 100
- Automatic transaxle155
 - driving with156,157,158
- Brakes151
 - anti-lock151,152
 - anti-lock brake system (ABS) warning light152
 - fluid, checking and adding195
 - shift interlock155
- Break-in period3
- Cargo net104
- CD player64,65,66,67
- Child safety seats
 - attaching with tether straps ..136
 - in rear seat133,136
 - tether anchorage hardware137,138,140
- Cleaning your vehicle230
 - built-in child seat141,142,145,146
 - engine compartment232
 - exterior231,234
 - exterior lamps233
 - interior234
 - plastic parts232
 - washing231
 - waxing231
 - wheels232
 - windows235
 - wiper blades233
- Compass, electronic
 - set zone adjustment22,23,24
- Console90
 - overhead86
- Controls
 - power seat108
- Coolant199
 - checking and adding197
 - refill capacities199
- Cupholder(s) .110,112,113,115,117
- Defrost
 - rear window37
- Doors
 - power sliding87,88,89,90
- Emission control system222
- Engine
 - check engine/service engine soon light9,10
 - coolant197
 - idle speed control206
 - service points190,191
 - starting after a collision167
- Engine block heater149
- Engine oil
 - checking and adding193
 - dipstick192
 - specifications192,194
- Exhaust fumes150
- Floor mats91
- Fuel
 - choosing the right fuel216
 - comparisons with EPA fuel economy estimates221
 - detergent in fuel217
 - filling your vehicle with fuel214,215
 - gauge12
 - quality217
 - running out of fuel218
 - safety information relating to automotive fuels214
- Fuses168,169

Index

- Gas mileage (see Fuel economy)218,219,220,221
- Gauges12
 - engine coolant temperature gauge13
- GVWR (Gross Vehicle Weight Rating)
 - calculating161
- Hazard flashers167
- Head restraints105,109,110
- Headlamps
 - aiming228,229,230
 - bulb specifications228
 - high beam8,26
 - warning chime11
- Heating27
 - heater only system ...27,28,29,30,31,32,33,34
 - rear seat controls35
- Hood189
- Ignition239
- Inspection/maintenance (I/M) testing223
- Instrument panel
 - cleaning233
- Keyless entry system
 - autolock99
- Keys
 - key in ignition chime11
 - positions of the ignition70
- Lamps
 - autolamp system27
 - daytime running light26
 - headlamps25
 - headlamps, flash to pass26
 - instrument panel, dimming25
 - interior lamps85,87
 - replacing bulbs224,226,227
- Lane change indicator (see Turn signal)74
- Liftgate103
- Lights, warning and indicator
 - air bag8
 - anti-lock brakes (ABS)8
 - anti-theft7
 - brake9
 - charging system6
 - door ajar10
 - high beam11
 - low fuel6
 - low washer fluid11
 - oil pressure8
 - overdrive off9
 - safety belt7
 - traction control off7
 - turn signal indicator7
- Locks
 - childproof80
- Lumbar support, seats108,109
- Message center14,15
 - system check button15,16
 - warning messages16,21
- Mirrors81
 - automatic dimming rearview mirror80
 - cleaning235
 - fold away79
 - heated79
 - side view mirrors (power)78
- Motorcraft parts218
- Octane rating217
- Odometer13
- Overdrive75,156
- Panic alarm feature, remote entry system95
- Parking brake152
- Power distribution box (see Fuses)173
- Power door locks79,80
- Power steering154
 - fluid, checking and adding200,201

Index

- Radio ...37,38,39,40,41,42,43,44,45,
46,47,48,49,50,51,52,53,54,
55,56,57,58,59,60,61,62,63
- Relays168
- Remote entry system91
illuminated entry26,96,99
locking/unlocking doors .92,93,94
replacement/additional
transmitters98
replacing the batteries97
- Reverse sensing system67
- Roof rack166
- Safety belts (see Safety
restraints)11
- Safety Compliance
Certification Label241
- Safety defects, reporting242
- Safety restraints
cleaning the safety belts123,
124,235
extension assembly122
for children131
lap belt121
warning light and chime ..11,122,
123
- Seat belts (see Safety
restraints)118,119,120,122
- Seats105
child safety seats132
cleaning233,234,235
- Seats-easy access/easyout
feature106
- Servicing your vehicle188
- Spark plugs, specifications236
- Specification chart, lubricants .238
- Speed control70
- Speedometer13
- Starting your vehicle147,149
jump starting182,183,185
- Steering wheel
tilting76
- Tachometer12
- Tires209,210,211
changing177,178,179,180
checking the pressure211
replacing212
rotating211
snow tires and chains213
tire grades210
treadwear210
- Towing162,163,164,165
wrecker187
- Traction control69,153
active light6
- Transaxle
fluid, refill capacities237
- Transmission
fluid, checking and adding
(automatic)201,202,203
- Trip odometer14
- Turn signal11
- Universal transmitter (see
garage door opener) ...81,82,83,84
- Vehicle dimensions239
- Vehicle Identification Number
(VIN)241
- Vehicle loading159
- Ventilating your vehicle150
- Warning chimes6
- Washer fluid196
- Water, Driving through159
- Windows77
rear wiper/washer75
- Windshield washer fluid and
wipers
checking and cleaning208
operation74
replacing wiper blades209

Filling station information

Item	Information
Recommended fuel	Unleaded fuel only - 87 octane
Fuel tank capacity	98.4L (26.0 gallons)
Engine oil capacity-3.0L engine (includes filter change)	4.3L (4.5 quarts). Use Motorcraft 5W30 Super Premium Motor Oil, Ford specification WSS-M2C153-G.
Engine oil capacity-3.8L engine (includes filter change)	4.7L (5.0 quarts). Use Motorcraft 5W30 Super Premium Motor Oil, Ford specification WSS-M2C153-G.
Tire size and pressure	See Safety Compliance Certification Label on the driver's side B-pillar.
Hood release	Pull handle under the left side of the instrument panel.
Coolant capacity (without rear heater) ¹	14.0L (14.8 quarts)
Coolant capacity (with rear heater) ¹	15.0L (15.9 quarts)
Power steering fluid capacity	Fill to line on reservoir or dipstick. Use Motorcraft MERCON® ATF.
Automatic transmission fluid capacity (AX4S) ²	11.6L (12.25 quarts). Use Motorcraft MERCON®V ATF.

¹ If your engine coolant is green in color, use Ford Premium Cooling System Fluid. If your engine coolant is orange in color, use Ford Extended Life Engine Coolant. Refer to *Adding engine coolant, in the Maintenance and Care chapter*.

² Ensure correct automatic transmission fluid is used for a specific application. Check the container to verify the fluid is MERCON® and/or MERCON® V approved. Some fluids have been approved as meeting both MERCON® and MERCON® V requirements and will be labeled as such. Fluids labeled as meeting only MERCON® or only MERCON® V requirements must not be used interchangeably. DO NOT mix MERCON® and MERCON® V. Transmission fluid requirements are indicated on the dipstick or on the dipstick handle. Refer to your Scheduled Maintenance Guide to determine the correct service interval.