

Contents

Before driving

Introduction	2
--------------	---

Instrumentation	5
-----------------	---

Controls and features	25
-----------------------	----

Seating and safety restraints	78
-------------------------------	----

Starting and driving

Starting	110
----------	-----

Driving	117
---------	-----

Roadside emergencies	147
----------------------	-----

Servicing

Maintenance and care	165
----------------------	-----

Capacities and specifications	222
-------------------------------	-----

Reporting safety defects	232
--------------------------	-----

Index	233
-------	-----

Introduction

ICONS

Indicates a warning. Read the following section on *Warnings* for a full explanation of them.



Indicates that vehicle information related to recycling and other environmental concerns will follow.



We must all play our part in protecting the environment. Correct vehicle usage and the authorized disposal of waste cleaning and lubrication materials are significant steps towards this aim.

WARNINGS

How can you reduce the risk of personal injury and prevent possible damage to others, your vehicle and its equipment?

In this owner's guide, answers to such questions are contained in comments highlighted by the warning triangle symbol.

BREAKING-IN YOUR VEHICLE

There are no particular breaking-in rules for your vehicle. Simply avoid driving too briskly during the first 1,600 km (1,000 miles) of driving. Vary speeds frequently. This is necessary to give the moving parts a chance to break in.

If possible, you should avoid full use of the brakes for the first 1,600 km (1,000 miles).

From 1,600 km (1,000 miles) onwards you can gradually increase the performance of your vehicle up to the permitted maximum speeds.

INFORMATION ABOUT THIS GUIDE

The information found in this guide was in effect at the time of printing. Ford may change the contents without notice and without incurring obligation.

SPECIAL NOTICES

Notice to owners of utility type vehicles

Before you drive your vehicle, please read this owner's guide carefully. Your vehicle is not a passenger car. As with other vehicles of this type, failure to operate this vehicle correctly may result in loss of control or an accident. Be sure to read *Control Trac - Automatic Four-Wheel Drive System (if equipped)* in the *Driving* chapter as well as the special "Four Wheeling" supplement included with AWD and 4WD vehicles.

Using your vehicle as an ambulance



Do not use this vehicle as an ambulance.

Introduction

Using your vehicle as a snowplow



Do not use this vehicle for snowplowing.

Instrumentation

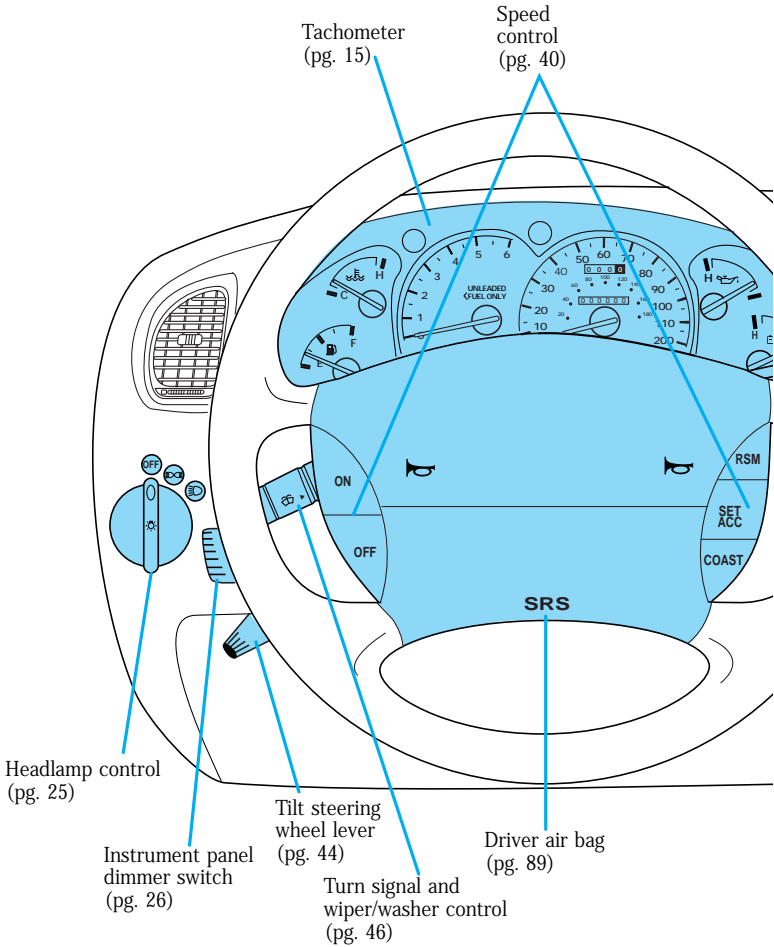

Instrumentation

Gearshift (includes overdrive button) (pg. 121)

Electronic sound system; refer to Audio Guide (pg. 36)

Rear wiper/washer control (pg. 37)

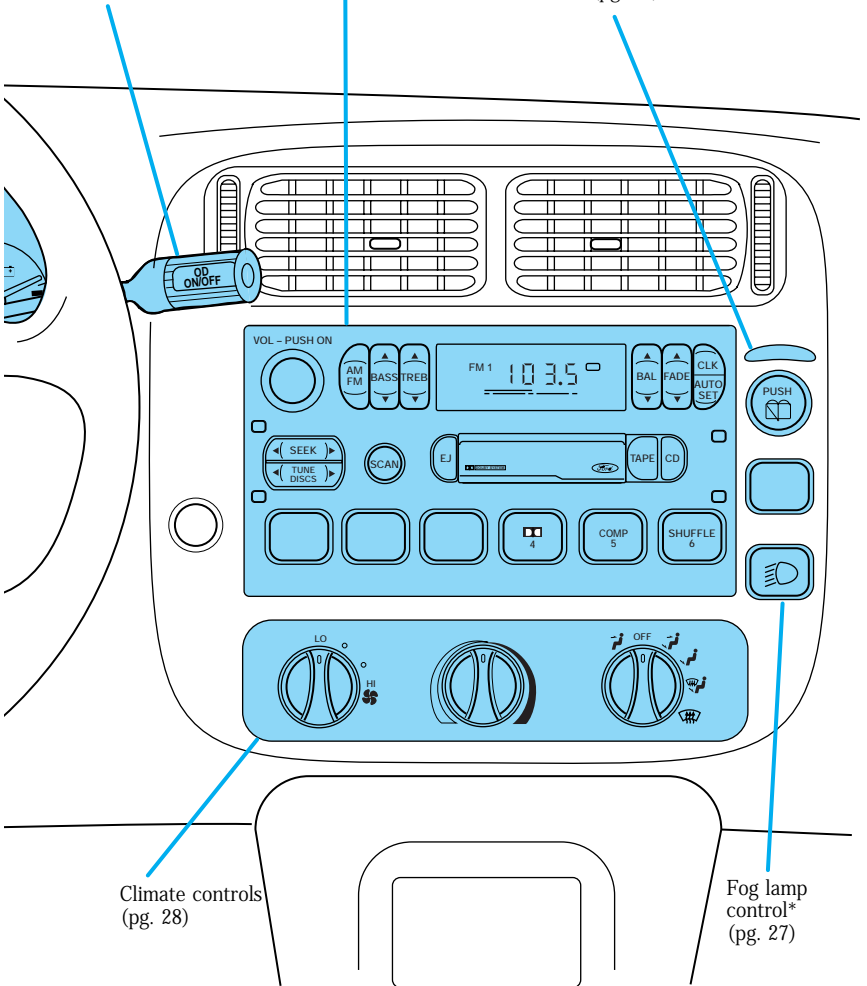

Climate controls (pg. 28)

Fog lamp control* (pg. 27)

* if equipped

Instrumentation

INSTRUMENT CLUSTER LIGHTS AND CHIMES

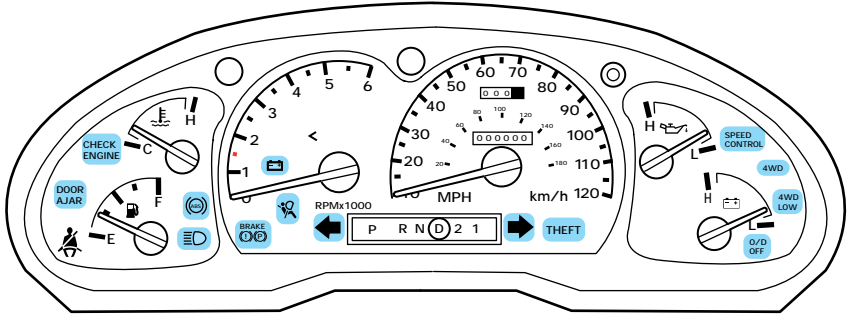

Speed control (if equipped)

Illuminates when either the SET ACC or RSM switches are pressed and remains illuminated until the speed control is either disengaged or turned off.

**SPEED
CONT**

O/D off indicator

O/D OFF illuminates when the Transmission Control Button on the end of the gearshift lever is pressed and the **(D)** (Overdrive) mode is turned off.

**O/D
OFF**

O/D OFF indicates the status of the transmission and may flash steadily if a malfunction is detected. If the flashing persists, have your transmission serviced by your dealer or qualified service technician as soon as possible.

If the condition persists, your transmission may be damaged.

Instrumentation

Check engine

Illuminates when the engine's Emission Control System requires service. It will also illuminate when the ignition key is in the On position and the engine is Off.

**CHECK
ENGINE**

Anti-theft system (if equipped)

Illuminates when the anti-theft system is arming and flashes when the anti-theft system is armed.

THEFT

Turn signal

Illuminates when the left or right turn signal or the hazard lights are turned on.



Four wheel drive indicator (if equipped)

Illuminates when four wheel drive is activated in the high range mode.

4WD

Four wheel drive — low (if equipped)

Illuminates when four wheel drive is activated in the low range mode.

**4WD
LOW**

Instrumentation

Door ajar

Illuminates when the ignition switch is in the ON or START position and any door or the liftgate is open.

**DOOR
AJAR**

Check gage

Illuminates when the key is in the ON position and the engine coolant temperature gauge, the engine oil pressure gauge and the fuel level gauge need to be checked. Refer to *Engine coolant temperature gauge*, *Engine oil pressure gauge* or *Fuel gauge* in the *Instrumentation* chapter for more information.

**CHECK
GAGE**

Charging system

Briefly illuminates when the ignition is turned on and the engine is off. The light also illuminates when the battery is not charging properly, requiring electrical system service.

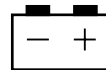

Fuel reset

Illuminates when the ignition key is turned to the ON position and the fuel pump shut-off switch has been triggered. For more information, refer to *Fuel pump shut-off switch* in the *Roadside emergencies* chapter.

**FUEL
RESET**

Safety belt

Illuminates when the ignition is switched on to remind you to fasten your safety belts. For more information, refer to *Using the safety restraints properly* in the *Seating and safety restraints* chapter.



Brake system warning

Extinguishes when the parking brake is released. Illumination after releasing the parking brake indicates low brake fluid level.



High beams

Illuminates when the headlamp high beams are on.



Anti-lock brake system (ABS)

Momentarily illuminates when the ignition is turned on and the engine is off. If the light stays on or continues to flash, the ABS needs to be serviced.



Air bag readiness

Briefly illuminates when the ignition is turned on. If the light fails to illuminate, continues to flash or remains on, have the system serviced immediately.



Headlamps on warning chime

Sounds when the headlamps are on, the ignition is off (and the key

Instrumentation

is not in the ignition) and the driver's door is opened.

Key-in-ignition warning chime

Sounds when the key is left in the ignition in the Off/Lock or Acc position and the driver's door is opened.

Safety belt warning chime

For information on the safety belt warning chime, refer to the *Seating and safety restraints* chapter.

Supplemental restraint system (SRS) warning chime

For information on the SRS warning chime, refer to the *Seating and safety restraints* chapter.

INSTRUMENT CLUSTER GAUGES

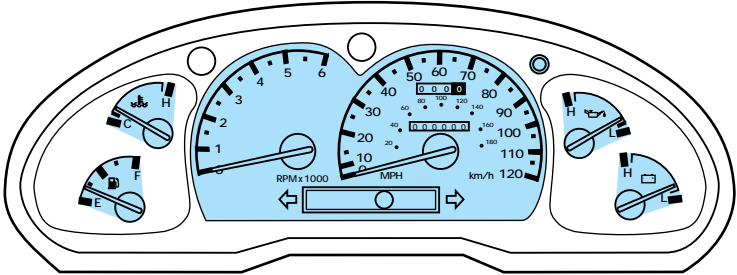

Engine coolant temperature gauge

Indicates the temperature of the engine coolant. At normal operating temperature, the needle remains within the “NORM” area. If it enters the red section, the engine is overheating. Switch off the ignition and let it cool. Refer to *Checking and adding engine coolant* in the *Maintenance and care* chapter.

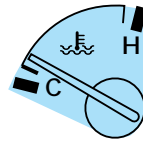

Engine oil pressure gauge

This shows the engine oil pressure in the system. Sufficient pressure exists as long as the needle remains in the “NORM” range.

If the gauge indicates constantly low pressure at normal engine speed, refer to *Checking and adding engine oil* in the *Maintenance and care* chapter. If the gauge indicates a low pressure and the engine oil level is correct, switch off the engine immediately

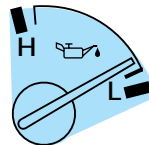

Instrumentation

and have your vehicle checked at your dealership or by a qualified technician.

Speedometer

Indicates the current vehicle speed.

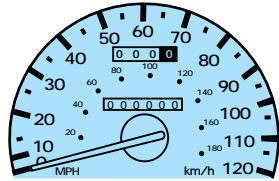

Odometer

Registers the total mileage of the vehicle.

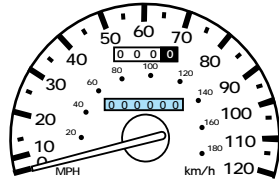

Trip odometer

Can register the mileage of individual journeys. To reset, depress the control.

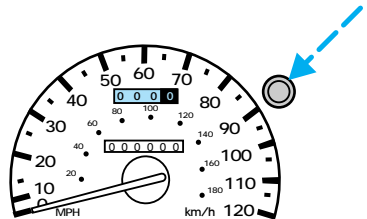

Tachometer

Indicates the engine speed in revolutions per minute.

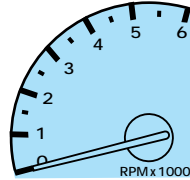

Charging system gauge

This gauge shows the battery voltage when the ignition key is in the ON position. If the pointer moves and stays outside of the normal range, have the vehicle's electrical system checked as soon as safely possible.

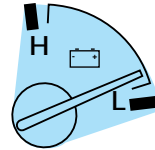

Fuel gauge

The fuel gauge displays the approximate level of usable fuel left in the fuel reservoir.

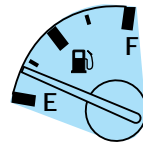

Instrumentation

MESSAGE CENTER (IF EQUIPPED)

With the ignition in the ON position, the message center displays important vehicle information through a constant monitor of vehicle systems. You may select display features on the message center for a display of status preceded by a brief indicator chime. The system will also notify you of potential vehicle problems with a display of system warnings.

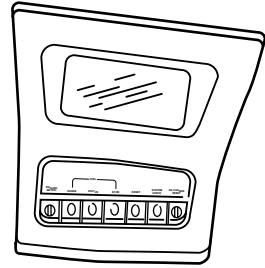

Selectable features

English/metric display

Press to toggle the message center display between metric or English units.

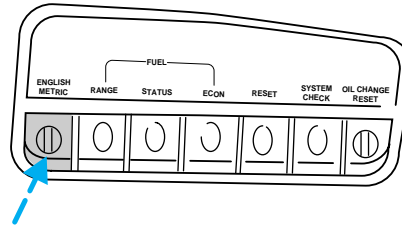

Fuel range

Press once to display the approximate kilometers (miles) left to drive before the fuel tank is empty.

Press again to display the distance driven since fuel was last added to the tank.

For maximum accuracy of this display feature, the ignition should be in the Off position during fueling. The display FUEL LEVEL ERROR indicates a problem with the fuel indication system. See your dealer or qualified service technician for system maintenance.

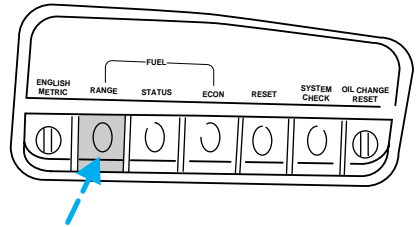

Fuel status

Press once to display the approximate amount of fuel remaining in the fuel tank.

Press again to display the approximate amount of fuel used since the system was last reset.

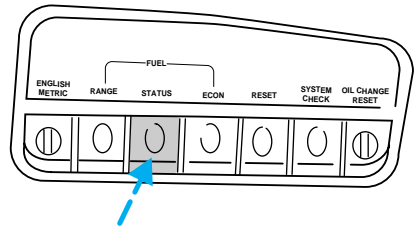

Instrumentation

Fuel economy

Press once to display your vehicle's average fuel economy in kilometers/liters (miles/gallons).

Press again to display the fuel economy that your vehicle is getting at that particular time. Your vehicle must be moving in order for this display to function properly.

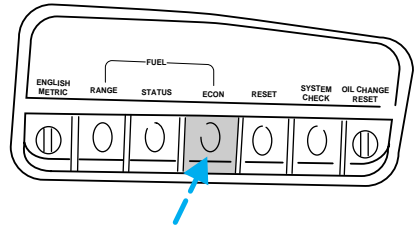

Reset

Press the reset control to reset the current feature being displayed. Warnings, distance driven, average fuel economy, fuel used and personalized oil reset percentage are the only features that respond to reset.

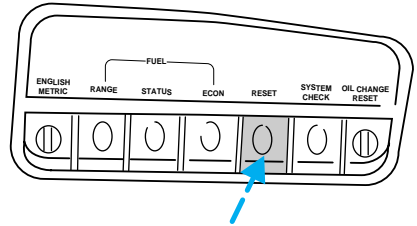

System check

Press the system check control to display the status of the following systems:

- engine oil life left
- engine oil level
- voltage level
- engine coolant temperature
- washer fluid level
- head lamps
- tail lamps
- brake lamps

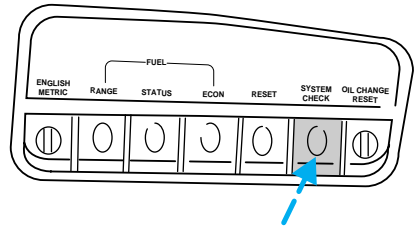

- automatic ride control (if equipped)
- fuel level

The engine oil life left has two phases. The first display will indicate the oil change status (OK, SOON, REQUIRED). The second display will indicate the percentage of oil life remaining. The display OIL TEMP SIGNAL ERROR indicates a problem with the system. Following this display, contact your dealer or qualified service technician for system maintenance.

Operating the message center during system check

The message center controls will operate as follows during the system check sequence:

1. Press the system check controls to advance to the next display.
2. Press the reset control to immediately conclude the system check.
3. Press the range, fuel status or fuel economy control to conclude the system check and display the requested feature.
4. Press the metric/English control to conclude the system check and change the previous display to the new mode.
5. Press the oil change reset control to conclude the system check and begin the oil change reset procedure.

Instrumentation

Engine oil life left

The engine oil left has two phases. The first display will indicate the percentage the oil change status (OK, SOON, REQUIRED). The second display will indicate the percentage of oil life remaining. The display OIL TEMP SIGNAL ERROR indicates a problem with the system. Following this display, contact your dealer or qualified service technician for system maintenance.

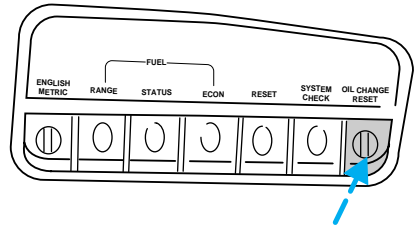

Message center warnings

Check air ride system

This warning message is displayed when an air suspension system fault has been detected. If this warning message is displayed while driving, safety pull off the road. If the vehicle is loaded beyond the recommended payload, the CHECK AIR RIDE SYSTEM message will be displayed. This is a normal condition if the vehicle is overloaded. To correct this condition:

1. Remove or redistribute the load according to the recommended maximum requirements.
2. Turn the ignition from On to Off and back On again.
3. If the warning message reappears, turn the airsuspension

switch Off and have your vehicle serviced as soon as possible.

Air ride switch off

The air ride suspension switch is off. Refer to *Air suspension system* in the *Controls and features* chapter for more information.

Change oil soon

The engine oil life remaining is 5% or less. After you have the oil changed, you must reset the M/C Oil Life Left feature as follows:

1. Turn the ignition to the On or Acc position.
2. Press and hold the OIL CHANGE RESET control for five seconds. After a successful reset, the message center will display "OIL LIFE RESET TO 100%."

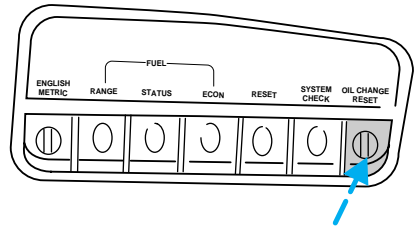

You may also set a Personalized Oil Reset Procedure using the following:

1. Turn the ignition to the ON or ACC position.
2. Press and hold the OIL CHANGE RESET control and press the RESET control while the display is counting down the five seconds to reset. The display will

Instrumentation

change to “START OIL LIFE AT XXX%.”

3. Press the OIL CHANGE RESET control until the displayed percentage is the Personalized Oil Reset Percentage you desire.

Check charging system

The electrical system is not maintaining a proper voltage. Have the electrical system checked as soon as safely possible.

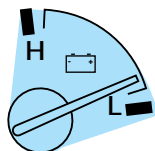

Check engine temp

The engine coolant is overheating. Refer to *Engine coolant temperature gauge* in the *Instrumentation* chapter for more information regarding the engine coolant system.

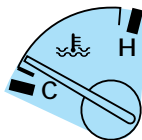

Check exterior lamps

At least one brake lamp, rear side marker or low beam headlamp is burned out. To determine which lamp is burned out:

1. Turn ignition switch to OFF to reset M/C.

2. With the brake lamps, parking lamps and headlamps off, turn the ignition switch to ON or ACC.

3. After M/C briefly illuminates (about two seconds), press the brake pedal. If “CHECK EXTERIOR LAMPS” is displayed, then a brake lamp is burned out. If this message is not displayed, proceed to the next step.

4. Turn the light switch to the parking lamp positions. If “CHECK EXTERIOR LAMPS” is displayed, then a rear side marker is burned out. If this message is not displayed, proceed to the next step.

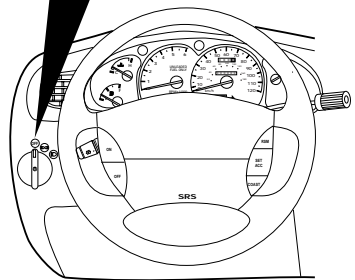
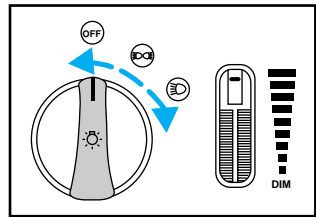

5. Turn the light switch to the headlamp position. If “CHECK EXTERIOR LAMPS” is displayed, then a low beam headlamp is burned out.

If you use additional lights, such as trailer lights, or replace bulbs with equipment that is not equal to the original Ford equipment, you may

Instrumentation

get a false warning or no warning at all.

Door ajar

The ignition switch is in the On or Start position and a door is open.

Low fuel level

The fuel level is low.

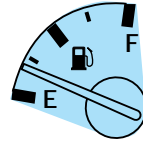

Low oil level

The oil level is low. Refer to *Checking and adding engine oil* in the *Maintenance and care* chapter for more information.

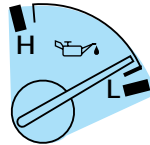

Low washer fluid

The washer fluid reservoir is less than one quarter full.

Controls and features

HEADLAMP CONTROL

Rotate the headlamp control to the desired position:

OFF — Lamps off

 Parking lamps, side marker lamps, instrument panel lamps, license plate lamps and tail lamps on

 Headlamps on

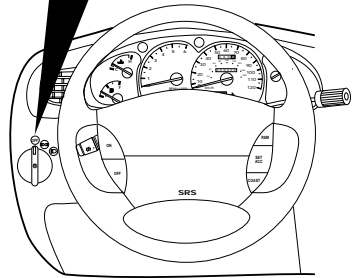
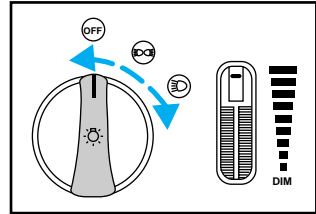

Controls and features

Instrument panel dimmer control

To adjust the instrument panel dimmer control:

- Rotate the control up to brighten the instrument panel lighting.
- Rotate the control down to dim the instrument panel lighting.

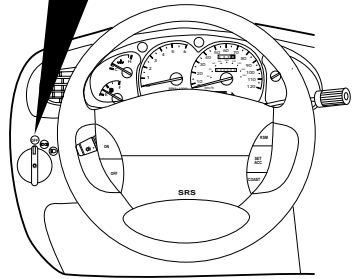
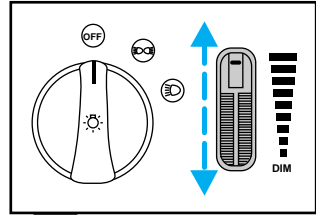

Daytime running light (DRL) system (if equipped)

The DRL system turns on the highbeam headlamps, with a reduced light output, when:

- the vehicle is running and the ignition is in the On position
- the vehicle has a fully released parking brake
- the headlamp system is in the  position

Controls and features



The Daytime Running Light (DRL) system will not illuminate the tail lamps and parking lamps. Turn on your headlamps at dusk. Failure to do so may result in a collision.

Foglamp control (if equipped)

Press the foglamp control to activate the foglamps.

Press the foglamp control a second time to deactivate the foglamps.

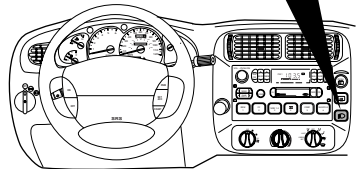
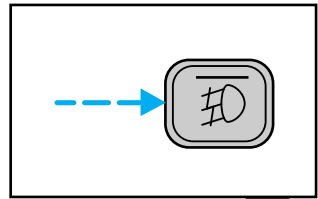

Controls and features

PARKING BRAKE

For information on the parking brake, refer to *Preparing to start the vehicle* in the *Driving* chapter.

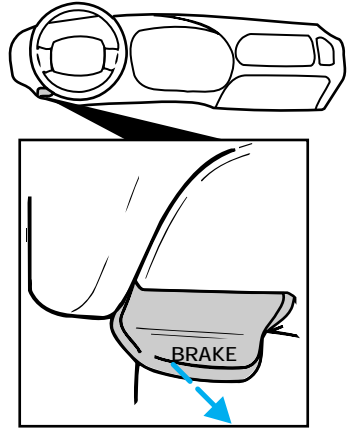

CLIMATE CONTROL SYSTEM

Manual heating and air conditioning system

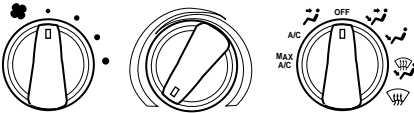

Controls and features

Fan speed

Turn the control to the right to increase fan speed.

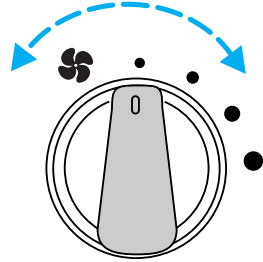

Temperature

Turn the temperature control to the desired mix of warm and cool air (left for cooler and right for warmer).

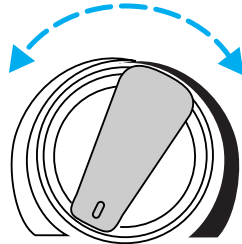

Controlling airflow

Turn the mode control to the desired airflow position.

- The A/C compressor operates in the mode positions marked *.

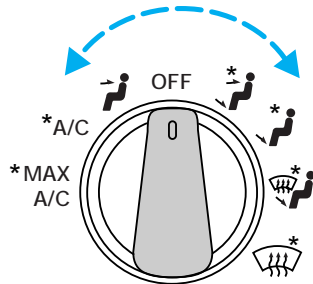

Controls and features

Using MAX A/C mode

The MAX A/C mode recirculates the air and directs it to flow through the instrument panel vents.

This mode is noisier, but provides quicker cooling than A/C mode. The compressor only functions if the outside temperature is above 10°C (50°F).

Select MAX A/C for airflow through these vents:

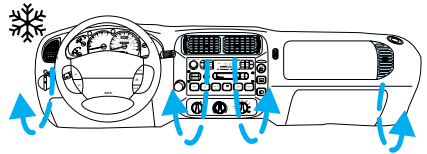

Off mode

Select the OFF position for all climate control functions to cease. The outside inlet door will close and the fan is shut off.

Drive with the climate control system on (either in heating or A/C mode) to reduce humidity in your vehicle.

Using A/C mode

The A/C mode directs outside conditioned air to flow through the instrument panel vents. The A/C mode can be used for heating, ventilating or air conditioning. The A/C compressor only functions in the A/C mode if the outside temperature is above 10°C (50°F).

Controls and features

Select A/C for air to flow through these vents:

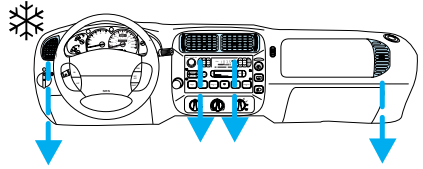

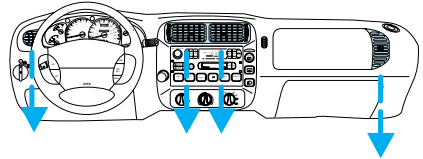

Using the panel mode

Select  for air to flow through these vents:



Using the panel/floor mode

The  mode directs outside air to flow between the panel and floor vents. The air conditioning compressor will function provided the outside temperature is above 10°C (50°F).

Select the  for air to flow through these vents:

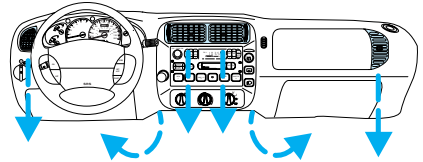

Using the floor mode

Select the  for air to flow through these vents:

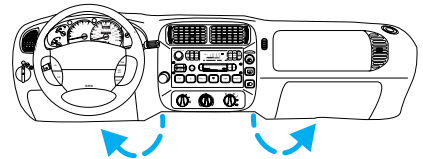

Using the defrost/floor mode

The  directs outside air to flow through the floor vents and

Controls and features

windshield defroster vents. The air conditioning compressor will function to dehumidify the windows provided the outside temperature is above 10°C (50°F).

Select the  for air to flow through these vents:

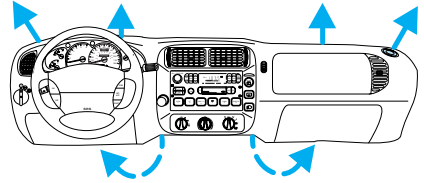

Using the defrost mode

In addition to defogging and demisting, in defrost mode your vehicle has the capability to demist the front side windows. The air conditioning compressor will function to dehumidify the windows provided the outside temperature is above 10°C (50°F).

Select the  mode for air to flow through these vents:

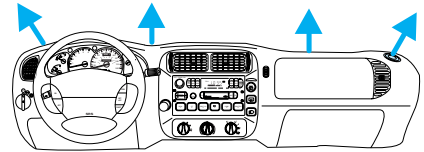

Electronic automatic temperature control (EATC) system (if equipped)

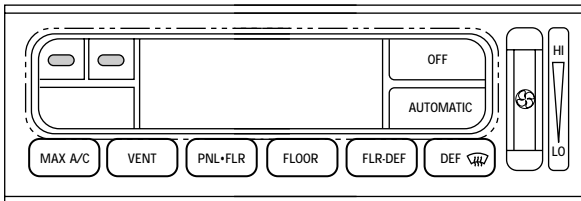

Controls and features

The EATC feature will maintain a selected temperature and automatically control airflow. You may manually override the EATC operation. The EATC will only operate with the ignition in the On position.

To maximize system efficiency:

- Do not put items under the front seats that will interfere with the air flow to the rear seats.
- Keep the air intake vents clear of any snow, ice or leaves.

Automatic operation

To turn on the EATC:

- Press AUTO or any the six override controls.
- Select the desired temperature.

To turn off the EATC:

- Press the OFF control.
- When the system is off, the display window will be blank.

When AUTO is selected, the system will automatically determine fan speed and airflow location and under normal conditions should need no additional adjustment.



75 °F
AUTO

Controls and features

Temperature selection

For maximum continuous cooling, press the blue portion of the TEMP control until 16°C (60°F) is displayed.

For maximum continuous heating, press the red portion of the TEMP control until 32°C (90°F) is displayed.

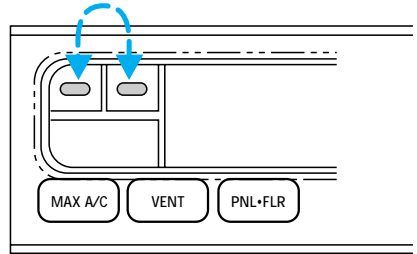

The display window will indicate the temperature and operating mode that you have selected.

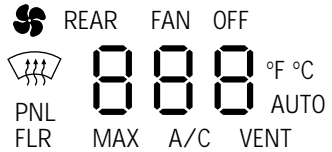

The TEMP control will increase or decrease the set temperature in one degree increments between 36°C (65 °F) and 47°C (85°F). To scroll quickly through the temperatures, until either maximum continuous cooling or maximum continuous heating is reached, press and hold the TEMP control.

Controls and features

Fan speed

Once AUTO is selected, fan speed is adjusted automatically for selected temperature conditions.



Override automatic fan speed at any time by turning the FAN control up for HI and down for LO fan speeds. To return to automatic fan control, press AUTO.

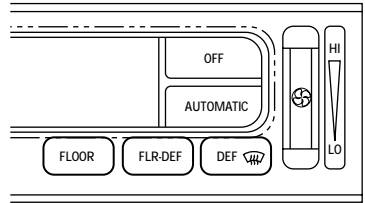

Manual override

If an override control is pressed, your EATC selection determines airflow location only. Fan speed will remain automatic unless the FAN control is adjusted.

The override controls are located on the bottom portion of the EATC.

- **MAX A/C** — Uses recirculated air to cool the vehicle. The A/C compressor is optional.
- **VENT** — Brings in outside air through the instrument panel vents. The A/C compressor is not optional.

Controls and features

- **OFF** — Outside air is shut out and the fan will not operate.
- **PNL & FLR** — Directs air through the instrument panel registers and front floor vent and rear air ducts (if equipped).
- **FLOOR** — Directs airflow through the front floor vent and rear air ducts (if equipped).
- **FLR & DEF** — Directs outside air through the floor vents and defroster.
- **DEFROST** — Directs outside air through the defroster. Use this mode to demist and defog the windshield. In humid weather, select DEF before starting your engine to help to prevent windshield fogging.

To toggle between Fahrenheit and Celsius:

- Press the MAX A/C and  OFF control at the same time.
- If the battery is disconnected, the display will revert to Fahrenheit.

Servicing the EATC

If the EATC is not operating properly, consult your dealer or qualified service technician.

AUDIO SYSTEM

Refer to the *Audio Guide* for instructions on how to operate the audio system.

Controls and features

Rear window defroster

Press the defroster control to clear the rear window of thin ice and fog.

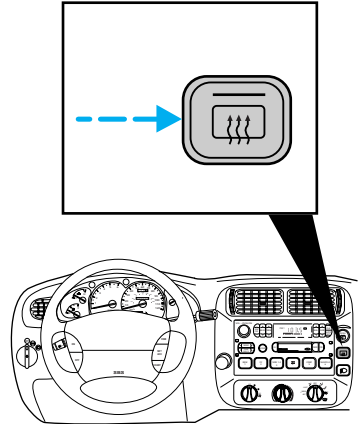

The ignition must be in the ON position to operate the rear window defroster.

The defroster turns off automatically after 10 minutes or when the ignition is turned to the OFF position. To manually turn off the defroster before ten minutes have passed, push the control again.

REAR WINDOW WIPER AND WASHER (IF EQUIPPED)

Washer

Press for rear washer fluid operation.

Controls and features

Wipers

For rear wiper operation, rotate the rear window wiper and washer control to the desired interval position.

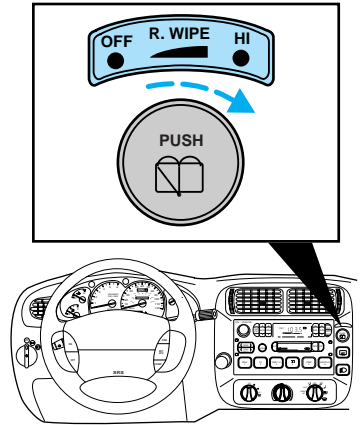

Automatic ride control (if equipped)

Your vehicle is equipped with an automatic ride control system. This system is designed to level your vehicle when towing or carrying a heavy load.

To prevent sudden vehicle movement, turn off the air suspension switch prior to jacking, towing or hoisting the vehicle.

4WD CONTROL (IF EQUIPPED)

This control operates the Control Trac 4WD. Refer to *Control trac system* in the *Driving* chapter for more information.

FUEL PUMP SHUT-OFF SWITCH

For information on the fuel pump shut-off switch, refer to *Fuel pump shut-off switch* in the *Roadside emergencies* chapter.

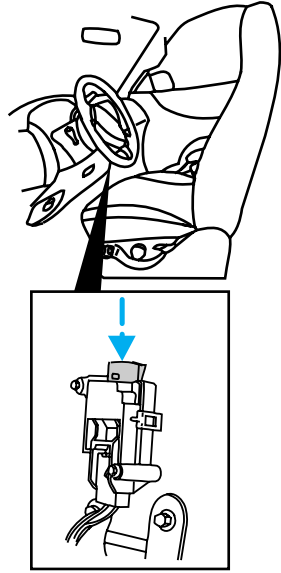

POSITIONS OF THE IGNITION

1. ACCESSORY allows the electrical accessories such as the radio and wipers/washer to operate while the engine is not running.
2. LOCK locks the steering wheel and gearshift lever and allows key removal.
3. OFF shuts off the ignition and accessories and allows the gearshift and steering wheel to move.
4. ON tests the warning lights. The key must remain here when the engine is running.

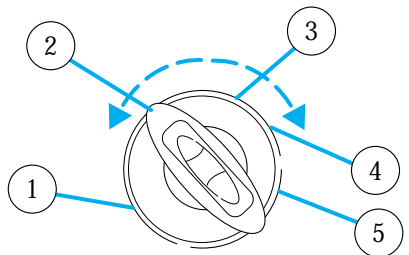

Controls and features

5. START cranks the engine. The key must return to ON when running.

SPEED CONTROL (IF EQUIPPED)

To turn speed control on

Press ON.

Vehicle speed cannot be controlled until the vehicle is travelling at or above 48 km/h (30 mph).

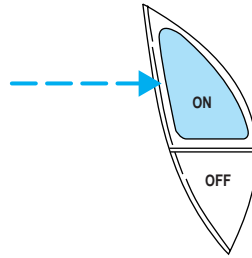

Do not use the speed control in heavy traffic or on roads that are winding, slippery, or unpaved.



Do not shift the transmission into N (Neutral) with the speed control on.

To turn speed control off

Press OFF or turn off the vehicle ignition.

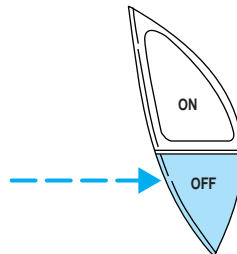

Controls and features

Once speed control is switched off, the previously programmed set speed will be erased.

To set a speed

Press SET ACC. For speed control to operate, the speed control must be ON and the vehicle speed must be greater than 48 km/h (30 mph).

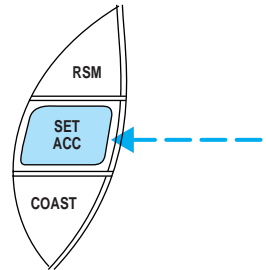

If you drive up or down a steep hill, your vehicle speed may vary momentarily slower or faster than the set speed. This is normal.

Speed control cannot reduce the vehicle speed if it increases above the set speed on a downhill. If your vehicle speed is faster than the set speed while driving on a downhill in Overdrive, you may want to shift to the next lower gear to reduce your vehicle speed.

If your vehicle slows down more than 16 km/h (10 mph) below your set speed on an uphill, your cruise control will disengage. This is normal. Pressing RSM will re-engage it.



Do not use the speed control in heavy traffic or on roads that are winding, slippery, or unpaved.

Controls and features

To set a higher set speed

- Press and hold SET ACC. Release the control when the desired vehicle speed is reached or
- Press and release SET ACC. Each press will increase the set speed by 1.6 km/h (1 mph) or
- Accelerate with your accelerator pedal, then press and release SET ACC.

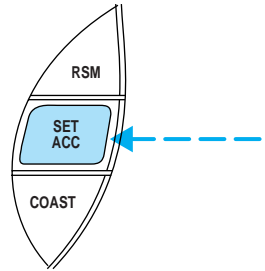

You can accelerate with the accelerator pedal at any time during speed control usage. Releasing the accelerator pedal will return your vehicle to the previously programmed set speed.

To set a lower set speed

- Press and hold COAST. Release the control when the desired speed is reached or
- Press and release COAST. Each press will decrease the set speed by 1.6 km/h (1 mph) or
- Depress the brake pedal. When the desired vehicle speed is reached, press SET ACC.

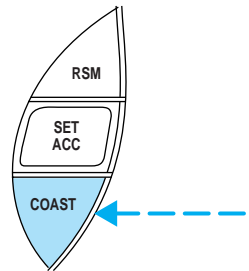

Controls and features

To return to a set speed

- Press RSM. For RSM to operate, the vehicle speed must be faster than 48 km/h (30 mph).

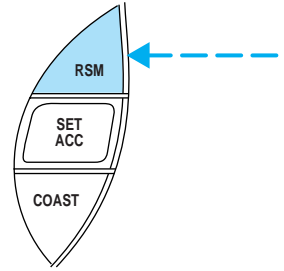

To disengage speed control

- Depress the brake pedal or
- Depress the clutch pedal (if equipped)

Disengaging the speed control will not erase the previously programmed set speed.

Pressing OFF will erase the previously programmed set speed.

Indicator light

Lights when the speed control is turned on and remains lit until either the speed control or the ignition is turned off.

**SPEED
CONT**

Controls and features

TILT STEERING

Pull the lever to adjust the steering column angle. Push the lever back up to lock the steering wheel into position.

 Never adjust the steering wheel when the vehicle is moving.

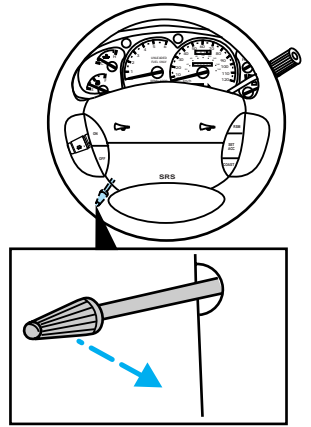

HAZARD FLASHER SWITCH

For more information on the hazard flasher control, refer to the *Roadside emergencies* chapter.

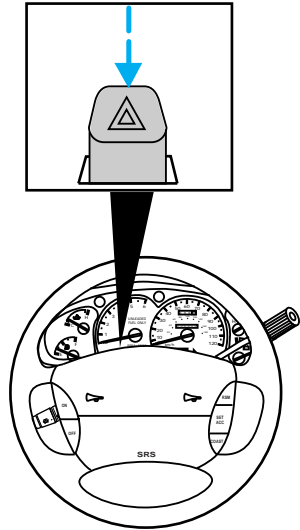

Controls and features

FLASH-TO-PASS

Pull toward you and release quickly for “flash-to-pass” operation.

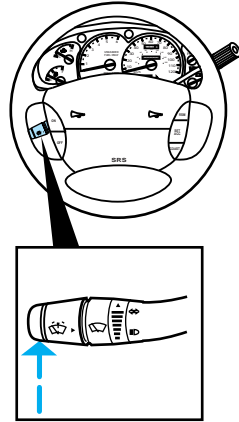

USING OVERDRIVE

Overdrive is the normal drive position and will stay on automatically until deactivated.

The overdrive function allows automatic upshift to second, third and fourth gear.

Controls and features

Deactivating overdrive

To deactivate overdrive, press the control at the end of the gearshift lever. The $\frac{O}{D}$
 OFF will illuminate.

Deactivate overdrive when:

- driving with a heavy load
- driving in hilly terrain
- additional engine braking is desired

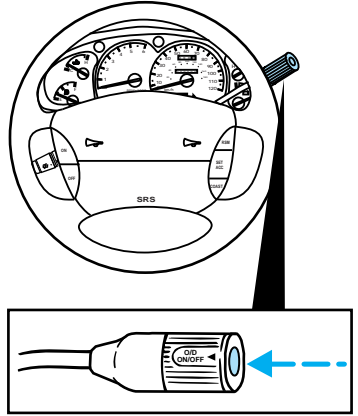

WINDSHIELD WIPERS AND WASHER

Wipers

Rotate the windshield wiper control to the desired interval speed.

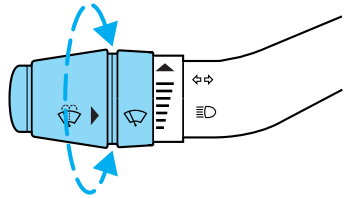

Washer

- Press the windshield wiper control for washer fluid operation.
- Press once for a single wipe.
- Press and hold for a constant cycle.

Controls and features

Speed dependent wipers (if equipped)

This feature operates only in the intermittent wiping mode. In position one (slowest delay) this feature will not function. At higher speeds, the Speed Dependent feature shortens the delay between wipes when you use the variable interval wipers. Delay will automatically adjust at speeds between 16 and 105 km/h (10 and 65 mph). This will help compensate for the extra moisture that accumulates on your windshield at higher speeds.

Map lamps

Press the left or right control to turn the lamp on.

Press again to turn the lamp off.

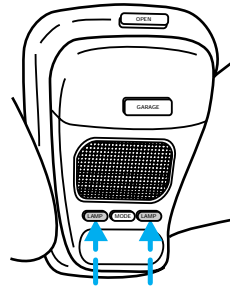

AUTOLAMP DELAY SYSTEM (IF EQUIPPED)

The autolamp sets the headlamps to turn on and off automatically. The autolamp may be set to:

- turn on the lamps automatically at night
- turn off the lamps automatically during daylight

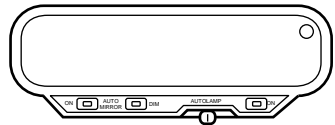

Controls and features

- keep the lamps on for up to three minutes after the key is turned to OFF

Setting autolamp

1. Make sure that the headlamp control is in the Off position. Leaving the headlamp control on will override the autolamp.

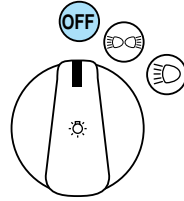

2. Turn the ignition to the ON position or start the vehicle.
3. Slide the delay control all the way to the left.

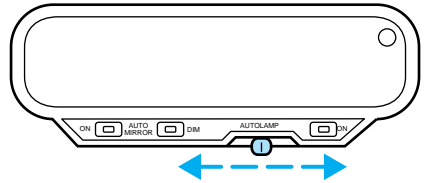

4. Press the ON/OFF control. The lamp indicator will glow.

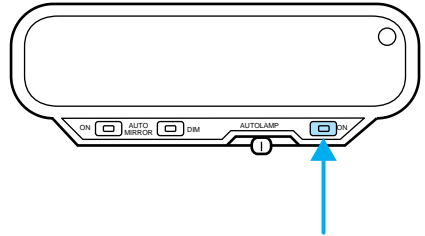

5. The autolamp automatically turns the lamps on and off. The indicator light will illuminate when the headlamps turn on.

Controls and features

AUTOMATIC DIMMING FEATURE (IF EQUIPPED)

The autolamp/automatic dimming mirror is equipped with an automatic dimming feature. This feature will change from the normal state to the non-glare “active” state when bright lights (glare) reach the mirror. When the mirror detects bright light from front or behind, it will adjust automatically to minimize glare.

To activate the mirror, have the key in the ON position and push the ON button once. The lamp indicator will glow. Press again to turn off.

To temporarily darken push the DIM button. The mirror will return to normal as soon as the button is released.

The mirror will automatically return to the normal position whenever the vehicle is placed in R (Reverse) (when the mirror is in the ON position). This helps to ensure a bright clear view in the mirror when backing up.

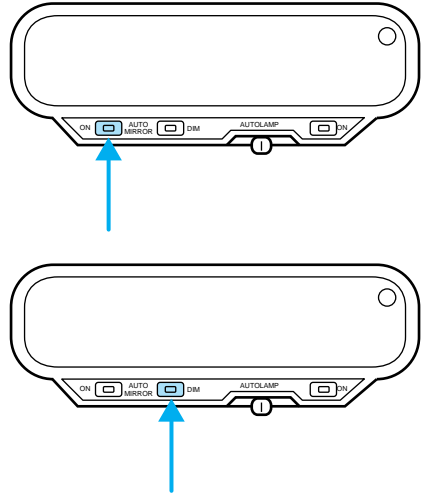

Controls and features

Adjusting the rearview mirror

The inside rearview mirror may be adjusted at the two pivot points near the mirror face and the windshield.

COMPASS (IF EQUIPPED)

Compass display

The compass reading may be affected when you drive near large buildings, bridges, power lines and powerful broadcast antenna. Magnetic or metallic objects placed in or on the vehicle may also affect compass accuracy. Adjustments may need to be made to the zone and calibration of the compass.

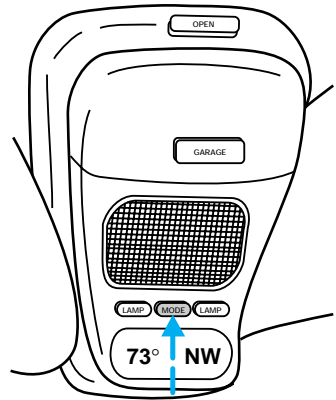

Controls and features

Compass zone adjustment

1. Determine which magnetic zone you are in by referring to the zone map.

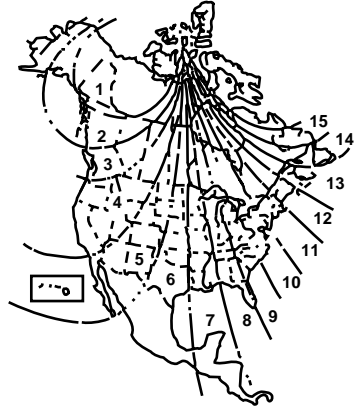

2. Press and hold the MODE control until VAR appears in the display, then release. The display should show the current zone number.

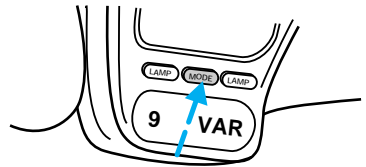

3. Press the MODE control until the desired zone number appears. The display will flash and then return to normal operation. The zone is now updated.

Compass calibration adjustment

Perform this adjustment in an open area free from steel structures and high voltage lines:

- Press and hold the MODE control until CAL appears in the display (approximately eight seconds) and release.
- Drive the vehicle slowly (less than 5 km/h [3 mph]) in circles

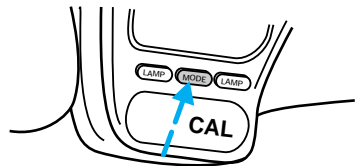

Controls and features

until CAL indicator turns off in about 2–3 complete circles.

MESSAGE CENTER (IF EQUIPPED)

This feature displays a variety of system display features. Refer to *Message center* in the *Instrumentation* chapter.

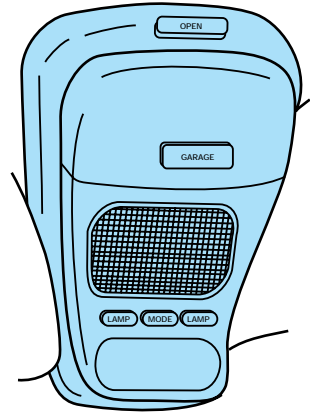

Storage compartment (if equipped)

Press the OPEN control to open the storage compartment. The door will open slightly and can be moved to full open.

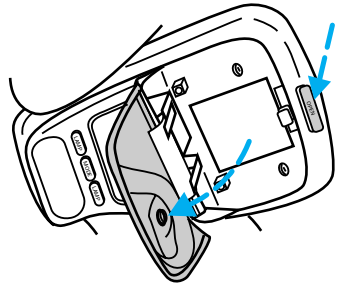

Installing a garage door opener (if equipped)

The storage compartment can be converted to accommodate a

Controls and features

variety of aftermarket garage door openers:

- Remove the storage clip from the door.
- Place Velcro[™] hook onto side of aftermarket transmitter opposite of actuator control.

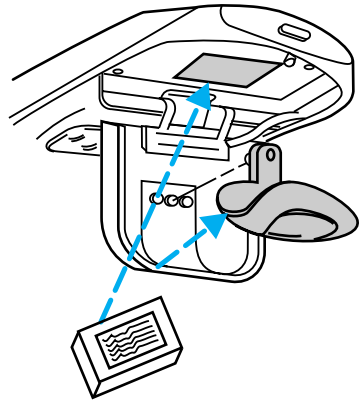

- Place transmitter into storage compartment, control down.
- Place the provided height adaptors onto the back of the GARAGE control as needed.
- Press the GARAGE control to activate the transmitter.

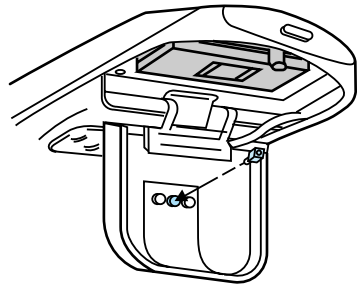

Controls and features

MOON ROOF (IF EQUIPPED)

Press and hold the rear portion of the moon roof control to open.

Press and hold the front portion of the moon roof control to close.

The moon roof has a sliding shade that can be manually opened or closed when the glass panel is shut.

To close the shade, pull it toward the front of the vehicle.

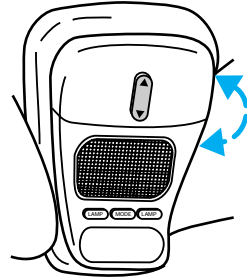

Do not let children play with the moon roof. They may seriously hurt themselves.

POWER DOOR LOCKS (IF EQUIPPED)

Press U to unlock all doors and L to lock all doors.

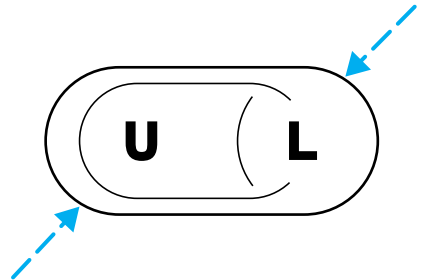

Two-step unlock (if equipped)

This feature allows you to unlock all doors of the vehicle with the key.

1. Unlock the driver door.

Controls and features

2. Repeat unlock procedure within four seconds. All doors will unlock when the key is returned to the vertical position.

Two-step unlock can be activated by all outside locks on vehicles with keyless entry and anti-theft (if equipped).

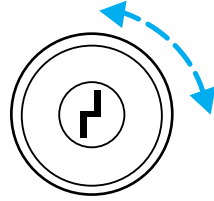

CHILDPROOF DOOR LOCKS

When these locks are set, the rear doors cannot be opened from the inside. The rear doors can be opened from the outside when the doors are unlocked.

Move lock control up to engage the lock. Move control down to disengage childproof locks.

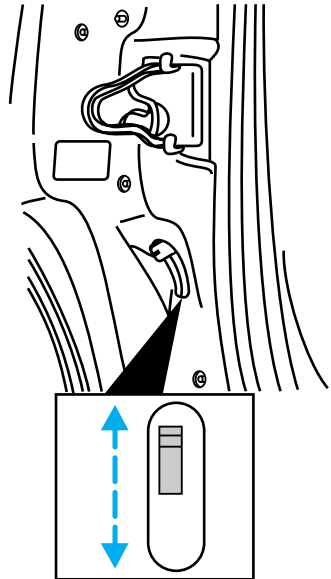

Controls and features

POWER WINDOWS

Press and hold the rocker switches to open and close windows. When AUTO is pressed and released quickly, the driver's window will open completely without holding the switch down. Each passenger has window controls.

- Press the top portion of the rocker switch to close.
- Press the bottom portion of the rocker switch to open.
- Press AUTO and release quickly. The window will open fully. Depress again to stop window operation.

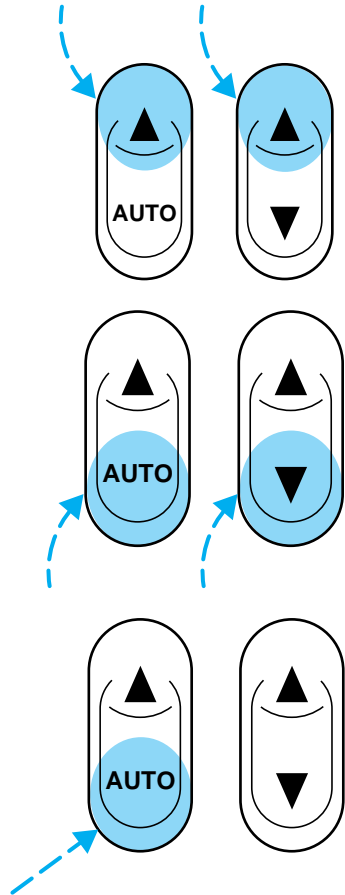

Controls and features

- Press the left side of the button to lock. Press the right side to unlock.

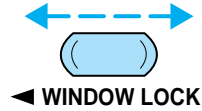

REAR LIFTGATE

The liftgate area is only intended for cargo, not passengers. You can open and close the liftgate from outside the vehicle. It cannot be opened from inside the cargo area.

To open the liftgate turn the handle to the right.

To open the liftgate window turn the handle to the left.

To lock the liftgate you can use the key, the power door locks, or depress the key lock cylinder before closing the liftgate.

The liftgate door and window should be closed before driving your vehicle. If not, possible damage may occur to the liftgate door lift cylinders and attaching hardware.



Make sure that the liftgate door and/or window are closed to prevent exhaust fumes from being drawn into the vehicle. This will also prevent passengers and cargo from falling out. If you must drive with the liftgate door or window open, keep the vents open so outside air comes into the vehicle.

Controls and features

Power mirrors (if equipped)

To adjust the power outside mirrors:

1. Select the mirror you want to adjust:

Left Driver side mirror

Right Passenger side mirror

2. Move the mirror control in the desired direction.

3. Lock the mirror by moving the selector to the center position.

Heated outside mirrors (if equipped)

Both mirrors are heated automatically to remove ice, mist and fog when the rear window defrost is activated.

Do not remove ice from the mirrors with a scraper or attempt to readjust the mirror glass if it is frozen in place. These actions could cause damage to the glass and mirrors.

CONSOLES

Center console features

Your vehicle may be equipped with a variety of console features. These include:

- auxiliary power point
- utility compartment
- ashtray
- cupholders
- tissue box

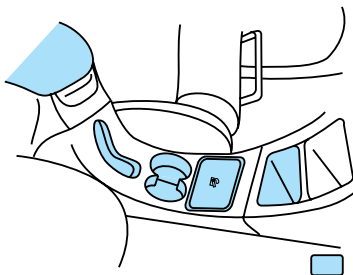

Controls and features

- utility compartment with cassette/compact disc storage and coinholder
- compact disc changer
- cellular phone



Use only soft cups in the cupholder. Hard objects can injure you in a collision.

Auxiliary power point

The power point is an additional power source for electrical accessories.

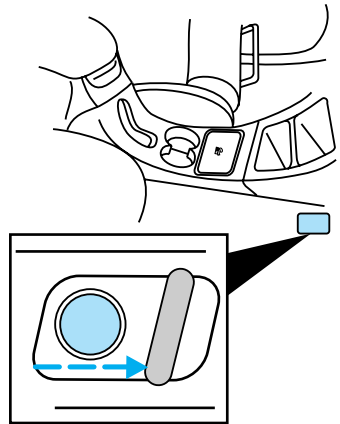

Replacing the tissue box

To replace the center console tissue box:

Controls and features

1. Lift the armrest and slide coinholder/tissue tray out of the console in an upward motion.
2. Replace the tissue box.
3. Slide coinholder/tissue tray into console locating pins at bottom of tray. Fit into slots in console bracket.

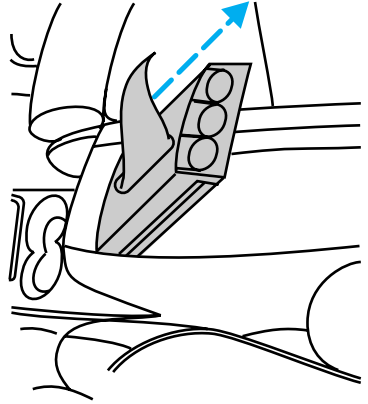

Cellular phone (if equipped)

Your cellular phone is equipped with a number of features including voice activation, hands-free operation, speed dialing and radio program muting during phone operation. For detailed information on the operation of your phone, refer to the manufacturer's instructions contained with the phone.

Compact disc changer (if equipped)

The compact disc changer is located inside the center console.

For information on the compact disc changer, refer to the "Audio Guide".

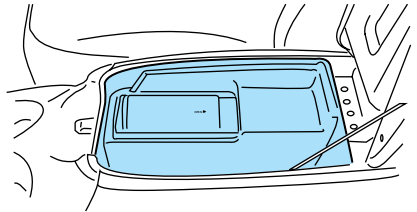

Controls and features

Rear console features

The rear console incorporates the following features:

- air vents
- audio system controls
- rear seat climate controls
- cupholders

Refer to the “Audio Guide” for more information on the rear console audio system controls.

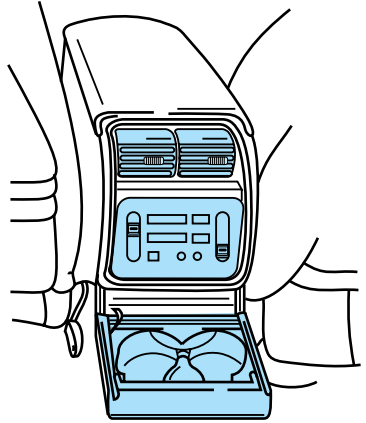

Rear console climate controls

Turn the air distribution control to the desired airflow position.

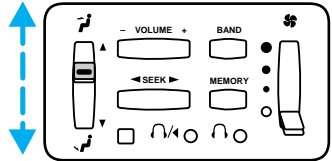

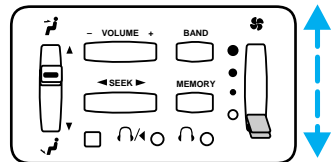

Turn the fan speed dial to the desired position.

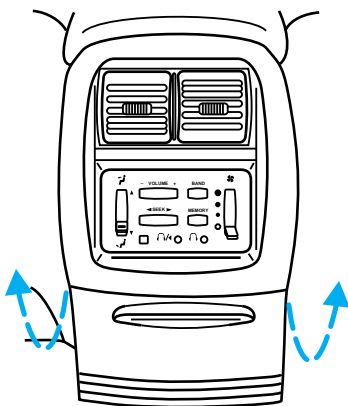

Controls and features

Select  for air to flow through these vents:



Select  for air to flow through these vents:

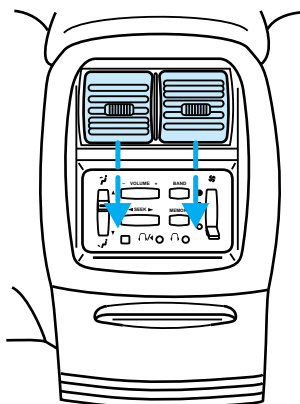

FLOOR MATS

Installing the floor mats

1. Move the driver's seat to the most rearward position.
2. Position the driver's side floor mat with the rear of the mat

Controls and features

against left (outboard) front edge of seat track mounting bracket.

3. Use a screwdriver to screw locator post into vehicle carpeting. Exert pressure while turning to pierce the carpeting.

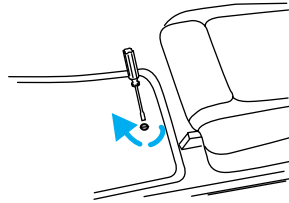

When installed properly, the locator will not screw down tightly, but will rotate freely.

Usage

1. To remove mat, pull up on rear of mat to release from locator post.
2. To re-install mat, align grommet in mat over the locator post and snap mat into place.

TRUNK MOUNTED CONTROLS

Spare tire and jack

Your vehicle is equipped with either a temporary spare tire and jack or a full-size spare tire located under the rear of the vehicle. For instructions on how to remove and mount the spare tire, refer to the *Roadside emergencies* chapter.

Controls and features

Cargo cover (if equipped)

Your vehicle is equipped with a cargo area shade that covers the luggage compartment of your vehicle.

To install the shade:

1. Position the shade in mounting brackets as shown. The tongue faces the rear of the vehicle.
2. Pull the end of the shade towards you and hook sides into notches in the rear trim panels.

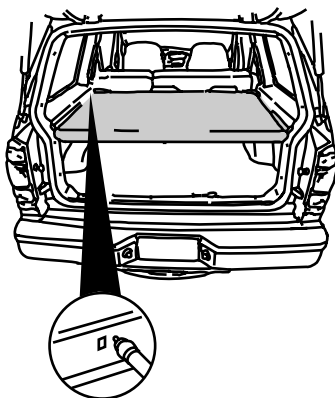

To prevent the possibility of injuries, the fasteners for the cargo area cover must be properly attached to the mounting clips on the rear trim panels.



Do not place any objects on the cargo area cover. They may obstruct your vision or strike occupants of the vehicle in the case of a sudden stop or collision.

Rewinding the shade

With extended use, the cargo shade may lose its spring tension. If this occurs, the shade must be manually rewound. This is a two-person operation.

Controls and features

1. Remove the shade from the vehicle and extend it with the smooth grain facing you.
2. Wrap the vinyl around the roller tube twice. Tuck the edges of the vinyl inside the end cap with each wrap.

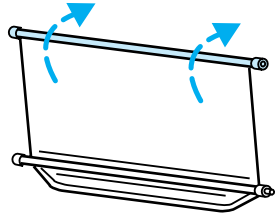

3. Fold the edges of the vinyl towards center, making sure that the edges clear the end cap slots. Use tape or a rubber band to hold the vinyl to the left side of the tube.

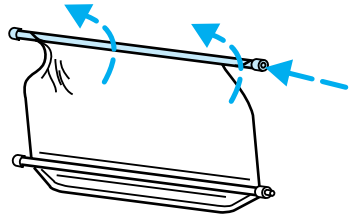

4. Push in the right end cap (marked RH) about $\frac{1}{4}$ of the total length to disengage the clutch and hold the end cap in while turning the roller tube toward you 14 times.
5. Let go of the right end cap. The clutch will now engage and stop the shade from losing its spring tension.
6. Unfold the vinyl and place it into the end cap slots.
7. Insert the shade into the side mounting brackets and check to make sure that it operates properly.

ANTI-THEFT SYSTEM (IF EQUIPPED)

When armed, the anti-theft system prevents unauthorized entry into your vehicle.

Controls and features

Illuminated entry system (if equipped)

The interior lamps illuminate when:

- either front door handle is lifted or
- the remote entry system is used to unlock the door or sound the personal alarm
- or the door is unlocked using the key (if equipped with two-step unlock).

The system automatically turns off after 25 seconds or when the ignition is turned to the START or ACC position.

The inside lights will not turn off if:

- they have been turned on with the dimmer control or
- any door is open.

Arming the anti-theft system

Turn the ignition Off and use one of the following methods to arm the system:

- Press the LOCK control on the remote entry transmitter.
- With the ignition in the OFF position, open either door and press the power lock button.
- Press the 7/8 and 9/10 buttons on the entry keypad to lock all doors.

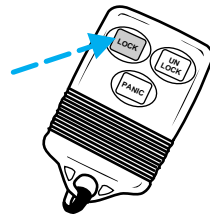
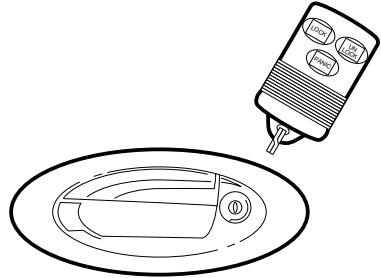

Identifying an armed anti-theft system

When the system is armed, the warning light will illuminate for 30 seconds. After 30 seconds, the light will flash.

If the system is armed with the doors open, the warning light will stay illuminated until all the doors are closed and then illuminate for 30 seconds and begin flashing.

When an unauthorized entry occurs, the activated system will:

- flash the headlamps, parklamps and the warning light in the instrument cluster.
- sound the horn.
- prohibit the vehicle from starting.

The flashing headlamps and honking horn will automatically shut off after about three minutes and will remain off unless another unauthorized entry is attempted. However, the vehicle will not start until the system is disarmed.

Controls and features

Disarming a triggered anti-theft system

Press either the UNLOCK or

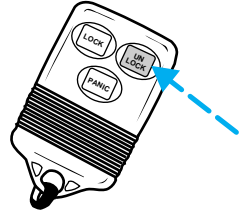

PANIC control to disarm a triggered anti-theft system or Unlock any door with the key.

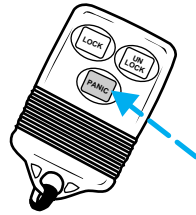

A triggered system may also be disarmed by inserting the key and turning the ignition to ACC or ON.

Disarming an untriggered anti-theft system

Press the UNLOCK control to disarm the untriggered system or unlock any door with the key. Or, use the keyless entry system 5 digit unlock code.

If the driver armed the system but did not exit the vehicle, the system can also be disarmed by inserting the key and turning the ignition to ON.

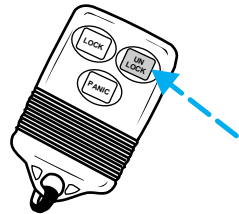

Controls and features

REMOTE ENTRY SYSTEM (IF EQUIPPED)

The remote entry system allows you to lock or unlock all vehicle doors without a key. The remote entry system features only operate with the ignition in the Off position.

It also arms and disarms the anti-theft system (if equipped). (For more information on the anti-theft system, refer to *Anti-theft system* in this chapter.) The remote entry features only operate with the ignition in the OFF position.

Unlocking the doors

Press UNLOCK to unlock the driver door. The interior lamps will illuminate.

Press UNLOCK a second time within five seconds to unlock all doors.

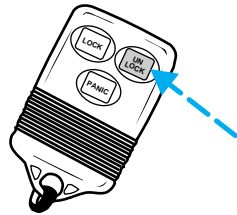

Controls and features

Locking the doors

Press LOCK to lock all doors.

To confirm all doors are closed and locked, press the LOCK control a second time within five seconds. The doors will lock again, the horn will chirp and the lamps will flash.

If the horn chirps twice, a door is still ajar and the anti-theft system will not arm.

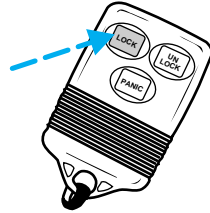

Sounding a panic alarm

Press the PANIC control to activate the horn and lights.

To deactivate the alarm, press the PANIC control again or turn the ignition to the Acc or On position.

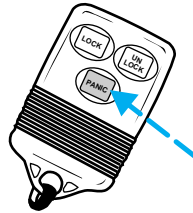

Remote memory seat feature (if equipped)

The remote keyless entry system can control the Memory Seat system (refer to the *Memory seat* section in the *Seating and safety restraints* chapter. Each of the first three transmitters programmed recall a different seat position.

Controls and features

Pressing UNLOCK once will:

- unlock the driver's door and
- move the seat to its corresponding memory seat position.

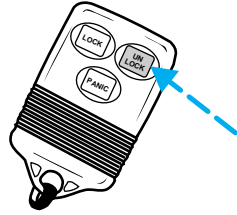

When your dealer programs new transmitters, the order of programming controls seat recall as follows:

- First transmitter programmed recalls seat position one
- Second transmitter programmed recalls seat position two
- Third transmitter programmed recalls seat position three
- Fourth transmitter programmed recalls no seat position

You may change seat positions at any time.

You can deactivate or reactivate the remote memory seat feature:

1. Make sure the anti-theft system (if equipped) is not armed or triggered, ignition is off and all doors and liftgate window are closed.
2. Turn the ignition key from OFF to ON.
3. Press the door power unlock on the door switch three times.
4. Turn the ignition key from ON to OFF.

Controls and features

5. Press the door power unlock switch three times.
6. Turn the ignition key back to ON within 30 seconds of step two.
7. The horn should chirp once. If not, wait 30 seconds and repeat steps one through six.
8. Press the door power unlock switch twice.
9. Press the door power lock switch.
10. The horn will chirp twice if the remote memory seat feature was deactivated, three times (two short chirps followed by a long chirp) if the remote memory seat feature was activated.
11. Turn the ignition key to OFF.
12. The horn will chirp once to confirm that you activated or deactivated the remote memory seat feature.

To reactivate the system, simply repeat the instruction for deactivating. By reentering the code that deactivates the remote memory seat, the keyless entry system reinstates the feature.

The memory seat function will continue to work from the door switch even when deactivated at the remote keyless entry module.

Replacing the batteries

The transmitter is powered by two coin-type three-volt lithium batteries. A decrease in operating range can be caused by:

Controls and features

- battery failure
- weather conditions
- structures around the vehicle

Replacement batteries for the remote entry and/or anti-theft system transmitters may be purchased at pharmacies, watch stores or at authorized dealers.

To replace the batteries:

1. Twist a thin coin between the two halves of the transmitter. **DO NOT TAKE THE FRONT PART OF THE TRANSMITTER APART.**
2. Place the positive (+) side of new batteries down.
3. Snap the two halves back together.

Replacing lost transmitters

Take all your vehicle's transmitters to your dealer for reprogramming if:

- a transmitter is lost or
- you want to purchase additional transmitters (up to four may be programmed).

This device complies with Part 15 of the FCC rules. Operation is subject to two of the following conditions: (1) The device may not cause harmful interference, and (2) This device must accept any interference received, including interference that may cause undesired operation.

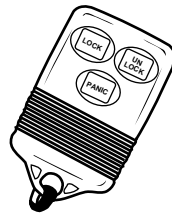

Controls and features

KEYLESS ENTRY SYSTEM (IF EQUIPPED)

You can lock or unlock the vehicle doors without using a key by using the drivers door keypad.

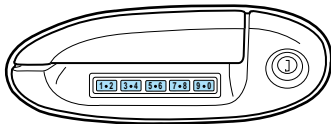

See also *Remote entry system (if equipped)* in this chapter.

The computer code that operates the keyless system is located on your owners wallet card found in the glove compartment.

When any button on the driver's door keypad is pressed the system will:

- turn on the interior lights for approximately 25 seconds and
- light up the keypad controls for five seconds.

Do not push the control keypad with any hard object that could damage the controls.

Locking the doors with the keyless entry system

To lock all the doors, press 7/8 and 9/0 at the same time. It is not necessary to first enter the keypad code.

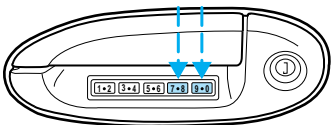

Unlocking the doors with the keyless entry system

The driver door must be unlocked before any other. If more than five seconds pass between pressing numbers, enter the code again.

Controls and features

The system has shut down if the keypad light is out. If the keyless entry system does not work, use the key or remote entry transmitter(s).

1. To unlock the driver door, enter one of the two codes. After pressing the fifth number, the driver door unlocks.
2. To unlock the passenger door(s) and liftgate, press the 3/4 button within five seconds of unlocking the driver door.

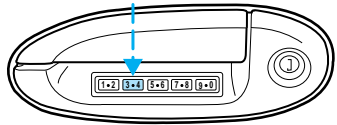

Programming your own entry code

This code does not replace the permanent code from the dealership.

To program your own code:

1. Select five digits for your personal code.
2. Enter the permanent code that the dealership gave you.
3. Within five seconds, press 1/2.

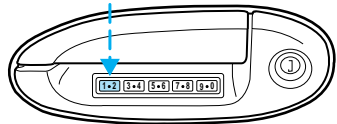

4. Within five seconds of pressing 1/2, enter your personal code, pressing each digit within five seconds of the previous digit.

You can now use either code. The system remembers only one personal code at a time.

To erase your personal code:

Controls and features

1. Enter the original permanent code.
2. Press 1/2 within five seconds of step one.

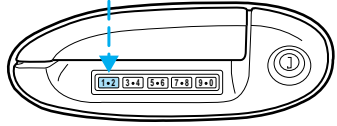

3. Wait six seconds.

For maximum security, do not set a code that presents the numbers in sequential order or uses the same button five times.

Operating your perimeter anti-theft system (if equipped) from the keyless entry pad

The keyless entry system arms by pressing 7/8 and 9/0.

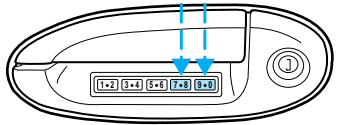

To disarm or reset a triggered anti-theft alarm, enter the five digit code.

All doors must be fully closed for the anti-theft system to arm. Refer to the *Anti-theft system* section, if equipped, in this chapter for more details.

Autolock (if equipped)

The autolock feature is part of your remote keyless entry system which locks all of the doors when:

- all vehicle doors are closed
- the ignition key is turned to the ON position
- the brake pedal is pressed

Controls and features

- you shift through R (reverse)
- one second has elapsed after the brake pedal is released.

The autolock feature repeats when:

- a door is opened and then all doors are closed
- the brake pedal is released.

The autolock feature can be disabled (or reenabled) by using the keyless entry system:

1. Enter your permanent five-digit entry code (not the user code you may have set).
2. Within five seconds, press and hold 7/8.
3. Within five more seconds, press and release 3/4.
4. Release 7/8.

To reactivate the system, repeat the system deactivating instructions.

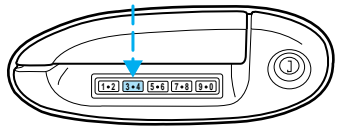

Seating and safety restraints

HEAD RESTRAINTS

Rear seat head restraints

Push to lower the head restraint.

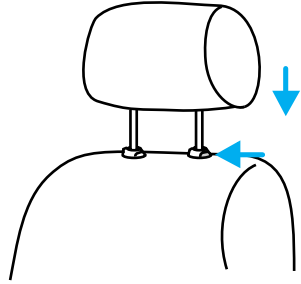

Rear seat four-way head restraints (if equipped)

Push or pull the head restraint to the desired position.

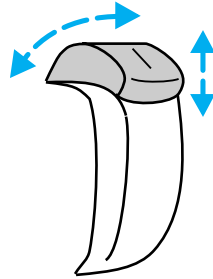

Seating and safety restraints

SEATING

Adjusting bench seating

Folding rear seats (if equipped)

If your vehicle is equipped with a built-in child safety seat, the seatback cannot be folded down unless the built-in child seat is fully stowed.

1. Press the lower release control downward to unlatch the seatback.
2. Rotate the seatback downward into the load floor position.
3. Press down on the top outboard area of the seatback until a click is heard. The seat is now latched in the load floor position.

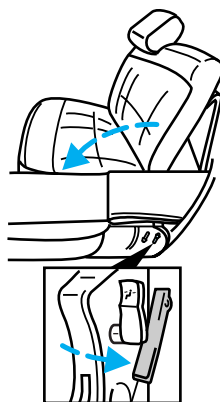

Returning to the upright position

1. Press downward on the upper outboard corner of the seatback and hold.
2. Pull the release handle upward to unlatch the seat.
3. Rotate the seatback upward until the seatback latches in the upright position. The seatback will click when it is locked into position.

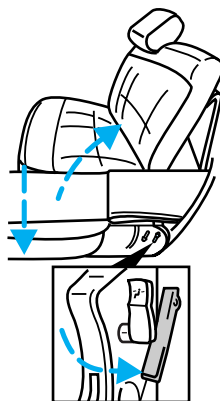

Seating and safety restraints

Manually adjusting the captain's chair

Lift to move the seat forward or backward.

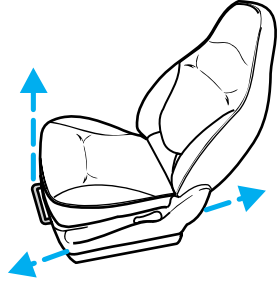

Pull up to recline the seat.

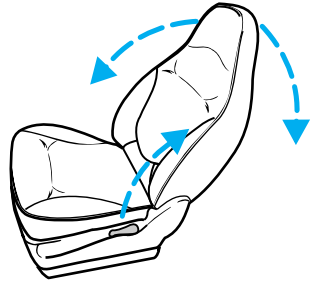

Adjusting the power front seats (if equipped)

Pull up to recline the seat.

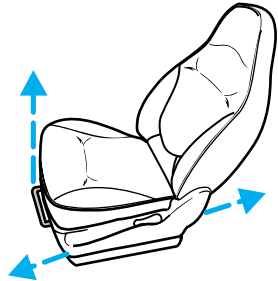

Seating and safety restraints

Press to tilt the front of the seat up or down.

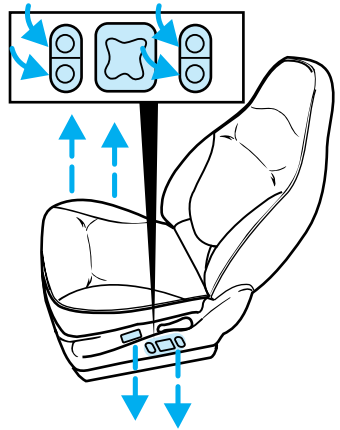

Press in the desired direction for seat adjust or to move the seat forward or back.

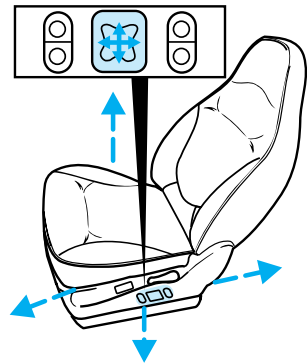

Seating and safety restraints

Press to increase (+) or decrease (-) lumbar support.

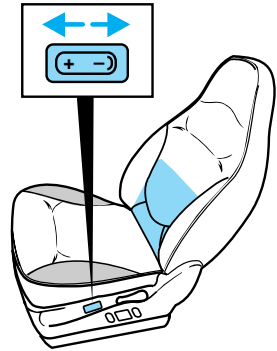

Memory seats (if equipped)

This system allows automatic positioning of the driver seat to three programmable positions.

- To program position one, move the driver seat to the desired position using the seat controls. Press the SET control. The SET control indicator light will briefly illuminate. While the light is illuminated, press control 1.
- To program position two, repeat the previous procedure using control 2.
- To program position three, repeat the previous procedure but press controls 1 and 2 simultaneously.

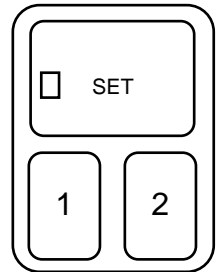

A position can only be recalled when the automatic transmission gearshift is in P (Park) or the manual transmission gearshift is in N (Neutral). A memory seat position may be programmed at any time.

Seating and safety restraints

SAFETY RESTRAINTS

Important safety restraints precautions

The use of safety belts helps to restrain both driver and passengers in case of a collision. In most states and Canada, the law requires the use of safety belts.



Always drive and ride with your seatback upright and the lap belt snug and low across the hips.



Lock the doors of your vehicle before driving to lessen the risk of the door coming open in a collision.



Cargo should always be secured to prevent it from shifting and causing damage to the vehicle or harm to passengers.



To prevent the risk of injury, make sure children sit where they can be properly restrained.

Seating and safety restraints

Using safety restraints properly

Combination lap and shoulder belts

Insert the tongue into the slot in the buckle fasten.

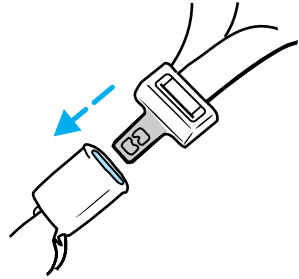

Push the red release button and remove the tongue from the slot to unfasten.

The outboard safety restraints in the vehicle are combination lap and shoulder belts. The front and rear seat passenger outboard safety belts have two types of locking modes.

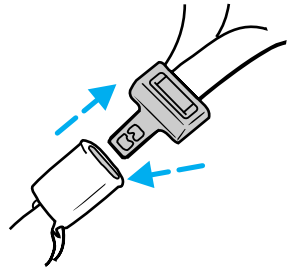

Vehicle sensitive (emergency) locking mode

The vehicle sensitive mode is the normal retractor mode which locks the belts in response to vehicle movement. For example, if the driver brakes suddenly, turns a corner sharply or your vehicle receives an impact of 8 km/h (5 mph) or more the combination safety belts will lock to help reduce the forward movement of the driver and passengers.

The retractor can be made to lock by pulling sharply on the belt.



Seating and safety restraints

Automatic locking mode

In this mode, the shoulder belt is automatically prelocked; however, the belt will retract to remove any slack in the shoulder belt.

The automatic locking mode is not available on the driver safety belt.

When to use the automatic locking mode

- When a tight lap and shoulder belt fit is desired.
- **Any time** a child safety seat is installed in the vehicle. For information on the proper use of a child safety seat, refer to *Child safety seats* later in this chapter.

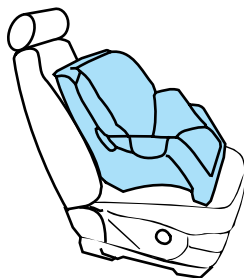

Using automatic locking mode

The automatic locking mode must be used when installing a child safety seat in any outboard passenger seat.

1. Buckle the combination lap and shoulder belt.
2. Grasp the shoulder belt portion and pull downward until the entire belt is extracted.
3. Allow the belt to retract. As the belt retracts, you will hear a clicking sound. This indicates that the safety belt is now in the automatic locking mode.

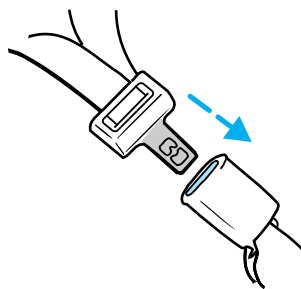

Seating and safety restraints

Canceling automatic locking mode

Disconnect the combination lap and shoulder belt and allow it to completely retract. This will cancel the automatic locking mode and activate the vehicle sensitive (emergency) locking mode.

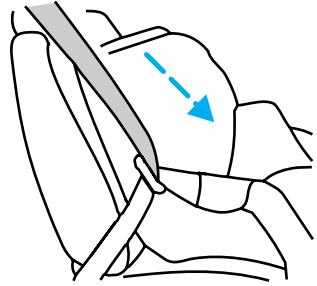

Front seat safety belt height adjustment

Adjust the height of the shoulder belt so that the belt rests across the middle of your shoulder.

To lower the height of the shoulder belt:

- Push the button down.
- Slide down.

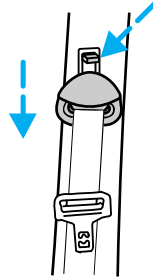

To raise the height of the shoulder belt:

- Slide up.
- Pull down on the height adjuster to make sure that it is locked in place.

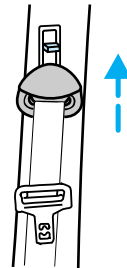

Seating and safety restraints

Using lap belts

Adjusting the lap belt

A lap belt is located in the center of the rear seat.

To shorten the belt:

- Buckle the belt.
- Pull the loose end of the belt until snug.

To lengthen the belt:

- Tip and pull the tongue.

Do not wear the lap belt around your waist.

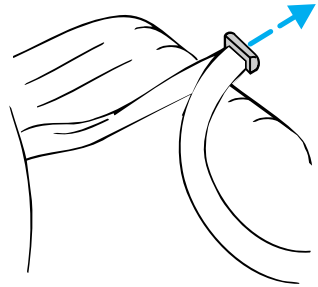

Safety belt indicator light and warning chime

 illuminates in the instrument cluster and a chime sounds to remind the occupants to fasten their safety belts:

Seating and safety restraints

Conditions of operation

If	Then
The driver's safety belt is not buckled before the ignition key is turned to On. .	The safety belt indicator illuminates for 1-2 minutes and the warning chime sounds for 4- 8 seconds.
The driver's safety belt is buckled while the indicator light is illuminated and the reminder chime is sounding . . .	The safety belt indicator light and reminder chime turn off.
The driver's safety belt is buckled before the ignition key is turned to On. . .	The safety belt indicator light and reminder chime remain off.

Energy absorbing sew pattern

The short plastic boot on the front safety belt at the passenger outboard anchor location covers an energy absorbing sew pattern on the safety belt.

In the event of a collision, the sew pattern may release and the colored label (REPLACE BELT) may become visible. If this occurs, *the safety belt must be replaced.*

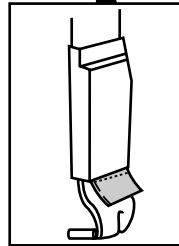
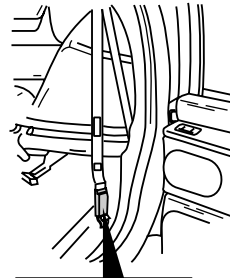

 Whenever the orange portion of the label is visible, the safety belt must be replaced.

 Failure to follow these instructions will affect the performance of the safety belts and increase the risk of personal injury.

Seating and safety restraints

Safety belt extension assembly

The safety belt may be too short even when it is fully extended. Approximately 20 cm (8 inches) may be added to the length of the belt with a safety belt extension (part # 611C22). Safety belt extensions are available at no cost from your dealer.

Only use extensions manufactured by the same supplier as the safety belt. Manufacturer identification is located at the end of the webbing on the label.

Do not use the extension to change the fit of the shoulder belt across the torso.

AIR BAG / SUPPLEMENTAL RESTRAINT SYSTEM (SRS)

Important supplemental restraint system (SRS) precautions

The supplemental restraint system is designed to:

- work with the safety belt to protect the driver and right front passenger
- reduce certain upper body injuries



Seating and safety restraints



Failure to follow these instructions will affect the performance of the safety belts and increase the risk of personal injury.



The right front passenger air bag is not designed to restrain occupants in the front seating position.



Do not place objects or mount equipment on or near the air bag covers that may come into contact with an inflating air bag.



Do not attempt to service, repair, or modify the Air Bag Supplemental Restraint System or its fuses. See your Ford or Lincoln-Mercury dealer.

Children and air bags

For additional important safety information, read all information on safety restraints in this guide.

Children should always wear their safety belts. Failure to follow these instructions may increase the risk of injury in a collision.

Seating and safety restraints



Rear-facing child seats or infant carriers should never be placed in the front seats.

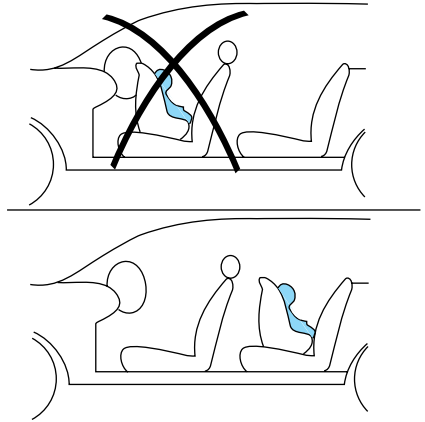

How does the air bag supplemental restraint system (SRS) work?

The SRS is designed to activate when the vehicle is in a collision, similar to hitting a fixed barrier head on at 12–24 km/h (8–14 mph).

The fact that the air bags did not inflate in a collision does not mean that something is wrong with the system. Rather, it means the forces were not of the type sufficient to cause activation.

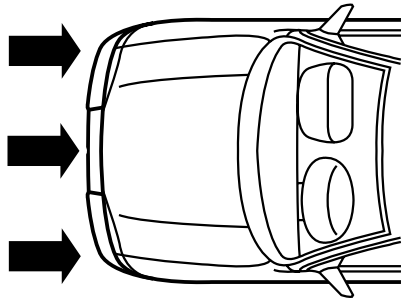

Seating and safety restraints

The air bags inflate and deflate rapidly upon activation.

After air bag deployment, it is normal to notice a smoke-like, powdery residue or smell the burnt propellant. This may consist of cornstarch, talcum powder (to lubricate the bag) or sodium compounds (e.g., baking soda) that result from the combustion process that inflates the air bag. Small amounts of sodium hydroxide may be present which may irritate the skin and eyes, but none of the residue is toxic.



Several air bag system components get hot after inflation. Do not touch them after inflation.



If the air bag is inflated, **the air bag will not function again and must be replaced immediately.** If the air bag is not replaced, the unrepaired area will increase the risk of injury in a collision.

The SRS consists of:

- driver and passenger air bag modules (which include the inflators and air bags),
- one or more impact and safing sensors,
- a readiness light and tone
- and the electrical wiring which connects the components.

Seating and safety restraints

The diagnostic module monitors its own internal circuits and the supplemental air bag electrical system readiness (including the impact sensors), the system wiring, the air bag system readiness light, the air bag back up power and the air bag ignitors.

Determining if the system is operational

The SRS uses a readiness light in the instrument cluster or a tone to indicate the condition of the system. Refer to the *Air bag readiness* section in the *Instrumentation* chapter. Routine maintenance of the air bag is not required.

A difficulty with the system is indicated by one or more of the following:

- The readiness light will either flash or stay lit.
- The readiness light will not illuminate immediately after ignition is turned on.
- A group of five beeps will be heard. The tone pattern will repeat periodically until the problem and light are repaired.



If any of these things happen, even intermittently, have the SRS serviced at your dealership or by a qualified technician immediately. Unless serviced, the system may not function properly in the event of a collision.

Seating and safety restraints

Disposal of air bags and air bag equipped vehicles

For disposal of air bags or air bag equipped vehicles, see your local dealership or qualified technician. Air bags **MUST BE** disposed of by qualified personnel.

CHILDREN AND SAFETY RESTRAINTS



To prevent the risk of injury, make sure children sit where they can be properly restrained.



Do not leave children, unreliable adults, or pets unattended in your vehicle.



Safety belts and seats can become hot in a vehicle that has been closed up in sunny weather; they could burn a small child. Check seat covers and buckles before you place a child anywhere near them.

Seating and safety restraints



It is extremely dangerous to ride in a cargo area, inside or outside of a vehicle. In a collision, people riding in these areas are more likely to be seriously injured or killed. Do not allow people to ride in any area of your vehicle that is not equipped with seats and safety belts. Be sure everyone in your vehicle is in a seat and using a safety belt properly.

Important child restraint precautions

You are required by law to use safety restraints for children in the U.S. and Canada. If small children ride in your vehicle (generally children who are four years old or younger and who weigh 18 kg [40 lbs] or less), you must put them in safety seats made especially for children. Check your local and state or provincial laws for specific requirements regarding the safety of children in your vehicle.



Never let a passenger hold a child on his or her lap while the vehicle is moving. The passenger cannot protect the child from injury in a collision.

Always follow the instructions and warnings that come with any infant or child restraint you might use.

When possible, place children in the rear seat of your vehicle.

Seating and safety restraints

Accident statistics suggest that children are safer when properly restrained in the rear seating positions than in the front seating position.

Children and safety belts

Children who are too large for child safety seats (as specified by your child safety seat manufacturer) should always wear safety belts.

Follow all the important safety restraint and air bag precautions that apply to adult passengers in your vehicle.

If the shoulder belt portion of a combination lap and shoulder belt can be positioned so it does not cross or rest in front of the child's face or neck, the child should wear the lap and shoulder belt. Moving the child closer to the center of the vehicle may help provide a good shoulder belt fit.

If the shoulder belt cannot be properly positioned:

- move the child to one of the seats with a lap belt only (if equipped)

OR

- if the child is the appropriate size, restrain the child in a safety seat.



Do not leave children, unreliable adults, or pets unattended in your vehicle.

Seating and safety restraints

To improve the fit of lap and shoulder belts on children who have outgrown child safety seats, Ford recommends use of a belt-positioning booster seat that is labelled as conforming to all Federal motor vehicle safety standards. Belt-positioning booster seats raise the child and provide a shorter, firmer seating cushion that encourages safer seating posture and better fit of lap and shoulder belts on the child. A belt-positioning booster should be used if the shoulder belt rests in front of the child's face or neck, or if the lap belt does not fit snugly on both thighs, or if the thighs are too short to let the child sit all the way back on the seat cushion when the lower legs hang over the edge of the seat cushion. You may wish to discuss the special needs of your child with your pediatrician.

Child safety seats



Carefully follow all of the manufacturer's instructions included with the safety seat you put in your vehicle. If you do not install and use the safety seat properly, the child may be injured in a sudden stop or collision.

Ford recommends the use of a child safety seat having a top tether strap. Install the child safety seat in a seating position which is capable of providing a tether

Seating and safety restraints

anchorage. For more information on top tether straps see *Attaching safety seats with tether straps* in this chapter.

When installing a child safety seat:

- Use the correct safety belt buckle for that seating position.
- Make sure the tongue is securely fastened in the buckle.
- Keep the buckle release button pointing up and away from the safety seat, with the tongue between the child seat and the release button, to prevent accidental unbuckling.
- Place seatbacks in the upright position.
- Put the safety belt in the automatic locking mode. Refer to *Using the automatic locking mode* in this chapter.

Installing child safety seats in combination lap and shoulder belt seating positions

1. Position the child safety seat in a seat with a combination lap and shoulder belt.

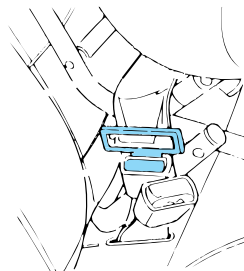

If you choose to install a child safety seat in the front passenger

Seating and safety restraints

seat, move the seat as far back as possible.



Rear-facing child seats or infant carriers should never be placed in the front seats.

2. Pull down on the shoulder belt and then grasp the shoulder belt and lap belt together.



3. While holding the shoulder and lap belt portions together, route the tongue through the child seat according to the child seat manufacturers' instructions. Be sure the belt webbing is not twisted.

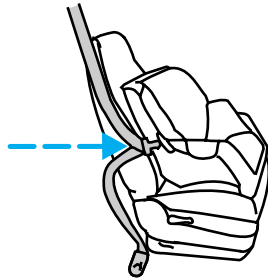

4. Insert the belt tongue into the proper buckle for that seating position until you hear and feel the latch engage. Make sure the tongue is latched securely by pulling on it.

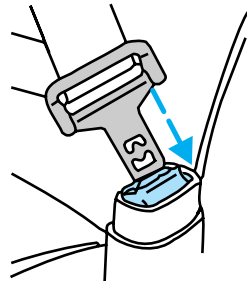

Seating and safety restraints

5. To put the retractor in the automatic locking mode, grasp the shoulder portion of the belt and pull downward until all of the belt is extracted and a click is heard.

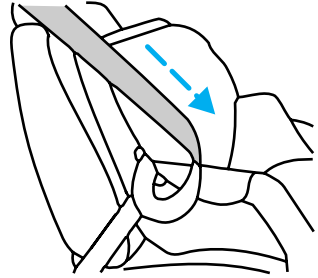

6. Allow the belt to retract. The belt will click as it retracts to indicate it is in the automatic locking mode.

7. Pull the lap belt portion across the child seat toward the buckle and pull up on the shoulder belt while pushing down with knee on the child seat.

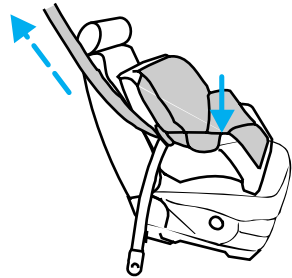

8. Allow the safety belt to retract to remove any slack in the belt.

9. Before placing the child in the seat, forcibly tilt the seat forward and back to make sure the seat is securely held in place.

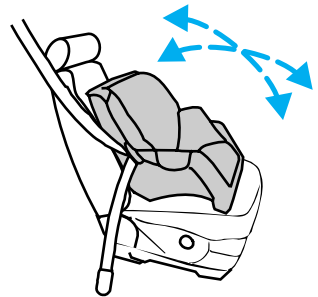

10. Try to pull the belt out of the retractor to make sure the retractor is in the automatic locking mode (you should not be

Seating and safety restraints

able to pull more belt out). If the retractor is not locked, unbuckle the belt and repeat steps two through nine.

Check to make sure the child seat is properly secured before each use.

Attaching safety seats with tether strap

Some manufacturers make safety seats that include a tether strap that goes over the back of the vehicle seat and attaches to an anchoring point. Other manufacturers offer the tether strap as an accessory. Contact the manufacturer of your child safety seat for information about ordering a tether strap.

Tether anchor hardware

Attachment holes (at each rear seating position) have been provided in your vehicle to attach anchor hardware, if required. Tether anchor hardware kits (part number 613D74), including instructions, may be obtained at no charge from any Ford or Lincoln-Mercury dealer.



Only use the tether attachment hole locations shown in the illustrations. The tether anchor may not perform properly if the wrong mounting location is used.

Seating and safety restraints

Built-in child seat (if equipped)

The rear seat may be equipped with a built-in child safety seat. This child seat conforms to all federal and Canadian motor vehicle safety standards. Read the labels located on the child seat cushion and shoulder belt for more information on the built-in child seat.

Use the built-in child seat **only** under the following conditions:

Child's age	Child's weight	Child's height
At least one year	10-27 kg (22-60 lb)	Shoulders must be below the shoulder harness slots on the built-in seat.

Children not meeting these requirements should be secured in an approved aftermarket seat. Refer to *Children and infant or child safety seats* in this chapter.

Placing your child in the built-in child seat



Failure to follow all of the instructions on the use of this child restraint system can result in your child striking the vehicle's interior during a sudden stop or crash.

Seating and safety restraints

 The second row seatback must be fully locked before operating the child restraint system. Check the position of the seatback release lever.

 Never use the Built-In Child Seat as a booster cushion with the adult safety belts. A child using the adult belts could slide forward and out from under the safety belts.

1. Grasp the strap and pull toward you approximately one inch, then slide hand under the head restraint and slide upwards to the full position.

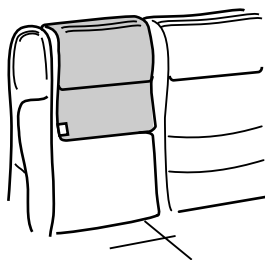

2. Pull both Velcro® straps to release the child seat cushion.

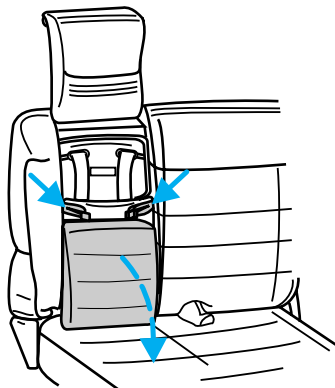

Seating and safety restraints

3. Lower the child seat cushion.

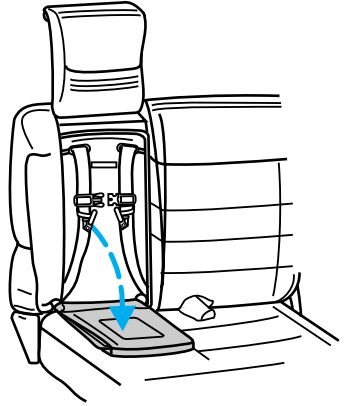

4. Unfold the cushion protector flap onto adult seat cushion.

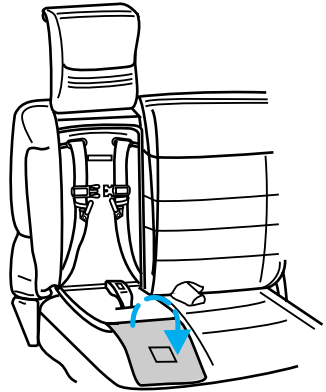

Seating and safety restraints

5. If connected, disconnect the chest clip and buckles.
6. Place the child in the seat and position the left shoulder belt over the child's left shoulder first, then place the right shoulder belt over the child's right shoulder.

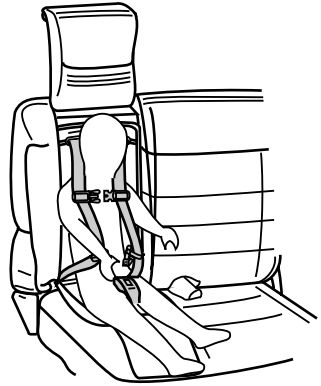

7. Insert the left and right safety belt tongues into the left and right slots of the crotch buckle. Verify that the indicator window on each tongue is green to ensure proper safety belt connections.

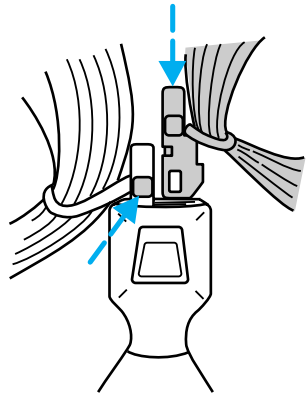

Seating and safety restraints



If both tongues do not latch in the buckle, do not use the child seat. See your dealer for repairs.

8. Fasten the right and left chest clip halves together and adjust the clip to comfortably hold the shoulder belts in place over the child's chest.

The chest clip is designed to easily pull apart in a collision. The clip helps to keep belts snug on a sleeping or squirming child.

9. Pull on the safety belt tongues to ensure that they are both securely latched. If they are not properly latched, repeat steps seven and eight.

If necessary, the shoulder belt may be put in automatic locking mode (ALR) to limit the child's movement in the seat. The ALR mode should be used if the child is sleeping or attempting to get out of the seat.

If not placed in ALR mode, the child seat shoulder belts are in vehicle sensitive (emergency locking) mode, which allow some movement of the shoulder belts (like adult shoulder belts).

In emergency locking mode, the shoulder belts of the child seat will lock in response to hard braking, hard cornering or if your vehicle is involved in a collision with an impact of 8 km/h (5 mph) or more.

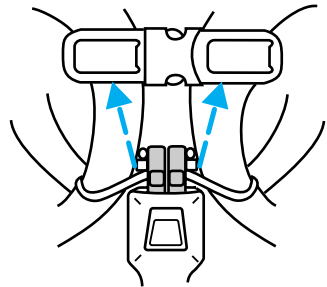
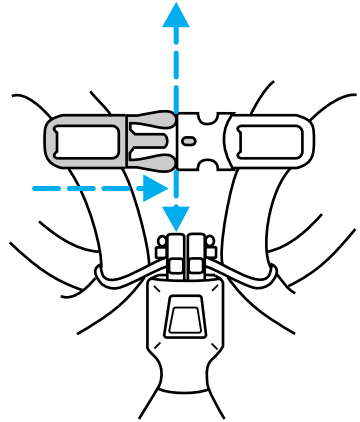

Seating and safety restraints

Activating the automatic locking mode (ALR) on the built-in child safety seat

1. Fully extend the right shoulder belt.
2. Allow the belts to tighten snugly against the child's shoulders.

Deactivating the automatic locking mode (ALR) on the built-in child safety seat

1. Disconnect the chest clip and remove the left and right safety belt tongues from the crotch buckle.
2. Allow the shoulder belts to fully retract.

Removing your child from the built-in child safety seat

1. Disconnect the chest clip by squeezing the release tabs together and pulling the two sides apart.
2. Press the release button on the crotch buckle.
3. Slide the shoulder belts off the child's shoulders and remove the child from the seat.

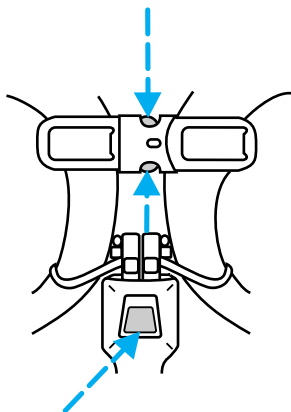

- If ALR is activated, hold either left or right shoulder belt out fully while helping the child slide arms out of the belts.

Seating and safety restraints

4. Fold the cushion protector flap onto the child seat cushion. Slide the belt tongues up and out of the way of the cushion, then return the child seat cushion to the stowed (upright) position.
5. Slide the Velcro® straps through the D-rings on the child seat cushion and attach.
6. Slide the head restraint down until the top of the head restraint is flush with the top of the adult seat back.
7. Press firmly on the top center of the built-in child safety seat head restraint to ensure it is stowed properly.

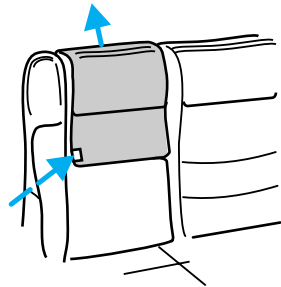

Inspecting the built-in child safety seat after a collision



Ford recommends that all safety belt assemblies and attaching hardware should be inspected by a qualified technician after any collision. Safety belt assemblies not in use during a collision should also be inspected and replaced if either damage or improper operation is noted.

Seating and safety restraints



All built-in child restraints, including seats, buckles, retractors, seat latches, interlocks, and attaching hardware should be inspected by a qualified dealer technician after any collision.

Starting

Important safety precautions

A computer system controls the engine's idle revolutions per minute (RPM). When the engine starts, the idle RPM runs faster to warm the engine. If the engine idle speed does not slow down automatically, have the vehicle checked. Do not allow the vehicle to idle for more than ten minutes.



Extended idling at high engine speeds can produce very high temperatures in the engine and exhaust system, creating the risk of fire or other damage.



Do not park, idle, or drive your vehicle in dry grass or other dry ground cover. The emission system heats up the engine compartment and exhaust system, which can start a fire.



Do not start your vehicle in a closed garage or in other enclosed areas. Exhaust fumes can be toxic. Always open the garage door before you start the engine. See *Guarding against exhaust fumes* in this chapter for more instructions.



If you smell exhaust fumes inside your vehicle, have your dealer inspect your vehicle immediately. Do not drive if you smell exhaust fumes.

Important ventilating information

If the engine is idling while the vehicle is stopped in an open area for long periods of time, open the windows at least 2.5 cm (one inch).

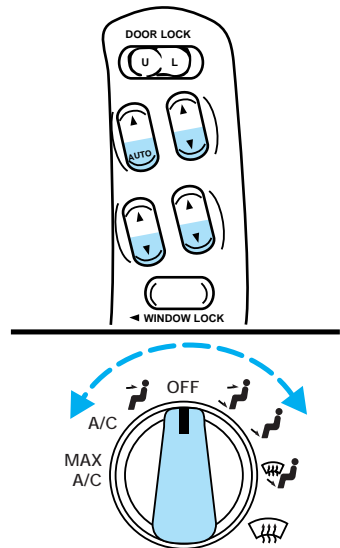

Adjust the heating or air conditioning to bring in fresh air.

Starting

Improve vehicle ventilation by keeping all air inlet vents clear of snow, leaves and other debris.

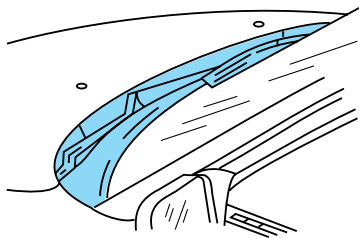

Guarding against exhaust fumes

Although odorless and colorless, carbon monoxide is present in exhaust fumes. Take precautions to avoid its dangerous effects.



If you ever smell exhaust fumes of any kind inside your vehicle, have your dealer inspect and fix your vehicle immediately. Do not drive if you smell exhaust fumes. These fumes are harmful and could kill you.

Have the exhaust and body ventilation systems checked whenever:

- the vehicle is raised for service
- the sound of the exhaust system changes
- the vehicle has been damaged in a collision

Preparing to start the vehicle

Engine starting is controlled by the spark ignition system. This system meets all Canadian Interference-Causing Equipment

standard requirements regulating the impulse electrical field strength of radio noise.

When starting a fuel-injected engine, avoid pressing the accelerator before or during starting. Only use the accelerator when you have difficulty starting the engine. For more information on starting the vehicle, refer to *Starting the vehicle* in this chapter.

Before starting the vehicle:

1. Make sure all vehicle occupants have buckled their safety belts. For more information on safety belts and their proper usage, refer to the *Seating and safety restraints* chapter.
2. Make sure the headlamps and vehicle accessories are off.

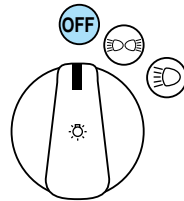

Starting

If starting a vehicle with an automatic transmission:

- Make sure the parking brake is set.
- Make sure the gearshift is in P (Park).

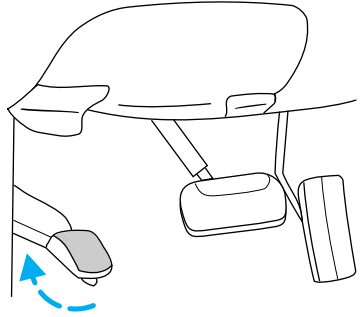

If starting a vehicle with a manual transmission:

- Make sure the parking brake is set.
- Push the clutch pedal to the floor.

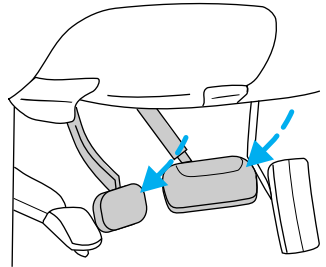
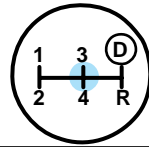

3. Turn the key to the ON position (without turning the key to START).

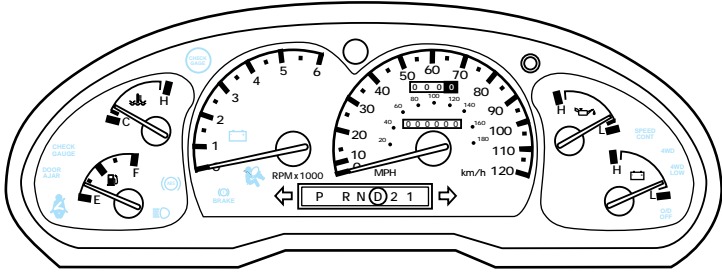

Make sure the following lights illuminate briefly. If a light fails to illuminate, have the vehicle serviced.

- If the driver's safety belt is fastened, the  light does not illuminate.

STARTING

Special conditions when starting

Starting the engine

1. Turn the key to 5 (Start) without pressing the accelerator and release as soon as the engine starts. The key will return to 4 (On).

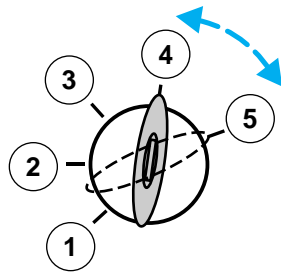

2. If the engine does not start within five seconds, wait ten seconds and try again.

3. If the engine does not start in two attempts OR the temperature is below -12°C (10°F), depress

Starting

accelerator and start the engine while holding the accelerator down. Release accelerator when engine starts.

4. After idling for a few seconds, apply the brake and release the parking brake.

Using the engine block heater (if equipped)

An engine block heater warms the engine coolant, which improves starting, warms up the engine faster and allows the heater-defroster system to respond quickly. They are strongly recommended if you live in a region where temperatures reach -23°C (-10°F) or below.

For best results, plug the heater in at least three hours before starting the vehicle. Using the heater for longer than three hours will not harm the engine, so the heater can be plugged in the night before starting the vehicle.



To prevent electrical shock, do not use your heater with ungrounded electrical systems or two-pronged (cheater) adapters.

BRAKES

Your brakes are self-adjusting. Refer to the “Service Guide” for maintenance scheduling.

Anti-lock brake system (ABS) (if equipped)

The ABS operates by detecting the onset of wheel lock up during brake applications and compensating for this tendency. The front wheels are prevented from locking even when the brakes are firmly applied. The accompanying illustration depicts the advantage of an ABS equipped vehicle (on bottom) to a non-ABS equipped vehicle (on top) during hard braking.

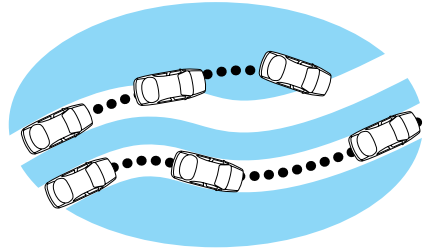

Using ABS

- In an emergency, apply full force on the brake. The ABS will be activated immediately, thus allowing you to retain full steering control of your vehicle and, providing there is sufficient space, will enable you to avoid obstacles and bring the vehicle to a quiet stop.
- We recommend that you familiarize yourself with this braking technique. However, avoid taking any unnecessary risks.

Driving

Parking brakes

To engage the parking brake:

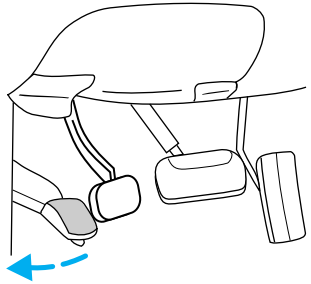

To disengage the parking brake:

 Always set the parking brake fully and make sure that the gearshift is securely latched in P (Park) (automatic transmission) or in 1 (First) (manual transmission).

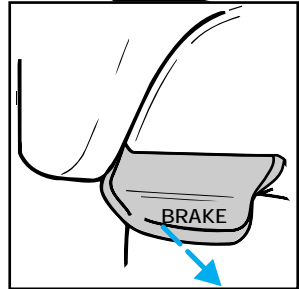
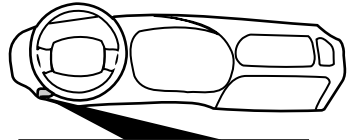

UNDERSTANDING THE TRACTION-LOK® REAR AXLE (IF EQUIPPED)

This axle provides added traction on slippery surfaces, particularly when one or more wheels are on a surface with poor traction.

Extended use of other than matching size tires on a Traction-Lok® rear axle could result in a permanent reduction in effectiveness. This loss of effectiveness does not affect normal driving and should not be noticeable to the driver.

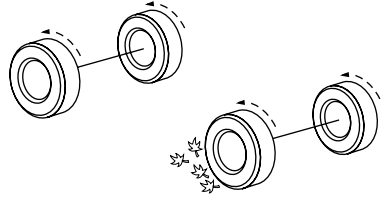

To avoid injury, never run the engine with one wheel off the ground, such as when changing a tire.

AUTOMATIC RIDE CONTROL SYSTEM (IF EQUIPPED)

The Automatic Ride Control System is designed to improve ride, handling and general vehicle performance for both on and off-road conditions by adjusting vehicle ride height and shock dampening (firm or soft).

The system automatically controls vehicle ride height over a range based on vehicle speed and the selections of four wheel drive modes or the Ride Control switch. The system keeps the vehicle at a constant level if a load is added or removed from the vehicle. Shock dampening is automatically set

Driving

based on driver and road inputs to optimize ride. The combination of firm dampening and height change also provides maximum suspension feedback for improved off-road safety and performance.

The vehicle will drop to its lowest position when the ignition is turned to the Off position to provide easy entry and exit to of the vehicle. As a safety consideration, whenever a door is opened (including the liftgate and liftgate glass), the system memorizes and maintains the height at the moment the door was opened. The system will maintain this height either until all doors are closed or until vehicle speed exceeds 16 kph (10 mph).

An on board air compressor and solenoids are used to raise and lower the vehicle. It is normal to occasionally a buzz or clicking from the vehicle even when the ignition is turned to Off. The system stays energized for 40 minutes after the ignition is turned off to compensate for any load changes after the vehicle is parked.

The Automatic Ride Control system operation can be monitored through the message center. Refer to *Message center* in the *Instrumentation* chapter.

Ride control switch (All wheel drive vehicles with Automatic Ride Control only)

The Ride Control switch provides direct control of the Automatic Ride Control system. The switch does **not** control or change the performance of the All Wheel Drive system.

The switch should be placed in the Normal position for all on road and most dirt, gravel or snow covered roads. For severe off-road conditions where additional body ground clearance is desired and vehicle speeds are below 30 mph, the Off-road position should be selected.

Service switch

The Automatic Ride Control service switch is mounted in the jack storage area. The switch should be turned off to deactivate the system during jacking, hoisting, towing or transport of the vehicle to avoid unexpected vehicle movement.

TRANSMISSION OPERATION

Driving an automatic transmission (if equipped)

Brake-shift interlock

Vehicles equipped with an automatic transmission are equipped with a brake-shift interlock feature that prevents the gearshift lever from being moved from the P (Park) position unless



Driving

the brake pedal is depressed. If you cannot move the gearshift lever from P (Park) with the brake pedal depressed:

1. Apply the parking brake.
2. Turn the ignition key to Lock, then remove the key.
3. Insert the key and turn the ignition off.
4. Apply the brake pedal and shift into N (Neutral).
5. Start the vehicle.

If it is necessary to use this procedure to move the gearshift lever, it is possible that a fuse may have blown and the vehicle's brakelamps may not be working. Refer to *Fuses and relays* in the *Roadside emergencies* chapter.

Driving (4R70W transmission-5.0L engines only)

Ⓞ **Overdrive** The normal driving position for the best fuel economy. Transmission operates in gears one through four.

Ⓞ can be deactivated by pressing the switch selector lever. The $\frac{O/D}{OFF}$ light will illuminate.

D Drive Not shown on the display. Activate by pressing the transmission control switch.

$\frac{O/D}{OFF}$ will illuminate in the instrument cluster. Transmission operates in gears one through three. D (Drive) provides more engine braking than

Ⓞ (Overdrive) and is useful when

towing a trailer or heavy loads through heavy terrain.

To return to **D** (Overdrive) mode, press the transmission control switch. $\frac{O/D}{OFF}$ will remain off.

When starting your vehicle, the transmission will automatically return to normal **D** (Overdrive) mode.

2 Second Use the 2 (Second) position to start-up on slippery roads or to provide additional braking on downgrades. Transmission operates in gears one and two.

1 Low Use the 1 (Low) position to provide maximum engine braking on steep downgrades. Upshifts may be made by shifting to the 2 (Second) position or to **D** (Overdrive). Selecting the 1 (Low) position at higher speeds causes the transmission to downshift through the gears and will shift to 1 (Low) after the vehicle decelerates to the proper speed.

Driving (5R55E transmission-4.0L engines only)

D Overdrive The normal driving position for the best fuel economy. Transmission operates in gears one through five.

D can be deactivated by pressing the transmission control switch on the selector lever. The $\frac{O/D}{OFF}$ will illuminate.

Driving

D Drive Not shown on the display.

Activate by pressing the transmission control switch.

$\frac{O/D}{OFF}$ will illuminate in the instrument cluster. Transmission operates in gears one through four. D (Drive) provides more engine braking than \textcircled{D} (Overdrive) and is useful when towing a trailer or heavy loads through heavy terrain.

To return to \textcircled{D} (Overdrive) mode, press the transmission control switch. $\frac{O/D}{OFF}$ will turn off.

When starting your vehicle, the transmission will automatically return to normal \textcircled{D} (Overdrive) mode.

2 Second Use the 2 (Second) position to start-up on slippery roads or to provide additional braking on downgrades.

Transmission operates in third gear.

1 Low Use the 1 (Low) position to provide maximum engine braking on steep downgrades. Upshifts may be made by shifting to the 2 (Second) position or to \textcircled{D} (Overdrive). Selecting the 1 (Low) position at high speeds causes the transmission to downshift through the gears and will shift to 1 (Low) after the vehicle decelerates to the proper speed.

Driving a manual transmission (if equipped)

Using the clutch

Vehicles equipped with a manual transmission have a starter interlock that prevents cranking the engine unless the clutch pedal is fully depressed.

When starting a vehicle with a manual transmission:

1. Put the gearshift lever in N (Neutral).
2. Hold down the brake pedal.
3. Depress the clutch pedal.
4. Crank the engine and let it idle for a few seconds.
 - Put the gearshift in 1 (First) or R (Reverse).
5. Release the clutch slowly while pressing gradually down on the accelerator pedal.
 - Do not drive with your foot resting on the clutch pedal. Do not use the clutch to hold your vehicle at a standstill while waiting on a hill. These actions may reduce clutch life.

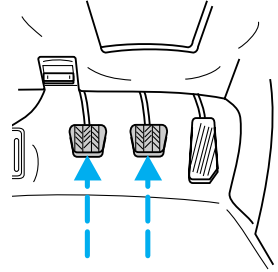

Recommended shift speeds

Upshifts when accelerating (for best fuel economy)		
Shift from:	Transfer case position	
	4AUTO or 4H	4L
1 - 2	14 km/h (10 mph)	5 km/h (4 mph)

Driving

Upshifts when accelerating (for best fuel economy)		
2 - 3	32 km/h (22 mph)	11 km/h (9 mph)
3 - 4	50 km/h (33 mph)	19 km/h (13 mph)
4 - 5 (Overdrive)	71 km/h (41 mph)	27 km/h (17 mph)
Upshifts when cruising (recommended for best fuel economy)		
— Shift from:	Transfer case position	
	4AUTO or 4H	4L
1 - 2	16 km/h (10 mph)	6 km/h (4 mph)
2 - 3	26 km/h (19 mph)	10 km/h (8 mph)
3 - 4	43 km/h (28 mph)	16 km/h (12 mph)
4 - 5 (Overdrive)	68 km/h (40 mph)	26 km/h (16 mph)
Maximum downshift speeds		
— Shift from:	Transfer case position	
	4AUTO or 4H	4L
5 (Overdrive) - 4	88 km/h (55 mph)	34 km/h (22 mph)
4 - 3	72 km/h (45 mph)	34 km/h (18 mph)
3 - 2	56 km/h (35 mph)	21 km/h (14 mph)
2 - 1	32 km/h (20 mph)	11 km/h (8 mph)

Parking

1. Apply the brake and shift into N (Neutral).

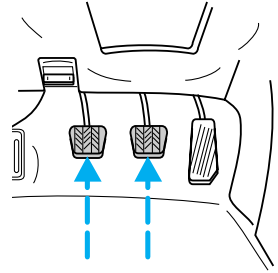

2. Engage the parking brake.

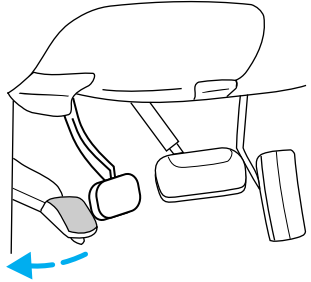

3. Shift into 1 (First).

4. Turn the ignition to Off.



Do not park your vehicle in Neutral, it may move unexpectedly and injure someone. Use 1 (First) gear and set the parking brake fully.

Reverse

Ensure that the vehicle is at a complete stop before shifting into R (Reverse). Failure to do so may damage the transmission.

Put the gearshift into N and wait at least several seconds before shifting into R.

Driving

You can shift into R (Reverse) only by moving the gearshift from left of 3 (Third) and 4 (Fourth) gears before you shift into R (Reverse). This is a special lockout feature that protects you from accidentally shifting into R (Reverse) when you downshift from 5 (Overdrive).

USING THE CONTROL TRAC 4WD SYSTEM (IF EQUIPPED)

Positions of the Control Trac system

4WD AUTO — Full power delivered to front and rear axles for increased traction. Use this mode for normal on-road operating conditions such as dry road surfaces, wet pavement, snow and gravel.

4WD HIGH — 4WD with full power to the rear axle and higher continuous power level to the front axle than 4WD AUTO. Use this mode for severe winter or off-road conditions such as deep snow, ice, shallow sand.

4WD LOW — Full power to both axles, including a lower gear ratio for low-speed. Use this mode for off-road applications that require extra power such as deep sand, steep grades and pulling a boat out of the water. 4WD LOW operation is not recommended on dry pavement.

Using the Control Trac system

Shifting between 4WD AUTO and 4WD HIGH

Either shift can be done at a stop, or at any forward speed.

- The 4WD HIGH light will illuminate when you switch the control to 4WD HIGH or turn off if you switch to 4WD AUTO.

Shifting from 4WD AUTO or 4WD HIGH to 4WD LOW

To perform this shift, complete the following steps:

1. Stop the vehicle and depress the brake.
2. Place the automatic transmission in N (Neutral) or depress the manual transmission clutch.
3. Rotate the 4WD control to 4WD LOW.

Shifting from 4WD LOW to 4WD AUTO or 4WD HIGH

To perform this shift, complete the following steps:

1. Bring the vehicle to a stop.
2. Depress and hold the brake.
3. Place the automatic transmission gearshift lever in N (Neutral) or depress the manual transmission clutch.
4. Move the 4WD control to the 4WD AUTO or 4WD HIGH position.

Driving

Driving off-road with 4WD

Your vehicle is specially equipped for driving on snow, sand, mud or other rough terrain and has operating characteristics that differ from those of other conventional vehicles.

When using 4WD, maintain steering wheel control at all times, especially in rough terrain. Since sudden changes in terrain can result in abrupt steering motion, always grip the steering wheel from the outside. Do not grip the spokes.

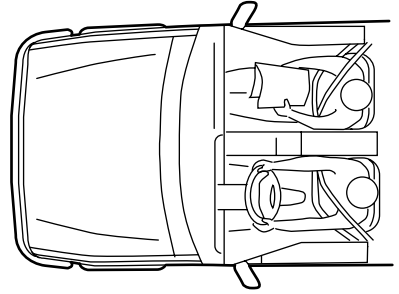

Drive cautiously to avoid vehicle damage from road debris such as rocks or stumps. Be sure to map out your route before driving in any off road area.

For more information on driving off-road and proper operation of your 4WD vehicle, refer the “Four Wheeling” supplement in your Owners Portfolio.

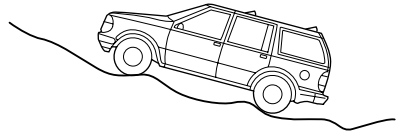

Driving over sand

When driving over sand, try to keep all four wheels on the most solid area of the trail. Do not reduce the tire pressures but shift to a lower gear and drive steadily through the terrain. Apply the

accelerator slowly and avoid spinning the wheels.

Driving through mud and water

After driving through mud, clean off residue stuck to rotating driveshafts and tires. Excess mud stuck on tires and rotating driveshafts causes an imbalance that could damage drive components.

If you must drive through high water, drive slowly. Traction or brake capability may be limited.

When driving through water, determine the depth; avoid water higher than the bottom of the hubs (if possible) and proceed slowly. If the ignition system gets wet, the vehicle may stall.

Once through water, always try the brakes. Wet brakes do not stop the vehicle as effectively as dry brakes. Drying can be improved by moving your vehicle slowly while applying light pressure on the brake pedal.

If the transmission and transfer case are submerged in water, their fluids should be checked and changed, if necessary.

If the rear axle is submerged in water, the rear axle lubricant should be checked and changed, if necessary. The rear axle is filled with a synthetic lubricant and does not normally require a lubricant change for the life of the vehicle. Rear axle lubricant quantities should not need to be checked unless a leak is suspected.

Driving

Driving Through Water

Do not drive quickly through standing water, especially if the depth is unknown. Traction or brake capability may be limited and if the ignition system gets wet, your engine may stall. Water may also enter your engine's air intake and severely damage your engine.

If driving through deep or standing water is unavoidable, proceed very slowly. Never drive through water that is higher than the bottom of the hubs (truck) / wheel rims (car).

Once through the water, always try the brakes. Wet brakes do not stop the vehicle as effectively as dry brakes. Drying can be improved by moving your vehicle slowly while applying light pressure on the brake pedal.

Driving on hill or slope terrain

When driving on a hill, avoid driving crosswise or turning on steep slopes. You could lose traction and slip sideways. Drive straight up, straight down or avoid the hill completely. Know the conditions on the other side of a hill before driving over the crest.

When climbing a steep hill, start in a lower gear rather than downshifting to a lower gear from a higher gear once the ascent has started. This reduces strain on the engine and the possibility of stalling.

When descending a steep hill, avoid sudden braking. Rapid pumping of the brake pedal will help slow the vehicle and still maintain steering control.

When speed control is on and you are driving uphill, your vehicle speed may drop considerably, especially if you are carrying a heavy load.

If vehicle speed drops more than 15–25 km/h (8–14 mph), the speed control will cancel automatically. Resume speed with accelerator pedal.

If speed control cancels after climbing the hill, reset speed by pressing and holding the SET ACCEL button (to resume speeds over 50 km/h (30 mph)).

Automatic transmission may shift frequently while driving up steep grades. Eliminate frequent shifting by shifting out of **Ⓧ** (Overdrive) into D (Drive).

Driving on snow and ice

Avoid sudden applications of power and quick changes of direction on snow and ice. Apply the accelerator slowly and steadily when starting from a full stop.

When braking, apply the brakes as you normally would. In order to allow the anti-lock brake system (ABS) to operate properly, keep steady pressure on the brake pedal.

Driving

Allow more stopping distance and drive slower than usual. Consider using one of the lower gears.

Control trac system indicator lights

4WD and 4WD LOW indicator lights are located in the instrument cluster. If either light flashes, see your dealer or qualified service technician.

4WD

The indicator lights will also illuminate under the following conditions:

4WD
LOW

- **4WD AUTO mode** — Neither light will illuminate.
- **4WD HIGH mode** — Only the 4WD high light illuminates.
- **4WD LOW mode** — The 4WD LOW light illuminates.

ALL WHEEL DRIVE (AWD) SYSTEM (5.0L ENGINES ONLY)

Your vehicle is equipped with an all wheel drive (AWD) transfer case. Power is constantly supplied to all four wheels through the transfer case. The AWD system is full time and has no external controls.

Like all utility type vehicles, your AWD vehicle has special design and equipment features that make it capable of performing in a variety of off-road applications. Specific design characteristics give these vehicles higher centers of gravity than ordinary passenger cars.



Utility and four-wheel drive vehicles are NOT designed for cornering at speeds as high as passenger cars any more than low-slung sports cars are designed to perform satisfactorily under off-road conditions. Avoid sharp turns or abrupt maneuvers in these vehicles.

LOADING YOUR VEHICLE

Before loading your vehicle, familiarize yourself with these terms:

- **Base curb weight** —Weight of the vehicle including any standard equipment, fluids, lubricants, etc. It does not include passengers or aftermarket equipment.
- **Payload** — Combined maximum allowable weight of passengers, cargo and optional equipment.
- **GVW (Gross Vehicle Weight)** — Base curb weight plus the payload weight. The GVW is not a limit or a specification.
- **GVWR (Gross Vehicle Weight Rating)** — Maximum total weight of the base vehicle, passengers, optional equipment and cargo. The GVWR is specific to each vehicle and is listed on the Safety Compliance Certification Label on the driver's door pillar.

Driving

- **GAWR (Gross Axle Weight Rating)** — Carrying capacity for each axle system (front and rear). The GAWR is specific to each vehicle and is listed on the Safety Compliance Certification Label on the driver door pillar.
- **GCW (Gross Combined Weight)** — The GCW is the maximum combined weight of the towing vehicle (including passengers and cargo) and the loaded trailer. The GCW is specified by the manufacturer to indicate the combined maximum loaded weight that the vehicle is designed to tow.

Payload = GVWR minus Base curb weight

To obtain the correct weights for your vehicle, try taking your vehicle to a shipping company or an inspection station for trucks.

Do not use replacement tires with lower weight capacities than the originals because they might lower the vehicle's GVWR and GAWR. (Replacement tires with a higher weight limit than the originals do not increase the GVWR or the GAWR limitations.)

In high altitudes, engines will lose power at a rate of 3% power per 300 m (1000 ft) increase in elevation. A reduction in GVW and GCW is recommended for maximum vehicle performance.



Do not exceed the GVWR or the GAWR specified on the Safety Compliance Certification Label.



It is extremely dangerous to ride in a cargo area, inside or outside of a vehicle. In a collision, people riding in these areas are more likely to be seriously injured or killed. Do not allow people to ride in any area of your vehicle that is not equipped with seats and safety belts. Be sure everyone in your vehicle is in a seat and using a safety belt properly.

Driving with a heavy load

The total vehicle weight plus the total weight of passengers and cargo should never exceed the GVWR.

The weight that the vehicle carries over the front and rear axles should never exceed the GVWR for the respective axle.

The weight limits of your vehicle's tires affect the GVWR or GAWR limitations. Using tires with higher weight limits than the original tires will not increase the GVWR or GAWR of your vehicle; using tires with lower weight limits may lower the GVWR or GAWR of your vehicle.

Driving

TRAILER TOWING

Trailer towing with your vehicle may require the use of a trailer tow option package.

Trailer towing puts additional loads on your vehicle's engine, transmission, axle, brakes, tires, and suspension. For your safety and to maximize vehicle performance, be sure to use the proper equipment while towing.

Follow these guidelines to ensure safe towing procedure:

- Stay within your vehicle's load limits.
- Thoroughly prepare your vehicle for towing. Refer to *Preparing to tow* in this chapter.
- Use extra caution when driving while trailer towing. Refer to *Driving while towing* in this chapter.
- Service your vehicle more frequently if you tow a trailer. Refer to the severe duty schedule in the "Service Guide".
- Do not tow a trailer until your vehicle has been driven at least 800 km (500 miles).
- Refer to the instructions included with towing accessories for the proper installation and adjustment specifications.
- Speed control may shut off if you are towing on long, steep grades.

Do not exceed the maximum loads listed on the Safety Compliance Certification label. For load specification terms found on the label, refer to *Loading your vehicle* in this chapter. Remember to figure in the tongue load of your loaded vehicle when figuring the total weight.

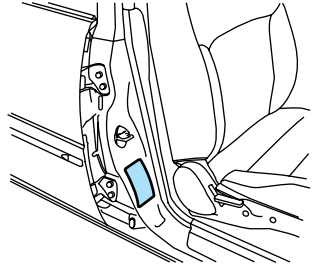

Preparing to tow

Use the proper equipment for towing a trailer and make sure that it is properly attached to your vehicle. See your dealer or a reliable trailer retailer if you require assistance.

Auxiliary coolers are recommended for the power steering system and automatic transmission system if you are planning on:

- towing farther than 80 km (50 miles)
- towing in hilly terrain
- towing frequently

Trailer towing tables

TRAILER TOWING TABLE 4X2 MANUAL TRANSMISSION				
GCWR (Gross Combined Weight Rating)/Trailer Weights				
Engine (EFI)	Rear Axle Ratio	Maximum GCWR Kg(Lb)	Trailer Weight Range Kg(lb) (0-Maximum)	Maximum Frontal Area of Trailer Ft ²
2-DOOR				
4.0 L	3.27	2,721 (6,000)	0-907 (0-2,000)	50

Driving

TRAILER TOWING TABLE 4X2 MANUAL TRANSMISSION

4.0 L	3.73	3,175 (7,000)	0-1,406 (0-3,100)	50
4-DOOR				
4.0 L	3.27	2,721 (6,000)	0-861 (0-1,900)	50
4.0 L	3.73	3,175 (7,000)	0-1,315 (0-2,900)	50

TRAILER TOWING TABLE 4X4 MANUAL TRANSMISSION

GCWR (Gross Combined Weight Rating)/Trailer Weights

2-DOOR				
4.0 L	3.27	2,721 (6,000)	0-816 (0-1,800)	50
4.0 L	3.55	2,948 (6,500)	0-1,043 (0-2,300)	50
4.0 L	3.73	3,175 (7,000)	0-1,270 (0-2,800)	50
4-DOOR				
4.0 L	3.55	2,948 (6,500)	0-952 (0-2,100)	50
4.0 L	3.73	3,175 (7,000)	0-1,179 (0-2,600)	50

NOTES:

- For high altitude operation, reduce GCW by 2% per 300 meters (1,000 ft) elevation.
- For definitions of terms used in this table and instructions on how to calculate your vehicle load, refer to *Loading your vehicle* in this chapter.
- Maximum trailer weights shown. The combined weight of the completed towing vehicle and the loaded trailer must not exceed the GCWR.

TRAILER TOWING TABLE 4X2 AUTOMATIC TRANSMISSION				
GCWR (Gross Combined Weight Rating)/Trailer Weights				
Engine (EFI)	Rear Axle Ratio	Maximum GCWR Kg(Lb)	Trailer Weight Range Kg(Lb) 0-Maximum	Maximum Frontal Area of Trailer Ft ²
2-DOOR				
4.0 L	3.27	3,175 (7,000)	0-1,360 (0-3,000)	50
4.0 L	3.55	3,628 (8,000)	0-1,814 (0-4,000)	50
4.0 L	3.73	4,082 (9,000)	0-2,267 (0-5,000)	50
4-DOOR				
4.0 L	3.55	4,082 (9,000)	0-2,177 (0-4800)	50
4.0 L	3.73	4,535 (10,000)	0-2,630 (0-5,800)	50
4.0 L	4.10	4,535 (10,000)	0-2,630 (0-5,800)	50
5.0 L	3.73	4,990 (11,080)	0-3,039 (0-6,700)	50
TRAILER TOWING TABLE 4X4 AUTOMATIC TRANSMISSION				
GCWR (Gross Combined Weight Rating)/Trailer Weights				
2-DOOR				
4.0 L	3.27	3,175 (7,000)	0-1,270 (0-2,800)	50
4.0 L	3.55	3,628 (8,000)	0-1,723 (0-3,800)	50
4.0 L	3.73	4,082 (9,000)	0-2,177 (0-4,800)	50
4-DOOR				
4.0 L	3.55	4,082 (9,000)	0-2,086 (0-4,600)	50

Driving

TRAILER TOWING TABLE 4X4 AUTOMATIC TRANSMISSION

4.0 L	3.73	4,535 (10,000)	0-2,540 (0-5,600)	50
4.0 L	4.10	4,535 (10,000)	0-2,540 (0-5,600)	50

TRAILER TOWING TABLE AWD AUTOMATIC TRANSMISSION

GCWR (Gross Combined Weight Rating)/Trailer Weights

4-DOOR

5.0 L	3.73	4,990 (11,000)	0-2,902 (0-6,400)	50
-------	------	-------------------	----------------------	----

NOTES:

- For high altitude operation, reduce GCW by 2% per 300 meters (1,000 ft) elevation.
- For definition of terms and instructions on calculating your vehicle's load, refer to *Loading your vehicle* in this chapter.
- Maximum trailer weights shown. The combined weight of the completed towing vehicle and the loaded trailer must not exceed the GCWR.

Calculating trailer loads

To determine the amount of weight that your vehicle can carry:

- Obtain ratings from the Safety Compliance Certification label and the trailer towing specifications in this chapter.
- Weigh your vehicle as you customarily operate the vehicle without cargo.
- Subtract the total weight of passengers, driver and optional equipment to determine the total weight that your vehicle can carry.

Trailer weight range

The range is between zero and the maximum trailer weight rating found in this chapter.

Using trailer brakes

Use electric brakes or manual, automatic or surge type hydraulic brakes that meet Federal and local regulations. Install and adjust brakes according to the manufacturer's instructions.



Do not connect a trailer's hydraulic brake system directly to your vehicle's brake system. Your vehicle may not have enough braking power and your chances of having a collision greatly increase.

Using safety chains

Always connect the trailer's safety chains to the vehicle. To connect the chains, cross the chains under the trailer tongue and attach to the vehicle frame or hook retainers (not the bumper). Make sure there is enough slack to allow the vehicle to turn corners.

Using trailer lamps

See your local trailer retailer or rental agency for proper instructions and equipment for hooking up trailer lamps.

Do not hook the trailer lights directly into the vehicle's wiring system. If the trailer lamps are not

Driving

working properly, the warning lights in the instrument cluster may not work properly.

Using a hitch

Do not use hitches that:

- clamp onto the vehicle bumper
- attach to the axle.

Distribute the load so that only 10 to 15% of the total weight of the trailer is on the tongue. tie down the load so that it does not shift and change the weight on the hitch. Follow the towing instructions of a reputable rental agency.

Driving while towing a trailer

Do not drive faster than 70 km/h (45 mph) while towing a 454 kg (1000 lb) trailer. Do not drive faster than 72 km/h (45 mph) with any weight trailer while towing in hilly terrain or on hot days.

Speed control (if equipped) may not work properly while towing on long, steep grades.

If driving with an automatic transmission:

- use D or L rather than while towing up or down steep hills
- anticipate stops and brake gradually.

Towing behind another vehicle

Do not tow your vehicle behind another vehicle, such as an RV, unless front wheel dollies are used.

Your vehicle can not be flat towed with all wheels on the ground.

Servicing while towing

If you tow a trailer for long distances, your vehicle requires more frequent service than a vehicle not used for towing. Refer to the “Service Guide” for more information on maintenance intervals.

Using a step bumper

The rear bumper is equipped with an integral hitch and requires only a ball with a $\frac{3}{4}$ inch shank diameter. The bumper has a Class II capability (1590 kg / 3500 lb trailer weight and 159 kg / 350 lb tongue weight).

Use a frame mounted weight distributing hitch for trailers over 1590 kg (3500 lb).

Launching or retrieving a boat

When backing down a ramp during boat launching or retrieval,

- Do not allow the static water level to rise above the bottom edge of the rear bumper and
- Do not allow waves to break higher than 15 cm (six inches) above the bottom edge of the rear bumper.

Exceeding these limits may allow water to enter critical vehicle components, adversely affecting driveability, emissions and reliability.

Driving

USING THE LUGGAGE RACK (IF EQUIPPED)

Maximum load is 100 lbs, evenly distributed. If it is not possible to distribute the load, position it as far rearward as possible.

Adjustable tie down loops must be used to secure the load.

To adjust cross-bar position:

1. Loosen the thumbwheel at both ends of the cross-bar (both cross-bars are adjustable).
2. Slide cross-bar to the desired location.
3. Tighten thumbwheel at both ends of the cross-bar.

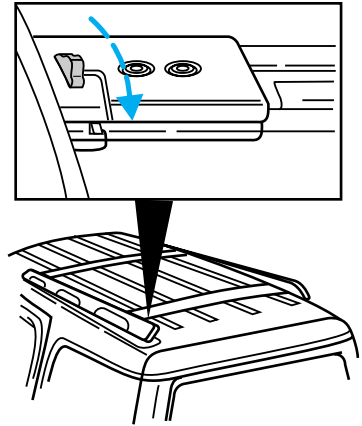

FUEL CONSUMPTION

Fuel economy can be improved by avoiding:

- lack of regular, scheduled maintenance
- excessive speed
- rapid acceleration

Roadside emergencies

HAZARD LIGHTS CONTROL

Use only in an emergency to warn traffic of vehicle breakdown, approaching danger, etc. Depress to activate all indicators simultaneously. Depress again to switch off. The warning lights can be operated when the ignition is off.

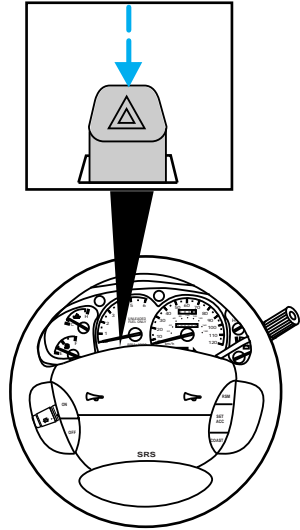

FUEL PUMP SHUT-OFF SWITCH

If the engine cranks but does not start after a collision, the fuel pump shut-off switch may have been activated. The shut-off switch is a device intended to stop the electric fuel pump when your vehicle has been involved in a substantial jolt.

Roadside emergencies

1. Turn the ignition switch to the Off position.
2. Check fuel system for leaks.
3. If no fuel leak is apparent, reset the fuel pump shut-off switch by pushing in the button on the switch.
4. Turn the ignition switch to the On position. Pause for a few seconds and return the key to the Off position.
5. Make a further check for leaks in the fuel system.

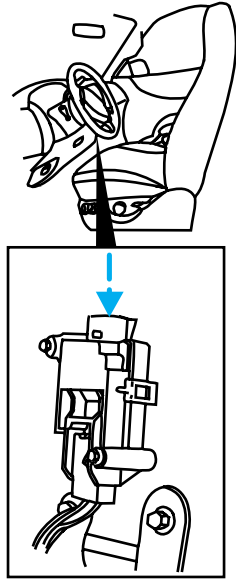

FUSES AND RELAYS

If electrical components in the vehicle are not working, a fuse may have blown. Blown fuses are identified by a broken wire. Check the appropriate fuses before replacing any electrical components.

Use the fuse puller tool provided on the passenger compartment fuse panel cover to replace the fuses.

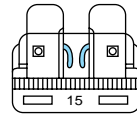

Roadside emergencies



Always replace a fuse with one that has the specified amperage rating. Using a fuse with a higher amperage rating can cause severe wire damage and could start a fire.

Even after a fuse is replaced, it will continue to blow if the cause of the overload is not identified and corrected. If the fuse continues to blow, have the vehicle's electrical system checked by a qualified service technician.

To reset a circuit breaker, press the reset button.

Fuses

Standard fuse amperage ratings and colors

Fuse rating	Color
7.5 amp	Brown
10 amp	Red
15 amp	Blue
20 amp	Yellow
30 amp	Light green
30 amp fuse link	Pink
40 amp	Green
60 amp fuse link	Yellow
80 amp fuse link	Black
100 amp fuse link	Blue

Roadside emergencies

Passenger compartment fuse panel

Pull the panel out to access the passenger compartment fuse panel.

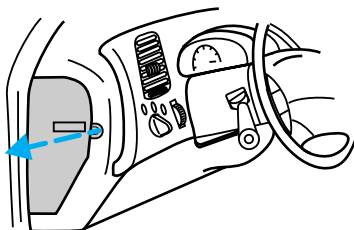

Use the fuse puller tool provided on the fuse panel cover to replace fuses.

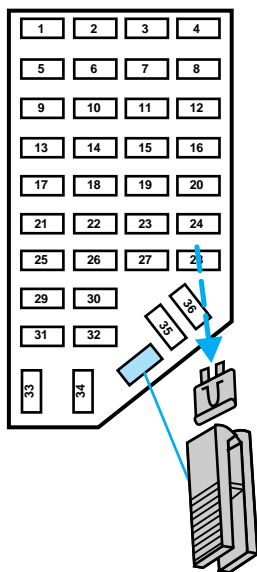

Roadside emergencies

Number	Fuse Amperage Rating	Circuits Protected
1	7.5 amp	Power mirror, power antenna
2	7.5 amp	High-mount brakelamp
3	15 amp	Parking lamp, instrument cluster gauges
4	10 amp	Left headlamp, lamp out warning
5	10 amp	OBD system
6	7.5 amp	Air bag system, blower relay, EATC
7	7.5 amp	Illumination switches
8	10 amp	Right headlamp, fog lamp system, DRL, lamp out warning
9	10 amp	EATC system, seat memory, message center, cellular phone, autolamps
10	7.5 amp	EATC system, rear blower, speed control, GEM system, brake interlock, overhead console, automatic ride control, lamp out warning
11	7.5 amp	Warning lamps, autolamp
12	10 amp	Front washer, rear washer & wiper

Roadside emergencies

Number	Fuse Amperage Rating	Circuits Protected
13	15 amp	PCM system, stoplamps, AWD, anti-lock brake, speed control, trailer tow
14	10 amp	Anti-lock system
15	7.5 amp	Air bag system, instrument cluster
16	30 amp	Wiper run relay
17	25 amp	Cigar lighter
18	15 amp	A/C system
19	25 amp	Ignition coil, PCM system
20	7.5 amp	Radio, power antenna, GEM system, anti-theft, cellular phone
21	15 amp	Turn/hazard flasher
22	10 amp	Turn signals
23	10 amp	Rear wiper system
24	10 amp	Starter relay
25	7.5 amp	Speedometer, GEM system
26	10 amp	5R55E/4R70W overdrive, DRL system, backup lamps, AWD, rear defroster
27	10 amp	Under hood lamp, map lamps, glove box lamp, dome lamp, visor lamps, accessory delay, dimmer switch illumination, 4x4 system

Roadside emergencies

Number	Fuse Amperage Rating	Circuits Protected
28	7.5 amp	Memory seat, GEM system
29	10 amp	Audio system
30	-	Not used
31	7.5 amp	Rear blower system
32	7.5 amp	Heated mirror, rear defroster
33	15 amp	High beam lamps
34	7.5 amp	Lux audio system

Power distribution box



Always replace the cover to the Power Distribution Box before reconnecting the battery or refilling fluid reservoirs.

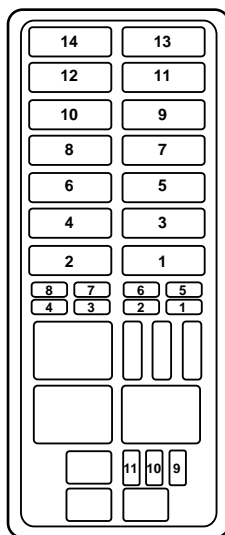

High current fuse rating	Color
30 amp	Light green
40 amp	Orange
50 amp	Red
60 amp	Blue

Roadside emergencies

Maxi fuses		
Fuse	Amperage	Circuits protected
1	30	Rear window defrost
2	30	PCM power relay
3	20	Fuel system, anti-theft system
4	20	Headlamps
5	30	ABS system
6	30	ABS system
7	20	Trailer park LP and trailer stop LP
8	30	Battery saver relay and headlamp relay
9	50	Blower motor
10	30	Power locks, power windows and power seats
11	20	PCM memory and horn
12	50	Air ride control relay
13	60	Instrument panel fuse panel
14	60	Ignition
Mini fuses		
1	30	JBL system
2	15	Rear wiper system
3	30	Power point
4	20	4WD system
5	15	Air suspension system
6	15	Alternator system
7	10	Air bag system
8	15	DRL/Fog lamps/Off-road lamps
9	-	Not used

Roadside emergencies

Maxi fuses		
10	-	Not used
11	20	HEGO system

Relay number	Circuits connected
1	Wiper run relay
2	Horn relay
3	Wiper HI/LO relay
4	WOT A/C relay
5	PCM power relay
6	Fuel pump relay
Diode number	Circuits connected
1	ABS diode
2	PCM diode

Relays

Relays are located in the power distribution box.

Relays receive signals from components or systems and transfer these signals to activate or deactivate other components or systems.

Ford recommends that relays be replaced by a qualified service technician.

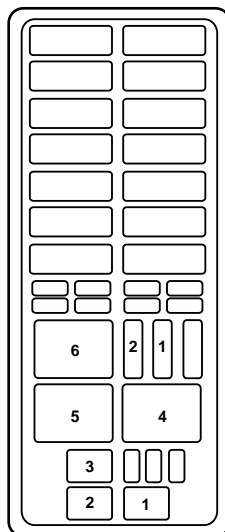

Roadside emergencies

Relay number	Circuits protected
1	Wiper run relay
2	Horn relay
3	Wiper HI/LO relay
4	WOT A/C relay
5	PCM power relay
6	Fuel pump relay
Diode number	Circuits protected
1	ABS diode
2	PCM diode

CHANGING TIRES

Tire change procedure

1. Park on a level surface.
2. Activate the hazard flashers.

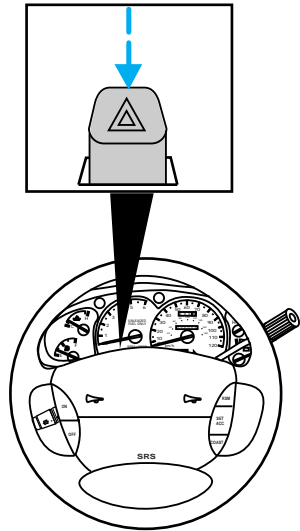

- Before beginning the tire change procedure, ensure that the Automatic Ride Control service switch is turned off.

Roadside emergencies

3. Engage the parking brake.
4. Place the automatic transmission gearshift in P (Park). Place the manual transmission gearshift in 1 (First).
5. Block the diagonally opposite wheel.

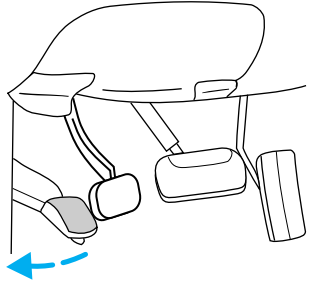

6. Remove the jack and lug wrench.

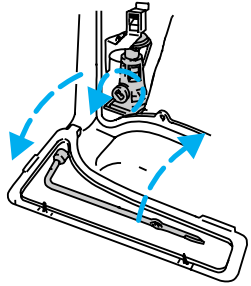

7. Remove the jack handle located under the rear seat.

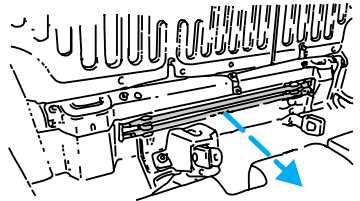

Roadside emergencies

8. Assemble the jack handle to the lug wrench.

9. Insert the drive section of the jack handle into the actuator hole and turn counterclockwise until the cable is slack enough to allow the spare tire to be pulled rearward from under the vehicle.

10. Slide spare tire rearward and remove retainer.

11. Insert tapered end of the lug wrench behind hubcaps and twist them off.

12. Loosen the wheel lug nuts with the lug wrench about one half turn each.

13. Position the jack on the lower suspension arm to raise the front wheel. Position the jack under the rear axle to raise the rear wheel.

• **Never use the differential as a jacking point.**

14. Turn the jack handle clockwise until the tire just clears the ground.

15. Remove the wheel lug nuts and flat tire and install the spare tire.

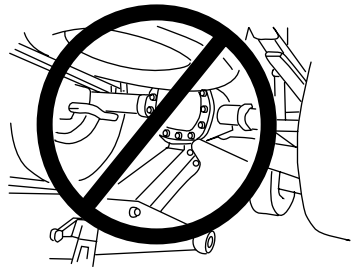
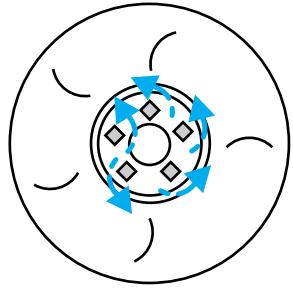
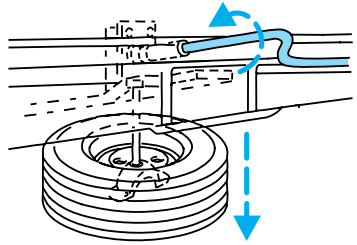

Roadside emergencies

16. Install the lug nuts and tighten until snug.

17. Lower the vehicle and tighten the lug nuts as shown.

18. Unblock the wheels and place the flat tire, jack handle and lug wrench away.

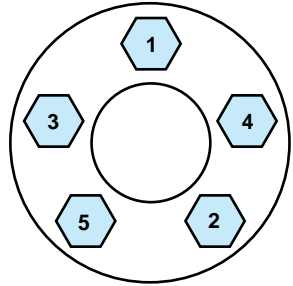

Stowing flat tires

Stow aluminum wheel and tire with the valve stem down.

To stow largest flat tire, place it inside the vehicle and secure with a webbing retainer.

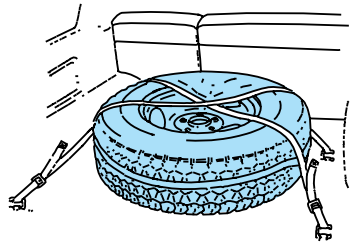

The conventional spare tire (if equipped)

Your vehicle may be equipped with a conventional spare tire which can be used as a spare or a regular tire. This spare tire is identical to the other tires on your vehicle, although the wheel style may not match.

The temporary spare tire (if equipped)

Your vehicle may be equipped with a temporary spare tire. This spare is smaller than a regular tire and is intended for emergency use only. Use this spare when you get a flat

Roadside emergencies

tire and replace it with a full-size tire as soon as possible.

It is not recommended that the vehicle be operated in 4WD HIGH or LOW modes with a temporary spare. If 4WD HIGH or LOW operation is necessary, do not operate above speeds of 16 km/h (10 mph) or for distances above 80 km (50 miles).

When driving with a temporary spare, **do not**:

- exceed 80 km/h (50 mph) under any circumstances.
- load your vehicle so that it exceeds the maximum load rating listed on the tire decal.
- tow a trailer.
- use tire chains on this tire.
- try to repair the temporary spare or remove it from its wheel.
- use the wheel for any other type of vehicle.
- drive through an automatic car wash.

JUMP STARTING YOUR VEHICLE



The gases around the battery can explode if exposed to flames, sparks, or lit cigarettes. An explosion could result in injury or vehicle damage.

Roadside emergencies



Do not push-start your vehicle. You could damage the catalytic converter. For further information, see *Jumper Cables* in the Index.



Batteries contain sulfuric acid which burns skin, eyes, and clothing.

Connecting the jumper cables

1. Position the vehicles so that they do not touch one another.
2. Switch off the engine. Switch off any unnecessary electrical equipment.
3. Connect the positive (+) terminal of the discharged battery (1) to the positive (+) terminal of the booster battery (2).
4. Connect one end of the second lead to the negative (-) terminal of the booster battery (3) and the other end to a metal part of the engine to be started (4), not to the negative (-) terminal of the discharged battery.
5. Make sure that the jumper leads are clear of moving parts of the engine.

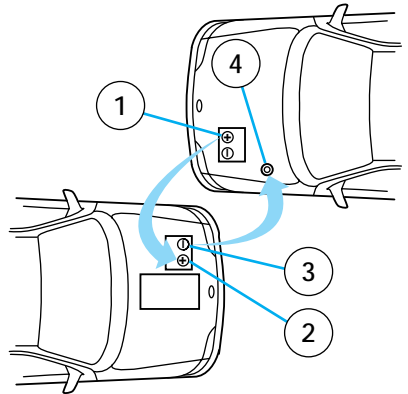

Roadside emergencies



Do not connect the end of the second cable to the negative ([-]) terminal of the battery to be jumped. A spark may cause an explosion of the gases that surround the battery.

Jump starting

1. Start the booster vehicle and run the engine at moderately increased speed.
2. Start the engine of the vehicle with the discharged battery.
3. Once the engine has been started, run both vehicles for a further three minutes before disconnecting the cable leads.

Removing the jumper cables

1. Remove the jumper cables in reverse order. Take the cable off the metallic surface (1) first, followed by the cable on the negative (-) booster battery terminal (2).
2. Remove the cable from the positive (+) terminal of the booster battery (3) and then the discharged battery (4).
3. After the disabled vehicle has been started, allow it to idle for a while so the engine can “relearn” its idle conditions.

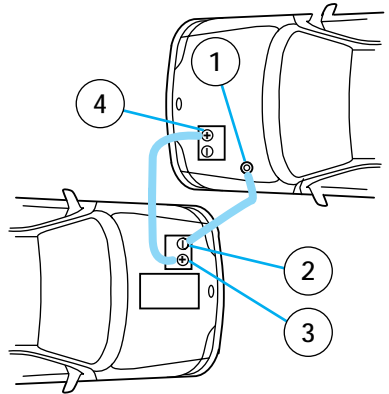

Roadside emergencies

WRECKER TOWING

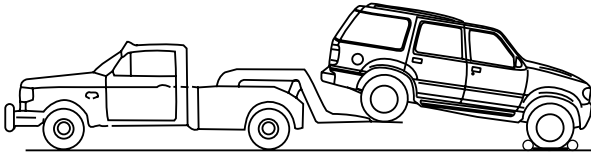
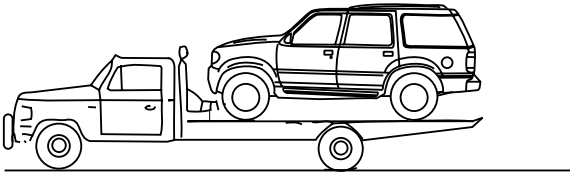
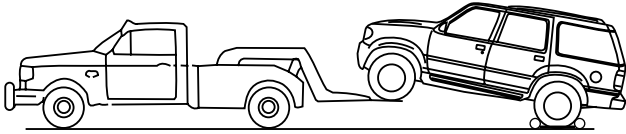

Ford recommends that your vehicle be towed with wheel lift and dollies or flatbed equipment. Do not tow with slingbelt equipment. Ford Motor Company has not developed or approved a T-hook or slingbelt towing procedure.

For vehicles equipped with control trac, the ignition must be in the OFF position when towing.

When calling for a tow truck, tell the operator what kind of vehicle you have. A towing manual is available for Ford Motor Company

Roadside emergencies

for all authorized tow truck operators. Have your tow truck driver refer to this manual for proper hook-up and towing procedures.

Neutral tow kit accessory

Neutral tow feature is an option which can be activated at any dealership that has a Service Bay Diagnostic System (SBDS). When activated the feature may be enabled by following the instruction located on the visor or the headliner.

The feature is available on vehicles with Control Trac and automatic transmission only. It is not available on vehicles with All-Wheel Drive.

There are no wrecker or recreational vehicle towing restrictions on method or distance if the above feature is activated and enabled.

See your dealer for more information.

SERVICE RECOMMENDATIONS

To help you service your vehicle:

- We highlight do-it-yourself items in the engine compartment for easy location.
- As possible, we design parts that can be replaced without tools.
- We provide you with a “Service Guide” which makes tracking routine service for your vehicle easy.

If your vehicle requires professional service, your dealership can provide necessary parts and service. Check your “Warranty Information Booklet” to find out which parts and services are covered.

Use only recommended fuels, lubricants, fluids and service parts conforming to specifications. Motorcraft parts are designed and built to provide the best performance in your vehicle.

Steps to take before performing maintenance

Precautions when servicing your vehicle

Be especially careful when inspecting or servicing your vehicle. Here are some general precautions for your safety:

- Do not work on a hot engine.
- If you must work with the engine running, avoid wearing loose clothing or jewelry that

Maintenance and care

could get caught in moving parts. Take precautions with long hair.

- Do not work on a vehicle with the engine running in an enclosed space, unless you are sure you have enough ventilation.
- Keep all lit cigarettes, open flames and other lit material away from the battery and all fuel related parts.

If you disconnect the battery, the engine must “relearn” its idle conditions before your vehicle will drive properly, as explained in *Battery* in this chapter.

Working with the engine off

- Automatic transmission:

1. Set the parking brake fully and ensure the gearshift is securely latched in P (Park).

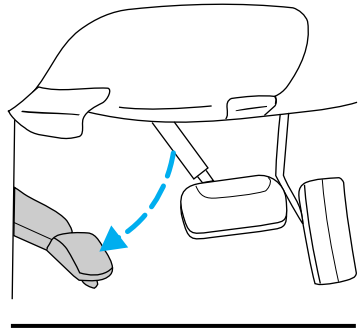

2. Turn off the engine and remove the key.

3. Block the wheels to prevent the vehicle from moving unexpectedly.

- Manual transmission:

Maintenance and care

1. Set the parking brake, depress the clutch and place the gearshift in 1 (First).

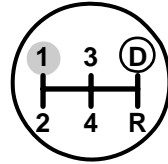
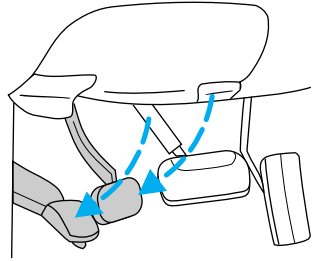

2. Turn off the engine and remove the key.

3. Block the wheels to prevent the vehicle from moving unexpectedly.

Maintenance and care

Working with the engine on

- Automatic transmission:
 1. Set the parking brake fully and ensure the gearshift is securely latched in P (Park).

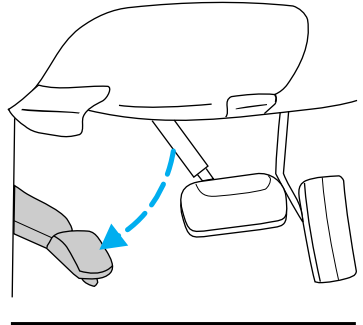

2. Block the wheels to prevent the vehicle from moving unexpectedly.



Do not start your engine with the air cleaner removed and do not remove it while the engine is running.

Maintenance and care

- Manual transmission:

1. Set the parking brake fully, and make sure the gearshift is securely latched in Neutral.
2. Block the wheels to prevent the vehicle from moving unexpectedly.

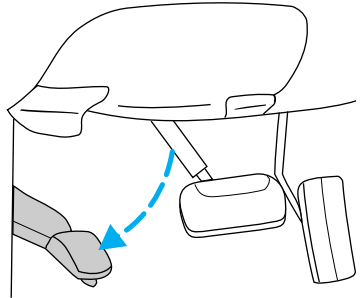

Opening the hood

To open the hood:

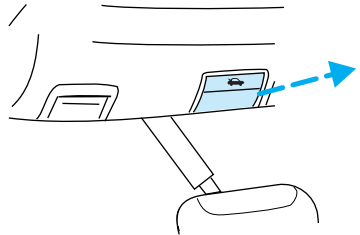

1. Inside the vehicle, pull the hood release handle located under the steering column on the instrument panel.
2. Outside the vehicle, release the auxiliary latch located in the grille opening.
3. Lift the hood and secure it in the upright position.
4. To close the hood shut it so that the auxiliary latch and primary latches are closed.

After closing the hood, try lifting it to ensure that it is closed securely.

Maintenance and care

IDENTIFYING COMPONENTS IN THE ENGINE COMPARTMENT

4.0L EFI engine

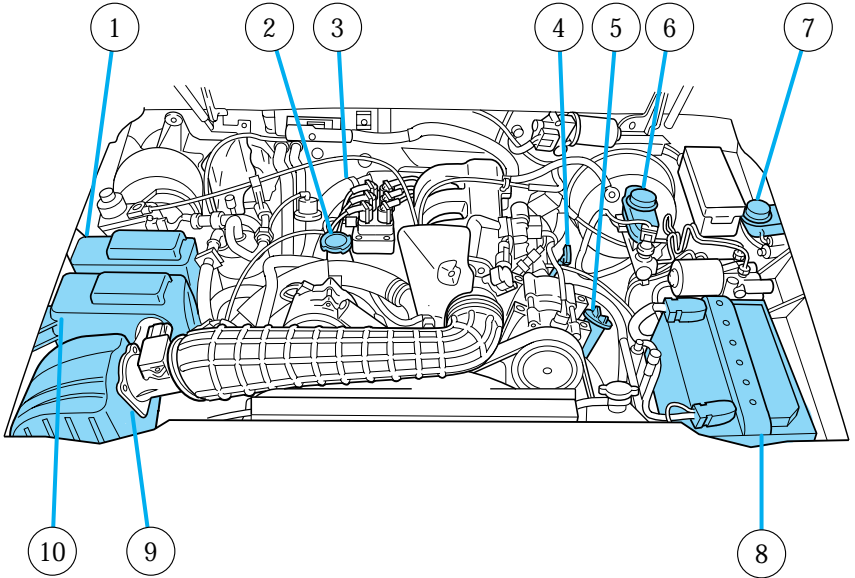

1. Windshield washer fluid reservoir
2. Engine oil fill cap
3. Transmission fluid dipstick (automatic transmission only)
4. Engine oil dipstick
5. Power steering fluid reservoir
6. Brake fluid reservoir
7. Clutch fluid reservoir (manual transmission only)
8. Battery

Maintenance and care

- 9. Air filter assembly
- 10. Engine coolant reservoir

4.0L SOHC engine

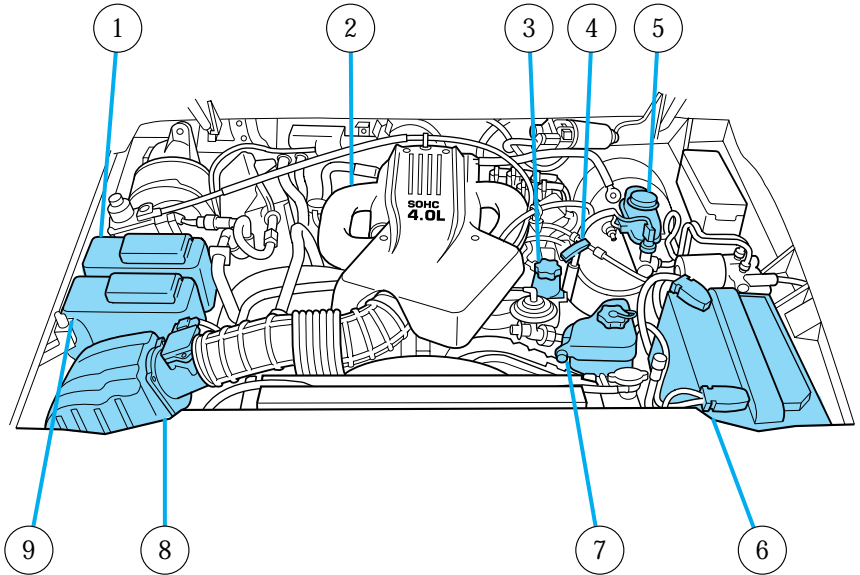

- 1. Windshield washer fluid reservoir
- 2. Transmission fluid dipstick
- 3. Engine oil fill cap
- 4. Engine oil dipstick
- 5. Brake fluid reservoir
- 6. Battery
- 7. Power steering fluid reservoir
- 8. Air filter assembly
- 9. Engine coolant reservoir

Maintenance and care

5.0L engine

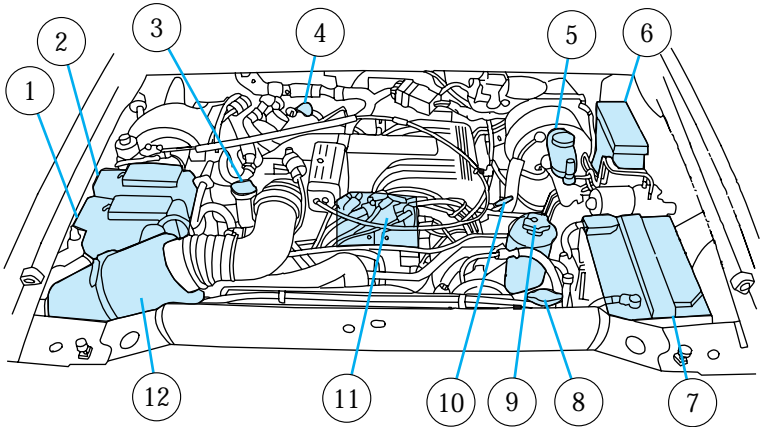

1. Engine coolant reservoir
2. Windshield washer fluid reservoir
3. Engine oil fill cap
4. Transmission fluid dipstick
5. Brake fluid reservoir
6. Power distribution box
7. Battery
8. Radiator cap
9. Power steering fluid reservoir
10. Engine oil dipstick
11. Ignition coil packs
12. Air filter assembly

CHECKING AND ADDING ENGINE OIL

Use WSS-M2C153-F motor oil CERTIFIED FOR GASOLINE ENGINES by the American Petroleum Institute.

Engine oils with an SAE 5W-30 viscosity and displaying the American Petroleum Institute certification mark are preferred for your vehicle. They provide the best engine performance, fuel economy and engine protection for all climates down to -25°C (-15°F).

Do not use:

- “non-detergent” oils
- oils labeled API SA, SB, SC, SD, SE, SF or SG
- additional engine oil additives, oil treatments or engine treatments

Additional engine oil additives, oil treatments or engine treatments are never needed and could, under certain conditions, lead to engine damage which is not covered by your Ford warranty.

Synthetic engine oils which are CERTIFIED and of the preferred viscosity may be used in your engine. The engine oil and oil filter must still be changed according to the “Service Guide”.

Checking the engine oil

Check the engine oil each time you fuel your vehicle.

To check the oil:

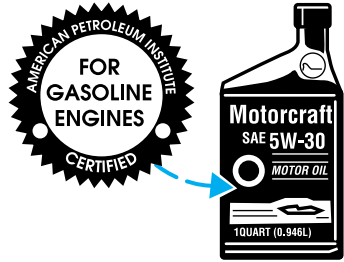

Maintenance and care

1. Make sure the vehicle is on level ground. If the engine is warm, turn the engine off and wait a few minutes for the oil to drain into the oil pan.
2. Set the parking brake and ensure the gearshift is securely latched in P (Park).
3. Open the hood. Protect yourself from engine heat.
4. Locate and carefully remove the engine oil dipstick.
5. Wipe the dipstick clean. Insert the dipstick fully, then remove it again. If the oil level falls between the MIN and MAX markings, there is no need to refill.
6. If the oil level is below the minimum line, add engine oil as necessary. If the oil level is above the maximum line, engine damage or high oil consumption may occur and some oil must be removed from the engine by a service technician.
7. Put the dipstick back in and ensure it is fully seated.

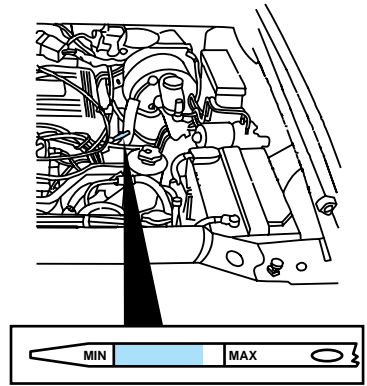

Adding engine oil

1. Check the engine oil. For instructions, refer to *Checking the engine oil* in this chapter.

Maintenance and care

2. If the fluid level is not within the normal range, add only certified engine oil of the preferred viscosity. Add engine oil through the oil filler cap. Remove the filler cap and use a funnel to pour oil in the opening.

3. Recheck the oil level. Make sure the oil level is not above the full mark on the dipstick.

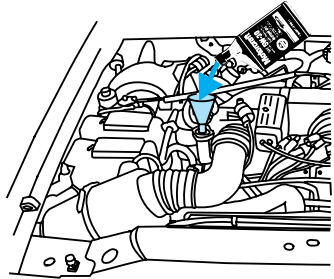

Your vehicle has an OIL LIFE LEFT function if you have the Vehicle Message Center. This device displays the percent of useful engine oil life left and when an oil change is required. Use of a CERTIFIED oil of the preferred viscosity is required for this device to work properly. Change your engine oil and oil filter when the Message Center displays CHANGE OIL SOON or OIL CHANGE REQUIRED. If the Message Center malfunctions, you may determine your oil change interval based on the following guidelines.

The Vehicle Message Center may be manually reset by depressing the Oil Change Reset switch for five seconds.



Continuous contact with **used** motor oil has caused cancer in laboratory mice.

Changing the engine oil and filter

Change your engine oil and filter according to the following

Maintenance and care

kilometers (mileage) and time requirements, whichever occurs first:

- Normal Schedule – 8,000 km (5,000 miles) or six months.
- Severe Duty Schedule – 5,000 km (3,000 miles) or three months. Severe duty operation would include extensive idling, trailer towing, driving in severe dust and police, taxi or delivery service.

Ford production and aftermarket (Motorcraft) oil filters are designed for added engine protection and long life. If a replacement oil filter is used that does not meet Ford material and design specifications, startup engine noises or knock may be experienced.

It is recommended you use the appropriate Motorcraft oil filter (or another brand meeting Ford specifications) for your engine application.

DRIVELINE UNIVERSAL JOINT AND SLIP YOKE

The universal joints standard with your vehicle do not require lubrication. If the original equipment universal joints are replaced with universal joints equipped with grease fittings, lubrication will be necessary at the intervals shown in the “Service Guide” supplement.

Maintenance and care

CHECKING AND ADDING BRAKE FLUID

Brake fluid should be checked and refilled as needed at least once each year:

- Clean the reservoir cap before removal to prevent dirt or water from entering the reservoir.
- Visually inspect the fluid level.
- If necessary, add brake fluid until the level reaches MAX. Do not fill above this line.
- Use only a DOT 3 brake fluid certified to meet Ford specifications. Refer to *Lubricant specifications* in the *Capacities and specifications* chapter.

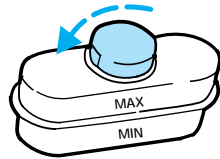

Brake fluid is toxic.



If you use a brake fluid that is not DOT 3, you will cause permanent damage to your brakes.



Do not let the reservoir for the master cylinder run dry. This may cause the brakes to fail.

CHECKING AND ADDING CLUTCH FLUID (IF EQUIPPED)

The clutch on your vehicle is self-adjusting and should not require any routine service.

Maintenance and care

During normal operation, the fluid level in the clutch fluid reservoir will slowly rise. If the fluid level drops, maintain the fluid level at the reservoir indicator.

Use only DOT 3 brake fluid designed to meet Ford specifications. Refer to the *Capacities and specifications* chapter.

1. Clean the reservoir cap before removal to prevent contaminants from entering the reservoir.
2. Remove the cap.
3. Add fluid until the level reaches the FULL line.

CHECKING AND ADDING WASHER FLUID

Important information about washer fluid

In freezing weather (temperatures below 0°C [32°F]), washer fluid containing a small amount of antifreeze is to be used. State or local regulations on volatile organic compounds may restrict the use of methanol, a common antifreeze additive. Use a non-methanol antifreeze in freezing weather only if the fluid does not damage the paint finish, wiper blades or washer system.



Windshield washer fluid contains methanol which is poisonous.

Maintenance and care

Checking and adding washer fluid for the windshield

If a visual inspection shows that washer fluid needs to be added to the reservoir:

1. Lift the windshield reservoir cover.
2. Add enough washer fluid to fill the reservoir.

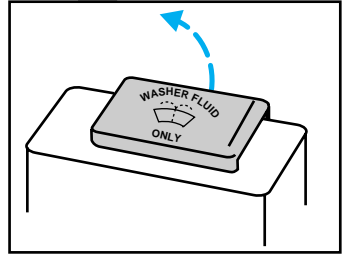
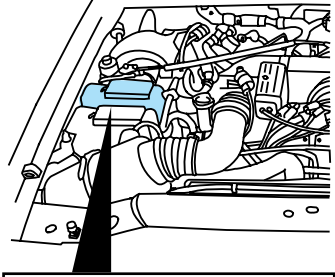

Checking and adding washer fluid for the rear window

The washer fluid for both the windshield and rear window is contained in the engine compartment reservoir. For information on checking and adding washer fluid to this reservoir, refer to Checking and adding washer fluid for the windshield above.

Maintenance and care

ENGINE COOLANT MAINTENANCE

Checking and adding engine coolant

Check the level of the coolant in the reservoir at least once a month. Be sure to read and understand *Precautions when servicing your vehicle* in this chapter.

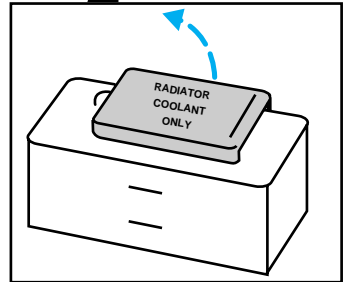
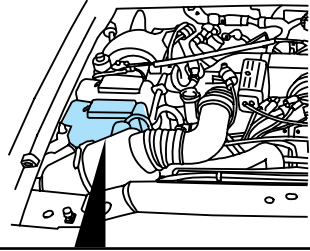

If the engine coolant has not been checked for a long period of time, the engine coolant reservoir may eventually empty. If this occurs, add engine coolant to the coolant reservoir. For more information on engine coolant maintenance, refer to *Adding engine coolant* in this chapter.

Automotive fluids are not interchangeable; do not use engine coolant, antifreeze or windshield washer fluid outside of its specified function and vehicle location.

When adding engine coolant

Ford recommends Ford Premium Cooling System Fluid, which is an optimized formula that will protect all metals and rubber elastomers used in Ford engines for four years or 80,000 km (50,000 miles).

It is neither necessary nor recommended to use supplemental coolant additives in your gasoline-powered vehicle. These additives may harm your engine cooling system.

When you change or add engine coolant, it is important to maintain engine coolant concentration between 40% (-24°C [-11°F]) and 60% (-52°C [-62°F]), depending on your local climate conditions.

A coolant concentration below 40% will result in a loss of freeze protection. A concentration above 60% may cause the engine to overheat on a warm day.

Refer to *Lubricant specifications* in the *Specifications and capacities* chapter. Use only a premium nationally-recognized brand name engine coolant or equivalent.



Always dispose of used automotive fluids in a responsible manner. Follow your community's standards for disposing of these types of fluids. Call your local recycling center to find out more about recycling automotive fluids.

Maintenance and care

Recycled engine coolant

Ford Motor Company recommends that Ford and Lincoln-Mercury dealers use recycled engine coolant produced by Ford-approved processes. Not all coolant recycling processes produce coolant which meets Ford specification ESE-M97B44-A, and use of such coolant may harm engine and cooling system components.



Always dispose of used automotive fluids in a responsible manner. Follow your community's regulations and standards for recycling and disposing of automotive fluids.

Coolant refill capacity

To find out how much fluid your vehicle's cooling system can hold, refer to *Refill capacities* in the *Capacities and specifications* chapter.

Have your dealer check the engine cooling system for leaks if you have to add more than a liter (quart) of engine coolant per month.

Severe winter climate

If you drive in extremely cold climates [less than -36°C (-34°F)], it may be necessary to increase the coolant concentration above 50%. Refer to the chart on the coolant container to ensure the coolant concentration in your vehicle is such that the coolant will not

Maintenance and care

freeze at the temperature level in which you drive during winter months. Never increase the engine coolant concentration above 60%. Leave a 50/50 mixture of engine coolant and water in your vehicle year-round in non-extreme climates.

Adding engine coolant

1. Before removing the engine coolant recovery cap, turn the engine off and allow it to cool.
2. When the engine is cool, lift and remove the cap.
 - Step back for a moment while the pressure in the reservoir is released.
 - Stand away from the reservoir opening, hot steam or coolant spray may be released.
3. Add engine coolant until the fluid level in the reservoir is between the MAX and MIN lines on the reservoir.

Follow the recommended service interval for changing engine coolant as outlined in the “Service Guide”. Refer to the *Capacities and specifications* chapter for more information on engine coolant specifications.

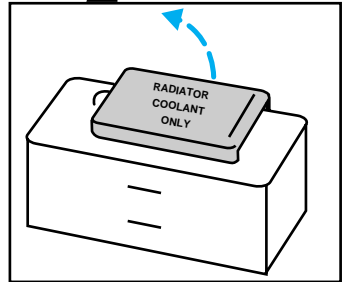
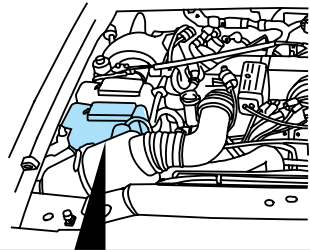

Maintenance and care

Checking the cooling system hoses

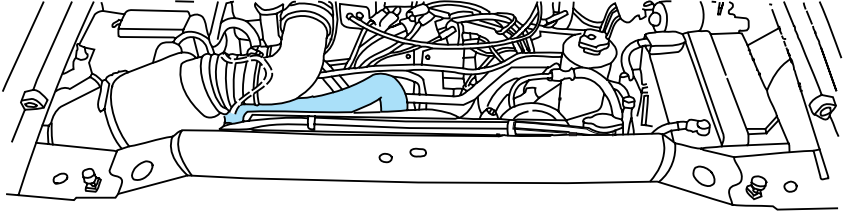

Inspect all engine and heater system hoses and hose connections for:

- deterioration
- leaks
- loose hose clamps

CHECKING AND ADDING POWER STEERING FLUID

Check the power steering fluid at least twice a year by completing the following steps:

1. Start the engine.

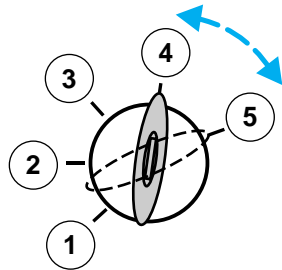

Maintenance and care

2. When the engine coolant temperature gauge reaches the normal zone, turn off the engine.

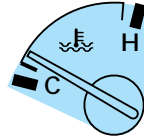

3. Open the hood.

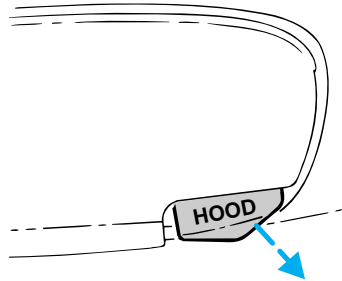

Maintenance and care

4. Visually inspect the fluid level in the power steering reservoir.

5. If necessary, add power steering fluid until the fluid level reaches MAX. Do not overfill the reservoir.

- As a maintenance precaution, visually inspect the lines and hoses of the power steering system for leaks and damage.
- If new fluid is frequently required, consult a qualified service technician.

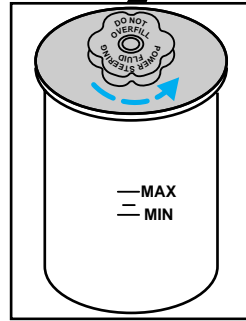
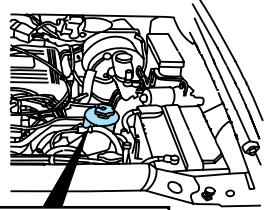

TRANSMISSION MAINTENANCE

Checking and adding automatic transmission fluid

Check the automatic transmission fluid according to the scheduled intervals in the "Service Guide".

Before adding any fluid, make sure the correct type will be used. This information is stamped on the dipstick.

Check the fluid after your vehicle has reached normal operating temperature, which is reached after driving approximately 32 km (20 miles).

Add fluid in .25L (1/2 pint) increments through the filler tube



until the level is at the correct area on the dipstick. If an overflow occurs, excess fluid should be removed by a qualified technician.

Checking and adding manual transmission fluid (if equipped)

1. Clean the filler plug.
2. Remove the filler plug and inspect the fluid level.
 - The fluid level should be at the bottom of the opening.
3. Add enough fluid through the filler opening so that the fluid level is at the bottom of the opening.

Use only fluid that meets Ford specifications. Refer to the *Capacities and specifications* chapter for more information on manual transmission fluid.

Driveline universal joint and slip yoke

The universal joints standard with your vehicle do not require lubrication. If the original equipment universal joints are replaced with universal joints equipped with grease fittings, lubrication will be necessary at the intervals shown in the *Service Guide* supplement.

Constant velocity or double carden joint (if equipped)

This component may be fitted with a flush-type grease fitting that requires an adaptor to permit proper lubrication. If replaced,

Maintenance and care

lubricate the driveline joint according to the maintenance intervals specified in the *Service Guide*.

CHECKING AND ADDING DIFFERENTIAL FLUID (IF EQUIPPED)

To check and add differential fluid, follow these steps:

1. Clean the filler plug.
 2. Remove the filler plug and inspect fluid level.
- Fluid level should be at the bottom of the opening.

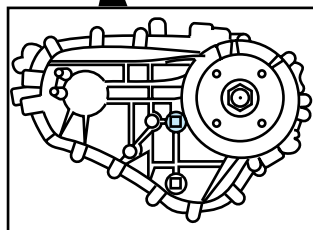
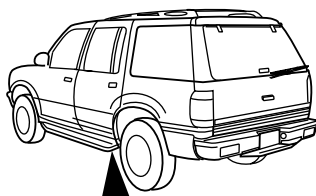

The rear axle is filled with synthetic lubricant and will not require a lubricant change during the life of the vehicle unless the rear axle has been submerged in water. In addition, rear axle lubricant quantities need not be checked or changed unless a leak is suspected or repair is needed.

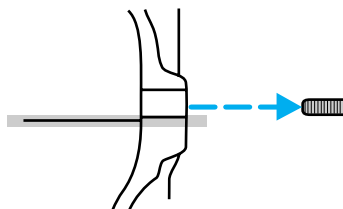

BATTERY MAINTENANCE

Important battery information

If the original equipment maintenance —free battery needs

Maintenance and care

replacement, it may be replaced with a low-maintenance battery. For information on appropriate replacement batteries, refer to *Motorcraft parts* in the *Capacities and specifications* chapter.



Applying too much pressure on the ends when lifting a battery could cause acid to spill. Lift the battery with a carrier or with your hands on the opposite corners.



Batteries normally produce explosive gases which can cause personal injury. Do not allow flames, sparks or lit tobacco to come near the battery. Always cover your face and protect your eyes and also provide ventilation.



Follow these steps to minimize risk of personal injury.

Servicing your battery

If replaced with a low-maintenance battery it will have removable vent caps for checking the electrolyte level and adding water. For more information on maintenance intervals for your battery, refer to the "Service Guide". Keep the electrolyte level up to the level indicator. Do not overfill.

If the electrolyte level becomes low, refill the battery with distilled

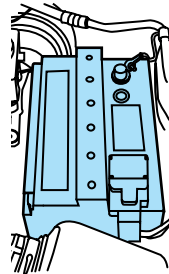

Maintenance and care

water. If necessary, distilled water may be substituted with tap water that is not hard and does not have high mineral or alkali content. If the battery needs water often, have the charging system checked for a possible malfunction.

Relearning the idle function

Because your vehicle's engine is electronically controlled, some control conditions are maintained by power from the battery. When the battery is disconnected or a new battery is installed, the computer must "relearn" its idle conditions before your vehicle can drive properly. To begin this process:

Maintenance and care

1. Put the automatic transmission gearshift in P (Park). Put the manual transmission gearshift in N (Neutral).

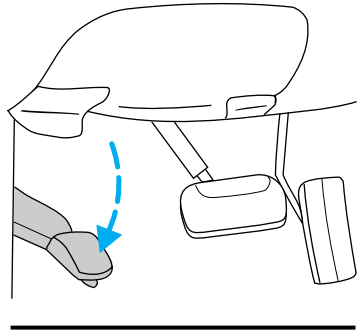

2. Turn off all accessories and start the vehicle.

3. Let the engine idle for at least one minute.

4. The relearning process will automatically complete as you drive the vehicle.

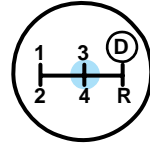

- If you do not allow the engine to relearn its idle, the idle quality of your vehicle may be adversely affected until the idle is eventually relearned.
- If the battery has been disconnected or if a new battery has been installed, the clock and preset radio stations must be reset once the battery is reconnected.

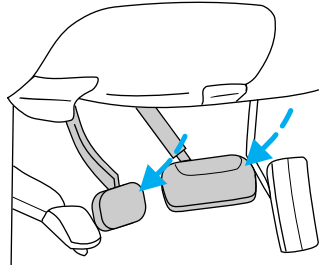

Maintenance and care



Always dispose of automotive batteries in a responsible manner. Follow your community's local standards for disposal. Call your local recycling center to find out more about recycling automotive batteries.



Battery saver control feature

Your vehicle is equipped with a battery saver control feature designed to prevent your battery from accidental wear down due to doors left ajar. For information on the system and its function, refer to the *Controls and features* chapter.

AIR CLEANER FILTER MAINTENANCE

Refer to the "Service Guide" for the appropriate intervals for changing the air cleaner filter.



Do not start your engine with the air cleaner removed and do not remove it while the engine is running.

Maintenance and care

Changing your air cleaner filter

To change your air cleaner filter, follow these steps:

1. Release the clamp locking clip on the front portion of the assembly.
2. Swing the left side of the assembly open.
3. Remove the air cleaner filter element from the open end of the engine air cleaner assembly and replace it with a new element.
4. Close the assembly and secure the locking clamp.

The air cleaner filter shown is typical of 4.0 L OHV and 5.0 L engines. The 4.0 L SOHC is comparable.

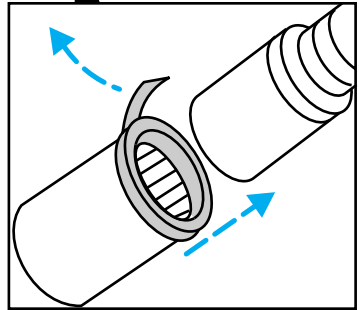
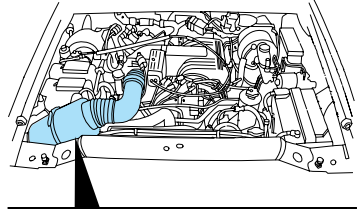

CHECKING AND REPLACING WIPER BLADES

Checking wiper blades

Check the windshield wiper blades at least twice a year or whenever they seem to work less effectively than usual. Substances such as tree sap and some hot wax treatments used by commercial car washes can reduce the effectiveness of wiper blades.

Maintenance and care

To make reaching the wiper blades easier, simply:

1. Turn the ignition to the ON position and turn the wipers on.

2. Wait for the wipers to reach a vertical position and turn the ignition to LOCK.

- Do not move the wipers manually across the windshield, this may cause damage to both wipers and windshield.

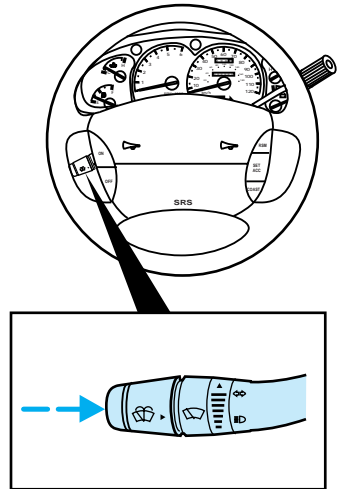
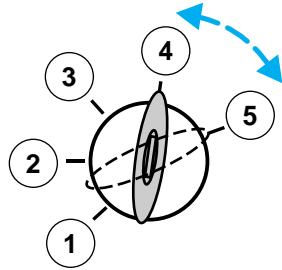

Inspect the wiper pivot arms on a regular basis to ensure that they move freely. Lubricate the pivot points as necessary.

Replacing wiper blades

If the wiper blades do not function properly after cleaning, replacement of the blade assembly or the blade element may be necessary.

Maintenance and care

The blade lengths for your vehicle are as follows:

- Windshield wiper blades — 56 cm (16 in)
- Liftgate wiper blades — 41 cm (22 in)

To replace the wiper blades:

1. Pull the wiper arm away from the windshield and lock into service position.
2. Turn the blade at an angle from the wiper arm. Push the lock pin with a screwdriver to release the blade and pull the wiper blade down toward the windshield to remove it from the wiper arm.
3. Attach the new wiper blade to the wiper arm and press it in place until a click is heard.

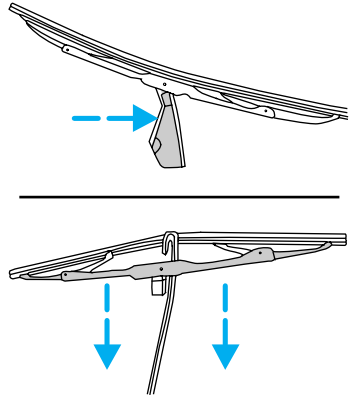

IMPORTANT TIRE MAINTENANCE INFORMATION

Information about tire quality grades

New vehicles are fitted with tires that have their Tire Quality Grade (described below) molded into the tire's sidewall. These Tire Quality Grades are determined by standards that the United States Department of Transportation has set.

Tire Quality Grades apply to new pneumatic tires for use on passenger cars. They do not apply to deep tread, winter-type snow

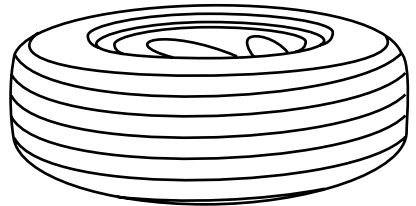

Maintenance and care

tires, space-saver or temporary use spare tires, tires with nominal rim diameters of 10 to 12 inches or limited production tires as defined in Title 49 Code of Federal Regulations Part 575.104(c) (2).

U.S. Department of Transportation-Tire quality grades:

The U.S. Department of Transportation requires Ford to give you the following information about tire grades exactly as the government has written it.

Treadwear

The treadwear grade is a comparative rating based on the wear rate of the tire when tested under controlled conditions on a specified government test course. For example, a tire grade 150 would wear one and one-half (1 1/2) times as well on the government course as a tire grade 100. The relative performance of tires depends upon the actual conditions of their use, however, and may depart significantly from the norm due to variations in driving habits, service practices, and differences in road characteristics and climate.

Traction A B C

The traction grades, from highest to lowest are A, B, and C, and they represent the tire's ability to stop on wet pavement as measured under test surfaces of asphalt and concrete. A tire marked C may have poor traction performance.

Warning: The traction grade assigned to this tire is based on braking (straightahead) traction tests and does not include cornering (turning) traction.

Temperature A B C

The temperature grades are A (the highest), B, and C, representing the tire's resistance to the generation of heat and its ability to dissipate heat when tested under controlled conditions on a specified indoor laboratory test wheel. Sustained high temperature can cause the material of the tire to degenerate and reduce tire life, and excessive temperature can lead to sudden tire failure. The grade C corresponds to a level of performance which all passenger car tires must meet under the Federal Motor Vehicle Safety Standard No. 109. Grades B and A represent higher levels of performance on the laboratory test wheel than the minimum required by law.



The temperature grade for this tire is established for a tire that is properly inflated and not overloaded. Excessive speed, underinflation, or excessive loading, either separately or in combination, can cause heat buildup and possible tire failure.

Checking the tire pressure

Check the tire pressure periodically and inflate tires as

Maintenance and care

necessary. To check the tire pressure, insert the tire pressure gauge into the valve stem.

The cold pressure amount is listed on the Safety Compliance Certification label.



Improperly inflated tires can affect vehicle handling and can fail suddenly, possibly resulting in loss of vehicle control.

Rotating tires

Rotate your tires at regular intervals for even wear. Rotation intervals are listed in the “Service Guide”.

- **Four tire rotation**

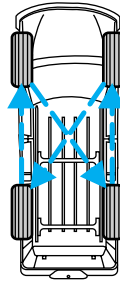

Maintenance and care

- **Five tire rotation**

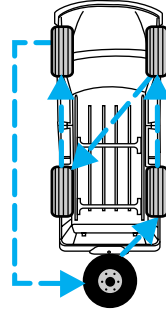

Replacing tires

Replace the tires when the wear band is visible through the tire treads.



When replacing full size tires, never mix radial, bias-belted, or bias-type tires. Use only the tire sizes that are listed on the tire pressure decal. Make sure that all tires are the same size, speed rating, and load-carrying capacity. Use only the tire combinations recommended on the decal. If you do not follow these precautions, your vehicle may not drive properly and safely.

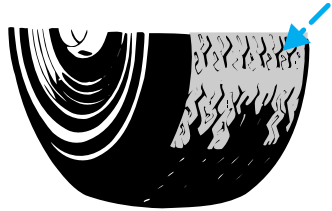

Maintenance and care



Make sure that all replacement tires are of the same size, type, load-carrying capacity and tread design (e.g., “All Terrain”, etc.), as originally offered by Ford.



Do not replace your tires with “high performance” tires or larger size tires.



Failure to follow these precautions may adversely affect the handling of the vehicle and make it easier to lose control and roll over.

Refer to the Safety Compliance Certification label to determine the specific size tire and wheel Ford Motor Company recommends for use on this vehicle.

When purchasing replacement tires for your vehicle, consult your dealer or qualified service technician to ensure that the correct tire types are used.

Using snow tires and chains



Snow tires must be the same size and grade as the tires you currently have on your vehicle.

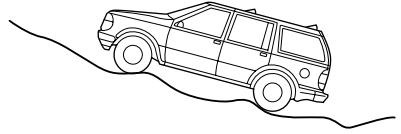

The tires on your vehicle have all-weather treads to provide traction in rain and snow. However, in some climates, using snow tires and chains may be necessary. Ford offers snow chains as a Ford approved accessory and recommends use of these or their equivalents. See your dealer or qualified service technician for more information on tire chains for your vehicle. Follow these guidelines when using snow tires and chains:

- Install chains securely, verifying that the chains do not touch any wiring, brake lines or fuel lines.
- Install the chains on the rear tires only.
- Drive cautiously. If you hear the chains rub or bang against the vehicle, stop and retighten

Maintenance and care

them. If this does not work, remove the chains to prevent vehicle damage.

- Avoid overloading your vehicle.
- Remove the tire chains when they are no longer needed. Do not use chains on dry roads.
- The suspension insulation and bumpers will help prevent vehicle damage. Do not remove these components from the vehicle when using snow tires and chains.

If equipped with 110 cm (17 inch) tires, your vehicle will not accommodate snow chains. Consult your dealer for information on other Ford approved methods of traction control.

IMPORTANT FUEL INFORMATION

Important safety precautions





Do not overfill the fuel tank. The pressure in an overfilled tank may cause leakage and lead to fuel spray and fire.



If you do not use the proper fuel cap, the pressure in the fuel tank can damage the fuel system or cause it to work improperly in a collision.

Maintenance and care

 The fuel system may be under pressure. If the fuel cap is venting vapor or if you hear a hissing sound, wait until it stops before completely removing the cap.

 Automotive fuels can cause serious injury or death if misused or mishandled.

Observe the following guidelines when handling automotive fuel:

- Extinguish all smoking materials and any open flames before fueling your vehicle.
- Always turn off the vehicle before fueling.
- Automotive fuels can be harmful or fatal if swallowed. If fuel is swallowed, call a physician immediately, even if no symptoms are immediately apparent. The toxic affects of fuel may not be visible for hours.
- Fuels can also be harmful if absorbed through the skin. If fuel is splashed on the skin, promptly remove contaminated clothing and wash skin thoroughly with soap and water.
- If fuel is splashed in the eyes, remove contact lenses, flush with water for 15 minutes and seek medical attention.
- Be particularly careful if you are taking “Antabuse” or other

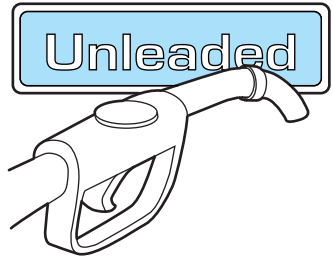

Maintenance and care

forms of disulfiram for the treatment of alcoholism.

Breathing gasoline vapors or skin contact could cause an adverse reaction. Consult a physician immediately.

Cleaner air

Ford approves the use of gasolines to improve air quality, including reformulated gasolines, that contain oxygenates such as a maximum of 10% ethanol or 15% MTBE. There should be no more than 5% methanol with cosolvents and additives to protect the fuel system.

Octane recommendations

Your vehicle is designed to use regular gasoline with an (R+M)/2 octane rating of 87. We do not recommend gasolines labeled as "regular" in high altitude areas that are sold with octane ratings of 86 or even less.

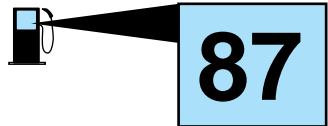

Do not be concerned if your vehicle sometimes knocks lightly. However, if it knocks heavily under most driving conditions on the recommended octane fuel, see your dealer or a qualified service technician to prevent any engine damage.

Fuel quality

If you are experiencing starting, rough idle or hesitation problems try a different brand of fuel. If the condition persists, see your dealer or a qualified service technician.

The American Automobile Manufacturers Association (AAMA) issued a gasoline specification to provide information on high quality fuels that optimize the performance of your vehicle. We recommend the use of gasolines that meet the AAMA specification if they are available.

It should not be necessary to add any aftermarket products to your fuel tank if you continue to use a high-quality fuel.

Choosing the right fuel

Use only UNLEADED FUEL. The use of leaded fuel is prohibited by law and could damage your vehicle. The damage may not be covered by your warranty.

Your vehicle was not designed to use fuel containing manganese-based additives such as MMT. Additionally, vehicles certified to California emission standards (indicated on the underhood Vehicle Emissions Control Information label) are designed to operate on California reformulated gasolines. If California reformulated gasoline is not available when you refuel, your vehicle can be operated on non-California fuels. However, even

Maintenance and care

though your engine will perform adequately on other gasolines, the performance of the emission control devices and systems may be adversely affected. Repair of damage caused by using a fuel that your vehicle was not designed for may not be covered by your warranty.

Calculating fuel economy

To accurately calculate your vehicle's fuel economy:

1. Fill the tank completely and record the initial odometer reading.
2. Each time you fill the tank, record the amount of fuel added (in liters or gallons).
3. After at least three to five fuel tank fill-ups, fill the fuel tank and record the current mileage reading.
4. Use one of the following equations to calculate fuel economy.

Liters used x 100 ÷ Total kilometers traveled

Total miles traveled ÷ Total gallons used

Keep a record for at least one month. This will provide an accurate estimate of the vehicle's fuel economy.

EMISSION CONTROL SYSTEM

Your vehicle is equipped with various emission control

Maintenance and care

components and a catalytic converter which will enable your vehicle to comply with applicable exhaust emission standards. To make sure that the catalytic converter and other emission control components continue to work properly:

- Use only unleaded fuel.
- Avoid running out of fuel.
- Do not turn off the ignition while your vehicle is moving, especially at high speeds.
- Have the services listed in your “Service Guide” performed according to the specified schedule.

The Scheduled Maintenance Services listed in the “Service Guide” are required because they are considered essential to the life and performance of your vehicle and to its emissions system.

If other than Ford, Motorcraft or Ford authorized parts are used for maintenance replacements or for service of components affecting emission control such non-Ford parts should be equivalent to genuine Ford Motor Company parts in performance and durability.



Do not park, idle, or drive your vehicle in dry grass or other dry ground cover. The emission system heats up the engine compartment and exhaust system, which can start a fire.

Maintenance and care

Watch for fluid leaks, strange odors, smoke, loss of oil pressure, the charging system warning light, the “Service Engine Soon” light or the temperature warning light. These events could indicate that the emission control system is not working properly.



If you smell exhaust fumes of any kind inside your vehicle, have the dealer inspect and fix your vehicle immediately. Do not drive if you smell exhaust fumes. These fumes are harmful and could kill you.

Do not make any unauthorized changes to your vehicle or engine. By law, vehicle owners and anyone who manufactures, repairs, services, sells, leases, trades vehicles, or supervises a fleet of vehicles are not permitted to intentionally remove an emission control device or prevent it from working. Information about your vehicle's emission system is on the Vehicle Emission Control Information Decal located on or near the engine. This decal identifies engine displacement and gives some tune up specifications.

Please consult your “Warranty Guide” for complete emission warranty information.

Readiness for inspection/maintenance testing

In some localities, it may be a legal requirement to pass an I/M test of

the on-board diagnostic (OBD-II) system. If your “check engine/service engine soon” light is on, reference the applicable light description in the *Warning Lights and Gauges* section of your owners guide. Your vehicle may not pass the I/M test with the “check engine/service engine soon” light on.

If the vehicle’s powertrain system or its battery has just been serviced, the OBD-II system is reset to a “not ready for I/M test” condition. To ready the OBD-II system for I/M testing, a minimum of 30 minutes of city and highway driving is necessary as described below:

- First, at least ten minutes of driving on an expressway or highway.
- Next, at least twenty minutes driving in stop and go, city type traffic with at least four idle periods.

Allow the vehicle to sit for at least 8 hours without starting the engine. Then, start the engine and complete the above driving cycle. The engine must warm up to its normal operating temperature. Once started, do not turn off the engine until the above driving cycle is complete.

Maintenance and care

REPLACING VEHICLE BULBS

Replacing the exterior bulbs

Check the operation of the following exterior lamps frequently:

- headlamps
- foglamps (if equipped)
- high-mount brakelamp
- license plate lamp
- tail lamps
- back-up lamps

Do not remove lamp bulbs unless they will be replaced immediately with new ones. If a bulb is removed for an extended period of time, contaminants may enter the lamp-housings and affect lamp performance.



Handle a halogen headlamp bulb carefully and keep out of children's reach. Grasp the bulb only by its plastic base and do not touch the glass. The oil from your hand could cause the bulb to break the next time the headlamps are operated.

Maintenance and care

Replacing the headlamps

1. With the flat side of the bulb's base facing upward, insert the glass end of the bulb into the socket. Turn the bulb left or right to line up the grooves in the plastic base with the tabs in the socket. Push the bulb into the socket until the plastic base contacts the rear of the socket.

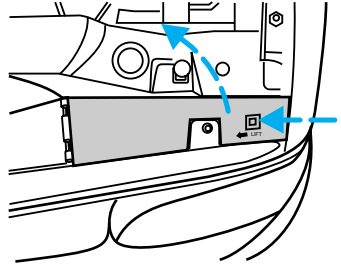

2. Slip the retaining ring over the plastic base until it hits the rear of the socket. Lock the ring by rotating it clockwise until you feel it stop.

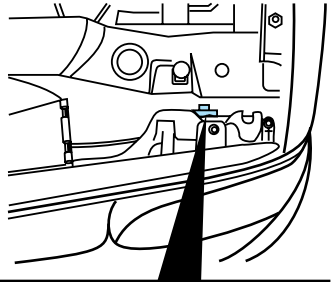

3. Press the electrical connector into the rear of the plastic base until it snaps, locking it into position.

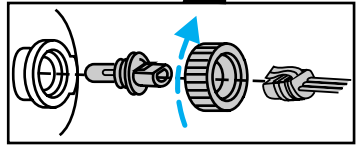

4. Turn the headlamps on and ensure they work properly.

Foglamps (if equipped)

1. Disconnect the electrical connector from the back of the foglamp by turning it counterclockwise.

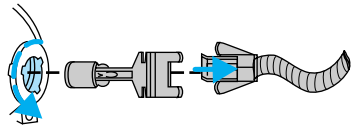

2. Remove the bulb by lifting the retaining clip and pulling the bulb from the assembly.

3. Replace the bulb and insert the bulb assembly back into the foglamp.

Maintenance and care

4. Lock the bulb assembly into place by turning it clockwise until it stops.

Highmount brakelamp

The highmount brakelamp is located just above the rear liftgate window. For bulb replacement, see a dealer or qualified service technician.

License plate lamps

To change either of the license plate lamp bulbs, follow this procedure:

1. Use a screwdriver to detach the lamp from the bumper.
2. Turn and pull the socket from the lamp and remove the bulb.
3. Replace the socket into the lamp and press the lamp back into the bumper.

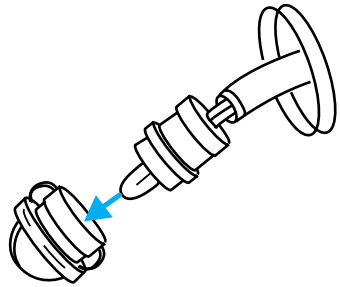

Tail lamps

The tail lamps, backup lamps and brake lamps are located in the same bezel. Follow these steps to replace any of the bulbs:

1. Remove the two retainer screws.
2. Remove the rear lamp by pulling rearward to disengage two lower barbed retainers.
3. Twist to remove the socket from the lamp.
4. Remove bulb from the socket.
5. Install bulb into socket.
6. Install socket into lamp.
7. Replace the rear lamp.

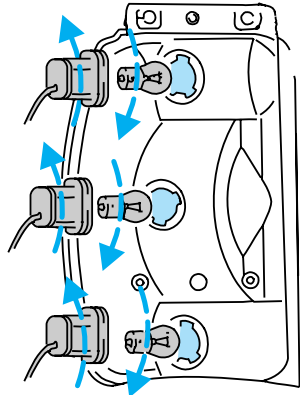

Maintenance and care

Replacing the interior bulbs

Check the operation of the following interior bulbs frequently:

- interior overhead lamp
- map lamp
- courtesy and cargo lamps

Map lamps

To change the map lamp bulbs:

1. Use a small screwdriver to pry off the lens.
2. To remove the bulbs, rotate each bulb holder counterclockwise. The bulb and bulb holder will drop out.
3. Pull the bulb from the bulb holder and replace it.
4. To replace the bulb, push it back into the assembly and rotate it clockwise.
5. Replace the lens by pressing it back in.

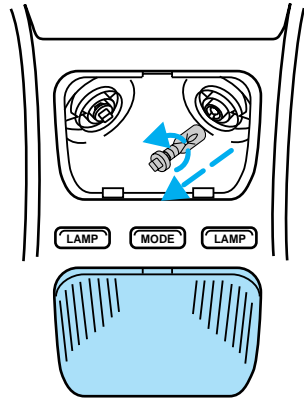

Bulb specifications

Function	Number of bulbs	Trade number
Exterior bulbs		
Front park/turn lamps	4	3156NAK
Headlamps	2	9007
Rear license plate lamps	2	3156
Backup lamp	2	3156K
Rear/turn/sidemarker	2	3156K
Rear/stop/tail	2	3157K
Interior illumination		

Maintenance and care

Function	Number of bulbs	Trade number
Cargo lamp	1	211-2
Interior overhead lamp	1	912 (906)
Front door courtesy lamp	1	168
Map lamps	2	168 (T10)
Ashtray lamp	1	161
Glove compartment lamp	1	194

AIMING THE HEADLAMPS

The alignment of your headlamps should be checked by a qualified service technician if:

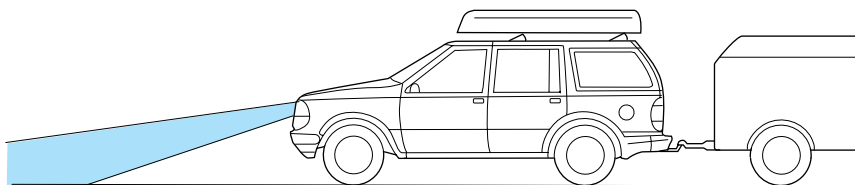

- Oncoming motorists frequently signal you to deactivate your high beams, and your high beams are not activated.
- The headlamps do not seem to provide enough light for clear night vision.
- The headlamp beams are pointed substantially away from a slightly down and to the right position.

CLEANING AND CARING FOR YOUR VEHICLE

Refer to the “Customer Assistance Guide” for a list of Ford-approved cleaners, polishes and waxes.

Washing your vehicle

Wash your vehicle regularly with cold or lukewarm water. Never use strong detergents or soap. If your vehicle is particularly dirty, use a quality car wash detergent. Always use a clean sponge, washing glove or similar device and plenty of water for best results. To avoid spots, avoid washing when the hood is still warm, immediately after or during exposure to strong sunlight.

During winter months, it is especially important to wash the vehicle on a regular basis. Large quantities of dirt and road salt are difficult to remove, and they also cause damage to the vehicle. Remove any exterior accessories, such as antennas, before entering a car wash.

- After washing, apply the brakes several times to dry them.

Waxing your vehicle

The best way to determine when the paintwork needs waxing is by noting when water stops beading on the surface. This could be every three or four months, depending on operating conditions.

Use only carnauba or synthetic-based waxes. Remove

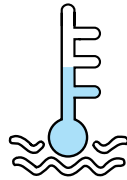

Maintenance and care

any bugs and tar before waxing vehicle. Use cleaning fluid or alcohol with a clean cloth to remove. Use tar remover to remove any tar spots.

Repairing paint chips

Minor scratches or paint damage from road debris may be repaired with touch-up paint, paint repair foil or aerosol paint spray from the Ford accessory line. Observe the application instructions on the products.

Remove particles such as bird droppings, tree sap, insect remains, tar spots, road salt and industrial fallout immediately.

Cleaning the wheels

Wash the wheels with the same detergent you use to clean the body of your vehicle. Do not use acid-based wheel cleaners, steel wool, fuel or strong detergents. Never use abrasives that will damage the finish of special wheel surfaces. Use a tar remover to remove grease and tar.

Cleaning the engine

Engines are more efficient when they are clean because grease and dirt buildup act as insulators and keep the engine warmer than normal. Follow these guidelines to clean your engine:

- Take care when using a power washer to clean the engine. The

Maintenance and care

high pressure fluid could penetrate the sealed parts and cause damage.

- Do not spray with cold water to avoid cracking the engine block.
- Cover the highlighted areas to prevent water damage when cleaning the engine.

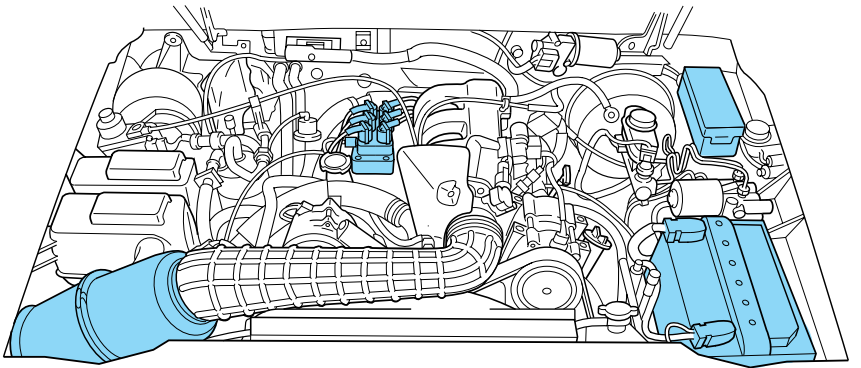
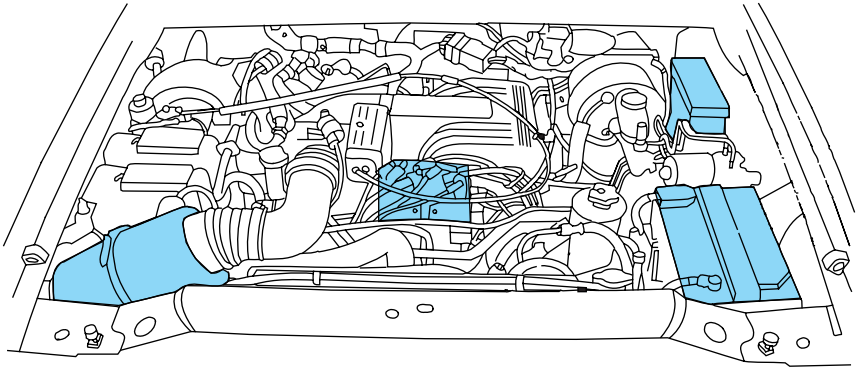

Maintenance and care

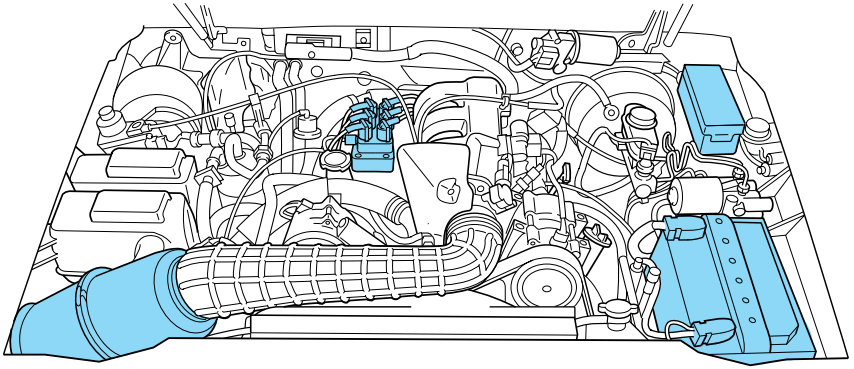

- Never wash or rinse the engine while it is running; water in the running engine may cause internal damage.

Cleaning plastic exterior parts

Use a vinyl cleaner for routine cleaning of plastic. Clean with a tar remover if necessary. Do not clean plastic parts with thinners, solvents or petroleum-based cleaners.

Cleaning the exterior lamps

Wash the exterior lamps with the same detergent you used to wash the exterior of your vehicle. Use glass cleaner or tar remover if necessary.

To avoid scratching the lamps, do not use a dry paper towel, chemical solvents or abrasive cleaners to clean the lamps.

Cleaning the wiper blades

If the wiper blades do not wipe properly, clean both the windshield and wiper blades using undiluted

Maintenance and care

windshield wiper solution or a mild detergent. Rinse thoroughly with clean water. To avoid damaging the blades, do not use fuel, kerosene, paint thinner or other solvents.

Cleaning the instrument panel

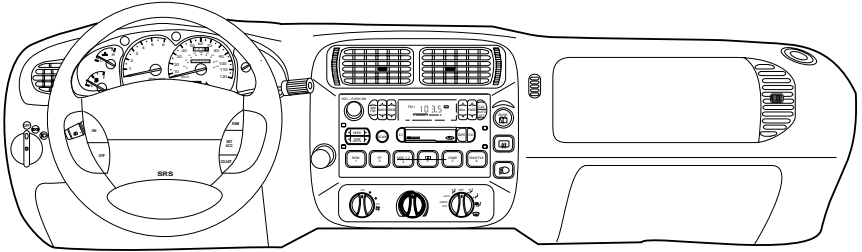

Clean the instrument panel with a damp cloth, then dry with a dry cloth.

Any cleaner or polish that increases the gloss of the upper portion of the instrument panel should be avoided. The dull finish in this area is to help protect the driver from undesirable windshield reflection.

Cleaning the interior fabric

Remove dust and loose dirt with a whisk broom or a vacuum cleaner. Remove fresh spots immediately. Follow the directions that come with the cleaner.

Cleaning leather seats (if equipped)

For routine cleaning, wipe the surface with a soft, damp cloth. For more thorough cleaning, wipe the surface with a leather and

Maintenance and care

vinyl cleaner or a mild soap.

Cleaning and maintaining the safety belts

Clean the safety belts with a mild soap solution recommended for cleaning upholstery or carpets. Do not bleach or dye the belts, because these actions may weaken the belt webbing.

All safety belt assemblies, including retractors, buckles, front seat belt buckle support assemblies (slide bar) (if equipped), shoulder belt height adjusters (if equipped), child safety seat tether bracket assemblies (if equipped) and attaching hardware should be inspected after any collision. Ford recommends that all safety belt assemblies used in vehicles involved in a collision be replaced. However, if the collision was minor and a qualified technician finds that the belts do not show damage and continue to operate properly, they do not need to be replaced. Safety belt assemblies not in use during a collision should also be inspected and replaced if either damage or improper operation is noted.

Cleaning the built-in child seat (if equipped)

Clean the built-in child seat with mild soap and water. Do not use household cleaning products because they may weaken the safety belt webbing or damage the vinyl parts of the seat.

Maintenance and care

The child seat liner is removable and may be machine-washed and air dried.

Capacities and specifications

MOTORCRAFT PART NUMBERS

Component	4.0L EFI engine	4.0L SOHC engine	5.0L engine
Air filter	FA-1616	FA-1658	FA-1658
Fuel filter	FG-872	FG-872	FG-872
Battery (standard)	BXT-58	BXT-58	BXT-65-650
Battery (optional)	BXT-65-650	BXT-65-650	BXT-65-850
Oil filter	FL-1A	FL-1A	FL-820S
PCV valve	EV-225	EV-225	EV-152
Spark plug ¹	AGSF-22PP ²	AGSF-22PP ²	AWSF-32EE ³

¹ Refer to the Vehicle Emission Control Information (VECI) decal in the engine for gap specifications. If a spark plug must be replaced, use only spark plugs with the service number suffix letter EE as shown on the engine decal.

² If a spark plug is removed for inspection, it must be reinstalled in the same cylinder. Cylinder numbers 1, 2, 3 have a PG suffix. Cylinder numbers 4, 5, 6 have a P suffix.

³ If a spark plug is removed for inspection it must be reinstalled in the same cylinder. Cylinder numbers 1, 2, 3, 4 have an EG suffix. Cylinder numbers 5, 6, 7, 8 have an E suffix.

Capacities and specifications

REFILL CAPACITIES

Fluid	Ford Part Name	Application	Capacity-liters (quarts)	
Engine oil (including filter change)	Motorcraft 5W30 Super Premium Motor Oil	All engines	4.7 (5.0)	
Brake fluid	Ford High Performance DOT 3 Brake Fluid	All	Fill to line in reservoir	
Power steering fluid	Motorcraft MERCON® ATF	All	Fill to line in reservoir	
Transmission fluid	Motorcraft MERCON® V ATF	Motorcraft MERCON® ATF	5-speed manual	2.6 (5.6 pints)
		4R70W Automatic (4 x 2)		13.1 (13.9)
		5R55E Automatic with 4.0L SOHC engine (4 x 2)		9.25 (9.75)
		5R55E Automatic with 4.0L SOHC engine (4 x 4)		9.55 (10.0)
Transfer case	Motorcraft MERCON® ATF	4WD	1.4 (1.5)	
		AWD	1.25 (1.3)	
Engine coolant	Ford Premium Cooling System Fluid	4.0L engine	7.4 (7.8)	
		5.0L engine	12.1 (12.8)	
Front axle fluid	Motorcraft SAE 80W90 Axle Lubricant	4 x 4 vehicles	1.7 (3.5 pints)	

Capacities and specifications

Fluid	Ford Part Name	Application	Capacity-liters (quarts)
Rear axle fluid ^{1,2,3,4}	Motorcraft SAE 80W90 Axle Lubricant	Vehicles with conventional axles	2.9-3.1 (5.50-5.80 pints)
	Motorcraft SAE 75W140 High Performance Synthetic Rear Axle Lubricant	Refer to footnotes 2 and 3	
Windshield washer fluid	Ultra-Clear Windshield Concentrate	Front	2.6 (2.7)
		Rear (if equipped)	3.1 (3.3)

¹ Fill to 3 mm (1/4" to 9/16") below bottom of fill hole.

² Vehicles equipped with 4.0L SOHC and 4.0L EI engines may have a limited slip differential. If your vehicle is equipped with a limited slip differential, add 4 ounces of additive friction modifier C8AZ-19B546-A, Ford specification EST-M2C118-A, for complete refill of 8.8 inch and 9.75 inch rear axles.

³ Vehicles equipped with 4.0L SOHC or 4.0L EFI engines and 3.73 or 4.10 rear axle ratios or 5.0L engines require synthetic rear axle lubricant. Rear axles containing synthetic lubricant are lubricated for life. These lubricants are not to be checked or changed unless a leak is suspected, service required or the axle assembly has been submerged in water. The axle lubricant should be changed any time the axle has been submerged

Capacities and specifications

in water. For Traction-Lok rear axles, add 4 ounces of additive friction modifier C8AZ-19B546-A, Ford specification EST-M2C118-A, whenever the lubricant is changed.

⁴ Refer to your “Service Guide” for axle fluid change intervals.

SPECIFICATIONS

Lubricant specifications

Item	Ford Part Name	Ford Part Number	Ford Specification
Windshield washer fluid reservoir	Ford Ultra-Clear Windshield Washer Fluid Concentrate	C9AZ-19550-AA OR -BA	ESR-M17P5-A
Body hinges, latches, door stricker plates and rotors, seat tracks, fuel filler door hinge and spring, hood latch, auxiliary latch	Multi-Purpose Grease	D7AZ-19584-AA OR D0AZ-19584-AA	ESR-M1C159-A AND ESB-M1C93-B
Steering column u-joints, parking brake linkage pivots and clevises, transmission control and clutch linkage pivots	Premium Life Long Grease	XG-1-C	ESA-M1C75-B

Capacities and specifications

Item	Ford Part Name	Ford Part Number	Ford Specification
Hydraulic clutch master cylinder and brake master cylinder	High Performance DOT 3 Brake Fluid	C6AZ-19542-AB	ESZ-M6C25-A
Driveshaft, slip spline, universal joints	Premium Long Life Grease	XG-1-C or K	ESA-M1C75-B
Door weatherstrips	Silicone Lubricants	COAZ-19553-AA	ESR-M13P4-A
Engine coolant	Ford Premium Cooling System Fluid	E2FZ-19549-AA	ESE-M97B44-A
ATX shift linkage	Premium Long Life Grease	XG-1-C	ESA-M1C75-B
Engine oil	Motorcraft Motor Oil 5W-30 Super Premium	XO-5W30-QSP	WSS-M2C153-F with API Certification Mark
Automatic transmission (4R70W)	Motorcraft MERCON® Automatic Transmission Fluid	XT-2-QDX	MERCON®
Automatic transmission (5R55E)	Motorcraft MERCON® V ATF	XT-2-QM	MERCON®
Power steering reservoir	Motorcraft MERCON® ATF	XT-2-QDX	MERCON®
Speedometer, parking brake cable	Speedometer Cable Lubricant	E6TZ-19581-A	ESF-M1C160-A
Engine oil lubricant	Motorcraft Long Life Oil Filter	FL-1A-4.0L FL-820-5.0L	ES-E1ZE-6714-AA

Capacities and specifications

Item	Ford Part Name	Ford Part Number	Ford Specification
Accelerator throttle lever ball stud	Premium Long Life Grease	XG-1-C	ESA-M1C175-B
Ford conventional and traction lok rear axles	Motorcraft SAE Premium Rear Axle Lubricant	XY-80W90-QL ¹²³	WSP-M2C197-A
Dana axles (front)	4x4 Gear Oil	F1TZ-19580-A	WSL-M2C191-A
Transfer case - Four wheel drive	Motorcraft MERCON® Automatic Transmission Fluid	XT-2-QDX	MERCON®
Brake and clutch pedal shaft	Premium Long-life Grease	XG-1-C or K	ESA-M1C75-B
5-speed manual transmission	Motorcraft MERCON® Automatic transmission fluid	XT-2-QDX	MERCON®
Transfer case Front Output Slip Shaft	Premium Long-Life Grease	XG-1-G or K	ESA-M1C75-B

¹ 4.0 L Explorer Conventional and Traction-lok rear axles are filled with XY-80W90-QL, Ford specification WSP-M2C197-A.

² 5.0 L Explorer Conventional and Traction-Lok rear axles are filled with Motorcraft Premium Synthetic rear axle lubricant, F1TZ-19580-B, Ford specification WSL-M2C192-A.

Capacities and specifications

³ Add 4-ounces of additive friction modifier C8AZ-19B546-A, Ford specification EST-M2C118-A, for complete Traction-lok rear axles.

ENGINE DATA

Engine	4.0L 2V V-6	4.0L 2V V-6 SOHC	5.0L 2V V-8
Cubic inches	245	245	302
Horsepower	160 @ 4200 rpm	205 @ 5000 rpm	211 @ 4600
Torque	225 @ 2800 rpm	250 @ 3000 rpm	274 @ 3200 rpm
Required fuel grade	87 octane	87 octane	87 octane
Firing order	1-4-2-5-3-6	1-4-2-5-3-6	1-3-7-2-6-5-4-8
Spark plug gap	1.3-1.4 mm (0.052-0.056 inch)	1.3-1.4 mm (0.052-0.056 inch)	1.3-1.4 mm (0.052-0.056 inch)
Ignition system	DIS	DIS	DIS

VEHICLE DIMENSIONS

Dimensions	cm(inches)
1 Overall length	468 cm (184.3 in)
2 Overall width	187 cm (70.2 in)
3 Maximum height	170 cm (67.3 in)
4 Wheelbase	284 cm (111.9 in)
5 Front track / rear	148 cm (58.3 in)

Capacities and specifications

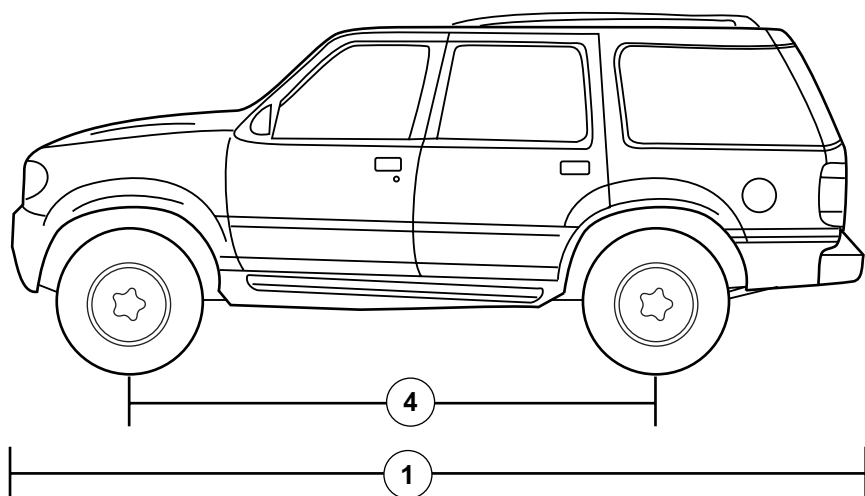

Capacities and specifications

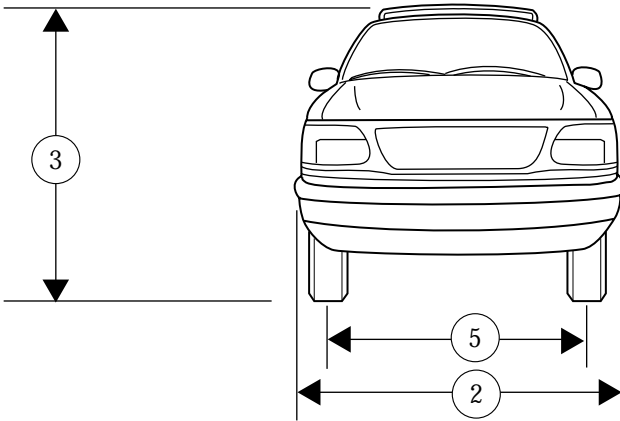

IDENTIFYING YOUR VEHICLE

Vehicle identification tag

The vehicle identification tag is located on the front panel of the engine compartment. This tag bears technical information on your vehicle and identifies various components.

Vehicle identification number

The vehicle identification number (VIN) is attached to a tag and is located on the front driver's side of the instrument panel. The VIN tag may be seen by looking through the windshield from the outside of the vehicle.

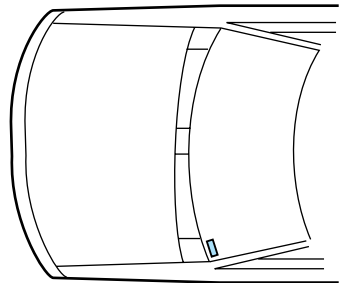

Capacities and specifications

Engine number

The engine number is stamped on the engine block.

Reporting safety defects

REPORTING SAFETY DEFECTS (U.S. ONLY)

If you believe that your vehicle has a defect that could cause a crash, or could cause injury or death, you should immediately inform the National Highway Traffic Safety Administration (NHTSA) in addition to Ford Motor Company.



If NHTSA receives similar complaints, it may open an investigation, and if it finds that a safety defect exists in a group of vehicles, it may order a recall and remedy campaign. However, NHTSA cannot become involved in individual problems between you, your dealer or Ford Motor Company.

To contact NHTSA, you may either call the Auto Safety Hotline toll-free at 1-800-424-9393 (202-366-0123 in the Washington D.C. area) or write to:

NHTSA
U.S. Department of Transportation
400 Seventh Street
Washington D.C. 20590

You can also obtain other information about motor vehicle safety from the Hotline.

- Air bag supplemental restraint system
 - and child safety seats90
 - description89
 - disposal94
 - indicator light93
 - passenger air bag91
- Air cleaner filter192
 - replacing193
- Air conditioning
 - manual heating and air conditioning system28,29,30,31,32
- Air suspension119
- All wheel drive (AWD)134
- Anti-theft system65
 - arming the system66
 - disarming a triggered system ..68
 - disarming an untriggered system68
 - warning light67
- Autolamp system (see Headlamps)49
- Automatic dimming mirror ...47,48
- Battery188
 - battery saver192
 - servicing188,189,190
- Brakes
 - adjustment117
 - anti-lock117
 - fluid, checking and adding177
 - parking118
- Break-in period2
- Built-in child seat102,107,108
- Bulbs, replacing208,210,211,212,213
 - specifications213
- Capacities for refilling fluids225
- Cargo area shade64
- Childproof locks55
- Cleaning your vehicle215
 - built-in child seat220
 - engine compartment216
 - fabric219
 - instrument panel219
 - plastic parts218
 - safety belts220
 - tail lamps218
 - washing215
 - waxing215
 - wheels216
- Climate control system28
 - automatic temperature control32,33,34,35,36
 - defrosting59,60
- Clutch
 - fluid177
- Compass, electronic50
 - calibration51
 - set zone adjustment51
- Console, description58,61
- Control trac 4WD system128
- Controls58,59
- Coolant (see Engine coolant)
 - proper solution181
- Daytime running light system ...26
- Differential fluid187
- Driveline universal joint and slip yoke176,187
- Driving under special conditions130
 - high water131
 - slippery roads132,133
 - towing a trailer144
- Emission control system206
- Engine228,231
 - service points170,171,172
- Engine block heater116
- Engine coolant
 - checking and adding180,183
 - checking hoses184
 - disposal182
 - refill capacities182

Index

- Engine oil
 - changing oil and oil filter175
 - specifications173
- Entry system
 - illumination66
- Exhaust fumes112
- Flashing the lights45
- Floor mats62,63
- Foglamps27
- Ford Extended Service Plan129
- Four way head restraints78
- Four-Wheel Drive vehicles
 - control trac38,128
 - driving off road130
- Fuel202
 - calculating fuel economy206
 - improving fuel economy146
 - octane rating204
 - quality205
 - safety information relating to automotive fuels202
- Fuel gauge15
- Fuel pump shut-off switch147
- Fuses148
- Gauges, Mechanical
 - engine coolant temperature gauge13
 - engine oil pressure gauge13
- Hazard flashers44,147
- Head restraints78
- Hitch144
- Hood169
- Identification Number, Vehicle (VIN)230
- Ignition
 - positions of the ignition39
- Jack63
- Jump-starting your vehicle 160,162
 - attaching cables161
 - disconnecting cables162
- Keyless entry system
 - autolock76
 - keypad74
 - locking and unlocking doors74
 - programming entry code75
- Lamps
 - instrument panel, dimming26
- Liftgate57
- Lights, warning and indicator
 - air bag11
 - anti-lock brakes (ABS)11
 - anti-theft9
 - brake11
 - charging system10
 - check engine9
 - door ajar10
 - four-wheel drive9
 - fuel reset10
 - high beam11
 - overdrive off8
 - safety belt11,87,88
- Luggage rack146
- Manual transmission
 - driving121,125,127
 - fluid, checking and adding187
- Message center ..16,17,18,19,20,52
 - air ride switch off21
 - change oil soon21
 - check air ride system20
 - check charging system22
 - check engine temperature22
 - check exterior lamps22
 - door ajar24
 - low fuel level24
 - low oil level24
 - low washer fluid24
 - warning messages20
- Moon roof54
- Motorcraft parts222
- Odometer14
- Overdrive45,46
- Overhead console
 - storage compartment52
- Parking brake28

- Power door locks54
- Power steering
 - fluid, checking and adding184
- Rear window
 - wiper37,38
- Refill capacities for fluids223
- Relays149,150,153
- Remote entry system69
 - locking/unlocking doors69,70
 - panic alarm70
 - replacement/additional transmitters73
 - replacing the batteries72
- Reporting safety defects232
- Restraints, safety (see Safety restraints)
 - head78
- Safety restraints
 - adjusting the safety belts86,87
 - energy absorbing sew pattern88,89
 - for children95
 - proper use83,84,85,86
- Safety seats for children
 - attaching with tether straps ..101
 - automatic locking mode (retractor)97,98
- Seats79
 - adjusting the seat, power80
 - bench (60-40 split)79
- Servicing your vehicle165
 - precautions when servicing ...165
 - servicing when you tow145
- Snowplowing4
- Special notice3
 - ambulance conversions3
 - utility-type vehicles3
- Specification chart, lubricants .225
- Speed control40
 - indicator light8,43
- Speedometer14
- Starting your vehicle110
 - preparing to start your vehicle112
 - starting a warm engine115
- Steering wheel
 - tilting44
- Storage compartments
 - overhead storage compartment52
- Tachometer
 - mechanical cluster15
- Tires
 - changing156
 - checking the pressure197
 - inspection and maintenance ..195
 - replacing199
 - rotating198
 - snow tires and chains201
 - spare tire156
 - tire grades195
 - treadwear196
- Traction-lok rear axle119
- Trailer towing138
 - safety chains143
 - tips139,144
 - trailer brakes143
 - trailer lamps143
- Transfer case (see Differential fluid)188
- Transmission
 - fluid, checking and adding (automatic)186
- Trip odometer14
- Turn signal
 - indicator lights9
- Two step lock54
- Vehicle dimensions228
- Vehicle headlamp aiming device (VHAD)214
- Vehicle Identification Number (VIN)230
- Ventilating your vehicle111

Voltmeter (see Battery voltage gauge)	15	Windshield washer fluid and wipers	193
Warning chimes		checking and adding fluid	178
headlamps on	11	checking and replacing wiper blades	193,194
key in ignition	12	liftgate reservoir	179
safety belt	12	operation	46
Washer fluid		specifications	178
reservoir	179	Wrecker towing	163
Windows			
power windows, operating	56		

Filling station information

FILLING STATION INFORMATION

Fuel	Unleaded fuel only - Octane 87
Fuel tank capacity (2 door)	66.2 L (17.3 gallons)
Fuel tank capacity (4 door)	79.5 L (20.8 gallons)
Engine oil	Use only engine oil displaying the American Petroleum Institute certification mark. SAE 5W-30 is preferred.
Tire size and pressure	Refer to the SCC label for tire specifications.
Hood release	Pull handle under the left side of the instrument panel.