

Contents

Before driving

Introduction	2
Instrumentation	5
Controls and features	15
Seating and safety restraints	37

Starting and driving

Starting	73
Driving	80
Roadside emergencies	100

Servicing

Maintenance and care	124
Capacities and specifications	173
Reporting safety defects	182
Index	183

Introduction

ICONS

Indicates a warning. Read the following section on *Warnings* for a full explanation of them.



Indicates that vehicle information related to recycling and other environmental concerns will follow.



We must all play our part in protecting the environment. Correct vehicle usage and the authorized disposal of waste cleaning and lubrication materials are significant steps towards this aim.

WARNINGS

How can you reduce the risk of personal injury and prevent possible damage to others, your vehicle and its equipment?

In this owner's guide, answers to such questions are contained in comments highlighted by the warning triangle symbol.

SPECIAL NOTICES

Using your light truck as an ambulance

If your light truck is equipped with the *Ford ambulance preparation package*, it may be utilized as an ambulance. Ford urges ambulance manufacturers to follow the recommendations of the *Ford incomplete vehicle manual*, *Ford truck body builder's layout book* and the *QVM guidelines* as well as pertinent supplements. For

Introduction

additional information, please contact the Light Truck Body Builders Advisory Service 1-800-635-5560.

Use of your Ford light truck as an ambulance, without the Ford Ambulance Preparation Package voids the Ford New Vehicle Limited Warranty and may void the Emissions Warranties. In addition, ambulance usage without the preparation package could cause high underbody temperatures, overpressurized fuel and a risk of spraying fuel which could lead to fires.

If your vehicle is equipped with the Ford ambulance preparation package, it will be indicated on the Safety Certification Compliance label. The label is located on the driver's side door pillar or on the rear edge of the driver's door. You can determine whether the ambulance manufacturer followed Ford's recommendations by directly contacting that manufacturer. Ford Ambulance preparation package is only available on certain 7.3L Diesel Econoline vehicles.

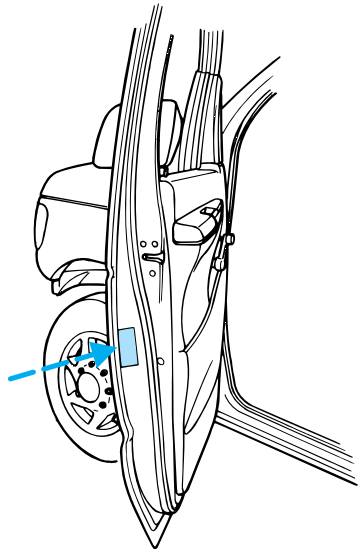

Diesel-powered vehicles

Read the 7.3L Diesel Engine Owner's Guide Supplement for information regarding correct operation and maintenance of your

Introduction

diesel-powered light truck.

BREAKING-IN YOUR VEHICLE

There are no particular breaking-in rules for your vehicle. Simply avoid driving too briskly during the first 1,600 km (1,000 miles) of driving. Vary speeds frequently. This is necessary to give the moving parts a chance to break in.

If possible, you should avoid full use of the brakes for the first 1,600 km (1,000 miles).

From 1,600 km (1,000 miles) onwards you can gradually increase the performance of your vehicle up to the permitted maximum speeds.

INFORMATION ABOUT THIS GUIDE

The information found in this guide was in effect at the time of printing. Ford may change the contents without notice and without incurring obligation.

Instrumentation

Instrumentation

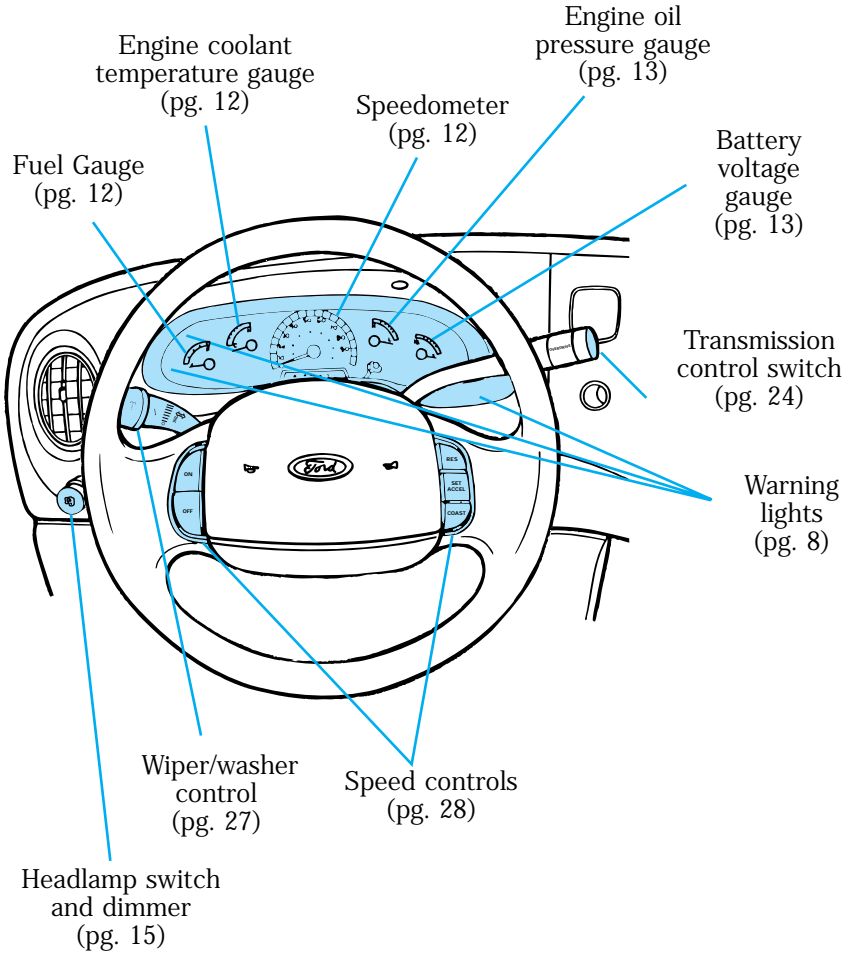

Instrumentation

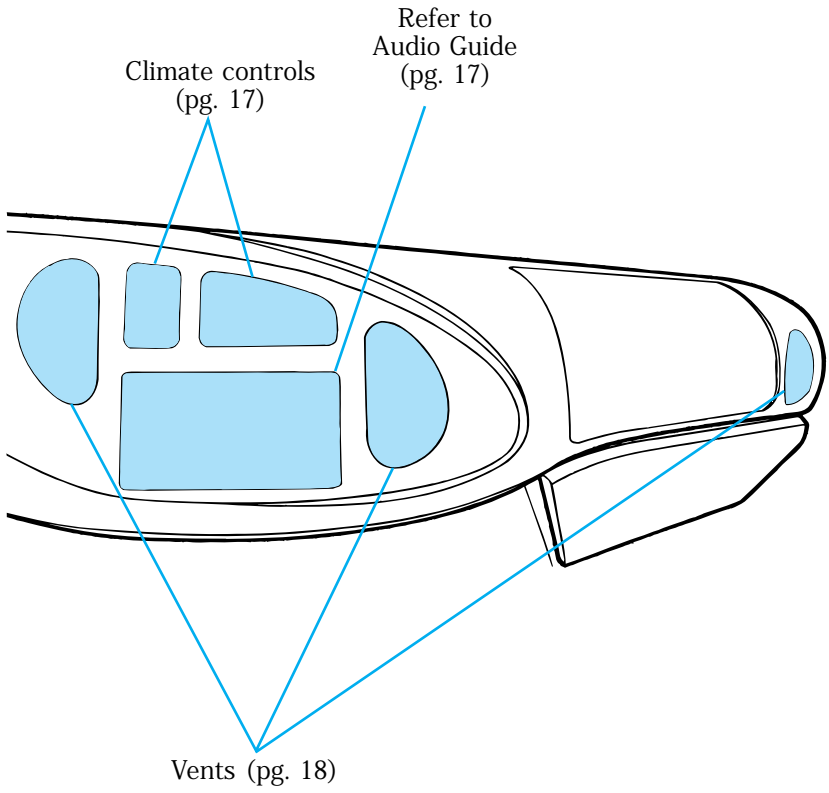

Instrumentation

INSTRUMENT CLUSTER LIGHTS

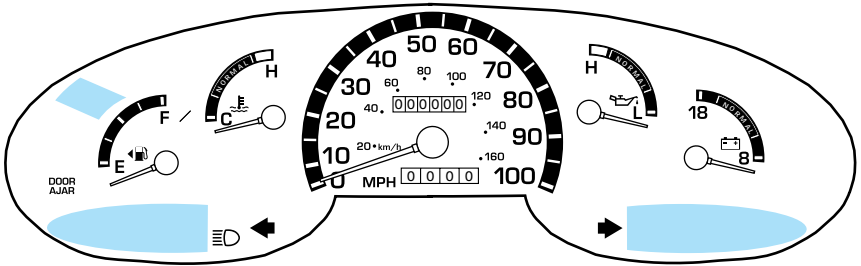

Brake system warning

This light illuminates when you turn the ignition key to START to verify that the indicator bulb is working. If the light stays on or comes on after you have released the parking brake fully, have the hydraulic brake system serviced.

This light also will illuminate if vacuum pressure is low on diesel engine vehicles.



Anti-lock brake system (ABS)

Momentarily illuminates when the ignition is turned on and the engine is off. If the light stays on or continues to flash, the ABS needs to be serviced.

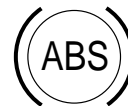

Service engine soon

This light illuminates when the engine's Emission Control System requires service. It will also illuminate when the ignition key is



in the ON position and the engine is off.

Transmission control indicator light (TCIL)

The Transmission Control Indicator Light (TCIL), which is located on the gearshift lever, may flash steadily if a malfunction is detected. If the TCIL is flashing, contact your Ford dealer as soon as possible. If this condition persists, damage to the transmission could occur.

The word “OFF” located on the end of the gearshift lever is the transmission control indicator light (TCIL).

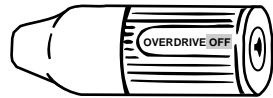

Safety belt

Illuminates when the ignition is switched on to remind you to fasten your safety belts. For more information, refer to *Using the safety restraints properly* in the *Seating and safety restraints* chapter.



Charging system

Briefly illuminates when the ignition is turned on and the engine is off. The light also illuminates when the battery is not charging properly, requiring electrical system service.

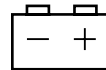

Air bag readiness

Briefly illuminates when the ignition is turned on. If the light fails to illuminate, continues to



Instrumentation

flash or remains on, have the system serviced immediately.

Turn signal

Illuminates when the left or right turn signal or the hazard lights are turned on.

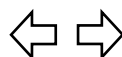

High beams

Illuminates when the headlamp high beams are on.



Door ajar (if equipped)

Illuminates when the ignition switch is in the ON or START position and any door is open.



Oil pressure/Engine coolant

This light will come on when the key is in the ON position and the:

- engine coolant temperature is very high
- engine oil pressure is low

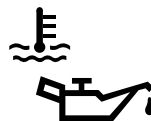

The light serves as a notice that a system needs your attention and to check the engine coolant temperature gauge and the engine oil pressure gauge.

Refer to engine coolant temperature gauge and engine oil pressure gauge in this section for more information.

WARNING CHIMES

Safety belt warning chime

For information on the safety belt warning chime, refer to the *Seating and safety restraints* chapter.

Supplemental restraint system (SRS) warning chime

For information on the SRS warning chime, refer to the *Seating and safety restraints* chapter.

Key-in-ignition warning chime/buzzer

Sounds when the key is left in the ignition and the driver's door is opened.

Headlamps on warning chime (if equipped)

Sounds when the headlamps are on, the ignition is off and the driver's door is opened.

GAUGES

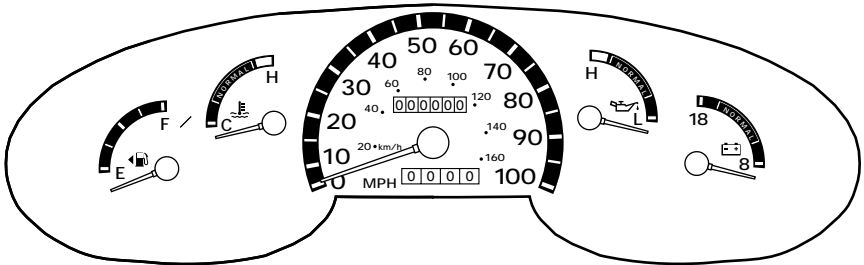

Instrumentation

Speedometer

Indicates the current vehicle speed.

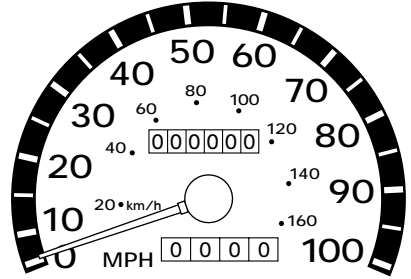

Fuel gauge

The fuel gauge displays approximately how much fuel is in the fuel tank, when the ignition switch is ON.

The fuel gauge indicator may vary slightly when the vehicle is in motion.

The vehicle should be refueled with the ignition key in the OFF position. If the vehicle is refueled with the key in the ON position, the key must be turned to the OFF position and then the vehicle started to get an accurate fuel gauge reading. If the vehicle is fueled with the key in the ON position and the above mentioned is not performed, it will take approximately 25 minutes for the gauge to go from “E” to “F.”

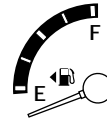

Engine coolant temperature gauge

Indicates the temperature of the engine coolant. At normal operating temperature, the needle remains within the normal area. If it enters the red section, the

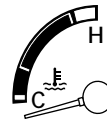

Instrumentation

engine is overheating. Switch off the ignition and let it cool. Refer to *Checking and adding engine coolant* in the *Maintenance and care* chapter.

Engine oil pressure gauge

This shows the engine oil pressure in the system. Sufficient pressure exists as long as the needle remains in the normal range.

If the gauge indicates constantly low pressure at normal engine speed, refer to *Checking and adding engine oil* in the *Maintenance and care* chapter. If the gauge indicates a low pressure and the engine oil level is correct, switch off the engine immediately and have your vehicle checked at your dealership or by a qualified technician.



Charging system gauge

If the pointer moves and stays outside of the normal range, have the vehicle's electrical system checked as soon as safely possible.

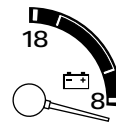

Odometer

Registers the total kilometers (mileage) of the vehicle.

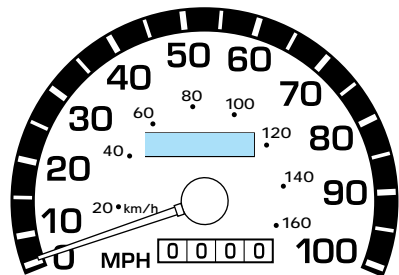

Instrumentation

Trip odometer

Can register the kilometers (mileage) of individual journeys.
To reset, depress the control.

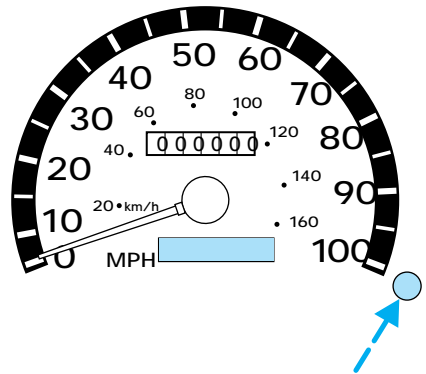

Controls and features

INSTRUMENT PANEL CONTROLS

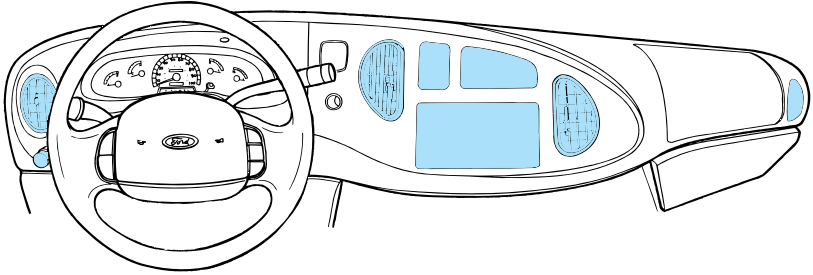

Headlamp control

1. Pull the headlamp control toward you to the first position. Parking lamps, tail lamps, license plate lamps and marker lamps are now on.

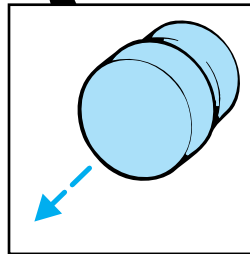
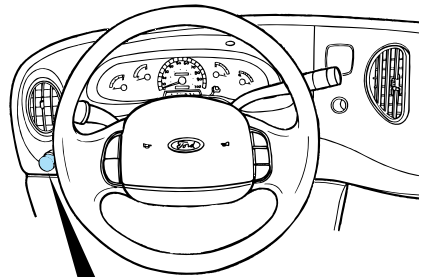

Controls and features

2. Pull the headlamp control toward you to the outer position. Headlamps are now on in addition to above.

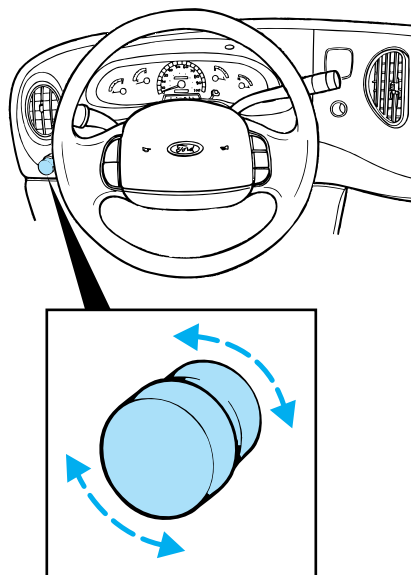

3. Rotate the control when it is in the on position to brighten or dim the instrument panel lamps. Rotate fully counterclockwise to operate courtesy and cargo lamps.

Daytime running light (DRL) system (if equipped)

The DRL system turns on the high beam headlamps, with a reduced light output, when:

- the vehicle is running (ignition switch is in the ON position)
- the vehicle has a fully released parking brake

Controls and features

- the headlamp system is in the OFF or park lamp position

Audio System

For information on the audio system, refer to the *Audio Guide*.

Power point electrical outlet

The power point is a power source for the operation of electrical accessories.

Do not use the cigarette lighter in place of the power point.

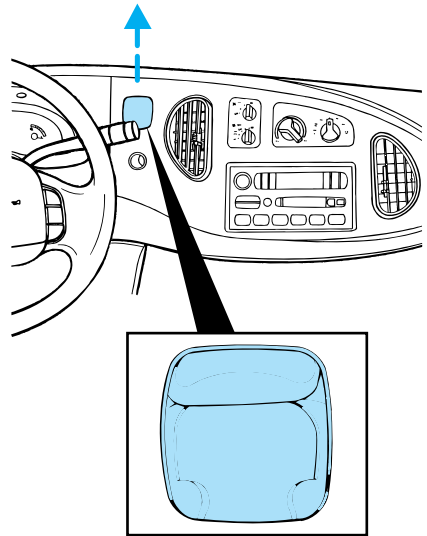

CLIMATE CONTROLS

Your vehicle has one of the following climate control systems:

- Manual heating system
- Manual heating and air conditioning system

In addition your vehicle may also be equipped with a auxiliary heater and air conditioning system.

In some modes, the systems function similarly; in modes where the systems do not function

Controls and features

similarly, the different functions are noted.

Vents

Airflow from the vents may be manually adjusted by moving the horizontal control or vertically adjusting the vent according to your airflow preference.

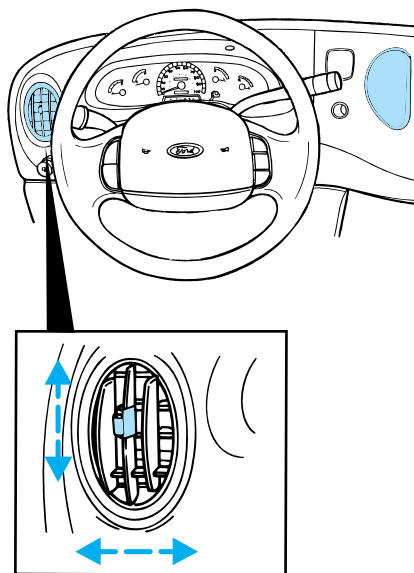

Fan speed

Turn the fan speed control to the desired speed.

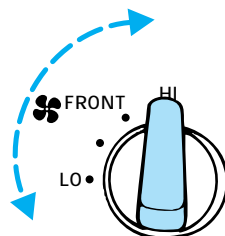

Controls and features

Temperature

Turn the temperature control to the desired mix of warm and cool air (left for cooler and right for warmer).

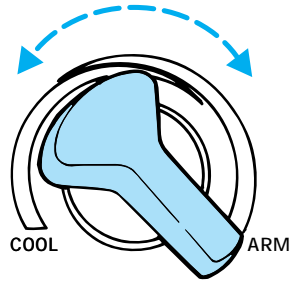

Controlling airflow

Turn the mode control to the desired airflow position.

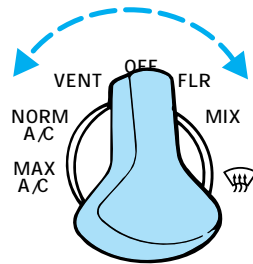

Using MAX A/C mode (if equipped)

The MAX A/C mode recirculates the air and directs it to flow through the instrument panel vents. The MAX A/C mode can be used for air conditioning or heating. This mode is noisier, but more economical than A/C mode. The MAX A/C mode only functions if the outside temperature is above 10°C (50°F).

Select the OFF position for all climate control functions to cease. The outside inlet door will close and the fan is shut off.

Controls and features

Drive with the climate control system on (either in heating or A/C mode) to reduce humidity in your vehicle.

Select MAX A/C for airflow through these vents:

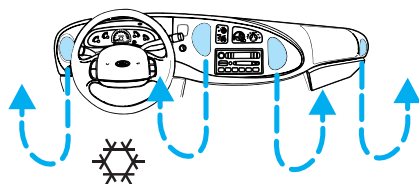

Using NORM A/C mode (if equipped)

The NORM A/C mode directs outside conditioned air to flow through the instrument panel vents. The NORM A/C mode can be used for heating, ventilating or air conditioning. The NORM A/C mode only functions if the outside temperature is above 10°C (50°F).

Select NORM A/C for air to flow through these vents:

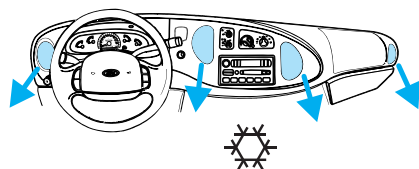

Using the vent mode

Select the VENT mode for air to flow through these vents:

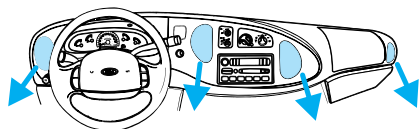

Using the floor mode

Select the FLOOR mode for air to flow through these vents:

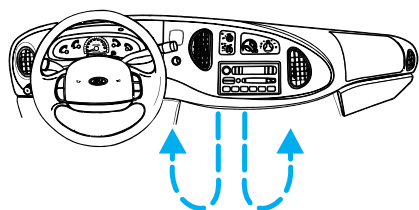

Controls and features

Using the mix mode

The MIX mode directs outside air to flow through the floor vents and windshield defroster vents. The air conditioning will function to dehumidify the windows provided the outside temperature is above 10°C (50°F).

Select the MIX mode for air to flow through these vents:

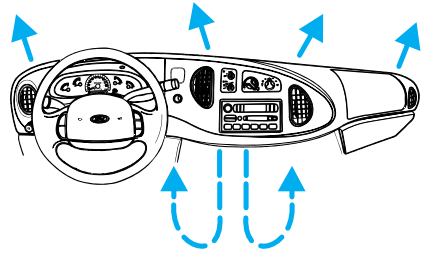

Using the mode

In addition to defogging and demisting, in defrost mode your vehicle has the capability to demist the front side windows. The air conditioning will function to dehumidify the windows provided the outside temperature is above 10°C (50°F).

Select the  mode for air to flow through these vents:

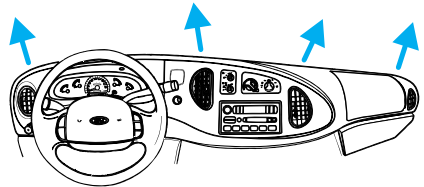

AUXILIARY HEATER AND AIR CONDITIONER (IF EQUIPPED)

If your vehicle is equipped with a factory installed auxiliary unit, the front control panel will include

Controls and features

separate controls for the front and rear fans.

In addition an auxiliary unit fan control is located in the headliner at a location between the front and rear seats.

- To control the auxiliary fan with this control, the rear fan switch on the front control unit must be in the rear control position.
- The auxiliary unit does not provide for mixing of hot and cold air. Adjustment of temperature in the rear may be accomplished by increasing or decreasing the rear fan speed.

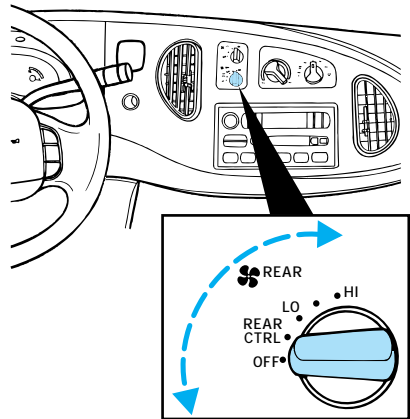
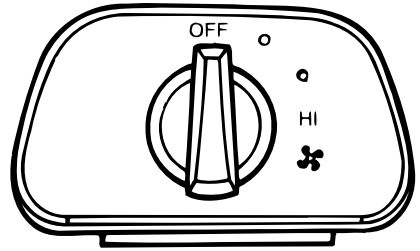

STEERING COLUMN CONTROLS

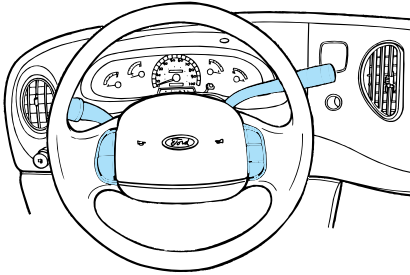

Ignition

ACCESSORY (1) allows operation of some accessories without starting the engine.

LOCK (2) locks the steering wheel and allows the key to be removed from the ignition. LOCK also locks the gearshift.

OFF (3) shuts off the engine and all accessories without locking the steering wheel or gearshift.

ON (4) allows testing of the vehicle's warning and indicator lights.

START (5) cranks the engine. The key returns to the ON position after it is released.

For more information on the vehicle ignition and starting the vehicle, refer to *Preparing to start*

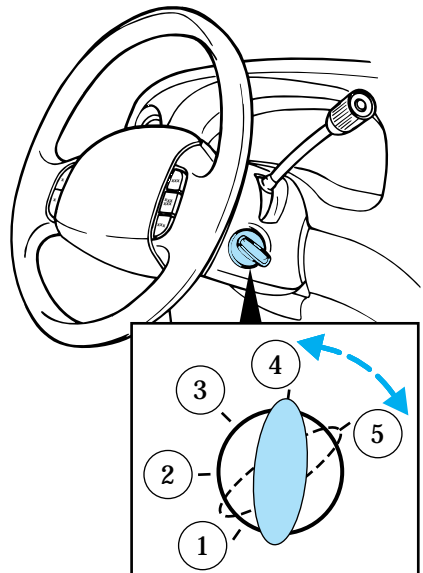

Controls and features

the vehicle in the *Starting* chapter.

Gearshift

For information on the gearshift, refer to *Automatic Transmission Operation* section of the *Driving* chapter.

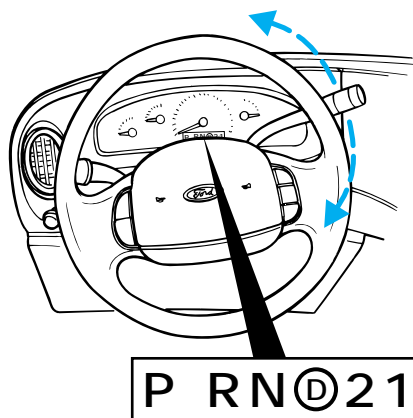

Using overdrive

Ⓓ (overdrive) is the normal drive position for the best fuel economy.

The overdrive function allows automatic upshift and downshift operation in all gears.

Controls and features

Deactivating overdrive

Press the transmission control switch (TCS) on the end of the gearshift lever. The Transmission Control Indicator Light (TCIL) (the word "OFF" on the gearshift lever) will illuminate. The transmission will only operate in gears one through three.

Deactivate overdrive when:

- driving with a heavy load
- driving in hilly terrain
- additional engine braking is desired

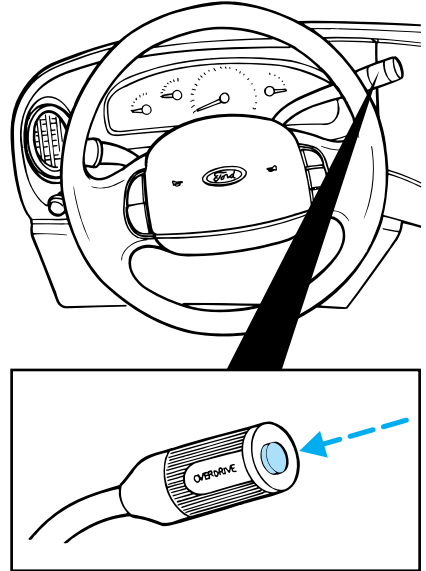

Activating overdrive

To return to normal overdrive operation, press the TCS again. The light illuminating the word "OFF" will turn off.

When restarting your vehicle, the transmission will automatically return to the normal overdrive operation mode.

Controls and features

Transmission control indicator light (TCIL)

The TCIL (the word “OFF”) located on the gearshift lever indicates the status of the transmission.

The TCIL may flash steady if a malfunction is detected. If this occurs have your transmission serviced by your Ford dealer as soon as possible or damage may occur.



Tilt steering

Pull the control to adjust the steering column angle. Push the control back up to lock the steering wheel into position.



Never adjust the steering wheel when the vehicle is moving.

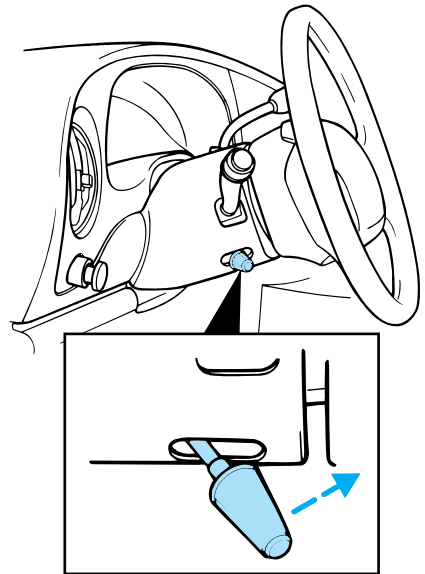

Controls and features

Hazard flasher control

For more information on the hazard flasher control, refer to the *Roadside emergencies* chapter.

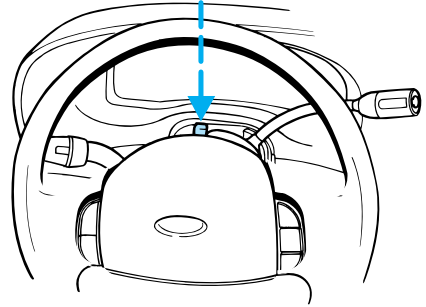

Windshield wipers and washer

- Push the end to activate the washer.
- Push end once for a single wipe.
- Push and hold for a constant cycle.

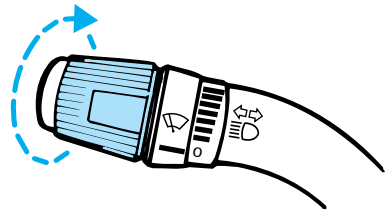
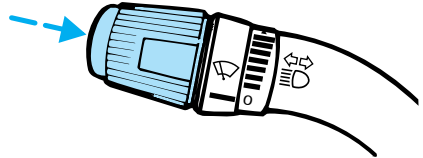

- Turn the dial to adjust intermittent wiper speed.

Flash— to— pass

Pull toward you and release for “flash-to-pass” operation.

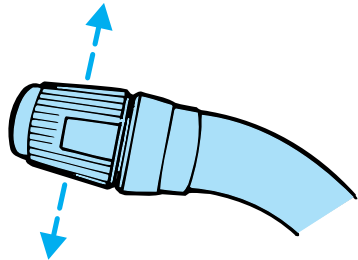

Controls and features

Speed control (if equipped)

To turn speed control on

- Press ON

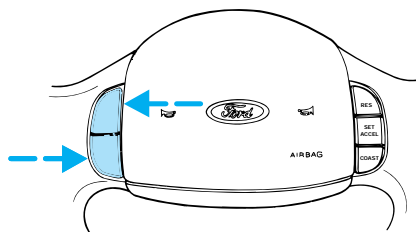

To turn speed control off

- Press OFF or
- Turn off the vehicle ignition.

Once speed control is switched off, the previously programmed set speed will be erased.

To set a speed

Press SET ACCEL. For speed control to operate, the speed control must be ON and the vehicle speed must be greater than 48 km/h (30 mph).

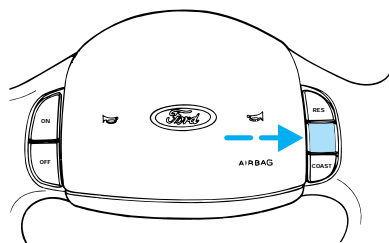

If you drive up or down a steep hill, your vehicle speed may vary momentarily slower or faster than the set speed. This is normal.

Speed control cannot reduce the vehicle speed if it increases above the set speed on a downhill. If your vehicle speed is faster than the set speed while driving on a downhill in Overdrive, you may want to shift to the next lower gear to reduce your vehicle speed.

Controls and features

If your vehicle slows down more than 16 km/h (10 mph) below your set speed on an uphill, your speed control will disengage. This is normal. Pressing RES will re-engage it.



Do not use the speed control in heavy traffic or on roads that are winding, slippery, or unpaved.

To set a higher speed

- Press and hold SET ACCEL. Release the switch when the desired vehicle speed is reached, or
- Press and release SET ACCEL. Each press will increase the set speed by 1.6 km/h (1 mph) or
- Accelerate with your accelerator pedal, then press SET ACCEL.

You may accelerate with the accelerator pedal at any time during speed control usage. Releasing the accelerator pedal will return your vehicle speed to the previously programmed set speed.

To set a lower set speed

- Press and hold COAST. Release the switch when the desired vehicle speed is reached, or
- Press and release COAST. Each press will decrease the set speed by 1.6 km/h (1 mph) or
- Depress the brake pedal. When the desired vehicle speed is reached press SET ACCEL.

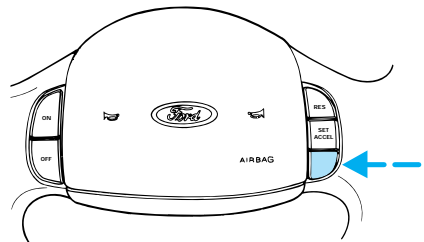
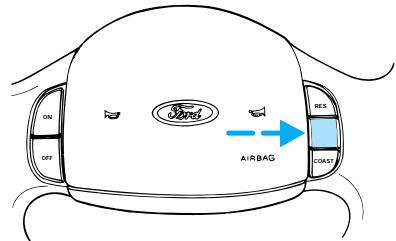

Controls and features

To disengage speed control

- Depress the brake pedal.

Disengaging the speed control will not erase the previously programmed set speed.

To return to a set speed

- Press RES. For RES to operate, the vehicle speed must be faster than 48 km/h (30 mph).

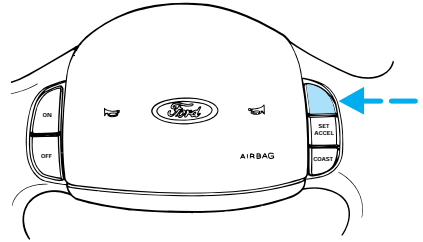

OVERHEAD CONTROLS

Cargo and dome lamps

Rear cargo lamps equipped with an ON/OFF/DOOR control will light when:

- the doors are closed and the switch is in the ON position
- either front door is open and the switch is in the DOOR position
- the headlamp control is rotated fully counterclockwise

When the cargo lamp switch is in the OFF position, it will not illuminate when you open the doors or turn the headlamp control.

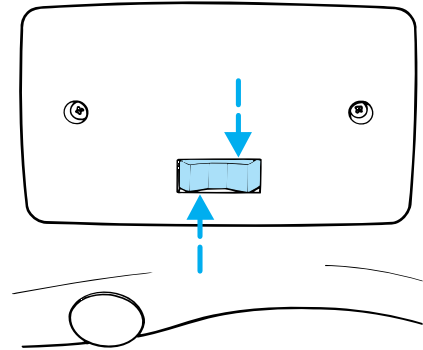

Controls and features

Courtesy/reading lamps

The courtesy/reading lamps will illuminate when:

- the lens is in the flat position and any door is open
- the lens is in the flat position and the headlamp control is rotated fully counterclockwise
- the lens is in the rotated position.

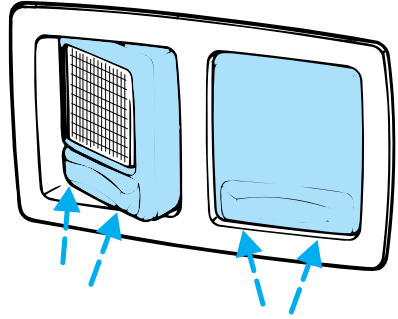

DOOR MOUNTED CONTROLS

Power outside mirrors (if equipped)

To adjust the outside mirrors:

1. Select the mirror you want to adjust:

- ◀ Driver side mirror
- ▶ Passenger side mirror

2. Move the mirror control in the desired direction.

3. Lock the mirror by moving the ◀▶ control to the center position.

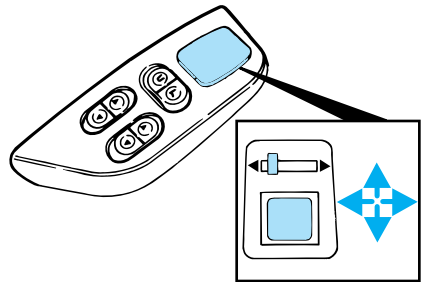

Controls and features

Power door locks (if equipped)

Push to lock or unlock the doors.

L All doors locked

U All doors unlocked

- Driver side

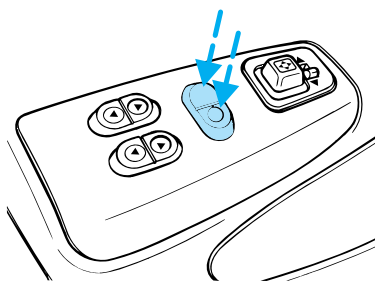

- Passenger side

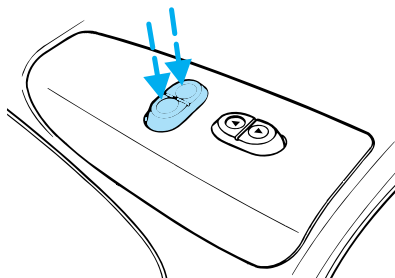

Controls and features

Power Windows (if equipped)

Driver side controls

Press the appropriate window switch to operate the power windows.

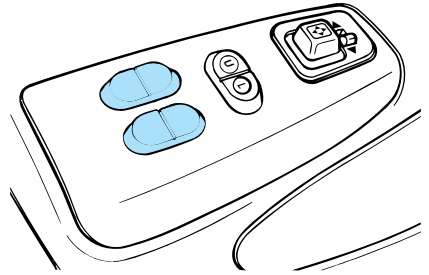

- Driver window

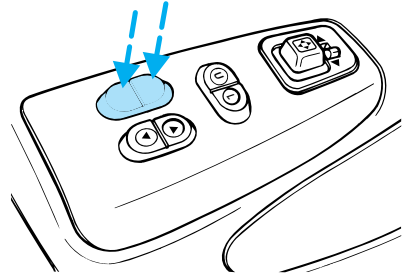

- Front passenger window

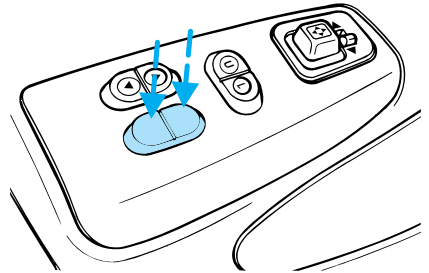

Controls and features

Passenger side controls

Press the window switch to operate the power window.

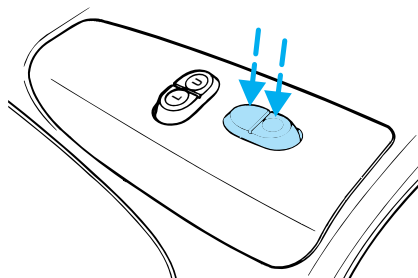

REMOTE ENTRY SYSTEM (IF EQUIPPED)

The remote entry system allows you to lock or unlock all vehicle doors without a key.

Unlocking the doors

Press UNLOCK to unlock the driver door. The interior lamps will illuminate.

Press UNLOCK a second time within five seconds to unlock all doors.

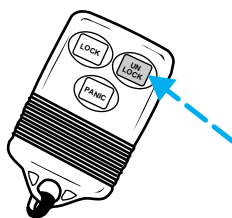

Locking the doors

Press LOCK to lock all doors.

To confirm all doors are closed and locked, press the LOCK button a second time within five seconds. The doors will lock again, the horn will chirp and the lamps will flash.

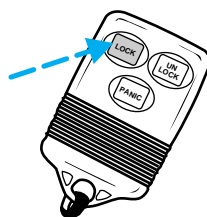

Controls and features

Sounding a panic alarm

Press the PANIC control to activate the alarm.

To deactivate the alarm, press the PANIC control again or turn the ignition to the ACC or ON position.

This device complies with part 15 of the FCC rules. Operation is subject to the following two conditions: (1) This device may not cause harmful interference, and (2) This device must accept any interference received, including interference that may cause undesired operation.

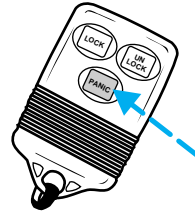

Replacing the batteries

The transmitter is powered by two coin type three-volt lithium batteries. A decrease in operating range can be caused by:

- battery failure
- weather conditions
- structures around the vehicle

To replace the batteries:

1. Twist a thin coin between the two halves of the transmitter. **DO NOT TAKE THE FRONT PART OF THE TRANSMITTER APART.**
2. Place the positive (+) side of new batteries down.
3. Snap the two halves back together.

Controls and features

Replacing lost transmitters

Take all your vehicle's transmitters to your dealer for reprogramming if:

- a transmitter is lost or
- you want to purchase additional transmitters (up to four may be programmed).

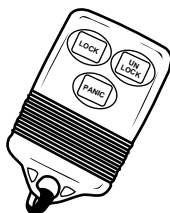

Illuminated entry system

The interior lamps illuminate when:

- either front door handle is lifted or
- the remote entry system is used to unlock the door or sound the personal alarm.

The system automatically turns off after 25 seconds or when the ignition is turned to the START or ACC position.

The inside lights will not turn off if:

- they have been turned on with the dimmer control or
- any door is open.

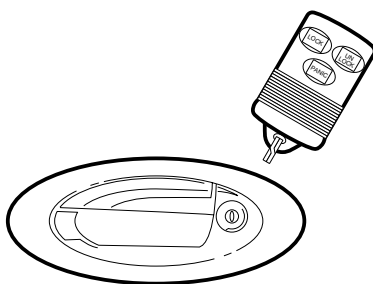

Seating and safety restraints

SEATS

Front seats

Adjusting manual seats

Lift the adjustment control to move the seat forward or backward.

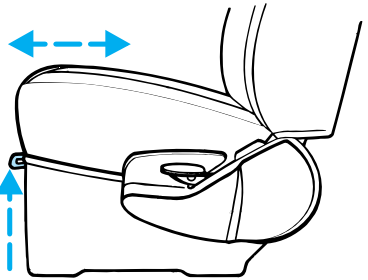

Pull the control up to recline the seat

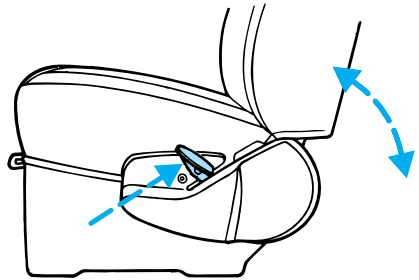

Never adjust the driver's seat or seatback when the vehicle is moving.



Do not pile cargo higher than the seatbacks to avoid injuring people in a collision or sudden stop.



Always drive and ride with your seatback upright and the lap belt snug and low across the hips.

Seating and safety restraints

Adjusting power seats

Pull the control up to recline the seat

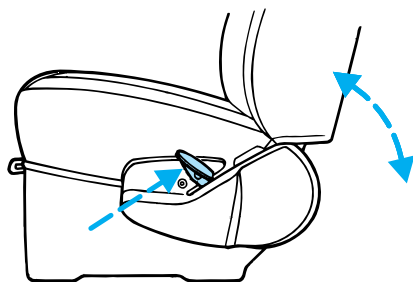

Move the control in the direction you want the seat to move.

- Forward to move seat forward
- Rearward to move seat rearward
- Up to raise the seat
- Down to lower the seat

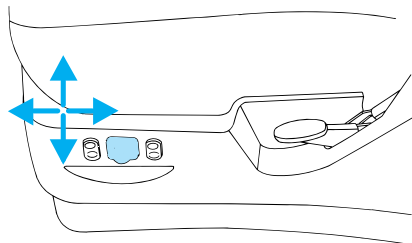

Push the control to tilt the front of the seat up or down.

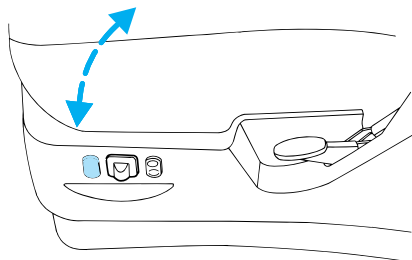

Push the control to tilt the rear of the seat up or down.

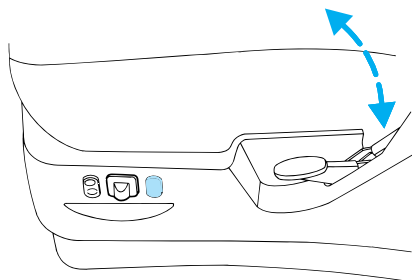

Seating and safety restraints

Lumbar support (if equipped)

Rotate the control on the seat to increase or decrease the lumbar support.

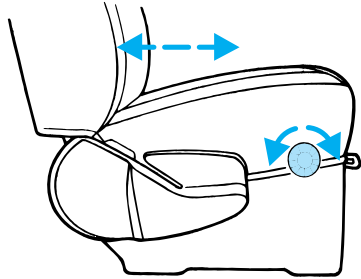

Rear bench seat

To remove the seats:

1. Disengage the lap/shoulder belt from the seat by inserting a key or small screwdriver into the slot in

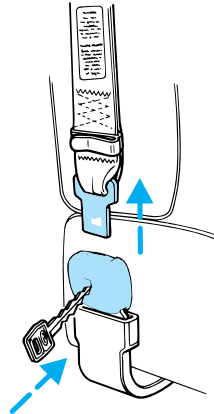

Seating and safety restraints

the detachable anchor and lifting upward.

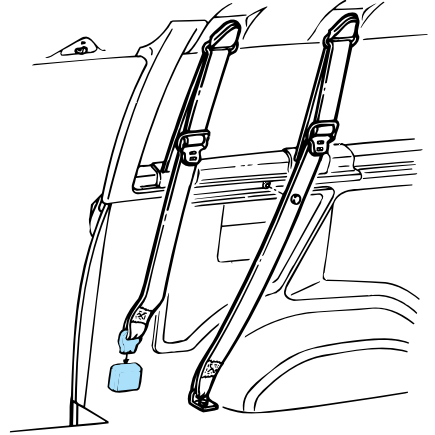

Stow the tongue end of the detachable anchor.

2. Lift and rotate the LH/RH seat latch handles rearward.
3. Lift the LH/RH latch rod hook ends out of the locking holes in the front strikers.
4. Move the seat rearward and lift the seats rear hooks away from the rear strikers prior to lifting the front hooks out from the front strikers.
5. Remove the seat assembly.

To install the seat:

1. Position the seat in the vehicle.
2. Align front hooks to front strikers, prior to lowering the rear hooks and aligning them with the rear strikers.

Seating and safety restraints

3. Engage the LH/RH latch rod hook ends in the front striker locking holes.
4. Rotate the LH/RH latch handles forward, and at the same time slide the seat assembly forward to engage the strikers. Continue forward movement until the seat reaches the end of its travel.
5. Make sure the safety belt is not twisted, then insert the seat belt tongue into detachable anchor until you hear a “click” and feel the latch engage.



Always latch the vehicle seat to the floor, whether the seat is occupied or empty. If not latched, the seat may cause injury during a sudden stop.

Quick release captains chair

To remove the seats:

1. Disengage the lap/shoulder belt from the seat by inserting a key or small screwdriver into the slot in

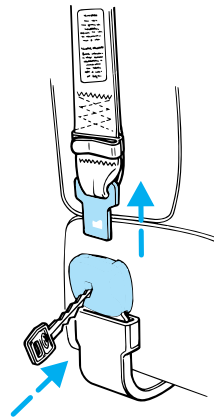

Seating and safety restraints

the detachable anchor and lifting upward.

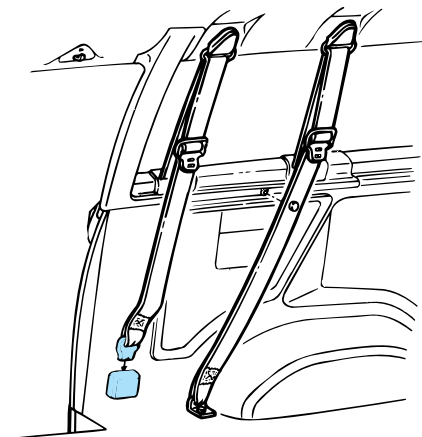

Stow the tongue end of the detachable anchor.

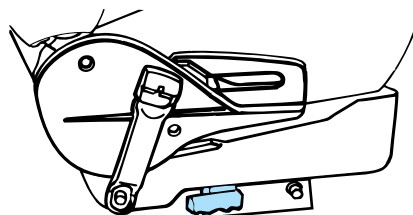

2. Pull the seat latch handle, then pull the seat toward the right side of the vehicle to disengage four pins from the floor mount.

3. Remove the seat.

Seating and safety restraints

To install the seats:

1. Position the seat to the floor mount.
2. Engage the four pins into the floor mount hole and push the seat toward the left side of the vehicle to fully engage.

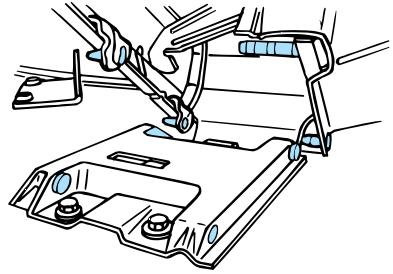

3. Pull the seat latch handle downward to lock the seat in position.
4. Make sure the safety belt is not twisted, then insert the seat belt tongue into detachable anchor until you hear a “click” and feel the latch engage.



Check to see that the seat and seatback is latched securely in position. Keep floor area free of objects that would prevent proper seat engagement. Never attempt to adjust the seat while the vehicle is in motion.

SAFETY RESTRAINTS

Safety restraints precautions



Always drive and ride with your seatback upright and the lap belt snug and low across the hips.

Seating and safety restraints



To prevent the risk of injury, make sure children sit where they can be properly restrained.



Never let a passenger hold a child on his or her lap while the vehicle is moving. The passenger cannot protect the child from injury in a collision.



It is extremely dangerous to ride in a cargo area, inside or outside of a vehicle. In a collision, people riding in these areas are more likely to be seriously injured or killed. Do not allow people to ride in any area of your vehicle that is not equipped with seats and safety belts. Be sure everyone in your vehicle is in a seat and using a safety belt properly.



Each seating position in your vehicle has a specific safety belt assembly which is made up of one buckle and one tongue that are designed to be used as a pair. 1) Use the shoulder belt on the outside shoulder only. Never wear the shoulder belt under the arm. 2) Never swing it around your neck over the inside shoulder. 3) Never use a single belt for more than one person.

Seating and safety restraints

Safety belt buckle pretensioner

Your vehicle is equipped with safety belt buckle pretensioners at the driver and front passenger seating positions.

The safety belt buckle pretensioner is a device which removes excess webbing from the safety belt system. The safety belt buckle pretensioner uses the same crash sensor system as the air bag supplemental restraint system (SRS). When the safety belt buckle pretensioner deploys, the buckle moves downward, pulling excess webbing from the lap and shoulder safety belt.

Combination lap and shoulder belts

To fasten the safety belt, insert the tongue into the slot in the buckle.

To disconnect the safety belt at:

- front seating positions, push the red release button on the end of

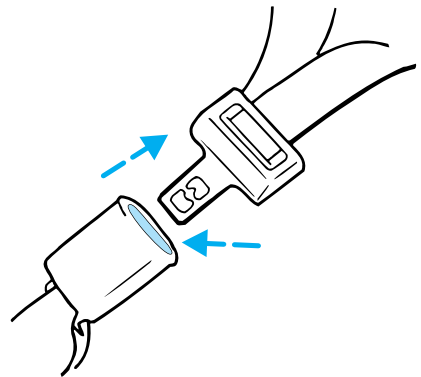

Seating and safety restraints

the buckle and remove the tongue from the buckle.

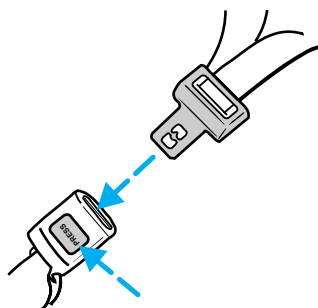

- rear seating positions, push the red release button on the side of the buckle and remove the tongue from the buckle.



The lap belts should fit snugly and as low as possible around the hips, not around the waist.

The outboard safety restraints in the vehicle are combination lap and shoulder belts. The front passenger and rear outboard seating positions safety belts have two types of locking modes.

Seating and safety restraints

Vehicle sensitive (emergency) locking mode

In this mode, the shoulder belt will allow freedom of movement, locking tight only on hard braking, hard cornering or impacts of approximately 8 km/h (5 mph) or more. The front seat belts can also be made to lock by jerking on the belt.

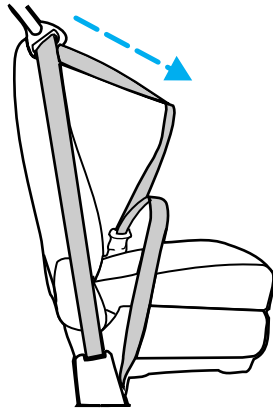

Automatic locking mode

In this mode, the safety belt is locked in a certain position by the occupant and remains locked until the webbing is fully retracted.

The automatic locking mode is not available on the driver belt.

When to use the automatic locking mode

- When a tight lap/shoulder fit is desired.
- **Any time** a child safety seat is installed in the vehicle. Refer to *Children and infant or Child safety seats* later in this section.

Seating and safety restraints

Using the automatic locking mode

1. Buckle the combination lap and shoulder belt.

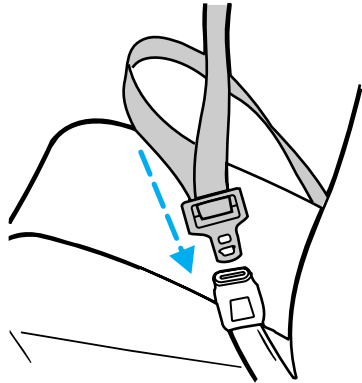

2. Grasp the shoulder portion and pull downward until the entire belt is extracted.

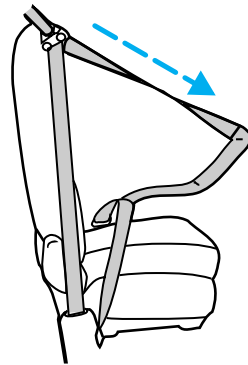

3. Allow the belt to retract. As the belt retracts, you will hear a clicking sound. This indicates the safety belt is now in the automatic locking mode.

Seating and safety restraints

Canceling the automatic locking mode

Disconnect the combination lap/shoulder belt and allow it to retract completely to cancel the automatic locking mode and activate the vehicle sensitive (emergency) locking mode.

Front safety belt height adjustment

Your vehicle has safety belt height adjustments for the driver and front passenger. Adjust the height of the shoulder belt so the belt rests across the middle of your shoulder.

To lower the height of the shoulder belt:

1. Push the button down
2. Slide down

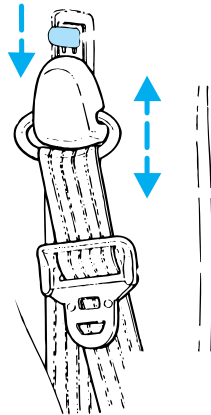

To raise the height of the shoulder belt:

1. Slide up
2. Pull down on the height adjustment assembly to make sure it is locked in place

Seating and safety restraints

Lap belts

The lap belts in the center seating position of the three-passenger bench seat and both inboard seats of the four-passenger bench seat do not adjust automatically. You must adjust them to fit snugly and low as possible around your hips. Do not wear the lap belt around your waist.

Make sure you insert the tongue into the correct buckle. If you need to lengthen the belt, turn the tongue at a right angle to the belt and pull across your lap until it reaches the buckle. If you need to tighten the belt, pull the loose end of the webbing until it is snug across the hips. Shorten and fasten the belt when not in use.

Safety belt extension assembly

If the safety belt assembly is too short, even when fully extended, 20 cm (eight inches) can be added to the safety belt assembly by adding a safety belt extension assembly. Safety belt extension assemblies are available for front or rear seating positions and are not interchangeable.

- Front seating positions (part number 611C22)
- Rear seating positions (part number 611C22)

Safety belt extension assemblies can be obtained from your dealer at no cost.

Seating and safety restraints

Use only extensions manufactured by the same supplier as the safety belt. Manufacturer identification is located at the end of the webbing on the label. Also, use the safety belt extension only if the safety belt is too short for you when fully extended. Do not use extension to change the fit of the shoulder belt across the torso.

Safety belt indicator light and warning chime

The seat belt warning light illuminates in the instrument cluster and a chime sounds to remind the occupants to fasten their safety belts.

Conditions of operation

If...	Then...
The driver's safety belt is not buckled before the ignition key is turned to ON...	The safety belt indicator illuminates and the warning chime/buzzer sounds for four to eight seconds.
The driver's side safety belt is buckled while the indicator light is illuminated and the warning chime is sounding...	The safety belt warning chime turns off.
The driver's safety belt is buckled before the ignition key is turned to ON...	The safety belt indicator chime/buzzer remains off.

Safety belt inspection after a collision, maintenance and care

Check the safety belt system periodically to make sure that it works properly and is not damaged. Check the safety belts to

Seating and safety restraints

make sure there are no nicks, wears or cuts.

All safety belt assemblies, including retractors, buckles, front seat belt buckle support assemblies (slide bar) (if so equipped), shoulder belt height adjusters (if so equipped), child safety seat tether bracket assemblies (if so equipped) and attaching hardware, should be inspected after any collision. Ford recommends that all safety belt assemblies used in vehicles involved in a collision be replaced. However, if the collision was minor and a qualified technician finds that the belts do not show damage and continue to operate properly, they do not need to be replaced. Safety belt assemblies not in use during a collision should also be inspected and replaced if either damage or improper operation is noted.

AIR BAG SUPPLEMENTAL RESTRAINT SYSTEM (SRS)

Important air bag precautions and warnings

Your vehicle is equipped with a supplemental restraint system designed to work with the safety belts to help protect you and your right front passenger in the event of certain collisions described in the section *How does the air bag supplemental restraint system work?*

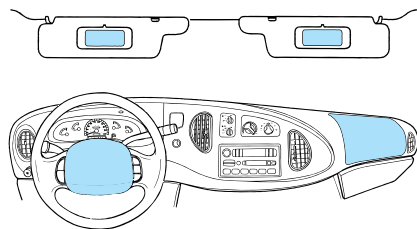

Seating and safety restraints



All occupants of the vehicle, including the driver, should always wear their safety belts, failure to do so may increase the risk of personal injury in the event of a collision.



The right front passenger air bag is not designed to restrain occupants in the center front seating position.



Do not place objects or mount equipment on or near the dashboard area, steering wheel or in front of the passenger that may come in contact with a deploying air bag. Failure to follow this instruction may increase the risk of personal injury in the event of a collision.



Do not attempt to service, repair, or modify the Air Bag Supplemental Restraint System or its fuses. See your Ford or Lincoln-Mercury dealer.





If you are close to an inflating air bag, it could seriously injure you. Sit against the seatback and position your seat such that it is as far back from the steering wheel as possible but still allows you to properly control the vehicle.

Seating and safety restraints

Children and air bags

 Children should be placed in the rear in an appropriate child safety seat that is properly secured to the vehicle.

 Children should always wear their safety belts. Failure to follow this instruction may increase the risk of personal injury in the event of a collision.

 Rear-facing infant seats **MUST** always be secured in the rear seat. In vehicles without a rear seat, a rear-facing infant seat should be secured in the front seat **ONLY** if your vehicle does not have a passenger side air bag or your vehicle is equipped with a passenger air bag deactivate switch and the switch is turned to "OFF."

 When using forward-facing child safety seats in vehicles with only two seating positions so the forward-facing child safety seat cannot be placed in the rear of the vehicle, move the passenger seat as far back from the instrument panel as possible. Never secure rear-facing infant seats in the front seat.

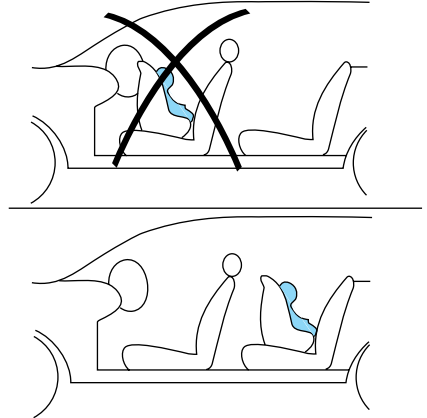

Seating and safety restraints

For additional important safety information on the proper use of seat belts, child seats and infant seats, please read the entire *Seating and safety restraints* chapter in this owner's guide.

How does the air bag supplemental restraint system work?

The Air Bag Supplemental Restraint System is designed to activate when the vehicle sustains sufficient longitudinal (lengthwise) deceleration that is equal to or greater than hitting an immovable barrier head on at a range of about 12–24 km/h (8–14 mph).

The fact that the air bags did not inflate in a collision does not mean that something is wrong with the system. Rather, it means the forces were not of the type sufficient to cause activation.

If the vehicle experiences sufficient longitudinal deceleration, the system is activated and the air bags inflate rapidly. After the air bag inflates, it will quickly deflate. This occurs so quickly that some people may not even realize that the air bag inflated.

After the air bag deployment, you may notice a smoke-like, powdery residue or smell the burnt propellant (which is used to lubricate the air bag) or sodium compounds, such as sodium carbonates (e.g., baking soda) that result from the combustion process

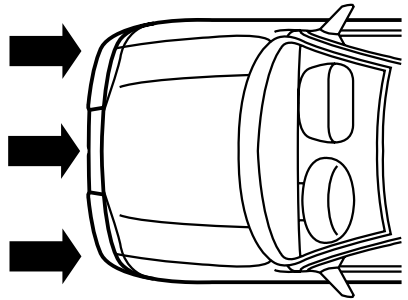

Seating and safety restraints

that inflates the air bag. Small amounts of sodium hydroxide may be present which may irritate the skin and eyes, but none of the residue is toxic.

The Air Bag Supplemental Restraint System will reduce, but not eliminate all injuries in an accident.



Several air bag system components get hot after inflation. Do not try to touch them after inflation.



The air bag will only inflate once and the pretensioners (if equipped) will only activate once. The system is designed to function on a one-time-only basis. If the air bag is inflated, **THE AIR BAG WILL NOT FUNCTION AGAIN AND MUST BE REPLACED IMMEDIATELY.** If the pretensioners activate (if equipped), **THE PRETENSIONERS WILL NOT FUNCTION AGAIN AND MUST BE REPLACED IMMEDIATELY.** If the pretensioners are not replaced, this will increase the risk of injury in a subsequent collision.

The SRS consists of:

- driver and passenger air bag modules (which include the inflators and air bags),

Seating and safety restraints

- one or more impact and safing sensors,
- a readiness light and tone,
- driver and front passenger safety belt buckle pretensioners
- and the electrical wiring which connects the components.

The diagnostic module monitors its own internal circuits and the supplemental air bag electrical system readiness (including the impact sensors), the system wiring, the air bag system readiness light, the air bag back up power and the air bag ignitors.

Determining if the system is operational

The SRS uses a readiness light in the instrument cluster or a tone to indicate the condition of the system. Refer to the *Air bag readiness* section in the *Instrumentation* chapter. Routine maintenance of the air bag is not required.

A difficulty with the system is indicated by one or more of the following:

- The readiness light will either flash or stay lit.
- The readiness light will not illuminate immediately after ignition is turned on.
- A group of five beeps will be heard. The tone pattern will repeat periodically until the problem and light are repaired.



Seating and safety restraints

If any of these things happen, even intermittently, have the SRS serviced at your dealership or by a qualified technician immediately. Unless serviced, the system may not function properly in the event of a collision.

Disposal of air bags and air bag equipped vehicles

For disposal of air bags or air bag equipped vehicles, see your local dealership or qualified technician. Air bags **MUST BE** disposed of by qualified personnel.

SAFETY RESTRAINTS FOR CHILDREN

Important child restraint precautions

You are required by law to use safety restraints for children in the U.S. and Canada. If small children ride in your vehicle (generally children who are four years old or younger and who weigh 18 kg [40 lbs] or less), you must put them in safety seats made especially for children. Check your local and state laws for specific requirements regarding the safety of children in your vehicle.



Never let a passenger hold a child on his or her lap while the vehicle is moving. The passenger cannot protect the child from injury in a collision.

Seating and safety restraints

Always follow the instructions and warnings that come with any infant or child restraint you might use.

Children should be placed in the rear seat of your vehicle. Accident statistics suggest that children are safer when properly restrained in the rear seating positions than in the front seating position.

Install forward-facing convertible safety seats only in vehicle seating positions equipped with lap-shoulder belts. Forward facing convertible safety seats can be used in the center of the three-passenger second row bench seat only if a top tether strap is used. Ford recommends placing forward-facing safety seats in the second row and using safety seats with top tether straps for added protection. For more information on top tether straps see *attaching safety seats with tether straps* in this section.

Any booster seat that places the vehicle's lap belt or shoulder belt around a shield above and ahead of the child's hips should not be used in this vehicle.



Do not use a forward-facing safety seat or an infant seat in the last row of a 12- or 15-passenger Club Wagon.

Seating and safety restraints

Children and safety belts

Children who are too large for child safety seats (as specified by your child safety seat manufacturer) should always wear safety belts.

Follow all the important safety restraint and air bag precautions that apply to adult passengers in your vehicle.

If the shoulder belt portion of a combination lap and shoulder belt can be positioned so it does not cross or rest in front of the child's face or neck, the child should wear the lap and shoulder belt. Moving the child closer to the center of the vehicle may help provide a good shoulder belt fit.

To improve the fit of lap and shoulder belts on children who have outgrown child safety seats, Ford recommends use of a belt-positioning booster seat that is labelled as conforming to all Federal motor vehicle safety standards. Belt-positioning booster seats raise the child and provide a shorter, firmer seating cushion that encourages safer seating posture and better fit of lap and shoulder belts on the child. A belt-positioning booster should be used if the shoulder belt rests in front of the child's face or neck, or if the lap belt does not fit snugly on both thighs, or if the thighs are too short to let the child sit all the way back on the seat cushion when the lower legs hang over the

Seating and safety restraints

edge of the seat cushion. You may wish to discuss the special needs of your child with your pediatrician.

Child and infant or child safety seats



Carefully follow all of the manufacturer's instructions included with the safety seat you put in your vehicle. If you do not install and use the safety seat properly, the child may be injured in a sudden stop or collision.

Ford recommends the use of a child safety seat having a top tether strap. Install the child safety seat in a seating position which is capable of providing a tether anchorage. For more information on top tether straps see *Attaching safety seats with tether straps* in this chapter.

When installing a child safety seat:

- Use the correct safety belt buckle for that seating position.
- Make sure the tongue is securely fastened in the buckle.
- Keep the buckle release button pointing up and away from the safety seat, with the tongue between the child seat and the release button, to prevent accidental unbuckling.
- Place seatbacks in the upright position.

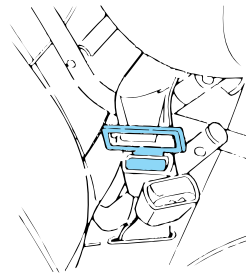

Seating and safety restraints

- Put the safety belt in the automatic locking mode. Refer to *Using the automatic locking mode* in this chapter.

Installing child safety seats in combination lap and shoulder belt seating positions

1. Position the child safety seat in a seat with a combination lap and shoulder belt.

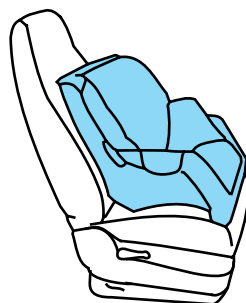

If you choose to install a child safety seat in the front passenger seat, move the seat as far back as possible.

Seating and safety restraints



Rear-facing child seats or infant carriers should never be placed in the front seats.

2. Pull down on the shoulder belt and then grasp the shoulder belt and lap belt together.

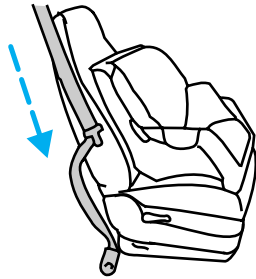

3. While holding the shoulder and lap belt portions together, route the tongue through the child seat according to the child seat manufacturers' instructions. Be

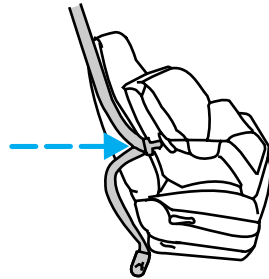

Seating and safety restraints

sure the belt webbing is not twisted.

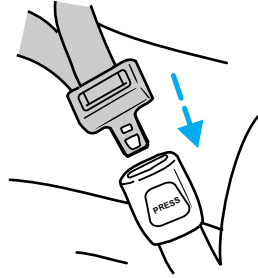

4. Insert the belt tongue into the proper buckle for that seating position until you hear and feel the latch engage. Make sure the tongue is latched securely by pulling on it.

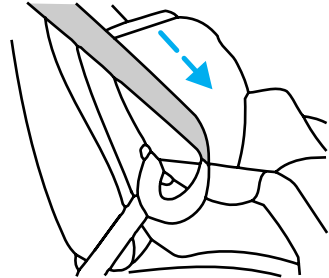

5. To put the retractor in the automatic locking mode, grasp the shoulder portion of the belt and

Seating and safety restraints

pull downward until all of the belt is extracted and a click is heard.

6. Allow the belt to retract. The belt will click as it retracts to indicate it is in the automatic locking mode.

7. Pull the lap belt portion across the child seat toward the buckle and pull up on the shoulder belt while pushing down with knee on the child seat.

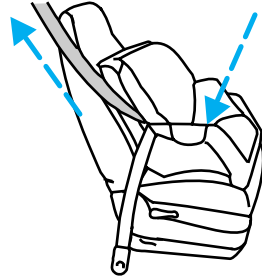

8. Allow the safety belt to retract to remove any slack in the belt.

9. Before placing the child in the seat, forcibly tilt the seat forward and back to make sure the seat is securely held in place.

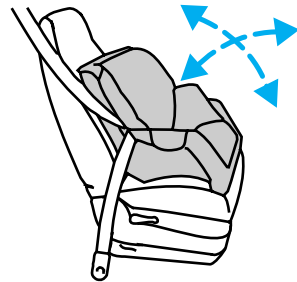

10. Try to pull the belt out of the retractor to make sure the retractor is in the automatic locking mode (you should not be

Seating and safety restraints

able to pull more belt out). If the retractor is not locked, unbuckle the belt and repeat steps two through nine.

Check to make sure the child seat is properly secured before each use.

Installing a child safety seat at the rear center seating position with locking adjustable lap belt

1. Lengthen the lap belt. To lengthen the belt, hold tongue so that its bottom is perpendicular to the direction of webbing while sliding the tongue up the webbing.
2. Place the child safety seat in the center seating position.
3. Route the tongue and webbing through the child seat according to the child seat manufacturer's instructions.
4. Insert the belt tongue into the proper buckle for the center seating position until you hear a snap and feel it latch. Make sure the tongue is securely fastened to the buckle by pulling on tongue.
5. Push down on the child seat while pulling on the loose end of the lap belt webbing to tighten the belt.
6. Before placing the child into child seat, forcibly tilt the child seat from side-to-side and in forward directions to ensure that the seat is held securely in place. If the child seat moves excessively,

Seating and safety restraints

repeat steps 5 and 6, or properly install the child seat in a different seating position.

Attaching safety seats with tether straps

Some manufacturers make safety seats that include a tether strap that goes over the back of the vehicle seat and attaches to an anchoring point. Other manufacturers offer the tether strap as an accessory. Contact the manufacturer of your child safety seat for information about ordering a tether strap.

Tether anchorage



Children should be placed in the rear in an appropriate child safety seat that is properly secured to the vehicle.



Rear-facing infant seats must always be secured in the rear seat. In vehicles without a rear seat, a rear-facing infant seat should be secured in the front seat only if your vehicle does not have a passenger side air bag or your vehicle is equipped with a passenger air bag deactivate switch and the switch is turned to "OFF."

Seating and safety restraints

 When using forward-facing child safety seats in vehicles with only two seating positions so the forward-facing child safety seat cannot be placed in the rear of the vehicle, move the passenger seat as far back from the instrument panel as possible.

Front passenger seating position

The front passenger seating position does not require any tether hardware. The tether can be attached directly to the rear of the front seat.

1. Position the child safety seat on the front right-hand passenger seat.
2. Adjust the front right-hand

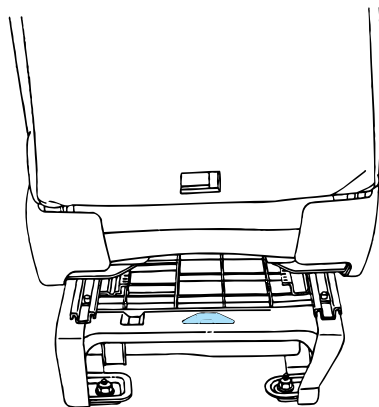

Seating and safety restraints

passenger seat full forward.

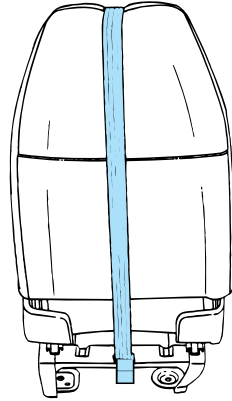

3. Route the child safety seat tether strap over the back of the front right-hand passenger seat as shown.

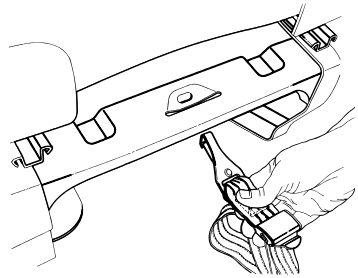

4. Grasp the tether strap and position it to the seat pedestal as shown.

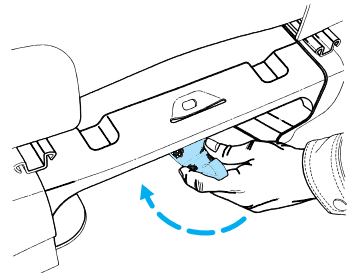

Seating and safety restraints

5. Rotate the tether strap as shown.

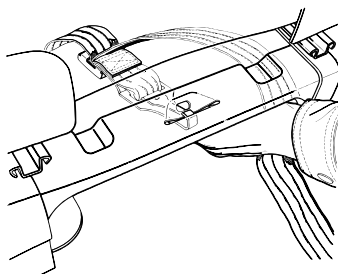

6. Clip the tether strap to the seat pedestal as shown.

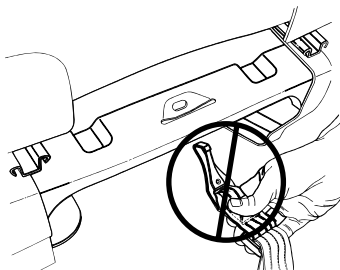

Do not clip the tether strap to the seat pedestal as shown.

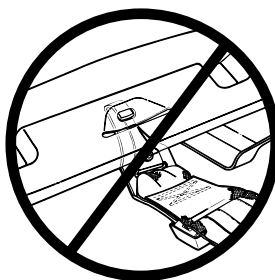

If the tether strap is clipped incorrectly (as shown) the child safety seat may not be retained

Seating and safety restraints

properly in the event of a collision.

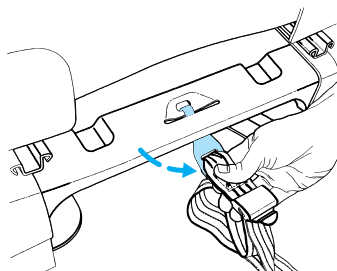

7. Rotate the tether strap clip as shown.

8. Adjust the front right-hand passenger seat to the full rearward position.

9. Refer to the instructions in this section under *Installing child safety seats in combination lap and shoulder belt seating positions* to secure the child safety seat.

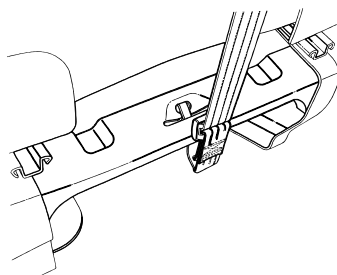

10. Tighten the child safety seat tether strap according to the manufacturers instructions.

For additional important safety information on the proper use of seatbelts, child seats and infant seats, please read the entire *Seating and safety restraints* chapter in this owner's guide.

Seating and safety restraints

Rear seating positions

Attachment holes have been provided in your vehicle to attach anchor hardware, if required. Tether anchor hardware kits (Part No. 613D74) including instructions, may be obtained at no charge from any Ford dealer.

- Second row bucket seats (at rear of lower seat frame)
- 3-passenger bench seat (on rear rail of seat cushion frame)

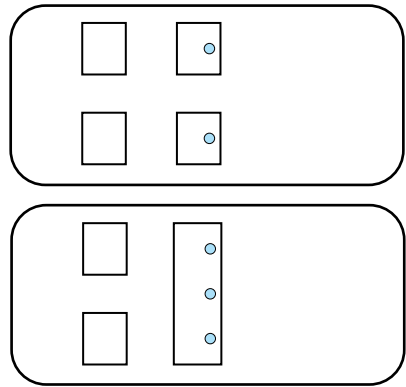

STARTING YOUR VEHICLE

Important safety precautions

A computer system controls the engine's idle revolutions per minute (RPM). When the engine starts, the idle RPM runs faster to warm the engine. If the engine idle speed does not slow down automatically, have the vehicle checked. Do not allow the vehicle to idle for more than ten minutes.



Extended idling at high engine speeds can produce very high temperatures in the engine and exhaust system, creating the risk of fire or other damage.



Do not park, idle, or drive your vehicle in dry grass or other dry ground cover. The emission system heats up the engine compartment and exhaust system, which can start a fire.



Do not start your vehicle in a closed garage or in other enclosed areas. Exhaust fumes can be toxic. Always open the garage door before you start the engine. See *Guarding against exhaust fumes* in this chapter for more instructions.

Starting



If you smell exhaust fumes inside your vehicle, have your dealer inspect your vehicle immediately. Do not drive if you smell exhaust fumes.

Preparing to start the vehicle

Engine starting is controlled by the spark ignition system. This system meets all Canadian Interference-Causing Equipment standard requirements regulating the impulse electrical field strength of radio noise.

When starting a fuel-injected engine, avoid pressing the accelerator before or during starting. Only use the accelerator when you have difficulty starting the engine. For more information on starting the vehicle, refer to *Starting the vehicle* in this chapter.

Before starting the vehicle:

1. Make sure all vehicle occupants have buckled their safety belts. For more information on safety belts and their proper usage, refer to

Starting

the *Seating and safety restraints* chapter.

2. Make sure the headlamps and vehicle accessories are off.

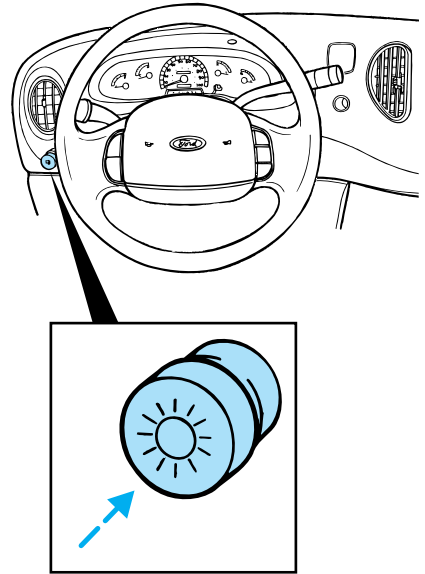

Starting

- Make sure the parking brake is set.

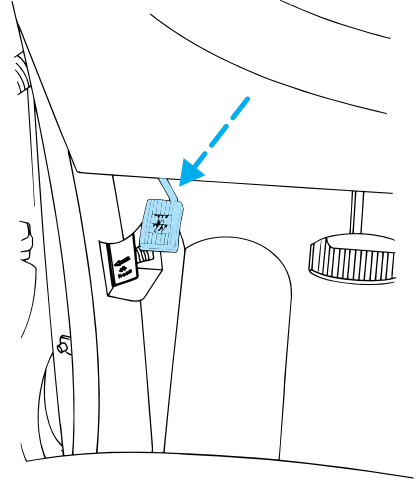

- Make sure the gearshift is in P.



3. Turn the key to the ON position (without turning the key to START.)

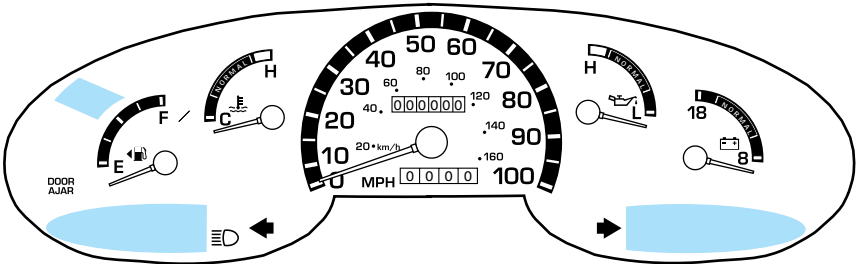

Make sure the corresponding lights illuminate briefly. If a light fails to illuminate, have the vehicle serviced.

- If the driver's safety belt is fastened, the  light does not illuminate.

STARTING PROCEDURE

Starting the engine

1. Turn the key to 5 (Start) without pressing the accelerator. The key will return to 4 (On).

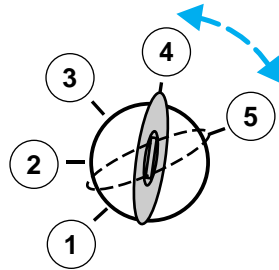

2. If the engine does not start within five seconds, wait ten seconds and try again.
3. If the engine does not start in two attempts OR the temperature is below -12°C (10°F), depress accelerator and start the engine while holding the accelerator down. Release accelerator when engine starts.
4. After idling for a few seconds, apply the brake and release the parking brake.

Using the engine block heater (if equipped)

An engine block heater warms the engine coolant, which improves starting, warms up the engine

Starting

faster and allows the heater-defroster system to respond quickly. They are strongly recommended if you live in a region where temperatures reach -23°C (-10°F) or below.

For best results, plug the heater in at least three hours before starting the vehicle. Using the heater for longer than three hours will not harm the engine, so the heater can be plugged in the night before starting the vehicle.



To prevent electrical shock, do not use your heater with ungrounded electrical systems or two-pronged (cheater) adapters.

Guarding against exhaust fumes

Although odorless and colorless, carbon monoxide is present in exhaust fumes. Take precautions to avoid its dangerous effects.



If you ever smell exhaust fumes of any kind inside your vehicle, have your dealer inspect and fix your vehicle immediately. Do not drive if you smell exhaust fumes. These fumes are harmful and could kill you.

Have the exhaust and body ventilation systems checked whenever:

- the vehicle is raised for service

- the sound of the exhaust system changes
- the vehicle has been damaged in a collision

Important ventilating information

If the engine is idling while the vehicle is stopped in a closed area for long periods of time, open the windows at least 2.5 cm (1 in).

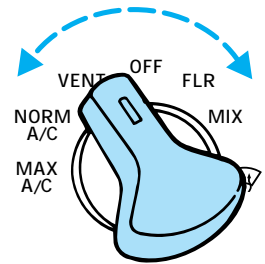

Adjust the heating or air conditioning (if equipped) to bring in fresh air.

Improve vehicle ventilation by keeping all air inlet vents clear of snow, leaves and other debris.

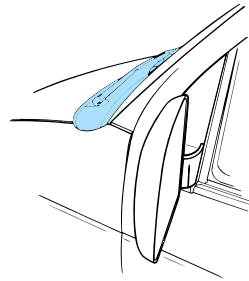

Driving

BRAKES

Your brakes are self-adjusting. Refer to the “Service Guide” for maintenance scheduling.

Anti-lock brake system (ABS) (if equipped)

The ABS operates by detecting the onset of wheel lock up during brake applications and compensating for this tendency. The front wheels are prevented from locking even when the brakes are firmly applied. The accompanying illustration depicts the advantage of an ABS equipped vehicle (on bottom) to a non-ABS equipped vehicle (on top) during hard braking.

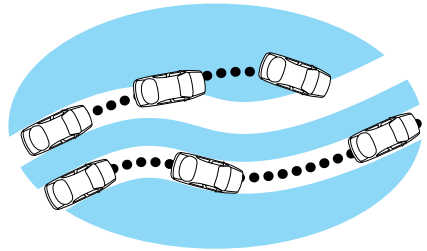

Using ABS

- In an emergency, apply full force on the brake. The ABS will be activated immediately, thus allowing you to retain full steering control of your vehicle and, providing there is sufficient space, will enable you to avoid obstacles and bring the vehicle to a quiet stop.
- We recommend that you familiarize yourself with this braking technique. However, avoid taking any unnecessary risks.

Parking brake

The parking brake should be used whenever you park your vehicle. It is not designed to stop a moving

vehicle. However, if the normal brakes fail, the parking brake can be used to stop your vehicle in an emergency. Since the parking brake applies only the rear brakes, the vehicle's stopping distance will increase greatly and the handling of your vehicle will be adversely affected.

Setting the parking brake

The brake light in the instrument cluster will illuminate and remain illuminated (when the ignition switch is turned to ON) until the parking brake is released.

- Fully depress the parking brake pedal.

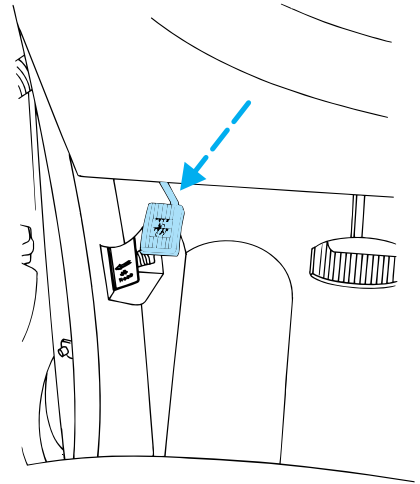

Driving

Releasing parking brake

- Push parking brake pedal down firmly, then release.

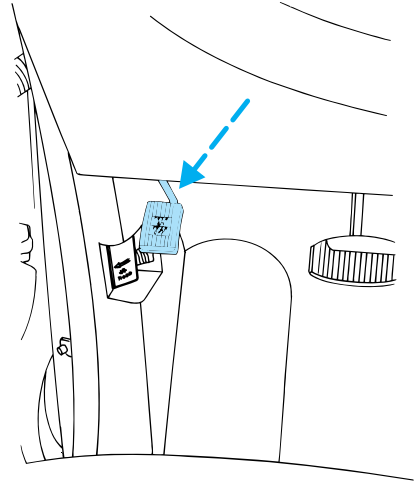

If the parking brake is fully released, but the Brake System light remains on, have the brakes checked immediately. They may not be working properly.

STEERING YOUR VEHICLE

If the amount of effort needed to steer your vehicle changes at a constant speed, have the vehicle power steering system checked.

Never hold the steering wheel to the extreme left or right for more than five seconds if the engine is running. This can damage the power steering pump.

After any severe impact or collision involving the front end, observe the steering wheel alignment. If the spoke of the

steering wheel seem to be in a different position while going straight down the road, have the suspension and steering checked for possible damage.

AUTOMATIC TRANSMISSION OPERATION

 Hold the brake pedal down while you move the gearshift lever from position to position. If you do not hold the brake pedal down, your vehicle may move unexpectedly and injure someone.

Pull the gearshift lever towards you and downward to move the automatic gearshift.

P (Park) — Always come to a complete stop before shifting into or out of P (Park).

 When you leave your vehicle, place the gearshift lever in P (Park). Set the parking brake fully, and shut off the engine. Never park your vehicle in N (Neutral). If you do not take these precautions, your vehicle may move suddenly and injure someone.

R (Reverse) — Always come to a complete stop before shifting into or out of R (Reverse).

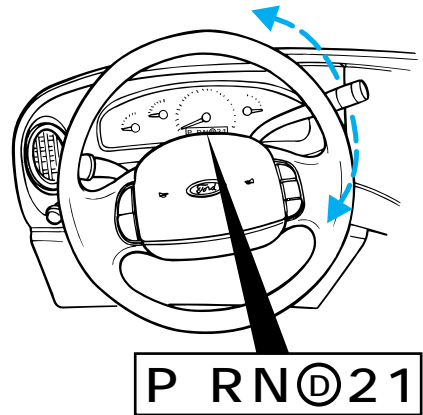

Driving

N (Neutral) — Vehicle is free to roll.

Ⓧ (**Overdrive**)— The normal driving position for the best fuel economy. Transmission operates automatically in gears one through four.

Ⓧ (Overdrive) can be deactivated by pressing the transmission control switch on the end of the gearshift lever. The transmission control indicator light (TCIL) (the word “OFF”) on the end of the gearshift lever will remain off.

D (Drive) — Not shown on the display. Activate by pressing the transmission control switch on the end of the gearshift lever. The TCIL (the word “OFF”) will illuminate on the gearshift lever.

Transmission operates in gears one through three. D (Drive) provides more engine braking than

Ⓧ (Overdrive) and is useful whenever driving conditions (i.e., city traffic, hilly terrain, etc.) cause the transmission to excessively shift between Ⓧ (Overdrive) and D (Drive).

Also deactivate Ⓧ (Overdrive) when:

- driving with a heavy load
- towing a trailer up or down steep hills
- additional engine braking is desired

To return to Ⓧ (Overdrive) mode, press the transmission control switch. The TCIL (the

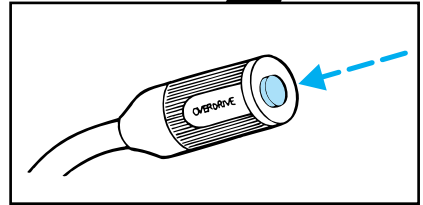
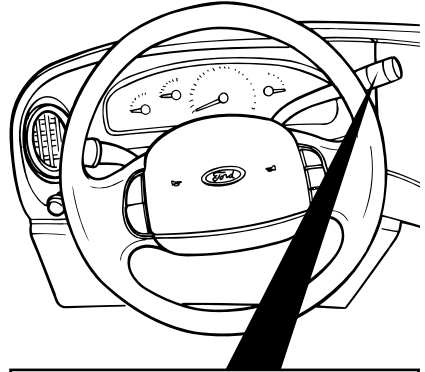

word “OFF”) will no longer be illuminated.

Each time the vehicle is started, the transmission will automatically return to normal overdrive mode and you must press the TCS to deactivate overdrive again if you do not want overdrive operation.

2 (Second) — Use 2 (Second) to start-up on slippery roads or to provide additional engine braking on downgrades. Transmission operates in first and second gears.

1 (Low) — Use 1 (Low) to provide maximum engine braking on steep downgrades. Upshifts can be made by shifting to 2 (Second) or to  (Overdrive). Selecting 1 (Low) at higher speeds causes a shift to 2 (Second), and will shift to 1 (Low) after vehicle decelerates to the proper speed.

Brake-shift interlock

The brake-shift interlock feature prevents you from shifting from P (Park) unless the brake pedal is depressed (with the ignition in the ON position). If you cannot move the gearshift out of P (Park) with the brake pedal depressed:

1. Turn ignition key to Off.
2. Apply the parking brake.
3. Turn ignition key to Lock and remove the key.
4. Re-insert the ignition key and turn it to Off.

Driving

5. Shift the transmission to N (Neutral).

6. Start the vehicle.

If you need to use the above procedure, it is possible that a fuse has blown and your brakelamps may not be functioning. Refer to the *Roadside emergencies* chapter for instructions on replacing fuses.



Do not drive your vehicle until you verify that the brakelamps are working.

VEHICLE LOADING



It is extremely dangerous to ride in a cargo area, inside or outside of a vehicle. In a collision, people riding in these areas are more likely to be seriously injured or killed. Do not allow people to ride in any area of your vehicle that is not equipped with seats and safety belts. Be sure everyone in your vehicle is in a seat and using a safety belt properly.

Before loading a vehicle, familiarize yourself with the following terms:

- **Base Curb Weight:** Weight of the vehicle including any standard equipment, fluids, lubricants, etc. It does not include passengers or aftermarket equipment.

- **Payload:** Combined maximum allowable weight of cargo, passengers and optional equipment. The payload equals Gross Vehicle Weight Rating (GVWR) minus base curb weight.
- **GVW (Gross Vehicle Weight):** Base curb weight plus the payload weight (including passengers, cargo and optional equipment. Remember, the GVW is not a limit or a specification.
- **GVWR (Gross Vehicle Weight Rating):** Maximum total weight of the base vehicle, passengers, optional equipment and cargo. The GVWR is specific to each particular vehicle and is listed on the Safety Compliance Certification Label on the driver door pillar.
- **GAWR (Gross Axle Weight Rating):** Carrying capacity for each axle system (front and rear). This amount is specific to each particular vehicle and is listed on the Safety Compliance Certification Label on the driver door pillar.
- **GCWR (Gross Combined Weight Rating):** Maximum combined weight of the towing vehicle (including passengers and cargo) and the trailer. The GCWR indicates the maximum loaded weight that the vehicle is allowed to tow.
- **Maximum trailer weight:** Maximum weight of a trailer the

Driving

loaded vehicle (including passengers and cargo) is permitted to tow. It is determined by subtracting the weight of the loaded towing vehicle from the GCWR of the towing vehicle.

- **Trailer weight range:** Specified weight range that the trailer must fall within that ranges from zero to the maximum trailer weight rating.

Remember to figure in the tongue load of your loaded trailer when figuring the total weight of your vehicle and rear axle loads.

Do not use replacement tires with lower weight capacities than the original because they may lower the vehicle's GVWR and GAWR limitations. Replacement tires with a higher weight limit than the originals do not increase the GVWR and GAWR limitations.

Calculating the load your vehicle can carry/tow

1. Use the Safety Compliance Certification Label to find the axle code number and engine type for your vehicle.
2. Use the appropriate maximum Gross Combined Weight Rating (GCWR) chart to find the maximum GCWR for your type engine and rear axle ratio.
3. Weigh your vehicle as you customarily operate the vehicle without cargo. To obtain correct weights, try taking your vehicle to a shipping company or an inspection station for trucks.
4. Subtract your loaded vehicle weight from the maximum GCWR on the following charts. This is the maximum trailer weight your vehicle can tow and must fall below the maximum shown under Maximum Trailer Weight on the chart.

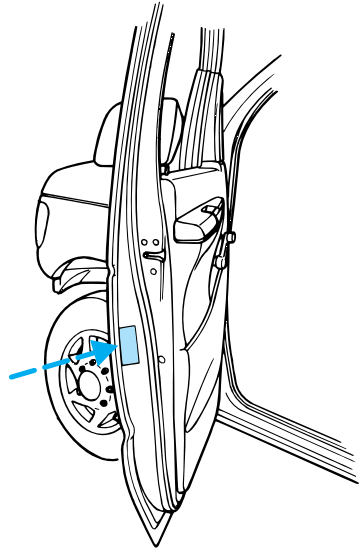

Trailer Towing Table				
GCWR (Gross Combined Weight Rating)/Trailer Weights				
Engine	Rear axle ratio	Maximum GCWR kg (lb)	Trailer weight range kg (lb) (0-Maximum)	Maximum Frontal Area Of Trailer Ft ²
Regular Van E-150				
4.2L	3.31	4,082 (9,000)	1,860 (4,100)	60
4.2L	3.55	4,536 (10,000)	2,313 (5,100)	60

Driving

Trailer Towing Table				
GCWR (Gross Combined Weight Rating)/Trailer Weights				
Engine	Rear axle ratio	Maximum GCWR kg (lb)	Trailer weight range kg (lb) (0-Maximum)	Maximum Frontal Area Of Trailer Ft ²
4.6L	3.31	4,990 (11,000)	2,766 (6,100)	60
4.6L	3.55	5,216 (11,500)	2,993 (6,600)	60
5.4L	3.55	5,443 (12,000)	3,130 (6,900)	60
Regular Van E-250				
4.2L	3.73	4,763 (10,500)	2,359 (5,200)	60
5.4L	3.73	5,897 (13,000)	3,402 (7,500)	60
Regular Van E-250 HD				
4.2L	4.09	4,990 (11,000)	2,586 (5,700)	60
5.4L	3.73	5,897 (13,000)	3,402 (7,500)	60
Super Van E-250				
4.2L	3.73	4,763 (10,500)	2,313 (5,100)	60
5.4L	3.73	5,897 (13,000)	3,357 (7,400)	60
Super Van E-250 HD				
4.2L	4.09	4,990 (11,000)	2,540 (5,600)	60
5.4L	3.73	5,897 (13,000)	3,356 (7,400)	60
Regular Van E-350				
5.4L	3.55	5,443 (12,000)	2,948 (6,500)	60

Driving

Trailer Towing Table				
GCWR (Gross Combined Weight Rating)/Trailer Weights				
Engine	Rear axle ratio	Maximum GCWR kg (lb)	Trailer weight range kg (lb) (0-Maximum)	Maximum Frontal Area Of Trailer Ft ²
5.4L	4.10	5,897 (13,000)	3,402 (7,500)	60
7.3L (Diesel)	3.55	7,258 (16,000)	4,536 (10,000)	60
7.3L (Diesel)	4.10	9,072 (20,000)	4,536 (10,000)	60
6.8L	3.73	6,804 (15,000)	4,218 (9,300)	60
6.8L	4.10	8,392 (18,500)	4,536 (10,000)	60
Super Van E-350				
5.4L	3.55	5,443 (12,000)	2,858 (6,300)	60
5.4L	4.10	5,897 (13,000)	3,311 (7,300)	60
7.3L (Diesel)	3.55	7,258 (16,000)	4,445 (9,800)	60
7.3L (Diesel)	4.10	9,072 (20,000)	4,536 (10,000)	60
6.8L	3.73	6,804 (15,000)	4,173 (9,200)	60
6.8L	4.10	8,392 (18,500)	4,536 (10,000)	60
Club Wagon E-150 (8 passenger)				
4.2L	3.31	4,082 (9,000)	1,678 (3,700)	60
4.2L	3.55	4,536 (10,000)	2,132 (4,700)	60

Driving

Trailer Towing Table				
GCWR (Gross Combined Weight Rating)/Trailer Weights				
Engine	Rear axle ratio	Maximum GCWR kg (lb)	Trailer weight range kg (lb) (0-Maximum)	Maximum Frontal Area Of Trailer Ft ²
4.6L	3.31	4,990 (11,000)	2,540 (5,600)	60
4.6L	3.55	5,216 (11,500)	2,767 (6,100)	60
5.4L	3.55	5,443 (12,000)	2,948 (6,500)	60
Club Wagon Regular E-350 (12 passenger)				
5.4L	3.55	5,443 (12,000)	2,722 (6,000)	60
5.4L	4.10	5,897 (13,000)	3,175 (7,000)	60
7.3L (Diesel)	3.55	7,258 (16,000)	4,309 (9,500)	60
7.3L (Diesel)	4.10	9,072 (20,000)	4,536 (10,000)	60
6.8L	3.73	6,804 (15,000)	4,037 (8,900)	60
6.8L	4.10	8,392 (18,500)	4,536 (10,000)	60
Club Wagon Super E-350 (15 passenger)				
5.4L	3.55	5,443 (12,000)	2,586 (5,700)	60
5.4L	4.10	5,897 (13,000)	3,039 (6,700)	60
7.3L (Diesel)	3.55	7,258 (16,000)	4,173 (9,200)	60
7.3L (Diesel)	4.10	9,072 (20,000)	4,536 (10,000)	60

Driving

Trailer Towing Table				
GCWR (Gross Combined Weight Rating)/Trailer Weights				
Engine	Rear axle ratio	Maximum GCWR kg (lb)	Trailer weight range kg (lb) (0-Maximum)	Maximum Frontal Area Of Trailer Ft ²
6.8L	3.73	6,804 (15,000)	3,901 (8,600)	60
6.8L	4.10	8,392 (18,500)	4,536 (10,000)	60
E-350 RV Cutaway (single rear wheel)				
7.3L (Diesel)	4.10	9,072 (20,000)	4,717 (10,400)	60
E-350 RV Cutaway (dual rear wheel)				
5.4L	4.10	5,897 (13,000)	1,134 (2,500)	60
6.8L	4.10	8,392 (18,500)	3,629 (8,000)	60
7.3L (Diesel)	4.10	9,072 (20,000)	4,309 (9,500)	60
E-350 Commercial Cutaway (single rear wheel)				
7.3L (Diesel)	4.10	9,072 (20,000)	4,717 (10,400)	60
E-350 Commercial Cutaway (dual rear wheel)				
5.4L	4.10	5,897 (13,000)	1,225 (2,700)	60
6.8L	4.10	8,392 (18,500)	3,720 (8,200)	60
7.3L (Diesel)	4.10	9,072 (20,000)	4,400 (9,700)	60
E-Super Duty				
6.8L	4.63	9,072 (20,000)	4,536 (10,000)	60
7.3L (Diesel)	4.63	9,072 (20,000)	4,536 (10,000)	60

Driving

Trailer Towing Table				
GCWR (Gross Combined Weight Rating)/Trailer Weights				
Engine	Rear axle ratio	Maximum GCWR kg (lb)	Trailer weight range kg (lb) (0-Maximum)	Maximum Frontal Area Of Trailer Ft ²
E-250/350 Stripped Chassis (single rear wheel)				
5.4L	4.10	5,897 (13,000)	1,542 (3,400)	60
6.8L	3.73	6,804 (15,000)	2,540 (5,600)	60
E-250/350 Stripped Chassis (dual rear wheel)				
5.4L	4.10	5,897 (13,000)	1,361 (3,000)	60
6.8L	4.10	8,392 (18,500)	3,856 (8,500)	60
For high altitude operation, reduce GCWR by 2% per 300 meters (1,000 ft) elevation. To determine the maximum trailer weight designed for you particular vehicle as equipped, follow the section Calculating the load your vehicle can tow/carry earlier in this chapter.				

TRAILER TOWING

Your vehicle may tow a class I, II or III trailer provided the maximum trailer weight is less than or equal to the maximum trailer weight listed for your engine and rear axle ratio on the above charts.

Your vehicle's load capacity is designated by weight, not by volume, so you cannot necessarily use all available space when loading a vehicle.

Distribute the load so that only 10 to 15% of the total is on the tongue. Tie down the load so that

it does not shift and change the weight on the hitch.

Towing a trailer places an additional load on your vehicle's engine, transmission, axle, brakes, tires and suspension. Inspect these components carefully after any towing operation.



Do not exceed the GVWR or the GAWR specified on the Safety Compliance Certification Label.



Towing trailers beyond the maximum recommended gross trailer weight could result in engine damage, transmission/axle damage, structural damage, loss of control, and personal injury.

Preparing to tow

Use the proper equipment for towing a trailer, and make sure it is properly attached to your vehicle. See your dealer or a reliable trailer dealer if you require assistance.

Hitches

Do not use or install hitches that clamp onto the bumper or to the axle. Underbody hitches are acceptable if installed properly.

Step bumper (if equipped)

Step bumpers have a built-in hitch and only require a ball with a 2.5 cm (1 in.) shank diameter. Step

Driving

bumpers have a Class III capability (2,270 kg [5,000 lb] trailer weight and 227 kg [500 lb] tongue weight.

Safety chains

Always use safety chains between your vehicle and trailer. Cross chains under the trailer tongue and allow slack for turning corners. Connect safety chains to the vehicle frame or hook retainers. Never attach chains to the bumper.

Trailer brakes

Trailer brakes are required on most towed vehicles weighing over 680 kg (1,500 lbs)



Do not connect a trailer's hydraulic brake system directly to your vehicle's brake system. Your vehicle may not have enough braking power and your chances of having a collision greatly increase.

Trailer lamps

Trailer lamps are required on most towed vehicles. Make sure your trailer lamps conform to Federal and local regulations. See your dealer or trailer rental agency for the proper instructions and equipment for hooking up trailer lamps.

Driving while you tow

Do not drive faster than 88 km/h (55 mph) while towing a trailer. Do not drive faster than 72 km/h (45 mph) with a trailer while towing in

hilly country or on hot days.

Speed control may shut off if you are towing on very long, steep grades.

When towing a trailer

If towing a trailer and your vehicle is not equipped with the Ford trailer tow package, an auxiliary transmission fluid cooler is recommended.

- Use D (Drive) rather than Ⓣ (Overdrive) while towing up or down steep hills. This will eliminate excessive downshifting and upshifting for optimum fuel economy and transmission cooling.
- Anticipate stops and brake gradually.
- Allow more room for stopping with a trailer attached.
- Practice turning, stopping and backing in an area before starting on a trip to get the feel of the vehicle/trailer combination.
- When turning, drive slightly beyond the normal turning point so the trailer wheels will clear curbs and other obstacles.
- When stopped in traffic for long periods of time in hot weather, place the gearshift in P (Park) to increase idle speed. This aids engine cooling and air conditioner efficiency.
- Vehicles with trailers should not be parked on a grade. If you

Driving

must park on a grade, place wheel chocks under the trailer's wheels.

- After you have travelled about 80 km (50 miles), thoroughly check your hitch, electrical connections and trailer wheel lug nuts.

Launching or retrieving a boat

When backing down a ramp during boat launching or retrieval,

- Do not allow the static water level to rise above the bottom edge of the rear bumper and
- Do not allow waves to break higher than 15 cm (six inches) above the bottom edge of the rear bumper.

Exceeding these limits may allow water to enter critical vehicle components, adversely affecting driveability, emissions and reliability.

Servicing when towing

If you tow a trailer for long distances, your vehicle will require more frequent service intervals. Follow the severe duty maintenance schedule outlined in the "Service Guide."

FUEL CONSUMPTION

Fuel economy can be improved by avoiding:

- lack of regular, scheduled maintenance
- excessive speed
- rapid acceleration

Roadside emergencies

HAZARD LIGHTS CONTROL

Use only in an emergency to warn traffic of vehicle breakdown, approaching danger, etc. Depress to activate all indicators simultaneously. Depress again to switch off. The warning lights can be operated when the ignition is off.

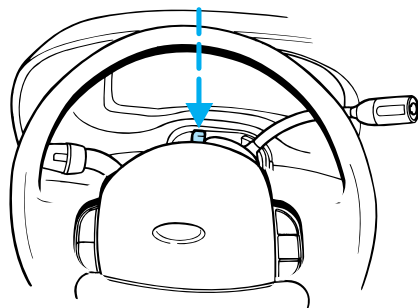

FUEL PUMP SHUT-OFF SWITCH

If the engine cranks but does not start after a collision, the fuel pump shut-off switch may have been activated. The shut-off switch is a device intended to stop the electric fuel pump when your vehicle has been involved in a substantial jolt.

1. Turn the ignition switch to the OFF position.
2. Check fuel system for leaks.

Roadside emergencies

3. If no fuel leak is apparent, reset the fuel pump shut-off switch by pushing in the button on the switch.

- Except commercial stripped chassis vehicles

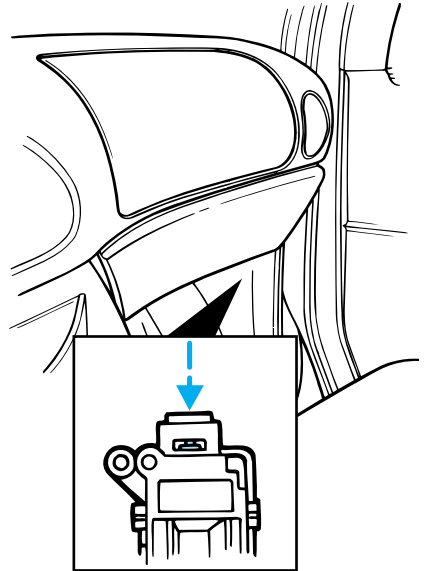

Roadside emergencies

- Commercial stripped chassis vehicles

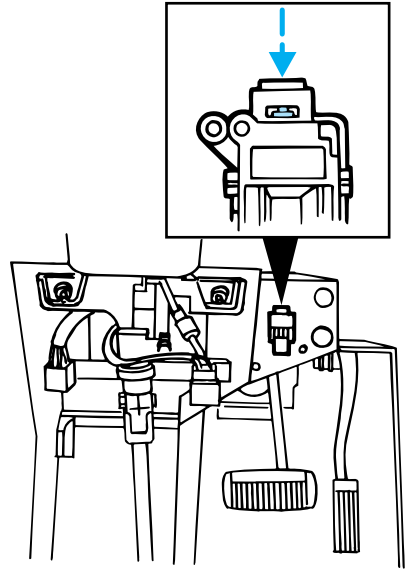

4. Turn the ignition switch to the ON position. Pause for a few seconds and return the key to the OFF position.

5. Make a further check for leaks in the fuel system.

FUSES AND RELAYS

Fuses

If electrical components in the vehicle are not working, a fuse may have blown. Check the appropriate fuses before replacing any electrical components. Blown fuses can be identified by a

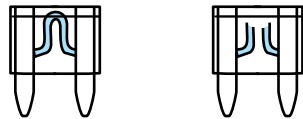

Roadside emergencies

separation in the metal wire inside the fuse.



Always replace a fuse with one that has the specified amperage rating. Using a fuse with a higher amperage rating can cause severe wire damage and could start a fire.

Even after a fuse is replaced, it will continue to blow if the cause of the overload is not identified and corrected. If a fuse continues to blow, have the vehicle's electrical system checked.

Standard fuse amperage rating and color

Fuse rating	Color
3 amp	Violet
4 amp	Pink
5 amp	Beige
10 amp	Red
15 amp	Blue
20 amp	Yellow
25 amp	Natural
30 amp	Light Green

High current fuse amperage rating and color

Fuse rating	Color
30 amp	Light Green
40 amp	Amber
50 amp	Red
60 amp	Blue

Roadside emergencies

Instrument panel fuse panel

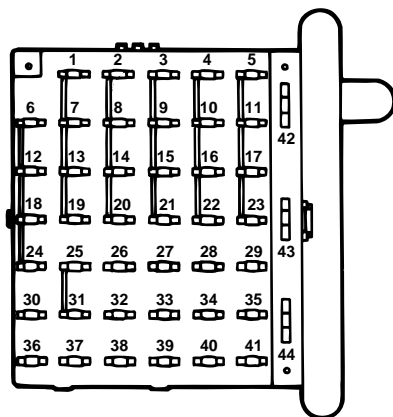
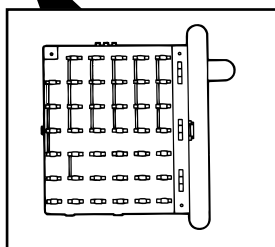
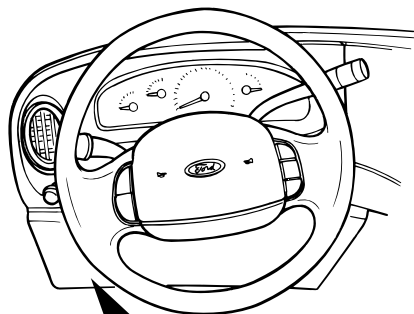

Roadside emergencies

Number	Fuse amperage rating	Circuits protected
1	20 amp	4WABS or RABS module
2	15 amp	4WABS relay (coil), RABS (diode/resistor), instrument cluster, warning chime
3	15 amp	Headlamp switch, radio sense, rear radio control, Remote keyless entry module
4	15 amp	Power mirrors, modified vehicle, power locks w/RKE, Headlamp switch (dome), illuminated entry, Courtesy lamp switches, Radio (KAP), Cluster (KAP), warning chime
5	20 amp	Remote keyless entry module, power door lock switches, memory lock
6	10 amp	Brake shift interlock, speed control, daytime running light module
7	10 amp	Multi-function switch

Roadside emergencies

Number	Fuse amperage rating	Circuits protected
8	30 amp	Noise suppression capacitor, ignition coil positive feed, PCM relay diode/PCM power relay, fuel heater (diesel), glow plug relay (diesel)
9	30 amp	Wiper control module, wiper motor
10	20 amp	Headlamp switch (exterior lamps), Multi-function switch (flash-to-pass)
11	15 amp	Stoplight switch, brake pressure switch, multi-function switch
12	15 amp	Digital transmission range sensor (backup lamps), auxiliary battery relay
13	15 amp	A/C mode switch, blend door actuator
14	5 amp	Instrument cluster (air bag and charge indicator lamps)
15	5 amp	Trailer tow battery charge relay (coil)
16	30 amp	Power seats
17	-	Not used
18	-	Not used
19	10 amp	Air bag module
20	5 amp	Overdrive cancel switch

Roadside emergencies

Number	Fuse amperage rating	Circuits protected
21	30 amp	Power windows
22	-	Not used
23	20 amp	Cigar lighter, data link connector
24	5 amp	Illuminated entry
25	10 amp	Left headlamp (low beam)
26	-	Not used
27	-	Not used
28	25 amp	Instrument panel power point
29	-	Not used
30	15 amp	Headlamps (high beam), Daytime running lamps (DRL), high beam indicator
31	10 amp	Right headlamp (low beam), Daytime running lamps (DRL)
32	-	Not used
33	-	Not used
34	10 amp	Digital transmission range sensor (start control)
35	-	Not used
36	5 amp	Panel illumination
37	-	Not used
38	10 amp	Air bag module
39	-	Not used
40	30 amp	Modified vehicle
41	30 amp	Modified vehicle
42	-	Not used

Roadside emergencies

Number	Fuse amperage rating	Circuits protected
43	-	Not used
44	-	Not used

Power distribution box

 Always disconnect the battery before servicing high current fuses.

 Always replace the cover to the Power Distribution Box before reconnecting the battery or refilling fluid reservoirs.

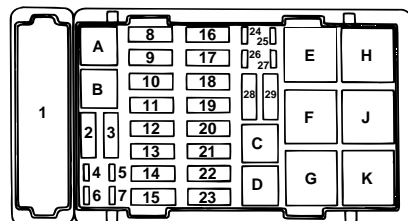
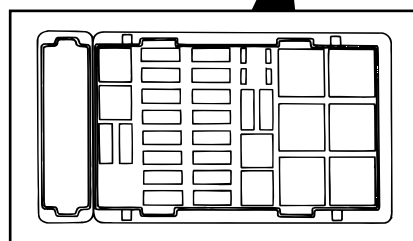
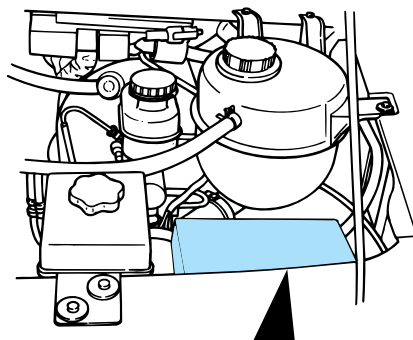

Number	Fuse amperage rating	Circuits protected
1	-	Generator to battery
2	-	Not used
3	-	Not used

Roadside emergencies

Number	Fuse amperage rating	Circuits protected
4	5 amp	PCM keep alive memory
5	10 amp	Right trailer turn signal
6	10 amp	Left trailer turn signal
7	-	Not used
8	60 amp	Instrument panel fuses
9	30 amp	PCM power relay
10	60 amp	Auxiliary battery
11	-	Not used
12	60 amp	Misc.
13	50 amp	Blower motor relay
14	30 amp	Trailer running lamps, trailer backup lamps
15	40 amp	Headlamp switch
16	50 amp	Auxiliary A/C, remote keyless entry module
17	30 amp	Fuel pump relay (gasoline), injector driver module relay (diesel)
18	60 amp	Modified vehicle power
19	60 amp	Anti-lock brake system (4WABS)
20	20 amp	Electric brake controller (trailer tow)
21	50 amp	Modified vehicle power
22	40 amp	Trailer battery charge (relay)

Roadside emergencies

Number	Fuse amperage rating	Circuits protected
23	60 amp	Ignition switch feed
24	-	Not used
25	-	Not used
26	10 amp	Alternator (diesel)
27	15 amp	Horn, daytime running lamp module
28	-	PCM diode
29	-	Not used

Roadside emergencies

Relays

Relays are located in the power distribution box

Ford recommends that relays be replaced by a qualified technician.

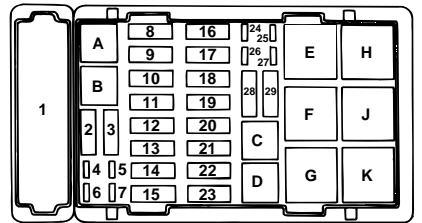
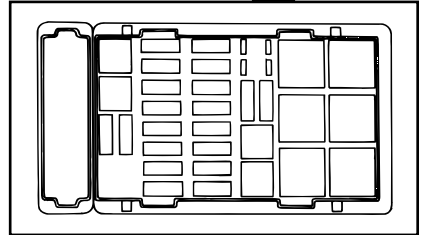
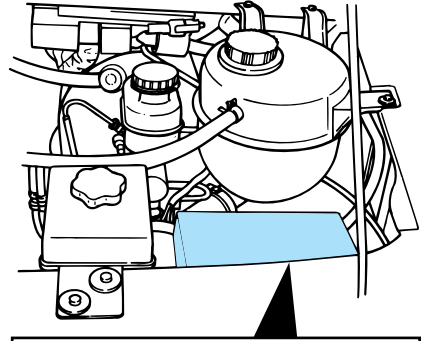

Position	Circuit
A	Not used
B	Not used
C	Trailer backup lamps
D	Trailer running lamps
E	Trailer battery charge relay
F	Not used
G	PCM
H	Blower motor

Roadside emergencies

Position	Circuit
J	Horn
K	Fuel pump or IDM

CHANGING TIRES

Spare tire location

The spare tire is stowed under the rear of your vehicle (except cutaway and stripped chassis models).

To remove the spare tire:

1. Open both rear doors and remove thumb screw and anti-theft bracket. If finger pressure will not remove thumb screw, use the lug wrench to loosen screw.

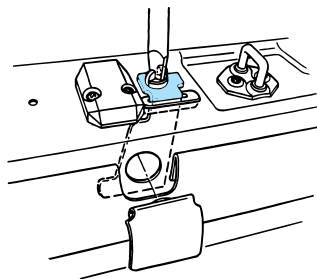

Roadside emergencies

2. Remove the access cover from the rubber strip behind the left door.
3. Insert the tapered end of the lug wrench or tip of jack handle through the access hole and into the tube.
4. Turn wrench or handle counterclockwise until cable is slack and tire can be slid rearward from under vehicle.

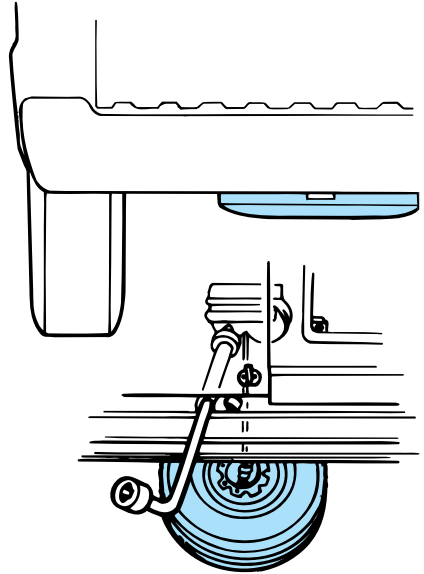

5. Remove retainer from spare tire.
To stow the cable retainer with the spare removed, turn the jack handle wrench clockwise until all slack is removed.

To stow the spare tire:

1. Lay tire on the ground under the rear of the vehicle with valve stem facing up. **Stow aluminum wheels with valve stem facing down.**
2. Install the retainer through wheel center.
3. Raise the tire by turning the wrench or handle clockwise.

Roadside emergencies

Continue until the lift mechanism “clicks.”

4. Check that the tire is tightly seated under the vehicle by pushing against tire. Retighten as necessary.

5. Replace the access cover, anti-theft bracket and thumb screw. Use finger pressure only to secure the thumb screw.



Make sure the spare tire and jacking equipment are stowed and secured in the proper storage location.



Never run the engine with one wheel off the ground.

Preparing to change the tire

1. Make sure your vehicle will not move or roll.

- Put the gearshift in P (Park)



Roadside emergencies

- Apply the parking brake

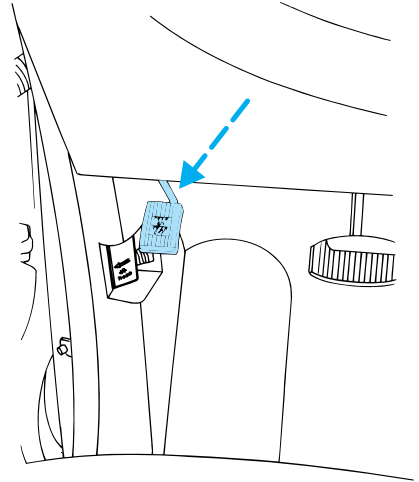

- Block the wheel that is diagonally opposite the tire you are changing

On E-Super Duty vehicles, the parking brake is on the transmission. Therefore, the vehicle will not be prevented from moving when a rear wheel is lifted, even if the parking brake is applied. Be sure to block both directions of the wheel that is diagonally opposite to the wheel that is being lifted.

Roadside emergencies



If the vehicle slips off the jack, you or someone else could be seriously injured.

2. Get out spare tire and jack.

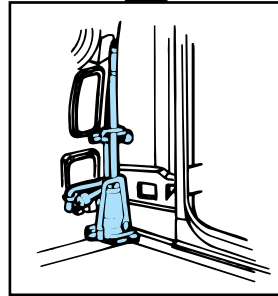
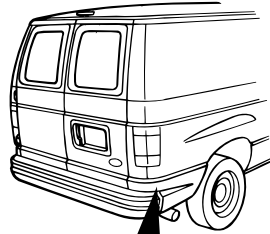

3. Use the tapered end of the lug nut wrench to unscrew wheel ornaments attached by retaining screws. Remove any wheel trim. Insert the tapered end of the lug nut wrench behind wheel covers or hubcaps and twist off.

Loosen the wheel nuts by pulling up on the handle of the lug nut wrench about one-half turn (counterclockwise). Do not remove the wheel lug nuts until you raise the tire off the ground.

Replacing the tire

1. Unfold the jack handle and lock into jack. Use the jack handle to

Roadside emergencies

slide the jack under the vehicle.

 To lessen the risk of personal injury, do not put any part of your body under the vehicle while changing a tire. Do not start the engine when your vehicle is on the jack. The jack is only meant for changing the tire.

2. Position the jack to raise the front or rear wheel.

Never use the differential housing as a lift point.

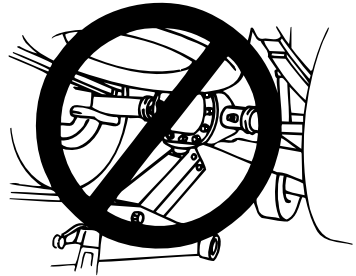

Rear axle jacking points:

- All models except E-Super Duty

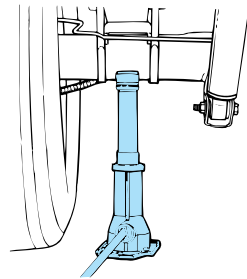

- E-Super Duty

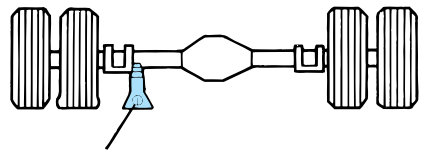

Roadside emergencies

Front axle jacking points:

- All models

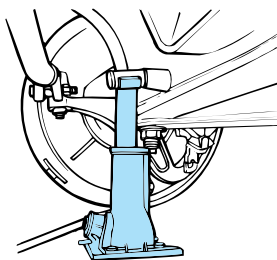

3. Turn the jack handle clockwise until the wheel is completely off the ground.

4. Remove the lug nuts with the lug nut wrench.

5. Replace the flat tire with the spare tire.

If your vehicle has dual rear wheels, there are locating pins on the hubs and wheels with corresponding holes. When you install the wheel make sure that the pins are aligned with the proper holes.

If your vehicle has single rear wheels, thread the lug nuts on the studs with the beveled face toward the wheel.

If your vehicle has dual rear wheels, thread the two element swiveling lug nut on the studs with the flange facing toward the wheel.

6. Use the lug nut wrench to screw the lug nut snugly against the wheel.

Roadside emergencies

7. Lower the vehicle by turning the jack handle counterclockwise.

8. Remove the jack and fully tighten the lug nuts in the following pattern:

5 lug wheel

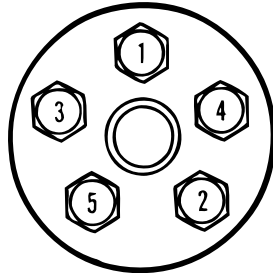

8 lug wheel

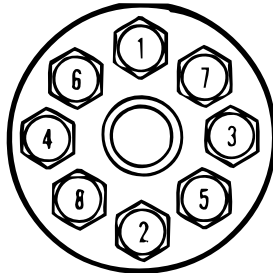

Never use wheels or lug nuts different than the original equipment as this could damage the wheel or mounting system. This damage could allow the wheels to come off while the vehicle is being driven.

9. Replace any wheel covers, ornaments or hub caps. make sure they are screwed or snapped in place.

10. Stow the jack, handle and lug wrench.

11. Unblock the wheels.

Roadside emergencies

On vehicles equipped with dual rear wheels retighten the wheel lug nuts to the specified torque at 160 km (100 miles), and again at 800 km (500 miles) of new vehicle operation and at intervals specified in the “Service Guide.”

On vehicles equipped with single rear wheels retighten the lug nuts to the specified torque at 800 km (500 miles) of operation after any wheel change or any time the lug nuts are loosened.

Model	Bolt Size	Wheel Lug nut Torque*	
		N•M	Ft-Lb
E-150	1/2-20	135	100
E-250, E-350 and E-Super Duty	9/16-18	190	140

* Torque specifications are for nut and bolt threads free of dirt and rust. Do not use oil or grease on threads. Use only Ford recommended replacement fasteners.

JUMP STARTING YOUR VEHICLE



The gases around the battery can explode if exposed to flames, sparks, or lit cigarettes. An explosion could result in injury or vehicle damage.

Roadside emergencies

 Do not push-start your vehicle. You could damage the catalytic converter. For further information, see *Jumper Cables* in the Index.

 Batteries contain sulfuric acid which burns skin, eyes, and clothing.

Connecting the jumper cables

1. Position the vehicles so that they do not touch one another.
2. Switch off the engine. Switch off any unnecessary electrical equipment.
3. Connect the positive (+) terminal of the discharged battery (1) to the positive (+) terminal of the booster battery (2).
4. Connect one end of the second lead to the negative (-) terminal of the booster battery (3) and the other end to a metal part of the engine to be started (4), not to the negative (-) terminal of the discharged battery.
5. Make sure that the jump leads are clear of moving parts of the engine.

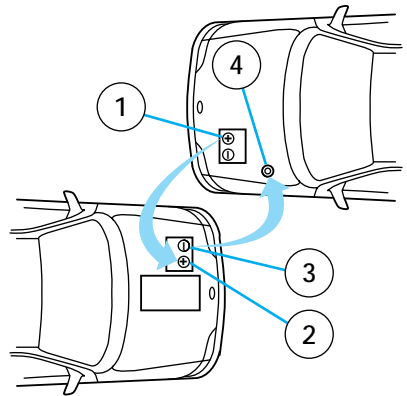

Roadside emergencies

 Do not connect the end of the second cable to the negative ([-]) terminal of the battery to be jumped. A spark may cause an explosion of the gases that surround the battery.

Jump starting

1. Start the booster vehicle and run the engine at moderately increased speed.
2. Start the engine of the vehicle with the discharged battery.
3. Once the engine has been started, run both vehicles for a further three minutes before disconnecting the leads.

Removing the jumper cables

1. Remove the jumper cables in reverse order. Take the cable off the metallic surface (1) first, followed by the cable on the negative (-) booster battery terminal (2).
2. Remove the cable from the positive (+) terminal of the booster battery (3) and then the discharged battery (4).
3. After the disabled vehicle has been started, allow it to idle for a while so the engine can “relearn” its idle conditions.

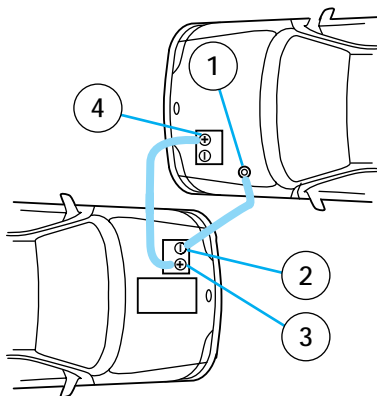

Roadside emergencies

WRECKER TOWING

The recommended method to tow your vehicle is with flatbed or wheel lift equipment. However, slingbelt towing is acceptable. On vehicles equipped with an air dam, the towbar will deform the rubber air dam.



Never use a tow bar that attaches to the bumper when you tow your vehicle. This could damage the bumper and cause an accident.

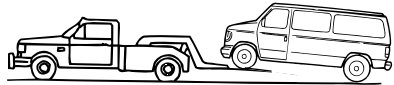
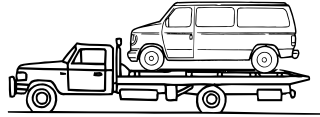
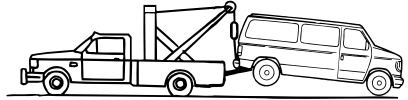

Maintenance and care

SERVICE RECOMMENDATIONS

To help you service your vehicle:

- We highlight do-it-yourself items in the engine compartment for easy location.
- As possible, we design parts that can be replaced without tools.
- We provide you with a “Service Guide” which makes tracking routine service for your vehicle easy.

If your vehicle requires professional service, your dealership can provide necessary parts and service. Check your “Warranty Information Booklet” to find out which parts and services are covered.

Use only recommended fuels, lubricants, fluids and service parts conforming to specifications. Motorcraft parts are designed and built to provide the best performance in your vehicle.

Precautions when servicing your vehicle

Be especially careful when inspecting or servicing your vehicle. Here are some general precautions for your safety:

- Do not work on a hot engine.

Maintenance and care



The cooling fan is automatic and may come on at any time. Always disconnect the negative terminal of the battery before working near the fan.

- If you must work with the engine running, avoid wearing loose clothing or jewelry that could get caught in moving parts. Take precautions with long hair.
- Do not work on a vehicle with the engine running in an enclosed space, unless you are sure you have enough ventilation.
- Keep all lit cigarettes, open flames and other lit material away from the battery and all fuel related parts.

If you disconnect the battery, the engine must “relearn” its idle conditions before your vehicle will drive properly, as explained in *Battery* in this chapter.

Maintenance and care

Working with the engine off

1. Set the parking brake fully and

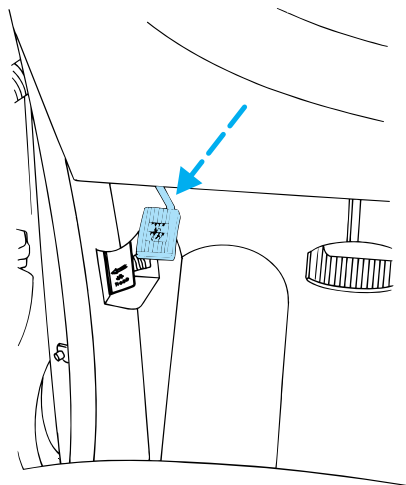

ensure the gearshift is securely latched in P (Park).

2. Turn off the engine and remove the key.
3. Block the wheels to prevent the vehicle from moving unexpectedly.

P R N D 2 1

Maintenance and care

Working with the engine on

1. Set the parking brake fully and

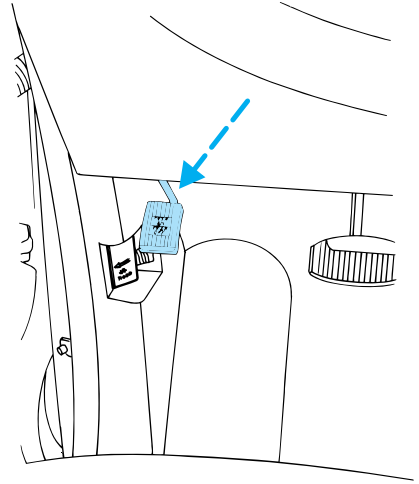

ensure the gearshift is securely latched in P (Park).

2. Block the wheels to prevent your vehicle from moving unexpectedly.



Do not start your engine with the air cleaner removed and do not remove it while the engine is running.

P R N  2 1

Maintenance and care

OPENING THE HOOD

1. Inside the vehicle, pull the hood release handle located under the bottom left corner of the instrument panel.

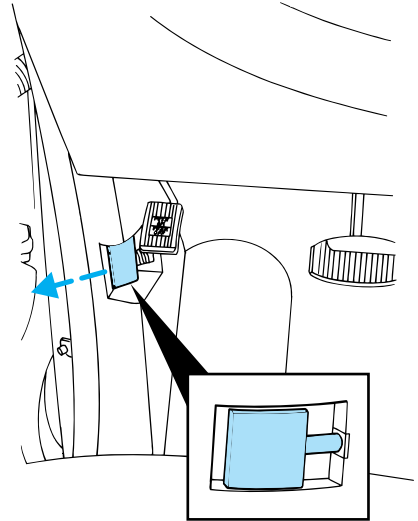

2. While applying downward pressure on the hood, push the hood latch handle located just left of the center of the hood.

3. Lift the hood.

After closing the hood, try to lift it to be sure that it is closed securely.

Lubricate the hood latch every six months to ensure proper operation.

Maintenance and care

ENGINE COMPARTMENT COMPONENTS

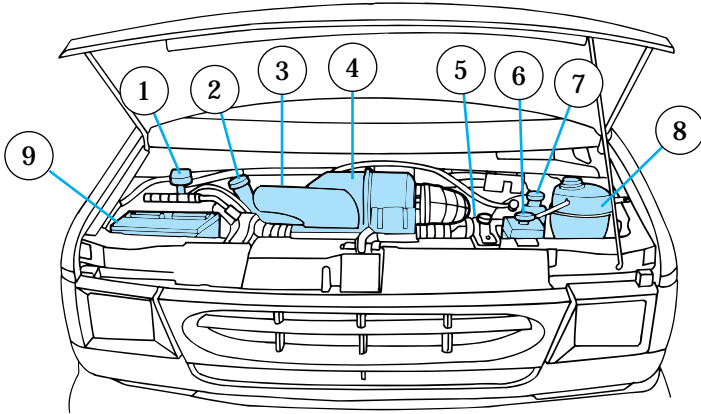

1. Windshield washer fluid reservoir
2. Engine oil filler
3. Automatic transmission fluid dipstick
4. Air cleaner
5. Engine oil dipstick
6. Power steering fluid reservoir
7. Brake master cylinder
8. Engine coolant recovery reservoir
9. Battery

Maintenance and care

CHECKING AND ADDING ENGINE OIL

Use WSS-M2C153-F motor oil CERTIFIED FOR GASOLINE ENGINES by the American Petroleum Institute.

Engine oils with an SAE 5W-30 viscosity and displaying the American Petroleum Institute certification mark are preferred for your vehicle. They provide the best engine performance, fuel economy and engine protection for all climates down to -25°C (-15°F).

Do not use:

- “non-detergent” oils
- oils labeled API SA, SB, SC, SD, SE, SF or SG
- additional engine oil additives, oil treatments or engine treatments

Additional engine oil additives, oil treatments or engine treatments are never needed and could, under certain conditions, lead to engine damage which is not covered by your Ford warranty.

Synthetic engine oils which are CERTIFIED and of the preferred viscosity may be used in your engine. The engine oil and oil filter must still be changed according to the “Service Guide”.

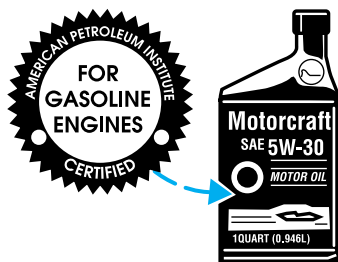

Maintenance and care

Checking the engine oil

Check the engine oil each time you fuel your vehicle.

To check the oil:

1. Make sure the vehicle is on level ground. If the engine is warm, turn the engine off and wait a few minutes for the oil to drain into the oil pan.
2. Set the parking brake and ensure the gearshift is securely latched in P (Park).
3. Open the hood. Protect yourself from engine heat.
4. Locate and carefully remove the engine oil dipstick.

4.2L/4.6L engines

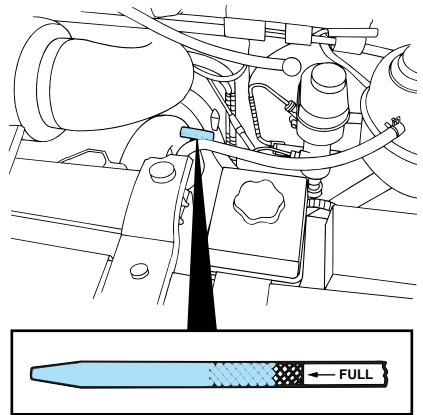

Maintenance and care

5.4L/6.8L engines

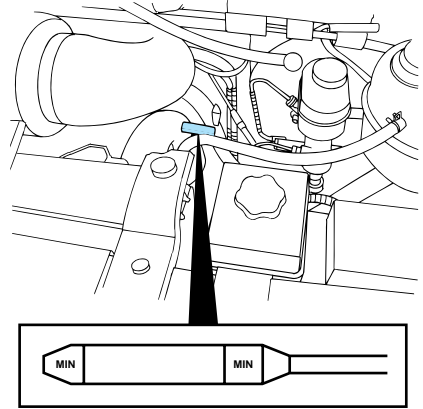

5. Wipe the dipstick clean. Insert the dipstick fully, then remove it again. The oil level should be in the range shown on the dipstick.
6. If the oil level is below the ADD or MIN line, add engine oil as necessary. If the oil level is beyond the FULL or MAX line, engine damage or high oil consumption may occur and some oil must be removed from the engine by a service technician.
7. Put the dipstick back in and ensure it is fully seated.

Maintenance and care

Adding engine oil

1. Check the engine oil. For instructions, refer to *Checking the engine oil* in this chapter.
2. If the fluid level is not within the normal range, add only certified engine oil of the preferred viscosity. Add engine oil through the oil filler cap. Remove the filler cap and use a funnel to pour oil in the opening.
3. Recheck the oil level. Make sure the oil level is not above the full mark on the dipstick.

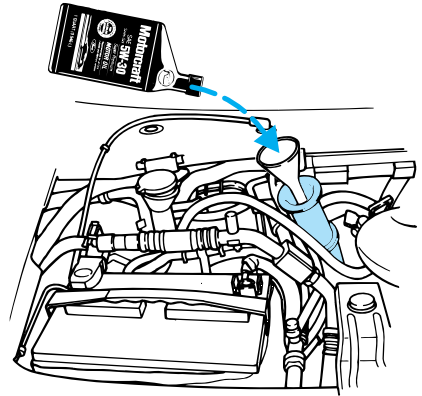

Continuous contact with **used** motor oil has caused cancer in laboratory mice.

Changing the engine oil and filter

Change your engine oil and filter according to the following kilometers (mileage) and time requirements, whichever occurs first:

- Normal Schedule – 8,000 km (5,000 miles) or six months.
- Severe Duty Schedule – 5,000 km (3,000 miles) or three months. Severe duty operation would include extensive idling, trailer towing, driving in severe dust and police, taxi or delivery service.

Maintenance and care

Ford production and aftermarket (Motorcraft) oil filters are designed for added engine protection and long life. If a replacement oil filter is used that does not meet Ford material and design specifications, startup engine noises or knock may be experienced.

It is recommended you use the appropriate Motorcraft oil filter (or another brand meeting Ford specifications) for your engine application.

CHECKING AND ADDING BRAKE FLUID

Brake fluid should be checked and refilled as needed at least once each year:

- Clean the reservoir cap before removal to prevent dirt or water from entering the reservoir.
- Visually inspect the fluid level.
- If necessary, add brake fluid until the level reaches MAX. Do not fill above this line.
- Use only a DOT 3 brake fluid certified to meet Ford specifications. Refer to *Lubricant specifications* in the *Capacities and specifications* chapter.

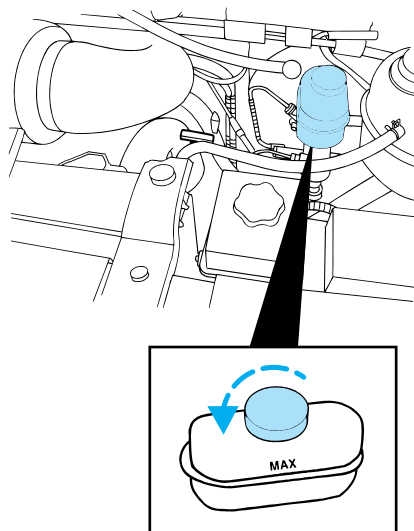

Brake fluid is toxic.

Maintenance and care



If you use a brake fluid that is not DOT 3, you will cause permanent damage to your brakes.



Do not let the reservoir for the master cylinder run dry. This may cause the brakes to fail.

WASHER FLUID

Use specially formulated windshield washer fluid rather than plain water, because specially formulated washer fluids contain additives that dissolve road grime. Washer fluids containing an appropriate antifreeze such as methanol should be used in freezing weather (temperatures below 0°C [32°F]). State or local regulations on volatile organic compounds may restrict the use of methanol, a common type of antifreeze. Use a non-methanol antifreeze to provide cold weather protection only if the fluid does not damage the paint finish, wiper blades or washer system.

Maintenance and care

Adding washer fluid

The vehicle's windshield washer reservoir is located on the passenger side of the engine compartment. If fluid needs to be added to the reservoir:

- Lift the windshield reservoir cover.
- Add enough washer fluid to fill the reservoir.

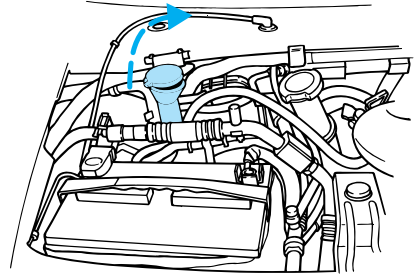

CHECKING AND ADDING ENGINE COOLANT

Check the level of the coolant in the reservoir at least once a month. Be sure to read and understand *Precautions when servicing your vehicle* in this chapter.

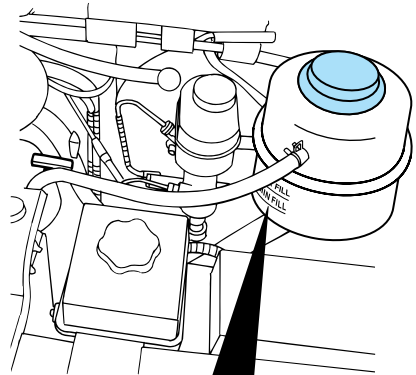

MAX FILL

MIN FILL

If the engine coolant has not been checked for a long period of time, the engine coolant reservoir may eventually empty. If this occurs, add engine coolant to the coolant reservoir. For more information on engine coolant maintenance, refer to *Adding engine coolant* in this chapter.

Maintenance and care

Automotive fluids are not interchangeable; do not use engine coolant, antifreeze or windshield washer fluid outside of its specified function and vehicle location.

When adding engine coolant

Ford recommends Ford Premium Cooling System Fluid, which is an optimized formula that will protect all metals and rubber elastomers used in Ford engines for four years or 80,000 km (50,000 miles).

It is neither necessary nor recommended to use supplemental coolant additives in your gasoline-powered vehicle. These additives may harm your engine cooling system.

When you change or add engine coolant, it is important to maintain engine coolant concentration between 40% (-24°C [-11°F]) and 60% (-52°C [-62°F]), depending on your local climate conditions.

A coolant concentration below 40% will result in a loss of freeze protection. A concentration above 60% may cause the engine to overheat on a warm day.

Refer to *Lubricant specifications* in the *Specifications and capacities* chapter. Use only a premium nationally-recognized brand name engine coolant or equivalent.



Always dispose of used automotive fluids in a responsible manner. Follow your community's

Maintenance and care

standards for disposing of these types of fluids. Call your local recycling center to find out more about recycling automotive fluids.

Adding engine coolant



Never remove the pressure cap while the engine is running or hot.

1. Before you remove the cap, turn the engine off and let it cool.
2. When the engine is cool, wrap a thick cloth around the cap and turn it slowly counterclockwise.
3. Step back while the pressure releases.
4. When you are sure that all the pressure has been released, use the cloth to remove the cap.
5. Add engine coolant until the level is between the MIN and MAX lines on the engine coolant recovery reservoir.

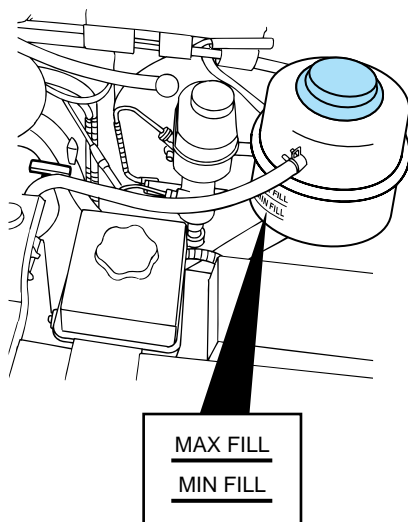

Follow the recommended service interval for changing engine coolant as outlined in the *Service Guide*.

Checking the cooling system hoses

Inspect all engine and heater system hoses and hose connections for:

- deterioration
- leaks

Maintenance and care

- loose hose clamps

What you should know about fail-safe cooling (if equipped)

If the engine coolant supply is depleted, this feature allows the vehicle to be driven temporarily before incremental component damage is incurred. The “fail safe” distance depends on ambient temperatures, vehicle load and terrain.

How fail-safe cooling works

If the engine overheats, the engine will automatically switch from eight to alternating four cylinder operation. Each disabled cylinder acts as an air pump and cools the engine.

When this occurs, the engine coolant temperature gauge will move into the red area and the  light illuminates.

The service engine soon light will illuminate, indicating that vehicle service is required.

The vehicle will still operate, but will have limited engine power and no air conditioning capability.

Continued operation will increase engine temperature and cause the engine to completely shut down. The vehicle will coast to a stop.

As the engine temperature cools, the engine may be re-started. Take your vehicle to a service facility as soon as possible to minimize engine damage.

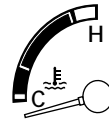

Maintenance and care

When fail-safe mode is activated

- Pull off the road as soon as possible.
- Immediately turn the engine off to prevent severe engine damage.
- Wait for the engine to cool.
- Check the coolant level.

CHECKING AND ADDING POWER STEERING FLUID

Check the power steering fluid level at least twice a year.

1. Remove the dipstick and wipe indicator clean.
2. Put dipstick back into reservoir and make sure it is fully seated.
3. Remove dipstick and read fluid level.
4. Add power steering fluid until the fluid level reaches full mark on dipstick.

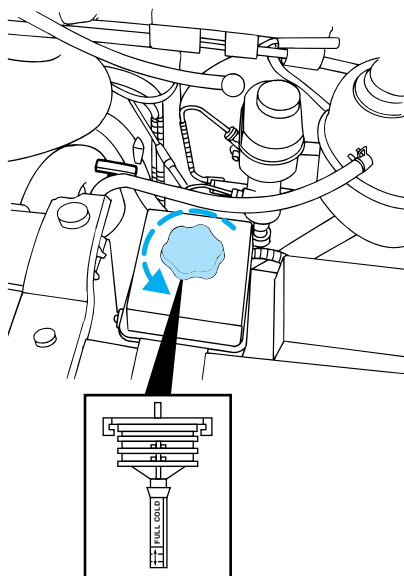

Use only fluid that meets Ford specifications. Refer to *Capacities and specifications*.

CHECKING AND ADDING AUTOMATIC TRANSMISSION FLUID

Service the automatic transmission according to the scheduled intervals in the "Service Guide."

Before adding any fluid, make sure the correct type will be used. This information is indicated on the dipstick.

Do not drive the vehicle if the fluid level is below the bottom hole on the blade type dipstick (4R70W transmission) or below the COLD area on the bullet type dipstick (E4OD transmission) and outside temperatures are above 10°C (50°F).

Your vehicle does not use up transmission fluid. However, it is recommended that you check the transmission fluid at least twice a year. The fluid level should be checked if the transmission is not working properly, i.e., if the transmission slips or shifts slowly or if you notice some sign of fluid leakage.

It is preferable to check the transmission fluid level at normal operating temperature, after approximately 32 km (20 miles) of driving. However, you can check the fluid level without driving to obtain a normal operating temperature if the outside temperature is above 10°C (50°F).

If your vehicle has been operated for an extended period at high

Maintenance and care

speeds, in city traffic during hot weather or pulling a trailer, the vehicle should be turned off for about 30 minutes to allow the fluid to cool before checking.

1. Park the vehicle on a level surface.
2. Start the engine and move the gearshift lever through all of the gear ranges. Allow sufficient time for each gear to engage.
3. Latch the gearshift lever in P (Park), set the parking brake and leave the engine running.
4. Remove the dipstick, wiping it clean with a clean, dry rag.
5. Install the dipstick.
6. Remove the dipstick and inspect the fluid level.

For 4R70W transmissions, the fluid level should be within the crosshatched area, or if the vehicle has not been driven, between the holes near the bottom of the indicator.

P R N  21

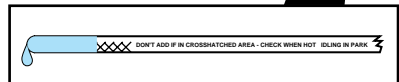
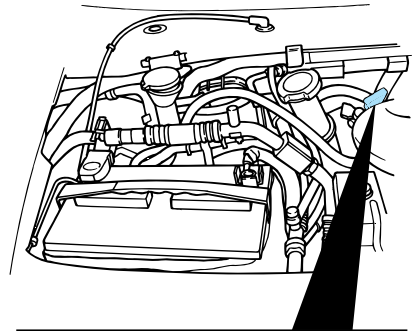

Maintenance and care

Do not drive if the fluid level is below bottom hole and outside temperature is 10°C (50°F) or above.

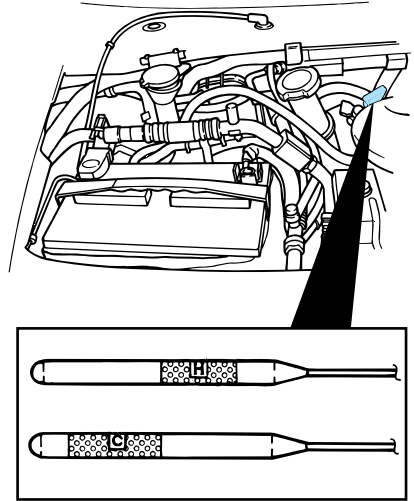

For E4OD transmissions, the fluid level should be within the HOT area, or if the vehicle has not been driven, within the COLD area.

Do not drive if the fluid level is below cold level area and outside temperature is 10°C (50°F) or above.

7. If necessary, add fluid in 250 ml (1/2 pint) increments through the filler tube until the level is at the correct area on the dipstick. If an overfill occurs, excess fluid should be removed by a qualified technician.

Maintenance and care

DRIVELINE UNIVERSAL JOINT AND SLIP YOKE

The universal joints standard with your vehicle do not require lubrication. If the original equipment universal joints are replaced with universal joints equipped with grease fittings, lubrication will be necessary at the intervals shown in the “Service Guide” supplement.

BATTERY

If the original equipment maintenance-free battery needs replacing, it may be replaced with a low-maintenance battery. For information on replacement batteries, refer to *Motorcraft part numbers* in the *Capacities and specifications* chapter.



The gases around the battery can explode if exposed to flames, sparks, or lit cigarettes. An explosion could result in injury or vehicle damage.



Batteries contain sulfuric acid which burns skin, eyes, and clothing.

Maintenance and care

Servicing your battery

The low-maintenance battery has removable vent caps for checking the electrolyte level and adding water. Check the electrolyte level every 24 months or 40,000 km (24,000 miles) in average temperatures below 32°C (90°F).

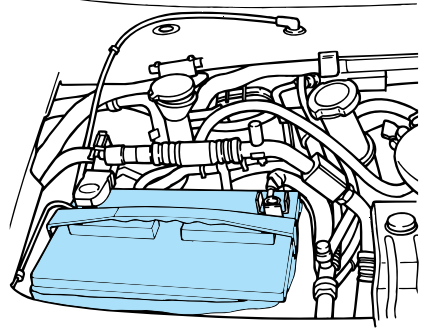

Keep the electrolyte level in each cell up to the level indicator. Do not overfill.

If the level gets low, refill the battery with distilled water. If the battery needs water quite often, have the charging system checked for a possible malfunction.

Relearning idle conditions

Because your vehicle's engine is electronically controlled by a computer, some control conditions are maintained by power from the battery. When the battery is disconnected or a new battery is installed, the computer must "relearn" its idle conditions before your vehicle will drive properly. To complete this process:

1. Put the gearshift in P (Park).
2. Turn off all accessories, and start the engine.
3. Let the engine idle for at least one minute.



Maintenance and care

4. The relearning process will automatically complete as you drive the vehicle.

- If you do not allow the engine to relearn its idle, the idle quality of your vehicle may be adversely affected until the idle is eventually relearned.
- If the battery has been disconnected or a new battery has been installed, the clock and preset radio stations must be reset once the battery is reconnected.
- Always dispose of used automotive batteries in a responsible manner. Follow your community's standards for disposal. Call your local recycling center to find out more about recycling automotive batteries.



Disconnecting dual batteries (if equipped)

Gasoline engines

Disconnect:

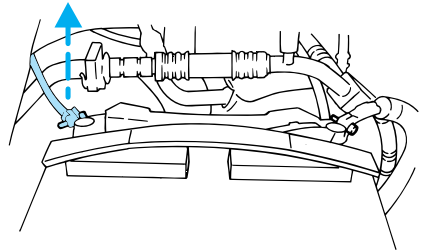

Maintenance and care

1. Disconnect the primary battery ground cable.

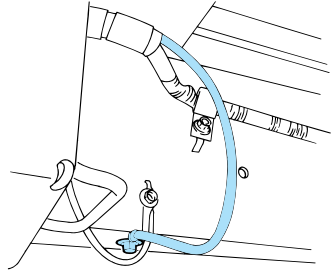

2. Disconnect the auxiliary battery frame ground.

Remove the ground bolt.

Pull the cable away from the frame and make sure that the cable does not contact the frame.

Connect:

1. Reconnect the auxiliary battery frame ground.

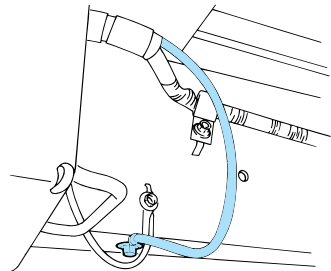

2. Reconnect the primary battery ground cable.

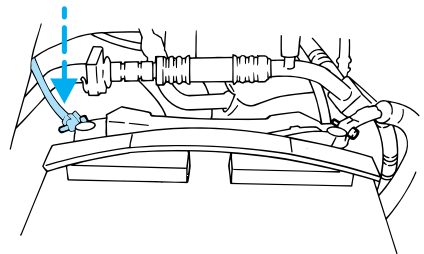

Maintenance and care

Diesel engines

Disconnect:

 Secondary positive cable remains energized after disconnection. make sure the tool does not contact any ground surface.

1. Disconnect the secondary positive cable from the primary battery terminal.
2. Wrap the secondary positive cable with a non-conductive material to insulate.
3. Disconnect the primary battery ground cable.
4. Disconnect the primary battery positive cable.

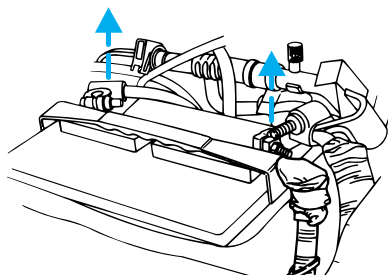
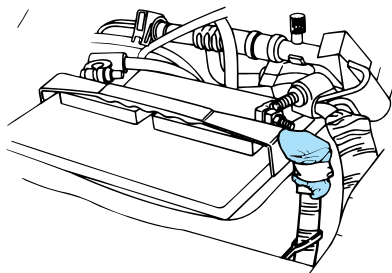
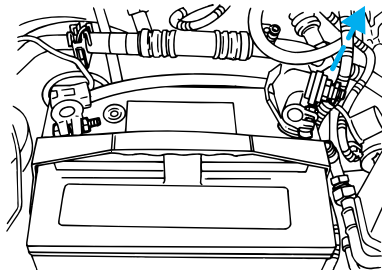

Maintenance and care

Connect:

 Secondary positive cable remains energized after disconnection. make sure the tool does not contact any ground surface.

1. Reconnect the primary battery positive cable.
2. Reconnect the primary battery ground cable.
3. Unwrap the secondary positive cable and reconnect to the primary battery terminal.

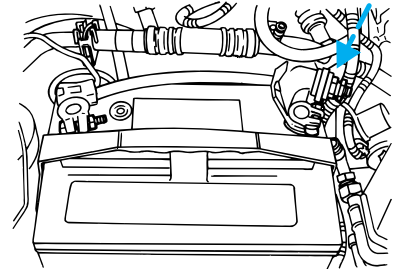
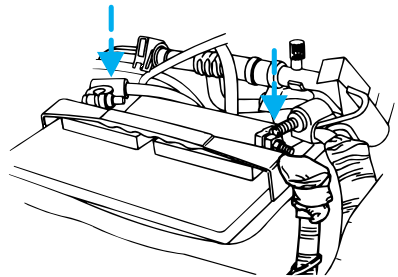

WIPER BLADES

Check the windshield wiper blades at least twice a year or whenever the wipers seem less effective than usual. Substances such as tree sap and some hot wax treatments used by commercial car washes can reduce the effectiveness of wiper blades.

To make reaching the wiper blades easy, simply turn the ignition to the ON position and turn the wipers on. Wait for the wipers to reach a vertical position and turn

Maintenance and care

the ignition to the LOCK position. Do not move the wipers manually across the windshield as this may cause damage to the wiper system.

Inspect the wiper arm pivots on a regular basis to ensure the wiper arms move freely. Lubricate the pivot points as necessary.

Replacing wiper blades

If the wiper blades do not work properly after cleaning, replacement of the blade assembly or the blade element may be necessary.

To replace the wiper blades:

1. Pull the wiper arm away from the windshield and lock it into the service position.
2. Turn the blade at an angle from the wiper arm. Depress the lock tab to release the wiper blade and pull the wiper blade down toward the windshield to remove it from the arm.
3. Attach the new wiper to the wiper arm and press it into place until a click is heard.

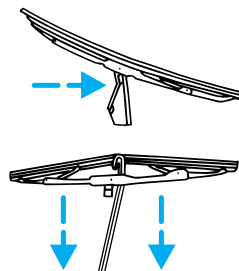

Maintenance and care

INFORMATION ABOUT TIRE QUALITY GRADES

New vehicles are fitted with tires that have their Tire Quality Grade (described below) molded into the tire's sidewall. These Tire Quality Grades are determined by standards that the United States Department of Transportation has set.

Tire Quality Grades apply to new pneumatic tires for use on passenger cars. They do not apply to deep tread, winter-type snow tires, space-saver or temporary use spare tires, tires with nominal rim diameters of 10 to 12 inches or limited production tires as defined in Title 49 Code of Federal Regulations Part 575.104(c) (2).

U.S. Department of Transportation-Tire quality grades: The U.S. Department of Transportation requires Ford to give you the following information about tire grades exactly as the government has written it.

Treadwear

The treadwear grade is a comparative rating based on the wear rate of the tire when tested under controlled conditions on a specified government test course. For example, a tire grade 150 would wear one and one-half (1 1/2) times as well on the government course as a tire grade 100. The relative performance of tires depends upon the actual

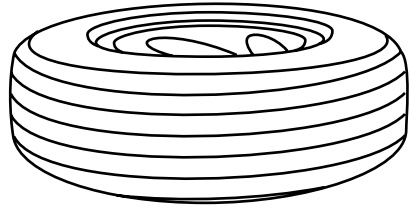

Maintenance and care

conditions of their use, however, and may depart significantly from the norm due to variations in driving habits, service practices, and differences in road characteristics and climate.

Traction A B C

The traction grades, from highest to lowest are A, B, and C, and they represent the tire's ability to stop on wet pavement as measured under test surfaces of asphalt and concrete. A tire marked C may have poor traction performance.

Warning: The traction grade assigned to this tire is based on braking (straightahead) traction tests and does not include cornering (turning) traction.

Temperature A B C

The temperature grades are A (the highest), B, and C, representing the tire's resistance to the generation of heat and its ability to dissipate heat when tested under controlled conditions on a specified indoor laboratory test wheel. Sustained high temperature can cause the material of the tire to degenerate and reduce tire life, and excessive temperature can lead to sudden tire failure. The grade C corresponds to a level of performance which all passenger car tires must meet under the Federal Motor Vehicle Safety Standard No. 109. Grades B and A represent higher levels of performance on the laboratory test

Maintenance and care

wheel than the minimum required by law.



The temperature grade for this tire is established for a tire that is properly inflated and not overloaded. Excessive speed, underinflation, or excessive loading, either separately or in combination, can cause heat buildup and possible tire failure.

SERVICING YOUR TIRES

Checking the tire pressure

Check the tire pressure periodically and inflate tires as necessary. To check the tire pressure, insert the tire pressure gauge into the valve system.

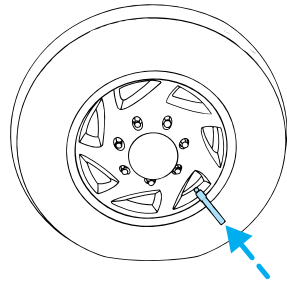

Maintenance and care

The cold pressure amount is listed on the Safety Compliance Certification label.



Improperly inflated tires can affect vehicle handling and can fail suddenly, possibly resulting in loss of vehicle control.

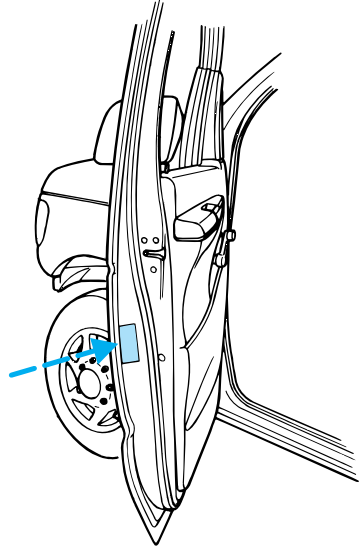

Rotating the tires

Rotate your tires at regular intervals for even wear. Rotation intervals are listed in the *Service Guide*.

- **Four tire rotation**

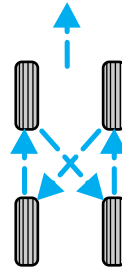

Maintenance and care

- **Five tire rotation**

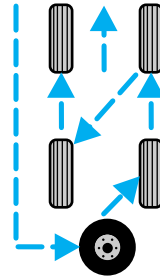

Replacing the tires

Replace the tires when the wear band is visible through the tire treads.

 When replacing full size tires, never mix radial, bias-belted, or bias-type tires. Use only the tire sizes that are listed on the tire pressure decal. Make sure that all tires are the same size, speed rating, and load-carrying capacity. Use only the tire combinations recommended on the decal. If you do not follow these precautions, your vehicle may not drive properly and safely.

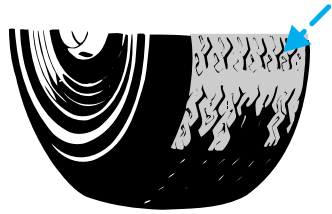

When purchasing replacement tires for your vehicle, consult your dealer or qualified service technician to ensure that the correct tire types are used.

Maintenance and care

Using snow tires and chains



Snow tires must be the same size and grade as the tires you currently have on your vehicle.

The tires on your vehicle have all—weather treads to provide traction in rain and snow. However, in some climates, using snow tires and chains may be necessary. Ford offers tire cables as a Ford approved accessory and recommends use of these or their equivalents. See your dealer or qualified service technician for more information on tire cables for your vehicle. Follow these guidelines when using snow tires and chains:

- Install chains securely, verifying that the chains do not touch any wiring, brake lines or fuel lines.
- Install the chains on the rear tires only.
- Drive cautiously. If you hear the chains rub or bang against the vehicle, stop and retighten them. If this does not work, remove the chains to prevent vehicle damage.
- Avoid overloading your vehicle.
- Remove the tire chains when they are no longer needed. Do not use chains on dry roads.
- The suspension insulation and bumpers will help prevent vehicle damage. Do not remove

Maintenance and care

these components from the vehicle when using snow tires and chains.

WHAT YOU SHOULD KNOW ABOUT AUTOMOTIVE FUEL

Important safety precautions



Do not overfill the fuel tank. The pressure in an overfilled tank may cause leakage and lead to fuel spray and fire.



If you do not use the proper fuel cap, the pressure in the fuel tank can damage the fuel system or cause it to work improperly in a collision.



The fuel system may be under pressure. If the fuel cap is venting vapor or if you hear a hissing sound, wait until it stops before completely removing the cap.



Automotive fuels can cause serious injury or death if misused or mishandled.

Maintenance and care

Observe the following guidelines when handling automotive fuel:

- Extinguish all smoking materials and any open flames before fueling your vehicle.
- Always turn off the vehicle before fueling.
- Automotive fuels can be harmful or fatal if swallowed. If fuel is swallowed, call a physician immediately, even if no symptoms are immediately apparent. The toxic affects of fuel may not be visible for hours.
- Fuels can also be harmful if absorbed through the skin. If fuel is splashed on the skin, promptly remove contaminated clothing and wash skin thoroughly with soap and water.
- If fuel is splashed in the eyes, remove contact lenses, flush with water for 15 minutes and seek medical attention.
- Be particularly careful if you are taking “Antabuse” or other forms of disulfiram for the treatment of alcoholism. Breathing gasoline vapors or skin contact could cause an adverse reaction. Consult a physician immediately.



Choosing the right fuel

Use only UNLEADED FUEL. The use of leaded fuel is prohibited by law and could damage your

Maintenance and care

vehicle. The damage may not be covered by your warranty.

Your vehicle was not designed to use fuel containing manganese-based additives such as MMT. Additionally, vehicles certified to California emission standards (indicated on the underhood Vehicle Emissions Control Information label) are designed to operate on California reformulated gasolines. If California reformulated gasoline is not available when you refuel, your vehicle can be operated on non-California fuels. However, even though your engine will perform adequately on other gasolines, the performance of the emission control devices and systems may be adversely affected. Repair of damage caused by using a fuel that your vehicle was not designed for may not be covered by your warranty.

Octane recommendations

Your vehicle is designed to use regular gasoline with an (R+M)/2 octane rating of 87. We do not recommend gasolines labeled as “regular” in high altitude areas that are sold with octane ratings of 86 or even less.

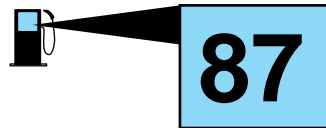

Do not be concerned if your vehicle sometimes knocks lightly. However, if it knocks heavily under most driving conditions on the

Maintenance and care

recommended octane fuel, see your dealer or a qualified service technician to prevent any engine damage.

Fuel quality

If you are experiencing starting, rough idle or hesitation problems try a different brand of fuel. If the condition persists, see your dealer or a qualified service technician.

The American Automobile Manufacturers Association (AAMA) issued a gasoline specification to provide information on high quality fuels that optimize the performance of your vehicle. We recommend the use of gasolines that meet the AAMA specification if they are available.

It should not be necessary to add any aftermarket products to your fuel tank if you continue to use a high-quality fuel.

Cleaner air

Ford approves the use of gasolines to improve air quality, including reformulated gasolines, that contain oxygenates such as a maximum of 10% ethanol or 15% MTBE. There should be no more than 5% methanol with cosolvents and additives to protect the fuel system.

Calculating fuel economy

To accurately calculate your vehicle's fuel economy:

Maintenance and care

1. Fill the tank completely and record the initial odometer reading.
2. Each time you fill the tank, record the amount of fuel added (in liters or gallons).
3. After at least three to five fuel tank fill-ups, fill the fuel tank and record the current mileage reading.
4. Use one of the following equations to calculate fuel economy.

Liters used x 100 ÷ Total kilometers traveled

Total miles traveled ÷ Total gallons used

Keep a record for at least one month. This will provide an accurate estimate of the vehicle's fuel economy.

WHAT YOU SHOULD KNOW ABOUT THE EMISSION CONTROL SYSTEM

Your vehicle is equipped with a catalytic convertor which enables your vehicle to comply with applicable exhaust emission requirements. For more information on your vehicle's emission control system, see the Vehicle Emission Control Information decal located on the left side of the engine compartment.

Follow these guidelines to ensure proper emission system operation:

Maintenance and care

- Use only unleaded fuel.
- Avoid running out of fuel.
- Do not turn off the ignition while the vehicle is in motion.
- Have regular maintenance checks performed according to the intervals in the *Service Guide*.

When servicing your vehicle, never use a metal exhaust collector. A metal collector may melt or deform plastic parts.



Do not park, idle, or drive your vehicle in dry grass or other dry ground cover. The emission system heats up the engine compartment and exhaust system, which can start a fire.



If you smell exhaust fumes inside your vehicle, have your dealer inspect your vehicle immediately. Do not drive if you smell exhaust fumes.



On vehicles without original equipment floor covering or insulation, do not let passengers ride in your truck in a manner that allows contact between skin and the metal floor.

If you notice one or more of the following, the emissions system may not be working properly. Have your vehicle serviced as soon as possible.

Maintenance and care

- Fluid leaks
- The  or service engine soon lights illuminate in the instrument cluster and remain lit.
- Strange odors
- Engine runs more than five seconds after shut-off or engine misfires, surges, stalls or backfires
- Loss of oil pressure

Important emission control information

By law, anyone who manufactures, repairs, services, leases, trades vehicles or supervises a fleet of vehicles is not permitted to intentionally remove an emission control device or prevent it from working. Do not make any unauthorized changes to the vehicle or engine. Changes that cause more unburned fuel to reach the exhaust system can increase the temperature of the engine or exhaust system.

When your vehicle is serviced, never use a metal exhaust collector. The use of a metal collector may melt or deform plastic parts.



Do not park, idle, or drive your vehicle in dry grass or other dry ground cover. The emission system heats up the engine compartment and exhaust system, which can start a fire.

Maintenance and care

Preparing your vehicle for inspection/maintenance (I/M) testing

In some localities it may be a legal requirement to pass an I/M test of the on-board diagnostic (OBD) II system. If your vehicle's powertrain system or battery has just been serviced, the OBD II system is reset to a condition unready for I/M testing. To ready the OBD II system for I/M testing, the law specifies that additional city and highway driving is necessary to complete the check of the OBD II system.

The driving modes required to reach the ready condition consist of a minimum of 30 minutes of city and highway driving:

- At least 20 minutes driving in stop and go city-type traffic with at least four idle periods.
- At least ten minutes of driving on an expressway or highway.

Before completing the above driving modes, the engine must be warmed up and at operating temperature. Once started, the vehicle must not be turned off during these modes.

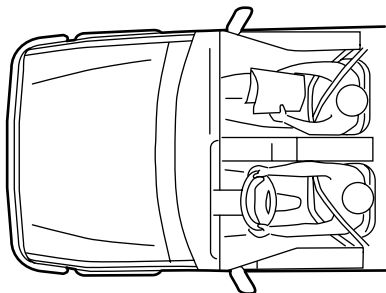

REPLACING BULBS

Replacing exterior bulbs

It is a good idea to check the operation of the following lights frequently:

- Headlamps
- Tail lamps
- Brakelamps
- High-mount brakelamp
- Backup lamps
- Hazard flashers
- Turn signals
- License plate lamp

Do not remove lamp bulbs unless they will be replaced immediately. If a bulb is removed for an extended period of time, contaminants may enter the lamp and affect performance.

Headlamp bulb (aerodynamic)



Handle a halogen headlamp bulb carefully and keep out of children's reach. Grasp the bulb only by its plastic base and do not touch the glass. The oil from your hand could cause the bulb to break the next time the headlamps are operated.

Maintenance and care

1. Open the hood.
2. Push each clip tab toward the engine compartment and lift upward to the stop position.
3. Remove the headlamp assembly.

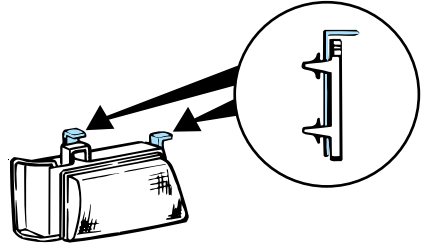

4. Remove bulb retention ring by turning it counterclockwise about 1/4 turn.

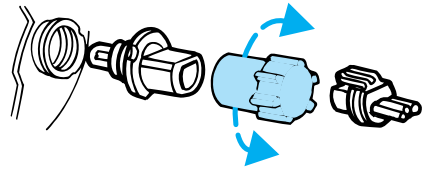

5. Pull bulb assembly out of headlamp assembly.
6. Pull out bulb.
7. Replace bulb.
8. Reverse steps 1–3 to replace headlamp assembly.

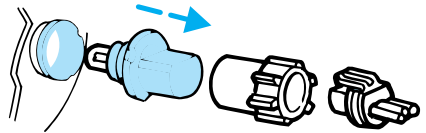

Bulb specifications

Description	Number of Bulbs	Trade Number
Front Lamps - Exterior		
Headlamps (low series)	2	H6054
Headlamps (high series)	2	9007
Park lamp and turn signal	2	3157NAK
Rear Lamps - Exterior		
Back-up lamps	2	3156K
License plate lamp	2	186
Stop/Tail/Side marker lamp	2	3357K
Turn lamp	2	3156K
High-mount brakelamp	2	912

Maintenance and care

Description	Number of Bulbs	Trade Number
Interior Courtesy Lamps		
Cargo lamp	1	211-2
Dome lamp (standard)	1	912
Instrument panel illumination	2	194
Map/reading lamp	2	211-2
Radio Illumination¹		
Instrument Panel		
Automatic transmission gear selector	1	194
Instrument Panel Controls		
A/C control	1	161
Heater control	1	161
Instrument Cluster		
Seat belt light	1	194
High beam indicator	1	194
Brake Warning	1	194
Turn signal indicator	1	194
Anti-lock brake system	1	194
Service engine soon	1	194
Air bag readiness	1	194
Door ajar	1	194
Oil pressure/engine coolant	1	194

¹Replaceable at Ford authorized radio service centers.

NA — Natural amber

K — Krypton filled bulb

Maintenance and care

CLEANING AND CARING FOR YOUR VEHICLE

Refer to the “Customer Assistance Guide” for a list of Ford-approved cleaners, polishes and waxes.

Washing your vehicle

Wash your vehicle regularly with cold or lukewarm water. Never use strong detergents or soap. If your vehicle is particularly dirty, use a quality car wash detergent. Always use a clean sponge, washing glove or similar device and plenty of water for best results. To avoid spots, avoid washing when the hood is still warm, immediately after or during exposure to strong sunlight.

During winter months, it is especially important to wash the vehicle on a regular basis. Large quantities of dirt and road salt are difficult to remove, and they also cause damage to the vehicle.

Remove any exterior accessories, such as antennas, before entering a car wash.

- After washing, apply the brakes several times to dry them.

Waxing your vehicle

The best way to determine when the paintwork needs waxing is by noting when water stops beading on the surface. This could be every three or four months, depending on operating conditions.

Use only carnauba or synthetic-based waxes. Remove

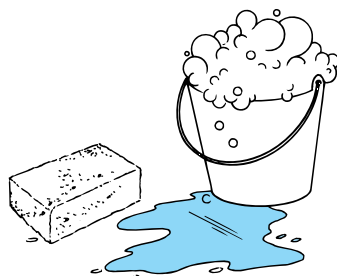

Maintenance and care

any bugs and tar before waxing vehicle. Use cleaning fluid or alcohol with a clean cloth to remove. Use tar remover to remove any tar spots.

Repairing paint chips

Minor scratches or paint damage from road debris may be repaired with touch-up paint, paint repair foil or aerosol paint spray from the Ford accessory line. Observe the application instructions on the products.

Remove particles such as bird droppings, tree sap, insect remains, tar spots, road salt and industrial fallout immediately.

Cleaning the wheels

Wash the wheels with the same detergent you use to clean the body of your vehicle. Do not use acid-based wheel cleaners, steel wool, fuel or strong detergents. Never use abrasives that will damage the finish of special wheel surfaces. Use a tar remover to remove grease and tar.

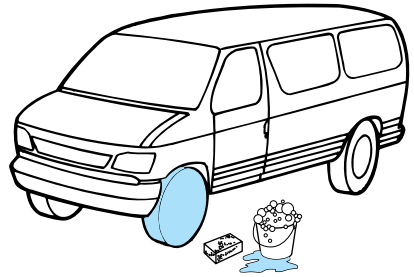

Cleaning the engine

Engines are more efficient when they are clean because grease and dirt buildup act as insulators and keep the engine warmer than normal. Follow these guidelines to clean your engine:

- Take care when using a power washer to clean the engine. The

Maintenance and care

high pressure fluid could penetrate the sealed parts and cause damage.

- Do not spray with cold water to avoid cracking the engine block.
- Cover the highlighted areas to prevent water damage when cleaning the engine.

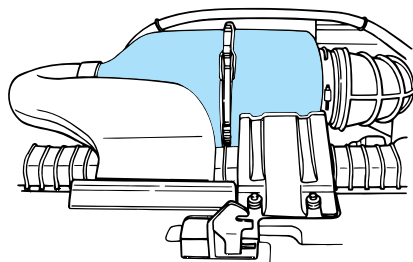

- Never wash or rinse the engine while it is running; water in the running engine may cause internal damage.

Cleaning plastic exterior parts

Use a vinyl cleaner for routine cleaning of plastic. Clean with a tar remover if necessary. Do not clean plastic parts with thinners, solvents or petroleum-based cleaners.

Cleaning the exterior lamps

Wash the exterior lamps with the same detergent you used to wash the exterior of your vehicle. Use glass cleaner or tar remover if necessary.

To avoid scratching the lamps, do not use a dry paper towel, chemical solvents or abrasive cleaners to clean the lamps.

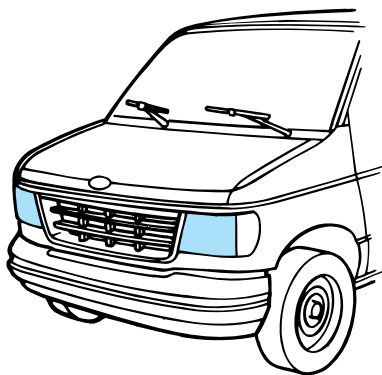

Maintenance and care

Cleaning the wiper blades

If the wiper blades do not wipe properly, clean both the windshield and wiper blades using undiluted windshield wiper solution or a mild detergent. Rinse thoroughly with clean water. To avoid damaging the blades, do not use fuel, kerosene, paint thinner or other solvents.

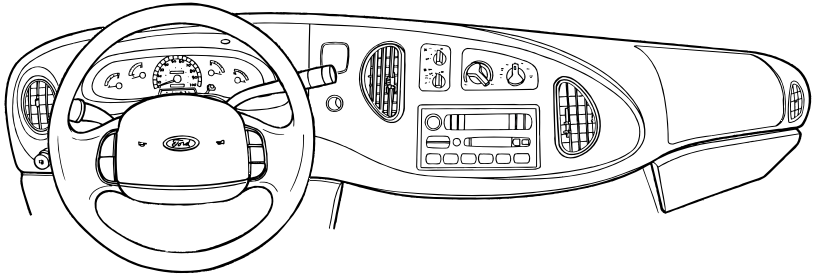

Cleaning the instrument panel

Clean instrument panel with a damp cloth, then dry with a dry cloth.

Any cleaner or polish that increases the gloss of the upper portion of the instrument panel should be avoided. The dull finish in this area is to help protect the driver from undesirable windshield reflection.

Cleaning the interior fabric

Remove dust and loose dirt with a whisk broom or a vacuum cleaner. Remove fresh spots immediately. Follow the directions that come with the cleaner.

Maintenance and care

Cleaning and maintaining the safety belts

Clean the safety belts with a mild soap solution recommended for cleaning upholstery or carpets. Do not bleach or dye the belts, because these actions may weaken the belt webbing.

Check the safety belt system periodically to make sure there are no nicks, wear or cuts. If your vehicle has been involved in an accident, have all the safety restraints examined by a qualified technician.

Capacities and specifications

MOTORCRAFT PART NUMBERS

Component	Engine application			
	4.2L	4.6L	5.4L	6.8L
Spark plug	AWSF-42EE	AWSF-32PP	AWSF-22E	AWSF-22E
Air filter	FA-1632	FA-1632	FA-1632	FA-1632
Oil filter	FL-400-S	FL-820-S	FL-820-S	FL-820-S
Fuel filter	FG-872	FG-872	FG-872	FG-872
Battery				
Standard	BXT-65-650	BXT-65-650	BXT-65-650	BXT-65-650
Optional	BXT-65-750	BXT-65-750	BXT-65-750	BXT-65-750
Auxiliary	BH-65DC	BH-65DC	BH-65DC	BH-65DC
P.C.V. valve	EV-152	EV-233	EV-233	EV-233

REFILL CAPACITIES

Fluid	Application	Capacity
Engine oil (includes filter change)	4.2L engine	5.7L (6.0 qts.)
	4.6L engine	5.7L (6.0 qts.)
	5.4L engine	5.7L (6.0 qts.)
	6.8L engine	5.7L (6.0 qts.)
Engine coolant	4.2L engine	22.0L (23.2 qts.)
	4.6L engine	23.7L (25.0 qts.)
	5.4L engine	27.4L (29.0 qts.)
	6.8L engine	29.0L (30.6 qts.)
Rear axle	Ford 8.8"/9.75" conventional and Traction-Lok	2.6L (5.5 pints) ¹
	Dana 9.75" (M60-IU)	3.0L (6.3 pints) ²
	Dana 10.5" (M70-2U)	3.1L (6.6 pints) ²
	Dana 10.5" M70-1HD)	3.5L (7.5 pints) ²
	Dana 11.25" (model 80)	3.5L (7.5 pints) ²

Capacities and specifications

Fluid	Application	Capacity
Transmission ³	Automatic (4R70W)	13.1L (13.9 qts.)
	Automatic (E4OD)	15.0L (15.9 qts.)
Fuel	138" wheelbase (except E-Super Duty)	132.5L (35.0 gal.)
	158" wheelbase (except E-Super Duty)	140L (37.0 gal.) ⁴
	176" wheelbase (except E-Super Duty)	140L (37.0 gal.) ⁴
	158" wheelbase (E-Super Duty)	208L (55 .0 gal.)
	176" wheelbase (E-Super Duty)	208L (55 .0 gal.)

¹Fill 6.4 mm to 14.2 mm (1/4" to 9/16") below bottom of fill hole.

²Fill Dana rear axles to 1/4" to 3/4" below bottom of fill hole.

³Always use dipstick to determine exact fluid requirement.

⁴Optional tank, 208L (55 gal.).

LUBRICANT SPECIFICATIONS

Item	Ford part name	Ford part number	Ford specification
Brake master cylinder	High Performance DOT 3 Motor Vehicle Brake Fluid	C6AZ-19542-AB	ESA-M6C25-A, DOT 3
Door weatherstrips	Silicone Lubricant	C0AZ-19553-AA and D7AZ-19553-AA	ESR-M13P4-A

Capacities and specifications

Item	Ford part name	Ford part number	Ford specification
Engine coolant	Ford Premium Cooling System Fluid	E2FZ-19549-AA	ESE-M97B44-A
Engine oil (gasoline)	Motorcraft 5W-30 Super Premium Motor Oil	XO-5W30-QSP	WSS-M2C153-F with API certification mark
Engine oil (diesel)	Consult separate diesel engine owner's guide supplement		
Hinges, latches and striker plates	Multi-Purpose Grease	D7AZ-19584-AA or D0AZ-19584-AA	ESR-M1C159-A and ESB-M1C93-B
Lock cylinders	Penetrating Lubricant	E8AZ-19501-B	—
Power steering reservoir	Motorcraft MERCON® Automatic Transmission Fluid	XT-2-QDX	MERCON
Automatic transmission	Motorcraft MERCON® Automatic Transmission Fluid	XT-2-QDX	MERCON
Windshield washer fluid reservoir	Ultra-Clear Windshield Washer Concentrate	C9AZ-19550-AC or BC	ESR-M17P5-A
Disc brake caliper rails	Silicone Brake Caliper and Dielectric compound	D7AZ-19A331-A WA-10	ESE-M1C171-A

Capacities and specifications

Item	Ford part name	Ford part number	Ford specification
Parking brake assembly (E-Super Duty)	Motorcraft MERCON® Automatic Transmission Fluid	XT-2-QDX	MERCON
Ford conventional and Traction-Lok axles *	Motorcraft SAE 75W140 High Performance Synthetic rear axle lubricant	F1TZ-19580-B	WSL-M2C192-A
Dana conventional and Traction-Lok axles **	Motorcraft SAE 80W90 Premium rear axle lubricant	XY-80W90-QL	WSP-M2C197-A
Dana 80 Axle (E-Super Duty)	Motorcraft SAE 75W140 High Performance Synthetic rear axle lubricant	F1TZ-19580-B	WSL-M2C192-A
Dana Axle (E-350 van/wagon w/4.10 ratio)	Motorcraft SAE 75W140 High Performance Synthetic rear axle lubricant	F1TZ-19580-B	WSL-M2C192-A

* Add 118 ml (4 oz.) of EST-M2C118-A (friction modifier Part No. C8AZ-19B546-A) for complete refill of Ford Traction-Lok rear axles.

** Add 237 ml (6 oz.) of EST-M2C118-A (friction modifier Part No. C8AZ-19B546-A) for

Capacities and specifications

complete refill of Dana
Traction-Lok rear axles.

ENGINE DATA

4.2L ENGINE

Displacement	4.2L (256 cid) V6
Bore X Stroke	96.8 x 95.0 mm (3.81 x 3.74 in.)
Induction	Sequential multi-port fuel injection
Ignition	Electronic distributorless ignition system (EDIS)
Firing order	1-4-2-5-3-6
Spark plug gap	1.37 mm (.054 in.)
Compression ratio	9.2:1

4.6L ENGINE

Displacement	4.6L (281 cid) V8
Bore X Stroke	90.2 x 90.0 mm (3.55 x 3.55 in.)
Induction	Sequential multi-port fuel injection
Ignition	Electronic distributorless ignition system
Firing order	1-3-7-2-6-5-4-8
Spark plug gap	1.37 mm (.054 in.)
Compression ratio	9.0:1

5.4L ENGINE

Displacement	5.4L (330 cid) V8
Bore X Stroke	90.2 x 105.8 mm (3.55 x 4.17 in.)
Induction	Sequential multi-port fuel injection
Ignition	Coil on plug
Firing order	1-3-7-2-6-5-4-8
Spark plug gap	1.37 mm (.054 in.)
Compression ratio	9.0:1

Capacities and specifications

6.8L ENGINE

Displacement	6.8L (415 cid) V10
Bore X Stroke	90.2 x 105.8 mm (3.55 x 4.17 in.)
Induction	Sequential multi-port fuel injection
Ignition	Coil on plug
Firing order	1-6-5-10-2-7-3-8-4-9
Spark plug gap	1.37 mm (.054 in.)
Compression ratio	9.0:1

Capacities and specifications

VEHICLE DIMENSIONS

Van/wagon models

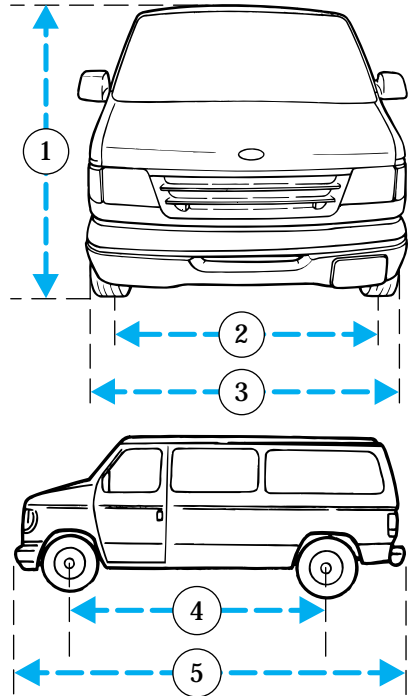

	E-150	E-250	E-350
1 = Overall height	2054.8 mm (80.9 in.)	2118.4 mm (83.4 in.)	2136.1 mm (84.1 in.)
2 = Track front/rear	1762.8 mm (69.4 in.)/1701.8 mm (67.0 in.)		
3 = Overall width (excluding mirrors)	2014.2 mm (79.3 in.)		
4 = Wheelbase	3505 mm (138 in.)		
5 = Overall length	Regular van, 5379.7 mm (211.8 in.) Super van, 5892.8 mm (232.0 in.)		

Capacities and specifications

Cutaway/commercial stripped chassis models

	E-250	E-350	E-Super Duty
1 = Overall height	Refer to Body Builder for specifications.		
2 = Track front/rear	1762.8 mm (69.4 in.)/1701.8 mm (67.0 in.)	1762.8 mm (69.4 in.)/SRW 1701.8 mm (67.0 in.), DRW 1859.3 mm (73.2 in.)	1762.8 mm (69.4 in.)/1973.6 mm (77.7 in.)
3 = Overall width (excluding mirrors)	Refer to Body Builder for specifications.		
4 = Wheelbase	3149.6 mm (124 in.)	3505 mm (138 in.) 4013 mm (158 in.) 4470 mm (176 in.)	4013 mm (158 in.) 4470 mm (176 in.)
5 = Overall length	Refer to Body Builder for specifications.		

VEHICLE IDENTIFICATION NUMBER

Complete Ford built vehicles

The vehicle identification number is attached to your vehicle in the following places:

- On the metal tag attached to the top of the instrument panel on the driver's side.

Capacities and specifications

- On the safety compliance certification label. This label is required by the National Highway Traffic Safety Administration and is made of special material. If it is tampered with, it will be destroyed or a destruction pattern will appear.

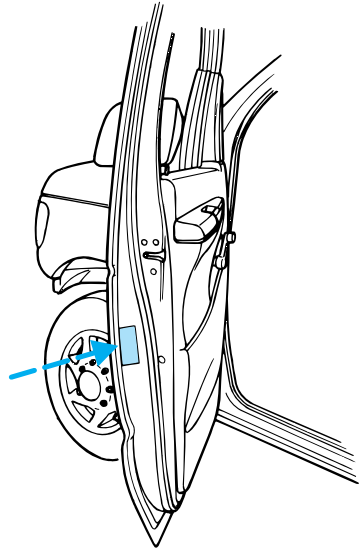

Incomplete vehicles

On completed derivations of incomplete vehicles, the safety compliance certification label is affixed at a location determined by a subsequent stage manufacturer of the completed vehicle. In these cases the completed vehicle is manufactured in two or more stages by two or more separate manufacturers.

Reporting safety defects

REPORTING SAFETY DEFECTS (U.S. ONLY)

If you believe that your vehicle has a defect that could cause a crash, or could cause injury or death, you should immediately inform the National Highway Traffic Safety Administration (NHTSA) in addition to Ford Motor Company.



If NHTSA receives similar complaints, it may open an investigation, and if it finds that a safety defect exists in a group of vehicles, it may order a recall and remedy campaign. However, NHTSA cannot become involved in individual problems between you, your dealer or Ford Motor Company.

To contact NHTSA, you may either call the Auto Safety Hotline toll-free at 1-800-424-9393 (202-366-0123 in the Washington D.C. area) or write to:

NHTSA

U.S. Department of Transportation
400 Seventh Street
Washington D.C. 20590

You can also obtain other information about motor vehicle safety from the Hotline.

Index

- Air bag supplemental restraint system52
 - and child safety seats54
 - description52
 - disposal58
 - indicator light57
 - passenger air bag55
- Audio system (see Electronic sound system)17
- Battery144
 - servicing145
- Brakes
 - adjustment80
 - anti-lock80
 - fluid, checking and adding134
 - parking80
- Brake-shift interlock85
- Break-in period4
- Bulbs, replacing165
 - headlamps166
 - specifications167
- Cleaning your vehicle168
 - engine compartment170
 - fabric172
 - instrument panel172
 - plastic parts171
 - safety belts172
 - tail lamps171
 - washing168
 - waxing169
 - wheels170
- Climate control system17
- Controls
 - steering column23
- Coolant (see Engine coolant) proper solution137
- Driveline universal joint and slip yoke144
- Driving under special conditions
 - heavy load86
- Emission control system162
 - emissions warranty163
- Engine178
 - check engine temperature warning, message center129
- Engine block heater77
- Engine coolant
 - checking and adding136
 - checking hoses138
- Engine oil
 - changing oil and oil filter133
 - specifications130
- Entry system
 - illumination36
- Exhaust fumes78
- Fail safe cooling139
- Flashing the lights27
- Fuel157
 - calculating fuel economy161
 - improving fuel economy99
 - octane rating160
 - quality160
 - safety information relating to automotive fuels157
- Fuel pump shut-off switch100
- Fuse panels
 - instrument panel104
 - power distribution box108
- Fuses102
- Gauges, Mechanical11
 - engine coolant temperature gauge12
 - engine oil pressure gauge13
 - fuel gauge12
- Gearshift24
- Hazard flashers27,100
- Headlamps
 - turning on and off15
- Hood128

Index

- Idle
 - relearning 145
- Ignition 23
- Inspection
 - maintenance testing 164
- Jump-starting your vehicle 120,122
 - attaching cables 121
 - disconnecting cables 122
- Lamps
 - cargo lamps 30
 - courtesy lamps 31
- Lights, warning and indicator
 - air bag 9
 - anti-lock brakes (ABS) 8
 - brake 8
 - charging system 9
 - check engine 8
 - door ajar 10
 - engine oil pressure 10
 - high beam 10
 - safety belt 9
- Load limits
 - trailer towing 89
- Lubricant specifications 175
- Odometer 13
- Overdrive 24
- Parking brake
 - operation 81,82
- Parts (see Motorcraft parts) 174
- Power features
 - door locks 32
 - mirrors 31
- Power point electrical outlet 17
- Power steering
 - fluid, checking and adding 140
- Refill capacities for fluids 174
- Relays 102,111
- Remote entry system 34
 - locking/unlocking doors 34
 - panic alarm 35
 - replacement/additional transmitters 36
 - replacing the batteries 35
- Reporting safety defects 183
- Safety restraints
 - adjusting the safety belts 49
 - automatic locking mode (retractor) 47
 - extension assembly 50
 - for children 58
 - lap and shoulder belts 45
 - maintenance 51
 - proper use 43
 - warning light and chime 51
- Safety seats for children
 - automatic locking mode (retractor) 61,62,66
- Seats 37
 - adjusting the seat, manual 37
 - adjusting the seat, power 38
 - bench seat 39
 - lumbar support 39
 - quick release rear captain's chair 41
- Servicing your vehicle 124
 - precautions when servicing ... 124
- Special notice 2
 - ambulance conversions 2
 - diesel-powered vehicles 3
- Speed control 28
 - accelerating 29
 - resetting 29
 - resuming a set speed 30
 - turning off 28
- Speedometer 12
- Starting your vehicle 73
 - preparing to start your vehicle 74
 - starting a warm engine 77
- Steering, power 82
- Steering wheel
 - tilting 26
- Tires 153
 - changing 112,114

Index

- checking the pressure153
- replacing116,155
- rotating155
- snow tires and chains156
- spare tire112
- tire grades151
- treadwear151
- Towing your vehicle123
- Trailer towing94
 - safety chains96
 - tips97
 - trailer brakes96
 - trailer lamps96
- Transmission
 - automatic operation83
 - fluid, checking and adding
(automatic)141
- Trip odometer14
- Turn signal
 - indicator lights10
- Vehicle Identification Number
(VIN)181
- Ventilating your vehicle79
- Voltmeter (see Battery voltage
gauge)13
- Warning chimes11
 - headlamps on11
 - key in ignition11
 - safety belt11
- Warning lights (see Lights)8
- Washer fluid135
- Windshield washer fluid and
wipers149
 - checking and replacing wiper
blades150
 - operation27

Filling station information

Fuel information	Unleaded only - 87 octane
Fuel tank capacity	Refer to Refill capacities in the <i>Capacities and specifications</i> chapter.
Engine oil specifications	Use only oil displaying the American Petroleum Institute Certification Mark SAE 5W-30
Tire size and pressure	See Safety Compliance Certification Label on inside of driver door
Hood release location	Bottom left of driver side instrument panel
Fuel filler location	Left rear of vehicle