

## VOICE RECOGNITION TIPS

### BLUETOOTH®

**Command** Example  
Dial <Phone #> — “Dial  
7-1-4-0-0-0-8-8-8-8”

Call <Name> — “Call John Smith”

Improving how you store your contacts can optimize your Bluetooth® Voice Recognition performance:

- Use full names instead of short or single-syllable names (“John or Dad”)
- Avoid using special characters/emojis or abbreviations (“Dr.”) when saving contacts

### NAVIGATION

**Command** Example  
Find Address — “1-2-3-4-5 1st Street,  
<House #, Street, Fountain Valley”  
City, State>

Find <POI Name> — “Find McDonald’s”

Located on Rearview Mirror

### LOCAL SEARCH



**Command** Example  
Find <POI Name> — “Find Lowe’s® near me”  
<POI Name> — “Starbucks®”

□ DEMONSTRATE AUTOMATIC CLIMATE CONTROL - page 17

□ DEMONSTRATE HOW TO OPERATE WINDSHIELD WIPER AND WASHER – page 12

□ HOW TO DEFROST

- 1 Press the front defrost button.
- 2 Set to warmest temperature setting.
- 3 Set to highest fan speed.

□ TIRE PRESSURE MONITORING SYSTEM (TPMS)- page 40

Low tire pressure indicator /  
TPMS malfunction indicator

NOTE: Tire pressure may vary in colder temperatures causing the low tire pressure indicator to illuminate. Inflate tires according to the Tire Pressure Label located on the driver’s side door pillar.

□ INTRODUCTION AND LOCATION OF THE SERVICE DEPARTMENT

□ SET FIRST SERVICE VALET APPOINTMENT

□ REVIEW FACTORY RECOMMENDED MAINTENANCE SCHEDULE

□ WAS THE CONDITION OF YOUR VEHICLE (AT DELIVERY) TO YOUR SATISFACTION?

□ GENESIS CONNECTED SERVICES

- Assist with creating a Genesis Owners account
- Assist with Genesis Connected Services enrollment
- Show Genesis Connected Services Users Manual
- Encourage customer to download the Genesis Intelligent Assistant App

Sales Consultant \_\_\_\_\_ Date \_\_\_\_\_ Sales Manager \_\_\_\_\_ Date \_\_\_\_\_

New Owner \_\_\_\_\_ Date \_\_\_\_\_

\_\_\_\_\_ @ \_\_\_\_\_  
Email \_\_\_\_\_

## MAINTENANCE

Scheduled Maintenance (Normal Usage)		2.5T		3.5T
Engine Oil And Filter	Replace	8,000 or 12 mos.	Replace	8,000 or 12 mos.
Fuel Additives	Add	7,500 or 12 mos.	Add	6,000 or 12 mos.
Tire Rotation	Perform	7,500 or 12 mos.	Perform	6,000 or 12 mos.
Vacuum Hose				
Air Conditioning Refrigerant				
Brake Hoses & Lines				
Drive Shafts & Boots				
Exhaust Pipe & Muffler				
Front Brake Disc/Pads, Calipers	Inspect	7,500 or 12 mos.	Inspect	6,000 or 12 mos.
Rear Brake Disc/Pads				
Steering Gear Box, Linkage & Boots/ Lower Arm Ball Joint, Upper Arm Ball Joint				
Suspension Mounting Bolts				
Propeller Shaft				
Air Cleaner Filer	Inspect	7,500 or 6 mos.	Inspect	7,500 or 6 mos.
	Replace	30,000 or 24 mos.	Replace	30,000 or 24 mos.
Climate Control Air Filter (For Evaporator And Blower Unit)	Replace	Every 12 mos.	Replace	Every 12 mos.
Fuel Tank Air Filter				
Fuel Filler Cap, Fuel tank	Inspect	16,000 or 24 mos.	Inspect	16,000 or 24 mos.
Brake Fluid				
Parking Brake				
Fuel Lines, Fuel Hoses And Connections	Inspect	16,000 or 24 mos.	Inspect	16,000 or 24 mos.
Front(AWD)/Rear Differential Oil	Inspect	30,000 or 48 mos.	Inspect	24,000 or 48 mos.
Drive Belt	Inspect	At first 48,000 or 72 mos.	Inspect	At first 48,000 or 72 mos.
		After that, every 8,000 or 12 mos.	Inspect	After that, every 8,000 or 12 mos.
Spark Plugs (Iridium Coated)	Replace	48,000	Replace	48,000
Coolant	Replace	First 120,000 or 120 mos.	Replace	First 120,000 or 120 mos.
		Subsequent, every 30,000 or 24 mos.		Subsequent, every 30,000 or 24 mos.
Automatic Transmission Fluid	No checks or services required for Normal Usage driving.			

\*Check the engine oil regularly between recommended oil change. Genesis Branded Vehicle recommend Full synthetic Oil.

\*The fuel filter is considered to be maintenance free but periodic inspection is recommended for this maintenance schedule depends on fuel quality. If there are some important safety matters like fuel flow restriction, surging, loss of power, hard starting problem etc, replace the fuel filter immediately regardless of maintenance schedule and consult an authorized HYUNDAI or KIA dealer for details.

\*See Owner’s Manual for details.

Looking For more detailed information? This Quick Reference Guide does not replace your vehicle’s Owner’s Manual. If you require additional information or are unsure of a specific issue, we recommend that you always refer to the vehicle’s Owner’s Manual or contact your authorized retailer of Genesis Branded Products. The information contained in this Quick Reference Guide is correct at the time of printing; however, specifications and equipment can change without notice. No warranty or guarantee is being extended in this Quick Reference Guide, and Genesis Brand reserves the right to change product specifications and equipment at any time without incurring obligations. Some vehicles are shown with optional equipment.

NP150-J2021  
(Rev 11/16/20)  
Printing 11/19/20

# GENESIS G80

## QUICK REFERENCE GUIDE



## GENESIS BRANDED VEHICLE OWNER PRIVACY POLICY

Your Genesis Branded Vehicle may be equipped with technologies and services that use information collected, generated, recorded or stored by the vehicle. We have created a Vehicle Owner Privacy Policy to explain how these technologies and services collect, use, and share this information.

You may read our Vehicle Owner Privacy Policy at [www.genesis.com/us/en/my-privacy-rights.html#owner](http://www.genesis.com/us/en/my-privacy-rights.html#owner). If you would like to receive a hard copy of our Vehicle Owner Privacy Policy, please contact Customer Care at:

Genesis Customer Care  
Genesis Motor America/Phoenix  
P.O. Box 83835  
Phoenix, AZ 85071-3835  
CustomerCare@genesismotorsusa.com

Genesis Customer Care Center representatives are available Monday through Friday, between the hours of 5:00 AM and 5:00 PM PST and Saturday between 6:30 AM and 3:00 PM PST (English). For Customer Care assistance in Spanish or Korean, representatives are available Monday through Friday between 6:30 AM and 3:00 PM PST.

Roadside Assistance: **1-844-340-9742**  
SiriusXM® Radio: **1-800-967-2346**  
Genesis Customer Care &  
Connected Services: **1-844-340-9741**  
**www.MyGenesis.com**



Instrument cluster  
Page 13



Navigation  
Page 29

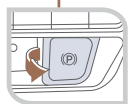
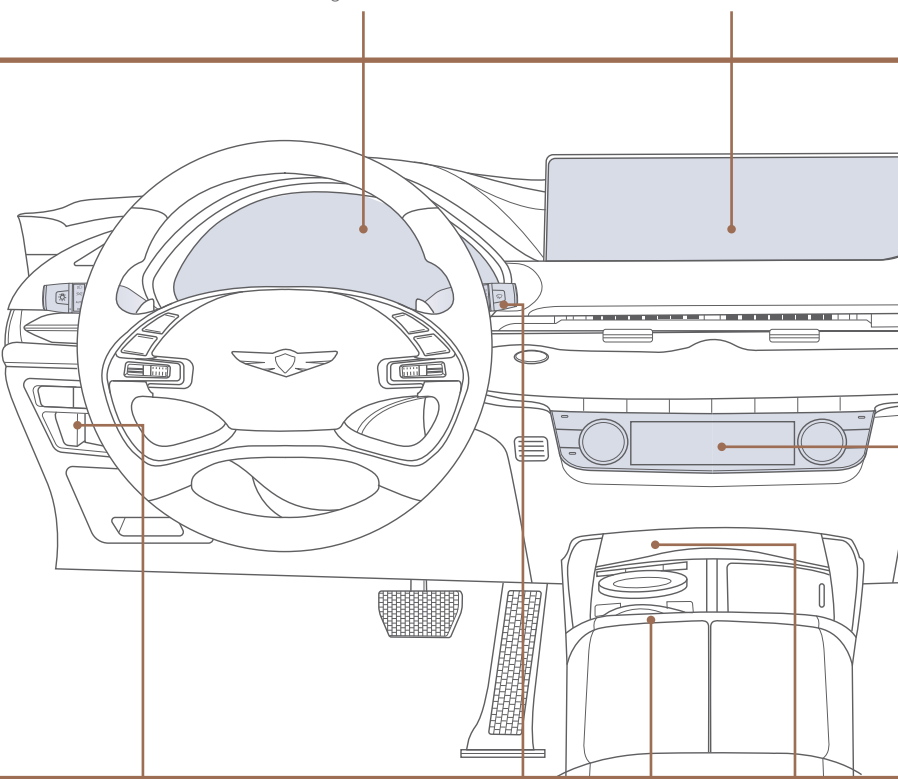

Electronic Parking Brake (EPB)  
Page 35

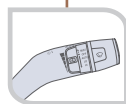

Wiper and washer  
Page 12



Shift by wire gear selector  
Page 34



USB Ports  
Page 30



Climate control system  
Page 17

## FEATURES AND CONTROLS

Climate control system	17
Door lock	02
Driver's main controls	08
Headlights and fog lights	11
Head-up display	16
Instrument cluster	13
Interior lights	10
LCD display control	15
LCD display view	15
Panoramic Sunroof	09
Seat-Driver position memory system	04
Seat-Front seat adjustment	03
Seat-Headrest adjustment	04
Seat-Seat warmer & cooler	05
Smart key	01
Smart trunk	07
Trunk lid control button	07
Trunk operation	06
Warnings and indicators	16
Wipers and washer	12

## INFOTAINMENT

Android Auto™	23
Apple CarPlay™	25
Audio control	31
Bluetooth Phone Pairing	19
Genesis Connected Services	20
Homelink wireless garage control system	32
Navigation	29
Radio	31
USB ports	30
Wireless cellular phone charging system	30

## DRIVING

Blind-Spot Collision-Avoidance Assist (BCA)	38
Driver Attention Warning (DAW)	34
Electronic Parking Brake (EPB)	35
Forward Collision Avoidance Assist (FCA)	39
Forward/Reverse Parking Distance Warning (PDW)	39
Highway Driving Assist (HDA)	38
Idle Stop and Go (ISG)	37
Lane Keeping Assist (LKA)	35
Shift by Wire Gear Selector	34
Smart Cruise Control (SCC)	36
Tire Pressure Monitoring System (TPMS)	40

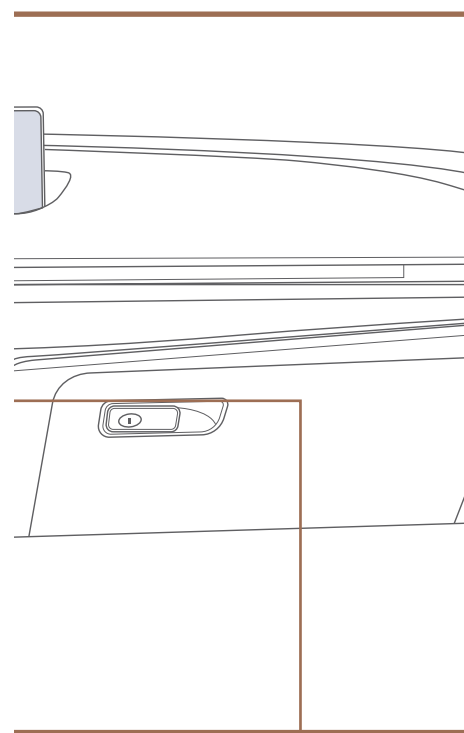

### ⚠ WARNING!

To reduce the risk of serious injury to yourself and others, read and understand the important SAFETY INFORMATION in your Owner's Manual.

Use this Quick Reference Guide to learn about the features that will enhance your enjoyment of your Vehicle. More detailed information about these features are available in your Owner's Manual.

\*Some vehicles may not be equipped with all the listed features.

## SMART KEY

### Type A

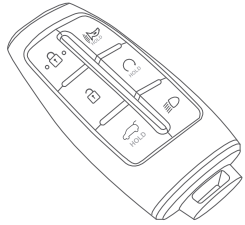

- Lock
- Unlock
- Trunk open
- Panic

### Type B

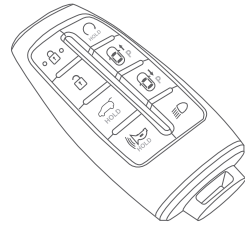

- Remote Start
- Remote Smart Parking Assist
- Lamp ON

### Remote start using Smart Key (if equipped)

You can start the vehicle using the Remote Start button on the smart key.

To start the vehicle remotely:

1. Press the door lock button on the smart key within 32 feet (10m) from the vehicle.
2. Press the Remote Start button for more than 2 seconds within 4 seconds after pressing the door lock button.
3. The hazard warning lights will blink and the engine will start.
4. To turn off the remote start function, press the Remote Start button once.

### Accessing mechanical key

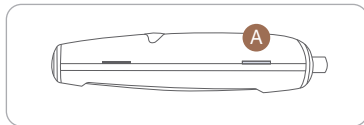

1. Place a soft cloth over the groove **A**, and pry open the smart key cover.

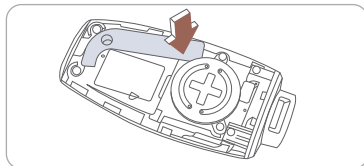

2. Press the mechanical key and remove it from the smart key FOB.

## DOOR LOCK

### Operating Door Locks from Outside the Vehicle

#### Mechanical Key

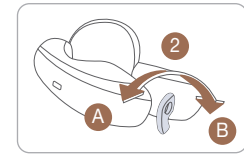
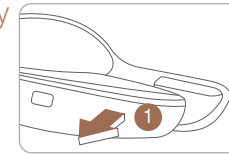

After pulling the door handle **1**, turn the key **2** toward the front of the vehicle to lock **A** or turn the key toward the rear of the vehicle to unlock **B**.

If you lock the driver's door with a mechanical key while the engine is running, turn the key **2** TWICE toward the front of the vehicle to lock **A**.

If you lock/unlock the driver's door with the mechanical key, only the driver's door will lock/unlock automatically, not others.

Once the doors are unlocked, they can be opened by pulling the door handle. When closing the door, push the door by hand. Make sure that doors are closed securely.

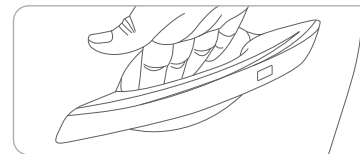

#### Driver's door Lock / Unlock

- **To Unlock** : Place your hand inside the door handle
- **To Lock** : Press the touch sensor on the outside of the handle to lock.

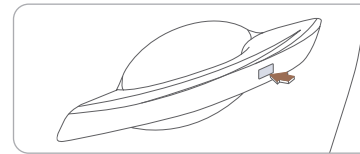

#### \* CAUTION

- If you locked the door with the touch sensor on the door handle, the doors cannot be unlocked with the sensor within 3 seconds.
- If you unlocked the door with the touch sensor on the door handle, the doors cannot be locked with the sensor within 2 seconds.

NOTE: User selectable option: Please see section 5 from your Owner's Manual for more details.

## FRONT SEAT ADJUSTMENT

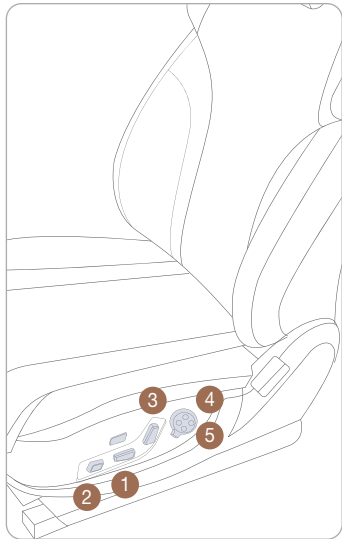

### Forward and backward ①



### Seat cushion length (for driver's seat) ②



### Seat cushion support (for driver's seat) ②

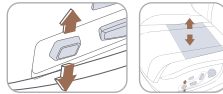

### Seatback angle ③

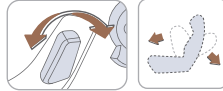

### Seat cushion height ①

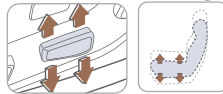

### Lumbar support ④

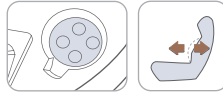

### Seat bolster adjustment (for driver's seat) ⑤

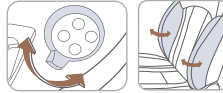

### Ergo Motion Seat (if equipped)

Ergo-Motion seat automatically adjusts the driver seat during long drives. Select seat settings on the infotainment settings screen to activate.

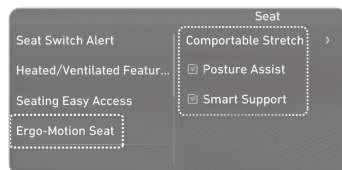

## HEADREST ADJUSTMENT

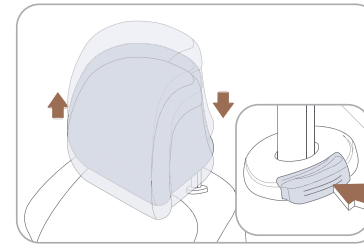

**To Raise Headrest:**  
Pull headrest up.

**To Lower Headrest:**  
Press lock button while pressing down on headrest.

**To adjust headrest forward (front seats only):**  
Pull forward to 1 of 3 positions.

**To adjust headrest rearward (front seats only):**  
Pull it fully forward to the farthest position and release it.

## DRIVER POSITION MEMORY SYSTEM

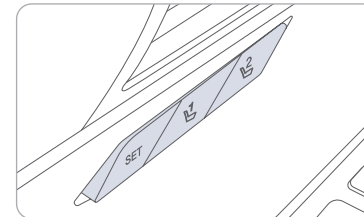

### To Store Settings

- Shift to P (Park) while the Engine Start/Stop button is in the ON position.
- Adjust the driver's seat position, outer side view mirror position, steering wheel position, instrument panel illumination intensity and head-up display height/brightness to the desired position.

**NOTE:** To reset the system, please refer to the Owner's Manual.

- Press the SET button. The system will beep once and notify you 'Press button to save settings' on the cluster LCD display.
- Press one of the memory buttons (1 or 2) within 4 seconds. The system will beep twice when the memory has been successfully stored.
- 'Driver 1 (or 2) settings saved' will appear on the cluster LCD display. The message appears only for the driver's seat position memory setting.

**NOTE:** Transmission must be in P (Park).

### To Recall

Press the desired memory button (1 or 2). The system will beep once.

## SEAT WARMER

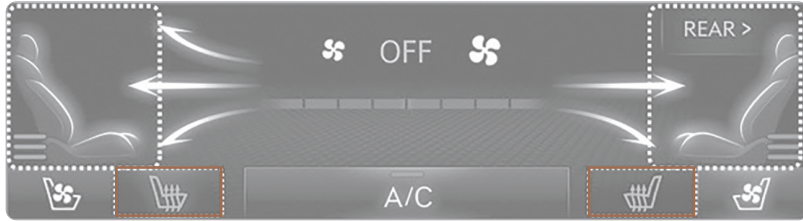

### - Warmer

Touch either of the seat warmer icons to warm the driver's seat or front passenger's seat, the setting is changed as follows:

Touch and hold the icon to turn OFF the seat warmers.

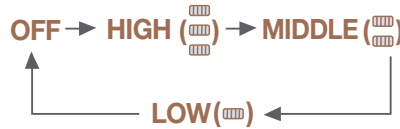

## SEAT COOLER

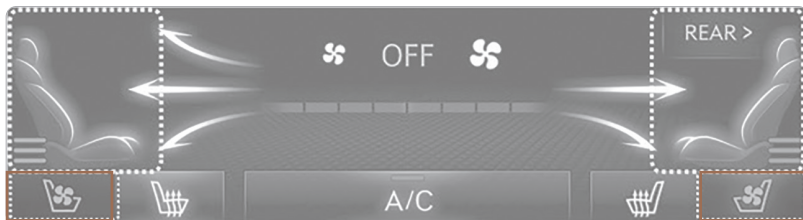

### - Air Ventilation

Touch either of the seat cooler icons to cool the driver's seat or front passenger's seat, the setting is changed as follows:

Touch and hold the icon to turn OFF the seat warmers.

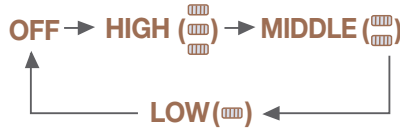

## TRUNK OPERATION

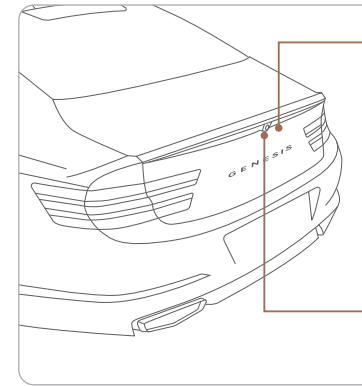

### Power trunk open button

Press to open. Smart key needs to be within the range.

**NOTE:** If all doors are unlocked, you can open the trunk without smart key.

### Power trunk open button on the smart key

Press and hold.

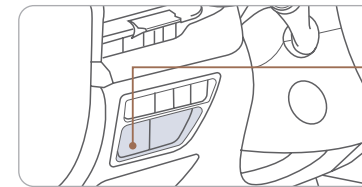

### Power trunk main control button

Press to open. Press and hold to close.

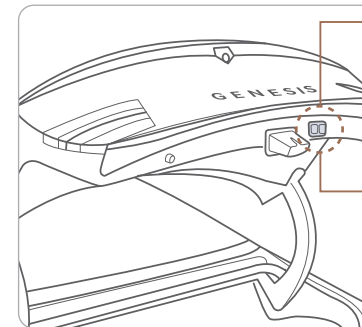

### Power trunk close button

Press to close.

### Power trunk lock button

Press to lock the trunk and doors will lock as well. Smart key needs to be within range.

**NOTES:** Trunk opening height adjustment is available in the Vehicle setup options. Please refer to your Owner's Manual for further information.

### **NOTES:**

When Customers slightly close the trunk lid manually, the trunk will close automatically

When Customers slightly open the trunk lid manually, the trunk can open automatically

## TRUNK LID CONTROL BUTTON

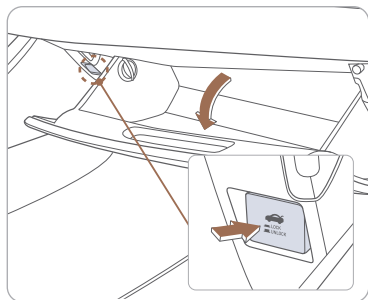

The trunk lid control button is used to prevent unauthorized access to the trunk.

1. Open the glove box.
2. Press the trunk lid control button. In this LOCK position, the trunk can only be opened with trunk release lever.
3. Close and lock the glove box with the mechanical key.

**NOTE:** Without the mechanical key, the smart key can only start the engine and operate door locks. Please refer to your Owner's manual to learn how to access the mechanical key.

## SMART TRUNK

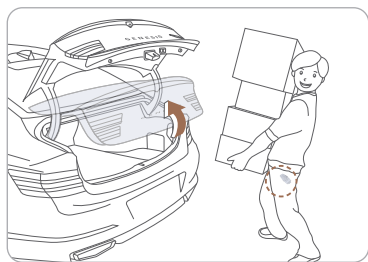

### Smart Trunk

When smart key is within range for 3 seconds, the trunk will automatically open.

**To enable Smart Trunk function:** Vehicle must be in P (Park) to adjust the settings located in the setup menu in the AVN system screen.

1. Select Setup > Vehicle > Door
2. Check "Smart Trunk".

**NOTE:** Function is active after 15 seconds when all doors are closed and locked. The vehicle will also provide an audible and visual alarm while activating. Please refer to your Owner's Manual for further information.

## DRIVER'S MAIN CONTROLS

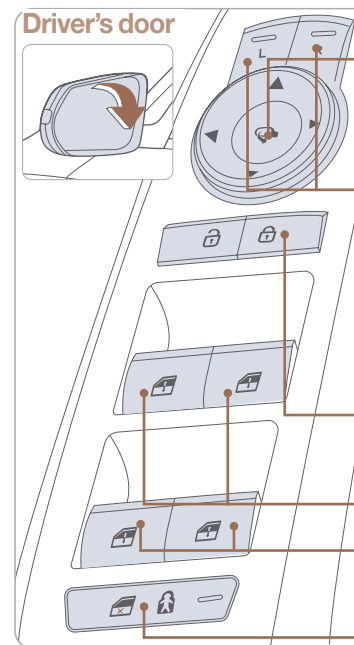

### Outside Rearview Mirror

- Press switch to unfold/fold mirrors. Press the lock or unlock button on the smart key, and the mirrors will be folded or unfolded.
- Press the L or R button to adjust the mirror by using the directional switch. If L or R button is still selected, both mirrors will tilt downward when reversing. Deselect L or R will disable the auto tilt down feature.

### Door Lock

- Locks/unlocks all doors.

### Window Switches

- Front power window switches.
- Rear power window switches.

### Electronic Child Lock (if equipped)

- When the electronic child lock button

### Mechanical Key

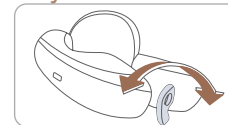

### Inside door handle of rear door

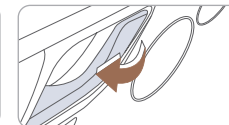

### Unlock switch of front LH/ RH side door

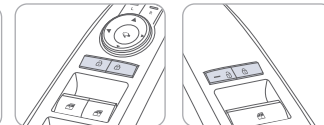

After parking and getting out of vehicle with Engine ON or Ignition ON, if all doors are locked by accident with rear door lock switch, which has all door lock function, Genesis cannot be unlocked with fob or O/S handle touch sensor.

※ Unlock the car using following method

- 1) Unlock with Mechanical key
- 2) Unlock with Bluelink App
- 3) (If any company in cabin and electronic child lock is off) Pull the inside door handle of rear door TWICE
- 4) (If any company in cabin and electronic child lock is off) Unlock with unlock switch of driver/passenger side door

## PANORAMIC SUNROOF

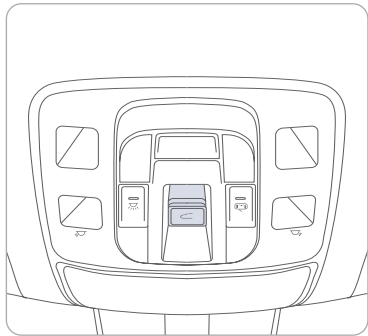

### Sunshade

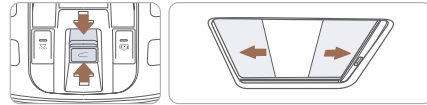

### Sliding the sunroof

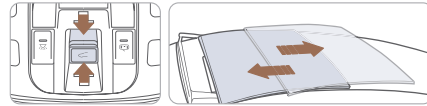

### Tilting the sunroof

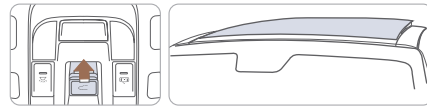

Sunroof Lever	Sunroof operation
Push backward to 2nd detent	Shade + Sunroof open
Push backward to 1st detent	Shade open
Push up	Tilt
Push forward to 2nd detent	Shade + Sunroof close
Push forward to 1st detent	Shade close

### When the sunshade is closed

If you push the sunroof control lever upwards, the sunshade will slide all the way open and then the sunroof glass will tilt open.

### When the sunshade is opened

If you push the sunroof control lever upwards, The sunroof glass will tilt open.

## INTERIOR LIGHTS

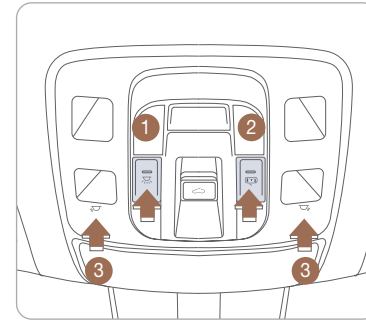

### Room Lamp (Rear)

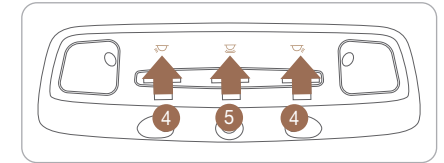

### Master Switch (☀) ①

Push the switch to turn front map lamp and rear room lamp on or off

When the Master Switch ① is pushed, the other Switches ②, ③, ④, ⑤ don't operate.

### Door Mode Switch (🚪) ②

When the Door Mode Switch ② is pushed, map lamp ③ and rear room lamp ④, ⑤ turn on if any door is opened and will turn off after all doors are closed.

### Map Lamp Touch Switch (☀, ☀) ③

Touch the symbol to turn on and off for each side of map lamp.

### Rear Map Lamp Touch Switch (☀, ☀) ④

Touch the symbol to turn on and off for each side of rear map lamp.

### Rear Mood Lamp Touch Switch (☀) ⑤

Touch the symbol to turn on and off rear mood lamp.



## HEADLIGHTS AND FOG LIGHTS

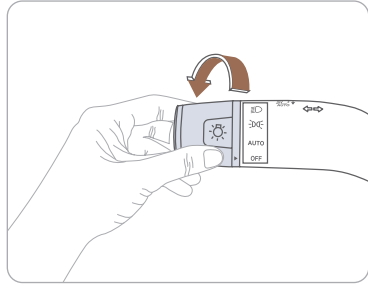

- ▶ | Headlights
- ▶ | Parking lights
- ▶ | **AUTO** Auto headlights
- ▶ | **OFF** All lights Off

### Headlight delay

Headlights may stay on for 15 seconds after exiting and locking up the vehicle. Press the remote lock button twice to turn the headlights off. Please refer to your Owner's Manual for further information.

Turn signals **A** and lane change **B** signals

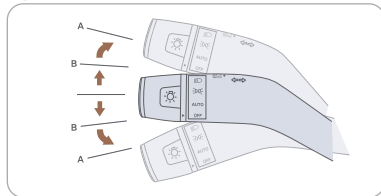

High beam

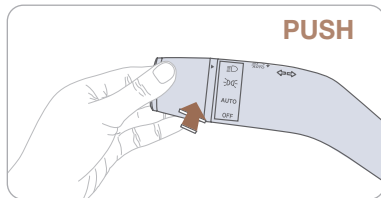

**NOTE:** To turn off the high beam, pull the lever towards you.

Flashing headlights

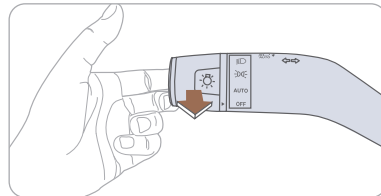

High Beam Assist

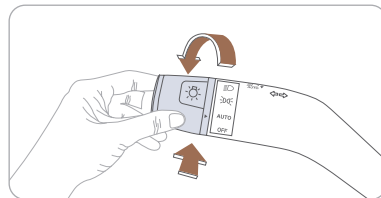

Function operation

1. Select auto position.
2. Push lever forward to engage Auto High beam.
3. Push lever forward again to disengage.

## WIPERS AND WASHER

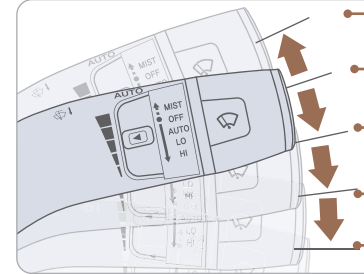

- **MIST** - Single wipe
- **OFF**
- **AUTO** - Auto control wipe
- **LO** - Low wiper speed
- **HI** - High wiper speed

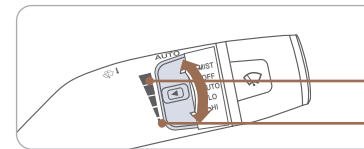

### Auto Control Wipe Adjustment

Adjust the control knob.

- Fastest wiper speed
- Slowest wiper speed

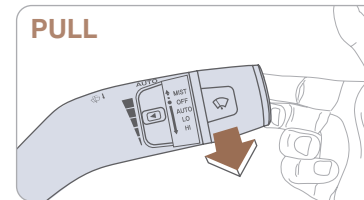

**PULL**

### Windshield Washer

Pull the lever gently toward you to spray washer fluid onto the windshield and to run the wipers 1-3 cycles.

This vehicle has a “hidden” wiper design which means they can't be lifted in their bottom resting position

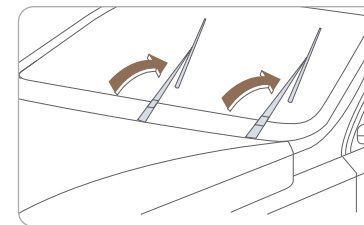

### Wiper Blade Removal

1. Within 20 seconds of turning off the engine, lift and hold the wiper lever up to MIST position for about 2 second until the wipers move to the top wipe position
2. At this position, you are able to lift the wipers off the windshield.
3. Gently put wipers back down onto windshield
4. Turn the wipers to any ON position to return to resting position

**NOTE:** To prevent damage to the hood and wiper arms, the wiper arms should only be lifted when in the top wiping position.

## INSTRUMENT CLUSTER

### Type A with 8" LCD Display



### Type B with 12.3" LCD Display with 3D feature



- 1 Tachometer
- 2 Speedometer
- 3 Engine coolant temperature gauge

- 4 Fuel gauge
- 5 Warning and indicator lights
- 6 LCD display

## LCD DISPLAY VIEW

View	Symbol	Explanation
Driving Assist		Driving Assist view displays the status of the vehicle's Driving Assistance systems.
Turn By Turn (TBT)		Turn By Turn view displays the state of the navigation.
Utility		Utility view displays driving information such as the trip distance, fuel economy and etc.

## LCD DISPLAY CONTROL

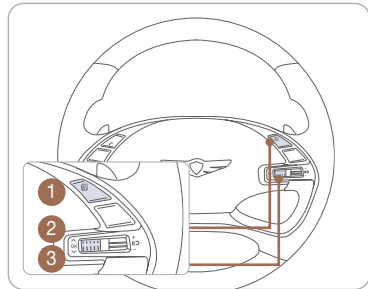

- 1 : VIEW button for changing View modes
- 2 : SCROLL UP, DOWN for changing items in Utility view and Option menu
- 3 : SELECT/RESET switch for entering Option menu (Press)  
 : SELECT/RESET switch for retrieving assist information or resetting the selected item (Press and hold)

## WARNINGS AND INDICATORS

Air bag warning light	Seat belt warning	Parking brake & Brake fluid warning light
Anti-lock Brake System (ABS) warning light	Electronic Brake Force Distribution (EBD) system warning light	
Electric Power Steering (EPS) warning light	Malfunction Indicator Lamp (MIL)	Charging system warning light
Engine coolant temperature warning light	Engine oil pressure warning light	Low fuel level warning light
Low tire pressure warning light	AWD LOCK	DBC
AWD warning light	Electric Parking Brake (EPB) warning light	Forward Collision-Avoidance Assist warning light
Master warning light	Electronic Stability Control (ESC) indicator	Electronic Stability Control (ESC) OFF indicator
Immobilizer indicator	Turn signal indicator	Low beam indicator
High beam indicator	Light ON indicator	High Beam Assist indicator
ECO indicator	Lane Keeping Assist indicator	Adaptive Front Lighting System
AUTO HOLD indicator	SPORT mode indicator	LED Headlight warning indicator

## HEAD-UP DISPLAY

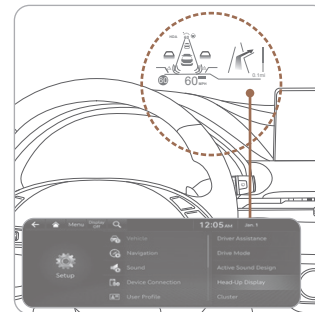

The Head-Up display is a transparent display which projects an image of selected information of the instrument cluster and navigation onto the windshield glass. To activate the head up display, select Head-Up Display in the Vehicle Settings menu on the infotainment screen. Adjust Head-Up Display height until in view.

**NOTE:** If you wear polarizing-filter sunglasses, it's difficult to read the Head Up Display information.

## CLIMATE CONTROL SYSTEM

### Front

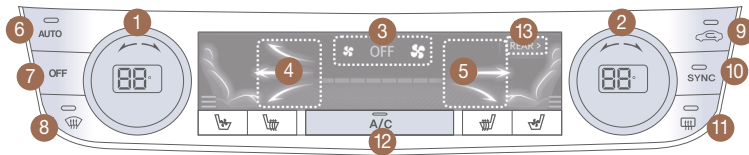

- 1 Driver's temperature control
- 2 Passenger's temperature control
- 3 Fan speed control
- 4 Driver's air vent selection
- 5 Passenger's air vent selection
- 6 AUTO (automatic control)
- 7 OFF (system off)
- 8 Front windshield defroster
- 9 Air intake control
- 10 SYNC
- 11 Rear window defroster
- 12 A/C (air conditioning)
- 13 Rear control

### Rear (if equipped)

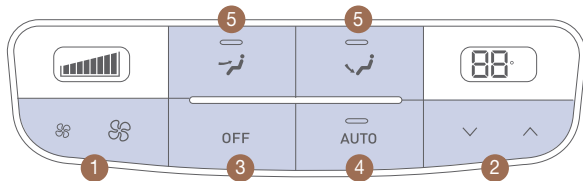

- 1 Fan speed control
- 2 Temperature control
- 3 OFF (system off)
- 4 AUTO (automatic control)
- 5 Mode selection

### SMART VENT

If cabin humidity increase while Climate Control is off, fresh air will be circulated into the cabin.

Please refer to the Owner's Manual for further details.

### AUTOMATIC HEATING / AIR CONDITIONING



Automatically controls the modes, fan speeds, air intake and air-conditioning functions.

### DEFOGGING/DEFROSTING



1. Press the front defrost button.

**NOTE:** Outside (fresh) air position will be selected when front defrost button is selected.

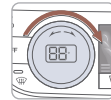

2. Select warmest temperature.

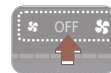

3. Set the fan speed to the highest speed setting.

**NOTE:** To reduce window fogging and improve visibility, keep the interior surface of the windshield clean by wiping it with a clean cloth and glass cleaner. In addition, position the air intake control to circulate fresh air whenever possible while operating the vehicle.

### SYSTEM OFF

Pressing the OFF button will place the system in below settings.

- Front blower will turn off.
- Outside (fresh) air position will be selected.
- Vented air will be at last set temperature.

### MODE SELECTION



Direction of air flow will change depending on which vent direction arrow is selected.

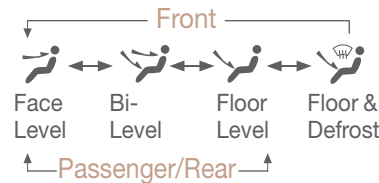

**NOTE:** Use a microfiber towel to prevent scratches on the climate controls while removing fingerprints, dust, or stains. Immediately wipe off any interior cleaning products to prevent damage to the climate controls.

### AIR INTAKE CONTROL



#### Recirculation mode

When Recirculation mode is selected, air from the passenger compartment will be recirculated through the system and heated or cooled according to the function selected.



#### Fresh mode

When Fresh mode is selected, air enters the vehicle from outside and is heated or cooled according to the function selected.

## BLUETOOTH PHONE PAIRING

### Pairing a new device

**NOTE:** Vehicle must be in (P) Park to complete pairing process.

1. Press the PHONE button in the head unit(or DIS navigation system) or  button in the steering wheel remote control.

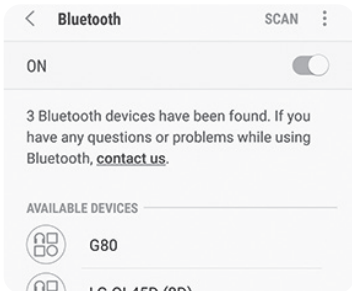
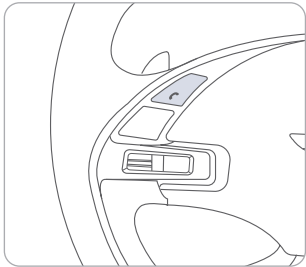

2. Search for the device name as displayed on your mobile phone and pair.



3. Confirm the 6-digit passkey displayed on the audio screen and the Bluetooth device identical.

4. Press OK in your Bluetooth device.
5. Pairing is complete.

#### Bluetooth pairing request

Passkey: 625259

Pair with G80?

CANCEL OK

## GENESIS CONNECTED SERVICES

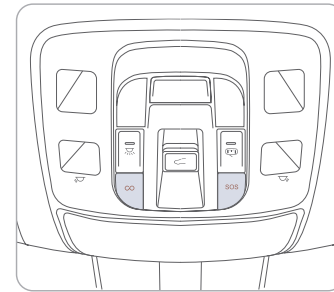

Genesis Connected Services subscription is required. To enroll, please visit your dealership or [MyGenesisUSA.com](http://MyGenesisUSA.com).

Press the **CO** button for access to the voice-response menu of services.

- You can say:  
Roadside Assistance  
Service Link  
Account Assistance

Press the **SOS** button for SOS Emergency Assistance.

Visit [MyGenesisUSA.com](http://MyGenesisUSA.com) for more information or refer to your Genesis Connected Services User's Manual for detailed information on system operation.

For immediate assistance with subscription services, please call 1-844-340-9741.

## Genesis Intelligent Assistant App



You can download the Genesis Intelligent Assistant App to your compatible smart phone from the following sites:

- iPhone® — Apple® App Store
- Android™ — Google Play™

## Remote Start

Remote Start enables you to remotely start your vehicle virtually from anywhere. For vehicles equipped with full-automatic temperature control, you can also enable climate control remotely and turn on the front window defroster, ensuring a warm or cool car is ready to go when you are.

- To use this feature, you must have a Genesis Connected Services Personal Identification Number (PIN). To create or change your PIN, log in to [MyGenesisUSA.com](http://MyGenesisUSA.com).

### Remember:

- Remote Start will automatically shut off after 10 minutes or after selected engine timer runs out.
- While this feature is active, the lights can blink until the vehicle is turned off or when vehicle is in operation.
- To continue to operate the vehicle, the proximity key must be inside the vehicle with the driver, prior to pressing the brake and being able to move the gearshift from the P (Park) position.

### Preconditions:

- Ignition is OFF
- Alarm is armed (i.e., vehicle locked by key fob or Remote Door Lock)
- Gearshift level is in the P (Park) position

- Brake pedal is not depressed
- Engine hood is securely closed
- All the doors are closed and locked
- The tailgate or trunk lid is closed
- The security / panic system is not activated
- The battery power is not low
- Vehicle is located in an open area
- It has been less than 7 days since last vehicle ignition off
- Vehicle located in area with good cell reception

### Remote Start will terminate:

- After 10 minutes or after selected engine timer runs out
- Brake is pressed without the proximity key inside the vehicle
- Accelerator pedal is pressed without the proximity key inside the vehicle
- Gearshift is changed without the proximity key inside the vehicle
- Alarm is triggered without the proximity key inside the vehicle
- The proximity key is not inside the vehicle after the door status is changed.

**Notice:** Laws in some communities may restrict the use of the features that remotely start the engine. For example, some laws may require a person using the remote start feature to have the vehicle in view when doing so, or limit the length of time a vehicle engine may idle. Please check local and state regulations for any requirements and restrictions on remote starting of vehicles and engine idling time.

### ⚠ WARNING!

Do not remote start vehicle in an enclosed environment (i.e., closed garage). Prolonged operation of a motor vehicle in an enclosed environment can cause a harmful build-up of carbon monoxide. Carbon monoxide is harmful to your health. Exposure to high levels of carbon monoxide can cause headaches, dizziness or in extreme cases unconsciousness and / or death. Do not leave children or animals unattended in a vehicle while using the remote start function.

### ⚠ CAUTION!

If the vehicle's windshield wipers are left on when the vehicle was last driven, then the wipers will turn on if the remote start function is activated. To avoid damage to the wiper blades (i.e., due to heavy ice or snow accumulated on the windshield), please always turn the vehicle's windshield wipers off when parking the vehicle.

## ANDROID AUTO™

### REQUIREMENTS:

- USB cable
- OS Android™ 5.0 or higher
- Compatible Android Phone
- Data and wireless plan for applicable features

### BEFORE YOU BEGIN:

- Android Auto features may operate differently than on your phone.
- Message and data charges may apply when using Android Auto.
- Android Auto relies on the performance of your phone. If you experience performance issues:
  - Close all apps and then restart them or
  - Disconnect and then reconnect your phone
- Using the USB cable that was provided with your phone is recommended.
- When Android Auto is active, press and hold the voice recognition button to make your requests.

### ANDROID AUTO SUPPORT



<https://support.google.com/androidauto/>

### DUAL VOICE RECOGNITION:

1. Pressing Voice Recognition button once will use vehicle onboard for requests.
2. Pressing and Holding Voice Recognition button will use Android Auto for requests.

## PHONE SETUP

Turn on Bluetooth® on your phone and connect the micro USB cable to your phone and the USB port on the vehicle.

Phone will prompt you to download the Android Auto app and update other needed apps (i.e. Google Maps™, Google Play Music™, Google Now™).

**NOTE:** Vehicle must be parked.

- Location mode setting should be set to High accuracy.
- Car and phone setup should be completed in one sitting. If phone setup needs to be resumed, recommend to Force Stop the Android Auto app on the Phone then reopen the app and accept the Disclaimer notifications.

## CAR SETUP

1. Go to settings on the head unit.
2. Touch the “Phone Projection” icon on screen.
3. Select “On” for Android Auto.
4. Connect your Android phone to the vehicle USB port. Agree to the notification and disclaimers on your phone then the “Android Auto” icon will appear confirming the setup.

For more detailed information on how to operate Android Auto, please refer to your navigation manual.

For additional Android Auto support, please refer to the Android Auto Support Website  
<https://support.google.com/androidauto/>

Android Auto, Google Play, Android, and other marks are trademarks of Google Inc.

## APPLE CARPLAY™

### REQUIREMENTS

- Apple Lightning® cable
- Latest iOS
- iPhone® 5 or above
- Data and wireless plan for applicable features

### BEFORE YOU BEGIN

- Apple® CarPlay features may operate differently than on your phone.
- Message and data charges may apply when using Apple CarPlay.
- Apple CarPlay relies on the performance of your phone. If you experience performance issues:
  - Close all apps and then restart them or
  - Disconnect and then reconnect your phone
- Using the Apple Lightning cable that was provided with your phone is recommended.
- When Apple CarPlay is active, press and hold the voice recognition button to make your requests

### PHONE SETUP

On your phone, go to Settings > General > CarPlay to allow CarPlay access.

On your phone, go to Settings > Siri and ensure Siri is turned ON.

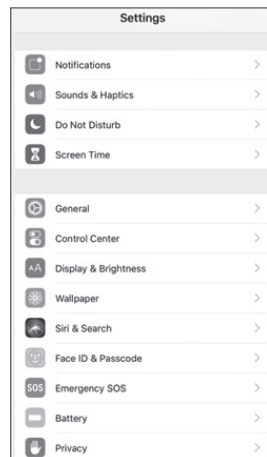

### CAR SETUP

1. Press the SETUP button.
2. Touch the “Phone Projection” icon on the screen.
3. Touch “Apple CarPlay” on the Connectivity Settings screen. Then touch “On” to enable Apple CarPlay.
4. Connect your Apple iPhone to the vehicle USB port then touch ‘OK’ when the pop-up message appears. The Apple CarPlay icon will now appear on the vehicle Home screen confirming the setup.

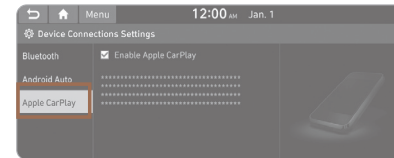

Apple CarPlay, Apple, and other marks are trademarks of Apple Inc.

### DUAL VOICE RECOGNITION:

1. Pressing Voice Recognition button once will use vehicle onboard for requests.
2. Pressing and Holding Voice Recognition button will use Apple Carplay for requests.



### CarPlay Home Screen

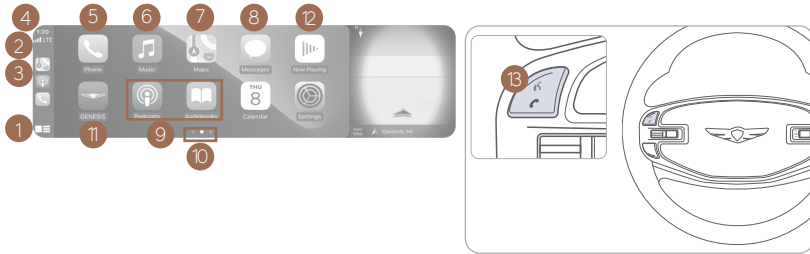

- 1 HOME ICON
- 2 WIRELESS CONNECTIVITY
- 3 CELLULAR SIGNAL
- 4 PHONE TIME
- 5 PHONE
- 6 APPLE MUSIC™
- 7 APPLE MAPS
- 8 MESSAGES
- 9 3RD PARTY APPS
- 10 SCREEN PAGE INDICATOR
- 11 EXIT TO HOME SCREEN
- 12 CURRENT CARPLAY AUDIO PLAYING
- 13 VOICE RECOGNITION

### SIRI

Apple CarPlay uses Siri to perform many actions like sending messages, placing calls, and looking up/setting POI/Destinations. A Siri session can be initiated on any screen by:

1. Touch and holding the HOME icon 1 on the CarPlay screen or
2. Press the steering wheel VOICE RECOGNITION 13 button.

Note: Ensure Siri feature is set to ON in your phone (Go to Settings > General > Siri).

3. Say any of the following commands;

- “Text <John Smith> ‘Call you later’” to send a text message.
- “Read text messages” to read available text message.
- “Call <John Smith>” to make a phone call.
- “Find <POI/Destination>” to locate a POI/Destination.

### PHONE

Touch the PHONE 5 icon to access the Phone screen. Siri will automatically asks ‘Who you would like to call’ when the PHONE 5 icon is selected.

NOTE: Phone call sound quality is dependent on the wired connection. Using the Lightning cable that came with the phone is recommended.

### APPLE MUSIC

Touch the APPLE MUSIC 6 icon to access the Apple Music screen.

### APPLE MAPS

Touch the APPLE MAPS 7 icon to access the Apple Map screen.

### MESSAGES

Touch the MESSAGES 8 icon to access the Message screen. Siri will automatically asks ‘To hear unread messages or create a new one’ when the MESSAGE icon is selected.

### 3rd PARTY APPS

Supported CarPlay apps that are downloaded on your phone will appear on the CarPlay screen. Touch the apps icons to access those supported apps.

NOTE: A list of the supported CarPlay supported apps can be found at <http://www.apple.com/ios/carplay/>

Ensure phone has latest version of the 3rd Party Apps.

## NAVIGATION

### Map position



- 1 Move to the Home Screen
- 2 Map view mode  
The map view can switch between Head Up and North Up.
- 3 Map Scale Display
- 4 Navigation Volume
- 5 Menu
- 6 Stop route/Resume route
- 7 Estimated arrival time and remaining distance
- 8 Current location and destination name display
- 9 Vehicle position mark
- 10 Route display
- 11 TBT (Turn by Turn): turns the TBT function on/off
- 12 Route: changes the route conditions when a route is set

**NOTE:** Map view can be changed by selecting Map view mode button.

## USB PORTS

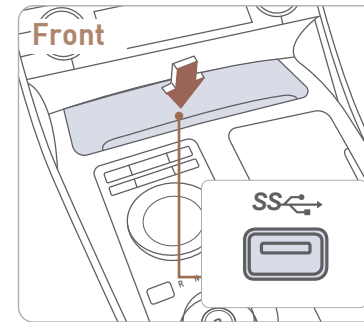

Plug in a USB cable or other media device to connect an external audio device and listen to it through the audio system in your vehicle.

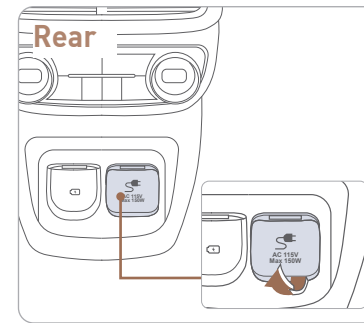

The rear USB charger is designed to recharge batteries of small size electrical devices using a USB cable. The AC inverter supplies 115 volts (150 watts) electric power to operate electric accessories or equipment.

## WIRELESS CELLULAR PHONE CHARGING SYSTEM

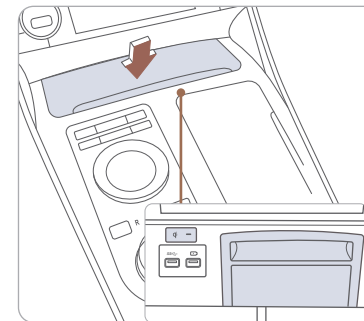

There is a wireless cellular phone charging system inside the front console. The system operates with all doors closed, and the ignition switch is in the ACC/ON position.

**NOTE:** The wireless cellular phone charging system supports only the Qi-enabled cellular phones (Qi).

**NOTE:** Do not place any metallic items such as coins, keys on the charger. Avoid putting credit cards, etc. on the charger as they might get damaged by the magnetic field.

## RADIO



- 1 Moves to home screen or the previous screen.
- 2 Moves to home screen.
- 3 Menu – Displays pop-up menu of each mode
- 4 Band - Selects the desired radio band by pressing [FM], [AM] or [SiriusXM].
- 5 Voice Recognition - Moves to voice recognition screen.
- 6 Mode display - Shows the mode currently in play.
- 7 Frequency Dial – Touch or drag to tune to the desired station.  
Press ☆ to add current station to the preset.

## AUDIO CONTROL

1. Users can set the volume level of each source (FM, AM, SXM, USB, BT and so on) individually by adjusting volume knob.
2. Then AVN (Headunit) will save the last volume levels of each source in the system sound settings.
3. If users change the source, the volume will revert to the previously set volume for that source.

## HOMELINK WIRELESS GARAGE CONTROL SYSTEM

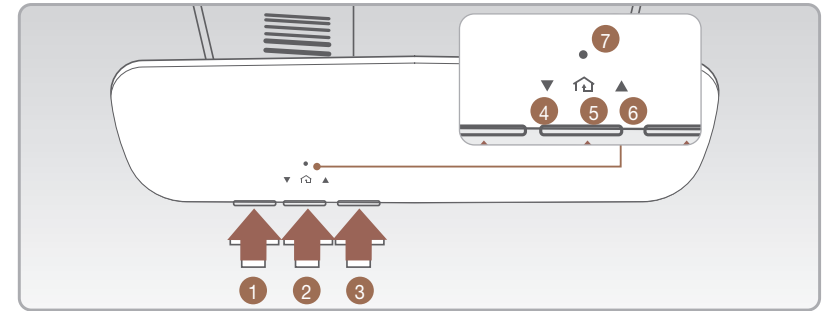

1. Press and release 1, 2 or 3 button.
  - If the indicator 7 is turned ON in Orange, go to Step 3 (programming mode)
  - If the indicator 7 is continuously turned ON or flashes in Green rapidly several times, go to Step 2 (erasing mode)
2. Press and hold the button you wish to program for approximately 15- 25 seconds until the LED flashes in Orange for several times.
3. Hold the Garage Door Opener Original Transmitter near the HomeLink Mirror.
4. Press the Original Transmitter button until the indicator 7 is turned continuously ON or flashes in Green for approximately 10 seconds and it indicates the programing is completed.

**NOTE:** If the indicator 7 flashes in Green continuously, but if the garage door opener does not operate, please continue to follow Rolling Code Programming steps below.

### Two Way Communication

Some new garage door openers come equipped with a two-way communication feature. If your garage door opener has this feature, please also continue to follow the Rolling Code Programming steps below. For more information and programming tips on two-way communication please visit [www.homelink.com/compatible/two-waycommunication](http://www.homelink.com/compatible/two-waycommunication) or call (800)-355-3515.



Indicator 4 & 6:  
 Flashes in orange → “Closing” & “Opening”  
 Solid Green → “Closed” & “Opened”

**NOTE:** If your garage door opener has Two-Way Communication functionality, it is possible for HomeLink to stop functioning the garage door shortly after initial programming, if the Two-Way Communication Programming wasn’t properly completed. If you experience this, completing the “Programming a New HomeLink Button” and “Two-Way Communication Programming” will restore door operation.

### Rolling Code Programming

- You may need a ladder to access your garage door opener.
- You may need help from a second person.
- Be prepared some of the steps are time sensitive.

1. Firmly press and release the “Learn”, Smart”, or “ Program” button of garage door opener on the ceiling while the indicator 7 flashes in Green. Once the button is pressed, you have approximately 30 seconds to initiate the next step.

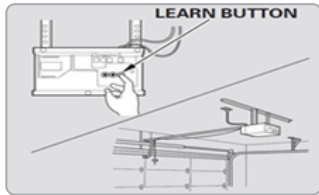

2. Return to the vehicle and firmly press the HomeLink button, hold for two seconds and release the button up to three times. Do not press the HomeLink button rapidly. At this point programming is complete and your device should operate.

For more detailed information, please refer to your Owner’s manual or visit [www.homelink.com](http://www.homelink.com) or call (800) 355-3515



### SHIFT BY WIRE GEAR SELECTOR

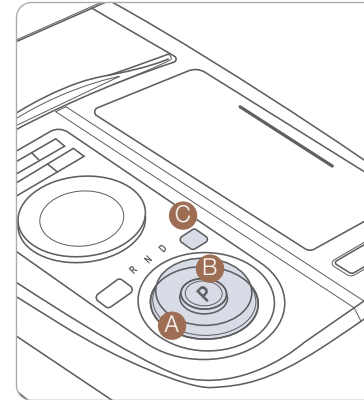

To shift the gear to P (Park), press the P button while depressing the brake pedal.

To shift the gear to N (Neutral), rotate the shift dial clockwise from R (Reverse) or counterclockwise from D (Drive) while depressing the brake pedal.

To shift the gear to R (Rear), rotate the shift dial counterclockwise while depressing the brake pedal.

**A** Rotary shifter (Rotary gear shift dial), **B** Park button, **C** P Release Cap

### DRIVER ATTENTION WARNING (DAW)

Driver Attention Warning is designed as a safety feature to warn or inattentive driving.

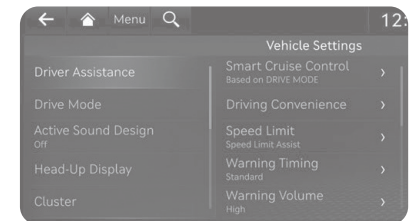
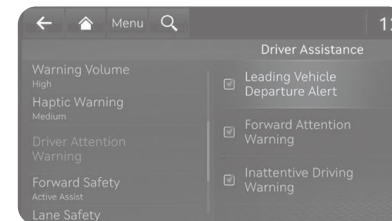

- To set Driver Attention Warning, go to: User settings > Vehicle > Driver Assistance > Driver Attention Warning. Driver Attention Warning is operable, when driving speed is above 40 mph.

## LANE KEEPING ASSIST (LKA)

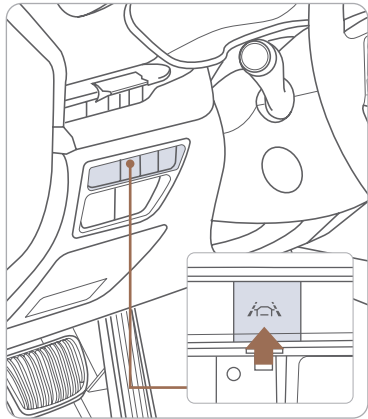

Lane Keeping Assist detects lane markers on the road, and helps prevent the vehicle from departing the lane while driving.

- To turn LKA on, press the Lane Safety button.
- To turn LKA off, press the button again.

LKA operates only when the vehicle speed is above 37 mph and when the  in the instrument cluster is green. LKA will not operate properly if the following conditions are present:

- the lane line is not clear
- on sharp bend in a road
- heavy fog

Refer to the Owner's Manual for more detailed information.

**NOTE:** During operation, you may feel the sensation of steering wheel movement. Depending on the road condition (gradient), the deflection driving may occur. LKA mode can be adjusted in the User Settings page of the infotainment system.

## ELECTRONIC PARKING BRAKE (EPB)

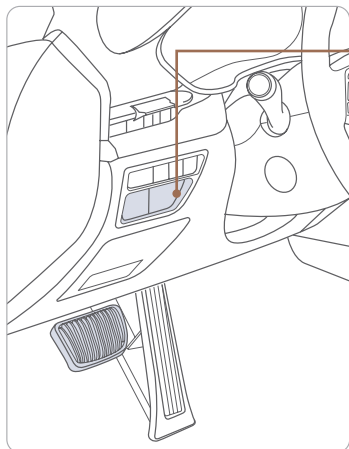

### Applying

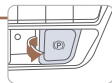

Stop the vehicle then pull the EPB switch.

### Releasing



Move shift lever from P/N to D/R while depressing the brake pedal.

or



Press the EPB switch while depressing the brake pedal.

**NOTE:** If necessary, emergency braking is possible by pulling and holding the EPB switch.

## SMART CRUISE CONTROL (SCC)

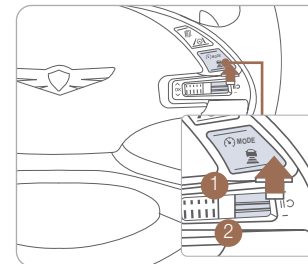
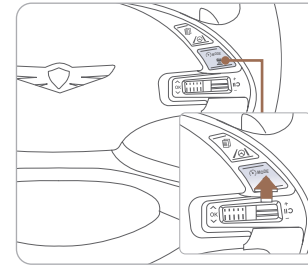

Smart Cruise Control helps maintain distance from the vehicle ahead and drive at a speed, set by the driver.

**To turn on SCC:**

1. Press the Driving Assist  MODE button to turn on SCC. The speed will be set to the current speed on the cluster.
2. If there is no vehicle in front of you, the set speed will be maintained, but if there is a vehicle in front of you, the speed may decrease to maintain the distance to the vehicle ahead. If the vehicle ahead accelerates, your vehicle will accelerate.

**To set vehicle distance**

Each time the button is pressed, the vehicle to vehicle distance changes as follows:

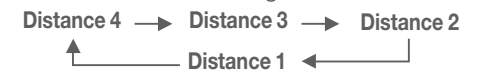

**Adjusting the vehicle speed**

1. Push '+' switch  UP to increase cruising speed.
2. Push '-' switch  DOWN to decrease cruising speed.

**NOTE:** Quick push up/down will change speed by 1 mph. Holding switch up/down will change speed by 5 mph.

**To Cancel Smart Cruise Control**

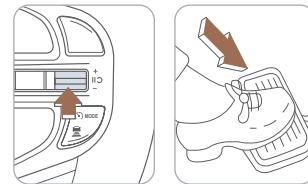

**To temporarily cancel SCC**

Press the switch or depress the brake pedal to temporarily cancel SCC.

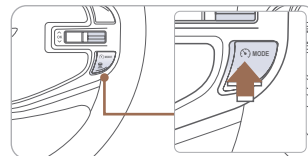

**To turn off the SCC**

Press the Driving Assist button to turn SCC off.

## IDLE STOP AND GO (ISG)

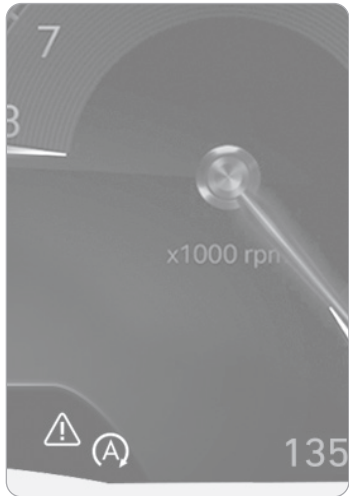

The ISG system will automatically shut off the engine when the vehicle is at a standstill (i.e. red stop light, stop sign, and traffic jam) to increase vehicle's fuel economy and reduce exhaust gas emissions. The auto stop indicator will illuminate in green on the instrument cluster when activated. To restart the engine in auto stop mode, release the brake pedal and press on the accelerator. The auto stop indicator goes OFF on the instrument cluster once the engine is restarted.

### Prerequisite for activation:

- The driver's seatbelt is fastened.
- The driver's door and the hood are closed.
- The brake pressure is adequate.
- The battery is sufficiently charged.
- The outside temperature is between 14°F and 95°F (-10°C and 35°C).
- Engine is warmed up.
- The incline is gradual.
- Steering wheel is turned less than 180 degrees.
- Shift lever is in DRIVE or NEUTRAL.

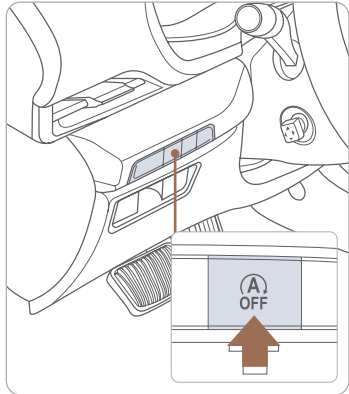

**NOTE:** The engine will not shut off if the prerequisites are not satisfied. In that case, the Auto Stop indicator will illuminate in yellow on the instrument cluster.

### To deactivate

Press the ISG OFF button, indicator illuminates.

### To activate

Press the ISG OFF button, indicator turns OFF.

## HIGHWAY DRIVING ASSIST (HDA)



Highway Driving Assist helps maintain a set distance and speed from the vehicle ahead when driving on a highway and helps center the vehicle in the lane while driving, even through a curve.

With the Engine Start/Stop button in the ON position, select or deselect 'Driver Assistance → Driving Convenience' from the setting menu to activate this setting.

**NOTE:** If the engine is turned off then on again, the system maintains the last setting.

### Operation :

- Driving on the highway main road.
  - Vehicle speed is under 120 mph (200 km/h).
- Press the Driving Assist button on the steering wheel.
  - If entering the main road of highways while SCC and LFA is operating, HDA will be automatically activated.

If HDA is operating, the indicator on the cluster will illuminate green.

## BLIND-SPOT COLLISION-AVOIDANCE ASSIST (BCA)

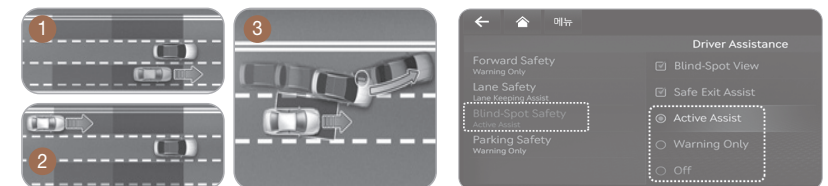

Blind-Spot Collision-Avoidance Assist helps avoid collisions with a rear side vehicle when changing lanes.

When operating the turn signal switch to change lanes, if there is a risk of collision with a rear side vehicle, BCA provides a warning or controls the vehicle to help avoid a collision depending on the collision risk levels.

## FORWARD COLLISION-AVOIDANCE ASSIST (FCA)



Forward Collision-Avoidance Assist designed to detect and monitor the vehicle ahead and warn the driver if a collision is imminent. On vehicles equipped with both front view camera and front radar sensor, a pedestrian or a cyclist detection is also available.

To operate the system, select 'Driver Assistance > Lane Safety' from the Settings menu.

**Active Assist:** FCA will activate emergency brake with a warning message, an audible warning and steering wheel vibration depending on the collision risk levels.

**Warning Only:** FCA will warn the driver with a warning message, an audible warning and steering wheel vibration depending on the collision risk levels.

**OFF:** FCA will off. The warning light will illuminate on the cluster.

**NOTE:** If driver does not maneuver to avoid impact when system detects a slower/stopped vehicle or pedestrian ahead, system applies automatic braking

## FORWARD/REVERSE PARKING DISTANCE WARNING (PDW)

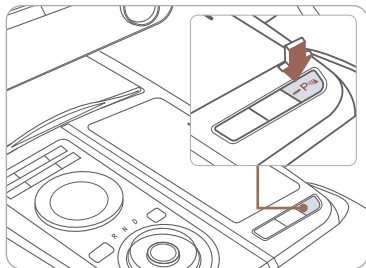

Forward/Reverse Parking Distance Warning will warn the driver if an obstacle is detected when the vehicle is moving forward or backward at low speeds.

### PDW On/Off

Press the Parking Safety button to turn On/Off:

On - LED On

Off - LED Off

If PDW is Off, PDW will turn On automatically when in Reverse.

PDW will not warn when vehicle is driven forward at speed above 6 mph.

**NOTE:** Forward Parking Distance Warning will not operate if the Parking Safety button is Off.

## TIRE PRESSURE MONITORING SYSTEM (TPMS)

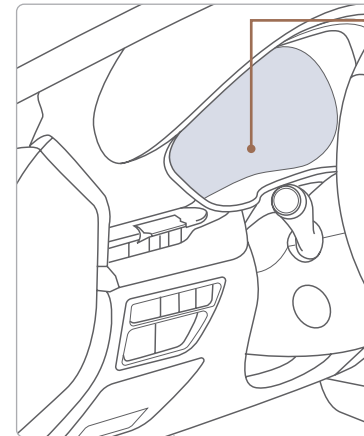

Low Tire Pressure Indicator / TPMS Malfunction Indicator

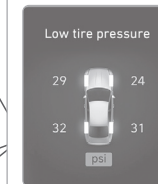

Low Tire Pressure / Tire Pressure Monitor / TPMS Malfunction Display (shown on the cluster LCD display)

### LOW TIRE PRESSURE INDICATOR

Illuminates if one or more of your tires are significantly under-inflated.

### TPMS MALFUNCTION INDICATOR

Blinks for approximately one minute, then remains illuminated when there is a malfunction with the TPMS. Inspect all tires and adjust tire pressure to specification. If the lamp remains illuminated, have the system checked by an authorized retailer of Genesis Brand Products as soon as possible.



To access the TPMS menu within the LCD display, press the Driving Assist mode button on the steering wheel to display tire pressure.

Tire pressures will display after driving a short distance. If a tire pressure drops lower than predetermined specification, the Low Tire Pressure Indicator (⚠️) will illuminate and the LCD display will indicate tire(s) requiring air.

## Program Coverage Summary

Genesis Service Valet is included for the first 3 years or 36,000 miles, whichever comes first, of ownership.			
Complimentary Services	Service Valet	Complimentary Loaner Vehicle	Maintenance
Original Owner or Lessee	Yes	Yes	Yes
Subsequent Owner or Lessee	Warranty Only	Warranty Only	No

See below for program terms and conditions.

## SERVICE VALET

Service Valet is available while your vehicle is receiving complimentary maintenance, wear items, or warranty repairs by an authorized Genesis retailer. Simply contact your authorized Genesis retailer's Service Experience Manager or contact the Customer Care Center at 844-340-9741 to make your appointment. The retailer will work with you to arrange your pickup and delivery time and location.

- Valet appointments must be made at least 2 business days in advance.
- Valet area of coverage is valid only within an estimated 1 hour drive time distance (based on traffic, weather, and road conditions) from the participating retailer location to the pickup/delivery location.
- Valet pickup and delivery must occur during normal business hours. After-hours pickup and delivery are at the discretion of your participating retailer.
- You must notify your Genesis Service Experience Manager 1 business day in advance if location or time of valet services changes. If a change or cancellation is not made at least 1 business day in advance, you may be charged a fee, or Service Valet may be cancelled.
- You will be charged a fee if you elect to extend the use of the courtesy replacement vehicle or delay the delivery of your vehicle.
- Prior to or at the time of your vehicle pickup, you will need to provide your valet with the following information if a courtesy replacement vehicle is needed:
  - Insurance company name, policy number, and expiration date
  - Driver's license number, state, expiration, and date of birth
  - Credit card number and expiration date (standard requirement for rental car use)
  - The above information for any additional drivers

Genesis brand vehicle owner must provide the valet with the Genesis brand vehicle that is currently registered in compliance with local and state laws. Road tolls incurred during the Service Valet may be charged to the vehicle owner.

## COMPLIMENTARY LOANER VEHICLE

We come to you and provide you with alternative transportation. While your vehicle is being serviced under this program, qualified drivers will be provided a courtesy replacement Genesis brand vehicle at no additional cost. You must be at least 25 years of age (in most states) with a valid driver's license to drive a loaner vehicle. Please provide your Service Advocate with the following information:

- Insurance company name, policy number, and expiration date
- Driver's license number, state, expiration and birth date
- Credit card number and expiration date (standard requirement for rental car use)
- The above information for any additional drivers

## COMPLIMENTARY MAINTENANCE COVERAGE

### Vehicle Eligibility

For original retail owners of the Genesis vehicle, all factory-recommended scheduled maintenance are covered for the first 3 years or 36,000 miles, whichever comes first. The Service Valet Program is applicable to all 2017 - 2019 model year Genesis brand vehicle United States specification vehicles purchased in the United States from authorized Genesis retailers. The program is not in effect outside of the United States.

- Vehicle coverage begins on the date of first retail sale. Fleet vehicles are excluded from this program.
- If the vehicle becomes damaged (such as by accident, fire, act of nature, etc.) and is subsequently titled salvaged, flooded, or reconstructed, it is no longer eligible for the benefits of the Genesis G80 complimentary maintenance Program.

### Guidelines for Scheduling Maintenance

The Service Valet Program covers factory-recommended scheduled maintenance for the first 3 years or 36,000 miles, whichever comes first. Covered maintenance costs include all labor and parts necessary to complete the factory recommended service. Having your vehicle serviced at the specified time/mile intervals is critical in maintaining long-term durability. Failure to have your vehicle serviced at the specified interval may invalidate the warranty under certain circumstances.

If for any reason a service is missed, the authorized Genesis retailer will perform the next or missed major service.

Some owners may wish to have their oil changed more frequently. The customer must pay for any additional services performed on the vehicle. Service procedures not specifically referenced in the Genesis Customer Care Quick Reference Guide must be preauthorized by a Genesis District Parts and Service Manager.



**Exclusions from Coverage**

The following items, without limitations, are not covered :

- Gasoline and gasoline additives
- State inspections
- Wear and tear of soft trim, including seats, carpets, door casings, wood veneer, headliner, and all chrome trim
- Wear and tear or damage to exterior body panels, trim, and glass
- Damage due to poor fuel quality, misuse, abuse, neglect, fire, accident, flood, or installation of unapproved parts and accessories
- Vehicles used in competitive events
- Vehicles with an unreadable/tampered VIN, or where true mileage cannot be determined
- Repairs and maintenance not performed at at an Authorized retailer of Genesis.
- Repairs covered under the New Vehicle Limited Warranty
- Required maintenance and covered wear parts replacement on United States specification vehicles operating outside the United States

**Transfer of Coverage**

The described coverage only applies to the original retail purchaser or original lessee of a Genesis Brand vehicle. The coverage is not transferable to subsequent owners, with the exception of immediate family members. Immediate family members include the following:

- Spouses or registered domestic partners
- Parents
- Children or stepchildren

Dealerships will verify that the owner/customer is the original owner/lessee. Certain limitations and exclusions apply to this program. Please refer to your New Vehicle Limited Warranty guide for warranty details.

\_\_\_\_\_  
 Guest Date

---

---

---

---

---

---

---

---

---

---

---

---

---

---

---

---

---

---

---

---

---

---

---

---

---

**GENESIS GUEST DELIVERY CHECKLIST**

GENESIS BRAND OWNER	RETAILER NAME
SALES CONSULTANT	DATE
VIN	PREVIOUS VEHICLE

**BEFORE DELIVERY**

- SET TIRE PRESSURE LF \_\_\_ RF \_\_\_ RR \_\_\_ LR \_\_\_
- VERIFY VEHICLE IS CLEAN, IN GOOD CONDITION, FREE OF CHIPS AND SCRATCHES · CLEAN WINDSHIELD AND BACK WINDOW
- ENSURE FLOORMATS ARE SNAPPED INTO PLACE

**WALK THE CUSTOMER THROUGH EACH OF THE FOLLOWING KEY DELIVERY FEATURES**

- REVIEW QUICK REFERENCE GUIDE
- PAIR CUSTOMER'S PHONE TO THE BLUETOOTH SYSTEM
- OPERATION OF THE NAVIGATION SYSTEM - page 29
- REVIEW AND TEAR OFF VOICE COMMAND / QUICK TIP CARD
- OPERATION OF THE AUDIO SYSTEM

**BLUETOOTH® HANDS-FREE**

- CONNECTING YOUR PHONE**
- On the radio:**
1. Select **All Menus**.
  2. Select **Setup**.
  3. Select **Bluetooth -> Bluetooth Connection**.
- \*\*Alternately, you can also press the green colored answer button on the steering wheel OR the PHONE hard key located on the center stack to initiate Bluetooth Pairing.**
4. Select **Add New Device**.
- In your phone's Bluetooth settings:**
5. Select the <Vehicle Name> on your phone
  6. Enter the passkey from the radio or accept the authorization pop-up on your phone.
- SWITCHING BETWEEN PAIRED PHONES**
- Using Voice Command:**  
 "Change Bluetooth device"
- On the radio:**
1. Select **All Menus**.
  2. Select **Setup**.
  3. Select **Bluetooth -> Bluetooth Connection**.
  4. Select **Connect** next to the desired phone.