

HYUNDAI

VOICE RECOGNITION TIPS (If equipped)

BLUETOOTH®

Command Example

Dial <Phone #> — “Dial 7-1-4-9-6-5-3-0-0-0”

Call <Name> — “Call John Smith”

Improving how you store your contacts can optimize your Bluetooth® Voice Recognition performance:

- Use full names instead of short or single-syllable names (“John or Dad”)
- Avoid using special characters/emojis or abbreviations (“Dr.”) when saving contacts

NAVIGATION

Command Example

Find Address — “1-2-3-4-5 1st Street, <House #, Street, City, State>”

Find <POI Name> — “Find McDonald’s”

Located on Rearview Mirror

LOCAL SEARCH

Command Example

Find <POI Name> — “Find Lowe’s® near me”

<POI Name> — “Starbucks®”

WINDSHIELD WIPER / WASHER - page 06

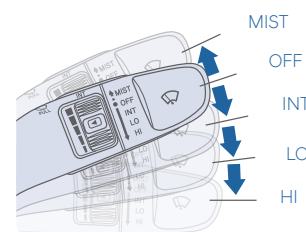

- To activate wipers, move the speed control switch down to one of the three positions (INT, LO, HI)
- To adjust “INT” speed, move the speed control switch.
- To spray the washer fluid, pull the lever towards you
- Push the lever up for a single wiper pass

UNLOCKING VEHICLE - page 01

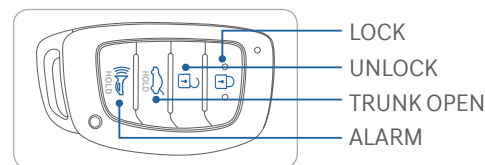

BLUE LINK - pages 22

- Assist with creating MyHyundai.com account
- Assist with Blue Link enrollment
- Encourage customer to download the MyHyundai with Blue Link app

- INTRODUCTION AND LOCATION OF THE SERVICE DEPARTMENT
- SET FIRST SERVICE APPOINTMENT
- REVIEW FACTORY RECOMMENDED MAINTENANCE SCHEDULE
- WAS THE CONDITION OF YOUR VEHICLE (AT DELIVERY) TO YOUR SATISFACTION?

Sales Consultant _____ Date _____ Sales Manager _____ Date _____

Customer _____ Date _____

Email _____

MAINTENANCE

Scheduled Maintenance	2.0L	1.4T/1.6T
Engine Oil and Filter*	Replace 7,500 or 12 mos.	Replace 6,000 or 12 mos.
Fuel Additive*	Add 7,500 or 12 mos.	Add 6,000 or 12 mos.
Tire Rotation	Perform 7,500	Perform 6,000
Air Cleaner Filter	Inspect 7,500 Replace 30,000	Inspect 6,000 Replace 24,000
Vacuum Hose	Inspect 7,500	Inspect 6,000
Climate Control Air Filter (for Evaporator and Blower Unit)	Replace 12 mos	Replace 12 mos
Air Conditioning Refrigerant	Inspect 7,500	Inspect 6,000
Brake Hoses & Lines	Inspect 7,500	Inspect 6,000
Drive Shafts & Boots	Inspect 7,500	Inspect 6,000
Exhaust Pipe & Muffler	Inspect 7,500	Inspect 6,000
Disc Brake Pads, Calipers	Inspect 7,500	Inspect 6,000
Rear Brake Drum / Linings	Inspect 7,500	Inspect 6,000
Steering Gear Box, Linkage & Boots / Lower Arm Ball Joint, Upper Arm Ball Joint	Inspect 7,500	Inspect 6,000
Suspension Mounting Bolts	Inspect 7,500	Inspect 6,000
Brake / Clutch Fluid	Inspect 15,000	Inspect 12,000
Crankcase Ventilation Hose	Inspect 15,000	Inspect 12,000
Fuel Filter	Inspect 15,000	Inspect 12,000
Fuel Lines, Fuel Hoses and Connections	Inspect 30,000	Inspect 24,000
Fuel Tank Air Filter	Inspect 15,000	Inspect 12,000
Parking Brake	Inspect 15,000	Inspect 12,000
Vapor Hose, Fuel Tank & Fuel Filler Cap	Inspect 15,000	Inspect 12,000
Spark Plugs	Replace 97,500	Replace 42,000
Drive Belt (Alt, A / C)	1st Inspect 60,000 or 72 mos. Add'l Inspect 15,000 or 24 mos.	1st Inspect 60,000 or 72 mos. Add'l Inspect 12,000 or 24 mos.
Coolant	1st Replace 120,000 or 120 mos. Add'l Replace 30,000 or 24 mos.	1st Replace 120,000 or 120 mos. Add'l Replace 30,000 or 24 mos.
Automatic Transmission Fluid	No check, No service required	-
Intelligent Variable Transmission Fluid	No check, No service required	
Intercooler, In / Out Hose, Air Intake Hose (1.4T/1.6T)	-	Inspect 6,000

*Check the engine oil regularly between recommended oil change. Hyundai recommends Quaker State oil.
*1 If TOP TIER Detergent Gasoline is not available, one bottle of additive is recommended. Additives are available from your authorized Hyundai dealer along with information on how to use them. Do not mix other additives.

*See Owner's Manual for details.

Looking for more detailed information? This Quick Reference Guide does not replace your vehicle's Owner's Manual. If you require additional information or are unsure of a specific issue, we recommend that you always refer to the vehicle's Owner's Manual or contact your authorized Hyundai dealer. The information contained in this Quick Reference Guide is correct at the time of printing; however, specifications and equipment can change without notice. No warranty or guarantee is being extended in this Quick Reference Guide, and Hyundai reserves the right to change product specifications and equipment at any time without incurring obligations. Some vehicles are shown with optional equipment.

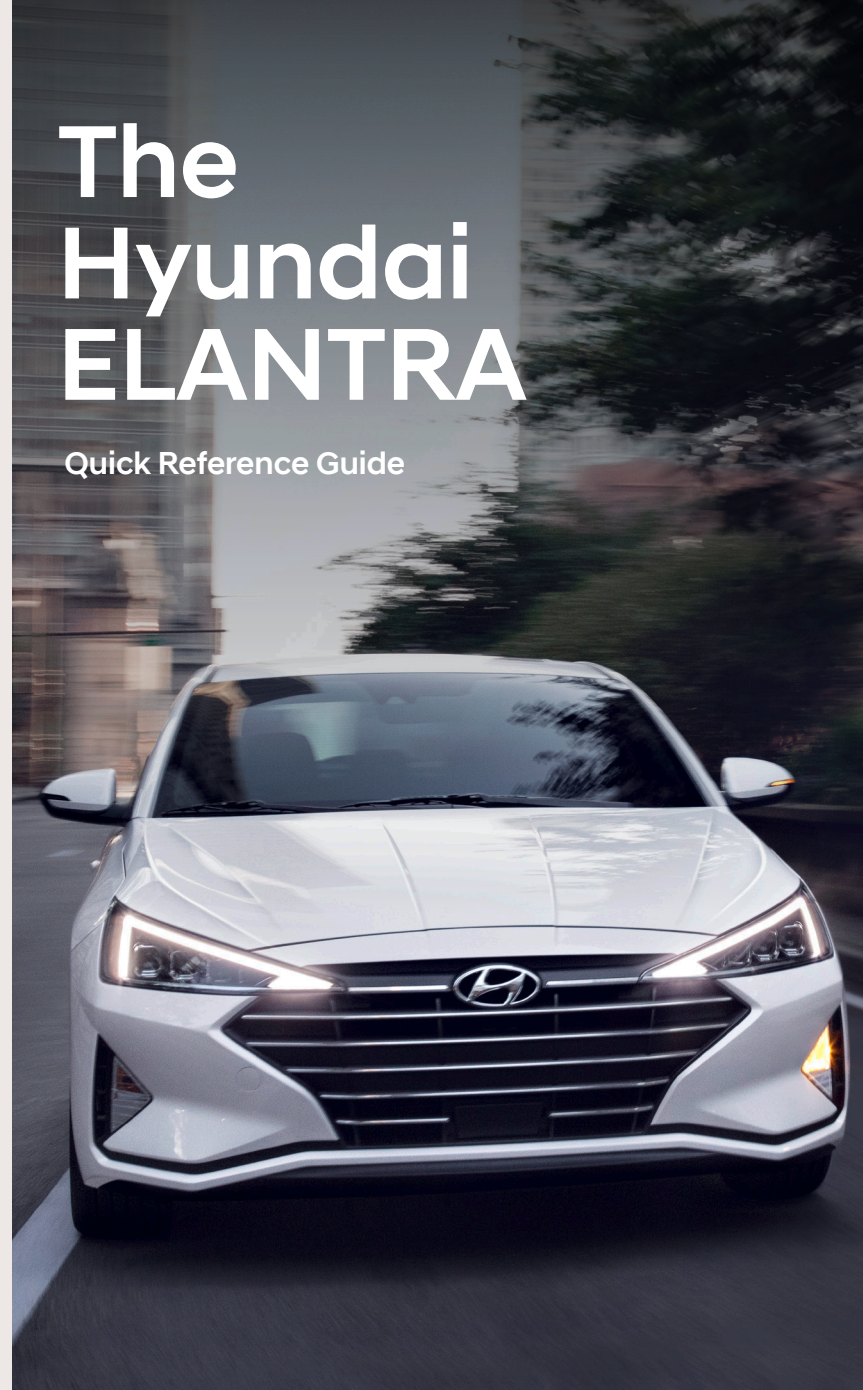

Roadside Assistance: 1-800-243-7766
 Consumer Affairs: 1-800-633-5151
 Sirius XM® Radio: 1-800-967-2346
 Blue Link: 1-855-2BLUELINK (1-855-225-8354)



HYUNDAI VEHICLE OWNER PRIVACY POLICY

Your Hyundai vehicle may be equipped with technologies and services that use information collected, generated, recorded or stored by the vehicle. Hyundai has created a Vehicle Owner Privacy Policy to explain how these technologies and services collect, use, and share this information.

You may read our Vehicle Owner Privacy Policy on the Hyundaiusa.com website at <https://www.hyundaiusa.com/owner-privacy-policy.aspx>. If you would like to receive a hard copy of our Vehicle Owner Privacy Policy, please contact our Customer Connect Center at:

Hyundai Motor America
Hyundai Customer Connect Center
P.O. Box 20850
Fountain Valley, CA 92728-0850
800-633-5151 consumeraffairs@hmausa.com

Hyundai's Customer Connect Center representatives are available Monday through Friday, between the hours of 5:00 AM and 7:00 PM PST and Saturday and Sunday between 6:30 AM and 3:00 PM PST (English). For Customer Connect Center assistance in Spanish or Korean, representatives are available Monday through Friday between 6:30 AM and 3:00 PM PST.

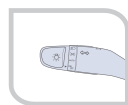

Headlights
Page 05



Instrument
Cluster
Page 11



Cruise Control/
Smart Cruise Control
Page 43

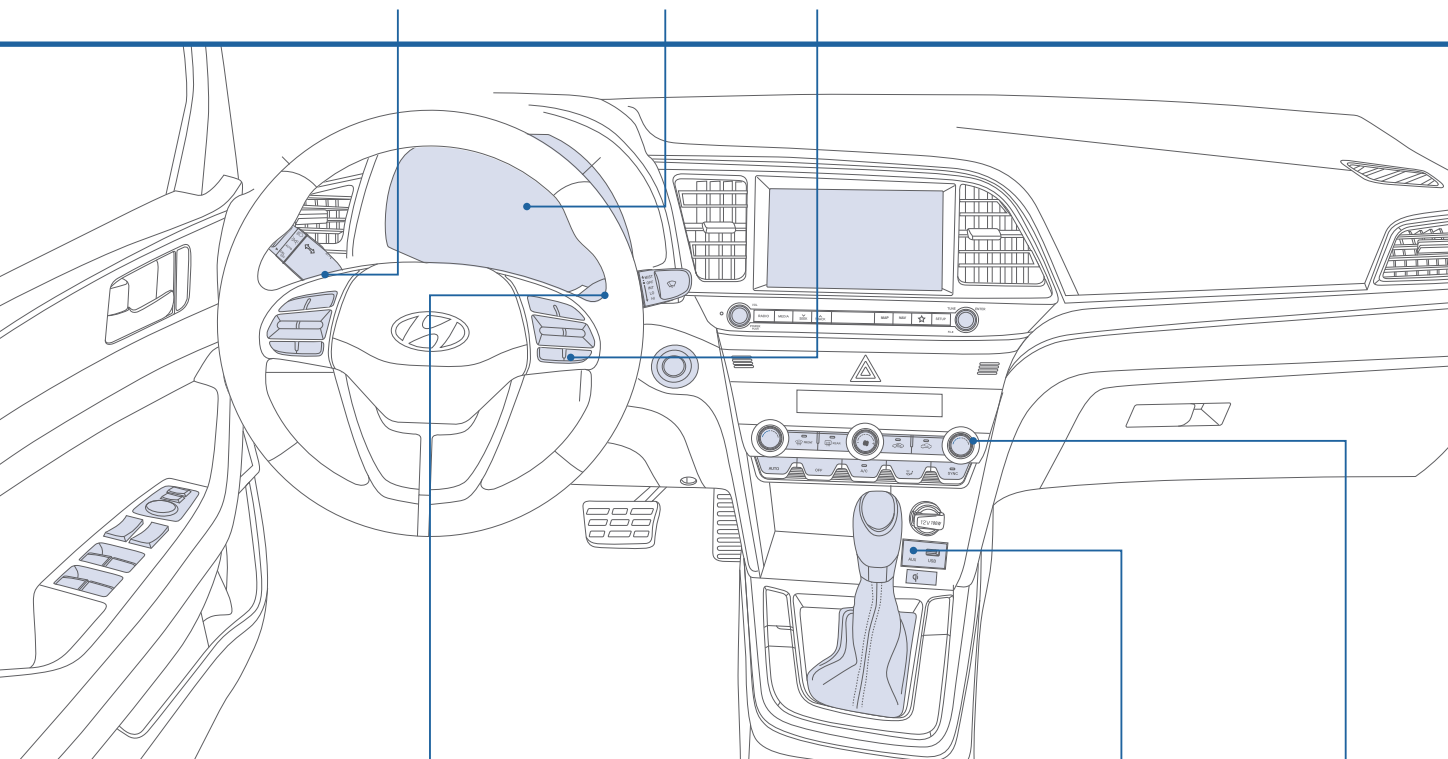

Wipers and
Washer
Page 06



AUX, USB
and iPod
Page 30

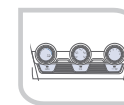

Climate
Control
Page 15

FEATURES AND CONTROLS

Child - Protector Rear Door Lock	04
Climate Control	15
Cluster (LCD) Display Mode Control	14
Cluster (LCD) Display Modes	13
Headlights	05
Homelink Wireless Control System	10
Instrument Cluster	11
Interior Lights	07
Seat-Driver Position Memory System	03
Seat-Front Seat Adjustment	02
Seat-Headrest Adjustment	03
Seat-Rear Seat Folding	04
Seat-Seat Belt Adjustment	03
Smart Key	01
Smart Trunk	09
Sunroof	07
Trunk Opening	08
Warnings and Indicators	14
Wipers and Washer	06

MULTIMEDIA

Android Auto	31
Apple CarPlay™	33
AUX, USB and iPod Port	30
Blue Link Multimedia/Map Updates	29
Blue Link Telematics System	22
Bluetooth Phone Call Operational Tips	20
Bluetooth Phone Pairing	19
Clock Adjustment	30
Navigation	27
Radio	25
Steering Wheel Audio Control	19
Voice recognition tips	21

DRIVING

Automatic Emergency Braking (AEB)	38
Cruise Control / Smart Cruise Control	43
Drive Mode Integrated Control System	41
Driver attention alert system	38
Forward collision-avoidance assist (FCA)	37
Intelligent Variable Transmission	44
Lane Keeping Assist (LKA)	37
Rear View Camera	40
Safe exit assist (SEA)	39
Tire Pressure Monitoring System (TPMS)	42

WARNING!

To reduce the risk of serious injury to yourself and others, read and understand the important SAFETY INFORMATION in your Owner's Manual.

Use this Quick Reference Guide to learn about the features that will enhance your enjoyment of your Hyundai. More detailed information about these features are available in your Owner's Manual.

* Some vehicles may not be equipped with all the listed features.

SMART KEY

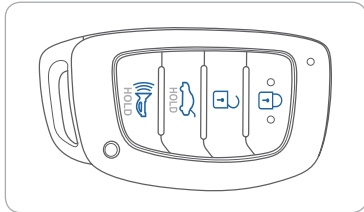

- Lock
- Unlock
- Trunk Open
- Panic

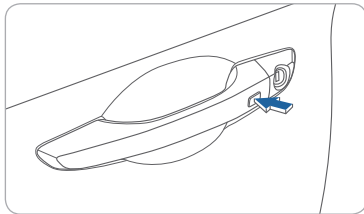

Driver's Door Lock / Unlock

Smart key must be within 28~40in. from the outside door handle.

Press: One time - Unlock driver door
Two times - Unlock all doors
Three times - Lock all doors

NOTE:

To unlock/lock all doors, the button must be pressed two times or three times within 4 seconds. User selectable option see Owner's Manual for more detail.

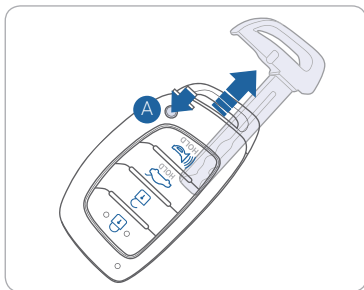

Removing the Mechanical Key

Press and hold the release button **A** to remove the mechanical key.

FRONT SEAT ADJUSTMENT (Manual)



Forward and Backward **1**



Seat Height **2**

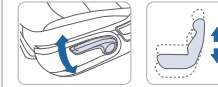

- Push down on the lever several times to lower the seat cushion.
- Pull up on the lever several times to raise it.

Seatback Angle **3**



FRONT SEAT ADJUSTMENT (Power, for the Driver's Seat)



Forward and Backward **1**

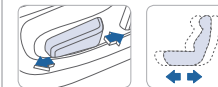

Seat Height

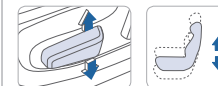

Seatback Angle **2**



Lumbar Support **3**

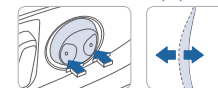

DRIVER POSITION MEMORY SYSTEM

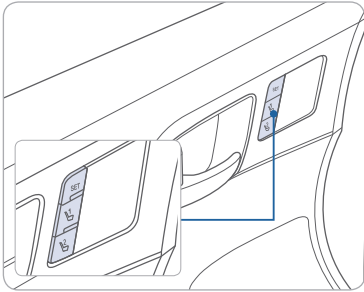

Storing

1. Adjust the driver's seat position, outside rearview mirror position and instrument panel illumination intensity.
2. Press the SET button. The system will beep once.
3. Press one of the memory buttons (1 or 2) within 5 seconds. The system will beep twice.

NOTE: Transmission must be in P (Park).

Recalling

Press the desired memory button (1 or 2). The system will beep once.

HEADREST ADJUSTMENT

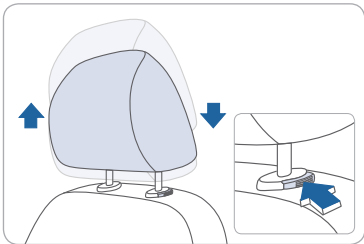

To Raise the Headrest:
Pull the headrest up.

To Lower the Headrest:
Press the lock button while pressing down on the headrest.

SEAT BELT ADJUSTMENT (Front seat)

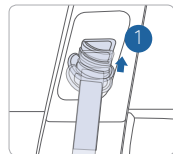
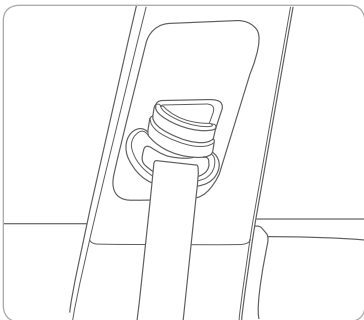

Pull up to raise.

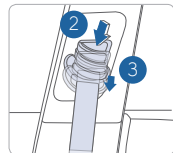

Press button and push down to lower.

REAR SEAT FOLDING

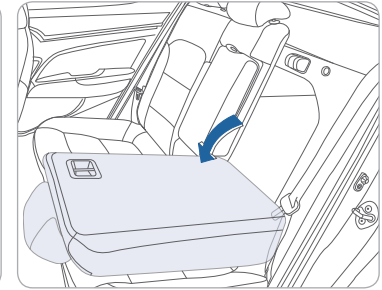
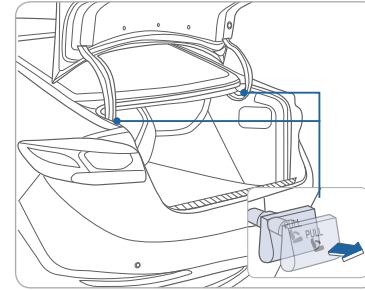

CHILD-PROTECTOR REAR DOOR LOCK

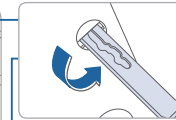
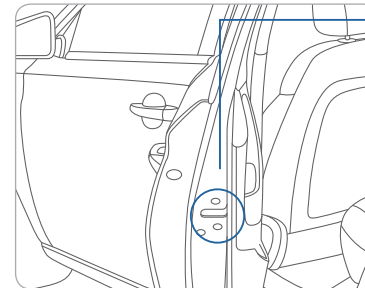

Lock

Insert a key or screw driver into the hole and turn it to the lock position.



Unlock

Insert a key or screw driver into the hole and turn it clockwise to the unlock position.

HEADLIGHTS

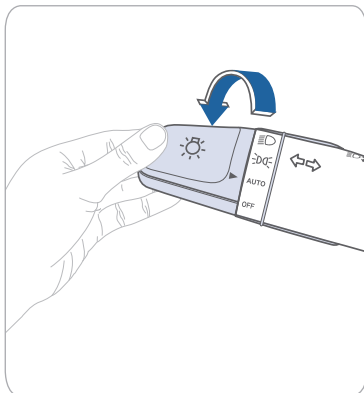

- ▶ | Headlight
- ▶ | Parking Light
- ▶ | **AUTO** Auto Light
- ▶ | **OFF** Headlight off, DRL on

NOTE:
To turn DRL OFF while parked, select the OFF position on the lever and engage the parking brake.

Headlight Delay

Headlights may stay on for 15 seconds after exiting and locking up the vehicle. Press the remote lock button twice to turn off the headlights.

Turn Signals and Lane Change Signals

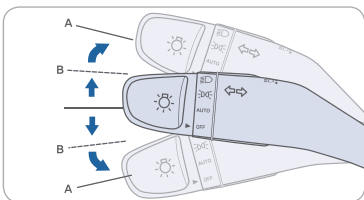

Flashing High Beam

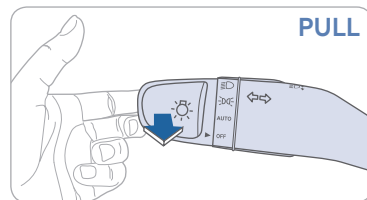

High Beam

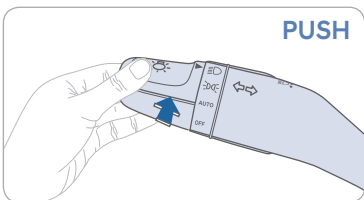

High Beam Assist

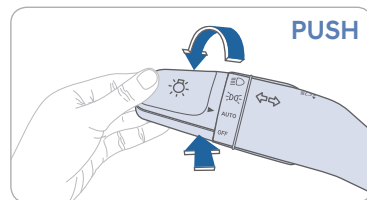

NOTE:

To turn off the high beam, pull the lever towards you.

High Beam Assist Function

1. Select the AUTO position on lever.
2. Push the lever forward to engage the High Beam Assist.
3. Pull the lever towards you to disengage.

WIPERS AND WASHER

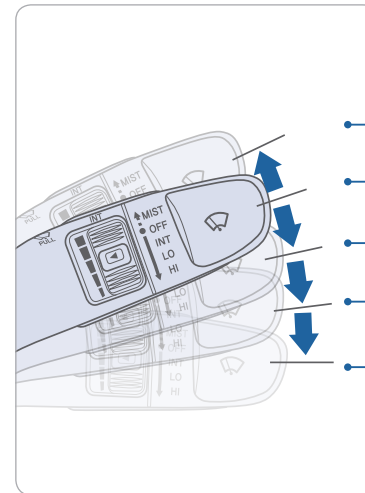

- MIST - Single wipe
- OFF
- INT - Intermittent wipe
- LO - Low wiper speed
- HI - High wiper speed

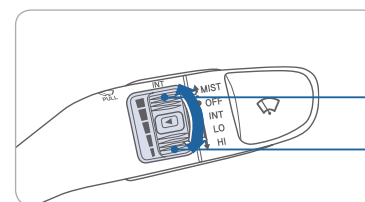

Intermittent Wipe Time Adjustment
Move the speed control switch

- Fastest wiper speed
- Slowest wiper speed

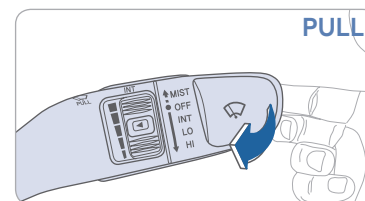

Windshield Washer
Pull the lever gently towards you to spray washer fluid on the windshield and to run the wipers 1-3 cycles.

SUNROOF

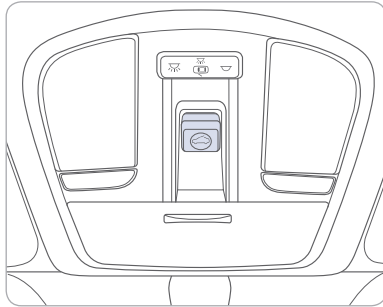

Sunshade



To open the sunshade, pull the sunroof control lever lightly backward to the first detent position. Push the sunroof control lever forward to close.

Sliding the Sunroof

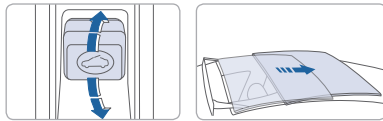

Pull and hold the sunroof control lever backward to the first detent to open the sunroof incrementally. Pull the sunroof control lever backward past the first detent to slide open the sunroof completely. Push the sunroof control lever forward to the second detent position to close sunroof glass with the sunshade.

Tilting the Sunroof

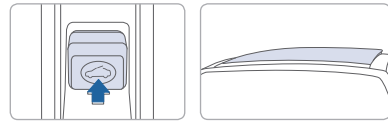

Push the sunroof control lever upward to tilt open the sunroof. Push again the sunroof control lever upward to tilt the sunroof glass closed.

INTERIOR LIGHTS

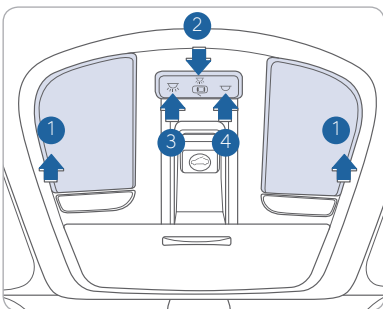

Front map lamp ①
Press the lens to turn the map lamp on or off.

Front door lamp () ②
Lights will turn on when any door is open.

Front room lamp () ③
Push the switch to turn the room lamp on.

Front room lamp () ④
Push the switch to turn the room lamp off.

TRUNK OPENING

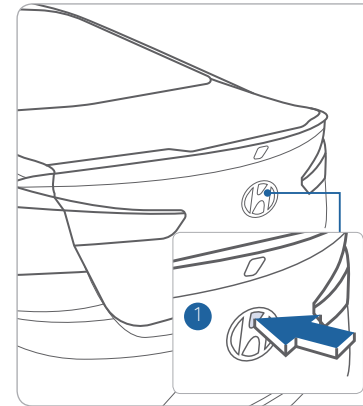

With Smart key

Press to open.
Smart key needs to be within the range.

NOTE:

If vehicle is unlocked, the trunk can be opened without the smart key. Press the button ① located on the emblem to open the trunk.

Without smart key, press and hold the trunk open button on the key fob to open the trunk.

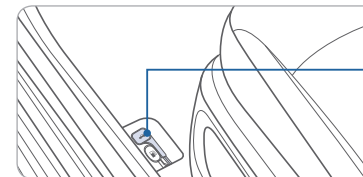

Pull the trunk release lever in the vehicle.

SMART TRUNK

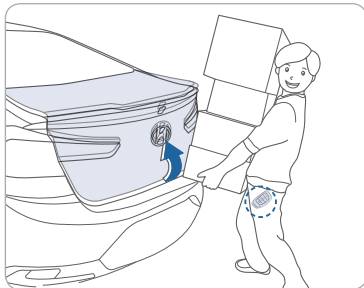

Smart Trunk

Trunk will open automatically when detecting smart key within the range (20-40 in) near the trunk for over 3 seconds.

To enable Smart Trunk function:

Vehicle must be in P (Park) to adjust the settings in the User Settings mode.

1. Select "Door / Trunk" in the User Settings in the instrument cluster.
2. Check "Smart Trunk".

NOTE:

Function is active after 15 seconds when all doors are closed and locked. The vehicle will also provide an audible and visual alarm while activating. Please refer to your Owner's Manual for further information.

HOMELINK WIRELESS CONTROL SYSTEM

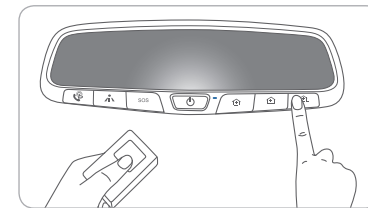
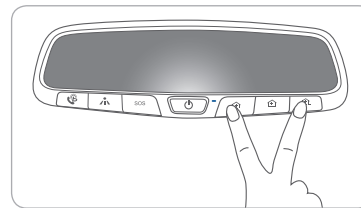

Standard Programming

To train most devices, follow these instructions:

1. Press and hold the two outside buttons on the Homelink® system until the LED starts to blink, release buttons.
2. Press and hold the desired Homelink® button and the transmit button on your rolling code transmitter at the same time until the Homelink® LED changes from a slow blink to a rapid blink. (Your Homelink® system is now programmed)
3. Locate the learn code button on your garage door opener. (These are located under the light cover or on the rear panel depending on model)
4. Press the learn code button on the garage door opener, a red LED will start to blink. (You will have 30 seconds to complete programming)
5. While the LED on the garage door opener is blinking, return to the vehicle and press the pre-programmed Homelink® button 4 times. (Or until the garage door operates).

For more detailed information, please refer to Section 3 of your Owner's Manual, or visit www.homelink.com or call (800) 355-3515.

INSTRUMENT CLUSTER

SE



Sport

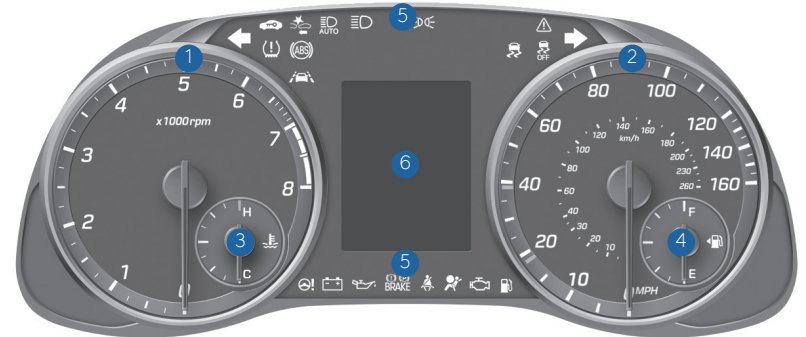

SEL, Value, Eco

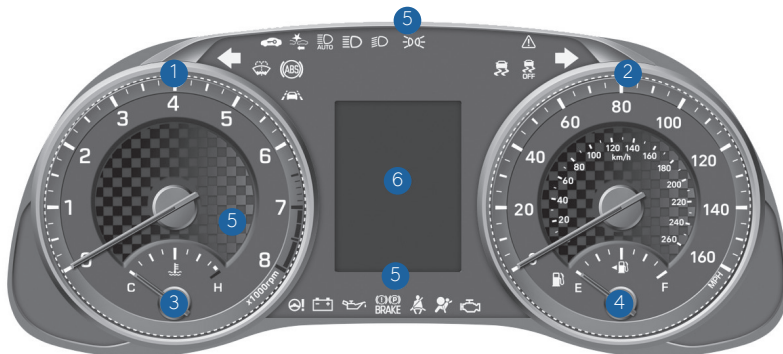

Limited

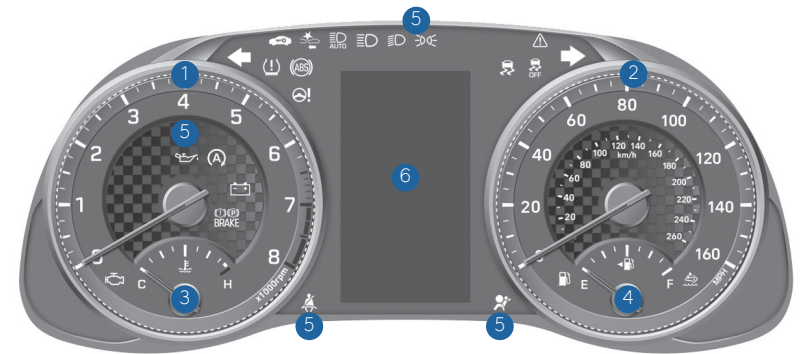

- ① Tachometer
- ② Speedometer
- ③ Engine Coolant Temperature Gauge
- ④ Fuel Gauge
- ⑤ Warning and Indicator Lights
- ⑥ LCD Display (including Trip Computer)

CLUSTER (LCD) DISPLAY MODES (for SEL trims and above) —

Modes	Symbol	Description
Trip Computer		This mode displays information related to driving such as tripmeter, fuel economy, etc. For more information, refer to "Trip Computer" in this chapter.
Turn By Turn (TBT) (if equipped)		This mode displays the state of the navigation.
Assist (if equipped)		The Driver Assist mode displays the status of the following features: - Smart Cruise Control (SCC) system - Lane keeping Assist (LKA) system - Driver Attention Warning (DAW) system - Tire pressure For more information, refer to "Smart Cruise Control", "Lane Keeping Assist (LKA) system", "Driver Attention Warning (DAW) system" in chapter 5 and "Tire Pressure Monitoring System (TPMS) in chapter 6.
User Settings		In this mode, you can change settings of the doors, lamps, etc.
Master Settings		The Master Warning mode displays warning messages related to the vehicle when on or more systems is not operating normally.

The information provided may differ depending on which functions are applicable to your vehicle.

CLUSTER (LCD) DISPLAY MODE CONTROL (for SEL trims and above)

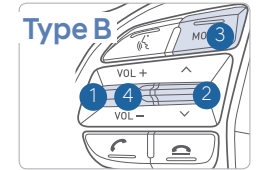
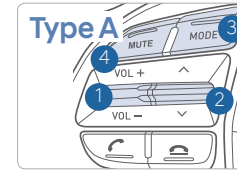
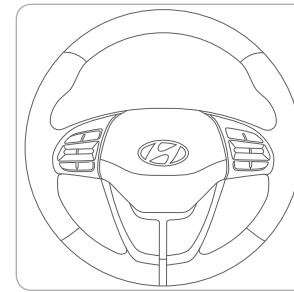

- ① : MODE button for changing modes
- ② ▲, ▼ : MOVE switch for changing items
- ③ OK : SELECT / RESET button for setting or resetting the selected item

WARNINGS AND INDICATORS

Air Bag Warning Light	Seat Belt Warning Light	Parking Brake & Brake Fluid Warning Light
Anti-Lock Brake System (ABS) Warning Light	Electronic Brake Force Distribution (EBD) System Warning Light	
Electric Power Steering (EPS) Warning Light	Malfunction Indicator Lamp (MIL)	Icy road warning light
Engine Oil Pressure Warning Light	Low Fuel Level Warning Light	Charging System Warning Light
Autonomous Emergency Braking (AEB) Warning Light	Headlight Warning Light	Low Tire Pressure Warning Indicator/TPMS Malfunction Lamp
Master Warning Light	Door Ajar Warning Light	Adaptive Front Lighting System (AFLS) Warning Light/Dynamic Bending Light (DBL)
Electronic Stability Control (ESC) Indicator	Electronic Stability Control (ESC) OFF Indicator	Trunk Open Warning Light
Turn Signal Indicator	High Beam Indicator	Immobilizer Indicator
Smart High Beam Indicator	CRUISE Cruise Indicator	Light ON Indicator
SPORT Mode Indicator	ECO Mode Indicator	SET Cruise SET Indicator
Lane Keeping Assist System (LKAS) Indicator		

MANUAL CLIMATE CONTROL

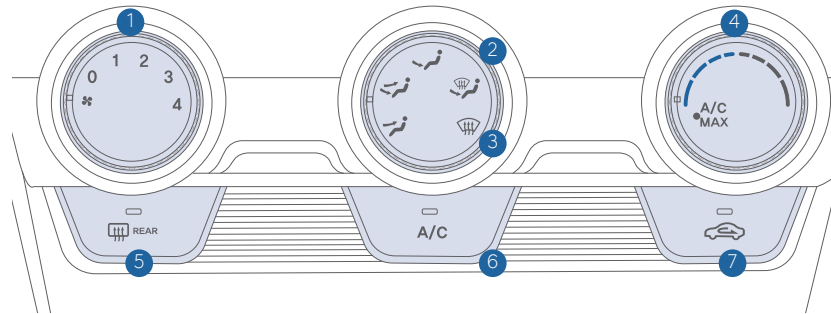

- 1 Fan Speed Control Knob
- 2 Mode Selection Knob
- 3 Front Windshield Defrost Mode
- 4 Temperature Control Knob
- 5 Rear Window Defroster Button
- 6 A / C (Air Conditioning) Button
- 7 Air Intake Control Button

DEFOGGING/ DEFROSTING



1. Select the Front Windshield Defrost Mode.



3. Set the fan speed to the medium speed.



2. Select the warmest temperature.

AIR INTAKE CONTROL

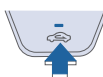

Recirculated air position (LED on)

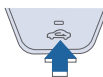

Outside (fresh) air position (LED off)

MODE SELECTION

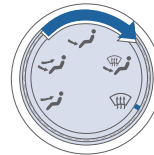

Changes the direction of the air flow as following:

-  Face-Level
-  Bi-Level
-  Floor-Level
-  Floor & Defrost-Level
-  Defrost-Level

REAR WINDOW DEFROSTER

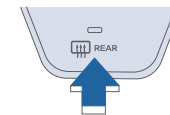

Press to activate / deactivate the rear defroster.

NOTE:

To reduce the tendency of the glass fogging and also to improve visibility, keep the interior surface of the windshield clean by wiping it with a clean cloth and glass cleaner. In addition, select air intake control to the outside (fresh) air position whenever possible while operating the vehicle.

AUTOMATIC CLIMATE CONTROL

- 1 Driver's Temperature Control Knob
- 2 Front Windshield Defrost Button
- 3 Rear Window Defrost Button
- 4 Fan Speed Control Knob
- 5 Air Intake Control Button (Recirculated air)
- 6 Air Intake Control Button (Outside air)

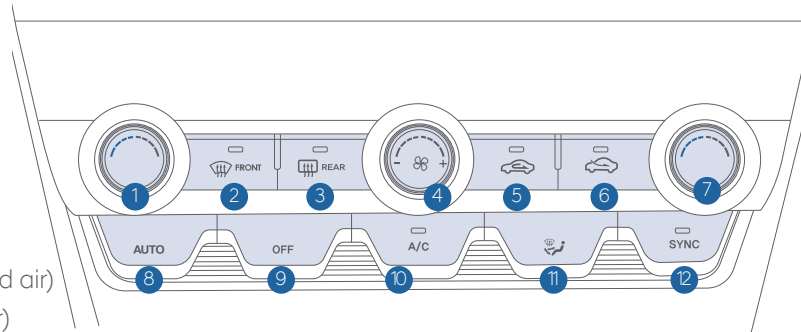

- 7 Passenger's Temperature Control Knob
- 8 AUTO (Automatic Control) Button
- 9 OFF Button
- 10 Air Conditioning Button
- 11 Mode Selection Button
- 12 SYNC Button

DEFOGGING/DEFROSTING SYSTEM OFF

1. Press the defrost button.
2. Select the warmest temperature.
3. Set the fan speed to the medium speed.

Pressing the OFF button will place the system to the OFF mode.

- Climate control fan will turn off.
- Outside (fresh) air position will be selected.
- Vented air will be at last set temperature.

NOTE:



To reduce the tendency of the glass fogging and also to improve visibility, keep the interior surface of the windshield clean by wiping it with a clean cloth and glass cleaner. In addition, select air intake control to the outside (fresh) air position whenever possible while operating the vehicle.

AUTOMATIC HEATING / AIR CONDITIONING

The modes, fan speeds, air intake and air conditioning will be controlled automatically by the temperature setting you select.

It is recommended to use the AUTO function with 73°F temperature set point for optimum comfort and efficiency. Adjust the temperature as desired.

AIR INTAKE CONTROL

-  Recirculated air position (LED on)
-  Outside (fresh) air position (LED off)

MODE SELECTION

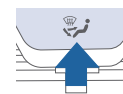

Changes the direction of the air flow as following:



STEERING WHEEL AUDIO CONTROL

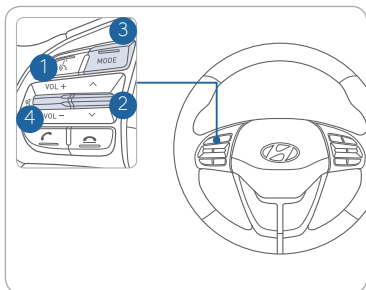

- 1 **VOICE RECOGNITION**
Activates the voice recognition system.
- 2 **SEEK / PRESET (▲/▼)**
Changes station.
- 3 **MODE**
Changes the audio source.
- 4 **VOLUME (VOL + / -)**
Increase or decrease the volume. Press to Mute.

Position, tone, priority and advanced sound settings can be customized in the audio/ navigation unit. Press the SETUP button then select Sound.

BLUETOOTH® PHONE PAIRING

Phone setup (pairing phone)

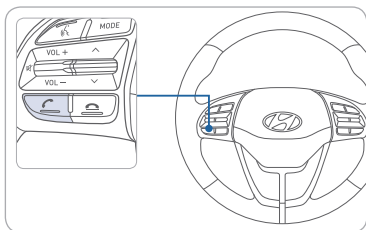

1. Press the PHONE() button in the head unit or CALL() button in the steering wheel remote control.
2. Pair your car after your mobile phone detects the Bluetooth device.
3. Enter the passkey or accept the authorization popup.
4. Connect Bluetooth.

NOTE: Vehicle must be parked to complete pairing process.

BLUETOOTH® PHONE CALL OPERATIONAL TIPS

In the following situations you or the other party may have difficulty hearing each other:

1. Keep the Bluetooth® volume to a low level. High level volume may result in distortion and echo.
2. When driving on a rough road, high speeds and/or with the window open.
3. When the air conditioning vents are facing the microphone and/or when the air conditioning fan is at the max speed.

Steering wheel bluetooth® control

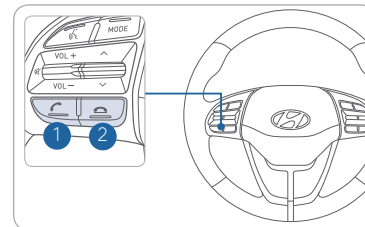

- 1 **CALL**
Places and transfers calls.
- 2 **END**
Ends calls or cancels functions.

To Answer a Call:

- Press the button on the steering wheel.

To Reject a Call:

- Press the button on the steering wheel.

To Adjust Ring Volume:

- Use the VOLUME buttons on the steering wheel while it is ringing.

To Transfer a Call to the Phone

(Private call on handset – do not use while driving):

- Press and hold the button on the steering wheel until the audio system transfers a call to the phone.

To Finish a Call:

- Press the button on the steering wheel.

VOICE RECOGNITION TIPS

Your vehicle is equipped with Voice Recognition Technology, which allows drivers to operate their phones without having to take their eyes off the road to minimize distractions.

Voice recognition performance may be affected if driving with windows and sun roof open; when the heating-cooling system is on; when driving in a tunnel or when driving on rugged and uneven roads.

Quick reference on using voice commands

To start voice command, press the  key, the following commands are available:

Command	Function
Call	Displays downloaded Contacts.
Call <Name>	Calls <Name> saved in Contacts.
Dial Number	Displays a screen where you can say a phone number to dial.
Dial <Phone #>	You can directly say the number to call. ex) Dial 111 555 1234
Redial	Calls the number you last dialed.

Making a call using voice recognition:

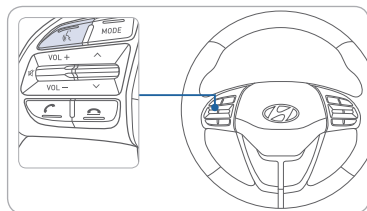

Press  button on the steering wheel control to activate voice recognition.

Press and hold  button to end voice recognition.

Calling by Name:

1. Press the  button.
2. Say the following command:
 - “Call <John Smith>”: Connects the call to John.
 - “Call <John Smith> <on Mobile / at Work / at Home / on Other>”: Connects the call to John’s Mobile, Work, Home, or Other phone number.

Dialing by Number:

1. Press the  button.
2. Say “Dial Number.”
3. Say the desired phone number.

For the complete list of commands, refer to your Owner’s Manual.

BLUE LINK TELEMATICS SYSTEM

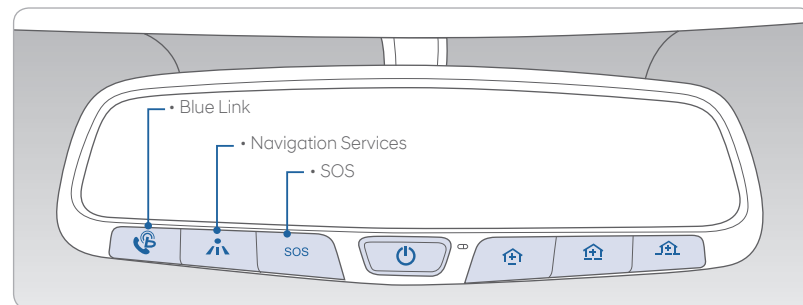

Blue Link subscription is required. To enroll, please visit your dealership or MyHyundai.com.

Press the  button to access the voice-response menu of services.

- You can say:

- Service Link
- Roadside Assistance
- Blue Link Account Assistance
- Help
- Cancel

For vehicles equipped with factory-installed navigation, press the  button for Destination Search by Voice.

Press the **SOS** button for SOS Emergency Assistance.

Visit HyundaiBlueLink.com for more information or refer to your Blue Link User’s Manual for detailed information on system operation.

For immediate assistance with subscription services, please call 1-855-2BLUELINK (1-855-225-8354).

Remote Start

Remote Start



You can download the Blue Link mobile app to your compatible smart phone from the following sites:

- iPhone® — Apple® App Store
- Android® — Google Play

Remote Start enables you to remotely start your vehicle from virtually anywhere. For navigation vehicles, you can also enable climate control remotely and turn on the rear-window defroster, ensuring a warm or cool car is ready to go when you are.

- To use this feature, you must have a Blue Link Personal Identification Number (PIN). To create or change your PIN, log on to www.MyHyundai.com.

Remember:

- Remote Start with Climate Control will automatically shut off after 10 minutes or after selected engine timer runs out in navigation vehicles.
- While this feature is active, the parking lights will blink until vehicle is turned off or when vehicle is in operation.
- To continue operation of the vehicle, the proximity key must be inside the vehicle with the driver prior to pressing the brake and being able to move the gearshift from the P (Park) position.

Preconditions:

- Ignition is OFF
- Alarm is armed (i.e., vehicle locked by key fob Remote Door Lock)
- Gearshift level is in the P (Park) position
- Brake pedal is not depressed
- Engine hood is securely closed
- All the doors are closed and locked
- The tailgate or trunk lid is closed
- The security/panic system is not activated
- The battery power is not low
- Vehicle is located in an open area
- It has been less than 4 days since last vehicle ignition off
- Vehicle located in area with good cell reception

Remote Start will terminate:

- After 10 minutes or after selected engine timer runs out in navigation vehicles
- Brake is pressed without proximity key inside vehicle
- Alarm is triggered without proximity key inside vehicle
- Door/trunk is opened from inside the vehicle

Notice: Laws in some communities may restrict the use of the features that remotely start the engine. For example, some laws may require a person using the remote start feature to have the vehicle in view when doing so or limit the length of time a vehicle engine may idle. Please check local and state regulations for any requirements and restrictions on remote starting of vehicles and engine idling time.

WARNING!

Do not remote start vehicle in an enclosed environment (i.e., closed garage). Prolonged operation of a motor vehicle in an enclosed environment can cause a harmful build-up of carbon monoxide. Carbon monoxide is harmful to your health. Exposure to high levels of carbon monoxide can cause headaches, dizziness or in extreme cases unconsciousness and/or death. Do not leave children or animals unattended in a vehicle while using the remote start function.

CAUTION!

If the vehicle's windshield wipers are left on when the vehicle was last driven, then the wipers will turn on if the remote start function is activated. To avoid damage to the wiper blades (i.e., due to heavy ice or snow accumulated on the windshield), please always turn the vehicle's windshield wipers off when parking the vehicle.

RADIO

Standard/Display Audio

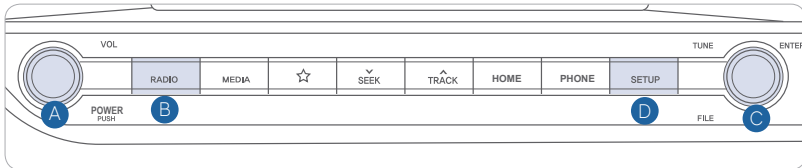

Navigation

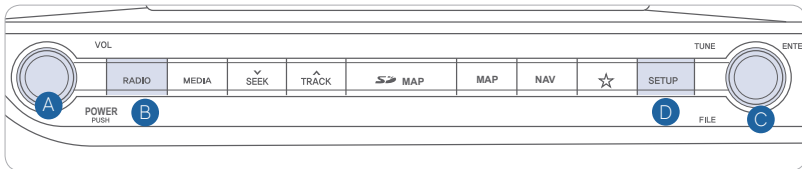

Press the POWER button **A** to turn on the radio.

- TUNING / LISTENING TO CHANNELS
 1. Press the RADIO button **B**.
 2. Rotate the TUNE knob **C** to a desired channel.

NOTE:

A clear view of the southern sky is recommended to ensure Sirius XM® radio reception.

- SETTING THE PRESET MEMORY BUTTONS (FM / AM / Sirius XM®)

Press and hold any preset button until an audible beep is heard to store current channel.



- ADJUSTING THE SOUND CONTROL

1. Press the SETUP button **D**.
2. Press the "Sound" button on the screen.
3. Touch the on-screen arrows to adjust the desired setting.



NAVIGATION

Basic features on the map screen



Press **[MAP]** button in the navigation head unit.

- | | |
|--|---|
| 1 Move to the Home Screen | 8 Touch to scroll the map |
| 2 Change the map view mode | 9 Start Guidance |
| 3 Voice Guidance On/Off | 10 Route Options |
| 4 Zoom in the map | 11 Save frequently used address to address book |
| 5 Set the zoom level automatically according to the guidance | 12 Find a POI (Point of Interest) around the current position |
| 6 Zoom out the map | 13 View the vehicle's current position on the map screen |
| 7 Quick and easy selection of a destination and options | |

Destination search screen



Press **[NAV]** button in the navigation head unit, and find a destination by using the **[Destination]** menu.

- | | |
|---|---|
| 1 Address : Set destination by address search. | 6 Restaurants : Select the desired destination among the searched restaurants. |
| 2 Previous destinations : Select from previously inputted addresses and POIs. | 7 Emergency : Select the desired destination among the searched emergency facilities. |
| 3 Online Search: Runs online search. | 8 Address Book : Search the destination with the address book. |
| 4 POI categories : Select the desired item in the sub-categories. | 9 Coordinates : You can find a destination by entering the coordinates of latitude and longitude. |
| 5 Gas stations : Select the desired destinations among the searched gas stations. | |

BLUE LINK MULTIMEDIA/MAP UPDATES

Your vehicle comes with three years of complimentary map downloads with an active Blue link subscription. A new update is released every Spring and Fall.

What are the benefits of updating?

Every year, 15% of roads and points of interest are changed. Regular map updates provide the latest roads, addresses, restaurants, hotels, and many other locations. It also includes multimedia software enhancements. For more detail, please visit the map update website.

How do I get an update?

- First, make sure you are an active Blue link subscriber. Visit www.MyHyundai.com.
- Then visit the map update website to register and check to see if a map update is available. www.mapnsoft.com/hyundai/mapcare

Three ways to get your updates:

- FREE - Download the software through the website using your personal media.
- \$25 + SHIPPING – Skip the download process and get a new media in the mail .
- Or, visit your local Hyundai dealership. Tip – ask them to order the media in advance!

CLOCK ADJUSTMENT

With Standard Radio (without touch screen)

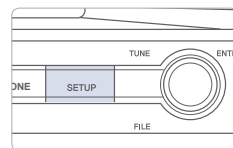

1. Press the SETUP button on the audio system.
2. Select “Date/Time” icon on the screen.
3. Set the date and time.

With Display Audio (touch screen)

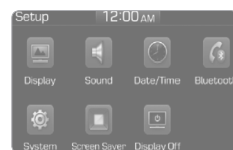

1. Press the SETUP button on the audio system.
2. Select “Date/Time” icon on the screen.
3. Set the date and time.

With Navigation

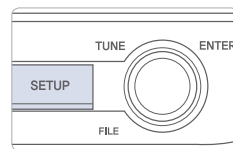

1. Press the SETUP button.
2. Select the “Date/Time” icon on the screen.
3. Select GPS time to ON.
4. Press back button to save changes and go to previous screen.

AUX, USB AND iPod PORT

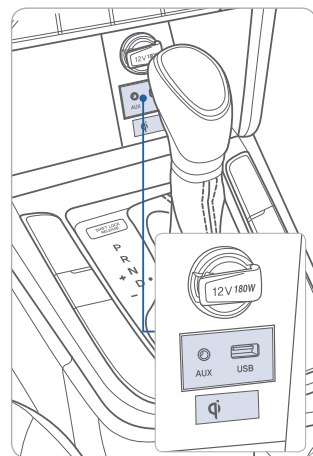

Use the AUX or USB ports to connect an external audio device and listen to it through the audio system in your vehicle.

Use this USB port to access Android Auto or Apple CarPlay with your compatible phone.

Wireless Cellular Phone Charging System (if equipped)

There is a wireless cellular phone charging system inside the front console. The system operates with all doors closed, and the ignition switch is in the ACC/ON position.

ANDROID AUTO™

REQUIREMENTS:

- USB cable
- OS Android™ 5.0 or higher
- Compatible Android Phone
- Data and wireless plan for applicable features

BEFORE YOU BEGIN:

- Android Auto features may operate differently than on your phone.
- Message and data charges may apply when using Android Auto.
- Android Auto relies on the performance of your phone. If you experience performance issues:
 - Close all apps and then restart them or
 - Disconnect and then reconnect your phone
- Using the USB cable that was provided with your phone is recommended.
- When Android Auto is active, your in-vehicle voice recognition system is disabled and you will be using talk to Google™ to make your requests.

ANDROID AUTO SUPPORT



<https://support.google.com/androidauto/>

PHONE SETUP

Activate Bluetooth on your phone and connect the USB cable from your mobile device to the USB Port in your vehicle.

Phone will prompt you to download the Android Auto app and update other needed apps (i.e. Google Maps™, Google Play Music™, Google Now™).

NOTE: Vehicle must be parked.

- Location mode setting should be set to High accuracy.
- Car and phone setup should be completed in one sitting. If phone setup needs to be resumed, recommend to Force Stop the Android Auto app on the Phone then reopen the app and accept the Disclaimer notifications.

CAR SETUP

1. Press the SETUP button on the radio.
2. Touch the “Phone Projection” icon on screen.
3. Select “On” for Android Auto.
4. Connect your Android phone to the vehicle USB port. Agree to the notification and disclaimers on your phone then the “Android Auto” icon will appear confirming the setup.

For more detailed information on how to operate Android Auto, please refer to your navigation manual.

For additional Android Auto support, please refer to the Android Auto Support Website
<https://support.google.com/androidauto/>

Android Auto, Google Play, Android, and other marks are trademarks of Google Inc.

APPLE CARPLAY™

REQUIREMENTS

- Apple Lightning® cable
- Latest iOS
- iPhone® 5 or above
- Data and wireless plan for applicable features

BEFORE YOU BEGIN

- Apple® CarPlay features may operate differently than on your phone.
- Message and data charges may apply when using Apple CarPlay.
- Apple CarPlay relies on the performance of your phone. If you experience performance issues:
 - Close all apps and then restart them or
 - Disconnect and then reconnect your phone
- Using the Apple Lightning cable that was provided with your phone is recommended.
- When Apple CarPlay is active, your voice recognition system is disabled and you will be using Siri® to make your requests.

PHONE SETUP

On your phone, go to Settings > General > CarPlay to allow CarPlay access.

On your phone, go to Settings > Siri and ensure Siri is turned ON.

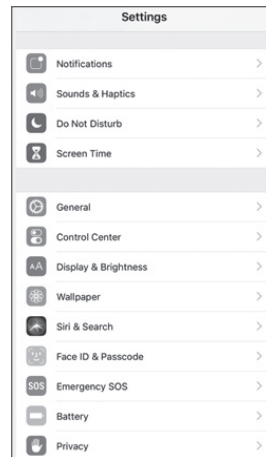

CAR SETUP

1. Press the SETUP button.
2. Touch the “Phone Projection” icon on the screen.
3. Touch “iOS” on the Phone Projection Settings screen then touch “On” to enable Apple CarPlay.
4. Connect your Apple iPhone to the vehicle USB port then touch ‘OK’ when the pop-up message appears. The Apple CarPlay icon will now appear on the vehicle Home screen confirming the setup.



Apple CarPlay, Apple, and other marks are trademarks of Apple Inc.

CarPlay Home Screen

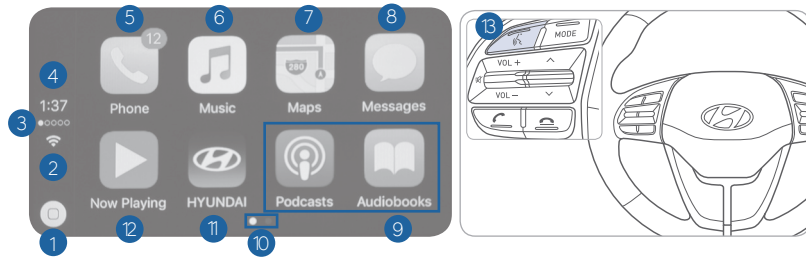

- | | |
|-------------------------|----------------------------------|
| 1 HOME ICON | 7 APPLE MAPS |
| 2 WIRELESS CONNECTIVITY | 8 MESSAGES |
| 3 CELLULAR SIGNAL | 9 3RD PARTY APPS |
| 4 PHONE TIME | 10 SCREEN PAGE INDICATOR |
| 5 PHONE | 11 EXIT TO HYUNDAI |
| 6 APPLE MUSIC™ | 12 CURRENT CARPLAY AUDIO PLAYING |
| | 13 VOICE COMMAND |

SIRI

Apple CarPlay uses Siri to perform many actions like sending messages, placing calls, and looking up/setting POI/Destinations. A Siri session can be initiated on any screen by:

1. Touch and holding the HOME icon 1 on the CarPlay screen or
2. Press the steering wheel VOICE COMMAND 13 button.

Note: Ensure Siri feature is set to ON in your phone (Go to Settings > General > Siri).

3. Say any of the following commands;
 - “Text <John Smith> ‘Call you later’” to send a text message.
 - “Read text messages” to read available text message.
 - “Call <John Smith>” to make a phone call.
 - “Find <POI/Destination>” to locate a POI/Destination.

PHONE

Touch the PHONE 5 icon to access the Phone screen. Siri will automatically asks ‘Who do you want to call’ when the PHONE 5 icon is selected.

NOTE: Phone call sound quality is dependent on the wired connection. Using the Lightning cable that came with the phone is recommended.

APPLE MUSIC

Touch the APPLE MUSIC 6 icon to access the Apple Music screen.

APPLE MAPS

Touch the APPLE MAPS 7 icon to access the Apple Map screen.

MESSAGES

Touch the MESSAGES 8 icon to access the Message screen. Siri will automatically asks ‘Want to hear unread messages or create a new one’ when the MESSAGE icon is selected.

3rd PARTY APPS

Supported CarPlay apps that are downloaded on your phone will appear on the CarPlay screen. Touch the apps icons to access those supported apps.

NOTE: A list of the supported CarPlay supported apps can be found at <http://www.apple.com/ios/carplay/>

Ensure phone has latest version of the 3rd Party Apps.

LANE KEEPING ASSIST (LKA)

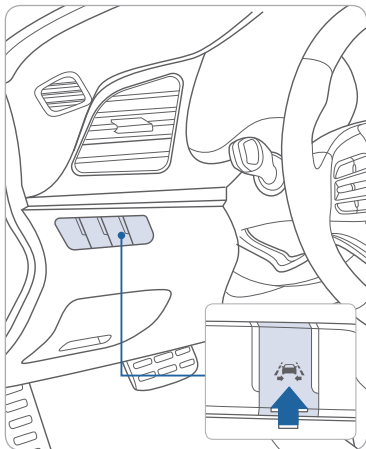

The Lane Keeping Assist (LKA) uses the front camera to monitor the lines on the road. In case of an unintended lane departure, it will warn the driver and can apply counter steering torque to guide the car back to the center of the lane.

- To turn on the LKA, press the LKA button.
- To turn off the LKA, press the LKA button again.

To adjust the settings of LKA, select the LKA sub menu in the LCD cluster display under User Settings.

LKA operates only while the vehicle speed is over 40mph and below 110mph. For more detailed information, please refer to Section 5 of the Owner's Manual.

FORWARD COLLISION-AVOIDANCE ASSIST (FCA)

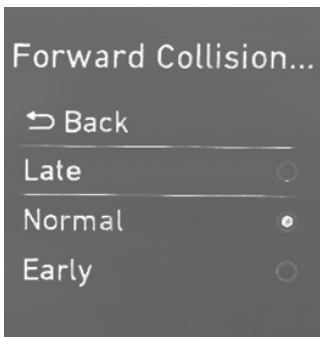

The Forward Collision Avoidance (FCA) system is designed to detect and monitor the vehicle ahead and warn the driver if a collision is imminent. On vehicles equipped with both camera and radar sensor, pedestrian detection is also available.

To operate the system, select the FCA (Forward Collision Avoidance Assist) sub menu in the LCD cluster display under User Settings. Please refer to your Owner's Manual for further information.

AUTOMATIC EMERGENCY BRAKING (AEB)

The Automatic Emergency Braking (AEB) system is designed to help detect and monitor the vehicle ahead or detect a pedestrian in the roadway through radar signals and camera recognition to warn the driver that a collision is imminent, and if necessary, apply emergency braking.

To activate or deactivate the AEB system, select or deselect: "User Settings → Driving Assist → Automatic Emergency Braking" The AEB deactivates when system setting is deselected. A warning light  will illuminate on the LCD display when the AEB system is deactivated. Please refer to the Owner's Manual for more information.

Caution: Do not try to test the AEB system.

DRIVER ATTENTION ALERT SYSTEM

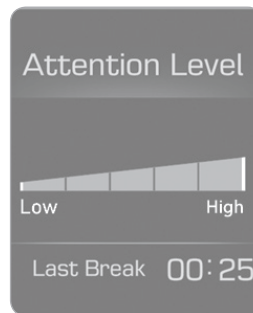

The Driver Attention Alert (DAA) system displays the condition of the driver's fatigue level and inattentive driving practices. The DAA system monitors the lane markers and driver's inputs to the steering wheel, accelerator pedal and brake pedal.

To turn ON the Driver Attention Alert system, turn on the engine, and then select 'User Settings → Driving Assist → Driver Attention Alert → Normal / Early' on the LCD Display.

The Driver Attention Alert system operates when driving over 40mph. The system can be reset when the driver turns the engine OFF.

For more detailed information on any of these topics, please refer to Section 5 of the Owner's Manual.

SAFE EXIT ASSIST (SEA)

The Safe Exit Assist system helps prevent passengers from opening the door when a vehicle is approaching from the rear area. After the vehicle stops and an approaching vehicle from the rear area is detected, the rear door does not open from the inside handle. A “check surroundings then try again” warning message will appear on the cluster and a warning sound will go off.



When an approaching vehicle from the rear is detected and the door is already opened, a “watch for traffic” warning message appears and a warning sound will go off.

Activate/Deactivate

Select the following items on the instrument cluster in order:

1. Select user settings mode in the cluster LCD display
2. Select Driver Assistance
3. Select Blind-Spot Safety
4. Select Safe Exit Assistance

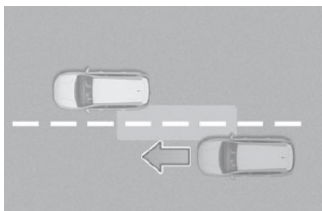

REAR VIEW CAMERA

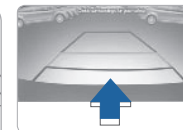
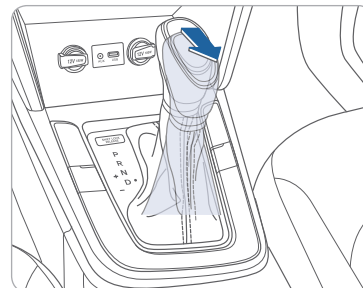

When the transmission is shifted into R (Reverse), the rear view camera displays the area behind the vehicle.

DRIVE MODE INTEGRATED CONTROL SYSTEM

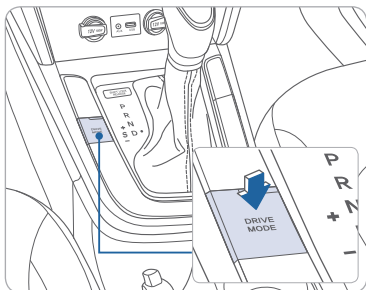

You can select the drive mode according to your preference or the road condition.

Each time you press the button, the drive mode changes as following :



NORMAL mode is not displayed on the instrument cluster.

NORMAL mode

Normal mode provides regular daily driving performance with some fuel efficiency. When Normal mode is selected, no indicator will illuminate on the instrument cluster.

SMART mode

Smart mode selects the proper driving mode between normal and sport by judging the driver's driving habits.

SPORT mode

Sport mode focuses on engaging driving dynamics by adjusting the steering feel along with the responsiveness of the engine and transmission.

NOTE:

Whenever the engine is restarted, the drive mode will revert back to the default normal mode.

To improve your fuel efficiency:

- Drive smoothly and accelerate at a moderate rate.
- Avoid heavy accelerations.
- Maintain steady cruising speed.
- Adjust the vehicle speed to the traffic condition and avoid speed changes.
- Avoid unnecessary braking.
- Keep the tires inflated to the recommended tire pressure.
- Do not idle the engine longer than necessary.

TIRE PRESSURE MONITORING SYSTEM (TPMS)

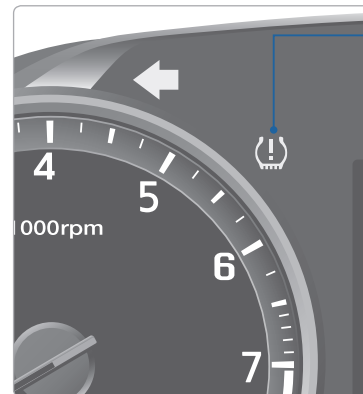

Low Tire Pressure Indicator / TPMS Malfunction Indicator

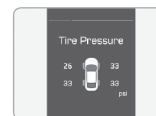

Low Tire Pressure Position Indicator and Tire Pressure Indicator (Shown on the LCD display)

LOW TIRE PRESSURE INDICATOR

Illuminates if one or more of your tire is significantly under-inflated.



TPMS MALFUNCTION INDICATOR

Blinks for approximately one minute, then remains illuminated when there is a malfunction with the TPMS. Inspect all tires and adjust the tire pressure to specification. If the lamp remains illuminated, have the system checked by an authorized Hyundai dealer as soon as possible.

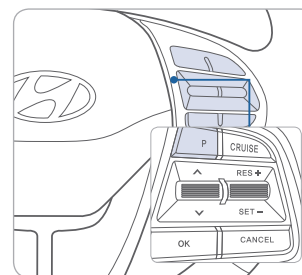
LOW TIRE PRESSURE POSITION INDICATOR AND TIRE PRESSURE INDICATOR (LCD DISPLAY)



Select the Assist mode  by pressing the mode button on the steering wheel to display tire pressure.

Tire pressures will display after driving a short distance. If a tire pressure drops lower than predetermined specification, the Low Tire Pressure Indicator  will illuminate and the LCD  display will indicate tire(s) requiring air.

The Tire Specification and Pressure Label located on the driver's side center pillar gives the tire pressures recommended for your car.

For information regarding your Spare Tire Kit or Tire Mobility Kit, please refer to chapter 6 in your Owner's Manual."

CRUISE CONTROL / SMART CRUISE CONTROL

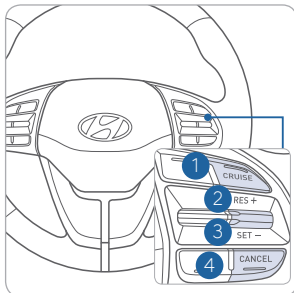

The Cruise Control system allows you to program the vehicle to maintain a constant speed without depressing the accelerator pedal.

- 1 To turn On / Off the Cruise Control
- 2 To Resume or Increase the Cruise Control speed
- 3 To Set or Decrease the Cruise Control speed
- 4 To Cancel the Cruise Control

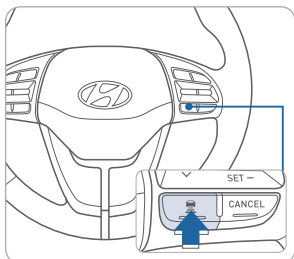

Setting Vehicle Distance (Smart Cruise Control only)

This system assist you in setting the distance from the vehicle ahead and will maintain the selected distance without you depressing the accelerator or the brake pedal.

Press the button to set and maintain the vehicle-to-vehicle distance without pressing the accelerator or brake pedal. The vehicle-to-vehicle distance 1 will automatically activate when you set the cruise speed 2. Each time the button is pressed, the vehicle-to-vehicle distance changes as follows:

Distance 4 (Longest) → Distance 3 → Distance 2
 ↑ Distance 1 (Shortest) ↓

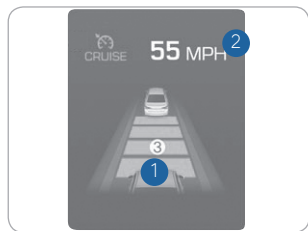

Setting Cruise Control

1. Press the "CRUISE" button 1 to turn on Cruise Control. The icon will illuminate in the instrument cluster.
2. Toggle "-SET" switch (3) DOWN to set cruising speed.

Adjusting the vehicle speed

1. Toggle "+RES" switch 2 UP to increase cruising speed.
2. Toggle "-SET" switch 3 DOWN to decrease cruising speed.

Note Quick toggle up/down will change speed by 1 mph. Holding switch up/down will change speed by 10 mph.

To Cancel Cruise Control

Press the "CANCEL" button 4 or depress the brake pedal.

INTELLIGENT VARIABLE TRANSMISSION (IVT)

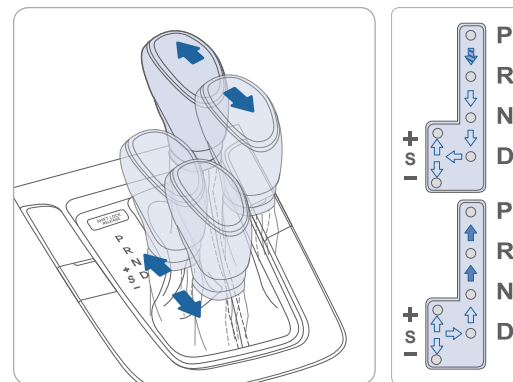

(➡): Press the shift button, then move the shift lever.

(⬅): Depress the brake pedal, press the shift button, and then move the shift lever.

(➡): Move the shift lever.

Manual shift mode

Move the shift lever from D (Drive) into the manual gate to select. Move the shift lever forward (+) to up shift or rearward (-) to downshift.

