

**BLUETOOTH®**

**Command**      **Example**  
 Dial <Phone #> — “Dial 7-1-4-9-6-5-3-0-0-0”  
 Call <Name> — “Call John Smith”

**Improving how you store your contacts can optimize your Bluetooth® Voice Recognition performance:**  
 • Use full names instead of short or single-syllable names (“John or Dad”)  
 • Avoid using special characters/emojis or abbreviations (“Dr.”) when saving contacts

UNLOCKING VEHICLE - page 01

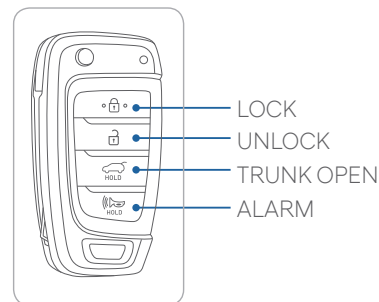

- INTRODUCTION AND LOCATION OF THE SERVICE DEPARTMENT
- SET FIRST SERVICE APPOINTMENT
- REVIEW FACTORY RECOMMENDED MAINTENANCE SCHEDULE
- WAS THE CONDITION OF YOUR VEHICLE (AT DELIVERY) TO YOUR SATISFACTION?
- BLUE LINK
  - Assist with creating MyHyundai.com account
  - Assist with Blue Link enrollment
  - Show Blue Link User's Manual
  - Encourage customer to download the MyHyundai with Blue Link app

Sales Consultant \_\_\_\_\_ Date \_\_\_\_\_ Sales Manager \_\_\_\_\_ Date \_\_\_\_\_

Customer \_\_\_\_\_ Date \_\_\_\_\_

Email \_\_\_\_\_

**MAINTENANCE**

Scheduled Maintenance	Normal Usage	Severe Usage*
Engine Oil and Filter	Replace 7,500 or 12 mos.	Replace 3,750 or 6 mos.
Fuel Additives *1	Add 7,500 or 12 mos.	Add Same as Normal
Tire Rotation	Perform 7,500	Perform 7,500
Air Cleaner Filter	Inspect 7,500	Inspect Same as Normal
	Replace 22,500	Replace More Frequently
Vacuum Hose	Inspect 7,500	Inspect Same as Normal
Climate Control Air Filter (for Evaporator and Blower Unit)	Replace Every 12 mos.	Replace More Frequently
Air Conditioning Refrigerant	Inspect 7,500	Inspect Same as Normal
Brake Hoses & Lines	Inspect 7,500	Inspect Same as Normal
Drive Shafts & Boots	Inspect 7,500	Inspect 3,750 or 6 mos.
Exhaust Pipe & Muffler	Inspect 7,500	Inspect Same as Normal
Front Brake Disc/Pads, Calipers	Inspect 7,500	Inspect More Frequently
Rear Brake Drum / Linings Rear Brake Disc / Pads	Inspect 7,500	Inspect More Frequently
Steering Gear Box, Linkage & Boots / Lower Arm Ball Joint, Upper Arm Ball Joint	Inspect 7,500	Inspect More Frequently
Suspension Mounting Bolts	Inspect 7,500	Inspect Same as Normal
Brake / Clutch Fluid	Inspect 15,000	Inspect Same as Normal
Crankcase Ventilation Hose	Inspect 15,000	Inspect Same as Normal
Fuel Filter	Inspect 15,000	Inspect Same as Normal
Fuel Lines, Fuel Hoses and Connections	Inspect 30,000	Inspect Same as Normal
Fuel Tank Air Filter	Inspect 15,000	Inspect Same as Normal
Parking Brake	Inspect 15,000	Replace More Frequently
Vapor Hose, Fuel Tank & Fuel Filler Cap	Inspect 15,000	Inspect Same as Normal
Spark Plugs	Replace 97,500	Replace More Frequently
Drive Belt (Alt, A / C)	1st Inspect 60,000 or 72 mos. Add'l Inspect 15,000 or 24 mos.	Inspect Same as Normal
Coolant	1st Inspect 120,000 or 120 mos. Add'l Replace 30,000 or 24 mos.	Replace Same as Normal
Manual Transmission Fluid	Inspect 30,000	Replace 75,000
Intelligent Variable Transmission Fluid	No checks, No services required	Replace 60,000

\*Check the engine oil regularly between recommended oil change. Hyundai recommends Quaker State oil.  
 \*1 If TOP TIER Detergent Gasoline is not available, one bottle of additive is recommended. Additives are available from your authorized Hyundai dealer along with information on how to use them. Do not mix other additives.

\*See Owner's Manual for details regarding Severe Usage maintenance recommendations.

**Looking For more detailed information?** This Quick Reference Guide does not replace your vehicle's Owner's Manual. If you require additional information or are unsure of a specific issue, We recommend that you always refer to the vehicle's Owner's Manual or contact your authorized Hyundai dealer. The information contained in this Quick Reference Guide is correct at the time of printing; however, specifications and equipment can change without notice. No warranty or guarantee is being extended in this Quick Reference Guide, and Hyundai reserves the right to change product specifications and equipment at any time without incurring obligations. Some vehicles are shown with optional equipment.

# The Hyundai ACCENT

Quick Reference Guide



Roadside Assistance: 1-800-243-7766  
 Consumer Affairs: 1-800-633-5151  
 Sirius XM® Radio: 1-800-967-2346  
 Blue Link: 1-855-2BLUELINK (1-855-225-8354)

## **HYUNDAI VEHICLE OWNER PRIVACY POLICY**

Your Hyundai vehicle may be equipped with technologies and services that use information collected, generated, recorded or stored by the vehicle. Hyundai has created a Vehicle Owner Privacy Policy to explain how these technologies and services collect, use, and share this information.

You may read our Vehicle Owner Privacy Policy on the Hyundaiusa.com website at <https://www.hyundaiusa.com/owner-privacy-policy.aspx>. If you would like to receive a hard copy of our Vehicle Owner Privacy Policy, please contact our Customer Connect Center at:

Hyundai Motor America  
Hyundai Customer Connect Center  
P.O. Box 20850  
Fountain Valley, CA 92728-0850  
800-633-5151 [consumeraffairs@hmausa.com](mailto:consumeraffairs@hmausa.com)

Hyundai's Customer Connect Center representatives are available Monday through Friday, between the hours of 5:00 AM and 7:00 PM PST and Saturday and Sunday between 6:30 AM and 3:00 PM PST (English). For Customer Connect Center assistance in Spanish or Korean, representatives are available Monday through Friday between 6:30 AM and 3:00 PM PST.



Headlights  
Page 07



Instrument  
Cluster  
Page 09

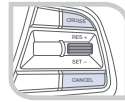

Cruise  
Control  
Page 35

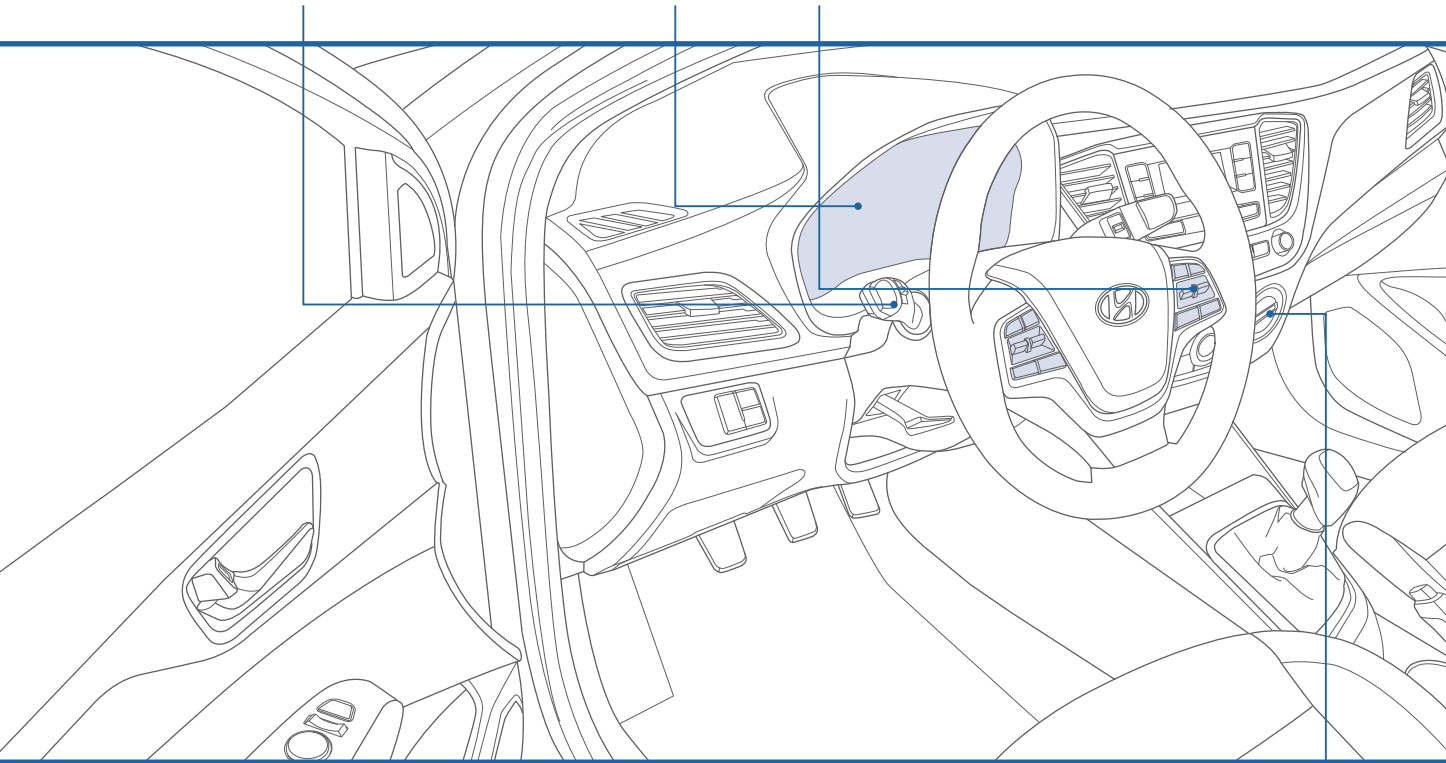

Climate  
Control  
Page 13

## FEATURES AND CONTROLS

Center console storage	06
Child-protector rear door lock	06
Climate Control	13
Display Mode Control	12
Display Modes	12
Driver's main controls	05
Engine start/stop button	02
Fuel filler lid	05
Headlights	07
Instrument Cluster	09
Instrument Panel Illumination	11
Remote & Smart Key	01
Seat-Front Seat Adjustment	03
Seat-Headrest Adjustment	03
Seat- Rear Seat Folding	03
Seat- Seat Belt Adjustment	04
Seat-Seat Warmer	04
Smart Trunk	04
Steering wheel adjustments	02
Warnings and indicators	11
Wipers and washer	08

## MULTIMEDIA

Android Auto™	21
Apple Carplay™	23
AUX and USB port	27
Blue Link Telematics System	28
Bluetooth Phone Call Operational Tips	19
Bluetooth Phone Operation	17
Clock adjustment	27
Steering Wheel Audio Control	19
Voice Recognition Tips	20

## DRIVING

Automatic emergency braking (AEB)	31
Cruise Control	35
Drive Mode Integrated Control System	34
Forward Collision-avoidance Assist (FCA)	33
Intelligent variable transmission	31
Manual transmission	31
Tire pressure monitoring system (TPMS)	32

### **WARNING!**

To reduce the risk of serious injury to yourself and others, read and understand the important SAFETY INFORMATION in your Owner's Manual.

Use this Quick Reference Guide to learn about the features that will enhance your enjoyment of your Hyundai. More detailed information about these features are available in your Owner's Manual.

\* Some vehicles may not be equipped with all the listed features.

## REMOTE & SMART KEY

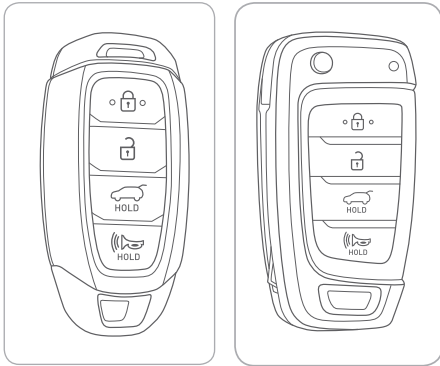

- Lock
- Unlock
- Trunk Unlock
- Panic

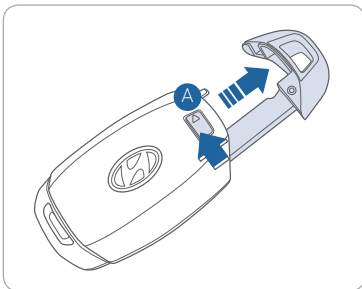

**Removing the mechanical key**  
Slide and hold the release button **A** to remove the mechanical key.

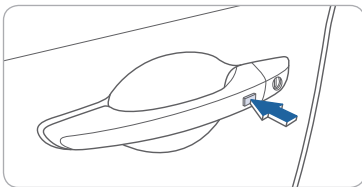

**Driver's door Lock / Unlock**  
Smart key must be within 28–40in. from the outside door handle.  
**Press:** One time - Unlock driver door  
Two times - Unlock all doors  
Three times - Lock all doors

**NOTE:** User selectable option : Please see section 3 from Owner's Manual for more details.

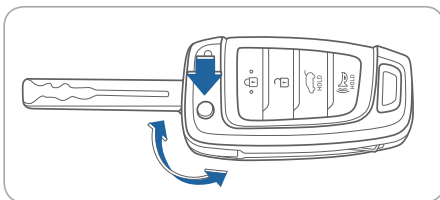

To unfold the mechanical key, press the release button on the remote.

## ENGINE START / STOP BUTTON

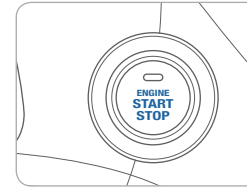

With the ignition OFF and foot OFF of the brake pedal, press the Engine Start / Stop button.

- Once for ACC (Accessory) mode.
- Twice for ON mode.
- Three times for OFF.

To start the engine in any mode (including OFF), press the Engine Start / Stop button while pressing down on the brake pedal (and the clutch pedal for the manual transmission).

To shut the engine OFF, place the shift lever in P (Park) and press the Engine Start / Stop button.

### Emergency Situations

#### To turn the engine off while moving

Press the Engine Start / Stop button for more than 2 seconds or 3 times consecutively within 3 seconds.

#### To restart the engine while moving

Press the Engine Start / Stop button with the shift lever in N (Neutral).

## STEERING WHEEL ADJUSTMENTS

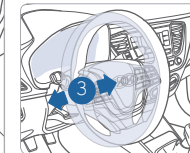
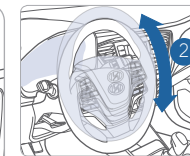
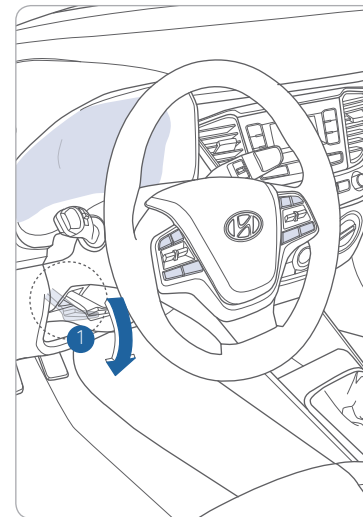

(if equipped)

**NOTE:** Do not adjust while driving.

1. Pull the lever **1** down.
2. Set the angle **2** and **3** distance (if equipped).
3. Pull the lever **1** up to lock position.

## FRONT SEAT ADJUSTMENT (Manual)

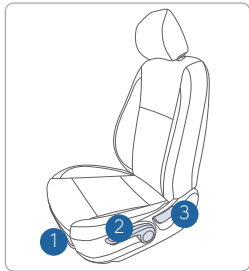

- 1 Forward and Backward
- 2 Seat Height
- 3 Seatback Angle

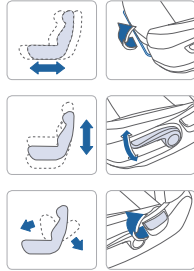

## HEADREST ADJUSTMENT

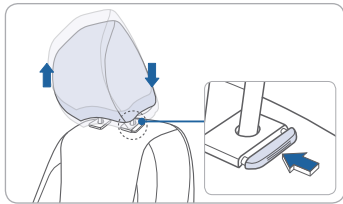

To Raise the Headrest:  
Pull the headrest up.

To Lower the Headrest:  
Press the lock button while  
pressing down on the headrest.

## REAR SEAT FOLDING

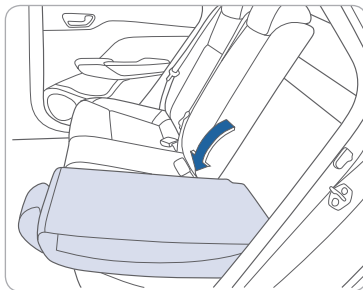
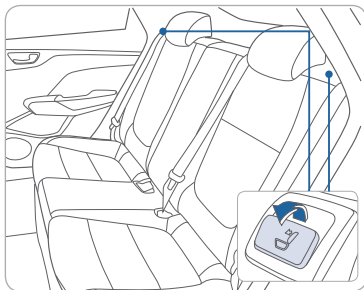

## SEAT WARMER (Front seat)

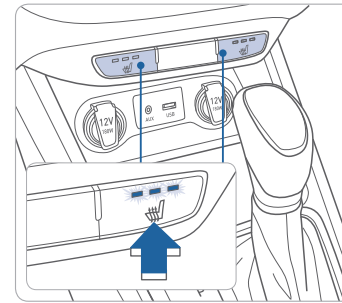

Each time you push the switch, the setting is changed as following:

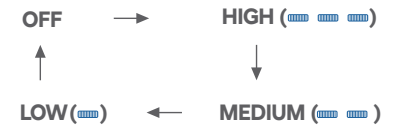

Seat warmer will default to "Off" once ignition is cycled off.

## SEAT BELT ADJUSTMENT (Front seat)

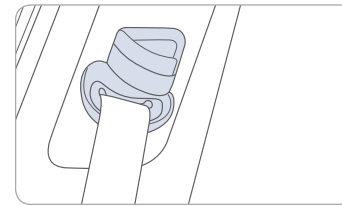

Pull up to raise.

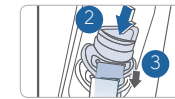

Press button and push down to lower.

## SMART TRUNK

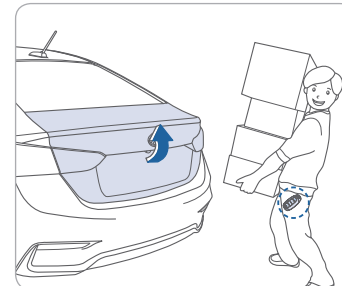

### Smart Trunk

Trunk will open automatically when detecting smart key within the range near the trunk for over 3 seconds.

To enable Smart Trunk function:  
Vehicle must be in P (Park) to adjust the settings in the User Settings mode.

1. Select "Door" in the User Settings in the instrument cluster.
2. Check "Smart Trunk".

### NOTE:

Function is active after 15 seconds when all doors are closed and locked. The vehicle will also provide an audible and visual alarm while activating. Please refer to your Owner's Manual for further information.

## DRIVER'S MAIN CONTROLS

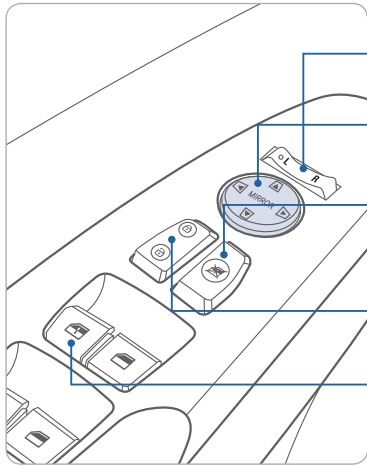

### Side View Mirror

Press either the L (Left) or R (Right) on the switch.

Adjust the mirror by using the mirror adjustment control switch.

### Power Window Lock Button

Disables the power window switches on the rear passenger doors.

### Door Lock

Locks / unlocks all doors.

### Window Auto Down / Up (if equipped)

Press past detent to fully open / close the window.

## FUEL FILLER LID

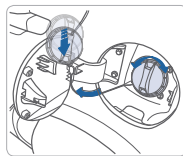
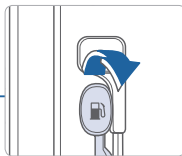
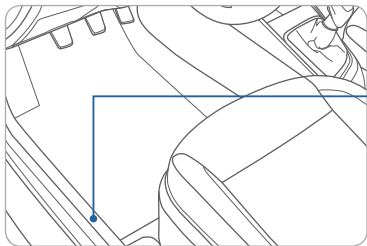

**NOTE:** Turn the fuel filler cap clockwise until one click is heard.

## CHILD-PROTECTOR REAR DOOR LOCK

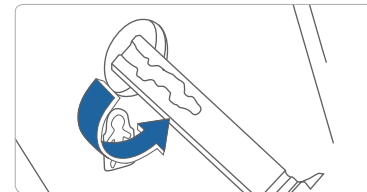
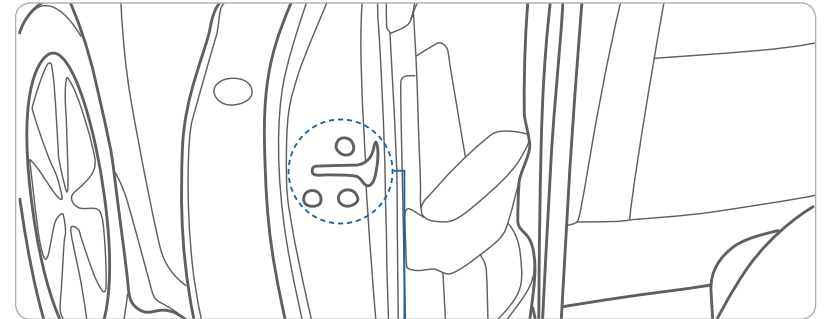

### Lock

Insert a key (or screw driver) into the hole and turn it to the lock position.

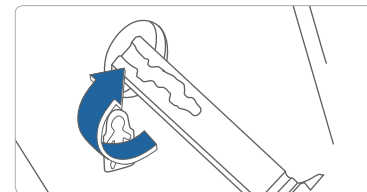

### Unlock

Insert a key (or screw driver) into the hole and turn it clockwise to the unlock position.

## CENTER CONSOLE STORAGE

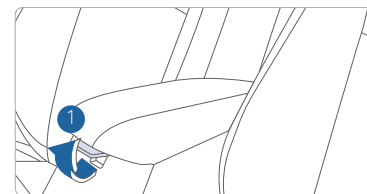

### To Open

Grab and hold the latch ① on the arm rest and lift the lid.

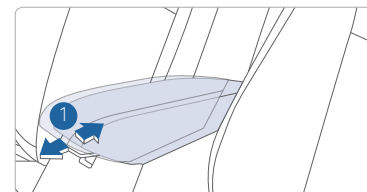

**Moving the armrest forward:** Pull up the latch ① and pull the armrest forward.

**Moving the armrest rearward:** Pull up the latch ① and push the armrest rearward.

## HEADLIGHTS

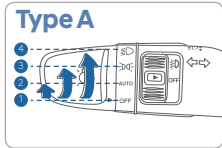

- ▶ | Headlight Position
- ▶ | Parking Light Position
- ▶ | **AUTO** Auto Light Position
- ▶ | **OFF** OFF Position

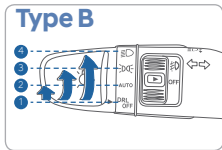

- ▶ | Headlight Position
- ▶ | Parking Light Position
- ▶ | **AUTO** Auto Light Position
- ▶ | **DRL OFF** DRL OFF Position

### Headlight Delay

Headlights may stay on for 15 seconds after exiting and locking up the vehicle. Press the lock button on the remote key or smart key twice to turn off the headlights.

### Turn Signals and Lane Change Signals

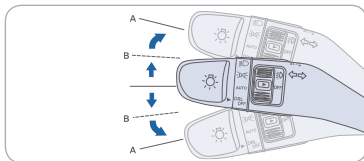

### High Beam

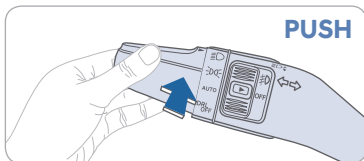

**NOTE:**  
To turn off the high beam, pull the lever towards you.

### Flashing High Beam

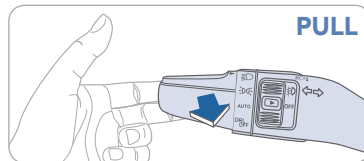

### Fog light

Rotate switch up to turn on fog lights. Rotate switch down to turn off fog lights.

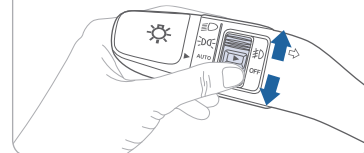

## WIPERS AND WASHER

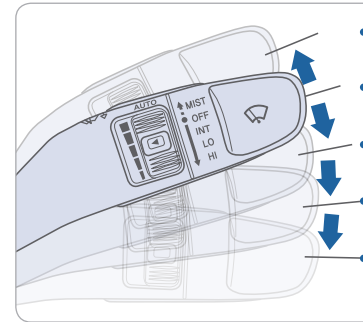

- **MIST** - Single wipe
- **OFF** - Off
- **INT** - Intermittent wipe
- **LO** - Low wiper speed
- **HI** - High wiper speed

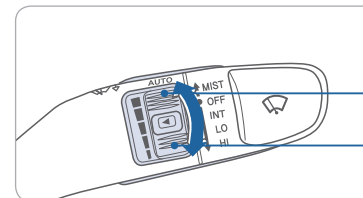

Intermittent Wipe Time Adjustment  
Move the speed control switch

- Fast wiper speed
- Slow wiper speed

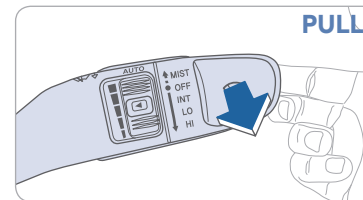

Windshield Washer  
Pull the lever gently towards you to spray washer fluid on the windshield and to run the wipers 1-3 cycles.

## INSTRUMENT CLUSTER

### Type A



- 1 Tachometer
- 2 Speedometer
- 3 Engine coolant temperature gauge
- 4 Fuel gauge
- 5 Warning and indicator lights
- 6 LCD display (including Trip computer)

### Type B





### WARNINGS AND INDICATORS

Air Bag Warning Light	Seat Belt Warning Light	Parking Brake & Brake Fluid Warning Light
Anti-Lock Brake System (ABS) Warning Light	Electronic Brake Force Distribution (EBD) System Warning Light	
Electric Power Steering (EPS) Warning Light	Malfunction Indicator Lamp (MIL)	Charging System Warning Light
Engine Oil Pressure Warning Light	Low Fuel Level Warning Light	Washer Fluid Warning Light
SPORT Mode Indicator	Master Warning Light	Electronic Stability Control (ESC) Indicator
Electronic Stability Control (ESC) OFF Indicator	Immobilizer Indicator	Turn Signal Indicator
High Beam Indicator	Light ON Indicator	Front Fog Indicator
Forward Collision-avoidance Assist (FCA) Warning light	CRUISE Cruise Indicator	SET Cruise SET Indicator
Low Tire Pressure Warning Indicator / TPMS Malfunction Lamp		

### INSTRUMENT PANEL ILLUMINATION

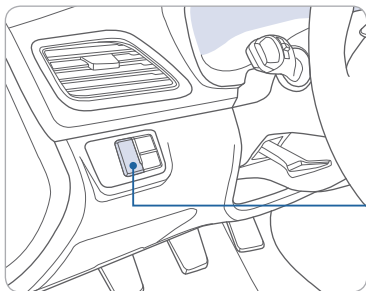

Press - or + to adjust the instrument cluster illumination brightness.



### DISPLAY MODES

Modes	Symbol	Description
Trip Computer		This mode displays driving information such as tripmeter, fuel economy, etc.
User Settings		In this mode, you can change settings of the doors, lamps, etc.
Warning		This mode displays warning messages related to the systems.

### DISPLAY MODE CONTROL

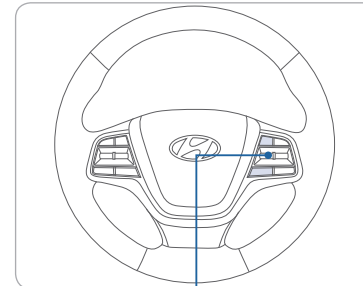

- TRIP: MODE** button for changing modes
- OK** : SELECT / RESET button for setting or resetting the selected item

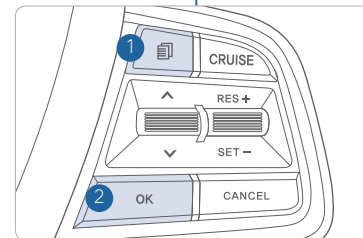

## CLIMATE CONTROL

### Manual

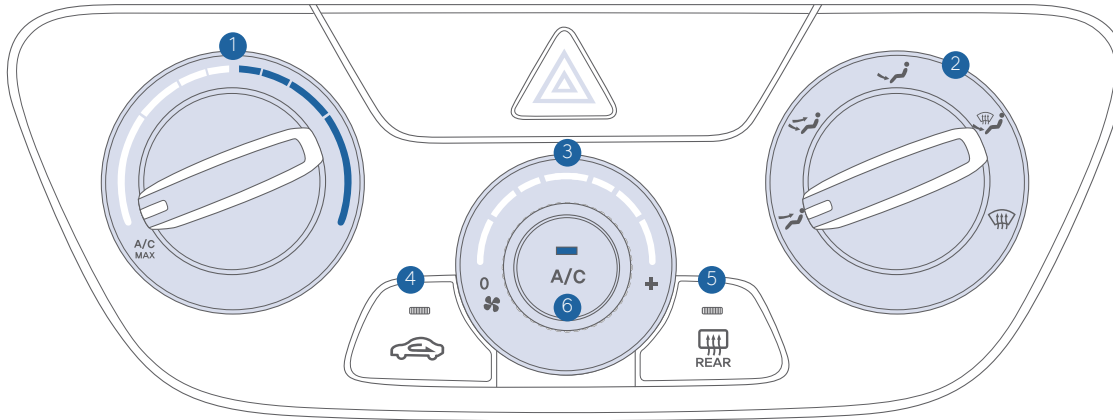

- 1 Temperature control knob
- 2 Mode selection knob
- 3 Fan speed control knob
- 4 Air intake control button
- 5 Rear window defroster button
- 6 A/C (Air conditioning) button

### DEFOGGING / DEFROSTING



1. Select the defrost position.



2. Set the temperature control to the warmest setting.



3. Set the fan speed to the medium setting.

### AIR INTAKE CONTROL



Recirculated air position (LED on)



Outside (fresh) air position (LED off)

### MODE SELECTION



Changes the direction of the air flow as following:

- Face-Level
- Bi-Level
- Floor-Level
- Floor & Defrost-Level
- Defrost-Level

### REAR WINDOW DEFROSTER

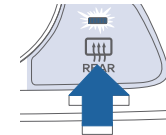

Press to activate / deactivate the rear defroster.

### NOTE:

To reduce the tendency of the glass fogging and also to improve visibility, keep the interior surface of the windshield clean by wiping it with a clean cloth and glass cleaner. In addition, select air intake control to the outside (fresh) air position whenever possible while operating the vehicle.

## Automatic

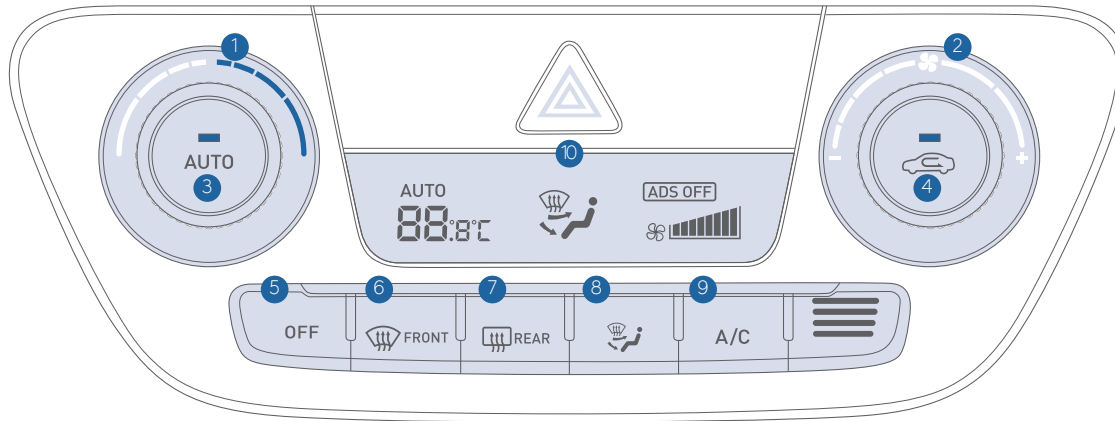

- 1 Temperature control knob
- 2 Fan speed control knob
- 3 AUTO (automatic control) button
- 4 Air intake control button
- 5 OFF button
- 6 Front windshield defrost button
- 7 Rear window defrost button
- 8 Mode selection button
- 9 Air conditioning button
- 10 Climate control information screen

### DEFOGGING/DEFROSTING SYSTEM OFF



1. Press the front windshield defrost control button.



2. Set the temperature control to the warmest setting.



3. Set the fan speed to the medium setting.

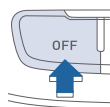

Pressing the OFF button will place the system to the OFF mode.

- Climate control fan will turn off.
- Outside (fresh) air position will be selected.
- Vented air will be at last set temperature.

### AUTOMATIC HEATING / AIR CONDITIONING



The modes, fan speeds, air intake and air conditioning will be controlled automatically by the temperature setting you select.

### AIR INTAKE CONTROL



Recirculated air position (LED on)



Outside (fresh) air position (LED off)

### MODE SELECTION

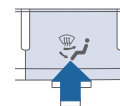

Changes the direction of the air flow as following:



### NOTE:

To reduce the tendency of the glass fogging and also to improve visibility, keep the interior surface of the windshield clean by wiping it with a clean cloth and glass cleaner. In addition, select air intake control to the outside (fresh) air position whenever possible while operating the vehicle.

## BLUETOOTH PHONE OPERATION

### Phone setup (pairing phone) with Audio (Type A)

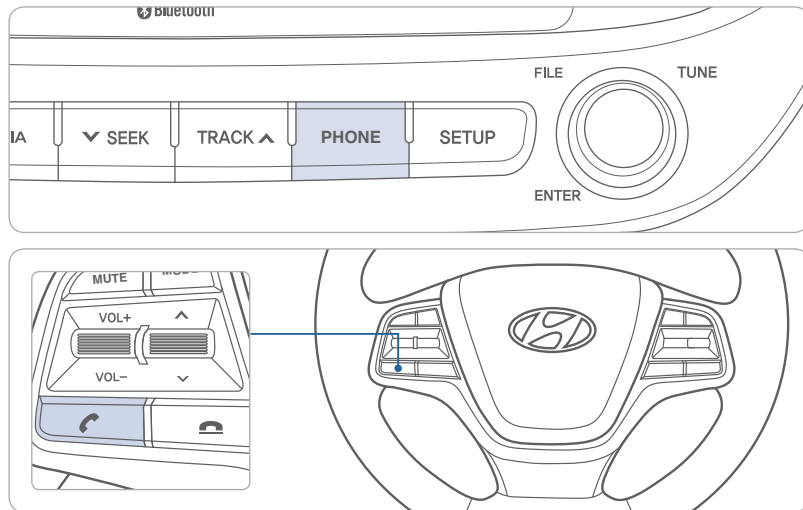

1. Press the PHONE button in the head unit or CALL button in the steering wheel remote control.

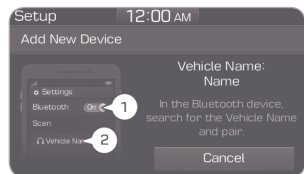

2. Search for the device name as displayed on your mobile phone and pair.

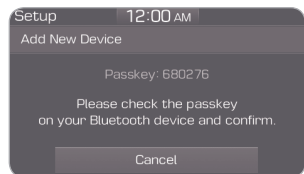

3. Confirm the 6-digit passkey displayed on the audio screen and the Bluetooth device are identical.

4. Press OK in your Bluetooth device.  
5. Pairing is complete.

**NOTE:** Vehicle must be parked to complete the pairing process.

### Phone setup (pairing phone) with Audio (Type B)

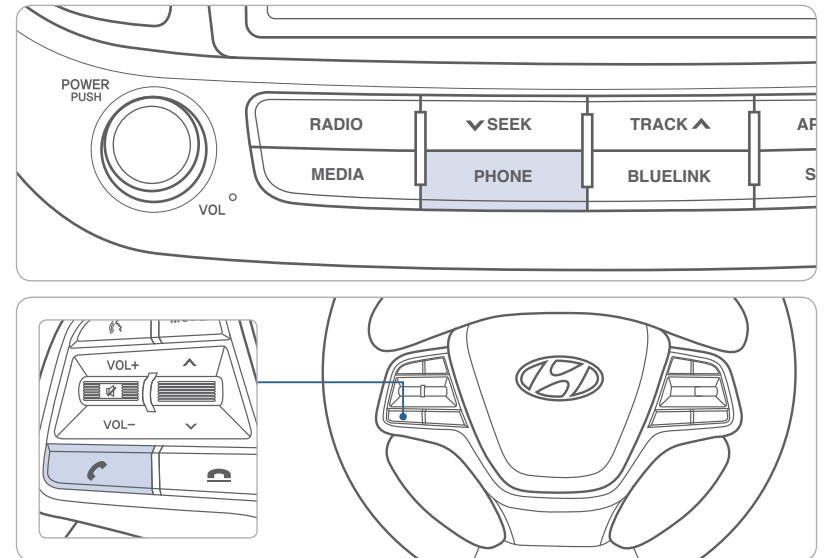

1. Press the PHONE button in the head unit or CALL button in the steering wheel remote control.
2. Pair your car after your mobile phone detects the Bluetooth device.
3. Enter the passkey or accept the authorization popup.
4. Connect Bluetooth.

**NOTE:** Vehicle must be parked to complete the pairing process.

## STEERING WHEEL AUDIO CONTROL

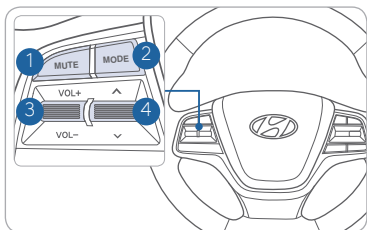

- 1 **MUTE**  
Mutes the audio.
- 2 **MODE**  
Changes the audio source.
- 3 **VOLUME (VOL + / -)**  
Increases or decreases the volume.
- 4 **SEEK / PRESET ( ^, v )**  
Changes the station.

## Bluetooth® PHONE CALL OPERATIONAL TIPS

In the following situations you or the other party may have difficulty hearing each other:

1. Keep the Bluetooth® volume to a low level. High level volume may result in distortion and echo.
2. When driving on a rough road, high speeds and / or with the window open.
3. When the air conditioning vents are facing the microphone and / or when the air conditioning fan is at the max speed.

### Steering wheel Bluetooth® control

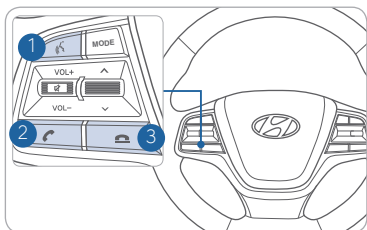

- 1 **TALK**  
Activates voice recognition.
- 2 **CALL**  
Places and transfers calls.
- 3 **END**  
Ends calls or cancels functions.

### To Answer a Call:

- Press the button on the steering wheel.

### To Reject a Call:

- Press the button on the steering wheel.

### To Adjust Ring Volume:

- Use the VOLUME buttons on the steering wheel.

### To Transfer a Call to the Phone

#### (Private call on handset – do not use while driving):

- Press and hold the button on the steering wheel until the audio system transfers a call to the phone.

### To Finish a Call:

- Press the button on the steering wheel.

### Making a call using voice recognition:

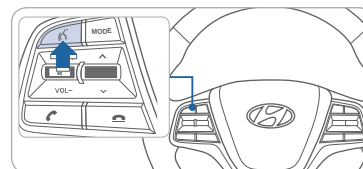

Press button on the steering wheel control to activate voice recognition.

Press and hold button to end voice recognition.

### Calling by Name:

1. Press the button.
2. Say the following command:
  - “Call <John Smith>”: Connects the call to John.
  - “Call <John Smith> on <on Mobile / at Work / at Home / on Other>”: Connects the call to John’s Mobile, Work, Home, or Other phone number.

### Dialing by Number:

1. Press the button.
2. Say “Dial Number.”
3. Say the desired phone number.

For complete list of commands, refer to your Owner’s Manual.

## VOICE RECOGNITION TIPS (if equipped)

Your vehicle is equipped with Voice Recognition technology which allows drivers to operate their phones without having to take their eyes off the road to minimize distractions.

Voice recognition performance may be affected if driving with windows and sun roof open; when the heating-cooling system is on; when passing in a tunnel or when driving on rugged and uneven roads.

### Quick reference on using voice commands

To start voice command, press the key, the following commands are available:

Command	Function
Call	Displays downloaded Contacts.
Call <Name>	Calls <Name> saved in Contacts.
Dial Number	Displays a screen where you can say a phone number to dial.
Dial <Phone #>	You can directly say the number to call. ex) Dial 111 555 1234
Redial	Directly calls at the number that you last dialed.
Call History	Displays your Call History.

## ANDROID AUTO™

### REQUIREMENTS:

- Micro USB cable
- OS Android™ 5.0 or higher
- Compatible Android Phone
- Data and wireless plan for applicable features

### BEFORE YOU BEGIN:

- Android Auto features may operate differently than on your phone.
- Message and data charges may apply when using Android Auto.
- Android Auto relies on the performance of your phone. If you experience performance issues:
  - Close all apps and then restart them or
  - Disconnect and then reconnect your phone
- Using the micro USB cable that was provided with your phone is recommended.
- When Android Auto is active, your in-vehicle voice recognition system is disabled and you will be using talk to Google™ to make your requests.

### ANDROID AUTO SUPPORT



<https://support.google.com/androidauto/>

## PHONE SETUP

Turn on Bluetooth® on your phone and connect the micro USB cable to your phone and the USB port on the vehicle.

Phone will prompt you to download the Android Auto app and update other needed apps (i.e. Google Maps™, Google Play Music™, Google Now™).

**NOTE:** Vehicle must be parked.

- Location mode setting should be set to High accuracy.
- Car and phone setup should be completed in one sitting. If phone setup needs to be resumed, recommend to Force Stop the Android Auto app on the Phone then reopen the app and accept the Disclaimer notifications.

## CAR SETUP

1. Press the SETUP button on the radio.
2. Touch the “Phone Projection” icon on screen.
3. Select “On” for Android Auto.
4. Connect your Android phone to the vehicle USB port. Agree to the notification and disclaimers on your phone then the “Android Auto” icon will appear confirming the setup.

For more detailed information on how to operate Android Auto, please refer to your navigation manual.

For additional Android Auto support, please refer to the Android Auto Support Website  
<https://support.google.com/androidauto/>

Android Auto, Google Play, Android, and other marks are trademarks of Google Inc.

## APPLE CARPLAY™

### REQUIREMENTS

- Apple Lightning® cable
- Latest iOS
- iPhone® 5 or above
- Data and wireless plan for applicable features

### BEFORE YOU BEGIN

- Apple® CarPlay features may operate differently than on your phone.
- Message and data charges may apply when using Apple CarPlay.
- Apple CarPlay relies on the performance of your phone. If you experience performance issues:
  - Close all apps and then restart them or
  - Disconnect and then reconnect your phone
- Using the Apple Lightning cable that was provided with your phone is recommended.
- When Apple CarPlay is active, your voice recognition system is disabled and you will be using Siri® to make your requests.

### PHONE SETUP

On your phone, go to Settings > General > Restrictions > CarPlay to allow CarPlay access.

On your phone, go to Settings > General > Siri and ensure Siri is turned ON.

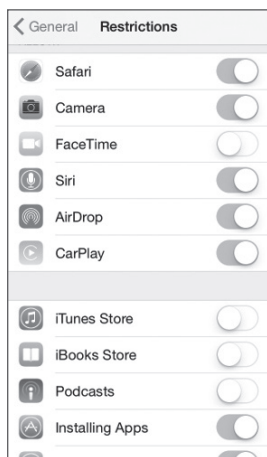

### CAR SETUP

1. Press the SETUP button.
2. Touch the “Phone Projection” icon on the screen.
3. Touch “iOS” on the Phone Projection Settings screen then touch “On” to enable Apple CarPlay.
4. Connect your Apple iPhone to the vehicle USB port then touch ‘OK’ when the pop-up message appears. The Apple CarPlay icon will now appear on the vehicle Home screen confirming the setup.

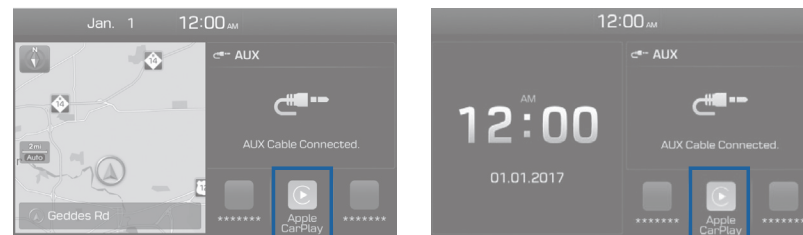

Apple CarPlay, Apple, and other marks are trademarks of Apple Inc.

## CarPlay Home Screen

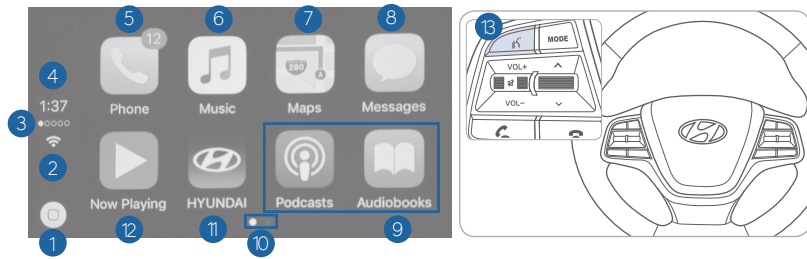

- |                         |                                  |
|-------------------------|----------------------------------|
| 1 HOME ICON             | 7 APPLE MAPS                     |
| 2 WIRELESS CONNECTIVITY | 8 MESSAGES                       |
| 3 CELLULAR SIGNAL       | 9 3RD PARTY APPS                 |
| 4 PHONE TIME            | 10 SCREEN PAGE INDICATOR         |
| 5 PHONE                 | 11 EXIT TO HYUNDAI               |
| 6 APPLE MUSIC™          | 12 CURRENT CARPLAY AUDIO PLAYING |
|                         | 13 VOICE RECOGNITION             |

## SIRI

Apple CarPlay uses Siri to perform many actions like sending messages, placing calls, and looking up/setting POI/Destinations. A Siri session can be initiated on any screen by:

1. Touch and holding the HOME icon 1 on the CarPlay screen or
2. Press the steering wheel VOICE RECOGNITION 13 button.

Note: Ensure Siri feature is set to ON in your phone (Go to Settings > General > Siri).

3. Say any of the following commands;
  - “Text <John Smith> ‘Call you later’” to send a text message.
  - “Read text messages” to read available text message.
  - “Call <John Smith>” to make a phone call.
  - “Find <POI/Destination>” to locate a POI/Destination.

## PHONE

Touch the PHONE 5 icon to access the Phone screen. Siri will automatically asks ‘Who you would like to call’ when the PHONE 5 icon is selected.

NOTE: Phone call sound quality is dependent on the wired connection. Using the Lightning cable that came with the phone is recommended.

## APPLE MUSIC

Touch the APPLE MUSIC 6 icon to access the Apple Music screen.

## APPLE MAPS

Touch the APPLE MAPS 7 icon to access the Apple Map screen.

## MESSAGES

Touch the MESSAGES 8 icon to access the Message screen. Siri will automatically asks ‘To hear unread messages or create a new one’ when the MESSAGE icon is selected.

## 3rd PARTY APPS

Supported CarPlay apps that are downloaded on your phone will appear on the CarPlay screen. Touch the apps icons to access those supported apps.

NOTE: A list of the supported CarPlay supported apps can be found at <http://www.apple.com/ios/carplay/>

Ensure phone has latest version of the 3rd Party Apps.



## CLOCK ADJUSTMENT

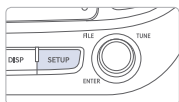

1. Press the SETUP button on the audio head unit.
2. Select Date/Time.

### Date/Time

Set the date, time displayed on the audio screen.

### Time Format

Choose between 12-hour and 24-hour time formats.



## AUX AND USB PORT

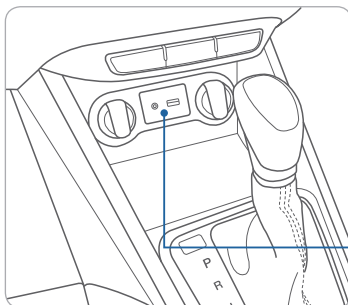

Use the input jack to connect an external audio device and listen to it through the audio system in your vehicle.

iPod® is a trademark of Apple, Inc.

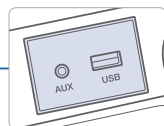

## BLUE LINK TELEMATICS SYSTEM

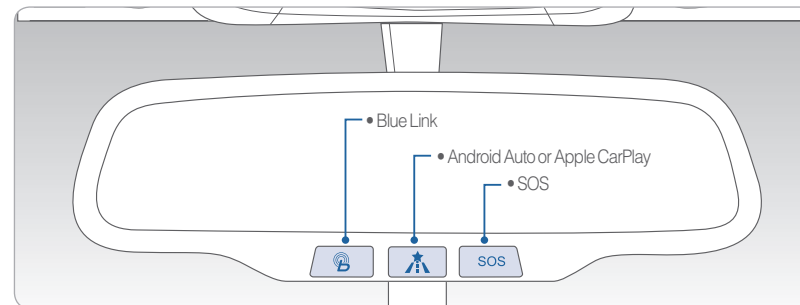

Blue Link subscription is required. To enroll, please visit your dealership or MyHyundai.com.

Press the  button to access the voice-response menu of services.

- You can say:

- Service Link
- Roadside Assistance
- Account Assistance
- Help
- Cancel

Press the  button to launch Android Auto or Apple CarPlay if a supported device is connected.

Press the **SOS** button for SOS Emergency Assistance.

Visit HyundaiBlueLink.com for more information or refer to your Blue Link User's Manual for detailed information on system operation.

For immediate assistance with subscription services, please call 1-855-2BLUELINK (1-855-225-8354).

Google™ is a registered trademark of Google, Inc.

## Blue Link Mobile App



You can download the Blue Link mobile app to your compatible smart phone from the following sites:

- iPhone® — Apple® App Store
- Android™ — Google Play™

Visit [HyundaiBlueLink.com](http://HyundaiBlueLink.com) FAQs to see a list of compatible devices.

## Remote Start

Remote Start enables you to remotely start your vehicle virtually from anywhere. For vehicles equipped with full-automatic temperature control, you can also enable climate control remotely and turn on the front window defroster, ensuring a warm or cool car is ready to go when you are.

- To use this feature, you must have a Blue Link Personal Identification Number (PIN). To create or change your PIN, log in to [www.MyHyundai.com](http://www.MyHyundai.com).

### Remember:

- Remote Start will automatically shut off after 10 minutes or after selected engine timer runs out in navigation vehicles.
- While this feature is active, the parking lights will blink until the vehicle is turned off or when vehicle is in operation.
- To continue to operate the vehicle, the proximity key must be inside the vehicle with the driver, prior to pressing the brake and being able to move the gearshift from the P (Park) position.

**NOTE:** Remote Start is not available on all models. Remote Start is only available for Push Start equipped vehicle with an Automatic Transmission. Remote Start with Climate Control additionally requires Fully Automatic Temperature Control.

### Preconditions:

- Ignition is OFF
- Alarm is armed (i.e., vehicle locked by key fob Remote Door Lock)
- Gearshift level is in the P (Park) position
- Brake pedal is not depressed
- Engine hood is securely closed
- All the doors are closed and locked
- The tailgate or trunk lid is closed
- The security / panic system is not activated
- The proximity key is not inside the vehicle
- The battery power is not low
- Vehicle is located in an open area
- It has been less than 4 days since last vehicle ignition off
- Vehicle located in area with good cell reception

### Remote Start will terminate:

- After 10 minutes or after selected engine timer runs out in navigation vehicles
- Brake is pressed without the proximity key inside the vehicle
- Alarm is triggered without the proximity key inside the vehicle
- Door / trunk is opened from inside the vehicle

**Notice:** Laws in some communities may restrict the use of the features that remotely start the engine. For example, some laws may require a person using the remote start feature to have the vehicle in view when doing so, or limit the length of time a vehicle engine may idle. Please check local and state regulations for any requirements and restrictions on remote starting of vehicles and engine idling time.

### ⚠ WARNING!



Do not remote start vehicle in an enclosed environment (i.e., closed garage). Prolonged operation of a motor vehicle in an enclosed environment can cause a harmful build-up of carbon monoxide. Carbon monoxide is harmful to your health. Exposure to high levels of carbon monoxide can cause headaches, dizziness or in extreme cases unconsciousness and / or death. Do not leave children or animals unattended in a vehicle while using the remote start function.

### ⚠ CAUTION!

If the vehicle's windshield wipers are left on when the vehicle was last driven, then the wipers will turn on if the remote start function is activated. To avoid damage to the wiper blades (i.e., due to heavy ice or snow accumulated on the windshield), please always turn the vehicle's windshield wipers off when parking the vehicle.

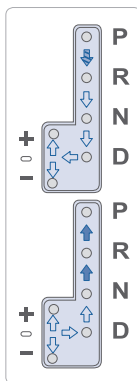
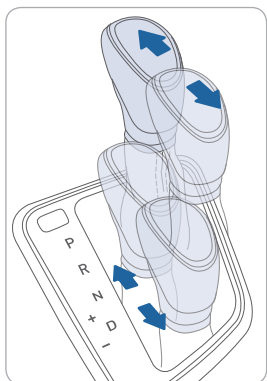
## INTELLIGENT VARIABLE TRANSMISSION



- (): Depress the brake pedal and press the shift button while moving the shift lever.
- (): Press the shift button while moving the shift lever.
- (): The shift lever can freely operate.

### Manual shift mode

Move the shift lever from D (Drive) into the manual gate to select. Move the shift lever forward (+) to shift up or rearward (-) to shift down one gear.

## MANUAL TRANSMISSION



### Engaging reverse

When shifting into R (Reverse) gear, depress the button **1** and then shift into R (Reverse) gear position.

## AUTOMATIC EMERGENCY BRAKING (AEB)

The Automatic Emergency Braking (AEB) system is designed to help detect and monitor the vehicle ahead in the roadway through radar signals and camera recognition to warn the driver that a collision is imminent, and if necessary, apply emergency braking.

To activate the system, select 'User Settings → Driving Assist → Assist Emergency Braking' on the LCD display. The system deactivates, when the system setting is cancelled

## TIRE PRESSURE MONITORING SYSTEM (TPMS)

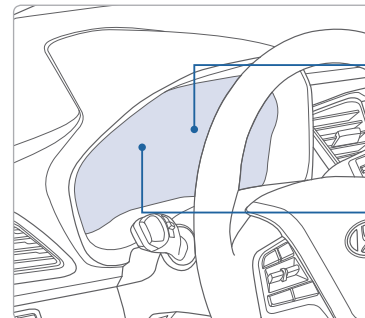

Low Tire Pressure Indicator / TPMS Malfunction Indicator



Low Tire Pressure / Tire Pressure Monitor / TPMS Malfunction Display (shown on the cluster LCD display)

### LOW TIRE PRESSURE INDICATOR

Illuminates if one or more of your tire is significantly under-inflated.

### TPMS MALFUNCTION INDICATOR

Blinks for approximately one minute, then remains illuminated when there is a malfunction with the TPMS. Inspect all tires and adjust the tire pressure to specification. If the lamp remains illuminated, we recommend the vehicle be checked by an authorized HYUNDAI dealer.

### LOW TIRE PRESSURE / TIRE PRESSURE MONITOR / TPMS MALFUNCTION DISPLAY (LCD DISPLAY)

Tire pressures will display after driving a short distance. If a tire pressure drops lower than predetermined specification, the Low Tire Pressure Indicator will illuminate and the LCD display will indicate tire(s) requiring air.

## FORWARD COLLISION-AVOIDANCE ASSIST (FCA) SYSTEM

Forward Collision Avoidance Assist (FCA) system disabled. Radar blocked



Emergency Braking



The radar type Forward Collision-Avoidance Assist (FCA) system is to help reduce or to avoid accident risk. In certain circumstances, it recognizes the distance from the vehicle ahead through the sensors (i.e. radar), and, if necessary, warns the driver or applies emergency braking of accident risk with the warning message or the warning alarms.

### NOTE:

Radar type FCA system does not operate for pedestrians in front.

To activate the system, select 'User Settings → Driving Assist → Forward Collision-Avoidance Assist (FCA)' The system deactivates, when the system setting is canceled.

The system will activate when the ESC (Electronic Stability Control) is on, and driving speed exceeds approximately 6 mph.

## DRIVE MODE INTEGRATED CONTROL SYSTEM

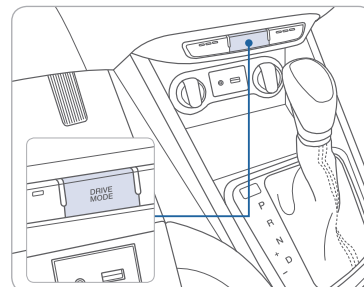

You can select the drive mode according to your preference or the road condition. The system resets to NORMAL mode when the engine is restarted.

Each time you press the button, the drive mode changes as following :



NORMAL mode is not displayed on the instrument cluster.

### NORMAL mode

Normal mode provides regular daily driving performance with some fuel efficiency.

### SPORT mode

Sport mode focuses on managing the driving dynamics by adjusting the steering effort along with the responsiveness of the engine and transmission.

#### Driving suggestions to improve fuel economy:

- Drive smoothly.
- Accelerate at moderate speed.
- Try to maintain your speed with traffic to prevent unnecessary speed adjustments.
- Always maintain a safe driving distance from the vehicle in front of you so you can avoid unnecessary braking.

## CRUISE CONTROL

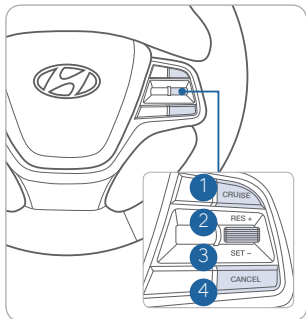

The Cruise Control system allows you to program the vehicle to maintain a constant speed without depressing the accelerator pedal.

- 1 To turn On / Off the Cruise Control
- 2 To Resume or Increase the Cruise Control speed
- 3 To Set or Decrease the Cruise Control speed
- 4 To Cancel the Cruise Control

### Setting Cruise Control

1. Press the "CRUISE" button ① to turn on Cruise Control. The icon will illuminate in the instrument cluster.
2. Toggle "-SET" switch (3) DOWN to set cruising speed.

### Adjusting the vehicle speed

1. Toggle "+RES" switch ② UP to increase cruising speed.
2. Toggle "-SET" switch ③ DOWN to decrease cruising speed.

#### NOTE:

Quick toggle up/down will change speed by 1mph, Holding switch up/down will change speed by 5 mph.

### To Cancel Cruise Control

Press the "CANCEL" button ④ or depress the brake pedal.

#### NOTE:

The system cancels automatically if vehicle speed is under 20mph. Depress the accelerator or brake pedal to actively adjust the vehicle speed, and the distance to the vehicle ahead.

Large memo area with horizontal lines for handwritten notes.

**ACCENT CUSTOMER DELIVERY CHECK LIST**

HYUNDAI OWNER	DEALERSHIP NAME
SALES CONSULTANT	DATE
VIN	PREVIOUS VEHICLE

**BEFORE DELIVERY**

- SET TIRE PRESSURE LF\_\_\_RF\_\_\_RR\_\_\_LR\_\_\_
- VERIFY VEHICLE IS CLEAN, IN GOOD CONDITION, FREE OF CHIPS AND SCRATCHES · CLEAN WINDSHIELD AND BACK WINDOW
- ENSURE FLOORMATS ARE SNAPPED INTO PLACE

**WALK THE CUSTOMER THROUGH EACH OF THE FOLLOWING KEY DELIVERY FEATURES**

- REVIEW QUICK REFERENCE GUIDE
- PAIR CUSTOMER'S PHONE TO THE BLUETOOTH SYSTEM
- REVIEW AND TEAR OFF VOICE COMMAND / QUICK TIP CARD
- HOW TO DEFROST
  - ① Press the front defrost button
  - ② Set to the warmest temperature setting
  - ③ Set to the highest fan speed



**CONNECTING YOUR PHONE**

- On the radio:**
1. Push the **SETUP** button.
  2. Select **Bluetooth**.
  3. Select **Bluetooth Connection**.
  4. Select **Add New**.
- In your phone's Bluetooth settings:**
5. Select the <Vehicle Name> on your phone.
  6. Enter the passkey from the radio or accept the authorization pop-up on your phone.

**SWITCHING BETWEEN PAIRED PHONES**

**Using Voice Command:**  
"Change Bluetooth device"

- On the radio:**
1. Push the **SETUP** button.
  2. Select **Bluetooth**.
  3. Select **Bluetooth Connection**.
  4. Select **Connect** next to the desired phone.

For more information, visit [HyundaiBluetooth.com](http://HyundaiBluetooth.com)