

OWNER'S MANUAL

Operation

Maintenance

Specifications

All information in this Owner's Manual is current at the time of publication. However, Genesis Branded Vehicle reserves the right to make changes at any time so that our policy of continual product improvement may be carried out.

This manual applies to all Genesis Branded Vehicle models and includes descriptions and explanations of optional as well as standard equipment.

As a result, you may find material in this manual that does not apply to your specific vehicle.

CAUTION: MODIFICATIONS TO YOUR GENESIS BRANDED VEHICLE

Your Genesis Branded Vehicle should not be modified in any way. Such modifications may adversely affect the performance, safety or durability of your Genesis Branded Vehicle and may, in addition, violate conditions of the limited warranties covering the vehicle. Certain modifications may also be in violation of regulations established by the U.S. Department of Transportation and other federal or state agencies.

TWO-WAY RADIO OR CELLULAR TELEPHONE INSTALLATION

Your vehicle is equipped with electronic fuel injection and other electronic components. It is possible for an improperly installed/adjusted two-way radio or cellular telephone to adversely affect electronic systems. For this reason, we recommend that you carefully follow the radio manufacturer's instructions or consult your authorized retailer of Genesis Branded products for precautionary measures or special instructions if you choose to install one of these devices.

SAFETY AND VEHICLE DAMAGE WARNING

This manual includes information titled as DANGER, WARNING, CAUTION and NOTICE.

These titles indicate the following:

DANGER

DANGER indicates a hazardous situation which, if not avoided, will result in death or serious injury.

CAUTION

CAUTION indicates a hazardous situation which, if not avoided, could result in minor or moderate injury.

WARNING

WARNING indicates a hazardous situation which, if not avoided, could result in death or serious injury.

NOTICE

NOTICE indicates a situation which, if not avoided, could result in vehicle damage.

Genesis Branded Vehicle Owner Privacy Policy

Your Genesis Branded vehicle may be equipped with technologies and services that use information collected, generated, recorded or stored by the vehicle. Genesis Branded Vehicle has created a Vehicle Owner Privacy Policy to explain how these technologies and services collect use and share this information.

You may read our Vehicle Owner Privacy Policy on the GenesisMotorsUSA.com website at:
<http://www.genesismotorsusa.com/privacy-policy.html>

If you would like to receive a hard copy of our Vehicle Owner Privacy Policy, please contact our Genesis Customer Care at:

Genesis Customer Care
PO BOX 20650
Fountain Valley, CA 92728
844-340-9741

Genesis Customer Care representatives are available Monday through Friday, between the hours of 5:00 AM and 7:00 PM PST and Saturday and Sunday between 6:30 AM and 3:00 PM PST (English).

For Genesis Customer Care assistance in Spanish or Korean, representatives are available Monday through Friday between 6:30 AM and 3:00 PM PST.

INTRODUCTION

Congratulations, and thank you for choosing the Genesis Branded Vehicle. We are pleased to welcome you to the growing number of discerning people who drive the Genesis Branded Vehicle. We are very proud of the advanced engineering and high-quality construction of each Genesis Branded Vehicle we build.

Your Owner's Manual will introduce you to the features and operation of your new Genesis Branded Vehicle. To become familiar with your new Genesis Branded Vehicle, so that you can fully enjoy it, read this Owner's Manual carefully before driving your new vehicle.

This manual contains important safety information and instructions intended to familiarize you with your vehicle's controls and safety features so you can safely operate your vehicle.

This manual also contains information on maintenance designed to enhance safe operation of the vehicle. It is recommended that all service and maintenance on your car be performed by an authorized retailer of Genesis Branded products. Retailers of Genesis Branded products are prepared to provide high-quality service, maintenance and any other assistance that may be required.

This Owner's Manual should be considered a permanent part of your vehicle, and should be kept in the vehicle so you can refer to it at any time. The manual should stay with the vehicle if you sell it to provide the next owner with important operating, safety and maintenance information.

GENESIS CUSTOMER CARE

CAUTION

Severe engine and transmission damage may result from the use of poor quality fuels and lubricants that do not meet Genesis Branded Vehicle specifications. You must always use high quality fuels and lubricants that meet the specifications listed on Page 8-6 in the Vehicle Specifications section of the Owner's Manual.

Copyright 2019 Genesis Customer Care. All rights reserved. No part of this publication may be reproduced, stored in any retrieval system or transmitted in any form or by any means without the prior written permission of Genesis Customer Care.

GUIDE TO GENUINE GENESIS PARTS

1. What are Genesis Parts?

Genesis Parts are the same parts used by HYUNDAI Motor Company to manufacture vehicles. They are designed and tested for the optimum safety, performance, and reliability to our customers.

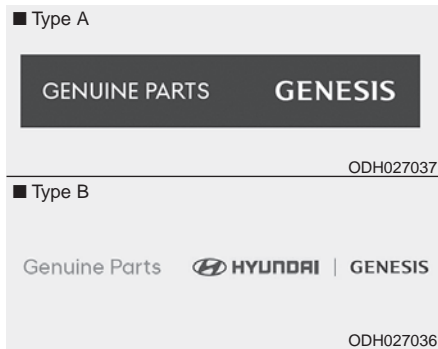

2. Why should you use Genuine Genesis Parts?

Genuine Genesis Parts are engineered and built to meet rigid manufacturing requirements. Damage caused by using imitation, counterfeit or used salvage parts is not covered under the Genesis Branded New Vehicle Limited Warranty or any other Genesis Branded Vehicle warranty.

In addition, any damage to or failure of Genuine Genesis Part caused by the installation or failure of an imitation, counterfeit or used salvage part is not covered by any Genesis Branded Vehicle Warranty.

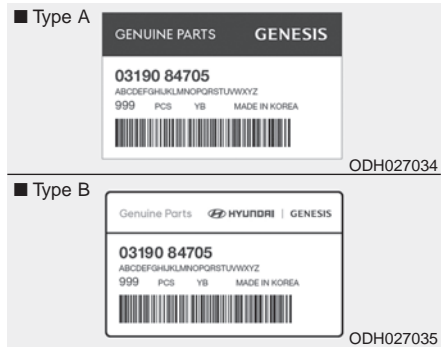

3. How can you tell if you are purchasing Genuine Genesis Parts?

Look for the Genuine Genesis Parts Logo on the package.

Genuine Genesis Parts exported to the U.S. are packaged with labels written only in English.

Genuine Genesis Parts are only sold through an authorized retailer of Genesis Branded products.

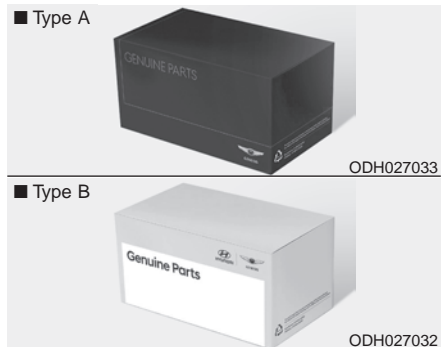

HOW TO USE THIS MANUAL

We want to help you get the greatest possible driving pleasure from your vehicle. Your Owner's Manual can assist you in many ways. To gain an overview of the contents of your Owner's Manual, use the Table of Contents in the front of the manual. The first page of each Chapter includes a detailed Table of Contents of the topics in that Chapter.

To quickly locate information about your vehicle, use the Index in the back of the manual. It is an alphabetical list of what is in this manual and the page number where it can be found.

For your convenience, we have incorporated tabs on the right-hand page edges. These tabs are coded with the Chapter titles to assist you with navigating through the manual.

SAFETY MESSAGES

Your safety, and the safety of others, is very important. This Owner's Manual provides you with many safety precautions and operating procedures. This information alerts you to potential hazards that may hurt you or others, as well as damage to your vehicle.

Safety messages found on vehicle labels and in this manual describe these hazards and what to do to avoid or reduce the risks.

Warnings and instructions contained in this manual are for your safety. Failure to follow safety warnings and instructions can lead to serious injury or death.

Throughout this manual DANGER, WARNING, CAUTION, NOTICE and the SAFETY ALERT SYMBOL will be used.



This is the safety alert symbol. It is used to alert you to potential physical injury hazards. Obey all safety messages that follow this symbol to avoid possible injury or death. The safety alert symbol precedes the signal words DANGER,

DANGER

DANGER indicates a hazardous situation which, if not avoided, will result in death or serious injury.

CAUTION

CAUTION indicates a hazardous situation which, if not avoided, could result in minor or moderate injury.

WARNING

WARNING indicates a hazardous situation which, if not avoided, could result in death or serious injury.

NOTICE

NOTICE indicates a situation which, if not avoided, could result in vehicle damage.

FUEL REQUIREMENTS

Your new vehicle is designed to obtain maximum performance with UNLEADED FUEL, as well as minimize exhaust emissions and spark plug fouling.

Your new vehicle is designed to use only unleaded fuel having an octane number $((R+M)/2)$ of 87 (Research Octane Number 91) or higher. For improved vehicle performance, premium unleaded fuel with an octane number $((R+M)/2)$ of 91 (Research Octane Number 96) or higher is recommended. (Do not use methanol blended fuels.)

NOTICE

To prevent damage to the engine and engine components, never add any fuel system cleaning agents to the fuel tank other than what has been specified.

Consult an authorized retailer of Genesis Branded products for additional information.

WARNING

- Do not "top off" after the nozzle automatically shuts off when refueling.
- Always check that the fuel cap is installed securely to prevent fuel spillage in the event of an accident.

Gasoline containing alcohol or methanol

Gasohol, a mixture of gasoline and ethanol (also known as grain alcohol) are being marketed along with or instead of leaded or unleaded gasoline. For example, "E15" is a gasohol comprised of 15% ethanol and 85% gasoline.

Do not use gasohol containing more than 15% ethanol, and do not use gasoline or gasohol containing any methanol. Either of these fuels may cause drivability problems and damage to the fuel system, engine control system and emission control system.

Discontinue using gasohol of any kind if drivability problems occur.

"E85" fuel is an alternative fuel comprised of 85 percent ethanol and 15 percent gasoline, and is manufactured exclusively for use in Flexible Fuel Vehicles. "E85" is not compatible with your vehicle. Use of "E85" may result in poor engine performance and damage to your vehicle's engine and fuel system. Genesis Branded Vehicle recommends that customers do not use fuel with an ethanol content exceeding 15 percent.

NOTICE

To prevent damage to your vehicle's engine and fuel system:

- **Never use gasohol which contains methanol.**
- **Never use gasohol containing more than 15% ethanol.**
- **Never use leaded fuel or leaded gasohol.**
- **Never use "E85" fuel.**

Your New Vehicle Limited Warranty does not cover damage to the fuel system or any performance problems caused by the use of "E85" fuel.

Using Fuel Additives (except Detergent Fuel Additives)

Using fuel additives such as:

- Silicone fuel additive
- Ferrocene (iron-based) fuel additive
- Other metallic-based fuel additives

may result in cylinder misfire, poor acceleration, engine stalling, damage to the catalyst, or abnormal corrosion, and may cause damage to the engine resulting in a reduction in the overall life of the powertrain.

- The Malfunction Indicator Lamp (MIL) may illuminate.

NOTICE

Damage to the fuel system or performance problem caused by the use of these fuels or fuel additives may not be covered by your New Vehicle Limited Warranty.

Gasoline containing MMT

Some gasoline contains harmful manganese-based fuel additives such as MMT (Methylcyclopentadienyl Manganese Tricarbonyl).

Genesis Branded Vehicle does not recommend the use of gasoline containing MMT.

This type of fuel can reduce vehicle performance and affect your emission control system.

The malfunction indicator lamp on the cluster may come on.

Detergent Fuel Additives

Genesis Branded Vehicle recommends that you use good quality gasolines treated with detergent additives such as TOP TIER Detergent Gasoline, which help prevent deposit formation in the engine. These gasolines will help the engine run cleaner and enhance performance of the Emission Control System. For more information on TOP TIER Detergent Gasoline, please go to the website (www.toptiergas.com).

For customers who do not use TOP Tier Detergent Gasoline regularly, and have problems starting or the engine does not run smoothly, detergent-based fuel additives that you can purchase separately may be added to the gasoline. If TOP TIER Detergent Gasoline is not available, one bottle of additive added to the fuel tank at every 7,500 miles or 12 months is recommended.

Additives are available from your authorized retailer of Genesis Branded products along with information on how to use them. Do not mix other additives.

Operation in foreign countries

If you are going to drive your vehicle in another country, be sure to:

- Observe all regulations regarding registration and insurance.
- Determine that acceptable fuel is available.

VEHICLE MODIFICATIONS

- This vehicle should not be modified. Modification of your vehicle could affect its performance, safety or durability and may even violate governmental safety and emissions regulations.

In addition, damage or performance problems resulting from any modification may not be covered under warranty.

- If you use unauthorized electronic devices, it may cause the vehicle to operate abnormally, wire damage, battery discharge and fire. For your safety, do not use unauthorized electronic devices.

NOTICE

All warning sounds (e.g. welcome/good-bye sound, virtual engine sound) are generated from the exterior amplifiers. If necessary, we recommend you to purchase Genuine Genesis Part to replace an exterior amplifier. Any unauthorized product may cause a malfunction of the exterior amplifiers.

VEHICLE BREAK-IN PROCESS

By following a few simple precautions for the first 600 miles (1,000 km) you may add to the performance, economy and life of your vehicle.

- Do not race the engine.
- While driving, keep your engine speed (rpm, or revolutions per minute) between 2,000 rpm and 4,000 rpm.
- Do not maintain a single speed for long periods of time, either fast or slow. Varying engine speed is needed to properly break-in the engine.
- Avoid hard stops, except in emergencies, to allow the brakes to seat properly.

WARNING

CALIFORNIA PROPOSITION 65 WARNING

Items contained in motor vehicles or emitted from them are known to the State of California to cause cancer and birth defects or reproductive harm. These include:

- Gasoline and its vapors
- Engine exhaust
- Used engine oil
- Interior passenger compartment components and materials
- Component parts which are subject to heat and wear

In addition, battery posts, terminals and related accessories contain lead, lead compounds and other chemicals known to the State of California to cause cancer and reproductive harm.

VEHICLE DATA COLLECTION AND EVENT DATA RECORDERS

This vehicle is equipped with an event data recorder (EDR). The main purpose of an EDR is to record, in certain crash or near crash-like situations, such as an air bag deployment or hitting a road obstacle, data that will assist in understanding how a vehicle's systems performed. The EDR is designed to record data related to vehicle dynamics and safety systems for a short period of time, typically 30 seconds or less. The EDR in this vehicle is designed to record such data as:

- How various systems in your vehicle were operating;
- Whether or not the driver and passenger safety belts were buckled/ fastened;
- How far (if at all) the driver was depressing the accelerator and/or brake pedal; and,
- How fast the vehicle was traveling.

These data can help provide a better understanding of the circumstances in which crashes and injuries occur. NOTE: EDR data are recorded by your vehicle only if a non-trivial crash situation occurs; no data are recorded by the EDR under normal driving conditions and no personal data (e.g., name, gender, age, and crash location) are recorded. However, other parties, such as law enforcement, could combine the EDR data with the type of personally identifying data routinely acquired during a crash investigation.

To read data recorded by an EDR, special equipment is required, and access to the vehicle or the EDR is needed. In addition to the vehicle manufacturer, other parties, such as law enforcement, that have the special equipment, can read the information if they have access to the vehicle or the EDR.

TABLE OF CONTENTS

Your Vehicle at a Glance	1
Safety System of Your Vehicle	2
Convenient Features of Your Vehicle	3
Multimedia System	4
Driving Your Vehicle	5
What to Do in an Emergency	6
Maintenance	7
Specifications, Consumer Information and Reporting Safety Defects	8
Index	I

1. Your Vehicle at a Glance

Exterior Overview	1-2
Interior Overview	1-4
Instrument Panel Overview (I)	1-5
Instrument Panel Overview (II)	1-6
Engine Compartment	1-7

EXTERIOR OVERVIEW

■ Front view



1. Hood.....	3-41	5. Sunroof.....	3-37
2. Headlamp.....	7-70	6. Front windshield wiper blades.....	7-31
3. Tires and wheels.....	7-37, 8-4	7. Windows.....	3-33
4. Outer side view mirror.....	3-29	8. Side repeater lamp.....	7-70

■ Rear view

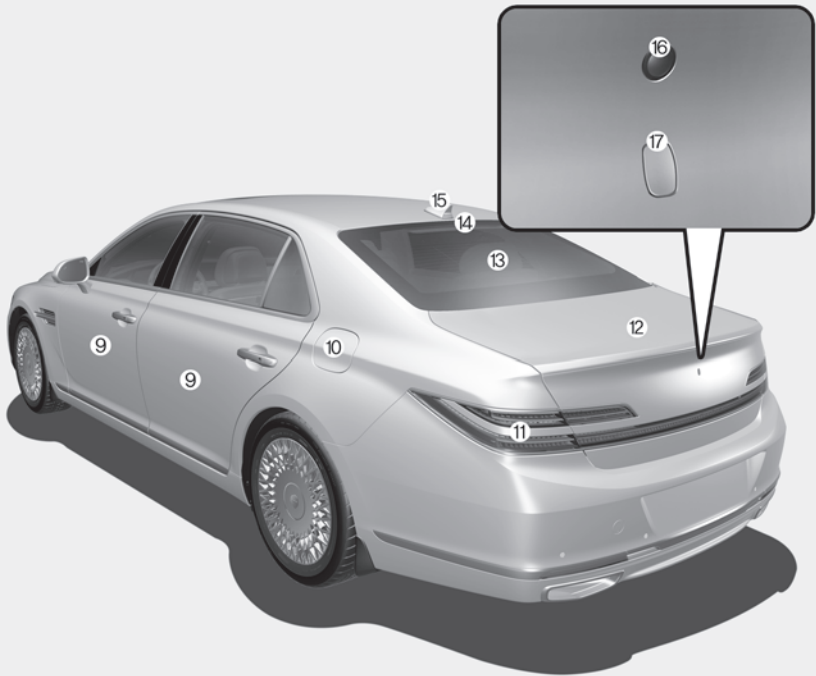

The actual shape may differ from the illustration.

OHI019002N

9. Door locks.....	3-9	14. High mounted stop lamp.....	7-71
10. Fuel filler door	3-51	15. Combination antenna	4-3
11. Rear combination lamp	7-71	16. Rear view camera	3-110
12. Trunk	3-42	17. Trunk open switch	3-42
13. Defroster	3-132		
/ Glass antenna	4-3		

INTERIOR OVERVIEW

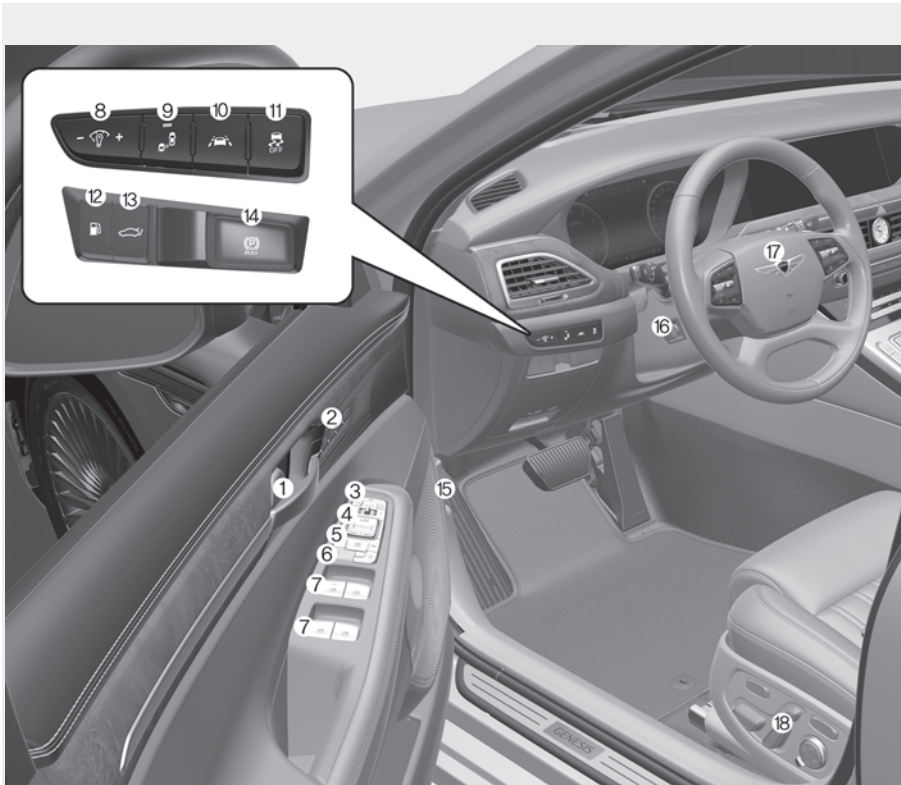

The actual shape may differ from the illustration.

OHI018003

- | | | | |
|--|------|--|-------|
| 1. Door lock/unlock button..... | 3-11 | 10. Lane Keeping Assist (LKA) switch..... | 5-124 |
| 2. Seat position memory system | 3-16 | 11. ESC (Electronic Stability Control) | |
| 3. Side view mirror folding switch..... | 3-31 | OFF button | 5-33 |
| 4. Side view mirror control switch | 3-30 | 12. Fuel filler door release button | 3-51 |
| 5. Power window lock switch..... | 3-36 | 13. Power trunk main control button | 3-42 |
| 6. Central door lock switch | 3-12 | 14. Electronic Parking Brake (EPB)..... | 5-22 |
| 7. Power window switches | 3-33 | 15. Hood release lever | 3-41 |
| 8. Instrument panel illumination control | | 16. Steering wheel tilt/telescopic control.... | 3-21 |
| switch..... | 3-55 | 17. Steering wheel..... | 3-20 |
| 9. Blind-Spot Collision Warning (BCW) | | 18. Seat adjustment switch | 2-4 |
| / Blind-Spot Collision-Avoidance Assist | | | |
| (BCA) switch..... | 5-68 | | |

INSTRUMENT PANEL OVERVIEW (I)

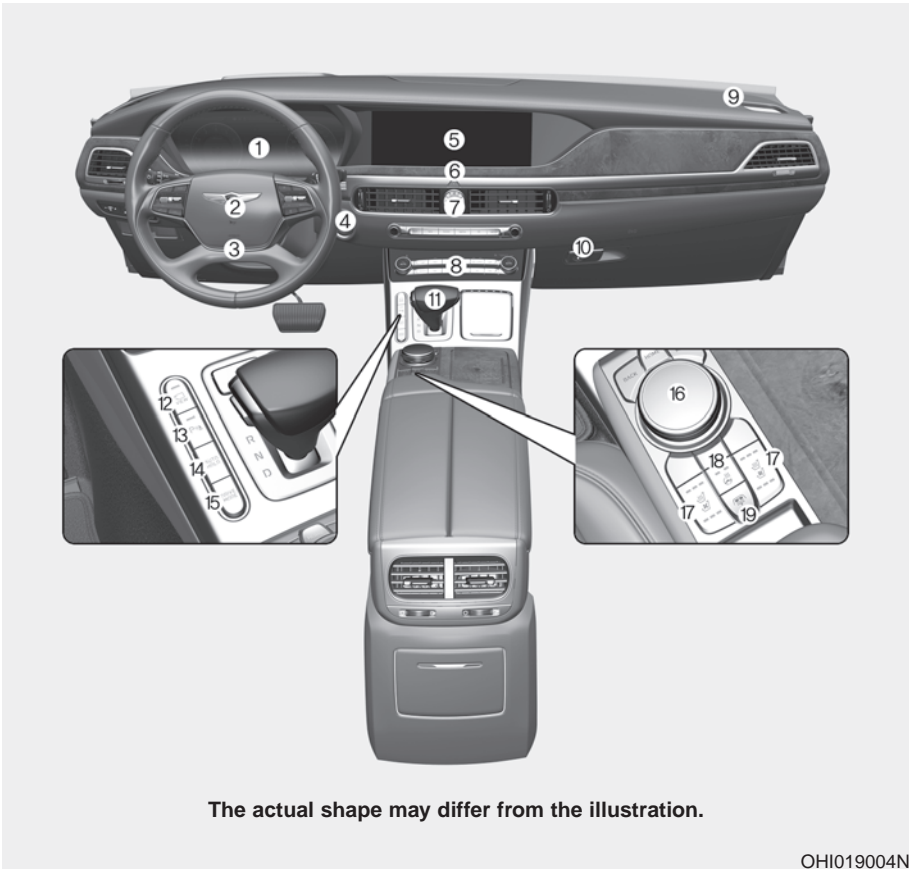

OHIO19004N

- | | | | |
|--|------------|--|-------|
| 1. Instrument cluster..... | 3-54 | 10. Glove box | 3-140 |
| 2. Horn..... | 3-22 | 11. Automatic transmission shift lever..... | 5-10 |
| 3. Driver's front air bag..... | 2-59 | 12. Surround view monitor | 3-114 |
| 4. Engine Start/Stop button..... | 5-6 | 13. Parking distance warning system | 3-102 |
| 5. AVN (Audio / Video / Navigation) system | 4-5 | 14. Auto Hold..... | 5-27 |
| 6. Hazard warning flasher | 6-2 | 15. Drive mode button..... | 5-45 |
| 7. Clock..... | AVN manual | 16. Center control panel..... | 4-5 |
| 8. Climate control system..... | 3-117 | 17. Seat warmers and coolers..... | 2-28 |
| 9. Passenger's front air bag | 2-59 | 18. Heated steering wheel switch | 3-21 |
| | | 19. Rear window sunshade folding button..... | 3-149 |

INSTRUMENT PANEL OVERVIEW (II)

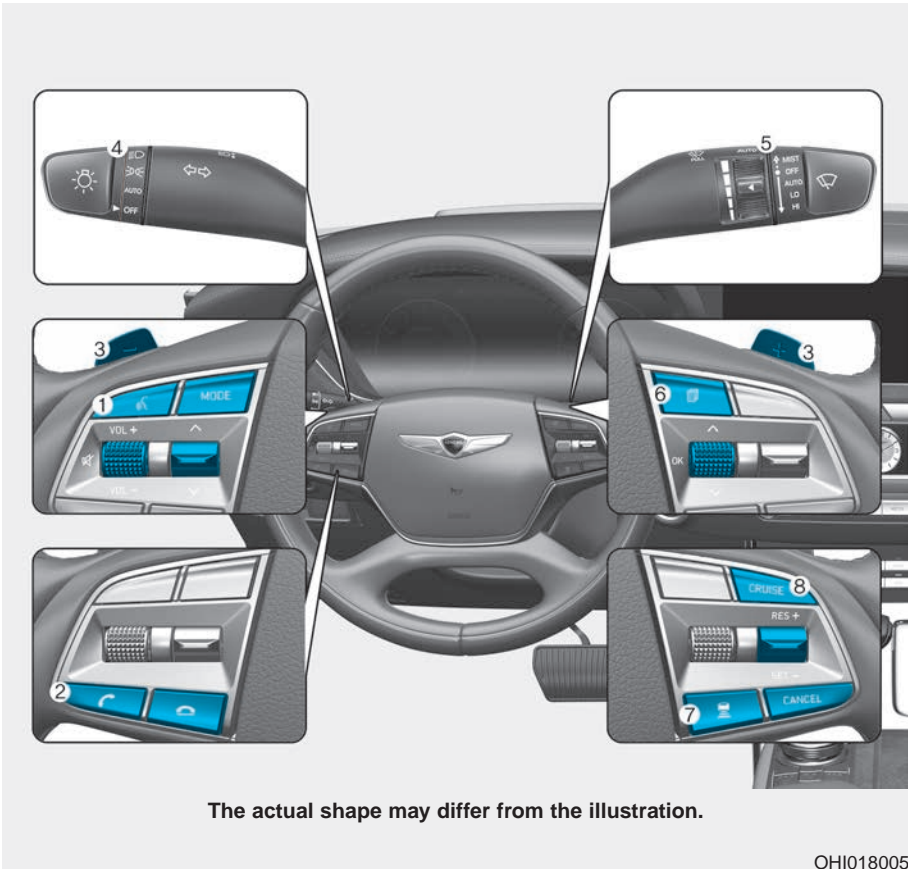

- | | |
|---|---|
| 1. Audio remote control buttons.....4-4 | 6. LCD display control.....3-78 |
| 2. <i>Bluetooth</i> [®] wireless technology4-6 | 7. Smart cruise control vehicle-to-vehicle
distance button.....5-103 |
| 3. Paddle shifter (manual shift mode).....5-15 | 8. Smart cruise control switch.....5-96 |
| 4. Light control / Turn signals lever3-88 | |
| 5. Wiper and washer control lever3-100 | |

ENGINE COMPARTMENT

■ 3.3 T-GDI

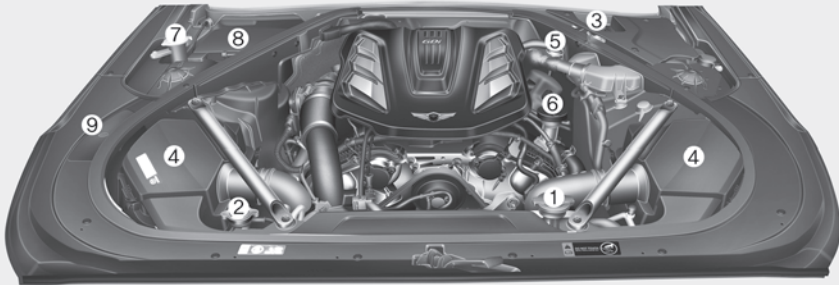

■ 5.0 GDI

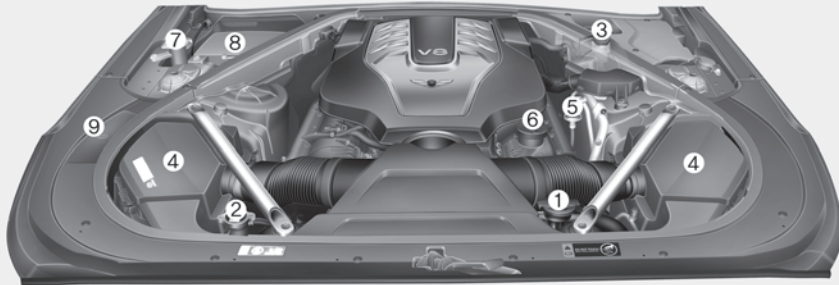

The actual engine compartment in the vehicle may differ from the illustration.

OHI078001/OHI078003

- | | |
|--------------------------------------|--|
| 1. Engine coolant reservoir.....7-24 | 6. Engine oil filler cap7-22 |
| 2. Radiator cap7-25 | 7. Windshield washer fluid reservoir7-28 |
| 3. Brake fluid reservoir.....7-27 | 8. Fuse box7-54 |
| 4. Air cleaner.....7-29 | 9. Jumper terminal6-5 |
| 5. Engine oil dipstick7-22 | |

2. Safety System of Your Vehicle

Important Safety Precautions	2-2	Air bag - Advanced Supplemental Restraint System.....	2-57
Always Wear Your Seat Belt	2-2	Where Are the Air Bags?	2-59
Restrain All Children	2-2	How Does the Air Bags System Operate?	2-63
Air Bag Hazards	2-2	What to Expect after an Air Bag Inflates.....	2-67
Driver Distraction.....	2-2	Occupant Classification System (OCS)	2-68
Control Your Speed	2-3	Why Didn't My Air Bag Go Off in a Collision?	2-74
Keep Your Vehicle in Safe Condition	2-3	SRS Care.....	2-79
Seats	2-4	Additional Safety Precautions	2-80
Safety Precautions	2-6	Air Bag Warning Labels	2-81
Front Seats	2-7		
Rear Seats.....	2-14		
Head Restraints	2-22		
Seat Warmers and Coolers	2-28		
Seat Belts	2-32		
Seat Belt Safety Precautions	2-32		
Seat Belt Warning Light	2-33		
Seat Belt Restraint System	2-34		
Pre-Active Seat Belt (PSB).....	2-41		
Additional Seat Belt Safety Precautions.....	2-42		
Care of Seat Belts.....	2-45		
Child Restraint System	2-46		
Children Always in the Rear	2-46		
Selecting a Child Restraint System (CRS)	2-47		
Installing a Child Restraint System (CRS).....	2-49		

IMPORTANT SAFETY PRECAUTIONS

You will find many safety precautions and recommendations throughout this section, and throughout this manual. The safety precautions in this section are among the most important.

Always Wear Your Seat Belt

A seat belt is your best protection in all types of accidents. Air bags are designed to supplement seat belts, not replace them. So even though your vehicle is equipped with air bags, ALWAYS make sure you and your passengers wear your seat belts, and wear them properly.

Restrain All Children

All children under age 13 should ride in your vehicle properly restrained in a rear seat, not the front seat. Infants and small children should be restrained in an appropriate child restraint. Larger children should use a booster seat with the lap/shoulder belt until they can use the seat belt properly without a booster seat.

Air Bag Hazards

While air bags can save lives, they can also cause serious or fatal injuries to occupants who sit too close to them, or who are not properly restrained. Infants, young children, and shorter adults are at the greatest risk of being injured by an inflating air bag. Follow all instructions and warnings in this manual.

Driver Distraction

Driver distraction presents a serious and potentially deadly danger, especially for inexperienced drivers. Safety should be the first concern when behind the wheel and drivers need to be aware of the wide array of potential distractions, such as drowsiness, reaching for objects, eating, personal grooming, other passengers, and using cellular phones.

Drivers can become distracted when they take their eyes and attention off the road or their hands off the wheel to focus on activities other than driving. To reduce your risk of distraction or getting into an accident:

- ALWAYS set up your mobile devices (i.e., MP3 players, phones, navigation units, etc.) when your vehicle is parked or safely stopped.
- ONLY use your mobile device when allowed by laws and when conditions permit safe use. NEVER text or email while driving. Most states have laws prohibiting drivers from texting. Some states and cities also prohibit drivers from using handheld phones.
- NEVER let the use of a mobile device distract you from driving. You have a responsibility to your passengers and others on the road to always drive safely, with your hands on the wheel as well as your eyes and attention on the road.

Control Your Speed

Excessive speed is a major factor in crash injuries and deaths. Generally, the higher the speed, the greater the risk, but serious injuries can also occur at lower speeds. Never drive faster than is safe for current conditions, regardless of the maximum speed posted.

Keep Your Vehicle in Safe Condition

Having a tire blowout or a mechanical failure can be extremely hazardous. To reduce the possibility of such problems, check your tire pressures and condition frequently, and perform all regularly scheduled maintenance.

SEATS

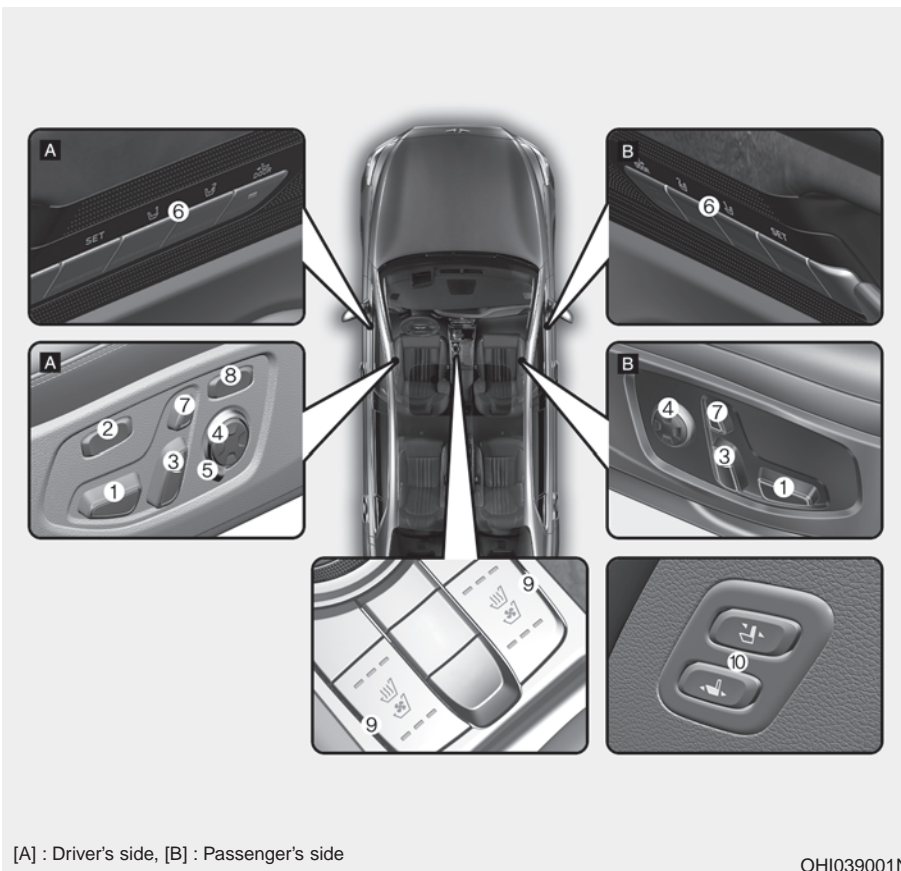

Front seat

- (1) Seat sliding forward or rearward
/ Seat cushion tilt adjustment
/ Seat cushion height adjustment
- (2) Seat cushion extension adjustment
- (3) Seatback angle adjustment
- (4) Lumbar support adjustment
- (5) Seatback bolster adjustment
- (6) Seat position memory system
- (7) Head restraint adjustment
- (8) Shoulder adjustment
- (9) Seat warmer
/ Seat cooler (by air)
- (10) Walk-in seat switch
(for front passenger seat)

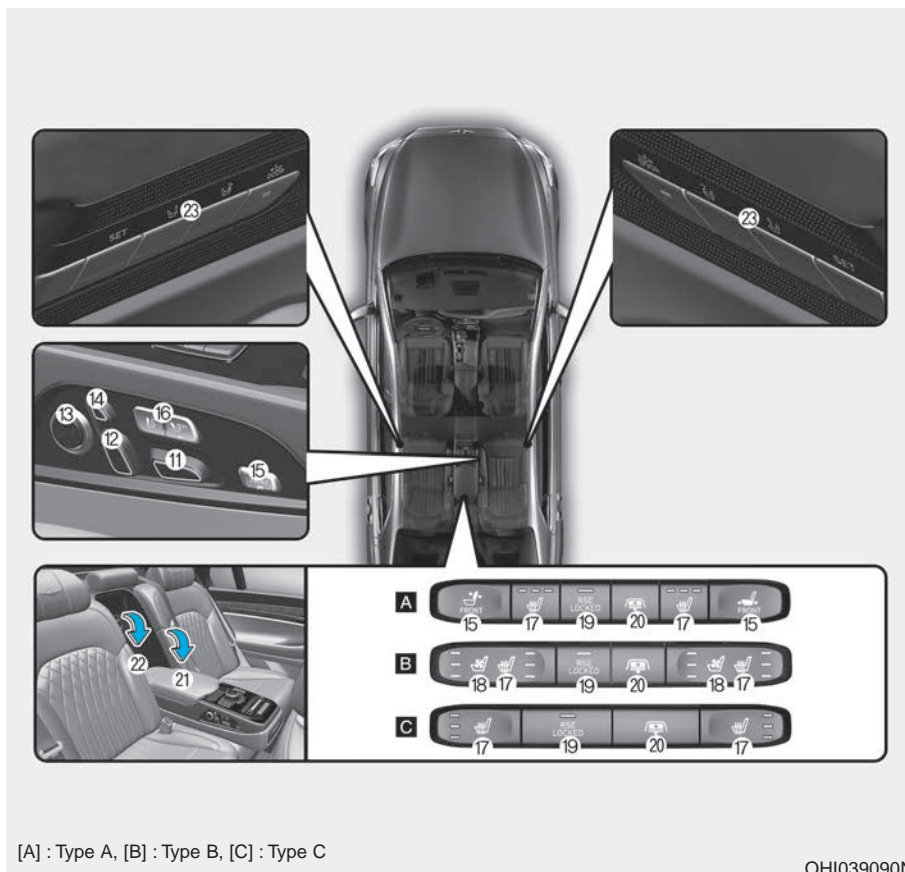

Rear seat

- (11) Seat sliding forward or rearward /Seat cushion tilt adjustment (right side)
- (12) Seat sliding or shoulder adjustment
- (13) Lumbar support adjustment
- (14) Head restraint adjustment
- (15) FRONT button (to control front passenger seat)
- (16) Seat mode switches
- (17) Seat warmer
- (18) Seat cooler
- (19) RSE (Rear Seat Entertainment) LOCKED indicator
- (20) Rear window sunshade control (details in Chapter 3)
- (21) Armrest
- (22) Ski through
- (23) Seat position memory system (details in Chapter 3)

Safety Precautions

Adjusting the seats so that you are sitting in a safe, comfortable position plays an important role in driver and passenger safety together with the seat belts and air bags in an accident.

WARNING

Do not use a cushion that reduces friction between the seat and the passenger. The passenger's hips may slide under the lap portion of the seat belt during an accident or a sudden stop. Serious or fatal internal injuries could result because the seat belt cannot operate properly.

Air bags

You can take steps to reduce the risk of being injured by an inflating air bag. Sitting too close to an air bag greatly increases the risk of injury in the event the air bag inflates.

The National Highway Traffic Safety Administration (NHTSA) recommends that drivers allow at least 10 inches (25 cm) between the center of the steering wheel and their chest.

WARNING

To reduce the risk of serious injury or death from an inflating air bag, take the following precautions:

- **Adjust the driver's seat as far to the rear as possible while maintaining the ability to maintain full control of the vehicle.**
- **Adjust the front passenger seat as far to the rear as possible.**
- **Hold the steering wheel by the rim with hands at the 9 o'clock and 3 o'clock positions to minimize the risk of injuries to your hands and arms.**
- **NEVER place anything or anyone between you and the steering wheel and the air bag.**
- **Do not allow the front passenger to place feet or legs on the dashboard to minimize the risk of leg injuries.**

Seat belts

Always fasten your seat belt before starting any trip.

At all times, passengers should sit upright and be properly restrained. Infants and small children must be restrained in appropriate child restraint systems. Children who have outgrown a booster seat must be restrained using the seat belts.

WARNING

Take the following precautions when adjusting your seat belt:

- NEVER use one seat belt for more than one occupant.
- Always position the seatback upright with the lap portion of the seat belt snug and low across the hips.
- NEVER allow children or small infants to ride on a passenger's lap.
- Do not route the seat belt across your neck, across sharp edges, or reroute the shoulder strap away from your body.
- Do not allow the seat belt to become caught or jammed.

Front Seats

The front seat can be adjusted by using the switches located on the outside of the seat cushion. Before driving, adjust the seat to the proper position so that you can easily control the steering wheel, foot pedals and controls on the instrument panel.

WARNING

Take the following precautions when adjusting your seat:

- NEVER attempt to adjust the seat while the vehicle is moving. The seat could respond with unexpected movement and may cause loss of vehicle control resulting in an accident.
- Do not place anything under the front seats. Loose objects in the driver's foot area could interfere with the operation of the foot pedals, causing an accident.
- Do not allow anything to interfere with the normal position and proper locking of the seatback.
- Do not place a cigarette lighter on the floor or seat. When you operate the seat, gas may exit out of the lighter causing a fire.
- Use extreme caution when picking up small objects trapped under the seats or between the seat and the center console. Your hands might be cut or injured by the sharp edges of the seat mechanism.

 **WARNING**

To prevent injury:

- Do not adjust your seat while wearing your seat belt. Moving the seat cushion forward may cause strong pressure on your abdomen.
- Do not allow your hands or fingers to get caught in the seat mechanisms while the seat is moving.

 **WARNING**

NEVER allow children in the vehicle unattended. The power seats are operable when the engine is turned off.

NOTICE

To prevent damage to the seats:

- Always stop adjusting the seats when the seat has been adjusted as far forward or rearward as possible.
- Do not adjust the seats longer than necessary when the engine is turned off. This may result in unnecessary battery drain.
- Do not operate two or more seats at the same time. This may result in an electrical malfunction.

Forward and rearward adjustment



To move the seat forward or rearward:

1. Push the control switch forward or rearward.
2. Release the switch once the seat reaches the desired position.

i Information

The forward/rearward seat adjustment may be restricted, when the seat-back is leaned back. Adjust your seat, as follows, before adjusting the seat position rearward.

- Push and hold the control switch rearward as far as possible, release the control switch, and re-push the control switch rearward again. Then, the seat position is adjusted rearward, while putting the seat-back upright.

Seat cushion extension adjustment (for driver's seat)



To move the front part of the cushion forward:

1. Push the front part of the control switch to move the seat cushion to the desired length.
2. Release the switch once the seat cushion reaches the desired length.

To move the front part of the cushion rearward:

1. Push the rear part of the control switch to move the seat cushion to the desired length.
2. Release the switch once the seat cushion reaches the desired length.

NOTICE

Be careful not to damage your body or clothes when using the cushion adjustment.

Seatback angle



To recline the seatback:

1. Push the control switch forward or rearward.
2. Release the switch once the seatback reaches the desired position.

i Information

The seatback angle adjustment may be restricted, when the seatback is reclined to some point. At this time, release the seatback angle switch and then re-push the switch rearward. The front seat will slide forward and the seatback angle will recline even more.

Reclining seatback

Sitting in a reclined position when the vehicle is in motion can be dangerous. Even when buckled up, the protections of your restraint system (seat belts and air bags) is greatly reduced by reclining your seatback.

! WARNING

NEVER ride with a reclined seatback when the vehicle is moving.

Riding with a reclined seatback increases your chance of serious or fatal injuries in the event of a collision or sudden stop.

Driver and passengers should ALWAYS sit well back in their seats, properly belted, and with the seatbacks upright.

Seat belts must be snug against your hips and chest to work properly. When the seatback is reclined, the shoulder belt cannot do its job because it will not be snug against your chest. Instead, it will be in front of you. During an accident, you could be thrown into the seat belt, causing neck or other injuries.

The more the seatback is reclined, the greater chance the passenger's hips will slide under the lap belt or the passenger's neck will strike the shoulder belt.

Seat cushion height and tilt

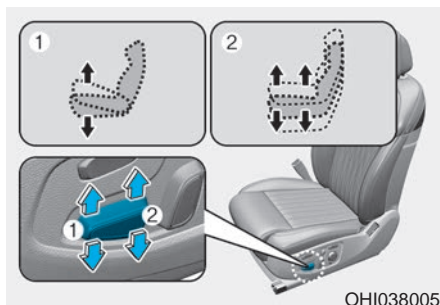

Seat cushion tilt (1)

To change the angle of the front part of the cushion:

Push the front portion of the control switch up to raise or down to lower the front part of the seat cushion.

Release the switch once the seat reaches the desired position.

Seat cushion height (2)

To change the height of the seat cushion:

Push the rear portion of the control switch up to raise or down to lower the height of the seat cushion.

Release the switch once the seat reaches the desired position.

Lumbar support

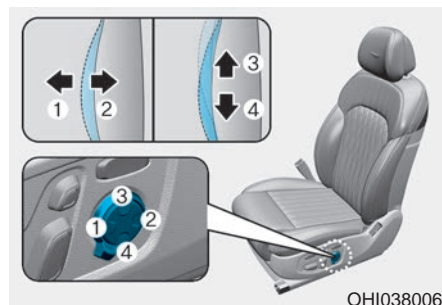

The lumbar support can be adjusted by pressing the lumbar support switch.

- Press the front portion of the switch (1) to increase support or the rear portion of the switch (2) to decrease support.
- To move the support position up or down, press switch (3) or (4).

**Seat shoulder adjustment
(for driver's seat, if equipped)**

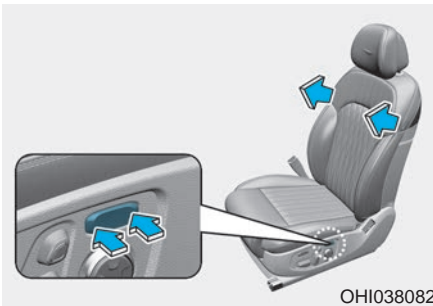

1. Push the control switch forward or rearward to move the shoulder angle to the desired position.
2. Release the switch once the seat reaches the desired position.

**Seatback bolster adjustment
(for driver's seat, if equipped)**

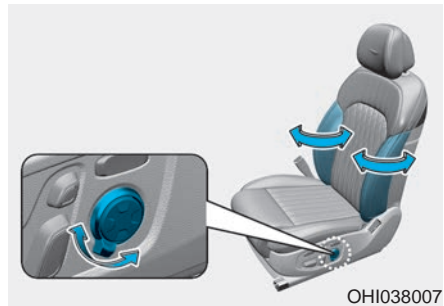

1. Push the adjustment lever clockwise, the seatback bolster will be adjusted inward. Push the switch counterclockwise, the seatback bolster will be adjusted outward.
2. Release the lever once the bolster reaches the desired position.

***i* Information**

To adjust the bolster height to its maximum in the default state, operate the lever for approximately 8 seconds. After that, release the lever because there is no change in height even if you continue to operate the lever.

Easy access switch (for passenger's seat)



A front seat moves slightly rearward, when a passenger opens a front door with the DOOR indicator illuminated. However, this function does not work if the seat is already at its farthest rear position.

A front seat moves slightly forward when a passenger closes a front door with the DOOR indicator illuminated.

To deactivate the easy access function, press the DOOR switch (indicator OFF).

Seatback pocket

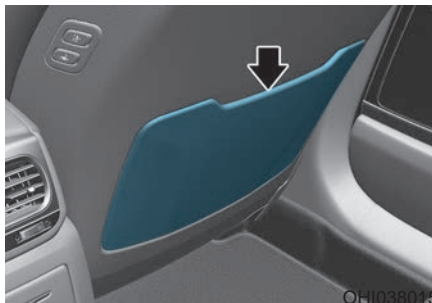

The seatback pocket is provided on the back of the front seatbacks.

⚠ WARNING

To prevent the Occupant Classification System from malfunctioning:

Do not hang onto the driver's and front passenger's seatback.

Rear Seats

⚠ WARNING

NEVER adjust the rear power seats when a Child Restraint System is installed in that seat.

⚠ WARNING

To prevent injury:

- Do not adjust your seat while wearing your seat belt. Moving the seat cushion forward may cause strong pressure on your abdomen.
- Do not allow your hands or fingers to get caught in the seat mechanisms while the seat is moving.

NOTICE

To prevent damage to the seats:

- Always stop adjusting the seats when the seat has been adjusted as far forward or rearward as possible.
- Do not adjust the seats longer than necessary when the engine is turned off. This may result in unnecessary drain of the battery.
- Do not operate two or more seats at the same time. This may result in an electrical malfunction.

Seat sliding, seatback angle and seat cushion tilt adjustment (if equipped)

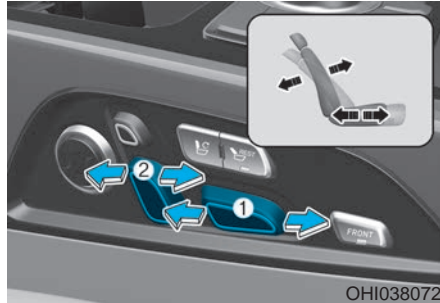

Vehicles not equipped with shoulder adjustment

- **Seat sliding**
Push the control switch (1) forward or rearward to slide the seat to the desired position. Release the switch once the seat reaches the desired position. The seatback angle is adjusted automatically along with the seat sliding position.
- **Seatback angle**
Push the control switch (2) forward or rearward to move the seatback angle to the desired position. Release the switch once the seat reaches the desired position. The seat sliding position is adjusted automatically along with the seatback angle.

Vehicles equipped with shoulder adjustment

- **Seat sliding and Seatback angle**
Push the control switch (1) forward or rearward to slide the seat and seatback angle to the desired position. Release the switch once the seat reaches the desired position.
- **Shoulder adjustment**
Push the control switch (2) forward or rearward to move the shoulder angle to the desired position. Release the switch once the seat reaches the desired position.

Cushion tilt adjustment (1, if equipped)

Push the front portion of the control switch (1) up to raise or down to lower the front part of the seat cushion.

Lumbar support (if equipped)

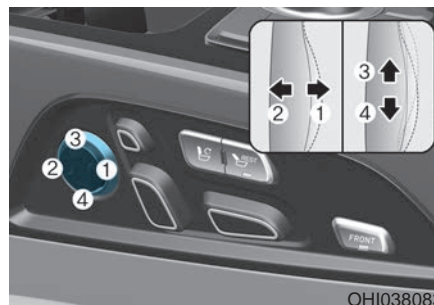

The lumbar support can be adjusted by pressing the lumbar support switch.

- Press the front portion of the switch (1) to increase support or the rear portion of the switch (2) to decrease support.
- To move the support position up or down, press switch (3) or (4).

⚠ WARNING

Do not adjust your seat position forward while fastening the seatbelt. It may apply abnormally high pressure on your abdomen. Adjust your seat position first, and then fasten the seatbelt.

Easy access switch (if equipped)



Vehicles equipped with the IMS

The rear seat moves slightly rearward, when a passenger opens the rear door with the DOOR indicator illuminated.

The rear seat moves slightly forward when a passenger closes the rear door with the DOOR indicator illuminated.

To deactivate the easy access function, press the DOOR switch (indicator OFF).

Vehicles not equipped with the IMS

For vehicles equipped with rear power seats, the rear seat moves slightly rearward, when a passenger opens the rear door.

The rear seat moves slightly forward when a passenger closes the rear door.

※ IMS : Integrated Memory System

Additional switches for adjusting the front passenger seat



Walk-in seat switch

The rear seat passenger may use the switches to control the front passenger seat.

- Sliding forward or rearward:

To move the front passenger seat forward, press the switch (1). To move the front passenger seat rearward, press the switch (2).

- Angle adjustment:

To recline the front passenger seat forward, press the switch (3). To recline the front passenger seat rearward, press the switch (4).

WARNING

Do not adjust the passenger seat when a passenger is seated.

VIP switches for adjusting the front passenger seat (if equipped)

A passenger, who occupies a rear seat behind the front passenger's seat, can control the front passenger's seat position by operating the switch.

i Information

VIP convenient function switches for adjusting the front passenger's seat do not operate in the following situations.

- A passenger occupies the front passenger's seat.
- An item occupies the front passenger's seat.
- The front passenger's door is open.
- The front passenger's seatbelt is fastened.

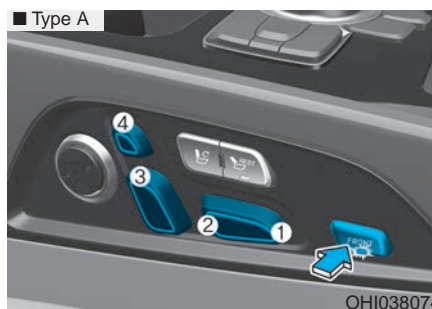

Press the FRONT button. When the FRONT indicator illuminates, a rear seat passenger can control the front passenger's seat position back and forth (1), seat cushion height (2), seatback angle (3), and head restraint position (4).

When the VIP convenient function is not used over a certain period of time, the FRONT indicator automatically goes out. Then, the switches may be used to control the rear seat.

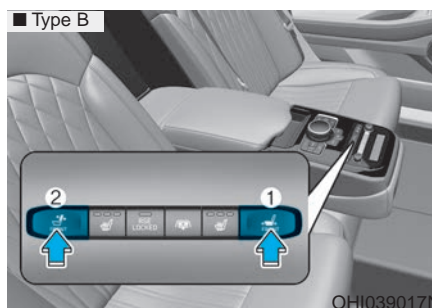

A rear seat passenger can control the front passenger's seat position back and forth (1) and seatback angle (2).

i Information

Rear seat controls can be deactivated or activated using the AVN system.

For more information, refer to the "Setup" section of the AVN system manual.

VIP seat mode switches (if equipped)



Relaxation mode

Press the switch (1) to adjust both the front passenger's seat and the rear seat, as follows.

- Front passenger's seat
 1. The seat position is adjusted forward, the seatback is leaned forward, and the head restraint is lowered.
 2. The head restraint is moved rearward, and the seat cushion tilt is lowered.
 3. The seat cushion height is lowered.
- Rear seat
 1. The seatback (including the shoulder portion) is leaned back, the head restraint is moved rearward, and the head restraint is lowered.
 2. The seat position is adjusted forward, the seat cushion tilt is raised and the lower lumbar support is increased.

i Information

Relaxation mode switches for adjusting the front passenger's seat do not operate in the following situations.

- When the Engine Start/Stop button is in the OFF position.
- A passenger occupies the front passenger's seat.
- An item occupies the front passenger's seat.
- The front passenger's door is open.
- The front passenger's seatbelt is fastened.

NOTICE

- Do not re-press the relaxation mode switch again, while operating the seat positions for relaxation mode. It may abruptly stop the seat movement.
- When you operate the seat control switch while adjusting the seat positions for the relaxation mode, it stops the automatic seat position adjustment. In this case, manually adjust the seat positions.
- Any items, which occupy the front passenger's seat, may get damaged while automatically adjusting the seat positions for the relaxation mode. Do not put any items on the front passenger's seat.

Return function

Press the switch (2) to adjust both the front passenger's seat and the rear seat, as follows.

- Rear seat
 1. The seat position is adjusted to the rearmost position, the seat cushion tilt is adjusted to the lowest position, and the lumbar support is decreased.
 2. The head restraint is lowered, and the seatback (including the shoulder portion) is leaned backward.

- Front passenger's seat
 1. The seat position is adjusted rearward, and the seatback is leaned back.
 2. The seat cushion height is raised, and the head restraint is adjusted to the lowest height.

Information

Return function switch for adjusting the front passenger's seat do not operate in the following situations.

- When Engine Start/Stop button is in the OFF position.
- A passenger occupies the front passenger's seat.
- An item occupies the front passenger's seat.
- The front passenger's door is open.
- The front passenger's seatbelt is fastened.

NOTICE

- Do not re-press return function switch again, while operating the seat positions for relaxation mode. It may abruptly stop the seat movement.
- When you operate the control switch while adjusting the seat positions with return function switch, it stops the automatic seat position adjustment. In this case, manually adjust the seat positions.

Rear switches operating limitation

■ Type A

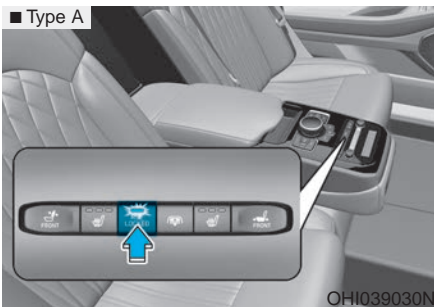

■ Type B

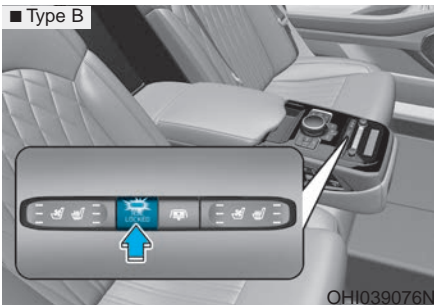

■ Type C

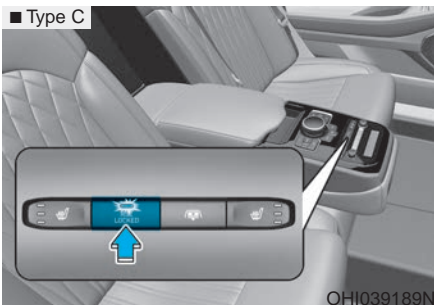

To activate or deactivate the rear seat controls, go to the AVN system screen and select 'Setup → General Settings' and select or deselect 'Lock Rear Controls' (the RSE LOCKED indicator on the rear armrest will turn off).

If the 'Lock Rear Controls' is selected (the RSE LOCKED indicator on the rear armrest will turn on), the rear controls are inoperable. If the 'Lock Rear Controls' is deselected (the RSE LOCKED indicator on the rear armrest will turn off), the rear controls are enabled.

For detailed information, scan the QR code in a separately supplied simple manual.

CAUTION

Deactivate the rear switch operation (RSE LOCKED indicator is on) when a child occupies a rear seat.

Armrest



The armrest is located in the center of the rear seat.

Grab the handle (1) on the upper end of the arm rest. Then, pull down the handle to use the arm rest.

Cup holder/Storage compartment

For further details, refer to "Rear Console Storage" and "Cup Holder" in chapter 3.

NOTICE

- Do not put any items on the rear center seat. Those items may get damaged, when the arm rest is pulled down.
- Do not attempt to fold back the arm rest, when the cup holder is extended out.

Carrying long/narrow cargo



Additional cargo space is provided to accommodate long/narrow cargo (skis, poles, etc.) not able to fit properly in the trunk when closed.

1. Pull the armrest down.
2. Pull the cover down while pushing the release lever down.

NOTICE

- Be careful when loading cargo through the rear passenger seats to prevent damage to the vehicle interior.
- When both the armrest and the panel, are folded down, put back the panel first, before folding back the armrest. If not, the panel knobs and the arm rest knobs may interfere with each other and get damaged.

 **CAUTION**

- **Make sure the engine is off, the vehicle is shifted to P (Park) and the parking brake is applied whenever loading or unloading cargo. The vehicle may move if the shift lever is inadvertently moved to another position.**
- **When cargo is loaded through the rear passenger seats, ensure the cargo is properly secured to prevent it from moving while driving.**

 **WARNING**

Cargo should always be secured to prevent it from being thrown about the vehicle in a collision and causing injury to the vehicle occupants. Do not place objects in the rear seats, since they cannot be properly secured and may hit the front seat occupants in a collision.

Head Restraints

The vehicle's front and rear seats have adjustable head restraints. The head restraints provide comfort for passengers, but more importantly they are designed to help protect passengers from whiplash and other neck and spinal injuries during an accident, especially in a rear impact collision.

 **WARNING**

To reduce the risk of serious injury or death in an accident, take the following precautions when adjusting your head restraints:

- **Always properly adjust the head restraints for all passengers BEFORE starting the vehicle.**
- **NEVER let anyone ride in a seat with the head restraints removed or reversed.**



- Adjust the head restraints so the middle of the head restraint is at the same height as the height of the top of the eyes.
- **NEVER** adjust the head restraint position of the driver's seat when the vehicle is in motion.
- Adjust the head restraint as close to the passenger's head as possible. Do not use a seat cushion that holds the body away from the seatback.
- Make sure the head restraint locks into position after adjusting it.

NOTICE

To prevent damage, **NEVER** hit or pull on the head restraints.

CAUTION

When there is no occupant in the rear seats, adjust the height of the head restraints to the lowest position. The rear seat head restraints can reduce the visibility of the rear area.

Front seat head restraints

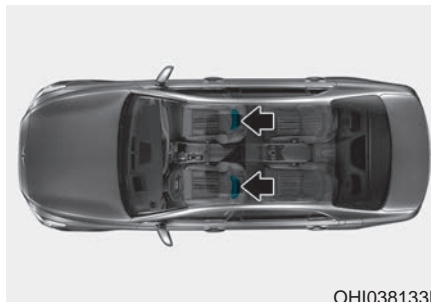

The driver's and front passenger's seats are equipped with adjustable head restraints for the passengers safety and comfort.



Forward and rearward adjustment

1. Push the control switch forward or rearward to move the head restraint.
2. Release the switch once the head restraint reaches the desired position.



Adjusting the height up and down

1. Push the control switch up to raise or down to lower the head restraint.
2. Release the switch once the head restraint reaches the desired position.

NOTICE

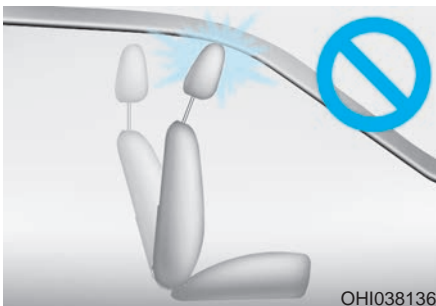

If you recline the seatback towards the front with the head restraint and seat cushion raised, the head restraint may come in contact with the sunvisor or other parts of the vehicle.

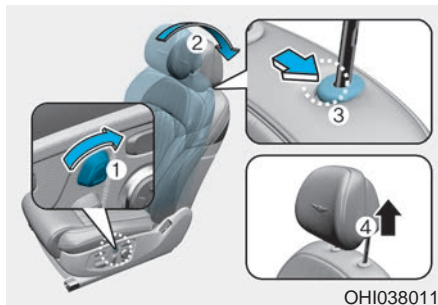

Removal/Reinstall

To remove the head restraint:

1. Recline the seatback (2) using the seatback angle switch (1).
2. Raise the head restraint as far as it can go.
3. Insert a thin-pointed tool into the head restraint adjustment pole (3), and then remove the head restraint (4).

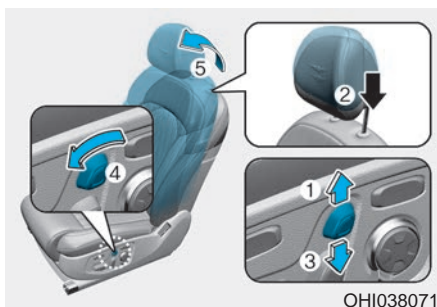

To reinstall the head restraint :

1. Recline the seatback.
2. Push the head restraint height control switch (1) up as far as it can go.
3. Put the head restraint poles (2).
4. Adjust the head restraint to the appropriate height (3).
5. Recline the seatback (5) using the seatback angle switch (4).

Rear seat head restraints

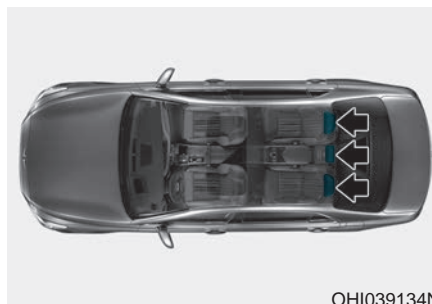

The rear seats are equipped with head restraints in all the seating positions for the passenger's safety and comfort.

Manual adjustment (if equipped)

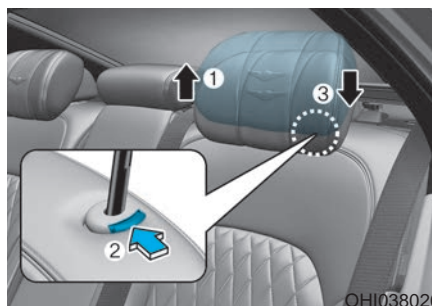

- Adjusting the height up and down (manual, if equipped)

To raise the head restraint:

1. Pull it up to the desired position (1).

To lower the head restraint:

1. Push and hold the release button (2) on the head restraint support.
2. Lower the head restraint to the desired position (3).

Power adjustment (if equipped)

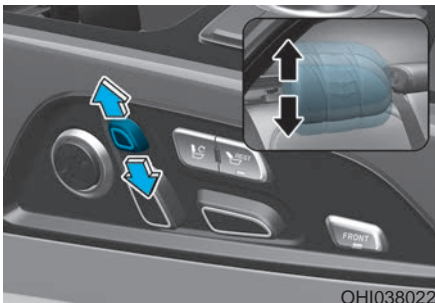

- Adjusting the height up and down
 1. Push the control switch up to raise or down to lower the head restraint.
 2. Release the switch once the head restraint reaches the desired position.

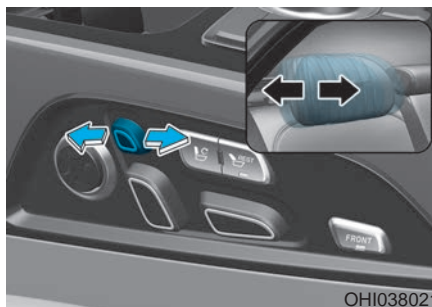

- Adjusting the head restraints forward and rearward
 1. Push the control switch forward to move the head restraint forward. Push the control switch rearward to move the head restraint rearward.
 2. Release the switch once the head restraint reaches the desired position.

NOTICE

Pay extreme caution not to damage the connectors, while removing the head restraint. If the connectors are damaged, the head restraint power adjustment may not work properly.

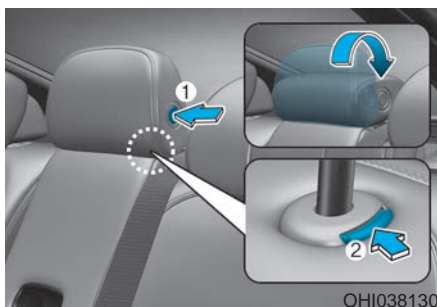

Folding the center head restraint (if equipped)

To fold the center head restraint :

- When the rear-center head restraint is not used, manually fold back the rear-center head restraint while pressing the button (1) on the side. To use the rear-center head restraint again, manually pull up the rear-center head restraint, until it is securely latched.
- You can remove the rear-center head restraint by manually pulling up the rear-center head restraint, while pressing the release button (2).
- You can adjust the rear-center head restraint to the further lower height by pressing the button (2), which is located under the rear-center head restraint, with the arm-rest folded back.

i Information

If the center head restraint is in the lowest position, raise the head restraint before folding back the arm-rest.

⚠ CAUTION

When the center head restraint is not in use, fold the head restraint back to prevent it from interfering with your vision through the rear window.

Seat Warmers and Coolers

Seat warmers

Seat warmers are provided to warm the seats during cold weather.

WARNING

The seat warmers can cause a **SERIOUS BURN**, even at low temperatures and especially if used for long periods of time.

Passengers must be able to feel if the seat is becoming too warm so they can turn it off, if needed.

People who cannot detect temperature change or pain to the skin should use extreme caution, especially the following types of passengers:

- Infants, children, elderly or disabled persons, or hospital outpatients.
- People with sensitive skin or who burn easily.
- Fatigued individuals.
- Intoxicated individuals.
- People taking medication that can cause drowsiness or sleepiness.

WARNING

NEVER place anything on the seat that insulates against heat when the seat warmer is in operation, such as a blanket or seat cushion. This may cause the seat warmer to overheat, causing a burn or damage to the seat.

NOTICE

To prevent damage to the seat warmers and seats:

- Never use a solvent such as paint thinner, benzene, alcohol or gasoline to clean the seats.
- Do not place heavy or sharp objects on seats equipped with seat warmers.
- Do not change the seat cover. It may damage the seat warmer.

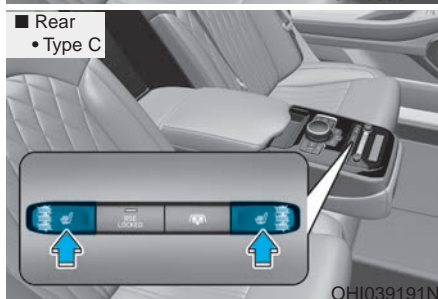
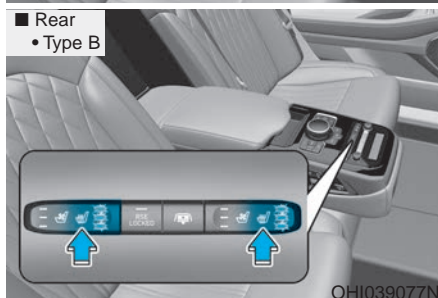
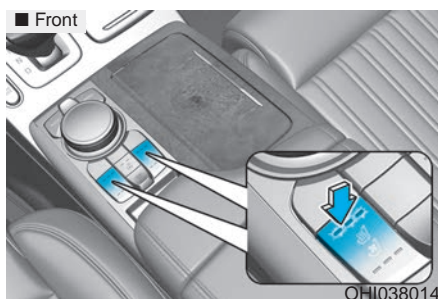

While the engine is running, push the switch to warm the seat.

During mild weather or under conditions where the operation of the seat warmer is not needed, keep the switches in the OFF position.

- Manual temperature control

Each time you push the switch, the temperature setting of the seat is changed as follows:



- Automatic temperature control

The seat warmer starts to automatically control the seat temperature in order to prevent low temperature burns after being manually turned ON.



You may manually press the switch to increase seat temperature. However, it soon returns to automatic mode.

- When pressing the switch for more than 1.5 seconds with the seat warmer operating, the seat warmer will turn OFF.
- The seat warmer automatically turns off if a passenger is not seated for approximately 40 minutes.
- The seat warmer defaults to the OFF position whenever the Engine Start/Stop button is in the ON position.

Seat coolers (if equipped)

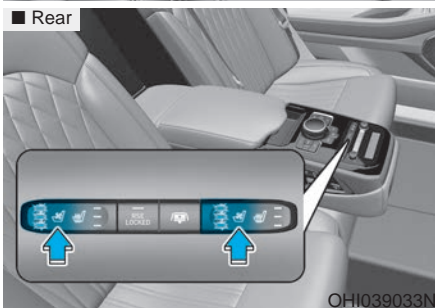
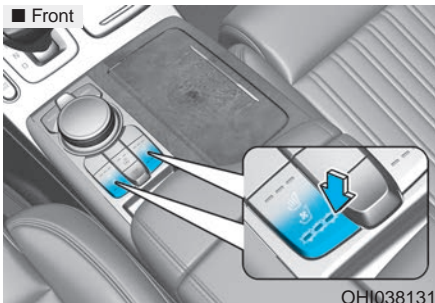

While the engine is running, push the switch to cool the seat.

- Each time you push the switch, the air flow changes as follows:



- If the seat cooler for the rear seat is positioned at HIGH, the airflow speed will increase according to vehicle speed (e.g. If vehicle speed is high, airflow speed will increase.)

The seat coolers are provided to cool the seats by blowing air through small vent holes on the surface of the seat cushions and seatbacks.

When the operation of the seat cooler is not needed, keep the switches in the OFF position.

- When pressing the switch for more than 1.5 seconds with the seat cooler operating, the seat cooler will turn OFF.
- The seat cooler automatically turns off if a passenger is not seated for approximately 40 minutes.
- The seat cooler defaults to the OFF position whenever the Engine Start/Stop button is in the ON position.

i Information

- If the outside temperature is under 33°F (2°C), the seat cooler may not operate.
- Use the seat cooler when the climate control system is on. Using the seat cooler for prolonged periods of time with the climate control system off could cause the climate control seat performance to be reduced.

NOTICE

To prevent damage to the seat cooler and seats:

- **Never use a solvent such as paint thinner, benzene, alcohol or gasoline to clean the seats.**
- **Avoid spilling liquids on the surface of the seats and seatbacks; this may cause the air vent holes to become blocked and not work properly.**
- **Do not place materials such as plastic bags or newspapers under the seats. They may block the air intake causing the air vents to not work properly.**
- **Do not change the seat covers. It may damage the seat cooler.**
- **If the air vents do not operate, restart the vehicle. If there is no change, have your vehicle inspected by an authorized retailer of Genesis Branded products.**

SEAT BELTS

This section describes how to use the seat belts properly. It also describes some of the things not to do when using seat belts.

Seat Belt Safety Precautions

Always fasten your seat belt and make sure all passengers have fastened their seat belts before starting any trip. Air bags are designed to supplement the seat belt as an additional safety device, but they are not a substitute. Most states require all occupants of a vehicle to wear seat belts.

WARNING

Seat belts must be used by ALL passengers whenever the vehicle is moving. Take the following precautions when adjusting and wearing seat belts:

- **ALWAYS** properly restrain children under age 13 in the rear seats.
- **NEVER** allow children to ride in the front passenger seat. If a child age 13 or older must be seated in the front seat, move the seat as far back as possible and properly restrain them in the seat.
- **NEVER** allow an infant or child to be carried on an occupant's lap.
- **NEVER** ride with the seatback reclined when the vehicle is moving.

- **Do not allow children to share a seat or seat belt.**
- **Do not wear the shoulder belt under your arm or behind your back.**
- **Always wear both the shoulder portion and lap portion of the lap/shoulder belt.**
- **Do not use the seat belt if it is twisted. A twisted seat belt will not protect you properly in an accident.**
- **Do not use a seat belt if the webbing or hardware is damaged.**
- **Do not latch the seat belt into the buckles of other seats.**
- **NEVER** unfasten the seat belt while driving. This may cause loss of vehicle control resulting in an accident.
- **Make sure there is nothing in the buckle interfering with the seat belt latch mechanism. This may prevent the seat belt from fastening securely.**
- **No modifications or additions should be made by the user which will either prevent the seat belt adjusting devices from operating to remove slack, or prevent the seat belt assembly from being adjusted to remove slack.**

⚠ WARNING

Damaged seat belts and seat belt assemblies will not operate properly. Always replace:

- Frayed, contaminated, or damaged webbing
- Damaged hardware
- The entire seat belt assembly after it has been worn in an accident, even if damage to webbing or assembly is not apparent

Seat Belt Warning Light***Seat belt warning*****Driver's seat belt warning**

As a reminder to the driver, the seat belt warning light will illuminate for approximately 6 seconds each time the Engine Start/Stop button is in the ON or START position regardless of belt fastening. At this time, if the seat belt is not fastened a warning chime will sound for 6 seconds.

If you continue not to fasten the seat belt and you drive over 6 mph (9 km/h), the warning light will stay illuminated.

If you continue not to fasten the seat belt and you drive over 12 mph (20 km/h) the seat belt warning chime will sound for approximately 100 seconds and the corresponding warning light will blink.

If you unfasten the seat belt while driving under 12 mph (20 km/h), the seat belt warning light will illuminate until the seat belt is fastened.

If you unfasten the seat belt while driving over 12 mph (20 km/h), the seat belt warning chime will sound for approximately 100 seconds and the corresponding warning light will blink.

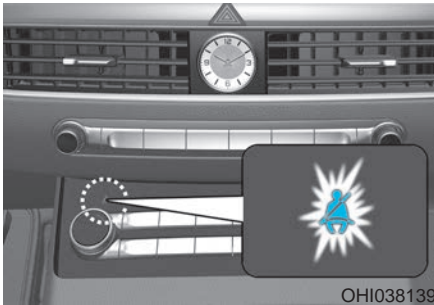

Front passenger's seat belt warning

As a reminder to the front passenger, the front passenger's seat belt warning lights will illuminate for approximately 6 seconds each time the Engine Start/Stop button is in the ON or START position regardless of belt fastening.

If you continue not to fasten the seat belt and you drive over 6 mph (9 km/h), the warning light will stay illuminated.

If you continue not to fasten the seat belt and you drive over 12 mph (20 km/h) the seat belt warning chime will sound for approximately 100 seconds and the corresponding warning light will blink.

If you unfasten the seat belt while driving under 12 mph (20 km/h) the seat belt warning light will illuminate until the seat belt is fastened.

If you unfasten the seat belt while driving over 12 mph (20 km/h), the seat belt warning chime will sound for approximately 100 seconds and the corresponding warning light will blink.

Seat Belt Restraint System

WARNING

Improperly positioned seat belts may increase the risk of serious injury in an accident. Take the following precautions when adjusting the seat belt:

- Position the lap portion of the seat belt as low as possible across your hips, not on your waist, so that it fits snugly.
- Position one arm under the shoulder belt and the other over the belt, as shown in the illustration.
- Always position the shoulder belt anchor into the locked position at the appropriate height.
- Never position the shoulder belt across your neck or face.

Front Seat Belt – Driver's 3-point system with emergency locking retractor



To fasten your seat belt:

Pull the seat belt out of the retractor and insert the metal tab (1) into the buckle (2). There will be an audible "click" when the tab locks into the buckle.

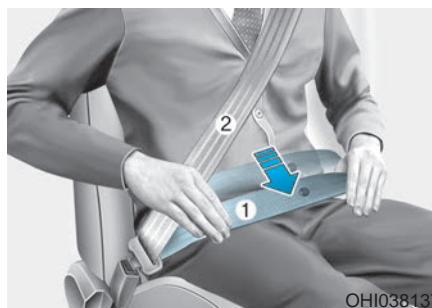

You should place the lap belt (1) portion across your hips and the shoulder belt (2) portion across your chest.

The seat belt automatically adjusts to the proper length after the lap belt portion is adjusted manually so that it fits snugly around your hips. If you lean forward in a slow, easy motion, the belt will extend and move with you.

If there is a sudden stop or impact, the belt will lock into position. It will also lock if you try to lean forward too quickly.

***i* Information**

If you are not able to smoothly pull enough of the seat belt out from the retractor, firmly pull the seat belt out and release it. After release, you will be able to pull the belt out smoothly.

Height adjustment

You can adjust the height of the shoulder belt anchor to one of the three different positions for maximum comfort and safety.

The shoulder portion should be adjusted so it lies across your chest and midway over your shoulder nearest the door, not over your neck.

To adjust the height of the seat belt anchor, lower or raise the height adjuster into an appropriate position.

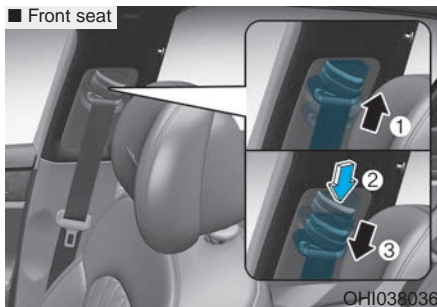

To raise the height adjuster, pull it up (1). To lower it, push it down (3) while pressing the height adjuster button (2).

Release the button to lock the anchor into position. Try sliding the height adjuster to make sure that it has locked into position.



To release your seat belt:

Press the release button (1) in the locking buckle.

When it is released, the belt should automatically draw back into the retractor. If this does not happen, check the belt to be sure it is not twisted, then try again.

Rear Seat Belt – Passenger's 3-point system with convertible locking retractor

This type of seat belt combines the features of both an emergency locking retractor seat belt and an automatic locking retractor seat belt. Convertible retractor type seat belts are installed in the rear seat positions to help accommodate the installation of child restraint systems. Although a convertible retractor is also installed in the front passenger seat position, NEVER place any infant/child restraint system in the front seat of the vehicle.

To fasten your seat belt:

Pull the seat belt out of the retractor and insert the metal tab into the buckle. There will be an audible "click" when the tab locks into the buckle. When not securing a child restraint, the seat belt operates in the same way as the driver's seat belt (Emergency Locking Retractor Type). It automatically adjusts to the proper length only after the lap belt portion of the seat belt is adjusted manually so that it fits snugly across your hips.

When the seat belt is fully extended from the retractor to allow the installation of a child restraint system, the seat belt operation changes to allow the belt to retract, but not to extend (Automatic Locking Retractor Type). Refer to the "Using a Child Restraint System" section in this chapter.



To release your seat belt:

Press the release button (1) in the locking buckle.

When it is released, the belt should automatically draw back into the retractor. If this does not happen, check the belt to be sure it is not twisted, then try again.

NOTICE

Although the seat belt retractor provides the same level of protection for seated passengers in either emergency or automatic locking modes, the emergency locking mode allows seated passengers to move freely in their seat while keeping some tension on the belt. During a collision or sudden stop, the retractor automatically locks the belt to help restrain your body.

To deactivate the automatic locking mode, unbuckle the seat belt and allow the belt to fully retract.

Rear center seat belt



1. Take out the buckle (2), which is stored between the seat/seatback cushions.
2. Insert the metal plate (1) into the buckle (2), until it clicks.

You can make sure its secure fastening by pulling the seatbelt webbing. The buckle with 'CENTER' mark should be used for the 3-point seatbelt.

3. Restore the buckle between the seat/seatback cushion after unfastening the seatbelt.

Pre-tensioner seat belt (Driver and front passenger)



Your vehicle is equipped with driver's and front passenger's Pre-tensioner Seat Belts (Retractor Pretensioner and Emergency Fastening Device System). The purpose of the pre-tensioner is to make sure the seat belts fit tightly against the occupant's body in certain frontal collisions. The Emergency Fastening Device System may be activated in certain crashes where the frontal collision is severe enough, together with the air bags.

When the vehicle stops suddenly, or if the occupant tries to lean forward too quickly, the seat belt retractor will lock into position. In certain frontal collisions, the pre-tensioner will activate and pull the seat belt into tighter contact against the occupant's body.

(1) Retractor Pretensioner

The purpose of the retractor pretensioner is to make sure that the shoulder belts fit in tightly against the occupant's upper body in certain frontal collisions.

(2) Emergency Fastening Device System

The purpose of the Emergency Fastening Device System is to make sure that the pelvis belts fit in tightly against the occupant's lower body in certain frontal collisions.

If the system senses excessive tension on the driver or passenger's seat belt when the pre-tensioner system activates, the load limiter inside the retractor pretensioner will release some of the pressure on the affected seat belt.

⚠ WARNING

Pre-Tensioner Seat Belts (retractor pre-tensioner seat belt and emergency fastening device) that malfunction may not protect you properly during an accident. Take the following precautions:

- **Always wear your seat belt and sit properly in your seat.**
- **Do not use the seat belt if it is loose or twisted. A loose or twisted seat belt will not protect you properly in an accident.**
- **Do not place anything near the buckle. This may adversely affect the buckle and cause it to function improperly.**

- **Always replace your pre-tensioners after activation or an accident.**
- **NEVER inspect, service, repair or replace the pre-tensioners yourself. This must be done by an authorized retailer of Genesis Branded products.**
- **Do not hit the seat belt assemblies.**

⚠ WARNING

Do not touch the pre-tensioner seat belt assemblies for several minutes after they have been activated. When the pre-tensioner seat belt mechanism deploys during a collision, the pre-tensioners become hot and can burn you.

NOTICE

Body work on the front area of the vehicle may damage the pre-tensioner seat belt (retractor pre-tensioner seat belt and emergency fastening device) system.

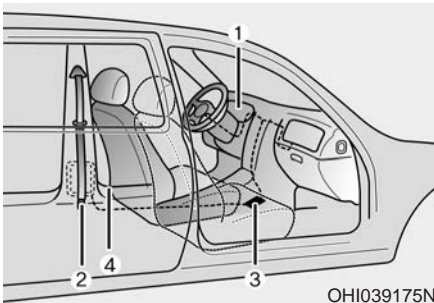

The Pre-Tensioner Seat Belt System consists mainly of the following components. Their locations are shown in the illustration above:

1. SRS air bag warning light
2. Retractor pre-tensioner
3. SRS control module
4. Emergency Fastening Device System

i Information

The sensor that activates the SRS air bag is connected with the pre-tensioner seat belts. The SRS air bag warning light on the instrument panel will illuminate for approximately 6 seconds after the Engine Start/Stop button in the ON position, and then it should turn off.

If the pre-tensioner is not working properly, the warning light will illuminate even if the SRS air bag is not malfunctioning. If the warning light does not illuminate, stays illuminated or illuminates when the vehicle is being driven, have an authorized retailer of Genesis Branded products inspect the pre-tensioner seat belts and SRS air bags as soon as possible.

i Information

- Both the driver's and front passenger's pre-tensioner seat belts may be activated in certain frontal or side collisions or rollovers.
- When the pre-tensioner seat belts are activated, a loud noise may be heard and fine dust, which may appear to be smoke, may be visible in the passenger compartment. These are normal operating conditions and are not hazardous.
- Although it is non-toxic, the fine dust may cause skin irritation and should not be inhaled for prolonged periods. Wash all exposed skin areas thoroughly after an accident in which the pre-tensioner seat belts were activated.
- The pre-tensioner seat belt system may get adversely affected by installing an audio system to the center console or welding/painting the frontal vehicle body.
In this case, consult an authorized retailer of Genesis Branded products. The air bag warning light illuminates, if there is a malfunction with the pre-tensioner seat belt system.
- In following situations, immediately have the air bag system and the pre-tensioner seat belt system checked by an authorized retailer of Genesis Branded products.
 - The air bag warning light does not illuminate at all after turning ON the engine.
 - The air bag warning light remains ON over 6 seconds after turning ON the engine.

⚠ WARNING

- Fasten your seat belt while sitting properly in an upright position to maximize the effectiveness of the pre-tensioner seat belt system.
- A pre-tensioner seat belt system is designed to activate only once. Replace the pre-tensioner seat belt system, if it was activated in an accident.
- Properly fasten a seat belt in an upright position to maximize protection from a pre-tensioner seat belt system. The pre-tensioner seat belt instantly tightens the seat belt to hold an occupant body in position in forward collision.
- A pre-tensioner seat belt system is designed to activate only once. Replace the pre-tensioner seat belt system, if it was activated in an accident.

**Pre-Active Seat Belt (PSB)
(if equipped)**

The purpose of the pre-active seat belt is to tighten the seat belt when a collision is sensed, during emergency braking, or when a loss of control is sensed.

NOTICE

The pre-active seat belt is a supplementary system. The pre-active seat belt activates only when the passenger is wearing his/her seat belt.

Warning message



Check Pre-active Seat Belt

The pre-active seat belt warning will turn on if there is a problem with your pre-active seat belt.

Have the system checked by an authorized retailer of Genesis Branded products if the warning message comes on while the vehicle is in motion. When the PSB warning message disappears, the master warning light (⚠) will illuminate.

Pre-active seat belt operation

In order to maximize the safety of the passenger, the pre-active seat belt system operates as below.

- Full retraction
The seat belt is tightened when:
 - Emergency braking situation occurs
 - Losing control of the vehicle
 - The vehicle senses a collision
 - Driving on a slippery frozen road
- Slack removal
Tightens a loose seat belt if vehicle speed is over 9.3 mph (15 km/h).
- Belt parking
Tightens a loose seat belt when the seat belt is unfastened.

Additional Seat Belt Safety Precautions

Seat belt use during pregnancy

The seat belt should always be used during pregnancy. The best way to protect your unborn child is to protect yourself by always wearing the seat belt.

Pregnant women should always wear a lap-shoulder seat belt. Place the shoulder belt across your chest, routed between your breasts and away from your neck. Place the lap belt line so that it fits snugly and as low as possible across the hips, not across the abdomen.

⚠ WARNING

- **A pregnant woman or a patient is more vulnerable to any impacts on the abdomen during an abrupt stop or accident. If you are in an accident while pregnant, we recommend you consult your doctor.**
- **To reduce the risk of serious injury or death to an unborn child during an accident, pregnant women should NEVER place the lap portion of the seat belt above or over the area of the abdomen where the unborn child is located.**

Seat belt use and children

Infant and small children

All 50 states have child restraint laws which require children to travel in approved child restraint devices, including booster seats. The age at which seat belts can be used instead of child restraints differs among states, so you should be aware of the specific requirements in your state, and where you are travelling. Infant and child restraints must be properly placed and installed in a rear seat. For more information refer to the "Child Restraint Systems" section in this chapter.

Small children are best protected from injury in an accident when properly restrained in the rear seat by a child restraint system that meets the requirements of the Federal Motor Vehicle Safety Standards. Before buying any child restraint system, make sure that it has a label certifying that it meets Federal Motor Vehicle Safety Standard FMVSS 213. The restraint must be appropriate for your child's height and weight. Check the label on the child restraint for this information. Refer to the "Child Restraint Systems" section in this chapter.

⚠ WARNING

ALWAYS properly restrain infants and small children in a child restraint appropriate for the child's height and weight.

To reduce the risk of serious injury or death to a child and other passengers, **NEVER** hold a child in your lap or arms when the vehicle is moving. The violent forces created during an accident will tear the child from your arms and throw the child against the interior of the vehicle.

Larger children

Children under age 13 and who are too large for a booster seat must always occupy the rear seat and use the available lap/shoulder belts. A seat belt should lie across the upper thighs and be snug across the shoulder and chest to restrain the child safely. Check belt fit periodically. Children are afforded the most safety in the event of an accident when they are restrained by a proper restraint system and/or seat belts in the rear seat. Always have the LATCH system inspected by your authorized retailer of Genesis Branded products after an accident. An accident can damage the LATCH system and may not properly secure the child restraint.

If a larger child over age 13 must be seated in the front seat, the child must be securely restrained by the available lap/shoulder belt and the seat should be placed in the rear-most position.

If the shoulder belt portion slightly touches the child's neck or face, try placing the child closer to the center of the vehicle. If the shoulder belt still touches their face or neck they need to be returned to an appropriate booster seat in the rear seat.

WARNING

- **Always make sure children are wearing their seat belts and that they are properly adjusted before driving.**
- **NEVER allow the shoulder belt to contact the child's neck or face.**
- **Do not allow more than one child to use a single seat belt.**

Transporting an injured person

A seat belt should be used when an injured person is being transported. Consult a physician for specific recommendations.

One person per belt

Two people (including children) should never attempt to use a single seat belt. This could increase the severity of injuries in case of an accident.

Do not lie down

Sitting in a reclined position when the vehicle is in motion can be dangerous. Even when buckled up, the protections of your restraint system (seat belts and air bags) is greatly reduced by reclining your seatback.

To reduce the chance of injuries in the event of an accident and to achieve the maximum effectiveness of the restraint system, all passengers should be sitting up and the front and rear seats should be in an upright position when the car is moving.

A seat belt cannot provide proper protection if the person is lying down in the rear seat or if the front or rear seats are in a reclined position.

⚠ WARNING

- **NEVER** ride with a reclined seatback when the vehicle is moving.
- Riding with a reclined seatback increases your chance of serious or fatal injuries in the event of a collision or sudden stop.
- Drivers and passengers should always sit well back in their seats, properly belted, and with the seatbacks upright.

Care of Seat Belts

Seat belt systems should never be disassembled or modified. In addition, care should be taken to assure that seat belts and belt hardware are not damaged by seat hinges, doors or other abuse.

Periodic inspection

All seat belts should be inspected periodically for wear or damage of any kind. Any damaged parts should be replaced as soon as possible by an authorized retailer of Genesis Branded products.

Keep belts clean and dry

Seat belts should be kept clean and dry. If belts become dirty, they can be cleaned by using a mild soap solution and warm water. Bleach, dye, strong detergents or abrasives should not be used because they may damage and weaken the fabric.

When to replace seat belts

The entire seat belt assembly or assemblies should be replaced if the vehicle has been involved in an accident. This should be done even if no damage is visible. Additional questions concerning seat belt operation should be directed to an authorized retailer of Genesis Branded products.

CHILD RESTRAINT SYSTEM

Children Always in the Rear

WARNING

Always properly restrain children in the rear seats of the vehicle.

Children of all ages are safer when restrained in the rear seat. A child riding in the front passenger seat can be forcefully struck by an inflating air bag resulting in SERIOUS INJURY or DEATH.

Children under age 13 must always ride in the rear seats and must always be properly restrained to minimize the risk of injury in an accident, sudden stop or sudden maneuver. According to accident statistics, children are safer when properly restrained in the rear seats than in the front seat. **Even with air bags, children can be seriously injured or killed.** Children too large for a child restraint must use the seat belts provided.

All 50 states have child restraint laws which require children to travel in approved child restraint devices. The laws governing the age or height/weight restrictions at which seat belts can be used instead of child restraints differs among states, so you should be aware of the specific requirements in your state, and where you are travelling.

Child restraint systems must be properly placed and installed in the rear seat. You must use a commercially available child restraint system that meets the requirements of the Federal Motor Vehicle Safety Standards (FMVSS 213).

Child restraint systems are generally designed to be secured in a vehicle seat by lap belt portion of a lap/shoulder belt, or by a LATCH system in the rear seats of the vehicle.

Child restraint system (CRS)

Infants and younger children must be restrained in an appropriate rear-facing or forward-facing CRS that has first been properly secured to the rear seat of the vehicle. Read and comply with the instructions for installation and use provided by the manufacturer of the child restraint.

⚠ WARNING

An improperly secured child restraint can increase the risk of **SERIOUS INJURY** or **DEATH** in an accident. Always take the following precautions when using a child restraint system:

- **NEVER** install a child or infant restraint in the front passenger's seat.
- Always properly secure the child restraint to a rear seat of the vehicle.
- Always follow the child restraint system manufacturer's instructions for installation and use.
- Always properly restrain your child in the child restraint.
- If the vehicle head restraint prevents proper installation of a child seat (as described in the child restraint system manual), the head restraint of the respective seating position shall be readjusted or entirely removed.
- Do not use an infant carrier or a child safety seat that "hooks" over a seatback, it may not provide adequate protection in an accident.
- After an accident, have retailer of Genesis Branded products check the child restraint system, seat belts, tether anchors and lower anchors.

Selecting a Child Restraint System (CRS)

When selecting a CRS for your child, always:

- Make sure the CRS has a label certifying that it meets applicable Federal Motor Vehicle Safety Standards (FMVSS 213).
- Select a child restraint based on your child's height and weight. The required label or the instructions for use typically provide this information.
- Select a child restraint that fits the vehicle seating position where it will be used.
- Read and comply with the warnings and instructions for installation and use provided with the child restraint system.

Child restraint system types

There are three main types of child restraint systems: rearward-facing seats, forward-facing seats, and booster seats. They are classified according to the child's age, height and weight.

Rearward-facing child restraints**⚠ WARNING**

NEVER install a child or infant restraint in the front passenger's seat.

Placing a rearward-facing child restraint in the front seat can result in **SERIOUS INJURY** or **DEATH** if the child restraint is struck by an inflating air bag.



A rearward-facing child seat provides restraint with the seating surface against the back of the child. The harness system holds the child in place, and in an accident, acts to keep the child positioned in the seat and reduce the stress to the neck and spinal cord.

All children under age one must always ride in a rearward-facing infant child restraint.

Convertible and 3-in-1 child seats typically have higher height and weight limits for the rearward-facing position, allowing you to keep your child rearward-facing for a longer period of time.

Continue to use a rearward-facing child seat for as long as your child will fit within the height and weight limits allowed by the child seat manufacturer. It's the best way to keep them safe. Once your child has outgrown the rearward-facing child restraint, your child is ready for a forward-facing child restraint with a harness.



Forward-facing child restraints

A forward-facing child seat provides restraint for the child's body with a harness. Keep children in a forward-facing child seat with a harness until they reach the top height or weight limit allowed by your child restraint's manufacturer.

Once your child outgrows the forward-facing child restraint, your child is ready for a booster seat.

Booster seats

A booster seat is a restraint designed to improve the fit of the vehicle's seat belt system. A booster seat positions the seat belt so that it fits properly over the lap of your child.

Keep your child in a booster seat until they are big enough to sit in the seat without a booster and still have the seat belt fit properly. For a seat belt to fit properly, the lap belt must lie snugly across the upper thighs, not the stomach. The shoulder belt should lie snug across the shoulder and chest and not across the neck or face. Children under age 13 must always ride in the rear seats and must always be properly restrained to minimize the risk of injury.

Installing a Child Restraint System (CRS)

WARNING

Before installing your child restraint system always:

- Read and follow the instructions provided by the manufacturer of the child restraint.
- Read and follow the instructions regarding child restraint systems in this manual.

Failure to follow all warnings and instructions could increase the risk of the **SERIOUS INJURY** or **DEATH** if an accident occurs.

WARNING

If the vehicle head restraints prevents proper installation of a child seat (as described in the child seat system manual, the head restraints of the respective seating position shall be readjusted or entirely removed.

After selecting a proper child seat for your child, check to make sure it fits properly in your vehicle. Follow the instructions provided by the manufacturer when installing the child seat. Note these general steps when installing the seat to your vehicle:

- **Properly secure the child restraint to the vehicle.** All child restraints must be secured to the vehicle with the lap part of a lap/shoulder belt or with the LATCH system.

- **Make sure the child restraint is firmly secured.** After installing a child restraint to the vehicle, push and pull the seat forward-and-back and side-to-side to verify that it is securely attached to the seat. A child restraint secured with a seat belt should be installed as firmly as possible. However, some side-to-side movement can be expected.
- **Secure the child in the child restraint.** Make sure the child is properly strapped in the child restraint according to the manufacturer instructions.

WARNING

A child restraint in a closed vehicle can become very hot. To prevent burns, check the seating surface and buckles before placing your child in the child restraint.

CAUTION

Deactivate the rear switch operation (RSE LOCKED indicator is on) when a child occupies a rear seat.

NOTICE

Do not adjust the seat position after installing the Child Restraint System. When the Child Restraint System is installed, any attempt to adjust the seat position may damage either the seat belt system or the Child Restraint System.

Information

When installing the Child Restraint System, the rear power adjustment seat must be adjusted to the rearmost position.

Lower Anchors and Tether for Children (LATCH System)

The LATCH system holds a child restraint during driving and in an accident. This system is designed to make installation of the child restraint easier and reduce the possibility of improperly installing your child restraint. The LATCH system uses anchors in the vehicle and attachments on the child restraint. The LATCH system eliminates the need to use seat belts to secure the child restraint to the rear seats.

Lower anchors are metal bars built into the vehicle. There are two lower anchors for each LATCH seating position that will accommodate a child restraint with lower attachments.

To use the LATCH system in your vehicle, you must have a child restraint with LATCH attachments.

The child seat manufacturer will provide you with instructions on how to use the child seat with its attachments for the LATCH lower anchors.

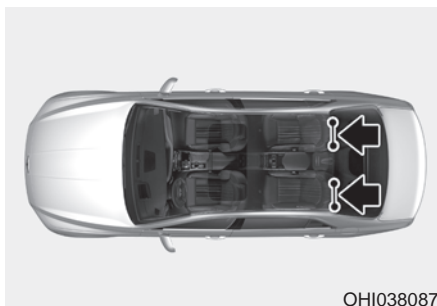

OHI038087

LATCH anchors have been provided in the left and right outboard rear seating positions. Their locations are shown in the illustration. There are no LATCH anchors provided for the center rear seating position.

⚠ WARNING

Do not attempt to install a child restraint system using LATCH anchors in the rear center seating position. There are no LATCH anchors provided for this seat. Using the outboard seat anchors can damage the anchors which may break or fail in a collision resulting in serious injury or death.

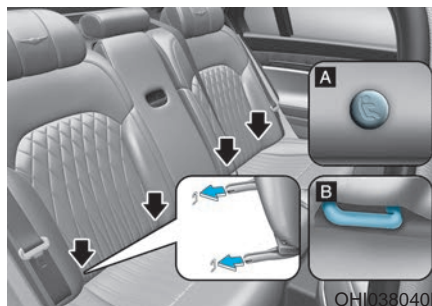

OHI038040L

[A] : Lower Anchor Position Indicator

[B] : Lower Anchor

The lower anchor position indicator symbols are located on the left and right rear seat backs to identify the position of the lower anchors in your vehicle (see arrows in illustration).

The LATCH anchors are located between the seatback and the seat cushion of the rear seat left and right outboard seating positions.

NOTICE

Before installing the Child Restraint System, make sure that there is no object (e.g. toy, pen, wire) around the lower anchor area. Those objects may damage either the seat belt system or the Child Restraint System during the installment procedure. If necessary, have the vehicle inspected by an authorized retailer of Genesis Branded products.

Securing a child restraint with the LATCH anchors system

To install a LATCH-compatible child restraint in either of the rear outboard seating positions:

1. Move the seat belt buckle away from the lower anchors.
2. Move any other objects away from the anchors that could prevent a secure connection between the child restraint and the lower anchors.
3. Place the child restraint on the vehicle seat, then attach the seat to the lower anchors according to the instructions provided by the child restraint manufacturer.
4. Follow the child restraint instructions for properly adjusting and tightening the lower attachments on the child restraint to the lower anchors.

WARNING

Take the following precautions when using the LATCH system:

- **Read and follow all installation instructions provided with your child restraint system.**
- **To prevent the child from reaching and taking hold of unretracted seat belts, buckle all unused rear seat belts and retract the seat belt webbing behind the child. Children can be strangled if a shoulder belt becomes wrapped around their neck and the seat belt tightens.**
- **NEVER attach more than one child restraint to a single anchor. This could cause the anchor or attachment to come loose or break.**
- **Always have the LATCH system inspected by your authorized retailer of Genesis Branded products after an accident. An accident can damage the LATCH system and may not properly secure the child restraint.**

NOTICE

The recommended weight for the LATCH system is under 65 lb (30 kg).

How to determine an appropriate child restraint weight:

Child weight + Child restraint weight < 65 lb (30kg)

Securing a child restraint seat with "Tether Anchor" system



First secure the child restraint with the LATCH lower anchors or the seat belt. If the child restraint manufacturer recommends that the top tether strap be attached, attach and tighten the top tether strap to the top tether strap anchor.

Child restraint hook holders are located on the package tray.

⚠ WARNING

Take the following precautions when installing the tether strap:

- Read and follow all installation instructions provided with your child restraint system.
- **NEVER** attach more than one child restraint to a single tether anchor. This could cause the anchor or attachment to come loose or break.
- Do not attach the tether strap to anything other than the correct tether anchor. It may not work properly if attached to something else.
- Do not use the tether anchors for adult seat belts or harnesses, or for attaching other items or equipment to the vehicle.



To install the tether anchor:

1. Route the child restraint tether strap over the child restraint seatback. Route the tether strap under the head restraint and between the head restraint posts, or route the tether strap over the top of the vehicle seatback. Make sure the strap is not twisted.
2. Connect the tether strap hook to the tether anchor, then tighten the tether strap according to the child seat manufacturer's instructions to firmly secure the child restraint to the seat.
3. Check that the child restraint is securely attached to the seat by pushing and pulling the seat forward-and-back and side-to-side.

Securing a child restraint with lap/shoulder belt

When not using the LATCH system, all child restraints must be secured to a vehicle rear seat with the lap part of a lap/shoulder belt.

⚠ WARNING

ALWAYS place a rear-facing child restraint in the rear seat of the vehicle.

Placing a rear-facing child restraint in the front seat can result in serious injury or death if the child restraint is struck by an inflating air bag.

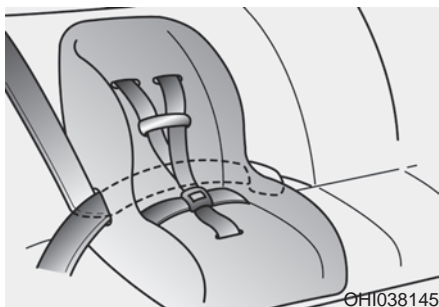

Automatic locking mode

Since all passenger seat belts move freely under normal conditions and only lock under extreme or emergency conditions (emergency locking mode), you must manually pull the seat belt all the way out to shift the retractor to the "Automatic Locking" mode to secure a child restraint.

The "Automatic Locking" mode will help prevent the normal movement of the child in the vehicle from causing the seat belt to loosen and compromise the child restraint system. To secure a child restraint system, use the following procedure.

To install a child restraint system on the rear seats, do the following:

1. Place the child restraint system on a rear seat and route the lap/shoulder belt around or through the child restraint, following the restraint manufacturer's instructions.

Be sure the seat belt webbing is not twisted.

i Information

When using the rear center seat belt, you should also refer to the "Rear Seat Belt – Passenger's 3-point system" section in this chapter.

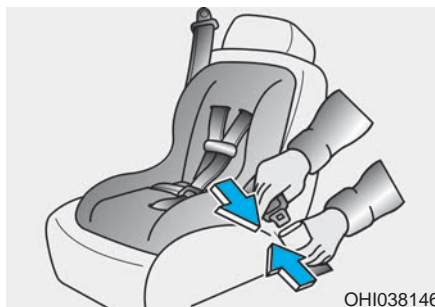

2. Fasten the lap/shoulder belt latch into the buckle. Listen for the distinct "click" sound.

i Information

Position the release button so that it is easy to access in case of an emergency.



3. Pull the shoulder portion of the seat belt all the way out. When the shoulder portion of the seat belt is fully extended, it will shift the retractor to the "Automatic Locking" (child restraint) mode.



4. Slowly allow the shoulder portion of the seat belt to retract and listen for an audible "clicking" or "ratcheting" sound. This indicates that the retractor is in the "Automatic Locking" mode. If no distinct sound is heard, repeat steps 3 and 4.
5. Remove as much slack from the belt as possible by pushing down on the child restraint system while feeding the shoulder belt back into the retractor.
6. Push and pull on the child restraint system to confirm that the seat belt is holding it firmly in place. If it is not, release the seat belt and repeat steps 2 through 6.
7. Double check that the retractor is in the "Automatic Locking" mode by attempting to pull more of the seat belt out of the retractor. If you cannot, the retractor is in the "Automatic Locking" mode.

If your CRS manufacturer instructs or recommends you to use a tether anchor with the lap/shoulder belt, refer to the previous pages for more information.

i Information

When the seat belt is allowed to retract to its fully stowed position, the retractor will automatically switch from the "Automatic Locking" mode to the emergency lock mode for normal adult usage.

⚠ WARNING

If the retractor is not in the "Automatic Locking" mode, the child restraint can move when your vehicle turns or stops suddenly. A child can be seriously injured or killed if the child restraint is not properly anchored in the car, including manually pulling the seat belt all the way out to shift the retractor to the "Automatic Locking" mode.

To remove the child restraint, press the release button on the buckle and then pull the lap/shoulder belt out of the restraint and allow the seat belt to retract fully.

AIR BAG - ADVANCED SUPPLEMENTAL RESTRAINT SYSTEM

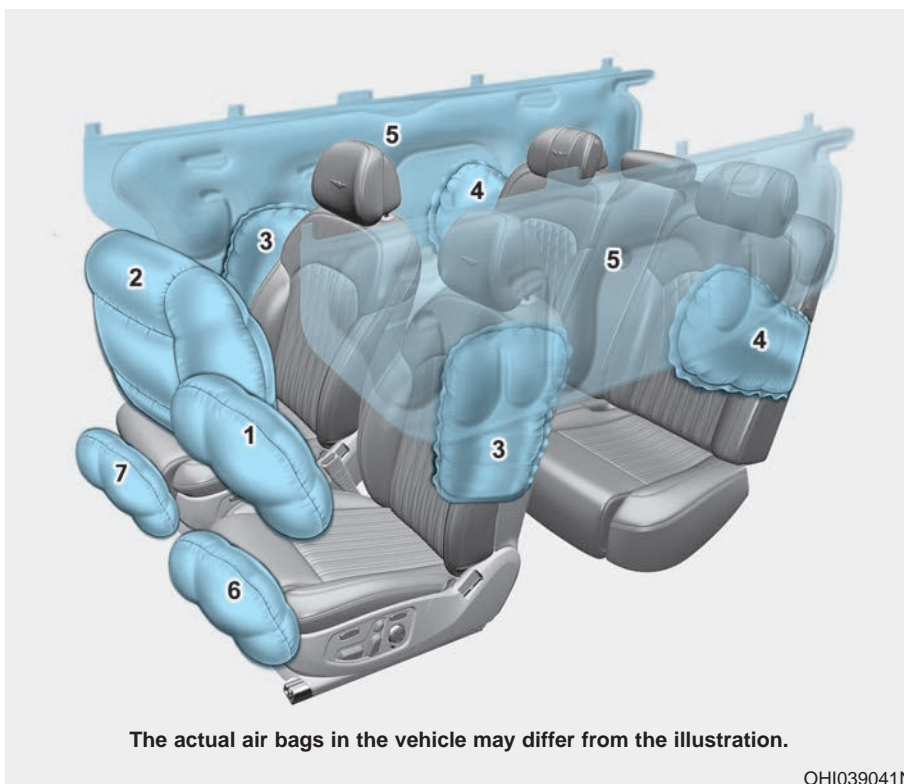

- (1) Driver's front air bag
- (2) Passenger's front air bag
- (3) Side air bag (front)
- (4) Side air bag (rear, if equipped)
- (5) Curtain air bag
- (6) Driver's knee air bag
- (7) Passenger's knee air bag

This vehicle is equipped with an Advanced Supplemental Air Bag System for the driver's seat and front passenger's seats.

The front air bags are designed to supplement the three-point seat belts. For these air bags to provide protection, the seat belts must be worn at all times when driving.

You can be severely injured or killed in an accident if you are not wearing a seat belt. Air bags are designed to supplement seat belts, but do not replace them. Also, air bags are not designed to deploy in every collision. In some accidents, the seat belts are the only restraint protecting you.

WARNING

AIR BAG SAFETY PRECAUTIONS

ALWAYS use seat belts and child restraints - every trip, every time, everyone! Even with air bags, you can be seriously injured or killed in a collision if you are improperly belted or not wearing your seat belt when the air bag inflates.

NEVER place a child in any child restraint or booster seat in the front passenger seat. An inflating air bag could forcefully strike the infant or child causing serious or fatal injuries.

ABC - Always Buckle Children under age 13 in the back seat. It is the safest place for children of any age to ride. If a child age 13 or older must be seated in the front seat, he or she must be properly belted and the seat should be moved as far back as possible.

All occupants should sit upright with the seatback in an upright position, centered on the seat cushion with their seat belt on, legs comfortably extended and their feet on the floor until the vehicle is parked and the engine is turned off. If an occupant is out of position during an accident, the rapidly deploying air bag may forcefully contact the occupant causing serious or fatal injuries.

You and your passengers should never sit or lean unnecessarily close to the air bags or lean against the door or center console.

Move your seat as far back as possible from front air bags, while still maintaining control of the vehicle. The U.S. National Highway Traffic Safety Administration (NHTSA) recommends that drivers allow at least 10 inches (25 cm) between the center of the steering wheel and the chest.

Where Are the Air Bags?

Driver's and passenger's front air bags

Your vehicle is equipped with a Advanced Supplemental Restraint System (SRS) and lap/shoulder belts at both the driver and passenger seating positions. The SRS consists of air bags which are located in the center of the steering wheel, in the driver's side lower crash pad below the steering wheel column and the passenger's side front panel pad above the glove box.

Additionally, knee air bags are provided for both the driver and front passenger which is located under the steering wheel and below the glove box.

The air bags are labeled with the letters "AIR BAG" embossed on the pad covers.

■ Driver's front air bag



■ Passenger's front air bag



■ Driver's knee air bag

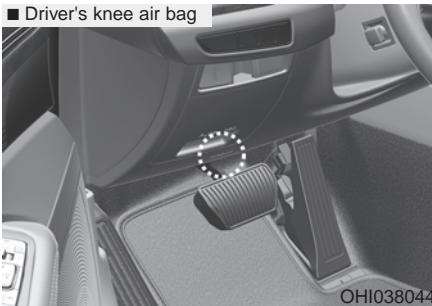

■ Passenger's knee air bag

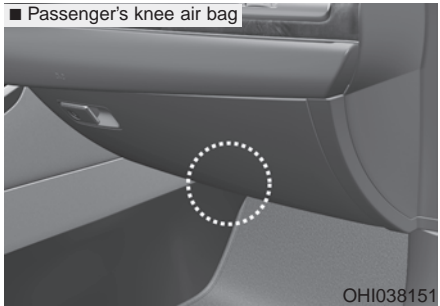

The purpose of the SRS is to provide the vehicle's driver and front passengers with additional protection than that offered by the seat belt system alone. The SRS uses sensors to gather information about the driver's and front passenger's seat belt usage and impact severity.

The seat belt buckle sensors determine if the driver and front passenger's seat belts are fastened. These sensors provide the ability to control the SRS deployment based on whether or not the seat belts are fastened, and how severe the impact is. The advanced SRS offers the ability to control the air bag inflation within two levels. A first stage level is provided for moderate-severity impacts. A second stage level is provided for more severe impacts.

According to the impact severity, and seat belt usage, the SRS Control Module (SRSCM) controls the air bag inflation. Failure to properly wear seat belts can increase the risk or severity of injury in an accident.

WARNING

To reduce the risk of serious injury or death from an inflating front air bags, take the following precautions:

- **Seat belts must be worn at all times to help keep occupants positioned properly.**
- **Move your seat as far back as possible from front air bags, while still maintaining control of the vehicle.**
- **Never lean against the door or center console.**
- **Do not allow the front passenger to place their feet or legs on the dashboard.**
- **No objects (such as crash pad cover, cellular phone holder, cup holder, perfume or stickers) should be placed over or near the air bag modules on the steering wheel, instrument panel, windshield glass, and the front passenger's panel above the glove box. Such objects could cause harm if the vehicle is in a crash severe enough to cause the air bags to deploy.**

Side air bags



Your vehicle is equipped with a side air bag in each front seat and outboard rear seats. The purpose of the air bag is to provide the vehicle's driver and the front passenger with additional protection than that offered by the seat belt alone.

The side air bags are designed to deploy only during certain side impact collisions, depending on the crash severity.

The side and curtain air bags on both sides of the vehicle may deploy if a rollover or possible rollover is detected.

For vehicles equipped with a rollover sensor the side air bags and pre-tensioners on both sides of the vehicle may deploy if a rollover or possible rollover is detected. However, the side air bags are not designed to deploy in all side impact or rollover situations.

WARNING

To reduce the risk of serious injury or death from an inflating side air bag, take the following precautions:

- **Seat belts must be worn at all times to help keep occupants positioned properly.**
- **Do not allow passengers to lean their heads or bodies onto doors, put their arms on the doors, stretch their arms out of the window, or place objects between the doors and seats.**
- **Hold the steering wheel at the 9 o'clock and 3 o'clock positions, to minimize the risk of injuries to your hands and arms.**
- **Do not use any accessory seat covers. This could reduce or prevent the effectiveness of the system.**

- Do not place any objects over the air bag or between the air bag and yourself. Also, do not attach any objects around the area the air bag inflates such as the door, side door glass, front and rear pillar.
- Do not place any objects between the door and the seat. They may become dangerous projectiles if the side air bag inflates.
- Do not install any accessories on the side or near the side air bags.
- Do not put any objects between the side airbag label and seat cushion. It could cause harm if the vehicle is in a crash severe enough to cause the air bags to deploy.
- Do not cause impact to the doors when the Engine Start/ Stop button is in the ON position or this may cause the side air bags to inflate.
- If the seat or seat cover is damaged, have the vehicle checked and repaired by an authorized retailer of Genesis Branded Vehicle.

Curtain air bags

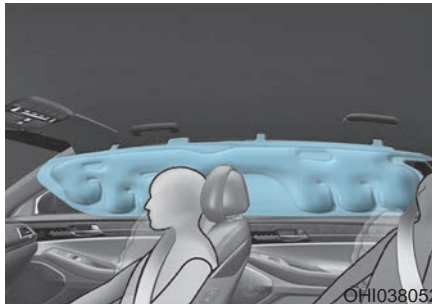

Curtain air bags are located along both sides of the roof rails above the front and rear doors.

They are designed to help protect the heads of the front seat occupants and the rear outboard seat occupants in certain side impact collisions.

The curtain air bags are designed to deploy only during certain side impact collisions, depending on the crash severity.

The side and curtain air bags on both sides of the vehicle may deploy if a rollover or possible rollover is detected.

However, the curtain air bags are not designed to deploy in all side impact or rollover situations.

⚠ WARNING

To reduce the risk of serious injury or death from an inflating curtain air bags, take the following precautions:

- All seat occupants must wear seat belts at all times to help keep occupants positioned properly.
- Properly secure child restraints as far away from the door as possible.
- Do not place any objects over the air bag. Also, do not attach any objects around the area the air bag inflates such as the door, side door glass, front and rear pillar, roof side rail.
- Do not hang other objects except clothes, especially hard or breakable objects. In an accident, it may cause vehicle damage or personal injury.
- Do not allow passengers to lean their heads or bodies onto doors, put their arms on the doors, stretch their arms out of the window, or place objects between the doors and seats.
- Do not open or repair the side curtain air bags.

How Does the Air Bags System Operate?

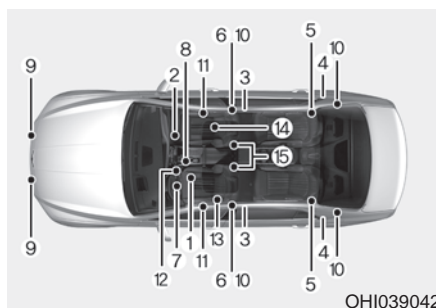

The SRS consists of the following components:

1. Driver's front air bag module
2. Passenger's front air bag module
3. Side air bag modules (front)
4. Side air bag modules (rear)
5. Curtain air bag modules
6. Retractor pre-tensioner assemblies
7. Air bag warning light
8. SRS control module (SRSCM) / Rollover sensor
9. Front impact sensors
10. Side impact sensor (speed)
11. Side impact sensor (pressure)
12. Driver's knee air bag module
13. Emergency fastening device
14. Occupant classification system
15. Driver's and front passenger's seat belt buckle sensors

The SRSCM (Supplemental Restraint System Control Module) continually monitors all SRS components while the Engine Start/Stop button is in the ON or START position to determine if a crash impact is severe enough to require air bag deployment or pre-tensioner seat belt deployment.



SRS warning light

The SRS (Supplement Restraint System) air bag warning light on the instrument panel displays the air bag symbol depicted in the illustration. The system checks the air bag electrical system for malfunctions. The light indicates that there is a potential malfunction with your air bag system, which could include your side and curtain air bags used for rollover protection.

WARNING

If your SRS malfunctions, the air bag may not inflate properly during an accident increasing the risk of serious injury or death.

If any of the following conditions occur, your SRS is malfunctioning:

- The light does not turn on for approximately six seconds when the Engine Start/Stop button is in the ON or START position.
- The light stays on after illuminating for approximately six seconds.
- The light comes on while the vehicle is in motion.
- The light blinks when the engine is running.

Have an authorized retailer of Genesis Branded products inspect the SRS as soon as possible if any of these conditions occur.

During a frontal collision, sensors will detect the vehicle's deceleration. If the rate of deceleration is high enough, the control unit will inflate the front air bags.

The front air bags help protect the driver and front passenger by responding to frontal impacts in which seat belts alone cannot provide adequate restraint. When needed, the side air bags help provide protection in the event of a side impact or rollover.

- Air bags are activated (able to inflate if necessary) only when the Engine Start/Stop button is in the ON or START position.
- Air bags inflate in the event of certain frontal or side collisions to help protect the occupants from serious physical injury.
- Generally, air bags are designed to inflate based upon the severity of a collision, its direction, etc. These two factors determine whether the sensors produce an electronic deployment/inflation signal.
- The front air bags will completely inflate and deflate in an instant. It is virtually impossible for you to see the air bags inflate during an accident. It is much more likely that you will simply see the deflated air bags hanging out of their storage compartments after the collision.
- In addition to inflating in certain side collisions, vehicles equipped with a rollover sensor, side and curtain air bags will inflate if the sensing system detects a rollover. When a rollover is detected, side and curtain air bags will remain inflated longer to help provide protection from ejection, especially when used in conjunction with the seat belts.
- To help provide protection, the air bags must inflate rapidly. The speed of air bag inflation is a consequence of extremely short time in which to inflate the air bag between the occupant and the vehicle structures before the occupant impacts those structures. This speed of inflation reduces the risk of serious or life-threatening injuries and is thus a necessary part of air bag design. However, the rapid air bag inflation can also cause injuries which can include facial abrasions, bruises and broken bones because the inflation speed also causes the air bags to expand with a great deal of force.
- There are even circumstances under which contact with the air bag can cause fatal injuries, especially if the occupant is positioned excessively close to the air bag.

You can take steps to help reduce the risk of being injured by an inflating air bag. The greatest risk is sitting too close to the air bag. An air bag needs about 10 inches (25 cm) of space to inflate. NHTSA recommends that drivers allow at least 10 inches (25 cm) between the center of the steering wheel and the chest.

⚠ WARNING

To reduce the risk of serious injury or death from an inflating air bag, take the following precautions:

- **NEVER** place a child restraint in the front passenger seat.
Always properly restrain children under age 13 in the rear seats of the vehicle.
- Adjust the front passenger's and driver's seats as far to the rear as possible while allowing you to maintain full control of the vehicle.
- Hold the steering wheel with hands at the 9 o'clock and 3 o'clock positions.
- Never place anything or anyone between the air bag and the seat occupant.
- Do not allow the front passenger to place their feet or legs on the dashboard.



When the SRSCM detects a sufficiently severe impact to the front of the vehicle, it will automatically deploy the front air bags.



Upon deployment, tear seams molded directly into the pad covers will separate under pressure from the expansion of the air bags. Further opening of the covers allows full inflation of the air bags.

A fully inflated air bag, in combination with a properly worn seat belt, slows the driver or the front passenger forward motion, reducing the risk of head and chest injury.

■ Driver's front air bag (3)



OHI038173L

■ Passenger's front air bag

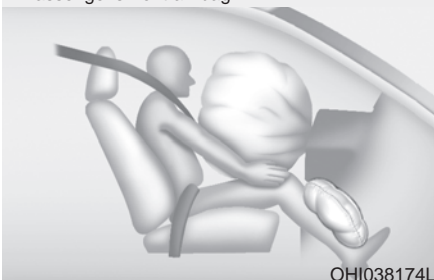

OHI038174L

After complete inflation, the air bag immediately starts deflating, enabling the driver to maintain forward visibility and the ability to steer or operate other controls.

⚠ WARNING

To prevent objects from becoming dangerous projectiles when the passenger's air bag inflates:

- Do not install or place any objects (drink holder, CD holder, stickers, etc.) on the front passenger's panel above the glove box where the passenger's air bag is located.
- Do not install a container of liquid air freshener near the instrument cluster or on the instrument panel surface.

What to Expect after an Air Bag Inflates

After a frontal or side air bag inflates, it will deflate very quickly. Air bag inflation will not prevent the driver from seeing out of the windshield or being able to steer. Curtain air bags may remain partially inflated for some time after they deploy.

⚠ WARNING

After an air bag inflates, take the following precautions:

- Open your windows and doors as soon as possible after impact to reduce prolonged exposure to the smoke and powder released by the inflating air bag.
- Do not touch the air bag storage area's internal components immediately after an air bag has inflated. The parts that come into contact with an inflating air bag may be very hot.
- Always wash exposed skin areas thoroughly with cold water and mild soap.
- Always have an authorized retailer of Genesis Branded products replace the air bag immediately after deployment. Air bags are designed to be used only once.

Noise and smoke from inflating air bag

When the air bags inflate, they make a loud noise and may produce smoke and powder in the air inside of the vehicle. This is normal and is a result of the ignition of the air bag inflator. After the air bag inflates, you may feel substantial discomfort in breathing because of the contact of your chest with both the seat belt and the air bag, as well as from breathing the smoke and powder. The powder may aggravate asthma for some people. If you experience breathing problems after an air bag deployment, seek medical attention immediately.

Though the smoke and powder are nontoxic, they may cause irritation to the skin, eyes, nose, throat, etc. If this is the case, wash and rinse with cold water immediately and seek medical attention if the symptoms persist.

Occupant Classification System (OCS)

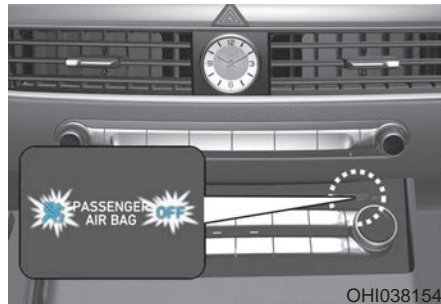

Your vehicle is equipped with an Occupant Classification System (OCS) in the front passenger's seat.

Main components of the Occupant Classification System

- A detection device located within the front passenger seat cushion.
- Electronic system to determine whether the passenger air bag systems should be activated or deactivated.
- An indicator light located on the instrument panel which illuminates the words "PASSENGER AIR BAG OFF" indicating the front passenger air bag system is deactivated.
- The instrument panel air bag indicator light is interconnected with the OCS.

Main components of the Occupant Classification System

The OCS is designed to help detect the presence of a properly-seated front passenger and determine if the passenger's front air bag should be enabled (may inflate) or not.

The purpose is to help reduce the risk of injury or death from an inflating air bag to certain front passenger seat occupants, such as children, by requiring the air bag to be automatically turned OFF.

For example, if a child restraint of the type specified in the regulations is on the seat, the occupant classification sensor can detect it and cause the air bag to turn OFF.

Front passenger seat adult occupants who are properly seated and wearing the seat belt properly, should not cause the passenger air bag to be automatically turned OFF. For small adults it may be turned OFF, however, if the occupant does not sit in the seat properly (for example, by not sitting upright, by sitting on the edge of the seat, or by otherwise being out of position), this could cause the sensor to turn the air bag OFF.

You will find the "PASSENGER AIR BAG OFF" indicator on the overhead console. This system detects the conditions 1-4 in the following table and activates or deactivates the front passenger air bag based on these conditions.

Always be sure that you and all vehicle occupants are seated properly and wearing the seat belt properly for the most effective protection by the air bag and the seat belt.

The OCS may not function properly if the passenger takes actions which can affect the classification system. These include:

- Failing to sit in an upright position.
- Leaning against the door or center console.
- Sitting towards the sides of the front of the seat.
- Putting their legs on the dashboard or resting them on other locations which reduce the passenger weight on the front seat.
- Wearing the seat belt improperly.
- Reclining the seatback.
- Wearing a thick cloth like ski wear or hip protection wear.
- Putting an additional thick cushion on the seat.
- Putting electrical devices (e.g. notebook, satellite radio) on the seat with inverter charging.

Condition and operation in the front passenger Occupant Classification System

Condition detected by the occupant classification system	Indicator/Warning light		Devices
	"PASSENGER AIR BAG OFF" indicator light	SRS warning light	Front passenger air bag
1. Adult * ¹	Off	Off	Activated
2. Infant * ² or child restraint system with 12 months old * ³ * ⁴	On	Off	Deactivated
3. Unoccupied	On	Off	Deactivated
4. Malfunction in the system	Off	On	Activated

*¹ The system judges a person of adult size as an adult. When a smaller adult sits in the front passenger seat, the system may recognize him/her as a child depending on his/her physique and posture.

*² Do not allow children to ride in the front passenger seat. When a larger child who has outgrown a child restraint system sits in the front passenger seat, the system may recognize him/her as an adult depending upon his/her physique or sitting position.

*³ Never install a child restraint system on the front passenger seat.

*⁴ The PASSENGER AIR BAG "OFF" indicator may turn on or off when a child above 12 months to 12 years old (with or without child restraint system) sits in the front passenger seat. This is a normal condition.

⚠ WARNING

Riding in an improper position or placing weight on the front passenger's seat when it is unoccupied by a passenger adversely affects the OCS. To reduce the risk of serious injury or death:



- **NEVER** put a heavy load in the front seat or seatback pocket, or hang any items on the front passenger seat.



- **NEVER** place your feet on the front passenger seatback.



- **NEVER** sit with your hips shifted towards the front of the seat.



- **NEVER** ride with the seatback reclined when the vehicle is moving.



- **NEVER** place your feet or legs on the dashboard.



- **NEVER** lean on the door or center console or sit on one side of the front passenger seat.



- Do not sit on the passenger seat wearing heavily padded clothes such as ski wear and hip protector.



- Do not use car seat accessories such as thick blankets and cushions which cover up the car seat surface.



- Do not place electronic devices such as laptops, DVD player, or conductive materials such as water bottles on the passenger seat.
- Do not use electronic devices such as laptops and satellite radios which use inverter chargers.



- If large quantity of liquid has been spilled on the passenger seat, the air bag warning light may illuminate or malfunction. Therefore, make sure the seat has been completely dried before driving the vehicle.

- Do not place sharp objects on the front passenger seat. These may damage the occupant classification system, if they puncture the seat cushion.
- Do not place any items under the front passenger seat.
- When changing or replacing the seat or seat cover, use original items only. The OCS has been developed based on using original Genesis Branded products seats only. Altering or changing the authentic parts may result in system malfunction and increase risk of injury when in collision. Any of the above could interfere with the proper operation of the OCS sensor thereby increasing the risk of an injury in an accident.



Proper seated position for OCS

If the "PASSENGER AIR BAG OFF" indicator is on when an adult is seated in the front passenger seat, place the Engine Start/Stop button in the OFF position and ask the passenger to sit properly (sitting upright with the seat back in an upright position, centered on the seat cushion with their seat belt on, legs comfortably extended and their feet on the floor). Restart the engine and have the person remain in that position. This will allow the system to detect the person and to enable the passenger air bag. If the "PASSENGER AIR BAG OFF" indicator is still on, ask the passenger to move to the rear seat.

WARNING

Never allow an adult passenger to ride in the front passenger seat when the "PASSENGER AIR BAG OFF" indicator is illuminated. During a collision, the air bag will not inflate if the indicator is illuminated. Have your passenger reposition himself in the seat. If the "PASSENGER AIR BAG OFF" indicator remains illuminated after the passenger repositions himself properly and the vehicle is restarted, have the passenger move to the rear seat because the air bag will not inflate.

Information

The "PASSENGER AIR BAG OFF" indicator illuminates for approximately 4 seconds after the Engine Start/Stop button is in the OFF position or after the engine is started. If the front passenger seat is occupied, the OCS will then classify the front passenger after several more seconds.

Do Not Install a Child Restraint in the Front Passenger's Seat



Even though your vehicle is equipped with the OCS, never install a child restraint in the front passenger's seat. An inflating air bag can forcefully strike a child or child restraint resulting in serious or fatal injury.

⚠ WARNING

- **NEVER** place a rearward-facing or forward-facing child restraint in the front passenger's seat of the vehicle.
- An inflating frontal air bag could forcefully strike a child resulting in serious injury or death.
- Always properly restrain children in an appropriate child restraint in the rear seat of the vehicle.

Why Didn't My Air Bag Go Off in a Collision?

Air bags are not designed to inflate in every collision. There are certain types of accidents in which the air bag would not be expected to provide additional protection. These include rear impacts, second or third collisions in multiple impact accidents, as well as low speed impacts. Damage to the vehicle indicates a collision energy absorption, and is not an indicator of whether or not an air bag should have inflated.

⚠ WARNING

To reduce the risk of an air bag deploying unexpectedly and causing serious injury or death:

- **Do not hit or allow any objects to impact the locations where air bags or sensors are installed.**
- **Do not perform maintenance on or around the air bag sensors. If the location or angle of the sensors is altered, the air bags may deploy when they should not or may not deploy when they should.**
- **Do not install bumper guards or replace the bumper with a non-Genuine Genesis Part. This may adversely affect the collision and air bag deployment performance.**
- **Press the Engine Start/Stop button to the OFF or ACC position when the vehicle is being towed to prevent inadvertent air bag deployment.**
- **Have all air bag repairs conducted by an authorized retailer of Genesis Branded products.**

Air bag collision sensors

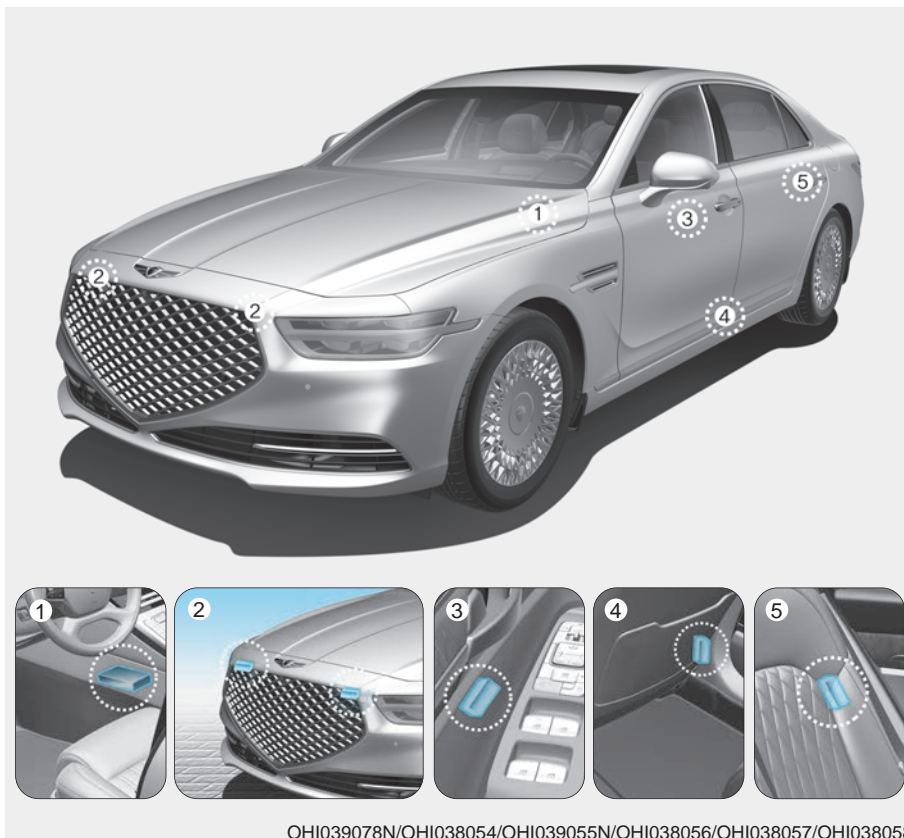

OHI039078N/OHI038054/OHI039055N/OHI038056/OHI038057/OHI038058

- | | |
|---|---|
| <p>(1) SRS control module
/ Rollover sensor</p> <p>(2) Front impact sensor
- on the front bumper</p> <p>(3) Side impact sensor (Pressure)
- on the front door</p> | <p>(4) Side impact sensor (Speed)
- under the B-pillar</p> <p>(5) Side impact sensor (Speed)
- under the C-pillar</p> |
|---|---|

Air bag inflation conditions



Front air bags

Front air bags and the driver's knee air bag are designed to inflate in a frontal collision depending on the severity of impact of the front collision.

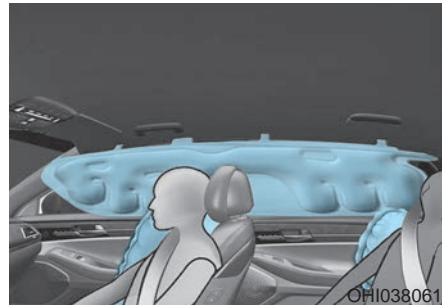

Side and curtain air bags

Side and curtain air bags are designed to inflate when an impact is detected by side collision sensors depending on the severity of impact resulting from a side impact collision.

Although the driver's and front passenger's air bags are designed to inflate only in frontal collisions, they also may inflate in other types of collisions if the front impact sensors detect a sufficient impact. Side and curtain air bags are designed to inflate only in side impact collisions or rollover situations, but they may inflate in other collisions if the side impact sensors detect a sufficient impact.

If the vehicle chassis is impacted by bumps or objects on unimproved roads, the air bags may deploy. Drive carefully on unimproved roads or on surfaces not designed for vehicle traffic to prevent unintended air bag deployment.

Air bag non-inflation conditions



In certain low-speed collisions the air bags may not deploy. The air bags are designed not to deploy in such cases because they may not provide benefits beyond the protection of the seat belts.



Front air bags are not designed to inflate in rear collisions, because occupants are moved backward by the force of the impact. In this case, inflated air bags would not provide any additional benefit.



Front air bags may not inflate in side impact collisions, because occupants move in the direction of the collision, and thus in side impacts, front air bag deployment would not provide additional occupant protection.

However, side and curtain air bags may inflate depending on the intensity, vehicle speed and angles of impact.

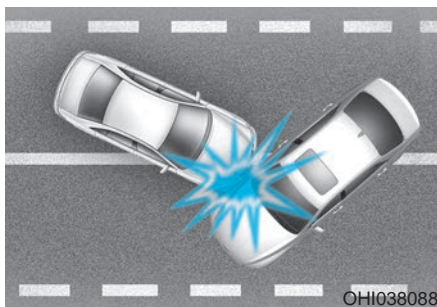

In an angled collision, the force of impact may direct the occupants in a direction where the air bags would not be able to provide any additional benefit, and thus the sensors may not deploy any air bags.

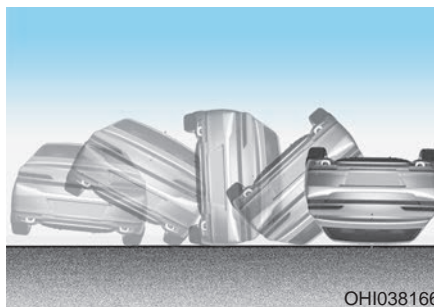

Front air bags may not inflate in rollover accidents because air bag deployment could not provide protection to the occupants.

However, side and curtain air bags may inflate when the vehicle is rolled over by a side impact collision.

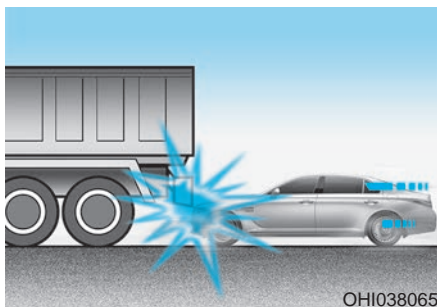

Just before impact, drivers often brake heavily. Such heavy braking lowers the front portion of the vehicle causing it to "ride" under a vehicle with a higher ground clearance. Air bags may not inflate in this "underride" situation because deceleration forces that are detected by sensors may be significantly reduced by such "underride" collisions.

i Information

Front air bags do not inflate in rollover accidents. However, side impact and curtain air bags may inflate in a rollover, when it is detected by the rollover sensor.

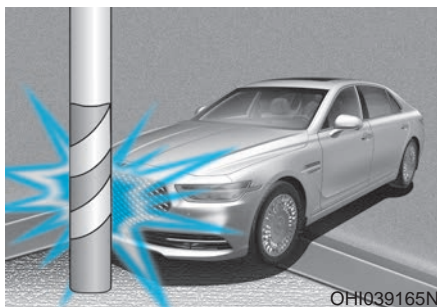

Air bags may not inflate if the vehicle collides with objects such as utility poles or trees, where the point of impact is concentrated and the collision energy is absorbed by the vehicle structure.

SRS Care

The SRS is virtually maintenance-free and there are no parts you can safely service by yourself. If the SRS air bag warning light does not illuminate when the Engine Start/Stop button is in the ON position, or continuously remains on, have your vehicle immediately inspected by an authorized retailer of Genesis Branded products.

Any work on the SRS system, such as removing, installing, repairing, or any work on the steering wheel, the front passenger's panel, front seats and roof rails must be performed by an authorized retailer of Genesis Branded products. Improper handling of the SRS system may result in serious personal injury.

WARNING

To reduce the risk of serious injury or death, take the following precautions:

- **Do not attempt to modify or disconnect the SRS components or wiring, including the addition of any kind of badges to the pad covers or modifications to the body structure.**
- **Do not place objects over or near the air bag modules on the steering wheel, instrument panel, or the front passenger's panel above the glove box.**
- **Clean the air bag pad covers with a soft cloth moistened with plain water. Solvents or cleaners could adversely affect the air bag covers and proper deployment of the system.**

- Always have inflated air bags replaced by an authorized retailer of Genesis Branded products.
- If components of the air bag system must be discarded, or if the vehicle must be scrapped, certain safety precautions must be observed. Consult an authorized retailer of Genesis Branded products for the necessary information. Failure to follow these precautions could increase the risk of personal injury.

Additional Safety Precautions

Passengers should not move out of or change seats while the vehicle is moving. A passenger who is not wearing a seat belt during a crash or emergency stop can be thrown against the inside of the vehicle, against other occupants, or be ejected from the vehicle.

Do not use any accessories on seat belts. Devices claiming to improve occupant comfort or reposition the seat belt can reduce the protection provided by the seat belt and increase the chance of serious injury in a crash.

Do not modify the front seats.

Modification of the front seats could interfere with the operation of the supplemental restraint system sensing components or side air bags.

Do not place items under the front seats. Placing items under the front seats could interfere with the operation of the supplemental restraint system sensing components and wiring harnesses.

Do not cause impact to the doors. Impact to the doors when the Engine Start/Stop button is in the ON position may cause the air bags to inflate.

Modifications to accommodate disabilities. If you require modification to your vehicle to accommodate a disability, contact Genesis Customer Care at 844 340-9741

Adding equipment to or modifying your air bag equipped vehicle

If you modify your vehicle by changing your vehicle's frame, bumper system, front end or side sheet metal or ride height, this may affect the operation of your vehicle's air bag system.

Air Bag Warning Labels

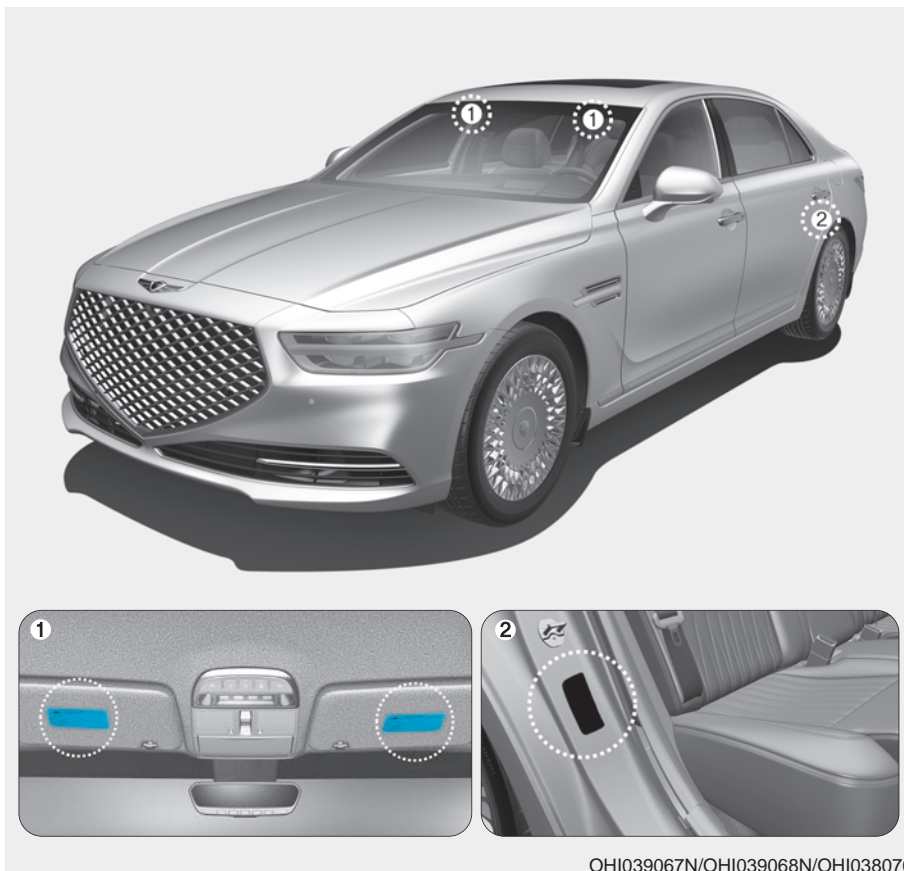

OHI039067N/OHI039068N/OHI038070

Air bag warning labels, required by the U.S. National Highway Traffic Safety Administration (NHTSA), are attached to alert the driver and passengers of potential risks of the air bag system. Be sure to read all of the information about the air bags that are installed on your vehicle in this Owners Manual.

3. Convenient Features of Your Vehicle

Accessing Your Vehicle	3-3	Sunroof	3-37
Smart Key	3-3	Sunroof Opening and Closing	3-38
Immobilizer System	3-8	Tilting the Sunroof	3-39
Door Locks	3-9	Sunshade	3-39
Operating Door Locks from Outside		Resetting the Sunroof	3-40
the Vehicle	3-9	Sunroof Open Warning.....	3-40
Operating Door Locks from Inside		Exterior Features	3-41
the Vehicle	3-11	Hood	3-41
Auto Door Lock and Unlock		Trunk.....	3-42
Features.....	3-13	Smart Trunk	3-48
Child-Protector Rear Door locks.....	3-13	Fuel Filler Door.....	3-51
Safe Exit Assist (SEA) System	3-14	Instrument Cluster	3-54
Theft-Alarm System	3-15	Instrument Cluster Control.....	3-55
Seat Position Memory System.....	3-16	Gauges and Meters	3-55
Storing Positions into Memory	3-16	Transmission Shift Indicator.....	3-59
Recalling Positions from Memory..	3-17	Warning and Indicator Lights	3-60
Resetting the Seat Position Memory		LCD Display Messages.....	3-71
System	3-17	LCD Display.....	3-78
Easy Access Function	3-18	LCD Display Control	3-78
Smart Posture Care System	3-19	LCD Display Modes	3-79
Steering wheel	3-20	Trip Computer	3-82
Motor-Driven Power		Trip Modes	3-82
Steering (MDPS).....	3-20	Vehicle Settings	3-85
Tilt Steering / Telescopic Steering	3-21	Head-Up Display	3-86
Heated Steering Wheel	3-21	Lighting	3-88
Horn	3-22	Exterior Lights	3-88
Mirrors	3-23	Interior Lights	3-95
Inside Rearview Mirror	3-23	Welcome System	3-99
Side View Mirrors	3-29	Wipers and Washers	3-100
Reverse Parking Aid Function.....	3-32	Windshield Wipers	3-100
Windows	3-33	Windshield Washers.....	3-101

3. Convenient Features of Your Vehicle

3

Parking Distance Warning (Reverse/Forward) System	3-102
Operation of the Parking Distance Warning System	3-103
Non-operational Conditions of Parking Distance Warning System	3-105
Parking Distance Warning System Precautions	3-106
Parking Collision-Avoidance Assist - Reverse	3-107
System Setting and Operation	3-107
Warning and System Control	3-108
Detecting Sensor	3-110
System Malfunction	3-112
Limitations of the System	3-112
Surround View Monitor.....	3-114
Blind-Spot View Monitor System	3-116
Automatic Climate Control System	3-117
Automatic Heating and Air Conditioning	3-118
Manual Heating and Air Conditioning	3-119
System Operation	3-129
System Maintenance.....	3-130
Defroster	3-132
Rear Window Defroster	3-132
Front Wiper Deicer.....	3-132
Windshield Defrosting and Defogging	3-133
Climate Control Additional Features.....	3-135
Auto Defogging System.....	3-135
Clean Air	3-136
Automatic Ventilation	3-136
Sunroof Inside Air Recirculation ..	3-137
Setting the Climate Control System in the AVN System Screen	3-137
Storage Compartment	3-139
Center Console Storage	3-139
Rear Console Storage	3-139
Glove Box	3-140
Sunglass Holder.....	3-140
Interior Features	3-141
Cup Holder	3-141
Sunvisor	3-142
Rear Mirror	3-142
Power Outlet	3-143
USB Charger.....	3-144
Wireless Cellular Phone Charging System	3-145
Coat hook	3-147
Clock	3-147
Bag Hanger	3-148
Floor Mat Anchor(s).....	3-148
Rear Window Sunshade	3-149
Rear Side Window Sunshade	3-150
Luggage Net Holder	3-151

ACCESSING YOUR VEHICLE

Smart Key

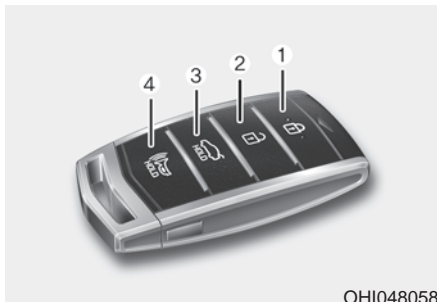

OHI048058

Your G90 uses a Smart Key, which you can use to lock or unlock the driver and passenger doors or the trunk.

1. Door Lock
2. Door Unlock
3. Trunk Unlock
4. Panic

Locking your vehicle

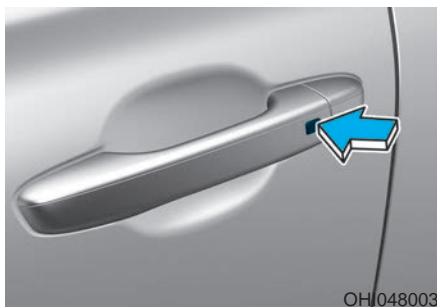

OHI048003

To lock your vehicle using the door handle button or the Smart Key:

1. Make sure all doors, the hood and the trunk are closed.
2. Make sure you have the smart key in your possession.

3. Press either the button on the door handle or the Door Lock button (1) on the smart key. The chime will sound once and the hazard warning lights will blink. Also, the outer side view mirror will fold, if the folding switch is in the AUTO position.
4. Make sure the doors are locked by checking the position of the door lock button inside the vehicle.

i Information

- **The door handle button will only operate when the smart key is within 28~40 inches (0.7~1 m) from the outside door handle.**
- **Pressing the door handle button does not unlock the doors. To unlock the doors, refer to the following page.**

Note that you cannot lock your vehicle using the door handle button if any of the following occur:

- The Smart Key is in the vehicle.
- The Engine Start/Stop button is in ACC or ON position.
- Any door except the trunk is open.

⚠ WARNING

Do not leave the Smart Key in your vehicle with unsupervised children. Unattended children could press the Engine Start/ Stop button and may operate power windows or other controls, or even make the vehicle move, which could result in serious injury or death.

Unlocking your vehicle

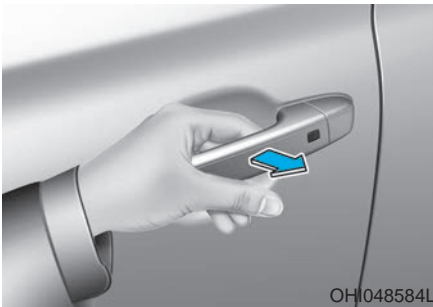

To unlock your vehicle:

1. Make sure you have the smart key in your possession.
2. Put your hand in the outside door handle or press the Door Unlock button (2) on the smart key. The driver's door will unlock and the hazard warning lights will blink two times. Also, the outer side view mirror will unfold, if the folding switch is in the AUTO position.

Two Press Unlock Feature

The priority for unlocking the driver door only, or unlocking all the doors with one press may be adjusted in the Settings menu in the AVN system screen.

The Two Press Unlock feature, when enabled, will require the user to press the door unlock button once for driver door only and twice for unlocking all the doors.

Select or Deselect the Two Press Unlock feature in the Settings menu in the AVN system screen. The option can be found under the following menu:

Setup → Vehicle Settings → Door/Trunk → 2 Press Unlock

***i* Information**

- **The door handle unlocking will only operate when the smart key is within 28-40 inches (0.7~1m) from the outside door handle.**
- **Either the driver or front passenger door can be opened with the door handle button when the smart key is within this range.**
- **If you put your hand in the front passenger outside door handle with the smart key in your possession, all the doors will unlock.**

i Information

- The doors may unlock if the inner sensor of the outer door handle is recognized while washing your car or due to heavy rain. However, the doors are automatically locked in 30 seconds unless a door is opened after they are unlocked.
- The doors may not unlock if you put your hand in the outside door handle with gloves on.
- The doors may not unlock if you suddenly approach the door and put your hand in the outside door handle.

Opening the trunk

To unlock and open the trunk:

1. Make sure you have the smart key in your possession.
2. Press either the trunk open switch on the outside of the trunk or press and hold the Trunk Unlock button (3) on the smart key for more than one second. The hazard warning lights will blink two times and the trunk will open.
3. Once the trunk is opened and then closed, the trunk will automatically re-lock after 30 seconds.

i Information

The trunk open switch will only operate when the smart key is within 28 inches (0.7 m) from the trunk.

Panic button

Press and hold the Panic button (4) for more than one second. The horn sounds and hazard warning lights blink for about 30 seconds. To cancel the panic mode, press any button on the Smart Key.

Start-up

You can start the engine without inserting the key.

For more information, refer to the "Engine Start/Stop Button" section in chapter 5.

NOTICE

To prevent damaging the smart key:

- **Keep the smart key in a cool, dry place to avoid damage or malfunction. Exposure to moisture or high temperature may cause the internal circuit of the smart key to malfunction which may not be covered under warranty.**
- **Avoid dropping or throwing the smart key.**
- **Protect the smart key from extreme temperatures.**

NOTICE

Always have the smart key with you when leaving the vehicle. If the smart key is left near the vehicle, the vehicle battery may be discharged.

Mechanical key

If the Smart Key does not operate normally, you can lock or unlock the door by using the mechanical key.



To remove the mechanical key from the smart key FOB, press and hold the release button (1) and then pull the mechanical key (2) outward.

To unlock the vehicle using the mechanical key, insert the mechanical key into the key hole in the driver door (Refer to page 3-9).

To reinstall the mechanical key into the FOB, insert the key in the top of the key FOB and push inward until a click sound is heard.

Loss of a smart key

A maximum of two Smart Keys can be registered to a single vehicle. If you happen to lose your smart key, you should immediately take the vehicle and remaining keys to your authorized retailer of Genesis Branded products or tow the vehicle, if necessary.

Smart key precautions

The smart key will not work if any of the following occur:

- The smart key is close to a radio transmitter such as a radio station or an airport which can interfere with normal operation of the transmitter.
- The smart key is near a mobile two way radio system or a cellular phone.
- Another vehicle's smart key is being operated close to your vehicle.
- If the smart key is in close proximity to your mobile phone, the signal could be blocked by your mobile phone's normal operational signals.

This is specifically relevant when the phone is active such as making and receiving calls, text messaging, and/or sending/receiving emails. When possible, avoid keeping the remote key and your mobile phone in the same location such as a pants or jacket pocket in order to avoid interference between the two devices.

NOTICE

Keep the smart key away from electromagnetic materials that blocks electromagnetic waves to the key surface.

i Information

This device complies with Part 15 of the FCC rules.

Operation is subject to the following three conditions:

1. This device may not cause harmful interference, and
2. This device must accept any interference received, including interference that may cause undesired operation.
3. Changes or modifications not expressly approved by the party responsible for compliance could void the user's authority to operate the device.

Restrictions in handling keys

When leaving keys with parking lot and valet attendants, the following procedures will ensure your vehicle's glove box compartment can only be opened with the mechanical key.

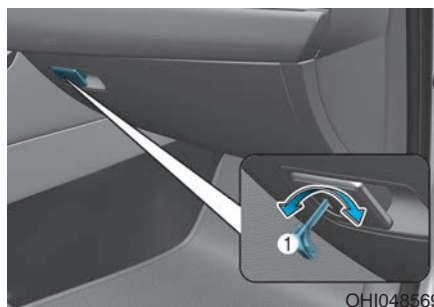

To lock:

1. Remove the mechanical key from the Smart Key.
2. Lock the glove box using the mechanical key (1).
3. Leave the smart key with the attendant and keep the mechanical key with you.

The Smart Key can only be used to start the engine and operate door locks.

To unlock:

Open the glove box with the mechanical key.

Battery replacement

If the Smart Key is not working properly, try replacing the battery with a new one.



Battery Type : CR2032

To replace the battery:

1. Remove the mechanical key.
2. Use a slim tool to pry open the rear cover of the smart key.
3. Remove the old battery and insert the new battery. Make sure the battery position is correct.
4. Reinstall the rear cover of the smart key.

i Information



An inappropriately disposed battery can be harmful to the environment and human health. Dispose of the battery according to your local law(s) or regulations.

Immobilizer System

The immobilizer system protects your vehicle from theft. If an improperly coded key (or other device) is used, the engine's fuel system is disabled.

When the Engine Start/Stop button is in the ON position, the immobilizer system indicator should come on briefly, then go off. If the indicator starts to blink, the system does not recognize the coding of the Smart Key.

Press the Engine Start/Stop button to the OFF position, then press the Engine Start/Stop button to the ON position again.

The system may not recognize your key's coding if another immobilizer key or other metal object (i.e., key chain) is near the key. The engine may not start because the metal may interrupt the transponder signal from transmitting normally.

If the system repeatedly does not recognize the coding of the key, contact an authorized retailer of Genesis Branded products.

Do not attempt to alter this system or add other devices to it. Electrical problems could result that may make your vehicle inoperable.

⚠ WARNING

In order to prevent theft of your vehicle, do not leave spare keys anywhere in your vehicle. Your immobilizer password is a customer unique password and should be kept confidential.

NOTICE

The transponder in your key is an important part of the immobilizer system. It is designed to give years of trouble-free service, however you should avoid exposure to moisture, static electricity and rough handling. Immobilizer system malfunction could occur.

***i* Information**

This device complies with Part 15 of the FCC rules.

Operation is subject to the following three conditions:

1. This device may not cause harmful interference, and
2. This device must accept any interference received, including interference that may cause undesired operation.
3. Changes or modifications not expressly approved by the party responsible for compliance could void the user's authority to operate the device.

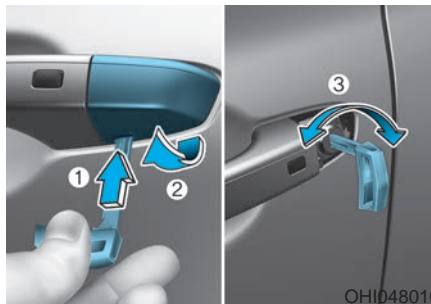
DOOR LOCKS**Operating Door Locks from Outside the Vehicle****Mechanical key**

To remove the cover:

1. Pull out the door handle.
2. Press the lock located at the bottom of the cover with a key or flat-blade screwdriver (1).
3. Push out the cover (2) while pressing the lock.

NOTICE

Be careful not to damage the cover while removing it or misplace it after removing it.

After removing the cover, turn the key toward the rear of the vehicle to unlock and toward the front of the vehicle to lock (3).

Once the doors are unlocked, they may be opened by pulling the door handle.

When closing the door, push the door by hand. Make sure that doors are closed securely.

Smart key

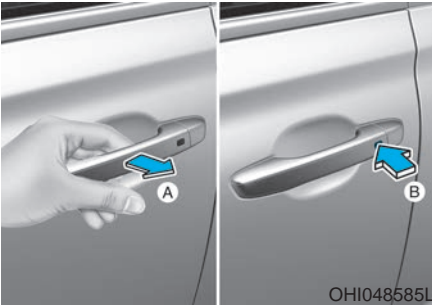

[A] : Unlock, [B] : Lock

To lock:

Press the button on the outside door handle while carrying the Smart Key with you or press the Door Lock button on the Smart Key.

To unlock:

- Put your hand in the driver's outside door handle while carrying the Smart Key with you, the driver's door will unlock.

Put your hand in the outside door handle again within 4 seconds, then all doors will unlock.

- Put your hand in the passenger's outside door handle, all doors will unlock.
- Press the Door Unlock button on the Smart Key, the driver's door will unlock.

Press the Door Unlock button on the Smart Key again within 4 seconds, then all doors will unlock.

- Once the doors are unlocked, they may be opened by pulling the door handle.

When closing the door, push the door by hand. Make sure that doors are closed securely.

i Information

You can change the system to the central door unlock mode in the Settings menu in the AVN system screen to unlock all the doors when you press the unlock button one time.

i Information

- In cold and wet climates, door lock and door mechanisms may not work properly due to freezing conditions.
- If the door is locked/unlocked multiple times in rapid succession with either the vehicle key or door lock switch, the system may stop operating temporarily in order to protect the circuit and prevent damage to system components.

Power door latch

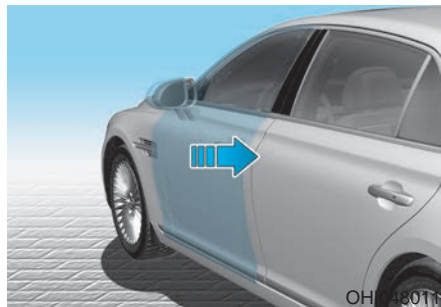

If a door isn't closed completely but is closed to the first detent position, the door will close automatically.

 **CAUTION**

To reduce the risk of injury:

- Before closing the door, check there are no obstructions in the path of the door.
- Keep your fingers away from the edge of the door or they may become trapped when the power door latch operates.

Operating Door Locks from Inside the Vehicle

With the door lock button

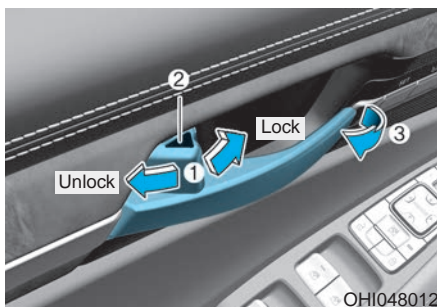

- To unlock a door, pull the door lock button (1) to the "Unlock" position. The red mark (2) on the door lock button will be visible.
- To lock a door, push the door lock button (1) to the "Lock" position. If the door is locked properly, the red mark (2) on the door lock button will not be visible.
- To open a door, pull the door handle (3) outward.
- If the inner door handle of the driver's (or front passenger's) door is pulled when the door lock button is in the lock position, the button is unlocked and door opens.

- The doors cannot be locked if the smart key is in the vehicle and any door is open.

Information

If a power door lock ever fails to function while you are in the vehicle try one or more of the following techniques to exit:

- Operate the door unlock feature repeatedly (both electronic and manual) while simultaneously pulling on the door handle.
- Operate the other door locks and handles, front and rear.
- Lower a front window and use the mechanical key to unlock the door from outside.

Information

When the vehicle's battery run out and you leave the vehicle, make sure all the doors are locked. You can lock the driver's door with a mechanical key and the rest of the doors with the lock button above the door inside handle.

With the central door lock switch

■ Driver's door

■ Passenger's door

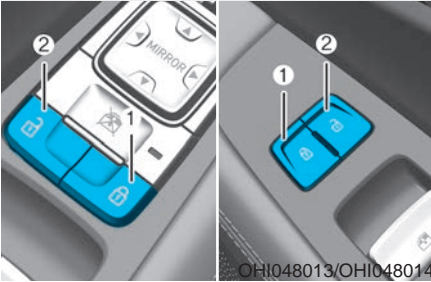

The driver side and front passenger side door armrest is equipped with a central door lock switch. The lock button is indicated by a (🔒) symbol. The unlock button is indicated by a (🔓) symbol.

When the lock button (1) is pressed, all the vehicle doors (and trunk) will lock.

When the unlock button (2) is pressed, all the vehicle doors (and trunk) will unlock.

⚠️ WARNING

The doors should always be fully closed and locked while the vehicle is in motion. If the doors are unlocked, the risk of being thrown from the vehicle in a crash is increased.

⚠️ WARNING

Do not leave children or animals unattended in your vehicle. An enclosed vehicle can become extremely hot, causing death or serious injury to unattended children or animals who cannot escape the vehicle. Children might operate features of the vehicle that could injure them, or they could encounter other harm, possibly from someone gaining entry to the vehicle.

⚠️ WARNING

Always secure your vehicle.
Leaving your vehicle unlocked can allow theft or entry into the vehicle.

To secure your vehicle, while depressing the brake pedal, shift the gear to the P (Park) position, engage the parking brake, and place the Engine Start/Stop button in the OFF position, close all windows, lock all doors, and always take the key with you.

⚠️ CAUTION

Opening a door when something is approaching may cause damage or injury. Be careful when opening doors and watch for vehicles, motorcycles, bicycles or pedestrians approaching the vehicle in the path of the door.

Auto Door Lock and Unlock Features

Your vehicle is equipped with features that will automatically lock or unlock your vehicle based on settings you select in the AVN system screen.

Auto LOCK - Enable on Speed

When this feature is set in the AVN system screen, all the doors will be locked automatically when the vehicle exceeds 9 mph (15 km/h).

Auto LOCK - Enable on Shift

When this feature is set in the AVN system screen, all the doors will be locked automatically when the vehicle is shifted out of P (Park) while the engine is running.

Auto UNLOCK - On Shift to P

When this feature is set in the AVN system screen, all the doors will be unlocked automatically when the vehicle is shifted back into P (Park).

Auto UNLOCK - Vehicle Off

When this feature is set in the AVN system screen, all the doors will be unlocked automatically when the vehicle is turned off.

For more information on these features, scan the QR code in a separately supplied simple manual.

Additional Unlock Safety Feature - Air Bag Deployment

As an additional safety feature, all doors will be automatically unlocked when an impact causes the air bags to deploy.

Child-Protector Rear Door locks



The child safety lock is provided to help prevent children seated in the rear from accidentally opening the rear doors. The rear door safety locks should be used whenever children are in the vehicle.

The child safety lock is located on the edge of each rear door. When the child safety lock is in the lock (1) position, the rear door will not open if the inner door handle is pulled.

You can only open the rear doors using the outside door handle (2).

To lock the child safety lock, insert a screwdriver into the hole and turn it to the lock position.

To allow a rear door to be opened from inside the vehicle, unlock the child safety lock.

⚠ WARNING

If children accidentally open the rear doors while the vehicle is in motion, they could fall out of the vehicle. The rear door safety locks should always be used whenever children are in the vehicle.

Safe Exit Assist (SEA) System (If equipped)



Once the system decides it is dangerous for a passenger to open a vehicle door by sensing the approaching of a vehicle from behind when the person is opening the door, the warning message “Watch for traffic” appears and the alarming sound will continue for maximum of five seconds.

This function works for ten minutes even after the ignition is turned off.

The function will be released as soon as the vehicle doors are locked with the smart key.

The alarming sound will continue while the Safe Exit Assist (SEA) system is in activation.

The Safe Exit Assist (SEA) system is activated when you select ‘Setup → Vehicle Settings → Driver Assistance → Blind-Spot Safety → Safe Exit Assist’ from the Settings menu in the AVN system screen.

For detailed information, scan the QR code in a separately supplied simple manual.

WARNING

If a vehicle is approaching from behind is too fast or a door is opened too suddenly the alarm system may not set off in time, which can increase the chance of an accident. Therefore, when exiting the vehicle, always check your surroundings to make sure that there are no vehicles or objects approaching.

WARNING

The safe Exist Assist (SEA) system may not operate normally when a vehicle is coming rapidly two lanes over from your vehicle or a vehicle is approaching at a fast speed from the rear in the lane next to your vehicle.

The Safe Exist Assist (SEA) system may be activated later than normal or may not operate normally if a vehicle is approaching fast from the rear of your vehicle.

The Safe Exist Assist (SEA) system will not operate if there is a malfunction with the Blind-Spot Collision Warning (BCW) system as follows:

- When the BCW warning message appears
- When the BCW sensor or the sensor surrounding is polluted or covered
- When the BCW does not warn or warns wrongly

For more details, refer to cautions and limitations in “Blind-Spot Collision Warning (BCW)/ Blind-Spot Collision-Avoidance Assist (BCA)” in chapter 5.

THEFT-ALARM SYSTEM

This system helps to protect your vehicle and valuables. The horn will sound and the hazard warning lights will blink continuously if any of the following occur:

- A door is opened without using the smart key.
- The trunk is opened without using the smart key.
- The engine hood is opened.

The alarm continues for 30 seconds, then the system resets. To turn off the alarm, unlock the doors with the smart key.

The Theft Alarm System automatically sets 30 seconds after you lock the doors and the trunk. For the system to activate, you must lock the doors and the trunk from outside the vehicle with the smart key or by pressing the button on the outside of the door handles with the smart key in your possession.

The hazard warning lights will blink and the chime will sound once to indicate the system is armed.

Once the security system is set, opening any door, the trunk, or the hood without using the smart key will cause the alarm to activate.

The Theft Alarm System will not set if the hood, the trunk, or any door is not fully closed. If the system will not set, check the hood, the trunk, or the doors are fully closed.

Do not attempt to alter this system or add other devices to it.

i Information

- **Do not lock the doors until all passengers have left the vehicle. If the remaining passenger leaves the vehicle when the system is armed, the alarm will be activated.**
- **If the vehicle is not disarmed with the smart key, open the doors by using the mechanical key or start the engine by directly pressing the Engine Start/Stop button with the smart key.**
- **When the system is disarmed but a door or trunk is not opened within 30 seconds, the system will be rearmed.**

SEAT POSITION MEMORY SYSTEM

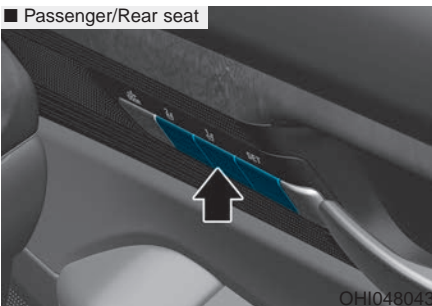
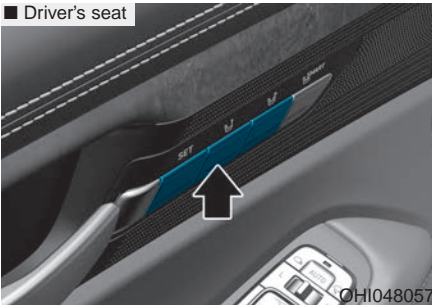

The Seat Position Memory System is provided to store and recall the following memory settings with a simple button operation.

- 1) Driver's seat position
 - Seat/Steering wheel/Outer side view mirror position
 - Instrument panel illumination intensity
 - Head-Up Display (HUD) height, rotation and brightness (if equipped)
- 2) Passenger/Rear seat position
 - Seat position

i Information

- If the battery is disconnected, the memory settings will be erased.
- If the Seat Position Memory System does not operate normally, have the system checked by an authorized retailer of Genesis Branded products.

Storing Positions into Memory

1. Check that the gear is in P (Park) while the Engine Start/Stop button is in the ON position.
2. Adjust the driver's seat position, outer side view mirror position, steering wheel position, instrument panel illumination intensity and head-up display height/brightness to the desired position.
3. Press the SET button. The system will beep once and notify you "Press button to save settings" on the LCD display.
4. Press one of the memory buttons (1 or 2) within 4 seconds. The system will beep twice when the memory has been successfully stored.
5. "Driver 1 (or 2) settings saved" will appear on the LCD display. The message appears only for the driver's seat position memory setting.

Recalling Positions from Memory

1. Check that the gear is in P (Park) while the Engine Start/Stop button is in the ON position.
2. Press the desired memory button (1 or 2). The system will beep once, and then the driver's seat position, outer side view mirror position, steering wheel position, instrument panel illumination intensity and head-up display height/brightness will automatically adjust to the stored positions.
3. "Driver 1(or 2) settings applied" will appear on the LCD display. The message appears only for the driver's seat position memory setting.

i Information

- If you press the SET button or number 1 button with the number 1 setting in operation, the setting will temporarily deactivate. If you press the number 2 button, the number 2 setting will activate.
- If you press the number 2 button or SET button with the number 2 button in operation, the number 2 setting will temporarily deactivate. Press the number 1 button, the number 1 setting will activate.
- If you operate the seat adjustment switch, side view mirror, steering wheel, instrument panel illumination or head-up display while recalling the stored positions, the pre-set settings will become ineffective.

Resetting the Seat Position Memory System

Take the following procedures to reset the seat position memory system, when it does not operate properly.

To reset the seat position memory system

1. Stop the vehicle and open the driver's door with the Engine Start/Stop button in the ON position and the gear shifted to P (Park).
2. Operate the control switch to set the driver's seat and seatback to the foremost position.
3. Simultaneously press the SET button and push forward the driver's seat movement switch over 2 seconds.

While resetting the seat position memory system

1. It starts with the notification sound.
2. The driver's seat and seatback is adjusted to the rearward position with the notification sound.
3. The driver's seat and seatback is re-adjusted to the default position (central position) with the notification sound.

However, in the following cases, the resetting procedure and the notification sound may stop.

- The memory button is pressed.
- The seat control switch is operated.
- The gear is shifted out of P (Park).
- The driving speed exceeds 2 mph (3 km/h).
- The driver's door is closed.

i Information

- **Reattempt to do the resetting procedure again when the resetting procedure incompletely stops or the notification sound do not stop.**
- **Make sure that there is no obstacle around the driver's seat in advance of resetting the seat position memory system.**

Easy Access Function

The system will move the driver's seat and steering wheel automatically as follows:

- **Exiting the vehicle:**

The driver's seat will move rearward and the steering wheel will move upward when the driver's door is opened and the Engine Start/Stop button is in the OFF position with the gear in P (Park).

However, the driver's seat may not move rearward if there is not enough space between the driver's seat and the rear seats.

Also, on a regular basis, the steering wheel will also move forward to adjust its location by itself.

- **Entering the vehicle:**

The driver's seat and steering wheel will move back to its original position when the Engine Start/Stop button is in the OFF position and the driver's door is closed with the smart key in possession or when the Engine Start/Stop button is changed to the ACC, ON or START position from the OFF position.

- When you enter or exit the vehicle, the seat bolster is automatically adjusted (if equipped).
 - When you enter, the seat bolster is adjusted to the position set by the driver.
 - When you exit, the seat bolster is adjusted to the default position.

You can activate or deactivate the Easy Access Function from the Settings menu in the AVN system screen. Select:

- Seat Easy Access : Setup → Vehicle Settings → Convenience → Seat/ Steering Wheel → Seat Easy Access → Off/Normal/Extended
- Steering Easy Access: Setup → Vehicle Settings → Convenience → Seat/ Steering Wheel → Steering Easy Access → On/Off

For detailed information, scan the QR code in a separately supplied simple manual.

- * Details for the Easy Access function for the front and rear passengers seat is explained in chapter 2.

SMART POSTURE CARE SYSTEM (IF EQUIPPED)



The Smart Posture Care system automatically provides a healthy posture (position) for the driver's back, and sets the steering wheel, outer side view mirrors, head-up display positions according to the driver's body measurements.

i Information

If the Seat Posture Care System does not operate normally, have the system checked by an authorized retailer of Genesis Branded products.

1. Check that the gear is in P (Park) while the Engine Start/Stop button is in the ON position.
2. Press the SMART button on the driver's door or select 'Setup → Vehicle Settings → Convenience → Smart Posture Care' from the Settings menu in the AVN system screen.
3. Enter information (Height, Pants Inseam Length, Weight) in the AVN system screen.
4. After entering the driver's information, press 'Adjust Posture'. The driver's seat, steering wheel, side view mirror and head-up display will be adjusted.
5. Press 'Save' and save the adjusted seat position in 'Driver 1' or 'Driver 2'.

Reference table

Height	4' 9" or Below ~ 6'6" or Above
Pants Inseam Length	Short/Average/Tall
Weight	109 lbs. or Below ~ 264 lbs. or Above

For detailed information, scan the QR code in a separately supplied simple manual.

STEERING WHEEL

Motor-Driven Power Steering (MDPS)

The system assists you with steering the vehicle. If the engine is turned off or if the power steering system becomes inoperative, you may still steer the vehicle, but it will require increased steering effort.

Should you notice any change in the effort required to steer during normal vehicle operation, have the system checked by an authorized retailer of Genesis Branded products.

NOTICE

If the Motor-Driven Power Steering (MDPS) System does not operate normally, the warning light (⊕!) will illuminate on the instrument cluster. You may steer the vehicle, but it will require increased steering efforts. Take your vehicle to an authorized retailer of Genesis Branded products and have the system checked as soon as possible.

i Information

The following symptoms may occur during normal vehicle operation:

- The steering effort may be high immediately after the Engine Start/Stop button is in the ON position.

This happens as the system performs the MDPS system diagnostics. When the diagnostics is completed, the steering wheel will return to its normal condition.

- A click noise may be heard from the MDPS relay after the Engine Start/Stop button is in the ON or OFF position.
- Motor noise may be heard when the vehicle is at a stop or at a low driving speed.
- When you operate the steering wheel in low temperatures, abnormal noise may occur. If the temperature rises, the noise will disappear. This is a normal condition.

Tilt Steering / Telescopic Steering

Adjust the steering wheel so it points toward your chest, not toward your face. Make sure you can see the instrument cluster warning lights and gauges. Always adjust the position of the steering wheel before driving.

⚠ WARNING

NEVER adjust the steering wheel while driving. This may cause loss of vehicle control resulting in an accident.



To change the steering wheel angle and height:

- Move the switch (1) up and down to adjust the angle (2).
- Move the switch forward or rearward to adjust the height (3).

NOTICE

Do not adjust the steering wheel longer than necessary when the engine is turned off. This may result in unnecessary battery drain.

Heated Steering Wheel

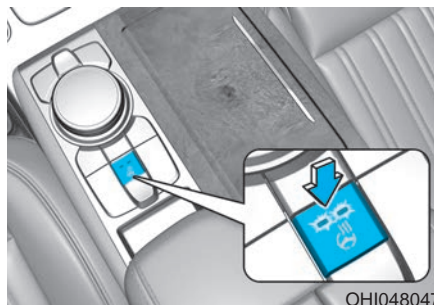

While the engine is running, push the switch to warm the steering wheel.

- Manual temperature control

Each time you push the switch, the temperature setting changes as follows:

OFF → HIGH (☀ ☀) → LOW (☀)
 ↑

- Automatic temperature control

- When the heated steering wheel switch is pressed to HIGH (☀ ☀) :

The heated steering wheel switch automatically changes to the LOW position after 30 minutes. You can turn off the heated steering wheel by pressing the switch to the OFF position.

- The heated steering wheel defaults to the OFF position whenever the Engine Start/Stop button is in the ON position.

Horn

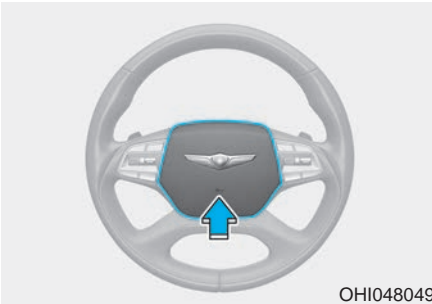

To sound the horn, press the area indicated by the horn symbol on your steering wheel (see illustration). The horn will operate only when this area is pressed.

NOTICE

Do not strike the horn severely to operate it, or hit it with your fist. Do not press on the horn with a sharp-pointed object.

MIRRORS

Inside Rearview Mirror

Before driving your vehicle, check to see that your inside rearview mirror is properly positioned. Adjust the rearview mirror so that the view through the rear window is properly centered.

⚠ WARNING

Make sure your line of sight is not obstructed. Do not place objects in the rear seat, cargo area, or behind the rear headrests which could interfere with your vision through the rear window.

⚠ WARNING

To prevent serious injury during an accident or deployment of the air bag, do not modify the rearview mirror and do not install a wide mirror.

⚠ WARNING

NEVER adjust the mirror while driving. This may cause loss of vehicle control resulting in an accident.

NOTICE

When cleaning the mirror, use a paper towel or similar material dampened with glass cleaner. Do not spray glass cleaner directly on the mirror as that may cause the liquid cleaner to enter the mirror housing.

Electrochromic mirror (ECM) with HomeLink® system and Genesis Connected Service (if equipped)

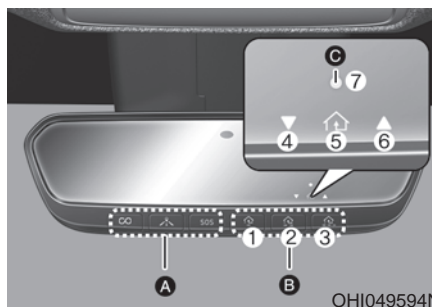

[A] : Genesis Connected Services buttons

[B] : HomeLink buttons,

[C] : HomeLink indicator

Your vehicle may be equipped with a Gentex Automatic-Dimming Mirror with an Integrated HomeLink® Wireless Control System.

During nighttime driving, this feature will automatically detect and reduce rearview mirror glare. The HomeLink® Universal Transceiver allows you to activate your garage door(s), electric gate, home lighting, etc.

- (1) HomeLink Channel 1
- (2) HomeLink Channel 2
- (3) HomeLink Channel 3
- (4) Garage Door Opener Status Indicator : Closing or Closed
- (5) HomeLink Operation Indicator
- (6) Garage Door Opener Status Indicator : Opening or Opened
- (7) HomeLink User Interface Indicator

Automatic-Dimming Night Vision Safety™ (NVS®) Mirror (if equipped)

The NVS® Mirror automatically reduces glare by monitoring light levels in the front and the rear of the vehicle. Any object that obstructs either light sensor will degrade the automatic dimming control feature.

For more information regarding NVS® mirrors and other applications, please refer to the Gentex website:

www.gentex.com

Your mirror will automatically dim upon detecting glare from the vehicles traveling behind you.

The mirror defaults to the ON position each time the vehicle is started.

Integrated HomeLink® Wireless Control System

The HomeLink® Wireless Control System can replace up to three handheld radio-frequency (RF) transmitters with a single built-in device. This innovative feature will learn the radio frequency codes of most current transmitters to operate devices such as gate operators, garage door openers, entry door locks, security systems, even home lighting. Both standard and rolling code-equipped transmitters can be programmed by following the outlined procedures.

Additional HomeLink® information can be found at: www.homelink.com, www.youtube.com/HomeLinkGentex or by calling 1-800-355-3515.

Retain the original transmitter of the RF device you are programming for use in other vehicles as well as for future HomeLink® programming. It is also suggested that upon the sale of the vehicle, the programmed HomeLink® buttons be erased for security purposes.

WARNING

Before programming HomeLink® to a garage door opener or gate operator, make sure people and objects are out of the way of the device to prevent potential harm or damage. Do not use the HomeLink® with any garage door opener that lacks the safety stop and reverse features required by U.S. federal safety standards (this includes any garage door opener model manufactured before April 1, 1982). A garage door that cannot detect an object - signaling the door to stop and reverse - does not meet current U.S. federal safety standards. Using a garage door opener without these features increases the risk of serious injury or death.

Programming HomeLink®

Please note the following:

- When programming a garage door opener, it is advised to park the vehicle outside of the garage.
- It is recommended that a new battery be placed in the hand-held transmitter of the device being programmed to HomeLink® for quicker training and accurate transmission of the radio-frequency signal.
- Some vehicles may require the Engine Start/Stop button to be in the ACC (or "Accessories") position for programming and/or operation of HomeLink®.
- In the event that there are still programming difficulties or questions after following the programming steps listed below, contact HomeLink® at: www.homelink.com, www.youtube.com/HomeLinkGent ex or by calling 1-800-355-3515.

Programming

To program most devices, follow these instructions:



1. Press and release (1), (2) or (3) button.
 - If the indicator (4) is turned ON in Orange, go to Step 3) since it is a new programming.
 - If the indicator (4) is continuously turned ON or flashes in Green rapidly several times, go to Step 2) since it is a programmed button.
2. Press and hold the button you wish to program for approximately 15-25 seconds until the LED flashes in Orange for several times.
3. Hold the Garage Door Opener Original Transmitter near the HomeLink Mirror.



4. Press the Original Transmitter button until the indicator (4) is turned continuously ON or flashes in Green for approximately 10 seconds and it indicates the programming is completed.

i Information

- Some garage door openers require to press the programmed button on the mirror up to three times right after the programming is just completed to operate the garage door.
- The indicator (4) is turned ON in Orange and flashes for about 60 seconds, during the programming mode and if a programming is not succeeded within the 60 seconds, the programming mode will be abort.

HomeLink® should now activate your rolling code equipped device.

Gate operator & Canadian programming

During programming, your handheld transmitter may automatically stop transmitting. Continue to press the Integrated HomeLink® Wireless Control System button while you press and re-press ("cycle") your handheld transmitter every two seconds until the frequency signal has been learned. The indicator light will flash slowly and then rapidly after several seconds upon successful training.



Operating HomeLink®

1. Press and release one of the HomeLink buttons (1, 2 or 3) that programmed.
2. The HomeLink indicator (4) will operate as below:
 - Indicates Green and is continuously ON (Fixed Code Garage Door Opener)
 - Flashes in Green rapidly (Rolling Code Garage Door Opener)

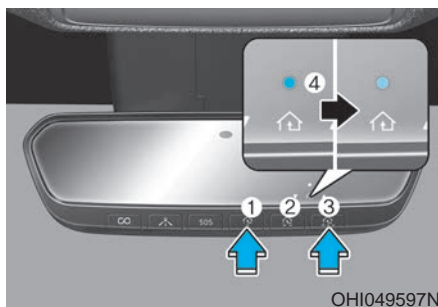

Erasing HomeLink® buttons

1. Press and hold the button (1) and (3) simultaneously.
2. The indicator (4) is turned continuously ON in orange for about 10 seconds.
3. Then the indicator (4) color changes to Green and flashes rapidly.

Release the buttons once the green indicator flashes.

4. Now HomeLink button (1), (2) and (4) memories are all cleared.

NVS® is a registered trademark and Z-Nav™ is a trademark of the Gentex Corporation, Zeeland, Michigan. HomeLink® is a registered trademark owned by Johnson Controls, Incorporated, Milwaukee, Wisconsin.

FCC ID: NZLUAHL5A

IC: 4112A-UAHL5A

i Information

This device complies with Part 15 of the FCC Rules.

Operation is subject to the following three conditions:

1. This device may not cause harmful interference, and
2. This device must accept any interference received, including interference that may cause undesired operation.
3. The transceiver has been tested and complies with FCC and Industry Canada rules. Changes or modifications not expressly approved by the party responsible for compliance could void the user's authority to operate the device.

Two Way Communication Programing

1. Complete the HomeLink "Programming" first.
2. Before the first 10 times HomeLink button is pressed after the programming, the following steps MUST occur to program two way communication. (only for some older garage doors)

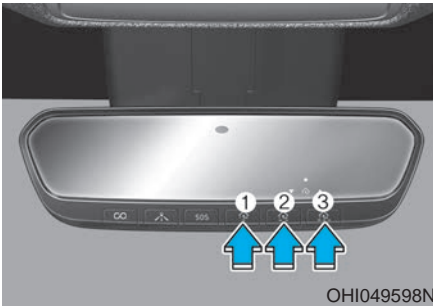

3. Press and release the programed HomeLink button to activate the garage door.
4. Once the garage door is stopped, press and release the "Learn" or "Smart" button on the Garage door opener within 1 minute from the time of pressing the programed HomeLink button on mirror.



5. If the both indicator (4) and (6) are flashing rapidly for about 5 seconds, the two way synchronization is completed.

i Information

Some newer garage door openers provide two-way communication synchronizing when programming the original transmitter.



Operating Two Way Communication

1. Press and release (1), (2) or (3) button.



2. The indicator (4) and (6) operates as below:

- If the indicator (4) flashes in Orange, it indicates that the garage door is "closing".
- If the indicator (4) is ON continuously in Green, it indicates that the garage door is "closed".
- If the indicator (6) flashes in Orange, it indicates that the garage door is "Opening".

- If the indicator (6) is ON continuously in Green, it indicates that the garage door is "Opened".
- If the indicator (4) or (6) does not turn to Green, it indicates that the last status of garage door was not received properly. The HomeLink mirror tries to receive the last known status of the garage door for a few seconds.

Recalling Garage Door Status

Homelink mirror with two way communication provides a way to view the last stored message from the garage door opener. In order to recall the last known status of the last activated device, press the buttons "1 and 2" OR "2 and 3" simultaneously.

- If the indicator (4) is ON continuously in Green, it indicates that the last activated device was "closed" properly.
- If the indicator (6) is ON continuously in Green, it indicates that the last activated device was "open" properly.

i Information

Two way communication range distance between "vehicle" and "garage door opener" is 100 m.

The range may be reduced or increased a little due to obstacle conditions around the garage door opener, such as houses or trees.

Side View Mirrors

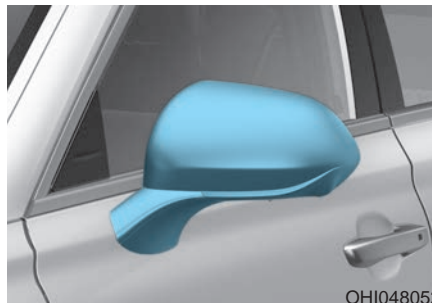

Make sure to adjust the side view mirrors to your desired position before you begin driving.

Your vehicle is equipped with both left-hand and right-hand side view mirrors. The mirrors can be adjusted remotely with the remote switch. The side view mirrors can be folded to help prevent damage when going through an automatic car wash or when passing through a narrow street.

The right side view mirror is convex. Objects seen in the mirror are closer than they appear.

Use the inside rearview mirror or look back directly to determine the actual distance of other vehicles prior to changing lanes.

⚠ WARNING

Do not adjust or fold the side view mirrors while driving. This may cause loss of vehicle control resulting in an accident.

NOTICE

- Do not scrape ice off the mirror face; this may damage the surface of the glass.
- If the mirror is jammed with ice, do not adjust the mirror by force. Use an approved spray de-icer (not radiator antifreeze) spray, or a sponge or soft cloth with very warm water, or move the vehicle to a warm place and allow the ice to melt.

NOTICE

Do not clean the mirror with harsh abrasives, fuel or other petroleum based cleaning products.

Adjusting the side view mirrors



1. Move the lever (1) either to the L (left side) or R (right side) to select the side view mirror you would like to adjust.
2. Use the mirror adjustment control (2) to position the selected mirror up, down, left or right.
3. After adjustment, move the lever (1) to the middle to prevent inadvertent adjustment.

NOTICE

- The mirrors stop moving when they reach the maximum adjusting angles, but the motor continues to operate while the switch is pressed. Do not press the switch longer than necessary, the motor may be damaged.
- Do not attempt to adjust the side view mirrors by hand otherwise the motor may be damaged.

Folding/Unfolding the side view mirrors



The outer side view mirror can be folded or unfolded by pressing the switch as below.

Left : The mirror will unfold.

Right : The mirror will fold.

Center (AUTO) :

The mirror will fold or unfold automatically as follows:

- The mirror will fold or unfold when the door is locked or unlocked by the smart key.
- The mirror will fold when the door is locked by the button on the outside door handle.
- The mirror unfold when you put your hand in the outside door handle with the smart key in possession.

- If 'Setup → Vehicle Settings → Convenience → Welcome Mirror/Light → Enable on Driver Approach' is selected from the Settings menu in the AVN system screen, the mirror will unfold when the vehicle is approached with the smart key in possession.

You can activate or deactivate this function from the Settings menu in the AVN system screen

For detailed information, scan the QR code in a separately supplied simple manual.

NOTICE

The electric type side view mirror operates even though the Engine Start/Stop button is in the OFF position. However, to prevent unnecessary battery discharge, do not adjust the mirrors longer than necessary while the engine is not running.

NOTICE

Do not fold the electric type side view mirror by hand. It could cause motor failure.

Reverse Parking Aid Function (if equipped)

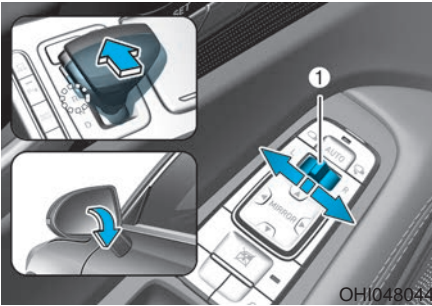

When you move the shift lever to the R (Reverse) position, the outer side view mirror(s) will rotate downwards to aid with driving in reverse.

The position of the outer side view mirror switch (1) determines whether or not the mirrors will move:

Left/Right : When either the L (Left) or R (Right) switch is selected, both outer side view mirrors will move.

Neutral : When neither switch is selected, the outer side view mirrors will not move.

The outer side view mirrors will automatically revert to their original positions if any of the following occur:

- The Engine Start/Stop button is pressed to either the OFF position or the ACC position.
- The shift lever is moved to any position except R (Reverse).
- The remote control outer side view mirror switch is not selected.

WINDOWS

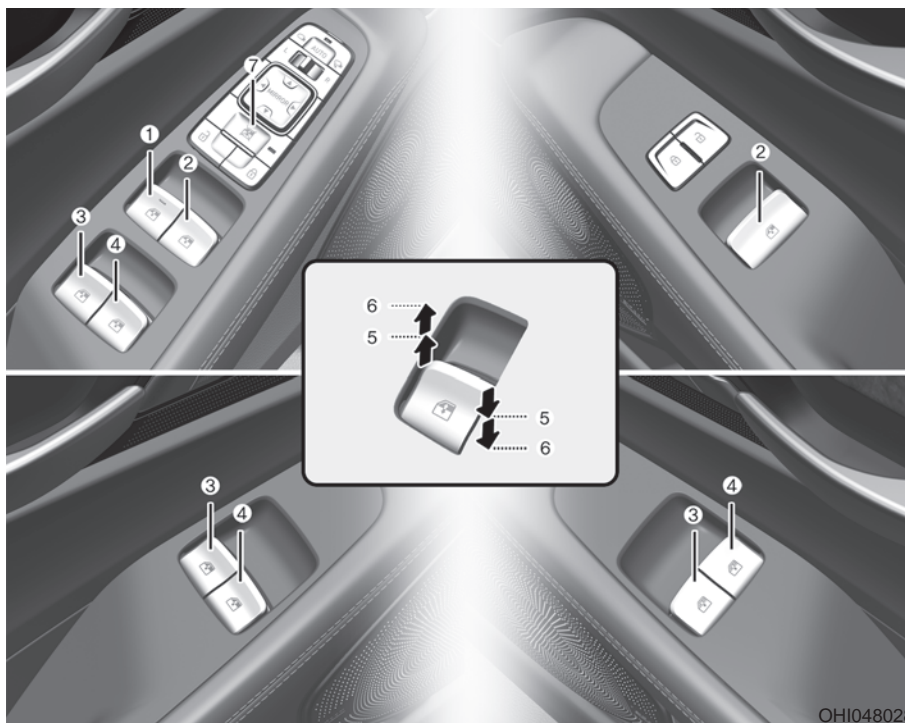

1. Driver's door power window switch
2. Front passenger's door power window switch
3. Rear door (left) power window switch
4. Rear door (right) power window switch
5. Window opening and closing
6. Automatic power window
7. Power window lock switch

The Engine Start/Stop button must be in the ON or START position to be able to raise or lower the windows. Each door has a Power Window switch to control that door's window. The driver has a Power Window Lock switch which can block the operation of passenger windows. The power windows will operate for approximately 30 seconds after the Engine Start/Stop button is in the OFF position.

However, if the front doors are opened, the Power Windows cannot be operated even within the 30 second period.

Window opening and closing

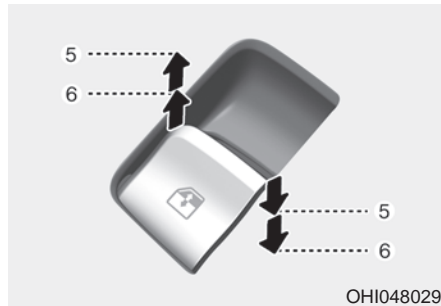

To open:

Press the window switch down to the first detent position (5). Release the switch when you want the window to stop.

To close:

Pull the window switch up to the first detent position (5). Release the window switch when you want the window to stop.

Auto up/down window

Pressing or pulling up the power window switch momentarily to the second detent position (6) completely lowers or lifts the window even when the switch is released. To stop the window at the desired position while the window is in operation, pull up or press down and release the switch.

To reset the power windows

If the power windows do not operate normally, the automatic power window system must be reset as follows:

1. Place the Engine Start/Stop button in the ON position.
2. Close the window and continue pulling up on the power window switch for at least one second.

If the power windows do not operate properly after resetting, have the system checked by an authorized retailer of Genesis Branded products.

Automatic reverse (if equipped)

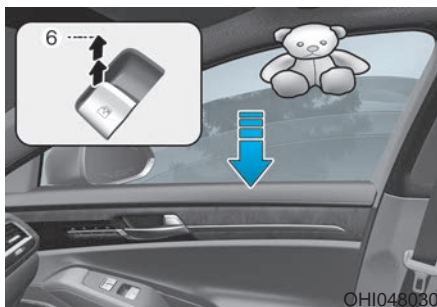

If a window senses any obstacle while it is closing automatically, it will stop and lower approximately 12 inches (30 cm) to allow the object to be cleared.

If the window detects the resistance while the power window switch is pulled up continuously, the window will stop upward movement then lower approximately 1 inch (2.5 cm).

If the power window switch is pulled up continuously again within 5 seconds after the window is lowered by the automatic window reverse feature, the automatic window reverse will not operate.

i Information

The automatic reverse feature is only active when the "Auto Up" feature is used by fully pulling up the switch to the second detent.

! WARNING

Make sure body parts or other objects are safely out of the way before closing the windows to avoid injuries or vehicle damage.

Objects less than 0.16 inch (4 mm) in diameter caught between the window glass and the upper window channel may not be detected by the automatic reverse window and the window will not stop and reverse direction.

Power window lock switch



The driver can disable the power window switches on the rear passenger's doors by pressing the power window lock switch.

When the power window lock switch is pressed:

- The rear passenger control will not be able to operate the rear passenger power window.
- Note that the front passenger control is still able to operate the front passenger window, and that the driver master control can still operate all the power windows.

⚠ WARNING

Do not allow children to play with the power windows. Keep the driver's door power window lock switch in the LOCK position. Serious injury or death can result from unintentional window operation by a child.

SUNROOF (IF EQUIPPED)



If your vehicle is equipped with a sunroof, you can slide or tilt your sunroof with the sunroof control lever located on the overhead console.

The sunroof can only be opened, closed, or tilted when the Engine Start/Stop button is in the ON or START position.

i Information

- In cold and wet climates, the sunroof may not work properly due to freezing conditions.
- After the vehicle is washed or in a rainstorm, be sure to wipe off any water that is on the sunroof before operating it.

⚠ WARNING

- **Never adjust the sunroof or sunshade while driving. This could result in loss of control and an accident that may cause death, serious injury, or property damage.**
- **Make sure heads, other body parts or objects are out of the way before using the sunroof.**

- **Do not extend your head, arms or body outside the sunroof while driving, to avoid serious injury.**
- **Do not leave the engine running and the key in your vehicle with unsupervised children. Unattended children could operate the sunroof, which could result in serious injury.**
- **Do not sit on the top of the vehicle. It may cause injuries or vehicle damage.**

NOTICE

- **Do not continue to move the sunroof control lever after the sunroof is fully opened, closed, or tilted. Damage to the motor or system components could occur.**
- **Make sure the sunroof is closed fully when leaving your vehicle. If the sunroof is open, rain or snow may leak through the sunroof and wet the interior as well as allow theft.**

Sunroof Opening and Closing

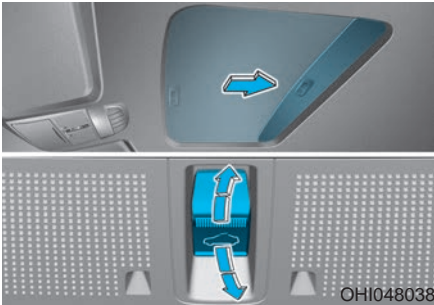

To open:

Press the sunroof control lever backward to the first detent position. Release the switch when you want the sunroof to stop.

To close:

Press the sunroof control lever forward to the first detent position. Release the switch when you want the sunroof to stop.

Sliding the Sunroof

Pressing the sunroof control lever backward or forward momentarily to the second detent position completely opens or closes the sunroof even when the switch is released. To stop the sunroof at the desired position while the sunroof is in operation, press the sunroof control lever backward or forward and release the switch.

Automatic reverse

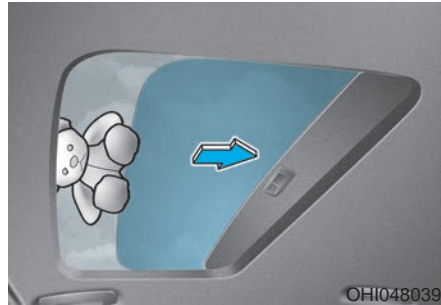

If the sunroof senses any obstacle while it is closing automatically, it will reverse direction then stop to allow the object to be cleared.

⚠ WARNING

Small objects that can get caught between the sunroof glass and the front glass channel may not be detected by the automatic reverse system. In this case, the sunroof glass will not detect the object and will not reverse direction.

Tilting the Sunroof

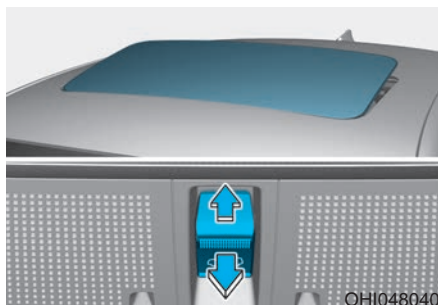

To open the sunroof, push the sunroof control lever upward to the second detent. The sunroof will tilt all the way open. To stop the sunroof tilting at any point, operate the control lever.

To close the sunroof, push the sunroof control lever forward until the sunroof moves to the desired position.

NOTICE

- Periodically remove any dirt that may accumulate on the sunroof guide rail or between the sunroof and roof panel which can make a noise.
- Do not try to open the sunroof when the temperature is below freezing or when the sunroof is covered with snow or ice, otherwise the motor could be damaged. In cold and wet climates, the sunroof may not work properly.

Sunshade



The sunshade will automatically open with the glass panel when the glass panel moves. Close it manually if you want it closed.

Resetting the Sunroof

The sunroof may need to be reset if the following conditions occur:

- The battery is discharged or disconnected or the sunroof fuse has been replaced or disconnected
- The sunroof control lever is not operating correctly

To reset the sunroof, perform the following steps:

1. Turn the engine on and close the sunroof glass and sunshade completely.
2. Release the control lever.
3. Push and hold the sunroof control lever forward for about 10 seconds until the sunroof moves slightly, then release the control lever.
4. Push and hold the sunroof control lever forward until the sunroof operates as follows:

TILT DOWN → SLIDE OPEN →
SLIDE CLOSE

Then, release the control lever.

When this is complete, the sunroof system is reset.

For more information, contact an authorized retailer of Genesis Branded products.

Information

If you do not reset the sunroof, it may not work properly.

Sunroof Open Warning (if equipped)



- If the driver turns off the engine when the sunroof is not fully closed, the warning chime will sound for approximately 3 seconds and the sunroof open warning will appear on the cluster LCD display.
- If the driver turns off the engine and opens the door when the sunroof is not fully closed, the sunroof open warning will appear on the cluster LCD display until the door is closed or the sunroof is fully closed.

Close the sunroof securely when leaving your vehicle.

EXTERIOR FEATURES

Hood

Opening the hood



1. Park the vehicle and set the parking brake.
2. Pull the release lever to unlatch the hood. The hood should pop open slightly.

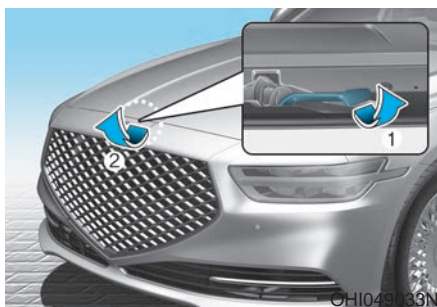

3. Go to the front of the vehicle, raise the hood slightly, push up the secondary latch (1) inside of the hood center and lift the hood (2). After it has been raised about halfway, it will raise completely by itself.

Closing the hood

1. Before closing the hood, check in and around the engine compartment to ensure the following:
 - Any tools or other loose objects are removed from the engine compartment area or hood opening area
 - All glove, rags, or other combustible material is removed from the engine compartment
 - All filler caps are tightly and correctly installed
2. Lower the hood halfway (lifted approximately 30 cm from the closed position) and push down to securely lock in place. Then double check to be sure the hood is secure. If the hood can be raised slightly, it is not securely locked. Open it again and close it with more force.

⚠ WARNING

- Before closing the hood, ensure all obstructions are removed from around hood opening.
- Always double check to be sure that the hood is firmly latched before driving away. Check there is no hood open warning light displayed on the instrument cluster. Driving with the hood opened may cause a total loss of visibility, which might result in an accident.
- Do not move the vehicle with the hood in the raised position, as vision is obstructed, which might result in an accident, and the hood could fall or be damaged.

Trunk

(1) Power Trunk Main Control button



(2) Power Trunk Open switch

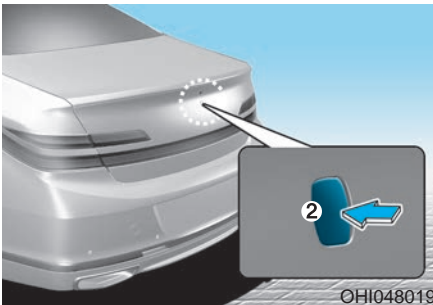

(3) Power Trunk Close button

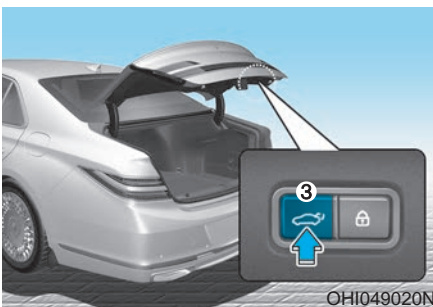

(4) Power Trunk Lock button

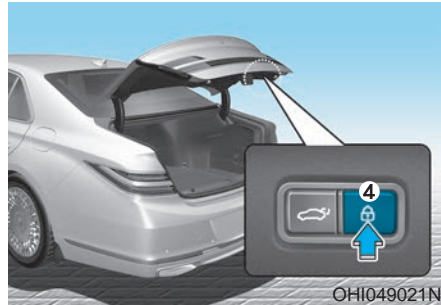

To open:

Do one of the following :

- Press the smart key Trunk Unlock button for more than one second.
- Press the Open switch (2) on the trunk. You need the smart key in your possession, when all doors are locked.
- Press the Power Trunk Main Control button (1).

To close:

Do one of the following:

- Press the Power Trunk Main Control button (1) until the Power Trunk is closed securely.
- Press the Close button (3) on the trunk.
- Press the Lock button (4) on the trunk while carrying the smart key with all the vehicle's doors closed. All doors will lock and arm the theft alarm system.

If you push a button or switch while the trunk is opening or closing, it could stop moving. Press any button to operate the Power Trunk again.

i Information

The Power Trunk Lock button will not work if you press the button when:

- Any door is open.
- The Engine Start/Stop button is not in the OFF position.
- The Smart Key is in the vehicle.

⚠ WARNING

Never leave children or animals unattended in your vehicle. Children or animals might operate the power trunk that could result in injury to themselves or others, or damage to the vehicle.

⚠ WARNING

Always keep the trunk lid completely closed while the vehicle is in motion. If it is left open or ajar, poisonous exhaust gases containing carbon monoxide (CO) may enter the vehicle and serious illness or death may result.

⚠ WARNING

Make sure there are no people or objects around the trunk before opening or closing the Power Trunk. Wait until the trunk is open fully and stopped before loading or unloading cargo from the vehicle.

NOTICE

- Do not close or open the Power Trunk manually. This may cause damage to the Power Trunk. If it is necessary to close or open the Power Trunk manually when the battery is drained or disconnected, do not apply excessive force.
- Do not leave the Power Trunk open for a long period of time. This may drain the battery.
- To prevent damage to the trunk lift cylinders and the attached hardware, always close the trunk before driving.

i Information

In cold and wet climates, trunk lock and trunk mechanisms may not work properly due to freezing conditions.

Power trunk non-opening or closing conditions:

- The Power Trunk will not open or close automatically, when the vehicle is moving more than 1.8 mph (3 km/h).
- The Power Trunk can be operated when the engine is not running. However, the Power Trunk operation consumes large amounts of vehicle electric power. To prevent the battery from draining, do not operate it excessively (e.g., more than approximately 10 times repeatedly.)
- Do not modify or repair any part of the Power Trunk by yourself. This must be done by an authorized retailer of Genesis Branded products.

- Before jacking up the vehicle to change a tire or repair the vehicle, open the Power Trunk. Do not operate the Power Trunk when the vehicle is raised or this could cause the Power Trunk to operate improperly.
- If there are obstacles such as snow on the Power Trunk, it may not open automatically. After removing the obstacle, try to open it again.

Automatic stop and reverse

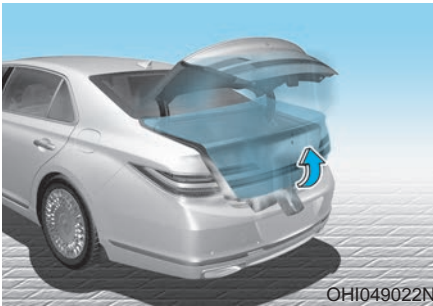

If, during power opening or closing, the trunk is blocked by an object or part of someone's body, the power trunk will detect the resistance and it will stop movement or move to the full open position to allow the object to be cleared.

However, if the resistance is weak such as from an object that is thin or soft, or the trunk is near the latched position, the automatic stop and reversal may not detect the resistance and the closing operation will continue. Also, if the Power Trunk is forced by a strong impact, the automatic stop and reverse may operate.

If the automatic stop and reverse feature operates more than twice during one opening or closing operation, the Power Trunk may stop at that position. If this occurs, close the trunk manually and operate the trunk automatically again.

3-44

⚠ WARNING

To prevent serious injury and damage take the following precautions when operating the power trunk:

- **Keep all faces, hands, arms, body parts and other objects away from the path of the power trunk.**
- **Do not intentionally place any body parts or objects in the path of the power trunk to make sure the automatic stop and reversal operates.**
- **Do not allow children to play with the power trunk.**

How to reset the power trunk

If the battery has been discharged or disconnected, or if the power trunk fuse has been replaced or removed, reset the power trunk by performing the following procedure:

1. Shift the vehicle to P (Park).
2. While pressing the power trunk close button, press the power trunk open switch for more than 3 seconds. A chime will sound.
3. Close the trunk manually.

If the Power Trunk doesn't work properly after performing the above procedure, have the system checked by an authorized retailer of Genesis Branded products.

Trunk lid control button

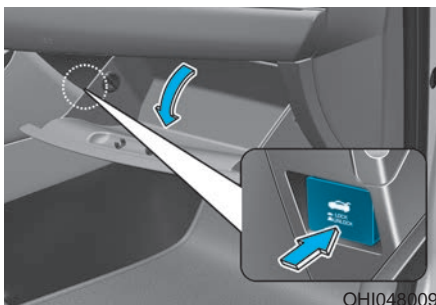

When the trunk lid control button is in the UNLOCK (button not pressed) position, the power trunk can be controlled with the power trunk main control button, power trunk open switch, power trunk, close button, and the smart key.

When this trunk lid control button is in the LOCK (button pressed) position, the power trunk can be opened using the trunk release lever.

The smart trunk does not operate, when the trunk lid control button is pressed to the LOCK position.

Even though the trunk lid control button is in the LOCK (button pressed) position, the trunk will still be propelled upward by mechanical force if the trunk is manually opened more than 10 degrees beyond the fully closed position. In addition, if the trunk is manually closed to the secondary latch position, the trunk will be electrically moved to the fully latched position.

NOTICE

Close the trunk, and keep the trunk lid control button in the LOCK (button pressed) position before washing the vehicle in an automatic car wash.

⚠ WARNING

Always keep the Trunk Lid Control Button in the LOCK (button pressed) position when not in use. Serious injury or death can result from unintentional operation by a child.

i Information

If the trunk lid control button is in the LOCK position, the Smart Trunk system will also be deactivated.

Power trunk opening height vehicle settings

You can select the fully open height of the power trunk from the Settings menu in the AVN system screen. Select:

- Setup → Vehicle Settings → Door/Trunk → Power Trunk Opening Height → 50% / 100%

For detailed information, scan the QR code in a separately supplied simple manual.

Emergency trunk safety release

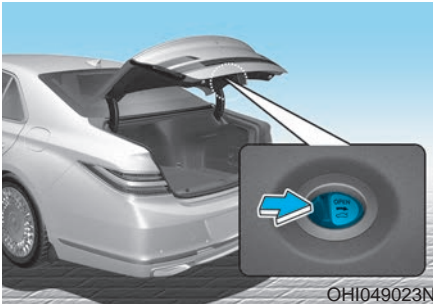

Your vehicle is equipped with an Emergency Trunk Safety Release lever located inside the trunk. When someone is inadvertently locked in the trunk, the trunk can be opened by moving the lever in the direction of the arrow and pushing the trunk open.

WARNING

- **You and your passengers must be aware of the location of the Emergency Trunk Safety Release lever in this vehicle and how to open the trunk in case you are accidentally locked in the trunk.**

- **NEVER** allow anyone to occupy the trunk of the vehicle at any time. If the trunk is partially or totally latched and the person is unable to get out, serious injury or death could occur due to lack of ventilation, exhaust fumes and rapid heat build-up, or because of exposure to cold weather conditions. The trunk is also a highly dangerous location in the event of a crash because it is not a protected occupant space but is a part of the vehicle's crush zone.
- Your vehicle should be kept locked and the Smart Key should be kept out of the reach of children. Parents should teach their children about the dangers of playing in trunks.
- Use the release lever for emergencies only.

Trunk release lever



When the vehicle battery is discharged or the trunk needs to be opened manually:

1. Open the cover (1) at the center of the rear seat. Pull the lever on the back of the cover all the way.

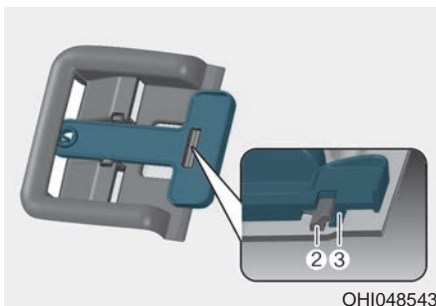

2. With the lever pulled to the end, fix the lever (3) on the projecting part (2).
3. Lift and open the trunk manually.
4. Remove the inserted lever to close the trunk.

NOTICE

If your vehicle is not equipped with a ski-through (type B), do not open the lever cover and use it as a ski-through purpose. Doing so may damage the cover.

⚠ WARNING

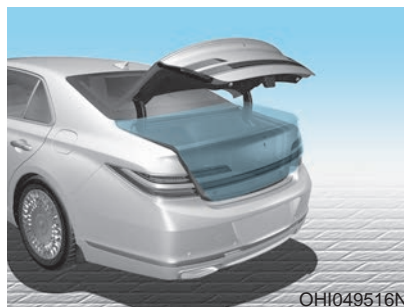

Make sure to at least have minimum space at the back and in the upper area of the trunk when opening or closing the trunk. If not, the trunk may hit the surrounding objects (wall, ceiling, vehicle, etc.) and result in damaging the vehicle or injuring the person near.

Smart Trunk (if equipped)

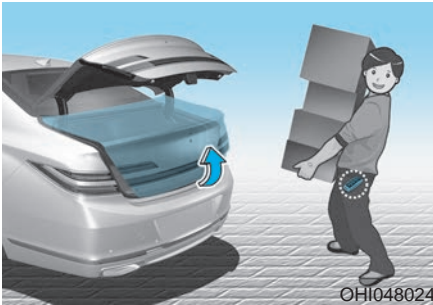

On a vehicle equipped with a smart key, the trunk can be opened with hands-free activation using the Smart Trunk system.

How to use the Smart Trunk

The hands-free smart trunk system can be opened automatically when the following conditions are met:

- The Smart Trunk option is enabled in the Settings menu in the AVN system screen.
- The Smart Trunk is activated and ready 15 seconds after all the doors are closed and locked.
- The Smart Trunk will open when the smart key is detected in the area behind the vehicle for 3 seconds.

***i* Information**

The Smart Trunk will NOT operate when:

- Any door is open, or all doors are closed but not locked.
- The smart key is detected within 15 seconds from when the doors were closed and locked.
- For vehicles equipped with illuminated exterior front door handles, if the smart key is detected within 15 seconds from when the doors were closed and locked or if the smart key is within 60 inches (1.5 m) from the front door handles.
- The smart key is in the vehicle.

1. Settings

To use this function, it must be activated from the Settings menu in the AVN system screen. Select:

- Setup → Vehicle Settings → Door/Trunk → Smart Trunk

For detailed information, scan the QR code in a separately supplied simple manual.

2. Detect and Alert

The Smart Trunk detecting area extends approximately 20-40 inch (50-100 cm) behind the vehicle. If you are positioned in the detecting area and are carrying the smart key, the hazard warning lights will blink and the chime will sound to alert you that the smart trunk will open.

i Information

Do not approach the detecting area if you do not want the trunk to open. If you have unintentionally entered the detecting area and the hazard warning lights and chime starts to operate, move away from the area behind the vehicle with the smart key. The trunk will remain closed.

3. Automatic opening

After the hazard warning lights blink and the chime sounds 6 times, the smart trunk will open.

How to deactivate the Smart Trunk function using the smart key

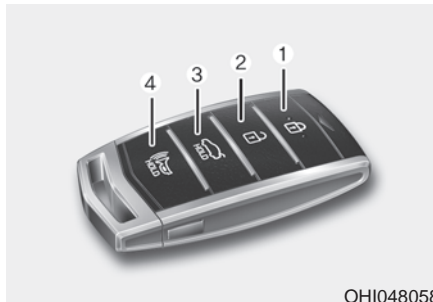

1. Door lock
2. Door unlock
3. Trunk open
4. Panic button

If you press any button on the smart key during the Detect and Alert stage, the Smart Trunk function will be deactivated.

Make sure to be aware of how to deactivate the Smart Trunk function for emergency situations.

i Information

- If you press the door unlock button (2), the Smart Trunk function will be deactivated temporarily. But, if you do not open any door for 30 seconds, the smart trunk function will be activated again.
- If you press the trunk open button (3) for more than 1 second, the trunk opens.
- The Smart Trunk function will still be activated if you press the door lock button (1) or trunk open button (3) on the smart key as long as the Smart Trunk is not already in the Detect and Alert stage.
- In case you have deactivated the Smart Trunk function by pressing the smart key button and opened a door, the smart trunk function can be activated again by closing and locking all doors.

Detecting area

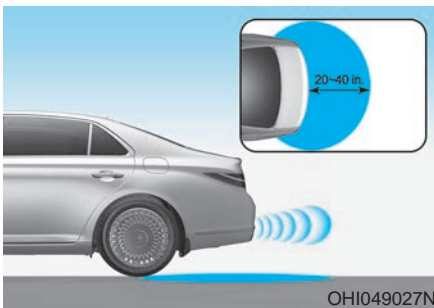

- The Smart Trunk detecting area extends approximately 20-40 inches (50-100 cm) behind the vehicle. If you are positioned in the detecting area and are carrying the smart key, the hazard warning lights will blink and the chime will sound for about 3 seconds to alert you that the smart trunk will open.

- The alert stops once the smart key is moved outside of the detecting area within the 3 second period.

i Information

- The Smart Trunk function may not operate properly if any of the following instances occur:
 - The smart key is close to a radio transmitter such as a radio station or an airport which can interfere with normal operation of the transmitter.
 - The smart key is near a mobile two way radio system or a cellular phone.
 - Another vehicle's smart key is being operated close to your vehicle.
- The Smart Trunk detecting area may change when:
 - The vehicle is parked on an incline or slope
 - One side of the vehicle is raised or lowered relative to the opposite side

Fuel Filler Door

Opening the fuel filler door



1. Turn the engine off.
2. Push the fuel filler door opener button.

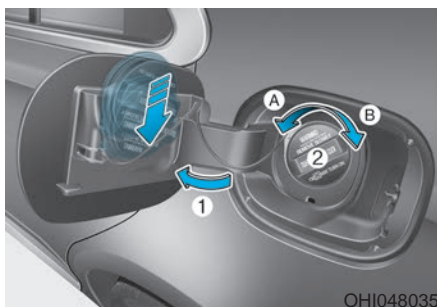

[A] : Open, [B] : Close

3. Pull the fuel filler door (1) outward to access the fuel tank cap.
4. To remove the fuel tank cap (2), turn it counterclockwise. You may hear a hissing noise as the pressure inside the tank equalizes.
5. Place the cap on the fuel filler door.

i Information

If the fuel filler door does not open because ice has formed around it, tap lightly or push on the door to break the ice and release the door. Do not pry on the door. If necessary, spray around the door with an approved de-icer fluid (do not use radiator anti-freeze) or move the vehicle to a warm place and allow the ice to melt.

Closing the fuel filler door

1. To install the fuel tank cap, turn it clockwise until it "clicks" one time.
2. Close the fuel filler door until it is latched securely.

⚠ WARNING

Gasoline is highly flammable and explosive. Failure to follow these guidelines may result in **SERIOUS INJURY** or **DEATH**:

- Read and follow all warnings posted at the gas station.
- Before refueling, note the location of the Emergency Gasoline Shut-Off, if available, at the gas station.
- Before touching the fuel nozzle, you should eliminate the potential build-up of static electricity by touching a metal part of the vehicle, a safe distance away from the fuel filler neck, nozzle, or other gas source, with your bare hand.
- Do not use cellular phones while refueling. Electric current and/or electronic interference from cellular phones can potentially ignite fuel vapors and cause a fire.

- Do not get back into a vehicle once you have begun refueling. You can generate a build-up of static electricity by touching, rubbing or sliding against any item or fabric capable of producing static electricity. Static electricity discharge can ignite fuel vapors causing a fire. If you must re-enter the vehicle, you should once again eliminate potentially dangerous static electricity discharge by touching a metal part of the vehicle, away from the fuel filler neck, nozzle or other gasoline source, with your bare hand.
- When using an approved portable fuel container, be sure to place the container on the ground prior to refueling. Static electricity discharge from the container can ignite fuel vapors causing a fire. Once refueling has begun, contact between your bare hand and the vehicle should be maintained until the filling is complete.
- Use only approved portable plastic fuel containers designed to carry and store gasoline.
- When refueling, always move the shift lever to the P (Park) position, set the parking brake, and place the Engine Start/Stop button to the OFF position. Sparks produced by electrical components related to the engine can ignite fuel vapors causing a fire.

- Do not use matches or a lighter and do not smoke or leave a lit cigarette in your vehicle while at a gas station, especially during refueling.
- Do not over-fill or top-off your vehicle tank, which can cause gasoline spillage.
- If a fire breaks out during refueling, leave the vicinity of the vehicle, and immediately contact the manager of the gas station and then contact the local fire department. Follow any safety instructions they provide.
- If pressurized fuel sprays out, it can cover your clothes or skin and thus subject you to the risk of fire and burns. Always remove the fuel cap carefully and slowly. If the cap is venting fuel or if you hear a hissing sound, wait until the condition stops before completely removing the cap.
- Always check that the fuel cap is installed securely to prevent fuel spillage in the event of an accident.

 **Information**

Make sure to refuel your vehicle according to the "Fuel Requirements" suggested in the Introduction chapter.

NOTICE

- Do not spill fuel on the exterior surfaces of the vehicle. Any type of fuel spilled on painted surfaces may damage the paint.
- If the fuel filler cap requires replacement, use only a Genesis cap or the equivalent specified for your vehicle. An incorrect fuel filler cap can result in a serious malfunction of the fuel system or emission control system.

Emergency fuel filler door release

If the fuel filler door does not open using the remote fuel filler door release button, you can open it manually. Pull the handle of the release located on the left side of the luggage compartment outward slightly.

NOTICE

Do not pull the handle excessively, otherwise the luggage area trim or release handle may be damaged.

INSTRUMENT CLUSTER



- | | |
|-------------------------------------|--|
| 1. Tachometer | 4. Fuel gauge |
| 2. Speedometer | 5. Warning and indicator lights |
| 3. Engine coolant temperature gauge | 6. LCD display (including trip computer) |

NOTICE

All warning sounds (e.g. welcome/good-bye sound, virtual engine sound) are generated from the exterior amplifiers. If necessary, we recommend you to purchase Genuine Genesis Part to replace an exterior amplifier. Any unauthorized product may cause a malfunction of the exterior amplifiers.

Instrument Cluster Control

Adjusting instrument cluster illumination



When the vehicle's parking lights or headlights are on, press the illumination control button to adjust the brightness of the instrument panel illumination.

When pressing the illumination control button, the interior switch illumination intensity is also adjusted.

⚠ WARNING

Never adjust the instrument cluster while driving. Doing so could lead to driver distraction which may cause an accident and lead to vehicle damage, serious injury, or death.



- The brightness of the instrument panel illumination is displayed.
- If the brightness reaches the maximum or minimum level, a chime will sound.

Gauges and Meters

Speedometer

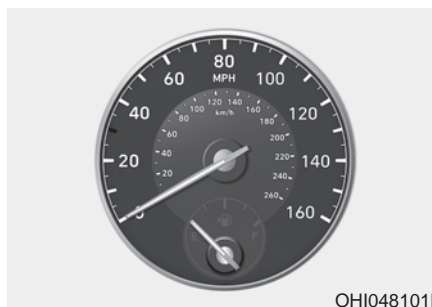

The speedometer indicates the speed of the vehicle and is calibrated in miles per hour (mph) and/or kilometers per hour (km/h).

Tachometer



The tachometer indicates the approximate number of engine revolutions per minute (rpm).

Use the tachometer to select the correct shift points and to prevent lugging and/or over-revving the engine.

NOTICE

Do not operate the engine within the tachometer's RED ZONE. This may cause severe engine damage.

Engine coolant temperature gauge



This gauge indicates the temperature of the engine coolant when the Engine Start/Stop button is in the ON position.

NOTICE

If the gauge pointer moves beyond the normal pointer range area toward the "H" position, it indicates overheating that may damage the engine.

Do not continue driving with an overheated engine. If your vehicle overheats, refer to "If the Engine Overheats" in chapter 6.

⚠ WARNING

Never remove the radiator cap or engine coolant reservoir cap when the engine is hot. The engine coolant is under pressure and could cause severe burn. Wait until the engine is cool before adding coolant to the reservoir.

Fuel gauge

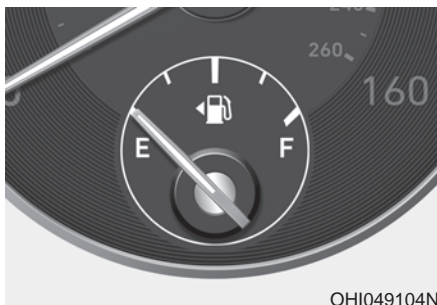

OHI049104N

This gauge indicates the approximate amount of fuel remaining in the fuel tank.

i Information

- The fuel tank capacity is given in chapter 8.
- The fuel gauge is supplemented by a low fuel warning light, which will illuminate when the fuel tank is nearly empty.
- On inclines or curves, the fuel gauge pointer may fluctuate or the low fuel warning light may come on earlier than usual due to the movement of fuel in the tank.

⚠ WARNING

Running out of fuel can expose vehicle occupants to danger. You must stop and obtain additional fuel as soon as possible after the warning light comes on or when the gauge indicator comes close to the "E (Empty)" level.

NOTICE

Avoid driving with an extremely low fuel level. Running out of fuel could cause the engine to misfire, damaging the catalytic converter.

Odometer



OHI049114N

The odometer indicates the total distance that the vehicle has been driven and should be used to determine when periodic maintenance should be performed.

Range

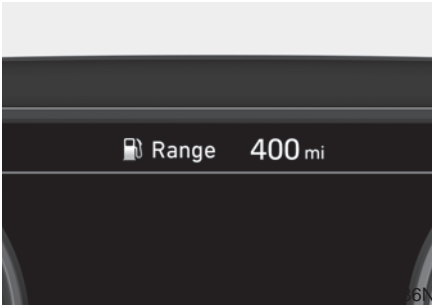

The range is the estimated distance the vehicle can be driven with the remaining fuel in the fuel tank.

If the estimated distance is below 1 mile (1 km), the cluster will display "---" as the range.

i Information

- If the vehicle is not on level ground or the battery power has been interrupted, the range function may not operate correctly.
- The range may differ from the actual driving distance as it is an estimate of the available driving distance.
- The range may not register additional fuel if less than 1.6 gallon (6 liters) of fuel are added to the vehicle.
- The range may vary significantly based on driving conditions, driving habits, and condition of the vehicle.

Outside temperature gauge



This gauge indicates the current outside air temperatures by 1°F (1°C). Note that the temperature indicated on the LCD display may not change as quickly as the outside temperature (there may be a slight delay before the temperature changes.)

You can change the temperature unit from the Settings menu in the navigation system screen. Select:

- Setup → General Settings → Unit → Temperature Unit → °C/°F

For detailed information, scan the QR code in a separately supplied simple manual.

For vehicles equipped with Automatic Climate Control, you can also:

- Press the AUTO button while pressing the OFF button on the climate control unit for 3 seconds

The temperature unit on the cluster LCD display and AVN system screen will change.

Transmission Shift Indicator

Automatic transmission shift indicator



This indicator informs the current gear engaged.

- Park : P
- Reverse : R
- Neutral : N
- Drive : D
- Manual shift mode : 1, 2, 3, 4, 5, 6,
7, 8

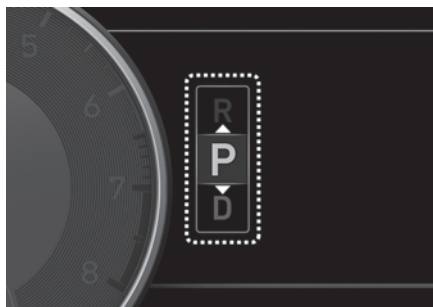

Shift indicator pop-up

The pop-up that indicates the current gear position is displayed in the cluster for about 2 seconds when shifting into other positions (P/R/N/D).

You can activate or deactivate the shift indicator pop-up function from the Settings menu in the AVN system screen. Select:

- Setup → Vehicle Settings → Cluster → Content Selection → Gear Position Pop-up

For detailed information, scan the QR code in a separately supplied simple manual.

Warning and Indicator Lights

Supplemental Restraint System Warning Light



This warning light illuminates:

- When you place the Engine Start/ Stop button to the ON position.
 - The air bag warning light illuminates for approximately 6 seconds and then turns off when all checks have been performed.
- The air bag warning light will remain illuminated if there is a malfunction with the Safety Restraint System (SRS) air bag operation.

If this occurs, have your vehicle inspected by an authorized retailer of Genesis Branded products.

Seat Belt Warning Light



This warning light informs the driver that the seat belt is not fastened.

For more details, refer to the "Seat Belts" in chapter 2.

Parking Brake & Brake Fluid Warning Light



This warning light illuminates:

- When you place the Engine Start/ Stop button to the ON position.
 - The parking brake & brake fluid warning light illuminates for approximately 3 seconds and will then turn off once the parking brake is released.
- Whenever the parking brake is applied.
- Whenever the brake fluid level in the reservoir is low.
 - If the warning light illuminates with the parking brake released, it indicates the brake fluid level in reservoir is low.

If the brake fluid level in the reservoir is low:

1. Drive carefully to the nearest safe location and stop your vehicle.
2. With the engine stopped, check the brake fluid level immediately and add fluid as required (**For more details, refer to "Brake Fluid" in chapter 7**). After adding brake fluid, check all brake components for fluid leaks. If a brake fluid leak is found, or if the warning light remains on, or if the brakes do not operate properly, do not drive the vehicle. Have the vehicle inspected by an authorized retailer of Genesis Branded products.

Dual-diagonal braking system

Your vehicle is equipped with dual-diagonal braking systems. This means you still have braking on two wheels even if one of the dual systems should fail.

With only one of the dual systems working, more than normal pedal travel and greater pedal pressure is required to stop the vehicle.

Also, the vehicle will not stop in as short a distance with only a portion of the brake system working.

If the brakes fail while you are driving, shift to a lower gear for additional engine braking and stop the vehicle as soon as it is safe to do so.

WARNING

Parking Brake & Brake Fluid Warning Light

Driving the vehicle with a warning light ON is dangerous. If the Parking Brake & Brake Fluid Warning Light illuminates with the parking brake released, it indicates that the brake fluid level is low.

If this occurs, have the vehicle inspected by an authorized retailer of Genesis Branded products.

Anti-lock Brake System (ABS) Warning Light



This warning light illuminates:

- When you place the Engine Start/ Stop button to the ON position.
 - The ABS warning light illuminates for approximately 3 seconds and then turns off.
- Whenever there is a malfunction with the ABS.

Note that the hydraulic braking system will still be operational even if there is a malfunction with the ABS.

If this occurs, have the vehicle inspected by an authorized retailer of Genesis Branded products.

Electronic Brake Force Distribution (EBD) System Warning Light



These two warning lights illuminate at the same time while driving:



When the ABS and regular brake system may not work normally.

If this occurs, have the vehicle inspected by an authorized retailer of Genesis Branded products.

 **WARNING**

Electronic Brake force Distribution (EBD) System Warning Light

When both ABS and Parking Brake & Brake Fluid Warning Lights are on, the brake system will not work normally and you may experience an unexpected and dangerous situation during sudden braking.

In this case, avoid high speed driving and abrupt braking.

Have the vehicle inspected by an authorized retailer of Genesis Branded products.

 **Information - Electronic Brake Force Distribution (EBD) System Warning Light**

When the ABS Warning Light is on or both ABS and Parking Brake & Brake Fluid Warning Lights are on, the speedometer, odometer, or tripmeter may not work. Also, the MDPS Warning Light may illuminate and the steering effort may increase or decrease.

If this occurs, have the vehicle inspected by an authorized retailer of Genesis Branded products.

Electronic Parking Brake (EPB) Warning Light



This warning light illuminates:

- When you place the Engine Start/Stop button to the ON position.
 - The EPB warning light illuminates for approximately 3 seconds and then turns off.
- Whenever there is a malfunction with the EPB.

If this occurs, have the vehicle inspected by an authorized retailer of Genesis Branded products.

 **Information**

The Electronic Parking Brake (EPB) Warning Light may illuminate when the Electronic Stability control (ESC) Indicator Light comes on to indicate that the ESC is not working properly (This does not indicate malfunction of the EPB).

Motor-Driven Power Steering (MDPS) Warning Light



This warning light illuminates:

- When you place the Engine Start/Stop button to the ON position.
 - The MDPS warning light illuminates for approximately 3 seconds and then turns off.
- When there is a malfunction with the MDPS.

If this occurs, have the vehicle inspected by an authorized retailer of Genesis Branded products.

Charging System Warning Light



When this warning light illuminates while the engine is running, the battery is not being charged. Immediately turn OFF all electrical accessories.

Try not to use electrically operated controls, such as the power windows. Keep the engine running.

Have the vehicle inspected by an authorized retailer of Genesis Branded products as soon as possible.

Engine Oil Pressure Warning Light



This warning light illuminates:

When the engine oil pressure is low.

If the engine oil pressure is low:

1. Drive carefully to the nearest safe location and stop your vehicle.
2. Turn the engine off and check the engine oil level (**For more details, refer to "Engine Oil" in chapter 7**). If the level is low, add oil as required.

If the warning light remains on after adding oil or if oil is not available, have the vehicle inspected by an authorized retailer of Genesis Branded products as soon as possible.

NOTICE

- If the engine does not stop immediately after the Engine Oil Pressure Warning Light is illuminated, severe damage could result.
- If the warning light stays on while the engine is running, it indicates that there may be serious engine damage or malfunction. In this case:
 1. Stop the vehicle as soon as it is safe to do so.
 2. Turn off the engine and check the oil level. If the oil level is low, fill the engine oil to the proper level.
 3. Start the engine again. If the warning light stays on after the engine is started, turn the engine off immediately. If this occurs, have the vehicle inspected by an authorized retailer of Genesis Branded products.

Malfunction Indicator Lamp (MIL)

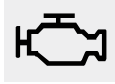

This warning light illuminates:

- When you place the Engine Start/Stop button to the ON position.
 - The Malfunction Indicator Lamp illuminates for approximately 3 seconds and then turns off.
- Whenever there is a malfunction with either the emission control system or the engine or the vehicle powertrain.

If this occurs, have the vehicle inspected by an authorized retailer of Genesis Branded products.

NOTICE

Driving with the Malfunction Indicator Lamp (MIL) on may cause damage to the emission control systems which could affect drivability and/or fuel economy.

NOTICE

If the Malfunction Indicator Lamp (MIL) illuminates, potential catalytic converter damage is possible which could result in loss of engine power.

If this occurs, have the vehicle inspected by an authorized retailer of Genesis Branded products.

Low Fuel Level Warning Light



This warning light illuminates:

When the fuel tank is nearly empty. Add fuel as soon as possible.

NOTICE

Driving with the Low Fuel Level warning light on or with the fuel level below "E" can cause the engine to misfire and damage the catalytic converter.

Low Tire Pressure Warning Light



This warning light illuminates:

- When you place the Engine Start/Stop button to the ON position.
 - The low tire pressure warning light illuminates for approximately 3 seconds and then turns off.
- When one or more of your tires are significantly underinflated.

For more details, refer to "Tire Pressure Monitoring System (TPMS)" in chapter 6.

This warning light remains ON after blinking for approximately 60 seconds, or repeatedly blinks ON and OFF in 3 second intervals:

- When there is a malfunction with the TPMS.

If this occurs, have the vehicle inspected by an authorized retailer of Genesis Branded products.

For more details, refer to "Tire Pressure Monitoring System (TPMS)" in chapter 6.

WARNING

Safe Stopping

- The TPMS cannot alert you to severe and sudden tire damage caused by external factors.
- If you notice any vehicle instability, immediately take your foot off the accelerator pedal, apply the brakes gradually with light force, and slowly move to a safe position off the road.

Master Warning Light



This indicator light illuminates:

- When there is a malfunction in operation in any of the following systems:
 - Pre-Active Seat Belt (PSB) malfunction (if equipped)
 - Haptic steering warning malfunction (if equipped)
 - LED headlamp malfunction (if equipped)
 - High Beam Assist malfunction (if equipped)
 - Electronic Control Suspension malfunction (if equipped)
 - Forward Collision-Avoidance Assist system malfunction (if equipped)
 - Forward Collision-Avoidance Assist radar blocked (if equipped)
 - Blind-Spot Collision Warning system malfunction (if equipped)
 - Blind-Spot Collision Warning radar blocked (if equipped)
 - Smart Cruise Control with Stop & Go malfunction (if equipped)
 - Smart Cruise Control with Stop & Go radar blocked (if equipped), etc.

All Wheel Drive (AWD) Warning Light (if equipped)

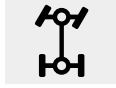

This warning light illuminates:

- Whenever there is a malfunction with the AWD system.
If this occurs, have the vehicle inspected by an authorized retailer of Genesis Branded products.

Forward Collision-Avoidance Assist (FCA) Warning Light (if equipped)



This warning light illuminates:

- When you place the Engine Start/Stop button to the ON position.
 - The FCA warning light illuminates for approximately 3 seconds and then turns off.
- Whenever there is a malfunction with the FCA.
If this occurs, have the vehicle inspected by an authorized retailer of Genesis Branded products.

For more details, refer to "Forward Collision-Avoidance Assist (FCA) system" in chapter 5.

Lane Keeping Assist (LKA) Indicator Light (if equipped)



This indicator light illuminates:

- [Green] When the system operating conditions are satisfied.
- [White] When the system operating conditions are not satisfied.
- [Yellow] Whenever there is a malfunction with the lane keeping assist system.

If this occurs, have the vehicle inspected by an authorized retailer of Genesis Branded products.

For more details, refer to "Lane Keeping Assist (LKA) system" in chapter 5.

Adaptive Front-Lighting System (AFS) Warning Light (if equipped)

AFS

This warning light illuminates:

- When you place the Engine Start/ Stop Button to the ON position.
 - The AFS warning light illuminates for approximately 3 seconds and then turns off.
- Whenever there is a malfunction with the AFS.

If there is a malfunction with the AFS:

1. Drive carefully to the nearest safe location and stop your vehicle.
2. Turn the engine off and restart the engine. If the warning light remains on, have the vehicle inspected by an authorized retailer of Genesis Branded products.

Icy Road Warning Light (if equipped)



This warning light is to warn the driver the road may be icy.

When the temperature on the outside temperature gauge is approximately below 40°F (4°C), the Icy Road Warning Light and Outside Temperature Gauge blinks and then illuminates. Also, the warning chime sounds 1 time.

You can activate or deactivate the shift indicator pop-up function from the Settings menu in the AVN system screen. Select:

- Setup → Vehicle Settings → Cluster → Content Selection → Icy Road Warning

For detailed information, scan the QR code in a separately supplied simple manual.

Information

If the icy road warning light appears while driving, you should drive more attentively and safely refraining from over-speeding, rapid acceleration, sudden braking or sharp turning, etc.

LED Headlamp Warning Light (if equipped)



This warning light illuminates:

- When you place the Engine Start/Stop button to the ON position.
 - The LED headlamp warning light illuminates for approximately 3 seconds and then turns off.
- Whenever there is a malfunction with the LED headlamp.
If this occurs, have the vehicle inspected by an authorized retailer of Genesis Branded products.

This warning light blinks:

When there is a malfunction with a LED headlamp related part.

If this occurs, have the vehicle inspected by an authorized retailer of Genesis Branded products.

NOTICE

Continuous driving with the LED Headlamp Warning Light on or blinking can reduce LED headlamp life.

AUTO HOLD Indicator Light



This indicator light illuminates:

- [White] When you activate the auto hold system by pressing the AUTO HOLD switch.
- [Green] When you stop the vehicle completely by depressing the brake pedal with the auto hold system activated.
- [Yellow] Whenever there is a malfunction with the auto hold system.
If this occurs, have the vehicle inspected by an authorized retailer of Genesis Branded products.

For more details, refer to "Auto Hold" in chapter 5.

Electronic Stability Control (ESC) Indicator Light



This indicator light illuminates:

- When you place the Engine Start/Stop button to the ON position.
 - The ESC indicator light illuminates for approximately 3 seconds and then turns off.
- Whenever there is a malfunction with the ESC system.

If this occurs, have the vehicle inspected by an authorized retailer of Genesis Branded products.

This indicator light blinks:

While the ESC is operating.

For more details, refer to "Electronic Stability Control (ESC)" in chapter 5.

Electronic Stability Control (ESC) OFF Indicator Light



This indicator light illuminates:

- When you place the Engine Start/Stop button to the ON position.
 - The ESC OFF indicator light illuminates for approximately 3 seconds and then turns off.
- When you deactivate the ESC system by pressing the ESC OFF button.

For more details, refer to "Electronic Stability Control (ESC)" in chapter 5.

Immobilizer Indicator Light



This indicator light illuminates for up to 30 seconds:

When the vehicle detects the smart key in the vehicle with the Engine Start/Stop button in the ACC or ON position.

- Once the smart key is detected, you can start the engine.
- The indicator light goes off after starting the engine.

This indicator light blinks for a few seconds:

When the smart key is not in the vehicle.

- If the smart key is not detected, you cannot start the engine.

This indicator light illuminates for 2 seconds and goes off:

If the smart key is in the vehicle and the Engine Start/Stop button is ON, but the vehicle cannot detect the smart key.

If this occurs, have the vehicle inspected by an authorized retailer of Genesis Branded products.

This indicator light blinks:

When there is a malfunction with the immobilizer system.

If this occurs, have the vehicle inspected by an authorized retailer of Genesis Branded products.

Turn Signal Indicator Light



This indicator light blinks:

When you operate the turn signal indicator light.

If any of the following occurs, there may be a malfunction with the turn signal system.

- The turn signal indicator light illuminates but does not blink
- The turn signal indicator light blinks rapidly
- The turn signal indicator light does not illuminate at all

If either of these conditions occur, have the vehicle inspected by an authorized retailer of Genesis Branded products.

Low Beam Indicator Light (if equipped)



This indicator light illuminates:

When the headlights are on.

High Beam Indicator Light



This indicator light illuminates:

- When the headlights are on and in the high beam position
- When the turn signal lever is pulled into the Flash-to-Pass position.

Light ON Indicator Light



This indicator light illuminates:

When the position lights or headlights are on.

High Beam Assist (HBA) indicator light (if equipped)



This indicator light illuminates:

- When the high-beam is on with the light switch in the AUTO light position.
- If your vehicle detects oncoming or preceding vehicles, the High Beam Assist (HBA) system will switch the high beam to low beam automatically.

For more details, refer to "High Beam Assist (HBA)" in this chapter.

LCD Display Messages

Vehicle is in N. Press START button and shift to P



This message is displayed if you try to turn off the vehicle with the gear in N (Neutral).

At this time, the Engine Start/Stop button changes to the ACC position. If you press the Engine Start/Stop button once more, it will turn to the ON position.

Low Key Battery



This message is displayed if the battery of the smart key is discharged while changing the Engine Start/Stop button to the OFF position.

Press brake pedal to start engine



This message is displayed if the Engine Start/Stop button changes to the ACC position twice by pressing the button repeatedly without depressing the brake pedal.

You can start the vehicle by depressing the brake pedal and then pressing the Engine Start/Stop button.

Key not in vehicle



This message is displayed if the smart key is not in the vehicle when you press the Engine Start/Stop button.

When attempting to start the vehicle, always have the smart key with you.

Key not detected



This message is displayed if the smart key is not detected when you press the Engine Start/Stop button.

Press START button with key



This message is displayed if you press the Engine Start/Stop button while the message "Key not detected" is displayed.

At this time, the immobilizer indicator light blinks.

Press START button again



This message is displayed if you were unable to start the vehicle when the Engine Start/Stop button was pressed.

If this occurs, attempt to start the engine by pressing the Engine Start/Stop button again.

If the message appears each time you press the Engine Start/Stop button, have the vehicle inspected by an authorized retailer of Genesis Branded products.

Check BRAKE SWITCH fuse



This message is displayed if the brake switch fuse is disconnected.

You need to replace the fuse with a new one. If that is not possible, you can start the engine by pressing the Engine Start/Stop button for 10 seconds in the ACC position.

Shift to P or N to start engine

OFI1048123L

This message is displayed if you try to start the engine in any other position except the P (Park) or N (Neutral) position.

***i* Information**

You can start the engine with the shift lever in the N (Neutral) position. But, for your safety, we recommend that you start the engine with the vehicle shifted to P (Park).

Door, hood, trunk open

OFI1048125

This warning is displayed if any door or the hood or the trunk is left open. The warning will indicate which door is open in the display.

 WARNING

Before driving the vehicle, you should confirm that the door/hood/trunk is fully closed.

Also, check there is no door/hood/trunk open warning light or message displayed on the instrument cluster.

Sunroof open (if equipped)



This warning is displayed if you turn off the engine when the sunroof is open.

Close the sunroof securely when leaving your vehicle.

Window open (if equipped)



This warning is displayed if you turn off the engine when any window is open.

Lights



This indicator displays which exterior light is selected using the lighting control.

You activate or deactivate Wiper/Lights display function from the Settings menu in the AVN system screen. Select:

- Setup → Vehicle Settings → Cluster → Content Selection → Wiper/Lights Display

For detailed information, scan the QR code in a separately supplied simple manual.

Wiper



This indicator displays which wiper speed is selected using the wiper control.

You activate or deactivate Wiper/Lights display function from the Settings menu in the AVN system screen. Select:

- Setup → Vehicle Settings → Cluster → Content Selection → Wiper/Lights Display

For detailed information, scan the QR code in a separately supplied simple manual.

Low Washer Fluid



This message is displayed if the washer fluid level in the reservoir is nearly empty.

Have the washer fluid reservoir refilled.

Low Fuel



This message is displayed if the fuel tank is almost out of fuel.

When this message is displayed, the low fuel level warning light in the cluster will come on.

It is recommended to look for the nearest fueling station and refuel as soon as possible.

Add fuel as soon as possible.

Engine has overheated



This message is displayed when the engine coolant temperature is above 120°C (248°F). This means that the engine is overheated and may be damaged.

If your vehicle is overheated, refer to "Overheating" in chapter 6.

Check headlamp LED



This message is displayed if there is a problem with the LED headlamp. We recommend that you have the vehicle inspected by an authorized retailer of Genesis Branded products.

Check turn signal (if equipped)



This message is displayed if there is a problem the turn signal. We recommend that you have the vehicle inspected by an authorized retailer of Genesis Branded products.

Check haptic steering wheel system (if equipped)



This message is displayed if there is a problem with the haptic steering wheel system. We recommend that you have the vehicle inspected by an authorized retailer of Genesis Branded products.

Battery discharging due to external electrical devices

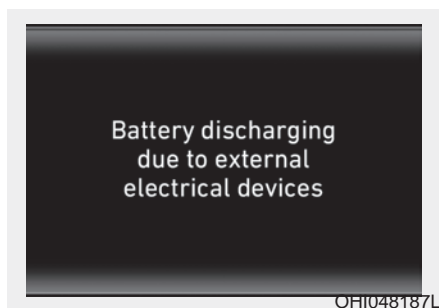

This message is displayed if the battery voltage is weak due to any non-factory electrical accessories (ex. dashboard camera) while parking. Be careful that the battery is not discharged.

If the warning message appears after removing the non-factory electrical accessories, we recommend that you have the vehicle inspected by an authorized retailer of Genesis Branded products.

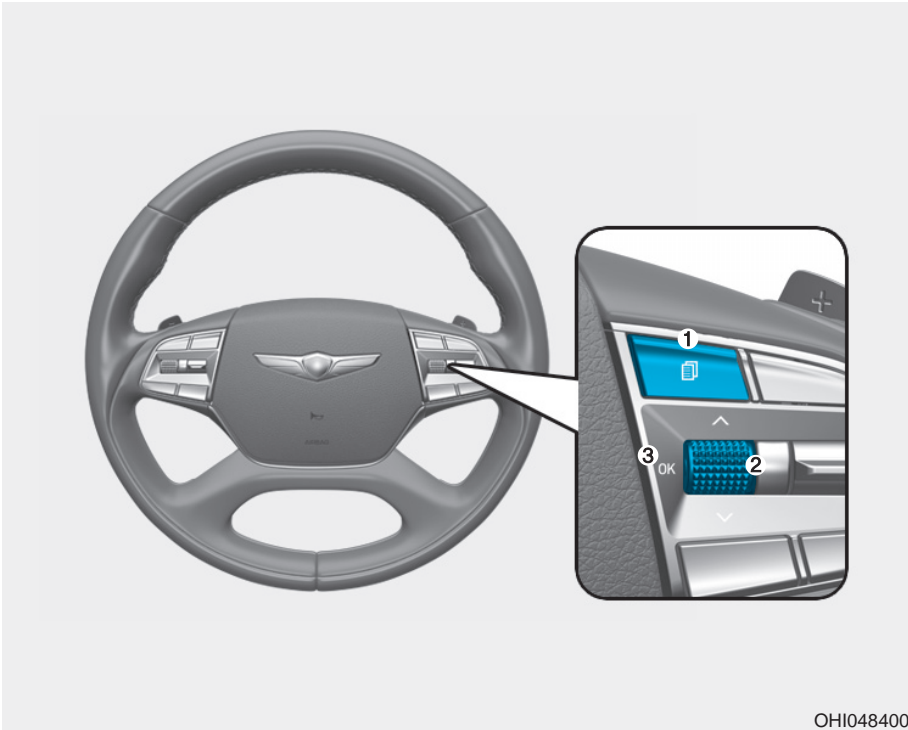

LCD DISPLAY

LCD Display Control









OHI048400

The LCD display modes can be changed by using the control buttons on the steering wheel.

1.  : MODE button for changing modes
2.  ,  : MOVE switch for changing items
3. OK : SELECT/RESET button for setting or resetting the selected item

LCD Display Modes

	 Menu			
	 Trip Computer	 TBT	 Assist	 Master warning
  Up/Down	Fuel Economy	Route Guidance	Smart Cruise Control	The Master Warning mode displays warning messages related to the vehicle when one or more systems is not operating normally.
	Accumulated Info	Destination Info	Lane Keeping Assist	
	Drive Info		Lane Following Assist	
	Digital Speedometer		Highway Driving Assist	
	Smart Shift		Driver Attention Warning	
			Tire Pressure	

The information provided differs according to the items applied to your vehicle.

Trip computer mode



The trip computer mode displays information related to vehicle driving parameters including fuel economy, tripmeter information and vehicle speed.

For more details, refer to "Trip Computer" in this chapter.

Turn By Turn (TBT) mode



This mode displays the state of the navigation.

Assist mode

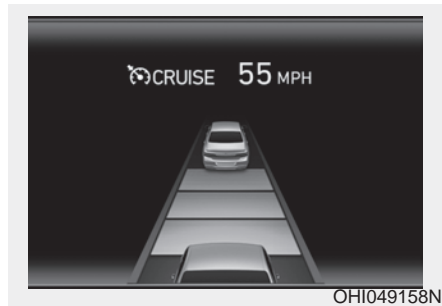

SCC/LKA/LFA/HDA

This mode displays the state of the Smart Cruise Control (SCC), Lane Keeping Assist (LKA), Lane Following Assist (LFA) and Highway Driving Assist.

For more details, refer to each system information in chapter 5.



Driver Attention Warning (DAW)

This mode displays information related to Driver Attention Warning (DAW).

For more details, refer to "Driver Attention Warning (DAW)" in chapter 5.



OH1048160L

Tire Pressure

This mode displays information related to Tire Pressure.

For more details, refer to "Tire Pressure Monitoring System (TPMS)" in chapter 6.

Master warning mode

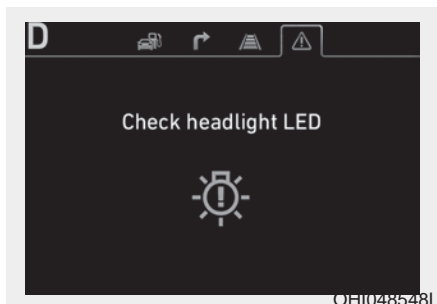

OH1048548L

This warning light informs the driver the following situations.

- Pre-Active Seat Belt (PSB) malfunction (if equipped)
- Haptic steering warning malfunction (if equipped)
- LED headlamp malfunction (if equipped)
- High Beam Assist malfunction (if equipped)
- Electronic Control Suspension malfunction (if equipped)

- Forward Collision-Avoidance Assist system malfunction (if equipped)
 - Forward Collision-Avoidance Assist radar blocked (if equipped)
 - Blind-Spot Collision Warning system malfunction (if equipped)
 - Blind-Spot Collision Warning radar blocked (if equipped)
 - Smart Cruise Control with Stop & Go malfunction (if equipped)
 - Smart Cruise Control with Stop & Go radar blocked (if equipped), etc.
- The Master Warning Light illuminates if one or more of the above warning situations occur.

At this time, a Master Warning icon (⚠) will appear beside the Assist icon (⚠), on the LCD display.

If the warning situation is solved, the master warning light will be turned off and the Master Warning icon will disappear.

TRIP COMPUTER

The trip computer is a microcomputer-controlled driver information system that displays information related to driving.

i Information

- Some driving information stored in the trip computer resets if the battery is disconnected.
- The vehicle must be driven for a minimum of 0.19 miles (300 meters) since the last ignition key cycle before the average fuel economy will be recalculated.

Trip Modes

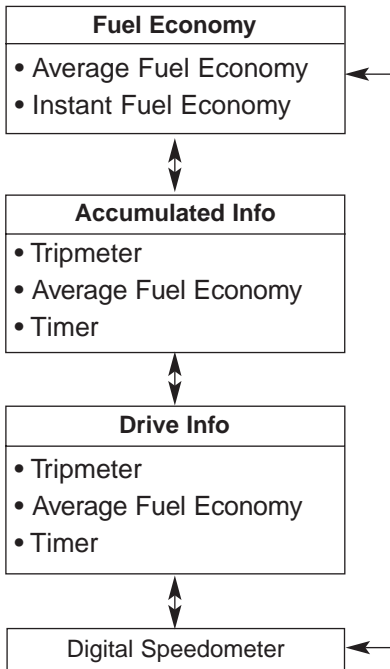

OHI048400

To change the trip mode, toggle the "△,▽" switch on the steering wheel.

Fuel economy



OHI049549N

Average Fuel Economy (1)

- The average fuel economy is calculated by the total driving distance and fuel consumption since the last average fuel economy reset.
- The average fuel economy can be reset both manually and automatically.

Manual reset

To clear the average fuel economy manually, press the OK button on the steering wheel for more than 1 second when the average fuel economy is displayed.

Automatic reset

To automatically reset the average fuel economy, select between "After Ignition" or "After Refueling" from the Settings menu in the AVN system screen

- After ignition: When the engine has been OFF for 4 hours or longer the average fuel economy will reset automatically.
- After refueling: The average fuel economy will reset automatically after adding 1.6 gallons (6 liters) of fuel or more and after driving speed exceeds 1 mph (1 km/h).

For more details, scan the QR code in a separately supplied simple manual.

Instant Fuel Economy (2)

The instantaneous fuel economy is displayed according to the bar graph in the LCD display while driving.

Accumulated Info display



This display shows the accumulated trip distance (1), the average fuel economy (2), and the total driving time (3).

The information is accumulated starting from the last reset.

To reset the details, press and hold the OK button when viewing the Accumulated driving info. The trip distance, the average fuel economy, and total driving time will reset simultaneously.

The accumulated driving information will continue to be counted while the engine is still running (for example, when the vehicle is in traffic or stopped at a stop light).

Drive Info display



This display shows the trip distance (1), the average fuel economy (2), and the total driving time (3).

The information is combined for each ignition cycle. However, when the engine has been OFF for 4 hours or longer the Drive Info screen will reset.

To reset the details, press and hold the OK button when viewing the Drive Info. The trip distance, the average fuel economy, and total driving time will reset simultaneously.

The driving information will continue to be counted while the engine is still running (for example, when the vehicle is in traffic or stopped at a stop light).

Digital speedometer



This digital speedometer shows the speed of the vehicle.

VEHICLE SETTINGS



The Vehicle Settings in the AVN system provides user options for a variety of settings including door lock/unlock features, convenience features, driver assistance settings, etc.

Use Settings menu

- Head-Up Display
- Driver Assistance
- Drive Mode
- Lights
- Door/Trunk
- Cluster
- Convenience
- Reset

The information provided may differ depending on which functions are applicable to your vehicle.

WARNING

Do not operate the Vehicle Settings while driving. This may cause distraction resulting in an accident.

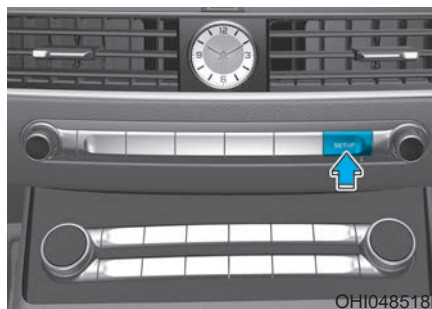

1. Press the SETUP button on the head unit of the AVN system.

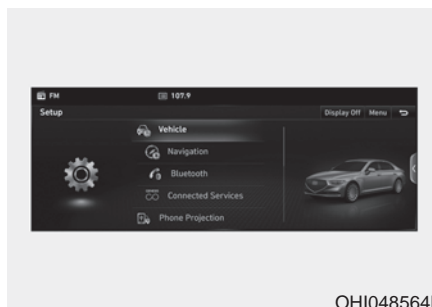

2. Select 'Setup → Vehicle Settings' and change the setting of the features.

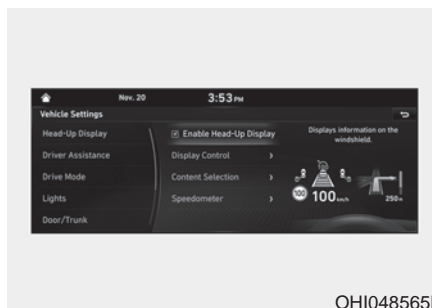

For detailed information, scan the QR code in a separately supplied simple manual.

HEAD-UP DISPLAY (IF EQUIPPED)

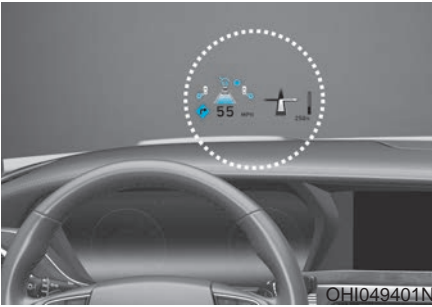

The Head-Up Display is an optional feature that allows the driver to view information projected onto a transparent screen while still keeping your eyes safely on the road ahead while driving.

Precautions while using the Head-Up Display

It may sometimes be difficult to read information on the Head-Up Display in the following situations.

- The driver is improperly positioned in the driver's seat.
- The driver wears polarizing-filter sunglasses.
- An object is located above the head-up display cover.
- The vehicle is driven on a wet road.
- Any improper lighting accessory is installed inside the vehicle, or there is incoming light from outside of the vehicle.
- The driver wears glasses.
- The driver wears contact lenses.

When it is difficult to read the head-up display information, adjust the head-up display angle or the head-up display brightness level.

Have your head-up display maintained by an authorized retailer of Genesis Branded products. The head-up display maintenance requires a special windshield exclusive for the head-up display.

NOTICE

- **Do not tint the front windshield glass or add other types of metallic coating. Otherwise, the head-up display image may be invisible.**
- **Do not place any accessories on the crash pad or attach any objects on the windshield glass.**

⚠ WARNING

The Blind-spot Collision Warning (BCW) system warnings on the head up display are supplemental. Do not solely depend on them to change lanes. Always take a look around before changing lanes.

***i* Information**

When replacing the front windshield glass of the vehicles equipped with the head-up display, replace it with a windshield glass designed for the head-up display operation.

Otherwise, duplicated images may be displayed on the windshield glass.

Head-up display ON/OFF



The Head-up display can be turned ON and OFF by selecting or deselecting 'Enable Head-Up Display' from the Settings menu in the AVN system screen. Select:

- Setup → Vehicle Settings → Head-Up Display → Enable Head-Up Display

For detailed information, scan the QR code in a separately supplied simple manual.

Head-up display setting

The driver can change the head-up display settings from Settings menu in the AVN system screen as follows.

- Display Control
- Content Selection
- Speedometer

For detailed information, scan the QR code in a separately supplied simple manual.

Head-up display information



1. Turn-by-turn (TBT) navigation information
2. Road information
3. Speedometer
4. Cruise system set speed
5. Smart Cruise Control (SCC) information
6. Lane Following Assist (LFA) system information
7. Lane Keeping Assist (LKA) system information
8. Blind-spot Collision Warning (BCW) system information
9. Highway Driving Assist (HAD) system information

The information provided may differ depending on which functions are applicable to your vehicle.

i Information

If you select the Turn By Turn (TBT) navigation information as Head-Up Display contents, the Turn By Turn (TBT) navigation information will not be displayed in the instrument cluster LCD display.

LIGHTING

Exterior Lights

Lighting control

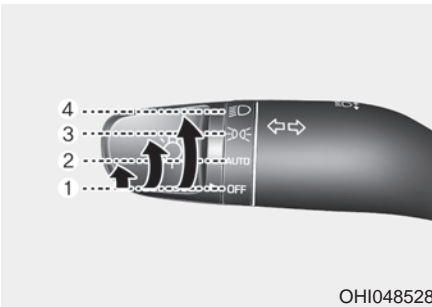

To operate the lights, turn the knob at the end of the control lever to one of the following positions:

1. OFF position
2. AUTO light position
3. Parking lamp position
4. Headlamp position

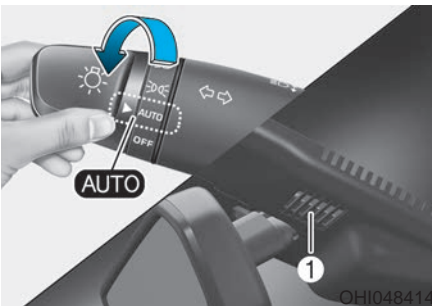

AUTO light position

The parking lamp and headlamp will be turned ON or OFF automatically depending on the amount of light outside the vehicle.

Even with the AUTO light feature in operation, it is recommended to manually turn ON the lamps when driving at night or in a fog, driving in the rain, or when you enter dark areas, such as tunnels and parking facilities.

NOTICE

- Do not cover or spill anything on the sensor (1) located at the upper end of the windshield glass.
- Do not clean the sensor using a window cleaner, the cleanser may leave a light film which could interfere with sensor operation.
- If your vehicle has window tint or other types of metallic coating on the front windshield, the AUTO light system may not work properly.



Parking lamp position (☽)

The parking lamp, license plate lamp and instrument panel lamp are turned ON.



OHI048529

Headlamp position (☾)

The headlamp, parking lamp, license plate lamp and instrument panel lamp are turned ON.

i Information

The Engine Start/Stop button must be in the ON position to turn on the headlamp.

High beam operation



OHI048532

To turn on the high beam headlamp, push the lever away from you. The lever will return to its original position. The high beam indicator will light when the headlamp high beams are switched on.

To turn off the high beam headlamp, pull the lever towards you. The low beams will turn on.

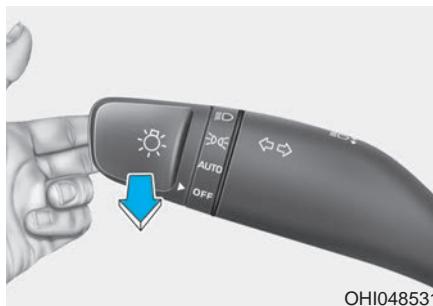

OHI048531

To flash the high beam headlamp, pull the lever towards you, then release the lever. The high beams will remain ON as long as you hold the lever towards you.

High Beam Assist (HBA) (if equipped)



The High Beam Assist (HBA) is a system that automatically adjusts the headlamp range (switches between high beam and low beam) depending on the brightness of detected vehicles and certain road conditions.

Operating condition

1. Place the headlamp switch in the AUTO position.
2. Turn on the high beam by pushing the lever away from you.

The High Beam Assist (HBA) () indicator will illuminate.

3. The High Beam Assist (HBA) will turn on when vehicle speed is above 25 mph (40 km/h).
 - If the headlamp lever is pushed away when the High Beam Assist (HBA) is operating, the High Beam Assist (HBA) will turn off and the high beam will be on continuously.
 - If the headlamp lever is pulled towards you when the high beam is off, the high beam will turn on without the High Beam Assist (HBA) canceled. When you let go of the headlamp lever, the lever will move to the middle and the high beam will turn off.

- If the headlamp lever is pulled towards you when the high beam is on by the High Beam Assist (HBA), the low beam will be on and the High Beam Assist (HBA) will turn off.
- If the headlamp lever is placed to the headlamp ON position, the High Beam Assist (HBA) will turn off and the low beam will be on continuously.

When the High Beam Assist (HBA) is on, the high beam switches to low beam if any of the following conditions occur :

- When the headlamp of an on-coming vehicle is detected.
- When the tail lamp of a vehicle in front is detected.
- When the headlamp or tail lamp of a motorcycle or a bicycle is detected.
- When the surrounding ambient light is bright enough that high beams are not required.
- When streetlights or other lights are detected.
- When the headlamp switch is not in the AUTO position.
- When the High Beam Assist (HBA) is off.
- When vehicle speed is below 15 mph (24 km/h).

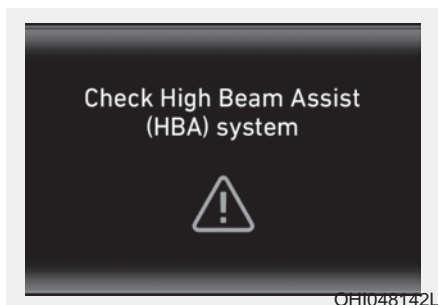

Warning light and message

When the High Beam Assist (HBA) is not working properly, the Check High Beam Assist warning message will come on for a few second. After the message disappears, the master warning light (⚠) will illuminate. Take your vehicle to an authorized retailer of Genesis Branded products and have the system checked.

⚠ WARNING

The High Beam Assist system may not work properly in the following situations.

- When the light from an oncoming or front vehicle is dim. Such examples may include:
 - Light from a vehicle is not detected because of lamp damage, or because it is hidden from sight, etc.
 - Headlamp of a vehicle is covered with dust, snow or water.
 - A vehicle's headlamps are off but the fog lamps are on and etc.

- When the system is affected by external conditions. Such examples may include:

- There is a lamp that has a similar shape as a vehicle's lamp.
- Headlamps have been damaged or not repaired properly.
- Headlamps are not aimed properly.
- Driving on a narrow curved road, rough road, uphill or downhill.
- Vehicle in front is partially visible on a crossroad or curved road.
- There is a traffic light, reflecting sign, flashing sign or mirror ahead.
- There is a temporary reflector or flash ahead (construction area).
- The road conditions are bad such as being wet, iced or covered with snow.
- A vehicle suddenly appears from a curve.
- The vehicle is tilted from a flat tire or being towed.
- The Lane Keeping Assist (LKA) system indicator (yellow) light illuminates.
- When front visibility is poor. Such examples may include:
 - Light from a vehicle is not detected because of exhaust fume, smoke, fog, snow, etc.
 - The front windshield is covered with foreign substance.

⚠ WARNING

- Do not attempt to disassemble the front view camera without the assistance of an authorized retailer of Genesis Branded products technician. If camera is removed for any reason, the system may need to be re-calibrated. Have the system inspected by an authorized retailer of Genesis Branded products.
- If the windshield of your vehicle is replaced, most likely the front view camera will need to be re-calibrated. If this occurs, have your vehicle inspected and have the system re-calibrated by an authorized retailer of Genesis Branded products.
- Be careful that water doesn't get into the High Beam Assist (HBA) unit and do not remove or damage related components of the High Beam Assist (HBA) system.
- Do not place objects on the dashboard that reflect light such as mirrors, white paper, etc. The system may not be able to function properly if sunlight is reflected.
- At times, the High Beam Assist (HBA) may not work properly. The system is for your convenience only. It is the responsibility of the driver for safe driving practices and always check the road conditions for your safety.
- When the system does not operate normally, switch the headlamp position manually between the high beam and low beam.

Turn signals and lane change signals

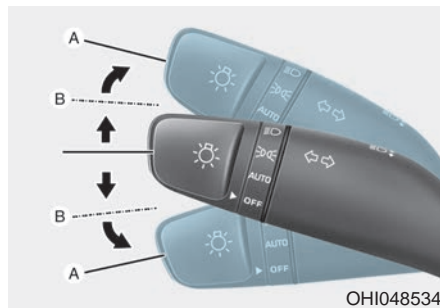

To signal a turn, push down on the lever for a left turn or up for a right turn in position (A).

If an indicator stays on and does not flash or if it flashes abnormally, one of the turn signal bulbs may be burned out and will require replacement.

Onetouch turn signal function

To activate the One Touch Turn Signal function, push the turn signal lever up or down to position (B) and then release it.

The lane change signals will blink 3, 5 or 7 times.

You can activate or deactivate the One Touch Turn Signal function or choose the number of blinking (3, 5, or 7) from the Settings menu in the AVN system screen. Select:

- Setup → Vehicle Settings → Lights → 1 Touch Turn Signal → Off / 3 flashes / 5 flashes / 7 flashes

For detailed information, scan the QR code in a separately supplied simple manual.

Battery saver function

The purpose of this feature is to prevent the battery from being discharged. The system automatically turns off the parking lamp when the driver turns the engine off and opens the driver-side door.

With this feature, the parking lamps will turn off automatically if the driver parks on the side of road at night.

If necessary, to keep the lamps on when the engine is turned off, perform the following:

- 1) Open the driver-side door.
- 2) Turn the parking lamps OFF and ON again using the light switch on the steering column.

Headlamp delay function

If the Engine Start/Stop button is placed in the ACC position or the OFF position with the headlamps ON, the headlamps (and/or parking lamps) remain on for about 5 minutes. However, if the driver's door is opened and closed, the headlights are turned off after 15 seconds. Also, with the engine off if the driver's door is opened and closed, the headlamps (and/or parking lamps) are turned off after 15 seconds.

The headlamps (and/or parking lamps) can be turned off by pressing the lock button on the smart key twice or turning the light switch to the OFF or AUTO position.

You can activate or deactivate the Headlamp Delay function from the Settings menu in the AVN system screen. Select:

- Setup → Vehicle Settings → Lights → Headlight Delay

For detailed information, scan the QR code in a separately supplied simple manual.

NOTICE

If the driver exits the vehicle through another door besides the driver door, the battery saver function does not operate and the headlamp delay function does not turn OFF automatically. This may cause the battery to discharge. To avoid battery discharge, turn OFF the headlamps manually from the headlamp switch before exiting the vehicle

AFS (Adaptive Front-Lighting System) (if equipped)



Adaptive front lighting system uses vehicle speed and angle, to keep your field of vision wide by leveling the headlamp.

Change the switch to the AUTO position when the engine is running. The adaptive front lighting system will operate when the headlamp is ON.

The system raises the low beam angle when the vehicle speed is above 72 mph (115 km/h), to secure safety during high speed driving.

To turn off AFS, change the switch to other positions. The headlamp leveling by the headlamp leveling device still operates even after the AFS has turned off.

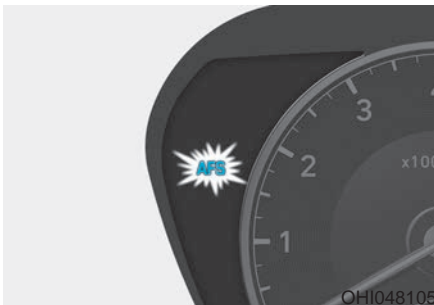

If the AFS malfunction indicator comes on, the AFS is not working properly.

Drive to the nearest safe location and restart the engine. If the indicator continuously remains on, we recommend that the system be checked by an authorized retailer of Genesis Branded products.

Daytime running light (DRL)

The Daytime Running Lights (DRL) can help others to see the front of your vehicle during the day, especially after dawn and before sunset.

The DRL system will turn OFF when:

- The light switch is in the parking or headlamp lamp position, including the operation that the parking lamp or headlamp is turned on automatically in the AUTO light position.
- The engine is turned off.
- The hazard warning flasher is on.
- The turn signal light is on.

If you turn on the turn signal light, only the corresponding daytime running lights will turn off.

- The parking brake is applied.

Headlamp leveling device

It automatically adjusts the headlamp beam level according to the number of passengers and loading weight in the luggage area.

And it offers proper headlamp beam under various conditions.

⚠ WARNING

If the function does not work properly, we recommend that the system be inspected by an authorized retailer of Genesis Branded products. Do not attempt to inspect or replace the wiring yourself.

Headlamp moisture removal function (if equipped)

When moisture fogs up inside of the headlamp, if the headlamp is on for certain period of time, the fan circulates the air inside to remove moisture. If the moisture is not removed, have the vehicle checked by an authorized retailer of Genesis Branded products.

Reverse guide lamp

When the shift lever is in R (Reverse), the back-up lamp turns on and the reverse guide lamp at the back of the vehicle lights the floor. The lamp informs nearby drivers know that your vehicle is backing up.

Interior Lights

⚠ WARNING

Do not use the interior lights when driving in the dark. The interior lights may obscure your view and cause an accident.

NOTICE

Do not use the interior lights for extended periods when the engine is turned off or the battery will discharge.

Interior lamp AUTO cut

The interior lamps will automatically go off approximately 20 minutes after the engine is turned off and the doors are closed. If a door is opened, the lamp will go off 40 minutes after the engine is turned off. If the doors are locked by the remote key or smart key and the vehicle enters the armed stage of the theft alarm system, the lamps will go off five seconds later.

Front lamps

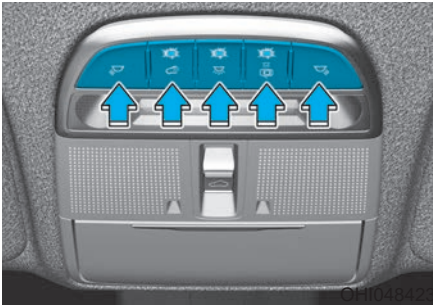

Press either of these buttons to turn the map lamp on or off. This light produces a spot beam for convenient use as a map lamp at night or as a personal lamp for the driver and the front passenger.



Press the button to turn ON all front lamps. Re-repress the button to turn OFF all front lamps.







The front or rear room lamps come on when the front or rear doors are opened if the engine is running or not. When doors are unlocked by the Smart Key, the front and rear lamps come on for approximately 30 seconds as long as any door is not opened. The front and rear room lamps go out gradually after approximately 30 seconds if the door is closed. However, if the Engine Start/Stop button is in the ON position or all doors are locked, the front and rear lamps will turn off. If a door is opened with the Engine Start/Stop button in the ACC position or the OFF position, the front and rear lamps stay on for about 20 minutes.

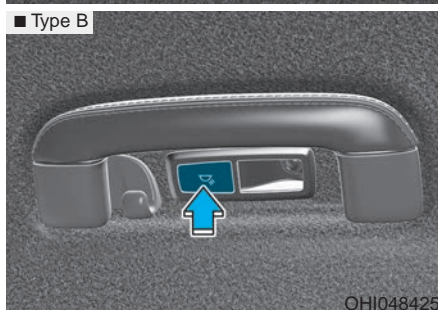
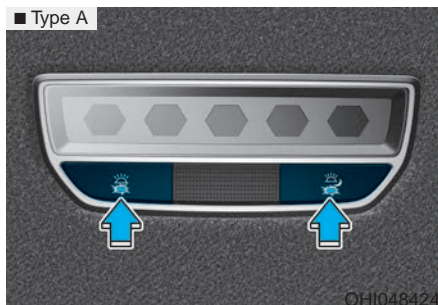

Press this button to turn the front and rear room lamps on and off.

Rear lamp



-  :
Press the button to turn ON both rear lamps. You cannot separately turn OFF the rear lamp type B. Re-press the button to turn OFF the rear lamps.
-  :
Press the button to dim the rear lamp type A. Re-press the button to turn OFF the lamp.
-  :
Press this button to turn the rear lamp type B on and off.

Trunk lamp

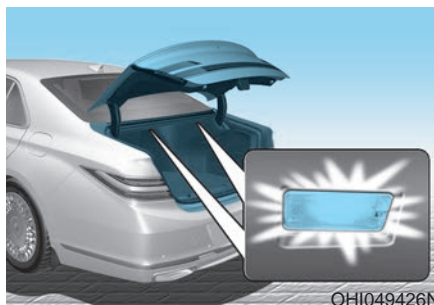

The trunk lamp comes on when the trunk is opened.

Vanity mirror lamp (Front)



Opening the lid of the vanity mirror will automatically turn on the mirror light.

Rear mirror lamp (if equipped)

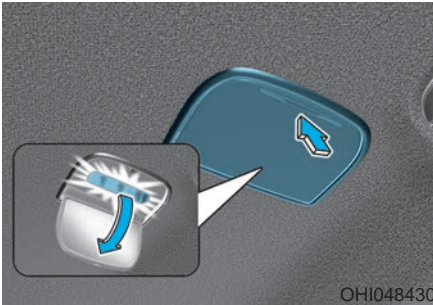

Press the cover and it will slowly open and the mirror lamp will turn ON.

Glove box lamp

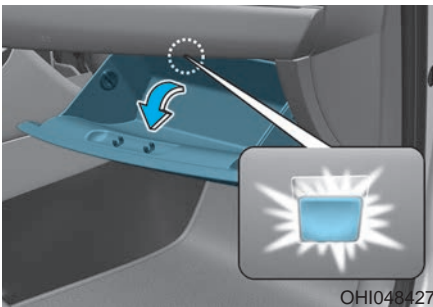

The glove box lamp comes on when the glove box is opened. If the glove box is not closed, the lamp will turn off after 20 minutes.

Puddle lamp

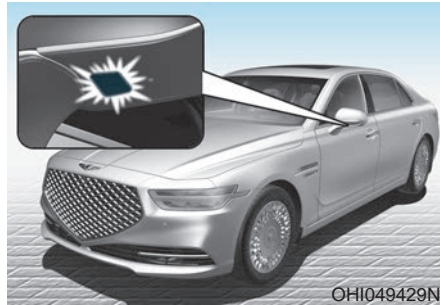

Welcome light

When all doors (and trunk) are closed and locked, the puddle lamp will come on for 15 seconds if the door is unlocked by the smart key or when you put your hand in the outside door handle with the smart key in possession.

For more details, refer to "Welcome System" in this chapter.

Escort light

When the Engine Start/Stop button is in the OFF position and the driver's door is opened, the puddle lamp will come on for 30 seconds. If the driver's door is closed within the 30 seconds, the puddle lamp will turn off after 15 seconds. If the driver's door is closed and locked, the puddle lamp will turn off immediately.

The Puddle Lamp Escort Light will turn on only the first time the driver's door is opened after the engine is turned off.

Welcome System

Welcome light



Puddle lamp and door handle lamp

With all the doors (and trunk) closed and locked, the puddle lamp and door handle lamp will come on for approximately 15 seconds if any of the below is performed.

- When the door unlock button is pressed on the smart key.
- When you put your hand in the outside door handle with the smart key in possession.
- If ' Setup → Vehicle Settings → Convenience → Welcome Mirror/Light → Enable on Driver Approach' is selected from the Settings menu in the AVN system screen, the lamps will turn on when the vehicle is approached with the smart key in possession.

You can activate or deactivate this function from the Settings menu in the AVN system screen

For detailed information, scan the QR code in a separately supplied simple manual.

Interior lamp

When the interior lamp switch is in the DOOR position and all doors (and trunk) are closed and locked, the room lamp will come on for 30 seconds if any of the below is performed.

- When the door unlock button is pressed on the smart key.
- When you put your hand into the door handle while carrying the smart key.

At this time, if you press the door lock or unlock button on the remote key or smart key the room lamp will turn off immediately.

WIPERS AND WASHERS

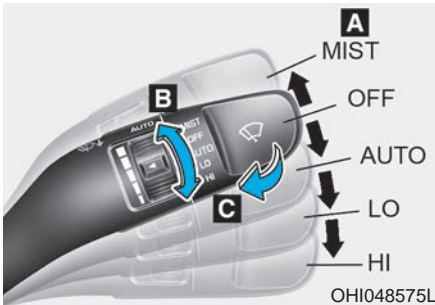

A : Wiper speed control

- MIST – Single wipe
- OFF – Off
- INT – Intermittent wipe
- LO – Low wiper speed
- HI – High wiper speed

B : Auto control wipe time adjustment

C : Wash with brief wipes

Windshield Wipers

Operates as follows when the ignition switch is in the ON position.

MIST : For a single wiping cycle, push the lever upward and release. The wipers will operate continuously if the lever is held in this position.

OFF : Wiper is not in operation.

INT : Wiper operates intermittently at the same wiping intervals. To vary the speed setting, move the speed control lever. The top most setting will run the wipers most frequently (for more rain). The bottom setting will run the wipers the least frequently (for less rain).

LO : The wiper runs at a lower speed.

HI : The wiper runs at a higher speed.

i Information

If there is heavy accumulation of snow or ice on the windshield, defrost the windshield for about 10 minutes, or until the snow and/or ice is removed before using the windshield wipers to ensure proper operation.

If you do not remove the snow and/or ice before using the wiper and washer, it may damage the wiper and washer system.

i Information

If the wiper switch is set in AUTO mode when Engine Start/Stop button is in the ON position, the wiper will operate once to perform a self-check of the system. Set the wiper to the OFF position when the wiper is not in use.

⚠ WARNING

To avoid personal injury from the windshield wipers, when the engine is running and the windshield wiper switch is placed in the AUTO mode:

- Do not touch the upper end of the windshield glass facing the rain sensor.
- Do not wipe the upper end of the windshield glass with a damp or wet cloth.
- Do not put pressure on the windshield glass.

NOTICE

- When washing the vehicle, set the wiper switch in the OFF (O) position to stop the auto wiper operation. The wiper may operate and be damaged if the switch is set in the AUTO mode while washing the vehicle.
- Do not remove the sensor cover located on the upper end of the passenger side windshield glass. Damage to system components could occur and may not be covered by your vehicle warranty.

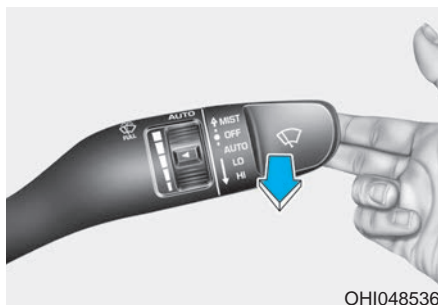
Windshield Washers

OHI048536

In the OFF position, pull the lever gently toward you to spray washer fluid on the windshield and to run the wipers 1-3 cycles. The spray and wiper operation will continue until you release the lever. If the washer does not work, you may need to add washer fluid to the washer fluid reservoir.

WARNING

When the outside temperature is below freezing, **ALWAYS** warm the windshield using the defroster to prevent the washer fluid from freezing on the windshield and obscuring your vision which could result in an accident and serious injury or death.

NOTICE

- To prevent possible damage to the washer pump, do not operate the washer when the fluid reservoir is empty.
- To prevent possible damage to the wipers or windshield, do not operate the wipers when the windshield is dry.
- To prevent damage to the wiper arms and other components, do not attempt to move the wipers manually.
- To prevent possible damage to the wipers and washer system, use anti-freezing washer fluids in the winter season or cold weather.

PARKING DISTANCE WARNING (REVERSE/FORWARD) SYSTEM

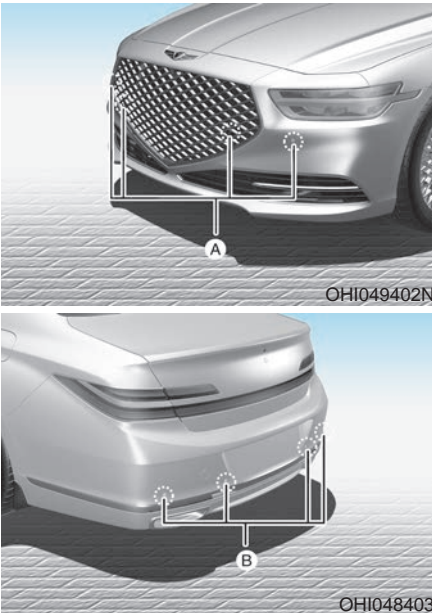

[A] : Front Sensor, [B] : Rear Sensor

The Parking Distance Warning (Reverse/Forward) system assists the driver during movement of the vehicle by chiming if any object is sensed within the distance of 39 inches (100 cm) in front and 47 inches (120 cm) behind the vehicle.

This system is a supplemental system that senses objects within the range and location of the sensors, it cannot detect objects in other areas where sensors are not installed.

WARNING

- **ALWAYS** look around your vehicle to make sure there are no objects or obstacles before moving the vehicle in any direction to prevent a collision.
- Always pay close attention when the vehicle is driven close to objects, particularly pedestrians, and especially children.
- Be aware that some objects may not be visible on the screen or be detected by the sensors, due to the objects distance, size or material, all of which can limit the effectiveness of the sensor.



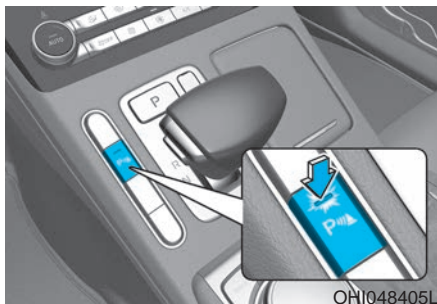



Operation of the Parking Distance Warning (Reverse/Forward) System



Operating condition

- This system will activate when the Parking Distance Warning system button is pressed with the engine running.
 - Sensing distance when backing up is approximately 47 in (120 cm) when you are driving less than 6 mph (10 km/h).
 - Sensing distance when moving forward is approximately 39 in (100 cm) when you are driving less than 6 mph (10 km/h).
- When more than two objects are sensed at the same time, the closest one will be recognized first.
 - If you move the shift lever to the R (Reverse) position with the engine running and the Parking Distance Warning system off, the system will operate automatically. But it will turn off automatically, when the vehicle speed exceeds 12 mph (20 km/h). The system will automatically operate again if vehicle speed returns to 6 mph (10 km/h).

Types of warning sound and indicator

Distance from object inches (cm)		Warning indicator		Warning sound
		When driving forward	When driving rearward	
24 ~ 39 (61 ~ 100)	Front		-	Buzzer beeps intermittently
24 ~ 47 (61 ~ 120)	Rear	-		Buzzer beeps intermittently
12 ~ 24 (31 ~ 60)	Front			Buzzer beeps frequently
	Rear	-		Buzzer beeps frequently
12 (30)	Front			Buzzer sounds continuously
	Rear	-		Buzzer sounds continuously

i Information

The indicator may differ from the illustration depending on objects or sensors status. If the indicator blinks, have your vehicle checked by an authorized retailer of Genesis Branded products.

NOTICE

When you shift the gear to R (Reverse) and if one or more of the below occurs you may have a malfunction with the Parking Distance Warning system.

- The audible warning does not sound.

- The buzzer sounds intermittently.
- A message appears on the instrument cluster LCD display.



OHI048174L

If one of the above occurs, have your vehicle checked by an authorized retailer of Genesis Branded products as soon as possible.

Non-operational Conditions of Parking Distance Warning (Reverse/Forward) System

The Parking Distance Warning (Reverse/Forward) system may not operate normally when any of the following occur:

- Moisture is frozen to the sensor.
- Sensor is covered with foreign matter, such as snow or water, or the sensor cover is blocked.

The Parking Distance Warning (Reverse/Forward) system may experience a malfunction when the following occurs:

- Driving on uneven road surfaces such as unpaved roads, gravel, bumps, or gradient.
- Objects generating excessive noise such as vehicle horns, loud motorcycle engines, or truck air brakes can interfere with the sensor.
- Heavy rain or water spray is present.
- Wireless transmitters or mobile phones are present near the sensor.
- The sensor is covered with snow.
- Any non-factory equipment or accessories have been installed, or if the vehicle bumper height or sensor installation has been modified.

Detecting range may decrease when:

- Outside air temperature is extremely hot or cold.
- Undetectable objects smaller than 40 inches (1 m) and narrower than 6 inches (14 cm) in diameter.

The following objects may not be recognized by the sensor:

- Sharp or slim objects such as ropes, chains or small poles.
- Objects, which tend to absorb sensor frequency such as clothes, spongy material or snow.

Parking Distance Warning (Reverse/Forward) System Precautions

- The Parking Distance Warning (Reverse/Forward) system may not operate consistently in some circumstances depending on the speed of the vehicle and the shapes of the objects detected.
- The Parking Distance Warning (Reverse/Forward) system may malfunction if the vehicle bumper height or sensor installation has been modified or damaged. Any non-factory installed equipment or accessories may also interfere with the sensor performance.
- The sensor may not recognize objects less than 12 in. (30 cm) from the sensor, or it may sense an incorrect distance. Use caution.
- When the sensor is blocked with snow, dirt, debris, or ice, the system may be inoperative until the snow or ice melts, or the debris is removed. Use a soft cloth to wipe debris away from the sensor.
- Do not push, scratch or strike the sensor with any hard objects that could damage the surface of the sensor. Sensor damage could occur.
- Do not spray the sensors or its surrounding area directly with a high pressure washer. Doing so may cause the sensors to fail to operate normally.

WARNING

Your new vehicle warranty does not cover any accidents or damage to the vehicle or injuries to its occupants related to a Parking Distance Warning (Reverse/Forward) system.

Always drive safely and cautiously.

PARKING COLLISION-AVOIDANCE ASSIST-REVERSE

Parking Collision-Avoidance Assist-Reverse (PCA-R) is a supplemental system that can warn the driver or apply braking force to reduce the possibility of collision with pedestrians when the vehicle is reversing.

WARNING

- **ALWAYS look around your vehicle to make sure there are no objects or pedestrian before moving the vehicle in any direction to prevent a collision.**
- **Do not solely rely on the Parking Collision-Avoidance Assist-Reverse (PCA-R) system. The system might not assist the driver leading to pedestrian injury or vehicle damage.**
- **Be aware that some objects may not be visible on the screen or be detected by the rear ultrasonic sensors, due to the objects' distance, size or material, all of which can limit the effectiveness of the sensors.**

System Setting and Operation

System setting

Parking Collision-Avoidance Assist-Reverse (PCA-R) can be activated from the Settings menu in the AVN system screen by following the procedure below.

1. Set the Engine Start/Stop button to the ON or START position.
2. Select 'Setup → Vehicle Settings → Driver Assistance → Parking Safety → Active Assist / Warning Only / Off' in the AVN system screen.

For detailed information, scan the QR code in a separately supplied simple manual.

- The system is ready for operation when 'Active Assist' is selected. In the event of an imminent collision with a pedestrian or an object, the system warns the driver or applies braking force to help avoid the collision.
- The system is ready for operation when 'Warning Only' is selected. In the event of an imminent collision with a pedestrian, the system warns the driver but does not assist in braking.
- The system deactivates when 'Off' is selected.

Operating conditions

Parking Collision-Avoidance Assist-Reverse (PCA-R) system enters the ready status, when 'Active Assist' or 'Warning Only' is selected in the AVN system screen and the following conditions are satisfied:

- The trunk is closed
- The shift lever is in R (Reverse)
- Vehicle speed is below 6 mph (10 km/h)
- System components such as the rear view camera and the rear ultrasonic sensors are in normal conditions

The driver needs to select 'Active Assist' on the AVN system screen for collision-avoidance assist.

The solid lines behind the vehicle in the cluster LCD display indicates that the system is ready to assist the driver.

Note that the system assists the driver only once. The driver has to shift the gear to R (Reverse) from another gear position to reactivate the system.

The performance of the Parking Collision Avoidance Assist-Reverse (PCA-R) system may vary under certain conditions. If the vehicle speed exceeds 2 mph (3 km/h), the system can assist only pedestrian collision avoidance.

As always, be careful when backing up your vehicle and be aware of your surroundings.

Warning and System Control

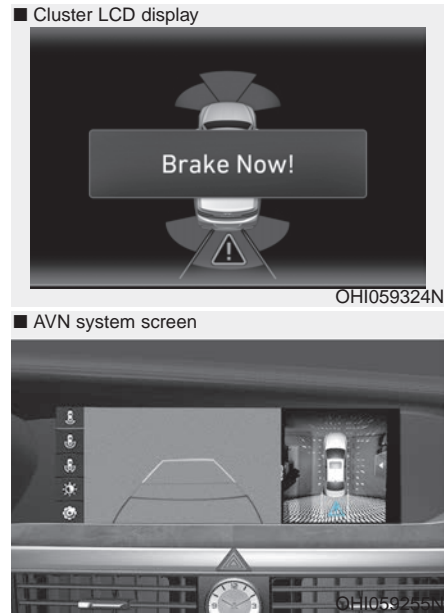

Active assist

- If the system detects a risk of collision with a pedestrian or an object behind the vehicle, the system will warn the driver with audible warning, steering wheel vibration, and warnings on the cluster LCD display and the AVN system screen.
- If the system detects imminent collision with a pedestrian or an object behind the vehicle, the system may apply braking power. The driver needs to pay attention as the brake will release within 2 seconds. The driver must immediately depress the brake pedal and check surroundings.

The brake assist will turn off when:

- The driver shifts the gear to P (Park) or D (Drive)
- The driver depresses the brake pedal with sufficient power
- The braking has been assisted for approximately 2 seconds

The warning will turn off when:

- The driver shifts the gear to P (Park), N (Neutral), or D (Drive)

The brake control may not operate properly depending on the status of the ESC (Electronic Stability Control). There will only be a warning when:

- The ESC (Electronic Stability Control) warning light is on
- The ESC (Electronic Stability Control) is engaged in a different function

Warning only

- If the system detects a risk of collision with a pedestrian or an object, the system will warn the driver with audible warning, steering wheel vibration, and warnings on the cluster LCD display and the AVN system screen.
- If 'Warning Only' is selected, braking will not be assisted.

The warning will turn off when:

- The driver shifts the gear to P (Park), N (Neutral), or D (Drive)

WARNING

- **Parking Collision-Avoidance Assist-Reverse system may not operate properly or may operate unnecessarily in some circumstances.**
- **Always pay extreme caution while driving. The driver is responsible for controlling the brake appropriately.**

CAUTION

- Always pay attention to road and traffic conditions while driving, whether or not there is a warning.
- Playing the vehicle audio system at high volume may prevent occupants from hearing the Parking Collision-Avoidance Assist-Reverse (PCA-R) system warning sounds.
- If any other warning sound, such as seat belt warning chime, is already generated, the Parking Collision-Avoidance Assist-Reverse (PCA-R) system warning may not sound.

i Information

The system can detect a pedestrian or an object when:

- A pedestrian is standing behind the vehicle.
- A large obstacle, such as a vehicle, is parked in the rear center of the vehicle.

Detecting Sensor

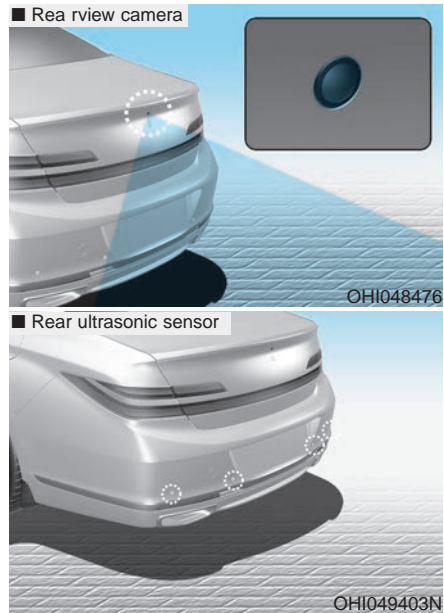

Rear view camera

The rear view camera acquires images for rear pedestrian detection. If the camera lens is covered with snow, rain, or a foreign substance, the system may not work properly. Always keep the camera lens clean.

Rear ultrasonic sensors

The rear ultrasonic sensors detect objects. The sensors are installed in the rear bumper. If the rear ultrasonic sensor(s) is covered with snow, rain, or a foreign substance, the system may not work properly. Always keep the rear bumper clean.

NOTICE

- The system may turn off if interfered by electromagnetic waves.
- Always keep the rear view camera and the ultrasonic sensors clean.
- Do not use any cleanser containing acid or alkaline detergents when cleaning the rear view camera lens. Use only a mild soap or neutral detergent, and rinse thoroughly with water.
- NEVER disassemble the rear view camera or the ultrasonic sensor components or apply any impact on the rear view camera or the ultrasonic sensor components.
- Do not apply unnecessary force on the rear view camera or the ultrasonic sensors. The system may not operate properly if the rear view camera or the ultrasonic sensor(s) is forcibly moved out of proper alignment. Have the vehicle inspected by an authorized retailer of Genesis Branded products.
- Do not spray the rear view camera or the ultrasonic sensors or their surrounding area directly with a high pressure washer. Shock applied from high pressure water may cause the device to malfunction.
- The system may not work properly if the bumper has been damaged, or if the rear bumper has been replaced or repaired.
- Do not apply foreign objects, such as a bumper sticker or a bumper guard, near the camera or sensors or apply paint to the bumper. Doing so may adversely affect the performance of the system.

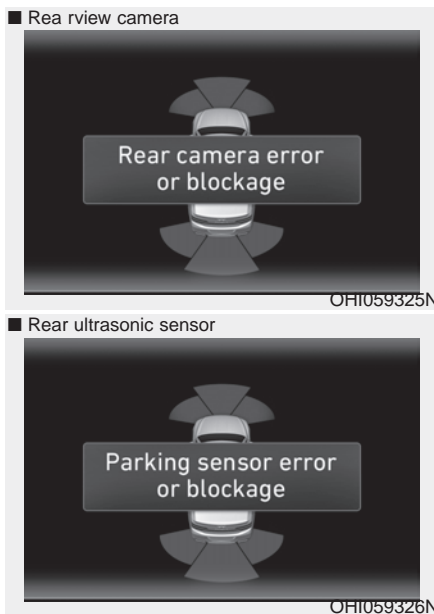
Warning message**Rear camera error or blockage/
Parking sensor error or blockage**

This warning message may appear when:

- The rear view camera or the ultrasonic sensor(s) is blocked by dirt, snow, or a foreign object.
- There is inclement weather, such as heavy snow, rain, etc.

If any of these conditions occur, the system may turn off automatically or not operate properly.

When the warning message is displayed in the cluster, make sure that the rear view camera and the rear ultrasonic sensors are clean.

System Malfunction



Check Parking Collision-Avoidance Assist system

If there is a problem with the Parking Collision-Avoidance Assist-Reverse (PCA-R) system or other related systems, a warning message will appear and the system will turn off automatically. Have the vehicle inspected by an authorized retailer of Genesis Branded products.

Limitations of the System

Parking Collision-Avoidance Assist-Reverse (PCA-R) system may not assist braking or alert the driver under the following conditions even if there are pedestrians or objects.

- Any non-factory equipment or accessories have been installed.
- The condition of the vehicle is unstable due to an accident or other causes.
- The height of the bumper or the sensor installation has been modified.
- The rear view camera or the ultrasonic sensor(s) is damaged.
- The rear view camera or the ultrasonic sensor(s) is stained with foreign matter, such as snow, dirt, etc.
- The rear view camera is obscured by a light source or by bad weather conditions, such as heavy rain, fog, snow, etc.
- The surrounding is either too dark or too bright.
- Outside air temperature is hot or cold.
- The wind is either strong (over 12 mph (20 km/h)) or blowing perpendicular to the rear bumper.
- Objects generating excessive noise, such as vehicle horns, loud motorcycle engines, or truck air brakes, are near the vehicle.
- An ultrasonic sensor with a similar frequency is near the vehicle.
- There is ground height difference between the vehicle and the pedestrian.
- The image of the pedestrian in the rear view camera is indistinguishable from the background.

- The pedestrian is near the rear edge of the vehicle.
- The pedestrian is not standing upright.
- The pedestrian is either too short or too tall for the system to recognize.
- The pedestrian is wearing clothes that are hard for the system to recognize.
- The pedestrian is wearing a cloth that does not reflect ultrasound well.
- The size, thickness, height, or shape of the object does not reflect ultrasound well (e.g., pole, bush, curbs, carts, edge of a wall, etc.).
- The pedestrian or the object is moving.
- The pedestrian or the object is very close to the rear of the vehicle.
- A wall is behind the pedestrian or the object.
- The object is not at the rear center of the vehicle.
- The plane of the obstacle is not parallel to the rear bumper.
- The road is slippery or inclined.
- The driver backs up the vehicle immediately after shifting to R (Reverse).
- The driver accelerates or turns the vehicle.
- The condition of the vehicle is unstable due to an accident or other causes.
- The height of the bumper or the sensor installation has been modified.
- The bumper height has changed due to heavy loads, tire pressure change, etc.
- The rear view camera or the ultrasonic sensor(s) is stained with foreign matter, such as snow, dirt, etc.
- The pattern on the road is mistaken for a pedestrian.
- There is a shadow or a light reflecting on the ground.
- Pedestrians or objects are around the path of the vehicle.
- Objects generating excessive noise, such as vehicle horns, loud motorcycle engines, or truck air brakes, are near the vehicle.
- The vehicle is backing towards a narrow passage or parking space.
- The vehicle is backing towards an uneven road surface, such as unpaved road, gravel, bump, gradient, etc.
- A trailer is attached to the vehicle.

Parking Collision-Avoidance Assist-Reverse (PCA-R) system may alert the driver or apply brake power unnecessarily under the following conditions even if there are "no" pedestrians or objects.

- Any non-factory equipment or accessories have been installed.

SURROUND VIEW MONITOR



The Surround View Monitor system can assist in parking by allowing the driver to see around the vehicle.

For detailed information, scan the QR code in a separately supplied simple manual.

- The system is activated when the following steps are performed.
 1. The surround view monitor button (1, indicator ON) is pressed
 2. The shift lever is in D (Drive), N (Neutral) or R (Reverse) and vehicle speed is under 10 mph (15 km/h)
- The system is deactivated when one of the following is performed.
 - The surround view monitor button (1, indicator OFF) is pressed again
 - Vehicle speed is over 10 mph (15 km/h)

- When vehicle speed is over 15km/h, the system will turn off. The system will not automatically turn on again, even though vehicle speed gets below 10 mph (15 km/h). Press the button (1, indicator ON) again, to turn on the system.
- When the vehicle is backing up, the system will turn ON regardless of vehicle speed or button status. However, if vehicle speed is over 10 mph (15 km/h) when driving forward, the Surround View Monitor system will turn off.
- An indicator on the screen appears when:
 - The trunk is opened
 - The driver's door is opened
 - The passenger's door is opened
 - The outer side view mirror is folded
- If the system is not operating normally, the system should be checked by an authorized retailer of Genesis Branded products.

CAUTION

ODH047435

- (1) Front camera
- (2) Left/Right camera
- (3) Rear camera

Surround View Monitor system only serves to assist the driver in parking. ALWAYS look around your vehicle to make sure there are no objects or obstacles before moving the vehicle.

NOTICE

Always keep the camera lens clean. The camera may not work normally if the lens is covered with foreign material.

BLIND-SPOT VIEW MONITOR SYSTEM



The Blind-Spot View Monitor system displays the left or right side of the rear blind spot area of your vehicle in the instrument cluster when the left or right turn signal is on. This function helps you drive safely when changing lanes.

- The system is activated when the following steps are performed.
 1. The engine is running.
 2. The turn signal is turned on.
- The system is deactivated when one of the following is performed.
 - The Engine Start/Stop button is in the OFF position.
 - The turn signal is turned off
 - The hazard warning flasher is on
 - A warning screen pops up and takes priority over the Blind-Spot View Monitor system.

WARNING

- This system is a supplemental system only. It is the responsibility of the driver to always check the area around the vehicle before and while making turns or changing lanes.
- **ALWAYS** look around your vehicle to make sure there are no objects or obstacles before moving the vehicle in any direction to prevent a collision.
- Objects are closer than they appear. Failure to visually confirm that is safe to change the lane before doing so may result in crash and serious injury or death.
- Always keep the camera lens clean. The camera may not work normally if the lens is covered with foreign substance.

AUTOMATIC CLIMATE CONTROL SYSTEM

■ Front



■ Rear



OHI048339L/OHI048302L

Front

1. Driver's temperature control knob
2. Driver's AUTO button
3. Driver's mode selection button
4. Front windshield defroster button
5. Rear window defroster button
6. SYNC button
7. AQS (Air quality system) button
8. Air intake control button
9. Passenger's mode selection button
10. Passenger's temperature control knob
11. Passenger's AUTO button
12. Driver's fan speed control button
13. OFF button

14. Climate control information screen selection button
15. Air conditioning button
16. Passenger's fan speed control button

Rear

17. Rear fan speed control knob
18. Rear mode selection button
19. Rear OFF button
20. Rear AUTO button
21. Rear temperature control knob
22. LCD display

Automatic Heating and Air Conditioning



The Automatic Climate Control System is controlled by setting the desired temperature.

1. Press the AUTO button.

The modes, fan speeds, air intake and air-conditioning will be controlled automatically by the temperature setting you select.

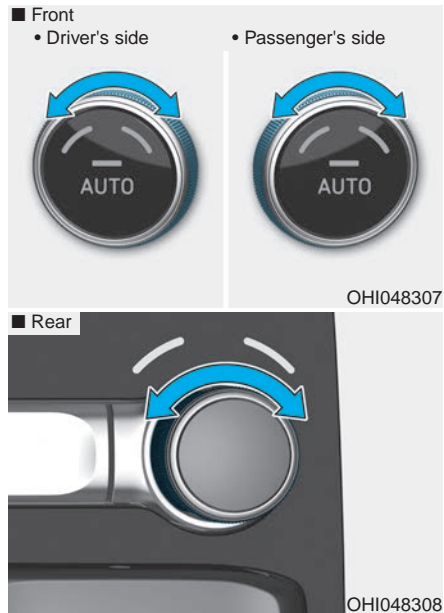

2. Turn the temperature control knob to the desired temperature. If the temperature is set to the lowest setting (Lo), the air conditioning system will operate continuously. After the interior has cooled sufficiently, adjust the knob to a higher temperature set point whenever possible.

To turn the automatic operation off, select any function of the following:

- Mode selection button
- Air conditioning button
- Front windshield defroster button (Press the button one more time to deselect the front windshield defroster function. The 'AUTO' sign will illuminate on the climate information screen once again.)
- Fan speed control button

The selected function will be controlled manually while other functions operate automatically.

For your convenience and to improve the effectiveness of the climate control, use the AUTO button and set the temperature to 72°F (22°C).

i Information



Never place anything near or covering the sensor (both inside and outside the vehicle) to ensure better control of the heating and cooling system.

Manual Heating and Air Conditioning

The heating and cooling system can be controlled manually by pushing buttons other than the AUTO button. In this case, the system works sequentially according to the order of buttons selected.

When pressing any button except the AUTO button while using automatic operation, the functions not selected will be controlled automatically.

1. Start the engine.
2. Set the mode to the desired position.

To improve the effectiveness of heating and cooling, select the mode according to the following:

- Heating:
- Cooling:

3. Set the temperature control to the desired position.
4. Set the air intake control to Fresh mode.
5. Set the fan speed control to the desired speed.
6. If air conditioning is desired, turn the air conditioning system on.
7. Press the AUTO button in order to convert to full automatic control of the system.

The climate control system settings will be maintained, even when the engine is turned OFF. However, the climate control system settings will be initialized when the battery has been discharged, or when the cables have been disconnected. In this case, adjust the climate control system settings again.

Mode selection

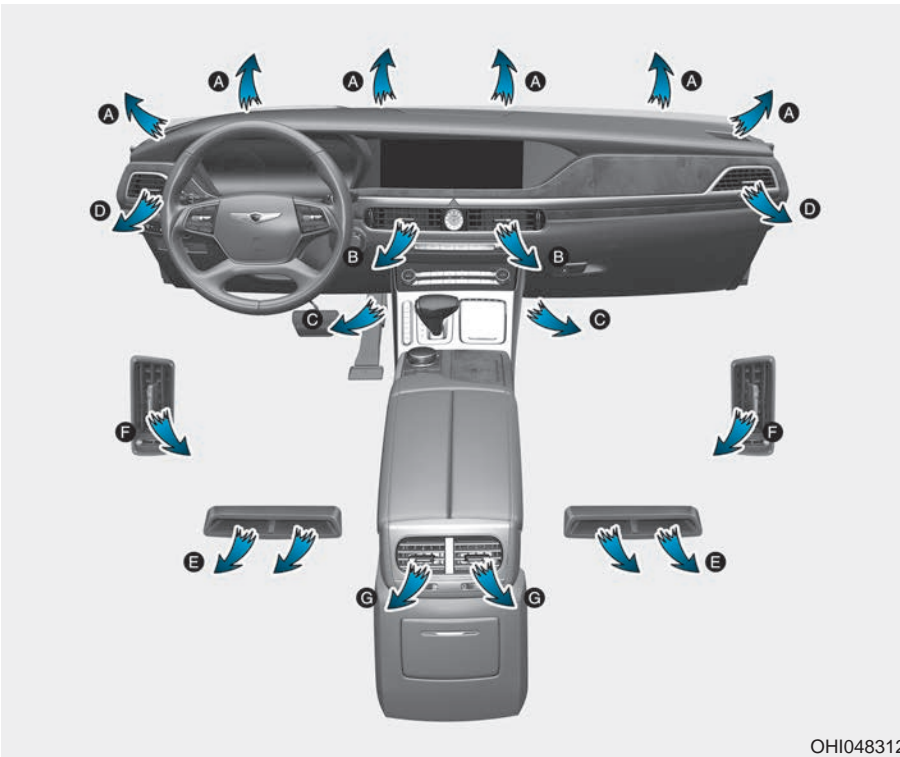

OHI048312

- **Side outlet vents (D)**

G90 is equipped with temperature sensors inside the side outlet vents to accurately measure and control air temperature both in the driver's seat and the front passenger's seat. However, when the side outlet vents are closed, the temperature sensor will measure air temperature only inside the side outlet vents. For accurate temperature control, open the side outlet vents.

- **Rear outlet vents (F)**

The rear outlet vents are controlled by the rear climate control system.

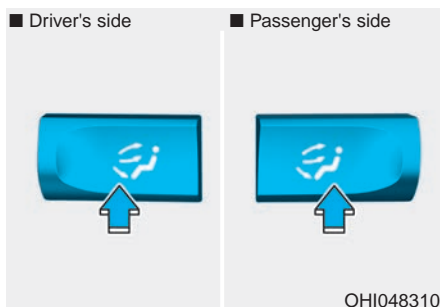

Front mode selection button

The mode selection button controls the direction of the air flow through the ventilation system.

The air flow outlet direction is cycled as follows:



i Information

The passenger's side cannot select the Floor & Defrost () mode.

Face-Level (B, C, D, F, G)

Air flow is directed toward the upper body and face. Additionally, each outlet can be controlled to direct the air discharged from the outlet.

A small amount of air blows from the floor air vents to help provide pleasant air quality inside the passenger compartment.

Bi-Level (B, C, D, E, F, G)

Air flow is directed towards the face and the floor.

Floor & Defrost (A, C, D, E)

Most of the air flow is directed to the floor and the windshield with a small amount directed to the side window defrosters.

Floor-Level (A, C, D, E)

Most of the air flow is directed to the floor, with a small amount of the air being directed to the windshield and side window defrosters.

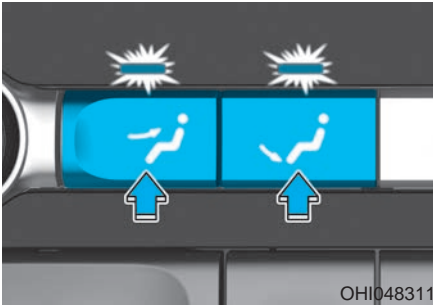

 **Bi-Level (E, F, G)**

Air flow is directed toward the face and floor

 **Floor-Level (E)**

Air flow is directed toward the floor.

Rear mode selection button

If you press the rear mode selection button, you can adjust the rear mode individually.

To adjust the rear mode individually, go to the AVN system screen and select 'Setup → General Settings' and deselect 'Lock Rear Controls' (the RSE LOCKED indicator on the rear armrest will turn off). If the 'Lock Rear Controls' is selected (the RSE LOCKED indicator on the rear armrest will turn on), the rear mode will operate same as the front mode.

For more information on the RSE LOCKED indicator, refer to “Rear Switches Operating Limitation” in chapter 2.

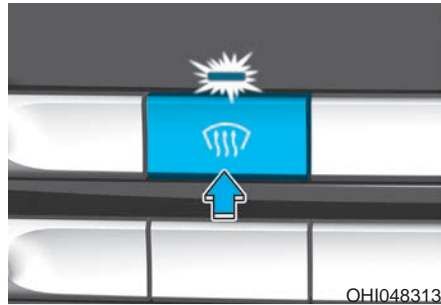

Defrost-Level (A, D)

Most of the air flow is directed to the windshield with a small amount of air directed to the side window defrosters.

The air flow outlet direction is cycled as follows:



 **Face-Level (F, G)**

Air flow is directed toward the upper body and face

 **Information**

The rear climate control system will be deactivated if the fan speed is set to the highest position with the front windshield defroster button ON. However, if the rear climate control switch is operated, the system will reactivate.

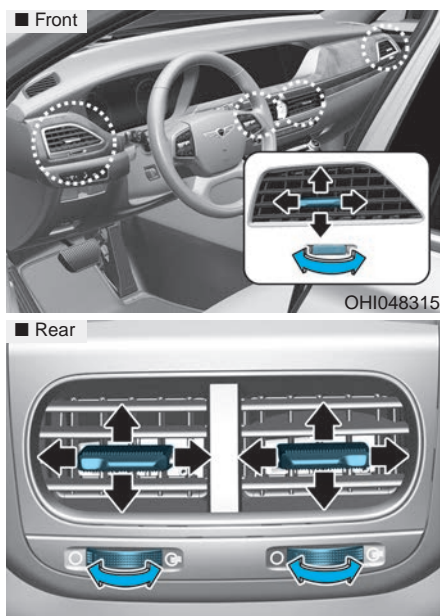

Instrument panel vents

The instrument panel vent air flow can be directed up/down or left/right using the vent adjustment lever.

The air flow can be closed using the thumbwheel. To close the vent rotate it left (⊗). To open the vent, rotate it right (⊙).

Temperature control

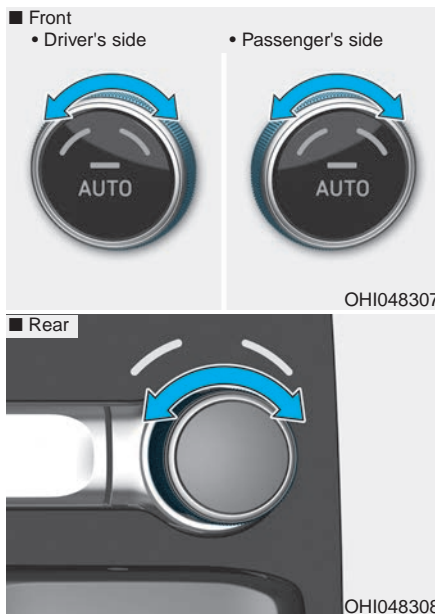

The temperature will increase by turning the knob to the right. The temperature will decrease by turning the knob to the left. The temperature will increase or decrease by 1°F (0.5°C). When set to the lowest temperature setting, the air conditioning will operate continuously.

Temperature conversion

If the battery has been discharged or disconnected, the temperature mode display will reset to Centigrade.

To change the temperature unit from °C to °F or °F to °C :

- Automatic climate control system

Press the AUTO button for 3 seconds while pressing the OFF button.

- AVN system screen

Select 'Setup → General Settings
→ Unit → Temperature Unit °C / °F'

For detailed information, scan the QR code in a separately supplied simple manual.

The temperature unit on the cluster LCD display and AVN system screen will change.

Adjusting the driver and passenger side temperature and air flow direction individually

Press the SYNC button again (LED OFF) to adjust the driver and front/rear passenger side temperature and air flow direction individually.

SYNC button

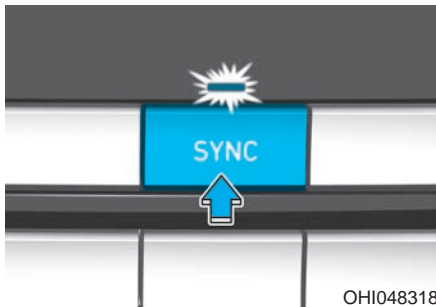

Adjusting the driver and passenger side temperature and air flow direction equally

- Press the SYNC button (LED ON) to adjust the driver and front/rear passenger side temperature and air flow direction equally.

The front and rear passenger side temperature and air flow direction will be set to the same temperature and air flow direction as the driver's side.

- Turn the driver side temperature control knob. The driver and passenger side temperature will be adjusted equally.

Press the driver side mode selection button. The driver and front/rear passenger side air flow will be adjusted equally.

Air intake control



The air intake control button is used to select either Fresh mode (outside air) or Recirculation mode (cabin air).

Recirculation mode



When Recirculation mode is selected, air from the passenger compartment will be recirculated through the system and heated or cooled according to the function selected.

Fresh mode



When Fresh mode is selected, air enters the vehicle from outside and is heated or cooled according to the function selected.

i Information

Operating the system primarily in Fresh mode is recommended. Use Recirculation mode temporarily only when needed.

Prolonged operation of the heater in Recirculation mode and without the A/C ON can cause fogging of the windshield.

In addition, prolonged use of the A/C ON in Recirculation mode may result in excessively dry, dehumidified air in the cabin and may promote formation of musty vent odor due to stagnant air.

⚠ WARNING

- Continued use of the climate control system operation in Recirculation mode for a prolonged period of time may cause drowsiness to the occupants in the cabin. This may lead to loss of vehicle control which may lead to an accident.
- Continued use of the climate control system operation in Recirculation mode with the A/C OFF may allow humidity to increase inside the cabin. This may cause condensation to accumulate on the windshield and obscure visibility.
- Do not sleep in your vehicle or remain parked in your vehicle with the windows up and either the heater or the air conditioning ON for prolonged periods of time. Doing so may increase the levels of carbon dioxide in the cabin which may lead to serious injury or death.

Air Quality System (AQS)



This system automatically senses outdoor air pollutants and minimizes their flow into the vehicle. However, unpleasant or foul odors that might be present may still be noticeable within the vehicle.

To turn the AQS ON, press the button.

If the windows fog up with the Recirculation mode or AQS mode selected, set the air intake control to Fresh mode or AQS control to OFF.

i Information

- The AQS button indicator will immediately illuminate when the engine is started with the AQS in the ON position. However, the AQS starts operating after 40 seconds.
- The AQS filters out toxic exhaust (i.e. NO, NO₂, SO₂, CO, C_xH_y) to prevent it from entering the passenger compartment but, does not totally block odor.

The AQS does not operate in any of the following situations :

- The AQS button is re-repressed to the OFF position.
- Either Fresh mode or the Recirculation mode is selected.
- The front defroster button is pressed ON or the Floor & Defrost () mode is selected.
- The temperature is set to either the highest (HI) or the lowest (Lo) position, while the climate control system is automatically controlled (AUTO button LED ON).
- The OFF button of the climate control system is selected.
- The Auto Defogging system operates to defog the front windshield.

Fan speed control

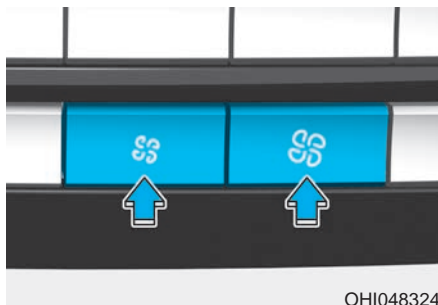

OHI048324

Front

Press the (🌀) button to increase fan speed and air flow. Press the (🌀) button to decrease fan speed and air flow.

Pressing the OFF button turns off the fan.

NOTICE

Operating the fan speed when the Engine Start/Stop button is in the ON position could cause the battery to discharge. Operate the fan speed when the engine is running.

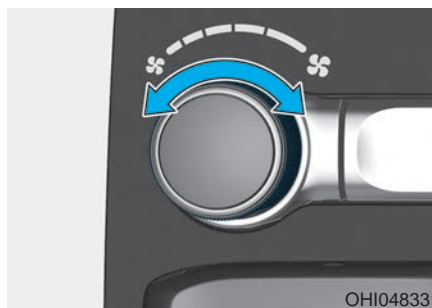

Rear

Turn the knob to the right (🌀) to increase fan speed and airflow. Turn the knob to the left (🌀) to decrease fan speed and airflow.

To adjust the rear fan speed control individually, go to the AVN system screen and select 'Setup → General Settings' and deselect 'Lock Rear Controls' (the RSE LOCKED indicator on the rear armrest will turn off). If the 'Lock Rear Controls' is selected (the RSE LOCKED indicator on the rear armrest will turn on), the rear fan speed control will operate same as the front fan speed control.

For more information on the RSE LOCKED indicator, refer to "Rear Switches Operating Limitation" in chapter 2.

Air conditioning

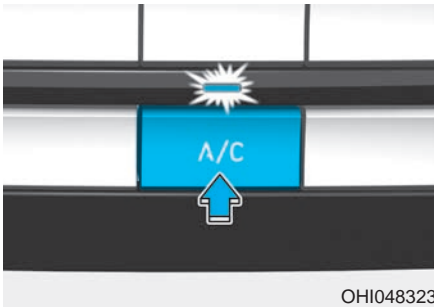

Push the A/C button to manually turn the system on (LED ON) and off.

OFF mode

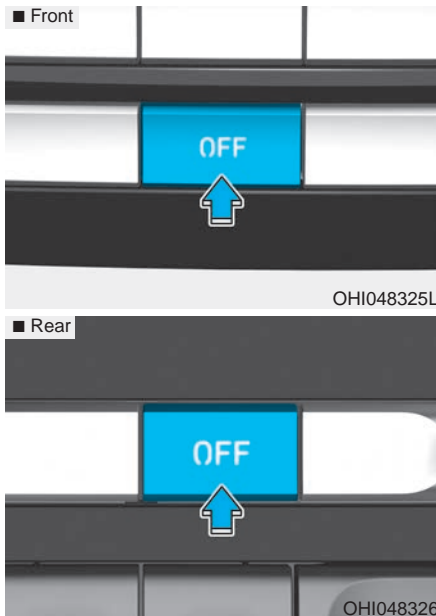

Push the OFF button to turn off the climate control system.

Climate control information screen selection button

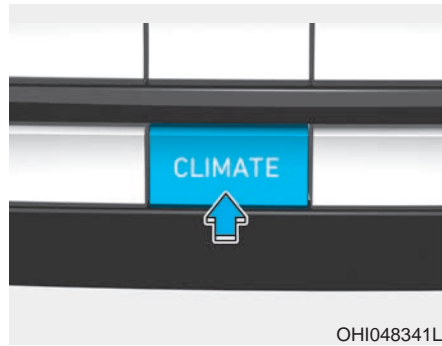

Press the climate control information screen selection button to display climate control information on the AVN system screen.

System Operation

Cooling / Ventilation

1. Select the Face Level  mode.
2. Set the air intake control to fresh mode.
3. Set the temperature control to the desired position.
4. Set the fan speed control to the desired speed.

Heating

1. Select the Floor Level  mode.
2. Set the air intake control to fresh mode.
3. Set the temperature control to the desired position.
4. Set the fan speed control to the desired speed.
5. If desired, turn the air conditioning ON with the temperature control knob set to heat in order to dehumidify the air before it enters into the cabin.

If the windshield fogs up, select the Floor & Defrost  mode or press the Front Defrost  mode.

Operation Tips

- To keep dust or unpleasant fumes from entering the car through the ventilation system, temporarily set the air intake control to the recirculation mode. Return the control to the to fresh mode when the unpleasant air outside has diminished. This will help keep the driver alert and comfortable.
- To help prevent the inside of the windshield from fogging, set the air intake control to fresh mode and the fan speed to the desired position, turn on the air conditioning system, and adjust the temperature control to the desired temperature.

Air conditioning

Your Genesis Branded Vehicle air conditioning system is filled with R-1234yf refrigerant.

1. Start the engine.
2. Press the air conditioning button.
3. Select the Face Level  mode.
4. Set the air intake control to Recirculation mode temporarily to allow the cabin to cool quickly. When the desired temperature in the cabin is reached, change the air intake control back to Fresh mode.
5. Adjust the fan speed control and temperature control to maintain maximum comfort.

When maximum cooling is desired, set the temperature control to the lowest temperature setting, then set the fan speed control to the highest setting.

NOTICE

When using the air conditioning system, monitor the engine temperature gauge closely while driving up hills or in heavy traffic when outside temperatures are high. Air conditioning system operation when climbing a steep grade or in high outside ambient temperatures can cause engine overheating.

Continue to use the fan, but turn the air conditioning system off if the engine temperature gauge indicates engine overheating.

Air conditioning system operation tips

- If the vehicle has been parked in direct sunlight during hot weather, open the windows for a short time to let the hot air inside the vehicle escape.
- After sufficient cooling has been achieved, switch back from recirculation mode to fresh mode.
- To help reduce moisture inside of the windows on rainy or humid days, decrease the humidity inside the vehicle by operating the air conditioning system with the windows and sunroof closed.
- Use the air conditioning system every month only for a few minutes to ensure maximum system performance.
- If you operate air conditioner excessively, the difference between the temperature of the outside air and that of the windshield could cause the outer surface of the windshield to fog up, causing loss of visibility. In this case, set the mode selection knob or button to the  position and fan speed control to the lowest speed.

System Maintenance

Cabin air filter

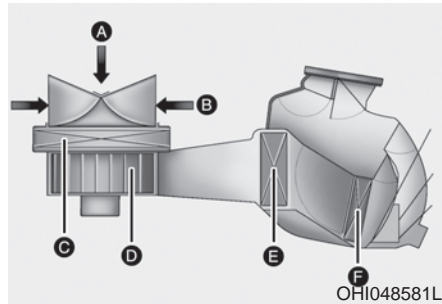

[A] : Outside air, [B] : Recirculated air
[C] : Climate control air filter, [D] : Blower
[E] : Evaporator core, [F] : Heater core

The cabin air filter is installed behind the glove box. It filters the dust or other pollutants that enter the vehicle through the heating and air conditioning system.

Have the cabin air filter replaced by an authorized retailer of Genesis Branded products according to the maintenance schedule. If the vehicle is being driven in severe conditions such as dusty or rough roads and/or if transporting pets or occupants smoke inside the vehicle, then more frequent cabin air filter inspections and changes are required.

If the air flow rate suddenly decreases, the system should be checked at an authorized retailer of Genesis Branded products.

Checking the amount of air conditioner refrigerant and compressor lubricant



When the amount of refrigerant is low, the performance of the air conditioning is reduced. Overfilling also reduces the performance of the air conditioning system.

Therefore, if abnormal operation is found, have the system inspected by an authorized retailer of Genesis Branded products.

NOTICE

It is important that the correct type and amount of oil and refrigerant is used. Otherwise, damage to the compressor and abnormal system operation may occur.

⚠ WARNING

Because the refrigerant is mildly flammable at very high pressure, the air conditioning system should only be serviced by trained and certified technicians. It is important that the correct type and amount of oil and refrigerant is used. Otherwise, it may cause damage to the vehicle and personal injury.

The air conditioning system should be serviced by an authorized retailer of Genesis Branded products.

Air Conditioning refrigerant label

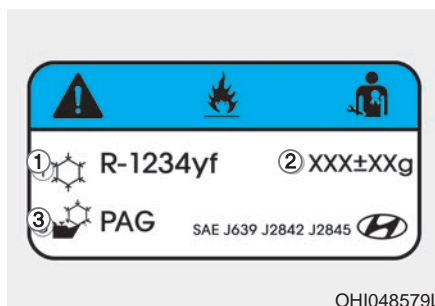

The actual Air Conditioning refrigerant label in the vehicle may differ from the illustration.

Each symbols and specification on air conditioning refrigerant label means as below :

1. Classification of refrigerant
2. Amount of refrigerant
3. Classification of Compressor lubricant

Refer to chapter 8 for more detail location of the air conditioning refrigerant label.

DEFROSTER

NOTICE

To prevent damage to the conductors bonded to the inside surface of the rear window, never use sharp instruments or window cleaners containing abrasives to clean the window.

If you want to defrost and defog the front windshield, refer to the "Windshield Defrosting and Defogging" section in this chapter.

Rear Window Defroster

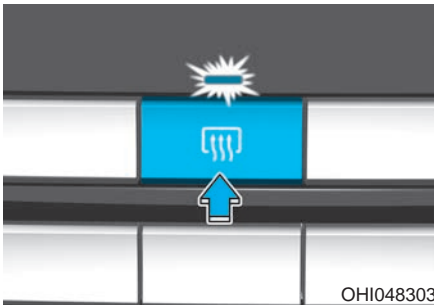

The defroster heats the window to remove frost, fog and thin ice from the interior and exterior of the rear window, while the engine is running.

- Press the Rear Window Defroster button to turn the rear window defroster ON and OFF. The Rear Window Defroster button LED will illuminate when the defroster is ON.
- The rear window defroster automatically turns off after approximately 20 minutes or when the engine is turned off.

i Information

If there is heavy accumulation of snow on the rear window, brush it off before operating the rear defroster.

Side view mirror defroster

The side view mirror defroster will operate at the same time as the rear window defroster.



Front Wiper Deicer (if equipped)

The front wiper deicer will operate at the same time as the rear window defroster.

WINDSHIELD DEFROSTING AND DEFOGGING

⚠ WARNING

Windshield heating

Do not use the  or  position during cooling operation in extremely humid weather. The difference between the temperature of the outside air and that of the windshield could cause the outer surface of the windshield to fog up, causing loss of visibility could cause an accident resulting in serious injury or death. In this case, set the mode selection knob or button to the  position and fan speed control knob or button to a lower speed.

- For maximum defrost performance, set the temperature control knob to the highest temperature setting (rotated all the way to the right) and the fan speed control to the highest setting.
- If warm air to the floor is desired while defrosting or defogging, set the mode to the floor-defrost position.
- Before driving, clear all snow and ice from the windshield, rear window, side view mirrors, and all side windows.
- Clear all snow and ice from the hood and air inlet in the cowl grill to improve heater and defroster efficiency and to reduce the probability of fogging up the inside of the windshield.

NOTICE

If the engine temperature is still cold after starting, then a brief engine warm up period may be required for the vented air flow to become warm or hot.

To defog inside windshield

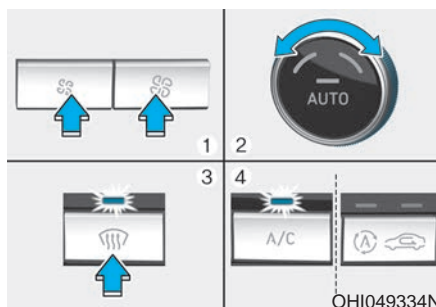

1. Set the fan speed to the desired position.
2. Select desired temperature.
3. Press the defroster button ().
4. Fresh mode will be selected automatically. Additionally, the air conditioning will automatically operate according to the detected ambient temperature.

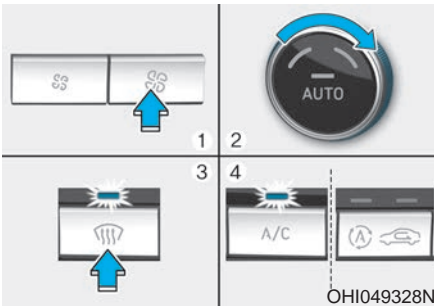

Check to make sure the air conditioning is ON. If the air conditioning button LED is not illuminated, press the air conditioning (A/C) button once to turn the air conditioner ON. Check to make sure the air intake control is in Fresh mode.

To defrost outside windshield



1. Set the fan speed to the highest position.
2. Set the temperature to the extreme hot (HI) position.
3. Press the defroster button ().
4. Fresh mode will be selected automatically. Additionally, the air conditioning will automatically operate according to the detected ambient temperature. Check to make sure the air intake control is in Fresh mode.

Defogging logic

To reduce the probability of fogging up the inside of the windshield, the air intake or air conditioning are controlled automatically according to certain conditions such as  or  positions. To cancel or reset the defogging logic, do the following.

1. Turn the engine ON.
2. Press the defroster button ().
3. While pressing the air conditioning (A/C) button, press the air intake control button at least 5 times within 3 seconds.

The air intake control button indicator will blink 3 times to indicate that the defogging logic has been disabled. Repeat the steps again to re-enable the defogging logic.

If the battery has been discharged or disconnected, it resets to the defog logic status.

CLIMATE CONTROL ADDITIONAL FEATURES

Auto Defogging System



Auto defogging helps reduce the possibility of fogging up the inside of the windshield by automatically sensing the moisture on inside the windshield. The auto defogging system operates when the climate control system is on.

i Information

The auto defogging system may not operate normally, when the outside temperature is below 14 °F (-10 °C).



When the Auto Defogging System operates, the indicator will illuminate.

If a high amount of humidity is detected in the vehicle, the Auto Defogging System will be enabled.

The following steps will be performed automatically:

- Step 1) The A/C button will turn ON.
- Step 2) The air intake control will change to Fresh mode under low outside temperature.
- Step 3) The mode will be changed to defrost to direct airflow to the windshield.
- Step 4) The fan speed will be set to MAX.

If the air conditioning is off or recirculation mode is manually selected while Auto Defogging System is ON, the Auto Defogging System Indicator will blink 3 times to signal that the manual operation has been canceled.

To cancel or activate the Auto Defogging System

Climate control system

• To cancel the auto defogging system

1. Press the Engine Start/Stop button to the ON or START position.
2. Press the front defroster button for approximately 3 seconds.
3. The front defroster button LED will blink 3 times and then ADS OFF will illuminate on the climate control information screen when the auto defogging system is canceled.

• To reactivate the auto defogging system

1. Press the Engine Start/Stop button to the ON or START position.
2. Press the front defroster button for approximately 3 seconds.
3. The front defroster button LED will blink 6 times and then ADS OFF will turn off on the climate control information screen when the auto defogging system is reactivated.



OHI048566L

AVN system screen

The Auto Defogging System can also be canceled or selected from the Settings menu in the AVN system screen.

For detailed information, scan the QR code in a separately supplied simple manual.

i Information

- When the air conditioning is turned on by Auto defogging system, if you try to turn off the air conditioning, the A/C button LED will blink 3 times and the air conditioning will not be turned off.
- To maintain the effectiveness and efficiency of the Auto Defogging System, do not select Recirculation mode while the system is operating.
- When the Auto Defogging System is operating, the fan speed adjustment button, the temperature adjustment knob, and the air intake control button are all disabled.

NOTICE

Do not remove the sensor cover located on the upper end of the driver side windshield glass.

Damage to system parts could occur and may not be covered by your vehicle warranty.

Clean Air

When the engine is running, the clean air function turns on automatically.

Also, the clean air function turns off automatically, when the Engine Start/Stop button is in the OFF position.

Automatic Ventilation (if equipped)

The system automatically selects the fresh mode when the climate control system operates over a certain period of time (approximately 30 minutes) in low temperature with the recirculation mode selected.

To cancel or reactivate the Automatic Ventilation

When the air conditioning system is on, select Face Level  mode and press the air recirculation mode button at least 5 times within 3 seconds while pressing the A/C button.

When the automatic ventilation is canceled, the air intake control button LED blinks 3 times. When the automatic ventilation is activated, the air intake control button LED blinks 6 times.

Sunroof Inside Air Recirculation (if equipped)

When the heater or air conditioning system is on with the sunroof opened, the fresh mode will be automatically selected. If you press the Recirculation mode button with the sunroof open, Recirculation mode activate but will only remain enabled for 3 minutes. After 3 minutes the air intake control will revert back to Fresh mode.

When the sunroof is closed, the air intake position will return to the original position that was selected.

Setting the Climate Control System in the AVN System Screen

Using the AVN System screen, select 'Home → Climate'.

The Climate settings screen will be displayed.

Climate information



OHI048181L

Climate information (e.g. temperature, air-flow direction, fan speed, etc.) of the driver's/front passenger's/rear seats is displayed.

Adjusting the rear climate control system



OHI048183L

Select 'Rear Climate Controls' and then adjust the temperature, fan speed and mode selection.

Also, the rear climate controls can be turned off by selecting OFF.

Smart ventilation



OHI048184L

- The smart ventilation system maintains pleasant/fresh air condition inside the passenger compartment by automatically detecting/controlling the temperature, humidity, etc., when you drive the vehicle with the climate control system in the OFF position. When the smart ventilation system starts to operate, the message, "SMART VENTILATION ON" appears for 5 seconds.
- Check the box next to 'Smart Vent' to turn on the function and uncheck the box to turn off the function.

i Information

- The smart ventilation system stops operating, when the OFF button of the climate control system is selected.
- The smart ventilation system stops operating, when any button of the climate control system is selected for operation.
- The smart ventilation system may not operate, when the vehicle is driven at low speed.

NOTICE

Pay extreme caution not to damage the CO2 sensor, which is located inside the glove box undercover.

Activate Carbon Dioxide monitor (if equipped)



OHI048185L

- When driving, the climate control system controls CO2 concentration and maintains pleasant air in the vehicle.
- Check the box next to 'Activate Carbon Dioxide Monitor' to turn on the function and uncheck the box to turn off the function.

For detailed information on the features described, scan the QR code in a separately supplied simple manual.

STORAGE COMPARTMENT

⚠ WARNING

Never store cigarette lighters, propane cylinders, or other flammable/explosive materials in the vehicle. These items may catch fire and/or explode if the vehicle is exposed to hot temperatures for extended periods.

⚠ WARNING

ALWAYS keep the storage compartment covers closed securely while driving. Items inside your vehicle are moving as fast as the vehicle. If you have to stop or turn quickly, or if there is a crash, the items may fly out of the compartment and may cause an injury if they strike the driver or a passenger.

NOTICE

To avoid possible theft, do not leave valuables in the storage compartments.

Center Console Storage



To open :
Press the button.

Rear Console Storage



To open :
Press the button.

Glove Box

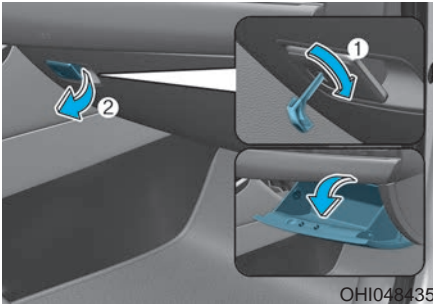

The glove box can be locked and unlocked with the mechanical key (1).

To open:
Pull the lever (2).

⚠ WARNING

ALWAYS close the glove box after use.

An open glove box can cause serious injury to the passenger in an accident, even if the passenger is wearing a seat belt.

Sunglass Holder

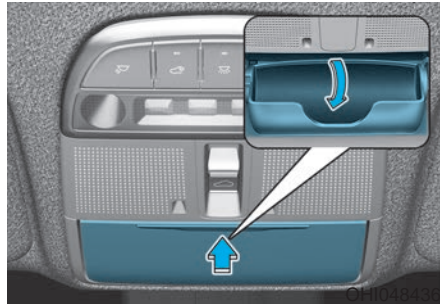

To open:
Push and release the cover and the holder will slowly open. Place your sunglasses in the compartment door with the lenses facing out.

To close:
Push back into position.
Make sure the sunglasses holder is closed while driving.

⚠ WARNING

- **Do not keep objects except sunglasses inside the sunglasses holder. Such objects can be thrown from the holder in the event of a sudden stop or an accident, possibly injuring the passengers in the vehicle.**
- **Do not open the sunglasses holder while the vehicle is moving. The rear view mirror of the vehicle can be blocked by an open sunglasses holder.**
- **Do not put the glasses forcibly into a sunglasses holder. It may cause personal injury if you try to open it forcibly when the glasses are jammed.**

INTERIOR FEATURES

Cup Holder

You can also store cups or small beverage cans inside.

Front seats



Press the cover and it will slowly open.

Rear seats



Press the cover and it will slowly open.

⚠ WARNING

- Avoid abrupt starting and braking when the cup holder is in use to prevent spilling your drink. If hot liquid spills, you could be burned. Such a burn to the driver could cause loss of vehicle control resulting in an accident.
- Do not place uncovered or unsecured cups, bottles, cans, etc., in the cup holder containing hot liquid while the vehicle is in motion. Injuries may result in the event of sudden stop or collision.
- Only use soft cups in the cup holders. Hard objects can injure you in an accident.

⚠ WARNING

Keep cans or bottles out of direct sun light and do not put them in a hot vehicle. It may explode.

NOTICE

- Keep your drinks sealed while driving to prevent spilling your drink. If liquid spills, it may get into the vehicle's electrical/electronic system and damage electrical/electronic parts.
- When cleaning spilled liquids, do not dry the cup holder using hot temperatures. This may damage the cup holder.

Sunvisor

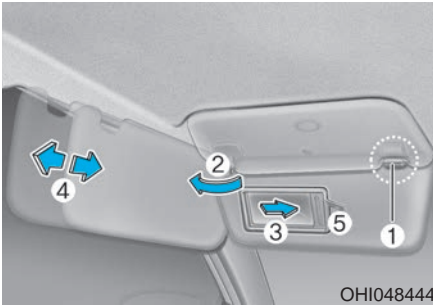

To use the sunvisor, pull it downward. To use the sunvisor to block the sun from the side window, pull it downward, release it from the bracket (1) and swing it to the side towards the window (2).

To use the vanity mirror, pull down the sunvisor and slide the mirror cover (3).

Adjust the sunvisor forward or backward (4) as needed. Use the ticket holder (5) to hold tickets.

Close the vanity mirror cover securely and return the sunvisor to its original position after use.

WARNING

For your safety, do not block your view when using the sunvisor.

NOTICE

Do not put several tickets in the ticket holder at one time. This could cause damage to the ticket holder.

Rear Mirror (if equipped)

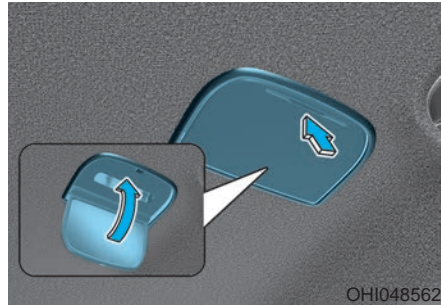

To open:

Press the cover and it will slowly open and the mirror lamp will turn ON.

To close:

Push back into position.

NOTICE

Make sure to close the rear mirror cover after use. If not, the rear mirror lamp remains ON, possibly draining the battery or damaging the rear mirror.

Power Outlet (if equipped)

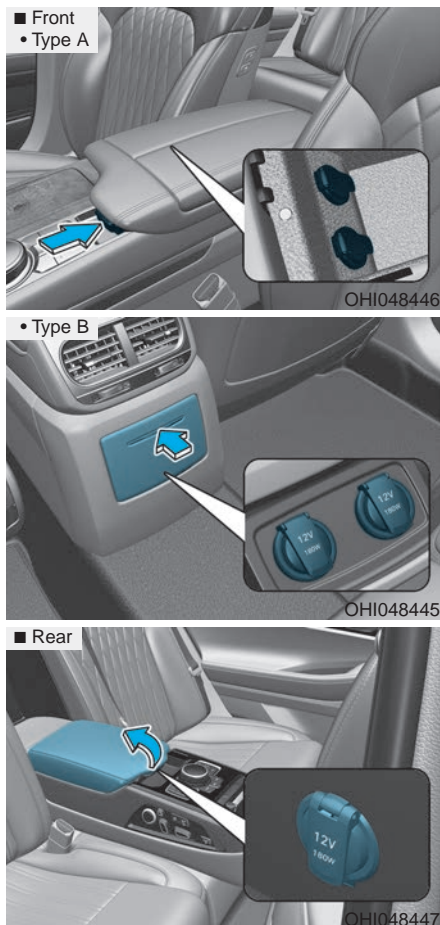

The power outlet is designed to provide power for mobile telephones or other devices designed to operate with vehicle electrical systems. The devices should draw less than 180 W (Watts) with the engine running.

⚠ WARNING

Avoid electrical shocks. Do not place your fingers or foreign objects (pin, etc.) into a power outlet or touch the power outlet with wet hands.

NOTICE

To prevent damage to the Power Outlets :

- Use the power outlet only when the engine is running and remove the accessory plug after use. Using the accessory plug for prolonged periods of time with the engine off could cause the battery to discharge.
- Only use 12V electric accessories which are less than 180 W (Watts) in electric capacity.
- Adjust the air-conditioner or heater to the lowest operating level when using the power outlet.
- Close the cover when not in use.
- Some electronic devices can cause electronic interference when plugged into a vehicle's power outlet. These devices may cause excessive audio static and malfunctions in other electronic systems or devices used in your vehicle.
- Push the plug in as far as it will go. If good contact is not made, the plug may overheat and the fuse may open.
- Plug in battery equipped electrical/electronic devices with reverse current protection. The current from the battery may flow into the vehicle's electrical/electronic system and cause system malfunction.

USB Charger (if equipped)

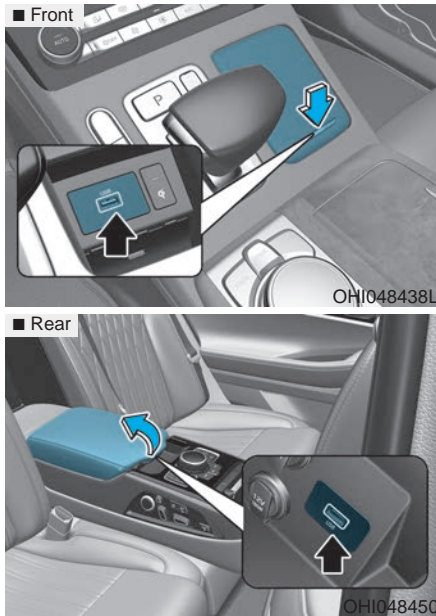

- A smart phone or a tablet PC, which adopts a different re-charging method, may not be properly re-charged. In this case, use an exclusive charger of your device.

The USB charger is designed to recharge batteries of small size electrical devices using a USB cable.

The electrical devices can be recharged when the Engine Start/Stop button is in the ACC, ON or START position.

Insert the USB charger into the USB port, and re-charge a smart phone or a tablet PC.

The battery charging state may be monitored on the electrical device.

Disconnect the USB cable from the USB port after use.

- A smart phone or a tablet PC may get warmer during the re-charging process. It does not indicate any malfunction with the charging system.

Wireless Cellular Phone Charging System (if equipped)



On certain models, the vehicle comes equipped with a wireless cellular phone charger.

The system is available when all doors are closed, and when the Engine Start/Stop button is in the ACC, ON or START position.

To charge a cellular phone

The wireless cellular phone charging system charges only the Qi-enabled cellular phones (). Read the label on the cellular phone accessory cover or visit your cellular phone manufacturer's website to check whether your cellular phone supports the Qi technology.

The wireless charging process starts when you put a Qi-enabled cellular phone on the wireless charging unit.

1. Remove other items, including the smart key, from the wireless charging unit. If not, the wireless charging process may be interrupted. Place the cellular phone on the center of the charging pad ().
2. The indicator light is orange when the cellular phone is charging. The indicator light turns green when phone charging is complete.

3. You can turn ON or OFF the wireless charging function from the Settings menu in the AVN system screen. Select:

- Setup → Vehicle Settings → Convenience → Wireless Charging

For detailed information, scan the QR code in a separately supplied simple manual.

If your cellular phone is not charging:

- Slightly change the position of the cellular phone on the charging pad.
- Make sure the indicator light is orange.

The indicator light will blink orange for 10 seconds if there is a malfunction in the wireless charging system.

In this case, temporarily stop the charging process, and re-attempt to charge your cellular phone again.

The system warns you with a message on the LCD display if the cellular phone is still on the wireless charging unit after the engine is turned OFF and the front door is opened.

For some manufacturers' cellular phones, the system may not warn you even though the cellular phone is left on the wireless charging unit. This is due to the particular characteristic of the cellular phone and not a malfunction of the wireless charging.

NOTICE

- The wireless cellular phone charging system may not support certain cellular phones, which are not verified for the Qi specification (Qi).
 - When placing your cellular phone on the charging mat, position the phone in the middle of the mat for optimal charging performance. If your cell phone is off to the side, the charging rate may be less and in some cases the cell phone may experience higher heat conduction.
 - In some cases, the wireless charging may stop temporarily when the Remote Key or Smart Key is used, either when starting the vehicle or locking/unlocking the doors, etc.
 - When charging certain cellular phones, the charging indicator may not change to green when the cell phone is fully charged.
 - The wireless charging process may temporarily stop, when temperature abnormally increases inside the wireless cellular phone charging system. Stop the charging cellular phone and wait until temperature falls to a certain level.
 - The wireless charging process may temporarily stop when there is any metallic item, such as a coin, between the wireless cellular phone charging system and the cellular phone.
 - When charging some cellular phones with a self-protection feature, the wireless charging speed may decrease and the wireless charging may stop.
- If the cellular phone has a thick cover, the wireless charging may not be possible.
 - If the cellular phone is not completely contacting the charging pad, wireless charging may not operate properly.
 - Some magnetic items like credit cards, phone cards or rail tickets may be damaged if left with the cellular phone during the charging process.
 - When any cellular phone without a wireless charging function or a metallic object is placed on the charging pad, a small noise may sound. This small sound is due to the vehicle discerning compatibility of the object placed on the charging pad. It does not affect your vehicle or the cellular phone in any way.

i Information

If the Engine Start/Stop button is in the OFF position, the charging also stops.

i Information

This device complies with part 15 of the FCC Rules.

Operation is subject to the following two conditions:

1. This device may not cause harmful interference, and
2. This device must accept any interference received, including interference that may cause undesired operation.

Coat hook

■ Type A



■ Type B

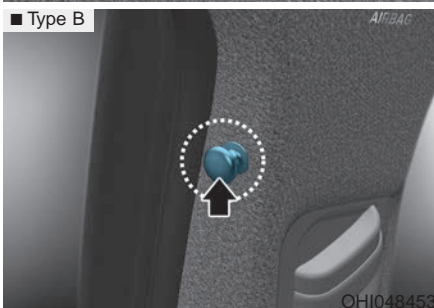

These hooks are not designed to hold large or heavy items.

⚠ WARNING



Do not hang other objects such as hangers or hard objects except clothes. Also, do not put heavy, sharp or breakable objects in the clothes pockets. In an accident or when the curtain air bag is inflated, it may cause vehicle damage or personal injury.

Clock

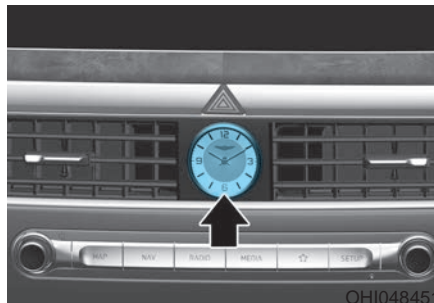

You can set the clock by using the AVN System.

For detailed information, scan the QR code in a separately supplied simple manual.

⚠ WARNING

Do not adjust the clock while driving. You may lose your steering control and cause an accident that results in severe personal injury.

Bag Hanger



Pull the strap (1) to hang a bag on the hook (2). Fold the hook when not in use.

NOTICE

Do not hang items that weigh over 22 lbs. (10 kg).

Floor Mat Anchor(s)

ALWAYS use the Floor Mat Anchors to attach the front floor mats to the vehicle. The anchors on the front floor carpet keep the floor mats from sliding forward.

! WARNING

The following must be observed when installing ANY floor mat to the vehicle.

- Ensure that the floor mats are securely attached to the vehicle's floor mat anchor(s) before driving the vehicle.
- Do not use ANY floor mat that cannot be firmly attached to the vehicle's floor mat anchors.
- Do not stack floor mats on top of one another (e.g. all-weather rubber mat on top of a carpeted floor mat). Only a single floor mat should be installed in each position.

IMPORTANT - Your vehicle was manufactured with driver's side floor mat anchors that are designed to securely hold the floor mat in place. To avoid any interference with pedal operation, Genesis Branded Vehicle recommends that the Genesis floor mat designed for use in your vehicle be installed.

Rear Window Sunshade

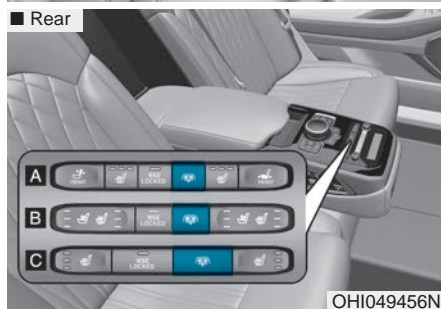
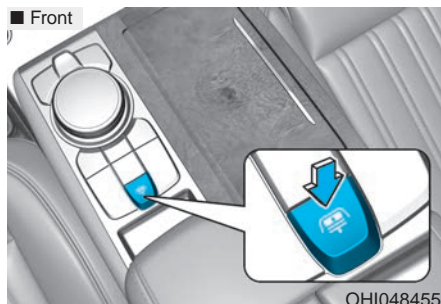

[A] : Type A, [B] : Type B, [C] : Type C

- To raise or lower the sunshade, press the button.

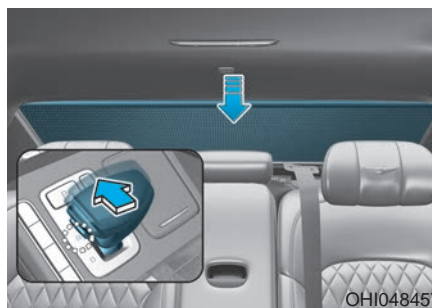

- The rear window sunshade will be lowered automatically when the vehicle is shifted to R (Reverse) and raised automatically when the vehicle is shifted from R (Reverse) to P (Park).
- After the rear window sunshade is lowered by shifting the vehicle to R (Reverse), if you drive more than 12 mph (20 km/h) with the shift lever in D (Drive), the rear window sunshade will be raised automatically.

NOTICE

Do not apply excessive force while operating the rear window sunshade. This could cause damage to the rear window sunshade.

Rear Side Window Sunshade

■ Driver's window switch



■ Rear window switch

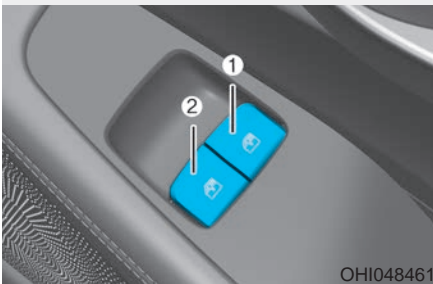

[1] : Right side, [2] Left side

For each of the rear doors, you can fold or unfold the rear side window sunshade by using the power window switch on each rear door. Both rear sunshades can also be operated from the switches on the driver's door.

To unfold:

1. Close the window by pulling up the switch.
2. To unfold the curtain, pull up the switch once more.

To fold:

1. If you want to open the shaded window, push down the switch one time to store the sunshade.
2. Push down the switch one more time to open the window.

i Information

If the upward or downward movement of the sunshade is blocked by an object or part of the body, the sunshade will detect the resistance and will stop movement and move downward or upward.

To reset the rear side window sunshades

If the sunshade is not operating normally, it must be reset as follows:

1. Start the engine.
2. Continue pulling up on the power window switch for at least 10 seconds.

If the rear side window sunshade does not work properly after following the above procedure, it is recommended that the system be checked by an authorized retailer of Genesis Branded products.

NOTICE

Do not apply excessive external force on the rear side window sunshade while operating. It may cause a malfunction.

Luggage Net Holder

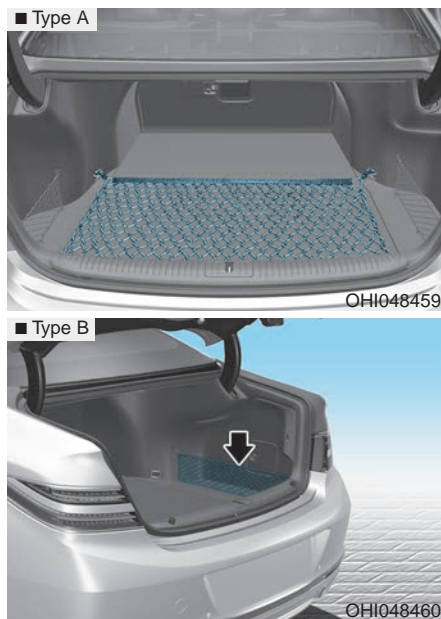

To help items from shifting in the trunk, you can use the holders located in the trunk to attach the luggage net.

Make sure the luggage net is securely attached to the holders in the trunk.

WARNING

Avoid eye injury. DO NOT overstretch the luggage net. ALWAYS keep your face and body out of the luggage net's recoil path. DO NOT use the luggage net when the strap has visible signs of wear or damage.

4. Multimedia System

Multimedia System	4-2
USB Port	4-2
Antenna	4-3
Steering Wheel Audio Control	4-4
DIS Navigation System	4-5
DVD Player	4-5
Bluetooth® Wireless Technology	4-6

MULTIMEDIA SYSTEM

NOTICE

- If you install an aftermarket HID head lamp, your vehicle's audio and electronic devices may not function properly.
- Prevent chemicals such as perfume, cosmetic oil, sun cream, hand cleaner, and air freshener from contacting the interior parts because they may cause damage or discoloration.

USB Port

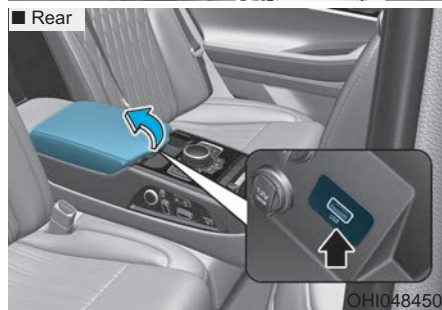
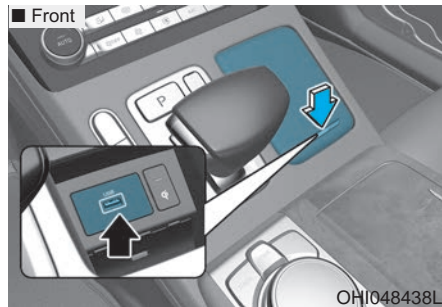

You can use a USB cable to connect audio devices to the vehicle USB port.

i Information

When using a portable audio device connected to the power outlet, noise may occur during playback. If this happens, use the power source of the portable audio device.

Antenna

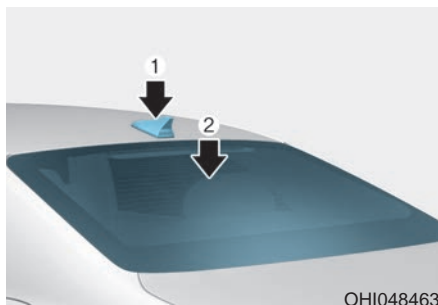

Combination antenna (1)

The combination antenna will receive AM, FM broadcast and SXM channel signals and transmit data.

Glass antenna (2)

Your vehicle uses a glass antenna to receive both AM and FM signals.

NOTICE

- Do not clean the inside of the rear window glass with a cleaner or scraper to remove foreign deposits as this may cause damage to the antenna elements.
- To prevent damage to the rear glass antenna, never use sharp instruments or window cleaner containing abrasives to clean the window. Clean the inside surface of the rear glass window with a piece of soft cloth.
- Avoid adding metallic coatings such as Ni, Cd, etc. These can degrade the receiving AM and FM broadcast signals.
- When putting a sticker on the inside surface of the rear window, be careful not to damage the rear glass antenna.
- Do not put sharp instruments nearby the rear glass antenna.

Steering Wheel Remote Control



NOTICE

Do not operate multiple audio remote control switches simultaneously.

VOLUME (VOL + / -) (1)

- Rotate the VOLUME scroll up to increase volume.
- Rotate the VOLUME scroll down to decrease volume.

SEEK/PRESET (^ / v) (2)

When shortly pressed (under 0.8 seconds)

- SXM/FM/AM: plays broadcast frequencies saved to presets.
- Media mode: plays previous/next file.

When pressed and held (over 0.8 seconds)

- SXM/FM/AM: changes the broadcast frequencies or channels until the button is released.
- Media mode: rewinds or fast forwards the file.

MODE (3)

- Press the MODE button to toggle through Radio/Media modes. Only active/available media can be accessed.
- Press and hold the button to turn AV ON/OFF.

MUTE () (4)

- Press the MUTE button to mute the sound.
- Press the MUTE button again to activate the sound.

Voice recognition () (5)

Press to activate voice recognition

For detailed information, scan the QR code in a separately supplied simple manual.

AVN (Audio / Video / Navigation) System

■ Front switch

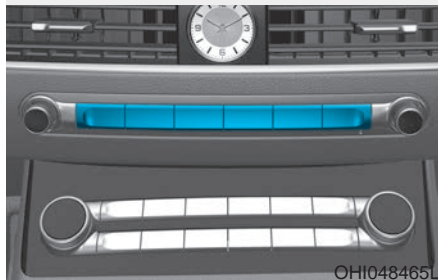

■ Center control panel

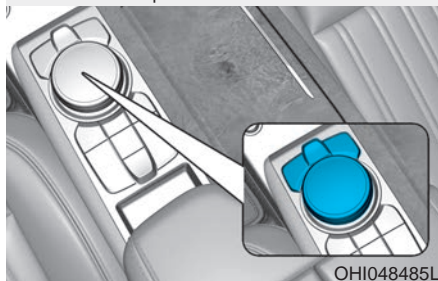

■ Rear remote switch



For detailed information, scan the QR code in a separately supplied simple manual.

DVD Player (if equipped)

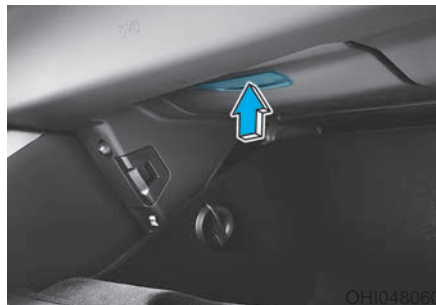

The DVD player is installed in the glove box. If you press the left upper side in the glove box, the DVD slot will come down.

For detailed information, scan the QR code in a separately supplied simple manual.

i Information

Video is not available while driving. Video is only available when the vehicle is stopped and the gear is shifted to P (Park).

Bluetooth® Wireless Technology

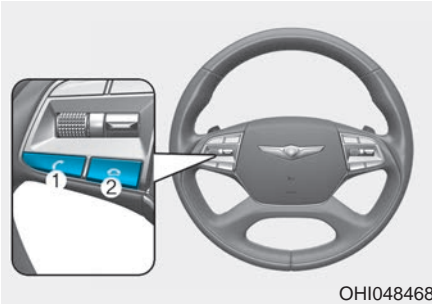

- (1) Call / Answer button
- (2) Call end button
- (3) Microphone

For detailed information, scan the QR code in a separately supplied simple manual.

 **CAUTION**

To avoid driver distractions, do not excessively operate the device while driving the vehicle which may lead to an accident.

5. Driving Your Vehicle

Before Driving	5-4	Genesis adaptive control	
Before Entering the Vehicle	5-4	suspension	5-44
Before Starting	5-4	Electronic Control Suspension	
Engine Start/Stop Button	5-6	(ECS)	5-44
Engine Stop/Start Button		Dynamic Stability Damping	
Positions	5-7	Control (DSDC)	5-44
Starting the Engine	5-8	Drive Mode Integrated Control	
Turning Off the Engine	5-9	System	5-45
Automatic Transmission.....	5-10	Drive Mode	5-45
Automatic Transmission		Coasting	5-49
Operation	5-10	Coasting Setting	5-49
Shift-lock System.....	5-14	Coasting Operating Conditions	5-49
When the Battery is Discharged.....	5-14	Coasting Release Conditions.....	5-50
Parking	5-15	Forward Collision-Avoidance Assist	
Paddle Shifter		(FCA) System - Sensor Fusion Type	
(Manual Shift Mode)	5-15	(Front Radar + Front Camera)	5-51
LCD Display Messages	5-16	System Setting and Operation	5-51
Good Driving Practices	5-19	FCA Warning Message and Brake	
Braking System	5-21	Control	5-53
Power Brakes	5-21	FCA Sensor (Front Radar/	
Disc Brakes Wear Indicator	5-22	Front Camera)	5-56
Electronic Parking Brake (EPB).....	5-22	System Malfunction	5-58
Auto Hold	5-27	Limitations of the System.....	5-59
Anti-lock Brake System (ABS)	5-31	Forward Collision-Avoidance	
Electronic Stability Control		Assist - Lane-Change Oncoming	
(ESC)	5-33	Function	5-66
Vehicle Stability Management		System Setting and Operation.....	5-66
(VSM).....	5-36	Limitations of the System.....	5-67
Hill-Start Assist Control (HAC)	5-37	Blind-Spot Collision Warning	
Good Braking Practices	5-38	(BCW)/Blind-Spot Collision-	
All Wheel Drive (AWD).....	5-39	Avoidance Assist (BCA)	5-68
Using All Wheel Drive (AWD)	5-39	System Description.....	5-68
Emergency Precautions	5-42	System Setting and Operation.....	5-69
		Warning and System Control	5-72

5. Driving Your Vehicle

- Detecting Sensor
 (Camera and Radar)5-75
- System Malfunction.....5-77
- Limitations of the System5-78
- Rear Cross-Traffic Collision
Warning (RCCW)/Rear
Cross-Traffic Collision-Avoidance
Assist (RCCA)5-82
 - System Description5-82
 - System Setting and Operation.....5-83
 - Warning and System Control5-85
 - Detecting Sensor5-88
 - System Malfunction5-89
 - Limitations of the System5-90
- Smart Cruise Control With Stop &
Go System5-95
 - Smart Cruise Control Switch5-96
 - Adjusting the Sensitivity of Smart
 Cruise Control5-97
 - Converting to Cruise Control
 Mode5-97
 - Smart Cruise Control Speed5-98
 - Smart Cruise Control Vehicle-to-
 Vehicle Distance5-103
 - Sensor to Detect Distance to the
 Vehicle Ahead5-106
 - System Malfunction5-107
 - Limitations of the System5-108
- Leading Vehicle Departure
Alert5-113
 - System Setting and Operation.....5-113
- Navigation-Based Smart Cruise
Control5-114
 - System Setting and Operation.....5-115
- Lane Following Assist (LFA)
System5-118
 - LFA Setting and Operation.....5-119
 - Warning Message5-120
 - Limitations of the System5-122
- Lane Keeping Assist (LKA)
System5-124
 - LKA operation.....5-125
 - Warning Light and Message5-127
 - Limitations of the System5-129
 - LKA System Setting5-131
- Highway Driving Assist (HDA)
System5-132
 - System Setting and Operation5-133
 - Warning Message.....5-135
- Driver Attention Warning (DAW)
System5-138
 - System Setting and Operation5-138
 - Resetting the System5-140
 - System Standby5-140
 - System Malfunction.....5-140
- Special Driving Conditions5-142
 - Hazardous Driving Conditions5-142
 - Rocking the Vehicle5-142
 - Smooth Cornering5-143
 - Driving at Night5-143
 - Driving in the Rain5-143
 - Driving in Flooded Areas5-144
 - Highway Driving.....5-144
- Winter Driving5-145
 - Snow or Icy Conditions5-145
 - Winter Precautions.....5-147
- Vehicle Load Limit5-149
 - Tire Loading Information Label ..5-150
- Trailer Towing5-154

⚠ WARNING**Carbon monoxide (CO) gas is toxic. Breathing CO can cause unconsciousness and death.**

Engine exhaust contains carbon monoxide which cannot be seen or smelled.

Do not inhale engine exhaust.

If at any time you smell engine exhaust inside the vehicle, open the windows immediately. Exposure to CO can cause unconsciousness and death by asphyxiation.

Be sure the exhaust system does not leak.

The exhaust system should be checked whenever the vehicle is raised to change the oil or for any other purpose. If you hear a change in the sound of the exhaust or if you drive over something that strikes the underneath side of the vehicle, have the exhaust system checked as soon as possible by an authorized retailer of Genesis Branded products.

Do not run the engine in an enclosed area.

Letting the engine idle in your garage, even with the garage door open, is a hazardous practice. Run the engine only long enough to start the engine and to move the vehicle out of the garage.

Avoid idling the engine for prolonged periods with people inside the vehicle.

If it is necessary to idle the engine for a prolonged period with people inside the vehicle, be sure to do so only in an open area with the air intake set at "Fresh" and fan control set to high so fresh air is drawn into the interior.

Keep the air intakes clear.

To assure proper operation of the ventilation system, keep the ventilation air intakes located in front of the windshield clear of snow, ice, leaves, or other obstructions.

If you must drive with the trunk open:

Close all windows.

Open instrument panel air vents.

Set the air intake control at "Fresh", the air flow control at "Floor" or "Face", and the fan control set to high.

 **WARNING**

**CALIFORNIA PROPOSITION 65
WARNING**

Engine exhaust and a wide variety of automobile components including components found in the interior furnishings in a vehicle, contain or emit harmful chemicals known to the State of California to cause cancer and birth defects and reproductive harm. In addition, certain fluids contained in vehicles and certain products of components contain or emit chemicals known to the State of California to cause cancer and birth defects or other reproductive harm.

BEFORE DRIVING

Before Entering the Vehicle

- Be sure all windows, outside mirror(s), and outside lights are clean and unobstructed.
- Remove frost, snow, or ice.
- Visually check the tires for uneven wear and damage.
- Check under the vehicle for any sign of leaks.
- Be sure there are no obstacles behind you if you intend to back up.

Before Starting

- Make sure the hood, the trunk, and the doors are securely closed and locked.
- Adjust the position of the seat and steering wheel.
- Adjust the inside and outer side view mirrors.
- Verify all the lights work.
- Fasten your seatbelt. Check that all passengers have fastened their seatbelts.
- Check the gauges and indicators in the instrument panel and the messages on the instrument display when the ignition switch is in the ON position.
- Check that any items you are carrying are stored properly or fastened down securely.

⚠ WARNING

To reduce the risk of **SERIOUS INJURY** or **DEATH**, take the following precautions:

- **ALWAYS** wear your seat belt. All passengers must be properly belted whenever the vehicle is moving. For more information, refer to "Seat Belts" in chapter 2.
- Always drive defensively. Assume other drivers or pedestrians may be careless and make mistakes.
- Stay focused on the task of driving. Driver distraction can cause accidents.
- Leave plenty of space between you and the vehicle in front of you.

⚠ WARNING

NEVER drink or take drugs and drive.

Drinking or taking drugs and driving is dangerous and may result in an accident and **SERIOUS INJURY** or **DEATH**.

Drunk driving is the number one contributor to the highway death toll each year. Even a small amount of alcohol will affect your reflexes, perceptions and judgment. Just one drink can reduce your ability to respond to changing conditions and emergencies and your reaction time gets worse with each additional drink.

Driving while under the influence of drugs is as dangerous or more dangerous than driving under the influence of alcohol.

You are much more likely to have a serious accident if you drink or take drugs and drive. If you are drinking or taking drugs, don't drive. Do not ride with a driver who has been drinking or taking drugs. Choose a designated driver or call a taxi.

ENGINE START/STOP BUTTON



Whenever the front door is opened, the Engine Start/Stop button will illuminate and will go off 30 seconds after the door is closed.

⚠ WARNING

To reduce risk of serious injury or death, **NEVER** allow children or any person who is unfamiliar with the vehicle to touch the Engine Start/Stop button or related parts. Unexpected and sudden vehicle movement can occur.

⚠ WARNING

To turn the engine off in an emergency:

Press and hold the Engine Start/Stop button for more than two seconds **OR** rapidly press and release the Engine Start/Stop button three times (within three seconds).

If the vehicle is still moving, you can restart the engine without depressing the brake pedal by pressing the Engine Start/Stop button with the shift lever in the N (Neutral) position.

⚠ WARNING

- **NEVER** press the Engine Start/Stop button while the vehicle is in motion except in an emergency. This will result in the engine turning off and loss of power assist for the steering and brake systems.

This may lead to loss of directional control and braking function, which could cause an accident.

- Before leaving the driver's seat, always make sure to press the P button to shift to P (Park), set the parking brake, press the Engine Start/Stop button to the OFF position, and take the Smart Key with you. Unexpected vehicle movement may occur if these precautions are not followed.

- **NEVER** reach through the steering wheel for the Engine Start/Stop button or any other control while the vehicle is in motion. The presence of your hand or arm in this area may cause a loss of vehicle control resulting in an accident.

Engine Stop/Start Button Positions

OFF

To turn off the engine, press the Engine Start/Stop button with the vehicle shifted to P (Park).

Note if the Engine Start/Stop button is pressed with the vehicle shifted to D (Drive) or R (Reverse), the vehicle will automatically shift to P (Park).

If the Engine Start/Stop button is pressed with the vehicle shifted to N (Neutral), the Engine Start/Stop button will go to the ACC position.

ACC

Press the Engine Start/Stop button when the button is in the OFF position without depressing the brake pedal.

Some of the electrical accessories are usable. The steering wheel unlocks.

i Information

If you leave the Engine Start/Stop button in the ACC position for more than one hour, the battery power will turn off automatically to prevent the battery from discharging.

ON

Press the Engine Start/Stop button while it is in the ACC position without depressing the brake pedal.

The warning lights can be checked before the engine is started.

i Information

Do not leave the Engine Start/Stop button in the ON position when the engine is not running to prevent the battery from discharging.

START

To start the engine, depress the brake pedal and press the Engine Start/Stop button with the vehicle shifted to the P (Park) or the N (Neutral) position.

For your safety, start the engine with the vehicle shifted to the P (Park) position.

i Information

If you press the Engine Start/Stop button without depressing the brake pedal, the engine does not start and the Engine Start/Stop button changes as follows:

OFF → ACC → ON → OFF

However, the engine may start if you depress the brake pedal within 0.5 second after pressing the Engine Start/Stop button from the OFF position.

Starting the Engine

WARNING

- Always wear appropriate shoes when operating your vehicle. Unsuitable shoes, such as high heels, ski boots, sandals, flip-flops, etc., may interfere with your ability to use the brake and accelerator pedals.
- Do not start the vehicle with the accelerator pedal depressed. The vehicle can move which can lead to an accident.
- Wait until the engine rpm is normal. The vehicle may suddenly move if the brake pedal is released when the rpm is high.

Information

- The engine will start by pressing the Engine Start/Stop button, only when the smart key is in the vehicle. Even if the smart key is in the vehicle, if it is far away from the driver, the engine may not start.
- When the Engine Start/Stop button is in the ACC, ON and START position, if any door is open, the system checks for the smart key. If the smart key is not in the vehicle, the warning "Key not in vehicle" will come on and if all doors are closed, the chime will also sound for about 5 seconds. Keep the smart key in the vehicle.

1. Always carry the smart key with you.
2. Make sure the parking brake is applied.
3. Make sure the vehicle is shifted to P (Park) by pressing the P button.
4. Depress the brake pedal.
5. Press the Engine Start/Stop button.

Information

- Do not wait for the engine to warm up while the vehicle remains stationary. Start driving at moderate engine speeds. (Steep accelerating and decelerating should be avoided.)
- Always start the vehicle with your foot on the brake pedal. Do not depress the accelerator while starting the vehicle. Do not race the engine while warming it up.

NOTICE

To prevent damage to the vehicle:

- If the engine stalls while you are in motion, do not attempt to shift the gear to the P (Park) position. If traffic and road conditions permit, you may put the shift lever in the N (Neutral) position while the vehicle is still moving and press the Engine Start/Stop button in an attempt to restart the engine.
- Do not push or tow your vehicle to start the engine.

NOTICE

To prevent damage to the vehicle:

When the stop lamp fuse is blown, you can't start the engine normally. Replace the fuse with a new one. If you are not able to replace the fuse, you can start the engine by pressing and holding the Engine Start/Stop button for 10 seconds with the Engine Start/Stop button in the ACC position.

Do not press the Engine Start/Stop button for more than 10 seconds except when the stop lamp fuse is blown.

For your safety always depress the brake pedal before starting the engine.

**i** Information

If the smart key battery is weak or the smart key does not work correctly, you can start the engine by pressing the Engine Start/Stop button with the smart key in the direction of the picture above.

Turning Off the Engine

1. Stop the vehicle and depress the brake pedal fully.
2. Press the P button to shift to P (Park).
3. Press the Engine Start/Stop button to the OFF position and apply the parking brake.

AUTOMATIC TRANSMISSION

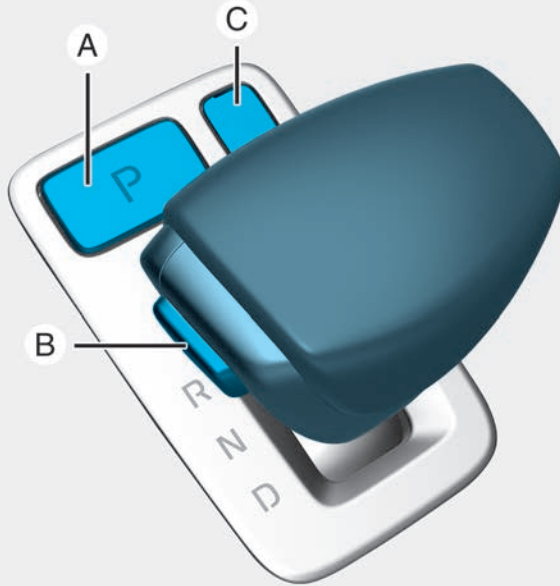

When you move the shift lever, depress the brake pedal while pressing the UNLOCK button.

OHI058010L

[A] : P button, [B] : UNLOCK button, [C] : P release button

Automatic Transmission Operation

The automatic transmission has eight forward speeds and one reverse speed. The individual speeds are selected automatically in the D (Drive) position.

⚠ WARNING

To reduce the risk of serious injury or death:

- **ALWAYS** check the surrounding areas near your vehicle for people, especially children, before shifting a vehicle into D (Drive) or R (Reverse).
- Before leaving the driver's seat, always make sure the the vehicle is shifted to the P (Park) position, then apply the parking brake, and place the Engine Start/Stop button in the OFF position. Unexpected and sudden vehicle movement can occur if these precautions are not followed.
- When using the paddle shifter (manual shift mode), do not use engine braking (shifting from a high gear to lower gear) rapidly on slippery roads. The vehicle may slip causing an accident.

Transmission ranges

The indicator in the instrument cluster displays the gear position when the Engine Start/Stop button is in the ON position.

P (Park)

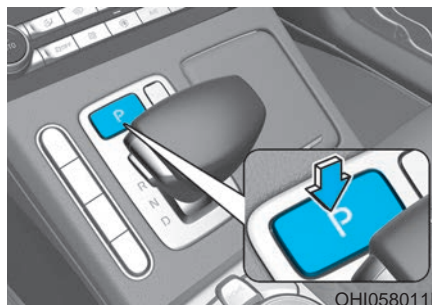

Always come to a complete stop before shifting into P (Park).

To shift the gear from R (Reverse), N (Neutral), D (Drive) or Manual mode to P (Park), press the P button.

If you turn off the engine in D (Drive), R (Reverse) or Manual shift mode the shifting automatically changes to P (Park).

When you park the vehicle, press the P button while depressing the brake pedal and then apply the parking brake.

⚠ WARNING

- **Shifting into P (Park) while the vehicle is in motion may cause you to lose control of the vehicle.**
- **After the vehicle has stopped, always make sure the vehicle is in P (Park), apply the parking brake, and turn the engine off.**
- **When parking on an incline, shift the gear to P (Park) and apply the parking brake to prevent the vehicle from rolling downhill.**

R (Reverse)

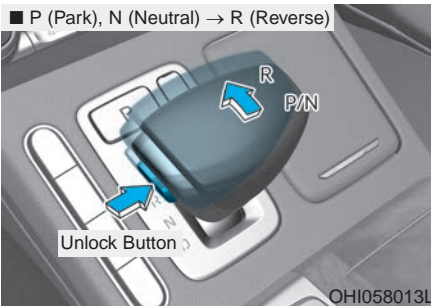
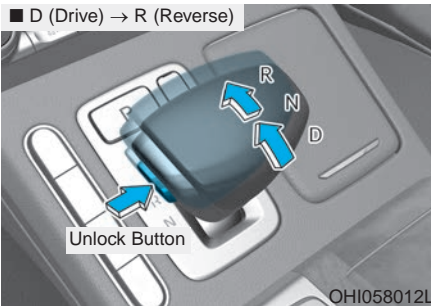

Use this position to drive the vehicle rearward.

To move the shift lever to R (Reverse), press the UNLOCK button while depressing the brake pedal and then move the shift lever forward.

N (Neutral)

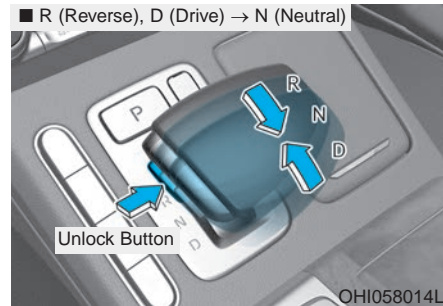

The wheels and transmission are not engaged.

Use N (Neutral) if you need to restart a stalled engine.

Shift into P (Park) if you need to leave your vehicle for any reason.

Always depress the brake pedal when you are shifting from N (Neutral) to another gear.

In N (Neutral), if the driver attempts to turn off the engine, the transmission remains in the N (Neutral) position and the Engine Start/Stop button will be in the ACC position.

To turn off the engine from the ACC position, press the Engine Start/Stop button to the ON position, press the P button, and then press the Engine Start/Stop button to the OFF position.

When either the driver's door or the front passenger's door is opened with the Engine Start/Stop button in the ACC position and the shift lever in N (Neutral) position, the engine is automatically turned OFF and the transmission automatically changes to the P (Park) position.

⚠ WARNING

Do not drive with the shift lever in N (Neutral). If the shift lever is moved to N (Neutral) while driving, the vehicle loses the ability to provide engine braking. Doing so may increase the risk of an accident.

Also, moving the shift lever back to D (Drive) while the vehicle is moving may severely damage the transmission.

D (Drive)

This is the normal driving position. The transmission will automatically shift through an 8-gear sequence, providing the best fuel economy and power.

For extra power when passing another vehicle or driving uphill, depress the accelerator pedal further until you feel the transmission downshift to a lower gear.

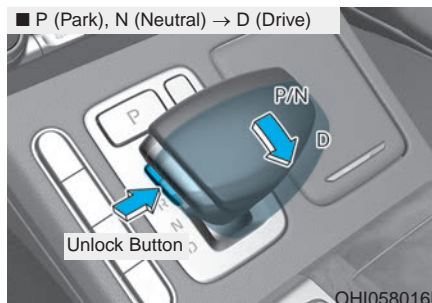
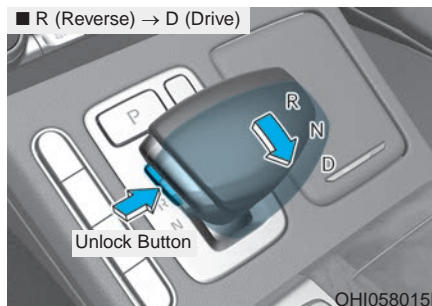

To shift into D (Drive), depress the brake pedal and press the UNLOCK button on the shift lever. Move the shift lever rearward.

To shift into D (Drive) from N (Neutral), you must depress the brake pedal.

NOTICE

Always come to a complete stop before shifting into D (Drive).

Shift-lock System

For your safety, the automatic transmission has a shift-lock system which prevents shifting the transmission from P (Park) into R (Reverse) or D (Drive) unless the UNLOCK button is pressed while depressing the brake pedal.

To shift from P (Park) into R (Reverse) or D (Drive):

1. Depress and hold the brake pedal.
2. Start the engine or place the Engine Start/Stop button in the ON position.
3. Move the shift lever to R (Reverse) or D (Drive) while pressing the UNLOCK button.

When the Battery is Discharged



You cannot move the shift lever, when the battery is discharged.

In emergencies, do the following to move the shift lever to N (Neutral) on a level ground.

1. Connect the battery cables from another vehicle or from a another battery to the jump-starting terminals inside the engine compartment.

For more details, refer to "Jump Starting" in chapter 6.

2. Release the parking brake with the Engine Start/Stop button in the ON position.
3. Press the Engine Start/Stop button to the OFF position.
4. Remove the cap-cover (1) and press the P release button (2) while depressing the brake pedal. Then, the gear will change to the N (Neutral) position. The button (2) operates only for 20 seconds to change the gear between P (Park) and N (Neutral) from the time when the button (2) is first pressed.

i Information

In situations when the gear needs to be shifted from P (Park) to N (Neutral) when the Engine Start/Stop button is in the OFF position, refer to step 4.

Parking

Always come to a complete stop and continue to depress the brake pedal. Shift the vehicle into the P (Park) position, apply the parking brake, and place the Engine Start/Stop button in the OFF position. Take the Key with you when exiting the vehicle.

! WARNING

- **When you stay in the vehicle with the engine running, be careful not to depress the accelerator pedal for a long period of time. The engine or exhaust system may overheat and start a fire.**
- **The exhaust gas and the exhaust system are very hot. Keep away from the exhaust system components.**
- **Do not stop or park over flammable materials, such as dry grass, paper or leaves. They may ignite and cause a fire.**

Paddle Shifter (Manual Shift Mode)

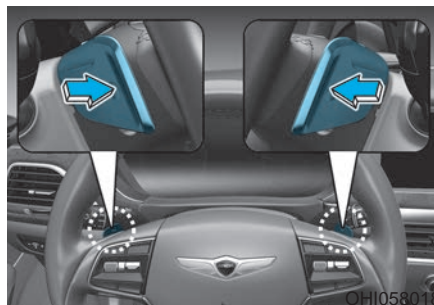

The paddle shifter is available when the shift lever is in the D (Drive) position.

Pull the [+] or [-] paddle shifter once to shift up or down one gear and the system changes from automatic shift mode to manual shift mode.

To change back to the automatic shift mode from manual shift mode, do one of the following:

- Move the shift lever down toward the D (Drive) position.
- Gently depress the accelerator pedal for more than 5 seconds.
- Drive the vehicle under 4 mph (7 km/h).
- Pull and hold the right side paddle shifter.

i Information

If the [+] and [-] paddle shifters are pulled at the same time, gear shift may not occur.

LCD Display Messages

Shifter system malfunction



OH1048134L

The message appears on the cluster LCD display when the transmission or the shift lever does not properly operate in the P (Park) position.

Immediately have the vehicle inspected by an authorized retailer of Genesis Branded products.

Check shift lever



OH1048133L

The message appears on the cluster LCD display when there is a malfunction with one of the key transmission shifter components.

Immediately have the vehicle inspected by an authorized retailer of Genesis Branded products.

Shifting conditions not met



OH1058019L

The message appears on the cluster LCD display when engine rpm is too high, or when driving speed is too fast to shift the gear.

Decrease the vehicle speed or slow down before shifting the gear.

Press brake pedal to change gear



OH1058222L

The message appears on the cluster LCD display when the brake pedal is not depressed while shifting the gear.

Depress the brake pedal and then shift the gear.

Shift to P after stopping

The message appears on the cluster LCD display when the gear is shifted to P (Park) while the vehicle is moving.

Stop the vehicle before shifting to P (Park).

Check P button

The message appears on the cluster LCD display when there is problem with the P button.

Immediately have the vehicle inspected by an authorized retailer of Genesis Branded products.

Press P for park

The message appears on the cluster LCD display to inform the driver to press the P button to shift to P (Park) when the driver moves the shift lever upward even though the gear is in R (Reverse).

Press brake pedal, then press P RELEASE button

The message appears on the cluster LCD display when the driver presses the P RELEASE button without depressing the brake pedal.

Depress the brake pedal before pressing the P RELEASE button.

Check P RELEASE button



The message appears on the cluster LCD display when there is problem with the P RELEASE button. Immediately have the vehicle inspected by an authorized retailer of Genesis Branded products.

PARK engaged



The message appears on the cluster LCD display when the P (Park) position is engaged.

Press UNLOCK to change gear



The message appears on the cluster LCD display when the UNLOCK button is not pressed while shifting the gear. Press the UNLOCK button and then shift the gear.

NEUTRAL engaged



The message appears on the cluster LCD display when the N (Neutral) position is engaged.

Good Driving Practices

- Never shift from P (Park) or N (Neutral) to any other position with the accelerator pedal depressed.
- Never shift into P (Park) when the vehicle is in motion.
Be sure the vehicle is completely stopped before you attempt to shift into R (Reverse) or D (Drive).
- Do not move the shift lever to N (Neutral) when driving. If the shift lever is moved to N (Neutral) while driving, the vehicle loses the ability to provide engine braking. Doing so may increase the risk of an accident.
- Do not drive with your foot resting on the brake pedal. Even light, but consistent pedal pressure can result in the brakes overheating, brake wear and possibly even brake failure.
- Depressing both accelerator and brake pedals at the same time can trigger logic for engine power reduction to assure vehicle deceleration. Vehicle acceleration will resume after the brake pedal is released.
- When driving in Manual shift mode with the paddle shifter, slow down before shifting to a lower gear. Otherwise, the lower gear may not be engaged if the engine rpms are outside of the allowable range.
- Always apply the parking brake when leaving the vehicle. Do not depend on placing the transmission in P (Park) to keep the vehicle from moving.
- Exercise extreme caution when driving on a slippery surface. Be especially careful when braking, accelerating or shifting gears. On a slippery surface, an abrupt change in vehicle speed can cause the drive wheels to lose traction and may cause loss of vehicle control resulting in an accident.
- Optimum vehicle performance and economy is obtained by smoothly depressing and releasing the accelerator.

 **WARNING**

To reduce the risk of **SERIOUS INJURY** or **DEATH**:

- **ALWAYS** wear your seat belt. In a collision, an unbelted occupant is significantly more likely to be seriously injured or killed than a properly belted occupant.
- Avoid high speeds when cornering or turning.
- Do not make quick steering wheel movements, such as sharp lane changes or fast, sharp turns.
- The risk of rollover is greatly increased if you lose control of your vehicle at highway speeds.
- Loss of control often occurs if two or more wheels drop off the roadway and the driver over steers to reenter the roadway.
- In the event your vehicle leaves the roadway, do not steer sharply. Instead, slow down before pulling back into the travel lanes.
- Genesis Branded Vehicle recommends you follow all posted speed limits.

 **Information - Kickdown Mechanism**

Use the kickdown mechanism for maximum acceleration. Depress the accelerator pedal beyond the pressure point. The automatic transmission will shift to a lower gear depending on the engine speed.

BRAKING SYSTEM

Power Brakes

Your vehicle has power-assisted brakes that adjust automatically through normal usage.

If the engine is not running or is turned off while driving, the power assist for the brakes will not work. You can still stop your vehicle by applying greater force to the brake pedal than typical. The stopping distance, however, will be longer than with power brakes.

When the engine is not running, the reserve brake power is partially depleted each time the brake pedal is applied. Do not pump the brake pedal when the power assist has been interrupted.

Pump the brake pedal only when necessary to maintain steering control on slippery surfaces.

WARNING

Take the following precautions:

- **Do not drive with your foot resting on the brake pedal. This will create abnormal high brake temperatures, excessive brake lining and pad wear, and increased stopping distances.**
- **When descending down a long or steep hill, move the gear shift lever to Manual Shift Mode and manually downshift to a lower gear in order to control your speed without using the brake pedal excessively. Applying the brakes continuously will cause the brakes to overheat and could result in a temporary loss of braking performance.**
- **Wet brakes may impair the vehicle's ability to safely slow down; the vehicle may also pull to one side when the brakes are applied. Applying the brakes lightly will indicate whether they have been affected in this way. Always test your brakes in this fashion after driving through deep water. To dry the brakes, lightly tap the brake pedal to heat up the brakes while maintaining a safe forward speed until brake performance returns to normal. Avoid driving at high speeds until the brakes function correctly.**

Disc Brakes Wear Indicator

When your brake pads are worn and new pads are required, you will hear a high pitched warning sound from your front or rear brakes. You may hear this sound come and go or it may occur whenever you depress the brake pedal.

Note that some driving conditions or climates may cause a brake squeal when you first apply (or lightly apply) the brakes. This is normal and does not indicate a problem with your brakes.

NOTICE

To avoid costly brake repairs, do not continue to drive with worn brake pads.

i Information

Always replace brake pads as complete front or rear axle sets.

Electronic Parking Brake (EPB)

Applying the parking brake



To apply the EPB (Electronic Parking Brake):

1. Depress the brake pedal.
2. Pull the EPB switch towards you.

Make sure the Parking Brake Warning Light comes on.

⚠ WARNING

To reduce the risk of SERIOUS INJURY or DEATH, do not operate the EPB while the vehicle is moving except in an emergency situation. It could damage the brake system and lead to an accident.

Releasing the parking brake



To release the EPB (Electronic Parking Brake):

- Place the Engine Start/Stop button in the ON or START position.
- Depress the brake pedal.
- Press the EPB switch.

Make sure the Parking Brake Warning Light goes off.

To release EPB (Electronic Parking Brake) automatically:

- Gear in P (Park)

With the engine running depress the brake pedal and shift out of P (Park) to R (Reverse) or D (Drive).
- Gear in N (Neutral)

With the engine running depress the brake pedal and shift out of N (Neutral) to R (Reverse) or D (Drive).
- Satisfy the following conditions
 1. Ensure seat belts are fastened and the doors, hood and trunk are closed.
 2. With the engine running, depress the brake pedal and shift out of P (Park) to R (Reverse), D (Drive) or Manual shift mode.
 3. Depress the accelerator pedal.

Make sure the Parking Brake Warning Light goes off.

i Information

- For your safety, you can engage the EPB even though the Engine Stop/Start button is in the OFF position (only if battery power is available), but you cannot release it.
- For your safety, depress the brake pedal and release the parking brake manually with the EPB switch when you drive downhill or when backing up the vehicle.

NOTICE

- If the parking brake warning light is still on even though the EPB has been released, have your vehicle checked by an authorized retailer of Genesis Branded products.
- Do not drive your vehicle with the EPB applied. It may cause excessive brake pad and brake rotor wear.

EPB (Electronic Parking Brake) may be automatically applied when:

- Requested by other systems
- The driver turns the engine off while Auto Hold is operating.

Warning messages



To release EPB, fasten seatbelt, close door, hood, and trunk

- If you try to drive with the EPB applied, a warning will sound and a message will appear.
- If the driver's seat belt is not fastened and the hood or trunk is opened, a warning will sound and a message will appear.
- If there is a problem with the vehicle, a warning may sound and a message may appear.

If the situation occurs, depress the brake pedal and release EPB by pressing the EPB switch.

! WARNING

- **Whenever leaving the vehicle or parking, always come to a complete stop and continue to depress the brake pedal. Move the shift lever into the P (Park) position, press the EPB switch, and press the Engine Start/Stop button to the OFF position. Take the Smart Key with you when exiting the vehicle.**

Vehicles not fully engaged in P (Park) with the parking brake set are at risk for moving inadvertently and causing injury to yourself or others.

- **NEVER allow anyone who is unfamiliar with the vehicle to touch the EPB switch. If the EPB is released unintentionally, serious injury may occur.**
- **Only release the EPB when you are seated inside the vehicle with your foot firmly on the brake pedal.**

NOTICE

- Do not apply the accelerator pedal while the parking brake is engaged. If you depress the accelerator pedal with the EPB engaged, a warning will sound and a message will appear. Damage to the parking brake may occur.
- Driving with the parking brake on can overheat the braking system and cause premature wear or damage to brake parts. Make sure the EPB is released and the parking brake warning light is off before driving.

i Information

- A clicking sound may be heard while operating or releasing the EPB. These conditions are normal and indicate that the EPB is functioning properly.
- When leaving your keys with a parking lot attendant or valet, make sure to inform him/her how to operate the EPB.

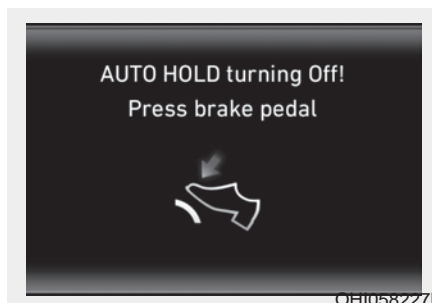

AUTO HOLD turning Off!
Press brake pedal

When the conversion from Auto Hold to EPB is not working properly a warning will sound and a message will appear.



Parking brake automatically engaged

If the EPB is applied while Auto Hold is activated, a warning will sound and a message will appear.

EPB malfunction indicator

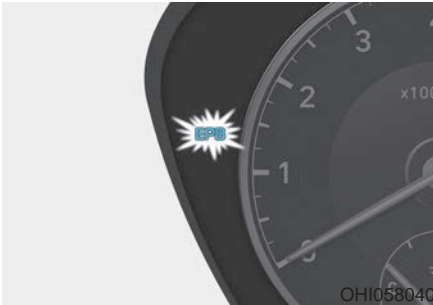

This warning light illuminates if the Engine Start/Stop button is pressed to the ON position and goes off in approximately 3 seconds if the system is operating normally.

If the EPB malfunction indicator remains on, comes on while driving, or does not come on when the Engine Start/Stop button is pressed to the ON position, this indicates that the EPB may have malfunctioned.

If this occurs, have the system checked by an authorized retailer of Genesis Branded products.

The EPB malfunction indicator may illuminate when the ESC indicator comes on to indicate that the ESC is not working properly, but it does not indicate a malfunction of the EPB.

NOTICE

- If the EPB warning light is still on, have the system checked by an authorized retailer of Genesis Branded products.
- If the parking brake warning light does not illuminate or blinks even though the EPB switch was pulled up, the EPB may not be applied.

- If the parking brake warning light blinks when the EPB warning light is on, press the EPB switch, then pull it up. Once more, press the switch back to its original position and pull it back up. If the EPB warning light does not go off, have your vehicle checked by an authorized retailer of Genesis Branded products.

Parking Brake Warning Light



Check the Parking Brake Warning Light by pressing the Engine Start/Stop button to the ON position (do not start the engine).

This light will be illuminated when the parking brake is applied with the Engine Start/Stop button in the START or ON position.

Before driving, be sure the parking brake is released and the Brake Warning Light is OFF.

If the Parking Brake Warning Light remains on after the parking brake is released while engine is running, there may be a malfunction in the brake system. Immediate attention is necessary.

If at all possible, cease driving the vehicle immediately. If that is not possible, use extreme caution while operating the vehicle and only continue to drive the vehicle until you can reach a safe location.

Emergency braking

If there is a problem with the brake pedal while driving, emergency braking is possible by pulling up and holding the EPB switch. Braking is possible only while you are holding the EPB switch. However, braking distance will be longer than normal.

⚠ WARNING

Do not operate the parking brake while the vehicle is moving except in an emergency situation. It could damage the brake system and lead to a severe accident.

i Information

During emergency braking the parking brake warning light will illuminate to indicate that the system is operating.

NOTICE

If you continuously notice a noise or burning smell when EPB is used for emergency braking, have your vehicle checked by an authorized retailer of Genesis Branded products as soon as possible.

When the EPB (Electronic Parking Brake) does not release

If the EPB does not release normally, contact an authorized retailer of Genesis Branded products by loading the vehicle on a flatbed tow truck and have the system checked.

Auto Hold

The Auto Hold maintains the vehicle in a standstill even though the brake pedal is not depressed after the driver brings the vehicle to a complete stop by depressing the brake pedal.

To apply:

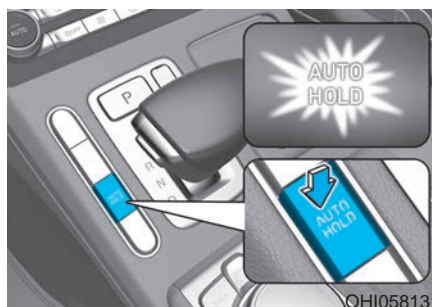

1. With the driver's door and engine hood closed, depress the brake pedal and then press the [AUTO HOLD] switch. The white AUTO HOLD indicator will come on and the system will be in the standby position.

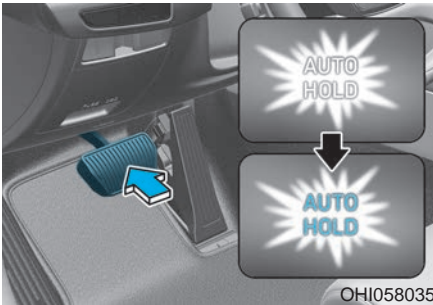

2. When you stop the vehicle completely by depressing the brake pedal, the Auto Hold maintains the brake pressure to hold the vehicle stationary. The indicator changes from white to green.
3. The vehicle will remain stationary even if you release the brake pedal.
4. If EPB is applied, Auto Hold will be released.

To release:

- If you depress the accelerator pedal with the shift lever in D (Drive) or Manual shift mode, the Auto Hold will be released automatically and the vehicle will start to move. The AUTO HOLD indicator changes from green to white.
- If the vehicle is restarted using the cruise control toggle switch (RES+ or SET-) while Auto Hold and cruise control is operating, the Auto Hold will be released regardless of accelerator pedal operation. The AUTO HOLD indicator changes from green to white.

⚠ WARNING

When the AUTO HOLD is automatically released by depressing the accelerator pedal, always take a look around your vehicle. Slowly depress the accelerator pedal for a smooth start.

To cancel:

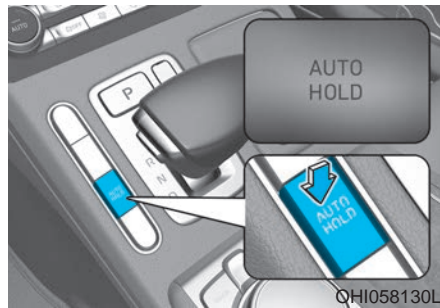

1. Depress the brake pedal.
2. Press the [AUTO HOLD] switch. The AUTO HOLD indicator will turn off.

⚠ WARNING

To prevent, unexpected and sudden vehicle movement, ALWAYS depress your foot on the brake pedal to cancel the Auto Hold before you:

- Drive downhill.
- Drive the vehicle in R (Reverse).
- Park the vehicle.

i Information

- The Auto Hold does not operate when:
 - The driver's door is opened
 - The engine hood is opened
 - The trunk is opened
 - The gear is shifted to P (Park)
 - EPB is applied
- For your safety, the Auto Hold automatically switches to EPB when:
 - The driver's door is opened
 - The engine hood is opened with the shift lever in D (Drive)
 - The vehicle is in a standstill for more than 10 minutes
 - The vehicle is standing on a steep slope
 - The vehicle moved several times

In these cases, the parking brake warning light comes on, the AUTO HOLD indicator changes from green to white, and warning sounds and a message will appear to inform you that EPB has been automatically engaged. Before driving again, depress the brake pedal, check the surrounding area near your vehicle and release the parking brake manually with the EPB switch.

- While operating Auto Hold, you may hear mechanical noise. However, it is normal operating noise.

NOTICE

If the AUTO HOLD indicator changes to yellow, the Auto Hold is not working properly. Contact an authorized retailer of Genesis Branded products.

⚠ WARNING

- Depress the accelerator pedal slowly when you start the vehicle.
- For your safety, cancel the Auto Hold when you drive downhill, back up the vehicle or park the vehicle.

NOTICE

If there is a malfunction with the driver's door or engine hood open detection system, the Auto Hold may not work properly.

Contact an authorized retailer of Genesis Branded products.

Warning messages



Parking brake automatically engaged

When the EPB is applied from Auto Hold, a warning will sound and a message will appear.



Press brake pedal to deactivate AUTO HOLD

If you did not apply the brake pedal when you release the Auto Hold by pressing the [AUTO HOLD] switch, a warning will sound and a message will appear.



AUTO HOLD turning Off! Press brake pedal

When the conversion from Auto Hold to EPB is not working properly a warning will sound and a message will appear.

When this message is displayed, the Auto Hold and EPB may not operate. For your safety, depress the brake pedal.



AUTO HOLD conditions not met. Close door and hood

When you press the [AUTO HOLD] switch, if the driver's door and engine hood are not closed, a warning will sound and a message will appear on the cluster LCD display.

Press the [AUTO HOLD] switch after closing the driver's door and hood.

Anti-lock Brake System (ABS)

WARNING

An Anti-Lock Braking System (ABS) or an Electronic Stability Control (ESC) system will not prevent accidents due to improper or dangerous driving maneuvers. Even though vehicle control is improved during emergency braking, always maintain a safe distance between you and objects ahead of you. Vehicle speeds should always be reduced during extreme road conditions. The braking distance for vehicles equipped with ABS or ESC may be longer than for those without these systems in the following road conditions.

Drive your vehicle at reduced speeds during the following conditions:

- Rough, gravel or snow-covered roads.
- On roads where the road surface is pitted or has different surface height.
- Tire chains are installed on your vehicle.

The safety features of an ABS or ESC equipped vehicle should not be tested by high speed driving or cornering. This could endanger the safety of yourself or others.

Using ABS

To obtain the maximum benefit from your ABS in an emergency situation, do not attempt to modulate your brake pressure and do not try to pump your brakes. Depress your brake pedal as hard as possible.

When you apply your brakes under conditions which may lock the wheels, you may hear sounds from the brakes, or feel a corresponding sensation in the brake pedal. This is normal and it means your ABS is active.

ABS does not reduce the time or distance it takes to stop the vehicle.

Always maintain a safe distance from the vehicle in front of you.

ABS will not prevent a skid that results from sudden changes in direction, such as trying to take a corner too fast or making a sudden lane change. Always drive at a safe speed for the road and weather conditions.

ABS cannot prevent a loss of stability. Always steer moderately when braking hard. Severe or sharp steering wheel movement can still cause your vehicle to veer into oncoming traffic or off the road.

On loose or uneven road surfaces, operation of the anti-lock brake system may result in a longer stopping distance than for vehicles equipped with a conventional brake system.

ABS is an electronic braking system that helps prevent a braking skid. ABS allows the driver to steer and brake at the same time.

The ABS warning light () will stay on for several seconds after the ignition switch is in the ON position. During that time, the ABS will go through self-diagnosis and the light will go off if everything is normal. If the light stays on, you may have a problem with your ABS. Contact an authorized retailer of Genesis Branded products as soon as possible.

 **WARNING**

If the ABS warning light () is on and stays on, you may have a problem with the ABS. Your power brakes will work normally. To reduce the risk of serious injury or death, contact your authorized retailer of Genesis Branded products as soon as possible.

NOTICE

When you drive on a road having poor traction, such as an icy road, and apply your brakes continuously, the ABS will be active continuously and the ABS warning light () may illuminate. Pull your vehicle over to a safe place and turn the engine off.

Restart the engine. If the ABS warning light is off, then your ABS system is normal.

Otherwise, you may have a problem with your ABS system. Contact an authorized retailer of Genesis Branded products as soon as possible.

 **Information**

When you jump start your vehicle because of a drained battery, the ABS warning light () may turn on at the same time. This happens because of the low battery voltage. It does not mean your ABS is malfunctioning. Have the battery recharged before driving the vehicle.

Electronic Stability Control (ESC)



The Electronic Stability Control (ESC) system helps to stabilize the vehicle during cornering maneuvers. ESC checks where you are steering and where the vehicle is actually going. ESC applies braking pressure to any one of the vehicle's brakes and intervenes in the engine management system to assist the driver with keeping the vehicle on the intended path. It is not a substitute for safe driving practices. Always adjust your speed and driving to the road conditions.

WARNING

Never drive too fast for the road conditions when cornering. The ESC system will not prevent accidents.

Excessive speed in turns, abrupt maneuvers, and hydroplaning on wet surfaces can result in severe accidents.

ESC operation

ESC ON condition

When the ignition switch is in the ON position, the ESC and the ESC OFF indicator lights illuminate for approximately three seconds. After both lights go off, the ESC is enabled.

When operating



When the ESC is in operation, the ESC indicator light blinks:

- When you apply your brakes under conditions which may lock the wheels, you may hear sounds from the brakes, or feel a corresponding sensation in the brake pedal. This is normal and it means your ESC is active.
- When the ESC activates, the engine may not respond to the accelerator as it does under routine conditions.
- If the Smart Cruise Control was in use when the ESC activates, the Smart Cruise Control automatically disengages. The Smart Cruise Control can be reengaged when the road conditions allow. See "Smart Cruise Control System" later in this chapter.
- When moving out of the mud or driving on a slippery road, the engine RPM (revolutions per minute) may not increase even if you press the accelerator pedal deeply. This is to maintain the stability and traction of the vehicle and does not indicate a problem.

ESC OFF condition



To cancel ESC operation:

• **State 1**



Press the ESC OFF button briefly. The ESC OFF indicator light and message "Traction Control disabled" will illuminate. In this state, the traction control function of ESC (engine management) is disabled, but the brake control function of ESC (braking management) still operates.

• **State 2**



Press and hold the ESC OFF button continuously for more than 3 seconds. The ESC OFF indicator light and message "Traction and Stability Control disabled" illuminates and a warning chime sounds. In this state, both the traction control function of ESC (engine management) and the brake control function of ESC (braking management) are disabled.

If the Engine Start/Stop button is pressed to the OFF position when ESC is off, ESC remains off. Upon restarting the engine, the ESC will automatically turn on again.

- ESC indicator light (blinks)



- ESC OFF indicator light (comes on)



Indicator lights

When the Engine Start/Stop button is placed to the ON position, the ESC indicator light illuminates, then goes off if the ESC system is operating normally.

The ESC indicator light blinks whenever the ESC is operating.

If ESC indicator light stays on, your vehicle may have a malfunction with the ESC system. When this warning light illuminates have your vehicle checked by an authorized retailer of Genesis Branded products as soon as possible.

The ESC OFF indicator light comes on when ESC is turned off.

WARNING

When the ESC is blinking, this indicates ESC is active:

Drive slowly and NEVER attempt to accelerate. NEVER turn the ESC off while the ESC indicator light is blinking or you may lose control of the vehicle resulting in an accident.

NOTICE

Driving with wheel and tire sizes different than original-equipment may cause the ESC system to malfunction. Before replacing tires, make sure all four tires and wheels are the same as the original size. Never drive the vehicle with different sized wheels and tires installed.

ESC OFF usage

When Driving

The ESC OFF mode should only be used briefly to help free the vehicle if stuck in snow or mud, by temporarily stopping operation of the ESC, to maintain wheel torque.

To turn ESC off while driving, press the ESC OFF button while driving on a flat road surface.

NOTICE

To prevent damage to the transmission:

- Do not allow wheel(s) of one axle to spin excessively while the ESC, ABS, and parking brake warning lights are displayed. The repairs would not be covered by the vehicle warranty. Reduce engine power and do not spin the wheel(s) excessively while these lights are displayed.
- When operating the vehicle on a dynamometer, make sure the ESC is turned off (ESC OFF light illuminated).

Information

Turning the ESC off does not affect ABS or standard brake system operation.

Vehicle Stability Management (VSM)

The Vehicle Stability Management (VSM) is a function of the Electronic Stability Control (ESC) system. It helps the vehicle stay stable when accelerating or braking suddenly on wet, slippery and rough roads where traction over the four tires can suddenly become uneven.

WARNING

Take the following precautions when using the Vehicle Stability Management (VSM):

- **ALWAYS check the speed and the distance to the vehicle ahead. The VSM is not a substitute for safe driving practices.**
- **Never drive too fast for the road conditions. The VSM system will not prevent accidents. Excessive speed in bad weather, slippery and uneven roads can result in severe accidents.**

VSM operation

VSM ON condition

The VSM operates when:

- The Electronic Stability Control (ESC) is on.
- Vehicle speed is approximately above 9 mph (15 km/h) on curve roads.
- Vehicle speed is approximately above 12 mph (20 km/h) when the vehicle is braking on rough roads.

When operating



When you apply your brakes under conditions which may activate the ESC, you may hear sounds from the brakes, or feel a corresponding sensation in the brake pedal. This is normal and it means your VSM is active.

NOTICE

The VSM does not operate when:

- **Driving on a banked road such as gradient or incline.**
- **Driving in reverse.**
- **The ESC OFF indicator light is on.**
- **The MDPS (Motor-Driven Power Steering) warning light (⊕!) is on or blinks.**

⚠ WARNING

If the ESC indicator light () or MDPS warning light () stays on or blinks, your vehicle may have a malfunction with the VSM system. When the warning light illuminates, have your vehicle checked by an authorized retailer of Genesis Branded products as soon as possible.

Driving with wheel and tire sizes different than original-equipment may cause the ESC system to malfunction. Before replacing tires, make sure all four tires and wheels are the same as the original size. Never drive the vehicle with different sized tires and wheels installed.

Hill-Start Assist Control (HAC)

The Hill-Start Assist Control (HAC) helps prevent the vehicle from rolling backwards when starting a vehicle from a stop on a hill. The system operates the brakes automatically for approximately 2 seconds and releases the brake after 2 seconds or when the accelerator pedal is depressed.

⚠ WARNING

Always be ready to depress the accelerator pedal when starting off on an incline. The HAC activates only for approximately 2 seconds.

NOTICE

- The HAC does not operate when the gear is shifted to P (Park) or N (Neutral).
- The HAC activates even though the ESC (Electronic Stability Control) is off but does not activate when the ESC has malfunctioned.

Good Braking Practices

WARNING

Whenever leaving the vehicle or parking, always come to a complete stop and continue to depress the brake pedal. Shift the gear to P (Park), apply the parking brake, and press the Engine Start/Stop button to the OFF.

Vehicles with the parking brake not fully engaged are at risk for moving inadvertently and causing injury to yourself or others.

Wet brakes can be dangerous! The brakes may get wet if the vehicle is driven through standing water or if it is washed. Your vehicle will not stop as quickly if the brakes are wet. Wet brakes may cause the products to pull to one side.

To dry the brakes, apply the brakes lightly until the braking action returns to normal, taking care to keep the vehicle under control at all times. If the braking action does not return to normal, stop as soon as it is safe to do so and call an authorized retailer of Genesis Branded products for assistance.

DO NOT drive with your foot resting on the brake pedal. Even light, but constant pedal pressure can result in the brakes overheating, brake wear, and possibly even brake failure.

If a tire goes flat while you are driving, apply the brakes gently and keep the vehicle pointed straight ahead while you slow down. When you are moving slowly enough for it to be safe to do so, pull off the road and stop in a safe location.

Keep your foot firmly on the brake pedal when the vehicle is stopped to prevent the vehicle from rolling forward.

ALL WHEEL DRIVE (AWD) (IF EQUIPPED)

Using All Wheel Drive (AWD)

The All Wheel Drive (AWD) system delivers engine power to front and rear wheels for maximum traction. AWD is useful when extra traction is required, such as when driving on, muddy, wet, or snow-covered roads.

If the system determines there is a need for four wheel drive, the engine's driving power is distributed to all four wheels automatically.

WARNING

If the AWD warning light () stays on the instrument cluster, your vehicle may have a malfunction with the AWD system.

When the AWD warning light () illuminates have your vehicle checked by an authorized retailer of Genesis Branded products as soon as possible.

WARNING

To reduce the risk of **SERIOUS INJURY** or **DEATH**:

- Do not drive in conditions that exceed the vehicles intended design such as challenging off-road conditions.
- Avoid high speeds when cornering or turning.
- Do not make quick steering wheel movements, such as sharp lane changes or fast, sharp turns.
- The risk of a rollover is greatly increased if you lose control of your vehicle at highway speeds.
- Loss of control often occurs if two or more wheels drop off the roadway and the driver over steers to reenter the roadway.
- In the event your vehicle leaves the roadway, do not steer sharply. Instead, slow down before pulling back into the travel lanes.
- Always drive safely and use caution when driving an AWD vehicle.

i Information

- Do not drive in water if the level is higher than the bottom of the vehicle.
- Check your brake condition once you are out of mud or water. Depress the brake pedal several times as you move slowly until you feel normal braking return.
- Shorten your scheduled maintenance interval if you drive in off-road conditions such as sand, mud or water (see "Maintenance Under Severe Usage Conditions" in chapter 7).
- Make sure that an AWD vehicle is towed by flatbed tow truck.

For safe AWD operation

Before driving

- Make sure all passengers are wearing seat belts.
- Sit upright and adjust the steering wheel to a position comfortable for you to drive.

Driving on snow-covered or icy roads

- Start off slowly by applying the accelerator pedal gently.
- Use of snow tires is recommended.

For more information on Snow Tires refer to "Winter Driving" in this chapter.

- Keep sufficient distance between your vehicle and the vehicle in front of you.
- When approaching a stop sign or stop light, release the accelerator pedal to provide engine braking during deceleration.
- Avoid speeding, rapid acceleration, sudden brake applications, and sharp turns to prevent skids.

Driving in sand or mud

- Maintain slow and constant speed.
- Keep sufficient distance between your vehicle and the vehicle in front of you.
- Reduce vehicle speed and always check the road condition.
- Avoid speeding, rapid acceleration, sudden brake applications, and sharp turns to prevent getting stuck.

NOTICE

When the vehicle is stuck in snow, sand or mud, avoid running the engine continuously at high rpm, doing so may damage the tires, transmission, differential or AWD system.

Information

- When using Snow Tires, mount them on all four wheels.
- When using AutoSock® (fabric snow chain), install them on all four tires. However, if you are in a situation to use only two AutoSock®, install them on the rear tires. In this case, drive a short distance to prevent damage to the AWD system.

For more information on Snow Tires and Tire Chains, refer to "Winter Driving" in this chapter.

Driving up or down hills

- Driving uphill
 - Before starting off, check if it is possible to drive uphill.
 - Drive as straight as possible.
- Driving downhill
 - Do not change gear while driving downhill. Select gear before driving downhill.
 - Drive slowly and select Manual Shift Mode to provide engine braking while driving downhill.
 - Drive straight as possible.

WARNING

Exercise extreme caution driving up or down steep hills. The vehicle may flip depending on the grade, terrain and water/mud conditions.

Emergency Precautions

Tires

When replacing the tires, be sure to equip all four tires with the same size, type, tread, brand and load-carrying capacity.

WARNING

Do not use tire and wheel with different size and type from the one originally installed on your vehicle. It can affect the safety and performance of your vehicle, which could lead to steering failure or rollover causing serious injury.

In an emergency situation, a compact spare tire may be used. But, do not use the compact spare tire continuously. Repair or replace the original tire as soon as possible to avoid failure of the differential or AWD system.



Tire size mismatch. Check all tire sizes.

If your vehicle is equipped with different tires (size, type, etc.) on the front and rear, the message will appear. To use the AWD system, equip the vehicle with the same tires on the front and rear.

WARNING

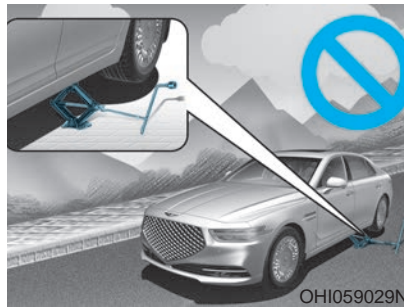

Never start or run the engine while an AWD vehicle is raised on a jack. The vehicle can slip or roll off of a jack causing serious injury or death to you or those nearby.

Towing

AWD vehicles must be towed with all wheels off the ground, either on a flatbed tow truck or using doilies.

For more details, refer to "Towing" in chapter 6.

Vehicle inspection

- If the vehicle needs to be operated on a vehicle lift do not attempt to stop any of the four wheels for turning. This could damage the system.
- Never engage the parking brake while running the engine on a car lift. This may damage the AWD system.

Dynamometer testing

An AWD vehicle must be tested on a special four wheel chassis dynamometer.

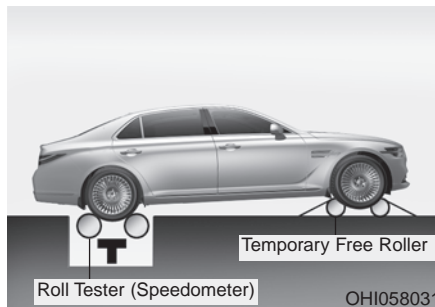

An AWD vehicle should not be tested on a 2WD roll tester. If a 2WD roll tester must be used, perform the following procedure:

1. Check the tire pressures recommended for your vehicle.
2. Place the rear wheels on the roll tester for a speedometer test as shown in the illustration.
3. Release the parking brake.
4. Place the front wheels on the temporary free roller as shown in the illustration.

⚠ WARNING

Keep away from the front of the vehicle while the vehicle is in gear on the dynamometer. The vehicle can jump forward and cause serious injury or death.

GENESIS ADAPTIVE CONTROL SUSPENSION (IF EQUIPPED)

Electronic Control Suspension (ECS)

The Electronic Control Suspension (ECS) controls the vehicle suspension automatically to maximize driving comfort by taking into account the driving conditions such as speed, surface of the road, cornering, stopping requirements and acceleration.

ECS (Electronic Control Suspension) malfunction indicator

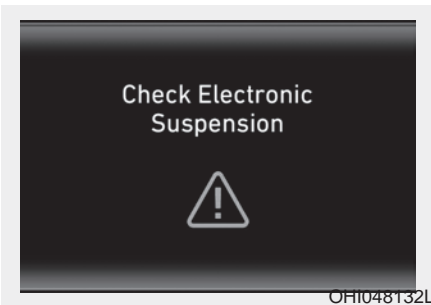

Check Electronic Suspension

If the ECS warning message comes on, you may have a problem with the ECS system. Have the system be checked by an authorized retailer of Genesis Branded products.

Dynamic Stability Damping Control (DSDC)

The Dynamic Stability Damping Control (DSDC) provides comfort riding and driving stability by meticulously optimizing the suspension power during sharp curving or abrupt obstacle avoidance.

Operating conditions

- The DSDC is activated, when driving speed exceeds 30 mph (50 km/h).
- The DSDC does not operate, when the Electronic Stability Control (ESC) is deactivated.

NOTICE

The Dynamic Stability Damping Control (DSDC) does not operate, when there is a malfunction with the Electronic Stability Control (ESC).

The Dynamic Stability Damping Control (DSDC) operation is limited in following situations:

- There are wide variations in tire pressures.
- The vehicle is driven on a steep slope.
- The vehicle is driven on a rough, rugged surface.

⚠ WARNING

NEVER install any tires/wheels in different sizes or of different models on your vehicle. It may cause a malfunction of the Dynamic Stability Damping Control (DSDC).

DRIVE MODE INTEGRATED CONTROL SYSTEM

Drive Mode



The drive mode may be selected according to the driver's preference or road condition.

The mode changes whenever the DRIVE MODE button is pressed.



- **COMFORT mode :**
COMFORT mode provides smooth driving and comfortable riding.
- **SPORT mode :**
SPORT mode provides sporty but firm riding.
- **ECO mode :**
ECO mode helps improve fuel efficiency for eco-friendly driving.
- **CUSTOM mode :**
The driver can separately adjust modes of each driving system.

COMFORT mode

COMFORT

When COMFORT mode is selected by pressing the DRIVE MODE button, the COMFORT indicator will illuminate on the instrument cluster.

SPORT

SPORT

When SPORT mode is selected by pressing the DRIVE MODE button, the SPORT indicator will illuminate on the instrument cluster.

- Whenever the engine is restarted, the drive mode will revert back to COMFORT mode. If SPORT mode is desired, re-select SPORT mode.
- When SPORT mode is activated:
 - The engine rpm will tend to remain raised over a certain length of time even after releasing the accelerator
 - Upshifts are delayed when accelerating
 - Seat bolsters are active (if equipped)

i Information

In SPORT mode, the fuel efficiency may decrease.

ECO mode



When ECO mode is selected by pressing the DRIVE MODE button, the ECO indicator will illuminate on the instrument cluster.

- If the vehicle is set to ECO mode, when the engine is turned OFF and restarted the drive mode setting will remain in ECO mode.

***i* Information**

Fuel efficiency depends on the driver's driving habit and road condition.

When ECO mode is activated:

- The acceleration response may be slightly reduced if the accelerator pedal is depressed moderately.
- The air conditioner performance may be limited.
- The shift pattern of the automatic transmission may change.
- The engine noise may be louder at some automatic transmission shifts as down-shift requires pressing down more on the accelerator.

The above situations are normal conditions when ECO mode is activated to help improve fuel efficiency.

Limitation of ECO mode operation:

If the following conditions occur while ECO mode is operating, the system operation is limited even though there is no change in the ECO indicator.

- When the coolant temperature is low:
The system will be limited until engine performance becomes normal.
- When driving up a hill:
The system will be limited to gain power when driving uphill because engine torque is restricted.
- When driving the vehicle in manual shift mode using the paddle shifter.
The system will be limited according to the shift location.

CUSTOM mode



When CUSTOM mode is selected by pressing the DRIVE MODE button, the CUSTOM mode indicator will illuminate on the instrument cluster.

- In CUSTOM mode, the driver can select separate modes and combine them in the AVN system screen.
 - Engine/Transmission: ECO/COMFORT/SPORT/SMART
 - Steering wheel: COMFORT/SPORT
 - Suspension: COMFORT/SPORT
 - AWD system: ECO/COMFORT/SPORT

For detailed information, scan the QR code in a separately supplied simple manual.

When SMART is selected for CUSTOM mode

SMART mode automatically controls the vehicle driving, such as gear shifting patterns, engine torque, riding quality (if equipped with the electronic suspension system), and power distribution (if equipped with the All-Wheel Drive (AWD) system), in accordance with the driver's driving habits.

Information

- **When you mildly drive the vehicle in SMART mode, the driving mode changes to ECO mode to improve fuel efficiency. However, the actual fuel efficiency may differ in accordance with your driving situations (i.e. upward/downward slope, vehicle deceleration/acceleration).**
- **When you dynamically drive the vehicle in SMART mode by abruptly decelerating or sharply turning the driving mode changes to SPORT mode. However, it may adversely affect fuel economy.**
- Various driving situations, which you may encounter in SMART mode
 - The driving mode automatically changes to ECO mode after a certain period of time, when you gently depress the accelerator pedal (Your driving is categorized to be economic.).
 - The driving mode automatically changes from SMART ECO mode to SMART COMFORT mode after a certain period of time, when you sharply or repetitively depress the accelerator pedal.
- The driving mode automatically changes to SMART COMFORT mode with the same driving patterns, when the vehicle starts to drive on an upward slope of a certain angle. The driving mode automatically returns to SMART ECO mode, when the vehicle enters a leveled road.
- The driving mode automatically changes to SMART SPORT, when you abruptly accelerate the vehicle or repetitively operate the steering wheel (Your driving is categorized to be sporty.). In this mode, your vehicle drives in a lower gear for abrupt accelerating/decelerating and increases the engine brake performance.
- You may still sense the engine braking performance, even when you release the accelerator pedal in SMART SPORT mode. It is because your vehicle remains in lower gear over a certain period of time for next acceleration. Thus, it is a normal driving situation, not indicating any malfunction.
- The driving mode automatically changes to SMART SPORT mode only in harsh driving situations. In most of the normal driving situations, the driving mode sets to be either in SMART ECO mode or in SMART COMFORT mode.

- Limitation of SMART mode

The SMART mode may be limited in following situations. (The OFF indicator illuminates in those situations.)

- The driver manually moves the shift lever :

It deactivates SMART mode. The vehicle drives, as the driver manually moves the shift lever.

- The cruise control is activated :

The cruise control system may deactivate the SMART mode when the vehicle is controlled by the set speed of the smart cruise control system. (SMART mode is not deactivated just by activating the cruise control system.)

- The transmission oil temperature is either extremely low or extremely high :

The SMART mode can be active in most of the normal driving situations. However, an extremely high/ low transmission oil temperature may temporarily deactivate the SMART mode, because the transmission condition is out of normal operation condition.

COASTING (IF EQUIPPED)

When certain conditions are met, the engine is automatically decoupled from the transmission while the shift lever is remained in D (Drive). In this Coasting mode, the engine stays at idling speed to reduce fuel consumption and increase coasting distance.

Coasting Setting

The Coasting function must be turned ON from the Settings menu in the AVN system screen. Select:

- Setup → Vehicle Settings → Drive Mode → Coasting

For detailed information, scan the QR code in a separately supplied simple manual.

When Coasting is turned ON and the conditions are met, the function operates with a "Coasting" message illuminated at the top center of the instrument cluster.

NOTICE

- **If the accelerator pedal is pressed quickly for accelerating with the Coasting function in operation, acceleration may occur after the engagement of the clutch inside the transmission. In turn, the driver may continue to feel acceleration even after the system is turned off.**
- **Driving with the Coasting function off may be required in some cases since the engine brake is not applied while the Coasting function is in operation.**
- **Operating the AVN system screen to activate or deactivate the Coasting function while driving may be dangerous as the driver's attention is dispersed.**

Coasting Operating Conditions

The Coasting function will operate when the accelerator pedal is depressed and released under the following conditions.

- The driving mode is ECO mode.
- SMART is selected for Engine/Transmission in CUSTOM mode from the AVN system screen and driver acceleration is SMART ECO
- ECO is selected for Engine/Transmission in CUSTOM mode from the AVN system screen
- The shift lever is in D (Drive)
- The Smart Cruise Control button is OFF
- The accelerator or brake pedal is not depressed
- The vehicle's speed is within 35–100 mph (55–160 km/h) range
- The road gradient is within -5~+5% range
- In SMART mode, if the distance between the vehicle ahead and the relative speed is within a certain range

i Information

- **If the front radar for smart cruise control system cannot operate normally, the inter-vehicle distance and relative speed condition are automatically ignored.**
- **The Coasting function works after the engine is turned on, the transmission is warmed up, and the engine sensor self-diagnosis is completed after starting.**
- **Depending on the driving situation, Coasting operation may be temporarily delayed even if the above conditions are met.**

Coasting Release Conditions

The Coasting function will be automatically released when the following conditions are met.

- The driving mode is COMFORT or SPORT mode.
- SMART is selected for Engine/Transmission in CUSTOM mode from the AVN system screen and driver acceleration is SMART COMFORT or SMART SPORT
- The Smart Cruise Control button is ON (the cruise indicator is ON)
- The vehicle's speed exceeds 35–100 mph (55–160 km/h) range
- The road gradient is under -5% or over +5%
- In SMART mode, if the distance between the vehicle ahead is too close of the relative speed changes momentarily
- If lane change is predicated in SMART mode (e.g. the turn signal is turned ON or a LKA warning appears due to steering wheel control, etc.)

Information

It is recommended to turn off the Coasting function if you are driving under frequently stop-and-go condition. Change the Drive Mode to COMFORT or SPORT mode or deselect Coasting from the AVN system screen.

FORWARD COLLISION-AVOIDANCE ASSIST (FCA) SYSTEM - SENSOR FUSION TYPE (FRONT RADAR + FRONT CAMERA)

The Forward Collision-Avoidance Assist (FCA) system is designed to help detect and monitor the vehicle ahead or help detect a pedestrian in the roadway through radar signals and camera recognition to warn the driver that a collision is imminent, and if necessary, apply emergency braking.

WARNING

Take the following precautions when using the Forward Collision-Avoidance Assist (FCA) system:

- This system is only a supplemental system and it is not intended to, nor does it replace the need for extreme care and attention of the driver. The sensing range and objects detectable by the sensors are limited. Pay attention to the road conditions at all times.
- Drive at posted speed limits and accordance to road conditions.
- Always drive cautiously to prevent unexpected and sudden situations from occurring. The Forward Collision-Avoidance system may not always stop the vehicle completely and is only intended to help mitigate a collision that is imminent.

System Setting and Operation

System setting

• Setting Forward Safety function

The Forward Collision-Avoidance Assist (FCA) can be activated from the Settings menu in the AVN system screen by following the procedure below.

1. Set the Engine Start/Stop button to the ON or START position.
2. Select 'Setup → Vehicle Settings → Driver Assistance → Forward Safety → Active Assist / Warning Only / Off' in the AVN system screen. **For detailed information, scan the QR code in a separately supplied simple manual.**
 - If you select 'Active Assist', the FCA system activates. The FCA produces warning messages and warning alarms in accordance with the collision risk levels. Braking assist will be applied in accordance with the collision risk.
 - If you select 'Warning Only', the FCA system activates and produces only warning alarms in accordance with the collision risk levels. Braking assist will not be applied in this setting.
 - If you select 'Off', the FCA system deactivates. The FCA warning light () illuminates on the cluster.

-  The warning light illuminates on the instrument cluster, when you cancel the FCA system.

The driver can monitor the FCA ON/OFF status in the instrument cluster. Also, the warning light illuminates when the ESC (Electronic Stability Control) is turned off. If the warning light remains ON when the FCA is activated, have the system checked by an authorized retailer of Genesis Branded products.

- Selecting Warning Timing

The driver can select the initial warning activation time from the Settings menu in the AVN system screen. Select:

- Setup → Vehicle Settings → Driver Assistance → Warning Timing → Normal / Late

For detailed information, scan the QR code in a separately supplied simple manual.

The options for the initial Forward Collision Warning includes the following:

- Normal:

When this option is selected, the initial Forward Collision Warning is activated sensitively. If you feel the warning activates too early, set the Forward Collision Warning to 'Late'.

Even though, 'Normal' is selected if the front vehicle suddenly stops the initial warning activation time may not seem fast.

- Late:

When this option is selected, the initial Forward Collision Warning is activated later than normal. This setting reduces the amount of distance between the vehicle or pedestrian ahead before the initial warning occurs.

Select 'Late' when traffic is light and when driving speed is slow.

When you accelerate suddenly to the vehicle ahead, the warning may seem to activate earlier even if 'Late' is selected.

Information

If you change the warning timing, the warning time of other systems may change.

Prerequisite for activation

The FCA system will activate when 'Active Assist' or 'Warning Only' under Forward Safety is selected in the AVN system screen, and when the following prerequisites are satisfied.

- ESC (Electronic Stability Control) is on.
- Vehicle speed is over 5 mph (8 km/h). (The FCA is only activated within a certain speed range.)
- The system detects a pedestrian or a vehicle in front, which may collide with your vehicle. However, FCA may not be activated or may only sound a warning alarm depending on the driving or vehicle conditions.

FCA may not operate properly according to the frontal situation or the direction of a pedestrian.

⚠ WARNING

- **To avoid driver distractions, do not attempt to set or cancel the FCA while driving the vehicle. Always completely stop the vehicle at a safe place before setting or canceling the system.**
- **FCA automatically activates upon placing the Engine Start/Stop button to the ON or START position. The driver can deactivate FCA by canceling the system setting in the AVN system screen.**
- **FCA automatically deactivates upon canceling ESC. When ESC is canceled, FCA cannot be activated in the AVN system screen. In this situation, the FCA warning light will illuminate which is normal.**

FCA Warning Message and Brake Control

FCA produces warning messages, warning alarms, and emergency braking based on the level of risk of a frontal collision, such as when a vehicle ahead suddenly brakes, or the system detects that a collision with a pedestrian is imminent.

Collision Warning (First warning)



- The warning message appears on the cluster LCD display with a warning chime. Additionally, some vehicle system intervention occurs by the engine management system to help decelerate the vehicle.
- Your vehicle speed may decelerate moderately.
- If FCA detects a vehicle in front, the system operates when your vehicle speed is between 5 mph (8 km/h) and 112 mph (180 km/h). Maximum vehicle speed may decrease depending on the condition of the vehicle ahead and surroundings.
- If FCA detects a pedestrian in front, the system operates when your vehicle speed is between 5 mph (8 km/h) and 56 mph (90 km/h). Maximum vehicle speed may decrease depending on the condition of the pedestrian ahead and surroundings.
- If you select 'Warning only' for the system setting, the FCA system activates and produces only warning alarms in accordance with the collision risk levels. You should control the brake directly because the FCA system will not control the brake.

Emergency braking (Second warning)



- The warning message appears on the cluster LCD display with a warning chime. Additionally, some vehicle system intervention occurs by the engine management system to help decelerate the vehicle.
- The brake control is maximized just before a collision, reducing impact when it strikes a forward vehicle.
- If FCA detects a vehicle in front, the system operates when your vehicle speed is above 5 mph (8 km/h) and 47 mph (75 km/h) or under. Maximum vehicle speed may decrease depending on the condition of the vehicle ahead and surroundings.
- If FCA detects a pedestrian in front, the system operates when your vehicle speed is 5 mph (8 km/h) or above and under 40 mph (65 km/h). Maximum vehicle speed may decrease depending on the condition of the pedestrian ahead and surroundings.

- If you select 'Warning only' for the system setting, the FCA system activates and produces only warning alarms in accordance with the collision risk levels. You should control the brake directly because the FCA system do not control the brake.

Brake operation

- In an urgent situation, the braking system enters into the ready status for prompt reaction against the driver's depressing the brake pedal.
- The FCA provides additional braking power for optimum braking performance, when the driver depresses the brake pedal.
- The braking control is automatically deactivated, when the driver sharply depresses the accelerator pedal, or when the driver abruptly operates the steering wheel.
- The FCA brake control is automatically canceled, when risk factors disappear.

CAUTION

- **The driver should always use extreme caution while operating the vehicle, whether or not there is a warning message or alarm from the FCA system.**
- **After the brake control is activated, the driver must immediately depress the brake pedal and check the surroundings. The brake activation by the system lasts for about 2 seconds.**

- **If any other warning sound such as seat belt warning chime is already generated, the Forward Collision-Avoidance Assist (FCA) system warning may not sound.**
- **Playing the vehicle audio system at high volume may prevent occupants from hearing the system warning sounds.**

WARNING

The braking control cannot completely stop the vehicle nor avoid all collisions. The driver should hold the responsibility to safely drive and control the vehicle.

WARNING

The FCA system logic operates within certain parameters, such as the distance from the vehicle or pedestrian ahead, the speed of the vehicle ahead, and the driver's vehicle speed. Certain conditions such as inclement weather and road conditions may affect the operation of the FCA system.

WARNING

Never deliberately drive dangerously to activate the system.

FCA Sensor (Front Radar/Front Camera)

■ Front radar



■ Front camera

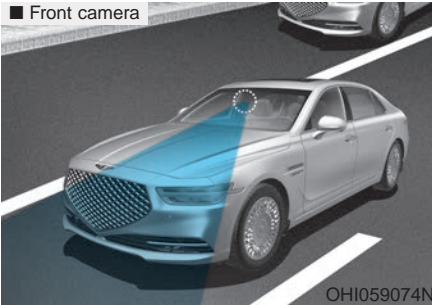

In order for the FCA system to operate properly, always make sure the sensor cover or sensor is clean and free of dirt, snow, and debris.

Dirt, snow, or foreign substances on the sensor cover or sensor may adversely affect the sensing performance of the sensor.

NOTICE

- Do not apply license plate frame or foreign objects such as a bumper sticker or a bumper guard near the radar sensor. Doing so may adversely affect the sensing performance of the radar.
- Always keep the radar sensor and cover clean and free of dirt and debris.
- Use only a soft cloth to wash the vehicle. Do not spray pressurized water directly on the sensor or sensor cover.
- Be careful not to apply unnecessary force on the radar sensor or sensor cover. If the sensor is forcibly moved out of proper alignment, the FCA system may not operate correctly. In this case, a warning message may not be displayed. Have the vehicle inspected by an authorized retailer of Genesis Branded products.
- If the front bumper becomes damaged in the area around the radar sensor, the FCA system may not operate properly. Have the vehicle inspected by authorized retailer of Genesis Branded products.
- Use only genuine parts to repair or replace a damaged sensor or sensor cover. Do not apply paint to the sensor cover.

NOTICE

- **NEVER** install any accessories or stickers on the front windshield, or tint the front windshield.
- **NEVER** place any reflective objects (i.e. white paper, mirror) over the dashboard. Any light reflection may prevent the system from functioning properly.
- **Pay extreme caution** to keep the camera dry.
- **NEVER** disassemble the camera assembly, or apply any impact on the camera assembly.

If the sensor is forcibly moved out of proper alignment, the FCA system may not operate correctly. In this case, a warning message may not be displayed. Have the vehicle inspected by an authorized retailer of Genesis Branded products.

i Information

Have the system checked by an authorized retailer of Genesis Branded products. when:

- The windshield glass is replaced.
- The radar sensor or cover gets damaged or replaced.

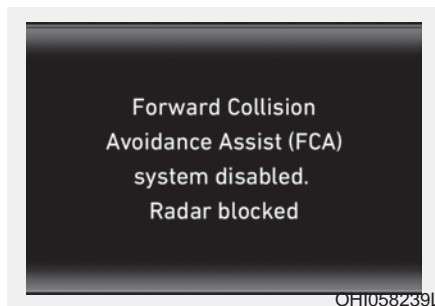
Warning message and warning light**Forward Collision-Avoidance Assist (FCA) system disabled. Radar blocked**

When the sensor cover is covered with dirt, snow, or debris, the FCA system may not be able to detect other vehicles. If this occurs, a warning message will appear on the cluster LCD display.

The system will operate normally when such dirt, snow or debris is removed.

FCA may not properly operate in an area (e.g. open terrain) where any objects or vehicles are not detected after turning on the engine.

Also, even though a warning message does not appear on the LCD display, the FCA may not properly operate.

⚠ WARNING

The FCA system may not activate according to road conditions, inclement weather, driving conditions or traffic conditions.

System Malfunction



Check Forward Collision-Avoidance Assist system

- When FCA is not working properly, the FCA warning light (🌟) will illuminate and the warning message will appear for a few seconds. After the message disappears, the master warning light (⚠️) will illuminate. In this case, have the vehicle inspected by an authorized retailer of Genesis Branded products.
- The FCA warning message may appear along with the illumination of the ESC (Electronic Stability Control) warning light. Both FCA warning light and warning message will disappear once the ESC warning light issue is resolved.

⚠️ WARNING

- **FCA is only a supplemental system for the driver's convenience. It is the driver's responsibility to control the vehicle operation. Do not solely depend on the FCA system. Rather, maintain a safe braking distance, and, if necessary, depress the brake pedal to reduce the driving speed or to stop the vehicle.**

- In certain instances and under certain driving conditions, the FCA system may produce a warning alarm and control the brake system unnecessarily. And, the FCA system may not produce a warning alarm and control the brake system due to detecting limitation of sensor.

Also due to sensing limitations, in certain situations, the front radar sensor or camera recognition system may not detect the vehicle or pedestrian ahead. The FCA system may not activate and the warning message may not be displayed.

- Even if there is any problem with the brake control function of the FCA system, the vehicle's basic braking performance will operate normally. However, brake control function for avoiding collision will not activate.
- If the vehicle in front stops suddenly, you may have less control of the brake system. Therefore, always keep a safe distance between your vehicle and the vehicle in front of you.
- The FCA system may activate during braking and the vehicle may stop suddenly shifting loose objects toward the passengers. Always keep loose objects secured.
- The FCA system may not activate if the driver applies the brake pedal to avoid collision.

- The brake control may be insufficient, possibly causing a collision, if a vehicle in front abruptly stops. Always pay extreme caution.
- Occupants may get injured, if the vehicle abruptly stops by the activated FCA system. Pay extreme caution.
- The FCA system operates only when the system detect vehicles or pedestrian in front of the vehicle.

WARNING

- The FCA system does not operate when the vehicle is in reverse.
- The FCA system is not designed to detect other objects on the road such as animals.
- The FCA system does not detect vehicles in the opposite lane.
- The FCA system does not detect cross traffic vehicles that are approaching.
- The FCA system cannot detect vehicles that are stopped vertically to your vehicle at a intersection or dead end street.

In these cases, you must maintain a safe braking distance, and if necessary, depress the brake pedal to reduce the driving speed in order to maintain a safe distance or to stop the vehicle.

Limitations of the System

The Forward Collision-Avoidance Assist (FCA) system is designed to monitor the vehicle ahead or a pedestrian in the roadway through radar signals and camera recognition to warn the driver that a collision is imminent, and if necessary, apply emergency braking.

In certain situations, the radar sensor or the camera may not be able to detect the vehicle or pedestrian ahead. In these cases, the FCA system may not operate normally. The driver must pay careful attention in the following situations where the FCA operation may be limited.

Detecting vehicles

The sensor may be limited when:

- The system may not operate for 15 seconds after the engine is started or the camera is initialized
- The radar sensor or camera is covered with a foreign object or debris
- The camera lens is contaminated due to tinted, filmed or coated windshield, damaged glass, or stuck of foreign matter (sticker, bug, etc.) on the glass
- Inclement weather such as heavy rain or snow obscures the field of view of the radar sensor or camera
- There is interference by electromagnetic waves
- There is severe irregular reflection from the radar sensor
- The radar/camera sensor recognition is limited
- The vehicle in front is too small to be detected (for example a motorcycle or a bicycle, etc.)

- The vehicle in front is an oversize vehicle or trailer that is too big to be detected by the camera recognition system (for example a tractor trailer, etc.)
- The camera's field of view is not well illuminated (either too dark or too much reflection or too much backlight that obscures the field of view)
- The vehicle in front does not have their rear lights properly turned ON or their rear lights are located unusually
- The outside brightness changes suddenly, for example when entering or exiting a tunnel
- Light coming from a street light or an oncoming vehicle is reflected on a wet road surface such as a puddle in the road
- The field of view in front is obstructed by sun glare
- The windshield glass is fogged up; a clear view of the road is obstructed
- The vehicle in front is driving erratically
- The vehicle is on unpaved or uneven rough surfaces, or road with sudden gradient changes
- The vehicle is driven near areas containing metal substances as a construction zone, railroad, etc.
- The vehicle drives inside a building, such as a basement parking lot
- The camera does not recognize the entire vehicle in front
- The camera is damaged
- The brightness outside is too low such as when the headlamps are not on at night or the vehicle is going through a tunnel
- The shadow is on the road by a median strip, trees, etc.
- The vehicle drives through a toll-gate.
- The rear part of the vehicle in front is not normally visible (the vehicle turns in other direction or the vehicle is overturned.)
- The adverse road conditions cause excessive vehicle vibrations while driving
- The sensor recognition changes suddenly when passing over a speed bump
- The vehicle in front is moving vertically to the driving direction
- The vehicle in front is stopped vertically
- The vehicle in front is driving towards your vehicle or reversing
- You are on a roundabout and the vehicle in front circles

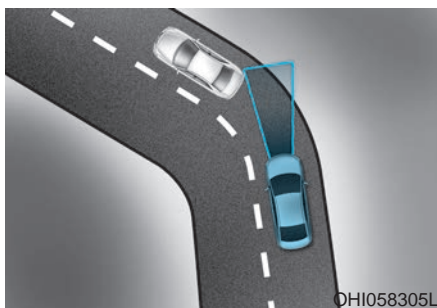

- Driving on a curve

The performance of the FCA system may be limited when driving on a curved road.

On curved roads, the other vehicle on the same lane is not recognized and the FCA system's performance may be degraded. This may result in unnecessary alarm or braking or no alarm or braking when necessary.

Also, in certain instances the front radar sensor or camera recognition system may not detect the vehicle traveling on a curved road.

In these cases, the driver must maintain a safe braking distance, and if necessary, depress the brake pedal to reduce your driving speed in order to maintain a safe distance.

The FCA system may recognize a vehicle in the next lane when driving on a curved road.

In this case, the system may unnecessarily alarm the driver and apply the brake.

Always pay attention to road and driving conditions, while driving. If necessary, depress the brake pedal to reduce your driving speed in order to maintain a safe distance.

Also, when necessary depress the accelerator pedal to prevent the system from unnecessarily decelerating your vehicle.

Check to be sure that the road conditions permit safe operation of FCA.

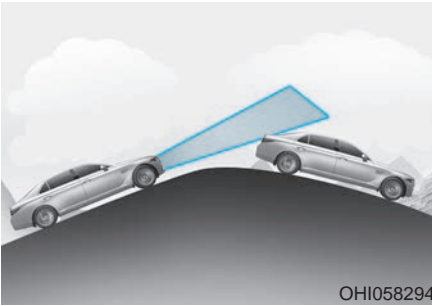

- Driving on a slope

The performance of the FCA decreases while driving upward or downward on a slope, not recognizing the vehicle in front in the same lane. It may unnecessarily produce the warning message and the warning alarm, or it may not produce the warning message and the warning alarm at all.

When the FCA suddenly recognizes the vehicle in front while passing over a slope, you may experience sharp deceleration.

Always keep your eyes forward while driving upward or downward on a slope, and, if necessary, depress the brake pedal to reduce your driving speed in order to maintain distance.

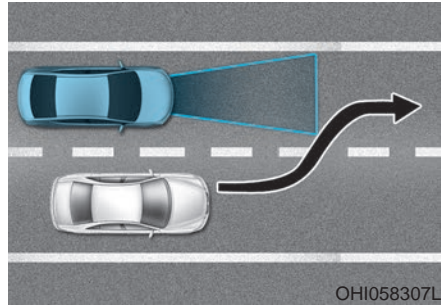

- Changing lanes

When a vehicle changes lanes in front of you, the FCA system may not immediately detect the vehicle, especially if the vehicle changes lanes abruptly. In this case, you must maintain a safe braking distance, and if necessary, depress the brake pedal to reduce your driving speed in order to maintain a safe distance.

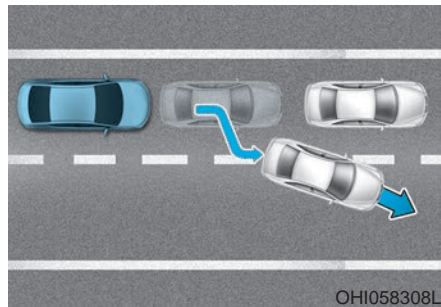

When driving in stop-and-go traffic, and a vehicle in front of you merges out of the lane, the FCA system may not immediately detect the new vehicle that is now in front of you. In this case, you must maintain a safe braking distance, and if necessary, depress the brake pedal to reduce your driving speed in order to maintain a safe distance.

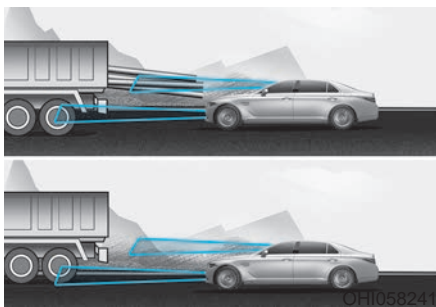

- Detecting the vehicle in front of you
If the vehicle in front of you has cargo that extends rearward from the cab, or when the vehicle in front of you has higher ground clearance, additional special attention is required. The FCA system may not be able to detect the cargo extending from the vehicle. In these instances, you must maintain a safe braking distance from the rearmost object, and if necessary, depress the brake pedal to reduce your driving speed in order to maintain distance.

Detecting pedestrians

The sensor may be limited when:

- The pedestrian is not fully detected by the camera recognition system, for example, if the pedestrian is leaning over or is not fully walking upright
- The pedestrian is moving very quickly or appears abruptly in the camera detection area
- The pedestrian is wearing clothing that easily blends into the background, making it difficult to be detected by the camera recognition system
- The outside lighting is too bright (e.g. when driving in bright sunlight or in sun glare) or too dark (e.g. when driving on a dark rural road at night)
- It is difficult to detect and distinguish the pedestrian from other objects in the surroundings, for example, when there is a group of pedestrians or a large crowd
- There is an item similar to a person's body structure
- The pedestrian is small
- The pedestrian has impaired mobility
- The sensor recognition is limited
- The radar sensor or camera is covered with a foreign object or debris
- The camera lens is contaminated due to tinted, filmed or coated windshield, damaged glass, or stuck of foreign matter (sticker, bug, etc.) on the glass

- The brightness outside is too low such as when the headlamps are not on at night or the vehicle is going through a tunnel
- Inclement weather such as heavy rain or snow obscures the field of view of the radar sensor or camera
- Light coming from a street light or an oncoming vehicle is reflected on a wet road surface such as a puddle in the road
- The field of view in front is obstructed by sun glare
- The windshield glass is fogged up; a clear view of the road is obstructed
- The adverse road conditions cause excessive vehicle vibrations while driving
- The sensor recognition changes suddenly when passing over a speed bump
- You are on a roundabout
- The pedestrian suddenly interrupts in front of the vehicle
- There is any other electromagnetic interference
- The construction area, rail or other metal object is near

WARNING

- **Do not use the Forward Collision-Avoidance Assist (FCA) system when towing a vehicle. Application of the FCA system while towing may adversely affect the safety of your vehicle or the towing vehicle.**
- **Use extreme caution when the vehicle in front of you has cargo that extends rearward from the cab, or when the vehicle in front of you has higher ground clearance.**
- **The FCA system is designed to help detect and monitor the vehicle ahead or detect a pedestrian in the roadway through radar signals and camera recognition. It is not designed to detect motorcycles, or smaller wheeled objects such as luggage bags, shopping carts, or strollers.**
- **Never try to test the operation of the FCA system. Doing so may cause severe injury or death.**
- **If the front bumper, front glass, radar or camera have been replaced or repaired, have the vehicle inspected by an authorized retailer of Genesis Branded products.**

***i* Information**

In some instances, the FCA system may be canceled when subjected to electromagnetic interference.

***i* Information**

This device complies with Part 15 of the FCC rules.

Operation is subject to the following three conditions:

1. This device may not cause harmful interference, and
2. This device must accept any interference received, including interference that may cause undesired operation.
3. Changes or modifications not expressly approved by the party responsible for compliance could void the user's authority to operate the device.

***i* Information**

Radio frequency radiation exposure information:

This equipment complies with FCC radiation exposure limits set forth for an uncontrolled environment.

This equipment should be installed and operated with minimum distance of 8 in. (20 cm) between the radiator (antenna) and your body.

This transmitter must not be co-located or operating in conjunction with any other antenna or transmitter.

FORWARD COLLISION-AVOIDANCE ASSIST - LANE-CHANGE ONCOMING FUNCTION

The Forward Collision-Avoidance Assist-Lane-Change Oncoming function detects the oncoming vehicle with a front view camera at the front windshield. And it assists the driver's steering to help avoid collision with an oncoming vehicle and keep the vehicle within the lanes, when the vehicle drives over the centreline.

⚠ WARNING

- **This function is only a supplemental system and it is not intended to, nor does it replace the need for extreme care and attention of the driver. The sensing range and objects detectable by the sensors are limited. Pay attention to the road conditions at all times.**
- **Always drive cautiously to prevent accidents from any unexpected or sudden situations. The function does not steer the vehicle completely and is not a collision avoidance system.**

System Setting and Operation

System setting

The Forward Collision-Avoidance Assist-Lane-Change Oncoming function can be activated from the Settings menu in the AVN system screen by following the procedure below.

1. Set the Engine Start/Stop button to the ON or START position.
2. Select 'Setup → Vehicle Settings → Driver Assistance → Forward Safety → Active Assist' in the AVN system screen.

For more details, refer to "LCD Display Modes" in chapter 3.

Warning message and function control



- If FCA is operating, the warning message "Emergency Steering" appears on the LCD display with an audible warning when:
 - The vehicle speed is over 40 mph (64 km/h) and the vehicle crosses the centreline when an oncoming vehicle is approaching.
- Additionally, the system provides steering assistance to return the vehicle back into the lane.

⚠ WARNING

- The steering control cannot completely avoid collision with an oncoming vehicle. It is the responsibility of the driver to always be aware of the surroundings and steer the vehicle.
- The function is operated with certain conditions, depending on the distance and speed of the oncoming vehicle, the speed of your vehicle, etc. The function can be canceled or not work properly according to the road conditions and surroundings. Always be cautious when driving.
- Never deliberately drive dangerously to activate the system.

Limitations of the System

- Refer to "Limitations of the System" of Lane Keeping Assist (LKA) System's in this chapter.
- Refer to "Detecting Vehicles" of Forward Collision-Avoidance Assist's in this chapter.

 Information

This device complies with Part 15 of the FCC rules.

Operation is subject to the following three conditions:

1. This device may not cause harmful interference, and
2. This device must accept any interference received, including interference that may cause undesired operation.
3. Changes or modifications not expressly approved by the party responsible for compliance could void the user's authority to operate the device.

 Information

Radio frequency radiation exposure information:

This equipment complies with FCC radiation exposure limits set forth for an uncontrolled environment.

This equipment should be installed and operated with minimum distance of 8 in. (20 cm) between the radiator (antenna) and your body.

This transmitter must not be co-located or operating in conjunction with any other antenna or transmitter.

BLIND-SPOT COLLISION WARNING (BCW)/BLIND-SPOT COLLISION-AVOIDANCE ASSIST (BCA)

System Description

Blind-Spot Collision Warning (BCW)

The Blind-Spot Collision Warning (BCW) system uses radar sensors in the rear bumper to monitor and warn the driver when it detects an approaching vehicle in the driver's blind spot area.

1) Blind-Spot Area

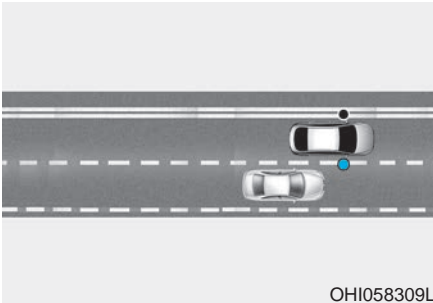

The blind spot detection range varies relative to vehicle speed.

Note that if your vehicle is traveling much faster than the vehicles around you, the warning will not occur.

2) Closing at high speed

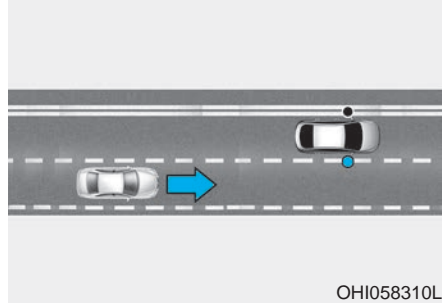

The Lane Change Assist feature will alert you when it detects a vehicle is approaching in an adjacent lane at a high rate of speed. If the driver activates the turn signal when the system detects an oncoming vehicle, the system sounds an audible alert.

Blind-Spot Collision-Avoidance Assist (BCA)

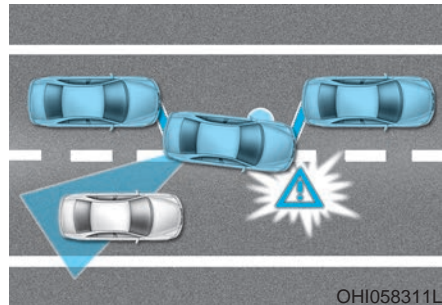

The Blind-Spot Collision-Avoidance Assist (BCA) system helps detect the front lane through the camera installed on the upper front windshield and helps detect the side/rear areas through radar sensors.

The Blind-Spot Collision-Avoidance Assist system may activate the Electronic Stability Control (ESC) if there is a possible collision with an approaching vehicle while changing lanes. It is to help mitigate the collision risk or collision damage.

WARNING

- **Always be aware of road conditions while driving and be alert for unexpected situations even though the Blind-Spot Collision Warning system and Blind-Spot Collision-Avoidance Assist system are operating.**
- **The Blind-Spot Collision Warning (BCW) system and Blind-Spot Collision-Avoidance Assist (BCA) system are supplemental systems to assist you. Do not entirely rely on the systems. Always pay attention, while driving, for your safety.**
- **The Blind-Spot Collision Warning (BCW) system and Blind-Spot Collision-Avoidance Assist (BCA) system are not substitutes for proper and safe driving. Always drive safely and use caution when changing lanes or backing up the vehicle. The Blind-Spot Collision Warning (BCW) system and Blind-Spot Collision-Avoidance Assist (BCA) system may not detect every object alongside the vehicle.**

System Setting and Operation

System setting

• Setting Blind-Spot Safety function

The Blind-Spot Collision Warning (BCW) and Blind-Spot Collision-Avoidance Assist (BCA) can be activated from the Settings menu in the AVN system screen by following the procedure below.

1. Set the Engine Start/Stop button to the ON or START position.
2. Select 'Setup → Vehicle Settings → Driver Assistance → Blind-Spot Safety → Active Assist / Warning Only / Off' in the AVN system screen. **For detailed information, scan the QR code in a separately supplied simple manual.**
 - BCA and BCW turn on and are ready to be operated when 'Active Assist' is selected. Then, if a vehicle approaches the driver's blind spot area a warning sounds or braking power is applied.
 - BCW turns on and is ready to be operated when 'Warning Only' is selected. Then, if a vehicle approaches the driver's blind spot area, a warning sounds but braking is not applied.
 - The system is deactivated and the indicator on the BCW/BCA button is turned off when 'Off' is selected.



- If you press the BCW/BCA switch while 'Active Assist' or 'Warning Only' is selected, the indicator on the switch will turn off and the system will deactivate.
- If you press the BCW/BCA switch while the system is canceled, the indicator on the button illuminates and the system activates. In this case, the system returns to the state (Active Assist or Warning Only) before the engine was turned off.
When the system is initially turned on or when the engine is turned off then on again while the system is activating, the warning light will illuminate for 3 seconds on the outer side view mirror.
- If the engine is turned off then on again, the system maintains the last setting.

• Setting Warning Timing

The driver can select the initial warning activation time from the Settings menu in the AVN system screen. Select:

- Setup → Vehicle Settings → Driver Assistance → Warning Timing → Normal/Late

For detailed information, scan the QR code in a separately supplied simple manual.

The options for the initial Blind-Spot Collision Warning includes the following:

- Normal:

When this option is selected, the initial Blind-Spot Collision Warning is activated normally. If this setting feels sensitive, change the option to 'Late'.

The warning activation time may feel late if a vehicle at the side or rear abruptly accelerates.

- Late:

Select this warning activation time when the traffic is light and you are driving at low speeds.

i Information

If you change the warning timing, the warning time of other systems may change.

- **Setting Warning Volume**

The driver can select the warning volume from the Settings menu in the AVN system screen. Select:

- Setup → Vehicle Settings → Driver Assistance → Warning Volume → High/Medium/Low/Off

For detailed information, scan the QR code in a separately supplied simple manual.

***i* Information**

If you change the warning volume, the warning volume of other systems may change.

Operating conditions

The system enters the ready status, when 'Active Assist' or 'Warning Only' is selected in the AVN system screen and the following conditions are satisfied:

- **Active Assist**

- 1) The Blind-Spot Collision-Avoidance Assist system will operate when:
 - Vehicle speed is above 40 mph (60 km/h)
 - The system detects both of the lane lines.
 - An approaching vehicle is detected next to or behind your vehicle.
- 2) The Blind-Spot Collision Warning system will operate when:
 - The vehicle speed is above approximately 20 mph (30 km/h).

- **Warning Only**

- 1) The Blind-Spot Collision Warning system will operate when:
 - The vehicle speed is approximately 20 mph (30 km/h).
 - The Blind-Spot Collision-Avoidance Assist system is not activated when "Warning Only" is selected for the system setting.

Warning and System Control

Blind-Spot Collision Warning (BCW) system

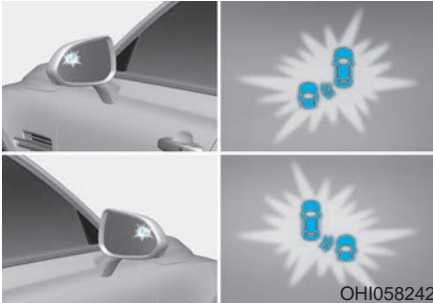

First stage alert

If a vehicle is detected within the boundary of the system, a warning light will illuminate on the outer side view mirror and the head up display. If the detected vehicle is no longer within the blind spot area, the warning will turn off according to the driving conditions of the vehicle.

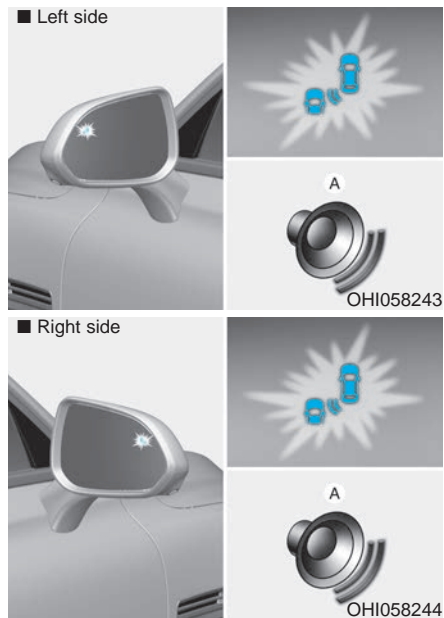

[A] : Warning sound

Second stage alert

A warning chime to alert the driver will activate when:

1. A vehicle has been detected in the blind spot area by the radar system (the warning light will illuminate on the outer side view mirror and/or the head up display (i.e, in the first stage alert)) AND
2. The turn signal is applied (same side as where the vehicle is being detected).

When this alert is activated, the warning light on the outer side view mirror and/or the head up display will also blink.

If you turn off the turn signal indicator, the second stage alert (the warning chime and the blinking warning light) will be deactivated.

If the detected vehicle is no longer within the blind spot area, the warning will turn off according to the driving conditions of the vehicle.

WARNING

- The warning light on the outer side view mirror will illuminate whenever a vehicle is detected at the rear side by the system.

To avoid accidents, do not focus only on the warning light and neglect to see the surroundings of the vehicle.

- Drive safely even though the vehicle is equipped with a Blind-Spot Collision Warning (BCW) system. Do not solely rely on the system but check your surroundings before changing lanes or backing the vehicle up.
- The system may not alert the driver in some situations due to system limitations so always check your surroundings while driving.

CAUTION

- Always pay attention to road and traffic conditions while driving, whether or not the warning light on the outer side view illuminates or there is a warning alarm.
- Playing the vehicle audio system at high volume may prevent occupants from hearing the Blind-Spot Collision Warning system warning sounds.
- If any other warning sound such as seat belt warning chime is already generated, the Blind-Spot Collision Warning (BCW) system warning may not sound.

Blind-Spot Collision-Avoidance Assist (BCA) system



The Blind-Spot Collision-Avoidance Assist (BCA) system may apply braking power, when an approaching vehicle is detected within a certain distance next to or behind your vehicle.

In this situation, the system gently apply braking power on the tire, which is located in the opposite side of the possible-colliding point. The instrument cluster will inform the driver of the system activation.

Blind-Spot Collision-Avoidance Assist (BCA) system is automatically deactivated when:

- The vehicle drives a certain distance away
- The vehicle direction is changed against the possible-colliding point
- The steering wheel is abruptly moved

- The brake pedal is depressed
- After a certain period of time

The driver should drive the vehicle in the middle of the vehicle lanes to keep the system in the ready status.

When the vehicle drives too close to one side of the vehicle lanes, the system may not properly operate.

In addition, the system may not properly control your vehicle in accordance with driving situations. Thus, always pay close attention to road conditions.

⚠ WARNING

- **The driver is responsible for accurate steering.**
- **Do not unnecessarily operate the steering wheel, when the Blind-Spot Collision-Avoidance Assist System is in operation.**
- **Always pay attention to road and traffic conditions while driving. The Blind-Spot Collision-Avoidance Assist system may not operate or unnecessarily operate depending on certain situations.**
- **The Blind-Spot Collision-Avoidance Assist system is not a substitute for safe driving practices, but is a supplemental system only. It is the responsibility of the driver to always drive cautiously to prevent unexpected and sudden situations from occurring. Pay attention to road conditions at all times.**

Detecting Sensor (Camera and Radar)

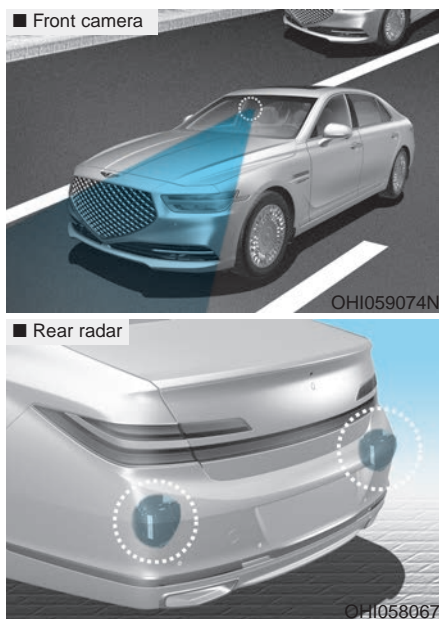

Front camera

The front camera function as a sensor detecting the lane. If the sensor is covered with snow, rain or foreign substance, the system may temporarily be canceled and not work properly. Always keep the sensor clean.

Refer to Lane Keeping Assist (LKA) System for cautions for the front camera sensor.

Rear radar

The rear radars are located inside the rear bumper for detecting the side and rear areas. Always keep the rear bumper clean for proper operation of the system.

NOTICE

- The system may not work properly when the bumper has been damaged, or if the rear bumper has been replaced or repaired.
- The sensing range differs somewhat according to the width of the road. When the road is narrow, the system may detect other vehicles in the next lane.
- The system may turn off if interfered by electromagnetic waves.
- Always keep the sensors clean.
- NEVER disassemble the sensor component or apply any impact on the sensor component.
- Be careful not to apply unnecessary force on the radar sensor or sensor cover. If the sensor is forcibly moved out of proper alignment, the system may not operate correctly. In this case, a warning message may not be displayed. Have the vehicle inspected by an authorized retailer of Genesis Branded products.
- Do not apply foreign objects such as a bumper sticker or a bumper guard near the radar sensor or apply paint to the sensor area. Doing so may adversely affect the performance of the sensor.
- NEVER install any accessories or stickers on the front windshield, or tint the front windshield.
- Pay extreme caution to keep the camera sensor dry.
- NEVER place any reflective objects (i.e. white paper, mirror) over the dashboard. Any light reflection may prevent the system from functioning properly.

Warning message



Blind-Spot Collision Warning (BCW) system disabled. Radar blocked

This warning message may appear when:

- One or both of the sensors on the rear bumper is blocked by dirt or snow or a foreign object.
- Driving in rural areas where the sensor does not detect another vehicle for an extended period of time.
- When there is inclement weather such as heavy snow or rain.
- A trailer or carrier is installed.

If any of these conditions occur, the light on the BCW/BCA switch and the system will turn off automatically.

When the BCW canceled warning message is displayed in the cluster, check to make sure that the rear bumper is free from any dirt or snow in the areas where the sensor is located. Remove any dirt, snow, or foreign material that could interfere with the radar sensors.

After any dirt or debris is removed, the system should operate normally after about 10 minutes of driving the vehicle.

If the system still does not operate normally, have the vehicle inspected by an authorized retailer of Genesis Branded products.

i Information

Turn off the BCW/BCA and RCCW/RCCA systems when a trailer or carrier is installed.

- **Press the BCW/BCA switch (the indicator on the switch will turn off)**
- **Deactivate the RCCW/RCCA system by deselecting 'Setup → Vehicle Settings → Driver Assistance → Parking Safety → Rear Cross-Traffic Safety' in the AVN system screen**

System Malfunction



Check Blind-Spot Collision Warning (BCW) system

If there is a problem with the BCW system, a warning message will appear and the light on the switch will turn off. The system will turn off automatically. BCA will not operate also if the BCW system turns off due to malfunction. Have the vehicle inspected by an authorized retailer of Genesis Branded products.



Check Blind-Spot Collision-Avoidance Assist (BCA)

If there is a problem with the BCA system, a warning message will appear. The system will turn off automatically. BCW will still operate even if the BCA system turns off due to malfunction. Have the vehicle inspected by an authorized retailer of Genesis Branded products to use BCA system.

Limitations of the System

The driver must be cautious in the below situations because the system may not detect other vehicles or objects in certain circumstances:

- When a trailer or carrier is installed.
- The vehicle driven in inclement weather such as heavy rain or snow.
- The sensor is covered with rain, snow, mud, etc.
- The rear bumper where the sensor is located is covered with a foreign object such as a bumper sticker, a bumper guard, a bike rack, etc.
- The rear bumper is damaged, or the sensor is out of the original default position.
- The vehicle height gets lower or higher due to heavy loading in a trunk, abnormal tire pressure, etc.
- When the temperature of the rear bumper is high.
- When the sensors are blocked by other vehicles, walls or parking-lot pillars.
- The vehicle is driven on a curved road.
- The vehicle is driven through a toll-gate.
- The road pavement (or the peripheral ground) abnormally contains metallic components (i.e. possibly due to subway construction).
- There is a fixed object near the vehicle, such as a guardrail.
- While going down or up a steep road where the height of the lane is different.
- Driving on a narrow road where trees or grass or overgrown.
- Driving in rural areas where the sensor does not detect another vehicle or structure for an extended period of time.
- Driving on a wet road.
- Driving on a road where the guardrail or wall is in double structure.
- A big vehicle is near such as a bus or truck.
- When the other vehicle approaches very close.
- When the other vehicle passes at a very fast speed.
- While changing lanes.
- If the vehicle has started at the same time as the vehicle next to you and has accelerated.
- When the vehicle in the next lane moves two lanes away from you OR when the vehicle two lanes away moves to the next lane from you.
- A motorcycle or bicycle is near.
- A flat trailer is near.
- If there are small objects in the detecting area such as a shopping cart or a baby stroller.
- If there is a low height vehicle such as a sports car.
- The brake pedal is depressed.
- ESC (Electronic Stability Control) is activated.
- ESC (Electronic Stability Control) malfunctions.
- The tire pressure is low or a tire is damaged.
- The brake is reworked.

- The vehicle abruptly changes driving direction.
- The vehicle makes sharp lane changes.
- The vehicle sharply stops.
- Temperature is extremely low around the vehicle.
- The vehicle severely vibrates while driving over an uneven/bumpy road, or concrete patch.
- The vehicle drives on a slippery surface due to snow, water puddle, or ice.
- The Lane Keeping Assist (LKA) does not operate normally.

For more details refer to "Lane Keeping Assist (LKA) system" in this chapter.

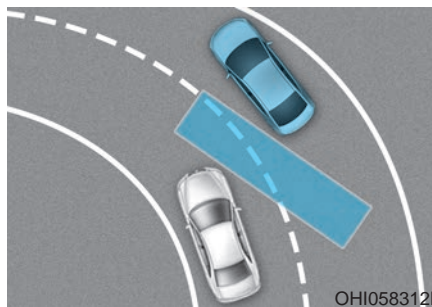

- **Driving on a curve**

The BCW and BCA systems may not operate properly when driving on a curved road. In certain instances, the system may not detect the vehicle in the next lane.

Always pay attention to road and driving conditions, while driving.

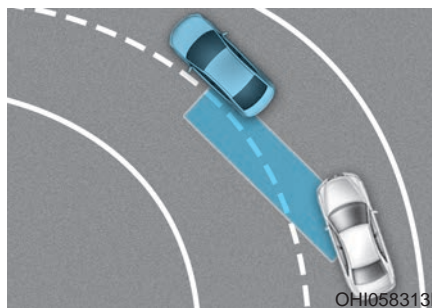

The BCW and BCA systems may not operate properly when driving on a curved road. In certain instances, the system may recognize a vehicle in the same lane.

Always pay attention to road and driving conditions, while driving.

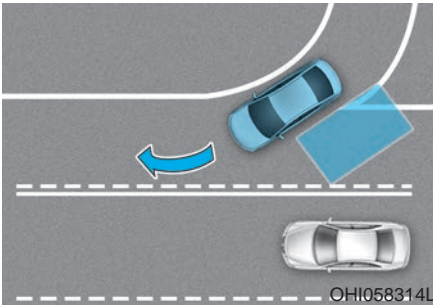

- Driving where the road is merging/dividing

The BCW and BCA systems may not operate properly when driving where the road is merging/dividing. In certain instances, the system may not detect the vehicle in the next lane.

Always pay attention to road and driving conditions, while driving.

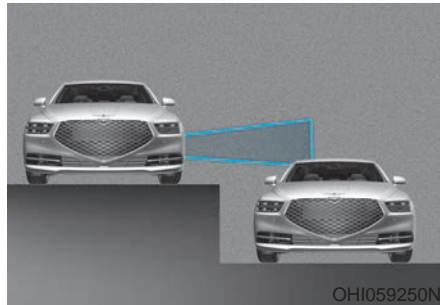

- Driving where the heights of the lanes are different

The BCW and BCA systems may not operate properly when driving where the heights of the lanes are different.

In certain instances, the system may not detect the vehicle on a road with different lane heights (i.e. underpass joining section, grade separated intersections, etc.).

Always pay attention to road and driving conditions, while driving.

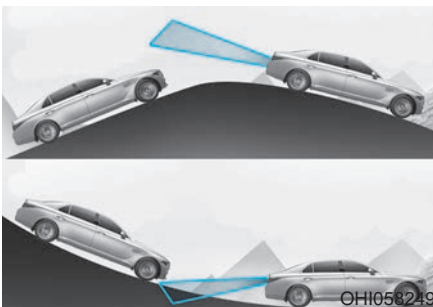

- Driving on a slope

The BCW and BCA systems may not operate properly when driving on a slope. In certain instances the system may not detect the vehicle in the next lane.

Also, in certain instances, the system may recognize the ground or structures.

Always pay attention to road and driving conditions, while driving.

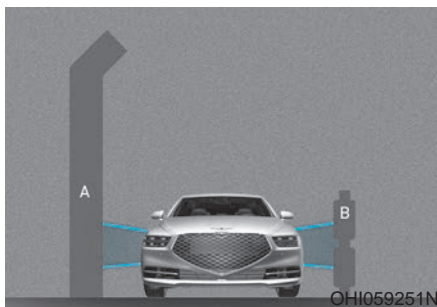

[A] : Noise barrier, [B] : Guardrail

- Driving where there is a structure beside the road

The BCW and BCA systems may not operate properly when driving where there is structure beside the road.

In certain instances, the system may recognize the structures (i.e. noise barriers, guardrail, double guardrail, median strip, bollard, street light, road sign, tunnel wall, etc.) beside the road.

Always pay attention to road and driving conditions, while driving.

i Information

This device complies with Part 15 of the FCC rules.

Operation is subject to the following three conditions:

1. This device may not cause harmful interference, and
2. This device must accept any interference received, including interference that may cause undesired operation.
3. Changes or modifications not expressly approved by the party responsible for compliance could void the user's authority to operate the device.

i Information

Radio frequency radiation exposure information:

This equipment complies with FCC radiation exposure limits set forth for an uncontrolled environment.

This equipment should be installed and operated with minimum distance of 8 in. (20 cm) between the radiator (antenna) and your body.

This transmitter must not be co-located or operating in conjunction with any other antenna or transmitter.

REAR CROSS-TRAFFIC COLLISION WARNING (RCCW)/ REAR CROSS-TRAFFIC COLLISION-AVOIDANCE ASSIST (RCCA)

System Description

Rear Cross-Traffic Collision Warning (RCCW) system

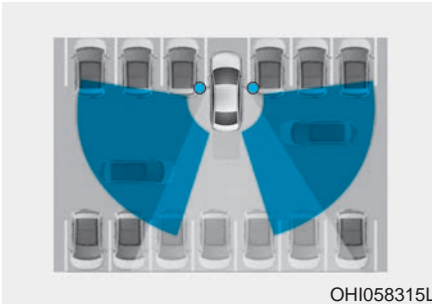

The Rear Cross-Traffic Collision Warning (RCCW) system uses radar sensors to monitor the approaching cross traffic from the left and right side of the vehicle when your vehicle is in reverse.

The blind spot detection range varies relative to the approaching vehicle speed.

Rear Cross-Traffic Collision-Avoidance Assist (RCCA) system

The Rear Cross-Traffic Collision-Avoidance Assist (RCCA) system monitors approaching cross traffic from the left and right side of the vehicle when your vehicle is in reverse.

The Rear Cross-Traffic Collision-Avoidance Assist (RCCA) system may activate the Electronic Stability Control (ESC) in accordance with a possible collision with an approaching vehicle. It is to lower the possible collision risk or mitigate the possible collision damage.

⚠ WARNING

- Always be aware of road and traffic conditions while driving and be alert for unexpected situations even though the Rear Cross-Traffic Collision Warning system and Rear Cross-Traffic Collision-Avoidance Assist system are operating.
- The Rear Cross-Traffic Collision Warning system and Rear Cross-Traffic Collision-Avoidance Assist system are supplemental systems to assist you. Do not entirely rely on the systems. Always pay attention, while driving, for your safety.
- The Rear Cross-Traffic Collision Warning system and Rear Cross-Traffic Collision-Avoidance Assist system are not substitutes for proper and safe driving. Always drive safely and use caution when backing up the vehicle.

System Setting and Operation

System setting

• Setting Rear Cross-Traffic Safety function

The Rear Cross-Traffic Collision Warning (RCCW) and Rear Cross-Traffic Collision Avoidance-Assist (RCCA) can be activated from the Settings menu in the AVN system screen by following the procedure below.

1. Set the Engine Start/Stop button to the ON or START position.
2. Select 'Setup → Vehicle Settings → Driver Assistance → Parking Safety → Rear Cross-Traffic Safety' in the AVN system screen. **For detailed information, scan the QR code in a separately supplied simple manual.**
 - RCCA and RCCW turn on and are ready to be operated when the 'Rear Cross-Traffic Safety' is selected.
- When the engine is turned off then on again, the systems will be ready to be operated.
- When the system is initially turned on and engine is turned off then on again, the warning light will illuminate for 3 seconds on the side view mirror.

• Setting Warning Timing

The driver can select the initial warning activation time from the Settings menu in the AVN system screen. Select:

- Setup → Vehicle Settings → Driver Assistance → Warning Timing → Normal/Late

For detailed information, scan the QR code in a separately supplied simple manual.

The options for the initial Rear Cross-Traffic Collision Warning includes the following:

- Normal:

When this option is selected, the initial Rear Cross-Traffic Collision Warning is activated normally. If this setting feels sensitive, change the option to 'Late'.

The warning activation time may feel late if the a vehicle at the side or rear abruptly accelerates.

- Late:

Select this warning activation time when the traffic is light and you are driving at low speeds.

Information

If you change the warning timing, the warning time of other systems may change.

- **Setting Warning Volume**

The driver can select the warning volume from the Settings menu in the AVN system screen. Select:

- Setup → Vehicle Settings → Driver Assistance → Warning Volume → High/Medium/Low/Off

For detailed information, scan the QR code in a separately supplied simple manual.

***i* Information**

If you change the warning volume, the warning volume of other systems may change.

Operating conditions

To operate:

1. Select 'Setup → Vehicle Settings → Driver Assistance → Parking Safety → Rear Cross-Traffic Safety' in the AVN system screen. **For detailed information, scan the QR code in a separately supplied simple manual.** The system will turn on and standby to operate.
2. The system will operate when vehicle speed is below 7 mph (10 km/h) and with the shift lever in R (Reverse).
 - * The system will not operate when the vehicle speed exceeds 7 mph (10 km/h). The system will operate again when the speed is below 5 mph (8 km/h).

The system's detecting range is within approximately 82 ft. (25 m).

An approaching vehicle will be detected if vehicle speed is between 5-23 mph (8-36 km/h).

Note that the detecting range and operating speed may vary under certain conditions. As always, use caution and pay close attention to your surroundings when backing up your vehicle.

Warning and System Control

Rear Cross-Traffic Collision Warning (RCCW) system

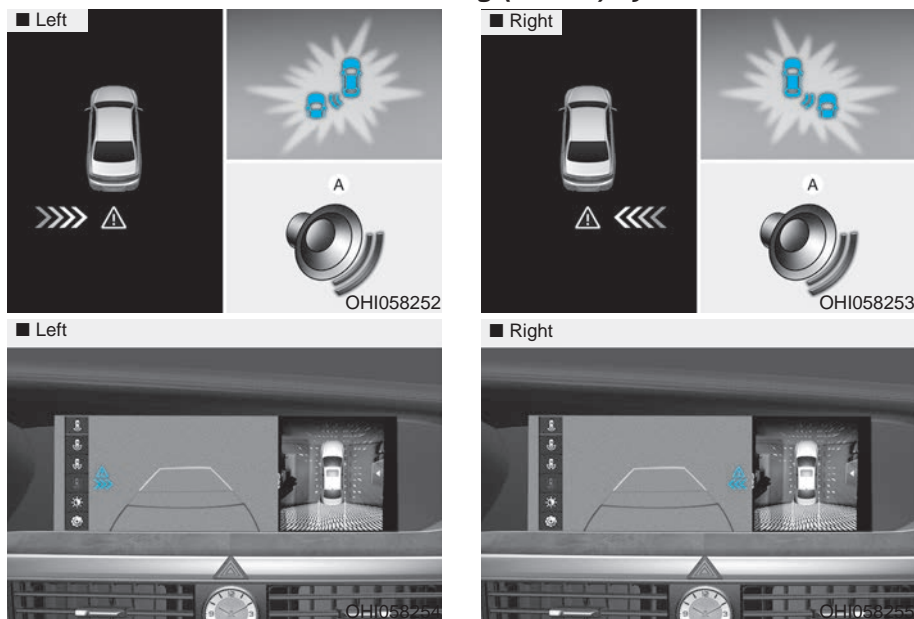

If the vehicle detected by the sensors approaches from the rear left/right side of your vehicle, the warning chime will sound, the warning light on the outer side view mirror will blink and a warning will appear on the cluster LCD display. If the rear view monitor system is operating, a warning will also appear on the AVN system screen.

The warning will stop when:

- the detected vehicle moves out of the sensing area or
- when the vehicle is right behind your vehicle or
- when the vehicle is not approaching your vehicle or
- when the other vehicle slows down.

Rear Cross-Traffic Collision-Avoidance Assist (RCCA) system

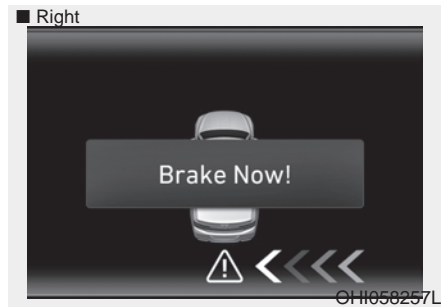
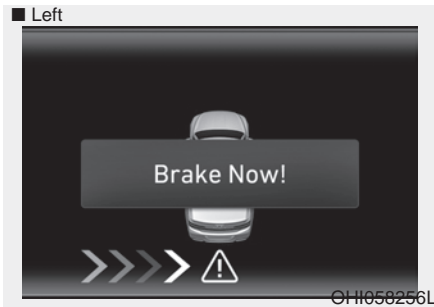

If the risk of collision is detected while the RCCW is generated, brake control may be activated. The instrument cluster will inform the driver of the brake control. If the rear view monitor system is operating, a warning will also appear on the AVN system screen.

After the brake control is activated, the driver must immediately depress the brake pedal and check the surroundings.

- The brake activation by the system lasts for about 2 seconds.
The driver must pay attention as the brake is disengaged after 2 seconds.
- The brake control by the system is canceled if the driver depresses the brake pedal with sufficient power.
- Brake control is activated once for each right/left approach after shifting the shift lever to R (Reverse).

The brake control may not operate properly according to the status of the ESC (Electronic Stability Control). The same warning message is displayed on the instrument cluster when:

- The ESC (Electronic Stability Control) warning light is on.
- The ESC (Electronic Stability Control) is engaged in a different function.

**CAUTION**

- When the operation condition of the Rear Cross-Traffic Collision Warning system is satisfied, the warning will occur every time a vehicle approaches the side or rear of your stopped (0 mph (0 km/h) vehicle speed) vehicle.
- The system's warning or brake may not operate properly if the left or right of your vehicle's rear bumper is blocked by a vehicle or obstacle.
- Always pay attention to road and traffic conditions while driving, whether or not the warning light on the outer side view mirror illuminates or there is a warning alarm.
- Playing the vehicle audio system at high volume may prevent occupants from hearing the system's warning sounds.
- If any other warning sound such as seat belt warning chime is already generated, the Rear Cross-Traffic Collision Warning system warning may not sound.

**WARNING**

- Drive safely even though the vehicle is equipped with a Rear Cross-Traffic Collision Warning system and Rear Cross-Traffic Collision-Avoidance Assist system. Do not solely rely on the system but check your surrounding when backing the vehicle up.
- The driver is responsible for accurate brake control.
- Always pay extreme caution while driving. The Rear Cross-Traffic Collision Warning system and Rear Cross-Traffic Collision-Avoidance Assist system may not operate properly or unnecessarily operate depending on traffic and driving conditions.
- The Rear Cross-Traffic Collision-Avoidance Assist system is not a substitute for safe driving practices, but a convenience function only. It is the responsibility of the driver to always drive cautiously to prevent unexpected and sudden situations from occurring. Pay attention to the road conditions at all times.

Detecting Sensor

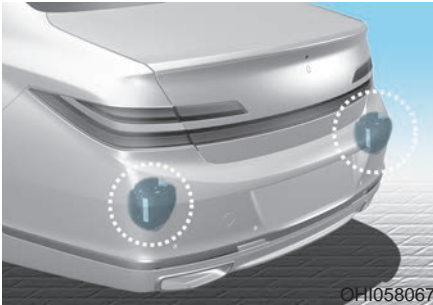

The rear radars are located inside the rear bumper for detecting the side and rear areas. Always keep the rear bumper clean for proper operation of the system.

NOTICE

- The system may not work properly when the bumper has been damaged, or if the rear bumper has been replaced or repaired.
- The system may turn off if interfered by electromagnetic waves.
- Always keep the sensors clean.
- NEVER disassemble the sensor component or apply any impact on the sensor component.
- Be careful not to apply unnecessary force on the radar sensor or sensor cover. If the sensor is forcibly moved out of proper alignment, the system may not operate correctly. In this case, a warning message may not be displayed. Have the vehicle inspected by an authorized retailer of Genesis Branded products.

- Do not apply foreign objects such as a bumper sticker or a bumper guard near the radar sensor or apply paint to the sensor area. Doing so may adversely affect the performance of the sensor.

Warning message



Blind-Spot Collision Warning (BCW) system disabled. Radar blocked

This warning message may appear when:

- One or both of the sensors on the rear bumper is blocked by dirt or snow or a foreign object.
- Driving in rural areas where the sensor does not detect another vehicle for an extended period of time.
- When there is inclement weather such as heavy snow or rain.

If any of these conditions occur, the light on the BCW/BCA switch and the system will turn off automatically.

When the BCW canceled warning message is displayed in the cluster, check to make sure that the rear bumper is free from any dirt or snow in the areas where the sensor is located. Remove any dirt, snow, or foreign material that could interfere with the radar sensors.

After any dirt or debris is removed, the system should operate normally after about 10 minutes of driving the vehicle.

If the system still does not operate normally, have the vehicle inspected by an authorized retailer of Genesis Branded products.

i Information

Turn off the BCW/BCA and RCCW/RCCA systems when a trailer or carrier is installed.

- Press the BCW/BCA switch (the indicator on the switch will turn off)
- Deactivate the RCCW/RCCA system by deselecting 'Setup → Vehicle Settings → Driver Assistance → Parking Safety → Rear Cross-Traffic Safety' in the AVN system screen

System Malfunction



Check Blind-Spot Collision Warning system

If there is a problem with the BCW system, a warning message will appear and the light on the switch will turn off. The system will turn off automatically. RCCW and RCCA will not operate also if the BCW system turns off due to malfunction. Have the vehicle inspected by an authorized retailer of Genesis Branded products.

Limitations of the System

The driver must be cautious in the below situations because the system may not detect other vehicles or objects in certain circumstances:

- When a trailer or carrier is installed.
- The vehicle drives in inclement weather such as heavy rain or snow.
- The sensor is polluted with rain, snow, mud, etc.
- The rear bumper where the sensor is located is covered with a foreign object such as a bumper sticker, a bumper guard, a bike rack, etc.
- The rear bumper is damaged, or the sensor is out of the original default position.
- The vehicle height gets lower or higher due to heavy loading in a trunk, abnormal tire pressure, etc.
- When the temperature of the rear bumper is high.
- When the sensors are blocked by other vehicles, walls or parking-lot pillars.
- The vehicle drives on a curved road.
- The road pavement (or the peripheral ground) abnormally contains metallic components (i.e. possibly due to subway construction).
- There is a fixed object near the vehicle, such as a guardrail.
- While going down or up a steep road where the height of the lane is different.
- Driving on a narrow road where trees or grass or overgrown.
- Driving in rural areas where the sensor does not detect another vehicle for an extended period of time.
- Driving on a wet road.
- Driving on a road where the guardrail or wall is in double structure.
- A big vehicle is near such as a bus or truck.
- When the other vehicle approaches very close.
- When the other vehicle passes at a very fast speed.
- While changing lanes.
- If the vehicle has started at the same time as the vehicle next to you and has accelerated.
- When the vehicle in the next lane moves two lanes away from you OR when the vehicle two lanes away moves to the next lane from you.
- A motorcycle or bicycle is near.
- A flat trailer is near.
- If there are small objects in the detecting area such as a shopping cart or a baby stroller.
- If there is a low height vehicle such as a sports car.
- The brake pedal is depressed.
- ESC (Electronic Stability Control) is activated.
- ESC (Electronic Stability Control) malfunctions.
- The tire pressure is low or a tire is damaged.
- The brake is reworked.
- The vehicle sharply stops.
- Temperature is extremely low around the vehicle.
- The vehicle severely vibrates while driving over an uneven/bumpy road, or concrete patch.
- The vehicle drives on a slippery surface due to snow, water puddle, or ice.

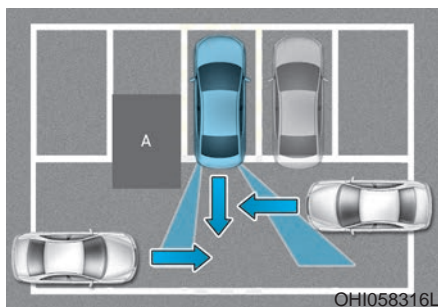

[A] : Structure

- Driving where there is a vehicle or structure near

The system may not operate properly when driving where there is a vehicle or structure near.

In certain instances, the system may not detect the vehicle approaching from behind and the warning or brake may not operate properly.

Always pay attention to your surrounding while driving.

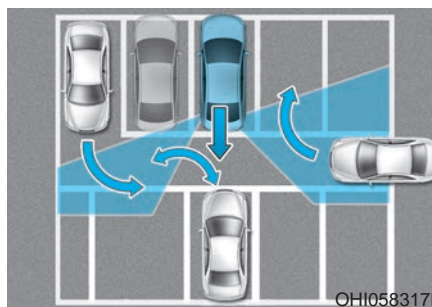

- When the vehicle is in a complex parking environment

The system may not operate properly when the vehicle is in a complex parking environment.

In certain instances, the system may not be able to exactly determine the risk of collision for the vehicles which are parking or pulling out near your vehicle (e.g. a vehicle escaping beside your vehicle, a vehicle parking or pulling out in the rear area, a vehicle approaching your vehicle making a turn, etc.).

If this occurs, the warning or brake may not operate properly.

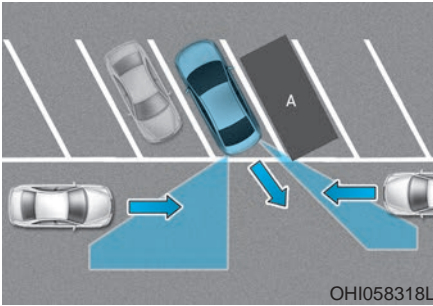

[A] : Vehicle

- When the vehicle is parked diagonally

The system may not operate properly when the vehicle is parked diagonally.

In certain instances, when the diagonally parked vehicle is pulled out of the parking space, the system may not detect the vehicle approaching from the rear left/right of your vehicle. In this case, the warning or brake may not operate properly.

Always pay attention to your surrounding while driving.

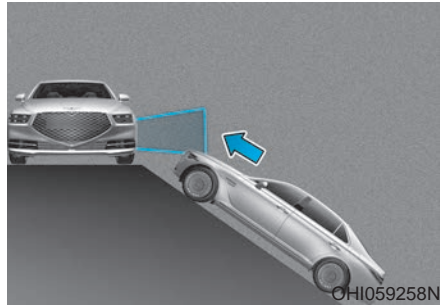

- When the vehicle is on/near a slope

The system may not operate properly when the vehicle is on/near a slope.

In certain instances, the system may not detect the vehicle approaching from the rear left/right and the warning or brake may not operate properly.

Always pay attention to your surrounding while driving.

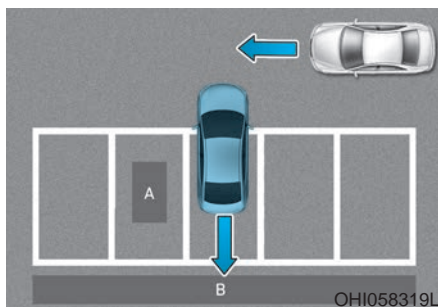

[A] : Structure, [B] : Wall

- Pulling into the parking space where there is a structure

The system may not operate properly when pulling in the vehicle to the parking space where there is a structure at the back or side of your vehicle.

In certain instances, when backing into the parking space, the system may falsely detect the vehicle moving in front of your vehicle. In this case, the warning or brake may operate.

Always pay attention to the parking space while driving.

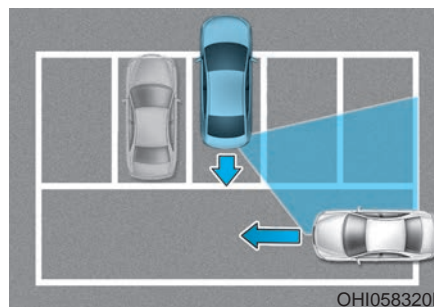

- When the vehicle is parked rearward

If the vehicle is parked rearward and the sensor detects the another vehicle in the rear area of the parking space, the system can warn or control braking. Always pay attention to the parking space while driving.

i Information

This device complies with Part 15 of the FCC rules.

Operation is subject to the following three conditions:

1. This device may not cause harmful interference, and
2. This device must accept any interference received, including interference that may cause undesired operation.
3. Changes or modifications not expressly approved by the party responsible for compliance could void the user's authority to operate the device.

***i* Information**

Radio frequency radiation exposure information:

This equipment complies with FCC radiation exposure limits set forth for an uncontrolled environment.

This equipment should be installed and operated with minimum distance of 8 in. (20 cm) between the radiator (antenna) and your body.

This transmitter must not be co-located or operating in conjunction with any other antenna or transmitter.

SMART CRUISE CONTROL WITH STOP & GO SYSTEM

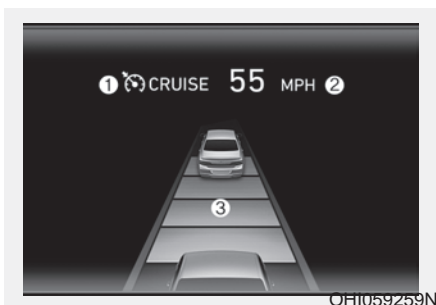

- (1) Cruise indicator
- (2) Set speed
- (3) Vehicle-to-vehicle distance

To see the SCC screen on the LCD display on the cluster, select Assist mode (). For more details, refer to "LCD Display Modes" in chapter 3.

The Smart Cruise Control system allows you to program the vehicle to help maintain the desired speed and minimum distance between the vehicle ahead.



The Smart Cruise Control system will automatically adjust your vehicle speed to maintain your programmed speed and following distance without requiring you to depress the accelerator or brake pedals.

WARNING

The Smart Cruise Control system is not a substitute for safe driving practices, but a convenience function only. It is the responsibility of the driver to always check the speed and distance to the vehicle ahead.

WARNING

Take the following precautions :

- Always set the vehicle speed under the speed limit.
- If the Smart Cruise Control is left on, ( CRUISE indicator light in the instrument cluster is illuminated) the Smart Cruise Control can be activated unintentionally. Keep the Smart Cruise Control system off ( CRUISE indicator light OFF) when the Smart Cruise Control is not in use, to avoid inadvertently setting a speed.
- Use the Smart Cruise Control system only when traveling on open highways in good weather.

WARNING

For your safety, please read the owner's manual before using the Smart Cruise Control system.

- Do not use the Smart Cruise Control when it may not be safe to keep the vehicle at a constant speed:
 - When driving in heavy traffic or when traffic conditions make it difficult to drive at a constant speed
 - When driving on rainy, icy, or snow-covered roads
 - When driving on a steep downhill or uphill
 - When driving in windy areas
 - When driving in parking lots
 - When driving near crash barriers
 - When driving on a sharp curve
 - When driving with limited view (possibly due to bad weather, such as fog, snow, rain or sandstorm)
 - When the vehicle sensing ability decreases due to vehicle modification resulting level difference of the vehicle's front and rear
- Unexpected situations may lead to possible accidents. Pay attention continuously to road conditions and driving even when the smart cruise control system is being operated.

Smart Cruise Control Switch

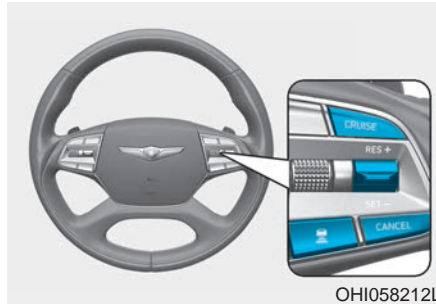

CRUISE : Turns cruise control system on or off.

RES+: Resumes or increases cruise control speed.

SET-: Sets or decreases cruise control speed.

 : Sets vehicle-to-vehicle distance.

CANCEL : Cancels cruise control operation.

Adjusting the Sensitivity of Smart Cruise Control

The sensitivity of vehicle speed when following the front vehicle to maintain the set distance can be adjusted. Select 'Setup → Vehicle Settings → Driver Assistance → SCC Reaction → Fast / Normal / Slow' from the Settings menu in the AVN system screen.

For detailed information, scan the QR code in a separately supplied simple manual.

You may select one of the three stages you prefer.

- Fast:

Vehicle speed following the front vehicle to maintain the set distance is faster than normal speed.

- Normal:

Vehicle speed following the front vehicle to maintain the set distance is normal.

- Slow:

Vehicle speed following the front vehicle to maintain the set distance is slower than normal speed.

Information

The last selected speed sensitivity of the smart cruise control is remained in the system.

Converting to Cruise Control Mode

The driver may choose to only use the conventional Cruise Control mode (speed control function) by doing as follows:

1. Turn the Smart Cruise Control System on (the cruise indicator light will be on but the system will not be activated).
2. Push and hold the Vehicle-to-Vehicle Distance button for more than 2 seconds.
3. Choose between "Smart Cruise Control" and "Cruise Control".

When the system is canceled using the CRUISE button or the CRUISE button is used after the engine is turned on, the Smart Cruise Control mode will turn on.

WARNING

When using the Cruise Control mode, you must manually adjust the distance to other vehicles by depressing the brake pedal. The system does not automatically adjust the distance to vehicles in front of you.

Smart Cruise Control Speed

To set Smart Cruise Control speed

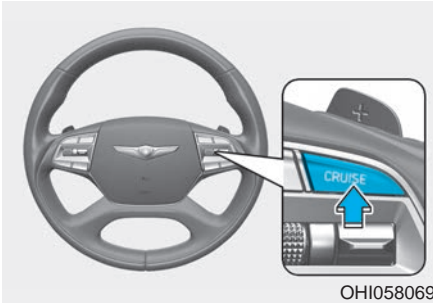

1. Push the CRUISE button on the steering wheel to turn the system on. The cruise indicator will illuminate.
2. Accelerate to the desired speed. The Smart Cruise Control speed can be set when vehicle speed is between as follows.
 - 5–120 mph (10–200 km/h):
when there is no vehicle in front
 - 0–120 mph (0–200 km/h):
when there is a vehicle in front

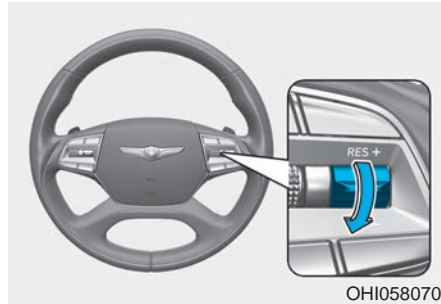

3. Push the toggle switch down (SET-). The Set Speed and Vehicle-to-Vehicle Distance on the LCD display will illuminate.
4. Release the accelerator pedal. The desired speed will automatically be maintained.

If there is a vehicle in front of you, the speed may decrease to maintain the distance to the vehicle ahead.

On a steep grade, the vehicle may slow down or speed up slightly while going uphill or downhill.

i Information

- Vehicle speed may decrease on an upward slope and increase on a downward slope.
- The speed is set to 20 mph (30 km/h) when there is a preceding car in front, and when your vehicle speed is between 0-20 mph (0-30 km/h).

To increase Smart Cruise Control set speed

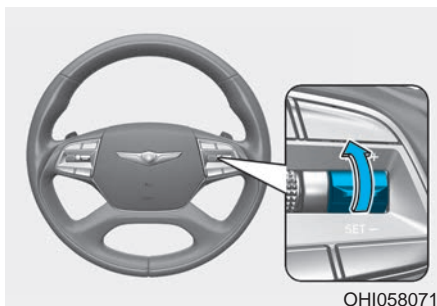

Follow either of these procedures:

- Push the toggle switch up (RES+), and release it immediately. The cruising speed will increase by 1 mph (1 km/h) each time you move the toggle switch up in this manner.
- Push the toggle switch up (RES+), and hold it. Your vehicle set speed will increase by 5 mph (10 km/h). Release the toggle switch at the speed you want.
- You can set the speed to 120 mph (200 km/h).

To decrease the Smart Cruise Control set speed

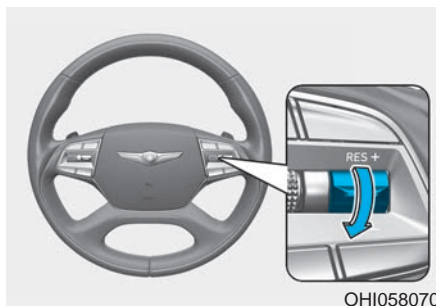

Follow either of these procedures:

- Push the toggle switch down (SET-), and release it immediately. The cruising speed will decrease by 1 mph (1 km/h) each time you move the toggle switch down in this manner.
- Push the toggle switch down (SET-), and hold it. Your vehicle set speed will decrease by 5 mph (10 km/h). Release the toggle switch at the speed you want.
- You can set the speed to 20 mph (30 km/h).

CAUTION

Check the traffic and driving conditions before using the toggle switch. Driving speed may sharply increase, when you push up and hold the toggle switch.

To temporarily accelerate with the Smart Cruise Control on

If you want to speed up temporarily when the Smart Cruise Control is on, depress the accelerator pedal. Increased speed will not interfere with Smart Cruise Control operation or change the set speed.

To return to the set speed, take your foot off the accelerator pedal.

If you push the toggle switch down (SET-) at increased speed, the cruising speed will be set again.

***i* Information**

Be careful when accelerating temporarily, because the speed is not controlled automatically at this time even if there is a vehicle in front of you.

Smart Cruise Control will be temporarily canceled when:

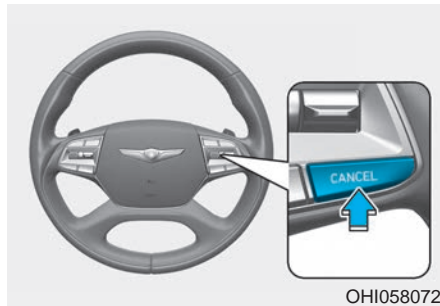

Canceled manually

- Depressing the brake pedal.
- Pushing the CANCEL button located on the steering wheel.

The Smart Cruise Control turns off temporarily when the Set Speed and Vehicle-to-Vehicle Distance indicator on the cluster LCD display turns off.

The cruise indicator ( CRUISE) is illuminated continuously.

Canceled automatically

- The driver's door is opened.
- The vehicle is shifted to N (Neutral), R (Reverse) or P (Park).
- EPB (Electronic Parking Brake) is applied.
- The vehicle speed is over 130 mph (210 km/h).
- The ESC (Electronic Stability Control), TCS (Traction Control System) or ABS is operating.
- The ESC is turned off.
- The sensor or the cover is dirty or covered with foreign matter.
- The vehicle is stopped for more than 5 minutes.

- The vehicle stops and goes repeatedly for a long period of time.
- The accelerator pedal is continuously depressed for a long period of time.
- The engine performance is abnormal.
- Engine rpm is in the red zone.
- The driver starts driving by pushing the toggle switch up (RES+)/down (SET-) or depressing the accelerator pedal, after the vehicle is stopped by the Smart Cruise Control system with no other vehicle ahead.
- The driver starts driving by pushing the toggle switch up (RES+)/down (SET-) or depressing the accelerator pedal, after stopping the vehicle with a vehicle stopped far away in front.
- The braking control is operated for FCA (Forward Collision-Avoidance Assist)
- The engine is stopped by ISG (Idle Stop & Go) (if equipped).

Each of these actions will cancel the Smart Cruise Control operation. The Set Speed and Vehicle-to-Vehicle Distance on the cluster LCD display will go off.

In a condition the Smart Cruise Control is canceled automatically, the Smart Cruise Control will not resume even though the RES+ or SET- toggle switch is pushed.

Also, if the Smart Cruise Control is canceled automatically while the vehicle is at a standstill, EPB (Electronic Parking Brake) will be applied.

i Information

If the Smart Cruise Control is canceled during a situation that is not described, have the system checked by an authorized retailer of Genesis Branded products.

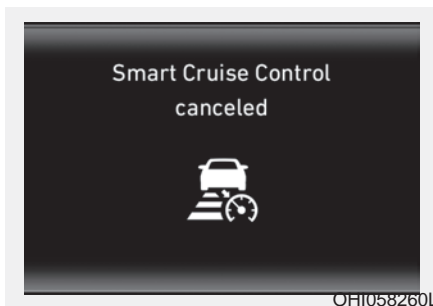

Smart Cruise Control canceled

If the system is canceled, the warning chime will sound and a message will appear for a few seconds.

You must adjust the vehicle speed by depressing the accelerator or brake pedal according to the road and driving conditions.

Always check the road conditions. Do not rely on the warning chime.

To resume Smart Cruise Control set speed

If any method other than the cruise toggle switch was used to cancel cruising speed and the system is still activated, the cruising speed will automatically resume when you push the toggle switch up (RES+) or down (SET-).

If you push the toggle switch up (RES+), the speed will resume to the recently set speed. However, if vehicle speed drops below 5 mph (10 km/h), it will resume when there is a vehicle in front of your vehicle.

⚠ WARNING

- **To avoid collisions, always be aware of the selected speed and vehicle to vehicle distance settings when activating your smart cruise control system.**
- **Always maintain sufficient braking distance and decelerate your vehicle by applying the brakes if necessary.**

To turn Cruise Control off

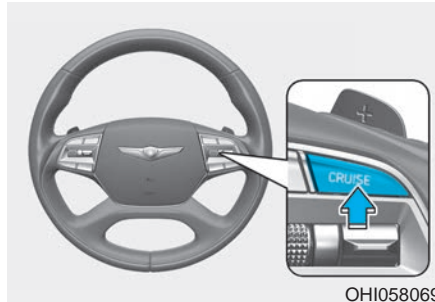

- Push the CRUISE button. The cruise indicator will go off.

If you wish not to use the cruise control system, always turn the system off by pushing the CRUISE button.

Smart Cruise Control Vehicle-to-Vehicle Distance

To set Vehicle-to-Vehicle Distance

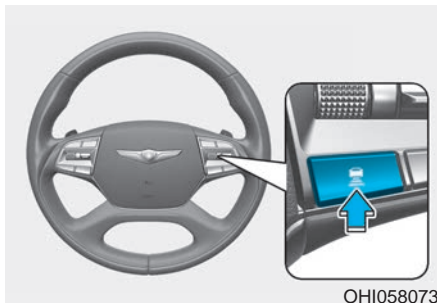

When the Smart Cruise Control system is ON, you can set and maintain the distance from the vehicle ahead of you without pressing the accelerator or brake pedal.

Each time the button is pressed, the vehicle to vehicle distance changes as follows:

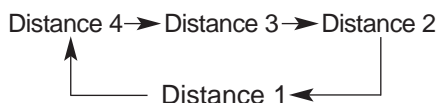

For example, if you drive at 56 mph (90 km/h), the distance maintain as follows:

- Distance 4 - approximately 172 feet
- Distance 3 - approximately 130 feet
- Distance 2 - approximately 106 feet
- Distance 1 - approximately 82 feet

i Information

The distance is set to the last set distance when the system is used for the first time after starting the engine.

When the lane ahead is clear:



The vehicle speed will maintain the set speed.

When there is a vehicle ahead of you in your lane:

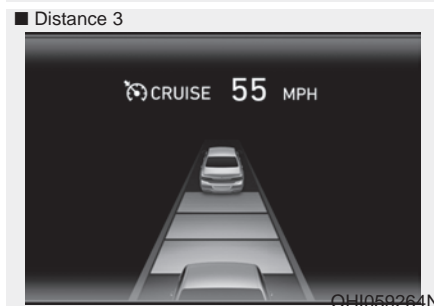
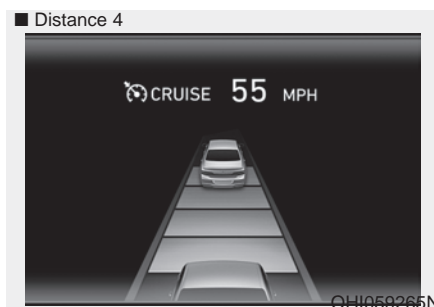

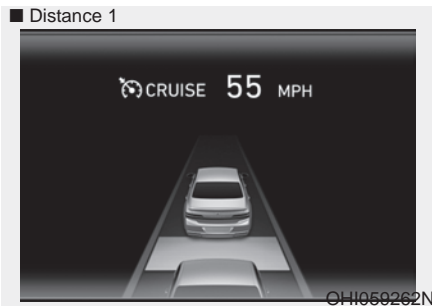
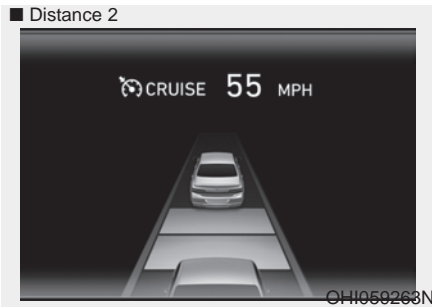

- A vehicle will appear in front on the cluster LCD display when a vehicle is actually detected in front of your vehicle.
- Your vehicle speed will slow down or speed up to maintain the selected distance.
- If the vehicle ahead speeds up, your vehicle will travel at a steady cruising speed after accelerating to the set speed.
- If distance from the front vehicle has been changed due to accelerating or decelerating of front vehicle, the distance on the cluster LCD display may change.



When using the Smart Cruise Control System:

- The warning message appears and warning chime sounds if the vehicle is unable to maintain the selected distance from the vehicle ahead.
- If the warning message appears and warning chime sounds, depress the brake pedal to actively adjust the vehicle speed, and the distance to the vehicle ahead.
- Even if the warning message does not appear and warning chime does not sound, always pay attention to the driving conditions to prevent dangerous situations from occurring.
- Playing the vehicle audio system at high volume may prevent occupants from hearing the system warning sounds.

 **CAUTION**



OHI058266L

If the vehicle ahead (vehicle speed: less than 20 mph (30 km/h)) moves to the next lane, the warning chime will sound and a message "Watch for surrounding vehicles" will appear. Adjust your vehicle speed for vehicles or objects that can suddenly appear in front of you by depressing the brake pedal. Always pay attention to the road condition ahead.

In traffic situation



OHI058267L

Use switch or pedal to accelerate

- In traffic, your vehicle will stop if the vehicle ahead of you stops. Also, if the vehicle ahead of you starts moving, your vehicle will start as well. However, if the vehicle stops for more than 3 seconds, you must depress the accelerator pedal or push up the toggle switch (RES+) or push down the toggle switch (SET-) to start driving.
- If you push the smart cruise control toggle switch (RES+ or SET-) while Auto Hold and smart cruise control is operating the Auto Hold will be released regardless of accelerator pedal operation and the vehicle will start to move. The AUTO HOLD indicator changes from green to white.

Sensor to Detect Distance to the Vehicle Ahead



The Smart Cruise Control uses a sensor to detect distance to the vehicle ahead.

If the sensor is covered with dirt or other foreign matter, the vehicle to vehicle distance control may not operate correctly.

Always keep the sensor clean.

Warning message



Smart Cruise Control disabled. Radar blocked

When the sensor lens cover is covered with dirt, snow, or debris, the Smart Cruise Control system operation may stop temporarily. If this occurs, a warning message will appear on the cluster LCD display.

Remove any dirt, snow, or debris and clean the radar sensor lens cover before operating the Smart Cruise Control system.

The Smart Cruise Control system may not properly activate, if the radar is totally covered, or if any substance is not detected after turning ON the engine (e.g. in an open terrain).

i Information

For the SCC operation is temporarily stopped if the radar is blocked, but you wish to use cruise control mode (speed control function), you must convert to the cruise control mode (refer to "To convert to Cruise Control mode" in the following page).

! CAUTION

- Do not apply license plate frame or foreign objects such as a bumper sticker or a bumper guard near the radar sensor. Doing so may adversely affect the sensing performance of the radar.
- Always keep the radar sensor and lens cover clean and free of dirt and debris.
- Use only a soft cloth to wash the vehicle. Do not spray pressurized water directly on the sensor or sensor cover.

- **Be careful not to apply unnecessary force on the radar sensor or sensor cover. If the sensor is forcibly moved out of proper alignment, the Smart Cruise Control system may not operate correctly. In this case, a warning message may not be displayed. Have the vehicle inspected by an authorized retailer of Genesis Branded products.**
- **If the front bumper becomes damaged in the area around the radar sensor, the Smart Cruise Control system may not operate properly. Have the vehicle inspected by an authorized retailer of Genesis Branded products.**
- **Use only Genuine Genesis Parts to repair or replace a damaged sensor or sensor cover. Do not apply paint to the sensor cover.**

System Malfunction

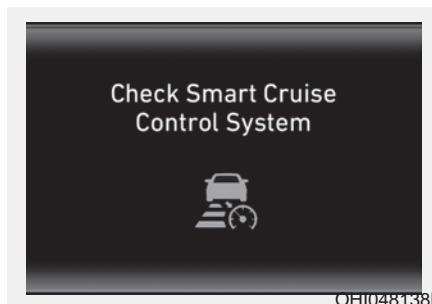

Check Smart Cruise Control System

The message will appear when the vehicle to vehicle distance control system is not functioning normally.

Take your vehicle to an authorized retailer of Genesis Branded products and have the system checked.

Limitations of the System

The Smart Cruise Control system may have limits to its ability to detect distance to the vehicle ahead due to road and traffic conditions.

On curves

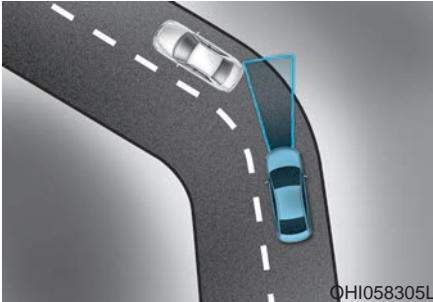

- The Smart Cruise Control system may not detect a moving vehicle in your lane, and then your vehicle could accelerate to the set speed. Also, the vehicle speed will decrease when the vehicle ahead is recognized suddenly.
- Select the appropriate set speed on curves and apply the brakes or accelerator pedal if necessary.



Your vehicle speed can be reduced due to a vehicle in the adjacent lane. Apply the accelerator pedal and select the appropriate set speed.

Check to be sure that the road conditions permit safe operation of the Smart Cruise Control.

On inclines

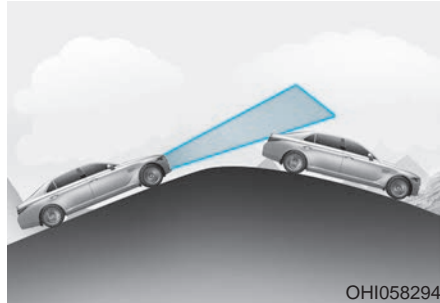

- During uphill or downhill driving, the Smart Cruise Control system may not detect a moving vehicle in your lane, and cause your vehicle to accelerate to the set speed. Also, the vehicle speed will rapidly decrease when the vehicle ahead is recognized suddenly.
- Select the appropriate set speed on inclines and apply the brake or accelerator pedal if necessary.

Lane changing

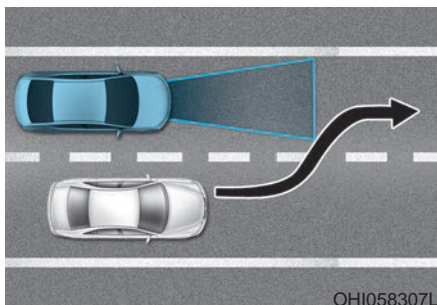

- A vehicle which moves into your lane from an adjacent lane cannot be recognized by the sensor until it is in the sensor's detection range.
- The radar may not detect immediately when a vehicle cuts in suddenly. Always pay attention to the traffic, road and driving conditions.
- If a slower vehicle moves into your lane, your speed may decrease to maintain the distance to the vehicle ahead.
- If a faster vehicle which moves into your lane, your vehicle will accelerate to the set speed.

Vehicle recognition

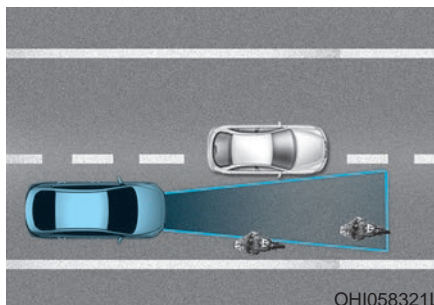

Some vehicles in your lane cannot be recognized by the sensor:

- Narrow vehicles such as motorcycles or bicycles
- Vehicles offset to one side
- Slow-moving vehicles or sudden-decelerating vehicles
- Stopped vehicles
- Vehicles with small rear profile such as trailers with no loads

A vehicle ahead cannot be recognized correctly by the sensor if any of following occurs:

- When the vehicle is pointing upwards due to overloading in the luggage compartment
- While the steering wheel is operating
- When driving to one side of the lane
- When driving on narrow lanes or on curves

Apply the brake or accelerator pedal if necessary.

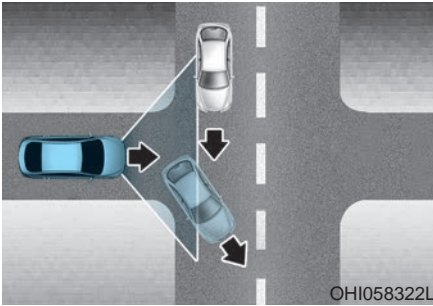

- Your vehicle may accelerate when a vehicle ahead of you disappears.
- When you are warned that the vehicle ahead of you is not detected, drive with caution.

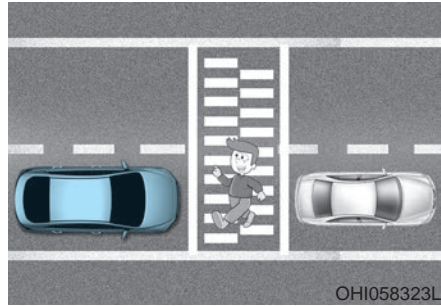

- Always look out for pedestrians when your vehicle is maintaining a distance with the vehicle ahead.

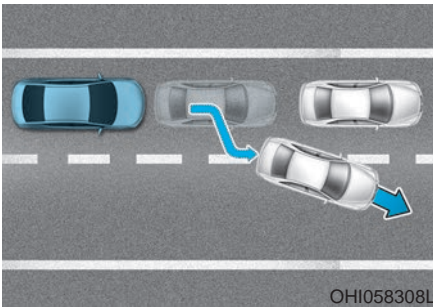

- When driving in stop-and-go traffic, and a vehicle in front of you merges out of the lane, the system may not immediately detect the new vehicle that is now in front of you. In this case, you must maintain a safe braking distance, and if necessary, depress the brake pedal to reduce your driving speed in order to maintain a safe distance.

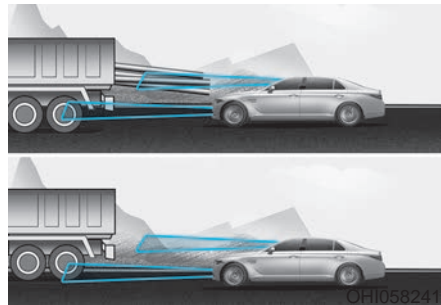

- Always be cautious for vehicles with higher height or vehicles carrying loads that sticks out from the back of the vehicle.

⚠ WARNING

When using the Smart Cruise Control take the following precautions:

- If an emergency stop is necessary, you must apply the brakes. The smart cruise control system cannot guarantee the stop for every emergency situation.
- Keep a safe distance according to road conditions and vehicle speed. If the vehicle to vehicle distance is too close during a high-speed driving, a serious collision may result.
- Always maintain sufficient braking distance and decelerate your vehicle by applying the brakes if necessary.
- The Smart Cruise Control system cannot recognize a stopped vehicle, pedestrians or an oncoming vehicle. Always look ahead cautiously to prevent unexpected and sudden situations from occurring.
- Vehicles moving in front of you with a frequent lane change may cause a delay in the system's reaction or may cause the system to react to a vehicle actually in an adjacent lane. Always drive cautiously to prevent unexpected and sudden situations from occurring.
- Always be aware of the selected speed and vehicle to vehicle distance. The driver should not solely rely on the system but always pay attention to driving conditions and control your vehicle speed.

- The Smart Cruise Control system may not recognize complex driving situations so always pay attention to driving conditions and control your vehicle speed.
- The Smart Cruise Control system may recognize a pedestrian, bicycle, motorcycle, etc. as a vehicle. Always, look ahead cautiously to prevent unexpected and sudden situations from occurring.
- Turn off the Smart Cruise Control system when the vehicle is being towed.
- The Smart Cruise Control system may operate limitedly when towing a trailer or vehicle so always drive cautiously to prevent unexpected and sudden situations from occurring.

NOTICE

The Smart Cruise Control system may not operate temporarily due to:

- Electrical interference
- A modified suspension
- Differences of tire abrasion or tire pressure
- Installing different type of tires

i Information

This device complies with Part 15 of the FCC rules.

Operation is subject to the following three conditions:

1. This device may not cause harmful interference, and
2. This device must accept any interference received, including interference that may cause undesired operation.
3. Changes or modifications not expressly approved by the party responsible for compliance could void the user's authority to operate the device.

i Information

Radio frequency radiation exposure information:

This equipment complies with FCC radiation exposure limits set forth for an uncontrolled environment.

This equipment should be installed and operated with minimum distance of 8 in. (20 cm) between the radiator (antenna) and your body.

This transmitter must not be co-located or operating in conjunction with any other antenna or transmitter.

LEADING VEHICLE DEPARTURE ALERT

The Leading Vehicle Departure Alert system alerts the driver of the departure of the vehicle in front when the vehicle is stopped and the Smart Cruise Control (SCC) system is operating.

System Setting and Operation

System setting

The Leading Vehicle Departure Alert can be activated from the Settings menu in the AVN system screen by following the procedure below.

1. Set the Engine Start/Stop button to the ON or START position.
2. Select 'Setup → Vehicle Settings → Driver Assistance → Leading Vehicle Departure Alert' in the AVN system screen. **For detailed information, scan the QR code in a separately supplied simple manual.**

System standby



Use switch or pedal to accelerate

While the Smart Cruise Control (SCC) system is operating, your vehicle stops behind the vehicle in front when it stops. The message shown above is displayed on the cluster within 3 seconds after the stop and the system will be in the standby position.

System operation



Leading vehicle is driving away

If the driver does not take action for a certain period of time after the vehicle in front departs, the message shown above is displayed on the cluster.

The vehicle departs automatically if the accelerator pedal is depressed or RES+ or SET- toggle switch is pushed up or down when there is a vehicle in front.

The Smart Cruise Control (SCC) system is deactivated if the accelerator pedal is depressed or RES+ or SET- toggle switch is pushed up or down when there is no vehicle in front.

WARNING

Always check the front of the vehicle and road conditions before departure.

NAVIGATION-BASED SMART CRUISE CONTROL (IF EQUIPPED)

The Navigation-based Smart Cruise Control system will help automatically adjust your speed when a curved road is ahead by receiving road information from the navigation while the Smart Cruise Control is operating.

WARNING

- The Navigation-based Smart Cruise Control system is not a substitute for safe driving practices, but a convenience function. It is the responsibility of the driver to always be aware of the surroundings and drive safely.
- The Navigation-based Smart Cruise Control system relies entirely on the road information provided by the navigation system and may accelerate above speed limit. It is the responsibility of the driver to follow traffic laws and avoid accidents.
- For your safety, please read the owner's manual before using the system.

Information

- The Navigation-based Smart Cruise Control system is available only on controlled access road of certain highways.

* Controlled access road indicates roads with limited entrances and exits that allow uninterrupted high speed traffic flow. Only passenger cars and motorcycles are allowed on controlled access roads.

Available highway (Controlled access road)

USA	Select Interstate Highways, U.S. Highways (Federal Highways), and State Highways
Canada	Select Provincial and Territorial Highways

- Additional highways may be expanded by navigation updates.

System Setting and Operation

System setting

- With the Engine Start/Stop button in the ON or START position, the Navigation-based Smart Cruise Control can be activated by selecting 'Setup → Vehicle Settings → Driver Assistance → Highway Auto Curve Slowdown' from the Settings menu in the AVN system screen. Deselect the setting to turn off the system. **For detailed information, scan the QR code in a separately supplied simple manual.**
- If the engine is turned off then on again, the system maintains the last setting.

Operating conditions

Select 'Highway Auto Curve Slowdown' from the Settings menu in the AVN system screen and satisfy the following conditions for the system to operate.

- Driving on the highway main line
- Smart Cruise Control is operating

If all the mentioned conditions are satisfied, the system is ENABLED and the 'AUTO' symbol on the cluster will illuminate white.

System operation



System standby

If the system is ENABLED, the **AUTO** symbol on the cluster will illuminate white.



System in operation

If the vehicle decelerates in a curve, the **AUTO** symbol on the cluster will illuminate green.

- This system works only for curved sections located on highway main lines.
- Depending on the curve ahead on the road, the vehicle will decelerate, and after passing the curve, the vehicle will accelerate to the Smart Cruise Control set speed.
- The higher the driving speed, the faster the vehicle is decelerated.

- The system responds to curves located on the destination set in the navigation. If the destination is not set, the system will respond to road information of the expected route.

i Information

- Navigation-based Smart Cruise Control is limited in other countries.
- The system may not operate due to the existence of leading vehicles and the driving situations of the vehicle.
- The system operates regardless of whether the sharp curve warning appears on the navigation, but the time gap could occur between the warning and system operation.
- The navigation only provides curve information within permitted speed ranges so that the system may not decrease its speed during extreme over-speed driving.
- The system is not designed to work on highways other than mentioned as a controlled access road.
- The system automatically cancels when you leave the highway.
- Highway Driving Assist and Navigation-based Smart Cruise Control uses the same **AUTO** symbol that indicates the status of the system. Therefore, even if the Navigation-based Cruise Control is off, the **AUTO** symbol may be displayed.
- If there is a problem with Navigation-based Smart Cruise Control, the system cannot be activated in the AVN system screen, and the **AUTO** symbol will turn off. However, if Highway Driving Assist is activated, the **AUTO** symbol will be displayed.
- After you pass through a tollgate on a highway, the system operates based on the first lane. If you enter one of the other lanes, the system might not properly decelerate.
- If you over speed, the system may not decelerate the vehicle in a curve.
- Deceleration by the system may not be sufficient if the driver accelerates while the system is operating,
- Deceleration by the system may not be sufficient due to road conditions such as uneven road surfaces, narrow lanes, etc.
- If the road is controlled, due to construction or holiday events, the system might not work properly.

 **CAUTION**

The Navigation-based Cruise Control system may not function properly in the following situations:

- The navigation is not working properly.
- The navigation is not updated.
- The real-time GPS or map information provided has errors.
- The navigation is overloaded by performing functions such as route search, video playback, voice recognition, etc. are performing simultaneously.
- GPS signals are blocked in areas such as a tunnel.
- The driver goes off course or the route to the destination is changed or canceled by resetting the navigation.
- The vehicle enters a service station or rest area.
- A section of the highway's shape has changed.
- Android Auto or Car Play is operating.
- The navigation cannot detect the current vehicle position (ex: elevated roads including overpass adjacent to general roads or nearby roads exist in a parallel way).
- The navigation is being updated while driving.
- The navigation is being reset while driving.
- The road is slippery due to bad weather such as rain or snow.

 **Information**

This device complies with Part 15 of the FCC rules.

Operation is subject to the following three conditions:

1. This device may not cause harmful interference, and
2. This device must accept any interference received, including interference that may cause undesired operation.
3. Changes or modifications not expressly approved by the party responsible for compliance could void the user's authority to operate the device.

 **Information**

Radio frequency radiation exposure information:

This equipment complies with FCC radiation exposure limits set forth for an uncontrolled environment.

This equipment should be installed and operated with minimum distance of 8 in. (20 cm) between the radiator (antenna) and your body.

This transmitter must not be co-located or operating in conjunction with any other antenna or transmitter.

LANE FOLLOWING ASSIST (LFA) SYSTEM

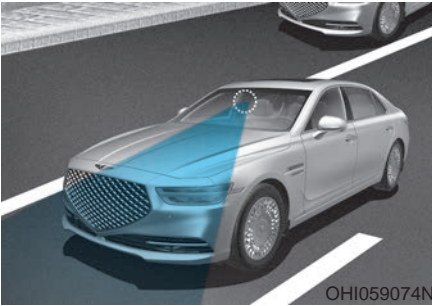

The Lane Following Assist (LFA) system helps detect lane markers on the road with a front view camera at the front windshield, and assists the driver's steering to help keep the vehicle between lanes.

⚠ WARNING

The Lane Following Assist (LFA) system is not a substitute for safe driving practices, but a convenience function. It is the responsibility of the driver to always be aware of the surroundings and steer the vehicle.

⚠ WARNING

Take the following precautions when using the Lane Following Assist (LFA) system:

- **Do not turn the steering wheel suddenly when the steering wheel is being assisted by the system.**
- **LFA system helps the driver to keep the vehicle in the center of the lane by assisting the driver's steering. However, the driver should not solely rely on the system but always pay attention on the steering wheel to stay in the lane.**
- **The operation of the LFA system can be canceled or not work properly according to road condition and surroundings. Always be cautious when driving.**
- **Do not disassemble the LFA system camera temporarily to tint the window or attach any types of coatings and accessories. If you disassemble the camera and assemble it again, we recommend that you take your vehicle to an authorized retailer of Genesis Branded products and have the system checked for calibration.**
- **When you replace the windshield glass, LFA system camera or related parts of the steering wheel, take your vehicle to an authorized retailer of Genesis Branded products and have the system checked for calibration.**

- The system helps detect lane markers and controls the steering wheel by a camera, therefore, if the lane markers are hard to detect, the system may not work properly.

Please refer to "Limitations of the System".

- Do not remove or damage the related parts of LFA system.
- You may not hear a warning sound of LFA system if the audio volume is high.
- Do not place objects on the dashboard that reflects light such as mirrors, white paper, etc. This may prevent the LFA system from functioning properly.
- Always have your hands on the steering wheel while the LFA system is activated.
- The steering wheel is not continuously controlled so if the vehicle speed is at a higher rate when leaving a lane the vehicle may not be controlled by the system. The driver must always follow the speed limit when using the system.
- If you attach objects to the steering wheel, the system may not assist steering or the hands off alarm may not work properly.

LFA Setting and Operation

System setting

- With the Engine Start/Stop button is in the ON or START position, the Lane Following Assist can be activated by selecting 'Setup → Vehicle Settings → Driver Assistance → Lane Following Assist' from the Settings menu in the AVN system screen. Deselect the setting to turn off the system. **For detailed information, scan the QR code in a separately supplied simple manual.**
- If the engine is turned off then on again, the system maintains the last setting.

Operating conditions

Select 'Lane Following Assist' from the Settings menu in the AVN system screen and satisfy the following conditions for the system to operate.

- The Smart Cruise Control is operating
- Vehicle speed is lower than 95 mph (153 km/h)

When the system is activated, the indicator () on the cluster will illuminate. The color of the indicator will change depending on the condition of the LFA system.

- Green : Steering assist mode is ON
- White : Steering assist mode is OFF

LFA operation



If the vehicle is inside the lane with both lanes detected by the system (lane color changes from gray to white), and there is no abrupt steering made by the driver, the LFA system changes to steering assist mode.

The  indicator light will come on green, and the system helps the vehicle stay in line by controlling the steering wheel.

When the steering wheel is not controlled temporarily, the  indicator light will flash green and change to white.

Warning Message



Keep hands on steering wheel

If the driver takes their hands off the steering wheel for several seconds while the LFA system is activated, the system will warn the driver.

Information

Hold the steering wheel tight. Otherwise, the LFA system could misjudge that the driver's hands are off the steering wheel, and the above warning may occur.

WARNING

The warning message may appear late according to road conditions. Therefore, always have your hands on the steering wheel while driving.



Driving Convenience systems canceled

If the driver still does not have their hands on the steering wheel after the message "Keep hands on steering wheel", the LFA system will be canceled. However, if the Smart Cruise Control is reactivated manually by the driver, the Lane Following Assist System will reactivate.

To activate Smart Cruise control, refer to "Smart Cruise Control with Stop and Go" in chapter 5.

WARNING

- **The LFA system is a supplemental system only. It is the responsibility of the driver to safely steer the vehicle and to maintain it in its lane.**
- **Turn off the LFA system and drive without using the system in the following situations:**
 - In bad weather
 - In bad road conditions
 - When the steering wheel needs to be controlled by the driver frequently.
 - When towing a vehicle or trailer

Information

- **Even though the steering is assisted by the system, the driver may control the steering wheel.**
- **The steering wheel may feel heavier when the steering wheel is assisted by the system than when it is not.**



Check Lane Following Assist (LFA) system

If there is a problem with the system a message will appear for a few seconds. If the problem continues, we recommend that you have the vehicle inspected by an authorized retailer of Genesis Branded products.

The LFA system will not be in the ENABLED state and/or the steering wheel will not be assisted when:

- The turn signal is turned on before changing a lane. If you change lanes without the turn signal on, the steering wheel might be controlled.
- The vehicle is not driven in the middle of the lane when the system is turned on or right after changing a lane.
- ESC (Electronic Stability Control) or VSM (Vehicle Stability Management) is activated.
- The vehicle is driven on a sharp curve.
- Vehicle speed is over 95 mph (153 km/h).
- The vehicle makes sharp lane changes.
- The vehicle brakes suddenly.
- Only one lane marker is detected.
- The lane is very wide or narrow.
- There are more than two lane markers on the road (e.g. construction area).
- Radius of a curve is too small.
- The vehicle is driven on a steep incline.
- The steering wheel is turned suddenly.
- The system may not operate for 15 seconds after the engine is started or the camera is initialized.

Limitations of the System

The LFA system may operate prematurely even if the vehicle does not depart from the intended lane, OR, the LFA system may not assist your steering or warn you if the vehicle leaves the intended lane under the following circumstances:

When the lane and road conditions are poor

- It is difficult to distinguish the lane marking from the road surface or the lane marking is faded or not clearly marked.
- It is difficult to distinguish the color of the lane marker from the road.
- There are markings on the road surface that look like a lane marker that is inadvertently being detected by the camera.
- The lane marker is indistinct or damaged.
- The lane marker is merged or divided. (e.g. tollgate)
- The lane number increases or decreases or the lane marker are crossing complicatedly.
- There are more than two lane markers on the road in front of you.
- The lane marker is very thick or thin.
- The lane is very wide or narrow.
- The lane marker ahead is not visible due to rain, snow, water on the road, damaged or stained road surface, or other factors.
- The shadow is on the lane marker by a median strip, trees, guardrail, noise barriers, etc.
- The lane markers are complicated or a structure substitutes for the lines such as a construction area.

- There are crosswalk signs or other symbols on the road.
- The lane marker in a tunnel is stained with oil, etc.
- The lane suddenly disappears such as at the intersection.
- Driving on a steep grade, over a hill, or when driving on a curved road.
- The adverse road conditions cause excessive vehicle vibrations while driving.

When external condition is intervened

- The brightness outside changes suddenly such as when entering or exiting a tunnel, or when passing under a bridge.
- The brightness outside is too low such as when the headlamps are not on at night or the vehicle is going through a tunnel.
- There is a boundary structure in the roadway such as a concrete barrier, guardrail and reflector post that is inadvertently being detected by the camera.
- When light coming from a street light or an oncoming vehicle is reflected on a wet road surface such as a puddle in the road.
- The field of view in front is obstructed by sun glare.
- There is not enough distance between you and the vehicle in front to be able to detect the lane marker or the vehicle ahead is driving on the lane marker.

- The surrounding of the inside rear view mirror temperature is high due to direct sunlight, etc.

- The sensor recognition changes suddenly when passing over a speed bump or driving on a steep up/down or right/left grade

When front visibility is poor

- The windshield or the camera lens is covered with dirt or debris.
- The windshield glass is fogged up; a clear view of the road is obstructed.
- Placing objects on the dashboard, etc.
- The sensor cannot detect the lane because of fog, heavy rain or snow.

LANE KEEPING ASSIST (LKA) SYSTEM

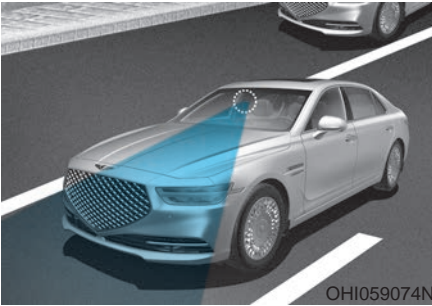

The Lane Keeping Assist (LKA) system with a camera at the front windshield, helps detect lane markers on the road, and assists the driver's steering to help keep the vehicle between lanes.

When the system detects the vehicle straying from its lane, it alerts the driver with a visual and audible warning, while applying a counter-steering torque, trying to help prevent the vehicle from moving out of its lane.

WARNING

The Lane Keeping Assist (LKA) system is not a substitute for safe driving practices, but a convenience function. It is the responsibility of the driver to always be aware of the surroundings and steer the vehicle.

WARNING

Take the following precautions when using the Lane Keeping Assist (LKA) system:

- Do not turn the steering wheel suddenly when the steering wheel is being assisted by the system.
- LKA system helps to prevent the driver from moving out of the lane unintentionally by assisting the driver's steering. However, the driver should not solely rely on the system but always pay attention on the steering wheel to stay in the lane.
- The operation of the LKA system can be canceled or not work properly according to road condition and surroundings. Always be cautious when driving.
- Do not disassemble the LKA system camera temporarily to tint the window or attach any types of coatings and accessories. If you disassemble the camera and assemble it again, take your vehicle to an authorized retailer of Genesis Branded products and have the system checked for calibration.
- When you replace the windshield glass, LKA system camera or related parts of the steering wheel, take your vehicle to an authorized retailer of Genesis Branded products and have the system checked for calibration.

- The system helps detect lane markers and controls the steering wheel by a camera, therefore, if the lane markers are hard to detect, the system may not work properly.

Please refer to "Limitations of the System".

- Do not remove or damage the related parts of LKA system.
- You may not hear a warning sound of LKA system if the audio volume is high.
- If any other warning sound such as seat belt warning chime is already generated, the Lane Keeping Assist (LKA) system warning may not sound.
- Do not place objects on the dashboard that reflects light such as mirrors, white paper, etc. This may prevent the LKA system from functioning properly.
- Always have your hands on the steering wheel while the LKA system is activated.
- The steering wheel is not continuously controlled so if the vehicle speed is at a higher rate when leaving a lane the vehicle may not be controlled by the system. The driver must always follow the speed limit when using the system.
- If you attach objects to the steering wheel, the system may not assist steering or the hands off alarm may not work properly.

LKA operation



To activate/deactivate the LKA system:

With the Engine Start/Stop button in the ON or START position, press the LKA system switch located on the instrument panel on the left hand side of the steering wheel. The indicator in the instrument cluster will initially illuminate () white. This indicates the LKA system is in the READY but NOT ENABLED state.

If you press the LKA switch again, the indicator on the cluster will go off.



Note that the vehicle speed must be at least approximately 40 mph (64 km/h) to ENABLE the

LKA system. The indicator in the cluster will illuminate green.

The color of indicator will change depending on the condition of LKA system.

- White : Sensor does not detect lane markers or vehicle speed is under 40 mph (64 km/h).
- Green : Sensor detects lane markers and the system is able to control vehicle steering.

i Information

If the indicator (white) is activated from the previous ignition cycle, the system will turn ON without any additional control. If you press the LKA switch again, the indicator on the cluster goes off.

LKA system operation



- To see the LKA system screen on the LCD display in the cluster, select Assist mode (). For more details, refer to "LCD Display Modes" in chapter 3.



- If vehicle speed is over 40 mph (64 km/h) and the system detects lane markers, the color changes from gray to white.

- If your vehicle departs from the projected system lane in front of you, the LKA system operates as follows:

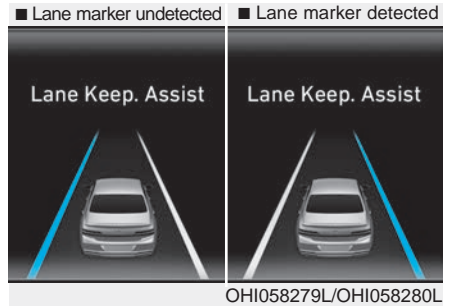

- A visual warning appears on the cluster LCD display. Either the left lane marker or the right lane marker in the cluster LCD display will blink depending on which direction the vehicle is veering. Also, the steering wheel will vibrate along with a warning sound.
- The LKA system will help control the vehicle's steering to prevent the vehicle from crossing the lane maker in below conditions.

- Vehicle speed is over 40 mph (64 km/h)
- When driving, the vehicle is located between both lanes normally.
- The steering wheel is not turned suddenly.

When lane markers are detected and all the conditions to activate the LKA system are satisfied, a LKA system indicator light () will change from white to green. This indicates that the LKA system is in the ENABLED state and the steering wheel will be controlled.

Warning Light and Message

Keep hands on steering wheel



If the driver takes their hands off the steering wheel for several seconds while the LKA system is activated, the system will warn the driver.

i Information

If the steering wheel is held with a light grip, the message may appear because the LKA system may not recognize that the driver has their hands on the steering wheel.

⚠ WARNING

The warning message may appear late according to road conditions. Therefore, always have your hands on the steering wheel while driving.

⚠ WARNING

- The LKA system is a supplemental system only. It is the responsibility of the driver to safely steer the vehicle and to maintain it in its lane.
- Turn off the LKA system and drive without using the system in the following situations:
 - In bad weather
 - In bad road conditions
 - When the steering wheel needs to be controlled by the driver frequently.
 - When towing a vehicle or trailer

i Information

- Even though the steering is assisted by the system, the driver may control the steering wheel.
- The steering wheel may feel heavier when the steering wheel is assisted by the system than when it is not.

Check Lane Keeping Assist (LKA) system



If there is a problem with the system a message will appear for a few seconds. If the problem continues the LKA system failure indicator will illuminate.

LKA system indicator



The LKA system indicator (yellow) will illuminate if the LKA system is not working properly. Have the system checked by an authorized retailer of Genesis Branded products.

When there is a problem with the system do one of the following:

- Turn the system on after turning the engine off and on again.
- Check if the Engine Start/Stop button is in the ON position.
- Check if the system is affected by the weather (e.g. fog, heavy rain, etc.).
- Check if there is foreign matter on the camera lens.

If the problem is not solved, we recommend that the system be checked by an authorized retailer of Genesis Branded products.

The LKA system will not be in the **ENABLED** state and/or the steering wheel will not be assisted when:

- The turn signal is turned on before changing a lane. If you change lanes without the turn signal on, the steering wheel might be controlled.
- The vehicle is not driven in the middle of the lane when the system is turned on or right after changing a lane.
- ESC (Electronic Stability Control) or VSM (Vehicle Stability Management) is activated.
- The vehicle is driven on a sharp curve.

- Vehicle speed is below 35 mph (56 km/h) and over 110 mph (177 km/h).
- The vehicle makes sharp lane changes.
- The vehicle brakes suddenly.
- The lane is very wide or narrow.
- There are more than two lane markers such as a construction area.
- The vehicle is driven on a steep incline.
- The steering wheel is turned suddenly.
- The system may not operate for 15 seconds after the engine is started or the camera is initialized.

Limitations of the System

The LKA system may operate prematurely even if the vehicle does not depart from the intended lane, OR, the LKA system may not assist your steering or warn you if the vehicle leaves the intended lane under the following circumstances:

When the lane and road conditions are poor

- It is difficult to distinguish the lane marking from the road surface or the lane marking is faded or not clearly marked.
- It is difficult to distinguish the color of the lane marker from the road.
- There are markings on the road surface that look like a lane marker that is inadvertently being detected by the camera.
- The lane marker is indistinct or damaged.
- The lane marker is merged or divided (e.g. tollgate).
- The lane number increases or decreases or the lane marker are crossing complicatedly.
- There are more than two lane markers on the road in front of you.
- The lane marker is very thick or thin.
- The lane (or road width) is very wide or narrow.
- The lanes ahead are not visible due to rain, snow, water on the road, damaged or stained road surface, or other factors.
- The shadow is on the lane marker by a median strip, trees, guardrail, noise barriers, etc.

- The lane markers are complicated or a structure substitutes for the lines such as a construction area.
- There are crosswalk signs or other symbols on the road.
- The lane marker in a tunnel is stained with oil, etc.
- The lane suddenly disappears such as at the intersection.

When external condition is intervened

- The brightness outside changes suddenly such as when entering or exiting a tunnel, or when passing under a bridge.
- The brightness outside is too low such as when the headlamps are not on at night or the vehicle is going through a tunnel.
- There is a boundary structure in the roadway such as a concrete barrier, guardrail and reflector post that is inadvertently being detected by the camera.
- When light coming from a street light or an oncoming vehicle is reflected on a wet road surface such as a puddle in the road.
- The field of view in front is obstructed by sun glare.
- There is not enough distance between you and the vehicle in front to be able to detect the lane marker or the vehicle ahead is driving on the lane marker.
- Driving on a steep grade, over a hill, or when driving on a curved road.
- The adverse road conditions cause excessive vehicle vibrations while driving.

- The surrounding of the inside rear view mirror temperature is high due to direct sunlight, etc.

When front visibility is poor

- The windshield or the camera lens is covered with dirt or debris.
- The windshield glass is fogged up; a clear view of the road is obstructed.
- Placing objects on the dashboard, etc.
- The sensor cannot detect the lane because of fog, heavy rain or snow.

LKA System Setting

• Setting LKA function

The driver can change between 'Lane Keeping Assist' and 'Lane Departure Warning' from the Settings menu in the AVN system screen. Select:

- Setup → Vehicle → Driver Assistance → Lane Safety

For detailed information, scan the QR code in a separately supplied simple manual.

- Lane Keeping Assist

Lane Keeping Assist guides the driver to help keep the vehicle within the lanes. It rarely controls the steering wheel, when the vehicle drives well inside the lanes. However, it starts to control the steering wheel, when the vehicle is about to deviate out of the lane.

- Lane Departure Warning

Lane Departure Warning alerts the driver with a visual warning and a warning alarm when the system detects the vehicle departing the lane. The steering wheel will not be controlled.

- Off

If you select 'Off', the LKA system is deactivated.

HIGHWAY DRIVING ASSIST (HDA) SYSTEM (IF EQUIPPED)

The Highway Driving Assist (HDA) system helps keep the vehicle between lanes, maintain a distance with the vehicle ahead, and automatically adjusts the vehicle speed to the speed limit while driving on the highway.

WARNING

- The Highway Driving Assist (HDA) system is not a substitute for safe driving practices, but a convenience function. It is the responsibility of the driver to always be aware of the surroundings and drive safely.
- The Highway Driving Assist (HDA) system relies entirely on the road information provided by the navigation system. It is the responsibility of the driver to follow traffic laws and avoid accidents.
- For your safety, please read the owner's manual before using the system.

Information

- The Highway Driving Assist (HDA) system is available only on controlled access road of certain highways.
- ✳ Controlled access road indicates roads with limited entrances and exits that allow uninterrupted high speed traffic flow. Only passenger cars and motorcycles are allowed on controlled access roads.

Available highway (Controlled access road)

USA	Select Interstate Highways
Canada	Select Provincial and Territorial Highways

- Additional highways may be expanded by navigation updates.

System Setting and Operation

System setting

- With the Engine Start/Stop button in the ON or START position, the Highway Driving Assist can be activated by selecting 'Setup → Vehicle Settings → Driver Assistance → Highway Driving Assist' from the Settings menu in the AVN system screen. Deselect the setting to turn off the system. **For detailed information, scan the QR code in a separately supplied simple manual.**
- If the engine is turned off then on again, the system maintains the last setting.

Operating conditions

Select 'Highway Driving Assist' from the Settings menu in the AVN system screen and satisfy the following conditions for the system to operate.

- Driving on the highway main line
- Smart Cruise Control is operating
 - If the Smart Cruise Control is in the READY state the Highway Driving Assist will be in the READY state. The  HDA indicator on the cluster will illuminate white.
- Vehicle speed is under 95 mph (153 km/h)

If all the mentioned conditions are satisfied, the system is ENABLED and the  HDA indicator on the cluster will illuminate green.

Steering wheel control



Steering control

If the vehicle detects both lane markers (lane color white), the  indicator light will change from white to green. This indicates that the steering wheel is being controlled.



Temporary deactivation

The  indicator light changes from green to white when the steering wheel control is temporarily deactivated. Even if the steering wheel is not controlled, the distance between the vehicle ahead will be maintained.

Speed setting



Automatic speed setting mode

The system enters the automatic speed setting mode when:

1. The operating conditions are satisfied
 -  **HDA** indicator will illuminate green
2. The Smart Cruise Control set speed and the highway speed limit matches

If the system changes to the automatic speed mode, the **AUTO** symbol will turn green and a chime will sound.

When the highway speed limit changes, the set speed automatically changes to the changed speed limit.



Manual speed setting mode

If the speed is set manually using the RES+ or SET- toggle switch on the steering wheel, the set speed on the cluster will turn white and the 'AUTO' symbol will disappear.

Warning Message

Hands-off warning



Keep hands on steering wheel

If the driver takes their hands off the steering wheel for several seconds while the HDA system is activated, the system will warn the driver.

i Information

If the steering wheel is held with a light grip, the message may appear because the HDA system may not recognize that the driver has their hands on the steering wheel.

⚠ WARNING

The warning message may appear late according to road conditions. Therefore, always have your hands on the steering wheel while driving.



Highway Driving Assist (HDA) system canceled

If the driver still does not have their hands on the steering wheel after the message "Keep hands on steering wheel", the HDA system will be canceled. However, if the Smart Cruise Control is reactivated manually by the driver, the Highway Driving Assist System will reactivate.

To activate Smart Cruise control, refer to "Smart Cruise Control with Stop and Go" in chapter 5.

The HDA system will not be in the ENABLED state and/or the steering wheel will not be assisted when:

- The turn signal is turned on before changing a lane. If you change lanes without the turn signal on, the steering wheel might be controlled.
- The vehicle is not driven in the middle of the lane when the system is turned on or right after changing a lane.
- ESC (Electronic Stability Control) or VSM (Vehicle Stability Management) is activated.
- The vehicle is driven on a sharp curve.
- Vehicle speed is over 95 mph (153 km/h).

- The vehicle makes sharp lane changes.
- The vehicle brakes suddenly.
- Only one lane marker is detected.
- The lane is very wide or narrow.
- There are more than two lane markers on the road (e.g. construction area).
- Radius of a curve is too small.
- The vehicle is driven on a steep incline.
- The steering wheel is turned suddenly.

System malfunction



Check Highway Driving Assist (HDA) system

If there is a problem with the system, a message will appear for a few seconds. If the problem continues, have the vehicle inspected by an authorized retailer of Genesis Branded products.

i Information

- **High Driving Assist is limited in other countries.**
 - **High Driving Assist only operates based on the speed limits of the highway but it does not work with the speed cameras.**
- **The time gap could occur between the navigation speed warning and system operation.**
 - **The system is not designed to work on highways other than mentioned as a controlled access road. The system automatically cancels when you leave the highway.**
 - **If there is a problem with Highway Driving Assist, the system cannot be activated in the AVN system screen.**
 - **If your vehicle is 1640 ft. (500 m) ahead and behind of an open toll-gate, the system is automatically canceled. Also, it is converted to Smart Cruise Control automatically with a pop-up message on the navigation.**
 - **In the automatic speed setting mode, the vehicle automatically accelerates or decelerates when the highway speed limit changes.**
 - **If your vehicle speed exceeds 95 mph (153 km/h), Highway Driving Assist is automatically canceled. Also, it is converted to Smart Cruise Control automatically with a pop-up message on the navigation.**
 - **If you enter a rest area on the highway or a IC/JC (intersection/junction) without a destination set, the system is canceled later than when the vehicle actually leaves the highway.**

 **CAUTION**

The Highway Driving Assist system may not function properly in the following situations:

- The navigation is not working properly.
- The navigation is not updated.
- The real-time GPS or map information provided has errors.
- The navigation is overloaded by performing functions such as route search, video playback, voice recognition, etc. are performing simultaneously.
- GPS signals are blocked in areas such as a tunnel.
- The driver goes off course or the route to the destination is changed or canceled by resetting the navigation.
- The vehicle enters a service station or rest area
- Android Auto or Car Play is operating.
- The navigation cannot detect the current vehicle position (ex: elevated roads including overpass adjacent to general roads or nearby roads exist in a parallel way).
- The navigation is being updated while driving.
- The navigation is being reset while driving.
- The road is slippery due to bad weather such as rain or snow.

 **Information**

- For information's on vehicle to vehicle distance control and the front radar, refer to "Smart Cruise Control (Stop & Go)" in this chapter.
- For information's on steering control and distance control and the front camera, refer to "Lane Following Assist (LFA)" in this chapter.

 **Information**

This device complies with Part 15 of the FCC rules.

Operation is subject to the following three conditions:

1. This device may not cause harmful interference, and
2. This device must accept any interference received, including interference that may cause undesired operation.
3. Changes or modifications not expressly approved by the party responsible for compliance could void the user's authority to operate the device.

 **Information**

Radio frequency radiation exposure information:

This equipment complies with FCC radiation exposure limits set forth for an uncontrolled environment.

This equipment should be installed and operated with minimum distance of 8 in. (20 cm) between the radiator (antenna) and your body.

This transmitter must not be co-located or operating in conjunction with any other antenna or transmitter.

DRIVER ATTENTION WARNING (DAW) SYSTEM

The Driver Attention Warning (DAW) system displays the condition of the driver's fatigue level and inattentive driving practices.

System Setting and Operation

System setting

- **Selecting Forward Safety function**

The Driver Attention Warning (DAW) can be activated from the Settings menu in the AVN system screen by following the procedure below.

1. Set the Engine Start/Stop button to the ON or START position.
2. Select 'Setup → Vehicle Settings → Driver Assistance → Attention Warning'. in the AVN system screen. **For detailed information, scan the QR code in a separately supplied simple manual.**

- **Selecting Warning Timing**

The driver can select the initial warning activation time from the Settings menu in the AVN system screen. Select:

- Setup → Vehicle Settings → Driver Assistance → Warning Timing → Normal / Later

For detailed information, scan the QR code in a separately supplied simple manual.

The options for the initial Driver Attention Warning includes the following:

- Normal:

The Driver Attention Warning system helps alert the driver of his/her fatigue level or inattentive driving practices faster than Later mode.

- Later:

The Driver Attention Warning system helps alert the driver of his/her fatigue level or inattentive driving practices later than Normal mode.

The set-up of the Driver Attention Warning system will be maintained as selected when the engine is restarted.

Information

If you change the warning timing, the warning timing of other systems may change.

Display of the driver's attention level

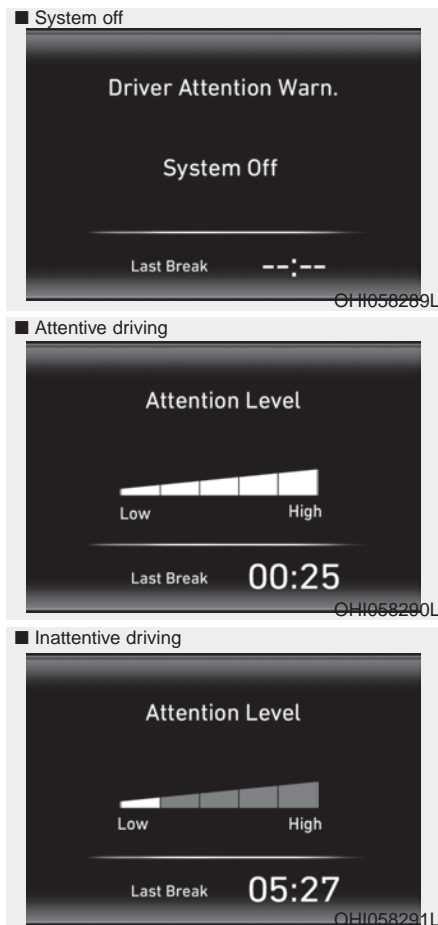

- The driver can monitor his/her driving conditions on the cluster LCD display.

The DAW screen will appear when you select the Assist mode tab (A) on the LCD display if the system is activated. **For more details, refer to "LCD Display Modes" in chapter 3.**

- The driver's attention level is displayed on the scale of 1 to 5. The lower the level is, the more inattentive the driver is.
- The level decreases when the driver does not take a break for a certain period of time.
- The level increases when the driver attentively drives for a certain period of time.
- When the driver turns on the system while driving, it displays 'Last Break time' and level.

Take a break



- The "Consider taking a break" message appears on the cluster LCD display and a warning sounds to suggest that the driver take a break, when the driver's attention level is below 1.
- The Driver Attention Warning (DAW) system will not suggest a break, when the total driving time is shorter than 10 minutes.



CAUTION

If any other warning sound such as seat belt warning chime is already generated, the Driver Attention Warning (DAW) system warning may not sound.

Resetting the System

- The last break time is set to 00:00 and the driver's attention level is set to 5 (very attentive) when the driver resets the Driver Attention Warning (DAW) system.
- The Driver Attention Warning (DAW) system resets the last break time to 00:00 and the driver's attention level to 5 in the following situations.
 - The engine is turned OFF.
 - The driver unfastens the seat belt and then opens the driver's door.
 - The vehicle is stopped for more than 10 minutes.
- The Driver Attention Warning (DAW) system operates again, when the driver restarts driving.

System Standby



The Driver Attention Warning (DAW) system enters the ready status and displays the 'Standby' screen in the following situations.

- The system is unable to collect data to monitor the driver's driving conditions.
- Driving speed remains over 110 mph (177 km/h).

System Malfunction



Check Driver Attention Warning (DAW) system

When the "Check Driver Attention Warning (DAW) system" warning message appears, the system is not working properly. In this case, have the vehicle inspected by an authorized retailer of Genesis Branded products.

⚠ WARNING

- **The Driver Attention Warning (DAW) system is not a substitute for safe driving practices, but a convenience function only. It is the responsibility of the driver to always drive cautiously to prevent unexpected and sudden situations from occurring. Pay attention to the road conditions at all times.**
- **The driver who feels fatigued should take a break, even though there is no break suggestion by the Driver Attention Warning (DAW) system.**

i Information

The system may suggest a break according to the driver's driving pattern or habits even if the driver doesn't feel fatigue.

NOTICE

The Driver Attention Warning (DAW) system utilizes the camera sensor on the front windshield for its operation. To keep the camera sensor in the best condition, you should observe the followings:

- Never install any accessories or stickers on the front windshield, or tint the front windshield.
- NEVER place any reflective objects (i.e. white paper, mirror) over the dashboard. Any light reflection may prevent the system from functioning properly.
- Pay extreme caution to keep the camera sensor dry.
- Never disassemble the camera assembly, or apply any impact on the camera assembly.

If the sensor is forcibly moved out of proper alignment, the system may not operate correctly. Take your vehicle to an authorized retailer of Genesis Branded products and have the system checked for calibration.



CAUTION

The Driver Attention Warning (DAW) system may not provide alerts in the following situations:

- The lane detection performance is limited. For more information, refer to "Lane Keeping Assist (LKA) system" in this chapter.

- The vehicle is erratically driven or is abruptly turned for obstacle avoidance (e.g. construction area, other vehicles, fallen objects, bumpy road).
- Forward drivability of the vehicle is severely undermined (possibly due to wide variation in tire pressures, uneven tire wear-out, toe-in/toe-out alignment).
- The vehicle drives on a curvy road.
- The vehicle drives through a windy area.
- The vehicle drives on a bumpy road.
- The vehicle is controlled by the following driving assist systems:
 - Forward Collision-avoidance Assist (FCA)
 - Blind-Spot Collision Warning (BCW)/Blind-Spot Collision Assist (BCA)
 - Smart Cruise Control (SCC)
 - Lane Following Assist (LFA)
 - Lane Keeping Assist (LKA)



CAUTION

Playing the vehicle audio system at high volume may prevent occupants from hearing the Driver Attention Warning (DAW) system warning sounds.

SPECIAL DRIVING CONDITIONS

Hazardous Driving Conditions

When hazardous driving elements are encountered such as water, snow, ice, mud and sand, take the below suggestions:

- Drive cautiously and keep a longer braking distance.
- Avoid abrupt braking or steering.
- When your vehicle is stuck in snow, mud, or sand, use second gear. Accelerate slowly to avoid unnecessary wheel spin.
- Put sand, rock salt, tire chains or other non-slip materials under the wheels to provide additional traction while the vehicle becomes stuck in ice, snow, or mud.

WARNING

Downshifting with an automatic transmission while driving on slippery surfaces can cause an accident. The sudden change in tire speed could cause the tires to skid. Be careful when downshifting on slippery surfaces.

Rocking the Vehicle

If it is necessary to rock the vehicle to free it from snow, sand, or mud, first turn the steering wheel right and left to clear the area around your front wheels. Then, shift back and forth between R (Reverse) and a forward gear.

Try to avoid spinning the wheels, and do not race the engine.

To prevent transmission wear, wait until the wheels stop spinning before shifting gears. Release the accelerator pedal while shifting, and press lightly on the accelerator pedal while the transmission is in gear. Slowly spinning the wheels in forward and reverse directions causes a rocking motion that may free the vehicle.

WARNING

If the vehicle is stuck and excessive wheel spin occurs, the temperature in the tires can increase very quickly. If the tires become damaged, a tire blow out or tire explosion can occur. This condition is dangerous - you and others may be injured. Do not attempt this procedure if people or objects are anywhere near the vehicle.

If you attempt to free the vehicle, the vehicle can overheat quickly, possibly causing an engine compartment fire or other damage. Try to avoid spinning the wheels as much as possible to prevent overheating of either the tires or the engine. DO NOT allow the vehicle to spin the wheels above 35 mph (56 km/h).

i Information

The ESC system must be turned OFF before rocking the vehicle.

NOTICE

If you are still stuck after rocking the vehicle a few times, have the vehicle pulled out by a tow vehicle to avoid engine overheating, possible damage to the transmission, and tire damage. See "Towing" in chapter 6.

Smooth Cornering

Avoid braking or gear changing in corners, especially when roads are wet. Ideally, corners should always be taken under gentle acceleration.

Driving at Night

Night driving presents more hazards than driving in the daylight. Here are some important tips to remember:

- Slow down and keep more distance between you and other vehicles, as it may be more difficult to see at night, especially in areas where there may not be any street lights.
- Adjust your mirrors to reduce the glare from other driver's headlamps.
- Keep your headlamps clean and properly aimed. Dirty or improperly aimed headlamps will make it much more difficult to see at night.
- Avoid staring directly at the headlamps of oncoming vehicles. You could be temporarily blinded, and it will take several seconds for your eyes to readjust to the darkness.

Driving in the Rain

Rain and wet roads can make driving dangerous. Here are a few things to consider when driving in the rain or on slick pavement:

- Slow down and allow extra following distance. A heavy rainfall makes it harder to see and increases the distance needed to stop your vehicle.
- Turn OFF your Cruise Control.
- Replace your windshield wiper blades when they show signs of streaking or missing areas on the windshield.
- Be sure your tires have enough tread. If your tires do not have enough tread, making a quick stop on wet pavement can cause a skid and possibly lead to an accident. **See "Tire Replacement" in chapter 7.**
- Turn on your headlamps to make it easier for others to see you.
- Driving too fast through large puddles can affect your brakes. If you must go through puddles, try to drive through them slowly.
- If you believe your brakes may be wet, apply them lightly while driving until normal braking operation returns.

Hydroplaning

If the road is wet enough and you are going fast enough, your vehicle may have little or no contact with the road surface and actually ride on the water. The best advice is SLOW DOWN when the road is wet.

The risk of hydroplaning increases as the depth of tire tread decreases, refer to "Tire Replacement" in chapter 7.

Driving in Flooded Areas

Avoid driving through flooded areas unless you are sure the water is no higher than the bottom of the wheel hub. Drive through any water slowly. Allow adequate stopping distance because brake performance may be reduced.

After driving through water, dry the brakes by gently applying them several times while the vehicle is moving slowly.

Highway Driving

Tires

Adjust the tire inflation, as specified. Under-inflation may overheat or damage the tires.

Do not install worn-out or damaged tires, which may reduce traction or fail the braking operation.

Information

Never over-inflate your tires above the maximum inflation pressure, as specified on your tires.

Fuel, engine coolant and engine oil

Driving at higher speeds on the highway consumes more fuel and is less efficient than driving at a slower, more moderate speed. Maintain a moderate speed in order to conserve fuel when driving on the highway.

Be sure to check both the engine coolant level and the engine oil before driving.

Drive belt

A loose or damaged drive belt may overheat the engine.

WARNING

Utility vehicles have a significantly higher rollover rate than other types of vehicles. To prevent rollovers or loss of control:

- Take corners at slower speeds than you would with a passenger vehicle.
- Avoid sharp turns and abrupt maneuvers.
- Do not modify your vehicle in any way that you would raise the center of gravity.
- Keep tires properly inflated.
- Do not carry heavy cargo on the roof.

WARNING

In a rollover crash, an unbelted person is significantly more likely to die than a person wearing a seat belt. Make sure all passengers are wearing their seat belts.

WINTER DRIVING

The severe weather conditions of winter quickly wear out tires and cause other problems. To minimize winter driving problems, you should take the following suggestions:

Snow or Icy Conditions

You need to keep sufficient distance between your vehicle and the vehicle in front of you.

Apply the brakes gently. Speeding, rapid acceleration, sudden brake applications, and sharp turns are potentially very hazardous practices. During deceleration, use engine braking to the fullest extent. Sudden brake applications on snowy or icy roads may cause the vehicle to skid.

To drive your vehicle in deep snow, it may be necessary to use snow tires or to install tire chains on your tires.

Always carry emergency equipment. Some of the items you may want to carry include tire chains, tow straps or chains, a flashlight, emergency flares, sand, a shovel, jumper cables, a window scraper, gloves, ground cloth, coveralls, a blanket, etc.

Snow tires

We recommend you use snow tires when road temperature is below 45°F (7°C). Refer to the below chart, and mount the recommended snow tire for your vehicle.

Standard tire				Recommended snow tire			
Front		Rear		Front		Rear	
Tire size	Wheel size	Tire size	Wheel size	Tire size	Wheel size	Tire size	Wheel size
245/45R19	8.5Jx19	275/40R19	9.5Jx19	245/45R19	8.5Jx19	275/40R19	9.5Jx19

If you mount snow tires on your vehicle, make sure to use the same inflation pressure as the original tires. However, if you mount 245/45R19 size tire on the rear, the tire inflation pressure should maintain 35psi. Mount snow tires on all four wheels to balance your vehicle's handling in all weather conditions. The traction provided by snow tires on dry road may not be as high as your vehicle's original equipment tires. Check with the tire dealer for maximum speed recommendations.

i Information

Do not install studded tires without first checking local, state and municipal regulations for possible restrictions against their use.

Tire chains



Since the sidewalls on some radial tires are thinner than other types of tires, they may be damaged by mounting certain types of tire chains on them. Do not mount tire chains on vehicles equipped with aluminum wheels; if unavoidable use AutoSock® (fabric snow chain or similar). Install AutoSock® after reviewing the instructions provided with AutoSock®. Damage to your vehicle caused by improper use of fabric snow chains are not covered by your vehicle manufacturer's warranty.

WARNING

The use of AutoSock® (fabric snow chain) may adversely affect vehicle handling:

- Drive less than 20 mph (30 km/h) or the AutoSock® manufacturer's recommended speed limit, whichever is lower.
- Drive carefully and avoid bumps, holes, sharp turns, and other road hazards, which may cause the vehicle to bounce.
- Avoid sharp turns or locked wheel braking.

AutoSock® is a Registered trademark of AutoSock.

Information

- Install AutoSock® (fabric snow chain) on the rear tires. It should be noted that installing AutoSock® on the tires will provide a greater driving force, but will not prevent side skids.
- Do not install studded tires without first checking local, state and municipal regulations for possible restrictions against their use.

Chain Installation

When installing AutoSock® (fabric snow chain), follow the manufacturer's instructions and mount them as tightly as possible. Drive slowly (less than 20 mph (30 km/h)) with AutoSock® installed. If you hear the fabric snow chains contacting the body or chassis, stop and tighten them. If they still make contact, slow down until the noise stops. Remove the AutoSock® (fabric snow chain) as soon as you begin driving on cleared roads.

When mounting AutoSock® (fabric snow chain), park the vehicle on level ground away from traffic.

Turn on the vehicle Hazard Warning Flasher and place a triangular emergency warning device behind the vehicle (if available).

Always place the vehicle in P (Park), apply the parking brake and turn off the engine before installing AutoSock®.

NOTICE

When using AutoSock® (fabric snow chain):

- **Wrong size fabric snow chains or improperly installed fabric snow chains can damage your vehicle's brake lines, suspension, body and wheels.**
- **If you hear noise caused by fabric snow chains contacting the body, retighten the chain to prevent contact with the vehicle body.**
- **To prevent body damage, retighten the fabric snow chains after driving 0.3~0.6 miles (0.5~1.0 km).**

AutoSock® is a Registered trademark of AutoSock.

Winter Precautions

Use high quality ethylene glycol coolant

Your vehicle is delivered with high quality ethylene glycol coolant in the cooling system. It is the only type of coolant that should be used because it helps prevent corrosion in the cooling system, lubricates the water pump and prevents freezing. Be sure to replace or replenish your coolant in accordance with the maintenance schedule in chapter 7. Before winter, have your coolant tested to assure that its freezing point is sufficient for the temperatures anticipated during the winter.

Change to "winter weight" oil if necessary

In some climates it is recommended that a lower viscosity "winter weight" oil be used during cold weather. See chapter 8 for recommendations. If you aren't sure what weight oil you should use, consult an authorized retailer of Genesis Branded products.

Check battery and cables

Winter puts additional burdens on the battery system. Visually inspect the battery and cables as described in chapter 7. The level of charge in your battery can be checked by an authorized retailer of Genesis Branded products or a service station.

Check spark plugs and ignition system

Inspect your spark plugs as described in chapter 7 and replace them if necessary. Also check all ignition wiring and components to be sure they are not cracked, worn or damaged in any way.

Use approved window washer anti-freeze in system

To keep the water in the window washer system from freezing, add an approved window washer anti-freeze solution in accordance with instructions on the container. Window washer anti-freeze is available from an authorized retailer of Genesis Branded products and most auto parts outlets. Do not use engine coolant or other types of anti-freeze as these may damage the paint finish.

Do not let your parking brake freeze

Under some conditions your parking brake can freeze in the engaged position. This is most likely to happen when there is an accumulation of snow or ice around or near the rear brakes or if the brakes are wet. If there is a risk the parking brake may freeze, apply it only temporarily while you put the gear in P and block the rear wheels so the car cannot roll. Then release the parking brake.

Do not let ice and snow accumulate underneath

Under some conditions, snow and ice can build up under the fenders and interfere with the steering. When driving in severe winter conditions where this may happen, you should periodically check underneath the car to be sure the movement of the front wheels and the steering components is not obstructed.

Don't place foreign objects or materials in the engine compartment

Placement of foreign object or materials which prevent cooling of the engine, in the engine compartment, may cause a failure or combustion. The manufacturer is not responsible for the damage caused by such placement.

To keep locks from freezing

To keep the locks from freezing, squirt an approved de-icer fluid or glycerine into the key opening. If a lock is covered with ice, squirt it with an approved de-icing fluid to remove the ice. If the lock is frozen internally, you may be able to thaw it out by using a heated key. Handle the heated key with care to avoid injury.

VEHICLE LOAD LIMIT

Two labels on your driver's door sill show how much weight your vehicle was designed to carry: the Tire and Loading Information Label and the Certification Label.

Before loading your vehicle, familiarize yourself with the following terms for determining your vehicle's weight ratings, from the vehicle's specifications and the Certification Label:

Base Curb Weight

This is the weight of the vehicle including a full tank of fuel and all standard equipment. It does not include passengers, cargo, or optional equipment.

Vehicle Curb Weight

This is the weight of your new vehicle when you picked it up from your dealer plus any aftermarket equipment.

Cargo Weight

This figure includes all weight added to the Base Curb Weight, including cargo and optional equipment.

GAW (Gross Axle Weight)

This is the total weight placed on each axle (front and rear) - including vehicle curb weight and all payload.

GAWR (Gross Axle Weight Rating)

This is the maximum allowable weight that can be carried by a single axle (front or rear). These numbers are shown on the Certification Label. The total load on each axle must never exceed its GAWR.

GVW (Gross Vehicle Weight)

This is the Base Curb Weight plus actual Cargo Weight plus passengers.

GVWR (Gross Vehicle Weight Rating)

This is the maximum allowable weight of the fully loaded vehicle (including all options, equipment, passengers and cargo). The GVWR is shown on the Certification Label located on the driver's door sill.

Tire Loading Information Label

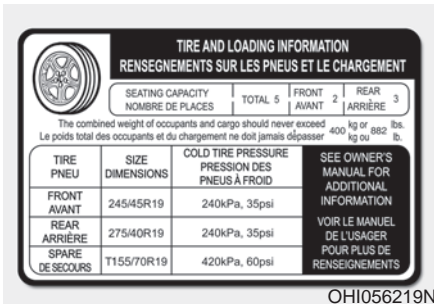

The label located on the driver's door sill gives the original tire size, cold tire pressures recommended for your vehicle, the number of people that can be in your vehicle and vehicle capacity weight.

Vehicle capacity weight

882 lbs. (400 kg)

Vehicle capacity weight is the maximum combined weight of occupants and cargo. If your vehicle is equipped with a trailer, the combined weight includes the tongue load.

Seating capacity

Total : 5 persons

(Front seat : 2 persons,

Rear seat : 3 persons)

Seating capacity is the maximum number of occupants including a driver, your vehicle may carry. However, the seating capacity may be reduced based upon the weight of all of the occupants, and the weight of the cargo being carried or towed. Do not overload the vehicle as there is a limit to the total weight, or load limit including occupants and cargo, the vehicle can carry.

Towing capacity

We do not recommend using this vehicle for trailer towing.

Cargo capacity







The cargo capacity of your vehicle will increase or decrease depending on the weight and the number of occupants and the tongue load, if your vehicle is equipped with a trailer.

Steps for determining correct load limit

1. Locate the statement "The combined weight of occupants and cargo should never exceed XXX kg or XXX lbs." on your vehicle's placard.
2. Determine the combined weight of the driver and passengers that will be riding in your vehicle.
3. Subtract the combined weight of the driver and passengers from XXX kg or XXX lbs.
4. The resulting figure equals the available amount of cargo and luggage load capacity. For example, if the "XXX" amount equals 1400 lbs. and there will be five 150 lb passengers in your vehicle, the amount of available cargo and luggage load capacity is 650 lbs. (1400 - 750 (5 x 150) = 650 lbs.)
5. Determine the combined weight of luggage and cargo being loaded on the vehicle. That weight may not safely exceed the available cargo and luggage load capacity calculated in Step 4.
6. If your vehicle will be towing a trailer, load from your trailer will be transferred to your vehicle. Consult this manual to determine how this reduces the available cargo and luggage load capacity of your vehicle.

⚠ WARNING

Do not overload the vehicle as there is a limit to the total weight, or load limit, including occupants and cargo, the vehicle can carry. Overloading can shorten the life of the vehicle. If the GVWR or the GAWR is exceeded, parts on the vehicle can break, and it can change the handling of your vehicle. These could cause you to lose control and result in an accident.

<p>Example 1</p>	<div style="display: flex; align-items: center; justify-content: center;"> <div style="background-color: black; color: white; padding: 10px; margin-right: 10px;"> <p style="text-align: center;">Vehicle Capacity</p> </div> <div style="margin-right: 10px;"> \geq </div> <div style="display: flex; align-items: center; margin-right: 10px;">  </div> <div style="margin-right: 10px;"> $+$ </div> <div style="display: flex; align-items: center;">  </div> </div> <div style="display: flex; justify-content: space-around; margin-top: 10px;"> <div style="text-align: center;"> <p>Maximum Load (1400 lbs.) (635 kg)</p> </div> <div style="text-align: center;"> <p>Passenger Weight (150 lbs. \times 2 = 300 lbs.) (68 kg \times 2 = 136 kg)</p> </div> <div style="text-align: center;"> <p>Cargo Weight (1100 lbs.) (499 kg)</p> </div> </div>
<p>Example 2</p>	<div style="display: flex; align-items: center; justify-content: center;"> <div style="background-color: black; color: white; padding: 10px; margin-right: 10px;"> <p style="text-align: center;">Vehicle Capacity</p> </div> <div style="margin-right: 10px;"> \geq </div> <div style="display: flex; align-items: center; margin-right: 10px;">  </div> <div style="margin-right: 10px;"> $+$ </div> <div style="display: flex; align-items: center;">  </div> </div> <div style="display: flex; justify-content: space-around; margin-top: 10px;"> <div style="text-align: center;"> <p>Maximum Load (1400 lbs.) (635 kg)</p> </div> <div style="text-align: center;"> <p>Passenger Weight (150 lbs. \times 5 = 750 lbs.) (68 kg \times 5 = 340 kg)</p> </div> <div style="text-align: center;"> <p>Cargo Weight (650 lbs.) (295 kg)</p> </div> </div>
<p>Example 3</p>	<div style="display: flex; align-items: center; justify-content: center;"> <div style="background-color: black; color: white; padding: 10px; margin-right: 10px;"> <p style="text-align: center;">Vehicle Capacity</p> </div> <div style="margin-right: 10px;"> \geq </div> <div style="display: flex; align-items: center; margin-right: 10px;">  </div> <div style="margin-right: 10px;"> $+$ </div> <div style="display: flex; align-items: center;">  </div> </div> <div style="display: flex; justify-content: space-around; margin-top: 10px;"> <div style="text-align: center;"> <p>Maximum Load (1400 lbs.) (635 kg)</p> </div> <div style="text-align: center;"> <p>Passenger Weight (172 lbs. \times 5 = 860 lbs.) (78 kg \times 5 = 390 kg)</p> </div> <div style="text-align: center;"> <p>Cargo Weight (540 lbs.) (245 kg)</p> </div> </div>

Certification label

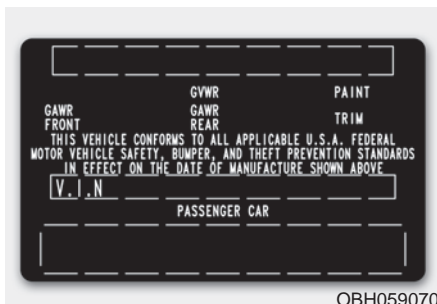

OBH059070

The certification label is located on the driver's door sill at the center pillar and shows the maximum allowable weight of the fully loaded vehicle. This is called the GVWR (Gross Vehicle Weight Rating). The GVWR includes the weight of the vehicle, all occupants, fuel and cargo.

This label also tells you the maximum weight that can be supported by the front and rear axles, called Gross Axle Weight Rating (GAWR).

The total weight of the vehicle, including all occupants, accessories, cargo, and trailer tongue load must not exceed the Gross Vehicle Weight Rating (GVWR) or the Gross Axle Weight Rating (GAWR). To find out the actual loads on your front and rear axles, you need to go to a weigh station and weigh your vehicle. Be sure to spread out your load equally on both sides of the centerline.

WARNING

Overloading

- Never exceed the GVWR for your vehicle, the GAWR for either the front or rear axle and vehicle capacity weight. Exceeding these ratings can affect your vehicle's handling and braking ability, and cause an accident.
- Do not overload your vehicle. Overloading your vehicle can cause heat buildup in your vehicle's tires and possible tire failure, increased stopping distances and poor vehicle handling—all of which may result in a crash.

NOTICE

Overloading your vehicle may cause damage. Repairs would not be covered by your warranty. Do not overload your vehicle.

 **WARNING**

If you carry items inside your vehicle (e.g., suitcases, tools, packages, or anything else), they are moving as fast as the vehicle. If you have to stop or turn quickly, or if there is a crash, the items will keep going and can cause an injury if they strike the driver or a passenger.

- Put items in the cargo area of your vehicle. Try to spread the weight evenly.
- Do not stack items, like suitcases, inside the vehicle above the tops of the seats.
- Do not leave an unsecured child restraint in your vehicle.
- When you carry something inside the vehicle, secure it.

TRAILER TOWING

We do not recommend using this vehicle for trailer towing.

6. What to Do in an Emergency

Hazard Warning Flasher	6-2
In Case of an Emergency While Driving.....	6-2
If the Engine Stalls While Driving....	6-2
If the Engine Stalls at a Crossroad or Crossing	6-2
If you Have a Flat Tire While Driving.....	6-3
If the Engine Will Not Start	6-3
If the Engine Doesn't Turn Over or Turns Over Slowly.....	6-3
If the Engine Turns Over Normally but Doesn't Start	6-3
Jump Starting	6-4
Push-Starting.....	6-6
If the Engine Overheats	6-7
Tire Pressure Monitoring System (TPMS)	6-9
Check Tire Pressure.....	6-9
Tire Pressure Monitoring System ..	6-10
Low Tire Pressure Telltale	6-11
Low Tire Pressure LCD Display with Position Indicator	6-11
TPMS Malfunction Indicator	6-12
Changing a Tire with TPMS.....	6-13
If You Have a Flat Tire	6-15
Jack Label.....	6-21
Towing.....	6-22
Towing Service.....	6-22
Removable Towing Hook.....	6-24
Emergency Towing.....	6-24

HAZARD WARNING FLASHER

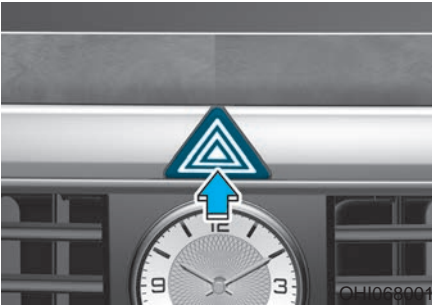

The hazard warning flasher serves as a warning to other drivers to exercise extreme caution when approaching, overtaking, or passing your vehicle.

It should be used whenever emergency repairs are being made or when the vehicle is stopped near the edge of a roadway.

To turn the hazard warning flasher on or off, press the hazard warning flasher button. The button is located in the center fascia panel. Both the left and right turn signal lights will flash simultaneously.

- The hazard warning flasher operates whether your vehicle is running or not.
- The turn signals do not work when the hazard flasher is on.

IN CASE OF AN EMERGENCY WHILE DRIVING

If the Engine Stalls While Driving

- Reduce your speed gradually, keeping a straight line. Move cautiously off the road to a safe place.
- Turn on your hazard warning flasher.
- Try to start the engine again. If your vehicle will not start, contact an authorized retailer of Genesis Branded products or seek other qualified assistance.

If the Engine Stalls at a Crossroad or Crossing

If the engine stalls at a crossroad or crossing, if safe to do so, move the shift lever to the N (Neutral) position and then push the vehicle to a safe location.

If you Have a Flat Tire While Driving

If a tire goes flat while you are driving:

- Take your foot off the accelerator pedal and let the vehicle slow down while driving straight ahead. Do not apply the brakes immediately or attempt to pull off the road as this may cause loss of vehicle control resulting in an accident. When the vehicle has slowed to such a speed that it is safe to do so, brake carefully and pull off the road. Drive off the road as far as possible and park on firm, level ground. If you are on a divided highway, do not park in the median area between the two traffic lanes.
- When the vehicle is stopped, press the hazard warning flasher button, shift the gear to P (Park), apply the parking brake, and press the Engine Start/Stop button to the OFF position.
- Have all passengers get out of the vehicle. Be sure they all get out on the side of the vehicle that is away from traffic.
- When changing a flat tire, follow the instructions provided later in this chapter.

IF THE ENGINE WILL NOT START

If the Engine Doesn't Turn Over or Turns Over Slowly

- Be sure to shift the gear to N (Neutral) or P (Park). The engine starts only when the gear is in N (Neutral) or P (Park).
- Turn on the interior light. If the light dims or goes out when you operate the starter, the battery is drained.

Do not push or pull the vehicle to start it. This could cause damage to your vehicle. **See instructions for "Jump Starting" provided in this chapter.**

NOTICE

Push or pull starting the vehicle may cause the catalytic converter to overload which can lead to damage to the emission control system.

If the Engine Turns Over Normally but Doesn't Start

Check the fuel level and add fuel if necessary.

If the engine still does not start, have your vehicle checked by an authorized retailer of Genesis Branded products.

JUMP STARTING

Jump starting can be dangerous if done incorrectly. Follow the jump starting procedure in this section to avoid serious injury or damage to your vehicle. If in doubt about how to properly jump start your vehicle, we strongly recommend that you have a service technician or towing service do it for you.

WARNING

To prevent **SERIOUS INJURY** or **DEATH** to you or bystanders, always follow these precautions when working near or handling the battery:



Always read and follow instructions carefully when handling a battery.



Wear eye protection designed to protect the eyes from acid splashes.



Keep all flames, sparks, or smoking materials away from the battery.



Hydrogen is always present in battery cells, is highly combustible, and may explode if ignited.



Keep batteries out of reach of children.



Batteries contain sulfuric acid which is highly corrosive. Do not allow acid to contact your eyes, skin or clothing.

If acid gets into your eyes, flush your eyes with clean water for at least 15 minutes and get immediate medical attention. If acid gets on your skin, thoroughly wash the area. If you feel pain or a burning sensation, get medical attention immediately.

- When lifting a plastic-cased battery, excessive pressure on the case may cause battery acid to leak. Lift with a battery carrier or with your hands on opposite corners.
- Do not attempt to jump start your vehicle if your battery is frozen.
- **NEVER** attempt to recharge the battery when the vehicle's battery cables are connected to the battery.
- The electrical ignition system works with high voltage. **NEVER** touch these components with the engine running or when the Engine Start/Stop button is in the ON position.

i Information



An inappropriately disposed battery can be harmful to the environment and human health. Dispose of the battery according to your local law(s) or regulations.

NOTICE

To prevent damage to your vehicle:

- Only use a 12-volt power supply (battery or jumper system) to jump start your vehicle.
- Do not attempt to jump start your vehicle by push-starting.

Jump starting procedure

i Information

Your vehicle has a battery in the trunk compartment, but when you jump start your vehicle, use the jumper terminal in the engine compartment.

1. Position the vehicles close enough that the jumper cables will reach, but do not allow the vehicles to touch.
2. Avoid fans or any moving parts in the engine compartment at all times, even when the vehicles are turned off.
3. Turn off all electrical devices such as radios, lights, air conditioning, etc. Put the vehicles in P (Park) and set the parking brakes. Turn both vehicles OFF.
4. Open the engine hood.

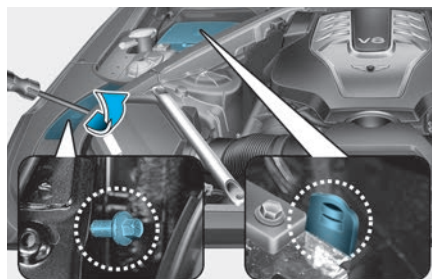

OH1068005

5. Open the small service cover with a screwdriver.
6. Remove the engine compartment fuse box cover.

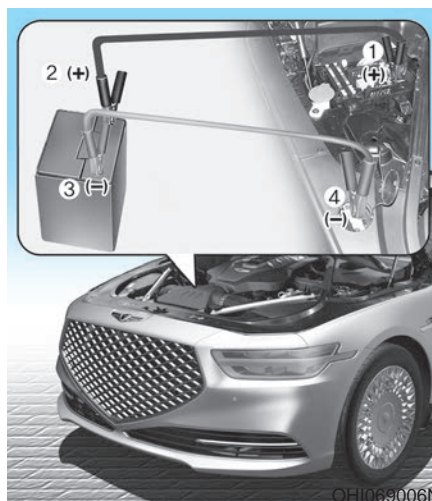

OH1069006N

7. Connect the jumper cables in the exact sequence shown in the illustration. First connect one jumper cable to the red, positive (+) jumper terminal of your vehicle (1).
8. Connect the other end of the jumper cable to the red, positive (+) battery/jumper terminal of the assisting vehicle (2).

9. Connect the second jumper cable to the black, negative (-) battery/chassis ground of the assisting vehicle (3).
10. Connect the other end of the second jumper cable to the black, negative (-) chassis ground of your vehicle (4).

Do not allow the jumper cables to contact anything except the correct battery or jumper terminals or the correct ground. Do not lean over the battery when making connections.
11. Start the engine of the assisting vehicle and let it run at approximately 2,000 rpm for a few minutes. Then start your vehicle.
12. Keep your vehicle operating for at least 30 minutes at idle or driving to assure your battery receives enough charge to be able to start on its own after the vehicle is shut off. A complete dead battery may require as long as 60 minutes runtime to fully recharge it. If vehicle is run for less, the battery may not restart. If you continue to have problem, have your authorized retailer of Genesis Branded products test the battery.

If your vehicle will not start after a few attempts, it probably requires servicing. In this event please seek qualified assistance. If the cause of your battery discharging is not apparent, have your vehicle checked by an authorized retailer of Genesis Branded products.

Disconnect the jumper cables in the exact reverse order you connected them:

1. Disconnect the jumper cable from the black, negative (-) chassis ground of your vehicle (4).
2. Disconnect the other end of the jumper cable from the black, negative (-) battery/chassis ground of the assisting vehicle (3).
3. Disconnect the second jumper cable from the red, positive (+) battery/jumper terminal of the assisting vehicle (2).
4. Disconnect the other end of the jumper cable from the red, positive (+) jumper terminal of your vehicle (1).

Push-Starting

Vehicles equipped with automatic transmission cannot be push-started.

Follow the directions in this chapter for jump-starting.

IF THE ENGINE OVERHEATS

If your temperature gauge indicates overheating, you experience a loss of power, or hear loud pinging or knocking, the engine may be overheating. If this happens, you should:

1. Pull off the road and stop as soon as it is safe to do so.
2. Shift the gear to P (Park) and set the parking brake. If the air conditioning is ON, turn it OFF.
3. If engine coolant is running out under the vehicle or steam is coming out from the hood, stop the engine. Do not open the hood until the coolant has stopped running or the steaming has stopped. If there is no visible loss of engine coolant and no steam, leave the engine running and check to be sure the engine cooling fan is operating. If the fan is not running, turn the engine off.

WARNING

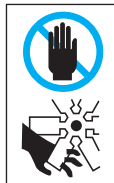

While the engine is running, keep hands, clothing and tools away from the moving parts such as the cooling fan and drive belt to prevent serious injury.

4. Check for coolant leaking from the radiator, hoses or under the vehicle. (If the air conditioning had been in use, it is normal for cold water to be draining from it when you stop.)
5. If engine coolant is leaking out, stop the engine immediately and call the nearest authorized retailer of Genesis Branded products for assistance.

⚠ WARNING

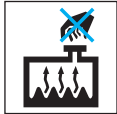

Your vehicle is equipped with a pressurized coolant reserve tank. **NEVER** remove the radiator

cap, drain plug and heater hose connector cap (refer to the below picture) while the engine and radiator are hot. Hot coolant and steam may blow out under pressure, causing serious injury.

Turn the engine off and wait until the engine cools down. Use extreme care when removing the coolant reserve tank cap. Wrap a towel or thick rag around it, and turn it counter-clockwise slowly to release some of the pressure from the system. Step back while the pressure is released.

When you are sure all the pressure has been released, continue turning the cap counter-clockwise to remove it.

■ Heater hose connector cap (for 5.0 GDI engine)

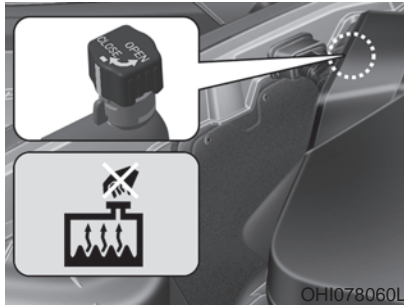

6. If you cannot find the cause of the overheating, wait until the engine temperature has returned to normal. Then, if coolant has been lost, carefully add coolant to the reservoir to bring the fluid level in the reservoir up to the halfway mark.

7. Proceed with caution, keeping alert for further signs of overheating. If overheating happens again, call an authorized retailer of Genesis Branded products for assistance.

NOTICE

Serious loss of coolant indicates a leak in the cooling system and should be checked as soon as possible by an authorized retailer of Genesis Branded products.

TIRE PRESSURE MONITORING SYSTEM (TPMS)

Check Tire Pressure



- (1) Low Tire Pressure / TPMS Malfunction Indicator Lamp
- (2) Low Tire Pressure / Tire Pressure Monitor / TPMS Malfunction Display (shown on the cluster LCD display)

- You can check the tire pressure in the Assist mode on the cluster.
- **Refer to the "LCD Display Modes" in chapter 3.**
- Tire pressure is displayed after a few minutes of driving after initial engine start up.
- If tire pressure is not displayed when the vehicle is stopped, "Drive to display" message will appear. After driving, check the tire pressure.
- The displayed tire pressure values may differ from those measured with a tire pressure gauge.
- You can change the tire pressure unit from the Settings menu in the AVN system screen. Select:
 - Setup → General Settings → Unit → Tire Air Pressure Unit → psi / kpa / bar

For detailed information, scan the QR code in a separately supplied simple manual.

Tire Pressure Monitoring System

WARNING

Over-inflation or under-inflation can reduce tire life, adversely affect vehicle handling, and lead to sudden tire failure that may cause loss of vehicle control resulting in an accident.

Each tire, including the spare (if provided), should be checked monthly when cold and inflated to the inflation pressure recommended by the vehicle manufacturer on the vehicle placard or tire inflation pressure label. (If your vehicle has tires of a different size than the size indicated on the vehicle placard or tire inflation pressure label, you should determine the proper tire inflation pressure for those tires.)

As an added safety feature, your vehicle has been equipped with a tire pressure monitoring system (TPMS) that illuminates a low tire pressure telltale when one or more of your tires is significantly under-inflated. Accordingly, when the low tire pressure telltale illuminates, you should stop and check your tires as soon as possible, and inflate them to the proper pressure. Driving on a significantly under-inflated tire causes the tire to overheat and can lead to tire failure.

Under-inflation also reduces fuel efficiency and tire tread life, and may affect the vehicle's handling and stopping ability.

Please note that the TPMS is not a substitute for proper tire maintenance, and it is the driver's responsibility to maintain correct tire pressure, even if under-inflation has not reached the level to trigger illumination of the TPMS low tire pressure telltale.

Your vehicle has also been equipped with a TPMS malfunction indicator to indicate when the system is not operating properly. The TPMS malfunction indicator is combined with the low tire pressure telltale. When the system detects a malfunction, the telltale will flash for approximately one minute and then remain continuously illuminated. This sequence will continue upon subsequent vehicle start-ups as long as the malfunction exists.

When the malfunction indicator is illuminated, the system may not be able to detect or signal low tire pressure as intended. TPMS malfunctions may occur for a variety of reasons, including the installation of replacement or alternate tires or wheels on the vehicle that prevent the TPMS from functioning properly.

Always check the TPMS malfunction telltale after replacing one or more tires or wheels on your vehicle to ensure that the replacement or alternate tires and wheels allow the TPMS to continue to function properly.

i Information

If any of the below happens, have the system checked by an authorized retailer of Genesis Branded products.

1. The Low Tire Pressure Telltale/ TPMS Malfunction Indicator does not illuminate for 3 seconds when the Engine Start/Stop button is pressed to the ON position or engine is running.
2. The TPMS Malfunction Indicator remains illuminated after blinking for approximately 1 minute.
3. The Low Tire Pressure Position Telltale remains illuminated.



Low Tire Pressure Telltale



Low Tire Pressure LCD Display with Position Indicator

OHI048568L

When the tire pressure monitoring system warning indicators are illuminated and the warning message is displayed on the cluster LCD display, one or more of your tires is significantly under-inflated. The LCD position indicator will indicate which tire is significantly under-inflated by illuminating the corresponding position light.

If any of your tire pressures are indicated as being low, immediately reduce your speed, avoid hard cornering, and anticipate increased stopping distances. You should stop and check your tires as soon as possible. Inflate the tires to the proper pressure as indicated on the vehicle's placard or tire inflation pressure label located on the driver's side center pillar outer panel.

If you cannot reach a service station or if the tire cannot hold the newly added air, replace the low pressure tire with the spare tire.

The Low Tire Pressure LCD position indicator will remain on and the TPMS Malfunction Indicator may blink for one minute and then remain illuminated until you have the low pressure tire repaired and replaced on the vehicle.

i Information

The spare tire is not equipped with a tire pressure sensor.

NOTICE

In winter or cold weather, the Low Tire Pressure Telltale may be illuminated if the tire pressure was adjusted to the recommended tire inflation pressure in warm weather. It does not mean your TPMS is malfunctioning because the decreased temperature leads to a proportional lowering of tire pressure.

When you drive your vehicle from a warm area to a cold area or from a cold area to a warm area, or the outside temperature is greatly higher or lower, you should check the tire inflation pressure and adjust the tires to the recommended tire inflation pressure.

⚠ WARNING

Low pressure damage

Significantly low tire pressure makes the vehicle unstable and can contribute to loss of vehicle control and increased braking distances.

Continued driving on low pressure tires can cause the tires to overheat and fail.



TPMS Malfunction Indicator

The TPMS Malfunction Indicator will illuminate after it blinks for approximately one minute when there is a problem with the Tire Pressure Monitoring System.

Have the system checked by an authorized retailer of Genesis Branded products as soon as possible.

i Information

If there is a malfunction with the TPMS, the individual tire pressures in the cluster LCD display will not be available. Have the system checked by an authorized retailer of Genesis Branded products as soon as possible.

NOTICE

The TPMS Malfunction Indicator may illuminate after blinking for one minute if the vehicle is near electric power supply cables or radio transmitters such as police stations, government and public offices, broadcasting stations, military installations, airports, transmitting towers, etc.

Additionally, the TPMS Malfunction Indicator may illuminate if snow chains are used or electronic devices such as computers, chargers, remote starters, navigation, etc. This may interfere with normal operation of the TPMS.

Changing a Tire with TPMS

If you have a flat tire, the Low Tire Pressure and LCD position indicator will come on. Have the flat tire repaired by an authorized retailer of Genesis Branded products as soon as possible or replace the flat tire with the spare tire.

NOTICE

Never use a puncture-repairing agent not approved by authorized retailer of Genesis Branded products to repair and/or inflate a low pressure tire. Tire sealant not approved by authorized retailer of Genesis Branded products may damage the tire pressure sensor.

The spare tire does not come with a tire pressure monitoring sensor. When the low pressure tire or the flat tire is replaced with the spare tire, the Low Tire Pressure LCD position indicator will remain on. Also, the TPMS Malfunction Indicator will illuminate after blinking for one minute if the vehicle is driven at speed above 15.5 mph (25 km/h) for approximately 20 minutes.

Once the original tire equipped with a tire pressure monitoring sensor is reinflated to the recommended pressure and reinstalled on the vehicle, the Low Tire Pressure LCD position indicator and TPMS Malfunction Indicator will go off within a few minutes of driving.

If the indicators do not disappear after a few minutes, please visit an authorized retailer of Genesis Branded products.

Each wheel is equipped with a tire pressure sensor mounted inside the tire behind the valve stem (except for the spare tire). You must use TPMS specific wheels. It is recommended that you always have your tires serviced by an authorized retailer of Genesis Branded products.

You may not be able identify a tire with low pressure by simply looking at it. Always use a good quality tire pressure gage to measure the tire's inflation pressure. Please note that a tire that is hot (from being driven) will have a higher pressure measurement than a tire that is cold.

A cold tire means the vehicle has been sitting for 3 hours and driven for less than 1 mile (1.6 km) in that 3 hour period.

Allow the tire to cool before measuring the inflation pressure. Always be sure the tire is cold before inflating to the recommended pressure.

WARNING

- **The TPMS cannot alert you to severe and sudden tire damage caused by external factors such as nails or road debris.**
- **If you feel any vehicle instability, immediately take your foot off the accelerator, apply the brakes gradually with light force, and slowly move to a safe position off the road.**

⚠ WARNING

Tampering with, modifying, or disabling the Tire Pressure Monitoring System (TPMS) components may interfere with the system's ability to warn the driver of low tire pressure conditions and/or TPMS malfunctions. Tampering with, modifying, or disabling the Tire Pressure Monitoring System (TPMS) components may void the warranty for that portion of the vehicle.

***i* Information**

This device complies with Part 15 of the FCC rules.

Operation is subject to the following three conditions:

- 1. This device may not cause harmful interference, and**
- 2. This device must accept any interference received, including interference that may cause undesired operation.**
- 3. Changes or modifications not expressly approved by the party responsible for compliance could void the user's authority to operate the equipment.**

IF YOU HAVE A FLAT TIRE

⚠ WARNING

Changing a tire can be dangerous. Follow the instructions in this section when changing a tire to reduce the risk of serious injury or death.

⚠ CAUTION

Be careful as you use the jack handle to stay clear of the flat end. The flat end has sharp edges that could cause cuts.

Jack and tools



- ① Jack handle
- ② Jack
- ③ Wheel lug nut wrench

The jack, jack handle, and wheel lug nut wrench are stored in the luggage compartment under the luggage box cover.

The jack is provided for emergency tire changing only.



Turn the winged hold down bolt counterclockwise to remove the spare tire.

Store the spare tire in the same compartment by turning the winged hold down bolt clockwise.

To prevent the spare tire and tools from "rattling", store them in their proper location.



If it is hard to loosen the tire hold-down wing bolt by hand, you can loosen it easily using the jack handle.

1. Put the jack handle (1) inside of the tire hold-down wing bolt.
2. Turn the tire hold-down wing bolt counterclockwise with the jack handle.

Changing tires

⚠ WARNING

A vehicle can slip or roll off of a jack causing serious injury or death to you or those nearby. Take the following safety precautions:

- Never place any portion of your body under a vehicle that is supported by a jack.
- **NEVER** attempt to change a tire in the lane of traffic. **ALWAYS** move the vehicle completely off the road on level, firm ground away from traffic before trying to change a tire. If you cannot find a level, firm place off the road, call a towing service for assistance.
- Be sure to use the jack provided with the vehicle.
- **ALWAYS** place the jack on the designated jacking positions on the vehicle and **NEVER** on the bumpers or any other part of the vehicle for jacking support.
- Do not start or run the engine while the vehicle is on the jack.
- Do not allow anyone to remain in the vehicle while it is on the jack.
- Keep children away from the road and the vehicle.

Follow these steps to change your vehicle's tire:

1. Park on a level, firm surface.
2. Shift the gear to P (Park), apply the parking brake, and press the Engine Start/Stop button to the OFF position.
3. Press the hazard warning flasher button.
4. Remove the wheel lug nut wrench, jack, jack handle, and spare tire from the vehicle.



5. Block both the front and rear of the tire diagonally opposite of the tire you are changing.

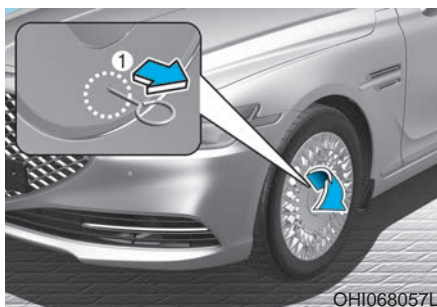

6. Insert the tool (1, if equipped) into the hole and pull out the wheel cover.

NOTICE

When removing the wheel cover, if you use any other tool except the tool (1) provided, the wheel cover may be damaged.



7. Loosen the wheel lug nuts counterclockwise one turn each in the order shown above, but do not remove any lug nuts until the tire has been raised off of the ground.

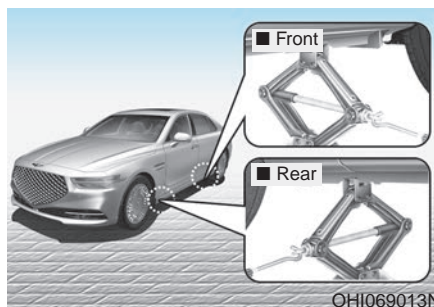

8. Place the jack at the designated jacking position under the frame closest to the tire you are changing. The jacking positions are plates welded to the frame with two notches. Never jack at any other position or part of the vehicle. Doing so may damage the side seal molding or other parts of the vehicle.

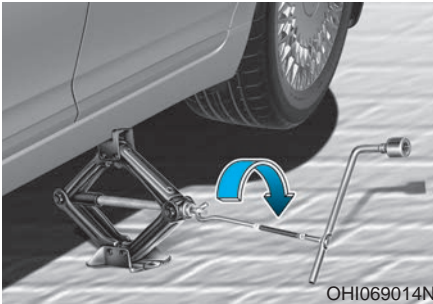

9. Insert the jack handle into the jack and turn it clockwise, raising the vehicle until the tire clears the ground. Make sure the vehicle is stable on the jack.
10. Loosen the lug nuts with the wheel lug nut wrench and remove them with your fingers. Remove the wheel from the studs and lay it flat on the ground out of the way. Remove any dirt or debris from the studs, mounting surfaces, and wheel.
11. Install the spare tire onto the studs of the hub.
12. Tighten the lug nuts with your fingers onto the studs with the smaller end of the lug nuts closest to the wheel.
13. Lower the vehicle to the ground by turning the jack handle counterclockwise.

14. Use the wheel lug nut wrench to tighten the lug nuts in the order shown. Double-check each lug nut until they are tight. After changing tires, have an authorized retailer of Genesis Branded products tighten the lug nuts to their proper torque as soon as possible. **The wheel lug nut should be tightened to 79-94 lbf-ft (11~13 kgf-m).**

If you have a tire gauge, check the tire pressure (see "Tires and Wheels" in chapter 8 for tire pressure instructions.). If the pressure is lower or higher than recommended, drive slowly to the nearest service station and adjust it to the recommended pressure. Always reinstall the valve cap after checking or adjusting tire pressure. If the cap is not replaced, air may leak from the tire. If you lose a valve cap, buy another and install it as soon as possible. After changing tires, secure the flat tire and return the jack and tools to their proper storage locations.

NOTICE

Your vehicle has metric threads on the studs and lug nuts. Make certain during tire changing that the same nuts that were removed are reinstalled. If you have to replace your lug nuts make sure they have metric threads to avoid damaging the studs and ensure the wheel is properly secured to the hub. Consult an authorized retailer of Genesis Branded products for assistance.

If any of the equipment such as the jack, lug nuts, studs, or other equipment is damaged or in poor condition, do not attempt to change the tire and call for assistance.

Use of compact spare tires

Compact spare tires are designed for emergency use only. Drive carefully on the compact spare tire and always follow the safety precautions.

 WARNING

To prevent compact spare tire failure and loss of control possibly resulting in an accident:

- **Use the compact spare tire only in an emergency.**
- **NEVER operate your vehicle over 50 mph (80 km/h).**
- **Do not exceed the vehicle's maximum load rating or the load carrying capacity shown on the sidewall of the compact spare tire.**
- **Do not use the compact spare tire continuously. Repair or replace the original tire as soon as possible to avoid failure of the compact spare tire.**

When driving with the compact spare tire mounted to your vehicle:

- Check the tire pressure after installing the compact spare tire. The compact spare tire should be inflated to 60 psi (420 kPa).
- Do not take this vehicle through an automatic car wash while the compact spare tire is installed.
- Do not use the compact spare tire on any other vehicle because this tire has been designed especially for your vehicle.
- The compact spare tire's tread life is shorter than a regular tire. Inspect your compact spare tire regularly and replace worn compact spare tires with the same size and design, mounted on the same wheel.
- Do not use more than one compact spare tire at a time.

i Information

When the original tire and wheel are repaired and reinstalled on the vehicle, the lug nut torque must be set correctly. The correct lug nut tightening torque is 79~94 lbf·ft (11~13 kgf·m).

NOTICE

To prevent damaging the compact spare tire and your vehicle:

- **Drive slowly enough for the road conditions to avoid all hazards, such as a potholes or debris.**
- **Avoid driving over obstacles. The compact spare tire diameter is smaller than the diameter of a conventional tire and reduces the ground clearance approximately 1 inch (25 mm).**
- **Do not use tire chains on the compact spare tire. Because of the smaller size, a tire chain will not fit properly.**
- **Do not use the compact spare tire on any other wheels, nor should standard tires, snow tires, wheel covers or trim rings be used with the compact spare wheel.**

Jack Label

■ Example

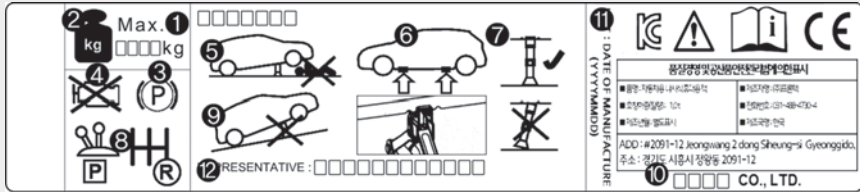

OHYK065011

The actual Jack label in the vehicle may differ from the illustration.

For more detailed specifications, refer to the label attached to the jack.

1. Model Name
2. Maximum allowable load
3. When using the jack, set your parking brake.
4. When using the jack, stop the engine.
5. Do not get under a vehicle that is supported by a jack.
6. The designated locations under the frame
7. When supporting the vehicle, the base plate of jack must be vertical under the lifting point.
8. Shift into Reverse gear on vehicles with manual transmission or move the shift lever to the P (Park) position on vehicles with automatic transmission.
9. The jack should be used on firm level ground.
10. Jack manufacture
11. Production date
12. Representative company and address

TOWING

Towing Service

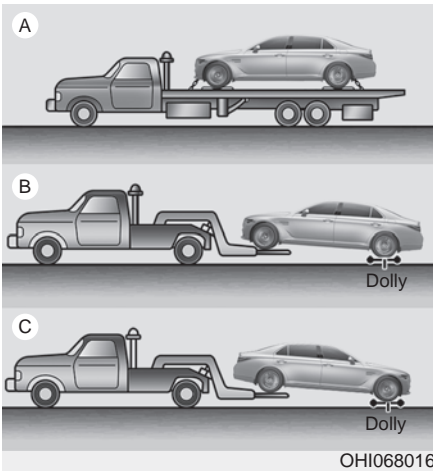

If emergency towing is necessary, we recommend having it done by an authorized retailer of Genesis Branded products or a commercial tow-truck service. Proper lifting and towing procedures are necessary to prevent damage to the vehicle. The use of wheel dollies or flatbed is recommended.

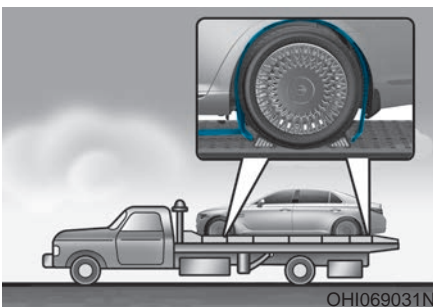

When towing the vehicle by flatbed equipment, secure wheels by using chocks and tie-down straps (or soft belts).

Do not place straps over body panels or through the wheels.

NOTICE

Do not lift the vehicle by the tow fitting or body and chassis parts. Otherwise the vehicle may be damaged.

On AWD vehicles, your vehicle must be towed with a wheel lift and dollies or flatbed equipment with all the wheels off the ground.

NOTICE

AWD vehicle should never be towed with the wheels on the ground. This can cause serious damage to the transmission or the AWD system.

On 2WD vehicles, it is acceptable to tow the vehicle with the front wheels on the ground (without dollies) and the rear wheels off the ground.

If any of the loaded wheels or suspension components are damaged or the vehicle is being towed with the rear wheels on the ground, use a towing dolly under the rear wheels.

When being towed by a commercial tow truck and wheel dollies are not used, the rear of the vehicle should always be lifted, not the front.

NOTICE

- Do not tow the vehicle with the rear wheels on the ground as this may cause damage to the vehicle.

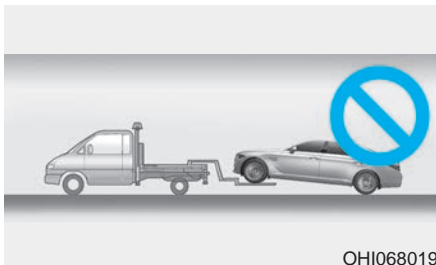

OHI068019

- Do not tow with sling-type equipment. Use a wheel lift or flatbed equipment.

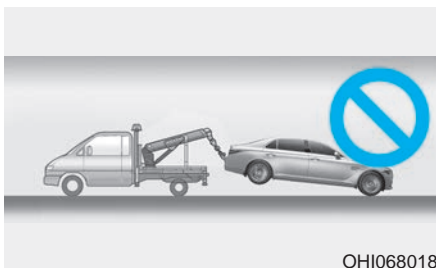

OHI068018

WARNING

If your vehicle is equipped with a rollover sensor, place the Engine Start/Stop button in the OFF position. The side impact and curtain air bag may deploy if the sensor detects the situation as a rollover.

When towing your vehicle in an emergency without wheel dollies:

1. Release EPB before turning off the engine.
2. Press the Engine Start/Stop button to the OFF position.
3. Change the gear to N (Neutral) by pressing the P release button (need to remove cap-cover) while pressing the brake pedal.

For more details, refer to "Automatic Transmission – When the Battery is Discharged" in chapter 5.

NOTICE

Failure to place the shift lever in N (Neutral) when being towed with the front wheels on the ground can cause internal damage to the transmission.

Removable Towing Hook

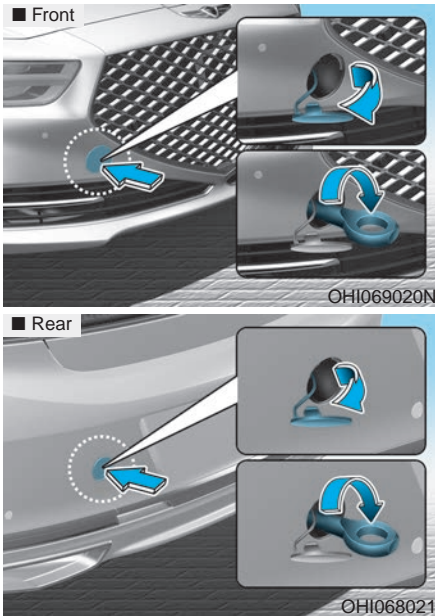

1. Open the tailgate, and remove the towing hook from the tool case.
2. Remove the hole cover pressing the lower part of the cover on the front or rear bumper.
3. Install the towing hook by turning it clockwise into the hole until it is fully secured.
4. Remove the towing hook and install the cover after use.

Emergency Towing

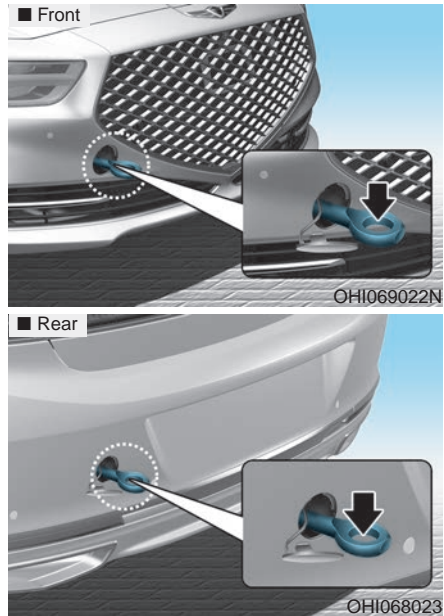

If towing is necessary, we recommend you have it done by an authorized retailer of Genesis Branded products or a commercial tow truck service.

If a towing service is not available in an emergency, your vehicle may be temporarily towed using a cable or chain secured to the emergency towing hook at the front (or rear) of the vehicle.

Use extreme caution when towing the vehicle with a cable or chain. A driver must be in the vehicle to steer it and operate the brakes.

Towing in this manner may be done only on hard-surfaced roads for a short distance and at low speeds. Also, the wheels, axles, power train, steering and brakes must all be in good condition.

⚠ CAUTION

The driver must be in the vehicle for steering and braking operations when the vehicle is being towed. Passengers other than the driver must not be in the vehicle.

Always follow these emergency towing precautions:

- Place the shift lever in N (Neutral).
- Release the parking brake.
- Depress the brake pedal with more force than normal as you will have reduced braking performance.
- More steering effort will be required because the power steering system will be disabled.
- Use a vehicle heavier than your own to tow your vehicle.
- The drivers of both vehicles should communicate with each other frequently.
- Before emergency towing, check that the hook is not broken or damaged.
- Fasten the towing cable or chain securely to the hook.
- Do not jerk the hook. Apply steady and even force.

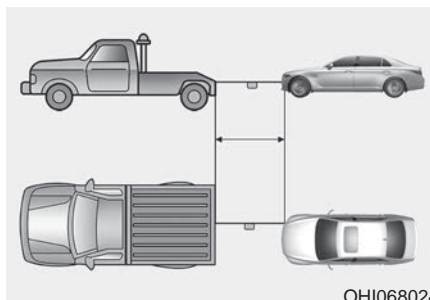

- Use a towing cable or chain less than 16 feet (5 m) long. Attach a white or red cloth (about 12 inch (30 cm) wide) in the middle of the cable or chain for easy visibility.
- Drive carefully so the towing cable or chain remains tight during towing.
- Before towing, check the automatic transmission for fluid leaks under your vehicle. If the automatic transmission fluid is leaking, flatbed equipment or a towing dolly must be used.

NOTICE

Accelerate or decelerate the vehicle in a slow and gradual manner while maintaining tension on the tow rope or chain to start or drive the vehicle, otherwise tow hooks and the vehicle may be damaged.

NOTICE

To avoid damage to your vehicle and vehicle components when towing:

- Always pull straight ahead when using the towing hooks. Do not pull from the side or at a vertical angle.
- Do not use the towing hooks to pull a vehicle out of mud, sand or other conditions from which the vehicle cannot be driven out under its own power.
- Limit the vehicle speed to 10 mph (15 km/h) and drive less than 1 mile (1.5 km) when towing to avoid serious damage to the automatic transmission.

7. Maintenance

Engine Compartment.....	7-3	Cabin Air Filter	7-30
Maintenance Services	7-5	Filter Inspection.....	7-30
Owner's Responsibility	7-5	Wiper Blades	7-31
Owner Maintenance Precautions....	7-5	Blade Inspection.....	7-31
Owner Maintenance.....	7-6	Blade Replacement	7-31
Owner Maintenance Schedule	7-7	Battery	7-33
Scheduled Maintenance Service ..	7-8	Battery Usage Recommendations..	7-34
Normal Maintenance Schedule		Battery Replacement	7-34
(5.0 GDI)	7-9	Battery Recharging	7-35
Maintenance Under Severe Usage		Reset features	7-36
Conditions (5.0 GDI)	7-12	Tires and Wheels	7-37
Normal Maintenance Schedule		Tire Care	7-37
(3.3 Turbo-GDI)	7-14	Recommended Cold Tire Inflation	
Maintenance Under Severe Usage		Pressures.....	7-38
Conditions (3.3 Turbo-GDI)	7-17	Check Tire Inflation Pressure	7-39
Explanation of Scheduled		Tire Rotation	7-39
Maintenance Items	7-19	Wheel Alignment and Tire	
Engine Oil	7-22	Balance	7-40
Checking the Engine Oil Level	7-22	Tire Replacement.....	7-41
Checking the Engine Oil and Filter ..	7-23	Wheel Replacement	7-42
Engine Coolant	7-24	Tire Traction	7-42
Checking the Engine Coolant		Tire Maintenance.....	7-42
Level.....	7-24	Tire Sidewall Labeling.....	7-42
Changing Engine Coolant	7-26	Tire Terminology and Definitions..	7-46
Brake Fluid.....	7-27	All Season Tires	7-50
Checking the Brake Fluid Level.....	7-27	Summer Tires	7-50
Washer Fluid	7-28	Snow Tires	7-50
Checking the Washer Fluid Level ..	7-28	Radial-Ply Tires	7-50
Air Cleaner	7-29	Low Aspect Ratio Tires	7-51
Filter Replacement	7-29		

7. Maintenance

Fuses	7-52
Instrument Panel Fuse	
Replacement.....	7-53
Engine Compartment Panel Fuse	
Replacement	7-54
Fuse/Relay Panel Description.....	7-56
Light Bulbs	7-69
Headlamp, Parking Lamp,	
Turn Signal Lamp, Daytime Running	
Light and Side Marker	
Replacement.....	7-70
Side Repeater Lamp Replacement..	7-70
Rear Combination Light Bulb	
Replacement	7-71
High Mounted Stop Light	
Replacement	7-71
License Plate Light Replacement ..	7-72
Interior Light Bulb Replacement....	7-72
Appearance Care	7-74
Exterior Care.....	7-74
Interior Care.....	7-80
Emission Control System.....	7-84
Crankcase Emission Control	
System	7-84
Evaporative Emission Control System	
Including Onboard Refueling Vapor	
Recovery (ORVR)	7-84
Exhaust Emission Control System..	7-85
California Perchlorate Notice	7-87

ENGINE COMPARTMENT

■ 3.3 T-GDI

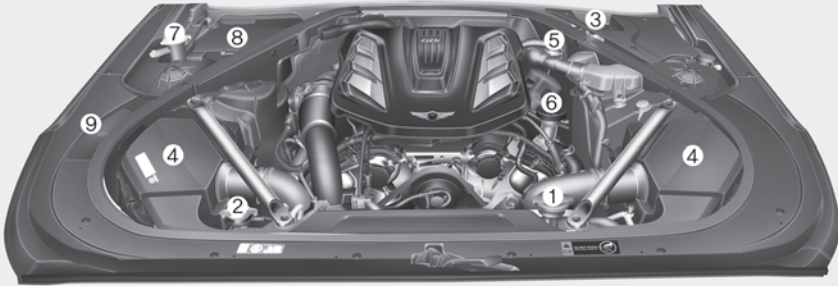

The actual engine compartment in the vehicle may differ from the illustration.

OHI078001

- | | |
|-----------------------------|--------------------------------------|
| 1. Engine coolant reservoir | 6. Engine oil filler cap |
| 2. Radiator cap | 7. Windshield washer fluid reservoir |
| 3. Brake fluid reservoir | 8. Fuse box |
| 4. Air cleaner | 9. Jumper terminal |
| 5. Engine oil dipstick | |

■ 5.0 GDI

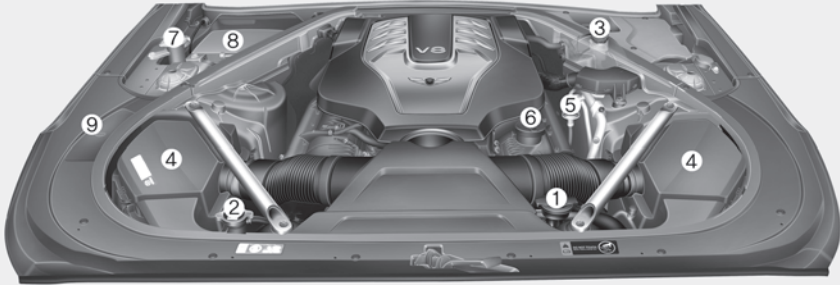

The actual engine compartment in the vehicle may differ from the illustration.

OHI078003

- | | |
|-----------------------------|--------------------------------------|
| 1. Engine coolant reservoir | 6. Engine oil filler cap |
| 2. Radiator cap | 7. Windshield washer fluid reservoir |
| 3. Brake fluid reservoir | 8. Fuse box |
| 4. Air cleaner | 9. Jumper terminal |
| 5. Engine oil dipstick | |

MAINTENANCE SERVICES

You should exercise the utmost care to prevent damage to your vehicle and injury to yourself whenever performing any maintenance or inspection procedures.

We recommend you have your vehicle maintained and repaired by an authorized retailer of Genesis Branded products. An authorized retailer of Genesis Branded products meets Genesis Branded Vehicle's high service quality standards and receives technical support from Genesis Branded Vehicle in order to provide you with a high level of service satisfaction.

Owner's Responsibility

Maintenance service and record retention are the owner's responsibility.

You should retain documents that show proper maintenance has been performed on your vehicle in accordance with the scheduled maintenance service charts shown on the following pages. You need this information to establish your compliance with the servicing and maintenance requirements of your vehicle warranties.

Detailed warranty information is provided in your Owner's Handbook & Warranty Information booklet.

Repairs and adjustments required as a result of improper maintenance or a lack of required maintenance are not covered.

Owner Maintenance Precautions

Inadequate, incomplete or insufficient servicing may result in operational problems with your vehicle that could lead to vehicle damage, an accident, or personal injury. This chapter provides instructions only for the maintenance items that are easy to perform. Several procedures can be done only by an authorized retailer of Genesis Branded products with special tools.

Your vehicle should not be modified in any way. Such modifications may adversely affect the performance, safety or durability of your vehicle and may, in addition, violate conditions of the limited warranties covering the vehicle.

Certain modifications may also be in violation of regulations established by the U.S. Department of Transportation and other federal or state agencies.

NOTICE

Improper owner maintenance during the warranty period may affect warranty coverage.

For details, read the separate Owner's Handbook & Warranty Information booklet provided with the vehicle.

If you're unsure about any service or maintenance procedure, have it done by an authorized retailer of Genesis Branded products.

OWNER MAINTENANCE

WARNING

Performing maintenance work on a vehicle can be dangerous. If you lack sufficient knowledge and experience or the proper tools and equipment to do the work, have it done by an authorized retailer of Genesis Branded products.

ALWAYS follow these precautions for performing maintenance work:

- Park your vehicle on level ground. Shift the gear to P (Park), apply the parking brake, and press the Engine Start/Stop button to the OFF position.
- Block the tires (front and back) to prevent the vehicle from moving.
Remove loose clothing or jewelry that can become entangled in moving parts.
- If you must run the engine during maintenance, do so out doors or in an area with plenty of ventilation.
- Keep flames, sparks, or smoking materials away from the battery and fuel-related parts.

WARNING



Touching metal parts

Do not touch metal parts (including strut bars) while the engine is operating or hot. Doing so could result in serious personal injury. Turn the engine off and wait until the metal parts cool down to perform maintenance work on the vehicle.

The following lists are vehicle checks and inspections that should be performed by the owner or an authorized retailer of Genesis Branded products at the frequencies indicated to help ensure safe, dependable operation of your vehicle.

Any adverse conditions should be brought to the attention of your dealer as soon as possible.

These Owner Maintenance vehicle checks are generally not covered by warranties and you may be charged for labor, parts and lubricants used.

Owner Maintenance Schedule

When you stop for fuel:

- Check the engine oil level.
- Check the coolant level in the engine coolant reservoir.
- Check the windshield washer fluid level.
- Check the tire for low or under-inflated tires.

WARNING

Be careful when checking your engine coolant level when the engine is hot. This may result in coolant being blown out of the opening and cause serious burns and other injuries.

While operating your vehicle:

- Note any changes in the sound of the exhaust or any smell of exhaust fumes in the vehicle.
- Check for vibrations in the steering wheel. Notice if there is any increased steering effort or looseness in the steering wheel, or change in its straight-ahead position.
- Notice if your vehicle constantly turns slightly or "pulls" to one side when traveling on smooth, level road.
- When stopping, listen and check for unusual sounds, pulling to one side, increased brake pedal travel or "hard-to-push" brake pedal.
- If any slipping or changes in the operation of your transmission occurs, check the transmission fluid level.
- Check the automatic transmission P (Park) function.
- Check the parking brake.
- Check for fluid leaks under your vehicle (water dripping from the air conditioning system during or after use is normal).

At least monthly:

- Check coolant level in the engine coolant reservoir.
- Check the operation of all exterior lights, including the brake lights, turn signals and hazard warning flashers.
- Check the inflation pressures of all tires including the spare for tires that are worn, show uneven wear, or are damaged.
- Check for loose wheel lug nuts.

At least twice a year: (i.e., every Spring and Autumn)

- Check radiator, heater and air conditioning hoses for leaks or damage.
- Check windshield washer spray and wiper operation. Clean wiper blades with a clean cloth dampened with washer fluid.
- Check headlamp alignment.
- Check muffler, exhaust pipes, shields and clamps.
- Check the seat belts for wear and function.

At least once a year:

- Clean body and door drain holes.
- Lubricate door hinges and hood hinges.
- Lubricate door and hood locks and latches.
- Lubricate door rubber weather strips.
- Lubricate door checker.
- Check the air conditioning system.
- Inspect and lubricate automatic transmission linkage and controls.
- Clean the battery and terminals.
- Check the brake fluid level.

SCHEDULED MAINTENANCE SERVICE

Follow Normal Maintenance Schedule if the vehicle is usually operated where none of the following conditions apply.

If any of the following conditions apply, you must follow the Maintenance Under Severe Usage Conditions.

- Repeated driving short distance of less than 5 miles (8 km) in normal temperature or less than 10 miles (16 km) in freezing temperature
- Extensive engine idling or low speed driving for long distances
- Driving on rough, dusty, muddy, unpaved, graveled or salt-spread roads
- Driving in areas using salt or other corrosive materials or in very cold weather
- Driving in heavy dust conditions
- Driving in heavy traffic area
- Driving on uphill, downhill, or mountain road repeatedly
- Towing a trailer or using a camper, or roof rack
- Driving as a patrol car, taxi, other commercial use of vehicle towing
- Frequently driving in stop-and-go condition

For additional information or assistance see an authorized retailer of Genesis Branded products.

Normal Maintenance Schedule (5.0 GDI)

The following maintenance services must be performed to ensure good emission control and performance. Keep receipts for all vehicle emission services to protect your warranty. Where both mileage and time are shown, the frequency of service is determined by whichever occurs first.

MAINTENANCE INTERVALS	Number of months or driving distance, whichever comes first															
	Months	12	24	36	48	60	72	84	96	108	120	132	144	156	168	180
MAINTENANCE ITEM	Miles×1,000	7.5	15	22.5	30	37.5	45	52.5	60	67.5	75	82.5	90	97.5	105	112.5
	Km×1,000	12	24	36	48	60	72	84	96	108	120	132	144	156	168	180
Drive belts *1	At first, inspect at 60,000 miles (96,000 km) or 72 months, after that, inspect every 15,000 miles (24,000 km) or 24 months															
Engine oil and engine oil filter	R	R	R	R	R	R	R	R	R	R	R	R	R	R	R	R
Fuel additives *2	Add every 7,500 miles (12,000 km) or 12 months															
Air cleaner filter	I	I	I	R	I	I	I	I	R	I	I	I	R	I	I	I
Spark plugs	Replace every 97,500 miles (156,000 km)															
Rotate tires	Rotate every 7,500 miles (12,000 km)															
Climate control air filter (for evaporator and blower unit)	R	R	R	R	R	R	R	R	R	R	R	R	R	R	R	R

I : Inspect and if necessary, adjust, correct, clean or replace.

R : Replace or change.

*1 : The drive belt should be replaced when cracks occur or tension is reduced.

*2 : If TOP TIER Detergent Gasoline is not available, one bottle of additive is recommended. Additives are available from your authorized retailer of Genesis Branded products along with information on how to use them. Do not mix other additives.

Normal Maintenance Schedule (5.0 GDI) (CONT.)

MAINTENANCE INTERVALS	Number of months or driving distance, whichever comes first															
	Months	12	24	36	48	60	72	84	96	108	120	132	144	156	168	180
MAINTENANCE ITEM	Milesx1,000	7.5	15	22.5	30	37.5	45	52.5	60	67.5	75	82.5	90	97.5	105	112.5
	Kmx1,000	12	24	36	48	60	72	84	96	108	120	132	144	156	168	180
Vacuum hose		I	I	I	I	I	I	I	I	I	I	I	I	I	I	I
Engine coolant		At first, replace at 120,000 miles (192,000 km) or 10 years after that, replace every 30,000 miles (48,000 km) or 24 months														
Battery condition		I	I	I	I	I	I	I	I	I	I	I	I	I	I	I
Brake lines, hoses and connections		I	I	I	I	I	I	I	I	I	I	I	I	I	I	I
Front brake disc/pads, calipers		I	I	I	I	I	I	I	I	I	I	I	I	I	I	I
Rear brake disc/pads		I	I	I	I	I	I	I	I	I	I	I	I	I	I	I
Steering gear rack, linkage and boots / lower arm ball joint, upper arm ball joint		I	I	I	I	I	I	I	I	I	I	I	I	I	I	I
Driveshaft and boots		I	I	I	I	I	I	I	I	I	I	I	I	I	I	I
Suspension mounting bolts		I	I	I	I	I	I	I	I	I	I	I	I	I	I	I
Air conditioner refrigerant		I	I	I	I	I	I	I	I	I	I	I	I	I	I	I
Air conditioner compressor		I	I	I	I	I	I	I	I	I	I	I	I	I	I	I
Propeller shaft		I	I	I	I	I	I	I	I	I	I	I	I	I	I	I
Exhaust pipe and muffler		I	I	I	I	I	I	I	I	I	I	I	I	I	I	I

I : Inspect and if necessary, adjust, correct, clean or replace.

R : Replace or change.

Normal Maintenance Schedule (5.0 GDI) (CONT.)

MAINTENANCE INTERVALS	Number of months or driving distance, whichever comes first															
	Months	12	24	36	48	60	72	84	96	108	120	132	144	156	168	180
MAINTENANCE ITEM	Milesx1,000	7.5	15	22.5	30	37.5	45	52.5	60	67.5	75	82.5	90	97.5	105	112.5
	Kmx1,000	12	24	36	48	60	72	84	96	108	120	132	144	156	168	180
Automatic transmission fluid ^{*3}		No check, No service required														
Front (AWD) / rear differential oil ^{*4}					I				I				I			
Vapor hose, fuel filler cap and fuel tank			I		I		I		I		I		I		I	
Fuel tank air filter ^{*5}			I		I		I		I		I		I		I	
Fuel filter ^{*5}			I		I		I		I		I		I		I	
Fuel lines, hoses and connections					I				I				I			
Parking brake			I		I		I		I		I		I		I	
Brake fluid			I		I		I		I		I		I		I	

I : Inspect and if necessary, adjust, correct, clean or replace.

R : Replace or change.

^{*3} : Use only the specified automatic transmission fluid. (Refer to "Recommended lubricants and capacities" in chapter 8 or the label in the engine compartment.)

^{*4} : Front/rear differential oil should be changed anytime, front/rear differential have been submerged in water.

^{*5} : Fuel filter & Fuel tank air filter are considered to be maintenance free but periodic inspection is recommended for this maintenance schedule depends on fuel quality. If there are some important safety matters like fuel flow restriction, surging, loss of power, hard starting problem, etc. replace the fuel filter immediately regardless of maintenance schedule and consult an authorized retailer of Genesis Branded products for details.

Maintenance Under Severe Usage Conditions (5.0 GDI)

The following items must be serviced more frequently on cars normally used under severe driving conditions. Refer to the chart below for the appropriate maintenance intervals.

R : Replace

I : Inspect and, after inspection, clean, adjust, repair or replace if necessary

Maintenance item	Maintenance operation	Maintenance Intervals	Driving condition
Engine oil and filter	R	Every 3,750 miles (6,000 km) or 6 months	A, B, C, D, E, F, G, H, I, J, K
Air cleaner filter	I	More frequently	C, E
Spark plugs	R	More frequently	A, B, F, H, I, K
Automatic transmission fluid	R	Every 60,000 miles (96,000 km)	A, C, D, E, F, G, H, I
Front brake disc/pads, calipers	I	More frequently	C, D, G, H
Rear brake disc/pads	I	More frequently	C, D, G, H
Parking brake	I	More frequently	C, D, G, H
Steering gear box, linkage & boots/ Lower arm ball joint, upper arm ball joint	I	More frequently	C, D, E, F, G, H, I
Drive shafts and boots	I	More frequently	C, D, E, F, G, H, I, J
Front(AWD)/ Rear differential oil	R	Every 75,000 miles (120,000 km)	C, E, G, H, I, J
Climate control air filter (for evaporator and blower unit)	R	More frequently	C, E, G
Propeller shaft	I	More frequently	C, D, E, F, G, H, I, J

SEVERE DRIVING CONDITIONS

- A -Repeatedly driving short distance of less than 5 miles (8 km) in normal temperature or less than 10 miles (16 km) in freezing temperature
- B -Extensive engine idling or low speed driving for long distances
- C -Driving on rough, dusty, muddy, unpaved, graveled or salt- spread roads
- D -Driving in areas using salt or other corrosive materials or in very cold weather
- E -Driving in heavy dust conditions
- F -Driving in heavy traffic area
- G -Driving on uphill, downhill, or mountain road repeatedly
- H -Towing a trailer, or using a camper, or roof rack
- I -Driving as a patrol car, taxi, other commercial use or vehicle towing
- J -Driving over 106 mph (170 km/h)
- K -Frequently driving in stop-and-go conditions

Normal Maintenance Schedule (3.3 Turbo-GDI)

MAINTENANCE INTERVALS	Number of months or driving distance, whichever comes first															
	Months	12	24	36	48	60	72	84	96	108	120	132	144	156	168	180
MAINTENANCE ITEM	Miles×1,000	6	12	18	24	30	36	42	48	54	60	66	72	78	84	90
	Km×1,000	10	20	30	40	50	60	70	80	90	100	110	120	130	140	150
Drive belts *1		At first, inspect at 60,000 miles (100,000 km) or 72 months, after that, inspect every 12,000 miles (20,000 km) or 24 months														
Engine oil and engine oil filter		R	R	R	R	R	R	R	R	R	R	R	R	R	R	R
Fuel additives *2		Add every 6,000 miles (10,000 km) or 12 months														
Air cleaner filter		I	I	R	I	I	R	I	I	R	I	I	R	I	I	R
Spark plugs		Replace every 42,000 miles (70,000 km)														
Valve clearance *3		Inspect every 60,000 miles (100,000 km) or 72 months														
Rotate tires		Rotate every 6,000 miles (10,000 km)														
Climate control air filter (for evaporator and blower unit)		R	R	R	R	R	R	R	R	R	R	R	R	R	R	R

I : Inspect and if necessary, adjust, correct, clean or replace.

R : Replace or change.

*1 : The drive belt should be replaced when cracks occur or tension is reduced.

*2 : If TOP TIER Detergent Gasoline is not available, one bottle of additive is recommended. Additives are available from your authorized retailer of Genesis Branded products along with information on how to use them. Do not mix other additives.

*3 : Inspect for excessive valve noise and/or engine vibration and adjust if necessary. Have an authorized retailer of Genesis Branded products perform the operation.

Normal Maintenance Schedule (3.3 Turbo-GDI) (CONT.)

MAINTENANCE INTERVALS	Number of months or driving distance, whichever comes first															
	Months	12	24	36	48	60	72	84	96	108	120	132	144	156	168	180
MAINTENANCE ITEM	Miles×1,000	6	12	18	24	30	36	42	48	54	60	66	72	78	84	90
	Km×1,000	10	20	30	40	50	60	70	80	90	100	110	120	130	140	150
Vacuum hose		I	I	I	I	I	I	I	I	I	I	I	I	I	I	I
Engine coolant		At first, replace at 120,000 miles (200,000 km) or 10 years after that, replace every 30,000 miles (50,000 km) or 24 months														
Battery condition		I	I	I	I	I	I	I	I	I	I	I	I	I	I	I
Brake lines, hoses and connections		I	I	I	I	I	I	I	I	I	I	I	I	I	I	I
Front brake disc/pads, calipers		I	I	I	I	I	I	I	I	I	I	I	I	I	I	I
Rear brake disc/pads		I	I	I	I	I	I	I	I	I	I	I	I	I	I	I
Steering gear rack, linkage and boots / lower arm ball joint, upper arm ball joint		I	I	I	I	I	I	I	I	I	I	I	I	I	I	I
Driveshaft and boots		I	I	I	I	I	I	I	I	I	I	I	I	I	I	I
Suspension mounting bolts		I	I	I	I	I	I	I	I	I	I	I	I	I	I	I
Air conditioner refrigerant		I	I	I	I	I	I	I	I	I	I	I	I	I	I	I
Air conditioner compressor		I	I	I	I	I	I	I	I	I	I	I	I	I	I	I
Propeller shaft		I	I	I	I	I	I	I	I	I	I	I	I	I	I	I
Exhaust pipe and muffler		I	I	I	I	I	I	I	I	I	I	I	I	I	I	I

I : Inspect and if necessary, adjust, correct, clean or replace.

R : Replace or change.

Normal Maintenance Schedule (3.3 Turbo-GDI) (CONT.)

MAINTENANCE INTERVALS	Number of months or driving distance, whichever comes first															
	Months	12	24	36	48	60	72	84	96	108	120	132	144	156	168	180
MAINTENANCE ITEM	Miles×1,000	6	12	18	24	30	36	42	48	54	60	66	72	78	84	90
	Km×1,000	10	20	30	40	50	60	70	80	90	100	110	120	130	140	150
Automatic transmission fluid *4		No check, No service required														
Front (AWD) / rear differential oil *5					I				I					I		
Vapor hose, fuel filler cap and fuel tank			I		I		I		I		I		I		I	
Fuel tank air filter *6			I		I		I		I		I		I		I	
Fuel filter *6			I		I		I		I		I		I		I	
Fuel lines, hoses and connections					I		I		I		I		I		I	
Parking brake			I		I		I		I		I		I		I	
Brake fluid			I		I		I		I		I		I		I	

I : Inspect and if necessary, adjust, correct, clean or replace.

R : Replace or change.

*4 : Use only the specified automatic transmission fluid. (Refer to "Recommended lubricants and capacities" in chapter 8 or the label in the engine compartment.)

*5 : Front/rear differential oil should be changed anytime, front/rear differential have been submerged in water.

*6 : Fuel filter & Fuel tank air filter are considered to be maintenance free but periodic inspection is recommended for this maintenance schedule depends on fuel quality. If there are some important safety matters like fuel flow restriction, surging, loss of power, hard starting problem, etc. replace the fuel filter immediately regardless of maintenance schedule and consult an authorized retailer of Genesis Branded products for details.

Maintenance Under Severe Usage Conditions (3.3 Turbo-GDI)

The following items must be serviced more frequently on cars normally used under severe driving conditions. Refer to the chart below for the appropriate maintenance intervals.

R : Replace

I : Inspect and, after inspection, clean, adjust, repair or replace if necessary

Maintenance item	Maintenance operation	Maintenance Intervals	Driving condition
Engine oil and filter	R	Every 3,000 miles (5,000 km) or 6 months	A, B, C, D, E, F, G, H, I, J, K
Air cleaner filter	I	More frequently	C, E
Spark plugs	R	More frequently	A, B, F, H, I, K
Automatic transmission fluid	R	Every 60,000 miles (100,000 km)	A, C, D, E, F, G, H, I
Front brake disc/pads, calipers	I	More frequently	C, D, G, H
Rear brake disc/pads	I	More frequently	C, D, G, H
Parking brake	I	More frequently	C, D, G, H
Steering gear box, linkage & boots/ Lower arm ball joint, upper arm ball joint	I	More frequently	C, D, E, F, G, H, I
Drive shafts and boots	I	More frequently	C, D, E, F, G, H, I, J
Front (AWD)/ Rear differential oil	R	Every 72,000 miles (120,000 km)	C, E, G, H, I, J
Climate control air filter (for evaporator and blower unit)	R	More frequently	C, E, G
Propeller shaft	I	More frequently	C, D, E, F, G, H, I, J

SEVERE DRIVING CONDITIONS

- A -Repeatedly driving short distance of less than 5 miles (8 km) in normal temperature or less than 10 miles (16 km) in freezing temperature
- B -Extensive engine idling or low speed driving for long distances
- C -Driving on rough, dusty, muddy, unpaved, graveled or salt- spread roads
- D -Driving in areas using salt or other corrosive materials or in very cold weather
- E -Driving in heavy dust conditions
- F -Driving in heavy traffic area
- G -Driving on uphill, downhill, or mountain road repeatedly
- H -Towing a trailer, or using a camper, or roof rack
- I -Driving as a patrol car, taxi, other commercial use or vehicle towing
- J -Driving over 106 mph (170 km/h)
- K -Frequently driving in stop-and-go conditions

EXPLANATION OF SCHEDULED MAINTENANCE ITEMS

Engine Oil and Filter

The engine oil and filter should be changed at the intervals specified in the maintenance schedule. If the vehicle is being driven in severe conditions, more frequent oil and filter changes are required.

Drive Belts

Inspect all drive belts for evidence of cuts, cracks, excessive wear or oil saturation and replace if necessary. Drive belts should be checked periodically for proper tension and adjusted as necessary.

Fuel Filter

A clogged-up fuel filter may limit the vehicle driving speed, damage the emission system, and cause the hard starting. When a considerable amount of foreign substances are accumulated in the fuel tank, the fuel filter should be replaced.

Upon installing a new fuel filter, operate the engine for several minutes, and check the connections for any leakages. Fuel filters should be installed by an authorized retailer of Genesis Branded products.

Fuel Lines, Fuel Hoses and Connections

Check the fuel lines, fuel hoses and connections for leakage and damage. Have an authorized retailer of Genesis Branded products replace any damaged or leaking parts immediately.

Vapor Hose and Fuel Filler Cap

The vapor hose and fuel filler cap should be inspected at those intervals specified in the maintenance schedule. Make sure a new vapor hose or fuel filler cap is correctly replaced.

Air Cleaner Filter

A Genesis air cleaner filter is recommended when the filter is replaced.

Spark Plugs

Make sure to install new spark plugs of the correct heat range.

Valve Clearance (3.3 T-GDI)

Inspect for excessive valve noise and/or engine vibration and adjust if necessary. Have an authorized retailer of Genesis Branded products perform the operation.

Cooling System

Check cooling system components, such as radiator, coolant reservoir, hoses and connections for leakage and damage. Replace any damaged parts.

Engine Coolant

The coolant should be changed at the intervals specified in the maintenance schedule.

Automatic Transmission Fluid

Automatic transmission fluid should not be checked under normal usage conditions. But in severe conditions, the fluid should be changed at an authorized retailer of Genesis Branded products in accordance to the scheduled maintenance at the beginning of this chapter.

Information

Automatic transmission fluid color is red when new.

As the vehicle is driven, the automatic transmission fluid will begin to look darker. This is a normal condition and you should not judge the need to replace the fluid based upon the changed color.

NOTICE

The use of a non-specified fluid could result in transmission malfunction and failure.

Use only the specified automatic transmission fluid (refer to "Recommended Lubricants and Capacities" in chapter 8).

Brake Hoses and Lines

Visually check for proper installation, chafing, cracks, deterioration and any leakage. Replace any deteriorated or damaged parts immediately.

Brake Fluid

Check the brake fluid level in the brake fluid reservoir. The level should be between the MIN and the MAX marks on the side of the reservoir. Use only hydraulic brake fluid conforming to DOT 3 or DOT 4 specification.

Brake Transmission Fluid

Check the pads for excessive wear, discs for run out and wear, and calipers for fluid leakage.

Exhaust Pipe and Muffler

Visually inspect the exhaust pipes, muffler and hangers for cracks, deterioration, or damage. Start the engine and listen carefully for any exhaust gas leakage. Tighten connections or replace parts as necessary.

Suspension Mounting Bolts

Check the suspension connections for looseness or damage. Retighten to the specified torque.

Steering Gear Box, Linkage & Boots/Lower Arm Ball Joint

With the vehicle stopped and the engine off, check for excessive free-play in the steering wheel. Check the linkage for bends or damage. Check the dust boots and ball joints for deterioration, cracks, or damage.

Replace any damaged parts.

Drive Shafts and Boots

Check the drive shafts, boots and clamps for cracks, deterioration, or damage. Replace any damaged parts and, if necessary, repack the grease.

Air Conditioning Refrigerant

Check the air conditioning lines and connections for leakage and damage.

ENGINE OIL

Checking the Engine Oil Level

1. Follow all of the oil manufacturer's precautions.
2. Be sure the vehicle is on the level ground in P (Park) with the parking brake set. If possible, block the wheels.
3. Turn the engine on and allow the engine to reach normal operating temperature.
4. Turn the engine off and wait about five minutes for the oil to return to the oil pan.
5. Pull the dipstick out, wipe it clean, and re-insert it fully.

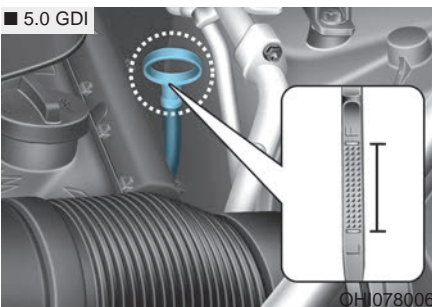
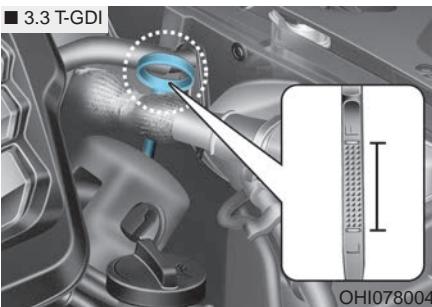

6. Pull the dipstick out again and check the level. The level should be between F and L.

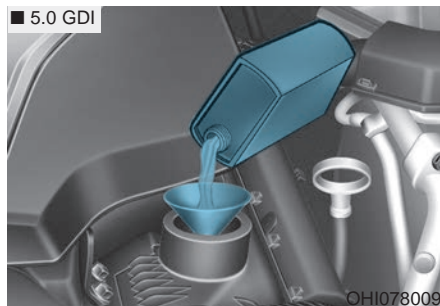
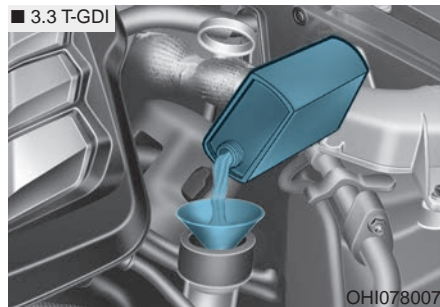

7. If it is near or at L, add enough oil to bring the level to F.

Use only the specified engine oil (refer to "Recommended Lubricants and Capacities" in chapter 8).

NOTICE

To prevent damage to your engine:

- Do not overfill with engine oil. Add oil in small quantities and recheck level to ensure engine is not overfilled.
- Do not spill engine oil when adding or changing engine oil. Use a funnel to help prevent oil from being spilled on engine components. Wipe off spilled oil immediately.

Checking the Engine Oil and Filter



Have engine oil and filter changed by an authorized retailer of Genesis Branded products according to the Maintenance Schedule at the beginning of this chapter.

WARNING

CALIFORNIA PROPOSITION 65 WARNING

Engine oil contains chemicals known to the State of California to cause cancer, birth defects and reproductive harm. Used engine oil may cause irritation or cancer of the skin if left in contact with the skin for prolonged periods of time. Always protect your skin by washing your hands thoroughly with soap and warm water as soon as possible after handling used oil.

ENGINE COOLANT

The high-pressure cooling system has a reservoir filled with year-round antifreeze coolant. The reservoir is filled at the factory.

Check the antifreeze protection and coolant level at least once a year, at the beginning of the winter season and before traveling to a colder climate.

Checking the Engine Coolant Level

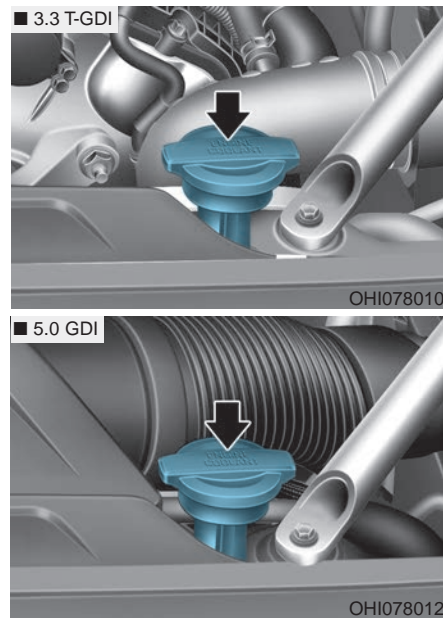

Check the condition and connections of all cooling system hoses and heater hoses. Replace any swollen or deteriorated hoses.

The coolant level should be filled between the F and the L marks on the side of the coolant reservoir when the engine is cool.

If the coolant level is low, add enough distilled (deionized) water to bring the level to the F mark, but do not overfill. If frequent additions are required, we recommend that you see an authorized retailer of Genesis Branded products for a cooling system inspection.

Recommended engine coolant

- When adding coolant, use only deionized water, distilled water or soft water for your vehicle and never mix hard water in the coolant filled at the factory.
- An incorrect coolant mixture can result in severe malfunction or engine damage.
- The engine in your vehicle has aluminum engine parts and must be protected by an ethylene-glycol with phosphate based coolant to prevent corrosion and freezing.
- Do not use alcohol or methanol coolant or mix them with the specified coolant.
- Do not use a solution that contains more than 60% antifreeze or less than 35% antifreeze, which would reduce the effectiveness of the solution.

For mixing percentage, refer to the following table:

Ambient Temperature	Mixture Percentage (volume)	
	Antifreeze	Water
5°F (-15°C)	35	65
-13°F (-25°C)	40	60
-31°F (-35°C)	50	50
-49°F (-45°C)	60	40

i Information

If in doubt about the mix ratio, a 50% water and 50% antifreeze mix is the easiest to mix together as it will be the same quantity of each. It is suitable to use for most temperature ranges of -31°F and higher.

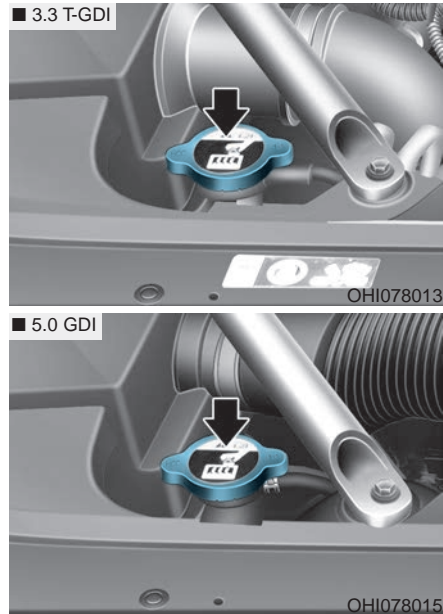

⚠ WARNING



Never remove the radiator cap or the drain plug while the engine and radiator are hot. Hot coolant and steam may blow out under pressure, causing serious injury. Turn the engine off and wait until the engine cools down. Use extreme care when removing the radiator cap. Wrap a thick towel around it, and turn it counterclockwise slowly to the first stop. Step back while the pressure is released from the cooling system.

When you are sure all the pressure has been released, press down on the cap, using a thick towel, and continue turning counterclockwise to remove it.

⚠ WARNING



The electric motor for the cooling fan may continue to operate or start up when the engine is not running and can cause serious injury. Keep hands, clothing and tools away from the rotating fan blades of the cooling fan.

Always turn off the engine unless the vehicle has to be inspected with the engine on. Be cautious as the cooling fan may operate if the negative (-) battery terminal is not disconnected.

Changing Engine Coolant

Have coolant changed by an authorized retailer of Genesis Branded products according to the Maintenance Schedule at the beginning of this chapter.

⚠ WARNING

Do not use engine coolant or antifreeze in the washer fluid reservoir.

Engine coolant can severely obscure visibility when sprayed on the windshield and may cause loss of vehicle control resulting in an accident.

Engine coolant may also cause damage to paint and body trim.

NOTICE

To prevent damage to engine parts, put a thick towel around the radiator cap before refilling the coolant to prevent the coolant from overflowing into engine parts, such as the alternator.

BRAKE FLUID

Checking the Brake Fluid Level

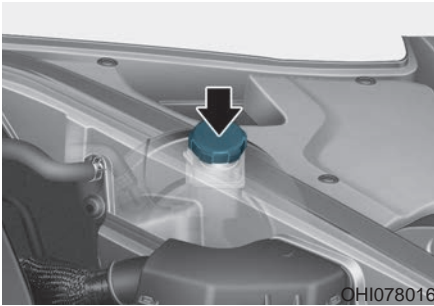

Check the fluid level in the reservoir periodically. The fluid level should be between MAX and MIN marks on the side of the reservoir.

Before removing the reservoir cap and adding brake fluid, clean the area around the reservoir cap thoroughly to prevent brake fluid contamination.

If the level is low, add the specified brake fluid to the MAX level. The level will fall with accumulated mileage. This is a normal condition associated with the wear of the brake linings. If the fluid level is excessively low, have the brake system checked by an authorized retailer of Genesis Branded products.

WARNING

If the brake system requires frequent additions of fluid this could indicate a leak in the brake system. Have the vehicle inspected by an authorized retailer of Genesis Branded products.

WARNING

Do not allow brake fluid to come in contact with your eyes. If brake fluid comes in contact with your eyes, flush your eyes with clean water for at least 15 minutes and get immediate medical attention.

NOTICE

- Do not allow brake fluid to contact the vehicle's body paint, as paint damage will result.
- Brake fluid, which has been exposed to open air for an extended time should NEVER be used as its quality cannot be guaranteed. It should be disposed of properly.
- Do not use the wrong kind of brake fluid. A few drops of mineral based oil, such as engine oil, in your brake system can damage brake system parts.

Information

Use only the specified brake fluid (refer to "Recommended Lubricants and Capacities" in chapter 8).

WASHER FLUID

Checking the Washer Fluid Level

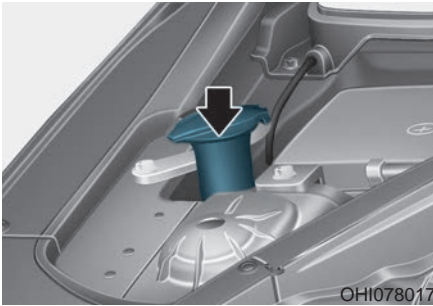

Check the fluid level in the washer fluid reservoir and add fluid if necessary. Plain water may be used if washer fluid is not available. However, use washer solvent with antifreeze characteristics in cold climates to prevent freezing.

WARNING

To prevent serious injury or death, take the following safety precautions when using washer fluid:

- Do not use engine coolant or antifreeze in the washer fluid reservoir. Engine coolant can severely obscure visibility when sprayed on the windshield and may cause loss of vehicle control resulting in an accident or damage to paint and body trim.
- Do not allow sparks or flame to contact the washer fluid or the washer fluid reservoir. Washer fluid may contain alcohol and can be flammable.
- Do not drink washer fluid and avoid contact with skin. Washer fluid is harmful to humans and animals.
- Keep washer fluid away from children and animals.

AIR CLEANER

Filter Replacement

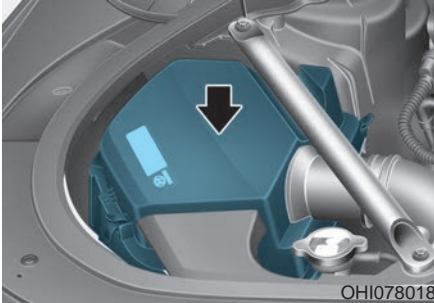

Do not attempt to wash or to rinse it, as water will damage the filter.

If soiled, the air cleaner filter must be replaced.

Visit an authorized retailer of Genesis Branded products to replace the air cleaner filter.

Replace the filter according to the Maintenance Schedule

i Information

If the vehicle is operated in extremely dusty or sandy areas, replace the air cleaner filter more often than the usual recommended intervals (refer to "Maintenance Under Severe Usage Conditions" in this chapter).

NOTICE

- Do not drive with the air cleaner filter removed. This will result in excessive engine wear.
- When removing the air cleaner filter, be careful that dust or dirt does not enter the air intake, or damage may result.
- Use Genuine Genesis Part, use of non-Genuine Genesis Part could damage the engine.

CABIN AIR FILTER

Filter Inspection

The cabin air filter should be replaced according to the Maintenance Schedule. If the vehicle is operated in severely air-polluted cities or on dusty rough roads for a long period, it should be inspected more frequently and replaced sooner. Replace the cabin air filter by following the procedure below and be careful to avoid damaging other components.

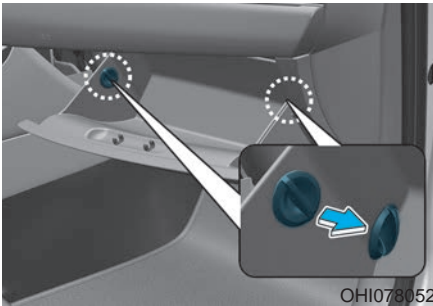

1. With the glove box open, remove the stoppers on both sides to allow the glove box to hang freely on the hinges.

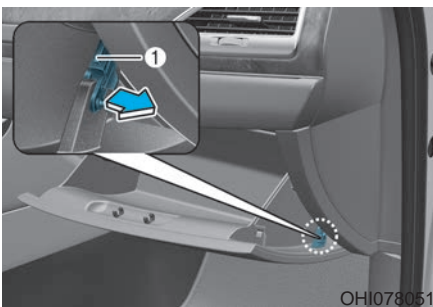

2. Remove the support rod (1).

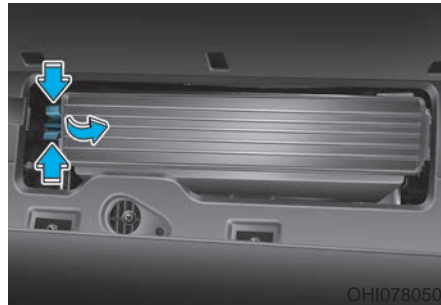

3. Press and hold the lock on the left side of the cover.

4. Pull out the cover.

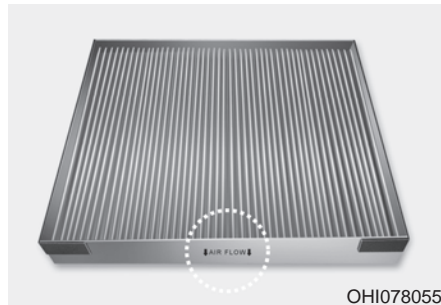

5. Replace the cabin air filter.

6. Reassemble in the reverse order of disassembly.

NOTICE

Install a new cabin air filter in the correct direction with the arrow symbol (↓) facing downwards to prevent noise and reduced effectiveness.

WIPER BLADES

Blade Inspection

Contamination of either the windshield or the wiper blades with foreign matter can reduce the effectiveness of the windshield wipers.

Common sources of contamination are insects, tree sap, and hot wax treatments used by some commercial car washes. If the blades are not wiping properly, clean both the window and the blades with a good cleaner or mild detergent, and rinse thoroughly with clean water.

NOTICE

To prevent damage to the wiper blades, arms or other components, do not:

- Use gasoline, kerosene, paint thinner, or other solvents on or near them.
- Attempt to move the wipers manually.
- Use non-specified wiper blades.

i Information

Commercial hot waxes applied by automatic car washes have been known to make the windshield difficult to clean.

Blade Replacement

When the wipers no longer clean adequately, the blades may be worn or cracked, and require replacement.

NOTICE

- In order to prevent damage to the hood and the wiper arms, the wiper arms should only be lifted when in the top wiping position.
- Always return the wiper arms to the windshield before driving.

NOTICE

The use of a non-specified wiper blade could result in wiper malfunction and failure.

Front windshield wiper service positions

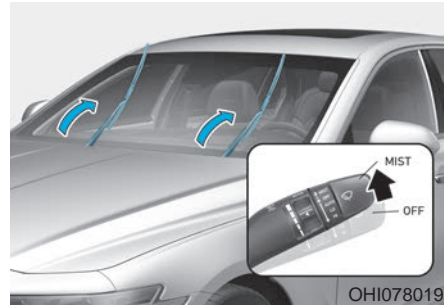

1. Within 20 seconds of turning off the engine, lift and hold the wiper lever up to the MIST position for about 2 seconds until the wipers move to the top wipe position.
2. At this time you can lift the wipers off the windshield.
3. Gently put the wipers back down onto the windshield.
4. Turn the wipers to any ON position to return the wipers to the bottom resting position.

Front windshield wiper blade replacement

1. Put the front windshield wipers into the service position.

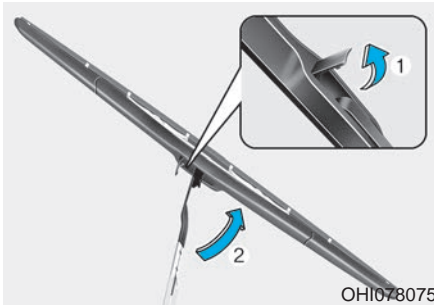

2. Open the wiper blade clip (1) and slightly rotate the wiper blade assembly (2) to expose the plastic locking clip.

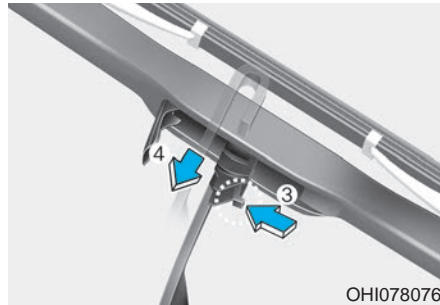

3. Press the locking clip (3) and pull down the wiper blade assembly (4).

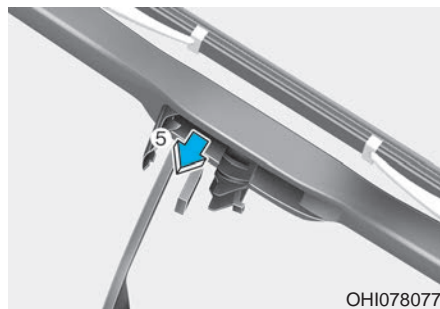

4. Remove the wiper blade assembly from the wiper arm (5).
5. Install a blade assembly in the reverse order of removal.
6. Return the wiper arm on the windshield.
7. Place the Engine Start/Stop button to the ON position. The wiper arms will return to the normal operating position.

BATTERY

WARNING

To prevent **SERIOUS INJURY** or **DEATH** to you or bystanders, always follow these precautions when working near or handling the battery:



Always read and follow instructions carefully when handling a battery.



Wear eye protection designed to protect the eyes from acid splashes.



Keep all flames, sparks, or smoking materials away from the battery.



Hydrogen is always present in battery cells, is highly combustible, and may explode if ignited.



Keep batteries out of reach of children.



Batteries contain sulfuric acid which is highly corrosive. Do not allow acid to contact your eyes, skin or clothing.

If acid gets into your eyes, flush your eyes with clean water for at least 15 minutes and get immediate medical attention. If acid gets on your skin, thoroughly wash the area. If you feel pain or a burning sensation, get medical attention immediately.

- When lifting a plastic-cased battery, excessive pressure on the case may cause battery acid to leak. Lift with a battery carrier or with your hands on opposite corners.

- Do not attempt to jump start your vehicle if your battery is frozen.
- **NEVER** attempt to recharge the battery when the vehicle's battery cables are connected to the battery.
- The electrical ignition system works with high voltage. **NEVER** touch these components with the engine running or when the Engine Start/Stop button is in the ON position.

WARNING

CALIFORNIA PROPOSITION 65 WARNING

Battery posts, terminals, and related accessories contain lead and lead compounds, chemicals known to the State of California to cause cancer, birth defects and reproductive harm. Batteries also contain other chemicals known to the State of California to cause cancer. Wash hands after handling.

NOTICE

- When you do not use the vehicle for a long time in a low temperature area, disconnect the battery and keep it indoors.
- Always charge the battery fully to prevent battery case damage in low temperature areas.

Battery Usage Recommendations



- Keep the battery securely mounted.
- Keep the battery top clean and dry.
- Keep the terminals and connections clean, tight, and coated with petroleum jelly or terminal grease.
- Rinse any spilled acid from the battery immediately with a solution of water and baking soda.

Battery Replacement

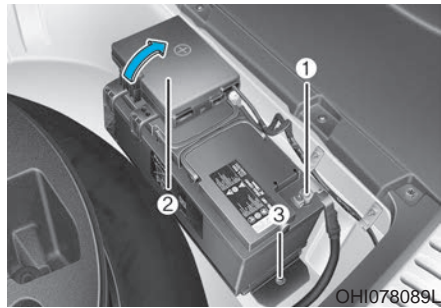

When replacing the battery, disconnect the negative (-) cable (1) and remove the positive (+) battery fuse box (2). Remove the battery hold down mounting bracket (3).

Battery Recharging

By battery charger

Your vehicle has a maintenance-free, calcium-based battery.

- If the battery becomes discharged in a short time (because, for example, the headlights or interior lights were left on while the vehicle was not in use), recharge it by slow charging (trickle) for 10 hours.
- If the battery gradually discharges because of high electric load while the vehicle is being used, recharge it at 20-30A for two hours.

NOTICE

AGM battery

- **Absorbent Glass Matt (AGM) batteries** are maintenance-free and we recommend that the AGM battery be serviced by an authorized retailer of Genesis Branded products. For charging your AGM battery, use only fully automatic battery chargers that are specially developed for AGM batteries.
- When replacing the AGM battery, we recommend that you use parts for replacement from an authorized retailer of Genesis Branded products.
- Do not open or remove the cap on top of the battery. This may cause leaks of internal electrolyte that could result in severe injury.

WARNING

Always follow these instructions when recharging your vehicle's battery to avoid the risk of SERIOUS INJURY or DEATH from explosions or acid burns:

- **Before performing maintenance or recharging the battery, turn off all accessories and press the Engine Start/Stop button to the OFF position.**
- **Keep all flames, sparks, or smoking materials away from the battery.**
- **Always work outdoors or in an area with plenty of ventilation.**
- **Wear eye protection when checking the battery during charging.**
- **The battery must be removed from the vehicle and placed in a well ventilated area.**
- **Watch the battery during charging, and stop or reduce the charging rate if the battery cells begin boiling violently.**

- The negative battery cable must be removed first and installed last when the battery is disconnected. Disconnect the battery charger in the following order:

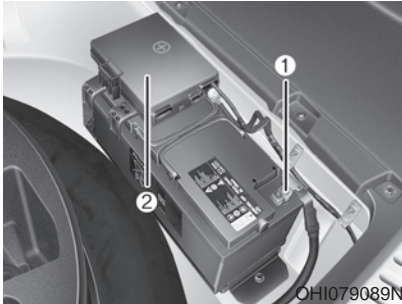

- (a) Turn off the battery charger main switch.
 - (b) Unhook the negative clamp from the negative battery terminal (1).
 - (c) Unhook the positive clamp from the positive battery terminal (2).
- Always use a Genuine Genesis Part approved battery when you replace the battery.

By jump starting

After a jump start from a good battery, drive the vehicle for 20-30 minutes before it is shutoff. The vehicle may not restart if you shut it off before the battery had a chance to adequately recharge. See "Jump Starting" in chapter 6 for more information on jump starting procedures.

i Information



An inappropriately disposed battery can be harmful to the environment and human health.

Dispose of the battery according to your local law(s) or regulation.

Reset features

The following items may need to be reset after the battery has been discharged or the battery has been disconnected.

- Seat position memory system (See chapter 3)
- Auto up/down window (See chapter 3)
- Sunroof (See chapter 3)
- Power trunk (See chapter 3)
- Trip computer (See chapter 3)
- Climate control system (See chapter 3)
- Clock (See AVN manual)
- Rear door window curtain (See chapter 3)
- AVN system (See AVN manual)

TIRES AND WHEELS

⚠ WARNING

Tire failure may cause loss of vehicle control resulting in an accident. To reduce risk of **SERIOUS INJURY** or **DEATH**, take the following precautions:

- Inspect your tires monthly for proper inflation as well as wear and damage.
- The recommended cold tire pressure for your vehicle can be found in this manual and on the tire label located on the driver's side center pillar. Always use a tire pressure gauge to measure tire pressure. Tires with too much or too little pressure wear unevenly causing poor handling.
- Check the pressure of the spare every time you check the pressure of the other tires on your vehicle.
- Replace tires that are worn, show uneven wear, or are damaged. Worn tires can cause loss of braking effectiveness, steering control, or traction.
- **ALWAYS** replace tires with the same size as each tire that was originally supplied with this vehicle. Using tires and wheels other than the recommended sizes could cause unusual handling characteristics, poor vehicle control, or negatively affect your vehicle's Anti-Lock Brake System (ABS) resulting in a serious accident.

Tire Care

For proper maintenance, safety, and maximum fuel economy, you must always maintain recommended tire inflation pressures and stay within the load limits and weight distribution recommended for your vehicle.



All specifications (sizes and pressures) can be found on a label attached to the driver's side center pillar.

Recommended Cold Tire Inflation Pressures

All tire pressures (including the spare) should be checked when the tires are cold. "Cold tires" means the vehicle has not been driven for at least three hours or driven less than one mile (1.6 km).

Warm tires normally exceed recommended cold tire pressures by 4 to 6 psi (28 to 41 kPa). Do not release air from warm tires to adjust the pressure or the tires will be under-inflated. For recommended inflation pressure, refer to "Tire and Wheels" in chapter 8.

WARNING

Recommended pressures must be maintained for the best ride, vehicle handling, and minimum tire wear.

Over-inflation or under-inflation can reduce tire life, adversely affect vehicle handling, and lead to sudden tire failure that could result in loss of vehicle control resulting in an accident.

Severe under-inflation can lead to severe heat build-up, causing blowouts, tread separation and other tire failures that can result in the loss of vehicle control resulting in an accident. This risk is much higher on hot days and when driving for long periods at high speeds.

NOTICE

- **Under-inflation results in excessive wear, poor handling and reduced fuel economy. Wheel deformation is also possible. Keep your tire pressures at the proper levels. If a tire frequently needs refilling, have it checked by an authorized retailer of Genesis Branded products.**
- **Over-inflation produces a harsh ride, excessive wear at the center of the tire tread, and a greater possibility of damage from road hazards.**

Check Tire Inflation Pressure

Check your tires, including the spare tire, once a month or more.

How to check

Use a good quality tire pressure gauge to check tire pressure. You can not tell if your tires are properly inflated simply by looking at them. Radial tires may look properly inflated when they are under-inflated.

Remove the valve cap from the tire valve stem. Press the tire gauge firmly onto the valve to get a pressure measurement. If the cold tire inflation pressure matches the recommended pressure on the tire and loading information label, no further adjustment is necessary. If the pressure is low, add air until you reach the recommended pressure. Make sure to put the valve caps back on the valve stems. Without the valve cap, dirt or moisture could get into the valve core and cause air leakage. If a valve cap is missing, install a new one as soon as possible.

If you overfill the tire, release air by pushing on the metal stem in the center of the tire valve. Recheck the tire pressure with the tire gauge. Be sure to put the valve caps back on the valve stems. Without the valve cap, dirt or moisture could get into the valve core and cause air leakage. If a valve cap is missing, install a new one as soon as possible.

Tire Rotation

To equalize tread wear, Genesis Branded Vehicle recommends that the tires be rotated every 7,500 miles (12,000 km) or sooner if irregular wear develops.

During rotation, check the tires for correct balance.

When rotating tires, check for uneven wear and damage. Abnormal wear is usually caused by incorrect tire pressure, improper wheel alignment, out-of-balance wheels, severe braking or severe cornering. Look for bumps or bulges in the tread or side of tire. Replace the tire if you find either of these conditions. Replace the tire if fabric or cord is visible. After rotation, be sure to bring the front and rear tire pressures to specification and check lug nut tightness (proper torque is 79~94 lbf-ft [11~13 kgf-m]).

■ 19 inch tire

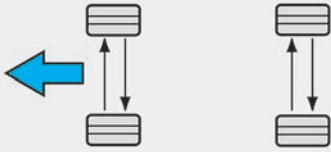

OHI078079

Disc brake pads should be inspected for wear whenever tires are rotated.

i Information

The front tire size is different from the rear tire size. So when you rotate tires, check the tire and wheel size.

⚠ WARNING

Do not use the compact spare tire for tire rotation.

Wheel Alignment and Tire Balance

The wheels on your vehicle were aligned and balanced carefully at the factory to give you the longest tire life and best overall performance.

In most cases, you will not need to have your wheels aligned again. However, if you notice unusual tire wear or your vehicle pulling one way or the other, the alignment may need to be reset.

If you notice your vehicle vibrating when driving on a smooth road, your wheels may need to be rebalanced.

NOTICE

Improper wheel weights can damage your vehicle's aluminum wheels. Use only approved wheel weights.

Tire Replacement



If the tire is worn evenly, a tread wear indicator will appear as a solid band across the tread. This shows there is less than 1/16 inch (1.6 mm) of tread left on the tire. Replace the tire when this happens.

Do not wait for the band to appear across the entire tread before replacing the tire.

⚠ WARNING

To reduce the risk of DEATH or SERIOUS INJURY:

- Replace tires that are worn, show uneven wear, or are damaged. Worn tires can cause loss of braking effectiveness, steering control, and traction.
- Always replace tires with the same size as each tire that was originally supplied with this vehicle. Using tires and wheels other than the recommended sizes could cause unusual handling characteristics, poor vehicle control, or negatively affect your vehicle's Anti-Lock Brake System (ABS) resulting in a serious accident.

- It is best to replace all four tires at the same time. If that is not possible, or necessary, then replace the two front or two rear tires as a pair.

Replacing just one tire can seriously affect your vehicle's handling.

- Tires degrade over time, even when they are not being used. Regardless of the remaining tread, Genesis Branded Vehicle recommends that tires be replaced after six (6) years of normal service.
- Heat caused by hot climates or frequent high loading conditions can accelerate the aging process. Failure to follow this warning may cause sudden tire failure, which could lead to a loss of vehicle control resulting in an accident.

Compact spare tire replacement

A compact spare tire has a shorter tread life than a regular size tire. Replace it when you can see the tread wear indicator bars on the tire. The replacement compact spare tire should be the same size and design tire as the one provided with your new vehicle and should be mounted on the same compact spare tire wheel. The compact spare tire is not designed to be mounted on a regular size wheel, and the compact spare tire wheel is not designed for mounting a regular size tire.

WARNING

The original tire should be repaired or replaced as soon as possible to avoid failure of the spare and loss of vehicle control resulting in an accident. The compact spare tire is for emergency use only. Do not operate your vehicle over 50 mph (80 km/h) when using the compact spare tire.

Wheel Replacement

When replacing the metal wheels for any reason, make sure the new wheels are equivalent to the original factory units in diameter, rim width and offset.

Tire Traction

Tire traction can be reduced if you drive on worn tires, tires that are improperly inflated or on slippery road surfaces. Tires should be replaced when tread wear indicators appear. To reduce the possibility of losing control, slow down whenever there is rain, snow or ice on the road.

Tire Maintenance

In addition to proper inflation, correct wheel alignment helps to decrease tire wear. If you find a tire is worn unevenly, have your dealer check the wheel alignment.

When you have new tires installed, make sure they are balanced. This will increase vehicle ride comfort and tire life. Additionally, a tire should always be rebalanced if it is removed from the wheel.

Tire Sidewall Labeling

This information identifies and describes the fundamental characteristics of the tire and also provides the tire identification number (TIN) for safety standard certification. The TIN can be used to identify the tire in case of a recall.

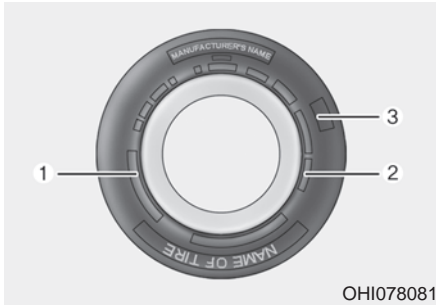

OHI078081

1. **Manufacturer or brand name**

Manufacturer or brand name is shown.

2. **Tire size designation**

A tire's sidewall is marked with a tire size designation. You will need this information when selecting replacement tires for your car. The following explains what the letters and numbers in the tire size designation mean.

Example tire size designation:

(These numbers are provided as an example only; your tire size designator could vary depending on your vehicle.)

245/45 R19 98W

245 - Tire width in millimeters.

45 - Aspect ratio. The tire's section height as a percentage of its width.

R - Tire construction code (Radial).

19 - Rim diameter in inches.

98 - Load Index, a numerical code associated with the maximum load the tire can carry.

W - Speed Rating Symbol. See the speed rating chart in this section for additional information.

Wheel size designation

Wheels are also marked with important information that you need if you ever have to replace one. The following explains what the letters and numbers in the wheel size designation mean.

Example wheel size designation:

8.5J X 19

8.5 - Rim width in inches.

J - Rim contour designation.

19 - Rim diameter in inches.

Tire speed ratings

The chart below lists many of the different speed ratings currently being used for passenger car tires. The speed rating is part of the tire size designation on the sidewall of the tire. This symbol corresponds to that tire's designed maximum safe operating speed.

Speed Rating Symbol	Maximum Speed
S	112 mph (180 km/h)
T	118 mph (190 km/h)
H	130 mph (210 km/h)
V	149 mph (240 km/h)
W	168 mph (270 km/h)
Y	186 mph (300 km/h)

3. Checking tire life (TIN : Tire Identification Number)

Any tires that are over six years old, based on the manufacturing date, (including the spare tire) should be replaced by new ones. You can find the manufacturing date on the tire sidewall (possibly on the inside of the wheel), displaying the DOT Code. The DOT Code is a series of numbers on a tire consisting of numbers and English letters. The manufacturing date is designated by the last four digits (characters) of the DOT code.

DOT : XXXX XXXX OOOO

The front part of the DOT means a plant code number, tire size and tread pattern and the last four numbers indicate week and year manufactured.

For example:

DOT XXXX XXXX 2719 represents that the tire was produced in the 27th week of 2019.

4. Tire ply composition and material

The number of layers or plies of rubber-coated fabric in the tire. Tire manufacturers also must indicate the materials in the tire, which include steel, nylon, polyester, and others. The letter "R" means radial ply construction; the letter "D" means diagonal or bias ply construction; and the letter "B" means belted-bias ply construction.

5. Maximum permissible inflation pressure

This number is the greatest amount of air pressure that should be put in the tire. Do not exceed the maximum permissible inflation pressure. Refer to the Tire and Loading Information label for recommended inflation pressure.

6. Maximum load rating

This number indicates the maximum load in kilograms and pounds that can be carried by the tire. When replacing the tires on the vehicle, always use a tire that has the same load rating as the factory installed tire.

7. Uniform tire quality grading

Quality grades can be found where applicable on the tire sidewall between tread shoulder and maximum section width.

For example:

TREADWEAR 200
TRACTION AA
TEMPERATURE A

Tread wear

The tread wear grade is a comparative rating based on the wear rate of the tire when tested under controlled conditions on a specified government test course. For example, a tire graded 150 would wear one-and-a-half times (1½) as well on the government course as a tire graded 100.

The relative performance of tires depends upon the actual conditions of their use, however, and may depart significantly from the norm due to variations in driving habits, service practices and differences in road characteristics and climate.

These grades are molded on the sidewalls of passenger vehicle tires. The tires available as standard or optional equipment on your vehicle may vary with respect to grade.

Traction - AA, A, B & C

The traction grades, from highest to lowest, are AA, A, B and C. Those grades represent the tire's ability to stop on wet pavement as measured under controlled conditions on specified government test surfaces of asphalt and concrete. A tire marked C may have poor traction performance.

WARNING

The traction grade assigned to this tire is based on straight-ahead braking traction tests, and does not include acceleration, cornering, hydroplaning, or peak traction characteristics.

Temperature - A, B & C

The temperature grades are A (the highest), B and C representing the tire's resistance to the generation of heat and its ability to dissipate heat when tested under controlled conditions on a specified indoor laboratory test wheel.

Sustained high temperature can cause the material of the tire to degenerate and reduce tire life, and excessive temperature can lead to sudden tire failure. Grade C responds to a level of performance which all passenger car tires must meet under the Federal Motor Vehicle Safety Standard No. 109. Grades B and A represent higher levels of performance on the laboratory test wheel than the minimum required by law.

WARNING

The temperature grade for this tire is established for a tire that is properly inflated and not overloaded. Excessive speed, under-inflation, over-inflation, or excessive loading, either separately or in combination, can cause heat build-up and possible sudden tire failure. This may cause loss of vehicle control resulting in an accident.

Tire Terminology and Definitions

Air Pressure

The amount of air inside the tire pressing outward on the tire. Air pressure is expressed in pounds per square inch (psi) or kilopascal (kPa).

Accessory Weight

This means the combined weight of optional accessories. Some examples of optional accessories are automatic transmission, power seats, and air conditioning.

Aspect Ratio

The relationship of a tire's height to its width.

Belt

A rubber coated layer of cords that is located between the plies and the tread. Cords may be made from steel or other reinforcing materials.

Bead

The tire bead contains steel wires wrapped by steel cords that hold the tire onto the rim.

Bias Ply Tire

A pneumatic tire in which the plies are laid at alternate angles less than 90 degrees to the centerline of the tread.

Cold Tire Pressure

The amount of air pressure in a tire, measured in pounds per square inch (psi) or kilopascals (kPa) before a tire has built up heat from driving.

Curb Weight

This means the weight of a motor vehicle with standard and optional equipment including the maximum capacity of fuel, oil and coolant, but without passengers and cargo.

DOT Markings

A code molded into the sidewall of a tire signifying that the tire is in compliance with the U.S. Department of Transportation motor vehicle safety standards. The DOT code includes the Tire Identification Number (TIN), an alphanumeric designator which can also identify the tire manufacturer, production plant, brand and date of production.

GVWR

Gross Vehicle Weight Rating

GAWR FRT

Gross Axle Weight Rating for the Front Axle.

GAWR RR

Gross Axle Weight Rating for the Rear axle.

Intended Outboard Sidewall

The side of an asymmetrical tire, that must always face outward when mounted on a vehicle.

Kilopascal (kPa)

The metric unit for air pressure.

Light truck(LT) tire

A tire designated by its manufacturer as primarily intended for use on light-weight trucks or multipurpose passenger vehicles.

Load ratings

The maximum load that a tire is rated to carry for a given inflation pressure.

Load Index

An assigned number ranging from 1 to 279 that corresponds to the load carrying capacity of a tire.

Maximum Inflation Pressure

The maximum air pressure to which a cold tire may be inflated. The maximum air pressure is molded onto the sidewall.

Maximum Load Rating

The load rating for a tire at the maximum permissible inflation pressure for that tire.

Maximum Loaded Vehicle Weight

The sum of curb weight; accessory weight; vehicle capacity weight; and production options weight.

Normal Occupant Weight

The number of occupants a vehicle is designed to seat multiplied by 150 pounds (68 kg).

Occupant Distribution

Designated seating positions.

Outward Facing Sidewall

An asymmetrical tire has a particular side that faces outward when mounted on a vehicle. The outward facing sidewall bears white lettering or bears manufacturer, brand, and/or model name molding that is higher or deeper than the same moldings on the inner facing sidewall.

Passenger (P-Metric) tire

A tire used on passenger cars and some light duty trucks and multipurpose vehicles.

Ply

A layer of rubber-coated parallel cords.

Pneumatic tire

A mechanical device made of rubber, chemicals, fabric and steel or other materials, that, when mounted on an automotive wheel provides the traction and contains the gas or fluid that sustains the load.

Pneumatic options weight

The combined weight of installed regular production options weighing over 5 lb. (2.3 kg) in excess of the standard items which they replace, not previously considered in curb weight or accessory weight, including heavy duty breaks, ride levelers, roof rack, heavy duty battery, and special trim.

Recommended Inflation Pressure

Vehicle manufacturer's recommended tire inflation pressure as shown on the tire placard.

Radial Ply Tire

A pneumatic tire in which the ply cords that extend to the beads are laid at 90 degrees to the centerline of the tread.

Rim

A metal support for a tire and upon which the tire beads are seated.

Sidewall

The portion of a tire between the tread and the bead.

Speed Rating

An alphanumeric code assigned to a tire indicating the maximum speed at which a tire can operate.

Traction

The friction between the tire and the road surface. The amount of grip provided.

Tread

The portion of a tire that comes into contact with the road.

Treadwear Indicators

Narrow bands, sometimes called "wear bars", that show across the tread of a tire when only 1/16 inch of tread remains.

UTQGS

Uniform Tire Quality Grading Standards is a tire information system that provides consumers with ratings for a tire's traction, temperature and treadwear. Ratings are determined by tire manufacturers using government testing procedures. The ratings are molded into the sidewall of the tire.

Vehicle Capacity Weight

The number of designated seating positions multiplied by 150 lbs. (68 kg) plus the rated cargo and luggage load.

Vehicle Maximum Load on the Tire

Load on an individual tire due to curb and accessory weight plus maximum occupant and cargo weight.

Vehicle Normal Load on the Tire

Load on an individual tire that is determined by distributing to each axle its share of the curb weight, accessory weight, and normal occupant weight and dividing by 2.

Vehicle Placard

A label permanently attached to a vehicle showing the original equipment tire size and recommended inflation pressure.

All Season Tires

Genesis Branded Vehicle specifies all season tires on some models to provide good performance for use all year round, including snowy and icy road conditions. All season tires are identified by ALL SEASON and/or M+S (Mud and Snow) on the tire sidewall. Snow tires have better snow traction than all season tires and may be more appropriate in some areas.

Summer Tires

Genesis Branded Vehicle specifies summer tires on some models to provide superior performance on dry roads. Summer tire performance is substantially reduced in snow and ice. Summer tires do not have the tire traction rating M+S (Mud and Snow) on the tire side wall. If you plan to operate your vehicle in snowy or icy conditions, Genesis Branded Vehicle recommends the use of snow tires or all season tires on all four wheels.

Snow Tires

If you equip your car with snow tires, they should be the same size and have the same load capacity as the original tires. Snow tires should be installed on all four wheels; otherwise, poor handling may result. Snow tires should carry 4 psi (28 kPa) more air pressure than the pressure recommended for the standard tires on the tire label on the driver's side of the center pillar, or up to the maximum pressure shown on the tire sidewall, whichever is less. Do not drive faster than 75 mph (120 km/h) when your vehicle is equipped with snow tires.

Radial-Ply Tires

Radial-ply tires provide improved tread life, road hazard resistance and smoother high speed ride. The radial-ply tires used on this vehicle are of belted construction, and are selected to complement the ride and handling characteristics of your vehicle. Radial-ply tires have the same load carrying capacity, as bias-ply or bias belted tires of the same size, and use the same recommended inflation pressure. Mixing of radial-ply tires with bias-ply or bias belted tires is not recommended. Any combinations of radial-ply and bias-ply or bias belted tires when used on the same vehicle will seriously deteriorate vehicle handling. The best rule to follow is: Identical pairs of radial-ply tires should always be used as a set for the front tires and a set for the rear tires.

Longer wearing tires can be more susceptible to irregular tread wear. It is very important to follow the tire rotation interval in this chapter to achieve the tread life potential of these tires. Cuts and punctures in radial-ply tires are repairable only in the tread area, because of sidewall flexing. Consult your tire dealer for radial-ply tire repairs.

WARNING

Do not mix bias ply and radial ply tires under any circumstances. This may cause unusual handling characteristics that may cause loss of vehicle control resulting in an accident.

Low Aspect Ratio Tires

Low aspect ratio tires, the aspect ratio is lower than 50, are provided for sporty looks.

Because low aspect ratio tires are optimized for handling and braking, their sidewall is a little stiffer than a standard tire. Also low aspect ratio tires tend to be wider and consequently have a greater contact patch with the road surface. In some instances they may generate more road noise compared with standard tires.

NOTICE

Because the sidewall of a low aspect ratio tire is shorter than a standard tire, the rim of the wheel and the tire itself is more easily susceptible to damage. Use caution when driving and follow the guidelines below to help minimize damage to the wheel and tire:

- When driving on a rough road or off road, drive cautiously because tires and wheels may be damaged. And after driving, inspect tires and wheels.
- When passing over a pothole, speed bump, manhole, or curb stone, drive slowly so that the tires and wheels are not damaged.
- If the tire is subjected to a severe impact, have the tire and wheel inspected by an authorized retailer of Genesis Branded products.
- Inspect the tire condition and pressure every 1,800 miles (3,000km).

NOTICE

- It is not easy to recognize tire damage with your own eyes. But if there is the slightest hint of tire damage, have the tire checked or replaced because the tire damage may cause air leakage from the tire.
- If the tire is damaged by driving on a rough road, off road, pothole, manhole, or curb stone, it will not be covered by the warranty.

FUSES

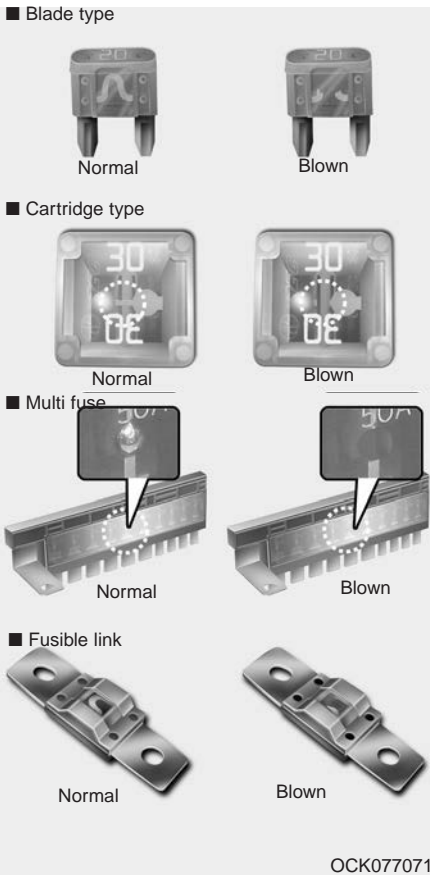

A vehicle's electrical system is protected from electrical overload damage by fuses.

This vehicle has 4 fuse panels, one located in the driver's side panel bolster, another in the engine compartment, and two others in the trunk compartment.

If any of your vehicle's lights, accessories, or controls do not work, check the appropriate circuit fuse. If a fuse has blown, the element inside the fuse will be melted or broken.

If the electrical system does not work, first check the driver's side fuse panel. Before replacing a blown fuse, turn the engine and all switches off, and then disconnect the negative battery cable. Always replace a blown fuse with one of the same rating.

If the replacement fuse blows, this indicates an electrical problem. Avoid using the system involved and immediately consult an authorized retailer of Genesis Branded products.

i Information

Four kinds of fuses are used: blade type for lower amperage rating, cartridge type, multi fuse and fusible link for higher amperage ratings.

! WARNING

NEVER replace a fuse with anything but another fuse of the same rating.

- A higher capacity fuse could cause damage and possibly cause a fire.
- Do not install a wire or aluminum foil instead of the proper fuse - even as a temporary repair. It may cause extensive wiring damage and possibly a fire.

NOTICE

Do not use a screwdriver or any other metal object to remove fuses because it may cause a short circuit and damage the system.

Instrument Panel Fuse Replacement



1. Turn the engine off.
2. Turn all other switches OFF.
3. Open the fuse panel cover.
4. Refer to the label on the inside of the fuse panel cover to locate the suspected fuse location.

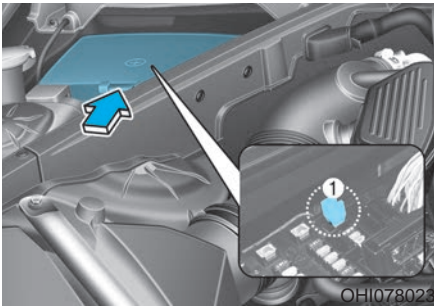

5. Pull the suspected fuse straight out. Use the removal tool (1) provided in the engine compartment fuse panel.
6. Check the removed fuse; replace it if it is blown. Spare fuses are provided in the instrument panel fuse panels (or in the engine compartment fuse panel).

7. Push in a new fuse of the same rating, and make sure it fits tightly in the clips. If it fits loosely, consult an authorized retailer of Genesis Branded products.

In an emergency, if you do not have a spare fuse, use a fuse of the same rating from a circuit you may not need for operating the vehicle.

If the headlamps or other electrical components do not work and the fuses are OK, check the fuse panel in the engine compartment. If a fuse is blown, it must be replaced with the same rating.

Fuse switch



Always, place the fuse switch to the ON position.

If you move the switch to the OFF position, some items such as the audio system and clock must be reset and the smart key may not work properly.

i Information



If the fuse switch is OFF, "Turn FUSE SWITCH on" message will appear.

NOTICE

- Always place the fuse switch in the ON position while driving the vehicle.
- Do not move the fuse switch repeatedly. The fuse switch may be damaged.

Engine Compartment Panel Fuse Replacement

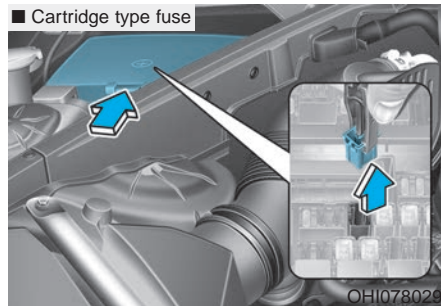
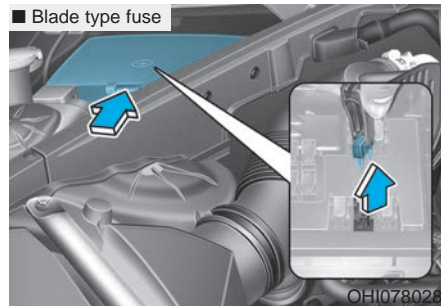

1. Turn the engine off.
2. Turn all other switches OFF.
3. Remove the fuse panel cover by pressing the tap and pulling up.
4. Check the removed fuse; replace it if it is blown. To remove or insert the fuse, use the fuse puller in the engine compartment fuse panel.
5. Push in a new fuse of the same rating, and make sure it fits tightly in the clips. If it fits loosely, consult an authorized retailer of Genesis Branded products.

NOTICE

After checking the fuse box in the engine compartment securely close the fuse box cover inside the engine compartment, until it clicks.

If the fuse box is not closed properly, water may leak in side, possibly causing a malfunction with the electrical system.

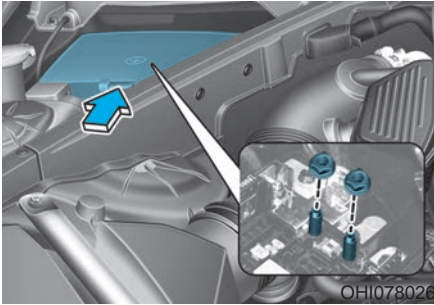
Main fuse

If the main fuse is blown, it must be removed as follows:

1. Turn off the engine.
2. Disconnect the negative battery cable.
3. Remove the fuse panel cover by pressing the tab and pulling it up.
4. Remove the nuts shown in the picture above.
5. Replace the fuse with a new one of the same rating.
6. Reinstall in the reverse order of removal.

i Information

If the main fuse is blown, consult an authorized retailer of Genesis Branded products.

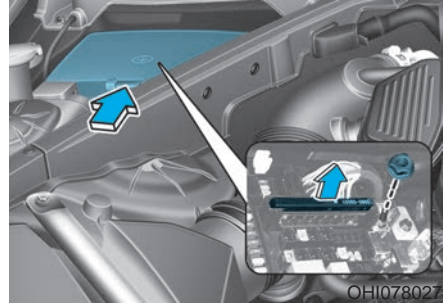
Multi fuse

If the multi fuse is blown, it must be removed as follows:

1. Turn off the engine.
2. Disconnect the negative battery cable.
3. Remove the fuse panel cover by pressing the tab and pulling it up.
4. Remove the nuts shown in the picture above.
5. Replace the fuse with a new one of the same rating.
6. Reinstall in the reverse order of removal.

i Information

If the multi fuse is blown, consult an authorized retailer of Genesis Branded products.

Fuse/Relay Panel Description

Instrument panel fuse panel (IGPM : Integrated Gateway Power Control Module)

Inside the fuse/relay box cover, you can find the fuse/relay label describing fuse/relay names and ratings.



i Information

Not all fuse panel descriptions in this manual may be applicable to your vehicle; the information is accurate at the time of printing. When you inspect the fuse box on your vehicle, refer to the fuse box label.

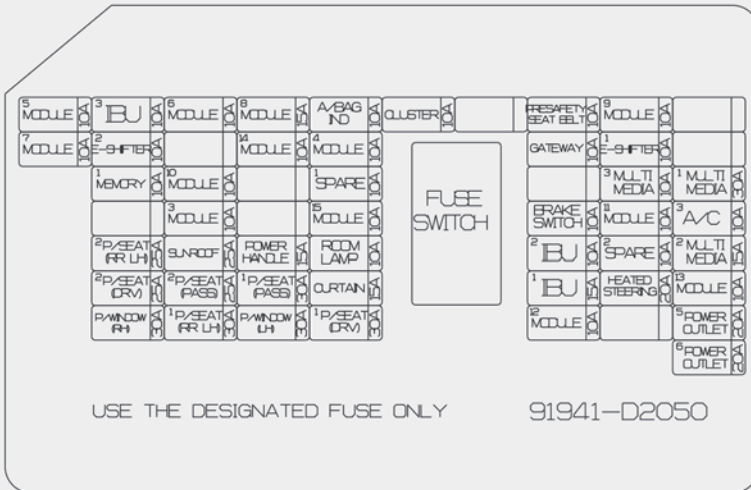

OHIO79033N

Instrument panel fuse panel

Fuse name	Fuse rating	Circuit protected
MODULE5	10A	Stop Lamp Switch, Driver/Passenger Door Module
MODULE7	10A	Electro Chromic Mirror, A/V & Navigation Head Unit, AMP, A/C Control Module, Front A/C Controller, Air Quality Sensor, Rear Seat Warmer Control Module LH/RH, Driver/Passenger CCS Module, Rear CCS Module LH/RH, Parking Collision Avoidance Assist Unit, Driver/Passenger IMS Control Module, Rear IMS Control Module LH/RH, Rear Seat Console Switch, Driver/Passenger Seat Warmer Control Module
IBU3	10A	IBU Control Module
E-SHIFTER2	10A	Electronic ATM Shift Lever
MEMORY1	10A	Security Indicator, A/C Control Module, Front A/C Controller, Instrument Cluster, Driver/Passenger IMS Control Module, Rear IMS Control Module LH/RH, Head-Up Display, Analog Clock, Driver/Passenger Seat Control Switch, Power Trunk Module, Rear Seat Control Switch LH/RH, Driver/Passenger Smart Key Outside Handle, Rear Smart Key Outside Handle LH/RH, Blind Spot Collision Warning Unit LH/RH
P/SEAT (RR LH) 2	25A	Rear IMS Control Module LH
P/SEAT (DRV) 2	25A	Driver IMS Control Module
P/WINDOW (RH)	30A	Passenger Power Window Module, Rear Power Window Module RH
MODULE 6	10A	Crash Pad Switch, Blind Spot Collision Warning Unit LH/RH, ECS Unit, Front Console Switch, Front Camera, Steering Tilt & Telescopic Module
MODULE 10	10A	Cooling Fan Controller (BLDC), Rear Seat Console Switch, Surround View Monitor, Parking Collision Avoidance Assist Unit
MODULE3	10A	GATEWAY (B+ (MCU)), Data Link Connector, Hazard Switch
SUNROOF	25A	Sunroof Motor
P/SEAT (PASS) 2	25A	Passenger IMS Control Module

Fuse name	Fuse rating	Circuit protected
P/SEAT (RR LH) 1	30A	Rear IMS Control Module LH Rear Electronic Power Seat Relay LH
MODULE8	15A	Head Lamp LH/RH, Auto Head Lamp Leveling Device Module
MODULE14	10A	Driver Power Outside Mirror
POWER HANDLE	15A	Steering Tilt & Telescopic Module
P/SEAT (PASS) 1	30A	Passenger IMS Control Module, Passenger Lumbar Support Unit
P/WINDOW (LH)	30A	Driver Power Window Module, Rear Power Window Module LH
A/BAG IND	10A	Instrument Cluster, Front A/C Controller
MODULE15	10A	Passenger Power Outside Mirror
CURTAIN	15A	IBU Control Module
MODULE4	10A	Metal Core Block (PCB #1 - Power Outlet Relay), Analog Clock, IBU Control Module, Overhead Console Lamp, AUX & USB Jack, AMP, Electronic ATM Shift Lever, Front Wireless Charger, Front Tray, Mood Lamp LH/RH, Front/Rear Console Lamp, A/V & Navigation Head Unit, Rear Audio Switch, Surround View Unit, Parking Collision Avoidance Assist Unit
ROOM LAMP	10A	Overhead Console Lamp, Front/Rear Vanity Lamp LH/RH, Room Lamp, Rear Personal Lamp LH/RH, Glove Box Lamp, Front Foot Lamp LH/RH, Front Mood Lamp LH/RH Luggage Lamp LH/RH, Driver/Passenger Seat Foot Lamp, Driver/Passenger Door Inside Handle Lamp, Trunk Lid Main Switch, Driver/Passenger Door Garnish Lamp, Rear Door Garnish Lamp LH/RH, Rear Door Inside Handle Lamp LH/RH
P/SEAT (DRV) 1	30A	Driver IMS Control Module, Driver Lumbar Support Unit
CLUSTER	10A	Instrument Cluster, Head-Up Display

Fuse name	Fuse rating	Circuit protected
PRE-SAFETY SEAT BELT	10A	Pre Active Seat Belt Unit
GATEWAY	10A	GATEWAY (IG1 (MCU))
BRAKE SWITCH	10A	Stop Lamp Switch, IBU Control Module
IBU2	10A	Start/Stop Button Switch
IBU1	15A	IBU Control Module
MODULE12	10A	Driver/Passenger Door Module, Rear Door Module LH/RH
MODULE9	10A	Multifunction Switch
E-SHIFTER1	10A	Electronic ATM Shift Lever
MULTI MEDIA3	10A	Rear Audio Switch, Rear USB Jack, Keyboard
MODULE11	10A	IBU Control Module
HEATED STEERING	20A	IBU Control Module
MULTI MEDIA1	30A	Fuse - MULTI MEDIA2, MULTI MEDIA3
A/C3	10A	Metal Core Block (PCB #1 - Blower Relay), Co2 Sensor, Rear Sub Junction Block (Rear Blower Relay), A/C Control Module, Front Incar Temperature Sensor, Front A/C Controller, Ionizer
MULTI MEDIA2	15A	A/V & Navigation Head Unit
POWER OUTLET5	15A	Front Power Outlet RH
POWER OUTLET6	20A	Front Power Outlet LH

Engine compartment fuse panel (Engine room junction block)

Inside the fuse/relay box cover, you can find the fuse/relay label describing fuse/relay names and ratings.

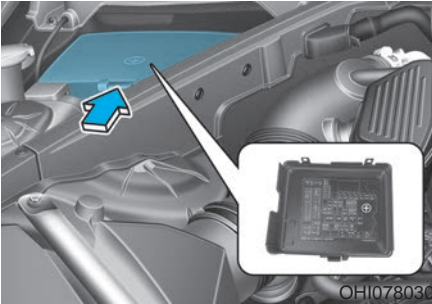

i Information

Not all fuse panel descriptions in this manual may be applicable to your vehicle; the information is accurate at the time of printing. When you inspect the fuse panel in your vehicle, refer to the fuse panel label.

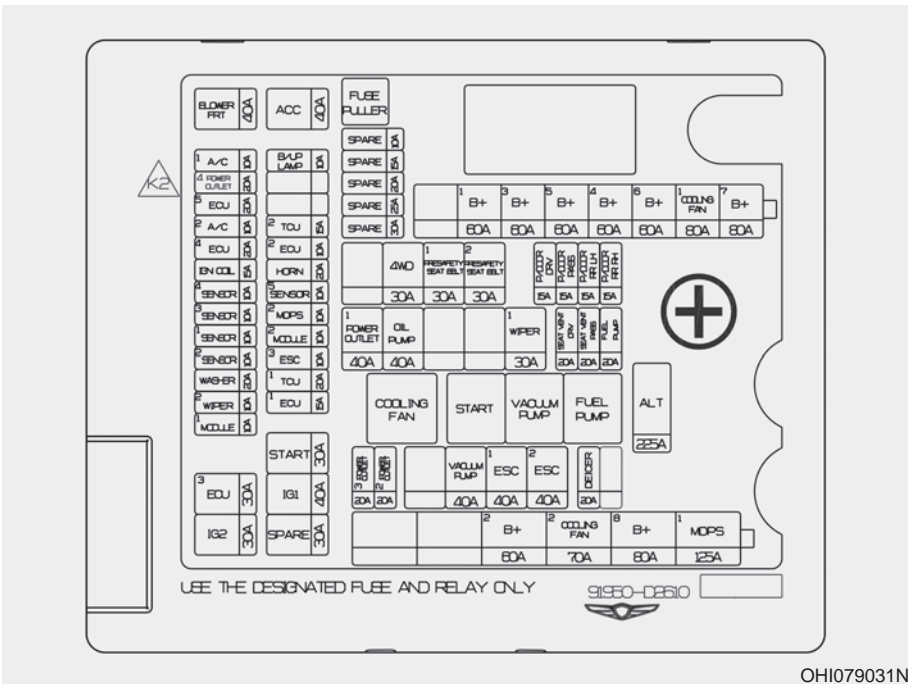

Engine compartment fuse panel

Fuse name	Fuse rating	Circuit protected
ALT	200A	Alternator, Multifuse (BATT) - B+7, COOLING FAN1, B+6, B+5, B+4, B+3, B+1, (Fuse - WIPER1, FUEL PUMP, POWER OUTLET1, 4WD, PRESAFETY SEAT BELT1, PRESAFETY SEAT BELT2, P/DOOR DRV, P/DOOR PASS, P/DOOR RR LH, P/DOOR RR RH, SEAT VENT DRV, SEAT VENT PASS)
B+1	60A	IGPM (Fuse - BRAKE SWITCH, MODULE14, MODULE15, Leak Current Autocut Device) (Fuse - ROOM LAMP, MEMORY1, MULTI MEDIA1, MULTI MEDIA2, MULTI MEDIA3)
B+3	60A	IGPM (IPS2/IPS3, Fuse - MODULE3, E-SHIFTER1)
B+5	60A	IGPM (Fuse - P/SEAT (RR LH) 2, P/SEAT (DRV) 2, P/WINDOW (RH), SUNROOF, P/SEAT (PASS) 2, P/SEAT (RR LH) 1)
B+4	60A	IGPM (IPS4/IPS8/IPS9/IPS10, Fuse - IBU1, IBU2, MODULE12)
B+6	60A	Metal Core Block (PCB #1 Fuse - ECU3, IG2, MODULE1)
B+7	80A	Metal Core Block (PCB #2 Fuse - ACC, B/UP LAMP, HORN)
B+2	60A	IGPM (Fuse - P/SEAT (DRV) 1, P/SEAT (PASS) 1, P/WINDOW LH, CURTAIN, POWER HANDLE)
B+8	80A	Metal Core Block (PCB #1 Fuse - BLOWER FRT, POWER OUTLET4, A/C2)
MDPS1	125A	MDPS Unit
POWER OUTLET3	20A	Front Power Outlet & Cigarette Lighter
POWER OUTLET2	20A	Front Power Outlet & Cigarette Lighter
VACUUM PUMP	40A	[3.3 T-GDI] Vacuum Pump Relay
ESC1	40A	ESC Control Module, Multipurpose Check Connector
ESC2	40A	ESC Control Module, Multipurpose Check Connector
DEICER	20A	Front Deicer Relay

Fuse name	Fuse rating	Circuit protected
POWER OUTLET1	40A	Power Outlet Relay
FUEL PUMP	20A	Fuel Pump Relay
WIPER1	30A	Wiper Motor
SEAT VENT DRV	20A	Driver CCS Module, Driver Seat Warmer Control Module
SEAT VENT PASS	20A	Passenger CCS Module, Passenger Seat Warmer Control Module
4WD	30A	4WD ECM
PRESAFETY SEAT BELT1	30A	Pre Active Seat Belt Unit
PRESAFETY SEAT BELT2	30A	Pre Active Seat Belt Unit
P/DOOR DRV	15A	Driver Door Latch
P/DOOR PASS	15A	Passenger Door Latch
P/DOOR RR LH	15A	Rear Door Latch LH
P/DOOR RR RH	15A	Rear Door Latch RH
IG2	30A	IG2 Relay
ECU3	30A	Engine Control Relay
MODULE1	10A	4WD ECM, Active Air Flap, Smart Cruise Control Radar
WIPER2	10A	Wiper Relay
WASHER	20A	Washer Relay
SENSOR2	10A	[3.3 T-GDI] Oxygen Sensor #1/#2/#3/#4, RCV Control Solenoid Valve, Electronic Thermostat [5.0 GDI] Oxygen Sensor #1/#2/#3/#4, Electronic Thermostat

Fuse name	Fuse rating	Circuit protected
SENSOR1	10A	[3.3 T-GDI] Oil Controlvalve #1/#2/#3/#4 (Intake/Exhaust), Purge Control Solenoid Valve, Oil Pressure Solenoid Valve, Canister Close Valve [5.0 GDI] Oil Controlvalve #1/#2/#3/#4 (Intake/ Exhaust), Purge Control Solenoid Valve, Canister Close Valve
SENSOR3	10A	Rear Sub Junction Block (Fuel Pump Relay)
SENSOR4	10A	[5.0 GDI] Camshaft Position Sensor #1/#2/#3/#4 (Intake/ Exhaust)
IGN COIL	15A	[3.3 T-GDI] Ignition Coil #1/#2/#3/#4/#5/#6 [5.0 GDI] Ignition Coil #1/#2/#3/#4/#5/#6/#7/#8
ECU4	20A	ECM
ECU5	20A	ECM
A/C2	10A	A/Con Comp Relay
POWER OUTLET4	20A	Power Outlet #2 Relay
A/C1	10A	A/C Control Module
BLOWER FRT	40A	Front Blower Relay
IG1	40A	IG1 Relay
START	30A	Engine Room Junction Block (Start Relay)
ECU1	15A	ECM
TCU1	20A	TCM
ESC3	10A	ESC Control Module

Fuse name	Fuse rating	Circuit protected
MODULE2	10A	4WD ECM, Active Air Flap, Smart Cruise Control Radar
MDPS2	10A	MDPS Unit, Steering Angle Sensor
SENSOR5	10A	[3.3 T-GDI] Engine Room Junction Block (Vacuum Pump-Relay), Brake Vacuum Switch
HORN	20A	Horn Relay
ECU2	10A	ECM
TCU2	15A	TCM, B/UP Lamp Relay, P/N Relay
B/UP LAMP	10A	B/Up Lamp Relay
ACC	40A	ACC Relay

**Trunk fuse panel
(Rear sub junction block)**

Inside the fuse/relay box covers, you can find the fuse/relay label describing fuse/relay names and ratings.



i Information

Not all fuse panel descriptions in this manual may be applicable to your vehicle; the information is accurate at the time of printing. When you inspect the fuse box on your vehicle, refer to the fuse box label.

	⁵ P/SEAT (RR RH)	³ P/SEAT (RR LH)	ECS	FUEL LID	¹ DOOR LOCK	TRUNK	FOG LAMP REAR	⁵ HEATER (RR LH)	² BLOWER (RR)		
	15A	15A	10A	10A	10A	10A	10A	20A	20A		
	POWER TRUNK	DOOR LOCK	RDM LH	P/SEAT (RR RH)	AIR BAG	RDM RH	⁵ HEATER (RR RH)	AMP	P/SEAT (RR RH)		
	30A	15A	15A	25A	15A	15A	20A	25A	30A		
	USE THE DESIGNATED FUSE ONLY										
	91941-D2150										
	<table border="1" style="margin-left: auto; margin-right: auto;"> <tr> <td>REAR HEATER</td> </tr> <tr> <td>40A</td> </tr> </table>									REAR HEATER	40A
REAR HEATER											
40A											

OHI079036N

Trunk fuse panel

Fuse name	Fuse rating	Circuit protected
REAR HEATED	40A	Rear Defogger Relay
POWER TRUNK	30A	Power Trunk Module
DOOR LOCK2	15A	Passenger Door Module
RDM LH	15A	Rear Door Module LH
P/SEAT (RR RH) 2	25A	Rear IMS Control Module RH
AIR BAG	15A	Air Bag Relay
RDM RH	15A	Rear Door Module RH
S/HEATER (RR RH)	20A	Rear CCS Module RH, Rear Seat Warmer Control Module RH
AMP	25A	AMP (Premium, Premium High)
P/SEAT (RR RH) 1	30A	Rear IMS Control Module RH, Rear Electronic Power Seat Relay RH
P/SEAT (RR RH) 3	15A	Rear Seat Lumbar Support Module RH
P/SEAT (RR LH) 3	15A	Rear Seat Lumbar Support Module LH
ECS	10A	ECS Unit
FUEL LID	10A	Fuel Lid Open Relay, Fuel Filler Door & Trunk Lid Switch
DOOR LOCK1	10A	Driver Door Module
TRUNK	10A	Trunk Lid Relay
S/HEATER (RR LH)	20A	Rear CCS Module LH, Rear Seat Warmer Control Module LH
BLOWER RR	20A	Rear Blower Relay

Trunk fuse panel (Battery junction block)

Inside the fuse/relay box covers, you can find the fuse/relay label describing fuse/relay names and ratings.



i Information

Not all fuse panel descriptions in this manual may be applicable to your vehicle; the information is accurate at the time of printing. When you inspect the fuse box on your vehicle, refer to the fuse box label.

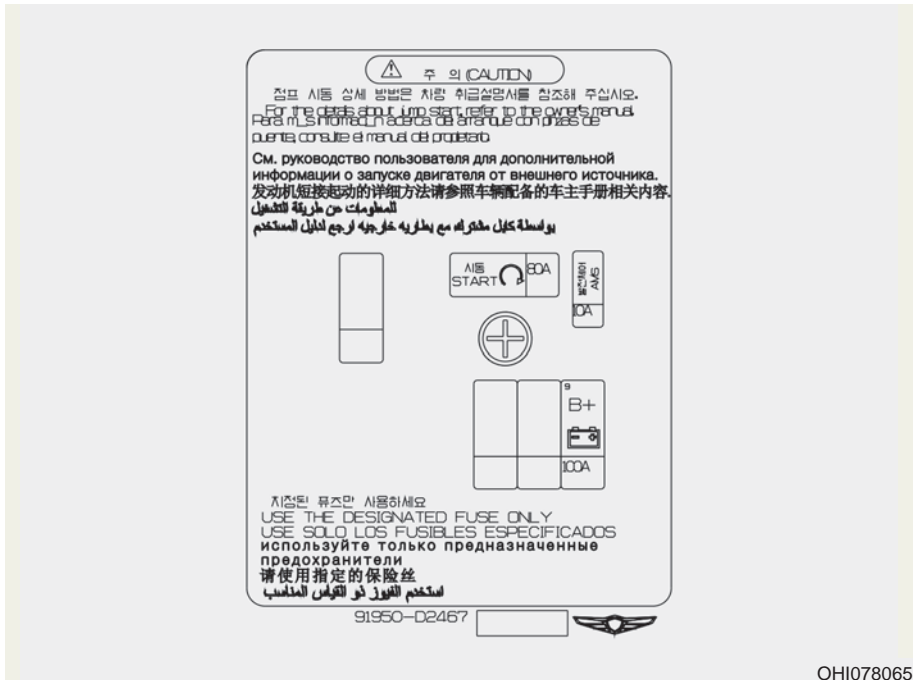

OH1078065

Trunk fuse panel

Fuse name	Fuse rating	Circuit protected
B+9	100A	Rear Sub Junction Block (Fuse - REAR HEATED, POWER TRUNK, DOOR LOCK2, RDM LH, P/SEAT (RR RH) 2, AIR BAG, RDM RH, AMP, S/HEATER (RR RH), P/SEAT (RR RH) 1, P/SEAT (RR RH) 3, P/SEAT (RR LH) 3, ECS, FUEL LID, DOOR LOCK1, TRUNK, S/HEATER (RR LH), BLOWER RR)
START	80A	Metal Core Block (PCB #2 Fuse - START, ECU1, TCU1, IG1)
AMS	10A	Battery Sensor

LIGHT BULBS

Consult an authorized retailer of Genesis Branded products to replace most vehicle light bulbs. It is difficult to replace vehicle light bulbs because other parts of the vehicle must be removed before you can get to the bulb. This is especially true for removing the headlamp assembly to get to the bulb(s).

Removing/installing the headlamp assembly can result in damage to the vehicle.

Information

After driving in heavy rain or washing the vehicle, headlamp and trunk lenses could appear frosty. This condition is caused by the temperature difference between the lamp inside and the outside temperature. This is similar to the condensation on your windows inside your vehicle when it rains and doesn't indicate a problem with your vehicle. If the water leaks into the lamp bulb circuitry, have your vehicle checked by an authorized retailer of Genesis Branded products.

WARNING

- Prior to replacing a lamp, depress the foot brake, shift the gear to P (Park) apply the parking brake, place the Engine Start/Stop button to the OFF position, and take the key with you when leaving the vehicle to avoid sudden movement of the vehicle and to prevent possible electric shock.
- Be aware the bulbs may be hot and may burn your fingers.

NOTICE

Light replacement

Be sure to replace the burned out bulb with one of the same wattage rating. Otherwise, it may cause damage to the fuse or electric wiring system.

NOTICE

To prevent damage, do not clean the headlamp with chemical solvents or strong detergents.

Information

- A normally functioning lamp may flicker momentarily to stabilize the vehicle's electrical control system. However, if the lamp goes out after flickering momentarily, or continues to flicker, have the system checked by an authorized retailer of Genesis Branded products.
- The parking lamp may not turn on when the parking lamp switch is turned on, but the parking lamp and headlamp switch may turn on when the headlamp switch is turned on. This may be caused by network failure or vehicle electrical control system malfunction. If this occurs, have the system checked by an authorized retailer of Genesis Branded products.

Headlamp, Parking Lamp, Turn Signal Lamp, Daytime Running Light and Side Marker Replacement

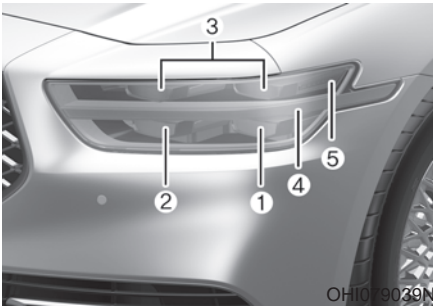

- (1) Headlamp (Low)
- (2) Headlamp (High/Low)
- (3) Parking lamp
- (4) Turn signal/Daytime running light/
Parking lamp
- (5) Side marker

If the LED lamp does not operate, have the system be checked by an authorized retailer of Genesis Branded products.

The LED lamps cannot be replaced as a single unit because it is an integrated unit. The LED lamps has to be replaced with the unit.

A skilled technician should check or repair the LED lamp, for it may damage related parts of the vehicle.

Side Repeater Lamp Replacement



If the side repeater lamp (LED) (1) does not operate, have the system be checked by an authorized retailer of Genesis Branded products.

The LED lamps cannot be replaced as a single unit because it is an integrated unit. The LED lamps has to be replaced with the unit.

A skilled technician should check or repair the LED lamp, for it may damage related parts of the vehicle.

Rear Combination Light Bulb Replacement

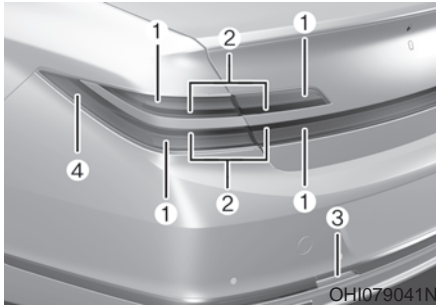

- (1) Stop/Tail lamp
- (2) Turn signal
- (3) Backup lamp
- (4) Side marker

If the LED lamp does not operate, have the system be checked by an authorized retailer of Genesis Branded products.

The LED lamps cannot be replaced as a single unit because it is an integrated unit. The LED lamps has to be replaced with the unit.

A skilled technician should check or repair the LED lamp, for it may damage related parts of the vehicle.

High Mounted Stop Light Replacement

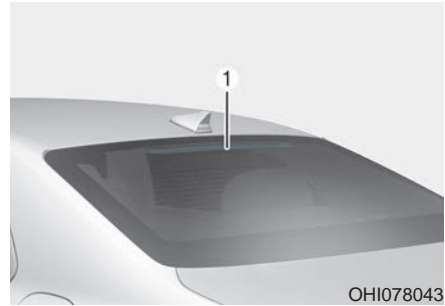

If the high mounted stop lamp (LED) (1) does not operate, have the system be checked by an authorized retailer of Genesis Branded products.

The LED lamps cannot be replaced as a single unit because it is an integrated unit. The LED lamps has to be replaced with the unit.

A skilled technician should check or repair the LED lamp, for it may damage related parts of the vehicle.

License Plate Light Replacement

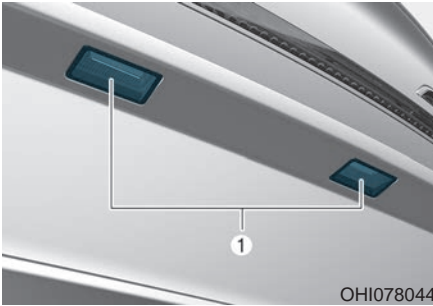

If the high mounted stop lamp (LED) (1) does not operate, have the system be checked by an authorized retailer of Genesis Branded products.

The LED lamps cannot be replaced as a single unit because it is an integrated unit. The LED lamps has to be replaced with the unit.

A skilled technician should check or repair the LED lamp, for it may damage related parts of the vehicle.

Interior Light Bulb Replacement

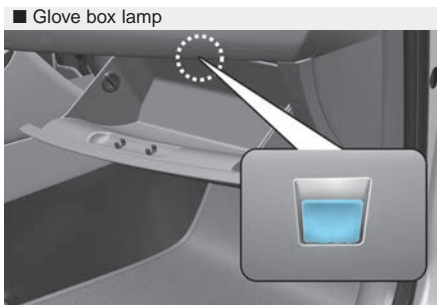
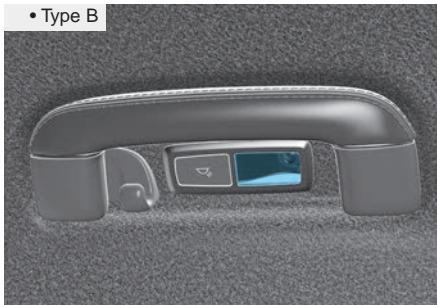
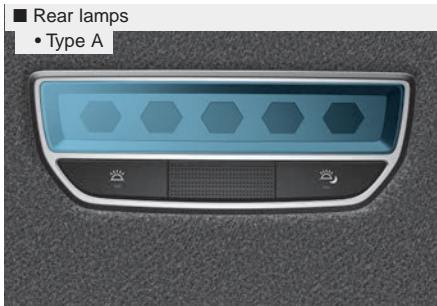
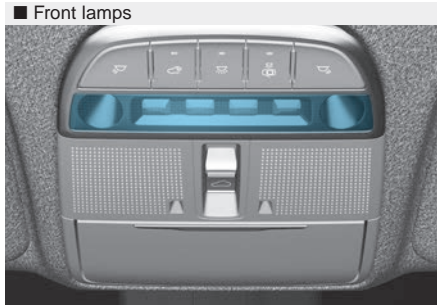

OHI078066/OHI078068/OHI078069/OHI078046

■ Vanity mirror lamp



■ Rear mirror lamp

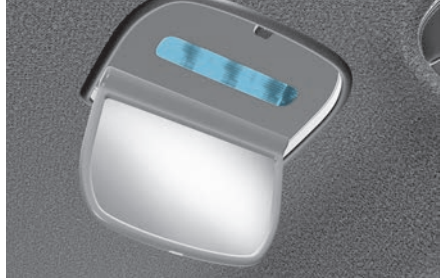

OHI078045/OHI078071/OHI078070

■ Trunk lamp

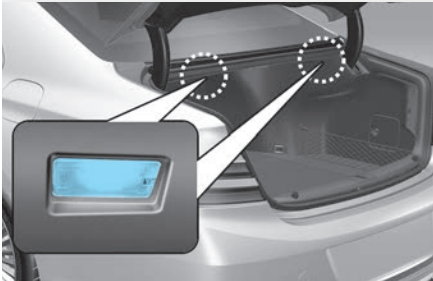

If the interior lamp (LED) (1) does not operate, have the system be checked by an authorized retailer of Genesis Branded products.

The LED lamps cannot be replaced as a single unit because it is an integrated unit. The LED lamps has to be replaced with the unit.

A skilled technician should check or repair the LED lamp, for it may damage related parts of the vehicle.

APPEARANCE CARE

Exterior Care

Exterior general caution

It is very important to follow the label directions when using any chemical cleaner or polish. Read all warning and caution statements that appear on the label.

High-pressure washing

- When using high-pressure washers, make sure to maintain sufficient distance from the vehicle. Insufficient clearance or excessive pressure can lead to component damage or water penetration.
- Do not spray the camera, sensors or its surrounding area directly with a high pressure washer. Shock applied from high pressure water may cause the device to not operate normally.
- Do not bring the nozzle tip close to boots (rubber or plastic covers) or connectors as they may be damaged if they come into contact with high pressure water.
- Do not use any high-pressure nozzles, which induce either one-direct water stream or water swirling.

Finish maintenance

Washing

To help protect your vehicle's finish from rust and deterioration, wash it thoroughly and frequently at least once a month with lukewarm or cold water.

If you use your vehicle for off-road driving, you should wash it after each off-road trip. Pay special attention to the removal of any accumulation of salt, dirt, mud, and other foreign materials. Make sure the drain holes in the lower edges of the doors and rocker panels are kept clear and clean.

Insects, tar, tree sap, bird droppings, industrial pollution and similar deposits can damage your vehicle's finish if not removed immediately.

Even prompt washing with plain water may not completely remove all these deposits. A mild soap, safe for use on painted surfaces, should be used.

After washing, rinse the vehicle thoroughly with lukewarm or cold water. Do not allow soap to dry on the finish.

WARNING

After washing the vehicle, test the brakes while driving slowly to see if they have been affected by water before getting on the road. If braking performance is impaired, dry the brakes by applying them lightly while maintaining a slow forward speed.

NOTICE

- Do not use strong soap, chemical detergents or hot water, and do not wash the vehicle in direct sunlight or when the body of the vehicle is warm.
- Be careful when washing the side windows of your vehicle. Especially, with high-pressure water, water may leak through the windows and wet the interior.
- To prevent damage to the plastic parts, do not clean with chemical solvents or strong detergents.

**NOTICE**

- Water washing in the engine compartment including high pressure water washing may cause the failure of electrical circuits located in the engine compartment.
- Never allow water or other liquids to come in contact with electrical/electronic components inside the vehicle as this may damage them.

NOTICE**Matte paint finish vehicle (if equipped)**

Automatic car wash which uses rotating brushes should not be used as this can damage the surface of your vehicle. A steam cleaner which washes the vehicle surface at high temperature may result the oil to adhere and leave stains that is difficult to remove.

Use a soft cloth (e.g. microfiber towel or sponge) when washing your vehicle and dry with a microfiber towel. When you hand wash your vehicle, you should not use a cleaner that finishes with wax. If the vehicle surface is too dirty (sand, dirt, dust, contaminant, etc.), clean the surface with water before washing the car.

Waxing

A good coat of wax provides a barrier between your paint and environmental contamination.

Keeping a good coat of wax on your vehicle will help protect it.

Wax the vehicle when water will no longer bead on the paint.

Always wash and dry the vehicle before waxing. Use a good quality liquid or paste wax, and follow the manufacturer's instructions. Wax all metal trim to protect it and to maintain its luster.

Removing oil, tar, and similar materials with a spot remover will usually strip the wax from the finish. Be sure to re-wax these areas even if the rest of the vehicle does not yet need waxing.

NOTICE

- Wiping dust or dirt off the body with a dry cloth will scratch the finish.
- Do not use steel wool, abrasive cleaners, or strong detergents containing highly alkaline or caustic agents on chrome-plated or anodized aluminum parts. This may result in damage to the protective coating and cause discoloration or paint deterioration.

NOTICE

**Matte paint finish vehicle
(if equipped)**

Do not use any polish protector such as a detergent, an abrasive and a polish. In case wax is applied, remove the wax immediately using a silicon remover and if any tar or tar contaminant is on the surface use a tar remover to clean. However, be careful not to apply too much pressure on the painted area.

Finish damage repair

Deep scratches or stone chips in the painted surface must be repaired promptly. Exposed metal will quickly rust and may develop into a major repair expense.

NOTICE

**Matte paint finish vehicle
(if equipped)**

In case of matte paint finish vehicles, it is impossible to modify only the damaged area and repair of the whole part is necessary. If the vehicle is damaged and painting is required, we recommend that you have your vehicle maintained and repaired by an authorized retailer of Genesis Branded products. Take extreme care, as it is difficult to restore the quality after the repair.

Bright-metal maintenance

- To remove road tar and insects, use a tar remover, not a scraper or other sharp object.
- To protect the surfaces of bright-metal parts from corrosion, apply a coating of wax or chrome preservative and rub to a high luster.
- During winter weather or in coastal areas, cover the bright metal parts with a heavier coating of wax or preservative. If necessary, coat the parts with non-corrosive petroleum jelly or other protective compound.

Underbody maintenance

Corrosive materials used for ice and snow removal and dust control may collect on the underbody. If these materials are not removed, accelerated rusting can occur on underbody parts such as the fuel lines, frame, floor pan and exhaust system, even though they have been treated with rust protection.

Thoroughly flush the vehicle underbody and wheel openings with lukewarm or cold water once a month, after off-road driving and at the end of each winter. Pay special attention to these areas because it is difficult to see all the mud and dirt. It will do more harm than good to wet down the road grime without removing it. The lower edges of doors, rocker panels, and frame members have drain holes that should not be allowed to clog with dirt; trapped water in these areas can cause rusting.

WARNING

After washing the vehicle, test the brakes while driving slowly to see if they have been affected by water. If braking performance is impaired, dry the brakes by applying them lightly while maintaining a slow forward speed.

Aluminum wheel maintenance

The aluminum wheels are coated with a clear protective finish.

- Do not use abrasive cleaner, polishing compound, solvent, or wire brushes on aluminum wheels.
- Clean the wheel when it has cooled.
- Use only a mild soap or neutral detergent, and rinse thoroughly with water. Also, clean the wheels after driving on salted roads.
- Do not wash the wheels with high-speed car wash brushes.
- Do not use cleaners containing acid or alkaline detergents.

Corrosion protection

Protecting your vehicle from corrosion

By using the most advanced design and construction practices to combat corrosion, Genesis Branded Vehicle produces cars of the highest quality. However, this is only part of the job. To achieve the long-term corrosion resistance your vehicle can deliver, the owner's cooperation and assistance is also required.

Common causes of corrosion

The most common causes of corrosion on your vehicle are:

- Road salt, dirt and moisture that is allowed to accumulate underneath the vehicle.
- Removal of paint or protective coatings by stones, gravel, abrasion or minor scrapes and dents which leave unprotected metal exposed to corrosion.

High-corrosion areas

If you live in an area where your vehicle is regularly exposed to corrosive materials, corrosion protection is particularly important. Some of the common causes of accelerated corrosion are road salts, dust control chemicals, ocean air and industrial pollution.

Moisture breeds corrosion

Moisture creates the conditions in which corrosion is most likely to occur. For example, corrosion is accelerated by high humidity, particularly when temperatures are just above freezing. In such conditions, the corrosive material is kept in contact with the car surfaces by moisture that is slow to evaporate.

Mud is particularly corrosive because it is slow to dry and holds moisture in contact with the vehicle. Although the mud appears to be dry, it can still retain the moisture and promote corrosion.

High temperatures can also accelerate corrosion of parts that are not properly ventilated so the moisture can be dispersed. For all these reasons, it is particularly important to keep your vehicle clean and free of mud or accumulations of other materials. This applies not only to the visible surfaces but particularly to the underside of the vehicle.

To help prevent corrosion

Keep your car clean

The best way to prevent corrosion is to keep your vehicle clean and free of corrosive materials. Attention to the underside of the vehicle is particularly important.

- If you live in a high-corrosion area — where road salts are used, near the ocean, areas with industrial pollution, acid rain, etc.—, you should take extra care to prevent corrosion. In winter, hose off the underside of your vehicle at least once a month and be sure to clean the underside thoroughly when winter is over.
- When cleaning underneath the vehicle, pay particular attention to the components under the fenders and other areas that are hidden from view. Do a thorough job; just dampening the accumulated mud rather than washing it away will accelerate corrosion rather than prevent it. Water under high pressure and steam are particularly effective in removing accumulated mud and corrosive materials.
- When cleaning lower door panels, rocker panels and frame members, be sure that drain holes are kept open so that moisture can escape and not be trapped inside to accelerate corrosion.

Keep your garage dry

Don't park your car in a damp, poorly ventilated garage. This creates a favorable environment for corrosion. This is particularly true if you wash your vehicle in the garage or drive it into the garage when it is still wet or covered with snow, ice or mud. Even a heated garage can contribute to corrosion unless it is well ventilated so moisture is dispersed.

Keep paint and trim in good condition

Scratches or chips in the finish should be covered with "touch-up" paint as soon as possible to reduce the possibility of corrosion. If bare metal is showing through, the attention of a qualified body and paint shop is recommended.

Bird droppings are highly corrosive and may damage painted surfaces in just a few hours. Always remove bird droppings as soon as possible.

Interior Care

Interior general precautions

Prevent caustic solutions such as perfume and cosmetic oil, from contacting the interior parts because they may cause damage or discoloration. If they do contact the interior parts, wipe them off immediately. See the instructions for the proper way to clean vinyl.

NOTICE

- **Never allow water or other liquids to come in contact with electrical/electronic components inside the vehicle as this may damage them.**
- **When cleaning leather products (steering wheel, seats etc.), use neutral detergents or low alcohol content solutions. If you use high alcohol content solutions or acid/alkaline detergents, the color of the leather may fade or the surface may get stripped off.**

Cleaning the upholstery and interior trim

Vinyl (if equipped)

Remove dust and loose dirt from vinyl with a whisk broom or vacuum cleaner. Clean vinyl surfaces with a vinyl cleaner.

Fabric (if equipped)

Remove dust and loose dirt from fabric with a whisk broom or vacuum cleaner. Clean with a mild soap solution recommended for upholstery or carpets. Remove fresh spots immediately with a fabric spot cleaner. If fresh spots do not receive immediate attention, the fabric can be stained and its color can be affected.

Also, its fire-resistant properties can be reduced if the material is not properly maintained.

NOTICE

Using anything but recommended cleaners and procedures may affect the fabric's appearance and fire-resistant properties.

Leather (if equipped)

- Features of seat leather
 - Leather is made from the outer skin of an animal, which goes through a special process to be available for use. Since it is a natural product, each part differs in thickness or density.
 - Wrinkles may appear as a natural result of stretching and shrinking depending on the temperature and humidity.
 - The seat is made of stretchable fabric to improve comfort.
 - The parts contacting the body are curved and the side supporting area is high which provides driving comfort and stability.
 - Wrinkles may appear naturally from usage. It is not a fault of the product.

NOTICE

- **Wrinkles or abrasions which appear naturally from usage are not covered by warranty.**
- **Belts with metallic accessories, zippers or keys inside the back pocket may damage the seat fabric.**
- **Make sure not to wet the seat. It may change the nature of natural leather.**
- **Jeans or clothes which could bleach may contaminate the surface of the seat covering fabric.**

- Caring for the leather seats
 - Vacuum the seat periodically to remove dust and sand on the seat. It will prevent abrasion or damage of the leather and maintain its quality.
 - Wipe the natural leather seat cover often with dry or soft cloth.
 - Use of a proper leather protector may prevent abrasion of the cover and helps maintain the color.
 - Be sure to read the instructions and consult a specialist when using leather coating or protective agents.
 - Light colored (beige, cream beige) leather is easily contaminated and the stain is noticeable. Clean the seats frequently.
 - Avoid wiping with wet cloth. It may cause the surface to crack.

- Cleaning the leather seats
 - Remove all contaminations instantly. Refer to instructions below for removal of each contaminant.
 - Cosmetic products (sunscreen, foundation, etc.)

Apply cleansing cream on a cloth and wipe the contaminated spot. Wipe off the cream with a wet cloth and remove water with a dry cloth.
 - Beverages (coffee, soft drink, etc.)

Apply a small amount of neutral detergent and wipe until contaminations do not smear.
 - Oil

Remove oil instantly with absorbable cloth and wipe with stain remover used only for natural leather.
 - Chewing gum

Harden the gum with ice and remove gradually.
- Handling prime napa leather (if equipped)

Try to avoid excessive sunlight and heat exposure. Excessive sunlight and heat exposure naturally fades and dries out napa leather, causing wrinkles and discoloration. If the napa leather is wet with liquid, immediately clean it with lint-free cloth to minimize damage. Do not scratch the napa leather surface with a sharp object. If your napa leather seat is bright colored, it may be contaminated or stained from dyed materials such as jeans.

Interior wooden trim

- Use a wooden furniture protector (e.g. wax, coating compound) to clean the interior wooden trim.
- Often wipe the interior wooden trim with a lint-free, clean cloth to maintain the unique wooden textures for a longer period of time.

NOTICE

- **If you spill beverage (e.g. water, coffee) over the interior wooden trim, immediately wipe it with clean, dry cloth.**
- **Sharp objects (e.g. driver, knife), adhesive materials, or tapes may damage the interior wooden trim.**
- **Any strong impacts may damage the interior wooden trim.**
- **If the coating finish over the interior wooden trim is removed, moisture may damage or change wood traits.**
- **If the interior wooden trim is damaged, you may get a splinter from the wood surface. Therefore, you should immediately have the damaged interior wooden trim replaced by an authorized retailer of Genesis Branded products.**

Cleaning the seat belt webbing

Clean the belt webbing with any mild soap solution recommended for cleaning upholstery or carpet. Follow the instructions provided with the soap. Do not bleach or re-dye the webbing because this may weaken the seat belt.

Cleaning the interior window glass

If the interior glass surfaces of the vehicle become fogged (that is, covered with an oily, greasy or waxy film), they should be cleaned with glass cleaner. Follow the directions on the glass cleaner container.

NOTICE

Do not scrape or scratch the inside of the rear window. This may result in damage to the rear window defroster grid.

EMISSION CONTROL SYSTEM

The emission control system of your vehicle is covered by a written limited warranty. Please see the warranty information contained in the Owner's Handbook & Warranty Information booklet in your vehicle.

Your vehicle is equipped with an emission control system to meet all applicable emission regulations. There are three emission control systems, as follows.

- (1) Crankcase emission control system
- (2) Evaporative emission control system
- (3) Exhaust emission control system

In order to ensure the proper function of the emission control systems, it is recommended that you have your vehicle inspected and maintained by an authorized retailer of Genesis Branded products in accordance with the maintenance schedule in this manual.

NOTICE

For the Inspection and Maintenance Test (with Electronic Stability Control (ESC) system)

- **To prevent the vehicle from misfiring during dynamometer testing, turn the Electronic Stability Control (ESC) system off by pressing the ESC switch (ESC OFF light illuminated).**
- **After dynamometer testing is completed, turn the ESC system back on by pressing the ESC switch again.**

1. Crankcase Emission Control System

The positive crankcase ventilation system is employed to prevent air pollution caused by blow-by gases being emitted from the crankcase. This system supplies fresh filtered air to the crankcase through the air intake hose. Inside the crankcase, the fresh air mixes with blow-by gases, which then pass through the PCV valve into the induction system.

2. Evaporative Emission Control System Including Onboard Refueling Vapor Recovery (ORVR)

The Evaporative Emission Control System is designed to prevent fuel vapors from escaping into the atmosphere. The ORVR system is designed to allow the vapors from the fuel tank to be loaded into a canister while refueling at the gas station, preventing the escape of fuel vapors into the atmosphere.

Canister

Fuel vapors generated inside the fuel tank are absorbed and stored in the onboard canister. When the engine is running, the fuel vapors absorbed in the canister are drawn into the surge tank through the purge control solenoid valve.

Purge Control Solenoid Valve (PCSV)

The purge control solenoid valve is controlled by the Engine Control Module (ECM); when the engine coolant temperature is low during idling, the PCSV closes so that evaporated fuel is not taken into the engine. After the engine warms-up during ordinary driving, the PCSV opens to introduce evaporated fuel to the engine.

3. Exhaust Emission Control System

The Exhaust Emission Control System is a highly effective system which controls exhaust emissions while maintaining good vehicle performance.

When the engine starts or fails to start, excessive attempts to restart the engine may cause damage to the emission system.

Engine exhaust (carbon monoxide) precautions

- Carbon monoxide can be present with other exhaust fumes. If you smell exhaust fumes of any kind in your vehicle, drive with all the windows fully open. Have your vehicle checked and repaired immediately.

⚠ WARNING

Engine exhaust gases contain carbon monoxide (CO). Though colorless and odorless, it is dangerous and could be lethal if inhaled. Follow the instructions on this page to avoid CO poisoning.

⚠ WARNING

CALIFORNIA PROPOSITION 65 WARNING

Engine exhaust and a wide variety of automobile components and parts, including components found in the interior furnishings in a vehicle, contain or emit chemicals known to the State of California to cause cancer and birth defects and reproductive harm. In addition, certain fluids contained in vehicles and certain products of component wear contain or emit chemicals known to the State of California to cause cancer and birth defects or other reproductive harm.

- Do not operate the engine in confined or closed areas (such as garages) any more than what is necessary to move the vehicle in or out of the area.
- When the vehicle is stopped in an open area for more than a short time with the engine running, adjust the ventilation system (as needed) to draw outside air into the vehicle.
- Never sit in a parked or stopped vehicle for any extended time with the engine running.
- When the engine stalls or fails to start, excessive attempts to restart the engine may cause damage to the emission control system.

Operating precautions for catalytic converters (if equipped)

⚠ WARNING

The exhaust system and catalytic converter are very hot during and immediately after the engine has been running. To avoid **SERIOUS INJURY or **DEATH**:**

- **Do not park, idle, or drive the vehicle over or near flammable objects, such as grass, vegetation, paper, leaves, etc. A hot exhaust system can ignite flammable items under your vehicle.**
- **Keep away from the exhaust system and catalytic converter or you may get burned.**

Also, Do not remove the heat sink around the exhaust system, do not seal the bottom of the vehicle, and do not coat the vehicle for corrosion control. It may present a fire risk under certain conditions.

Your vehicle is equipped with a catalytic converter emission control device. To prevent damage to the catalytic converter and to your vehicle, take the following precautions:

- Use only **UNLEADED FUEL** for gasoline engines.
- Do not operate the vehicle when there are signs of engine malfunction, such as misfire or a noticeable loss of performance.
- Do not misuse or abuse the engine. Examples of misuse are coasting with the engine off and descending steep grades in gear with the engine off.
- Do not operate the engine at high idle speed for extended periods (5 minutes or more).
- Do not modify or tamper with any part of the engine or emission control system. All inspections and adjustments must be made by an authorized retailer of Genesis Branded products.
- Avoid driving with extremely low fuel level. If you run out of gasoline, it could cause the engine to misfire and result in excessive loading of the catalytic converter.

CALIFORNIA PERCHLORATE NOTICE

Perchlorate Material-special handling may apply, See: www.dtsc.ca.gov/hazardouswaste/perchlorate.

Notice to California Vehicle Dismantlers:

Perchlorate containing materials, such as air bag inflators, seatbelt pretensioners and keyless remote entry batteries, must be disposed of according to Title 22 California Code of Regulations Section 67384.10 (a).

8. Specifications, Consumer information and Reporting safety defects

Dimensions	8-2
Engine	8-2
Bulb Wattage	8-3
Tires and Wheels	8-4
Luggage Volume	8-5
Gross Vehicle Weight.....	8-5
Air Conditioning System	8-5
Recommended Lubricants and Capacities.....	8-6
Recommended SAE Viscosity Number	8-7
Vehicle Identification Number (VIN)	8-8
Vehicle Certification Label	8-8
Tire Specification and Pressure Label	8-8
Engine Number	8-9
Refrigerant Label	8-9
Consumer Information.....	8-10
Reporting Safety Defects	8-11

DIMENSIONS

Items		in (mm)
Overall length		204.9 (5,205)
Overall width		75.4 (1,915)
Overall height		58.9 (1,495)
Front tread	245/45 R19	64.6 (1,640)
Rear tread	275/40 R19	64.5 (1,639)
Wheelbase		124.4 (3,160)

ENGINE

Items	3.3 T-GDI	5.0 GDI
Displacement cu. in (cc)	203.94 (3,342)	307.43 (5,038)
Bore x Stroke in. (mm)	3.62x3.29 (92x84)	3.77x3.42 (96x87)
Firing order	1-2-3-4-5-6	1-2-7-8-4-5-6-3
No. of cylinders	6, V-type	8, V-type

BULB WATTAGE

Light bulb		Bulb type	Wattage	
Front	Headlamp	Low	LED	
		High/Low	LED	
	Turn signal lamp		LED	LED
	Parking lamp			
	Side maker			
	Daytime running light (DRL)			
Side repeater lamp				
Rear	Rear combination lamp	Stop lamp	LED	LED
		Tail lamp		
		Turn signal lamp		
		Backup lamp		
		Side marker		
	High mounted stop lamp			
License plate lamp				
Interior	Front lamps		LED	LED
	Rear lamps			
	Front vanity mirror lamp			
	Rear mirror lamp			
	Globe box lamp			
	Trunk lamp			

TIRES AND WHEELS

Item	Tire size	Wheel size	Inflation pressure [kPa (psi)]				Wheel lug nut torque [kgf-m (lbf-ft, N-m)]
			Normal load *		Maximum load		
			Front	Rear	Front	Rear	
Full size tire	245/45 R19	8.5Jx19	240 (35)	-	240 (35)	-	11~13 (79~94, 107~127)
	275/40 R19	9.5Jx19	-	240 (35)	-	240 (35)	
Compact spare tire	T155/70 R19	4.0Tx19	420 (60)	420 (60)	420 (60)	420 (60)	

* Normal load : Up to 3 persons

Information

- It is permissible to add 3 psi to the standard tire pressure specification if colder temperatures are expected soon. Tires typically lose 1 psi (7 kPa) for every 12°F temperature drop. If extreme temperature variations are expected, recheck your tire pressure as necessary to keep them properly inflated.
- An air pressure generally decreases, as you drive up to a high-altitude area above sea level. Thus, if you plan to drive a high-altitude area, check the tire pressures in advance. If necessary, inflate them to a proper level. (Air inflation per altitude: +2.4psi/1mile)

NOTICE

When replacing tires, use the same size originally supplied with the vehicle. Using tires of a different size can damage the related parts or not work properly.

LUGGAGE VOLUME

Item	3.3 T-GDI	5.0 GDI
SAE	15.67 cu ft (444 l)	

GROSS VEHICLE WEIGHT

Items	3.3 T-GDI		5.0 GDI	
	2WD	AWD	2WD	AWD
Gross vehicle weight lbs (kg)	5,578 (2,530)	5,732 (2,600)	5,710 (2,590)	5,864 (2,660)

AIR CONDITIONING SYSTEM

Items	Weight of Volume	Classification
Refrigerant oz. (g)	22.22±0.88 (630±25)	R-1234yf
Compressor lubricant cu. in (cc)	3.52±0.35 (100±10)	PAG (FD46XG)

Contact an authorized retailer of Genesis Branded products for more details.

RECOMMENDED LUBRICANTS AND CAPACITIES

To help achieve proper engine and powertrain performance and durability, use only lubricants of the proper quality. The correct lubricants also help promote engine efficiency that results in improved fuel economy.

Lubricant		Volume	Classification
Engine oil ^{*1} ^{*2} (drain and refill) 	3.3 T-GDI		7.29 US qt. (6.9 l)
	5.0 GDI	2WD	8.45 US qt. (8.0 l)
		AWD	9.72 US qt. (9.2 l)
Automatic transmission fluid		9.72 US qt. (9.2 l)	GS ATF SP-IV-RR, Genesis/Hyundai ATF SP-IV-RR or other brands meeting the above specification approved by Genesis Customer Care
Engine coolant	3.3 T-GDI		10.36 US qt. (9.8 l)
	5.0 GDI	2WD	12.68 US qt. (12.0 l)
		AWD	12.05 US qt. (11.4 l)
Brake fluid		0.74~0.85 US qt. (0.7~0.8 l)	FMVSS116 DOT-3 or DOT-4
Front differential oil (AWD) ^{*5}		0.74 US qt. (0.7 l)	Hypoid gear oil MS517-15GT 75W/85 (GL-5)
Rear differential oil ^{*5}		1.48 US qt. (1.4 l)	(SK HK SYN GEAR OIL 75W/85 or equivalent)
Transfer case oil (AWD)		0.66 US qt. (0.62 l)	SHELL TF0870B
Fuel		21.9 US gal. (83 l)	Refer to "Fuel Requirements" in the Introduction chapter.

^{*1} : Refer to the recommended SAE viscosity numbers on the next page.

^{*2} : Engine oils labeled Energy Conserving Oil are now available. Along with other additional benefits, they contribute to fuel economy by reducing the amount of fuel necessary to overcome engine friction. Often, these improvements are difficult to measure in everyday driving, but in a year's time, they can offer significant cost and energy savings.

^{*3} : If the ACEA A5 engine oil is not available in your country, you are able to use API SM & ILSAC GF4 (or above) or ACEA A3.

^{*4} : If the API SM & ILSAC GF-4 engine oil is not available in your country, you are able to use API SL & ILSAC GF-3.

^{*5} : If the front/rear differential is submerged, we recommend that you visit an authorized retailer of Genesis Branded products to replace differential oil.

Recommended SAE Viscosity Number

NOTICE

Always be sure to clean the area around any filler plug, drain plug, or dipstick before checking or draining any lubricant. This is especially important in dusty or sandy areas and when the vehicle is used on unpaved roads. Cleaning the plug and dipstick areas will prevent dirt and grit from entering the engine and other mechanisms that could be damaged.

Engine oil viscosity (thickness) has an effect on fuel economy and cold weather operating (engine start and engine oil flowability). Lower viscosity engine oils can provide better fuel economy and cold weather performance, however, higher viscosity engine oils are required for satisfactory lubrication in hot weather. Using oils of any viscosity other than those recommended could result in engine damage. When choosing an oil, consider the range of temperature your vehicle will be operated in before the next oil change. Proceed to select the recommended oil viscosity from the chart.

■ 3.3 T-GDI

Temperature Range for SAE Viscosity Numbers										
Temperature	°C	-30	-20	-10	0	10	20	30	40	50
	(°F)	-10	0	20	40	60	80	100	120	
Engine Oil *1	10W-30									
	5W-30									

*1 : For better fuel economy, it is recommended to use the engine oil of a viscosity grade SAE 5W-30 (ACEA A5). However, if the engine oil is not available in your country, select the proper engine oil using the engine oil viscosity chart.

■ 5.0 GDI

Temperature Range for SAE Viscosity Numbers										
Temperature	°C	-30	-20	-10	0	10	20	30	40	50
	(°F)	-10	0	20	40	60	80	100	120	
Engine Oil *1	10W-30									
	5W-20, 5W-30									

*1 : For better fuel economy, it is recommended to use the engine oil of a viscosity grade SAE 5W-20 (API SM / ILSAC GF-4 (or above)). However, if the engine oil is not available in your country, select the proper engine oil using the engine oil viscosity chart.



VEHICLE IDENTIFICATION NUMBER (VIN)

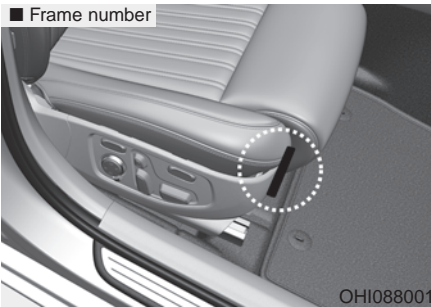

The vehicle identification number (VIN) is the number used in registering your car and in all legal matters pertaining to its ownership, etc.

The number is punched on the floor under the passenger seat. To check the number, open the cover.

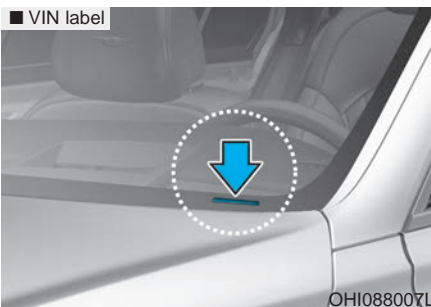

The VIN is also on a plate attached to the top of the dashboard. The number on the plate can easily be seen through the windshield from outside.

VEHICLE CERTIFICATION LABEL

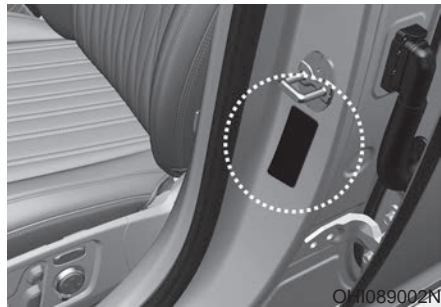

The vehicle certification label attached on the driver's side center pillar gives the Vehicle Identification Number (VIN).

TIRE SPECIFICATION AND PRESSURE LABEL

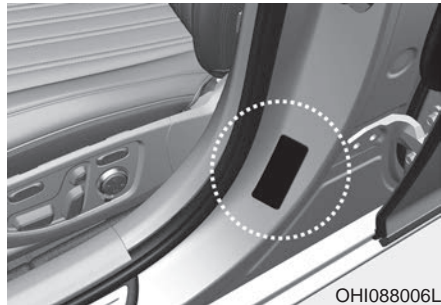

The tires supplied on your new vehicle are chosen to provide the best performance for normal driving.

The tire label located on the driver's side center pillar gives the tire pressures recommended for your car.

ENGINE NUMBER

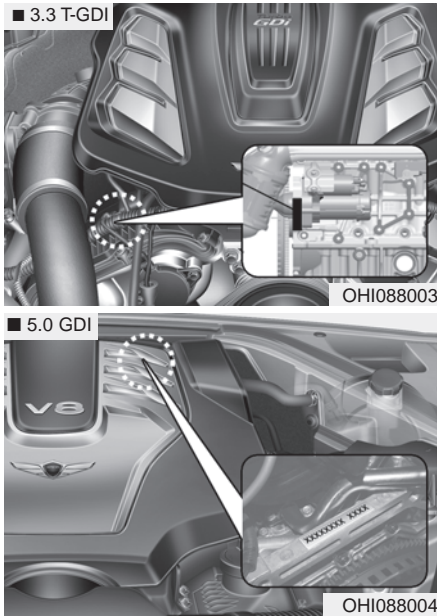

The engine number is stamped on the engine block as shown in the drawing.

REFRIGERANT LABEL (IF EQUIPPED)



The refrigerant label provides information such as refrigerant type and amount.

The label is located on the underside of the hood.

CONSUMER INFORMATION

This consumer information has been prepared in accordance with regulations issued by the National Highway Traffic Safety Administration of the U.S. Department of Transportation. Your retailer of Genesis Branded products will help answer any questions you may have as you read this information.

Genesis Branded Vehicles are designed and manufactured to meet or exceed all applicable safety standards.

For your safety, however, we strongly urge you to read and follow all directions in this Owner's Manual, particularly the information under the headings "**NOTICE**", "**CAUTION**" and "**WARNING**".

If, after reading this manual, you have any questions regarding the operation of your vehicle, please contact your nearest Genesis Customer Care Regional Office as listed in the following:

Eastern Region:

Connecticut, Delaware,
Maine, Massachusetts, New
Hampshire, New Jersey, New York,
Pennsylvania, Rhode Island, Vermont.

Eastern Region

1122 Cranbury South River Road
Jamesburg, NJ 08831
844-340-9741

Central Region:

Illinois, Indiana, Iowa, Kentucky,
Michigan, Minnesota, Nebraska,
North Dakota, South Dakota, Ohio,
Wisconsin, Kansas, Missouri.

Central Region

2 Trans Am Plaza Dr #500 Oakbrook
Terrace, IL 60181
844-340-9741

Southern Region:

Florida, Georgia, Maryland, North
Carolina, South Carolina, Virginia,
West Virginia.

Southern Region

3025 Chastain Meadows Parkway
Suite 100 Marietta, GA 30066
844-340-9741

Western Region:

Alaska, Hawaii, Arizona, California,
Colorado, Idaho, Montana, Nevada,
Oregon, Utah, Washington,
Wyoming.

Western Region

10550 Talbert Avenue P.O.Box 20850
Fountain Valley, California 92728-
0850
844-340-9741

South Central Region:

Alabama, Arkansas, Louisiana,
Mississippi, New Mexico, Oklahoma,
Tennessee, Texas.

South Central Region

1421 South Beltline Road, Suite 400
Coppell, TX 75019
844-340-9741

REPORTING SAFETY DEFECTS

If you believe that your vehicle has a defect which could cause a crash or could cause injury or death, you should immediately inform the National Highway Traffic Safety Administration (NHTSA) in addition to notifying Genesis Customer Care.

If NHTSA receives similar complaints, it may open an investigation, and if it finds that a safety defect exists in a group of vehicles, it may order a recall and remedy campaign. However, NHTSA cannot become involved in individual problems between you, your dealer, or Genesis Customer Care.

To contact NHTSA, you may call the Vehicle Safety Hotline toll-free at 1-888-327-4236 (TTY: 1-800-424-9153);

go to <http://www.safercar.gov>;

download the SaferCar mobile application;

or write to: Administrator, NHTSA.

1200 New Jersey Ave, SE.,
Washington, DC. 20590.

You can also obtain other information about motor vehicle safety from <http://www.safercar.gov>.

Index

A

AFS (Adaptive Front-Lighting System)	3-94
Air bag warning labels	2-81
Air bags	2-57
Additional safety precautions.....	2-80
Air bag collision sensors	2-75
Air bag inflation conditions	2-76
Air bag non-inflation conditions	2-77
Air bag warning labels	2-81
Curtain air bags	2-61
Driver's air bag	2-59
Driver's knee airbag	2-59
How does the air bags system operate?	2-63
Occupant Classification System (OCS) passenger seat	2-68
Passenger's knee air bag.....	2-59
Passenger's front air bag.....	2-59
Side air bags	2-61
SRS Care	2-79
SRS components and functions	2-63
SRS warning light	2-64
What to expect after an air bag inflates	2-67
Why didn't my air bag go off in a collision	2-74
Air cleaner	7-29
Air conditioning refrigerant label	3-131
Air conditioning system specification.....	8-5
Air conditioning system	3-117
Alarm system.....	3-15
All Wheel Drive (AWD)	5-39
Antenna	4-3
Anti-lock Brake System (ABS).....	5-31
Appearance care	7-74
Exterior care	7-74
Interior care	7-80
Armrest (rear seat).....	2-21
Auto defogging system	3-135
Auto light position.....	3-88

Automatic climate control system.....	3-117
Air conditioning	3-128
Air conditioning refrigerant label	3-131
Air intake control	3-125
Air quality system (AQS)	3-126
Automatic heating and air conditioning.....	3-118
Climate control information screen selection button	3-128
Fan speed control	3-127
Manual heating and air conditioning	3-119
Mode selection	3-120
OFF mode.....	3-128
SYNC button	3-124
System maintenance.....	3-130
Temperature control	3-123
Temperature unit conversion.....	3-123
Automatic transmission.....	5-10
Good driving practices	5-19
LCD display messages	5-16
Paddle shifter (manual mode)	5-15
Shift lock system.....	5-14
When the battery is discharged	5-14
Automatic ventilation.....	3-136
AVN (Audio/Video/Navigation) system	4-5

B

Bag hanger.....	3-148
Battery	7-33
Battery recharging	7-35
Battery saver function	3-93
Before driving	5-4
Blade type fuse.....	7-54
Blind-Spot Collision Warning (BCW)/Blind-Spot Collision-Avoidance Assist (BCA).....	5-68
Blind-Spot View Monitor system.....	3-116
<i>Bluetooth</i> [®] Wireless Technology.....	4-6
Bottle holder.....	3-136
Brake fluid.....	7-27

Brake system	5-21
Anti-lock Brake System (ABS)	5-31
Auto hold.....	5-27
Disc brakes wear indicator	5-22
Electronic Parking Brake (EPB)	5-22
Electronic Stability Control (ESC)	5-33
Good braking practices	5-38
Hill-Start Assist Control (HAC).....	5-37
Power brakes	5-21
Vehicle Stability Management (VSM).....	5-36
Bulb replacement.....	7-69
Daytime running lamp	7-70
Front parking lamp.....	7-70
Front turn signal lamp.....	7-70
Headlamp	7-70
High mounted stop lamp.....	7-71
Interior light bulb	7-72
License plate light bulb	7-72
Rear combination light bulb.....	7-71
Rear fog lamp.....	7-72
Side marker	7-70
Side repeater lamp.....	7-70
Bulb wattage.....	8-3
Button start/stop, see engine start/stop button	5-6

C

Cabin air filter	7-30
Capacities (Lubricants)	3-6
Care Exterior care	7-74
Interior care	7-80
Tire care.....	7-37
Cartridge type fuse	7-54
Center console storage	3-139
Central door lock switch	3-12
Certification label.....	8-8
Chains	
Tire chains	5-146
Changing a tire with TPMS	6-13
Check tire inflation pressure	7-39

Child restraint system (CRS)	2-46
Booster seats.....	2-48
Children always in the rear	2-46
Forward-facing child restraint system	2-48
Installing a child restraint system (CRS).....	2-49
Lap/shoulder belt.....	3-54
LATCH anchors system	2-52
Lower Anchors and Tether for children	2-53
Rearward-facing child restraint system.....	2-47
Selecting a child restraint system (CRS)	2-47
Tether Anchor	3-53
Child-protector rear door lock.....	3-13
Clean air	3-136
Coasting.....	5-49
Coat hook	3-147
Combined instrument, see instrument cluster	3-54
Compact spare tire replacement	7-42
Coolant	7-24
Cooling fluid, see engine coolant.....	7-24
Crankcase emission control system	7-84
Cup holder	3-141
Curtain air bags	2-61

D

Dashboard illumination, see instrument panel illumination	3-55
Dashboard, see instrument cluster	3-54
Daytime running light (DRL)	3-94
Defogging (Windshield).....	3-133
Defroster.....	3-127
Outside mirror defroster.....	3-127
Rear window defroster	3-127
Defrosting (Windshield).....	3-133
Dimensions	8-2
Display illumination, see instrument panel illumination	3-55
Displays, see instrument cluster	3-54
Door locks	3-9
Auto door lock/unlock features.....	3-13
Central door lock switch	3-12
Child-protector rear door lock	3-13
Power door latch	3-10
Safe Exit Assist (SEA) system.....	3-14

Drinks holders, see cup holders	3-141
Drive mode integrated control system	5-45
Driver Attention Warning (DAW)	5-138
Driver's air bag	2-59
Driver's knee airbag	2-59
Driving at night	5-143
Driving in flooded areas	5-144
Driving in the rain	5-143
DVD player	4-5
Dynamic Stability Damping Control (DSDC)	5-44

E

Electric chromic mirror (ECM).....	3-23
Electronic control suspension (ECS)	5-44
Electronic Parking Brake (EPB)	5-22
Electronic Stability Control (ESC).....	5-33
Emergency towing.....	6-24
Emission control system	7-84
Crankcase emission control system	7-84
Evaporative emission control System.....	7-84
Exhaust emission control system	7-85
Engine compartment	
3.3 T-GDI	7-3
5.0 GDI.....	7-4
Engine compartment panel fuse replacement	7-54
Engine coolant.....	7-24
Engine coolant temperature guage.....	3-56
Engine number	8-9
Engine oil	7-22
Engine specification	8-2
Engine Start/Stop button	5-6
Evaporative emission control System	7-84
Exhaust emission control system	7-85
Explanation of scheduled maintenance items	7-19
Exterior care	7-74

I

F

Flat tire
 Use of compact spare tires6-19

Floor mat anchor(s)3-148

Fluid
 Brake fluid.....7-27
 Washer fluid7-28

Forward Collision-Avoidance Assist (FCA)5-51
 Lane-Change Oncoming function5-66

Front seat adjustment2-7
 Easy access switch2-13
 Forward and rearward adjustment.....2-9
 Lumbar support2-11
 Seat bolster adjustment2-12
 Seat cushion height and tilt2-11
 Seat cushion length adjustment.....2-9
 Seat shoulder adjustment2-12
 Seatback angle.....2-10
 Seatback pocket.....2-13

Front seat head restraints
 Adjusting the height up and down2-24
 Forward and rearward adjustment.....2-23
 Removal/Reinstall2-24

Front wiper deicer3-127

Fuel filler door.....3-51

Fuel gauge3-57

Fuse switch.....7-54

Fuses.....7-52
 Blade type fuse.....7-54
 Cartridge type fuse7-54
 Engine compartment panel fuse replacement7-54
 Fuse switch.....7-54
 Fuse/relay panel description.....7-56
 Instrument panel fuse replacement7-53
 Main fuse.....7-55
 Multi fuse7-55

I-7

G

Gauges and meters3-55

Genesis adaptive control suspension.....5-44

 Dynamic Stability Damping Control (DSDC).....5-44

 Electronic Control Suspension (ECS).....5-44

Glove box3-140

Glove box lamp3-98

Gross vehicle weight8-5

H

Hazard warning flasher6-2

Hazardous driving conditions5-142

Head restraints.....2-22

 Front seat head restraints2-23

 Rear seat head restraints.....2-25

Headlamp delay function3-93

Headlamp leveling device3-95

Headlamp moisture removal function.....3-93

Headlamp position.....3-89

Headlight bulb replacement7-69

Head-up display.....3-86

Heated steering wheel3-21

Heater3-117

High Beam Assist (HBA).....3-90

High beam operation3-89

Highway driving.....5-144

Highway Driving Assist (HDA).....5-132

Hill-Start Assist Control (HAC).....5-37

HomeLink®.....3-23

Hood3-41

Horn3-22

If the engine doesn't turn over or turns over slowly	6-3
If the engine overheats	6-7
If the engine stalls at a crossroad or crossing	6-2
If the engine stalls while driving.....	6-2
If the engine turns over normally but doesn't start.....	6-3
If the engine will not start	6-3
If you have a flat tire.....	6-15
If you have a flat tire while driving	6-3
Important safety precautions	2-2
Air bag hazards	2-2
Always wear your seat belt	2-2
Control your speed	2-3
Driver distraction	2-2
Keep your vehicle in safe condition	2-3
Restrain all children	2-2
In case of emergency while driving	6-2
Indicator light	3-60
Inside rearview mirror.....	3-23
Instrument cluster.....	3-54
Instrument panel illumination	3-55
Assist mode	3-80
Gauges and meters	3-55
LCD display control.....	3-78
LCD display messages	3-71
LCD display modes.....	3-79
LCD display modes.....	3-74
Master warning mode.....	3-81
Transmission shift indicator	3-59
Trip computer	3-82
Trip computer mode	3-80
Turn By Turn (TBT) mode.....	3-80
Warning and indicator lights	3-60
Instrument panel fuse replacement	7-53
Interior care	7-80

Interior features

- Bag hanger 3-148
- Bottle holder..... 3-141
- Coat hook 3-147
- Cup holder..... 3-141
- Floor mat anchor(s)..... 3-148
- Luggage net (holder)..... 3-151
- Power outlet 3-143
- Rear mirror 3-142
- Rear side window sunshade 3-150
- Rear window sunshade..... 3-149
- Sunvisor..... 3-142
- USB charger 3-144
- Wireless cellular phone charging system..... 3-145

Interior lamp AUTO cut 3-95

Interior light..... 3-95

- Front lamps..... 3-96
- Front vanity mirror lamp..... 3-97
- Glove box lamp..... 3-98
- Interior lamp AUTO cut..... 3-95
- Puddle lamp..... 3-98
- Rear mirror lamp..... 3-98
- Rear lamps..... 3-97
- Trunk lamp 3-97

J

Jump starting 6-4

L

Label	
Refrigerant label.....	8-9
Tire sidewall labeling.....	7-42
Tire specification and pressure label.....	8-8
Vehicle certification label.....	8-8
Lane Following Assist (LFA).....	5-118
Lane Keeping Assist (LKA).....	5-124
Lap/shoulder belt.....	2-35
LCD display control.....	3-78
LCD display messages.....	3-71
LCD display modes.....	3-54
Leading Vehicle Departure Alert.....	5-113
Lighting.....	3-88
AFS (Adaptive Front-Lighting System).....	3-94
Auto light position.....	3-88
Battery saver function.....	3-93
Daytime running light (DRL).....	3-94
Headlamp delay function.....	3-93
Headlamp leveling device.....	3-95
Headlamp moisture removal function.....	3-95
Headlamp position.....	3-89
High Beam Assist (HBA).....	3-90
High beam operation.....	3-89
Parking lamp position.....	3-88
Reverse guide lamp.....	3-95
Turn signals.....	3-92
Lubricants and capacities.....	8-6
Luggage net (holder).....	3-151
Luggage volume.....	8-5

M

Main fuse.....	7-55
Maintenance.....	
Explanation of scheduled maintenance items.....	7-19
Maintenance services.....	7-5
Maintenance under severe usage conditions (3.3 T-GDI).....	7-17
Maintenance under severe usage conditions (5.0 GDI).....	7-12
Normal maintenance service (3.3 T-GDI).....	7-14
Normal maintenance service (5.0 GDI).....	7-9
Owner maintenance.....	7-6
Scheduled maintenance services.....	7-8
Tire maintenance.....	7-42
Maintenance services.....	7-5
Mirrors.....	3-23
Adjusting the side view mirrors.....	3-30
Electric chromic mirror (ECM).....	3-23
Folding/Unfolding the side view mirrors.....	3-31
HomeLink®.....	3-23
Inside rearview mirror.....	3-23
Reverse parking aid function.....	3-32
Side view mirror.....	3-29
Moonroof, see panorama sunroof.....	3-37
Motor-Driven Power Steering (MDPS).....	3-20
Multi fuse.....	7-55
Multimedia system.....	4-2
Antenna.....	4-3
AVN (Audio/Video/Navigation) system.....	4-5
Bluetooth® Wireless Technology.....	4-6
DVD player.....	4-5
Steering wheel remote control.....	4-4
USB port.....	3-2

N

Navigation-based Smart Cruise Control.....	5-114
--	-------

I

O

Occupant Classification System (OCS) passenger seat	2-68
Odometer	3-57
Oil (Engine).....	7-22
Outside mirror defroster	3-127
Outside temperature gauge.....	3-58
Owner maintenance	7-6

P

Paddle shifter (manual mode)	5-15
Panorama sunroof.....	3-37
Parking brake.....	5-27
Parking Collision-Avoidance Assist Reverse (PCA-R)	3-107
Parking distance warning	3-102
Parking lamp position	3-88
Passenger's knee air bag	2-59
Passenger's front air bag.....	2-59
Power door latch	3-10
Power outlet.....	3-143
Power steering	3-20
Power window lock button	3-36
Pre-Active Seat belt (PSB).....	2-41
Pre-tensioner seat belt	2-38
Puddle lamp.....	3-98

I-13

R

Range.....	3-58
Rear mirror lamp	3-98
Rear center seatbelt	2-38
Rear console storage	3-134
Rear Cross-Traffic Collision Warning (RCCW)/Rear Cross-Traffic Collision Avoidance Assist (RCCA).....	5-82
Rear mirror	3-142
Rear seat adjustment	2-14
Armrest.....	2-21
Carrying long/narrow cargo	2-21
Easy access switch	2-16
Lumbar support	2-15
Relaxation mode.....	2-18
Return function.....	2-19
RSE LOCKED indicator	2-20
Seat sliding, seatback angle and seat cushion tilt adjustment	2-14
Walk-in seat switch	2-16
Rear seat head restraints.....	2-25
Adjusting the head restraint back and forth (power)	2-26
Adjusting the height up and down (manual).....	2-25
Adjusting the height up and down (power)	2-26
Center head restraints.....	2-27
Rear side window sunshade	3-150
Rear window sunshade.....	3-149
Recommended cold tire inflation pressures.....	7-38
Recommended lubricants and capacities	8-6
Recommended SAE viscosity number.....	8-7
Refrigerant label.....	8-9
Removable towing hook	6-24
Replacement light bulb	7-69
Reverse guide lamp	3-95
Reverse parking aid function	3-32
Rocking the vehicle.....	5-142
Rotation (Tire).....	7-39

S

Safe Exit Assist (SEA) system	3-14
Scheduled maintenance services	7-8
Seat belt warning light	2-33
Seat belts	2-32
Additional seat belt safety precautions	2-42
Care of seat belts	2-45
Do not lie down	2-44
Height adjustment	2-36
Keep belts clean and dry	2-45
Lap/shoulder belt	2-35
One person per belt	2-44
Periodic inspection	2-45
Pre-Active Seat belt (PSB)	2-41
Pre-tensioner seat belt	2-38
Rear center seatbelt	2-38
Seat belt restraint system	2-34
Seat belt safety precautions	2-32
Seat belt use and children	2-43
Seat belt use during pregnancy	2-42
Seat belt warning light	2-33
Transporting an injured person	2-44
When to replace seat belts	2-45
Seat coolers	2-30
Seat position memory system	3-16
Seat warmers	2-28
Seatback pocket	2-13
Seats	2-4
Armrest (rear seat)	2-21
Front seat adjustment	2-7
Head restraints	2-22
Rear seat adjustment	2-14
Safety precautions	2-6
Seat coolers	2-30
Seat warmers	2-28
Seatback pocket	2-13
Shift lock system	5-14
Side air bags	2-61
Side view mirror	3-29
Smart Cruise Control system	5-95

Smart key.....	3-3
Battery replacement	3-8
Immobilizer system.....	3-8
Locking your vehicle	3-3
Mechanical key	3-6
Opening the trunk.....	3-5
Panic button.....	3-5
Unlocking your vehicle	3-4
Smart posture care system.....	3-19
Smart trunk.....	3-48
Smooth cornering.....	5-143
Snow tires.....	5-145
Spare tire	
Compact spare tire replacement.....	7-42
Special driving conditions	
Driving at night	5-143
Driving in flooded areas.....	5-144
Driving in the rain	5-143
Hazardous driving conditions	5-142
Highway driving.....	5-144
Rocking the vehicle.....	5-142
Smooth cornering	5-143
Speedometer	3-55
Starting difficulties, see engine will not start.....	6-3
Steering wheel	3-20
Heated steering wheel	3-21
Horn.....	3-22
Motor-Driven Power Steering (MDPS)	3-20
Power steering.....	3-20
Tilt steering/Telescopic steering.....	3-21
Steering wheel remote control	4-4
Storage compartment.....	3-139
Center console storage	3-139
Glove box	3-140
Rear console storage	3-139
Sunglass holder	3-140
Sunglass holder	3-140
Sunroof inside air recirculation.....	3-137
Sunroof, see panorama sunroof.....	3-37
Sunvisor.....	3-142
Surround view monitor.....	3-114

T

Tachometer	3-56
Theft-alarm system.....	3-15
Tilt steering/Telescopic steering.....	3-21
Tire chains	5-146
Tire pressure monitoring system (TPMS).....	6-9
Changing a tire with TPMS	6-13
Low tire pressure position and tire pressure telltale	6-11
Low tire pressure telltale	6-11
TPMS malfunction indicator.....	6-12
Tire rotation	7-39
Tire specification and pressure label.....	8-8
Tires and wheels.....	7-37
All season tires	7-50
Check tire inflation pressure	7-39
Compact spare tire replacement.....	7-42
Low aspect ratio tires	7-51
Radial-ply tires	7-50
Recommended cold tire inflation pressures	7-38
Snow tires.....	7-50
Summer tires	7-50
Tire care.....	7-37
Tire maintenance	7-42
Tire replacement.....	7-41
Tire rotation.....	7-39
Tire sidewall labeling.....	7-42
Tire terminology and definitions.....	7-46
Tire traction	7-42
Wheel alignment and tire balance.....	7-40
Wheel replacement	7-42, 8-4
Towing.....	6-22
Transmission shift indicator	3-59
Trip computer	3-82
Accumulated Info display	3-83
Digital speedometer	3-84
Driving Info display	3-84
Fuel economy	3-82

Trunk	3-42
Emergency trunk safety release	3-46
Power trunk	3-42
Smart trunk	3-48
Trunk release lever	3-47
Trunk lamp	3-97
Turn signals	3-92

U

USB charger	3-144
USB port.....	3-2

V

Vanity mirror lamp (front).....	3-97
Vehicle certification label.....	8-8
Vehicle identification number (VIN)	8-8
Vehicle load limit	5-149
Vehicle settings.....	3-85
Vehicle Stability Management (VSM).....	5-36

W

Warning and indicator lights	3-60
Warning light.....	3-54
Washer fluid	7-28
Welcome system.....	3-99
Wheel alignment and tire balance.....	7-40
Wheel replacement.....	7-42
Windows.....	3-33
Power window lock switch	3-36
Windshield defrosting and defogging	3-133
Windshield washers.....	3-101
Windshield wipers.....	3-100
Winter driving	5-145
Snow tires.....	5-145
Tire chains	5-146
Wiper blades replacement	7-31
Wipers and washers.....	3-100
Windshield washers.....	3-101
Windshield wipers.....	3-100
Wireless cellular phone charging system.....	3-145