

VOICE RECOGNITION TIPS

BLUETOOTH®

Command **Example**
 Dial <Phone #> — “Dial
 7-1-4-0-0-0-8-8-8-8”
 Call <Name> — “Call John Smith”

Improving how you store your contacts can optimize your Bluetooth® Voice Recognition performance:

- Use full names instead of short or single-syllable names (“John or Dad”)
- Avoid using special characters/emojis or abbreviations (“Dr.”) when saving contacts

NAVIGATION

Command **Example**
 Find Address — “1-2-3-4-5 1st Street,
 <House #, Street, Fountain Valley”
 City, State
 Find <POI Name> — “Find McDonald’s”

Located on Rearview Mirror
DESTINATION SEARCH BY VOICE 
Command **Example**
 Find <POI Name> — “Find Lowe’s® near me”
 <POI Name> — “Starbucks®”

DEMONSTRATE AUTOMATIC CLIMATE CONTROL - page 15

HOW TO DEFROST

- 1 Press the front defrost button.
- 2 Set to warmest temperature setting.
- 3 Set to highest fan speed.

TIRE PRESSURE MONITORING SYSTEM (TPMS)- page 37

Low tire pressure indicator /
 TPMS malfunction indicator



NOTE: Tire pressure may vary in colder temperatures causing the low tire pressure indicator  to illuminate. Inflate tires according to the Tire Pressure Label located on the driver’s side door pillar.

EXPLAIN IDLE STOP AND GO (ISG) FEATURE – page 38

INTRODUCTION AND LOCATION OF THE SERVICE DEPARTMENT

SET FIRST SERVICE VALET APPOINTMENT

REVIEW FACTORY RECOMMENDED MAINTENANCE SCHEDULE

WAS THE CONDITION OF YOUR VEHICLE (AT DELIVERY) TO YOUR SATISFACTION?

GENESIS CONNECTED SERVICES

- Assist with creating a Genesis Owners account
- Assist with Genesis Connected Services enrollment
- Show Genesis Connected Services Users Manual
- Encourage customer to download the Genesis Intelligent Assistant App

MAINTENANCE

Scheduled Maintenance (Normal Usage)		2.0T / 3.3T
Engine Oil And Filter	Replace	6,000 or 12 mos.
Fuel Additives	Add	6,000 or 12 mos.
Tire Rotation	Perform	6,000 or 12 mos.
Vacuum Hose		
Air Conditioning Refrigerant		
Brake Hoses & Lines		
Drive Shafts & Boots		
Exhaust Pipe & Muffler		
Front Brake Disc/Pads, Calipers	Inspect	6,000 or 12 mos.
Rear Brake Disc/Pads		
Steering Gear Box, Linkage & Boots/ Lower Arm Ball Joint, Upper Arm Ball Joint		
Suspension Mounting Bolts		
Propeller Shaft		
Air Cleaner Filter	Inspect	6,000 or 12 mos.
	Replace	18,000 or 36 mos.
Climate Control Air Filter (For Evaporator And Blower Unit)	Replace	Every 12 mos.
Fuel Lines, Fuel Hoses And Connections		
Front(AWD)/Rear Differential Oil	Inspect	24,000 or 48 mos.
Valve Clearance (3.3T and 3.8L)	Inspect	60,000 or 72 mos.
Drive Belt	Inspect	First 60,000 or 72 mos.
	Inspect	Subsequent, every 12,000 or 24 mos.
Spark Plugs (Iridium Coated)	Replace	42,000
Coolant	Replace	First 120,000 or 120 mos. Subsequent, every 30,000 or 24 mos.
Automatic Transmission Fluid	No checks or services required for Normal Usage driving.	
*Check the engine oil regularly between recommended oil change. Genesis Branded Vehicle recommend Quaker State oil.		
*See Owner’s Manual for details.		

Looking For more detailed information? This Quick Reference Guide does not replace your vehicle’s Owner’s Manual. If you require additional information or are unsure of a specific issue, we recommend that you always refer to the vehicle’s Owner’s Manual or contact your authorized retailer of Genesis Branded Products. The information contained in this Quick Reference Guide is correct at the time of printing; however, specifications and equipment can change without notice. No warranty or guarantee is being extended in this Quick Reference Guide, and Genesis Brand reserves the right to change product specifications and equipment at any time without incurring obligations. Some vehicles are shown with optional equipment.

 Sales Consultant Date Sales Manager Date

 New Owner Date

 Email @

GENESIS G70

QUICK REFERENCE GUIDE



GENESIS BRANDED VEHICLE OWNER PRIVACY POLICY

Your Genesis Branded Vehicle may be equipped with technologies and services that use information collected, generated, recorded or stored by the vehicle. Genesis Branded Vehicle has created a Vehicle Owner Privacy Policy to explain how these technologies and services collect, use, and share this information.

You may read our Vehicle Owner Privacy Policy on the GenesisMotorsUSA.com website at <https://www.genesis.com/us/en/privacy-policy.html>
If you would like to receive a hard copy of our Vehicle Owner Privacy Policy, please contact Customer Care at:

Genesis Customer Care
P.O. Box 20850
Fountain Valley, CA 92728
844-340-9741
CustomerCare@genisismotorsusa.com

Genesis Customer Care representatives are available Monday through Friday, between the hours of 5:00 AM and 7:00 PM PST and Saturday and Sunday between 6:30 AM and 3:00 PM PST (English).
For Customer Care assistance in Spanish or Korean, representatives are available Monday through Friday between 6:30 AM and 3:00 PM PST.

Roadside Assistance: **1-844-340-9742**
SiriusXM® Radio: **1-800-967-2346**
Genesis Customer Care &
Connected Services: **1-844-340-9741**
www.MyGenesisusa.com



Instrument cluster
Page 11



Smart cruise control
Page 34



Navigation
Page 20

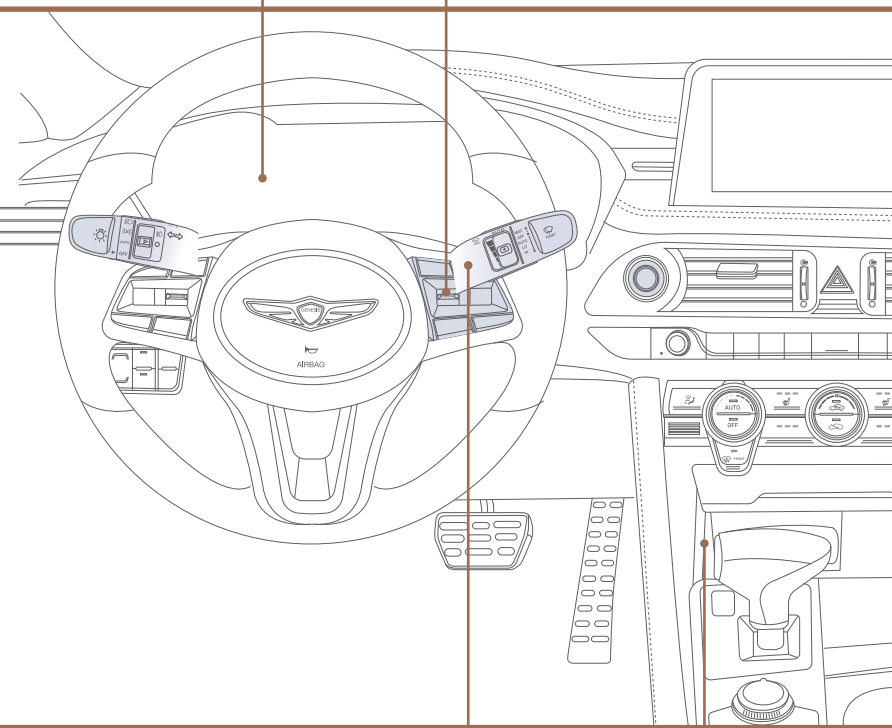

Wiper and washer
Page 09

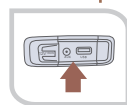

AUX and USB port
Page 18

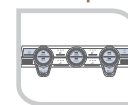
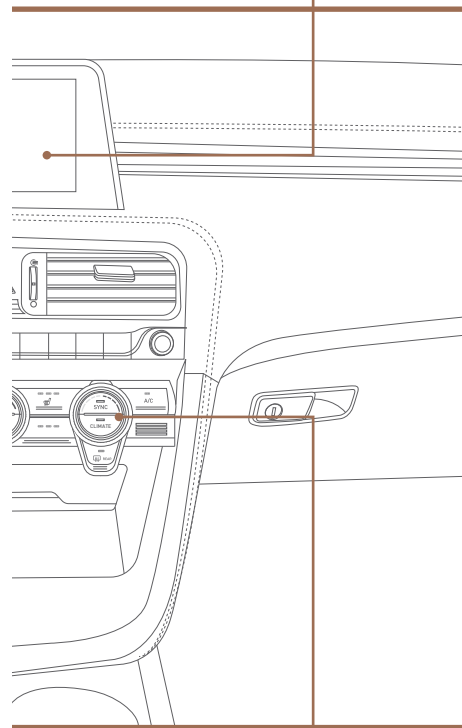

Climate control system
Page 15

FEATURES AND CONTROLS

Climate control system	15
Driver's main controls	07
Head-up display	14
Instrument cluster	11
Interior lights	08
LCD display control/modes	13
Panoramic sunroof	08
Occupant classification system	03
Seat-Climate control system seat	04
Seat-Driver position memory system	04
Seat-Front seat adjustment	02
Seat-Heatrest adjustment	02
Smart key	01
Smart trunk	06
Trunk operation	05
Warning and indicators	14
Wipers and washer	09
Wiper blades	10

INFOTAINMENT

Android Auto	25
Apple CarPlay™	27
Aux and USB Port	18
Bluetooth Phone Pairing	17
Genesis Connected Services	21
Homelink wireless garage control system	24
Navigation	20
Radio mode	19
Wireless cellular phone charging system	18

DRIVING

Auto hold	39
Blind-Spot Collision Warning (BCW)	35
Driver Attention Warning (DAW)	32
Electric parking brake (EPB)	39
Electronic stability control (ESC)	32
Forward Collision-Avoidance Assist (FCA)	36
Idle Stop and Go (ISG)	38
Lane Keeping Assist (LKA)	33
Parking assist system (PAS)	36
Rearview monitor	35
Shift by Wire (Electronic type shifter)	31
Smart cruise control	34
Tire Pressure Monitoring System (TPMS)	37

WARNING!

To reduce the risk of serious injury to yourself and others, read and understand the important SAFETY INFORMATION in your Owner's Manual.

Use this Quick Reference Guide to learn about the features that will enhance your enjoyment of your Genesis Branded Vehicle. More detailed information about these features are available in your Owner's Manual.





*Some vehicles may not be equipped with all the listed features.

This QRG provides instructional videos that are accessible by scanning the QR Codes found throughout the QRG with your smartphone/tablet.

In order to scan a QR Code, you will need to use a QR Code Reader App on your mobile device. You can download the app onto your device through an app store or marketplace.

SMART KEY



-  Lock
-  Unlock
-  Trunk open
-  Panic

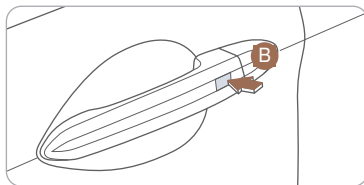

Driver's door Lock / Unlock
Smart key must be within 20~40 in. from the outside door handle.

Press: One time – Unlock driver door
Two times – Unlock all doors
Three times – Lock all doors

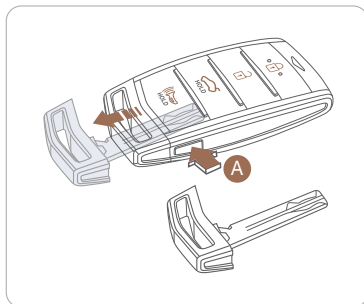





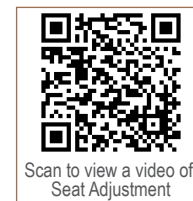
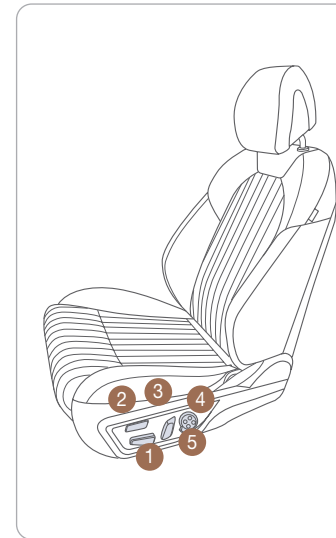

Remove mechanical key.
Press and hold the release button **A** to remove the mechanical key.

NOTE: The key hole is located under the key hole cover **B**.

FRONT SEAT ADJUSTMENT



- Forward and backward** **1**

- Seat cushion length** (if equipped) **2**

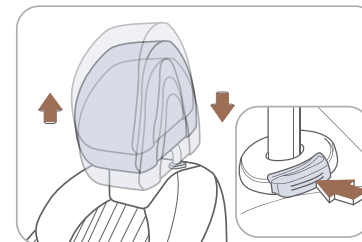
- Seatback angle** **3**

- Seat cushion height and tilt** **1**

- Lumbar support** **4**

- Seat bolster adjustment** (if equipped) **5**

HEADREST ADJUSTMENT



- To Raise Headrest:**
Pull headrest up.
- To Lower Headrest:**
Press lock button while pressing down on headrest.
- To adjust headrest forward (front seats only):**
Pull forward to 1 of 3 positions.
- To adjust headrest rearward (front seats only):**
Pull it fully forward to the farthest position and release it.

Easy Access Function (Driver's Seat)

Entering the vehicle

The driver's seat and steering wheel will move back to its original position when the Engine Start/Stop button is in the OFF position and the driver's door is closed with the smart key in possession.

Exiting the vehicle

The driver's seat will move rearward and the steering wheel will move upward when the driver's door is opened and the Engine Start/Stop button is in the OFF position with the gear in P (Park).

NOTE: The driver's seat may not move rearward if there is not enough space between the driver's seat and the rear seat.

You can activate/deactivate this function from the  User Settings mode in the cluster LCD display:

Seat Easy Access:

Convenience > Seat Easy Access > Off/Normal/Extended

Steering Easy Access:

Convenience > Steering Easy Access > On/Off

OCCUPANT CLASSIFICATION SYSTEM (OCS)

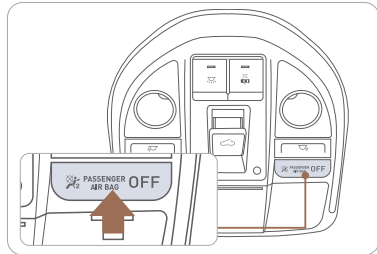

Your vehicle is equipped with an Occupant Classification System

(OCS) in the front passenger's seat that detects whether the passenger air bag system should be activated or deactivated.

The following items may affect the OCS operation:

- Car seat accessories such as thick blankets and cushions which cover up the car seat surface
- Placing materials such as water bottles on the seat
- Using electronic devices such as laptops and satellite radios which use inverter chargers
- Wet towels or liquid that has been spilled on the seat. Make sure the seat has been completely dried before driving the vehicle

DRIVER POSITION MEMORY SYSTEM

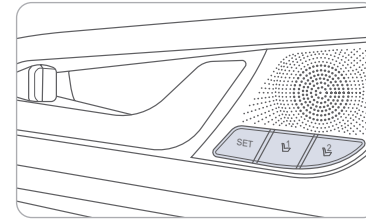

NOTE: For resetting, please see Owner's Manual for procedure.

Storing

1. Adjust the driver's seat, outside rearview mirrors, steering wheel, instrument panel illumination and head up display.
2. Press the SET button. The system will beep once.
3. Press one of the memory buttons (1 or 2) within 5 seconds. The system will beep twice.

NOTE: Transmission must be in P(Park).

Recalling

Press the desired memory button (1 or 2). The system will beep once.

CLIMATE CONTROL SYSTEM SEAT

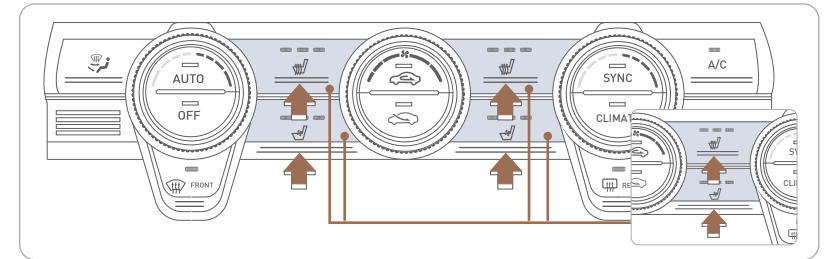

 - Heat  - Air Ventilation

Each time you push the button, the setting is changed as follows:

OFF → HIGH → MEDIUM → LOW



If you want to turn it off immediately, press and hold the button.

TRUNK OPERATION

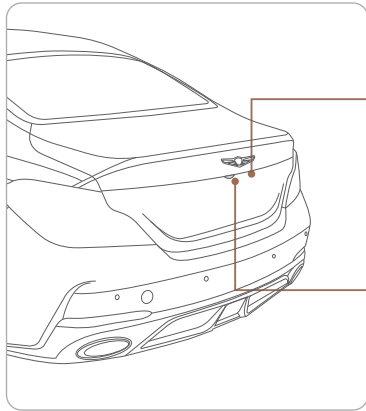

Power trunk open button

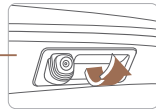

Press to open.
Smart key needs to be within the range.

Power trunk open button on the smart key



Press and hold.

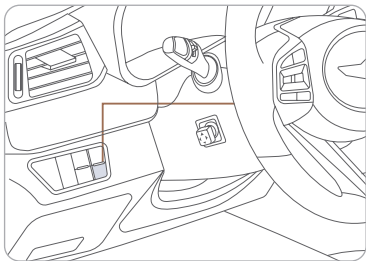

Power trunk main control button

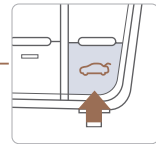

Press to open.
Press and hold to close.

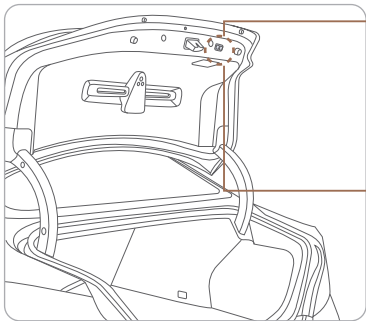

Power trunk close button

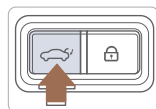

Press to close.

Power trunk lock button

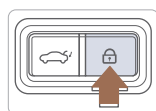

Press to lock the trunk
and doors will lock as
well.
Smart key needs to be
within range.

NOTES: Trunk opening height adjustment is available in the Vehicle setup options. Please refer to your Owner's Manual for further information.

SMART TRUNK

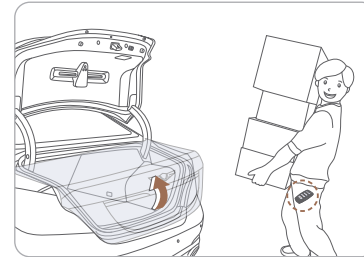

Scan to view a video of:
Smart Trunk

Smart Trunk

When smart key is within range for 3 seconds, the trunk will automatically open.

To enable Smart Trunk function:

Vehicle must be in P (Park) to adjust the settings located in the setup menu in the AVN system screen.

1. Select Setup > Vehicle > Door/Trunk
2. Check "Smart Trunk".

NOTE: Function is active after 15 seconds when all doors are closed and locked. The vehicle will also provide an audible and visual alarm while activating. Please refer to your Owner's Manual for further information.

DRIVER'S MAIN CONTROLS

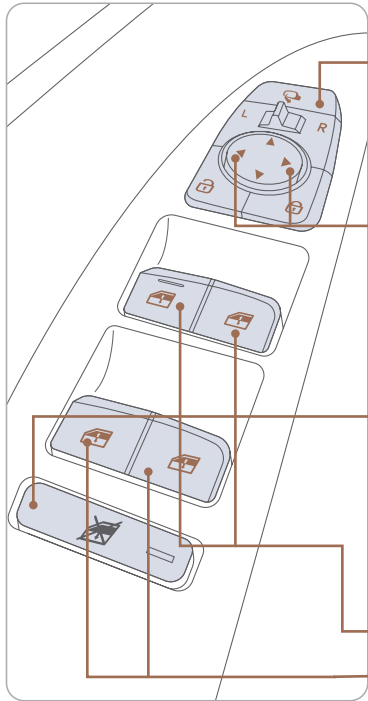

Outside Rearview Mirror

- Press switch left/right to unfold/fold mirrors. Press the lock or unlock button on the smart key, and the mirrors will be folded or unfolded when AUTO is set.
- Press the L or R button to adjust the mirror by using the directional switch. If L or R button is still selected, both mirrors will tilt downward when reversing. Deselect L or R will disable the auto tilt down feature.

Power window lock button

Disables the power window switches on the rear passenger doors.

Door Lock

Locks/unlocks all doors.

Window Switches

- Front power window switches.
- Rear power window switches.

PANORAMIC SUNROOF

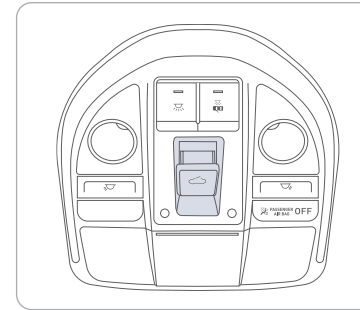

Sunshade



To open the sunshade, pull the sunroof control lever lightly backward to the first detent position. Push the sunroof control lever forward to close.

Sliding the sunroof



Pull the sunroof control lever backward past the first detent to slide open the sunroof control lever forward to the second detent position to close sunroof glass with the sunshade.

Tilting the sunroof



Push the sunroof control lever upward to tilt open the sunroof. Push again the sunroof control lever upward to tilt the sunroof glass closed.

INTERIOR LIGHTS

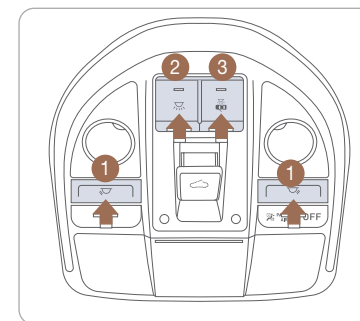

Front map lamp ①

Press the button to turn the map lamp on or off.

Front door lamp (☺) ②

Lights will turn on when any door is open.

Front room lamp (☼) ③

Push the switch to turn the room lamp on.

Front room lamp (☾)

Push the switch to turn the room lamp off.

WIPERS AND WASHER

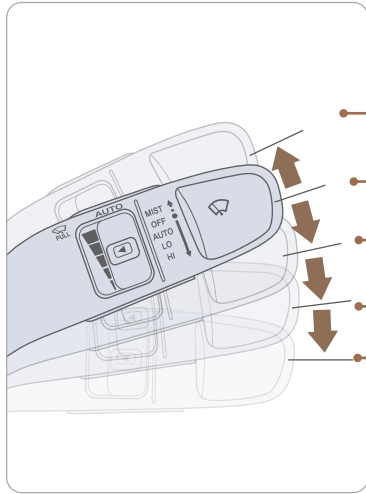

- **MIST** - Single wipe
- **OFF**
- **AUTO** - Auto control wipe
- **LO** - Low wiper speed
- **HI** - High wiper speed

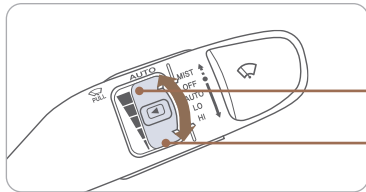

Auto control wipe interval adjustment
Adjust the control knob.

- Fastest wiper speed
- Slowest wiper speed

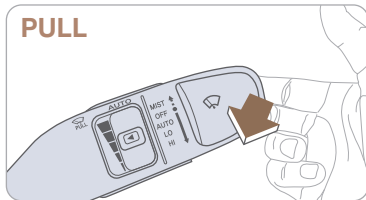

Windshield washer
Pull the lever gently toward you to spray washer fluid on the windshield and to run the wipers 1-3 cycles.

WIPER BLADES

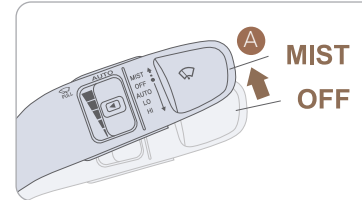

MIST
OFF

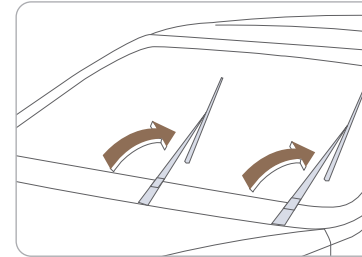

NOTE: To prevent damage to the hood and wiper arms, the wiper arms should only be lifted when in the top wiping position.



This vehicle has a “hidden” wiper design which means they cannot be lifted in their bottom resting position

Wiper Blade Removal

1. Within 20 seconds of turning off the engine, lift and hold the wiper lever up to the MIST **A** position for about 2 seconds until the wipers move to the top wipe position.
2. At this position, you are able to lift the wipers off the windshield.
3. Gently put wipers back down onto windshield.
4. Turn the wipers to any ON position to return to resting position.

INSTRUMENT CLUSTER

7" LCD Display

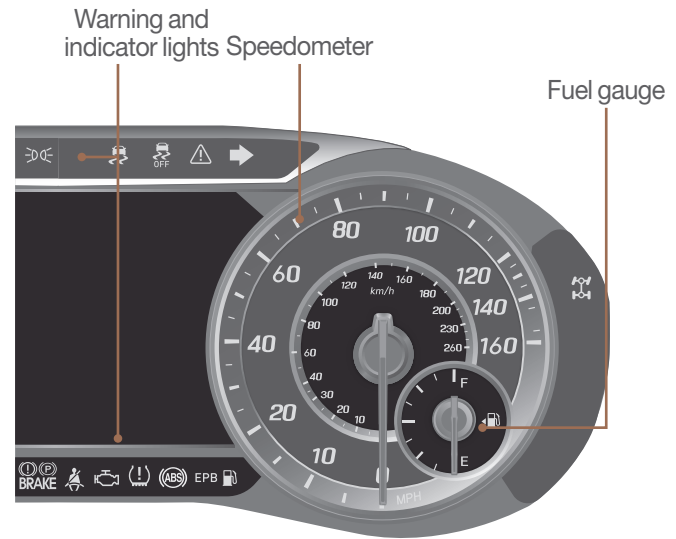
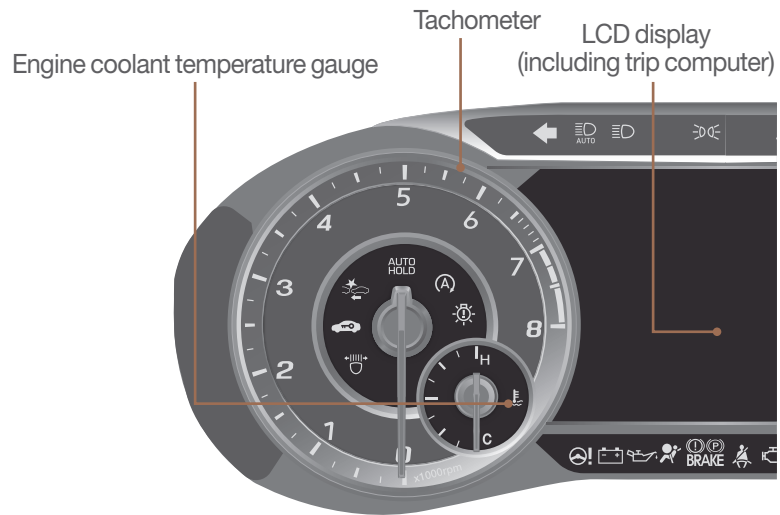

LCD DISPLAY MODES

Modes	Symbol	Explanation
Trip Computer		This mode displays driving information like the tripmeter, fuel economy, and so on.
Turn By Turn (TBT) (if equipped)		This mode displays the navigation turn by turn guidance.
Assist (if equipped)		This mode displays the state of the Driver Attention Warning (DAW) and Tire Pressure Monitoring System (TPMS).
Warning		Display service internal warning messages and tire pressures.
User Settings		Changes settings.

LCD DISPLAY CONTROL

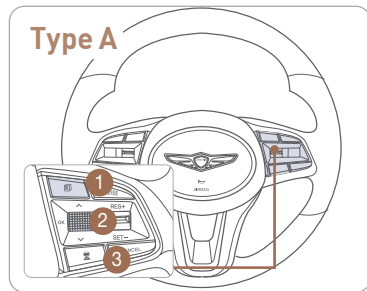

- 1 : MODE button for changing modes
- 2 : MOVE switch for changing items
- OK (Press) : SELECT/RESET button for setting or resetting the selected item
- 3 : BACK button for moving to upper level menu (if equipped)

WARNINGS AND INDICATORS

Air bag warning light	Seat belt warning	Parking brake & Brake fluid warning light
Anti-lock Brake System (ABS) warning light	Electronic Brake Force Distribution (EBD) system warning light	
Electric Power Steering (EPS) warning light	Malfunction Indicator Lamp (MIL)	Charging system warning light
Engine coolant temperature warning light	Engine oil pressure warning light	Low fuel level warning light
ECO indicator	Door open warning light	Trunk open warning light
AWD warning light	Electric Parking Brake (EPB) warning light	Forward Collision-Avoidance Assist (FCA)
Master warning light	Electronic Stability Control (ESC) indicator	Electronic Stability Control (ESC) OFF indicator
Immobilizer indicator	Turn signal indicator	Low beam indicator
High beam indicator	Light ON indicator	High Beam Assist
Front fog light indicator	Cruise indicator	Adaptive Front Lighting System
AUTO HOLD indicator	SPORT mode indicator	Lane Keeping Assist (LKA)
Low Tire Pressure Warning Indicator/TPMS Malfunction Lamp		LED Headlight warning indicator

HEAD UP DISPLAY

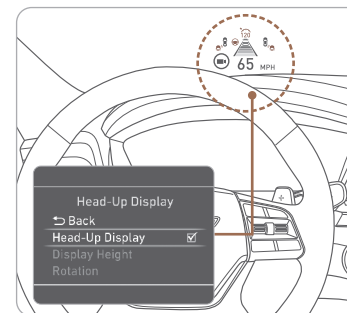

The head up display is a transparent display which projects an image of selected information from the instrument cluster and navigation on the windshield glass.

To activate the head up display, select "Head-up Display" on the "User Settings Mode" in the LCD display. Adjust "Head-up Display" height until in view.

NOTE: If you wear polarizing-filter sunglasses, it may be difficult to read the Head Up Display information.

CLIMATE CONTROL SYSTEM

Front

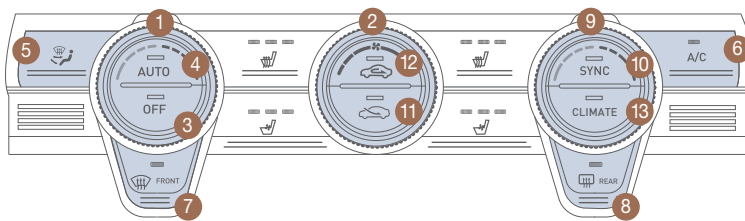

- 1 Driver's temperature control knob
- 2 Fan speed control button
- 3 OFF button
- 4 AUTO (automatic control) button
- 5 Mode selection button
- 6 Air conditioning button
- 7 Front windshield defrost button
- 8 Rear window defrost button
- 9 Passenger's temperature control knob

DEFOGGING/DEFROSTING

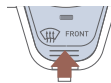

1. Press the front defrost button.

NOTE: Outside (fresh) air position will be selected when front defrost button is selected.

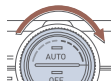

2. Select warmest temperature.

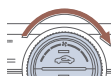

3. Set the fan speed to the highest speed.

NOTE: To reduce the glass fogging and improve visibility, keep the interior surface of the windshield clean by wiping it with a clean cloth and glass cleaner. In addition, select air intake control to the outside (fresh) air position whenever possible while operating the vehicle.

SYSTEM OFF

Pressing the OFF button will place the system in the OFF mode.

- Front blower will turn off.
- Outside (fresh) air position will be selected.
- Vented air will be at last set temperature.

Rear

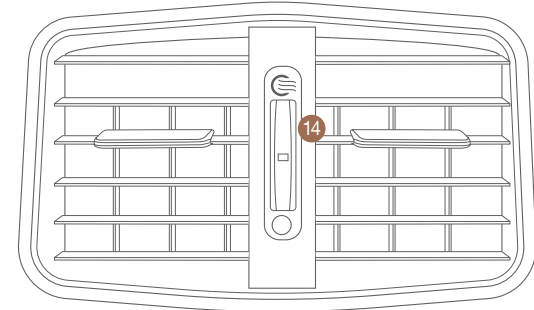

- 10 SYNC button (sync driver and passenger front air temperature)
- 11 Air intake control button (Outside air)
- 12 Air intake control button (Recirculated air)
- 13 Climate information screen selection button
- 14 Rear vent ON/OFF thumbwheel

MODE SELECTION



Changing the direction of the air flow as follow.

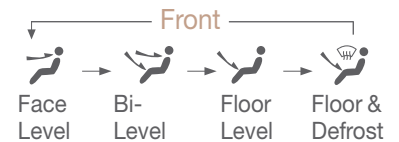

AIR INTAKE CONTROL



Recirculated air position



Outside (fresh) air position (type A)

AUTOMATIC HEATING / AIR CONDITIONING

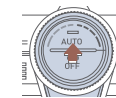

Automatically controls the modes, fan speeds, air intake and air-conditioning functions.

AUTO DEFOGGING SYSTEM (ADS)

Auto defogging helps reduce the possibility of fogging up the inside windshield automatically. This system operates when the heater or A/C is on.

SMART VENT

When cabin humidity increase while Climate Control is off, fresh air will be circulated into the cabin. This feature is located in the climate information screen.

Please refer to the Owner's Manual for more information.

BLUETOOTH PHONE PAIRING

Pairing a new device

NOTE: Vehicle must be in (P) Park to complete pairing process.

1. Press the PHONE button in the head unit (or DIS navigation system) or  button in the steering wheel remote control.

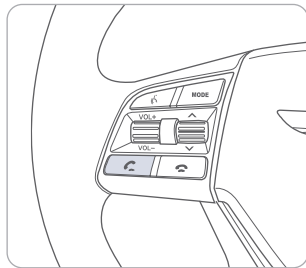
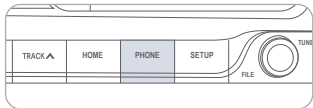

2. Search for the device name as displayed on your mobile phone and pair.



3. Confirm the 6-digit passkey displayed on the audio screen and the Bluetooth device identical.

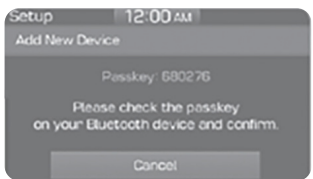

4. Press OK in your Bluetooth device.
5. Pairing is complete.

AUX AND USB PORT

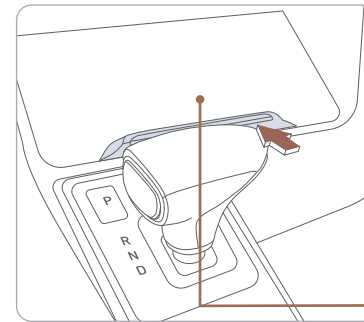

Use the input jack to connect an external audio device and listen to it through the audio system in your vehicle.

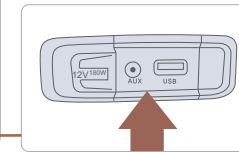

NOTE: To operate your smartphone through the vehicle's audio system, connect your Apple supplied USB cable to the USB port.

WIRELESS CELLULAR PHONE CHARGING SYSTEM

The system operates when all doors are closed, and the Engine Start/Stop button is in the ACC/ON position. When the charging process is completed, the indicator light changes from green to orange. If there is a malfunction, the indicator light turns orange and blinks for 10 seconds. In this case, remove the phone from the charging pad and then placing it back onto the pad. The wireless charging function can be turned ON or OFF.

NOTE: The wireless cellular phone charging system supports only the Qi-enabled cellular phones ().



Scan to view a video of:
Wireless Charging

RADIO MODE

How to set Preset



1. Press the **A** RADIO button.
2. Rotate **B** TUNE knob to select desired station from FM/AM/SiriusXM.
3. Press and hold on **C** screen to set Preset.

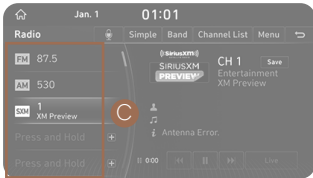

NAVIGATION

Map position

Standard AVN



- | | |
|---|--|
| <ol style="list-style-type: none"> 1 Move to the Home Screen 2 Map view mode
The map view can be switch between Head Up, North Up, and 3D View. 3 Navigation Voice Guidance On/Off 4 Zoom in the map 5 Map scale
Set the zoom level automatically according to the guidance. 6 Zoom out the map | <ol style="list-style-type: none"> 7 [MENU] button 8 Unified Search 9 Touch to scroll the map 10 Set a waypoint to the current route 11 Save frequently used address to address book 12 Find a POI (Point Of Interest) around the current position 13 Vehicle position |
|---|--|

GENESIS CONNECTED SERVICES

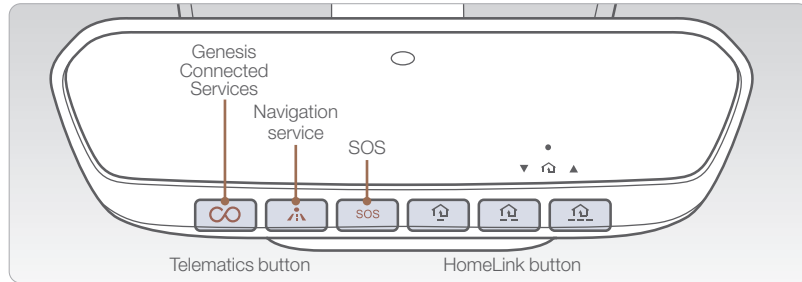

Genesis Connected Services subscription is required. To enroll, please visit your dealership or MyGenesisUSA.com.

Press the **∞** button for access to the voice-response menu of services.

- You can say:

- Roadside Assistance
- Service Link
- Account Assistance

Press the **📍** button for Destination Search by Voice.

Press the **SOS** button for SOS Emergency Assistance.

Visit MyGenesisUSA.com for more information or refer to your Genesis Connected Services User's Manual for detailed information on system operation.

For immediate assistance with subscription services, please call 1-844-340-9741.

Genesis Intelligent Assistant App

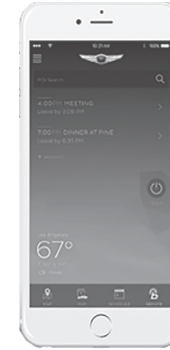

You can download the Genesis Intelligent Assistant App to your compatible smart phone from the following sites:

- iPhone® — Apple® App Store
- Android™ — Google Play™

Remote Start

Remote Start enables you to remotely start your vehicle virtually from anywhere. For vehicles equipped with full-automatic temperature control, you can also enable climate control remotely and turn on the front window defroster, ensuring a warm or cool car is ready to go when you are.

- To use this feature, you must have a Genesis Connected Services Personal Identification Number (PIN). To create or change your PIN, log in to MyGenesisUSA.com.

Remember:

- Remote Start will automatically shut off after 10 minutes or after selected engine timer runs out in navigation vehicles.
- While this feature is active, the parking lights will blink until the vehicle is turned off or when vehicle is in operation.
- To continue to operate the vehicle, the proximity key must be inside the vehicle with the driver, prior to pressing the brake and being able to move the gearshift from the P (Park) position.

NOTE: Remote Start is only available for push button start equipped vehicles with an Automatic Transmission or a Dual Clutch Transmission (DCT).

Preconditions:

- Ignition is OFF
- Alarm is armed (i.e., vehicle locked by key fob or Remote Door Lock)
- Gearshift level is in the P (Park) position
- Brake pedal is not depressed
- Engine hood is securely closed
- All the doors are closed and locked
- The tailgate or trunk lid is closed
- The security / panic system is not activated
- The proximity key is not inside the vehicle
- The battery power is not low
- Vehicle is located in an open area
- It has been less than 4 days since last vehicle ignition off
- Vehicle located in area with good cell reception

Remote Start will terminate:

- After 10 minutes or after selected engine timer runs out in navigation vehicles
- Brake is pressed without the proximity key inside the vehicle
- Alarm is triggered without the proximity key inside the vehicle
- Door / trunk is opened from inside the vehicle

Notice: Laws in some communities may restrict the use of the features that remotely start the engine. For example, some laws may require a person using the remote start feature to have the vehicle in view when doing so, or limit the length of time a vehicle engine may idle. Please check local and state regulations for any requirements and restrictions on remote starting of vehicles and engine idling time.

WARNING!

Do not remote start vehicle in an enclosed environment (i.e., closed garage). Prolonged operation of a motor vehicle in an enclosed environment can cause a harmful build-up of carbon monoxide. Carbon monoxide is harmful to your health. Exposure to high levels of carbon monoxide can cause headaches, dizziness or in extreme cases unconsciousness and / or death. Do not leave children or animals unattended in a vehicle while using the remote start function.

CAUTION!

If the vehicle's windshield wipers are left on when the vehicle was last driven, then the wipers will turn on if the remote start function is activated. To avoid damage to the wiper blades (i.e., due to heavy ice or snow accumulated on the windshield), please always turn the vehicle's windshield wipers off when parking the vehicle.

HOMELINK WIRELESS GARAGE CONTROL SYSTEM

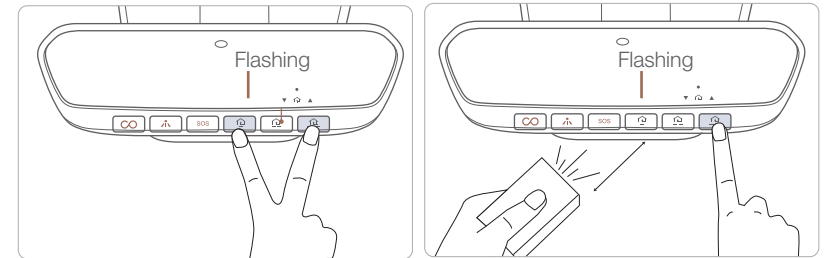

Standard Programming

1. For first time programming, press and hold the two outside buttons (,) until the indicator light starts to flash. (to reprogram buttons, skip this step)
2. Press and hold the desired button (, or) and your transmitter's button at the same time until the Homelink indicator light changes from a slow to a rapid blink.

(The transmitter has to be 1 to 3 inches away from the mirror)The desired Homelink button is now programmed.

NOTE: If you have a rolling code garage door opener, complete additional steps:

3. Locate the “Learn” or “Smart” button on your garage door opener. Press and release the button and complete Step 4 within 30 seconds.
4. Return to the vehicle and press the programmed Homelink button up to 4 times (or until the garaged door operates)

For more detailed information, please refer to your Owner's manual or visit www.homelink.com or call (800) 355-3515

ANDROID AUTO™

REQUIREMENTS:

- USB cable
- OS Android™ 5.0 or higher
- Compatible Android Phone
- Data and wireless plan for applicable features

BEFORE YOU BEGIN:

- Android Auto features may operate differently than on your phone.
- Message and data charges may apply when using Android Auto.
- Android Auto relies on the performance of your phone. If you experience performance issues:
 - Close all apps and then restart them or
 - Disconnect and then reconnect your phone
- Using the USB cable that was provided with your phone is recommended.
- When Android Auto is active, your in-vehicle voice recognition system is disabled and you will be using talk to Google™ to make your requests.

ANDROID AUTO SUPPORT



<https://support.google.com/androidauto/>

PHONE SETUP

Turn on Bluetooth® on your phone and connect the micro USB cable to your phone and the USB port on the vehicle.

Phone will prompt you to download the Android Auto app and update other needed apps (i.e. Google Maps™, Google Play Music™, Google Now™).

NOTE: Vehicle must be parked.

- Location mode setting should be set to High accuracy.
- Car and phone setup should be completed in one sitting. If phone setup needs to be resumed, recommend to Force Stop the Android Auto app on the Phone then reopen the app and accept the Disclaimer notifications.

CAR SETUP

1. Press the SETUP button.
2. Touch the “Phone Projection” icon on screen.
3. Select “On” for Android Auto.
4. Connect your Android phone to the vehicle USB port. Agree to the notification and disclaimers on your phone then the “Android Auto” icon will appear confirming the setup.

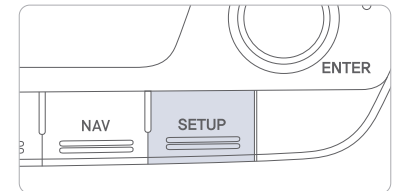

For more detailed information on how to operate Android Auto, please refer to your navigation manual.

For additional Android Auto support, please refer to the Android Auto Support Website
<https://support.google.com/androidauto/>

Android Auto, Google Play, Android, and other marks are trademarks of Google Inc.

APPLE CARPLAY™

REQUIREMENTS

- Apple Lightning® cable
- Latest iOS
- iPhone® 5 or above
- Data and wireless plan for applicable features

BEFORE YOU BEGIN

- Apple® CarPlay features may operate differently than on your phone.
- Message and data charges may apply when using Apple CarPlay.
- Apple CarPlay relies on the performance of your phone. If you experience performance issues:
 - Close all apps and then restart them or
 - Disconnect and then reconnect your phone
- Using the Apple Lightning cable that was provided with your phone is recommended.
- When Apple CarPlay is active, your voice recognition system is disabled and you will be using Siri® to make your requests.

PHONE SETUP

On your phone, go to Settings > General > CarPlay to allow CarPlay access.

On your phone, go to Settings > Siri and ensure Siri is turned ON.

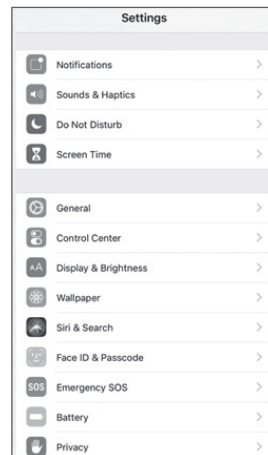

CAR SETUP

1. Press the SETUP button.
2. Touch the “Phone Projection” icon on the screen.
3. Touch “Apple CarPlay” on the Connectivity Settings screen. Then touch “On” to enable Apple CarPlay.
4. Connect your Apple iPhone to the vehicle USB port then touch ‘OK’ when the pop-up message appears. The Apple CarPlay icon will now appear on the vehicle Home screen confirming the setup.

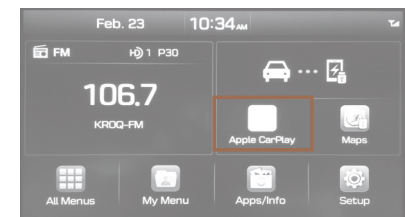
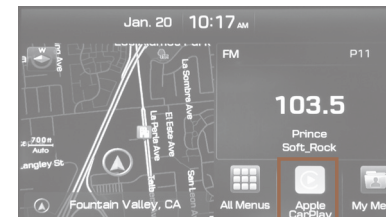

Apple CarPlay, Apple, and other marks are trademarks of Apple Inc.

CarPlay Home Screen



- | | |
|-------------------------|----------------------------------|
| 1 HOME ICON | 7 APPLE MAPS |
| 2 WIRELESS CONNECTIVITY | 8 MESSAGES |
| 3 CELLULAR SIGNAL | 9 3RD PARTY APPS |
| 4 PHONE TIME | 10 SCREEN PAGE INDICATOR |
| 5 PHONE | 11 EXIT TO HOME SCREEN |
| 6 APPLE MUSIC™ | 12 CURRENT CARPLAY AUDIO PLAYING |

SIRI

Apple CarPlay uses Siri to perform many actions like sending messages, placing calls, and looking up/setting POI/Destinations. A Siri session can be initiated on any screen by:

1. Touch and holding the HOME icon 1 on the CarPlay screen or
2. Press the steering wheel VOICE RECOGNITION 13 button.

Note: Ensure Siri feature is set to ON in your phone (Go to Settings > General > Siri).

3. Say any of the following commands;
 - “Text <John Smith> ‘Call you later’” to send a text message.
 - “Read text messages” to read available text message.
 - “Call <John Smith>” to make a phone call.
 - “Find <POI/Destination>” to locate a POI/Destination.

PHONE

Touch the PHONE 5 icon to access the Phone screen. Siri will automatically asks ‘Who you would like to call’ when the PHONE 5 icon is selected.

NOTE: Phone call sound quality is dependent on the wired connection. Using the Lightning cable that came with the phone is recommended.

APPLE MUSIC

Touch the APPLE MUSIC 6 icon to access the Apple Music screen.

APPLE MAPS

Touch the APPLE MAPS 7 icon to access the Apple Map screen.

MESSAGES

Touch the MESSAGES 8 icon to access the Message screen. Siri will automatically asks ‘To hear unread messages or create a new one’ when the MESSAGE icon is selected.

3rd PARTY APPS

Supported CarPlay apps that are downloaded on your phone will appear on the CarPlay screen. Touch the apps icons to access those supported apps.

NOTE: A list of the supported CarPlay supported apps can be found at <http://www.apple.com/ios/carplay/>

Ensure phone has latest version of the 3rd Party Apps.

SHIFT BY WIRE (Electronic type shifter)

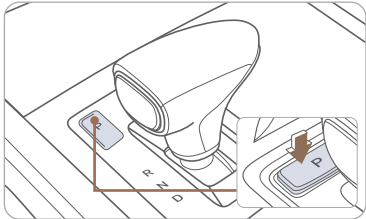

P (Park)

Always stop completely before shifting into P (Park). To shift the gear from R (Reverse), N (Neutral), D (Drive) or Manual mode to P (Park), press the [P] button while depressing the brake pedal.

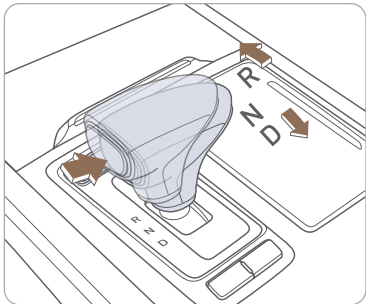

R (Reverse) / N (Neutral) / D (Drive)

To select gear, press the [UNLOCK] button while depressing the brake pedal and then move the shift lever forward (R side) or backward (D side).



Scan to view a video of Shift by Wire

Paddle Shifter (Manual Shift Mode)

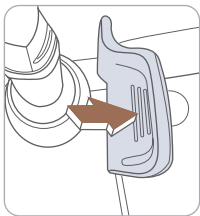

Press (-) to downshift

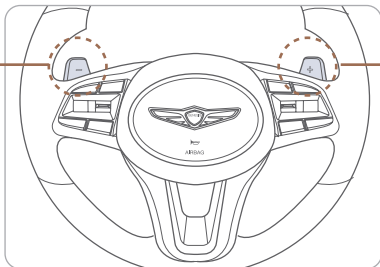

The Paddle shifter is available when the shift lever is in the D position.

Press the [+] or [-] paddle shifter once to shift up or down one gear.

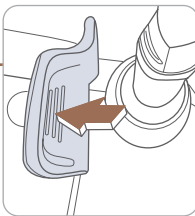

Press (+) to upshift

DRIVER ATTENTION WARNING (DAW)

The Driver Attention Warning (DAW) system is designed as a safety feature to help reduce drowsy or inattentive driving.

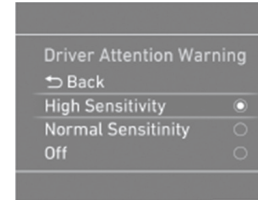

- To adjust the Driver Attention Alert sensitivity, go to: User Settings > Driving Assist > Driver Attention Warning > Normal or High in the instrument cluster.

OFF - Driver Attention Warning system is deactivated.

NORMAL - Driver Attention Warning system alerts the driver of his/her fatigue level or inattentive driving practices.

HIGH - Driver Attention Warning alerts the driver of his/her fatigue level or inattentive driving practices faster than Normal mode.

The Driver Attention Warning system is operable, when driving speed is above 40 mph.

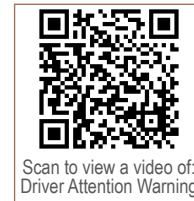

Scan to view a video of Driver Attention Warning

ELECTRONIC STABILITY CONTROL (ESC)

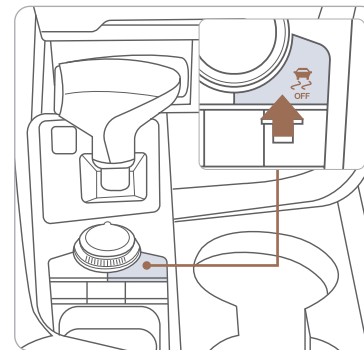

The ESC system is an electronic system designed to help the driver maintain vehicle control under adverse conditions.

Press  to turn ESC on or off.

LANE KEEPING ASSIST (LKA)

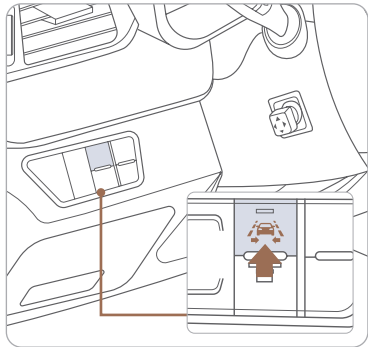

The Lane Keeping Assist (LKA) system helps detect lane markers on the road, and assists the driver's steering to help keep the vehicle between lanes.

- To turn LKA on, press the LKA switch.
- To turn LKA off, press the switch again.

LKA operates only when the vehicle speed is above 40 mph and when the LKA icon in the instrument cluster is green. LKA will not operate properly if the following conditions are present:

- the lane line is not clear
- on sharp bend in a road
- heavy fog

NOTE: The LKA system may not operate properly if the lane and road conditions are poor.

If the driver takes their hands off the steering wheel for several seconds while the LKA system is activated, the system will warn the driver.

NOTE: If the steering wheel is held very lightly the message may still appear because the LKA system may not recognize that the driver has their hands on the wheel.

Refer to the Owner's Manual for more detailed information.

NOTE: During operation, you may feel the sensation of steering wheel movement. Depending on the road condition (gradient), the deflection driving may occur. LKA settings can be adjusted in the User Settings page of the instrument cluster.



Scan to view a video of Lane Keeping Assist

SMART CRUISE CONTROL

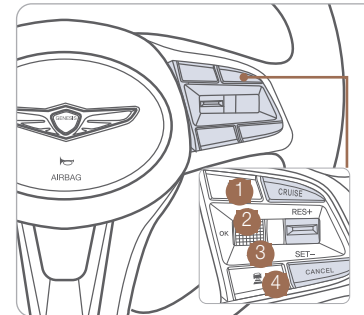

The cruise control system allows you to program the vehicle to maintain a constant speed without holding the accelerator pedal.

- 1 To turn On/Off cruise control.
- 2 Toggle switch UP to Resume or Increase the cruise control speed.
- 3 Toggle switch DOWN to Set or Decrease the cruise control speed.
- 4 To Cancel the Cruise Control.

Setting Cruise Control

1. Press the "CRUISE" button 1 to turn on Cruise Control. The icon will illuminate in the instrument cluster.
2. Toggle "-SET" switch (3) DOWN to set cruising speed.

Adjusting the vehicle speed

1. Toggle "+RES" switch 2 UP to increase cruising speed.
2. Toggle "-SET" switch 3 DOWN to decrease cruising speed.

NOTE: Quick toggle up/down will change speed by 1 mph. Holding switch up/down will change speed by 5 mph.

To Cancel Cruise Control

Press the "CANCEL" button 4 or depress the brake pedal.

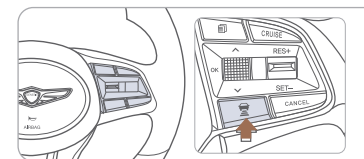

Setting vehicle distance (SMART CRUISE CONTROL only)

This system assist you in setting the distance from the vehicle ahead and will maintain the selected distance without you depressing the accelerator or the brake pedal.

However, in stop and go traffic if the vehicle stops for more than 3 seconds, you must depress the accelerator pedal or push the toggle switch to start driving. The vehicle to vehicle distance will automatically activate when you set the cruise speed.

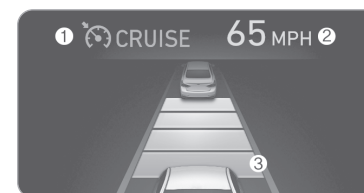

Each time the vehicle distance set button is pressed, the vehicle to vehicle distance changes as follows:



BLIND-SPOT COLLISION WARNING (BCW)

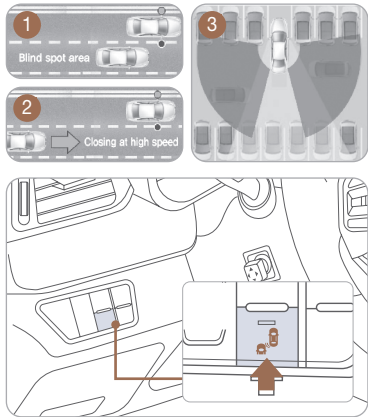

The BCW (Blind-Spot Collision Warning) system uses radar sensors to alert the driver while driving. It senses the rear side territory of the vehicle and provides information to the driver.

- 1 Blind-Spot Collision Warning
- 2 Lane change assist
- 3 Rear Cross-Traffic Collision Warning (RCCW)

- To turn the BCW on, press the BCW button. (indicator illuminated)
- To turn the BCW off, press the BCW button again.

The BCW system will activate once vehicle speed exceeds 20 mph.

The The RCCW (Rear Cross-Traffic Collision Warning) alert will activate, if vehicle is in reverse at speeds below 6 mph and BCW is activated.

NOTE: The RCCW system will only activate on the first reverse application from park.

Please refer to your Owner's Manual for further information.

REAR VIEW MONITOR

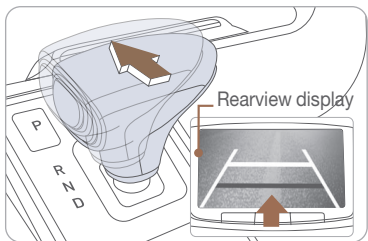

The rearview camera will activate when the engine is running and the shift lever is in the R (Reverse) position.

NOTE: Rearview display is selectable, see Owner's Manual for further details. The image displayed on the screen may become difficult to see under the following conditions:

- In the dark or at night.
 - When it is raining, or when water droplets are on the camera.
 - When the sun or the beam of headlights are shining into the camera lens.
- Use care to keep the camera lens clean and avoid applying any type of solvents, car wax, or window cleaners to the camera lens. If the lens becomes dirty, wipe the lens with a clean, soft cloth.



Scan to view a video of: Rear Cross Traffic Collision Warning (RCCW)

FORWARD COLLISION-AVOIDANCE ASSIST (FCA)

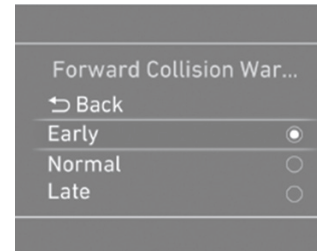

The Forward Collision Avoidance (FCA) system is designed to help detect and monitor the vehicle ahead and warn the driver if a collision is imminent. On vehicles equipped with both camera and radar sensor, pedestrian detection is also available.

To operate the system, select the FCA (Forward Collision Avoidance Assist) sub menu in the LCD cluster display under User Settings. Please refer to your Owner's Manual for further information.

Early: This setting maximizes the amount of distance between the vehicle or pedestrian ahead before the initial warning occurs.

Normal: This setting allows for a nominal amount of distance between the vehicle or pedestrian ahead before the initial warning occurs.

Late: This setting reduces the amount of distance between the vehicle or pedestrian ahead before the initial warning occurs.

PARKING ASSIST SYSTEM (PAS)

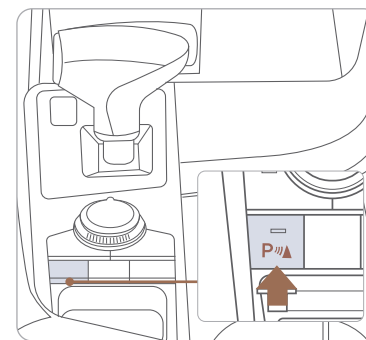

The parking assist system assists the driver during movement of the vehicle by chiming if any object is sensed within the distance of 3.3 ft in front and 4 ft behind the vehicle.

Press button to turn ON/OFF:
 ON – indicator light on
 OFF – indicator light off
 If the PAS is OFF, the system will turn ON automatically when the shift lever is in R (reverse).

NOTE: Front parking sensor will not operate if the PAS is OFF.

The system will automatically turn OFF when vehicle is driven forward at speed above 6 mph.

TIRE PRESSURE MONITORING SYSTEM (TPMS)

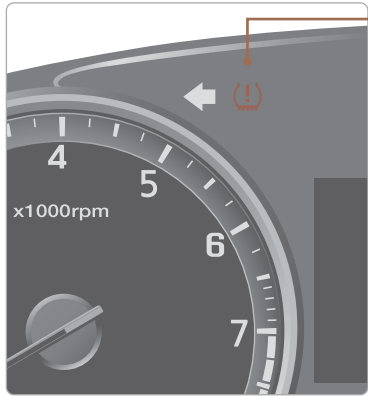

Low Tire Pressure Indicator /
TPMS Malfunction Indicator



Low Tire Pressure Position Telltale and
Tire Pressure Telltale
(Shown on the LCD display)

NOTE: Vehicle must
be driven for accurate
tire pressure reading.

LOW TIRE PRESSURE INDICATOR

Illuminates if one or more of your tires are significantly under-inflated.

TPMS MALFUNCTION INDICATOR

Blinks for approximately one minute, then remains illuminated when there is a malfunction with the TPMS. Inspect all tires and adjust tire pressure to specification. If the lamp remains illuminated, have the system checked by an authorized retailer of Genesis Brand Products as soon as possible.

LOW TIRE PRESSURE POSITION INDICATOR AND TIRE PRESSURE INDICATOR (LCD DISPLAY)

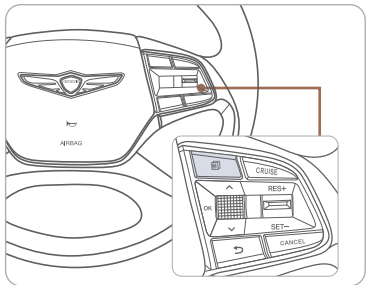

To access the TPMS menu within the LCD display, press the Assist mode button on the steering wheel to display tire pressure.

Tire pressures will display after driving a short distance. If a tire pressure drops lower than predetermined specification, the Low Tire Pressure Indicator (LTP) will illuminate and the LCD display will indicate tire(s) requiring air.

IDLE STOP AND GO (ISG)

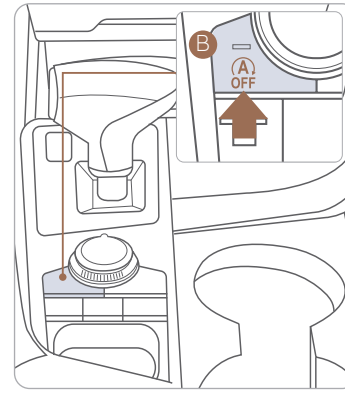

Scan to view a video of:
Idle Stop and Go

The ISG system will automatically shut off the engine when the vehicle is at a standstill (i.e. red stop light, stop sign, and traffic jam) to increase vehicle's fuel economy and reduce exhaust gas emissions. The auto stop indicator (A) will illuminate in green on the instrument cluster when activated. When the system is engaged, the indicator will illuminate green. To restart the engine in auto stop mode, release the brake pedal and press on the accelerator. The auto stop indicator goes OFF on the instrument cluster once the engine is restarted.

Prerequisite for activation:

- The driver's seatbelt is fastened.
- The driver's door and the hood are closed.
- The brake vacuum pressure is adequate.
- The battery is sufficiently charged.
- The outside temperature is between 14°F and 95°F (-10°C and 35°C).
- The engine coolant temperature is not too low.
- The system is not in the diagnostic mode.
- Steering wheel is turned less than 180 degrees.
- Shift lever is in DRIVE or NEUTRAL

The indicator will illuminate orange if the system requirements are not met.

To deactivate

Press the ISG OFF (B) button, indicator illuminates.

To activate

Press the ISG OFF (B) button, indicator turns OFF.

Note: If ISG is deactivated, it will be turned on again the next time the vehicle is turned on.

ELECTRIC PARKING BRAKE (EPB)

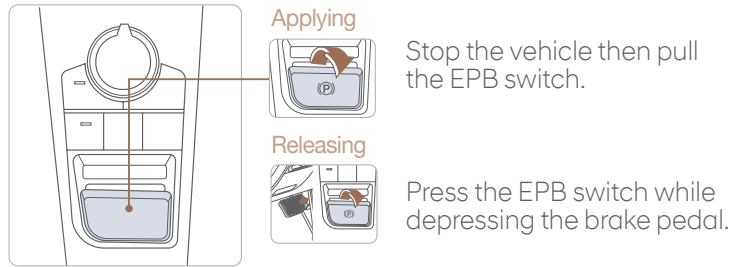

NOTE: If necessary, emergency braking is possible by pulling and holding the EPB switch.

AUTO HOLD

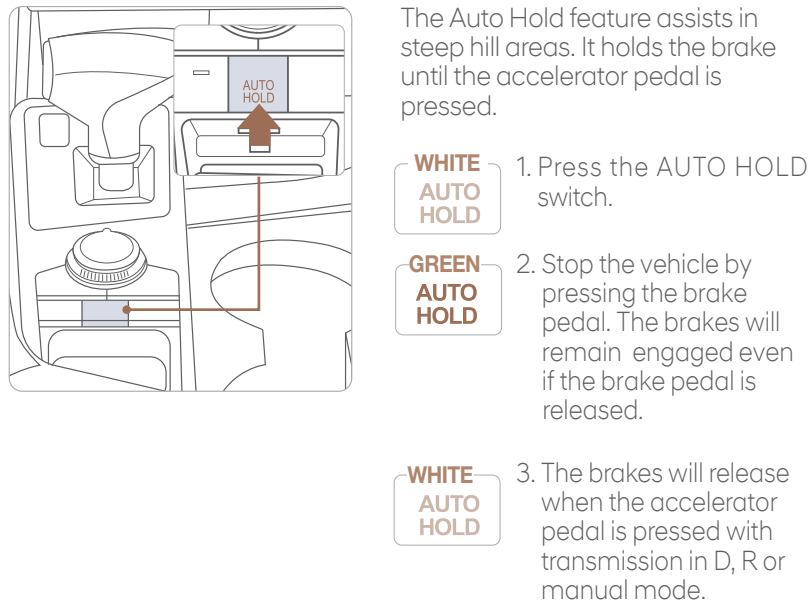

- WHITE AUTO HOLD** 1. Press the AUTO HOLD switch.
- GREEN AUTO HOLD** 2. Stop the vehicle by pressing the brake pedal. The brakes will remain engaged even if the brake pedal is released.
- WHITE AUTO HOLD** 3. The brakes will release when the accelerator pedal is pressed with transmission in D, R or manual mode.

To cancel the AUTO HOLD operation, press the AUTO HOLD switch again.

Program Coverage Summary

Genesis Service Valet is included for the first 3 years or 36,000 miles, whichever comes first, of ownership.			
Complimentary Services	Service Valet	Complimentary Loaner Vehicle	Maintenance
Original Owner or Lessee	Yes	Yes	Yes
Subsequent Owner or Lessee	Warranty Only	Warranty Only	No

See below for program terms and conditions.

SERVICE VALET

Service Valet is available while your vehicle is receiving complimentary maintenance, wear items, or warranty repairs by an authorized Genesis retailer. Simply contact your authorized Genesis retailer's Service Experience Manager or contact the Customer Care Center at 844-340-9741 to make your appointment. The retailer will work with you to arrange your pickup and delivery time and location.

- Valet appointments must be made at least 2 business days in advance.
- Valet area of coverage is valid only within an estimated 1 hour drive time distance (based on traffic, weather, and road conditions) from the participating retailer location to the pickup/delivery location.
- Valet pickup and delivery must occur during normal business hours. After-hours pickup and delivery are at the discretion of your participating retailer.
- You must notify your Genesis Service Experience Manager 1 business day in advance if location or time of valet services changes. If a change or cancellation is not made at least 1 business day in advance, you may be charged a fee, or Service Valet may be cancelled.
- You will be charged a fee if you elect to extend the use of the courtesy replacement vehicle or delay the delivery of your vehicle.
- Prior to or at the time of your vehicle pickup, you will need to provide your valet with the following information if a courtesy replacement vehicle is needed:
 - Insurance company name, policy number, and expiration date
 - Driver's license number, state, expiration, and date of birth
 - Credit card number and expiration date (standard requirement for rental car use)
 - The above information for any additional drivers

Genesis brand vehicle owner must provide the valet with the Genesis brand vehicle that is currently registered in compliance with local and state laws. Road tolls incurred during the Service Valet may be charged to the vehicle owner.

COMPLIMENTARY LOANER VEHICLE

We come to you and provide you with alternative transportation. While your vehicle is being serviced under this program, qualified drivers will be provided a courtesy replacement Genesis brand vehicle at no additional cost. You must be at least 25 years of age (in most states) with a valid driver's license to drive a loaner vehicle. Please provide your Service Advocate with the following information:

- Insurance company name, policy number, and expiration date
- Driver's license number, state, expiration and birth date
- Credit card number and expiration date (standard requirement for rental car use)
- The above information for any additional drivers

COMPLIMENTARY MAINTENANCE COVERAGE

Vehicle Eligibility

For original retail owners of the Genesis vehicle, all factory-recommended scheduled maintenance are covered for the first 3 years or 36,000 miles, whichever comes first. The Service Valet Program is applicable to all 2017 - 2019 model year Genesis brand vehicle United States specification vehicles purchased in the United States from authorized Genesis retailers. The program is not in effect outside of the United States.

- Vehicle coverage begins on the date of first retail sale. Fleet vehicles are excluded from this program.
- If the vehicle becomes damaged (such as by accident, fire, act of nature, etc.) and is subsequently titled salvaged, flooded, or reconstructed, it is no longer eligible for the benefits of the Genesis G80 complimentary maintenance Program.

Guidelines for Scheduling Maintenance

The Service Valet Program covers factory-recommended scheduled maintenance for the first 3 years or 36,000 miles, whichever comes first. Covered maintenance costs include all labor and parts necessary to complete the factory recommended service. Having your vehicle serviced at the specified time/mile intervals is critical in maintaining long-term durability. Failure to have your vehicle serviced at the specified interval may invalidate the warranty under certain circumstances.

If for any reason a service is missed, the authorized Genesis retailer will perform the next or missed major service.

Some owners may wish to have their oil changed more frequently. The customer must pay for any additional services performed on the vehicle. Service procedures not specifically referenced in the Genesis Customer Care Quick Reference Guide must be preauthorized by a Genesis District Parts and Service Manager.

COMPLIMENTARY MAINTENANCE COVERAGE (continued)

Exclusions from Coverage

The following items, without limitations, are not covered :

- Gasoline and gasoline additives
- State inspections
- Wear and tear of soft trim, including seats, carpets, door casings, wood veneer, headliner, and all chrome trim
- Wear and tear or damage to exterior body panels, trim, and glass
- Damage due to poor fuel quality, misuse, abuse, neglect, fire, accident, flood, or installation of unapproved parts and accessories
- Vehicles used in competitive events
- Vehicles with an unreadable/tampered VIN, or where true mileage cannot be determined
- Repairs and maintenance not performed at an Authorized retailer of Genesis.
- Repairs covered under the New Vehicle Limited Warranty
- Required maintenance and covered wear parts replacement on United States specification vehicles operating outside the United States

Transfer of Coverage

The described coverage only applies to the original retail purchaser or original lessee of a Genesis Brand vehicle. The coverage is not transferable to subsequent owners, with the exception of immediate family members. Immediate family members include the following:

- Spouses or registered domestic partners
- Parents
- Children or stepchildren

Dealerships will verify that the owner/customer is the original owner/lessee. Certain limitations and exclusions apply to this program. Please refer to your New Vehicle Limited Warranty guide for warranty details.

 Guest Date

GENESIS GUEST DELIVERY CHECKLIST

GENESIS BRAND OWNER	RETAILER NAME
SALES CONSULTANT	DATE
VIN	PREVIOUS VEHICLE

BEFORE DELIVERY

- SET TIRE PRESURE LF ___ RF ___ RR ___ LR ___
- VERIFY VEHICLE IS CLEAN, IN GOOD CONDITION, FREE OF CHIPS AND SCRATCHES · CLEAN WINDSHIELD AND BACK WINDOW
- ENSURE FLOORMATS ARE SNAPPED INTO PLACE

WALK THE CUSTOMER THROUGH EACH OF THE FOLLOWING KEY DELIVERY FEATURES

- REVIEW QUICK REFERENCE GUIDE
- PAIR CUSTOMER'S PHONE TO THE BLUETOOTH SYSTEM
- OPERATION OF THE NAVIAGATION SYSTEM - page 20
- REVIEW AND TEAR OFF VOICE COMMAND / QUICK TIP CARD
- OPERATION OF THE AUDIO SYSTEM

BLUETOOTH® HANDS-FREE



CONNECTING YOUR PHONE

- On the radio:**
1. Select **All Menus**.
 2. Select **Setup**.
 3. Select **Bluetooth -> Bluetooth Connection**.
- **Alternately, you can also press the green colored answer button on the steering wheel OR the PHONE hard key located on the center stack to initiate Bluetooth Pairing.**
4. Select **Add New Device**.

In your phone's Bluetooth settings:

5. Select the <Vehicle Name> on your phone
6. Enter the passkey from the radio or accept the authorization pop-up on your phone.

SWITCHING BETWEEN PAIRED PHONES

Using Voice Command:
 "Change Bluetooth device"

- On the radio:**
1. Select **All Menus**.
 2. Select **Setup**.
 3. Select **Bluetooth -> Bluetooth Connection**.
 4. Select **Connect** next to the desired phone.