

VOICE RECOGNITION TIPS (If equipped)

BLUETOOTH®

Command **Example**
 Dial <Phone #> — “Dial 7-1-4-9-6-5-3-0-0-0”
 Call <Name> — “Call John Smith”

Improving how you store your contacts can optimize your Bluetooth® Voice Recognition performance:
 • Use full names instead of short or single-syllable names (“John or Dad”)
 • Avoid using special characters/emojis or abbreviations (“Dr.”) when saving contacts

NAVIGATION

Command **Example**
 Find Address — “1-2-3-4-5 1st Street, <House #, Street, City, State>
 Find <POI Name> — “Find McDonald’s®”

Located on Rearview Mirror
DESTINATION SEARCH BY VOICE

Command **Example**
 Find <POI Name> — “Find Lowe’s® near me”
 <POI Name> — “Starbucks®”

WALK THE CUSTOMER THROUGH EACH OF THE FOLLOWING KEY DELIVERY FEATURES

- MANUAL / AUTOMATIC CLIMATE CONTROL – pages 17
 - Explain different air modes to a customer.

Manual



Automatic

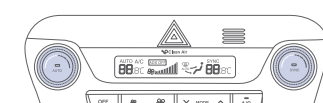

- DEFROST – page 17

- 1 Press the front defrost button.
- 2 Set to warmest temperature setting.
- 3 Set to highest fan speed.

- TIRE PRESSURE MONITORING SYSTEM (TPMS) – page 38

Explain TPMS function to customer.

- When illuminated, one or more tires are under-inflated
- Blinks for approximately one minute then remains illuminated when there is a malfunction with the TPM!
- You can also check the individual tire pressures in the Information Display mode in the LCD cluster. Tire pressures are displayed in the cluster after a few minutes of driving.



- VEHICLE SETTINGS – page 13

- Demonstrate vehicle settings in instrument cluster
- Demonstrate navigation use, enter dealer address
- Show radio presets

- BLUETOOTH – page 21

- Demonstrate phone pairing
- Refer to www.hyundaiusa.com/bluetooth
- Demonstrate QR code

- BLUE LINK – pages 24

- Assist with creating MyHyundai.com account
- Assist with Blue Link enrollment
- Show Blue Link Users Manual
- Encourage customer to download the MyHyundai by Blue Link app

- VOICE RECOGNITION – page 23

- Review Voice Recognition tips
- Show Voice Recognition tear off card and have owner place in convenient location

MAINTENANCE

Unit: mile

Scheduled Maintenance (Normal Usage)		2.0L GDI		2.4L GDI
Engine Oil & Filter	Replace	7,500 or 12 mos.	Replace	7,500 or 12 mos.
Fuel Additives	Add	7,500 or 12 mos.	Add	7,500 or 12 mos.
Battery Condition				
Brake Lines, Hoses & Connections				
Front Brake Disc/Pads, Calipers				
Rear Brake Disc/Pads				
Steering Gear Box, Linkage & Boots, Lower Arm Ball Joint, Upper Arm Ball Joint				
Drive Shafts & Boots	Inspect	7,500 or 12 mos.	Inspect	7,500 or 12 mos.
Suspension Mounting Bolts				
Air Conditioning Refrigerant				
Air Conditioning Compressor				
Propeller Shaft (AWD)				
Exhaust Pipe & Muffler				
Air Cleaner Filter	Inspect	7,500 or 12 mos.	Inspect	7,500 or 12 mos.
	Replace	30,000 or 48 mos.	Replace	30,000 or 48 mos.
Vacuum Hose	Inspect	7,500 or 12 mos.	Inspect	7,500 or 12 mos.
Climate Control Air Filter (For Evaporator and Blower Unit)	Replace	15,000 or 12 mos.	Replace	15,000 or 12 mos.
Tire Rotation	Perform	7,500	Perform	7,500
Vapor Hose, Fuel Tank Cap, Fuel Tank				
Fuel Tank Air Filter	Inspect	15,000 or 24 mos.	Inspect	15,000 or 24 mos.
Fuel Filter				
Parking Brake	Inspect	15,000 or 24 mos.	Inspect	15,000 or 24 mos.
Brake Fluid				
Fuel Lines, Fuel Hoses & Connections	Inspect	30,000 or 48 mos.	Inspect	30,000 or 48 mos.
Rear Axle Oil (AWD)	Inspect	30,000 or 48 mos.	Inspect	30,000 or 48 mos.
Transfer Case Oil (AWD)				
Drive Belts	Inspect	First 60,000 or 72 mos. Subsequent, every 15,000 or 24 mos.	Inspect	First 60,000 or 72 mos. Subsequent, every 15,000 or 24 mos.
Spark Plugs	Replace	97,500	Inspect	97,500
Engine Coolant	Replace	First 120,000 or 120 mos. Subsequent, every 30,000 or 24 mos.	Replace	First 120,000 or 120 mos. Subsequent, every 30,000 or 24 mos.
Valve Clearance	Inspect	-	Inspect	60,000 miles or 72 mos
Automatic Transmission Fluid		No check or services required for Normal Usage driving.		No check or services required for Normal Usage driving.

*See Owner's Manual for details.

Looking for more detailed information? This Quick Reference Guide does not replace your vehicle's Owner's Manual. If you require additional information or are unsure of a specific issue, you should always refer to the vehicle's Owner's Manual or contact your authorized Hyundai dealer.

The information contained in this Quick Reference Guide was correct at the time of printing; however, specifications and equipment can change without notice. No warranty or guarantee is being extended in this Quick Reference Guide, and Hyundai reserves the right to change product specifications and equipment at any time without incurring obligations. Some vehicles are shown with optional equipment. Specifications apply to U.S. vehicles only. Please contact your Hyundai dealer for current vehicle specifications.

NP150-D3201-9
 (Rev 10/05/18)
 Printing 10/08/18

The Hyundai TUCSON

Quick Reference Guide



Roadside Assistance: 1-800-243-7766
Consumer Affairs: 1-800-633-5151
Sirius XM® Radio: 1-800-967-2346
Blue Link: 1-855-2BLUELINK
 (1-855-225-8354)



HYUNDAI VEHICLE OWNER PRIVACY POLICY

Your Hyundai vehicle may be equipped with technologies and services that use information collected, generated, recorded or stored by the vehicle. Hyundai has created a Vehicle Owner Privacy Policy to explain how these technologies and services collect, use, and share this information.

You may read our Vehicle Owner Privacy Policy on the Hyundaiusa.com website at <https://www.hyundaiusa.com/owner-privacy-policy.aspx>. If you would like to receive a hard copy of our Vehicle Owner Privacy Policy, please contact our Customer Connect Center at:

Hyundai Motor America
Hyundai Customer Connect Center
P.O. Box 83835
Phoenix, AZ 85071-3835
800-633-5151
consumeraffairs@hmasusa.com

Hyundai's Customer Connect Center representatives are available Monday through Friday, between the hours of 5:00 AM and 7:00 PM PST and Saturday and Sunday between 6:30 AM and 3:00 PM PST (English). For Customer Connect Center assistance in Spanish or Korean, representatives are available Monday through Friday between 6:30 AM and 3:00 PM PST.

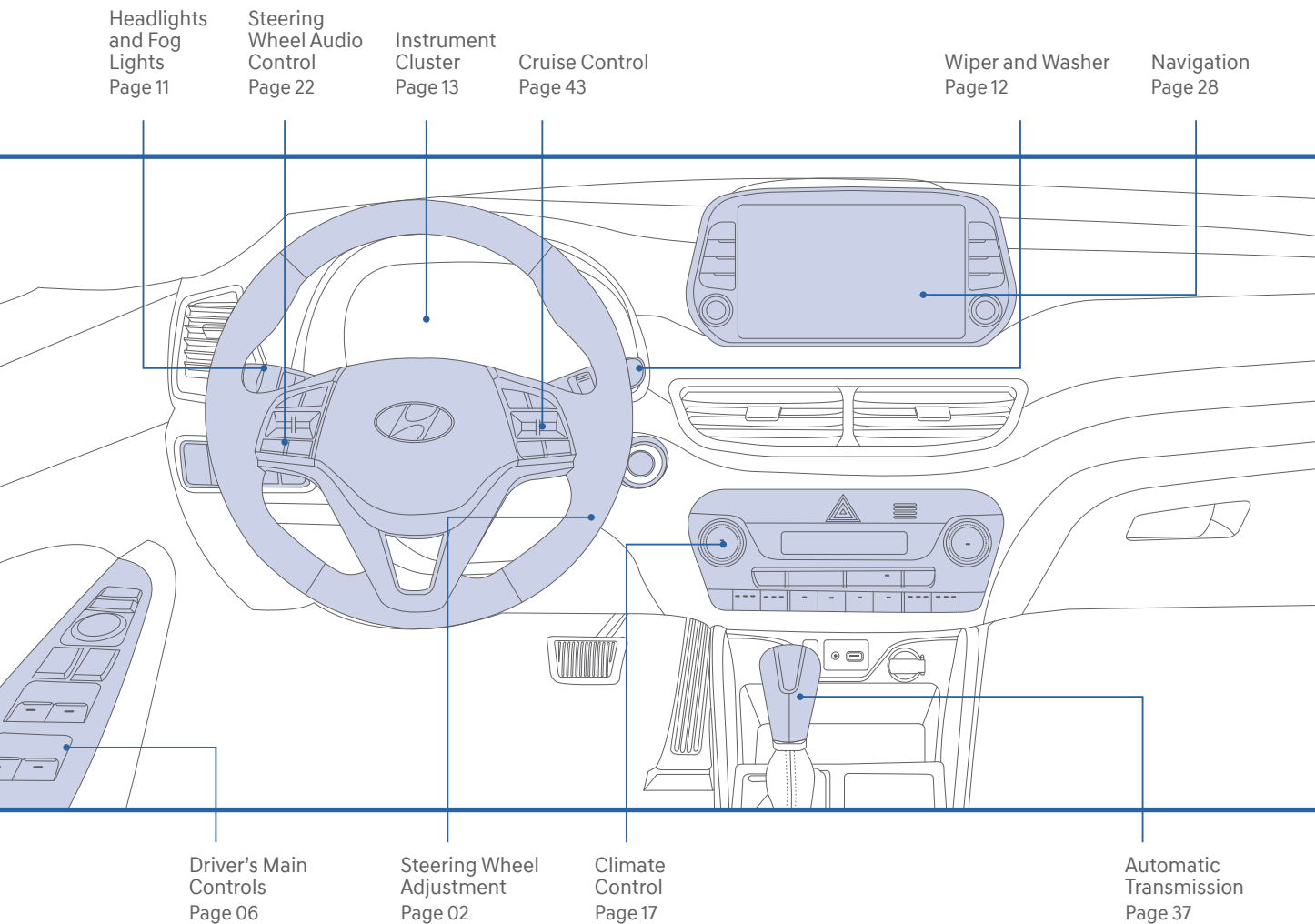

FEATURES AND CONTROLS

Child-Protector Rear Door Lock	06
Climate Control	17
Driver's Main Controls	06
Engine Start / Stop Button	02
Fuel Filler Door	07
Hands Free Smart Liftgate	07
Headlights and Fog Lights	11
Homelink Wireless Control System	10
Instrument Cluster	13
Instrument Panel Illumination	16
Interior Lights	09
LCD Display Control	15
LCD Display Modes	15
Panoramic Sunroof	08
Power Liftgate Operation	07
Seat-Headrest Adjustment	04
Seat-Front Seat Adjustment	03
Seat-Rear Seat Folding	04
Seat-Seat Belt Adjustment	04
Seat-Seat Warmer and Ventilated Seats	05
Smart Key	01
Steering Wheel Adjustment	02
Warnings and Indicators	16
Wiper and Washer	12

MULTIMEDIA

Android Auto	29
Apple Carplay™	31
AUX and USB Port	35
Blue Link Telematics System	24
Bluetooth Operational Tips	22
Bluetooth Phone Pairing	21
Navigation	28
Radio Mode	27
Rear USB Outlet	35
Steering Wheel Audio Control	22
Voice Recognition Tips	23
Wireless Cellular Phone Charging System	36

DRIVING

Automatic Transmission	37
AWD Lock	41
Blind Spot Collision Warning (BCW)	40
Cruise Control/Advance Smart Cruise Control	43
Downhill Brake Control (DBC)	39
Drive Attention Alert System	42
Drive Mode Integrated Control System	41
Electronic Stability Control (ESC)	39
Forward Collision-Avoidance Assist (FCA)	42
Lane Keeping Assist (LKS)	40
Multi-View Camera	44
Rearview Camera	44
Tire Pressure Monitoring System (TPMS)	38

Use this Quick Reference Guide to learn about the features that will enhance your enjoyment of your Hyundai. More detailed information about these features are available in your Owner's Manual.

* Some vehicles may not be equipped with all the listed features.

WARNING!

To reduce the risk of serious injury to yourself and others, read and understand the important SAFETY INFORMATION in your Owner's Manual.

SMART KEY

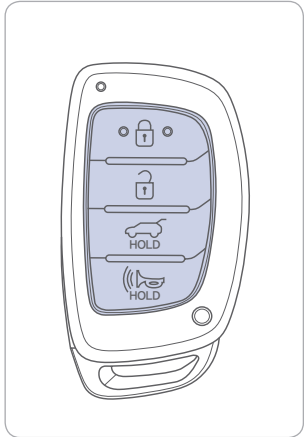

- Lock
- Unlock
- Liftgate Unlock
(Press and Hold. Will open if equipped with power liftgate.)
- Panic

NOTE :
For the User Selectable Option, please refer to your Owner's Manual for further information.

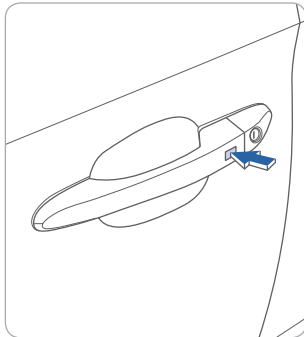

Driver's Door Lock / Unlock

Smart key must be within 28~40in. from the outside door handle.

- Press :** One time - Unlock driver door
Two times - Unlock all doors
Three times - Lock all doors

NOTE :
To unlock/lock all doors, the button must be pressed two times or three times within 4 seconds.

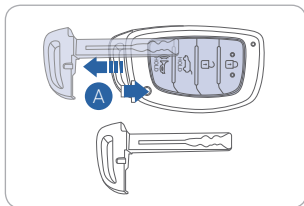

Removing the Mechanical Key

Press and hold the release **A** button and remove the key.

ENGINE START / STOP BUTTON

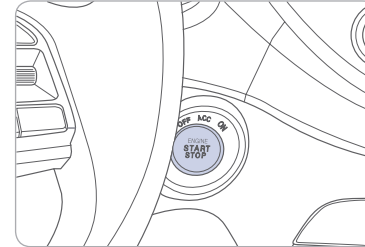

With the ignition OFF and foot OFF of the brake pedal, press the Engine Start / Stop button.

- Once for ACC (Accessory) mode.
- Twice for ON mode.
- Third for OFF.

To start the engine in any mode (including OFF), press the Engine Start / Stop button while pressing down on the brake pedal. To shut the engine OFF, place the shift lever in P (Park) and press the Engine Start / Stop button again.

Emergency Situations

Shutting Off the Engine while Driving

- Press the engine Start / Stop button for 2 seconds or more or 3 times consecutively within 3 seconds.

Restarting the Engine while Driving

- Press the engine Start / Stop button with the shift lever in N (Neutral).

STEERING WHEEL ADJUSTMENT

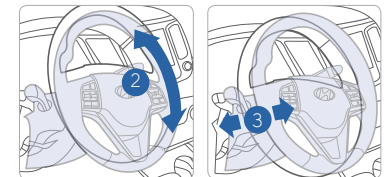
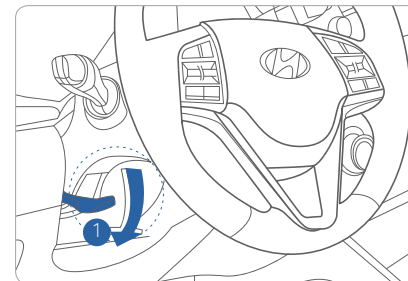

- NOTE :** Do not adjust while driving.
1. Pull the **1** lever down.
 2. Set the **2** angle and **3** distance.
 3. Pull the **1** lever up to lock position.

FRONT SEAT ADJUSTMENT (manual)

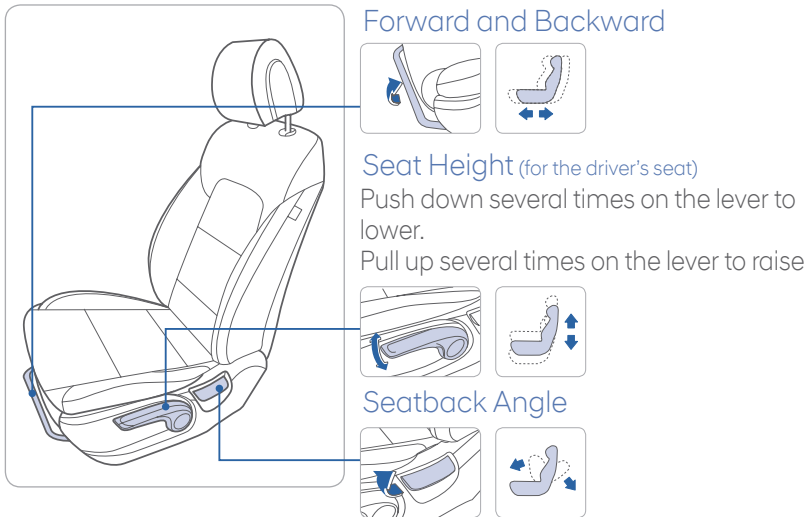

FRONT SEAT ADJUSTMENT (power)

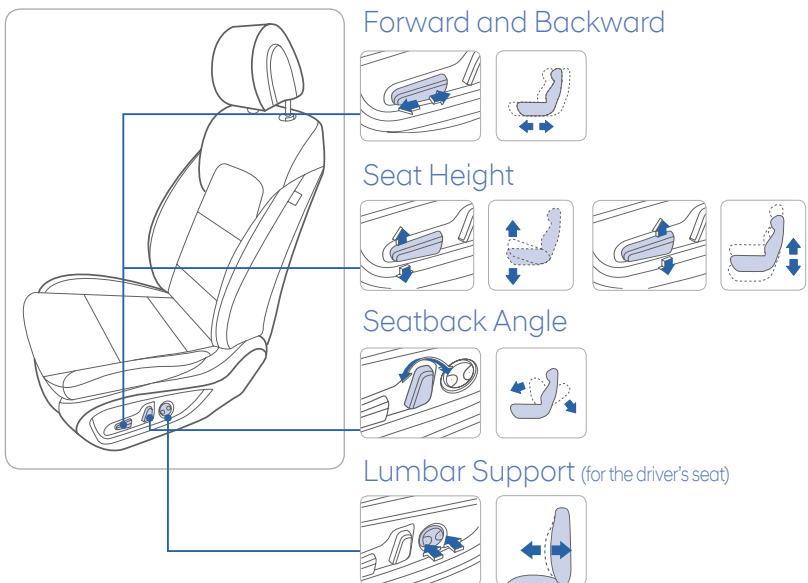

HEADREST ADJUSTMENT

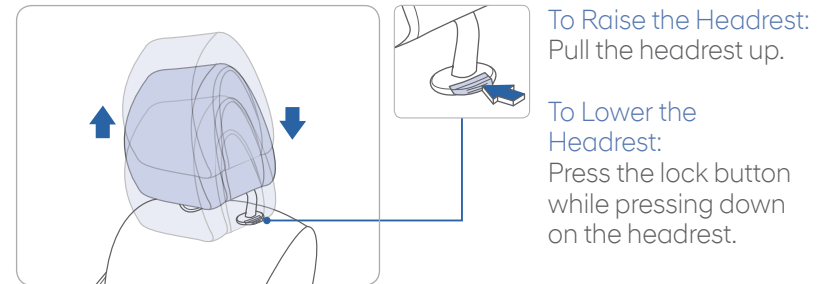

SEAT BELT ADJUSTMENT (front seat)

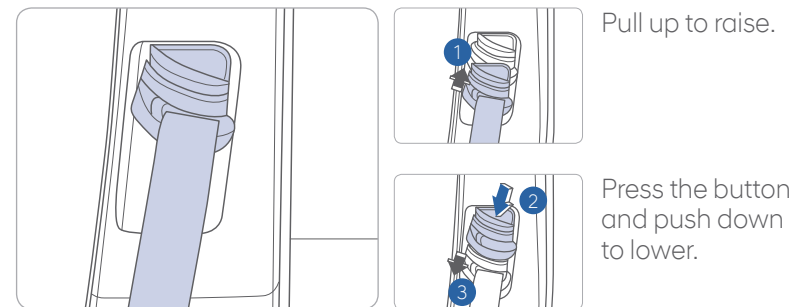

REAR SEAT FOLDING

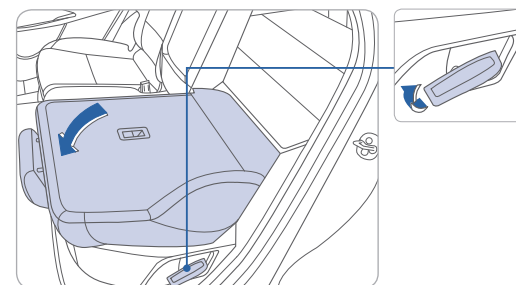

SEAT WARMER (front seats)

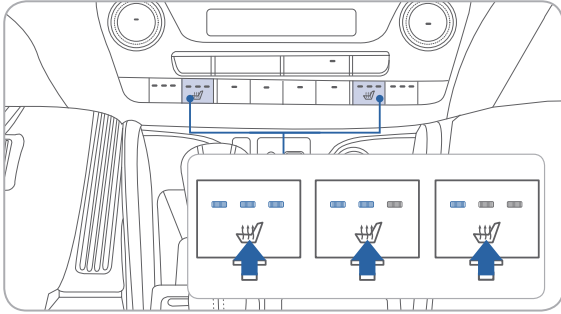

Each time you press the button, the setting is changed as follows:



AIR VENTILATION SEATS (front seats)

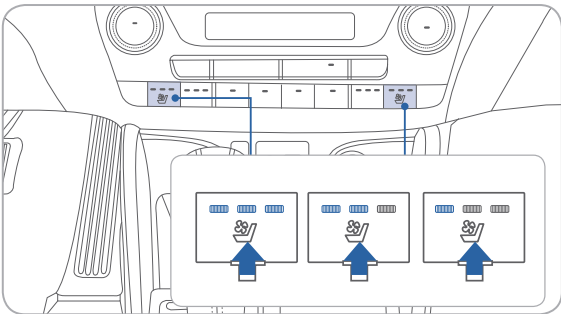

Each time you press the button, the setting is changed as follows:



Use with A/C on and Bi-Level mode for effective ventilation.

CHILD-PROTECTOR REAR DOOR LOCK

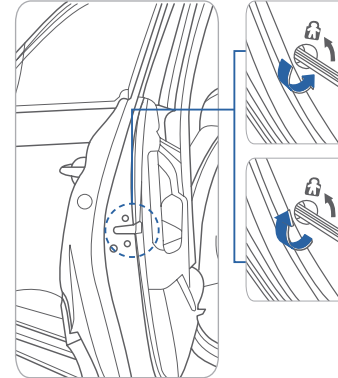

Lock

Insert a key into the hole and turn it to the lock position.

Unlock

Insert a key into the hole and turn clockwise to the unlock position.

DRIVER'S MAIN CONTROLS

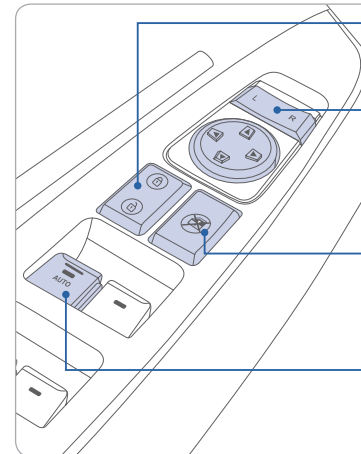

Door Lock

Locks / unlocks all doors and tailgate.

Outside Rearview Mirrors

Press L (left) or R (right) on the switch. Adjust the mirror by using the mirror adjustment control switch.

Power Window Lock Switch

Disables the power window switches on the rear passenger doors.

Window Auto Up / Down (if equipped)

Press past detent to fully open / close the window.

FUEL FILLER DOOR

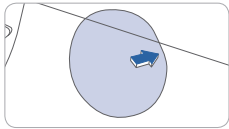

1. Push the center edge of the fuel filler door when the driver's door is unlocked.

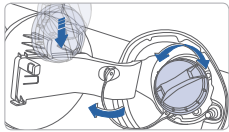

2. Remove the fuel tank cap.

NOTE:

Tighten the fuel filler cap until one click is heard.

POWER LIFTGATE OPERATION

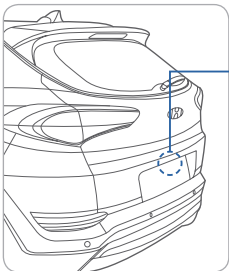

Press to open. Smart key must be within the range.

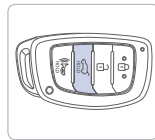

Press and hold to open.

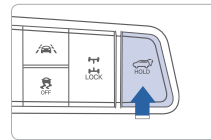

Press and hold the power Liftgate button located on the dash panel to the left of the steering wheel.

HANDS FREE SMART LIFTGATE

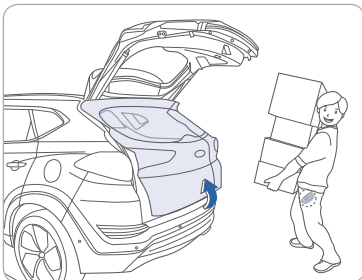

On vehicles equipped with Smart Liftgate, the liftgate can be opened with no-touch activation.

To activate

To activate the Smart Liftgate, go to User Settings Mode on the LCD display and select Smart Liftgate.

Hands Free Smart Liftgate will operate when:

The liftgate (tailgate) can be opened with no touch activation by satisfying all the conditions below.

- After 15 seconds when all doors are closed and locked
- Smart key positioned in the detecting area for more than 3 seconds.

Refer to Owner's Manual for more information on hands free Smart Liftgate.

PANORAMIC SUNROOF

Sunshade

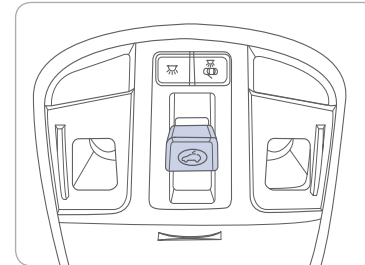

To open the sunshade, pull the sunroof control switch rearward **1** to the first detent position.

To close the sunshade when the sunroof glass is closed, push the sunroof control switch forward **2**.

Sliding the Sunroof

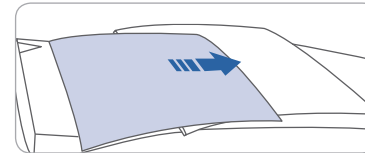

Pull the sunroof control switch backward to the second detent position. First the sunshade will open and then the sunroof will open automatically.

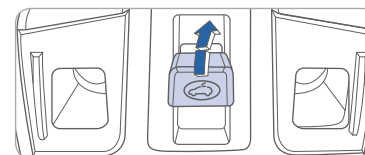

Push the sunroof control switch forward to the first detent position to close the sunroof.

Push the sunroof control switch to the second detent position to close both the sunroof and the sunshade automatically.

Tilting the Sunroof

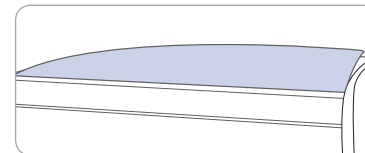

Open

Push the sunroof control switch upward to tilt the sunroof.

Close

Push it upward again to close the sunroof.

You can also push the sunroof control switch forward to close the sunroof.

Push it forward to the second detent position to close the sunroof and the sunshade.

INTERIOR LIGHTS

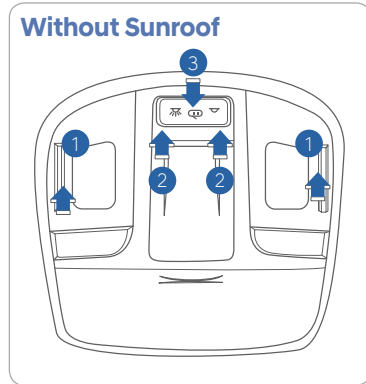

Front Map Lamp ①
Press the switch to turn on / off the map lamp.

Front Room Lamp (☞☜) ②
(Without Sunroof)
Press the switch to turn on / off the room lamp.

Front Room Lamp (☞☜) ②
(With Sunroof)
Press the switch to turn on / off the room lamp.

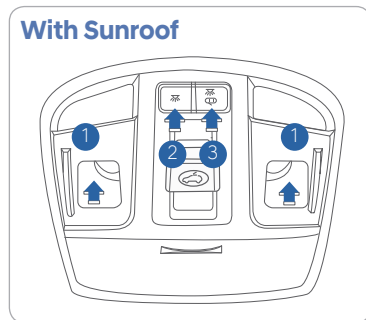

Front Door Lamp (☞☜) ③
(With Sunroof)
Lights will turn on when any door is opened.

HOMELINK WIRELESS CONTROL SYSTEM

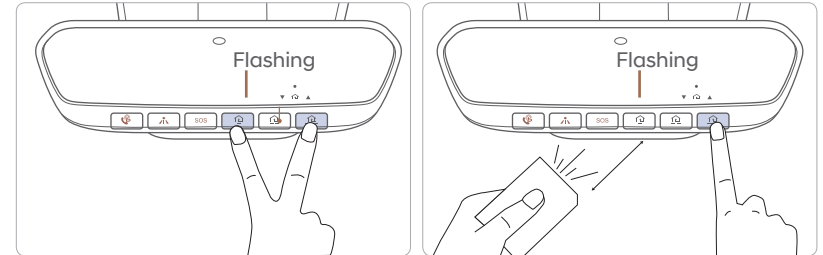

Standard Programming

To train most devices, follow these instructions:

1. Press and hold the two outside buttons on the Homelink® system until the LED starts to blink, release buttons.
2. Press and hold the desired Homelink® button and the transmit button on your rolling code transmitter at the same time until the Homelink® LED changes from a slow blink to a rapid blink. (Your Homelink® system is now programmed)
3. Locate the learn code button on your garage door opener. (These are located under the light cover or on the rear panel depending on model)
4. Press the learn code button on the garage door opener, a red LED will start to blink. (You will have 30 seconds to complete programming)
5. While the LED on the garage door opener is blinking, return to the vehicle and press the pre-programmed Homelink® button 4 times. (Or until the garage door operates).

HEADLIGHTS AND FOG LIGHTS

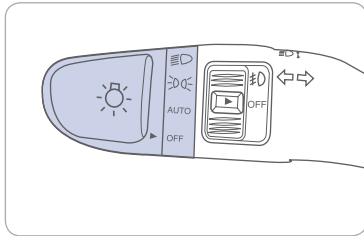

- ▶ | Headlights
- ▶ | Parking Lights
- ▶ | **AUTO** Auto Lights
- ▶ | **OFF** All Lights Off

Headlights Delay

Headlights may stay on for 15 seconds after exiting and locking up the vehicle. Press the remote lock button twice to turn the headlights off. Please refer to your Owner's Manual for further information.

Turn Signals and Lane Change Signals

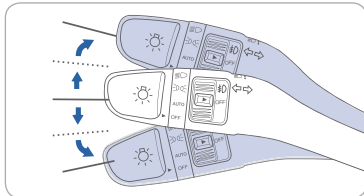

Flashing the Headlights

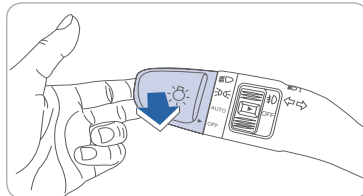

High Beams

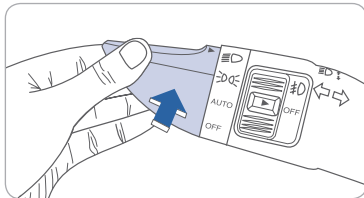

Fog Lights

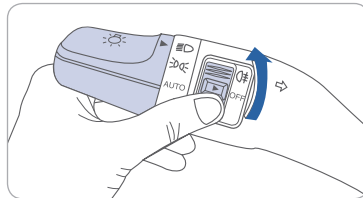

To turn on the high beams, push the lever away from you. The lever will return to its original position and the high beam indicator in the cluster will illuminate.

To turn the high beams off, pull the lever towards you.

To flash the high beams, pull the lever towards you, then release the lever. The high beams will remain ON as long as you hold the lever towards you.

WIPER AND WASHER

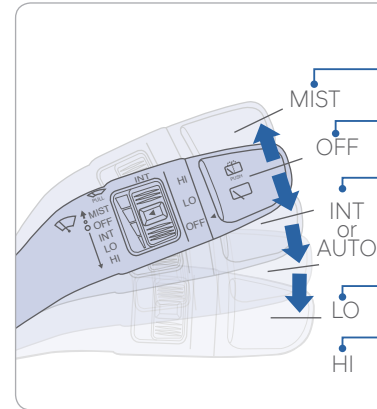

- MIST** - Single wipe
- OFF** - Off
- INT or AUTO** - Intermittent wipe or Auto control wipe
- LO** - Low wiper speed
- HI** - High wiper speed

Intermittent Wipe Time Adjustment

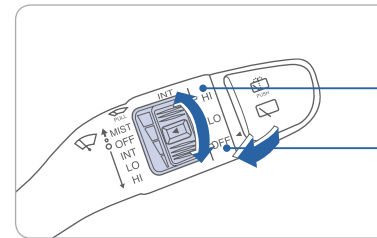

- More frequent wipes
- Less frequent wipes

Wash with Brief Wipes

Pull the lever toward you

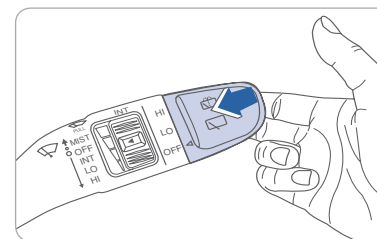

Rear Wiper / Washer Control

- HI** - High wiper speed
- LO** - Low wiper speed
- OFF** - Off

• Push away for rear wash

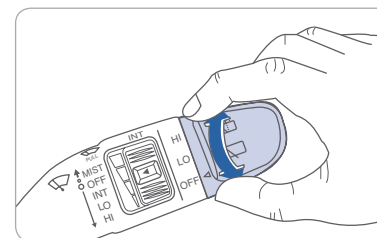

INSTRUMENT CLUSTER

Type A

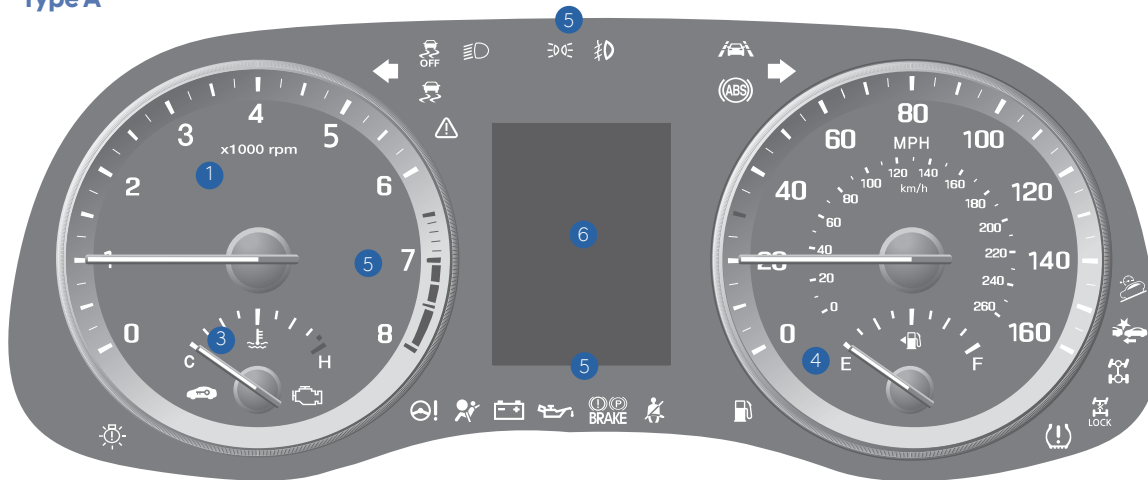

1. Tachometer
2. Speedometer
3. Engine Coolant Temperature Gauge
4. Fuel Gauge
5. Warning and Indicator Lights
6. LCD Display (Including Trip Computer)

Type B

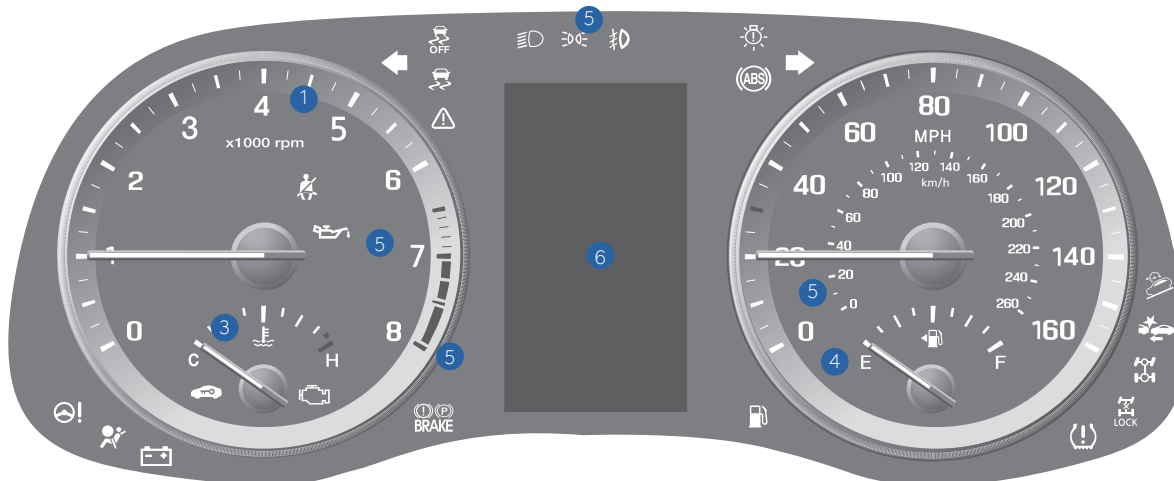

LCD DISPLAY MODES

Modes	Symbol	Description
Trip Computer		Displays the most recent driving information including average fuel economy, trip, odometer, average speed, etc.
Turn BY Turn (TBT)		Displays turn-by-turn directions in the LCD cluster with navigation.
LDWS		Displays the state of the Lane Departure Warning System (LDWS).
Audio		Displays the state of the Audio System.
Information	or or	Displays the service interval and warning messages.
User Settings		Changes the settings.

LCD DISPLAY CONTROL

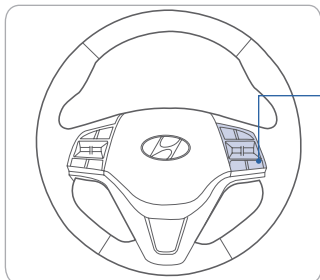

- 1 : MODE button for changing modes
- 2 : MOVE switch for changing items
- 3 : SELECT / RESET button for setting or resetting the selected item

WARNINGS AND INDICATORS

WARNINGS AND INDICATORS		
Air Bag Warning Light	Seat Belt Warning Light	Parking Brake & Brake Fluid Warning Light
ABS Warning Light	Electronic Brake Force Distribution (EBD) System Warning Light	
Electric Power Steering System Warning Light	Malfunction Indicator	Charging System Warning Light
Engine Oil Pressure Warning Light	Low Fuel Level Warning Light	Low Tire Pressure Warning Indicator/TPMS Malfunction Lamp
Automatic Emergency Braking (AEB) Warning Light	All Wheel Drive (AWD) Warning Light	Headlight Warning Light
Master Warning Light	ESC (Electronic Stability Control) Indicator	ESC (Electronic Stability Control) OFF Indicator
Immobilizer Indicator	Turn Signal Indicator	High Beam Indicator
Light ON Indicator	Front Fog Indicator Light	CRUISE Cruise Indicator
SET Cruise SET Indicator	SPORT mode Indicator	Downhill Brake Control (DBC) Indicator Light
Lane Departure Warning System (LDWS) Indicator	All Wheel Drive (AWD) LOCK LOCK Indicator Light	

INSTRUMENT PANEL ILLUMINATION

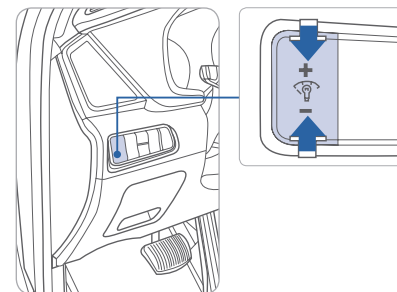

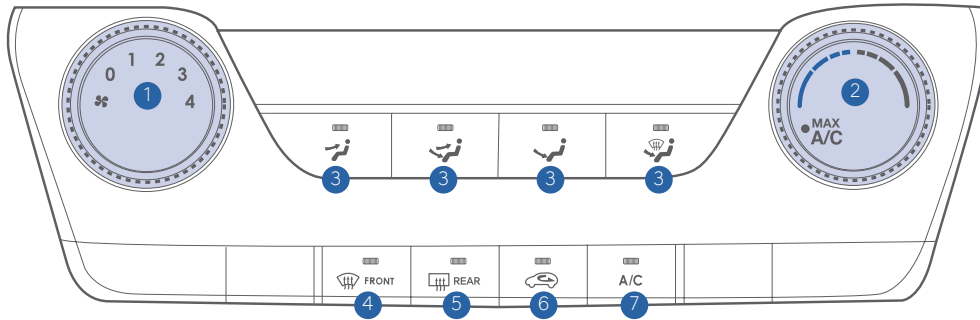

Press + or - to adjust the illumination brightness of the instrument cluster.

MANUAL CLIMATE CONTROL



1. Fan Speed Control Knob
2. Temperature Control Knob
3. Mode Selection Buttons
4. Front Windshield Defroster Button
5. Rear Window Defroster Button
6. Air Intake Control Button
7. A/C (Air Conditioning) Button

DEFROSTING / DEFOGGING

1. Press the front windshield defroster button. 
2. Set the temperature control to the warmest setting. 
3. Set the fan speed to the medium setting. 

NOTE:

To reduce the tendency of the glass to fog up and also to improve visibility, keep the surface of the windshield clean by wiping it occasionally with glass cleaner and a clean cloth.

In addition, select air intake control to the outside (fresh) air position whenever possible while operating the vehicle.

AIR INTAKE CONTROL

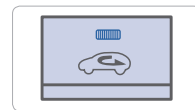
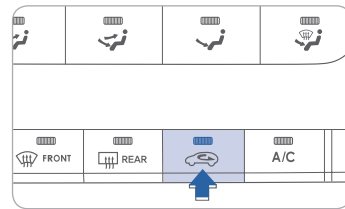

Recirculated air position

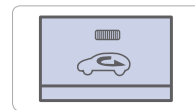



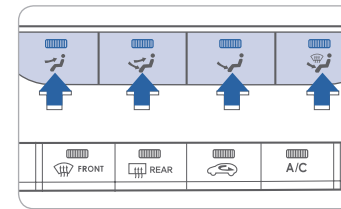

Outside (fresh) air position

MODE SELECTION



Changes the direction of the air flow as following:

-  Face Level
-  Bi-Level
-  Floor Level
-  Floor / Defrost Level

REAR WINDOW DEFROSTER

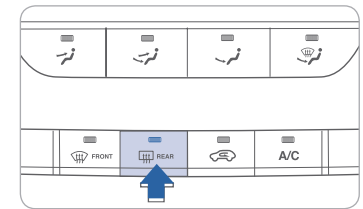

Press to activate / deactivate the rear defroster.

MAX A/C MODE

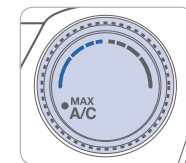

The MAX A/C automatically selects the A/C, recirculated air, and face level vents. This helps to cool the cabin down more quickly. Select normal A/C after initial cool down to resume fresh airflow and maintain efficiency.

AUTOMATIC CLIMATE CONTROL

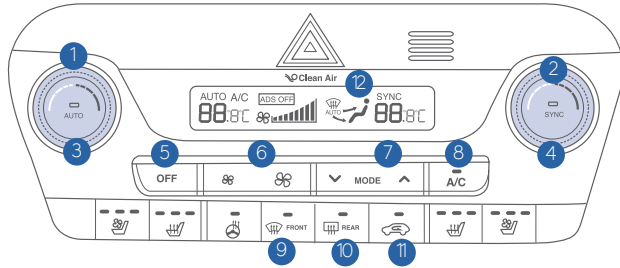

- 1 Driver's Temperature Control Knob
- 2 Passenger's Temperature Control Knob
- 3 AUTO (Automatic Control) Button
- 4 SYNC Button
- 5 OFF Button
- 6 Fan Speed Control Button
- 7 Mode Selection Button
- 8 Air Conditioning Button
- 9 Front Windshield Defroster Button
- 10 Rear Window Defroster Button
- 11 Air Intake Control Button
- 12 Climate Control Information Screen

DEFROSTING / DEFOGGING



1. Press the front windshield defroster button.



2. Set the temperature control to the warmest setting.

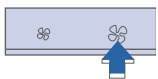

3. Set the fan speed to the medium setting.

SYSTEM OFF MODE

Pressing the OFF button will turn the automatic climate control system off.

- The fan will turn off.
- The outside (fresh) air position will be selected.
- The vented air temperature will be at the last temperature setting.

REAR WINDOW DEFROSTER

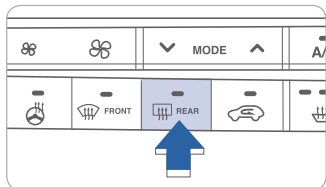

Press to activate / deactivate the rear defroster.

NOTE:

To reduce the tendency of the glass to fog up and also to improve visibility, keep the surface of the windshield clean by wiping it occasionally with glass cleaner and a clean cloth.

In addition, select air intake control to the outside (fresh) air position whenever possible while operating the vehicle.

AUTOMATIC HEATING AND COOLING



1. Press the AUTO button.



2. Set the temperature control to the desired setting.

The modes, fan speeds, air intake and air conditioning will be controlled automatically according to the temperature setting.

AIR INTAKE CONTROL

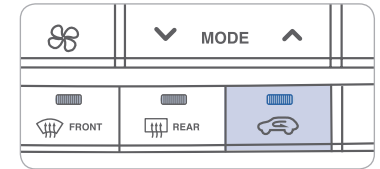

Recirculated air position

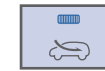

Outside (fresh) air position (Type A)



Outside (fresh) air position (Type B)

SYNC BUTTON



Press the SYNC button ON to operate the driver and passenger temperature equally. Press the SYNC button OFF to operate the driver and passenger side temperature individually. The button indicator will turn off.

MODE SELECTION

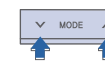

Changes the direction of the air flow as following:



BLUETOOTH PHONE PAIRING

With Display Audio



1. Press the PHONE button.
2. Search for car name on the Bluetooth list from your mobile phone and pair device.
3. Input the passkey. (Initial passkey is 0000)
4. Bluetooth becomes connected.



With Navigation



1. Press the PHONE button in the head unit or  button in the steering wheel remote controller.
2. Press <YES> to search for Bluetooth phones.
3. Pair your car after your mobile phone detects the Bluetooth device.
4. Enter the passkey or accept the authorization popup. (The default passkey is 0000.)
5. Connect Bluetooth.

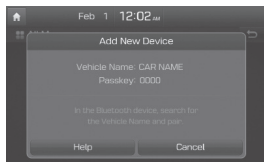

NOTE: Vehicle must be parked to complete the pairing process.

STEERING WHEEL AUDIO CONTROL

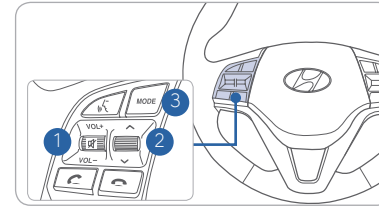

- 1 **VOLUME**
Raises or lowers the speaker volume. Press to Mute.
- 2 **SEEK / PRESET**
Changes the station.
- 3 **MODE**
Changes the audio source.

BLUETOOTH OPERATIONAL TIPS

In the following situations you or the other party may have difficulty hearing each other:

1. Keep the Bluetooth volume low. High level volume may result in distortion and echo.
2. When driving on a rough road, high speeds and/or with the window open.
3. When the air conditioning vents are facing the microphone and/or when the air conditioning fan is at the max speed.

Steering wheel bluetooth control

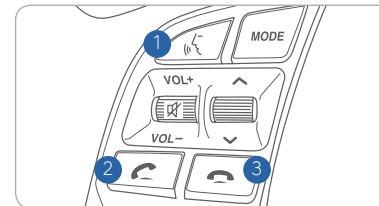

- 1 **TALK**
Activates the voice recognition.
- 2 **CALL**
Places and transfers calls.
- 3 **END**
Ends calls or cancels functions.

To Answer a Call:

- Press the  button on the steering wheel.

To Reject a Call:

- Press the  button on the steering wheel.

To Adjust Ring Volume:

- Use the VOLUME buttons on the steering wheel.

To Transfer a Call to the handset (private mode):

- Press and hold the  button on the steering wheel until the audio system transfers a call to the phone.

To Finish a Call:

- Press the  button on the steering wheel.

Making a call using voice recognition:

The menu tree identifies available voice recognition Bluetooth® functions.

Calling by Name:

1. Press the  button.
2. Say the following command:
 - “Call <John>”: Connects the call to John.
 - “Call <John> <on Mobile / at Work / at Home >”: Connects the call to John’s Mobile, Home, or at Work phone number.

Dialing by Number:

1. Press the  button.
2. Say “Dial Number”.
3. Say the desired phone number.

For the complete list of commands, please refer to your Owner’s Manual.

VOICE RECOGNITION TIPS

Your vehicle is equipped with a Voice Recognition technology which allows drivers to operate their phones without having to take their eyes off of the road to minimize distractions.

Voice recognition performance may be affected if driving with windows and sunroof open; when the heating-cooling system is on; when passing in a tunnel or when driving on rugged and uneven roads.

Quick reference on using voice commands:

To start a voice command, press the  button, the following commands are available:

Command	Function
More Help	Provides guidance on commands that can be used anywhere in the system.
Help	Provides guidance on commands that can be used within the current mode.
Calls <Name>	Calls <Name> saved in Contacts. Ex) Call “John”
Dial <Number>	Call can be made by dialing the spoken numbers. Ex) Call “123”
Phone	Provides guidance on Phone related commands. After saying this command, say “Call History”, “Contacts” to execute the corresponding functions.
Contacts (Call by Name)	Displays the Contacts screen. After saying this command, say the name of a contact saved in the Contacts to automatically connect a call.
Dial Number	Displays the Dial number screen. After saying this command, you can say the number which you want to call.

BLUE LINK TELEMATICS SYSTEM

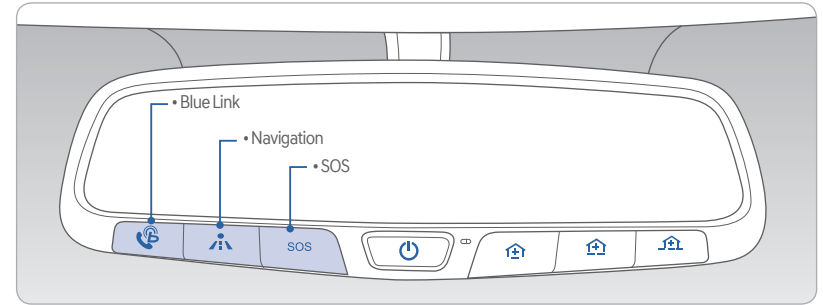

Press the  button for access to the voice-response menu of services.

You can say:

- "Service Link" to schedule a service appointment.
- "Roadside Assistance" for roadside services.
- "Blue Link Account Assistance" for help with your Blue Link subscription.
- Press the  button for Destination Search by Voice.
- Press the **SOS** button for SOS Emergency Assistance.
- Refer to your Blue Link User’s Manual for detailed information on system operation.
- For immediate assistance with subscription services, please call 1-855-2BLUELINK (1-855-225-8354).

Google® is a registered trademark of Google Inc.

Remote Start

Remote Start



You can download the Blue Link mobile app to your compatible smart phone from the following sites:

- iPhone® — Apple® App Store
- Android® — Google Play

Remote Start enables you to remotely start your vehicle from virtually anywhere. For navigation vehicles, you can also enable climate control remotely and turn on the rear-window defroster, ensuring a warm or cool car is ready to go when you are.

- To use this feature, you must have a Blue Link Personal Identification Number (PIN). To create or change your PIN, log on to www.MyHyundai.com.

Remember:

- Remote Start with Climate Control will automatically shut off after 10 minutes or after selected engine timer runs out in navigation vehicles.
- While this feature is active, the parking lights will blink until vehicle is turned off or when vehicle is in operation.
- To continue operation of the vehicle, the proximity key must be inside the vehicle with the driver prior to pressing the brake and being able to move the gearshift from the P (Park) position.

Preconditions:

- Ignition is OFF
- Alarm is armed (i.e., vehicle locked by key fob Remote Door Lock)
- Gearshift level is in the P (Park) position
- Brake pedal is not depressed
- Engine hood is securely closed
- All the doors are closed and locked
- The tailgate or trunk lid is closed
- The security/panic system is not activated
- The proximity key is not inside the vehicle
- The battery power is not low
- Vehicle is located in an open area
- It has been less than 4 days since last vehicle ignition off
- Vehicle located in area with good cell reception

Remote Start will terminate:

- After 10 minutes or after selected engine timer runs out in navigation vehicles
- Brake is pressed without proximity key inside vehicle
- Alarm is triggered without proximity key inside vehicle
- Door/trunk is opened from inside the vehicle

Notice: Laws in some communities may restrict the use of the features that remotely start the engine. For example, some laws may require a person using the remote start feature to have the vehicle in view when doing so or limit the length of time a vehicle engine may idle. Please check local and state regulations for any requirements and restrictions on remote starting of vehicles and engine idling time.

⚠ WARNING!

Do not remote start vehicle in an enclosed environment (i.e., closed garage). Prolonged operation of a motor vehicle in an enclosed environment can cause a harmful build-up of carbon monoxide. Carbon monoxide is harmful to your health. Exposure to high levels of carbon monoxide can cause headaches, dizziness or in extreme cases unconsciousness and/or death. Do not leave children or animals unattended in a vehicle while using the remote start function.

⚠ CAUTION!

If the vehicle's windshield wipers are left on when the vehicle was last driven, then the wipers will turn on if the remote start function is activated. To avoid damage to the wiper blades (i.e., due to heavy ice or snow accumulated on the windshield), please always turn the vehicle's windshield wipers off when parking the vehicle.

RADIO MODE

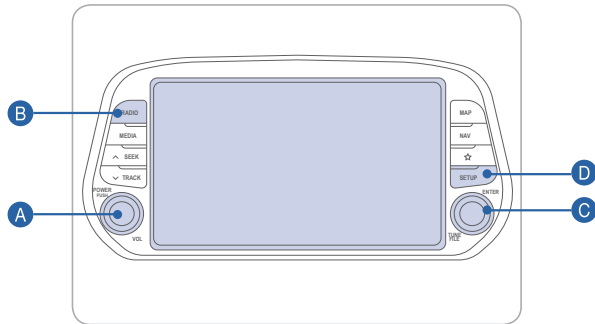

Press **POWER** button **A** to turn radio on.

• TUNING/LISTENING TO CHANNELS

1. Press **RADIO** button **B**.
2. Rotate **TUNE** knob **C** to desired channel.

NOTE :

A clear view of the southern sky helps to ensure XM® radio reception.

• SETTING PRESET MEMORY BUTTONS (FM/AM/XM®)

Press and hold any preset button (1-6) until audible beep is heard to store current channel.

• ADJUSTING THE SOUND CONTROL

1. Press **SETUP** button **D** and press the sound button on the display.
2. To adjust the Fader/Balance, select the position tab. Touch the on-screen arrows to adjust the desired setting for front, rear, left, or right balance.
3. To adjust the Bass/Midrange/Treble, select the tone tab. Touch the on-screen arrows to adjust the tonal sound settings to the desired level.



NAVIGATION

Basic features on the map screen

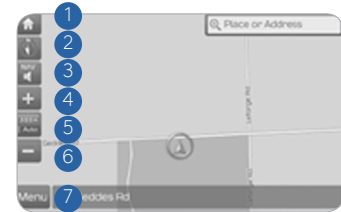

- 1 Move to the Home Screen
- 2 Change the map view mode
- 3 Voice Guidance On/Off
- 4 Zoom in the map
- 5 Set the zoom level automatically according to the guidance
- 6 Zoom out the map
- 7 Quick and easy selection of a destination and options
- 8 Touch to scroll the map
- 9 Start Guidance
- 10 Route Options
- 11 Save frequently used address to address book
- 12 Find a POI (Point of Interest) around the current position
- 13 View the vehicle's current position on the map screen

Destination search screen

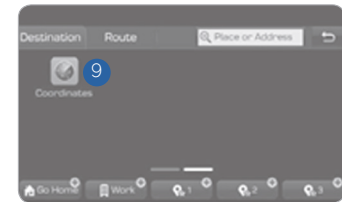

Press **[NAV]** button in the navigation head unit, and finds a destination by using the **[Destination]** menu.

- 1 Address : Set destination by address search.
- 2 Previous destinations : Select from previously inputted addresses and POIs.
- 3 Online Search: Runs online search.
- 4 POI categories : Select the desired item in the sub-categories.
- 5 Gas stations : Select the desired destinations among the searched gas stations.
- 6 Restaurants : Select the desired destination among the searched restaurants.
- 7 Emergency : Select the desired destination among the searched emergency facilities.
- 8 Address Book : Search the destination with the address book.
- 9 Coordinates : You can find a destination by entering the coordinates of latitude and longitude.

ANDROID AUTO™

REQUIREMENTS:

- Micro USB cable
- OS Android™ 5.0 or higher
- Compatible Android Phone
- Data and wireless plan for applicable features

BEFORE YOU BEGIN:

- Android Auto features may operate differently than on your phone.
- Message and data charges may apply when using Android Auto.
- Android Auto relies on the performance of your phone. If you experience performance issues:
 - Close all apps and then restart them or
 - Disconnect and then reconnect your phone
- Using the micro USB cable that was provided with your phone is recommended.
- When Android Auto is active, your in-vehicle voice recognition system is disabled and you will be using talk to Google™ to make your requests.

ANDROID AUTO SUPPORT



<https://support.google.com/androidauto/>

PHONE SETUP

Turn on Bluetooth® on your phone and connect the micro USB cable to your phone and the USB port on the vehicle.

Phone will prompt you to download the Android Auto app and update other needed apps (i.e. Google Maps™, Google Play Music™, Google Now™).

NOTE Vehicle must be parked.

- Location mode setting should be set to High accuracy.
- Car and phone setup should be completed in one sitting. If phone setup needs to be resumed, recommend to Force Stop the Android Auto app on the Phone then reopen the app and accept the Disclaimer notifications.

CAR SETUP

1. Press the SETUP button on the radio.
2. Touch the “Phone Projection” icon on screen.
3. Select Enable Android Auto.
4. Connect your Android phone to the vehicle USB port. Agree to the notification and disclaimers on your phone then the “Android Auto” icon will appear confirming the setup.

For more detailed information on how to operate Android Auto, please refer to your navigation manual.

For additional Android Auto support, please refer to the Android Auto Support Website
<https://support.google.com/androidauto/>

Android Auto, Google Play, Android, and other marks are trademarks of Google Inc.

APPLE CARPLAY™

REQUIREMENTS

- Apple Lightning® cable
- Latest iOS
- iPhone® 5 or above
- Data and wireless plan for applicable features

BEFORE YOU BEGIN

- Apple® CarPlay features may operate differently than on our phone.
- Message and data charges may apply when using Apple CarPlay.
- Apple CarPlay relies on the performance of your phone. If you experience performance issues:
 - Close all apps and then restart them or
 - Disconnect and then reconnect your phone
- Using the Apple Lightning cable that was provided with your phone is recommended.
- When Apple CarPlay is active, your voice recognition system is disabled and you will be using Siri® to make your requests.

PHONE SETUP

On your phone, go to Settings > General > Restrictions > CarPlay to allow CarPlay access.

On your phone, go to Settings > General > Siri and ensure Siri is turned ON.

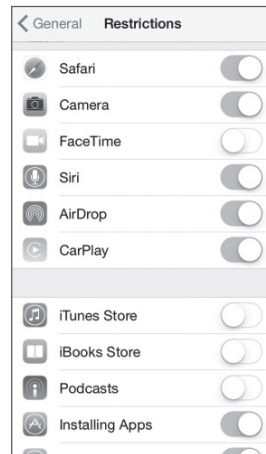

CAR SETUP

1. Press the SETUP button.
2. Touch the "Phone Projection" icon on the screen.
3. Touch "iOS" on the Connectivity Settings screen then touch Enable Apple CarPlay.
4. Connect your Apple iPhone to the vehicle USB port then touch 'OK' when the pop-up message appears. The Apple CarPlay icon will now appear on the vehicle Home screen confirming the setup.

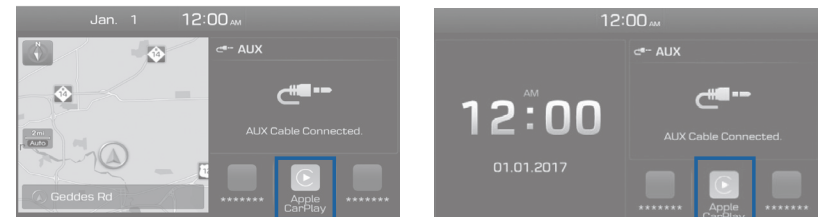

Apple CarPlay, Apple, and other marks are trademarks of Apple Inc.

CarPlay Home Screen

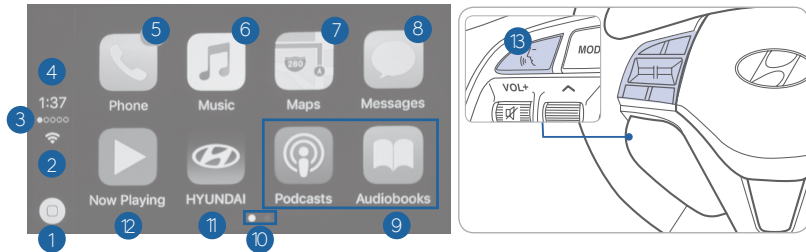

- | | |
|-------------------------|----------------------------------|
| 1 HOME ICON | 7 APPLE MAPS |
| 2 WIRELESS CONNECTIVITY | 8 MESSAGES |
| 3 CELLULAR SIGNAL | 9 3RD PARTY APPS |
| 4 PHONE TIME | 10 SCREEN PAGE INDICATOR |
| 5 PHONE | 11 EXIT TO HYUNDAI |
| 6 APPLE MUSIC™ | 12 CURRENT CARPLAY AUDIO PLAYING |

SIRI

Apple CarPlay uses Siri to perform many actions like sending messages, placing calls, and looking up/setting POI/Destinations. A Siri session can be initiated on any screen by:

1. Touch and holding the HOME icon 1 on the CarPlay screen or
2. Press the steering wheel VOICE RECOGNITION 13 button.

NOTE Ensure Siri feature is set to ON in your phone (Go to Settings > General > Siri).

3. Say any of the following commands;

- “Text <John Smith> ‘Call you later’” to send a text message.
- “Read text messages” to read available text message.
- “Call <John Smith>” to make a phone call.
- “Find <POI/Destination>” to locate a POI/Destination.

PHONE

Touch the PHONE 5 icon to access the Phone screen. Siri will automatically asks ‘Who you would like to call’ when the PHONE 5 icon is selected.

NOTE: Phone call sound quality is dependent on the wired connection. Using the Lightning cable that came with the phone is recommended.

APPLE MUSIC

Touch the APPLE MUSIC 6 icon to access the Apple Music screen.

APPLE MAPS

Touch the APPLE MAPS 7 icon to access the Apple Map screen.

MESSAGES

Touch the MESSAGES 8 icon to access the Message screen. Siri will automatically asks ‘To hear unread messages or create a new one’ when the MESSAGE icon is selected.

3rd PARTY APPS

Supported CarPlay apps that are downloaded on your phone will appear on the CarPlay screen. Touch the apps icons to access those supported apps.

NOTE A list of the supported CarPlay supported apps can be found at <http://www.apple.com/ios/carplay/>

Ensure phone has latest version of the 3rd Party Apps.

AUX AND USB PORT

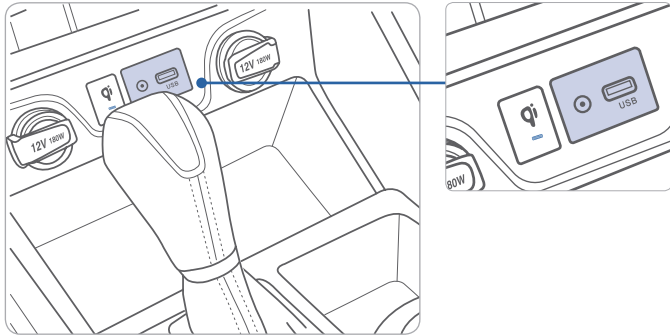

Use the Aux input jack to connect an external audio device.
 Use the media USB port to connect a USB device with music files or to access features on your smartphone using Apple CarPlay or Android Auto phone projection.
 Use the charging USB port to charge an external device such as a cell phone.

REAR USB OUTLET

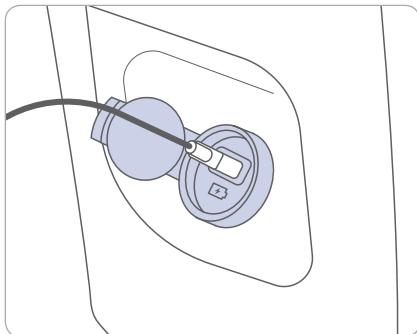

On the lower rear console there is an additional USB port for charging only.

WIRELESS CELLULAR PHONE CHARGING SYSTEM

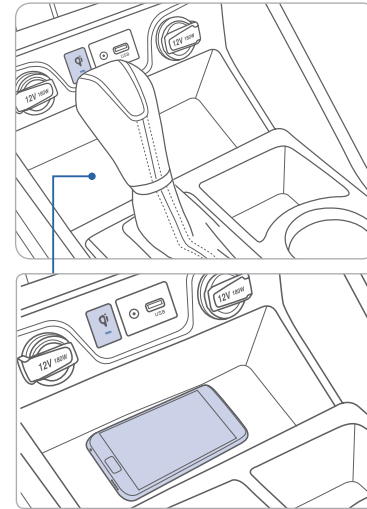

There is a wireless cellular phone charging system inside the front console. The system operates with all doors closed, and the ignition switch is in the ACC/ON position.

NOTE:
 The wireless cellular phone charging system supports only the Qi-enabled cellular phones (Qi).

NOTE:
 Do not place any metallic items such as coins, keys on the charger. Avoid putting credit cards, etc. on the charger as they might get damaged by the magnetic field.

AUTOMATIC TRANSMISSION

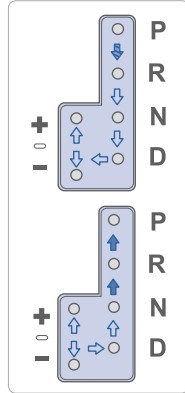
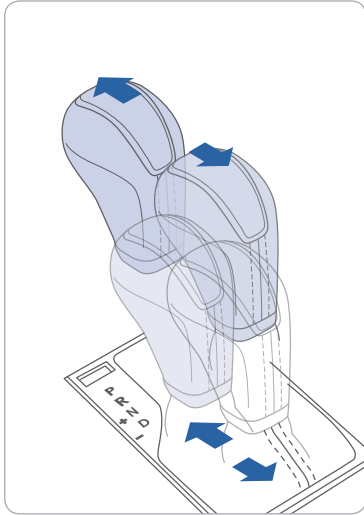

- (➡): Press the shift button, then move the shift lever.
- (⬆️): Depress the brake pedal, press the shift button, and then move the shift lever.
- (➡): Move the shift lever.

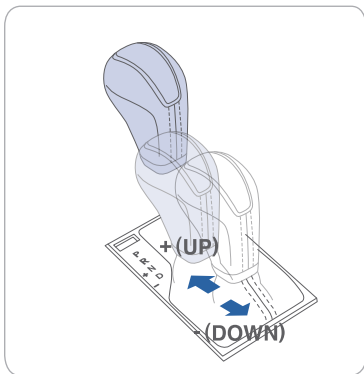

Sport mode

Move the shift lever from D (Drive) into the manual gate to select. Move the shift lever forward (+) to upshift or rearward (-) to downshift.

TIRE PRESSURE MONITORING SYSTEM (TPMS)

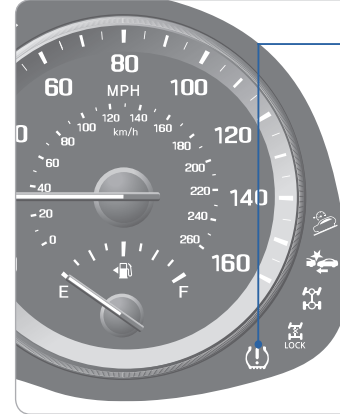

Low Tire Pressure Indicator / TPMS Malfunction Indicator



Low Tire Pressure Monitor with Location Indicator (Shown on the LCD display)

LOW TIRE PRESSURE INDICATOR

Illuminates if one or more of your tires are significantly under-inflated.

TPMS MALFUNCTION INDICATOR

Blinks for approximately one minute, then remains illuminated when there is a malfunction with the TPMS. Inspect all tires and adjust the tire pressure to specification. If the lamp remains illuminated, have the system checked by an authorized Hyundai dealer as soon as possible.

LOW TIRE PRESSURE LOCATION INDICATOR AND TIRE PRESSURE INDICATOR (LCD DISPLAY)

Tire pressures will be displayed after driving a short distance. If a tire pressure drops lower than predetermined specification, the Low Tire Pressure Indicator (⚠️) will illuminate and the LCD (📺) display will indicate the tire(s) requiring air.

ELECTRONIC STABILITY CONTROL (ESC)

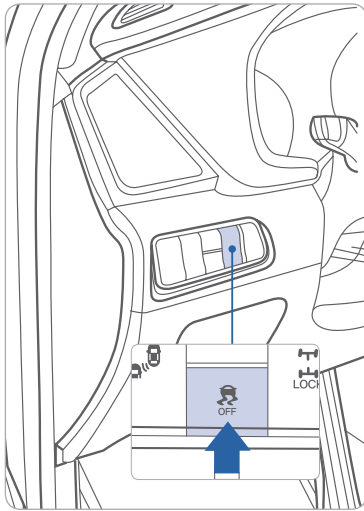

The ESC system is an electronic system designed to help the driver maintain vehicle control under adverse conditions.

The ESC automatically selects the ON position when the engine is started.

- To turn off the Traction Control, press the ESC OFF button shortly.
- To turn off the Traction and the Stability Control, press the ESC OFF button for over 3 seconds.

DOWNHILL BRAKE CONTROL (DBC)

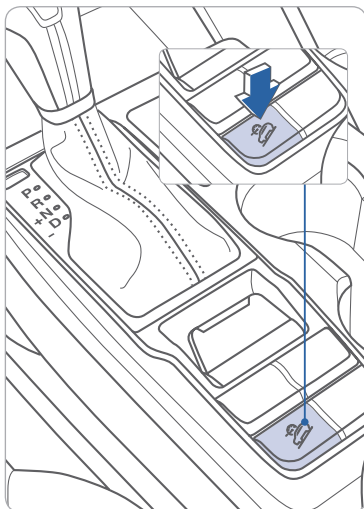

The Downhill Brake Control (DBC) helps the driver maintain a slow speed on a steep downhill without depressing the brake pedal. The system automatically applies the brakes to keep the vehicle speed under 5 mph.

NOTE:

When activated, the speed of the vehicle will be reduced. Please refer to your Owner's Manual for further information.

LANE KEEPING ASSIST (LKA)

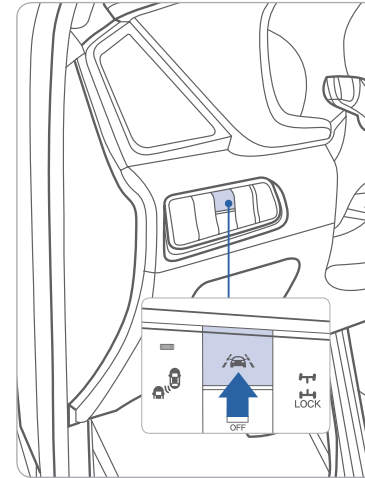

The Lane Keeping Assist (LKA) uses the front camera to monitor the lines on the road. In case of an unintended lane departure, it will warn the driver and can apply counter steering torque to guide the car back to the center of the lane.

- To turn on the LKA, press the LKA button.
- To turn off the LKA, press the LKA button again.

To adjust the settings of LKA, select the LKA sub menu in the LCD cluster display under User Settings.

BLIND SPOT COLLISION WARNING (BCW)

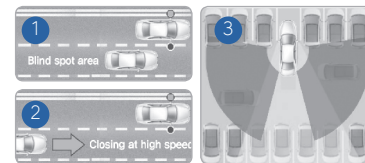

The BCW (Blind-Spot Collision Warning) system uses a radar sensor to alert the driver while driving.

The system monitors the rear area of the vehicle and provides information to the driver. The system incorporates the following functions:

- 1 Blind-Spot Collision Warning (BCW)
- 2 Lane Change Assist (LCA)
- 3 Rear Cross-Traffic Collision Warning (RCCW)- in reverse gear under 6 mph

- To turn on the BCW, press the BCW button (indicator illuminated).
- To turn off the BCW, press the BCW button again.

The BCW and LCA systems will activate once the vehicle speed exceeds 20 mph. The RCCW system activates in reverse gear under 6 mph.

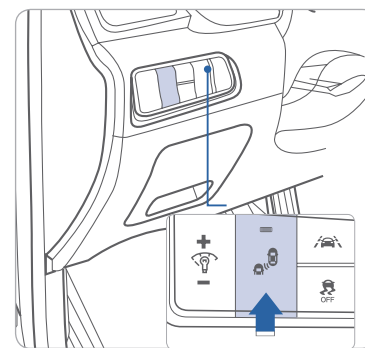

DRIVE MODE INTEGRATED CONTROL SYSTEM

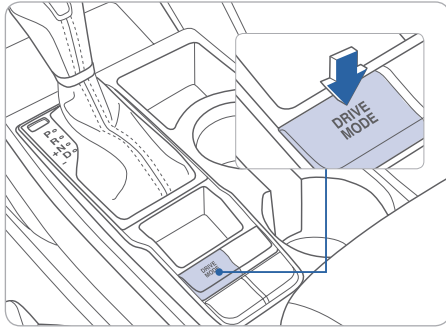

You can select the DRIVE mode according to your preference or the road condition. The system defaults to NORMAL mode each time you start your vehicle.

Each time you press the button, the drive mode changes as follows :



NORMAL mode

NORMAL mode is not displayed on the instrument cluster.

Sport mode

Sport mode focuses on dynamic driving by controlling the steering wheel effort, and engine / transmission performance.

AWD LOCK

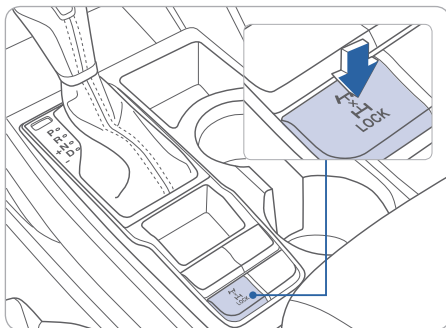

During off-road or inclement weather conditions, press the AWD LOCK switch to drive in full-time AWD. This will divide the power between the front and rear wheels (only when the vehicle speed is under 19 mph). The AWD LOCK indicator light on the instrument cluster will illuminate.

FORWARD COLLISION-AVOIDANCE ASSIST (FCA)

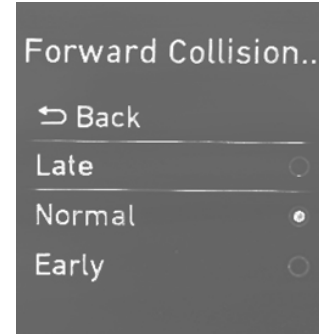

The Forward Collision Avoidance (FCA) system is designed to detect and monitor the vehicle ahead and warn the driver if a collision is imminent. On vehicles equipped with both camera and radar sensor, pedestrian detection is also available.

To operate the system, select the FCA (Forward Collision Avoidance Assist) sub menu in the LCD cluster display under User Settings. Please refer to your Owner's Manual for further information.

DRIVER ATTENTION ALERT SYSTEM

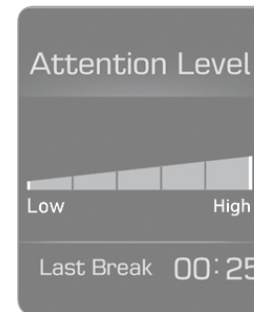

The Driver Attention Alert (DAA) system displays the condition of the driver's fatigue level and inattentive driving practices. The DAA system monitors the lane markers and driver's inputs to the steering wheel, accelerator pedal and brake pedal.

To turn ON the Driver Attention Alert system, turn on the engine, and then select 'User Settings → Driving Assist → Driver Attention Alert → Normal / Early' on the LCD Display.

The Driver Attention Alert system operates when driving over 40mph. The system can be reset when the driver turns the engine OFF.

For more detailed information on any of these topics, please refer to Section 5 of the Owner's Manual.

CRUISE CONTROL / ADVANCED SMART CRUISE CONTROL

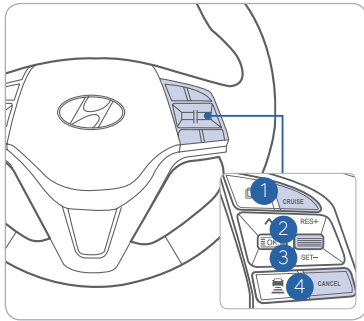

The Cruise Control system allows you to program the vehicle to maintain a constant speed without depressing the accelerator pedal.

- 1 To turn on/off the cruise control.
- 2 To resume or increase the cruise control speed.
- 3 To set or decrease the cruise control speed.
- 4 To cancel the cruise control set speed.

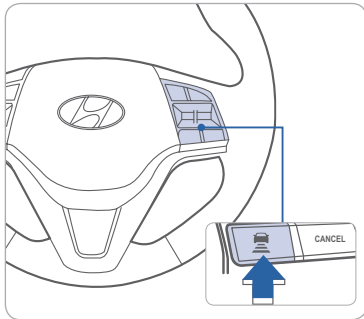

Setting Vehicle Distance (Smart Cruise Control only)

This system allows you to program the vehicle to maintain constant speed and minimum distance between the vehicle ahead. The vehicle to vehicle distance 1 will automatically activate when you set the cruise speed 2. Each time the vehicle distance set button is pressed, the vehicle to vehicle distance changes as following:

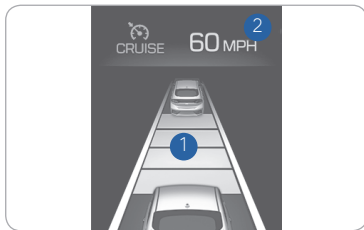
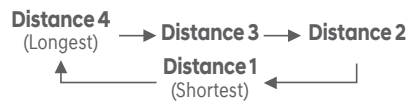

Advanced Smart Cruise Control will stop your vehicle if the vehicle ahead of you stops. If the vehicle ahead of you starts moving, your vehicle will start as well. However, if the vehicle stops for more than 3 seconds, you must depress the accelerator pedal or push up/down the toggle switch (RES+/SET-) to start driving.

For more detailed information please refer to Section 5 of the Owner's Manual.

REARVIEW CAMERA

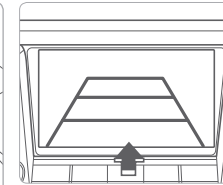
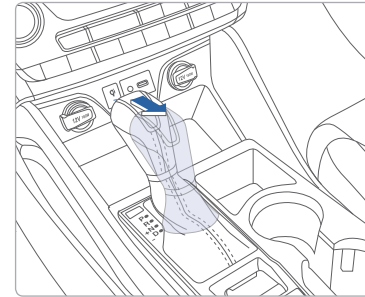

When the transmission is shifted into the R (Reverse), the rearview camera displays the area behind the vehicle.

MULTI-VIEW CAMERA SYSTEM

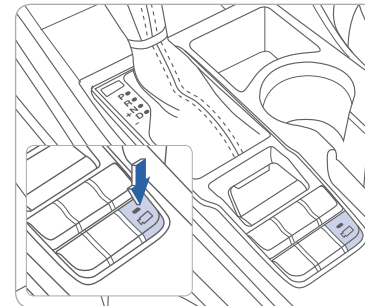

This parking support system displays an all-around view of the vehicle when parking. Press the switch to activate/deactivate the system.

Operating conditions

The shift lever is in D, N, or R position with the ignition ON

The vehicle speed is less than 10 mph

Large memo area with horizontal lines for notes.

TUCSON CUSTOMER DELIVERY CHECKLIST

HYUNDAI OWNER	DEALERSHIP NAME
SALES CONSULTANT	DATE
VIN	PREVIOUS VEHICLE

BEFORE DELIVERY

- SET TIRE PRESURE LF___ RF___ RR___ LR___
- VERIFY VEHICLE IS CLEAN, IN GOOD CONDITION, FREE OF CHIPS AND SCRATCHES · CLEAN WINDSHIELD AND BACK WINDOW
- ENSURE FLOORMATS ARE SNAPPED INTO PLACE

BLUETOOTH® HANDS-FREE
HYUNDAI

CONNECTING YOUR PHONE

On the radio:

1. Push the **SETUP** button.
2. Select **Bluetooth**.
3. Select **Bluetooth Connection**.
4. Select **Add New**.

In your phone's **Bluetooth** settings:

5. Select the <Vehicle Name> on your phone.
6. Enter the passkey from the radio or accept the authorization pop-up on your phone.

SWITCHING BETWEEN PAIRED PHONES

Using **Voice Command**: "Change Bluetooth device"

On the radio:

1. Push the **SETUP** button.
2. Select **Bluetooth**.
3. Select **Bluetooth Connection**.
4. Select **Connect** next to the desired phone.

For more information, visit HyundaiBluetooth.com