

# HYUNDAI

## ***OWNER'S MANUAL***

Operation  
Maintenance  
Specifications

**All information in this Owner's Manual is current at the time of publication. However, HYUNDAI reserves the right to make changes at any time so that our policy of continual product improvement may be carried out.**

**This manual applies to all HYUNDAI models and includes descriptions and explanations of optional as well as standard equipment. As a result, you may find material in this manual that does not apply to your specific vehicle.**

## CAUTION: MODIFICATIONS TO YOUR HYUNDAI

Your HYUNDAI should not be modified in any way. Such modifications may adversely affect the performance, safety or durability of your HYUNDAI and may, in addition, violate conditions of the limited warranties covering the vehicle. Certain modifications may also be in violation of regulations established by the U.S. Department of Transportation and other federal or state agencies.

## TWO-WAY RADIO OR CELLULAR TELEPHONE INSTALLATION

Your vehicle is equipped with electronic fuel injection and other electronic components. It is possible for an improperly installed/adjusted two-way radio or cellular telephone to adversely affect electronic systems. For this reason, we recommend that you carefully follow the radio manufacturer's instructions or consult your HYUNDAI dealer for precautionary measures or special instructions if you choose to install one of these devices.

## SAFETY AND VEHICLE DAMAGE WARNING

This manual includes information titled as DANGER, WARNING, CAUTION and NOTICE.

These titles indicate the following:

### DANGER

**DANGER** indicates a hazardous situation which, if not avoided, will result in death or serious injury.

### WARNING

**WARNING** indicates a hazardous situation which, if not avoided, could result in death or serious injury.

### CAUTION

**CAUTION** indicates a hazardous situation which, if not avoided, could result in minor or moderate injury.

### **NOTICE**

**NOTICE** indicates a situation which, if not avoided, could result in vehicle damage.



## HYUNDAI VEHICLE OWNER PRIVACY POLICY

Your Hyundai vehicle may be equipped with technologies and services that use information collected, generated, recorded or stored by the vehicle. Hyundai has created a Vehicle Owner Privacy Policy to explain how these technologies and services collect use and share this information.

You may read our Vehicle Owner Privacy Policy on the Hyundaiusa.com website at:  
<https://www.hyundaiusa.com/owner-privacy-policy.aspx>

If you would like to receive a hard copy of our Vehicle Owner Privacy Policy, please contact our Customer Connect Center at:

Hyundai Customer Care  
P.O. Box 20850  
Fountain Valley, CA 92728  
800-633-5151  
[consumeraffairs@hmausa.com](mailto:consumeraffairs@hmausa.com)

Hyundai's Customer Connect Center representatives are available Monday through Friday, between the hours of 5:00 AM and 7:00 PM PST and Saturday and Sunday between 6:30 AM and 3:00 PM PST (English).

For Customer Connect Center assistance in Spanish or Korean, representatives are available Monday through Friday between 6:30 AM and 3:00 PM PST.

## INTRODUCTION

Congratulations, and thank you for choosing HYUNDAI. We are pleased to welcome you to the growing number of discriminating people who drive HYUNDAIS. We are very proud of the advanced engineering and high-quality construction of each HYUNDAI we build.

Your Owner's Manual will introduce you to the features and operation of your new HYUNDAI. To become familiar with your new HYUNDAI, so that you can fully enjoy it, read this Owner's Manual carefully before driving your new vehicle.

This manual contains important safety information and instructions intended to familiarize you with your vehicle's controls and safety features so you can safely operate your vehicle.

This manual also contains information on maintenance designed to enhance safe operation of the vehicle. It is recommended that all service and maintenance on your car be performed by an authorized HYUNDAI dealer. HYUNDAI dealers are prepared to provide high-quality service, maintenance and any other assistance that may be required.

This Owner's Manual should be considered a permanent part of your vehicle, and should be kept in the vehicle so you can refer to it at any time. The manual should stay with the vehicle if you sell it to provide the next owner with important operating, safety and maintenance information.

## HYUNDAI MOTOR AMERICA

### CAUTION

**Severe engine and transmission damage may result from the use of poor quality fuels and lubricants that do not meet HYUNDAI specifications. You must always use high quality fuels and lubricants that meet the specifications listed on Page 8-8 in the Vehicle Specifications section of the Owner's Manual.**

Copyright 2018 HYUNDAI Motor America. All rights reserved. No part of this publication may be reproduced, stored in any retrieval system or transmitted in any form or by any means without the prior written permission of HYUNDAI Motor America.

## GUIDE TO HYUNDAI GENUINE PARTS

### 1. What are HYUNDAI Genuine Parts?

HYUNDAI Genuine Parts are the same parts used by HYUNDAI Motor Company to manufacture vehicles. They are designed and tested for the optimum safety, performance, and reliability for our customers.



### 2. Why should you use genuine parts?

HYUNDAI Genuine Parts are engineered and built to meet rigid manufacturing requirements. Damage caused by using imitation, counterfeit or used salvage parts is not covered under the HYUNDAI New Vehicle Limited Warranty or any other HYUNDAI warranty.

In addition, any damage to or failure of HYUNDAI Genuine Parts caused by the installation or failure of an imitation, counterfeit or used salvage part is not covered by any HYUNDAI Warranty.



### 3. How can you tell if you are purchasing HYUNDAI Genuine Parts?

Look for the HYUNDAI Genuine Parts Logo on the package (see below).

HYUNDAI Genuine Parts exported to the U.S. are packaged with labels written only in English.

HYUNDAI Genuine Parts are only sold through authorized HYUNDAI Dealerships.

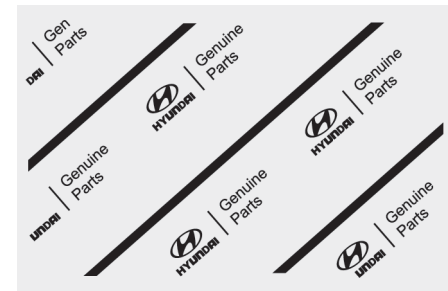

### HOW TO USE THIS MANUAL

We want to help you get the greatest possible driving pleasure from your vehicle. Your Owner's Manual can assist you in many ways. To gain an overview of the contents of your Owner's Manual, use the Table of Contents in the front of the manual. The first page of each Chapter includes a detailed Table of Contents of the Topics in that Chapter.

To quickly locate information about your vehicle, use the Index in the back of the manual. It is an alphabetical list of what is in this manual and the page number where it can be found.

For your convenience, we have incorporated tabs on the right-hand page edges. These tabs are coded with the Chapter titles to assist you with navigating through the manual.

### SAFETY MESSAGES

Your safety, and the safety of others, is very important. This Owner's Manual provides you with many safety precautions and operating procedures. This information alerts you to potential hazards that may hurt you or others, as well as damage to your vehicle.

Safety messages found on vehicle labels and in this manual describe these hazards and what to do to avoid or reduce the risks.

Warnings and instructions contained in this manual are for your safety. Failure to follow safety warnings and instructions can lead to serious injury or death.

Throughout this manual DANGER, WARNING, CAUTION, NOTICE and the SAFETY ALERT SYMBOL will be used.



This is the safety alert symbol. It is used to alert you to potential physical injury hazards. Obey all safety messages that follow this symbol to avoid possible injury or death. The safety alert symbol precedes the signal words DANGER, WARNING and CAUTION.

#### DANGER

**DANGER** indicates a hazardous situation which, if not avoided, will result in death or serious injury.

#### WARNING

**WARNING** indicates a hazardous situation which, if not avoided, could result in death or serious injury.

**CAUTION**

**CAUTION** indicates a hazardous situation which, if not avoided, could result in minor or moderate injury.

**NOTICE**

**NOTICE** indicates a situation which, if not avoided, could result in vehicle damage.

**FUEL REQUIREMENTS**

Your new vehicle is designed to obtain maximum performance with UNLEADED FUEL, as well as minimize exhaust emissions and spark plug fouling.

Your new vehicle is designed to use only unleaded fuel having an octane number ((R+M)/2) of 87 (Research Octane Number 91) or higher. (Do not use methanol blended fuels)

**NOTICE**

**To prevent damage to the engine and engine components, never add any fuel system cleaning agents to the fuel tank other than what has been specified.**

**Consult an authorized HYUNDAI dealer for additional information.**

**WARNING**

- **Do not "top off" after the nozzle automatically shuts off when refueling.**
- **Always check that the fuel cap is installed securely to prevent fuel spillage in the event of an accident.**

***Gasoline containing alcohol or methanol***

Gasohol, a mixture of gasoline and ethanol (also known as grain alcohol) are being marketed along with or instead of leaded or unleaded gasoline. For example, "E15" is a gasohol comprised of 15% ethanol and 85% gasoline.

Do not use gasohol containing more than 15% ethanol, and do not use gasoline or gasohol containing any methanol. Either of these fuels may cause drivability problems and damage to the fuel system, engine control system and emission control system. Discontinue using gasohol of any kind if drivability problems occur.

"E85" fuel is an alternative fuel comprised of 85 percent ethanol and 15 percent gasoline, and is manufactured exclusively for use in Flexible Fuel Vehicles. "E85" is not compatible with your vehicle. Use of "E85" may result in poor engine performance and damage to your vehicle's engine and fuel system. HYUNDAI recommends that customers do not use fuel with an ethanol content exceeding 15 percent.

### **NOTICE**

**To prevent damage to your vehicle's engine and fuel system:**

- **Never use gasohol which contains methanol.**
- **Never use gasohol containing more than 15% ethanol.**
- **Never use leaded fuel or leaded gasohol.**
- **Never use "E85" fuel.**

**Your New Vehicle Limited Warranty does not cover damage to the fuel system or any performance problems caused by the use of "E85" fuel.**

### ***Using Fuel Additives (except Detergent Fuel Additives)***

Using fuel additives such as:

- Silicone fuel additive
  - Ferrocene (iron-based) fuel additive
  - Other metallic-based fuel additives
- may result in cylinder misfire, poor acceleration, engine stalling, damage to the catalyst, or abnormal corrosion, and may cause damage to the engine resulting in a reduction in the overall life of the powertrain.
- The Malfunction Indicator Lamp (MIL) may illuminate.

### **NOTICE**

**Damage to the fuel system or performance problem caused by the use of these fuels or fuel additives may not be covered by your New Vehicle Limited Warranty.**

### ***Gasoline containing MMT***

Some gasoline contains harmful manganese-based fuel additives such as MMT (Methylcyclopentadienyl Manganese Tricarbonyl).

HYUNDAI does not recommend the use of gasoline containing MMT.

This type of fuel can reduce vehicle performance and affect your emission control system.

The malfunction indicator lamp on the cluster may come on.

### ***Detergent Fuel Additives***

HYUNDAI recommends that you use good quality gasolines treated with detergent additives such as TOP TIER Detergent Gasoline, which help prevent deposit formation in the engine. These gasolines will help the engine run cleaner and enhance performance of the Emission Control System. For more information on TOP TIER Detergent Gasoline, please go to the website ([www.toptiergas.com](http://www.toptiergas.com)).

## VEHICLE BREAK-IN PROCESS

For customers who do not use TOP Tier Detergent Gasoline regularly, and have problems starting or the engine does not run smoothly, detergent-based fuel additives that you can purchase separately may be added to the gasoline. If TOP TIER Detergent Gasoline is not available, one bottle of additive added to the fuel tank according to the maintenance schedule is recommended (refer to the Maintenance Schedule in chapter 7).

Additives are available from your authorized HYUNDAI dealer along with information on how to use them. Do not mix other additives.

### ***Operation in foreign countries***

If you are going to drive your vehicle in another country, be sure to:

- Observe all regulations regarding registration and insurance.
- Determine that acceptable fuel is available.

No special break-in period is needed. By following a few simple precautions for the first 600 miles (1,000 km) you may add to the performance, economy and life of your vehicle.

- Do not race the engine.
- While driving, keep your engine speed (rpm, or revolutions per minute) between 2,000 rpm and 4,000 rpm.
- Do not maintain a single speed for long periods of time, either fast or slow. Varying engine speed is needed to properly break-in the engine.
- Avoid hard stops, except in emergencies, to allow the brakes to seat properly.

### WARNING

#### **CALIFORNIA PROPOSITION 65 WARNING**

**Items contained in motor vehicles or emitted from them are known to the State of California to cause cancer and birth defects or reproductive harm. These include:**

- Gasoline and its vapors
- Engine exhaust
- Used engine oil
- Interior passenger compartment components and materials
- Component parts which are subject to heat and wear

**In addition, battery posts, terminals and related accessories contain lead, lead compounds and other chemicals known to the State of California to cause cancer and reproductive harm.**

### VEHICLE DATA COLLECTION AND EVENT DATA RECORDERS

This vehicle is equipped with an event data recorder (EDR). The main purpose of an EDR is to record, in certain crash or near crash-like situations, such as an air bag deployment or hitting a road obstacle, data that will assist in understanding how a vehicle's systems performed. The EDR is designed to record data related to vehicle dynamics and safety systems for a short period of time, typically 30 seconds or less. The EDR in this vehicle is designed to record such data as:

- How various systems in your vehicle were operating;
- Whether or not the driver and passenger safety belts were buckled/ fastened;
- How far (if at all) the driver was depressing the accelerator and/or brake pedal; and,
- How fast the vehicle was traveling.

These data can help provide a better understanding of the circumstances in which crashes and injuries occur. **NOTE:** EDR data are recorded by your vehicle only if a non-trivial crash situation occurs; no data are recorded by the EDR under normal driving conditions and no personal data (e.g., name, gender, age, and crash location) are recorded. However, other parties, such as law enforcement, could combine the EDR data with the type of personally identifying data routinely acquired during a crash investigation.

To read data recorded by an EDR, special equipment is required, and access to the vehicle or the EDR is needed. In addition to the vehicle manufacturer, other parties, such as law enforcement, that have the special equipment, can read the information if they have access to the vehicle or the EDR.



## TABLE OF CONTENTS

Your vehicle at a glance

1

Safety features of your vehicle

2

Convenient features of your vehicle

3

Multimedia System

4

Driving your vehicle

5

What to do in an emergency

6

Maintenance

7

Specifications, Consumer information and  
Reporting safety defects

8

Index

I

# Your vehicle at a glance

Exterior overview .....	1-2
Interior overview.....	1-4
Instrument panel overview .....	1-5
Engine compartment .....	1-6

## EXTERIOR OVERVIEW

### ■ Front view

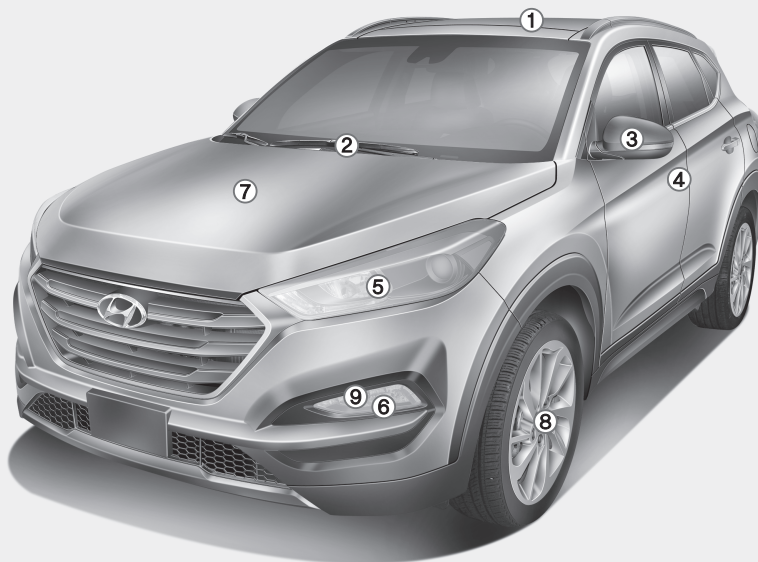

- 1. Panoramic sunroof\* .....3-42
  - 2. Front windshield wiper blades .....7-35
  - 3. Side view mirror .....3-35
  - 4. Door locks .....3-14
  - 5. Headlight .....7-69
  - 6. Front fog lamp\* .....3-110
  - 7. Hood .....3-46
  - 8. Tires and wheels .....7-40, 8-6
  - 9. Daytime running lamp\* .....3-112, 7-69
- \*: if equipped

※ The actual shape may differ from the illustration.

OTLA015001

■ Rear view



- 1. Antenna .....4-2
  - 2. Defroster.....3-126
  - 3. Parking assist system\* .....3-122
  - 4. Fuel filler door .....3-47
  - 5. Towing hook .....6-22
  - 6. Rear combination lamp .....7-79
  - 7. Rear window wiper blade .....7-36
  - 8. High mounted stop lamp .....7-82
  - 9. Rearview camera .....3-121
- \*: if equipped

※ The actual shape may differ from the illustration.

OTL015002

## INTERIOR OVERVIEW

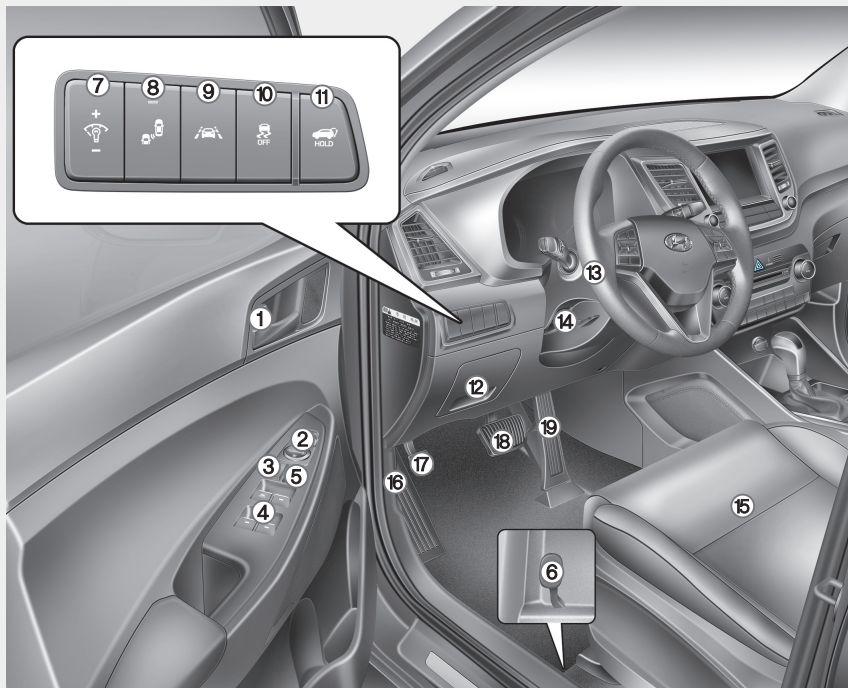

- 1. Door lock/unlock button .....3-15
- 2. Side view mirror control switch .....3-37
- 3. Central door lock switch .....3-16
- 4. Power window switches .....3-38
- 5. Power window lock switch.....3-41
- 6. Fuel filler door release lever .....3-47
- 7. Instrument panel illumination control switch .....3-64
- 8. Blind spot detection (BSD) system button\* .....5-50
- 9. Lane departure warning system (LDWS) button\* .....5-67
- 10. ESC OFF button .....5-32
- 11. Power liftgate button .....3-53
- 12. Fuse panel .....7-57
- 13. Steering wheel .....3-20
- 14. Steering wheel tilt/telescope lever .....3-21
- 15. Seat.....2-4
- 16. Hood release lever .....3-46
- 17. Parking brake .....5-28
- 18. Brake pedal .....5-27
- 19. Accelerator pedal

\* : if equipped

\* The actual shape may differ from the illustration.

OTLA015003

## INSTRUMENT PANEL OVERVIEW

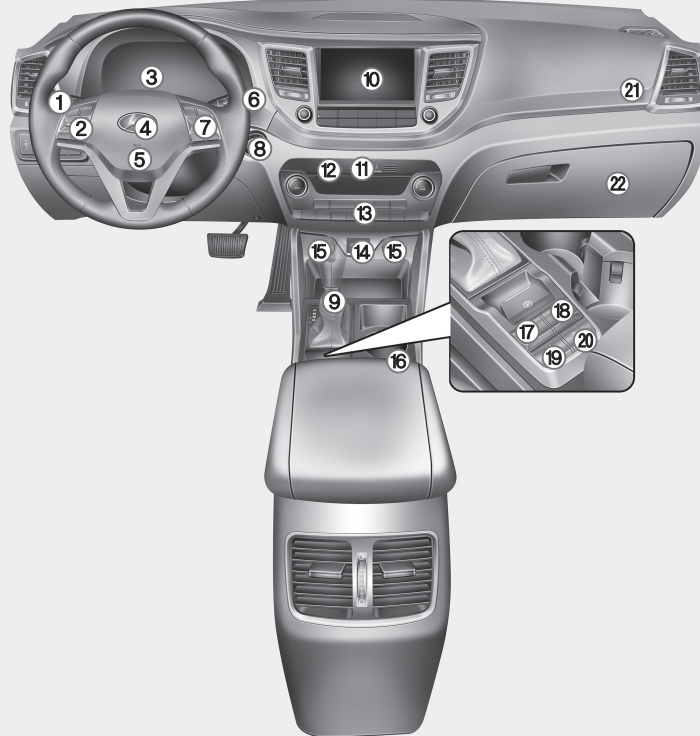

\* The actual shape may differ from the illustration.

1. Light control/Turn signals.....3-107
  2. Steering wheel audio controls\*/ .....4-3  
*Bluetooth*<sup>®</sup> wireless technology  
hands-free controls\*.....4-4
  3. Instrument cluster .....3-63
  4. Horn .....3-22
  5. Driver's front air bag .....2-48
  6. Wiper/Washer .....3-118
  7. Cruise Control buttons/switch .....5-72
  8. Engine Start/Stop button/  
Key ignition switch .....5-9
  9. Automatic transmission/  
Dual clutch transmission shifter.....5-18
  10. Audio/AVN\* .....4-4
  11. Hazard warning flasher button .....6-2
  12. PASSENGER AIR BAG OFF  
indicator .....2-57
  13. Climate control system.....3-126, 3-137
  14. AUX, USB .....4-2
  15. Power outlet.....3-156
  16. Cup holder .....3-155
  17. Drive mode integrated control  
system .....5-46
  18. DBC button .....5-37
  19. AWD LOCK button\* .....5-41
  20. Rear parking assist system\* .....3-122
  21. Passenger's front air bag.....2-48
  22. Glove box.....3-153
- \* : if equipped

## ENGINE COMPARTMENT

■ Gamma 1.6 Turbo-GDI

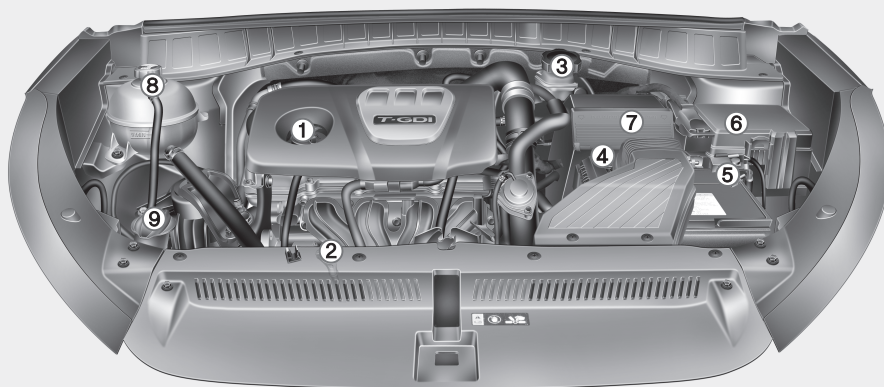

- 1. Engine oil filler cap .....7-23
- 2. Engine oil dipstick .....7-22
- 3. Brake fluid reservoir .....7-28
- 4. Positive battery terminal .....7-37
- 5. Negative battery terminal.....7-37
- 6. Fuse box .....7-57
- 7. Air cleaner.....7-30
- 8. Engine coolant reservoir .....7-24
- 9. Windshield washer fluid reservoir .....7-29

**The actual engine compartment in the vehicle may differ from the illustration.**

OTLE075002

■ Nu 2.0 GDI

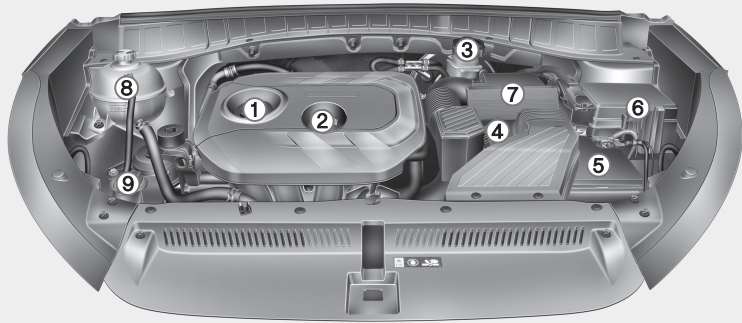

■ Theta II 2.4 GDI

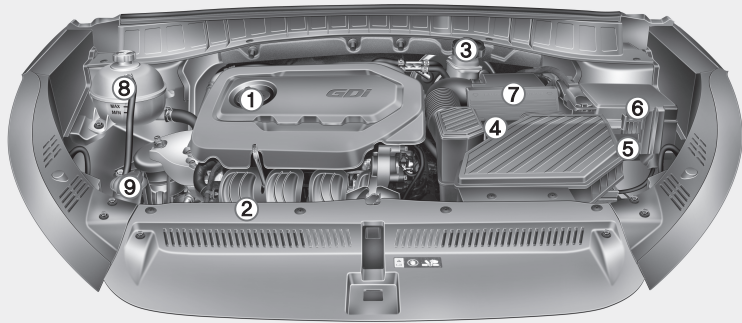

- 1. Engine oil filler cap .....7-23
- 2. Engine oil dipstick .....7-22
- 3. Brake fluid reservoir.....7-28
- 4. Positive battery terminal .....7-37
- 5. Negative battery terminal.....7-37
- 6. Fuse box .....7-57
- 7. Air cleaner.....7-30
- 8. Engine coolant reservoir .....7-24
- 9. Windshield washer fluid reservoir .....7-29

The actual engine compartment in the vehicle may differ from the illustration.



# Safety system of your vehicle

This chapter provides you with important information about how to protect yourself and your passengers. It explains how to properly use your seats and seat belts, and how your air bags work. Additionally, this chapter explains how to properly restrain infants and children in your vehicle.

<b>Important Safety Precautions</b> .....	2-2	<b>Child Restraint System (CRS)</b> .....	2-36
Always Wear Your Seat Belt.....	2-2	Children Always in the Rear.....	2-36
Restrain All Children.....	2-2	Selecting a Child Restraint System (CRS).....	2-37
Air Bag Hazards.....	2-2	Installing a Child Restraint System (CRS).....	2-39
Driver Distraction.....	2-2	<b>Air Bag -</b>	
Control Your Speed.....	2-3	<b>Advanced Supplemental Restraint System</b> .....	2-46
Keep Your Vehicle in Safe Condition.....	2-3	Where Are the Air Bags?.....	2-48
<b>Seats</b> .....	2-4	How Does the Air Bag System Operate?.....	2-51
Safety Precautions.....	2-5	What to Expect After an Air Bag Inflates.....	2-56
Front Seats.....	2-6	Occupant Classification System (OCS).....	2-57
Rear Seats.....	2-11	Why Didn't My Air Bag Go Off in a Collision?.....	2-62
Head restraints.....	2-14	SRS Care.....	2-67
Seat warmers and air ventilation seats.....	2-18	Additional Safety Precautions.....	2-68
<b>Seat Belts</b> .....	2-22	Air Bag Warning Labels.....	2-69
Seat Belt Safety Precautions.....	2-22		
Seat Belt Warning Light.....	2-23		
Seat Belt Restraint System.....	2-24		
Additional Seat Belt Safety Precautions.....	2-32		
Care of Seat Belts.....	2-35		

### IMPORTANT SAFETY PRECAUTIONS

You will find many safety precautions and recommendations throughout this section, and throughout this manual. The safety precautions in this section are among the most important.

#### Always Wear Your Seat Belt

A seat belt is your best protection in all types of accidents. Air bags are designed to supplement seat belts, not replace them. So even though your vehicle is equipped with air bags, **ALWAYS** make sure you and your passengers wear your seat belts, and wear them properly.

#### Restrain All Children

All children under age 13 should ride in your vehicle properly restrained in a rear seat, not the front seat. Infants and small children should be restrained in an appropriate child restraint. Larger children should use a booster seat with the lap/shoulder belt until they can use the seat belt properly without a booster seat.

#### Air Bag Hazards

While air bags can save lives, they can also cause serious or fatal injuries to occupants who sit too close to them, or who are not properly restrained. Infants, young children, and shorter adults are at the greatest risk of being injured by an inflating air bag. Follow all instructions and warnings in this manual.

#### Driver Distraction

Driver distraction presents a serious and potentially deadly danger, especially for inexperienced drivers. Safety should be the first concern when behind the wheel and drivers need to be aware of the wide array of potential distractions, such as drowsiness, reaching for objects, eating, personal grooming, other passengers, and using cellular phones.

Drivers can become distracted when they take their eyes and attention off the road or their hands off the wheel to focus on activities other than driving. To reduce your risk of distraction or getting into an accident:

- 
- ALWAYS set up your mobile devices (i.e., MP3 players, phones, navigation units, etc.) when your vehicle is parked or safely stopped.
  - ONLY use your mobile device when allowed by laws and when conditions permit safe use. NEVER text or email while driving. Most states have laws prohibiting drivers from texting. Some states and cities also prohibit drivers from using handheld phones.
  - NEVER let the use of a mobile device distract you from driving. You have a responsibility to your passengers and others on the road to always drive safely, with your hands on the wheel as well as your eyes and attention on the road.

### Control Your Speed

Excessive speed is a major factor in crash injuries and deaths. Generally, the higher the speed, the greater the risk, but serious injuries can also occur at lower speeds. Never drive faster than is safe for current conditions, regardless of the maximum speed posted.

### Keep Your Vehicle in Safe Condition

Having a tire blowout or a mechanical failure can be extremely hazardous. To reduce the possibility of such problems, check your tire pressures and condition frequently, and perform all regularly scheduled maintenance.

## SEATS

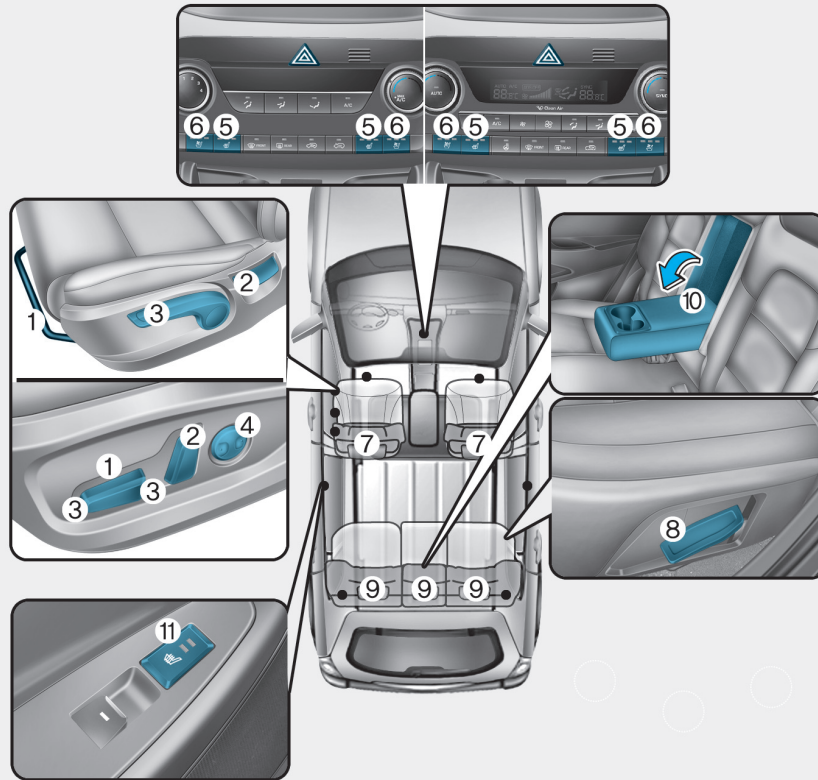

### Front seats

#### Front seat

- (1) Forward and backward
- (2) Seatback angle
- (3) Seat cushion height (Driver's seat)
- (4) Lumbar support (Driver's seat)\*
- (5) Seat warmer\*
- (6) Air ventilation seat\*
- (7) Head restraint

### Rear seat

- (8) Seatback angle and folding
- (9) Head restraint
- (10) Armrest
- (11) Seat warmer\*

\* : if equipped

## Safety Precautions

Adjusting the seats so that you are sitting in a safe, comfortable position plays an important role in driver and passenger safety together with the seat belts and air bags in an accident.

### WARNING

**Do not use a cushion that reduces friction between the seat and the passenger. The passenger's hips may slide under the lap portion of the seat belt during an accident or a sudden stop. Serious or fatal internal injuries could result because the seat belt cannot operate properly.**

### *Air bags*

You can take steps to reduce the risk of being injured by an inflating air bag. Sitting too close to an air bag greatly increases the risk of injury in the event the air bag inflates.

The National Highway Traffic Safety Administration (NHTSA) recommends that drivers allow at least 10 inches (25 cm) between the center of the steering wheel and their chest.

### WARNING

**To reduce the risk of serious injury or death from an inflating air bag, take the following precautions:**

- **Adjust the driver's seat as far to the rear as possible while maintaining the ability to maintain full control of the vehicle.**
- **Adjust the front passenger seat as far to the rear as possible.**
- **Hold the steering wheel by the rim with hands at the 9 o'clock and 3 o'clock positions to minimize the risk of injuries to your hands and arms.**
- **NEVER place anything or anyone between the steering wheel and the air bag.**
- **Do not allow the front passenger to place feet or legs on the dashboard to minimize the risk of leg injuries.**

### *Seat belts*

Always fasten your seat belt before starting any trip.

At all times, passengers should sit upright and be properly restrained. Infants and small children must be restrained in appropriate child restraint systems. Children who have outgrown a booster seat and adults must be restrained using the seat belts.

 **WARNING**

Take the following precautions when adjusting your seat belt:

- NEVER use one seat belt for more than one occupant.
- Always position the seatback upright with the lap portion of the seat belt snug and low across the hips.
- NEVER allow children or small infants to ride in a passenger's lap.
- Do not route the seat belt across your neck, across sharp edges, or reroute the shoulder strap away from your body.
- Do not allow the seat belt to become caught or jammed.

**Front Seats**

 **WARNING**

Take the following precautions when adjusting your seat:

- NEVER attempt to adjust the seat while the vehicle is moving. The seat could respond with unexpected movement and may cause loss of vehicle control resulting in an accident.
- Do not place anything under the front seats. Loose objects in the driver's foot area could interfere with the operation of the foot pedals, causing an accident.
- Do not allow anything to interfere with the normal position and proper locking of the seatback.
- Do not place a cigarette lighter on the floor or seat. When you operate the seat, gas may exit out of the lighter causing a fire.

(Continued)

(Continued)

- Use extreme caution when picking up small objects trapped under the seats or between the seat and the center console. Your hands might be cut or injured by the edges of the seat mechanism.

 **CAUTION**

To prevent injury:

- Do not adjust your seat while wearing your seat belt. Moving the seat cushion forward may cause strong pressure on your abdomen.
- Do not allow your hands or fingers to get caught in the seat mechanisms while the seat is moving.

## Manual adjustment

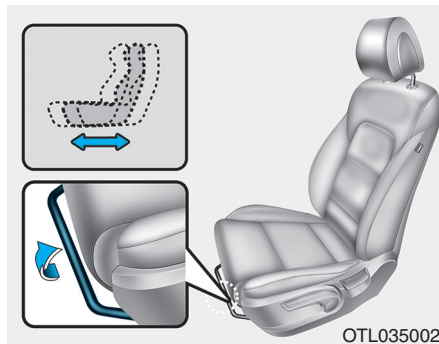

### Forward and rearward adjustment

To move the seat forward or rearward:

1. Pull up the seat slide adjustment lever and hold it.
2. Slide the seat to the position you desire.
3. Release the lever and make sure the seat is locked in place. Move forward and rearward without using the lever. If the seat moves, it is not locked properly.

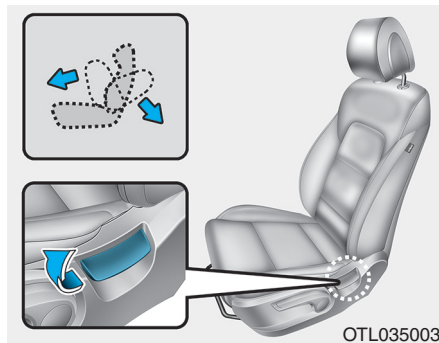

### Seatback angle

To recline the seatback:

1. Lean forward slightly and lift up the seatback lever.
2. Carefully lean back on the seat and adjust the seatback to the position you desire.
3. Release the lever and make sure the seatback is locked in place. (The lever **MUST** return to its original position for the seatback to lock.)

## Reclining seatback

Sitting in a reclined position when the vehicle is in motion can be dangerous. Even when buckled up, the protection of your restraint system (seat belts and air bags) is greatly reduced by reclining your seatback.

### ⚠ WARNING

**NEVER** ride with a reclined seatback when the vehicle is moving.

**Riding with a reclined seatback increases your chance of serious or fatal injuries in the event of a collision or sudden stop.**

**Drivers and passengers should ALWAYS sit well back in their seats, properly belted, and with the seatbacks upright.**

Seat belts must be snug against your hips and chest to work properly. When the seatback is reclined, the shoulder belt is not as effective because it will not be snug against your chest. Instead, it will be in front of you. During an accident, you could be thrown into the seat belt, causing neck or other injuries.

The more the seatback is reclined, the greater chance the passenger's hips will slide under the lap belt or the passenger's neck will strike the shoulder belt.

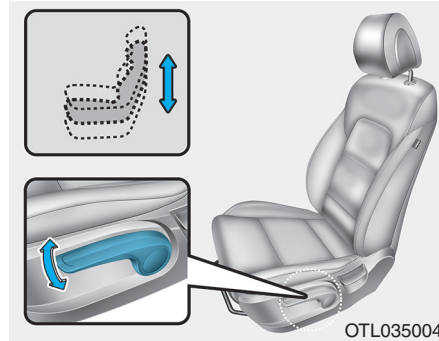

### Seat cushion height

To change the height of the seat cushion:

- Push down on the lever several times, to lower the seat cushion.
- Pull up on the lever several times, to raise the seat cushion.

### Power adjustment

The front seat can be adjusted by using the control switches located on the outside of the seat cushion. Before driving, adjust the seat to the proper position so that you can easily control the steering wheel, foot pedals and controls on the instrument panel.

### **⚠ WARNING**

**NEVER allow children in the vehicle unattended. The power seats are operable when the engine is turned off.**

### **NOTICE**

**To prevent damage to the seats:**

- **Always stop adjusting the seats when the seat has been adjusted as far forward or rearward as possible.**
- **Do not adjust the seats longer than necessary when the engine is turned off. This may result in unnecessary battery drain.**
- **Do not operate two or more seats at the same time. This may result in an electrical malfunction.**



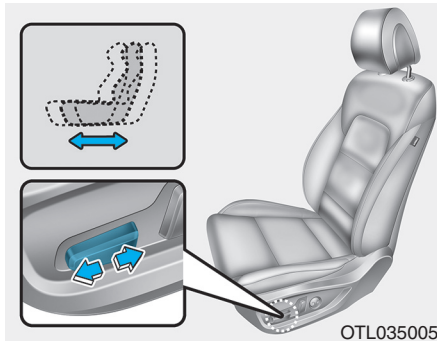

### Forward and rearward adjustment

To move the seat forward or rearward:

1. Push the control switch forward or rearward.
2. Release the switch once the seat reaches the desired position.

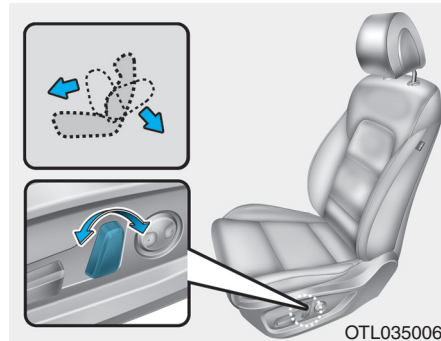

### Seatback angle

To recline the seatback:

1. Push the control switch forward or rearward.
2. Release the switch once the seatback reaches the desired position.

### Reclining seatback

Sitting in a reclined position when the vehicle is in motion can be dangerous. Even when buckled up, the protections of your restraint system (seat belts and air bags) is greatly reduced by reclining your seatback.

#### **⚠ WARNING**

**NEVER** ride with a reclined seatback when the vehicle is moving.

**Riding with a reclined seatback increases your chance of serious or fatal injuries in the event of a collision or sudden stop.**

**Driver and passengers should ALWAYS sit well back in their seats, properly belted, and with the seatbacks upright.**

Seat belts must be snug against your hips and chest to work properly. When the seatback is reclined, the shoulder belt cannot do its job because it will not be snug against your chest. Instead, it will be in front of you. During an accident, you could be thrown into the seat belt, causing neck or other injuries.

The more the seatback is reclined, the greater chance the passenger's hips will slide under the lap belt or the passenger's neck will strike the shoulder belt.

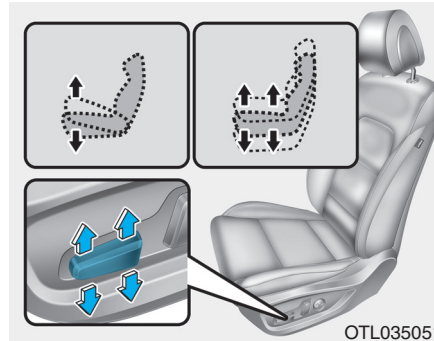

### Seat cushion height

To change the height of the seat cushion:

1. Pull the front portion of the control switch up to raise or push down to lower the front part of the seat cushion. Pull the rear portion of the control switch up to raise or push down to lower the seat cushion.
2. Release the switch once the seat reaches the desired position.

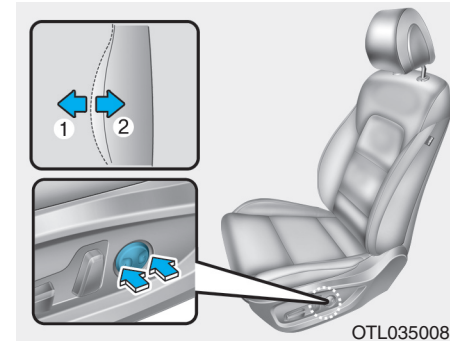

### Lumbar support (for driver's seat, if equipped)

To adjust the lumbar support:

1. Press the front portion of the switch to increase support or the rear portion of the switch to decrease support.
2. Release the switch once it reaches the desired position.

## Seatback pocket

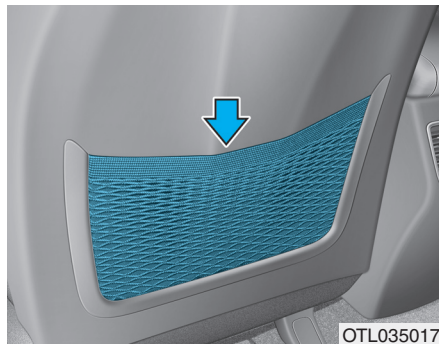

The seatback pocket is provided on the back of the front seatbacks.

### CAUTION

Do not put heavy or sharp objects in the seatback pockets. In an accident they could come loose from the pocket and injure occupants.

## Rear Seats

### Folding the rear seat

The rear seatbacks can be folded to facilitate carrying long items or to increase the luggage capacity of the vehicle.

### WARNING

- **Never allow passengers to sit on top of the folded down seatback while the vehicle is moving. This is not a proper seating position and no seat belts are available for use. This could result in serious injury or death in case of an accident or sudden stop.**
- **Objects carried on the folded down seatback should not extend higher than the top of the front seatbacks. This could allow cargo to slide forward and cause injury or damage during sudden stops.**

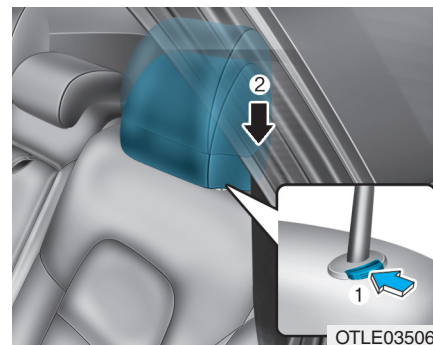

To fold down the rear seatback:

1. Set the front seatback to the upright position and if necessary, slide the front seat forward.
2. Lower the rear head restraints to the lowest position.

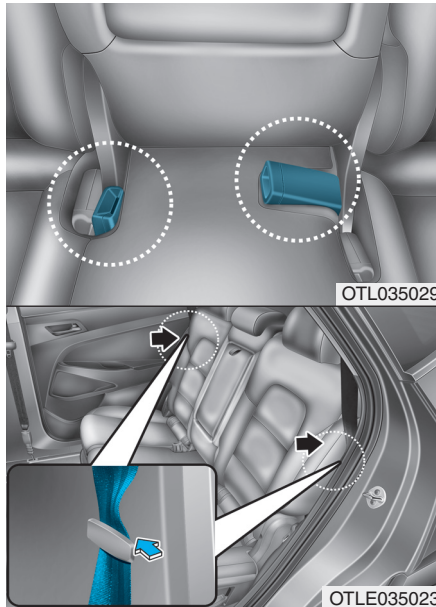

3. Insert the rear seat belt buckle in the pocket between the rear seatback and cushion, and insert the rear seat belt webbing in the guide to prevent the seat belt from being damaged.

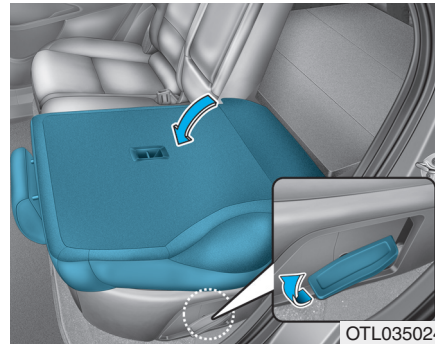

4. Fold the seatback toward the front of the vehicle.

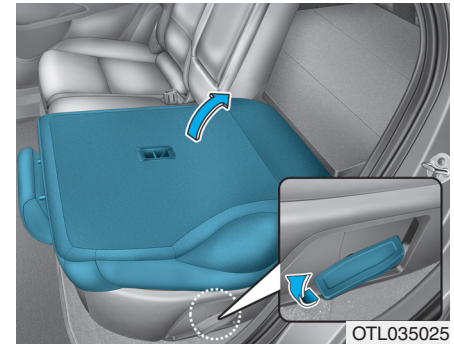

5. To use the rear seat, lift and pull the seatback rearward. Pull the seatback firmly until it clicks into place. Make sure the seatback is locked in place.

When you return the seatback to its upright position, always be sure it has locked into position by pushing on the top of the seatback.

**⚠ WARNING**

When returning the rear seatback from a folded to an upright position, hold the seatback and return it slowly. Ensure that the seatback is completely locked into its upright position by pushing on the top of the seatback. In an accident or sudden stop, the unlocked seatback could allow cargo to move forward with great force and enter the passenger compartment, which could result in serious injury or death.

**⚠ WARNING**

Do not place objects in the rear seats, since they cannot be properly secured and may hit vehicle occupants in a collision causing serious injury or death.

**⚠ WARNING**

Make sure the engine is off, the shift lever is in P (Park), and the parking brake is securely applied whenever loading or unloading cargo. Failure to take these steps may allow the vehicle to move if the shift lever is inadvertently moved to another position.

**Armrest**

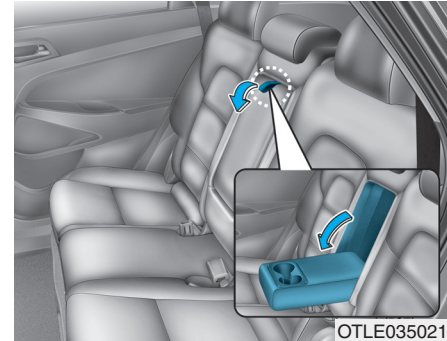

The armrest is located in the center of the rear seat. Pull the armrest down by using the strap from the seatback to use it.

You will find cup holders on the center armrest.

**CAUTION**

- Be careful when loading cargo through the rear passenger seats to prevent damage to the vehicle interior.
- When cargo is loaded through the rear passenger seats, ensure the cargo is properly secured to prevent it from moving while driving.
- Unsecured cargo in the passenger compartment can cause damage to the vehicle or injury to its occupants.

### Head restraints

The vehicle's front and rear seats have adjustable head restraints. The head restraints provide comfort for passengers, but more importantly they are designed to help protect passengers from whiplash and other neck and spinal injuries during an accident, especially in a rear impact collision.

**WARNING**

To reduce the risk of serious injury or death in an accident, take the following precautions when adjusting your head restraints:

- Always properly adjust the head restraints for all passengers **BEFORE** starting the vehicle.
- **NEVER** let anyone ride in a seat with the head restraints removed.

(Continued)

(Continued)

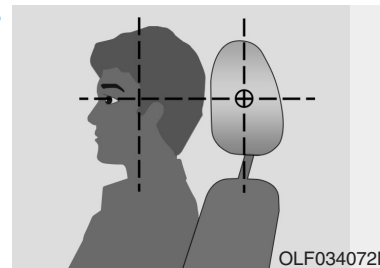

- Adjust the head restraints so the middle of the head restraints is at the same height as the height of the top of the eyes.
- **NEVER** adjust the head restraint position of the driver's seat when the vehicle is in motion.
- Adjust the head restraint as close to the passenger's head as possible. Do not use a seat cushion that holds the body away from the seatback.
- Make sure the head restraint locks into position after adjusting it.

**NOTICE**

To prevent damage, NEVER hit or pull on the head restraints.

**Front seat head restraints**

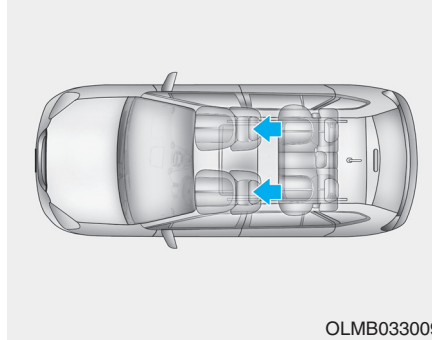

The vehicle's front seats are equipped with adjustable head restraints for both safety and comfort.

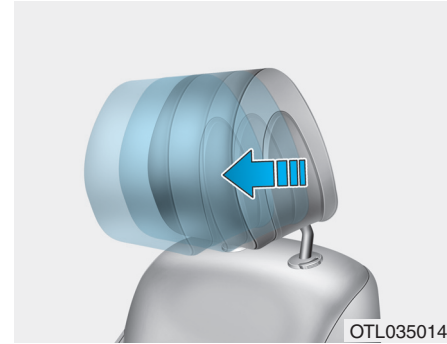

**Forward and rearward adjustment**

The headrest may be adjusted forward to 3 different positions by pulling the headrest forward to the desired detent. To adjust the headrest to its furthest rearwards position, pull it fully forward to the farthest position and release it.

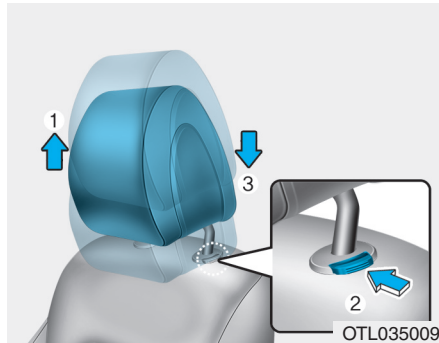

### Adjusting the height up and down

To raise the head restraint:

1. Pull it up to the desired position (1).

To lower the head restraint:

1. Push and hold the release button (2) on the head restraint support.
2. Lower the head restraint to the desired position (3).

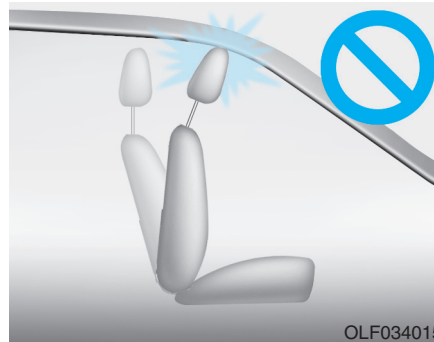

### NOTICE

**If you recline the seatback towards the front with the head restraint and seat cushion raised, the head restraint may come in contact with the sunvisor or other parts of the vehicle.**

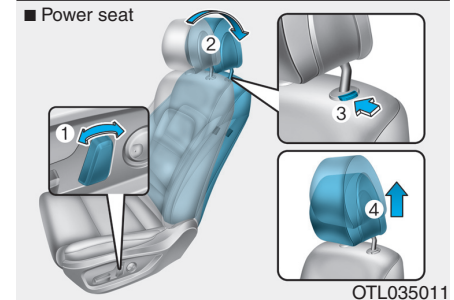
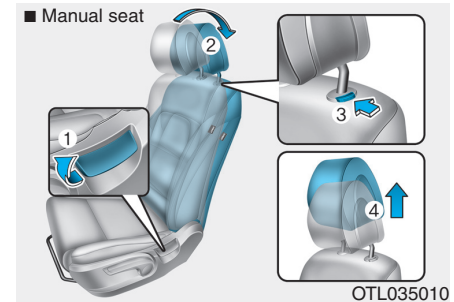

### Removal/Reinstallation

To remove the head restraint:

1. Recline the seatback (2) rearward using the seatback angle lever/switch (1).
2. Raise the head restraint as far as it can go.



3. Press the head restraint release button (3) while pulling upward on the head restraint (4).

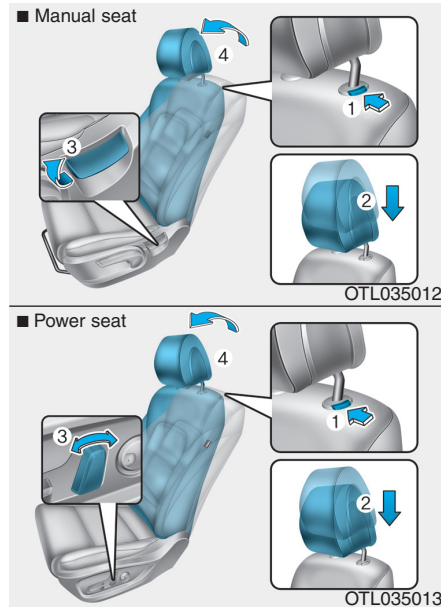

To reinstall the head restraint:

1. Put the head restraint poles (2) into the holes while pressing the release button (1).
2. Adjust the head restraint to the appropriate height.
3. Recline the seatback (4) forward using the seatback angle lever/switch (3).

## Rear seat head restraints

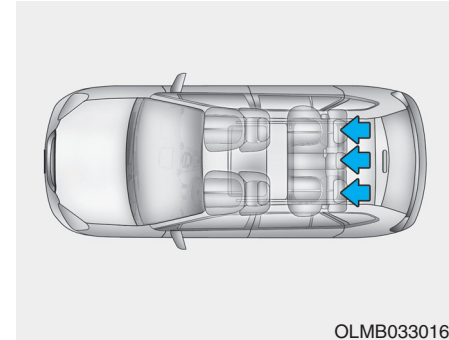

The rear seats are equipped with head restraints in all seating positions for passenger safety and comfort.

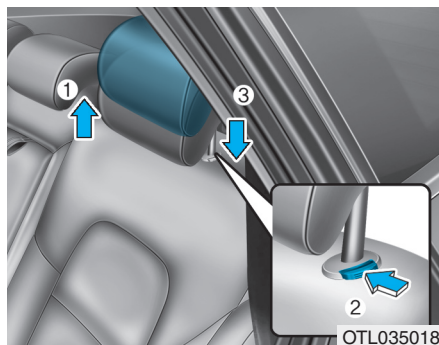

### Adjusting the height up and down

To raise the head restraint:

1. Pull it up to the desired position (1).

To lower the head restraint:

1. Push and hold the release button (2) on the head restraint support.
2. Lower the head restraint to the desired position (3).

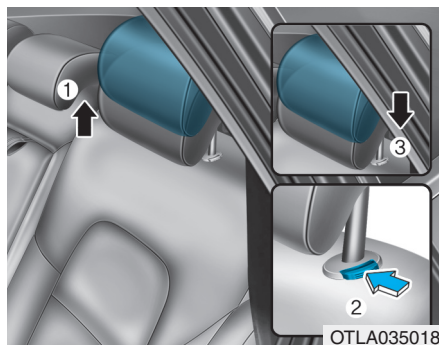

### Removal/Reinstallation

To remove the head restraint:

1. Raise the head restraint as far as it can go.
2. Press the head restraint release button (1) while pulling the head restraint up (2).

To reinstall the head restraint:

1. Put the head restraint poles into the holes (3) while pressing the release button (1).
2. Adjust the head restraint to the appropriate height.

## Seat warmers and air ventilation seats

### Front seat warmers (if equipped)

Seat warmers are provided to warm the seats during cold weather.

### **⚠ WARNING**

The seat warmers can cause a **SERIOUS BURN**, even at low temperatures and especially if used for long periods of time.

Passengers must be able to feel if the seat is becoming too warm so they can turn it off, if needed.

People who cannot detect temperature change or pain to the skin should use extreme caution, especially the following types of passengers:

- Infants, children, elderly or disabled persons, or hospital outpatients.
- People with sensitive skin or who burn easily.
- Fatigued individuals.
- Intoxicated individuals.

(Continued)

(Continued)

- People taking medication that can cause drowsiness or sleepiness.

### ⚠ WARNING

**NEVER** place anything on the seat that insulates against heat when the seat warmer is in operation, such as a blanket or seat cushion. This may cause the seat warmer to overheat, causing a burn or damage to the seat.

### NOTICE

To prevent damage to the seat warmers and seats:

- Never use a solvent such as paint thinner, benzene, alcohol or gasoline to clean the seats.
- Do not place heavy or sharp objects on seats equipped with seat warmers.
- Do not change the seat cover. It may damage the seat warmer.

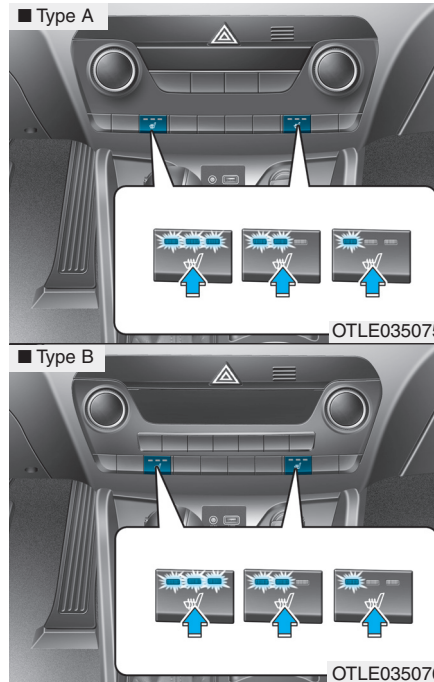

While the engine is running, push either of the switches to warm the driver's seat or front passenger's seat.

During mild weather or under conditions where the operation of the seat warmer is not needed, keep the switches in the OFF position.

- Each time you push the switch, the temperature setting of the seat is changed as follows :

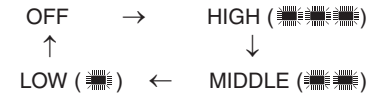

- When pressing the switch for more than 1.5 seconds with the seat warmer operating, the seat warmer will turn OFF.
- The seat warmer defaults to the OFF position whenever the ignition switch is in the ON position.

### **i** Information

With the seat warmer switch in the ON position, the heating system in the seat turns off or on automatically depending on the seat temperature.

**Front air ventilation seat  
(if equipped)**

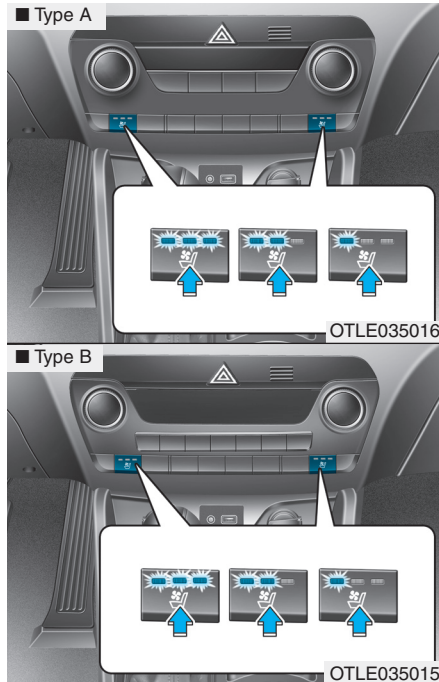

The air ventilation seats are provided to cool the front seats by blowing air through small vent holes on the surface of the seat cushions and seatbacks.

When the operation of the air ventilation seat is not needed, keep the switches in the OFF position.

While the engine is running, push the switch to cool the driver's seat or the front passenger's seat (if equipped).

- Each time you push the switch, the airflow changes as follows:

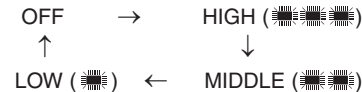

- When pressing the switch for more than 1.5 seconds with the air ventilation seat operating, the operation will turn OFF.
- The air ventilation seats defaults to the OFF position whenever the ignition switch is placed to the ON position.

**CAUTION**

**To prevent damage to the air ventilation seat:**

- Use the air ventilation seat **ONLY** when the climate control system is on. Using the air ventilation seat for prolonged periods of time with the climate control system off could cause the air ventilation seat to malfunction.
- Never use a solvent such as paint thinner, benzene, alcohol or gasoline to clean the seats.

(Continued)

**(Continued)**

- Avoid spilling liquids on the surface of the front seats and seatbacks; this may cause the air vent holes to become blocked and not work properly.
- Do not place materials such as plastic bags or newspapers under the seats. They may block the air intake causing the air vents to not work properly.
- Do not change the seat covers. It may damage the air ventilation seat.
- If the air vents do not operate, restart the vehicle. If there is no change, have the vehicle inspected by an authorized HYUNDAI dealer.

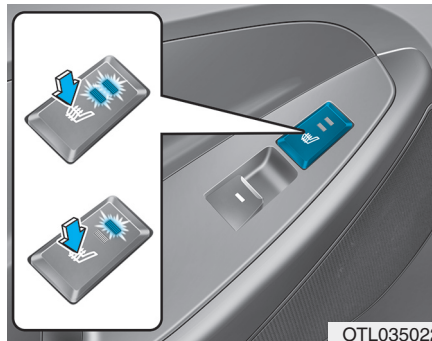
**Rear seat warmers (if equipped)**

OTL035022

While the engine is running, push either of the switches to warm the rear seat.

During mild weather or under conditions where the operation of the seat warmer is not needed, keep the switches in the OFF position.

Each time you push the switch, the temperature setting of the seat is changed as follows :

OFF → HIGH (☀️) → LOW (☀️)

The seat warmer defaults to the OFF position whenever the ignition switch is placed in the ON position.

***i* Information**

With the seat warmer switch in the ON position, the heating system in the seat turns off or on automatically depending on the seat temperature.

## SEAT BELTS

This section describes how to use the seat belts properly. It also describes some of the things not to do when using seat belts.

### Seat Belt Safety Precautions

Always fasten your seat belt and make sure all passengers have fastened their seat belts before starting any trip. Air bags are designed to supplement the seat belt as an additional safety device, but they are not a substitute. Most states require all occupants of a vehicle to wear seat belts.

#### WARNING

**Seat belts must be used by ALL passengers whenever the vehicle is moving. Take the following precautions when adjusting and wearing seat belts:**

- **ALWAYS** properly restrain children under age 13 in the rear seats.
- **NEVER** allow children to ride in the front passenger seat. If a child age 13 or older must be seated in the front seat, move the seat as far back as possible and properly restrain them in the seat.
- **NEVER** allow an infant or child to be carried on an occupant's lap.
- **NEVER** ride with the seatback reclined when the vehicle is moving.
- **Do not** allow children to share a seat or seat belt.

(Continued)

(Continued)

- **Do not** wear the shoulder belt under your arm or behind your back.
- **Always** wear both the shoulder portion and lap portion of the lap/shoulder belt.
- **Do not** use the seat belt if it is twisted. A twisted seat belt will not protect you properly in an accident.
- **Do not** use a seat belt if the webbing or hardware is damaged.
- **Do not** latch the seat belt into the buckles of other seats.
- **NEVER** unfasten the seat belt while driving. This may cause loss of vehicle control resulting in an accident.
- **Make sure** there is nothing in the buckle interfering with the seat belt latch mechanism. This may prevent the seat belt from fastening securely.

(Continued)

(Continued)

- No modifications or additions should be made by the user which will either prevent the seat belt adjusting devices from operating to remove slack, or prevent the seat belt assembly from being adjusted to remove slack.

**⚠ WARNING**

Damaged seat belts and seat belt assemblies will not operate properly. Always replace:

- Frayed, contaminated, or damaged webbing
- Damaged hardware
- The entire seat belt assembly after it has been worn in an accident, even if damage to webbing or assembly is not apparent

### Seat Belt Warning Light

*Seat belt warning light (for driver's seat)*



The driver's seat belt warning light and chime will come on according to the following table when the ignition switch is in the ON position.

Conditions		Warning Pattern	
Seat Belt	Vehicle Speed	Light (Blink)	Chime
Unbuckled		6 seconds	
Buckled		6 seconds	None
Buckled → Unbuckled	Below 3 mph (5 km/h)	6 seconds	None
	3 mph~ 6 mph	6 seconds	
	Above 6 mph (10 km/h)	6 sec. ON / 24 sec. OFF (11 times)	
Unbuckled	Above 6 mph (10 km/h)	6 seconds *1	
	↓ Below 3 mph (5 km/h)	↓ Stop *2	

\*1 : The Warning Pattern repeats 11 times with an interval of 24 seconds. If the driver's seat belt is buckled, the light will stop within 6 seconds and chime will stop immediately.

\*2 : The light will stop within 6 seconds and chime will stop immediately.

**Seat belt warning light  
(for front passenger's seat)**

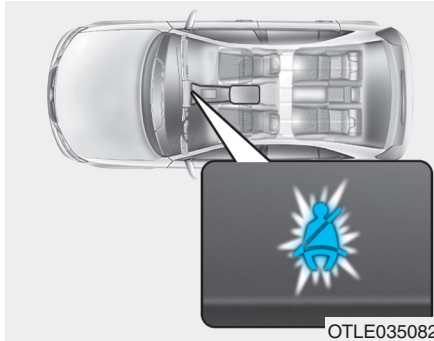

The front passenger's seat belt warning light will activate to the following table when the ignition switch is in "ON" position.

Conditions		Warning Pattern
Seat Belt	Vehicle Speed	Light-Blink
Unbuckled		6 seconds
Unbuckled	Above 6mph (10 km/h)	Continuously
Buckled		6 seconds
Buckled → Unbuckled	Above 6mph (10 km/h)	Continuously *1
	Below 6mph (10 km/h)	None

\*1 : The seat belt warning light will go off if the vehicle speed decreases below 3 mph (5 km/h). If the vehicle speed increases above 3 mph (5 km/h), the warning light will blink again.

**Seat Belt Restraint System**

**Seat Belt-Driver's 3-point system with emergency locking retractor**

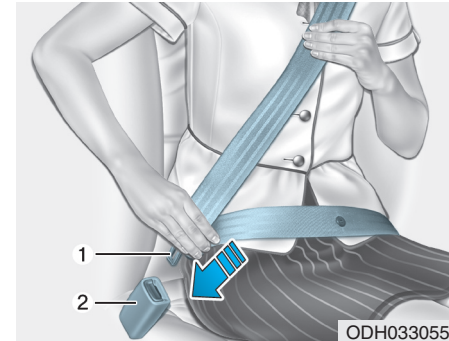

**To fasten your seat belt:**

Pull the seat belt out of the retractor and insert the metal tab (1) into the buckle (2). There will be an audible "click" when the tab locks into the buckle.



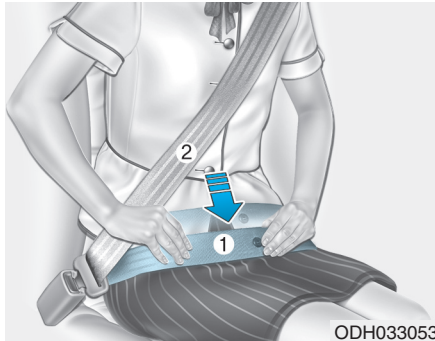

ODH033053

You should place the lap belt (1) portion across your hips and the shoulder belt (2) portion across your chest.

The seat belt automatically adjusts to the proper length after the lap belt portion is adjusted manually so that it fits snugly around your hips. If you lean forward in a slow, easy motion, the belt will extend and move with you.

If there is a sudden stop or impact, the belt will lock into position. It will also lock if you try to lean forward too quickly.

#### NOTICE

If you are not able to smoothly pull enough of the seat belt out from the retractor, firmly pull the seat belt out and release it. After release, you will be able to pull the belt out smoothly.

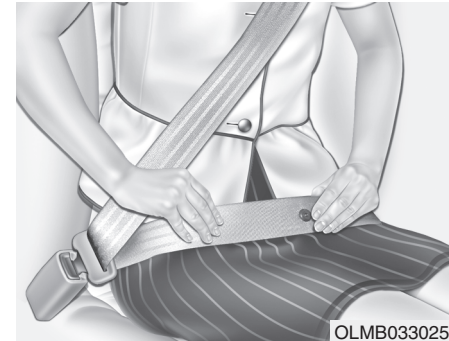

OLMB033025

#### ⚠ WARNING

Improperly positioned seat belts may increase the risk of serious injury in an accident. Take the following precautions when adjusting the seat belt:

- Position the lap portion of the seat belt as low as possible across your hips, not on your waist, so that it fits snugly.

(Continued)

### (Continued)

- Position one arm under the shoulder belt and the other over the belt, as shown in the illustration.
- Always position the shoulder belt anchor into the locked position at the appropriate height.
- Never position the shoulder belt across your neck or face.

### Height adjustment

You can adjust the height of the shoulder belt anchor to one of the four different positions for maximum comfort and safety.

The shoulder portion should be adjusted so it lies across your chest and midway over your shoulder nearest the door, not over your neck.

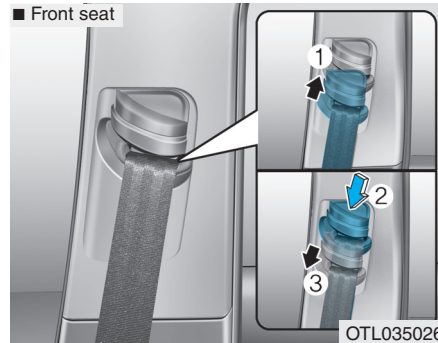

To adjust the height of the seat belt anchor, lower or raise the height adjuster into an appropriate position.

To raise the height adjuster, pull it up (1). To lower it, push it down (3) while pressing the height adjuster button (2).

Release the button to lock the anchor into position. Try sliding the height adjuster to make sure that it has locked into position.

### ***Rear Seat Belt – Passenger's 3-point system with convertible locking retractor***

This type of seat belt combines the features of both an emergency locking retractor seat belt and an automatic locking retractor seat belt. Convertible retractor type seat belts are installed in the rear seat positions to help accommodate the installation of child restraint systems. Although a convertible retractor is also installed in the front passenger seat position, NEVER place any infant/child restraint system in the front seat of the vehicle.

**To fasten the rear center seat belt**

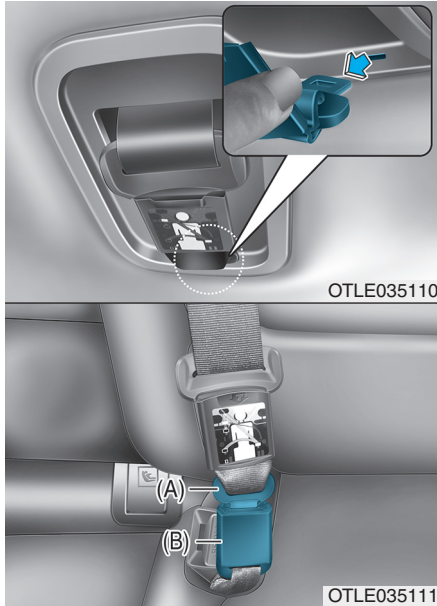

1. Extract the small tongue plate from the slot on the belt assembly pocket located in the headliner.

2. Insert the small tongue plate (A) into the primary buckle (B) located on the right hand (passenger) side of the center seat. Insert the buckle until an audible "click" is heard, indicating that the latch is locked. Make sure the belt is not twisted.

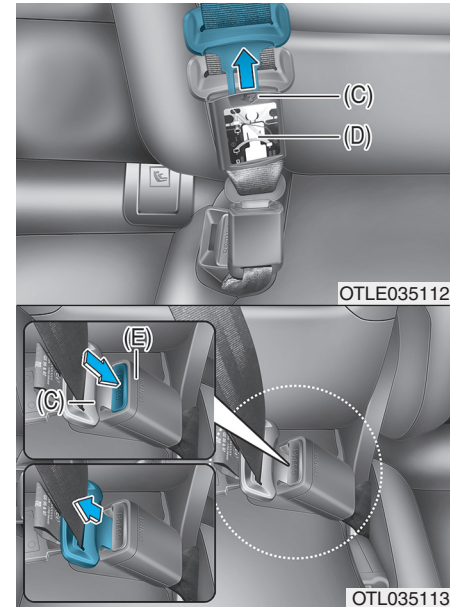

3. Slip the large tongue plate (C) out of the pocket (D) located on the belt assembly.

4. Pull the large tongue plate and insert it into the seat belt buckle (E) located on the left hand (driver) side of the center seat. Insert the buckle until an audible "click" is heard, indicating that the latch is locked. Make sure the belt is not twisted.

When using the rear center seat belt, the buckle with the "CENTER" mark must be used.

### **i** Information

**If you are not able to pull out the safety belt from the retractor, firmly pull the belt out and release it. After release, you will be able to pull the belt out smoothly.**

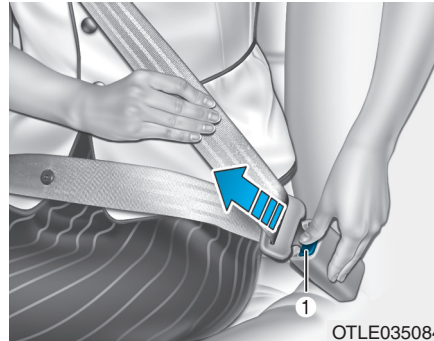

#### **To release your seat belt:**

Press the release button (1) in the locking buckle.

When it is released, the belt should automatically draw back into the retractor. If this does not happen, check the belt to be sure it is not twisted, then try again.

#### **To release the rear center seat-belt**

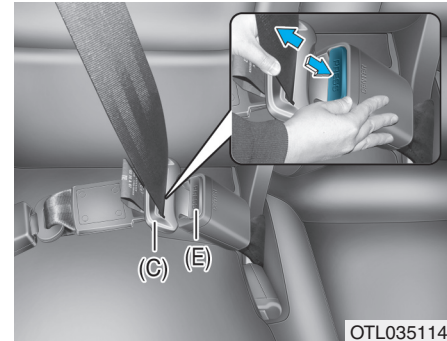

1. Press the release button on the rear center seat belt buckle (E) located on the left hand (driver) side of the center seat and remove the large tongue plate (C).

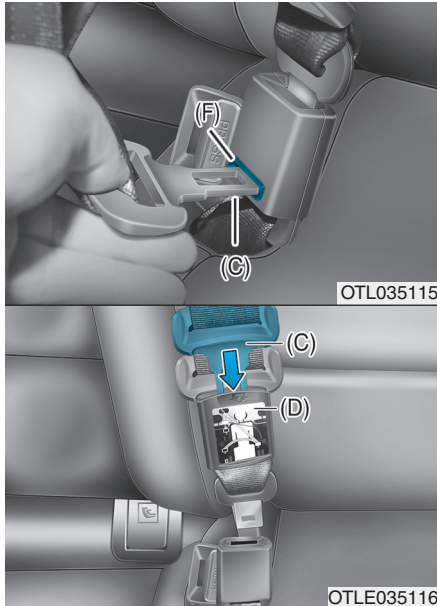

2. To release and retract the rear center seatbelt assembly, insert a small tool or key into the primary buckle release hole (F) located on the right hand (passenger) side of the center seat. You can also insert the large buckle (C) into the release hole to release the seat belt assembly.

Pull up on the seat belt webbing and allow the webbing to retract automatically.

3. Slip the large tongue plate (C) into the pocket (D) located on the belt assembly.

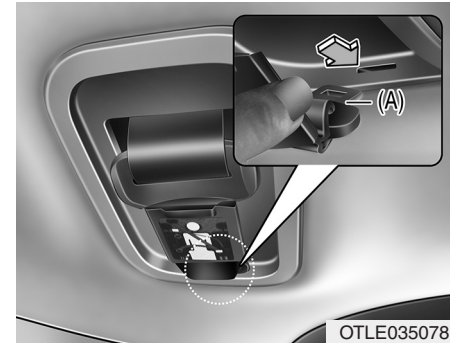

4. Insert the small tongue plate (A) into the slot on the belt assembly pocket located in the headliner.

### Pre-tensioner seat belt



Your vehicle is equipped with driver's and front passenger's Pre-tensioner Seat Belts (Retractor Pretensioner and Emergency Fastening Device (EFD)). The purpose of the pre-tensioner is to make sure the seat belts fit tightly against the occupant's body in certain frontal collisions. The Seat Belt Anchor Pre-tensioner may be activated in certain crashes where the frontal collision is severe enough, together with the air bags.

When the vehicle stops suddenly, or if the occupant tries to lean forward too quickly, the seat belt retractor will lock into position. In certain frontal collisions, the pre-tensioner will activate and pull the seat belt into tighter contact against the occupant's body.

#### (1) Retractor Pretensioner

The purpose of the retractor pre-tensioner is to make sure that the shoulder belts fit in tightly against the occupant's upper body in certain frontal collisions.

#### (2) Emergency Fastening Device (EFD) (for the driver's seat)

The purpose of the EFD is to make sure that the pelvic belts fit in tightly against the occupant's lower body in certain frontal collisions.

If the system senses excessive tension on the driver or passenger's seat belt when the pre-tensioner system activates, the load limiter inside the retractor pre-tensioner will release some of the pressure on the affected seat belt.

### WARNING

- **Always wear your seat belt and sit properly in your seat.**
- **Do not use the seat belt if it is loose or twisted. A loose or twisted seat belt will not protect you properly in an accident.**
- **Do not place anything near the buckle. This may adversely affect the buckle and cause it to function improperly.**
- **Always replace your pre-tensioners after activation or an accident.**
- **NEVER inspect, service, repair or replace the pre-tensioners yourself. This must be done by an authorized HYUNDAI dealer.**
- **Do not hit the seat belt assemblies.**

## WARNING

Do not touch the pre-tensioner seat belt assemblies for several minutes after they have been activated. When the pre-tensioner seat belt mechanism deploys during a collision, the pre-tensioners become hot and can burn you.

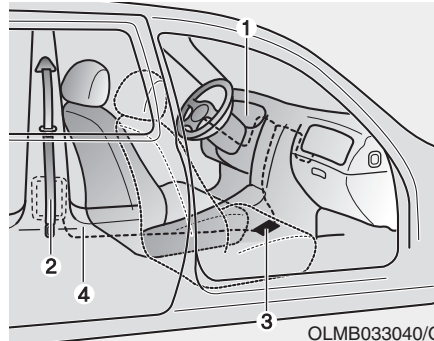

The Pre-Tensioner Seat Belt System consists mainly of the following components. Their locations are shown in the illustration above:

- (1) SRS air bag warning light
- (2) Retractor pre-tensioner
- (3) SRS control module
- (4) Emergency Fastening Device (EFD)

## NOTICE

The sensor that activates the SRS air bag is connected with the pre-tensioner seat belts. The SRS air bag warning light on the instrument panel will illuminate for approximately 6 seconds after the ignition switch is in the ON position, and then it should turn off.

If the pre-tensioner is not working properly, the warning light will illuminate even if the SRS air bag is not malfunctioning. If the warning light does not illuminate, stays illuminated or illuminates when the vehicle is being driven, have an authorized HYUNDAI dealer inspect the pre-tensioner seat belts and SRS air bags as soon as possible.



### NOTICE

- Both the driver's and front passenger's pre-tensioner seat belts may be activated in certain frontal or side collisions or rollovers.
- The passenger side pre-tensioners will not be activated if the seat belts are not worn at the time of the collision.
- When the pre-tensioner seat belts are activated, a loud noise may be heard and fine dust, which may appear to be smoke, may be visible in the passenger compartment. These are normal operating conditions and are not hazardous.
- Although it is non-toxic, the fine dust may cause skin irritation and should not be breathed for prolonged periods. Wash all exposed skin areas thoroughly after an accident in which the pre-tensioner seat belts were activated.

### Additional Seat Belt Safety Precautions

#### *Seat belt use during pregnancy*

The seat belt should always be used during pregnancy. The best way to protect your unborn child is to protect yourself by always wearing the seat belt.

Pregnant women should always wear a lap-shoulder seat belt. Place the shoulder belt across your chest, routed between your breasts and away from your neck. Place the lap belt below the belt line so that it fits snugly and as low as possible across the hips, not across the abdomen.

### WARNING

To reduce the risk of serious injury or death to an unborn child during an accident, pregnant women should **NEVER** place the lap portion of the seat belt above or over the area of the abdomen where the unborn child is located.

### *Seat belt use and children*

#### *Infant and small children*

All 50 states have child restraint laws which require children to travel in approved child restraint devices, including booster seats. The age at which seat belts can be used instead of child restraints differs among states, so you should be aware of the specific requirements in your state, and where you are travelling. Infant and child restraints must be properly placed and installed in a rear seat. For more information refer to the "Child Restraint Systems" section in this chapter.



 **WARNING**

**ALWAYS properly restrain infants and small children in a child restraint appropriate for the child's height and weight.**

**To reduce the risk of serious injury or death to a child and other passengers, NEVER hold a child in your lap or arms when the vehicle is moving. The violent forces created during an accident will tear the child from your arms and throw the child against the interior of the vehicle.**

Small children are best protected from injury in an accident when properly restrained in the rear seat by a child restraint system that meets the requirements of the Federal Motor Vehicle Safety Standards. Before buying any child restraint system, make sure that it has a label certifying that it meets Federal Motor Vehicle Safety Standard 213. The restraint must be appropriate for your child's height and weight. Check the label on the child restraint for this information. Refer to the "Child Restraint Systems" section in this chapter.

### Larger children

Children under age 13 and who are too large for a booster seat must always occupy the rear seat and use the available lap/shoulder belts. A seat belt should lie across the upper thighs and be snug across the shoulder and chest to restrain the child safely. Check belt fit periodically. Children are afforded the most safety in the event of an accident when they are restrained by a proper restraint system and/or seat belts in the rear seat. Always have the LATCH system inspected by your authorized HYUNDAI dealer after an accident. An accident can damage the LATCH system and may not properly secure the child restraint.

If a larger child over age 13 must be seated in the front seat, the child must be securely restrained by the available lap/shoulder belt and the seat should be placed in the rear-most position.

If the shoulder belt portion slightly touches the child's neck or face, try placing the child closer to the center of the vehicle. If the shoulder belt still touches their face or neck they need to be returned to an appropriate booster seat in the rear seat.

### **WARNING**

- **Always make sure children are wearing their seat belts and that they are properly adjusted before driving.**
- **NEVER allow the shoulder belt to contact the child's neck or face.**
- **Do not allow more than one child to use a single seat belt.**

### ***Transporting an injured person***

A seat belt should be used when an injured person is being transported. Consult a physician for specific recommendations.

### ***One person per belt***

Two people (including children) should never attempt to use a single seat belt. This could increase the severity of injuries in case of an accident.

### ***Do not lie down***

Sitting in a reclined position when the vehicle is in motion can be dangerous. Even when buckled up, the protections of your restraint system (seat belts and air bags) is greatly reduced by reclining your seatback.

To reduce the chance of injuries in the event of an accident and to achieve the maximum effectiveness of the restraint system, all passengers should be sitting up and the front and rear seats should be in an upright position when the car is moving.

A seat belt cannot provide proper protection if the person is lying down in the rear seat or if the front or rear seats are in a reclined position.

## WARNING

- **NEVER ride with a reclined seatback when the vehicle is moving.**
- **Riding with a reclined seatback increases your chance of serious or fatal injuries in the event of a collision or sudden stop.**
- **Drivers and passengers should always sit well back in their seats, properly belted, and with the seatbacks upright.**

## Care of Seat Belts

Seat belt systems should never be disassembled or modified. In addition, care should be taken to assure that seat belts and belt hardware are not damaged by seat hinges, doors or other abuse.

### *Periodic inspection*

All seat belts should be inspected periodically for wear or damage of any kind. Any damaged parts should be replaced as soon as possible by an authorized HYUNDAI dealer.

### *Keep belts clean and dry*

Seat belts should be kept clean and dry. If belts become dirty, they can be cleaned by using a mild soap solution and warm water. Bleach, dye, strong detergents or abrasives should not be used because they may damage and weaken the fabric.

### *When to replace seat belts*

The entire seat belt assembly or assemblies should be replaced if the vehicle has been involved in an accident. This should be done even if no damage is visible. Additional questions concerning seat belt operation should be directed to an authorized HYUNDAI dealer.

## CHILD RESTRAINT SYSTEM (CRS)

### Children Always in the Rear

#### WARNING

**Always properly restrain children in the rear seats of the vehicle.**

**Children of all ages are safer when restrained in the rear seat. A child riding in the front passenger seat can be forcefully struck by an inflating air bag resulting in SERIOUS INJURY or DEATH.**

Children under age 13 must always ride in the rear seats and must always be properly restrained to minimize the risk of injury in an accident, sudden stop or sudden maneuver. According to accident statistics, children are safer when properly restrained in the rear seats than in the front seat. **Even with air bags, children can be seriously injured or killed.** Children too large for a child restraint must use the seat belts provided.

All 50 states have child restraint laws which require children to travel in approved child restraint devices. The laws governing the age or height/weight restrictions at which seat belts can be used instead of child restraints differs among states, so you should be aware of the specific requirements in your state, and where you are travelling.

Child restraint systems must be properly placed and installed in the rear seat. You must use a commercially available child restraint system that meets the requirements of the Federal Motor Vehicle Safety Standards (FMVSS).

Child restraint systems are generally designed to be secured in a vehicle seat by lap belt portion of a lap/shoulder belt, or by a LATCH system in the rear seats of the vehicle.

#### ***Child restraint system (CRS)***

Infants and younger children must be restrained in an appropriate rear-facing or forward-facing CRS that has first been properly secured to the rear seat of the vehicle. Read and comply with the instructions for installation and use provided by the manufacturer of the child restraint.

#### WARNING

**An improperly secured child restraint can increase the risk of SERIOUS INJURY or DEATH in an accident. Always take the following precautions when using a child restraint system:**

- **NEVER install a child or infant restraint in the front passenger's seat.**
- **Always properly secure the child restraint to a rear seat of the vehicle.**

**(Continued)**

(Continued)

- Always follow the child restraint system manufacturer's instructions for installation and use.
- Always properly restrain your child in the child restraint.
- If the vehicle head restraint prevents proper installation of a child seat (as described in the child restraint system manual), the head restraint of the respective seating position shall be readjusted or entirely removed.
- Do not use an infant carrier or a child safety seat that "hooks" over a seatback, it may not provide adequate protection in an accident.
- After an accident, have a HYUNDAI dealer check the child restraint system, seat belts, tether anchors and lower anchors.

## Selecting a Child Restraint System (CRS)

When selecting a CRS for your child, always:

- Make sure the CRS has a label certifying that it meets applicable Federal Motor Vehicle Safety Standards (FMVSS 213).
- Select a child restraint based on your child's height and weight. The required label or the instructions for use typically provide this information.
- Select a child restraint that fits the vehicle seating position where it will be used.
- Read and comply with the warnings and instructions for installation and use provided with the child restraint system.

## Child restraint system types

There are three main types of child restraint systems: rear-facing seats, forward-facing seats, and booster seats. They are classified according to the child's age, height and weight.

### Rear-facing child seats

#### WARNING

**NEVER install a child or infant restraint in the front passenger's seat.**

**Placing a rear-facing child restraint in the front seat can result in SERIOUS INJURY or DEATH if the child restraint is struck by an inflating air bag.**

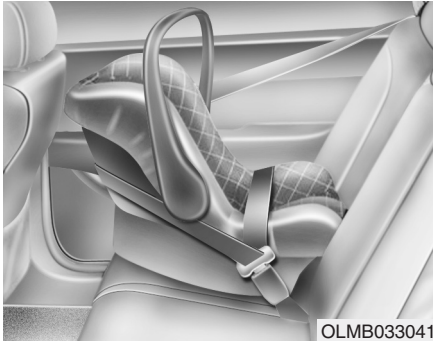

A rear-facing child seat provides restraint with the seating surface against the back of the child. The harness system holds the child in place, and in an accident, acts to keep the child positioned in the seat and reduce the stress to the neck and spinal cord.

All children under age one must always ride in a rear-facing infant child restraint.

Convertible and 3-in-1 child seats typically have higher height and weight limits for the rear-facing position, allowing you to keep your child rear-facing for a longer period of time.

Continue to use a rear-facing child seat for as long as your child will fit within the height and weight limits allowed by the child seat manufacturer. It's the best way to keep them safe. Once your child has outgrown the rear-facing child restraint, your child is ready for a forward-facing child restraint with a harness.



### **Forward-facing child restraints**

A forward-facing child seat provides restraint for the child's body with a harness. Keep children in a forward-facing child seat with a harness until they reach the top height or weight limit allowed by your child restraint's manufacturer.

Once your child outgrows the forward-facing child restraint, your child is ready for a booster seat.

### Booster seats

A booster seat is a restraint designed to improve the fit of the vehicle's seat belt system. A booster seat positions the seat belt so that it fits properly over the lap of your child.

Keep your child in a booster seat until they are big enough to sit in the seat without a booster and still have the seat belt fit properly. For a seat belt to fit properly, the lap belt must lie snugly across the upper thighs, not the stomach. The shoulder belt should lie snug across the shoulder and chest and not across the neck or face. Children under age 13 must always ride in the rear seats and must always be properly restrained to minimize the risk of injury.

### Installing a Child Restraint System (CRS)

#### WARNING

**Before installing your child restraint system always:**

- **Read and follow the instructions provided by the manufacturer of the child restraint.**
- **Read and follow the instructions regarding child restraint systems in this manual.**

**Failure to follow all warnings and instructions could increase the risk of the SERIOUS INJURY or DEATH if an accident occurs.**

#### WARNING

**If the vehicle head restraint prevents proper installation of a child seat (as described in the child seat system manual, the head restraint of the respective seating position shall be readjusted or entirely removed.**

After selecting a proper child seat for your child, check to make sure it fits properly in your vehicle. Follow the instructions provided by the manufacturer when installing the child seat. Note these general steps when installing the seat to your vehicle:

- **Properly secure the child restraint to the vehicle.** All child restraints must be secured to the vehicle with the lap part of a lap/shoulder belt or with the LATCH system.
- **Make sure the child restraint is firmly secured.** After installing a child restraint to the vehicle, push and pull the seat forward and from side-to-side to verify that it is securely attached to the seat. A child restraint secured with a seat belt should be installed as firmly as possible. However, some side-to-side movement can be expected.
- **Secure the child in the child restraint.** Make sure the child is properly strapped in the child restraint according to the manufacturer instructions.

**! CAUTION**

**A child restraint in a closed vehicle can become very hot. To prevent burns, check the seating surface and buckles before placing your child in the child restraint.**

***Lower Anchors and Tether for Children (LATCH) System***

The LATCH system holds a child restraint during driving and in an accident. This system is designed to make installation of the child restraint easier and reduce the possibility of improperly installing your child restraint. The LATCH system uses anchors in the vehicle and attachments on the child restraint. The LATCH system eliminates the need to use seat belts to secure the child restraint to the rear seats.

Lower anchors are metal bars built into the vehicle. There are two lower anchors for each LATCH seating position that will accommodate a child restraint with lower attachments.

To use the LATCH system in your vehicle, you must have a child restraint with LATCH attachments.

The child seat manufacturer will provide you with instructions on how to use the child seat with its attachments for the LATCH lower anchors.

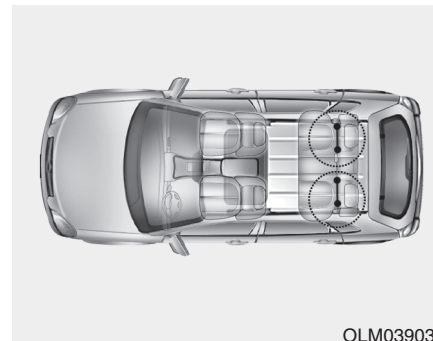

OLM039035

LATCH anchors have been provided in the left and right outboard rear seating positions. Their locations are shown in the illustration. There are no LATCH anchors provided for the center rear seating position.

**! WARNING**

**Do not attempt to install a child restraint system using LATCH anchors in the rear center seating position. There are no LATCH anchors provided for this seat. Using the outboard seat anchors can damage the anchors which may break or fail in a collision resulting in serious injury or death.**



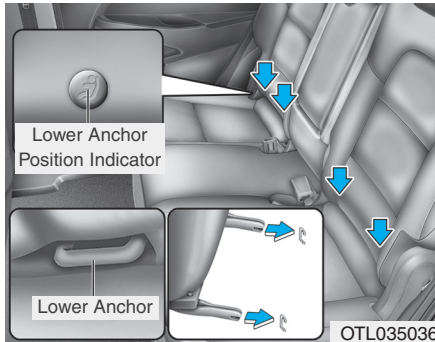

The lower anchor position indicator symbols are located on the left and right rear seat backs to identify the position of the lower anchors in your vehicle (see arrows in illustration).

The LATCH anchors are located between the seatback and the seat cushion of the rear seat left and right outboard seating positions.

To use the lower anchor, push the upper portion of the lower anchor cover.

### **Securing a child restraint with the LATCH anchors system**

To install a LATCH-compatible child restraint in either of the rear outboard seating positions:

1. Move the seat belt buckle away from the lower anchors.
2. Move any other objects away from the anchors that could prevent a secure connection between the child restraint and the lower anchors.
3. Place the child restraint on the vehicle seat, then attach the seat to the lower anchors according to the instructions provided by the child restraint manufacturer.
4. Follow the child restraint instructions for properly adjusting and tightening the lower attachments on the child restraint to the lower anchors.

### **⚠ WARNING**

**Take the following precautions when using the LATCH system:**

- **Read and follow all installation instructions provided with your child restraint system.**
- **To prevent the child from reaching and taking hold of unretracted seat belts, buckle all unused rear seat belts and retract the seat belt webbing behind the child. Children can be strangled if a shoulder belt becomes wrapped around their neck and the seat belt tightens.**
- **NEVER attach more than one child restraint to a single anchor. This could cause the anchor or attachment to come loose or break.**
- **Always have the LATCH system inspected by your authorized HYUNDAI dealer after an accident. An accident can damage the LATCH system and may not properly secure the child restraint.**

**NOTICE**

The recommended maximum weight for the LATCH system is 65 lbs. (30 kg). When selecting a proper child restraint, consider that the maximum total weight of the child plus the child restraint should be less than 65 lbs (30 kg).

As a guide, the MAX child restraint weight should be determined by the following calculation:

$$\text{Child Restraint Weight} = 65 - (\text{child's total weight in lbs.})$$

**Securing a child restraint seat with "Tether Anchor" system**

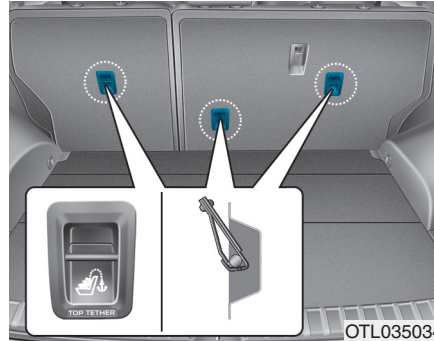

First secure the child restraint with the LATCH lower anchors or the seat belt. If the child restraint manufacturer recommends that the top tether strap be attached, attach and tighten the top tether strap to the top tether anchor.

Child restraint hook holders are located on the back of the rear seats.

**⚠ WARNING**

Take the following precautions when installing the tether strap:

- Read and follow all installation instructions provided with your child restraint system.
- NEVER attach more than one child restraint to a single tether anchor. This could cause the anchor or attachment to come loose or break.
- Do not attach the tether strap to anything other than the correct tether anchor. It may not work properly if attached to something else.
- Do not use the tether anchors for adult seat belts or harnesses, or for attaching other items or equipment to the vehicle.

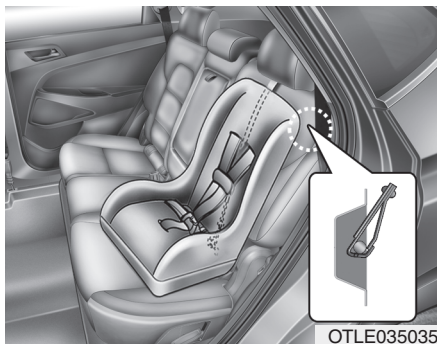

### **Securing a child restraint with a lap belt or lap/shoulder belt**

When not using the LATCH system, all child restraints must be secured to a vehicle rear seat with the lap part of a lap/shoulder belt.

#### **⚠ WARNING**

**ALWAYS place a rear-facing child restraint in the rear seat of the vehicle.**

**Placing a rear-facing child restraint in the front seat can result in serious injury or death if the child restraint is struck by an inflating air bag.**

To install the tether anchor:

1. Route the child restraint tether strap over the child restraint seatback. Route the tether strap under the head restraint and between the head restraint posts, or route the tether strap over the top of the vehicle seatback. Make sure the strap is not twisted.
2. Connect the tether strap hook to the tether anchor, then tighten the tether strap according to the child seat manufacturer's instructions to firmly secure the child restraint to the seat.
3. Check that the child restraint is securely attached to the seat by pushing and pulling the seat forward and from side-to-side.

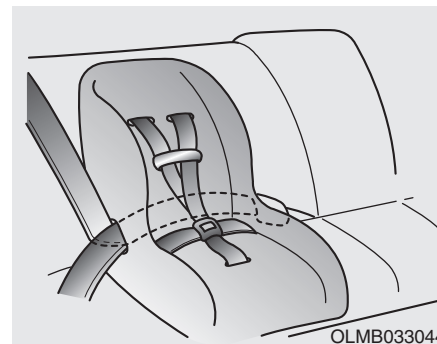

### **Automatic locking mode**

Since all passenger seat belts move freely under normal conditions and only lock under extreme or emergency conditions (emergency locking mode), you must manually pull the seat belt all the way out to shift the retractor to the “Automatic Locking” mode to secure a child restraint.

The “Automatic Locking” mode will help prevent the normal movement of the child in the vehicle from causing the seat belt to loosen and compromise the child restraint system. To secure a child restraint system, use the following procedure.

To install a child restraint system on the rear seats, do the following:

1. Place the child restraint system on a rear seat and route the lap/shoulder belt around or through the child restraint, following the restraint manufacturer's instructions.

Be sure the seat belt webbing is not twisted.

### NOTICE

**When using the rear center seat belt, you should also refer to the "3-point Rear Center Seat Belt" section in this chapter.**

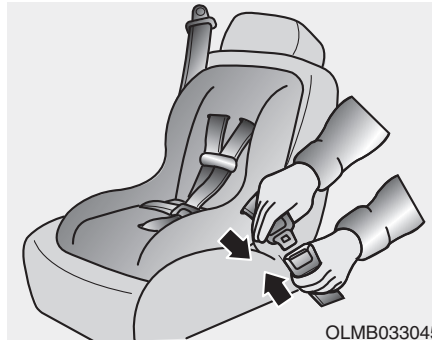

2. Fasten the lap/shoulder belt latch into the buckle. Listen for the distinct "click" sound.

### **i** Information

**Position the release button so that it is easy to access in case of an emergency.**

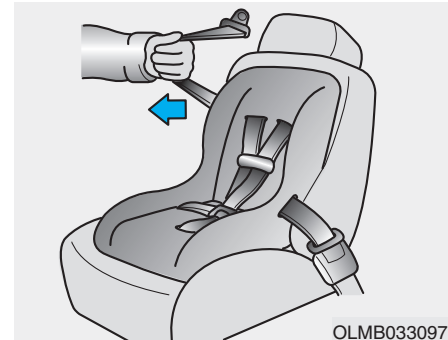

3. Pull the shoulder portion of the seat belt all the way out. When the shoulder portion of the seat belt is fully extended, it will shift the retractor to the "Automatic Locking" (child restraint) mode.



4. Slowly allow the shoulder portion of the seat belt to retract and listen for an audible "clicking" or "ratcheting" sound. This indicates that the retractor is in the "Automatic Locking" mode. If no distinct sound is heard, repeat steps 3 and 4.

5. Remove as much slack from the belt as possible by pushing down on the child restraint system while feeding the shoulder belt back into the retractor.
6. Push and pull on the child restraint system to confirm that the seat belt is holding it firmly in place. If it is not, release the seat belt and repeat steps 2 through 6.
7. Double check that the retractor is in the "Automatic Locking" mode by attempting to pull more of the seat belt out of the retractor. If you cannot, the retractor is in the "Automatic Locking" mode.

If your CRS manufacturer instructs or recommends you to use a tether anchor with the lap/shoulder belt, refer to the previous pages for more information.

**NOTICE**

**When the seat belt is allowed to retract to its fully stowed position, the retractor will automatically switch from the "Automatic Locking" mode to the emergency lock mode for normal adult usage.**

**⚠ WARNING**

**If the retractor is not in the "Automatic Locking" mode, the child restraint can move when your vehicle turns or stops suddenly. A child can be seriously injured or killed if the child restraint is not properly anchored in the car, including manually pulling the seat belt all the way out to shift the retractor to the "Automatic Locking" mode.**

To remove the child restraint, press the release button on the buckle and then pull the lap/shoulder belt out of the restraint and allow the seat belt to retract fully.

## AIR BAG – ADVANCED SUPPLEMENTAL RESTRAINT SYSTEM

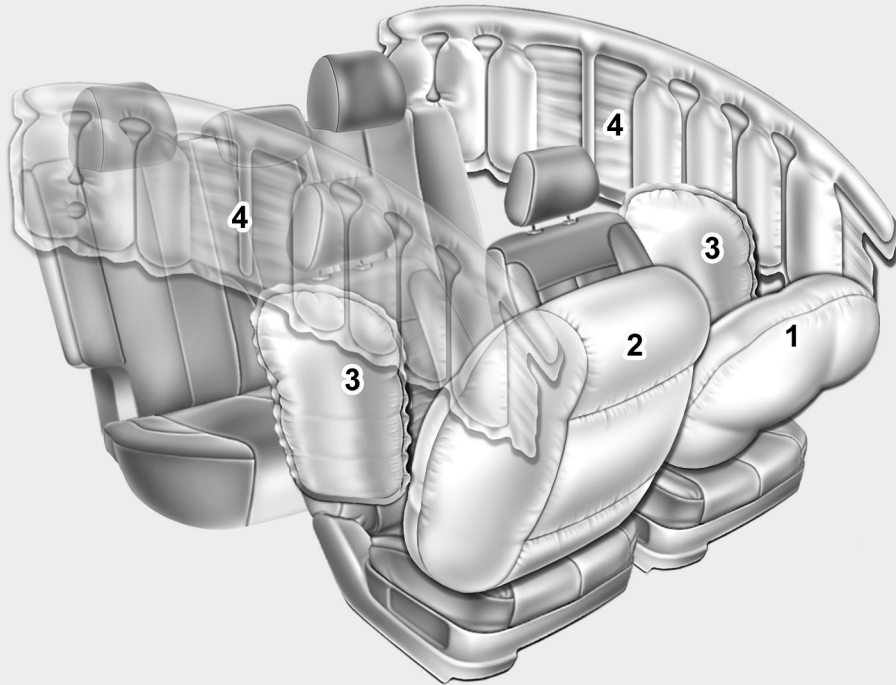

1. Driver's front air bag
2. Passenger's front air bag
3. Side air bag
4. Curtain air bag

The actual air bags in the vehicle may differ from the illustration.

OTLE035037

This vehicle is equipped with an Advanced Supplemental Air Bag System for the driver's seat and front passenger's seats.

The front air bags are designed to supplement the three-point seat belts. For these air bags to provide protection, the seat belts must be worn at all times when driving.

You can be severely injured or killed in an accident if you are not wearing a seat belt. Air bags are designed to supplement seat belts, but do not replace them. Also, air bags are not designed to deploy in every collision. In some accidents, the seat belts are the only restraint protecting you.

## WARNING

### AIR BAG SAFETY PRECAUTIONS

**ALWAYS** use seat belts and child restraints - every trip, every time, everyone! Even with air bags, you can be seriously injured or killed in a collision if you are improperly belted or not wearing your seat belt when the air bag inflates.

**NEVER** place a child in any child restraint or booster seat in the front passenger seat. An inflating air bag could forcefully strike the infant or child causing serious or fatal injuries.

**ABC - Always Buckle Children under age 13 in the back seat. It is the safest place for children of any age to ride. If a child age 13 or older must be seated in the front seat, he or she must be properly belted and the seat should be moved as far back as possible.**

**All occupants should sit upright with the seatback in an upright position, centered on the seat cushion with their seat belt on, legs comfortably extended and their feet on the floor until the vehicle is parked and the engine is turned off. If an occupant is out of position during an accident, the rapidly deploying air bag may forcefully contact the occupant causing serious or fatal injuries.**

**You and your passengers should never sit or lean unnecessarily close to the air bags or lean against the door or center console.**

**Move your seat as far back as possible from front air bags, while still maintaining control of the vehicle. The U.S. National Highway Traffic Safety Administration (NHTSA) recommends that drivers allow at least 10 inches (25 cm) between the center of the steering wheel and the chest.**

### Where Are the Air Bags?

#### ***Driver's and passenger's front air bags***

Your vehicle is equipped with a Advanced Supplemental Restraint System (SRS) and lap/shoulder belts at both the driver and passenger seating positions.

The SRS consists of air bags which are located in the center of the steering wheel, in the driver's side lower crash pad below the steering wheel column and the passenger's side front panel pad above the glove box.

The air bags are labeled with the letters "AIR BAG" embossed on the pad covers.

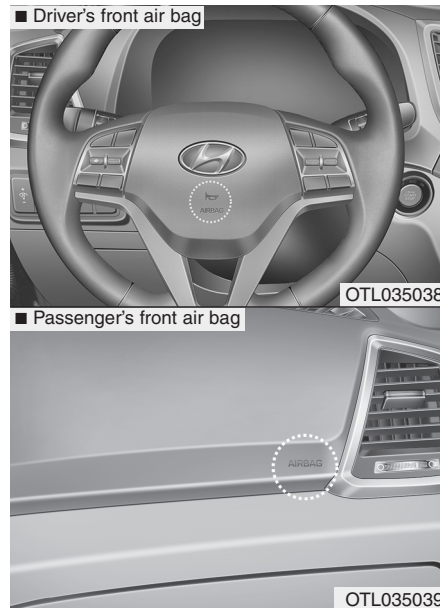

The purpose of the SRS is to provide the vehicle's driver and front passengers with additional protection than that offered by the seat belt system alone. The SRS uses sensors to gather information about the driver's and front passenger's seat belt usage and impact severity.

The seat belt buckle sensors determine if the driver and front passenger's seat belts are fastened. These sensors provide the ability to control the SRS deployment based on whether or not the seat belts are fastened, and how severe the impact is. The advanced SRS offers the ability to control the air bag inflation within two levels. A first stage level is provided for moderate-severity impacts. A second stage level is provided for more severe impacts.

According to the impact severity, and seat belt usage, the SRS Control Module (SRSCM) controls the air bag inflation. Failure to properly wear seat belts can increase the risk or severity of injury in an accident.

#### **⚠ WARNING**

**To reduce the risk of serious injury or death from an inflating front air bags, take the following precautions:**

**(Continued)**



**(Continued)**

- **Seat belts must be worn at all times to help keep occupants positioned properly.**
- **Move your seat as far back as possible from front air bags, while still maintaining control of the vehicle.**
- **Never lean against the door or center console.**
- **Do not allow the front passenger to place their feet or legs on the dashboard.**
- **No objects (such as crash pad cover, cellular phone holder, cup holder, perfume or stickers) should be placed over or near the air bag modules on the steering wheel, instrument panel, windshield glass, and the front passenger's panel above the glove box. Such objects could cause harm if the vehicle is in a crash severe enough to cause the air bags to deploy.**
- **Do not attach any objects on front windshield and inside mirror.**

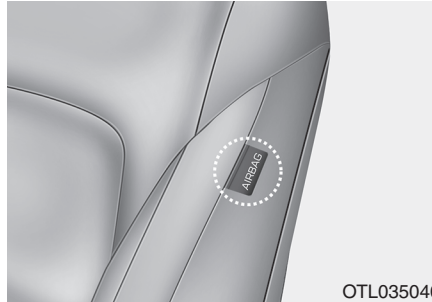
**Side air bags**

OTL035040

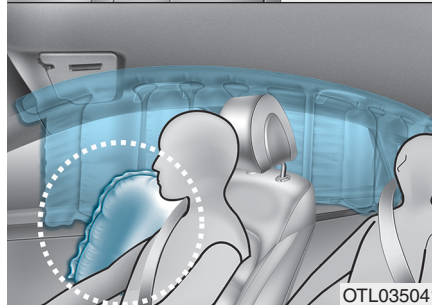

OTL035041

Your vehicle is equipped with a side air bag in each front seat. The purpose of the air bag is to provide the vehicle's driver and the front passenger with additional protection than that offered by the seat belt alone.

The side air bags are designed to deploy during certain side impact collisions, depending on the crash severity, angle, speed and point of impact.

The side and curtain air bags on both sides of the vehicle may deploy if a rollover or possible rollover is detected.

The side air bags are not designed to deploy in all side impact or rollover situations.

**⚠ WARNING**

To reduce the risk of serious injury or death from an inflating side air bag, take the following precautions:

- Seat belts must be worn at all times to help keep occupants positioned properly.
- Do not allow passengers to lean their heads or bodies onto doors, put their arms on the doors, stretch their arms out of the window, or place objects between the doors and seats.
- Hold the steering wheel at the 9 o'clock and 3 o'clock positions, to minimize the risk of injuries to your hands and arms.
- Do not use any accessory seat covers. This could reduce or prevent the effectiveness of the system.
- Do not place any objects over the air bag or between the air bag and yourself.

(Continued)

(Continued)

Also, do not attach any objects around the area the air bag inflates such as the door, side door glass, front and rear pillar.

- Do not place any objects between the door and the seat. They may become dangerous projectiles if the side air bag inflates.
- Do not install any accessories on the side or near the side air bags.
- Do not put any objects between the side airbag label and seat cushion. It could cause harm if the vehicle is in a crash severe enough to cause the air bags to deploy.
- Do not cause impact to the doors when the ignition switch is in the ON position or this may cause the side air bags to inflate.
- If the seat or seat cover is damaged, have the vehicle checked and repaired by an authorized HYUNDAI dealer.

**Curtain air bags**

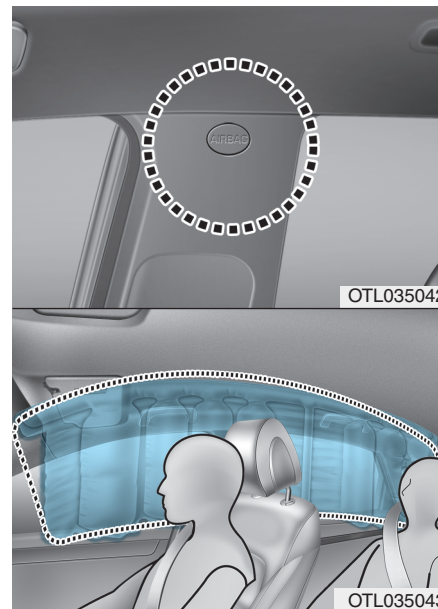

Curtain air bags are located along both sides of the roof rails above the front and rear doors.

They are designed to help protect the heads of the front seat occupants and the rear outboard seat occupants in certain side impact collisions.

The curtain air bags are designed to deploy during certain side impact collisions, depending on the crash severity, angle, speed and impact.

The side and curtain air bags on both sides of the vehicle may deploy if a rollover or possible rollover is detected.

The curtain air bags are not designed to deploy in all side impact or rollover situations.

### WARNING

**To reduce the risk of serious injury or death from an inflating curtain air bags, take the following precautions:**

- **All seat occupants must wear seat belts at all times to help keep occupants positioned properly.**

**(Continued)**

### **(Continued)**

- **Properly secure child restraints as far away from the door as possible.**
- **Do not place any objects over the air bag. Also, do not attach any objects around the area the air bag inflates such as the door, side door glass, front and rear pillar, roof side rail.**
- **Do not hang other objects except clothes, especially hard or breakable objects. In an accident, it may cause vehicle damage or personal injury.**
- **Do not allow passengers to lean their heads or bodies onto doors, put their arms on the doors, stretch their arms out of the window, or place objects between the doors and seats.**
- **Do not open or repair the side curtain air bags.**

## How Does the Air Bag System Operate?

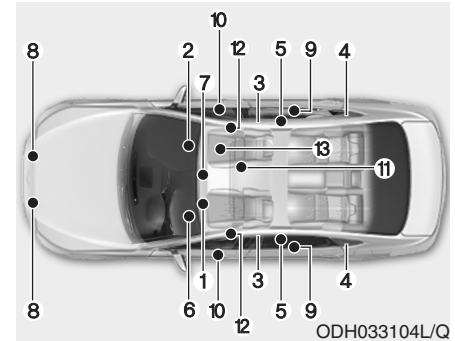

The SRS consists of the following components:

1. Driver's front air bag module
2. Passenger's front air bag module
3. Side air bag modules
4. Curtain air bag modules
5. Retractor pre-tensioner assemblies
6. Air bag warning light
7. SRS control module (SRSCM)/ Rollover sensor
8. Front impact sensors
9. Side impact sensors

10. Side pressure sensors
11. The front passenger's seat belt buckle sensors
12. Emergency Fastening Device (EFD)
13. Occupant classification system

The SRSCM continually monitors all SRS components while the Engine Start/Stop button is in the ON position to determine if a crash impact is severe enough to require air bag deployment or pre-tensioner seat belt deployment.

### **i** Information

The seat belt buckle sensor determines whether the front passenger's seat belt is fastened. According to whether the seat belt is fastened or not and how severe the impact is, this sensor provides the function to control the SRS deployment.



### SRS warning light

The SRS (Supplement Restraint System) air bag warning light on the instrument panel displays the air bag symbol depicted in the illustration. The system checks the air bag electrical system for malfunctions. The light indicates that there is a potential malfunction with your air bag system, which could include your side and curtain air bags used for rollover protection.

### **⚠** WARNING

**If your SRS malfunctions, the air bag may not inflate properly during an accident increasing the risk of serious injury or death.**

**If any of the following conditions occur, your SRS is malfunctioning:**

- **The light does not turn on for approximately six seconds when the ignition switch is in the ON position.**
- **The light remains illuminated after approximately six seconds.**
- **The light comes on while the vehicle is in motion.**
- **The light blinks when the engine is running.**

**Have an authorized HYUNDAI dealer inspect the SRS as soon as possible if any of these conditions occur.**

During a frontal collision, sensors will detect the vehicle's deceleration. If the deceleration rate (measured in g-force) is high enough the control unit will inflate the front air bags.

The front air bags help protect the driver and front passenger by responding to frontal impacts in which seat belts alone cannot provide adequate restraint. When needed, the side air bags help provide protection in the event of a side impact or rollover.

- Air bags are activated (able to inflate if necessary) only when the ignition switch is in the ON position.
- Air bags inflate in the event of certain frontal or side collisions to help protect the occupants from serious physical injury.
- There is no single speed at which the air bags will inflate. Generally, air bags are designed to inflate based upon the severity of a collision and its direction. These two factors determine whether the sensors produce an electronic deployment/inflation signal.

- Air bag deployment depends on a number of factors including vehicle speed, angles of impact and the density and stiffness of the vehicles or objects which your vehicle impacts during a collision. The determining factors are not limited to those mentioned above.

- The front air bags will completely inflate and deflate in an instant. It is virtually impossible for you to see the air bags inflate during an accident. It is much more likely that you will simply see the deflated air bags hanging out of their storage compartments after the collision.

- In addition to inflating in certain side collisions, vehicles equipped with a rollover sensor, side and curtain air bags will inflate if the sensing system detects a rollover.

When a rollover is detected, side and curtain air bags will remain inflated longer to help provide protection from ejection, especially when used in conjunction with the seat belts.

- To help provide protection, the air bags must inflate rapidly. The speed of air bag inflation is a consequence of extremely short time in which to inflate the air bag between the occupant and the vehicle structures before the occupant impacts those structures. This speed of inflation reduces the risk of serious or life-threatening injuries and is thus a necessary part of air bag design.

However, the rapid air bag inflation can also cause injuries which can include facial abrasions, bruises and broken bones because the inflation speed also causes the air bags to expand with a great deal of force.

- There are even circumstances under which contact with the air bag can cause fatal injuries, especially if the occupant is positioned excessively close to the air bag.

You can take steps to help reduce the risk of being injured by an inflating air bag. The greatest risk is sitting too close to the air bag. An air bag needs about 10 inches (25 cm) of space to inflate. NHTSA recommends that drivers allow at least 10 inches (25 cm) between the center of the steering wheel and the chest.

### WARNING

**To reduce the risk of serious injury or death from an inflating air bag, take the following precautions:**

- **NEVER place a child restraint in the front passenger seat.**

**Always properly restrain children under age 13 in the rear seats of the vehicle.**

- **Adjust the front passenger's and driver's seats as far to the rear as possible while allowing you to maintain full control of the vehicle.**
- **Hold the steering wheel with hands at the 9 o'clock and 3 o'clock positions.**
- **Never place anything or anyone between the air bag and the seat occupant.**
- **Do not allow the front passenger to place their feet or legs on the dashboard.**

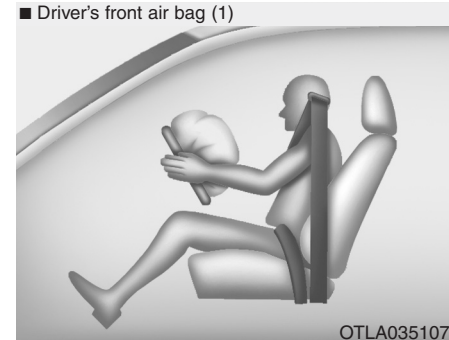

When the SRSCM detects a sufficiently severe impact to the front of the vehicle, it will automatically deploy the front air bags.

■ Driver's front air bag (2)



Upon deployment, tear seams molded directly into the pad covers will separate under pressure from the expansion of the air bags. Further opening of the covers allows full inflation of the air bags.

A fully inflated air bag, in combination with a properly worn seat belt, slows the driver or the front passenger forward motion, reducing the risk of head and chest injury.

■ Driver's front air bag (3)

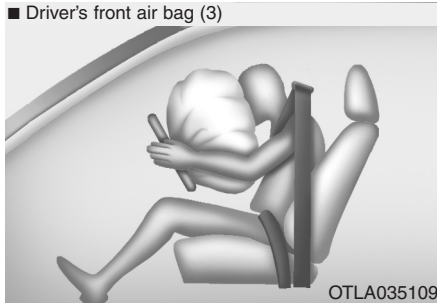

■ Passenger's front air bag



After complete inflation, the air bag immediately starts deflating, enabling the driver to maintain forward visibility and the ability to steer or operate other controls.

## ⚠ WARNING

To prevent objects from becoming dangerous projectiles when the passenger's air bag inflates:

- Do not install or place any objects (drink holder, CD holder, stickers, etc.) on the front passenger's panel above the glove box where the passenger's air bag is located.
- Do not install a container of liquid air freshener near the instrument cluster or on the instrument panel surface.

### What to Expect After an Air Bag Inflates

After a frontal or side air bag inflates, it will deflate very quickly. Air bag inflation will not prevent the driver from seeing out of the windshield or being able to steer. Curtain air bags may remain partially inflated for some time after they deploy.

#### WARNING

**After an air bag inflates, take the following precautions:**

- **Open your windows and doors as soon as possible after impact to reduce prolonged exposure to the smoke and powder released by the inflating air bag.**
- **Do not touch the air bag storage area's internal components immediately after an air bag has inflated. The parts that come into contact with an inflating air bag may be very hot.**

(Continued)

(Continued)

- **Always wash exposed skin areas thoroughly with luke-warm water and mild soap.**
- **Always have an authorized HYUNDAI dealer replace the air bag immediately after deployment. Air bags are designed to be used only once.**

### ***Noise and smoke from inflating air bag***

When the air bags inflate, they make a loud noise and may produce smoke and powder in the air inside of the vehicle. This is normal and is a result of the ignition of the air bag inflator. After the air bag inflates, you may feel substantial discomfort in breathing because of the contact of your chest with both the seat belt and the air bag, as well as from breathing the smoke and powder. The powder may aggravate asthma for some people. If you experience breathing problems after an air bag deployment, seek medical attention immediately.

Though the smoke and powder are nontoxic, they may cause irritation to the skin, eyes, nose, throat, etc. If this is the case, wash and rinse with cold water immediately and seek medical attention if the symptoms persist.



## Occupant Classification System (OCS)

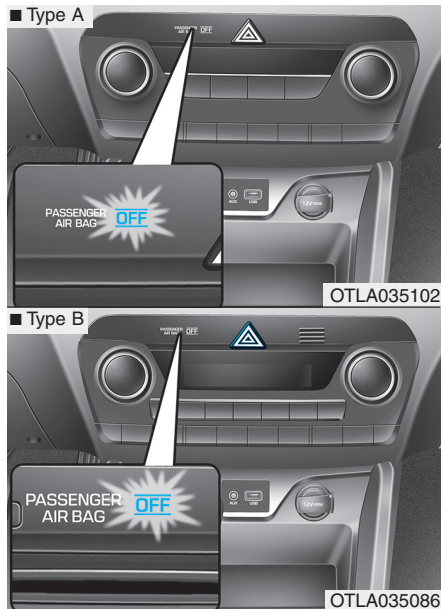

Your vehicle is equipped with an Occupant Classification System (OCS) in the front passenger's seat.

### Main components of the Occupant Classification System

- A detection device located within the front passenger seat cushion.
- Electronic system to determine whether the passenger air bag systems should be activated or deactivated.
- An indicator light located on the instrument panel which illuminates the words "PASSENGER AIR BAG OFF" indicating the front passenger air bag system is deactivated.
- The instrument panel air bag indicator light is interconnected with the OCS.

The OCS is designed to detect the presence of a properly-seated front passenger and determine if the passenger's front air bag should be enabled (may inflate) or not.

The purpose is to help reduce the risk of injury or death from an inflating air bag to certain front passenger seat occupants, such as children, by requiring the air bag to be automatically turned OFF.

For example, if a child restraint of the type specified in the regulations is on the seat, the occupant classification sensor can detect it and cause the air bag to turn OFF.

Front passenger seat adult occupants who are properly seated and wearing the seat belt properly, should not cause the passenger air bag to be automatically turned OFF. For small adults it may be turned OFF, however, if the occupant does not sit in the seat properly (for example, by not sitting upright, by sitting on the edge of the seat, or by otherwise being out of position), this could cause the sensor to turn the air bag OFF.

You will find the "PASSENGER AIR BAG OFF" indicator on the center facia panel. This system detects the conditions 1-4 in the following table and activates or deactivates the front passenger air bag based on these conditions.

Always be sure that you and all vehicle occupants are seated properly and wearing the seat belt properly for the most effective protection by the air bag and the seat belt.

The OCS may not function properly if the passenger takes actions which can affect the classification system. These include:

- Failing to sit in an upright position.
- Leaning against the door or center console.
- Sitting towards the sides of the front of the seat.
- Putting their legs on the dashboard or resting them on other locations which reduce the passenger weight on the front seat.
- Wearing the seat belt improperly.
- Reclining the seatback.
- Wearing a thick cloth like ski wear or hip protection wear.
- Putting an additional thick cushion on the seat.
- Putting electrical devices (e.g. notebook, satellite radio) on the seat with inverter charging.

### Condition and operation in the front passenger Occupant Classification System

Condition detected by the occupant classification system	Indicator/Warning light		Devices
	"PASSENGER AIR BAG OFF" indicator light	SRS warning light	Front passenger air bag
1. Adult *1	Off	Off	Activated
2. Infant *2 or child restraint system with 12 months old *3 *4	On	Off	Deactivated
3. Unoccupied	On	Off	Deactivated
4. Malfunction in the system	Off	On	Activated

\*1 The system judges a person of adult size as an adult. When a smaller adult sits in the front passenger seat, the system may recognize him/her as a child depending on his/her physique and posture.

\*2 Do not allow children to ride in the front passenger seat. When a larger child who has outgrown a child restraint system sits in the front passenger seat, the system may recognize him/her as an adult depending upon his/her physique or sitting position.

\*3 Never install a child restraint system on the front passenger seat.

\*4 The PASSENGER AIR BAG "OFF" indicator may turn on or off when a child above 12 months to 12 years old (with or without child restraint system) sits in the front passenger seat. This is a normal condition.

## ⚠ WARNING

Riding in an improper position or placing weight on the front passenger's seat when it is unoccupied by a passenger adversely affects the OCS. To reduce the risk of serious injury or death:



- NEVER put a heavy load in the front seat or seatback pocket, or hang any items on the front passenger seat.

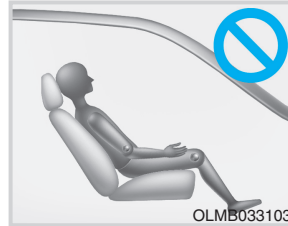

- NEVER ride with the seatback reclined when the vehicle is moving.

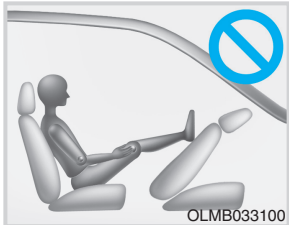

- NEVER place your feet on the front passenger seatback.



- NEVER place your feet or legs on the dashboard.

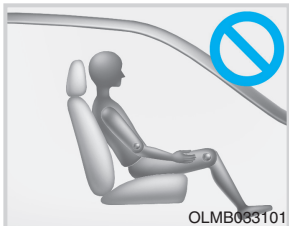

- NEVER sit with your hips shifted towards the front of the seat.



- NEVER lean on the door or center console or sit on one side of the front passenger seat.

(continued)

(continued)

- Do not put an electronic device (ex. Laptop computer, after market DMB, navigation, satellite audio, video game machine, MP3, AC inverter, etc.) in the front passenger seatback pocket or on the front passenger seat.
- Do not place a sitting mat on the front passenger seat.
- Do not place any items under the front passenger seat.
- Do not place sharp objects on the front passenger seat. These may damage the occupant classification system. If they puncture the seat cushion.
- Avoid spilling liquids on the front seat; this may cause the OCS not to work properly. Keep the front seat dry at all times.

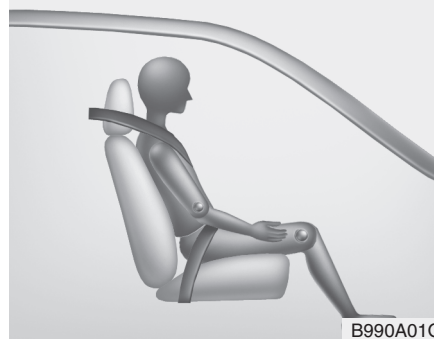

### Proper seated position for OCS

If the "PASSENGER AIR BAG OFF" indicator is on when an adult is seated in the front passenger seat, place the ignition switch in the LOCK/OFF position and ask the passenger to sit properly (sitting upright with the seat back in an upright position, centered on the seat cushion with their seat belt on, legs comfortably extended and their feet on the floor). Restart the engine and have the person remain in that position. This will allow the system to detect the person and to enable the passenger air bag. If the "PASSENGER AIR BAG OFF" indicator is still on, ask the passenger to move to the rear seat.

### WARNING

Never allow an adult passenger to ride in the front passenger seat when the "PASSENGER AIR BAG OFF" indicator is illuminated. During a collision, the air bag will not inflate if the indicator is illuminated. Have your passenger reposition themselves in the seat. If the "PASSENGER AIR BAG OFF" indicator remains illuminated after the passenger repositions himself properly and the vehicle is restarted, have the passenger move to the rear seat because the air bag will not inflate.

**NOTICE**

The "PASSENGER AIR BAG OFF" indicator illuminates for approximately 4 seconds after the ignition switch is in the ON position or after the engine is started. If the front passenger seat is occupied, the OCS will then classify the front passenger after several more seconds.

***Do Not Install a Child Restraint in the Front Passenger's Seat***

Even though your vehicle is equipped with the OCS, never install a child restraint in the front passenger's seat. An inflating air bag can forcefully strike a child or child restraint resulting in serious or fatal injury.

**⚠ WARNING**

- **NEVER** place a rear-facing or front-facing child restraint in the front passenger's seat of the vehicle.
- An inflating frontal air bag could forcefully strike a child resulting in serious injury or death.
- Always properly restrain children in an appropriate child restraint in the rear seat of the vehicle.

### Why Didn't My Air Bag Go Off in a Collision?

Air bags are not designed to inflate in every collision. There are certain types of accidents in which the air bag would not be expected to provide additional protection. These include rear impacts, second or third collisions in multiple impact accidents, as well as low speed impacts. Damage to the vehicle indicates a collision energy absorption, and is not an indicator of whether or not an air bag should have inflated.

### *Air bag collision sensors*

#### **WARNING**

**To reduce the risk of an air bag deploying unexpectedly and causing serious injury or death:**

- **Do not hit or allow any objects to impact the locations where air bags or sensors are installed.**
- **Do not perform maintenance on or around the air bag sensors. If the location or angle of the sensors is altered, the air bags may deploy when they should not or may not deploy when they should.**
- **Do not install bumper guards or replace the bumper with a non-genuine HYUNDAI parts. This may adversely affect the collision and air bag deployment performance.**

**(Continued)**

**(Continued)**

- **Place the ignition switch in the LOCK/OFF or ACC position when the vehicle is being towed to prevent inadvertent air bag deployment.**
- **Have all air bag repairs conducted by an authorized HYUNDAI dealer.**



1. SRS control module
2. Front impact sensor
3. Side pressure sensor (front)
4. Side impact sensor (rear)

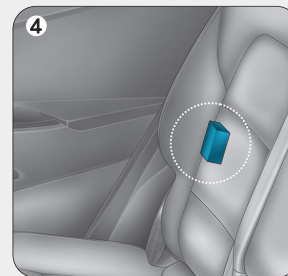
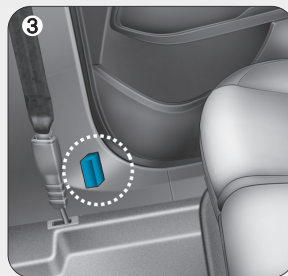
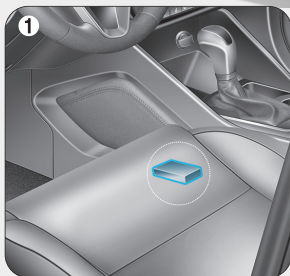

OTL035044/OTL035045/OTL035046/OTL035047/OTL035048

### Air bag inflation conditions

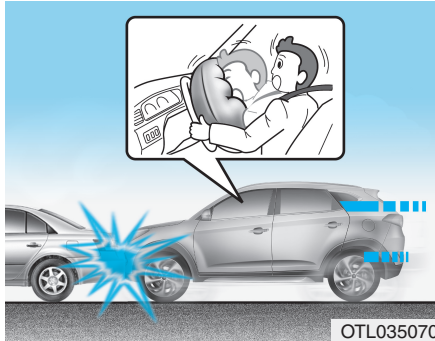

#### Front air bags

Front air bags are designed to inflate in a frontal collision depending on the severity, speed, or angles of impact of the front collision.

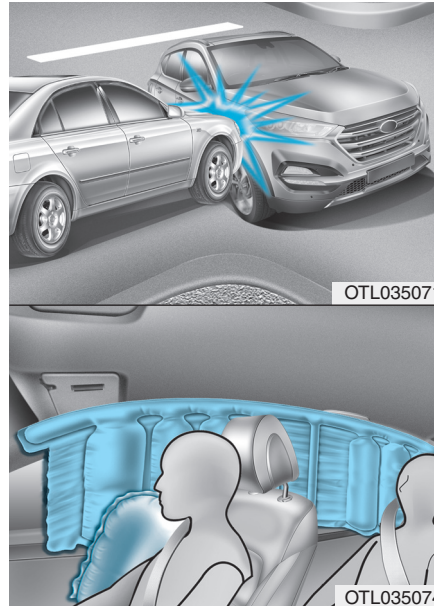

#### Side and curtain air bags

Side and curtain air bags are designed to inflate when an impact is detected by side collision sensors depending on the severity, speed, or angles of impact resulting from a side impact collision.

Although the driver's and front passenger's air bags are designed to inflate only in frontal collisions, they also may inflate in other types of collisions if the front impact sensors detect a sufficient impact. Side and curtain air bags are designed to inflate only in side impact collisions or rollover situations, but they may inflate in other collisions if the side impact sensors detect a sufficient impact.

If the vehicle chassis is impacted by bumps or objects on unimproved roads, the air bags may deploy. Drive carefully on unimproved roads or on surfaces not designed for vehicle traffic to prevent unintended air bag deployment.



## Air bag non-inflation conditions

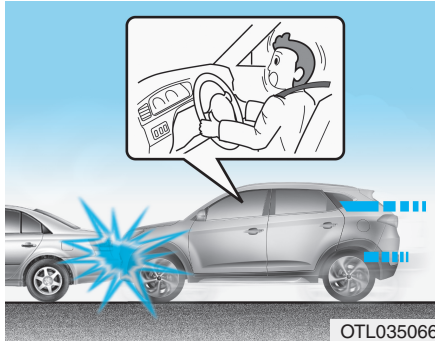

In certain low-speed collisions the air bags may not deploy. The air bags are designed not to deploy in such cases because they may not provide benefits beyond the protection of the seat belts.

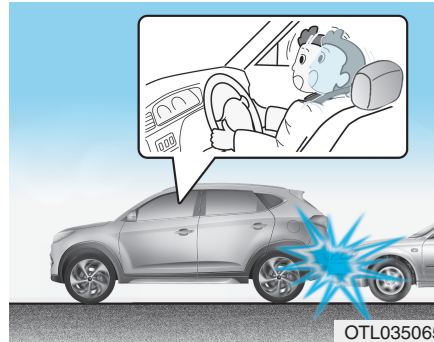

Front air bags are not designed to inflate in rear collisions, because occupants are moved backward by the force of the impact. In this case, inflated air bags would not provide any additional benefit.

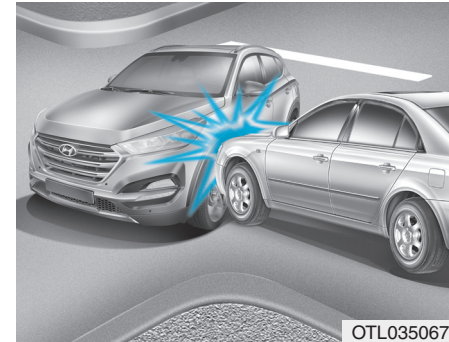

Front air bags may not inflate in side impact collisions, because occupants move in the direction of the collision, and thus in side impacts, front air bag deployment would not provide additional occupant protection.

However, side and curtain air bags may inflate depending on the severity, vehicle speed and angles of impact.

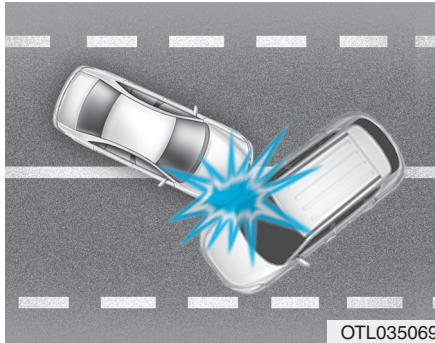

In an angled collision, the force of impact may direct the occupants in a direction where the air bags would not be able to provide any additional benefit, and thus the sensors may not deploy any air bags.

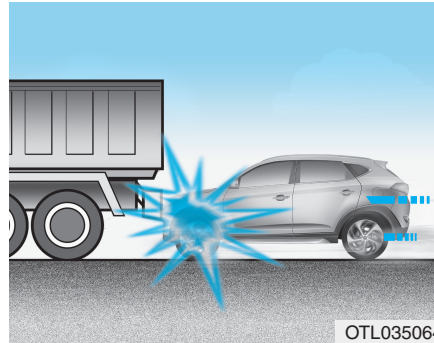

Just before impact, drivers often brake heavily. Such heavy braking lowers the front portion of the vehicle causing it to "ride" under a vehicle with a higher ground clearance. Air bags may not inflate in this "under-ride" situation because deceleration forces that are detected by sensors may be significantly reduced by such "under-ride" collisions.

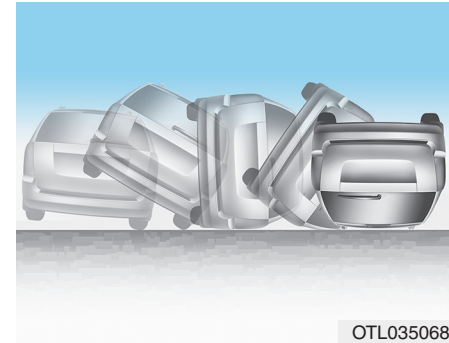

Front air bags may not inflate in rollover accidents because air bag deployment could not provide protection to the occupants.

However, side and curtain air bags may inflate when the vehicle is rolled over by a side impact collision.

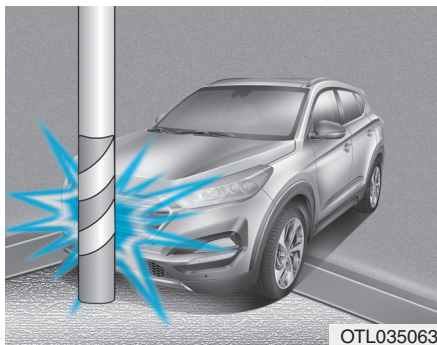

Air bags may not inflate if the vehicle collides with objects such as utility poles or trees, where the point of impact is concentrated and the collision energy is absorbed by the vehicle structure.

## SRS Care

The SRS is virtually maintenance-free and there are no parts you can safely service by yourself. If the SRS air bag warning light does not illuminate when the ignition switch or the engine Start/Stop button is in the ON position or continuously remains on, have your vehicle immediately inspected by an authorized HYUNDAI dealer.

Any work on the SRS system, such as removing, installing, repairing, or any work on the steering wheel, the front passenger's panel, front seats and roof rails must be performed by an authorized HYUNDAI dealer. Improper handling of the SRS system may result in serious personal injury.

## WARNING

**To reduce the risk of serious injury or death, take the following precautions:**

- **Do not attempt to modify or disconnect the SRS components or wiring, including the addition of any kind of badges to the pad covers or modifications to the body structure.**
- **Do not place objects over or near the air bag modules on the steering wheel, instrument panel, or the front passenger's panel above the glove box.**
- **Clean the air bag pad covers with a soft cloth moistened with plain water. Solvents or cleaners could adversely affect the air bag covers and proper deployment of the system.**
- **Always have inflated air bags replaced by an authorized HYUNDAI dealer.**

**(Continued)**

(Continued)

- **If components of the air bag system must be discarded, or if the vehicle must be scrapped, certain safety precautions must be observed. Consult an authorized HYUNDAI dealer for the necessary information. Failure to follow these precautions could increase the risk of personal injury.**

### Additional Safety Precautions

**Passengers should not move out of or change seats while the vehicle is moving.** A passenger who is not wearing a seat belt during a crash or emergency stop can be thrown against the inside of the vehicle, against other occupants, or be ejected from the vehicle.

**Do not use any accessories on seat belts.** Devices claiming to improve occupant comfort or reposition the seat belt can reduce the protection provided by the seat belt and increase the chance of serious injury in a crash

**Do not modify the front seats.**

Modification of the front seats could interfere with the operation of the supplemental restraint system sensing components or side air bags.

**Do not place items under the front seats.** Placing items under the front seats could interfere with the operation of the supplemental restraint system sensing components and wiring harnesses.

**Do not cause impact to the doors.** Impact to the doors when the ignition switch or the engine Start/Stop button is in the ON position may cause the air bags to inflate.

**Modifications to accommodate disabilities.** If you require modification to your vehicle to accommodate a disability, contact the HYUNDAI Customer Connect Center at 1-800-633-5151.

### *Adding equipment to or modifying your air bag equipped vehicle*

If you modify your vehicle by changing your vehicle's frame, bumper system, front end or side sheet metal or ride height, this may affect the operation of your vehicle's air bag system.

## Air Bag Warning Labels

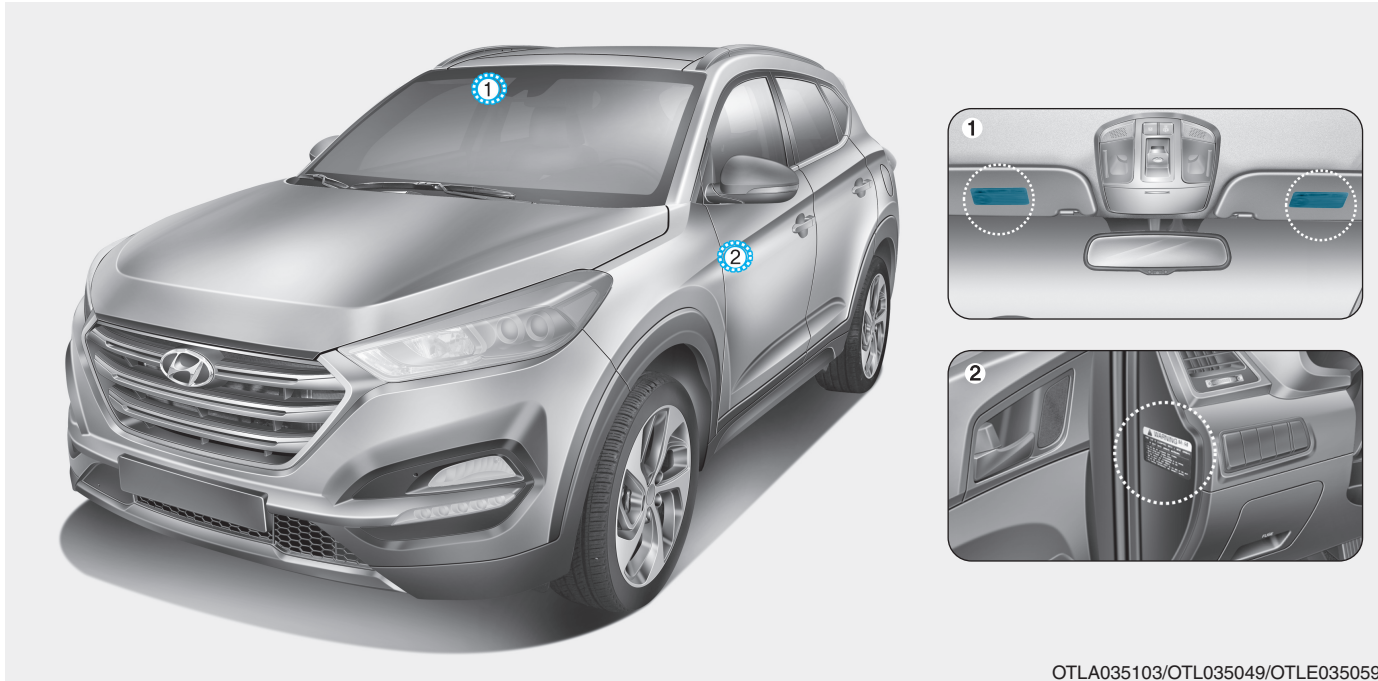

Air bag warning labels, required by the U.S. National Highway Traffic Safety Administration (NHTSA), are attached to alert the driver and passengers of potential risks of the air bag system. Be sure to read all of the information about the air bags that are installed on your vehicle in this Owners Manual.

## Convenient features of your vehicle

<b>Accessing your vehicle</b> .....	3-4
Remote Key.....	3-4
Smart Key.....	3-8
Immobilizer System.....	3-12
<b>Door locks</b> .....	3-14
Operating Door Locks from Outside the Vehicle.....	3-14
Operating Door Locks from Inside the Vehicle.....	3-15
Auto Door Lock/Unlock Features.....	3-18
Child-Protector Rear Door locks.....	3-18
<b>Theft-alarm system</b> .....	3-19
<b>Steering wheel</b> .....	3-20
Electric Power Steering (EPS).....	3-20
Tilt Steering / Telescope Steering.....	3-21
Heated Steering Wheel.....	3-21
Horn.....	3-22
<b>Mirrors</b> .....	3-23
Inside Rearview Mirror.....	3-23
Outside Rearview Mirror.....	3-35
<b>Windows</b> .....	3-38
Power Windows.....	3-39
<b>Panoramic sunroof</b> .....	3-42
Sunshade.....	3-43
Sliding the Sunroof.....	3-43
Tilting the Sunroof.....	3-44
Closing the Sunroof.....	3-44
To Reset the Sunroof.....	3-45
<b>Exterior features</b> .....	3-46
Hood.....	3-46
Fuel Filler Door.....	3-47
<b>Liftgate</b> .....	3-51
Non-Powered liftgate.....	3-51
Power liftgate.....	3-53
Smart Liftgate.....	3-59
<b>Instrument cluster</b> .....	3-63
Instrument Cluster Control.....	3-64
LCD Display Control.....	3-64
Gauges.....	3-65

<b>LCD Display</b> .....	<b>3-70</b>	<b>Wipers and washers</b> .....	<b>3-118</b>
LCD Modes.....	3-70	Windshield Wipers .....	3-118
Trip Computer Mode.....	3-71	Windshield Washers .....	3-119
Turn By Turn (TBT) Mode .....	3-72	Rear window wiper and washer switch .....	3-120
LDWS Mode.....	3-72	<b>Driver Assist System</b> .....	<b>3-121</b>
A/V Mode.....	3-72	Rear View Camera .....	3-121
Information Mode .....	3-73	Rear Parking Assist System .....	3-122
User Settings Mode.....	3-75	Rear parking assist system precautions.....	3-125
Warning Messages.....	3-81	<b>Defroster</b> .....	<b>3-126</b>
<b>Trip computer</b> .....	<b>3-89</b>	Rear Window Defroster .....	3-126
Overview.....	3-89	<b>Manual climate control system</b> .....	<b>3-127</b>
Trip A/B .....	3-90	Heating and Air Conditioning.....	3-128
Fuel Economy.....	3-91	System Operation .....	3-133
Digital Speedometer .....	3-93	System Maintenance.....	3-135
<b>Warning and indicator lights</b> .....	<b>3-94</b>	<b>Automatic climate control system</b> .....	<b>3-137</b>
Warning Lights.....	3-94	Automatic Heating and Air Conditioning.....	3-138
Indicator Lights.....	3-102	Manual Heating and Air Conditioning.....	3-139
<b>Light</b> .....	<b>3-107</b>	System Operation .....	3-145
Exterior Lights .....	3-107	System Maintenance.....	3-147
Welcome System.....	3-113	<b>Windshield defrosting and defogging</b> .....	<b>3-149</b>
Interior Lights .....	3-114	Manual Climate Control System .....	3-149
		Automatic Climate Control System .....	3-150
		Defogging logic.....	3-151

<b>Climate control additional features.....</b>	<b>3-152</b>
Automatic Ventilation.....	3-152
Sunroof Inside Air Recirculation .....	3-152
<b>Storage compartment.....</b>	<b>3-153</b>
Center Console Storage .....	3-153
Glove Box.....	3-153
Sunglass Holder.....	3-154
<b>Interior features.....</b>	<b>3-155</b>
Cup Holder .....	3-155
Sunvisor .....	3-156
Power Outlet .....	3-156
Clock.....	3-158
Clothes Hanger .....	3-158
Plastic bag hook.....	3-159
Floor Mat Anchor(s).....	3-159
Luggage net (holder) .....	3-160
Cargo security screen.....	3-160
Luggage tray.....	3-163
<b>Exterior features .....</b>	<b>3-164</b>
Roof rack .....	3-164



## ACCESSING YOUR VEHICLE

### Remote Key (if equipped)

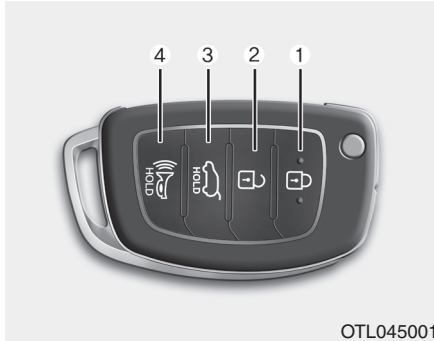

Your HYUNDAI uses a remote key, which you can use to lock or unlock the driver and passenger doors or the rear liftgate.

1. Door Lock
2. Door Unlock
3. Liftgate Unlock
4. Panic (if equipped)

### **Locking Your Vehicle**

To lock your vehicle:

1. Make sure all doors, the engine hood and the liftgate are closed.
2. Press the Door Lock button (1) on the remote key to lock all doors.
3. If the Door Lock button (1) is pressed once more within four seconds, the horn will beep once and the hazard warning lights will blink.
4. Make sure the doors are locked by checking the position of the door lock button inside the vehicle.

### **⚠ WARNING**

**Do not leave the keys in your vehicle with unsupervised children. Unattended children could place the key in the ignition switch and may operate power windows or other controls, or even make the vehicle move, which could result in serious injury or death.**

## Unlocking Your Vehicle

To unlock your vehicle:

1. Press the Door Unlock button (2) on the remote key. The driver's door will unlock. The hazard warning lights will blink two times.
2. If you press the Door Unlock button (2) again within four seconds, then all the doors will unlock.

### **i** Information

After unlocking the doors, the doors will automatically relock after 30 seconds unless a door is opened.

## Liftgate unlocking

To unlock the liftgate:

1. Press the Liftgate (tailgate) Unlock button (3) on the remote key for more than one second.
2. The hazard warning lights will blink two times.

Once the liftgate is opened and then closed, the liftgate will automatically lock after 30 seconds.

### **i** Information

- After unlocking the liftgate, the liftgate will lock automatically.
- The word "HOLD" is written on the button to inform you that you must press and hold the button for more than one second.

## Panic button (if equipped)

Press the Panic button (4) for more than one second. The horn sounds and hazard warning lights flash for about 30 seconds.

To cancel the panic mode, press any button on the remote key.

### Start-up

For more information, refer to the "Key Ignition Switch" section in chapter 5.

### NOTICE

To prevent damaging the remote key:

- Keep the remote key away from water or any liquid and fire. Internal circuits may malfunction if the inside of the remote key gets damp (from liquids or moisture) or if it is heated. This can exclude the remote key from warranty coverage.
- Avoid dropping or throwing the remote key.
- Protect the remote key from extreme temperatures.

### **Mechanical key**



If the remote key does not operate normally, you can lock or unlock the door by using the mechanical key.

To unfold the mechanical key, press the release button on the remote.

To return the key to its stored position, press the release button and fold the key back into the remote.

### **Remote key precautions**

The remote key will not work if any of the following occur:

- The key is in the ignition switch.
- You exceed the operating distance limit (about 90 feet [30 m]).
- The remote key battery is weak.
- Other vehicles or objects may be blocking the signal.
- The weather is extremely cold.
- The remote key is close to a radio transmitter such as a radio station or an airport which can interfere with normal operation of the remote key.

When the remote key does not work correctly, open and close the door with the mechanical key. If you have a problem with the remote key contact an authorized HYUNDAI dealer.

If the remote key is in close proximity to your mobile phone, the signal could be blocked by your mobile phone's normal operational signals. This is especially important when the phone is active such as making and receiving calls, text messaging, and/or sending/receiving emails.

When possible, avoid placing the remote key and your mobile phone in the same location such as a pants or jacket pocket in order to avoid interference between the two devices.

### **i** Information

This device complies with Part 15 of the FCC rules.

Operation is subject to the following three conditions:

1. This device may not cause harmful interference.
2. This device must accept any interference received, including interference that may cause undesired operation.
3. Changes or modifications not expressly approved by the party responsible for compliance could void the user's authority to operate the device.

### **NOTICE**

**Keep the remote key away from electromagnetic materials that block electromagnetic waves to the key surface.**

### **Battery replacement**

If the remote key is not working properly, try replacing the battery with a new one.



Battery Type: CR2032

To replace the battery:

1. Pry open the rear cover of the remote key.
2. Remove the old battery and insert the new battery. Make sure the battery position is correct.
3. Reinstall the rear cover of the remote key.

If you suspect your remote key might have sustained some damage, or you feel your remote key is not working correctly contact an authorized HYUNDAI dealer.

### **i** Information



**An inappropriately disposed battery can be harmful to the environment and human health. Dispose the battery according to your local law(s) and regulation.**

### Smart Key (if equipped)



Your HYUNDAI uses a Smart Key, which you can use to lock or unlock the driver and passenger doors or the liftgate.

1. Door Lock
2. Door Unlock
3. Liftgate Unlock
4. Panic

### Locking Your Vehicle

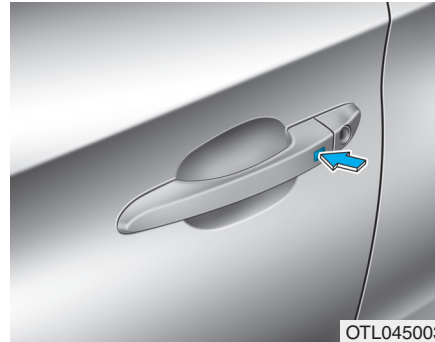

To lock your vehicle:

1. Make sure all doors, the engine hood and the liftgate are closed.
2. Make sure you have the smart key in your possession.
3. Press either the button on the door handle of the Door Lock button (1) or the button on the smart key. The chime will sound once and the hazard warning lights will blink.
4. Make sure the doors are locked by checking the position of the door lock button inside the vehicle.

### Information

The door handle button will only operate when the smart key is within 28~40 inches (0.7~1 m) from the outside door handle.

Even though you press the outside door handle button, the doors will not lock and the chime will sound for three seconds if any of the following occur:

- The Smart Key is in the vehicle.
- The Engine Start/Stop button is in ACC or ON position.
- Any door except the liftgate is open.

### WARNING

**Do not leave the Smart Key in your vehicle with unsupervised children. Unattended children could press the Engine Start/Stop button and may operate power windows or other controls, or even make the vehicle move, which could result in serious injury or death.**

## Unlocking Your Vehicle

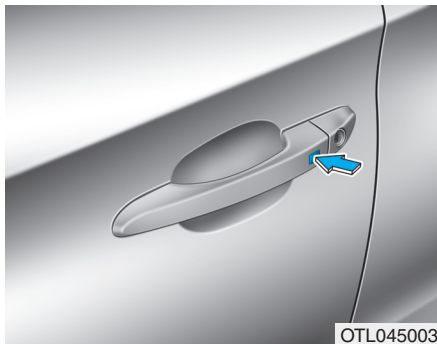

To unlock your vehicle:

1. Make sure you have the smart key in your possession.
2. Press either the button on the door handle of the Door Unlock button (2) or the smart key. The driver's door will unlock and the hazard warning lights will blink two times.
3. If you press the driver door outside door handle button or Door Unlock button on the smart key again within four seconds, then all the doors will unlock.

### **i** Information

- The door handle button will only operate when the smart key is within 28-40 inches (0.7~1m) from the outside door handle.
- Either the driver or front passenger door can be opened with the door handle button when the smart key is within this range.
- If you press the front passenger outside door handle, while carrying the Smart Key, all doors will unlock.
- After unlocking the doors, the doors will lock automatically after 30 seconds unless a door is opened.

## Opening the Liftgate

To open the liftgate:

1. Make sure you have the smart key in your possession.
2. Press either the liftgate handle button or press and hold the Liftgate Unlock button (3) on the smart key for more than one second. The hazard warning lights will blink two times.
3. Once the liftgate is opened and then closed, the liftgate will lock automatically.

### **i** Information

The liftgate handle button will only operate when the smart key is within 28 inches (0.7 m) from the liftgate handle.

### **Panic button**

Press the Panic button (4) and hold for more than one second. The horn sounds and hazard warning lights blink for about 30 seconds. To cancel the panic mode, press any button on the Smart Key.

### **Start-up**

You can start the engine without inserting the key.

**For more information, refer to the "Engine Start/Stop Button" section in chapter 5.**

### **NOTICE**

**To prevent damaging the smart key:**

- **Keep the smart key away from water or any liquid or fire. Internal circuits may malfunction if the inside of the smart key gets damp (from liquids or moisture) or if it is heated. This can exclude the smart key from warranty coverage.**
- **Avoid dropping or throwing the smart key.**
- **Protect the smart key from extreme temperatures.**

### **NOTICE**

**Always have the smart key with you when leaving the vehicle. If the smart key is left near the vehicle, the vehicle battery may be discharged.**

### **Mechanical key**

If the Smart Key does not operate normally, you can lock or unlock the door by using the mechanical key.



To remove the mechanical key from the smart key fob, press and hold the release button (1) and pull the mechanical key out.

To unlock the vehicle using the mechanical key, insert the mechanical key into the key hole on the driver door.

To reinstall the mechanical key, put the key into the hole and push it until a click sound is heard.

### **Loss of a smart key**

A maximum of two Smart Keys can be registered to a single vehicle. If you happen to lose your smart key, you should immediately take the vehicle and remaining keys to your authorized HYUNDAI dealer or tow the vehicle, if necessary.

### **Smart key precautions**

The smart key will not work if any of the following occur:

- The smart key is close to a radio transmitter such as a radio station or an airport which can interfere with normal operation of the transmitter.
- The smart key is near a mobile two way radio system or a cellular phone.
- Another vehicle's smart key is being operated close to your vehicle.

When the smart key does not work correctly, open and close the door with the mechanical key. If you have a problem with the smart key, contact an authorized HYUNDAI dealer.

If the smart key is in close proximity to your mobile phone, the signal could be blocked by your mobile phone's normal operational signals. This is especially important when the phone is active such as making and receiving calls, text messaging, and/or sending/receiving emails. When possible, avoid placing the remote key and your mobile phone in the same location such as a pants or jacket pocket in order to avoid interference between the two devices.

 **CAUTION**

**Keep the smart key away from electromagnetic materials that blocks electromagnetic waves to the key surface.**



### **i** Information

This device complies with Part 15 of the FCC rules.

Operation is subject to the following three conditions:

1. This device may not cause harmful interference.
2. This device must accept any interference received, including interference that may cause undesired operation.
3. Changes or modifications not expressly approved by the party responsible for compliance could void the user's authority to operate the device.

### **Battery replacement**

If the Smart Key is not working properly, try replacing the battery with a new one.

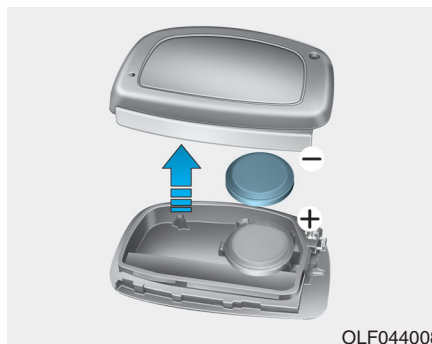

Battery Type: CR2032

To replace the battery:

1. Pry open the rear cover of the smart key.
2. Remove the old battery and insert the new battery.
3. Reinstall the rear cover of the smart key.

If you suspect your smart key might have sustained some damage, or you feel your smart key is not working correctly, contact an authorized HYUNDAI dealer.

### **i** Information



**An inappropriately disposed battery can be harmful to the environment and human health. Dispose the battery according to your local law(s) and regulation(s).**

## Immobilizer System

The immobilizer system protects your vehicle from theft. If an improperly coded key (or other device) is used, the engine's fuel system is disabled.

When the ignition switch is placed in the ON position, the immobilizer system indicator should come on briefly, then go off. If the indicator starts to blink, the system does not recognize the coding of the key.

Turn the ignition switch to the LOCK/OFF position, then turn the ignition switch to the ON position again.

The system may not recognize your key's coding if another immobilizer key or other metal object (i.e., key chain) is near the key. The engine may not start because the metal may interrupt the transponder signal from transmitting normally.

If the system repeatedly does not recognize the coding of the key, it is recommended that you contact your HYUNDAI dealer.

Do not attempt to alter this system or add other devices to it. Electrical problems could result that may make your vehicle inoperable.

### WARNING

**In order to prevent theft of your vehicle, do not leave spare keys anywhere in your vehicle. Your immobilizer password is a customer unique password and should be kept confidential.**

### NOTICE

**The transponder in your key is an important part of the immobilizer system. It is designed to give years of trouble-free service, however you should avoid exposure to moisture, static electricity and rough handling. Immobilizer system malfunction could occur.**

### Information

**This device complies with Part 15 of the FCC rules.**

**Operation is subject to the following three conditions:**

- 1. This device may not cause harmful interference.**
- 2. This device must accept any interference received, including interference that may cause undesired operation.**
- 3. Changes or modifications not expressly approved by the party responsible for compliance could void the user's authority to operate the device.**

## DOOR LOCKS

### Operating Door Locks from Outside the Vehicle

#### Mechanical key

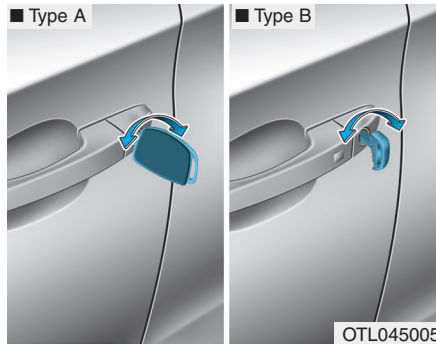

If you lock the driver's door with turning the key toward the front of the vehicle, all vehicle doors will lock. If you unlock the driver's door with turning the key toward the rear of the vehicle, the driver's door will unlock.

Once the doors are unlocked, they may be opened by pulling the door handle.

When closing the door, push the door by hand. Make sure that doors are closed securely.

#### Remote key



To lock the doors, press the Door Lock button (1) on the remote key.

Press the Door Unlock button (2) on the remote key, the driver's door will unlock. If you press the Door Unlock button on the remote key again within four seconds, then all the doors will unlock.

Once the doors are unlocked, they may be opened by pulling the door handle.

When closing the door, push the door by hand. Make sure that doors are closed securely.

#### **i** Information

- In cold and wet climates, door lock and door mechanisms may not work properly due to freezing conditions.
- If the door is locked/unlocked multiple times in rapid succession with either the vehicle key or door lock switch, the system may stop operating temporarily in order to protect the circuit and prevent damage to system components.

## Smart key

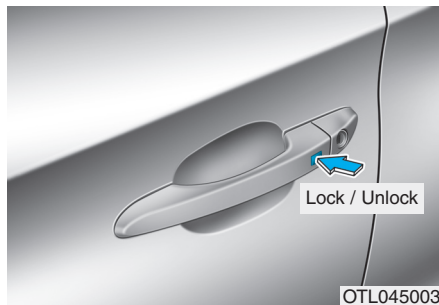

To lock the doors, press the button on the outside door handle while carrying the Smart Key with you or press the Door Lock button on the Smart Key.

Press the button on the driver's outside door handle while carrying the Smart Key with you or press the Door Unlock button on the Smart Key, the driver's door will unlock. If you press the button on the front passenger's outside door, all doors will unlock.

Once the doors are unlocked, they may be opened by pulling the door handle.

When closing the door, push the door by hand. Make sure that doors are closed securely.

### **i** Information

- **In cold and wet climates, door lock and door mechanisms may not work properly due to freezing conditions.**
- **If the door is locked/unlocked multiple times in rapid succession with either the vehicle key or door lock switch, the system may stop operating temporarily in order to protect the circuit and prevent damage to system components.**

## Operating Door Locks from Inside the Vehicle

### **With the door lock button**

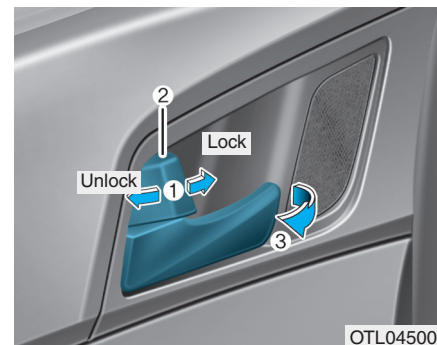

- To unlock a door, push the door lock button (1) to the "Unlock" position. The red mark (2) on the door lock button will be visible.
- To lock a door, push the door lock button (1) to the "Lock" position. If the door is locked properly, the red mark (2) on the door lock button will not be visible.
- To open a door, pull the door handle (3) outward.

- If the inner door handle of the driver door or front passenger door is pulled when the door lock button is in the lock position, the button is unlocked and the door will open.
- The front doors cannot be locked if the key is in the ignition switch and any front door is open.
- The doors cannot be locked if the smart key is in the vehicle and any door is open.

### **i** Information

**If a power door lock ever fails to function while you are in the vehicle try one or more of the following techniques to exit:**

- **Operate the door unlock feature repeatedly (both electronic and manual) while simultaneously pulling on the door handle.**
- **Operate the other door locks and handles, front and rear.**
- **Lower a front window and use the mechanical key to unlock the door from outside.**

### **With the central door lock switch**

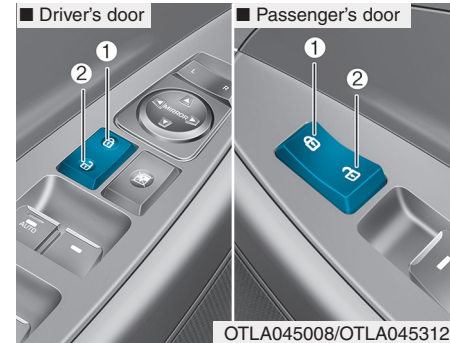

When pressing the (🔒) switch (1), all vehicle doors will lock.

When pressing the (🔓) switch (2), all vehicle doors will unlock.

If the key is in the ignition switch and any door is opened, the doors will not lock even though the lock button (1) of the central door lock switch is pressed.

If the smart key is in the vehicle and any door is opened, the doors will not lock even though the lock button (1) of the central door lock switch is pressed.

 **WARNING**

- The doors should always be fully closed and locked while the vehicle is in motion. If the doors are unlocked, the risk of being thrown from the vehicle in a crash is increased.
- Do not pull the inner door handle of the driver's or passenger's door while the vehicle is moving.

 **WARNING**

Do not leave children or animals unattended in your vehicle. An enclosed vehicle can become extremely hot, causing death or serious injury to unattended children or animals who cannot escape the vehicle. Children might operate features of the vehicle that could injure them, or they could encounter other harm, possibly from someone gaining entry to the vehicle.

 **WARNING**

**Always secure your vehicle.**

Leaving your vehicle unlocked increases the potential risk to you or others from someone hiding in your vehicle.

To secure your vehicle, while depressing the brake, move the shift lever to the P (Park) position, engage the parking brake, and place the ignition switch in the LOCK/OFF position, close all windows, lock all doors, and always take the key with you.

 **CAUTION**

Opening a door when something is approaching may cause damage or injury. Be careful when opening doors and watch for vehicles, motorcycles, bicycles or pedestrians approaching the vehicle in the path of the door.

 **WARNING**

If you stay in the vehicle for a long time while the weather is very hot or cold, there are risks of injuries or danger to life. Do not lock the vehicle from the outside when someone is in the vehicle.

### Auto Door Lock/Unlock Features

#### ***Impact sensing door unlock system***

All doors will be automatically unlocked when an impact causes the air bags to deploy.

#### ***Speed sensing door lock system***

All doors will be automatically locked when vehicle speed exceeds 9 mph (15 km/h).

All of the doors will be automatically unlocked after the engine is turned off.

#### ***Shift lever auto door lock***

All doors will be automatically locked when shifting the shift lever out of P (Park) with the engine running.

You can activate or deactivate the Auto Door Lock/Unlock features from the User Settings Mode on the LCD display.

**For more information, refer to the "LCD Display" section in this chapter.**

### Child-Protector Rear Door locks

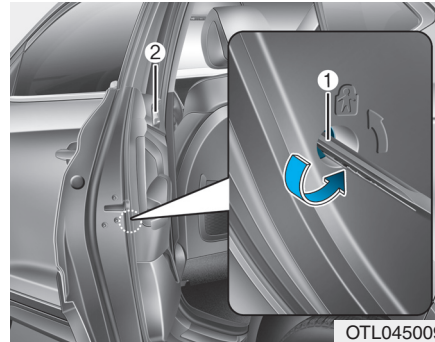

The child safety lock is provided to help prevent children seated in the rear from accidentally opening the rear doors. The rear door safety locks should be used whenever children are in the vehicle.

The child safety lock is located on the edge of each rear door. When the child safety lock is in the lock (1) position, the rear door will not open if the inner door handle (2) is pulled.

To lock the child safety lock, insert a screwdriver into the hole and turn it to the lock position.

To allow a rear door to be opened from inside the vehicle, unlock the child safety lock.

#### **⚠ WARNING**

**If children accidentally open the rear doors while the vehicle is in motion, they could fall out of the vehicle. The rear door safety locks should always be used whenever children are in the vehicle.**

## THEFT-ALARM SYSTEM

This system helps to protect your vehicle and valuables. The horn will sound and the hazard warning lights will blink continuously if any of the following occurs:

- A door is opened without using the remote key or smart key.
- The liftgate is opened without using the remote key or smart key.
- The engine hood is opened.

The alarm continues for 30 seconds, then the system resets. To turn off the alarm, unlock the doors with the remote key or smart key.

The Theft Alarm System automatically sets 30 seconds after you lock the doors and the liftgate. For the system to activate, you must lock the doors and the liftgate from outside the vehicle with the remote key or smart key or by pressing the button on the outside of the door handle with the smart key in your possession.

The hazard warning lights will blink and the chime will sound once to indicate the system is armed.

Once the security system is set, opening any door, the liftgate, or the hood without using the remote key or smart key will cause the alarm to activate.

The Theft Alarm System will not set if the hood, the liftgate, or any door is not fully closed. If the system will not set, check the hood, the liftgate, or the doors are fully closed.

Do not attempt to alter this system or add other devices to it.

### Information

- **Do not lock the doors until all passengers have left the vehicle. If the remaining passenger leaves the vehicle when the system is armed, the alarm will be activated.**
- **If the vehicle is not disarmed with the remote key or smart key, open the doors by using the mechanical key and place the ignition switch in the ON position (for remote key) or start the engine (for smart key) by directly pressing the ignition switch with the smart key.**
- **If the system is disarmed by unlocking the vehicle, but neither a door or the liftgate is opened within 30 seconds, the doors will relock and the system will rearm automatically.**



## STEERING WHEEL

### Electric Power Steering (EPS)

The system assists you with steering the vehicle. If the engine is turned off or if the power steering system becomes inoperative, you may still steer the vehicle, but it will require increased steering effort.

Should you notice any change in the effort required to steer during normal vehicle operation, have the system checked by an authorized HYUNDAI dealer.

#### CAUTION

**If the Electric Power Steering System does not operate normally, the warning light (⊗!) will illuminate on the instrument cluster. You may steer the vehicle, but it will require increased steering efforts. Take your vehicle to an authorized HYUNDAI dealer and have the system checked as soon as possible.**

#### Information

The following symptoms may occur during normal vehicle operation:

- The steering effort may be high immediately after placing the ignition switch in the ON position.  
This happens as the system performs the EPS system diagnostics. When the diagnostics are completed, the steering wheel will return to its normal condition.
- A click noise may be heard from the EPS relay after the ignition switch is in the ON or OFF position.
- Motor noise may be heard when the vehicle is at a stop or at a low driving speed.
- If the outside ambient temperature is low, when you operate the steering wheel a noise from the electric power steering may occur. As the temperature increases, the noise will disappear. This is a normal condition.

## Tilt Steering / Telescope Steering

When adjusting the steering wheel to a comfortable position, adjust the steering wheel so that it points toward your chest, not toward your face. Make sure you can see the instrument panel warning lights and gauges. After adjusting, push the steering wheel both up and down to be certain it is locked in position. Always adjust the position of the steering wheel before driving.

### WARNING

**NEVER adjust the steering wheel while driving. This may cause loss of vehicle control resulting in an accident.**



To adjust the steering wheel angle and height:

1. Pull down the lock-release lever (1).
2. Adjust the steering wheel to the desired angle (2) and height (3).
3. Pull up the lock-release lever to lock the steering wheel in place.

### Information

Sometimes the lock release lever may not engage completely. This may occur when the gears of the locking mechanism do not completely mesh. If this occurs, pull down on the lock-release lever, readjust the steering wheel again, and then pull back up on the release lever to lock the steering wheel in place.

### Heated Steering Wheel (if equipped)

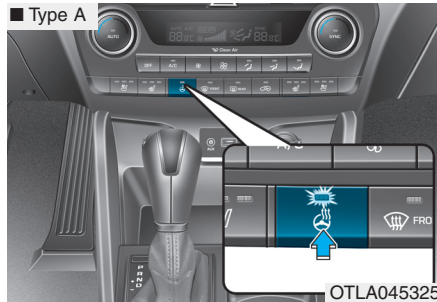

When the ignition switch is in the ON position or when the engine is running, press the heated steering wheel button to warm the steering wheel. The indicator on the button will illuminate.

To turn the heated steering wheel off, press the button again. The indicator on the button will turn off.

The heated steering wheel will automatically turn off after approximately 30 minutes.

#### **NOTICE**

**Do not install any cover or accessory on the steering wheel. The cover or accessory could cause damage to the heated steering wheel system.**

### Horn



To sound the horn, press the area indicated by the horn symbol on your steering wheel (see illustration). The horn will operate only when this area is pressed.

#### **NOTICE**

**Do not strike the horn severely to operate it, or hit it with your fist. Do not press on the horn with a sharp-pointed object.**

## MIRRORS

### Inside Rearview Mirror

Before you start driving, adjust the rearview mirror to center on the view through the rear window.

#### WARNING

Make sure your line of sight is not obstructed. Do not place objects in the rear seat, cargo area, or behind the rear headrests which could interfere with your vision through the rear window.

#### WARNING

To prevent serious injury during an accident or deployment of the air bag, do not modify the rearview mirror and do not install a wide mirror.

#### WARNING

**NEVER** adjust the mirror while driving. This may cause loss of vehicle control resulting in an accident.

#### NOTICE

When cleaning the mirror, use a paper towel or similar material dampened with glass cleaner. Do not spray glass cleaner directly on the mirror as this may cause the liquid cleaner to enter the mirror housing.

### Day/night rearview mirror (if equipped)

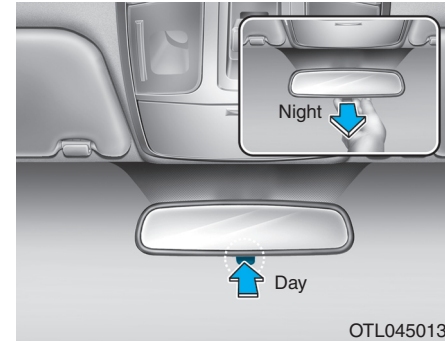

Make this adjustment before you start driving and while the day/night lever is in the day position.

Pull the day/night lever toward you to reduce glare from the headlights of the vehicles behind you during night driving.

Remember that you lose some rearview clarity in the night position.

### ***Electric chromic mirror with homelink system (if equipped)***

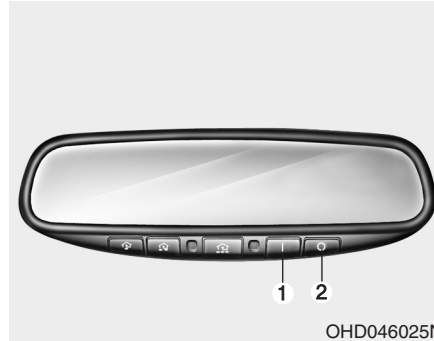

OHD046025N

#### **To operate the electric rearview mirror**

Press the I button (1) to turn the automatic-dimming function on. The mirror indicator light will illuminate.

Press the O button (2) to turn the automatic-dimming function off. The mirror indicator light will turn off.

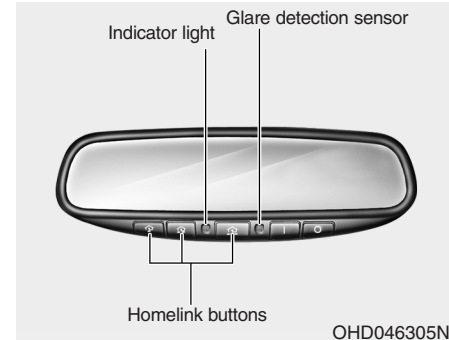

OHD046305N

#### **HomeLink® Wireless Control System**

Your new mirror comes with an integrated HomeLink Universal Transceiver, which allows you to program the mirror to activate your garage door(s), estate gate, home lighting, etc. The mirror actually learns the codes from your various existing transmitters.

## WARNING

- **When programming the HomeLink® Wireless Control System, you may be operating a garage door or gate operator. Make sure that people and objects are out of the way of the moving door or gate to prevent potential harm or damage.**
- **Do not use HomeLink with any garage door opener that lacks the safety stop and reverse feature as required by federal safety standards. (This includes any garage door opener model manufactured before April 1, 1982.) A garage door opener which cannot detect an object, signaling the door to stop and reverse, does not meet current federal safety standards. Using a garage door opener without these features increases risk of serious injury or death. For more information, call 1-800-355-3515 or on the internet at [www.homelink.com](http://www.homelink.com).**



Retain the original transmitter for future programming procedures (i.e., new vehicle purchase). It is also suggested that upon the sale of the vehicle, the programmed HomeLink buttons be erased for security purposes (follow step 1 in the “Programming” portion of this text).

## Programming

Your vehicle may require the ignition switch to be turned to the ACC position for programming and/or operation of HomeLink. It is also recommended that a new battery be replaced in the hand-held transmitter of the device being programmed to HomeLink for quicker training and accurate transmission of the radio-frequency.

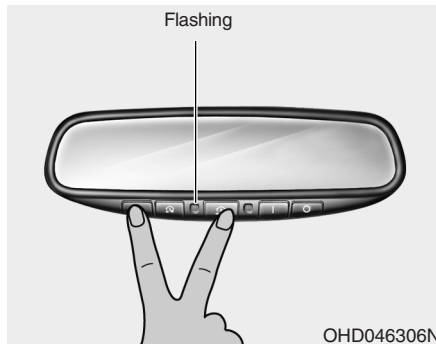
Follow these steps to train your HomeLink mirror:



1. When programming the buttons for the first time, press and hold the left and center buttons (  ,  ) simultaneously for approximately 20 seconds until the indicator light begins to flash. (This procedure erases the factory-set default codes. Do not perform this step to program additional hand-held transmitters.)

### **NOTICE**

For non rolling code garage door openers, follow steps 2 - 3.

For rolling code garage door openers, follow steps 2 - 6.

For Canadian Programming, please follow the Canadian Programming section.

For help with determining whether your garage is non-rolling code or rolling code, please refer to the garage door opener's manual or contact HomeLink customer service at 1-800-355-3515.

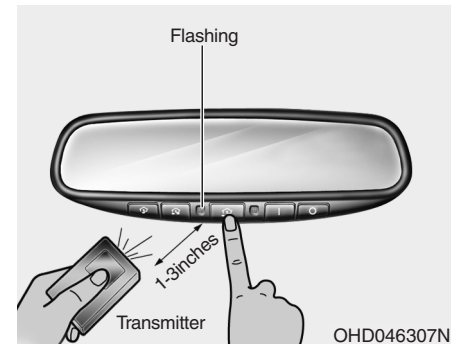

2. Press and hold the button on the HomeLink system you wish to train and the button on the transmitter while the transmitter is approximately 1 to 3 inches away from the mirror. Do not release the buttons until step 3 has been completed.
3. The HomeLink indicator light will flash, first slowly and then rapidly. When the indicator light flashes rapidly, both buttons may be released. (The rapid flashing light indicates successful programming of the new frequency signal.)

## **NOTICE**

**Some gate operators and garage door openers may require you to replace step #3 with the "cycling" procedure noted in the "Canadian Programming" section of this document.**

### **Rolling code programming**

To train a garage door opener (or other rolling code equipped devices) with the rolling code feature, follow these instructions after completing the "Programming" portion of this text. (A second person may make the following training procedures quicker & easier.)

4. Locate the "learn" or "smart" button on the device's motor head unit. Exact location and color of the button may vary by product brand. If there is difficulty locating the "learn" or "smart" button, reference the device's owner's manual or contact HomeLink at 1-800-355-3515 or on the internet at [www.homelink.com](http://www.homelink.com).
5. Press and release the "learn" or "smart" button on the device's motor head unit. You have 30 seconds to complete step number 6.
6. Return to the vehicle and firmly press and release the programmed HomeLink button up to three times. The rolling code equipped device should now recognize the HomeLink signal and activate when the HomeLink button is pressed. The remaining two buttons may now be programmed if this has not previously been done. Refer to the "Programming" portion of this text.



### Operating HomeLink

To operate, simply press the programmed HomeLink button. Activation will now occur for the trained product (garage door, security system, entry door lock, estate gate, or home or office lighting). For convenience, the hand-held transmitter of the device may also be used at any time. The HomeLink Wireless Controls System (once programmed) or the original hand-held transmitter may be used to activate the device (e.g. garage door, entry door lock, etc.). In the event that there are still programming difficulties, contact HomeLink at 1-800-355-3515 or on the internet at [www.homelink.com](http://www.homelink.com).

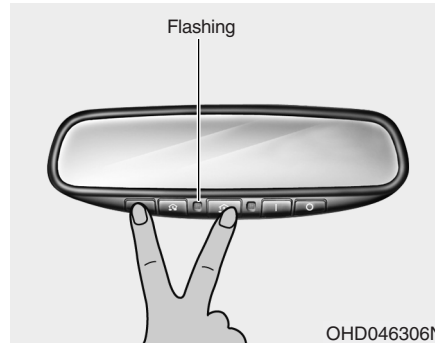

### Erasing programmed HomeLink buttons

To erase the three programmed buttons (individual buttons cannot be erased):

- Press and hold the left and center buttons simultaneously, until the indicator light begins to flash (approximately 20 seconds). Release both buttons. Do not hold for longer than 30 seconds.

HomeLink is now in the train (or learning) mode and can be programmed at any time.

### ***Electric chromic mirror (ECM) with HomeLink® system, compass and Blue Link® (for U.S.A)***

Your vehicle may be equipped with a Gentex Automatic-Dimming Mirror with a Z-Nav™ Electronic Compass Display and an Integrated HomeLink® Wireless Control System. During nighttime driving, this feature will automatically detect and reduce rearview mirror glare while the compass indicates the direction the vehicle is pointed. The HomeLink® Universal Transceiver allows you to activate your garage door(s), electric gate, home lighting, etc.



- (1) Telematics button
- (2) Telematics button
- (3) Telematics button
- (4) Compass control button & Dimming ON/OFF button
- (5) Status indicator LED
- (6) Channel 1 button
- (7) Channel 2 button
- (8) Channel 3 button
- (9) Compass display
- (10) Rear light sensor

### Automatic-Dimming Night Vision Safety™ (NVS®) Mirror (if equipped)

The NVS® Mirror automatically reduces glare by monitoring light levels in the front and the rear of the vehicle. Any object that obstructs either light sensor will degrade the automatic dimming control feature.

**For more information regarding NVS® mirrors and other applications, please refer to the Gentex website:**  
[www.gentex.com](http://www.gentex.com)

Your mirror will automatically dim upon detecting glare from the vehicles traveling behind you. The auto-dimming function can be controlled by pressing the Dimming ON/OFF button:

1. Pressing and holding the ☰ button for 3 seconds turns the auto-dimming function OFF which is indicated by the green Status Indicator LED turning off.
2. Pressing and holding the ☰ button for 3 seconds again turns the auto-dimming function ON which is indicated by the green Status Indicator LED turning on.



The mirror defaults to the ON position each time the vehicle is started.

### Z-Nav™ Compass Display

The NVS™ Mirror in your vehicle is also equipped with a Z-Nav™ Compass that shows the vehicle Compass heading in the Display Window using the 8 basic cardinal headings (N, NE, E, SE, etc.).

### Compass function

The Compass can be turned ON and OFF and will remember the last state when the ignition is cycled. To turn the display feature ON/OFF:

1. Press and release the  button within 1 second to turn the display feature OFF.
2. Press and release the  button again within 1 second to turn the display back ON.

Additional options can be set with press and hold sequences of the  button and are detailed below.

There is a difference between magnetic north and true north. To compensate for this difference you will need to adjust the Zone setting based on where you live.

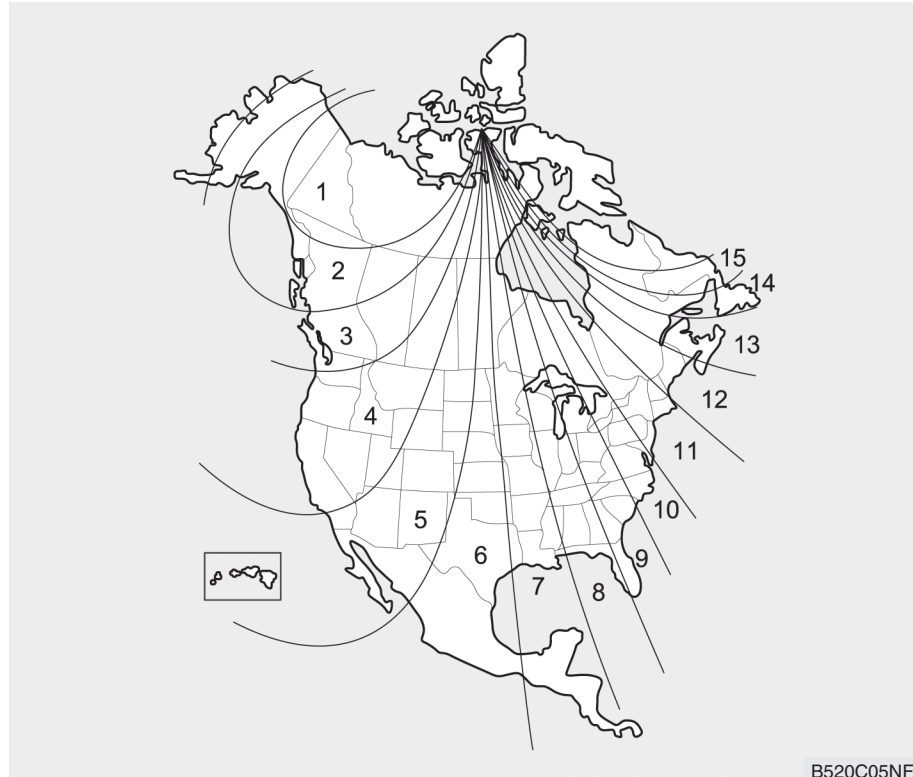

B520C05NF

To adjust the Zone setting:

1. Determine the desired Zone Number based upon your current location on the Zone Map.
2. Press and hold the  $\cup$  button for 6 seconds, the current Zone Number will appear on the display.
3. Pressing and holding the  $\cup$  button again will cause the numbers to increment (Note: they will repeat ...13, 14, 15, 1, 2, ...). Releasing the button when the desired Zone Number appears on the display will set the new Zone.
4. Within about 5 seconds the compass will start displaying a compass heading again.

There are some conditions that can cause changes to the vehicle magnets, such as installing a ski rack or a CB antenna. Body repair work on the vehicle can also cause changes to the vehicle's magnetic field. In these situations, the compass will need to be re-calibrated to quickly correct these changes.

If you need to recalibrate the compass:

1. Press and hold the  $\cup$  button for more than 9 seconds. When the compass memory is cleared a "C" will appear in the display.
2. Drive the vehicle in 2 complete circles at less than 5 mph (8 km/h).

### **Integrated HomeLink® Wireless Control System**

The HomeLink® Wireless Control System can replace up to three hand-held radio-frequency (RF) transmitters with a single built-in device. This innovative feature will learn the radio frequency codes of most current transmitters to operate devices such as gate operators, garage door openers, entry door locks, security systems, even home lighting. Both standard and rolling code-equipped transmitters can be programmed by following the outlined procedures.

Additional HomeLink® information can be found at: [www.homelink.com](http://www.homelink.com) or by calling 1-800-355-3515.

Retain the original transmitter of the RF device you are programming for use in other vehicles as well as for future HomeLink® programming. It is also suggested that upon the sale of the vehicle, the programmed HomeLink® buttons be erased for security purposes.

### WARNING

**Before programming HomeLink® to a garage door opener or gate operator, make sure people and objects are out of the way of the device to prevent potential harm or damage. Do not use the HomeLink® with any garage door opener that lacks the safety stop and reverse features required by U.S. federal safety standards (this includes any garage door opener model manufactured before April 1, 1982). A garage door that cannot detect an object - signaling the door to stop and reverse - does not meet current U.S. federal safety standards. Using a garage door opener without these features increases the risk of serious injury or death.**

### Programming HomeLink®



Please note the following:

- When programming a garage door opener, it is advised to park the vehicle outside of the garage.
- It is recommended that a new battery be placed in the hand-held transmitter of the device being programmed to HomeLink® for quicker training and accurate transmission of the radio-frequency signal.
- Some vehicles may require the ignition switch to be placed in the ACC (or "Accessories") position for programming and/or operation of HomeLink®.
- In the event that there are still programming difficulties or questions after following the programming steps listed below, contact HomeLink® at: [www.homelink.com](http://www.homelink.com) or by calling 1-800-355-3515.

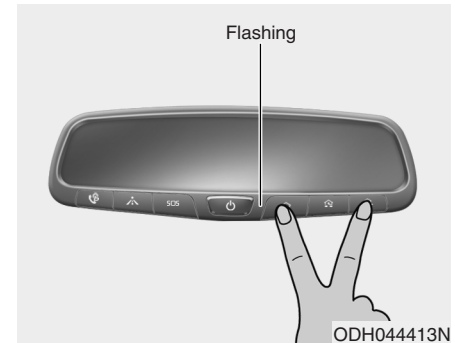
### Programming



To train most devices, follow these instructions:

1. For first-time programming, press and hold the two outside buttons (, ), HomeLink® Channel 1 and Channel 3, until the indicator light begins to flash (after 10 seconds). Release both buttons. Do not hold the buttons for longer than 20 seconds.

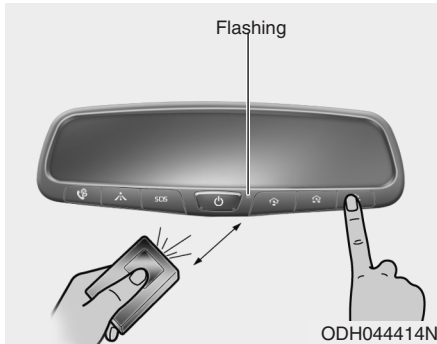

### **i** Information

Some devices may require you to replace this Programming step 3 with procedures noted in the "Gate Operator/Canadian Programming" chapter. If the HomeLink® indicator light does not change to a rapidly blinking light after performing these steps, contact HomeLink® at [www.homelink.com](http://www.homelink.com).

2. Position the end of your hand-held transmitter 1-3 inches (2-8 cm) away from the HomeLink® button you wish to program while keeping the indicator light in view.
3. Simultaneously press and hold both the HomeLink® and hand-held transmitter buttons until the HomeLink® indicator light changes from a slow to a rapid blinking light. Now you may release both the HomeLink® and hand-held transmitter buttons.

4. Firmly press, hold for 5 seconds and release the programmed HomeLink® button up to two separate times to activate the door. If the door does not activate, press and hold the just-trained HomeLink® button and observe the indicator light.
  - If the indicator light stays on constantly, programming is complete and your device should activate when the HomeLink® button is pressed and released.
  - If the indicator light blinks rapidly for 2 seconds and then turns to a constant light, continue with "Programming" steps 5-7 to complete the programming of a rolling code equipped device (most commonly a garage door opener).
5. At the garage door opener receiver (motor-head unit) in the garage, locate the "learn" or "smart" button. This can usually be found where the hanging antenna wire is attached to the motor-head unit.

6. Firmly press and release the "learn" or "smart" button. (The name and color of the button vary by manufacturer). There are 30 seconds to initiate step 7.
7. Return to the vehicle and firmly press, hold for 2 seconds and release the programmed HomeLink® button. Repeat the "press/hold/release" sequence a second time, and, depending on the brand of the garage door opener (or other rolling code equipped device), repeat this sequence a third time to complete the programming process.

HomeLink® should now activate your rolling code equipped device.

### *Gate operator & Canadian programming*

During programming, your handheld transmitter may automatically stop transmitting. Continue to press the Integrated HomeLink® Wireless Control System button (note steps 2 through 3 in the Programming portion of this document) while you press and re-press ("cycle") your handheld transmitter every two seconds until the frequency signal has been learned. The indicator light will flash slowly and then rapidly after several seconds upon successful training.

### *Operating HomeLink®*

To operate, simply press and release the programmed HomeLink® button. Activation will now occur for the trained device (i.e. garage door opener, gate operator, security system, entry door lock, home/office lighting, etc.). For convenience, the hand-held transmitter of the device may also be used at any time.

### *Reprogramming a single HomeLink® button*

To program a device to HomeLink® using a HomeLink® button previously trained, follow these steps:

1. Press and hold the desired HomeLink® button. DO NOT release the button.
2. The indicator light will begin to flash after 20 seconds. Without releasing the HomeLink® button, proceed with "Programming" step 2.

For questions or comments, contact HomeLink® at [www.homelink.com](http://www.homelink.com) or 1-800-355-3515.

### Erasing HomeLink® buttons

Individual buttons cannot be erased. However, to erase all three programmed buttons:

1. Press and hold the two outer HomeLink® buttons until the indicator light begins to flash after 10 seconds.
2. Release both buttons. Do not hold for longer than 20 seconds.

The Integrated HomeLink® Wireless Control System is now in the training (learn) mode and can be programmed at any time following the appropriate steps in the Programming chapters above.

NVS® is a registered trademark and Z-Nav™ is a trademark of the Gentex Corporation, Zeeland, Michigan. HomeLink® is a registered trademark owned by Johnson Controls, Incorporated, Milwaukee, Wisconsin.

**FCC ID: NZLTLMHL4**

**IC: 4112A-TLMHL4**

### **i** Information

**This device complies with Part 15 of the FCC Rules.**

**Operation is subject to the following three conditions:**

1. **This device may not cause harmful interference.**
2. **This device must accept any interference received, including interference that may cause undesired operation.**
3. **The transceiver has been tested and complies with FCC and Industry Canada rules. Changes or modifications not expressly approved by the party responsible for compliance could void the user's authority to operate the device.**

### Side View Mirrors

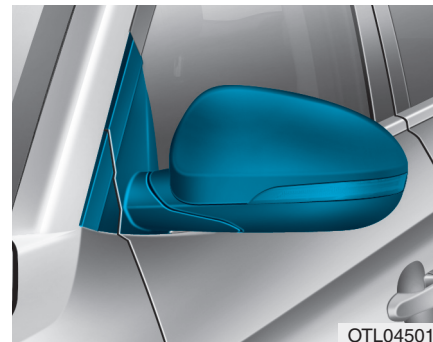

Be sure to adjust mirror angles before driving.

Your vehicle is equipped with both left-hand and right-hand side view mirrors. The mirrors can be adjusted remotely with the remote switch. The side view mirrors can be folded to prevent damage during an automatic car wash or when passing through a narrow street.

The right hand side view is convex. Objects seen in the mirror are closer than they appear.



Use the rear view mirror inside the vehicle or direct observation to determine the actual distance of following vehicles when changing lanes.

### **⚠ WARNING**

Do not adjust or fold the left and right side view mirrors while driving. This may cause loss of vehicle control resulting in an accident.

### **⚠ CAUTION**

- Do not scrape ice off the mirror face; this may damage the surface of the glass.
- If the mirror is jammed with ice, do not adjust the mirror by force. Use an approved de-icer spray. (Do not use radiator anti-freeze.) Wipe the mirror using a sponge or soft cloth with warm water. Or move the vehicle to a warm area and allow the ice to melt.

### **Blind Spot Mirror (if equipped)**

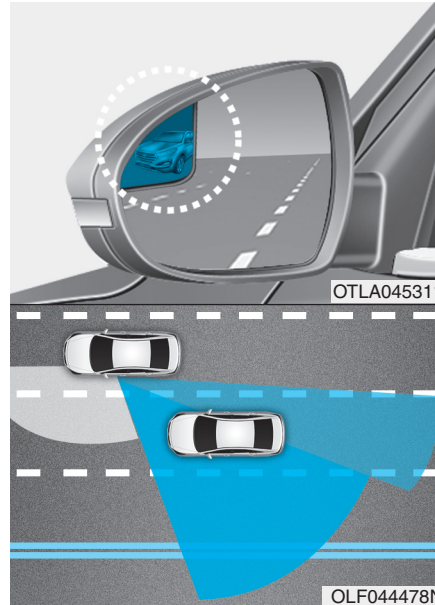

The Blind Spot Mirror (BSM) is a supplemental mirror that minimizes the driver's blind spot zone by expanding the field of view on the rear side of the vehicle. The blind spot mirror is equipped on the driver's left side view mirror.

### **⚠ WARNING**

- Always check the road condition while driving for unexpected situations even though the vehicle is equipped with a blind spot mirror.
- The blind spot mirror is a device made for convenience. Do not solely rely on the mirror but always pay attention to traffic around you.

### **NOTICE**

Do not clean the mirror with harsh abrasives, fuel or other petroleum based cleaning products.

## Side View Mirror Adjustment

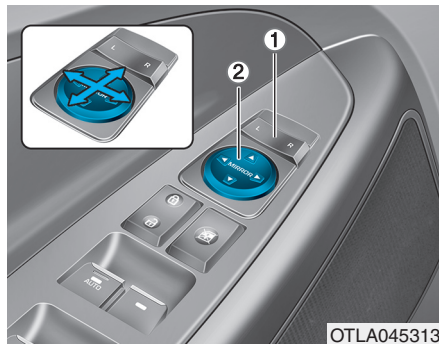

Adjusting the left and right side view mirrors:

1. Press either the L (driver's side) or R (passenger's side) button (1) to select the rearview mirror you would like to adjust.
2. Use the mirror adjustment control (2) to position the selected mirror up, down, left or right.
3. After adjustment, put the button into neutral (center) position to prevent inadvertent adjustment.

### NOTICE

- The mirrors stop moving when they reach the maximum adjusting angles, but the motor continues to operate while the switch is pressed. Do not press the switch longer than necessary, the motor may be damaged.
- Do not attempt to adjust the side view mirror by hand or the motor may be damaged.

## Folding the side view mirrors

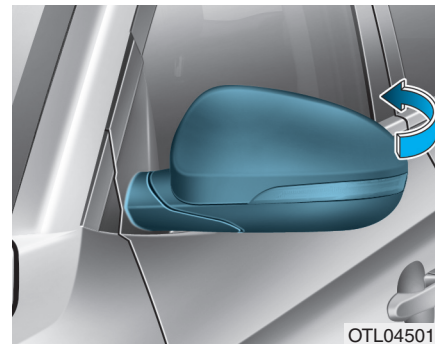

To fold either the left or right hand side view mirror, grasp the housing of the mirror and then fold it toward the rear of the vehicle.

## WINDOWS

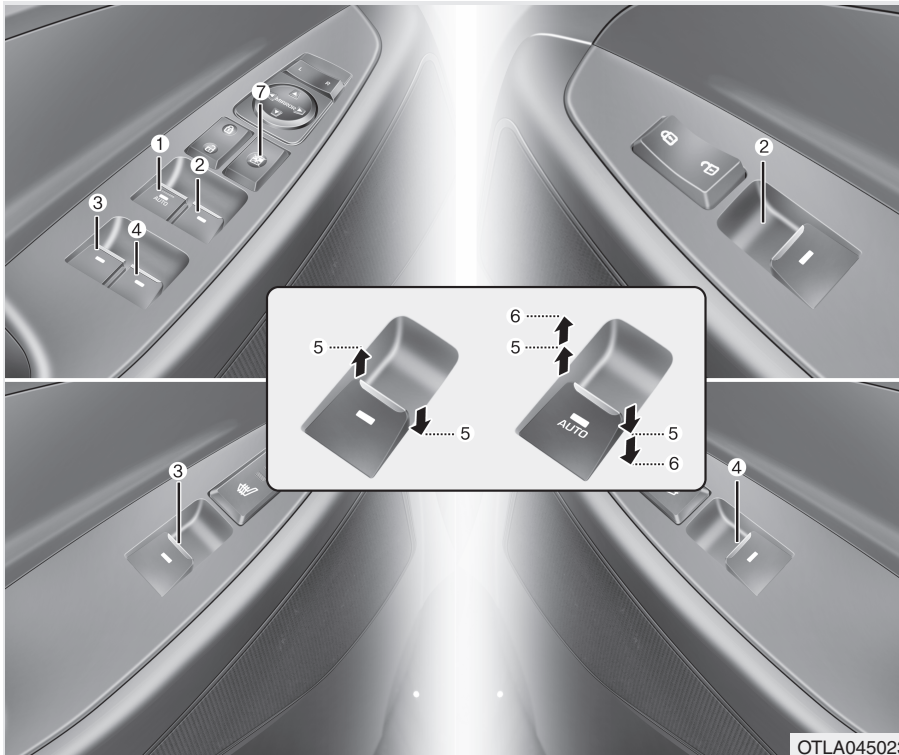

- (1) Driver's door power window switch
- (2) Front passenger's door power window switch
- (3) Rear door (left) power window switch
- (4) Rear door (right) power window switch
- (5) Window opening and closing
- (6) Automatic power window
- (7) Power window lock switch

## Power Windows

The ignition switch must be in the ON position to be able to raise or lower the windows. Each door has a Power Window switch to control that door's window. The driver has a Power Window Lock switch which can block the operation of passenger windows. The power windows will operate for approximately 30 seconds after the ignition switch is placed in the ACC or LOCK/OFF position. However, if the front doors are opened, the Power Windows cannot be operated even within the 30 second period.

### WARNING

**To avoid serious injury or death, do not extend your head, arms or body outside the windows while driving.**

### Information

- **In cold and wet climates, power windows may not work properly due to freezing conditions.**
- **While driving with the rear windows down or with the sunroof (if equipped) opened (or partially opened), your vehicle may demonstrate a wind buffeting or pulsation noise. This noise is normal and can be reduced or eliminated by taking the following actions. If the noise occurs with one or both of the rear windows down, partially lower both front windows approximately 1 inch (2.5 cm). If you experience the noise with the sunroof open, slightly close the sunroof.**

## Window opening and closing

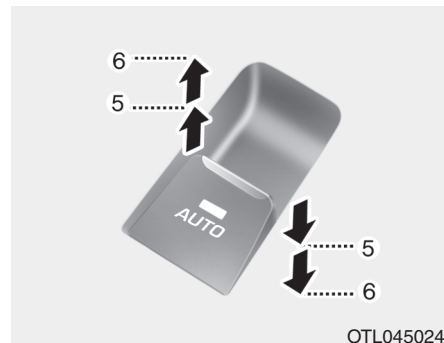

To open:

Press the window switch down to the first detent position (5). Release the switch when you want the window to stop.

To close:

Pull the window switch up to the first detent position (5). Release the window switch when you want the window to stop.

### ***Auto up/down window (if equipped)***

Pressing or pulling up the power window switch momentarily to the second detent position (6) completely lowers or lifts the window even when the switch is released. To stop the window at the desired position while the window is in operation, pull up or press down and release the switch.

### ***To reset the power windows***

If the power windows do not operate normally, the automatic power window system must be reset as follows:

1. Place the ignition switch to the ON position.
2. Close the window and continue pulling up on the power window switch for at least one second.

If the power windows do not operate properly after resetting, have the system checked by an authorized HYUNDAI dealer.

#### **⚠ WARNING**

**The automatic reverse feature doesn't activate while resetting the power window system. Make sure body parts or other objects are safely out of the way before closing the windows to avoid injuries or vehicle damage.**

### ***Automatic reverse (if equipped)***

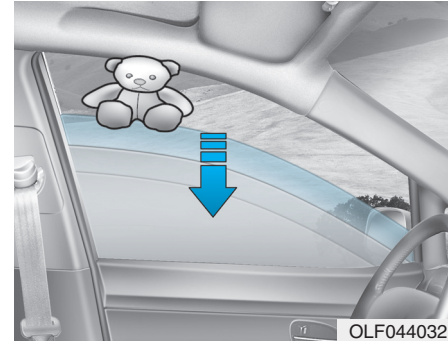

If a window senses any obstacle while it is closing automatically, it will stop and lower approximately 12 inches (30 cm) to allow the object to be cleared.

If the window detects the resistance while the power window switch is pulled up continuously, the window will stop upward movement then lower approximately 1 inch (2.5 cm).

If the power window switch is pulled up continuously again within 5 seconds after the window is lowered by the automatic window reverse feature, the automatic window reverse will not operate.

## **i** Information

The automatic reverse feature is only active when the "Auto Up" feature is used by fully pulling up the switch to the second detent.

### **⚠ WARNING**

Make sure body parts or other objects are safely out of the way before closing the windows to avoid injuries or vehicle damage.

Objects less than 0.16 inch (4 mm) in diameter caught between the window glass and the upper window channel may not be detected by the automatic reverse window and the window will not stop and reverse direction.

### **NOTICE**

Do not install any accessories on the windows. The automatic reverse feature may not operate.

## **Power window lock switch**



OTLA045025

The driver can disable the power window switches on the rear passenger doors by pressing the power window lock switch.

When the power window lock switch is pressed:

- The rear passenger control will not be able to operate the rear passenger power window
- Note that the front passenger control is still able to operate the front passenger window, and that the driver master control can still operate all the power windows.

### **⚠ WARNING**

Do not allow children to play with the power windows. Keep the driver's door power window lock switch in the LOCK position. Serious injury or death can result from unintentional window operation by a child.

### **NOTICE**

- To prevent possible damage to the power window system, do not open or close two windows or more at the same time. This will also ensure the longevity of the fuse.
- Never try to operate the main switch on the driver's door and the individual door window switch in opposite directions at the same time. If this is done, the window will stop and cannot be opened or closed.

## PAORAMIC SUNROOF (IF EQUIPPED)



The ignition switch must be in the ON position before you can open or close the sunroof.

The sunroof can be operated for approximately 30 seconds after the ignition key is removed or turned to the ACC or LOCK position. However, if the front doors are opened, the sunroof cannot be opened even within the 30 seconds period.

### **i** Information

- In cold and wet climates, the sunroof may not work properly due to freezing conditions.

(Continued)

(Continued)

- After the vehicle is washed or in a rainstorm, be sure to wipe off any water that is on the sunroof before operating it.

### **⚠** WARNING

- Never adjust the sunroof or sunshade while driving. This could result in loss of control and an accident that may cause death, serious injury, or property damage.
- Make sure heads, hands, arms or any other body parts or objects are out of the way before operating the sunroof.
- Do not extend your head, arms or body outside the sunroof while driving, to avoid serious injury.
- Do not leave the engine running and the key in your vehicle with unsupervised children. Unattended children could operate the sunroof, which could result in serious injury.

(Continued)

(Continued)

- The panorama sunroof is made of glass, subject to break in case of an accident. Passengers without the appropriate protection (e.g. seat belt, CRS, etc.) may project out through the broken glass and may be seriously injured or even result in death.
- Do not sit on the top of the vehicle. It may cause injury or vehicle damage.

### **NOTICE**

- Do not continue to move the sunroof control lever after the sunroof is fully opened, closed, or tilted. Damage to the motor or system components could occur.
- Make sure the sunroof is closed fully when leaving your vehicle. If the sunroof is left open, rain or snow may wet the interior of the vehicle. Also, leaving the sunroof open when the vehicle is unattended may invite theft.



## Sunshade



- To open the sunshade, pull the sunroof control lever backward (1) to the first detent position.
- To close the sunshade when the sunroof glass is closed, push the sunroof control lever forward (2).

## Sliding the Sunroof

### When the sunshade is closed

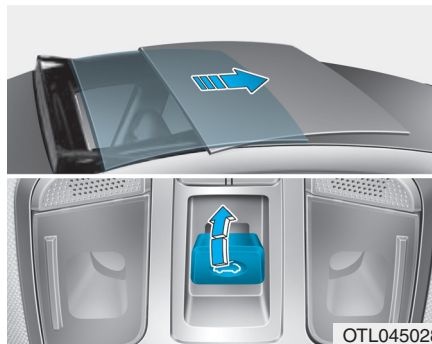

If you push the sunroof control lever backward past the first detent, the sunshade will slide all the way open and then the sunroof glass will slide all the way open.

To stop the sunroof movement at any point, push the sunroof control lever either forward or backward momentarily.

### When the sunshade is opened

If you pull the sunroof control lever backward, the sunroof glass will slide all the way open. To stop the sunroof movement at any point, pull or push the sunroof control lever momentarily.

### Information

Only the front glass of the panoramic sunroof opens and closes.



### Tilting the Sunroof

*When the sunshade is closed*



If you push the sunroof control lever upward, the sunshade will slide open then the sunroof glass will tilt open.

To stop the sunroof movement at any point, push the sunroof control lever momentarily.

*When the sunshade is opened*

If you push the sunroof control lever upward, the sunroof glass will tilt closed.

### Closing the Sunroof



**To close the sunroof glass only**

Push the sunroof control lever forward to the first detent position.

**To close the sunroof glass with the sunshade**

Push the sunroof control lever forward to the second detent position.

The sunroof glass will close, then the sunshade will close automatically.

To stop the sunroof movement at any point, push the sunroof control lever either forward or backward momentarily.

### Automatic reverse

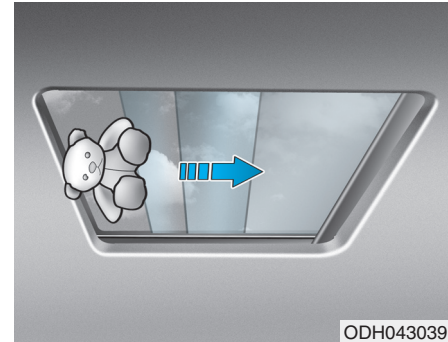

If the sunroof senses any obstacle while it is closing automatically, it will reverse direction then stop to allow the object to be cleared.

### ⚠ WARNING

**Small objects that can get caught between the sunroof glass and the front glass channel may not be detected by the automatic reverse system. In this case, the sunroof glass will not detect the object and will not reverse direction.**

**NOTICE**

- Periodically remove any dirt that may accumulate on the sunroof guide rail or between the sunroof and roof panel which can make a noise.
- Do not try to open the sunroof when the temperature is below freezing or when the sunroof is covered with snow or ice, otherwise the motor could be damaged. In cold and wet climates, the sunroof may not work properly.

**To Reset the Sunroof**

The sunroof may need to be reset if the following conditions occur:

- The battery is discharged or disconnected or the sunroof fuse has been replaced or disconnected
- The sunroof control lever is not operating correctly

To reset the sunroof, perform the following steps:

1. Turn the engine on and close the sunroof glass and sunshade completely.
2. Release the control lever.

3. Push and hold the sunroof control lever forward (to close the sunshade) for about 10 seconds until the sunroof moves slightly, then release the control lever.
4. Push and hold the sunroof control lever forward until the sunroof operates as follows:

Sunshade Open → Glass Tilt Open  
→ Glass Slide Open → Glass Slide Close  
→ Sunshade Close

Then, release the control lever.

When this is complete, the sunroof system is reset.

**i Information**

- **If the sunroof is not reset when the vehicle battery is disconnected or discharged, or the sunroof fuse is blown, the sunroof may not operate normally.**
- **For more detailed information, contact an authorized HYUNDAI dealer.**

## EXTERIOR FEATURES

### Hood

#### Opening the hood

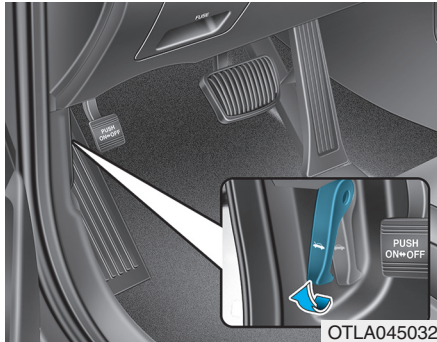

1. Park the vehicle and set the parking brake.
2. Pull the release lever to unlatch the hood. The hood should pop open slightly.

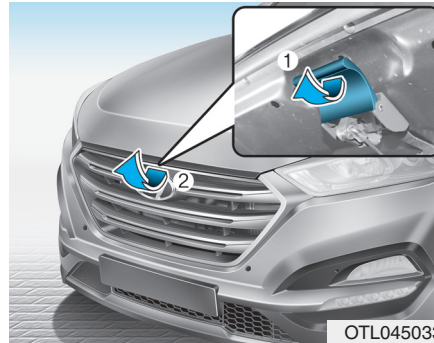

3. Go to the front of the vehicle, raise the hood slightly, push up the secondary latch (1) inside the hood center and lift the hood (2).

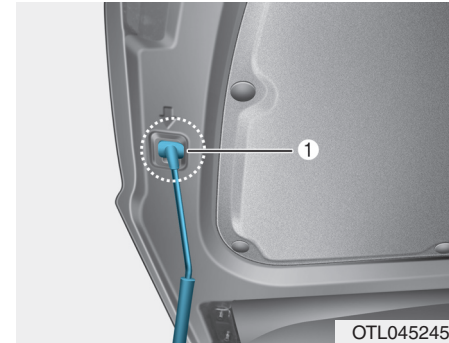

4. Pull out the support rod and hold the hood open with the support rod (1).

#### **⚠ WARNING**

**Grasp the support rod in the area wrapped in rubber. The rubber will help prevent you from being burned by hot metal when the engine is hot.**

## Closing the hood

1. Before closing the hood, check the following:
  - All filler caps in the engine compartment must be correctly installed.
  - Gloves, rags or any other combustible material must be removed from the engine compartment.
2. Return the support rod to its clip to prevent it from rattling.
3. Lower the hood halfway (lifted approximately 12 inches (30 cm) from the closed position) and push down to securely lock in place. Then double check to be sure the hood is secure.

## ⚠ WARNING

- Before closing the hood, ensure all obstructions are removed from around the hood opening.
- Always double check to be sure that the hood is firmly latched before driving away. Check there is no hood open warning light or message displayed on the instrument cluster. If the hood is not latched while the vehicle is moving, the chime will sound to warn the driver the hood is not fully latched. Driving with the hood opened may cause a total loss of visibility, which might result in an accident.
- Do not move the vehicle with the hood in the raised position, as vision is obstructed. Doing so could result in an accident. The hood could also fall and become damaged.

## Fuel Filler Door

### Opening the fuel filler door



The fuel filler door must be opened from inside the vehicle by pulling up on the fuel filler door release lever.

1. Turn the engine off. Locate the fuel filler door release lever on the floor on the left side of the driver seat.
2. Pull up on the release lever.

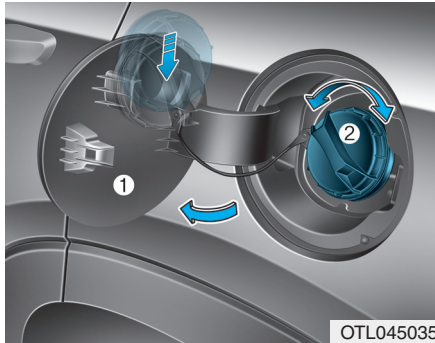

### **i** Information

If the fuel filler door does not open because ice has formed around it, tap lightly or push on the door to break the ice and release the door. Do not pry on the door. If necessary, spray around the door with an approved de-icer fluid (do not use radiator anti-freeze) or move the vehicle to a warm place and allow the ice to melt.

3. Pull the fuel filler door (1) outward to access the fuel tank cap.
4. To remove the fuel tank cap (2), turn it counterclockwise. You may hear a hissing noise as the pressure inside the tank equalizes.
5. Place the cap on the fuel filler door.

### **Closing the fuel filler door**

1. To install the fuel tank cap, turn it clockwise until it "clicks" one time.
2. Close the fuel filler door until it is latched securely.

### **⚠ WARNING**

**Gasoline is highly flammable and explosive. Failure to follow these guidelines may result in SERIOUS INJURY or DEATH:**

- Read and follow all warnings posted at the gas station.
- Before refueling, note the location of the Emergency Gasoline Shut-Off, if available, at the gas station.
- Before touching the fuel nozzle, you should eliminate the potential build-up of static electricity by touching a metal part of the vehicle, a safe distance away from the fuel filler neck, nozzle, or other gas source, with your bare hand.

(Continued)

(Continued)

- Do not use cellular phones while refueling. Electric current and/or electronic interference from cellular phones can potentially ignite fuel vapors and cause a fire.
- Do not get back into a vehicle once you have begun refueling. You can generate a buildup of static electricity by touching, rubbing or sliding against any item or fabric capable of producing static electricity. Static electricity discharge can ignite fuel vapors causing a fire. If you must re-enter the vehicle, you should once again eliminate potentially dangerous static electricity discharge by touching a metal part of the vehicle, away from the fuel filler neck, nozzle or other gasoline source, with your bare hand.

(Continued)

(Continued)

- When using an approved portable fuel container, be sure to place the container on the ground prior to refueling. Static electricity discharge from the container can ignite fuel vapors causing a fire.  
Once refueling has begun, contact between your bare hand and the vehicle should be maintained until the filling is complete.
- Use only approved portable plastic fuel containers designed to carry and store gasoline.
- When refueling, always move the shift lever to the P (Park) position, set the parking brake, and place the ignition switch to the LOCK/OFF position. Sparks produced by electrical components related to the engine can ignite fuel vapors causing a fire.

(Continued)

(Continued)

- Do not use matches or a lighter and do not smoke or leave a lit cigarette in your vehicle while at a gas station, especially during refueling.
- Do not over-fill or top-off your vehicle tank, which can cause gasoline spillage.
- If a fire breaks out during refueling, leave the vicinity of the vehicle, and immediately contact the manager of the gas station and then contact the local fire department. Follow any safety instructions they provide.
- If pressurized fuel sprays out, it can cover your clothes or skin and thus subject you to the risk of fire and burns. Always remove the fuel cap carefully and slowly. If the cap is venting fuel or if you hear a hissing sound, wait until the condition stops before completely removing the cap.

(Continued)

### (Continued)

- Always check that the fuel cap is installed securely to prevent fuel spillage in the event of an accident.

### Information

Make sure to refuel your vehicle according to the "Fuel Requirements" suggested in the Introduction chapter.

### **NOTICE**

- Do not spill fuel on the exterior surfaces of the vehicle. Any type of fuel spilled on painted surfaces may damage the paint.
- If the fuel filler cap requires replacement, use only a genuine HYUNDAI cap or the equivalent specified for your vehicle. An incorrect fuel filler cap can result in a serious malfunction of the fuel system or emission control system.



## LIFTGATE

### Non-Powered liftgate

#### Opening the liftgate

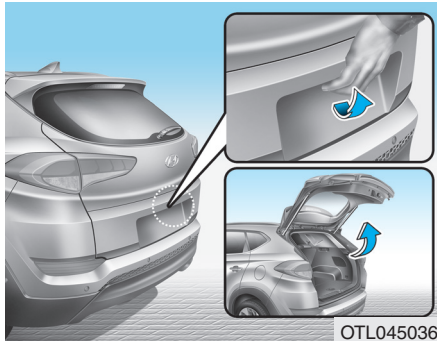

- The liftgate is locked or unlocked when all doors are locked or unlocked with the key, transmitter, smart key or central door lock switch.
- If unlocked, the liftgate can be opened by pressing the handle switch and pulling up on the handle.
- Only the liftgate is unlocked if the liftgate unlock button on the transmitter or smart key is pressed for about 1 second, or the liftgate handle button is pressed when the smart key is detected.

#### NOTICE

In cold and wet climates, door lock and door mechanisms may not work properly due to freezing conditions.

#### ⚠ WARNING

The liftgate swings upward. Make sure no objects or people are near the rear of the vehicle when opening the liftgate.

#### ⚠ CAUTION

Make certain that you close the liftgate before driving your vehicle. Possible damage may occur to the liftgate lift cylinders and attached hardware if the liftgate is not closed prior to driving.

#### Closing the liftgate

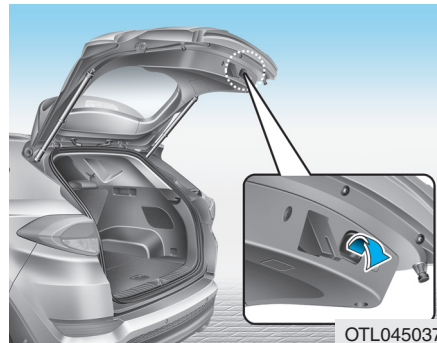

To close the liftgate, lower and push down the liftgate firmly. Make sure that the liftgate is securely latched.

#### ⚠ WARNING

Always keep the liftgate completely closed while the vehicle is in motion. If it is left open or ajar, poisonous exhaust gases containing carbon monoxide (CO) may enter the vehicle and serious illness or death may result.



**⚠ WARNING**

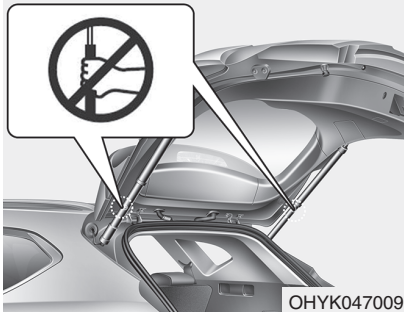

**Do not hold the part (gas lifter) that supports the liftgate. Be aware that the deformation of the part may cause vehicle damage and a risk of safety accident.**

**Emergency liftgate safety release**

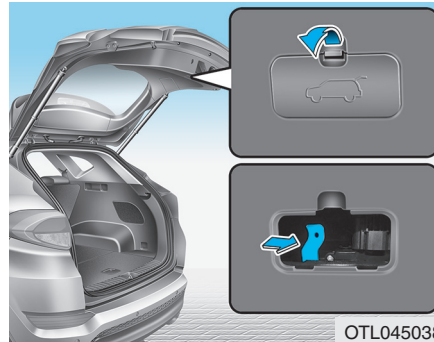

Your vehicle is equipped with the emergency liftgate safety release lever located on the bottom of the liftgate. To unlock and open the liftgate manually from inside the luggage compartment, perform the following steps:

1. Remove the cover.
2. Push the release lever to the right.
3. Push up the liftgate.

**⚠ WARNING**

- For emergencies, be fully aware of the location of the emergency liftgate safety release lever in this vehicle and how to open the liftgate if you are accidentally locked in the luggage compartment.
- No one should be allowed to occupy the luggage compartment of the vehicle at any time. The luggage compartment is a very dangerous location in the event of a crash.
- Use the release lever for emergencies only. Use extreme caution, especially while the vehicle is in motion.

### Power liftgate (if equipped)

#### Power liftgate button

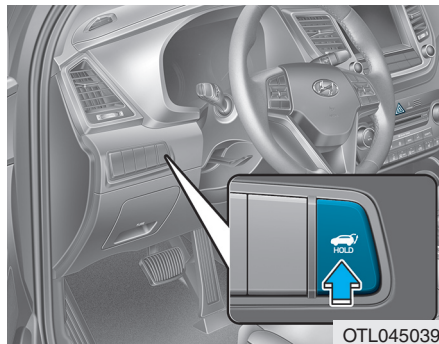

When the ignition switch is in the ON position and the shift lever is in Park (P), the power liftgate can be opened by using the console button on the dash.

Before using the power liftgate, make sure the power liftgate option is selected in the User Setting Modes in the cluster LCD display.

For more details, refer to "LCD Display" in this chapter.

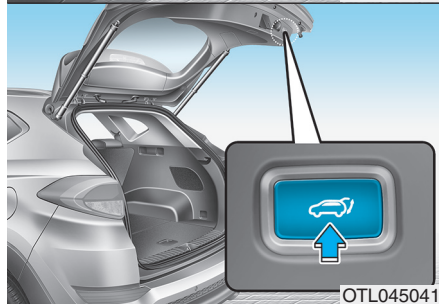
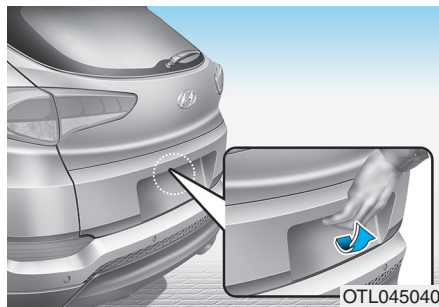

- (1) Power liftgate handle switch
- (2) Power liftgate inner switch

#### NOTICE

The power liftgate operates only when the automatic shift lever is in P (Park).

**⚠ WARNING**

Never leave children unattended in your vehicle. Children might operate the power liftgate. Doing so could result in injury to themselves or others, and could damage the vehicle.

**⚠ WARNING**

Make sure there are no people or objects around the liftgate before operating the power liftgate. Wait until the liftgate is opened fully and stopped before loading or unloading cargo or passengers from the vehicle.

**⚠ CAUTION**

Do not close or open the power liftgate manually. This may cause damage to the power liftgate. If it is necessary to close or open the power liftgate manually when the battery is discharged or disconnected, do not apply excessive force.

### Opening the liftgate

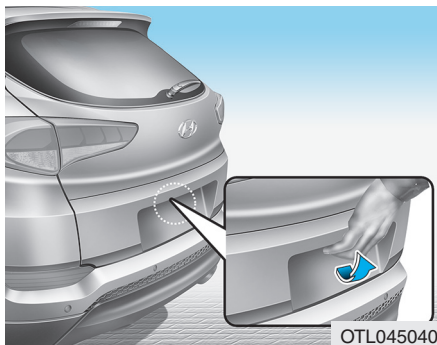

The power liftgate will open automatically by doing one of the following:

- Press and hold the liftgate unlock button on the smart key
- Press the liftgate outside handle button while having the smart key with you

In order to suddenly stop the movement of the liftgate while it is operating, quickly press the power liftgate inner button.

### Closing the liftgate



1. Press the power liftgate inner button for approximately 1 second.
2. The liftgate will close and lock automatically.

In order to suddenly stop the movement of the liftgate while it is operating, quickly press the power liftgate inner button.

### Power liftgate non-opening conditions

The power liftgate does not open when the vehicle is in motion.

#### **⚠ WARNING**

**The chime will sound if you drive with the liftgate opened.  
Stop your vehicle immediately at a safe place and check if your liftgate is opened.**

 **CAUTION**

Operating the power liftgate more than 5 times continuously could cause damage to the operating motor. In this case, the power liftgate system enters into thermal protection mode to prevent the motor from overheating. In thermal protection mode the power liftgate will not operate. If any of the power liftgate buttons are pressed to try to open the liftgate, the chime will sound 3 times but the liftgate will remain closed.

Allow the power liftgate system to cool for about 1 minute before operating the system again.

**NOTICE**

- The power liftgate can be operated when the engine is not running. However, the power liftgate operation consumes a large amount of electric power.

To prevent the battery from being discharged, do not operate it excessively (e.g. more than 5 times repeatedly).

- To prevent the battery from being discharged, do not leave the power liftgate in the open position for a long time.
- Do not modify or repair any part of the power liftgate by yourself. This must be done by an authorized HYUNDAI dealer.

(Continued)

(Continued)

- When jacking up the vehicle to change a tire or repair the vehicle, do not operate the power liftgate. This could cause the power liftgate to operate improperly.
- In cold and wet climates, the power liftgate may not work properly due to freezing conditions.

### Automatic reversal



During power opening and closing if the power liftgate is blocked by an object or part of the body, the power liftgate will detect the resistance.

- If resistance is detected while opening or closing the power liftgate, the liftgate will stop and move in the opposite direction.

However, in some instances the automatic reversal system may not detect the object if it is too soft or is very thin, or if the liftgate is almost fully closed near the latched position. Caution should be taken to prevent any objects from obstructing the liftgate opening.

If the automatic reversal feature operates more than 2 times while attempting to open or close the liftgate, the power liftgate may stop at that position. If this occurs, carefully close the liftgate manually, and then try to operate the power liftgate automatically again.

### WARNING

**Never intentionally place any object or part of your body in the path of the power liftgate to make sure the automatic reversal operates.**

### CAUTION

**Do not put heavy objects on the power liftgate before you operate the power liftgate feature. Additional weight may damage the operation of the system.**

### How to reset the power liftgate

If the battery has been discharged or disconnected, or if the power liftgate fuse has been replaced or removed, reset the power liftgate by performing the following procedure:

1. Put the shift lever in park (P).
2. Press the power liftgate inner button and the power liftgate outer handle button simultaneously for more than 3 seconds. The chime will sound.
3. Close the liftgate manually.

If the power liftgate does not work properly after the above procedure, have the system checked by an authorized HYUNDAI dealer.

#### NOTICE

**When operating the power liftgate, the gear shift lever must be in the (P) park position in order to operate normally.**

### Power liftgate opening height user setting

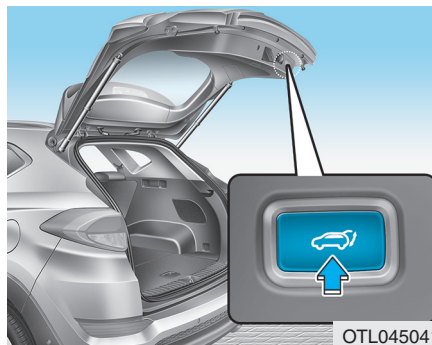

Follow the instructions below to set the fully open height of the power liftgate:

1. Position the liftgate manually to the height you prefer.
2. Press the power liftgate inner button for more than 3 seconds.
3. Close the liftgate manually after hearing the buzzer sound.

The liftgate will open to the manually adjusted height that was set.

#### ⚠ WARNING

**Always keep the liftgate completely closed while the vehicle is in motion. If it is left open or ajar, poisonous exhaust gases containing carbon monoxide (CO) may enter the vehicle and serious illness or death may result.**

**⚠ WARNING**

**Rear cargo area**

Occupants should never ride in the rear cargo area where no restraints are available. To avoid injury in the event of an accident or sudden stops, occupants should always be properly restrained.

**Emergency liftgate safety release**

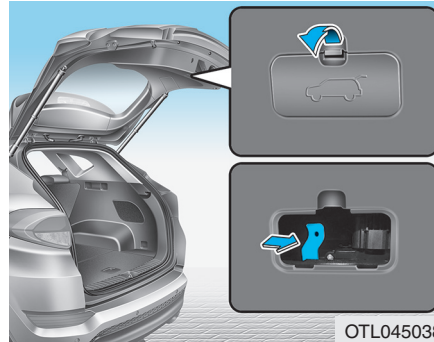

Your vehicle is equipped with the emergency liftgate safety release lever located on the bottom of the liftgate. To unlock and open the liftgate manually from inside the luggage compartment, perform the following steps:

1. Remove the cover.
2. Push the release lever to the right.
3. Push up the liftgate.

**⚠ WARNING**

- For emergencies, be fully aware of the location of the emergency liftgate safety release lever in this vehicle and how to open the liftgate if you are accidentally locked in the luggage compartment.
- No one should be allowed to occupy the luggage compartment of the vehicle at any time. The luggage compartment is a very dangerous location in the event of a crash.
- Use the release lever for emergencies only. Use extreme caution, especially while the vehicle is in motion.

## Smart Liftgate (if equipped)

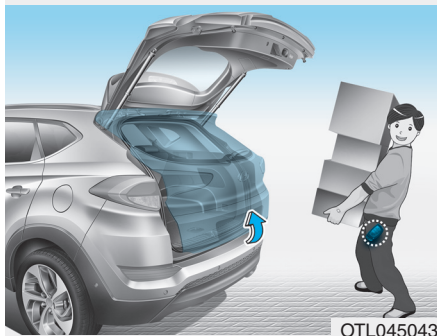

On vehicles equipped with a smart key, the liftgate can be opened with hands-free activation using the Smart Liftgate system.

### **How to use the Smart Liftgate**

The hands-free smart liftgate system can be opened automatically when the following conditions are met:

- The Smart Liftgate option is enabled in the User Settings in the cluster LCD display
- The Smart Liftgate is activated and ready 15 seconds after all the doors are closed and locked
- The Smart Liftgate will open when the smart key is detected in the area behind the vehicle for 3 seconds

### **NOTICE**

- **The Smart Liftgate will NOT operate when:**
  - Any door is open, or all doors are closed but not locked
  - The smart key is detected within 15 seconds from when the doors were closed and locked
  - For vehicles equipped with illuminated exterior front door handles, if the smart key is detected within 15 seconds from when the doors were closed and locked or if the smart key is within 60 inches (1.5m) from the front door handles
  - The smart key is in the vehicle.



### 1. Setting

To activate the Smart Liftgate, go to User Settings Mode and select Smart Liftgate on the LCD display.

※ For more details, refer to "LCD Display" in this chapter.

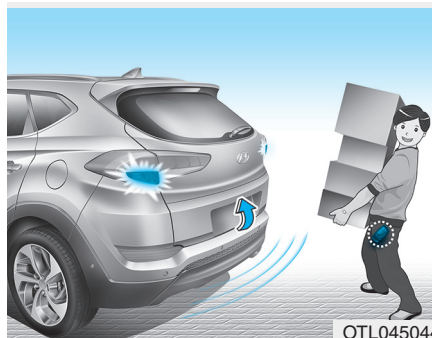

### 2. Detect and Alert

The Smart Liftgate detecting area extends approximately 20-40 in (50-100 cm) behind the vehicle. If you are positioned in the detecting area and are carrying the smart key, the hazard warning lights will blink and the chime will sound to alert you that the smart liftgate will open.

### NOTICE

**Do not approach the detecting area if you do not want the liftgate to open. If you have unintentionally entered the detecting area and the hazard warning lights and chime starts to operate, move away from the area behind the vehicle with the smart key. The liftgate will remain closed.**

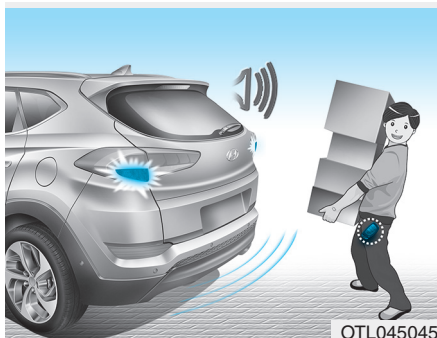

### 3. Automatic opening

After the hazard warning lights blink and the chime sounds 6 times, the power liftgate will open.

## ⚠ WARNING

- Make certain that you close the liftgate before driving your vehicle.
- Make sure there are no people or objects around the liftgate before opening or closing the liftgate.
- Make sure objects in the rear cargo area do not come out when opening the liftgate, especially if the vehicle is parked on a grade or incline.
- If you keep your vehicle parked and locked on your driveway, you may want to temporarily deactivate the Smart Liftgate system. Otherwise, standing at the rear of the vehicle with the smart key may cause the liftgate to open unintentionally.
- The key should be kept out of reach of children. Children may inadvertently open the Smart Liftgate while playing around the rear area of the vehicle.

### *How to deactivate the Smart Liftgate function using the smart key*



1. Door lock
2. Door unlock
3. Liftgate open
4. Panic

If you press any button on the smart key during the Detect and Alert stage, the Smart Liftgate function will be deactivated.

Make sure to be aware of how to deactivate the Smart Liftgate function for emergency situations.

### NOTICE

- If you press the door unlock button (2), the Smart Liftgate function will be deactivated temporarily. But, if you do not open any door for 30 seconds, the Smart Liftgate function will be activated again.
- If you press the liftgate open button (3) for more than 1 second, the liftgate opens.
- The Smart Liftgate function will still be activated if you press the door lock button (1) or liftgate open button (3) on the smart key as long as the Smart Liftgate is not already in the Detect and Alert stage.
- In case you have deactivated the Smart Liftgate function by pressing the smart key button and opened a door, the Smart Liftgate function can be activated again by closing and locking all doors.

### Detecting area

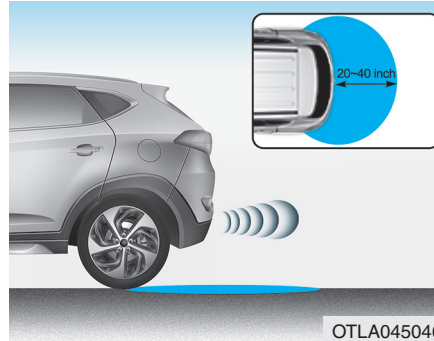

- The Smart Liftgate detecting area extends approximately 20-40 in (50-100 cm) behind the vehicle. If you are positioned in the detecting area and are carrying the smart key, the hazard warning lights will blink and the chime will sound for about 3 seconds to alert you that the smart liftgate will open.
- The alert stops once the smart key is moved outside of the detecting area within the 3 second period.

### NOTICE

- The Smart Liftgate function may not operate properly if any of the following instances occur:
  - The smart key is close to a radio transmitter such as a radio station or an airport which can interfere with normal operation of the transmitter.
  - The smart key is near a mobile two way radio system or a cellular phone.
  - Another vehicle's smart key is being operated close to your vehicle.
- The Smart Liftgate detecting area may change when:
  - The vehicle is parked on an incline or slope
  - One side of the vehicle is raised or lowered relative to the opposite side

## INSTRUMENT CLUSTER

### ■ Type A



### ■ Type B

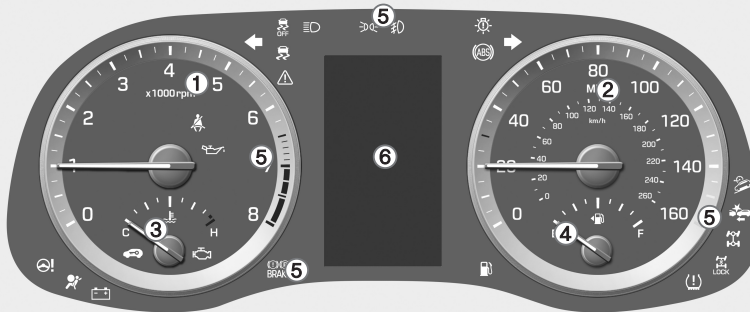

1. Tachometer
2. Speedometer
3. Engine coolant temperature gauge
4. Fuel gauge
5. Warning and indicator lights
6. LCD display (including Trip computer)

**The actual cluster in the vehicle may differ from the illustration.**

### Instrument Cluster Control

#### Adjusting instrument cluster illumination

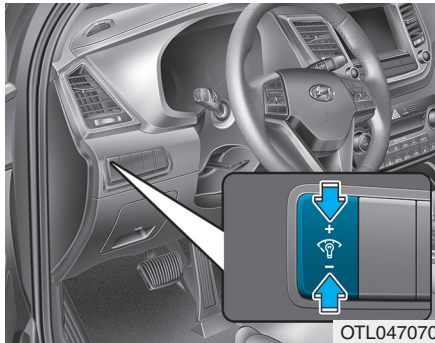

When the vehicle's parking lights or headlights are on, press the illumination control button to adjust the brightness of the instrument panel illumination.

When pressing the illumination control button, the interior switch illumination intensity is also adjusted.

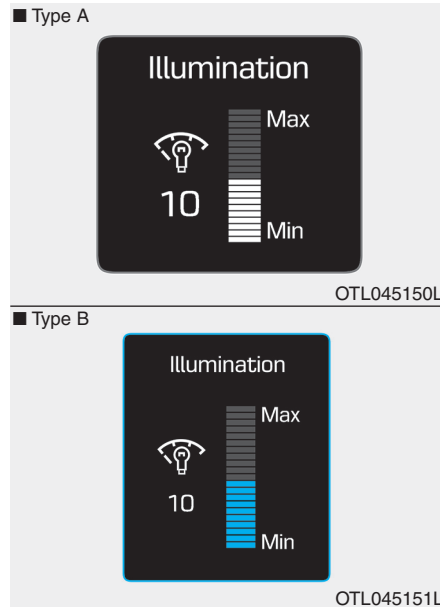

- The brightness of the instrument panel illumination is displayed.
- If the brightness reaches the maximum or minimum level, a chime will sound.

### LCD Display Control

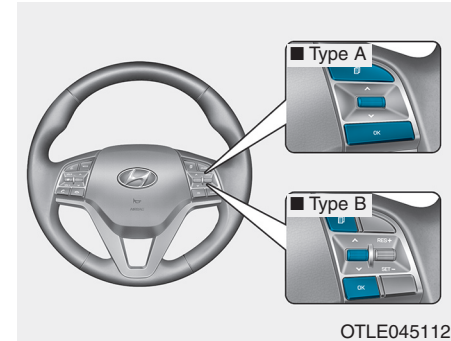

The LCD display modes can be changed by using the control buttons on the steering wheel.

- (1)  : MODE button for changing modes
- (2) ▲, ▼ : MOVE switch for changing items
- (3) OK : SELECT/RESET button for setting or resetting the selected item

**For more information on LCD Modes, refer to "LCD Display" in the next pages of this chapter.**

## Gauges

### Speedometer



The speedometer indicates the speed of the vehicle and is calibrated in miles per hour (mph) and/or kilometers per hour (km/h).

### Tachometer



The tachometer indicates the approximate number of engine revolutions per minute (rpm).

Use the tachometer to select the correct shift points and to prevent lugging and/or over-revving the engine.

#### **NOTICE**

**Do not operate the engine within the tachometer's RED ZONE. This may cause severe engine damage.**

### Engine Coolant Temperature Gauge



This gauge indicates the temperature of the engine coolant when the ignition switch or Engine Start/Stop button is ON.

### NOTICE

If the gauge pointer moves beyond the normal range area toward the "H" position, it indicates overheating that may damage the engine.

Do not continue driving with an overheated engine. If your vehicle overheats, refer to "If the Engine Overheats" in chapter 6.

### ⚠ WARNING

Never remove the radiator cap or reservoir cap when the engine is hot. The engine coolant is under pressure and could severely burn. Wait until the engine is cool before adding coolant to the reservoir.

### Fuel Gauge



This gauge indicates the approximate amount of fuel remaining in the fuel tank.

### **i** Information

- The fuel tank capacity is given in chapter 8.
- The fuel gauge is supplemented by a low fuel warning light, which will illuminate when the fuel tank is nearly empty.
- On inclines or curves, the fuel gauge pointer may fluctuate or the low fuel warning light may come on earlier than usual due to the movement of fuel in the tank.

## WARNING

Running out of fuel can expose vehicle occupants to danger. You must stop and obtain additional fuel as soon as possible after the warning light comes on or when the gauge indicator comes close to the "E (Empty)" level.

## NOTICE

Avoid driving with an extremely low fuel level. Running out of fuel could cause the engine to misfire, damaging the catalytic converter.

### Odometer

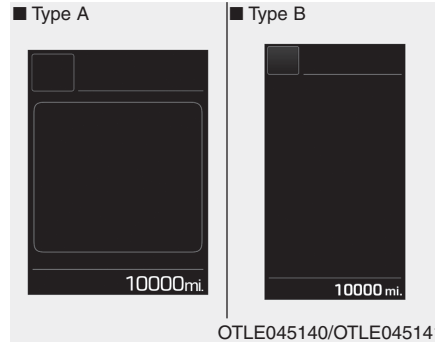

The odometer indicates the total distance that the vehicle has been driven and should be used to determine when periodic maintenance should be performed.

### Outside temperature gauge

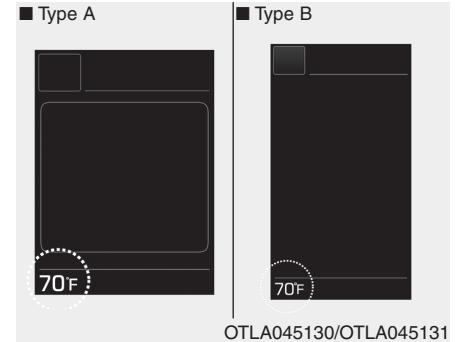

This gauge indicates the current outside air temperatures by 1°F (1°C).

- Temperature range : -40°F ~ 140°F  
(-40°C ~ 60°C)



The outside temperature on the display may not change immediately like a general thermometer to prevent the driver from being inattentive.

To change the temperature unit from °F to °C or °C to °F:

- Go to User Settings Mode → Other Features → Temperature Unit.
- Press the AUTO button for 3 seconds while pressing the OFF button. (Automatic climate control system)

Both the temperature unit on the cluster LCD display and climate control screen will change.

### **Automatic transmission shift indicator / Ecoshift dual clutch transmission shift indicator (If equipped)**

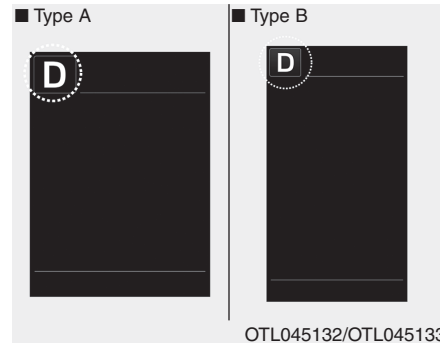

This indicator displays which automatic transmission shift lever is selected.

- Park : P
- Reverse : R
- Neutral : N
- Drive : D
- Manual Shift Mode
  - Auto Transmission : 1, 2, 3, 4, 5, 6
  - Ecoshift Dual Clutch Transmission: 1, 2, 3, 4, 5, 6, 7

### **Shift indicator pop-up (if equipped)**

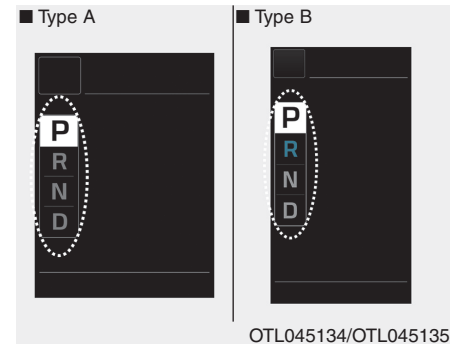

The pop-up displays the current gear position selected for 2 seconds (P/R/N/D).

## Icy Road Warning Light

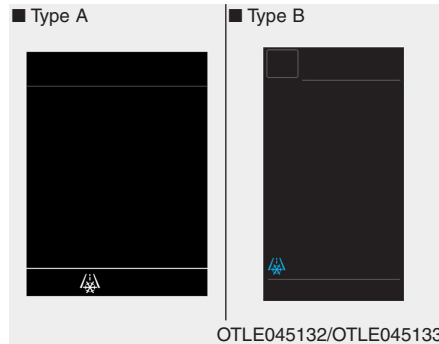

This warning light is to warn the driver the road may be icy.

When the following conditions occur, the warning light (including Outside Temperature Gauge) blinks 10 times and then illuminates, and also warning chime sounds 3 times.









- The temperature on the Outside Temperature Gauge is below approximately 39°F (4°C).

### **i** Information

**If the icy road warning light appears while driving, you should drive more attentively and safely refraining from over-speeding, rapid acceleration, sudden braking or sharp turning, etc.**

## LCD DISPLAY

### LCD Modes

Modes	Symbol	Description
Trip Computer		This mode displays information related to driving such as tripmeter, fuel economy, etc. <b>For more information, refer to "Trip Computer" in this chapter.</b>
Turn By Turn (TBT) (if equipped)		This mode displays the state of the navigation.
LDWS (If equipped)		This mode displays the state of the Lane Departure Warning System (LDWS). <b>For more information, refer to Lane Departure Warning System (LDWS) in chapter 5.</b>
A/V		This mode displays the state of the A/V system.
Information	 or  or 	This mode displays information such as tire pressure, service intervals, warning messages related to the Blind Spot Detection system, etc.
User Settings		In this mode, you can change settings of the doors, lamps, etc.

**For more information on controlling the LCD Modes, refer to "LCD Display Control" in the previous pages of this chapter.**

### **Edit, settings after engaging parking brake**



This warning message appears if you try to adjust the User Settings while driving.

For safety, change the User Settings after parking the vehicle and moving the shift lever to P (Park) position.

### **Quick Guide Help**

Press and hold the OK button in the User Settings Mode, the explanation about the selected item is displayed.

### **Trip Computer Mode**

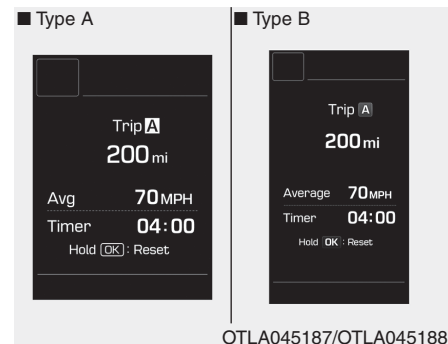

The trip computer mode displays information related to vehicle driving parameters including range, fuel economy, trip meter information and vehicle speed.

**For more information, refer to "Trip Computer" in this chapter.**

### Turn By Turn (TBT) Mode

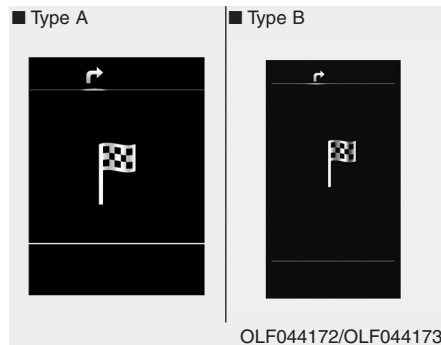

This mode displays the state of the navigation.

### LDWS Mode

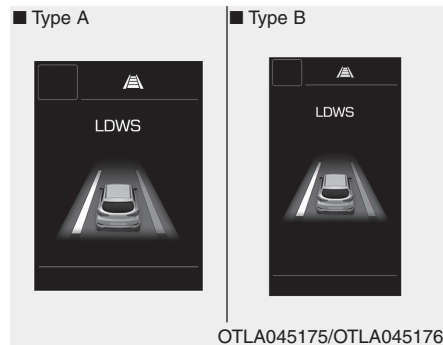

This mode displays the state of the Lane Departure Warning System (LDWS).

### A/V Mode

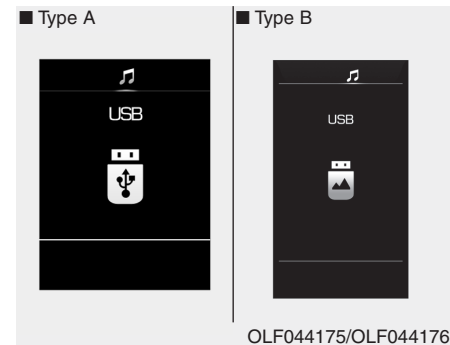

This mode displays the state of the A/V system.

**For more information, refer to "Lane Departure Warning System (LDWS)" in chapter 5.**

## Information Mode

### Service Interval

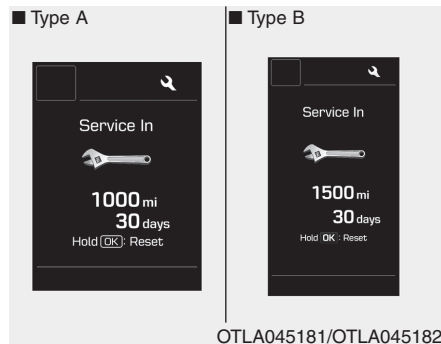

#### Service in

If the remaining mileage or time reaches 900 miles (1,500 km) or 30 days, "Service in" message is displayed for several seconds each time you set the ignition switch or Engine Start/Stop button to the ON position.

**For the setting of the service interval, refer to "User Settings Mode" of the LCD display.**

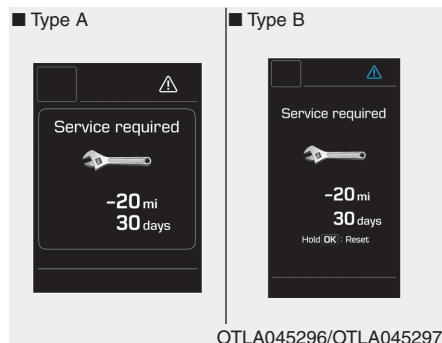

#### Service required

If you exceed the specified service interval, a message indicating, "Service required" will be displayed each time you turn ON the vehicle.

To reset the service interval, press the OK button for more than 1 second.

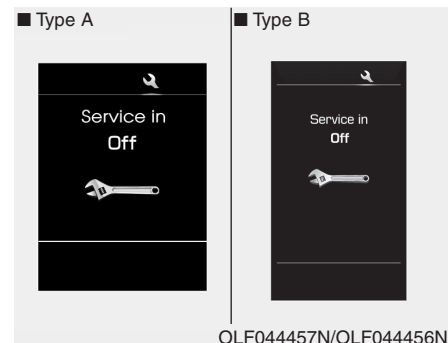

#### Service in OFF

If the service interval is not set, "Service in OFF" message is displayed.

### Information

If any of the following conditions occur, the mileage and number of days to service may be incorrect.

- The battery cable is disconnected.
- The fuse switch is turned off.
- The battery is discharged.

### **Warning Message**

If one of followings occurs, warning messages will be displayed on the information mode for several seconds.

- Malfunction of below systems
  - Low washer fluid
  - Blind Spot Detection (BSD) malfunction (if equipped)
  - Lane Departure Warning System (LDWS) malfunction (if equipped)
  - Tire Pressure Monitoring System
  - Service reminder and so on.

## User Settings Mode

In this mode, you can change setting of the instrument cluster, doors, lamps, and so on.

### Driving Assist

Items	Explanation
AEB (Automatic Emergency Braking, if equipped)	To activate or deactivate the AEB system. <b>For more details, refer to "Automatic Emergency Braking (AEB)" in chapter 5.</b>
FCW (Forward Collision Warning, if equipped)	To adjust the initial warning alert time for the Forward Collision Warning / Autonomous Emergency Braking system. The option settings are Late, Normal, or Early. <b>For more information, refer to "Autonomous Emergency Braking (AEB)" in chapter 5.</b>
RCTA (Rear Cross Traffic Alert, if equipped)	To activate or deactivate the RCTA system. <b>For more information, refer to "Rear Cross Traffic Alert (RCTA)" in chapter 5.</b>



### Door / Liftgate

Items	Explanation
Auto Lock	<ul style="list-style-type: none"> <li>• Disable : The auto door lock operation will be deactivated.</li> <li>• Enable on Speed: All doors will be automatically locked when the vehicle speed exceeds 9.3mph (15km/h).</li> <li>• Enable on Shift: All doors will be automatically locked if the automatic transmission shift lever is shifted from the P (Park) position to the R (Reverse), N (Neutral), or D (Drive) position.</li> </ul>
Auto Unlock	<ul style="list-style-type: none"> <li>• Disable : The auto door unlock operation will be canceled.</li> <li>• Driver Door (Key out) : Driver door will be automatically unlocked when the ignition key is removed from the ignition switch or the Engine Start/Stop button is set to the OFF position.</li> <li>• Driver Door (Shift P) : Driver door will be automatically unlocked if the automatic transaxle shift lever is shifted to the P (Park) position.</li> <li>• Doors(Key out) : All doors will be automatically unlocked when the ignition key is removed from the ignition switch or the Engine Star/Stop button is set to the OFF position.</li> <li>• Doors(Shift P) : All doors will be automatically unlocked if the automatic transaxle shift lever is shifted to the P (Park) position.</li> </ul>

(Continued)

(Continued)

Items	Explanation
Two Press Unlock	<ul style="list-style-type: none"><li>• OFF : The two press unlock function will be deactivated. Therefore, all doors will unlock if the door is unlocked.</li><li>• ON : The driver's door will unlock if the door is unlocked. When the door is unlocked again within 4 seconds, all doors will unlock.</li></ul>
Door Lock Sound	<ul style="list-style-type: none"><li>• Off : The Door Lock Sound feedback operation will be deactivated.</li><li>• On : After locking the door by pressing the lock button on the transmitter, if you press the lock button again within 4 seconds, the warning sound will operate once to indicate that all doors are locked.</li></ul>
Power liftgate (if equipped)	<ul style="list-style-type: none"><li>• Off: The Power Liftgate operation will be deactivated.</li><li>• On : The Power Liftgate operation will be activated</li></ul>
Smart liftgate (if equipped)	<ul style="list-style-type: none"><li>• Off: The Smart Liftgate function will be deactivated.</li><li>• On : The Smart Liftgate function will be activated</li></ul>

### Lights

Items	Explanation
One Touch Turn Signal	<ul style="list-style-type: none"><li>• Off: The one touch turn signal function will be deactivated.</li><li>• 3, 5, 7 Flashes : The turn signal indicator will blink 3, 5, or 7 times when the turn signal lever is moved slightly.</li></ul> <p><b>For more information, refer to "Light" in this chapter.</b></p>
Headlamp Delay	<ul style="list-style-type: none"><li>• On: The headlamp delay function will be activated.</li><li>• Off: The headlamp delay function will be deactivated.</li></ul> <p><b>For more information, refer to "Light" in this chapter.</b></p>
Welcome Light (if equipped)	<ul style="list-style-type: none"><li>• On: The welcome light function will be activated.</li><li>• Off: The welcome light function will be deactivated.</li></ul> <p><b>For more information, refer to "Welcome System" in this chapter.</b></p>

## Sound

Items	Explanation
BSD (Blind Spot Detection) Sound (if equipped)	<ul style="list-style-type: none"> <li>• Off : The BSD sound function will be deactivated.</li> <li>• On : The BSD sound function will be activated.</li> </ul>
Welcome Sound (if equipped)	<ul style="list-style-type: none"> <li>• Off : The welcome sound function will be deactivated.</li> <li>• On : The welcome sound function will be activated.</li> </ul>

## Service Interval

Items	Explanation
Service Interval	<p>In this mode, you can activate the service interval function with mileage (km or mi.) and period (months).</p> <ul style="list-style-type: none"> <li>• Off : The service interval function will be deactivated.</li> <li>• On : You can set the service interval (mileage and months).</li> </ul>

### Other Features

Items	Explanation
Fuel Economy Auto Reset	<ul style="list-style-type: none"> <li>• Off : The average fuel economy will not reset automatically whenever refueling.</li> <li>• After Ignition : The average fuel economy will reset automatically when driving.</li> <li>• After Refueling : The average fuel economy will reset automatically when refueling.</li> </ul> <p><b>For more details, refer to "Trip Computer" in this chapter.</b></p>
Steering position	If this item checked, the steering position will be displayed on the LCD.
Wiper/Lights Display	If this item checked, LCD display shows a selected wiper/light mode whenever you changed its mode.
Auto Rear Wiper	<ul style="list-style-type: none"> <li>• Off : The Auto Rear Wiper function will be deactivated.</li> <li>• ON : If you move the shift lever from D to R when the front wiper operates, the rear wiper will operate automatically. Then, if you move the shift lever from R to D, the rear wiper will stop.</li> </ul>
Fuel Economy Unit	Choose the fuel economy unit. (US gallon, UK gallon)
Temperature Unit	Choose the temperature unit. (°C, °F)
Tire Pressure Unit	Choose the tire pressure unit. (psi, kPa, Bar)
Gear Position Pop-up	If this item checked, the gear position will be displayed on the LCD when you move the shift lever.
Language	Choose the language.

## Warning Messages (if equipped)

### Shift to "P" or "N" to start engine

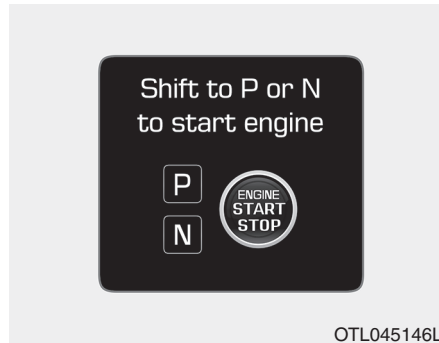

This warning message is displayed if you try to start the engine with the shift lever not in the P (Park) or N (Neutral) position.

### **i** Information

You can start the engine with the shift lever in the N (Neutral) position. But, for your safety, we recommend that you start the engine with the shift lever in the P (Park) position.

### Shift to "P"

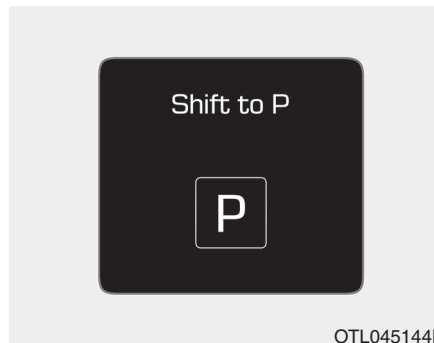

- This message is displayed if you try to turn off the engine without the shift lever in P (Park) position.
- At this time, the Engine Start/Stop button turns to the ACC position (If you press the Engine Start/Stop button once more, it will turn to the ON position).

### Press START button again

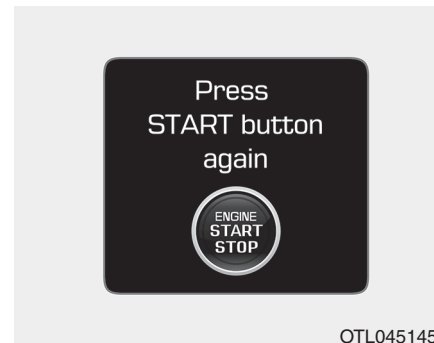

- This message is displayed if you were unable to start the vehicle when the Start/Stop button was pressed.
- If this occurs, attempt to start the engine by pressing the Start/Stop button again.
- If the warning message appears each time you press the Start/Stop button, have your vehicle inspected by an authorized Hyundai dealer.

### **Press brake pedal to start engine**

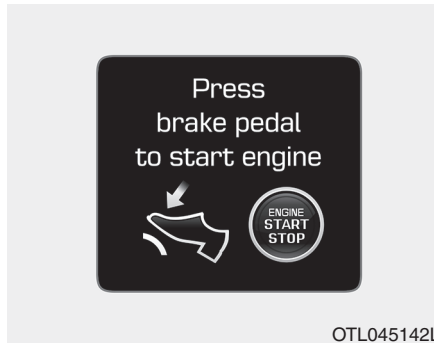

- This warning message is displayed if the Engine Start/Stop button changes to the ACC position twice by pressing the button repeatedly without depressing the brake pedal.
- In order to start the vehicle, press the brake pedal to start the engine.

### **Press START button with key**



- This warning message is displayed if you press the Engine Start/Stop button while the warning message "Key not detected" is shown.
- At this time, the immobilizer indicator light blinks.

### **Low Key Battery**

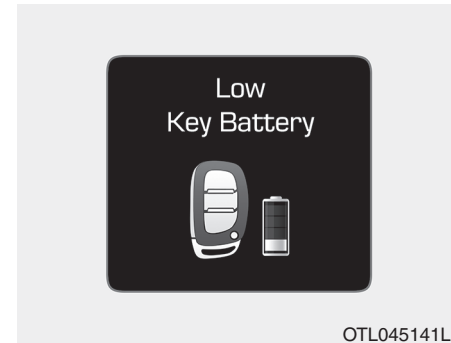

This warning message is displayed if the battery of the smart key is discharged when the Engine Start/Stop button changes to the OFF position.

### Key not detected



This warning message is displayed if the smart key is not detected when you press the Engine Start/Stop button.

### Key not in vehicle



- This warning message is displayed if the smart key is not in the vehicle when you press the Engine Start/Stop button.
- When attempting to start the vehicle, always have the smart key with you.

### Align steering wheel



- This warning message is displayed if you start the engine when the steering wheel is turned to more than 90 degrees to the left or right.
- In order to align the steering wheel, turn the wheel in the direction shown while the engine is running to straighten the steering wheel.



**Steering wheel aligning is completed**

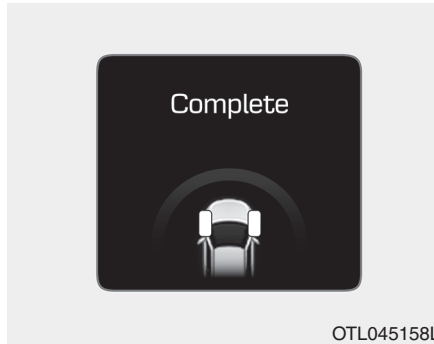

If the steering wheel aligning is completed after "Align steering wheel" warning message is displayed, this message is displayed for 2 seconds.

**Door / Hood / liftgate Open**

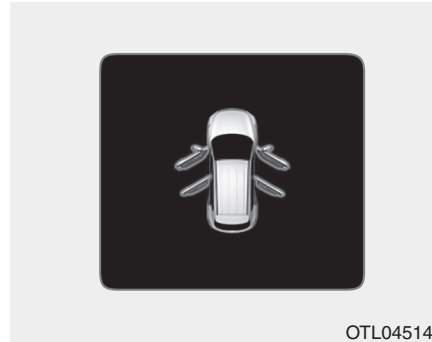

This warning message is displayed indicating which door, or the hood, or the liftgate is open.

**Sunroof Open**

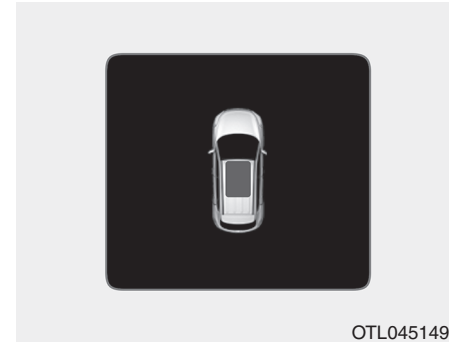

This warning message is displayed if you turn off the engine when the sunroof is open.

<p><b>CAUTION</b></p>
<p><b>Before driving the vehicle, you should confirm that the door/hood/liftgate is fully closed. Also, check there is no door/hood/liftgate open warning light or message displayed on the instrument cluster.</b></p>

### Heated Steering Wheel On

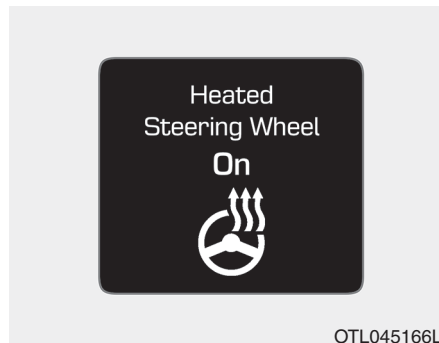

- This warning message is displayed if you turn on the heated steering wheel.

**For more details, refer to "Heated Steering Wheel" in this chapter.**

### Heated Steering Wheel Off

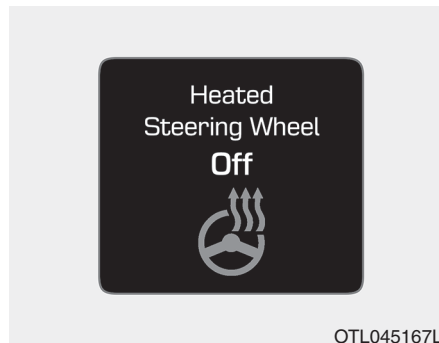

- This warning message is displayed if you turn off the heated steering wheel.

**For more details, refer to "Heated Steering Wheel" in this chapter.**

### Check BRAKE SWITCH fuse

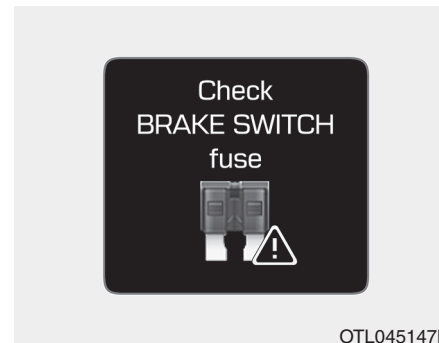

- This warning message is displayed if the brake switch fuse is disconnected.
- If this message is displayed, replace the fuse with a new one before starting the vehicle. If that is not possible, you can start the engine by pressing the Engine Start/Stop button for 10 seconds in the ACC position.

### Turn on "FUSE SWITCH"

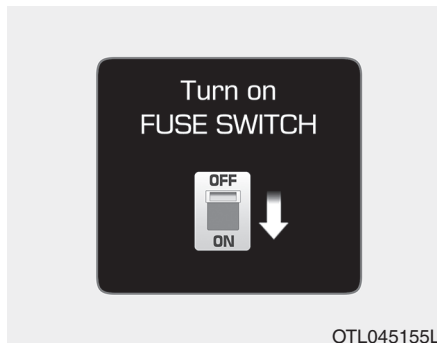

- This warning message is displayed if the fuse switch under the steering wheel is OFF.
- If this message is displayed, turn the fuse switch on.

**For more information, refer to "Fuses" in chapter 7.**

### Low Tire Pressure



This warning message is displayed if the tire pressure is low. The corresponding tire on the vehicle will be illuminated.

**For more information, refer to "Tire Pressure Monitoring System (TPMS)" in chapter 6.**

### Low Washer Fluid

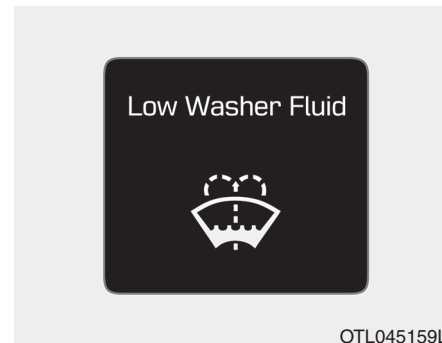

- This warning message is displayed on the service reminder mode if the washer fluid level in the reservoir is nearly empty.
- If this warning message is displayed, have the washer fluid reservoir refilled.

## Low Fuel

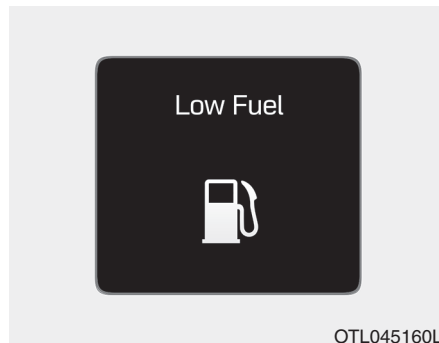

This warning message is displayed if the fuel tank is almost out of fuel.

When this message is displayed, the vehicle range is approximately 30 miles.

When this message is displayed, the low fuel level warning light in the cluster will come on.

It is recommended to look for the nearest fueling station and refuel as soon as possible.

## Engine has overheated

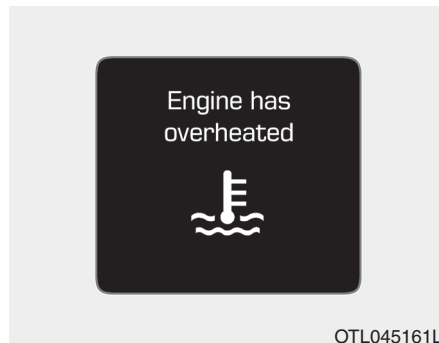

This warning message is displayed with a warning chime when the engine coolant temperature is above 248°F (120°C). This means that the engine is overheated and may be damaged.

**If your vehicle is overheated, refer to "Overheating" in chapter 6.**

## Check headlight

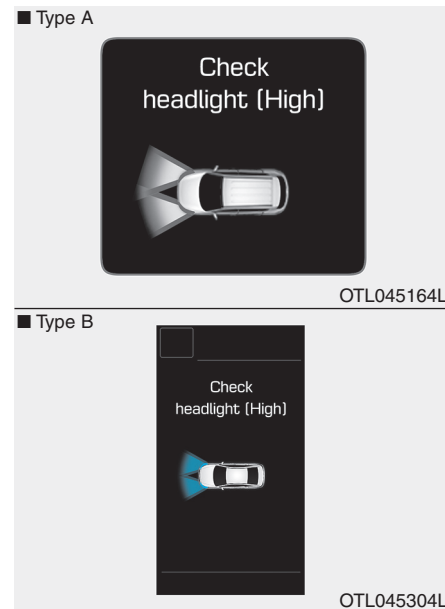

This warning message is displayed if one of the exterior bulbs (Headlamp, stop lamp, Turn signal lamp) is not operating properly. One of the bulbs may need to be replaced. If the vehicle is equipped with LED headlamps, have the vehicle inspected by an authorized HYUNDAI dealer.

3-87

**NOTICE**

When replacing the bulb, use the same wattage bulb.

For more information, refer to "BULB WATTAGE" in chapter 8.

**Check AEB system  
(if equipped)**

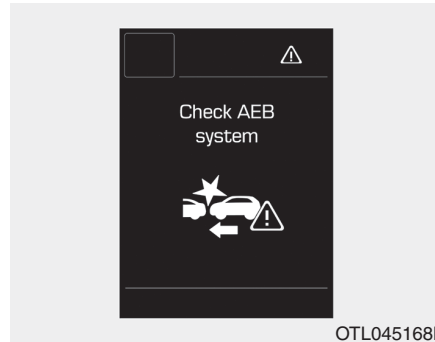

For more details, refer to "Automatic Emergency Braking (AEB) System" in chapter 5.

- This warning message is displayed if there is a problem with the Automatic Emergency Braking (AEB) system.
- In some cases, the AEB sensor or the cover located in the lower front grille may be dirty or obscured with dirt or snow. Check the sensor and cover and clean them by using a soft cloth.
- If the warning message persists, have your vehicle inspected by an authorized HYUNDAI dealer.

## TRIP COMPUTER

### Overview

The trip computer is a microcomputer-controlled driver information system that displays information related to driving.

### **i** Information

Some driving information stored in the trip computer (for example Average Vehicle Speed) resets if the battery is disconnected.

### Trip Modes

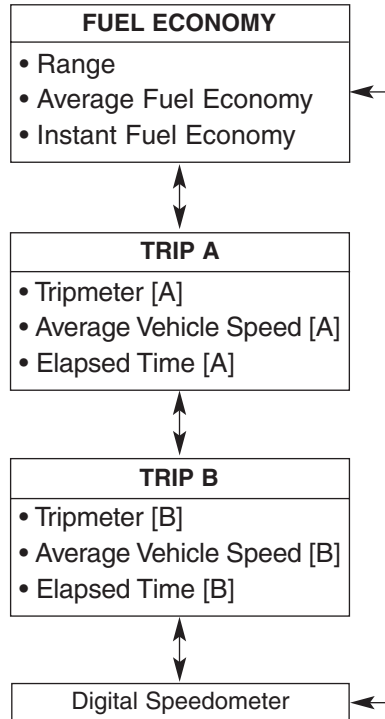

To change the trip mode, toggle the UP/DOWN arrow switch "▲ , ▼" on the steering wheel.

**For more information, refer to "LCD Display Control" in this chapter**

### Trip A/B

#### ■ Type A

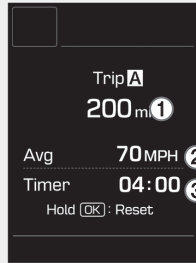

OTLA045187

#### ■ Type B

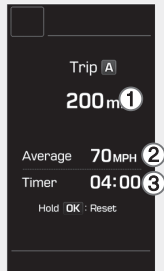

OTLA045188

### **i** Information

If you press and hold the OK button when viewing the tripmeter, the mileage, the average vehicle speed, and the timer will be reset simultaneously.

### **Tripmeter (1)**

- The tripmeter is the total driving distance since the last tripmeter reset.
  - Distance range:  
0.0 ~ 9999.9 mi. or km
- To reset the tripmeter, press the OK button on the steering wheel for more than 1 second when the tripmeter is displayed.

### **Average Vehicle Speed (2)**

- The average vehicle speed is calculated by the total driving distance and driving time since the last average vehicle speed reset.
  - Speed range: 0~160 MPH or 0~240 km/h
- To reset the average vehicle speed, press the OK button on the steering wheel for more than 1 second when the average vehicle speed is displayed.

### **i** Information

- The average vehicle speed is not displayed if the driving distance has been less than 0.19 miles (300 meters) since the ignition switch or the Engine Start/Stop button was turned to ON.
- The average vehicle speed will continue to be calculated and will start to decrease if the vehicle is stopped while the engine is still running (for example, when the vehicle is in traffic or stopped at a stop light.)

### Elapsed Time (3)

- The elapsed time is the total driving time since the last elapsed time reset.
  - Time range (hh:mm): 00:00 ~ 99:59
- To reset the elapsed time, press the OK button on the steering wheel for more than 1 second when the elapsed time is displayed.

### **i** Information

The elapsed time will continue to be counted while the engine is still running (for example, when the vehicle is in traffic or stopped at a stop light.)

### Range

■ Type A, C

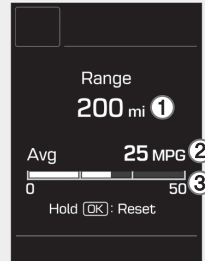

OTLE045264

■ Type B, D

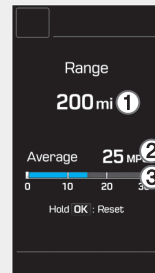

OTLE045265

### Range (1)

- The range is the estimated distance the vehicle can be driven with the remaining fuel in the fuel tank.
  - Distance range: 1 ~ 9999 mi. or 1 ~ 9999 km
- If the estimated distance is below 1 mi. (1 km), the trip computer will display “---” as the range.

### **i** Information

- If the vehicle is not on level ground or the battery power has been interrupted, the range function may not operate correctly.
- The range may differ from the actual driving distance as it is an estimate of the available driving distance.
- The trip computer may not register additional fuel if less than 1.6 gallons (6 liters) of fuel are added to the vehicle.
- The fuel economy and range may vary significantly based on driving conditions, driving habits, and condition of the vehicle.



### **Average Fuel Economy (2)**

- The average fuel economy is calculated by the total driving distance and fuel consumption since the last average fuel economy reset.
  - Fuel economy range:  
0.0 ~ 99.9 MPG or L/100km or km/L
- The average fuel economy can be reset both manually and automatically.

#### **Manual reset**

To clear the average fuel economy manually, press the OK button on the steering wheel for more than 1 second when the average fuel economy is displayed.

**For more information on the OK button, refer to the "LCD Display Control" in this chapter.**

### **Automatic reset**

To reset the average fuel economy automatically whenever refueling, select the "After refueling" mode in User Setting menu of the LCD display (**Refer to "LCD Display"**).

Under "After refueling" mode, the average fuel economy will be cleared to zero (---) when the vehicle speed exceeds 1 km/h after refueling more than 1.6 gallons (6 liters).

### **Information**

**The vehicle must be driven for a minimum of 0.19 mile [0.3 km] since the last ignition key cycle before the average fuel economy will be recalculated.**

### **Instant Fuel Economy (3)**

This mode displays the instantaneous fuel economy while driving when the vehicle speed is greater than 6.2 mph [10 kph].

- Fuel economy range:  
0 ~ 50 MPG or 0 ~ 30 L/100km

## Digital Speedometer

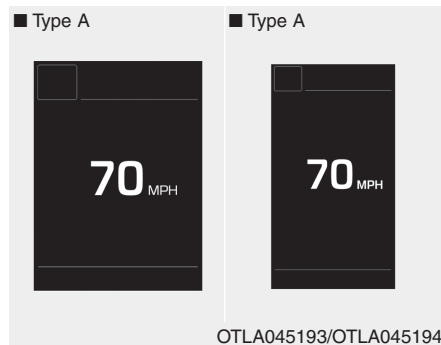

This message shows the speed of the vehicle (in mph.).

## Driving Info Display

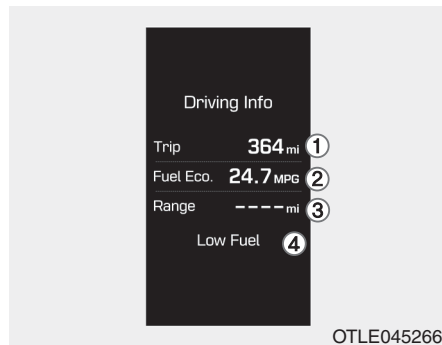

At the end of each driving cycle, the Driving Info message is displayed. This display shows the trip distance, the average fuel economy, and the remaining vehicle range.

This information is displayed for a few seconds when you turn off the ignition, and then goes off automatically. The information is calculated for each ignition cycle.

If the estimated remaining vehicle range is below 1 mile (1.6 km), the range will display as "- - -" and a "Low Fuel" warning message will be displayed.

## Information

If "Sunroof Open" warning message is displayed in the cluster, the Driving Information message may not be displayed.

## WARNING AND INDICATOR LIGHTS

### Warning Lights

#### **i** Information

Make sure that all warning lights are **OFF** after starting the engine. If any light is still **ON**, this indicates a situation that needs attention.

#### **Supplemental Restraint System Warning Light**



This warning light illuminates:

- Once you set the ignition switch or the Engine Start/Stop button to the ON position.
  - It illuminates for approximately 6 seconds and then goes off.
- When there is a malfunction with the SRS.

In this case, have your vehicle inspected by an authorized HYUNDAI dealer.

#### **Seat Belt Warning Light**



This warning light informs the driver that the seat belt is not fastened.

**For more information, refer to the "Seat Belts" in chapter 2.**

## Parking Brake & Brake Fluid Warning Light



### This warning light illuminates:

- Once you set the ignition switch or the Engine Start/Stop button to the ON position.
  - It illuminates for approximately 3 seconds.
  - It remains on if the parking brake is applied.
- When the parking brake is applied.
- When the brake fluid level in the reservoir is low.
  - If the warning light illuminates with the parking brake released, it indicates the brake fluid level in reservoir is low.

### If the brake fluid level in the reservoir is low:

1. Drive carefully to the nearest safe location and stop your vehicle.
2. With the engine stopped, check the brake fluid level immediately and add fluid as required (**For more information, refer to "Brake Fluid" in chapter 7**). After adding brake fluid, check all brake components for fluid leaks. If a brake fluid leak is found, or if the warning light remains on, or if the brakes do not operate properly, do not drive the vehicle. Have the vehicle inspected by an authorized HYUNDAI dealer.

### Dual-diagonal braking system

Your vehicle is equipped with dual-diagonal braking systems. This means you still have braking on two wheels even if one of the dual systems should fail.

With only one of the dual systems working, more than normal pedal travel and greater pedal pressure is required to stop the vehicle.

Also, the vehicle will not stop in as short a distance with only a portion of the brake system working.

If the brakes fail while you are driving, shift to a lower gear for additional engine braking and stop the vehicle as soon as it is safe to do so.

 **WARNING**

**Parking Brake & Brake Fluid Warning Light**

**Driving the vehicle with a warning light ON is dangerous. If the Parking Brake & Brake Fluid Warning Light illuminates with the parking brake released, it indicates that the brake fluid level is low.**

**In this case, have your vehicle inspected by an authorized HYUNDAI dealer.**

**Anti-lock Brake System (ABS) Warning Light**



**This warning light illuminates:**

- Once you set the ignition switch or the Engine Start/Stop button to the ON position.
  - It illuminates for approximately 3 seconds and then goes off.
- When there is a malfunction with the ABS (The normal braking system will still be operational without the assistance of the anti-lock brake system).

In this case, have your vehicle inspected by an authorized HYUNDAI dealer.

**Electronic Brake force Distribution (EBD) System Warning Light**



**These two warning lights illuminate at the same time while driving:**

When the ABS and regular brake system may not work normally.

In this case, have your vehicle inspected by an authorized HYUNDAI dealer.

## WARNING

### Electronic Brake force Distribution (EBD) System Warning Light

When both ABS and Parking Brake & Brake Fluid Warning Lights are on, the brake system will not work normally and you may experience an unexpected and dangerous situation during sudden braking.

In this case, avoid high speed driving and abrupt braking.

In this case, have your vehicle inspected by an authorized HYUNDAI dealer.

### Information - Electronic Brake force Distribution (EBD) System Warning Light

When the ABS Warning Light is on or both ABS and Parking Brake & Brake Fluid Warning Lights are on, the speedometer, odometer, or tripmeter may not work. Also, the EPS Warning Light may illuminate and the steering effort may increase or decrease.

In this case, have your vehicle inspected by an authorized HYUNDAI dealer.

### *Electronic Power Steering (EPS) Warning Light*



This warning light illuminates:

- Once you turn the ignition switch or the Engine Start/Stop button to the ON position.
  - It remains on until the engine is started.
- When there is a malfunction with the EPS.

In this case, have your vehicle inspected by an authorized HYUNDAI dealer.

### Malfunction Indicator Lamp (MIL)

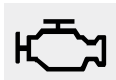

This warning light illuminates:

- Once you turn the ignition switch or Engine Start/Stop button to the ON position.
  - It remains on until the engine is started.
- When there is a malfunction with the emission control system.  
In this case, have your vehicle inspected by an authorized HYUNDAI dealer.

#### NOTICE

- Malfunction Indicator Lamp (MIL)  
Driving with the Malfunction Indicator Lamp (MIL) on may cause damage to the emission control systems which could affect drivability and/or fuel economy.

#### NOTICE

If the Malfunction Indicator Lamp (MIL) illuminates, potential catalytic converter damage is possible which could result in loss of engine power.

In this case, have your vehicle inspected by an authorized HYUNDAI dealer.

### Charging System Warning Light



If this warning light comes on while the engine is running, the battery is not being charged. Immediately turn off all electrical accessories. Try not to use electrically operated controls, such as the power windows. Keep the engine running; starting the engine will quickly discharge the battery.

**If there is a malfunction with either the alternator or electrical charging system:**

1. Drive carefully to the nearest safe location and stop your vehicle.
2. Turn the engine off and check the alternator drive belt for looseness or breakage.

If the belt is adjusted properly, there may be a problem in the electrical charging system.

In this case, have your vehicle inspected by an authorized HYUNDAI dealer.

## Engine Oil Pressure Warning Light



This warning light illuminates:

- Once you turn the ignition switch or the Engine Start/Stop button to the ON position.
  - It remains on until the engine is started.
- When the engine oil pressure is low.

If the engine oil pressure is low:

1. Drive carefully to the nearest safe location and stop your vehicle.
2. Turn the engine off and check the engine oil level (**For more information, refer to "Engine Oil" in chapter 7**). If the level is low, add oil as required.

If the warning light remains on after adding oil and restarting the engine or if oil is not available, turn off the engine. There is a mechanical concern that needs to be repaired before you can continue driving. In this case, have your vehicle inspected by an authorized HYUNDAI dealer.

### NOTICE

- Engine Oil Pressure Warning light

To prevent severe engine damage, after the Engine Oil Pressure Warning Light is illuminated and as soon as it is safe to do so, turn the engine off and check the oil level.

If the oil level is low, fill the engine oil to the proper level and start the engine again. If the light stays on with the engine running, turn the engine off immediately.

In this case, have your vehicle inspected by an authorized HYUNDAI dealer.

## Low Fuel Level Warning Light



This warning light illuminates:

When the fuel tank is nearly empty. Add fuel as soon as possible.

### NOTICE

- Low Fuel Level

Driving with the Low Fuel Level warning light on or with the fuel level below "E" can cause the engine to misfire and damage the catalytic converter.



### **Low Tire Pressure Warning Light**



**This warning light illuminates:**

- Once you turn the ignition switch or the Engine Start/Stop button to the ON position.
  - It illuminates for approximately 3 seconds and then goes off.
- When one or more of your tires are significantly underinflated (The location of each underinflated tire is displayed on the LCD display).

**For more information, refer to "Tire Pressure Monitoring System (TPMS)" in chapter 6.**

**This warning light remains ON after blinking for approximately 60 seconds, or repeatedly blinks ON and OFF in 3 second intervals:**

When there is a malfunction with the TPMS.

In this case, have your vehicle inspected by an authorized HYUNDAI dealer.

**For more information, refer to "Tire Pressure Monitoring System (TPMS)" in chapter 6.**

### **! WARNING**

#### **Safe Stopping**

- **The TPMS cannot alert you to severe and sudden tire damage caused by external factors.**
- **If you notice any vehicle instability, immediately take your foot off the accelerator pedal, apply the brakes gradually with light force, and slowly move to a safe position off the road.**

### **Automatic Emergency Braking (AEB) Warning light (if equipped)**



**This warning light illuminates :**

- When the AEB system is turned off.
- When the radar sensor or cover is blocked with dirt or snow. Check the sensor and cover and clean them by using a soft cloth.
- When there is a malfunction with AEB. In this case, have your vehicle inspected by an authorized HYUNDAI dealer.

### All Wheel Drive (AWD) Warning Light (if equipped)

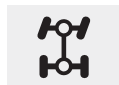

This warning light illuminates:

- Once you turn the ignition switch or Engine Start/Stop Button to the ON position.
  - It illuminates for approximately 3 seconds and then goes off.
- When there is a malfunction with the AWD system.

In this case, have your vehicle inspected by an authorized HYUNDAI dealer.

### Headlight Warning Light



This warning light illuminates:

This warning light illuminates if the headlamp (Low) is not operating properly. The headlamp (Low) bulb may need to be replaced. If the vehicle is equipped with LED headlamps, have the vehicle inspected by an authorized HYUNDAI dealer.

#### Information

**When replacing the bulb, use the same wattage bulb.**

**For more information, refer to "BULB WATTAGE" in chapter 8.**

### Master Warning Light



This indicator light illuminates

- When there is a malfunction in operation in any of the following systems:
  - Low washer fluid
  - Blind Spot Detection (BSD) malfunction (if equipped)
  - Lane Departure Warning System (LDWS) malfunction (if equipped)
  - Tire Pressure Monitoring System (TPMS)
  - Service reminder and so on.

To identify the details of the warning, look at the LCD display.

### **Adaptive Front Lighting System (AFLS) Warning Light (if equipped)** **AFLS**

**This warning light blinks:**

- When there is a malfunction with the AFLS.

**If there is a malfunction with the AFLS:**

1. Drive carefully to the nearest safe location and stop your vehicle.
2. Turn the engine off and restart the engine. If the warning light remains on, you have the vehicle inspected by an authorized HYUNDAI dealer.

### **Indicator Lights**

#### **Electronic Stability Control (ESC) Indicator Light**



**This indicator light illuminates:**

- Once you turn the ignition switch or the Engine Start/Stop button to the ON position.
  - It illuminates for approximately 3 seconds and then goes off.
- When there is a malfunction with the ESC system.

In this case, have your vehicle inspected by an authorized HYUNDAI dealer.

**This indicator light blinks:**

While the ESC is operating.

**For more information, refer to "Electronic Stability Control (ESC)" in chapter 5.**

#### **Electronic Stability Control (ESC) OFF Indicator Light**



**This indicator light illuminates:**

- Once you turn the ignition switch or the Engine Start/Stop button to the ON position.
  - It illuminates for approximately 3 seconds and then goes off.
- When you deactivate the ESC system by pressing the ESC OFF button.

**For more information, refer to "Electronic Stability Control (ESC)" in chapter 5.**

### **Immobilizer Indicator Light (With Smart Key) (if equipped)**



**This indicator light illuminates for up to 30 seconds:**

When the vehicle detects the smart key in the vehicle with the Engine Start/Stop button in the ACC or ON position.

- At this time, you can start the engine.
- The indicator light goes off after starting the engine.

**This indicator light blinks for a few seconds:**

When the smart key is not in the vehicle.

- At this time, you cannot start the engine.

**This indicator light illuminates for 2 seconds and goes off:**

If the smart key is in the vehicle and the Engine Start/Stop button is ON, but the vehicle cannot detect the smart key.

In this case, have your vehicle inspected by an authorized HYUNDAI dealer.

**This indicator light blinks:**

- When the battery voltage of the smart key is low.
  - At this time, you can not start the engine. However, you can start the engine if you press the ignition switch or the Engine Start/Stop button with the smart key. **(For more information, refer to "Starting the Engine" in chapter 5).**
- When there is a malfunction with the immobilizer system.

In this case, have your vehicle inspected by an authorized HYUNDAI dealer.

### **Turn Signal Indicator Light**

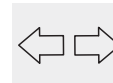

**This indicator light blinks:**

When you operate the turn signal indicator.

If any of the following occurs, there may be a malfunction with the turn signal system.

- The turn signal indicator light illuminates but does not blink
- The turn signal indicator light blinks rapidly
- The turn signal indicator light does not illuminate at all

If either of these conditions occur, have your vehicle inspected by an authorized HYUNDAI dealer.

**High Beam Indicator Light**



**This indicator light illuminates:**

- When the headlights are on and in the high beam position.
- When the turn signal lever is pulled into the Flash-to-Pass position.

**Light ON Indicator Light**



**This indicator light illuminates:**

When the tail lights or headlights are on.

**Front Fog Indicator Light (if equipped)**



**This indicator light illuminates:**

- When the front fog lights are on.

**Cruise Indicator Light (if equipped)**



**This indicator light illuminates:**

When the cruise control system is enabled.

**For more information, refer to "Cruise Control System" in chapter 5.**

**Cruise SET Indicator Light**

SET

**This indicator light illuminates:**

When the cruise control speed is set.

**For more information, refer to "Cruise Control System" in chapter 5.**

**SPORT Mode Indicator Light**

SPORT

**This indicator light illuminates:**

When you select "SPORT" mode as drive mode.

**For more information, refer to "Drive Mode Integrated Control System" in chapter 5.**

**ECO Mode Indicator Light (for Automatic transmission)**

ECO

**This indicator light illuminates :**

When you select "ECO" mode as drive mode.

**For more information, refer to "LCD Display" in this chapter.**

### Lane Departure Warning System (LDWS) Indicator Light (if equipped)



This indicator light illuminates:

- [Green] When you activate the lane departure warning system by pressing the LDWS button.
- [White] When system operating conditions are not satisfied or when the sensor does not detect the lane line.
- [Yellow] When there is a malfunction with the lane departure warning system.

In this case, have your vehicle inspected by an authorized HYUNDAI dealer.

For more information, refer to "Lane Departure Warning System (LDWS)" in chapter 5.

### All Wheel Drive (AWD) LOCK Indicator Light (if equipped)



This indicator light illuminates:

- Once you turn the ignition switch or Engine Start/Stop Button to the ON position.
  - It illuminates for approximately 3 seconds and then goes off.
- When you select AWD Lock mode by pressing the AWD LOCK button.
  - The AWD LOCK mode is to transfer a portion of the drive torque to the rear wheels for increased traction on wet pavement, snow covered roads or when driving off road.

#### CAUTION

##### AWD Lock Mode

**Do not use the AWD lock mode on dry paved roads. Doing so can cause abnormal noise or vibration, and may damage the AWD system.**

### Downhill Brake Control (DBC) Indicator Light



This warning light illuminates:

- Once you turn the ignition switch or Engine Start/Stop Button to the ON position.
  - It illuminates for approximately 3 seconds and then goes off.
- When you activate the DBC system by pressing the DBC button.

This warning light blinks:

- When the DBC is operating.

This warning light illuminates yellow:

- When there is a malfunction with the DBC system.

In this case, have your vehicle inspected by an authorized HYUNDAI dealer.

For more details, refer to "Downhill Brake Control (DBC) System" in chapter 5.

## LIGHT

### Exterior Lights

#### Lighting control

To operate the lights, turn the knob at the end of the control lever to one of the following positions:

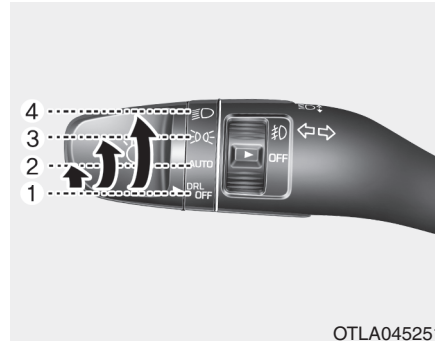

- (1) DRL OFF position
- (2) AUTO light position
- (3) Parking lamp position
- (4) Headlamp position

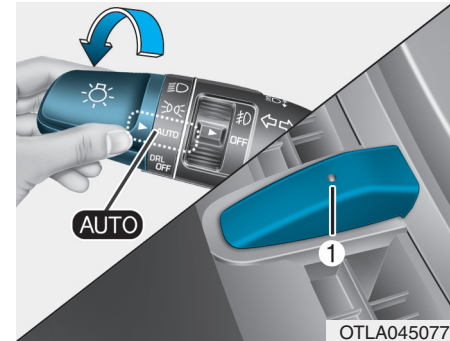

#### AUTO light position

The parking lamp and headlamp will be turned ON or OFF automatically depending on the amount of light outside the vehicle.

Even with the AUTO light feature in operation, it is recommended to manually turn ON the lamps when driving at night or in a fog, or when you enter dark areas, such as tunnels and parking facilities.



### NOTICE

- Do not cover or spill anything on the sensor (1) located in front of the instrument panel.
- Do not clean the sensor using a window cleaner, the cleaner may leave a light film which could interfere with sensor operation.
- If your vehicle has window tint or other types of metallic coating on the front windshield, the AUTO light system may not work properly.

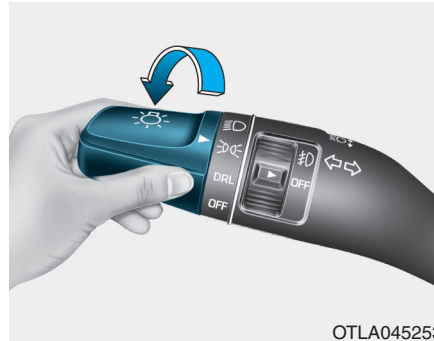

#### Parking lamp position (☀️)

The parking lamp, license plate lamp and instrument panel lamp are turned ON.



#### Headlamp position (☞)

The headlamp, parking lamp, license plate lamp and instrument panel lamp are turned ON.

#### **i** Information

The ignition switch must be in the ON position to turn on the headlamp.

## High beam operation

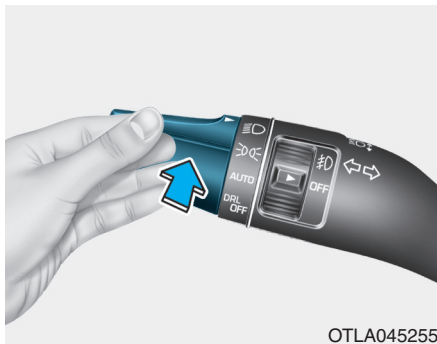

OTLA045255

To turn on the high beam headlamp, push the lever away from you. The lever will return to its original position. The high beam indicator will light when the headlamp high beams are switched on.

To turn off the high beam headlamp, pull the lever towards you. The low beams will turn on.

### WARNING

**Do not use high beam when there are other vehicles approaching you. Using high beam could obstruct the other driver's vision.**

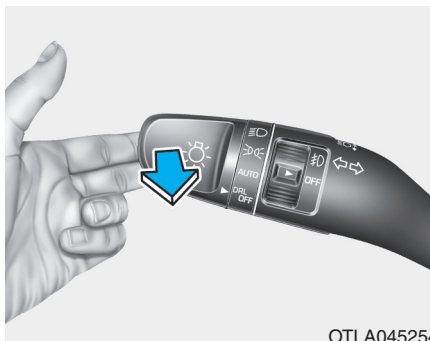

OTLA045254

To flash the high beam headlamp, pull the lever towards you, then release the lever. The high beams will remain ON as long as you hold the lever towards you.

## Turn signals and lane change signals

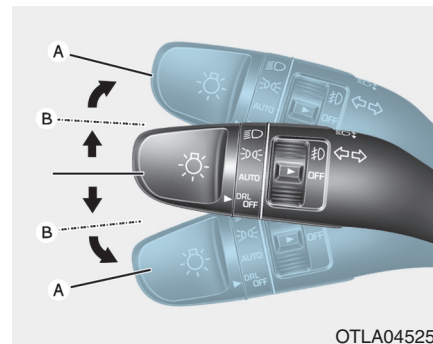

OTLA045257

To signal a turn, push down on the lever for a left turn or up for a right turn in position (A). To signal a lane change, move the turn signal lever slightly and hold it in position (B). The lever will return to the original position when released or when the turn is completed.

If an indicator stays on and does not flash or if it flashes abnormally, one of the turn signal bulbs may be burned out and will require replacement.

### One touch turn signal function

To activate the One Touch Turn Signal function, move the turn signal lever slightly and then release it. The turn signal indicators will blink 3, 5, or 7 times, depending on the User Settings on the LCD display.

You can activate or deactivate the One Touch Turn Signal function or choose the number of blinking (3, 5, or 7) from the User Settings Mode (Light) on the LCD display.

**For more information, refer to the "LCD Display" section in this chapter.**

### Front fog lamp (if equipped)



OTL047258

Fog lamps are used to provide improved visibility when visibility is poor due to fog, rain or snow, etc. Use the switch next to the headlamp switch to turn the fog lamps ON and OFF.

1. Turn on the parking lamp.
2. Turn the light switch (1) to the front fog lamp position.
3. To turn off the front fog lamp, turn the light switch to the front fog lamp position again or turn off the parking lamp.

### NOTICE

**When in operation, the fog lamps consume large amounts of vehicle electrical power. Only use the fog lamps when visibility is poor.**

## Adaptive Front Lighting System (AFLS) (if equipped)

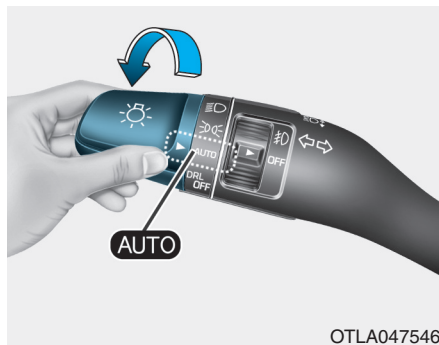

OTLA047546

Adaptive front lighting system uses the steering angle and vehicle speed, to keep your field of vision wide by swiveling and leveling the headlamp.

Change the switch to the AUTO position when the engine is running. The adaptive front lighting system will operate when the headlamp is ON. To turn off the AFLS, change the switch to other positions. After turning the AFLS off, headlamp swiveling no longer occurs, but leveling operates continuously.

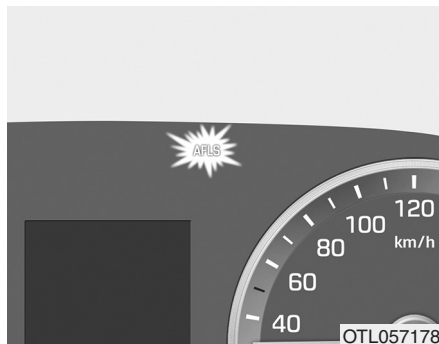

If the AFLS malfunction indicator comes on, the AFLS is not working properly. Drive to the nearest safe location and restart the engine. If the indicator continuously remains on, take your vehicle to an authorized HYUNDAI dealer and have the system checked.

## Battery saver function

The purpose of this feature is to prevent the battery from being discharged. The system automatically turns off the parking lamp when the key is removed (remote key) or when the driver turns the engine off (smart key) and opens the driver-side door.

With this feature, the parking lamps will turn off automatically if the driver parks on the side of road at night.

If necessary, to keep the lamps on when the engine is turned off, perform the following:

- 1) Open the driver-side door.
- 2) Turn the parking lamps OFF and ON again using the light switch on the steering column.

### **Headlamp delay function**

If the key is removed from the ignition switch or placed in the ACC position or the LOCK/OFF position with the headlamps ON, the headlamps (and/or parking lamps) remain on for about 5 minutes. However, if the driver's door is opened and closed, the headlights are turned off after 15 seconds. However, with the engine off if the driver's door is opened and closed, the headlamps (and/or parking lamps) are turned off after 15 seconds.

The headlamps (and/or parking lamps) can be turned off by pressing the lock button on the remote key or smart key twice or turning the light switch to the OFF or AUTO position. However, if you turn the light switch to the AUTO position when it is dark outside, the headlamps will not be turned off.

You can activate or deactivate the Headlamp Delay function from the User Settings Mode (Light) on the LCD display.

**For more information, refer to the "LCD Display" section in this chapter.**

#### **NOTICE**

**If the driver gets out of the vehicle through other doors (except driver's door), the battery saver function does not operate and the headlamp delay function does not turn off automatically. Therefore, it causes the battery to be discharged. In this case, make sure to turn off the headlamp switch before getting out of the vehicle.**

### **Daytime running light (DRL)**

The Daytime Running Lights (DRL) can make it easier for others to see the front of your vehicle during the day, especially after dawn and before sunset.

The DRL will turn off when:

1. The light switch is not in the AUTO position.
2. The parking brake is applied.
3. The engine is turned off.

## Welcome System (if equipped)

### Welcome light



### Door handle lamp (if equipped)

When all the doors (and tailgate) are closed and locked, the door handle lamp will come on for about 15 seconds if any of the below is performed.

- When the door unlock button is pressed on the remote key or smart key.
- When the button of the outside door handle is pressed.
- When the vehicle is approached with the smart key in possession.

### Headlamp and Parking lamp

When the headlamp (lamp switch in the headlamp or AUTO position) is on and all doors (and tailgate) are locked and closed, the parking lamp and headlamp will come on for 15 seconds if/or any of the below is performed.

- When the door unlock button is pressed on the remote key or smart key.

At this time, if you press the door lock or unlock button on the remote key or smart key the parking lamp and headlamp will turn off immediately.

You can activate or deactivate the Welcome Light from the User Settings Mode (Light) on the LCD display.

**For more information, refer to the "LCD Display" section in this chapter.**

### Interior lamp

When the interior lamp switch is in the DOOR position and all doors (and tailgate) are closed and locked, the room lamp will come on for 30 seconds if any of the below is performed.

- When the door unlock button is pressed on the remote key or smart key.
- When the button of the outside door handle is pressed.

At this time, if you press the door lock or unlock button on the remote key or smart key the room lamp will turn off immediately.

## Interior Lights

### WARNING

Do not use the interior lights when driving in the dark. The interior lights may obscure your view and cause an accident.

### NOTICE

Do not use the interior lights for extended periods when the engine is turned off or the battery will discharge.

### Interior lamp *AUTO cut*

The interior lamps will automatically go off approximately 20 minutes after the engine is turned off and the doors closed. If a door is opened, the lamp will go off 40 minutes after the engine is turned off. If the doors are locked by the remote key or smart key and the vehicle enters the armed stage of the theft alarm system, the lamps will go off five seconds later.

### Front lamps

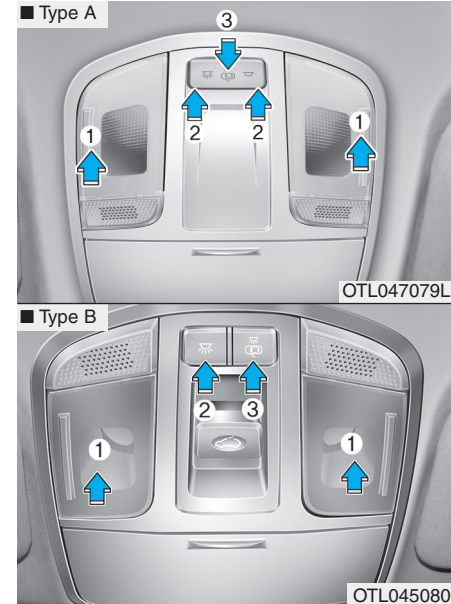



- (1) Front Map Lamp
- (2) Front Room Lamp
- (3) Front Door Lamp

### Front map lamp

- Press the map lamp cover (1) to turn ON the map lamp. Re-press the map lamp cover to turn OFF the map lamp.

### Front Room Lamp

-  :  
(Type A) Press the button to turn ON the map lamp for the front/rear seats.
-  :  
(Type A) Press the button to turn OFF the map lamp for the front/rear seats.

### Front Door Lamp

-  :

The map lamp for the front/rear seats is automatically turned ON for approximately 30 seconds, when a door is opened.

The map lamp for the front/rear seats is automatically turned ON for approximately 15 seconds, when the remote key (smart key) unlocks the doors. The map lamp fades out, when the ignition switch is pressed to the ON position in 15 seconds. The map lamp remains ON up to 20 minutes, when a door is opened with the ignition switch in the either the ACC or OFF position.

### Rear lamps

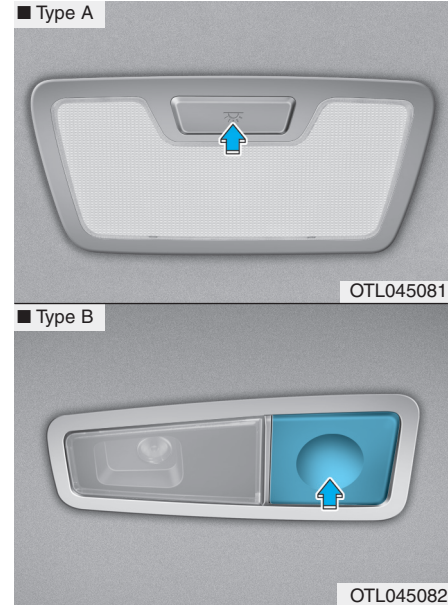

### Rear Room Lamp Switch ( ) :

Press this switch to turn the room lamp on and off.



**NOTICE**

Do not leave the lamp switches on for an extended period of time when the engine is turned off.

**Liftgate room lamp**

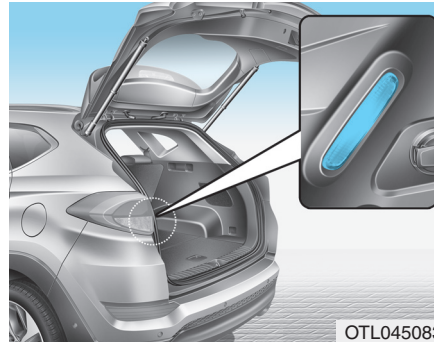

The liftgate room lamp comes on when the tailgate is opened.

**NOTICE**

The liftgate lamp comes on as long as the liftgate is open. To prevent unnecessary charging system drain, close the liftgate securely after using the liftgate.

**Glove box lamp**

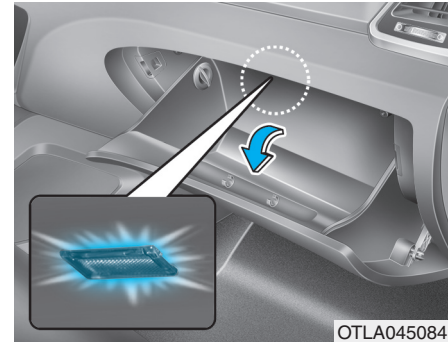

The glove box lamp comes on when the glove box is opened.

If the glove box is not closed, the lamp will turn off after 20 minutes.



**NOTICE**

To prevent possible battery discharge, securely close the glove box after use.

## Vanity mirror lamp



The vanity mirror lamp is located in the headliner just behind the sun visor. Push the switch to turn the vanity light on or off.

-  : The lamp will turn on if this button is pressed.
-  : The lamp will turn off if this button is pressed.

### CAUTION

#### Vanity mirror lamp

Always have the switch in the off position when the vanity mirror lamp is not in use. If the sunvisor is closed without the lamp off, it may discharge the battery or damage the sunvisor.

## WIPERS AND WASHERS

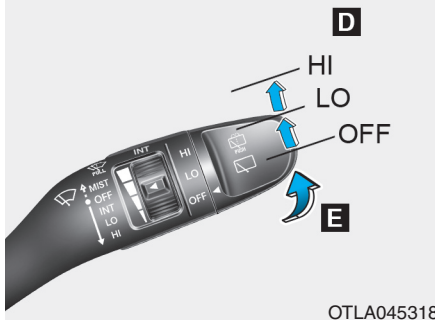
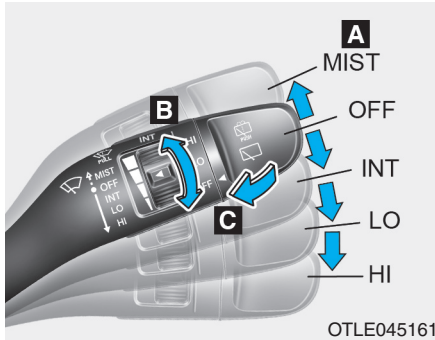

### A : Wiper speed control

- MIST – Single wipe
- OFF – Off
- INT – Intermittent wipe
- LO – Low wiper speed
- HI – High wiper speed

### B : Intermittent control wipe time adjustment

### C : Wash with brief wipes

### D : Rear wiper/washer control

- HI – High wiper speed
- LO – Low wiper speed
- OFF – Off

### E : Wash with brief wipes (rear)

## Windshield Wipers

Operates as follows when the ignition switch is in the ON position.

**MIST** : For a single wiping cycle, push the lever upward and release. The wipers will operate continuously if the lever is held in this position.

**OFF** : Wiper is not in operation.

**INT** : Wiper operates intermittently at the same wiping intervals. To vary the speed setting, move the speed control lever.

**LO** : The wiper operates continuously at a low speed.

**HI** : The wiper operates continuously at a higher speed.

### **i** Information

If there is heavy accumulation of snow or ice on the windshield, defrost the windshield for about 10 minutes, or until the snow and/or ice is removed before using the windshield wipers to ensure proper operation.

If you do not remove the snow and/or ice before using the wiper and washer, it may damage the wiper and washer system.

## Windshield Washers

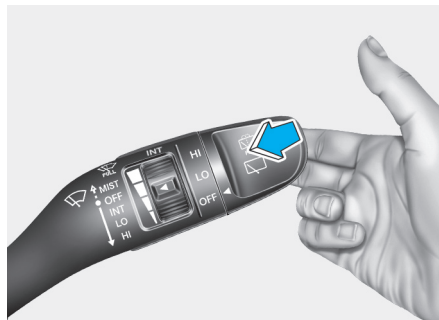

OTLE045164

In the OFF position, pull the lever gently toward you to spray washer fluid on the windshield and to run the wipers 1-3 cycles. The spray and wiper operation will continue until you release the lever. If the washer does not work, you may need to add washer fluid to the washer fluid reservoir.

If equipped with the Headlamp Washer, washer fluid will be sprayed on the headlamp at the same time you operate the windshield washer when:

1. The ignition switch is in the ON position.
2. The light switch is in the headlamp position.

### WARNING

**When the outside temperature is below freezing, ALWAYS warm the windshield using the defroster to prevent the washer fluid from freezing on the windshield and obscuring your vision which could result in an accident and serious injury or death.**

### NOTICE

- To prevent possible damage to the washer pump, do not operate the washer when the fluid reservoir is empty.
- To prevent possible damage to the wipers or windshield, do not operate the wipers when the windshield is dry.
- To prevent damage to the wiper arms and other components, do not attempt to move the wipers manually.
- To prevent possible damage to the wipers and washer system, use anti-freezing washer fluids in the winter season or cold weather.

### Rear window wiper and washer switch

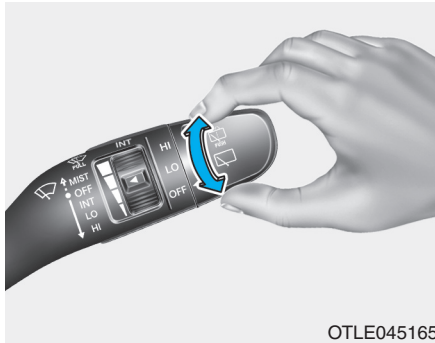

The rear window wiper and washer switch is located at the end of the wiper and washer switch lever. Turn the switch to the desired position to operate the rear wiper and washer.

HI – High wiper speed

LO – Low wiper speed

OFF – Off

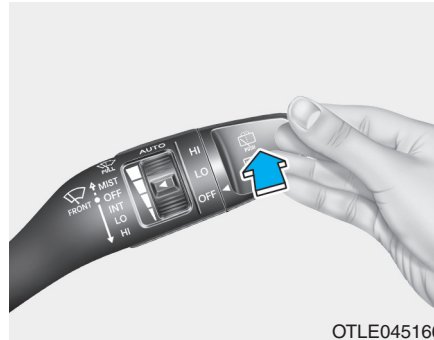

Push the lever away from you to spray rear washer fluid and to run the rear wipers 1~3 cycles. The spray and wiper operation will continue until you release the lever.

## DRIVER ASSIST SYSTEM

### Rear View Camera

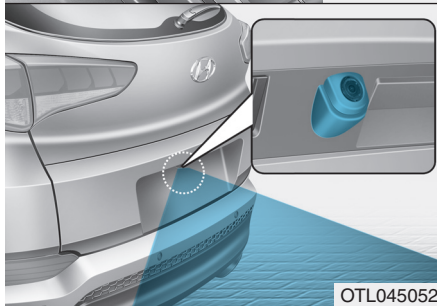
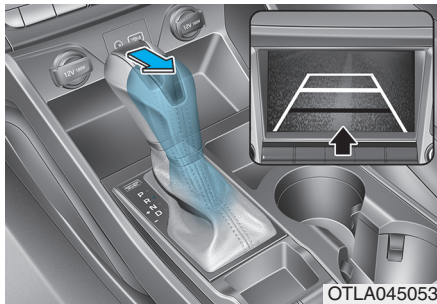

The Rear View Camera will activate when the engine is running and the shift lever is in the R (Reverse) position.

This is a supplemental system that provides a view of the area behind the vehicle through the A/V display while the vehicle is in the R (Reverse) position.

#### **! WARNING**

The Rear View Camera is not a safety device. It only serves to assist the driver in identifying objects directly behind the middle of the vehicle. The camera does NOT cover the complete area behind the vehicle.

#### **! WARNING**

- Never rely solely on the Rear View Camera when backing-up.
- ALWAYS look around your vehicle to make sure there are no objects or obstacles before moving the vehicle in any direction to prevent a collision.
- Always pay close attention when the vehicle is driven close to objects, particularly pedestrians, and especially children.

#### **NOTICE**

Always keep the camera lens clean. The camera may not work normally if the lens is covered with dirt or snow.

### Rear Parking Assist System (if equipped)

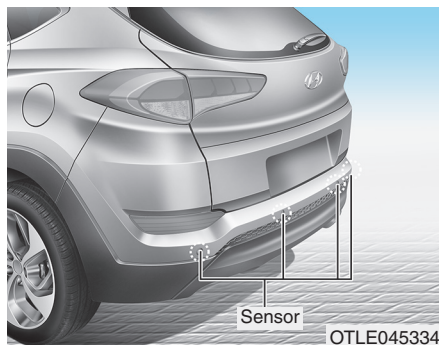

The Rear Parking Assist System assists the driver during reverse movement of the vehicle by chiming if any object is sensed within approximately 50 in (120 cm) behind the vehicle.

This system is a supplemental system that senses objects within the range and location of the sensors, it cannot detect objects in other areas where sensors are not installed.

#### **! WARNING**



- **ALWAYS** look around your vehicle to make sure there are not any objects or obstacles before moving the vehicle in any direction to prevent a collision.
- **Always** pay close attention when the vehicle is driven close to objects, particularly pedestrians, and especially children.
- **Be aware that some objects may not be visible on the screen or be detected by the sensors, due to the objects distance, size or material, all of which can limit the effectiveness of the sensor.**

### **Operation of the Rear Parking Assist System**

#### **Operating condition**

- This system will activate when backing up with the ignition switch in the ON position. However, if the vehicle speed exceeds 3 mph (5km/h), the system may not detect objects.
- If the vehicle speed exceeds 6 mph (10 km/h), the system will not warn you even though objects are detected.
- When more than two objects are sensed at the same time, the closest one will be recognized first.

## Types of warning sound and indicator

Types of warning sound	Indicator
When an object is 24 to 47 in (60 to 120 cm) from the rear bumper, the warning sound beeps intermittently.	
When an object is 12 to 24 in (30 to 60 cm) from the rear bumper, the warning sound beeps more frequently.	
When an object is within 12 in (30 cm) from the rear bumper, the warning sound beeps continuously.	

### NOTICE

- The indicator may differ from the illustration as objects or sensors status. If the indicator blinks, have your vehicle checked by an authorized HYUNDAI dealer.
- If the audible warning does not sound or if the buzzer sounds intermittently when shifting into R (Reverse) position, this may indicate a malfunction with the Parking Assist System. If this occurs, have your vehicle checked by an authorized HYUNDAI dealer as soon as possible.

## To turn off the Rear Parking Assist System

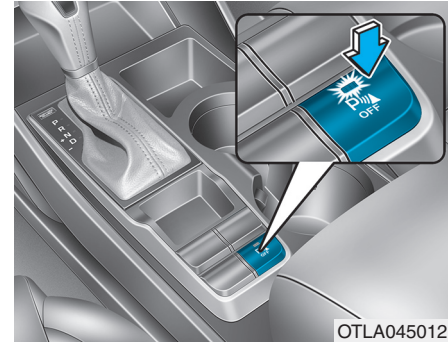

Push the button to turn off the Rear Parking Assist System. The indicator light on the button will turn on.



### ***Non-operational conditions of Parking Assist System***

#### **The Rear Parking Assist System may not operate normally when:**

- Moisture is frozen to the sensor.
- The sensor is covered with dirt or debris such as snow or ice, or the sensor cover is blocked.

#### **There is a possibility of the Rear Parking Assist System malfunction when:**

- Driving on uneven road surfaces such as unpaved roads, gravel, bumps, or gradient.
- Objects generating excessive noise such as vehicle horns, loud motorcycle engines, or truck air brakes can interfere with the sensor.
- Heavy rain or water spray is present.
- Wireless transmitters or mobile phones are present near the sensor.
- The sensor is covered with snow.
- Any non-factory equipment or accessories have been installed, or if the vehicle bumper height or sensor installation has been modified.

#### **Detecting range may decrease when:**

- Outside air temperature is extremely hot or cold.
- Undetectable objects smaller than 40 inches (1 m) and narrower than 6 inches (14 cm) in diameter.

#### **The following objects may not be recognized by the sensor:**

- Sharp or slim objects such as ropes, chains or small poles.
- Objects, which tend to absorb sensor frequency such as clothes, spongy material or snow.

## Rear parking assist system precautions

- The rear parking assist system may not operate consistently in some circumstances depending on the speed of the vehicle and the shapes of the objects detected.
- The rear parking assist system may malfunction if the vehicle bumper height or sensor installation has been modified or damaged. Any non-factory installed equipment or accessories may also interfere with the sensor performance.
- The sensor may not recognize objects less than 15 in. (40 cm) from the sensor, or it may sense an incorrect distance. Use caution.
- When the sensor is blocked with snow, dirt, debris, or ice, the rear parking assist system may be inoperative until the snow or ice melts, or the debris is removed. Use a soft cloth to wipe debris away from the sensor.
- Do not push, scratch or strike the sensor with any hard objects that could damage the surface of the sensor. Sensor damage could occur.

- Do not spray the sensors or its surrounding area directly with a high pressure washer. Doing so may cause the sensors to fail to operate normally.

### WARNING

**Your new vehicle warranty does not cover any accidents or damage to the vehicle or injuries to its occupants related to a Rear Parking Assist System. Always drive safely and cautiously.**

## DEFROSTER

### NOTICE

The rear window defroster is comprised of conductors bonded to the inside surface of the rear window. Never use sharp instruments or window cleaners that contain abrasives to clean the window. Damage to the rear window defroster may result.

If you want to defrost and defog the front windshield, refer to the "Windshield Defrosting and Defogging" section in this chapter.

### Rear Window Defroster

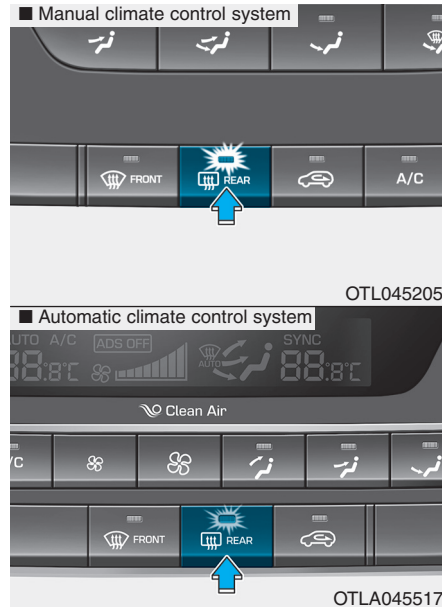

The defroster heats the window to remove frost, fog and thin ice from the interior and exterior of the rear window, while the engine is running.

- To activate the rear window defroster, press the rear window defroster button located on the climate control instrument panel display. The indicator on the rear window defroster button illuminates when the defroster is ON.
- To turn off the defroster, press the rear window defroster button again.

### **i** Information

- If there is heavy accumulation of snow on the rear window, brush it off before operating the rear defroster.
- The rear window defroster automatically turns off after approximately 20 minutes or when the ignition switch is in the LOCK/OFF position.

### *Outside rearview mirror defroster*

If your vehicle is equipped with the outside rearview mirror defrosters, they will operate at the same time you turn on the rear window defroster.

## MANUAL CLIMATE CONTROL SYSTEM (IF EQUIPPED)



1. Fan speed control knob
2. Temperature control knob
3. Mode selection buttons
4. Front windshield defroster button
5. Rear window defroster button
6. Air intake control button
7. A/C (Air conditioning) button

### Heating and Air Conditioning

1. Start the engine.
2. Set the mode to the desired position.

To improve the effectiveness of heating and cooling :

- Heating: 

- Cooling: 

3. Set the temperature control to the desired position.
4. Set the air intake control to the outside (fresh) air or recirculated air position.
5. Set the fan speed control to the desired speed.
6. If air conditioning is desired, turn the air conditioning system on.

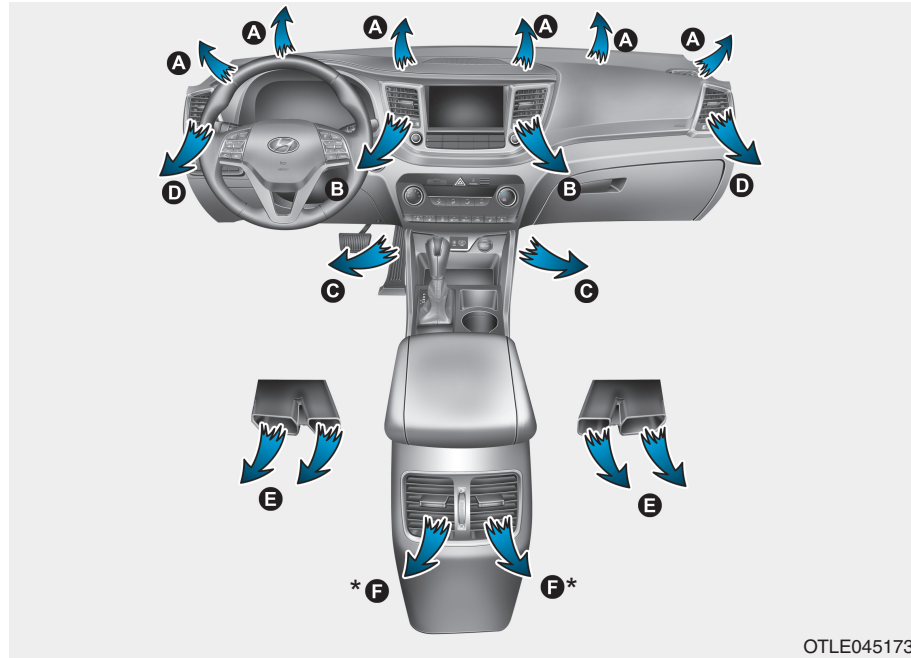

OTLE045173

\* : if equipped

## Mode selection



OTL045208

The mode selection button controls the direction of the air flow through the ventilation system.

Air can be directed to the floor, dashboard outlets, or windshield. Four symbols are used to represent Face, Bi-Level, Floor, Floor-Defrost and Front Defrost air position



### Face-Level (B, D, F)

Air flow is directed toward the upper body and face. Additionally, each outlet can be controlled to direct the air discharged from the outlet.



### Bi-Level (B, D, C, E, F)

Air flow is directed towards the face and the floor.



### Floor-Level (A, C, D, E, F)

Most of the air flow is directed to the floor, with a small amount of the air being directed to the windshield, side window defrosters, and side vents.



### Floor & Defrost (A, C, D, E, F)

Most of the air flow is directed to the floor and the windshield with a small amount directed to the side window defrosters, and side vents.



### Front Air Defrost (A, D)

Most of the air flow is directed to the windshield with a small amount of air directed to the side window defrosters.

In this mode the air conditioning and the recirculated air position will be selected automatically.

### **MAX A/C-Level (B, D)**

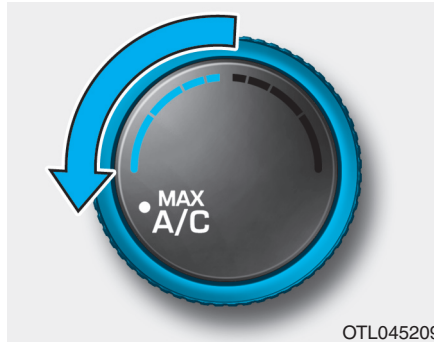

The MAX A/C mode is used to cool the inside of the vehicle faster. Air flow is directed toward the upper body and face.

In this mode, the air conditioning and the recirculated air position will be selected automatically.

### **Instrument panel vents**

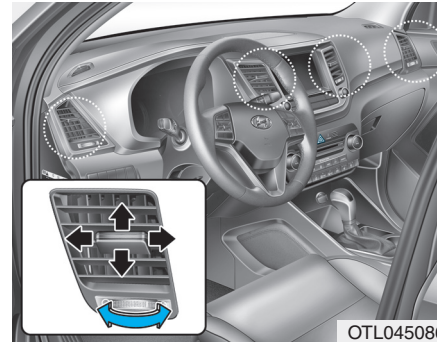

The outlet vents can be opened (☰) or closed (○) separately using the thumbwheel.

Also, you can adjust the direction of air delivered from these vents using the vent control lever as shown.

### **Temperature control**

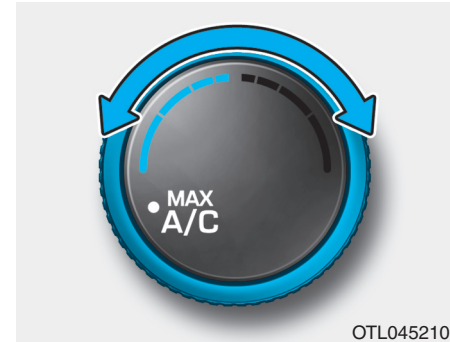

The temperature will increase by turning the knob to the right.

The temperature will decrease by turning the knob to the left.

## Air intake control



This button is used to select the outside (fresh) air position or recirculated air position.

## Recirculated air position



The indicator light on the button illuminates when the recirculated air position is selected.

With the recirculated air position selected, air from the passenger compartment will be drawn through the climate control system and heated or cooled according to the function selected.

## Outside (fresh) air position



The indicator light on the button will turn off when the outside (fresh) air position is selected.

With the outside (fresh) air position selected, air enters the vehicle from outside and is heated or cooled according to the function selected.

## Information

**Prolonged use of the air conditioning with the recirculated air position selected will result in excessively dry air in the passenger compartment.**



**⚠ WARNING**

- Continued use of the climate control system operation in the recirculated air position can cause drowsiness or sleepiness, that may cause loss of vehicle control resulting in an accident. Set the air intake control to the outside (fresh) air position as much as possible while driving.
- Continued use of the climate control system operation in the recirculated air position (without the air conditioning selected) may allow humidity to increase inside the vehicle which may fog the glass and obscure visibility.
- Do not sleep in a vehicle with the air conditioning or heating system on. It may cause serious injury or death due to a drop in the oxygen level and/or body temperature.

**Fan speed control**



OTL045212

Turn the knob to the right to increase the fan speed and airflow. Turn the knob to the left to decrease fan speed and airflow.

Setting the fan speed control knob to the “0” position turns off the fan.

**Air conditioning**



OTL045213

Press the A/C button to turn the system on (indicator light will illuminate) and off.

## System Operation

### Ventilation

1. Select the Face Level  mode.
2. Set the air intake control to the outside (fresh) air position.
3. Set the temperature control to the desired position.
4. Set the fan speed control to the desired speed.

### Heating

1. Select the Floor Level  mode.
2. Set the air intake control to the outside (fresh) air position.
3. Set the temperature control to the desired position.
4. Set the fan speed control to the desired speed.
5. If dehumidified heating is desired, turn the air conditioning system on.

If the windshield fogs up, select the Floor & Defrost  mode or press the Front Defrost  mode.

### Operation Tips

- To keep dust or unpleasant fumes from entering the car through the ventilation system, temporarily set the air intake control to the recirculated air position. Return the control to the fresh air position when the dust or odor has dissipated. This will help keep the driver alert and comfortable.
- To prevent the inside of the windshield from fogging, set the air intake control to the fresh air position and fan speed to the desired position, turn on the air conditioning system, and adjust the temperature control to desired temperature.

### Air conditioning

All HYUNDAI Air Conditioning Systems are filled with environmentally friendly R-134a refrigerant.

1. Start the engine.
2. Push the air conditioning button.
3. Set the mode to the Face Level  mode.
4. Set the air intake control to the recirculated air position. However, prolonged operation of the recirculated air position will excessively dry the air. In this case, switch the air intake control to the outside (fresh) air position. The indicator light on the button will turn OFF.
5. Adjust the fan speed control and temperature control to maintain maximum comfort.

When maximum cooling is desired, rotate the temperature control knob to the left-most position (MAX AC). Then set the fan speed control knob to the highest speed.

### **NOTICE**

**When using the air conditioning system, monitor the engine temperature gauge closely while driving up hills or in heavy traffic when outside temperatures are high. Air conditioning system operation can cause engine overheating. Continue to use the blower fan, but turn the air conditioning system off if the engine temperature gauge indicates engine overheating.**

### **Air conditioning system operation tips**

- If the vehicle has been parked in direct sunlight during hot weather, open the windows for a short time to let the hot air inside the vehicle escape.
  - After sufficient cooling has been achieved, switch back from the recirculated air to the fresh outside air position.
  - To help reduce moisture inside of the windows on rainy or humid days, decrease the humidity inside the vehicle by operating the air conditioning system with the windows and sunroof closed.
  - Use the air conditioning system every month for a few minutes to ensure maximum system performance.
- If you operate the air conditioner excessively, the difference between the temperature of the outside air and that of the windshield could cause the outer surface of the windshield to fog up, causing loss of visibility. In this case, set the mode selection button to the  position and set the fan speed control knob to the lowest speed setting.

## System Maintenance

### Climate control air filter

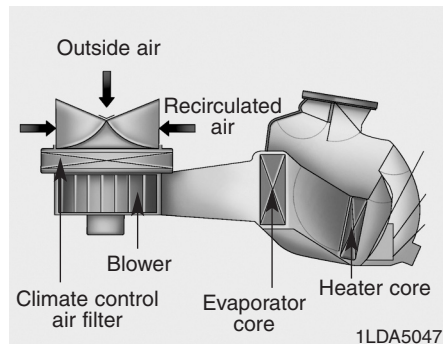

This filter is installed behind the glove box. It filters the dust or other pollutants that enter the vehicle through the heating and air conditioning system.

Have the climate control air filter replaced by an authorized HYUNDAI dealer according to the maintenance schedule. If the car is being driven in severe conditions such as dusty or rough roads, more frequent climate control filter inspections and changes are required.

If the air flow rate suddenly decreases, the system should be checked at an authorized HYUNDAI dealer.

### Checking the amount of air conditioner refrigerant and compressor lubricant

When the amount of refrigerant is low, the performance of the air conditioning is reduced. Overfilling also has a negative influence on the air conditioning system.

Therefore, if abnormal operation is found, have the system inspected by an authorized HYUNDAI dealer.

#### NOTICE

**It is important that the correct type and amount of oil and refrigerant is used. Otherwise, damage to the compressor and abnormal system operation may occur.**

#### ⚠ WARNING



**Because the refrigerant is at very high pressure, the air conditioning system should only be serviced by trained and certified technicians. It is important that the correct type and amount of oil and refrigerant is used, otherwise damage to the vehicle and personal injury may occur.**

The air conditioning system should be serviced by an authorized HYUNDAI dealer.

### **Air Conditioning refrigerant label**

■ Example

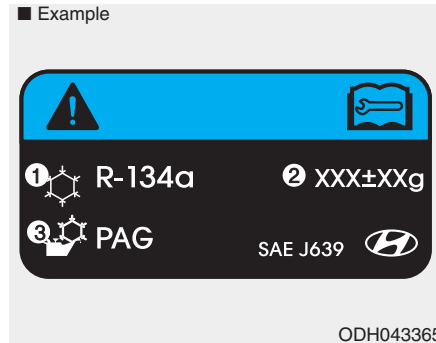

The actual Air Conditioning refrigerant label in the vehicle may differ from the illustration.

The symbols and specifications on the label refer to the following:

1. Classification of refrigerant
2. Amount of refrigerant
3. Classification of Compressor lubricant

Refer to chapter 8 for more detail location of the air conditioning refrigerant label.

## AUTOMATIC CLIMATE CONTROL SYSTEM

### ■ Type A



1. Driver's temperature control knob
2. Passenger's temperature control knob
3. AUTO (automatic control) button
4. SYNC button
5. OFF button
6. Fan speed control button
7. Mode selection button
8. Air conditioning button
9. Front windshield defrost button
10. Rear window defrost button
11. Air intake control button
12. Climate control information screen

### ■ Type B



OTLE045267R/OTLE045266R

### Automatic Heating and Air Conditioning



The Automatic Climate Control System is controlled by setting the desired temperature.

1. Press the AUTO button.

The modes, fan speeds, air intake and air-conditioning will be controlled automatically by the temperature setting you select.



2. Turn the temperature control knob to the desired temperature. If the temperature is set to the lowest setting (Lo), the air conditioning system will operate continuously.

To turn the automatic operation off, select any button of the following:

- Mode selection button
- Front windshield defroster button (Press the button one more time to deselect the front windshield defroster function. The 'AUTO' sign will illuminate on the information display once again.)
- Fan speed control button

The selected function will be controlled manually while other functions operate automatically.

For your convenience and to improve the effectiveness of the climate control, use the AUTO button and set the temperature to 73°F (23°C).



#### NOTICE

**A solar compensation sensor is located inside the vehicle on the center of the dash near the front windshield. In order to ensure optimum control of the heating and cooling system, never block the sensor or place anything near the sensor while the climate control system is operating.**



## Manual Heating and Air Conditioning

The heating and cooling system can be controlled manually by pushing buttons other than the AUTO button. In this case, the system works sequentially according to the order of buttons selected.

When pressing any button except the AUTO button while using automatic operation, the functions not selected will be controlled automatically.

1. Start the engine.
2. Set the mode to the desired position.

To improve the effectiveness of heating and cooling:

- Heating: 
- Cooling: 

3. Set the temperature control to the desired position.
4. Set the air intake control to the outside (fresh) air position.
5. Set the fan speed control to the desired speed.
6. If air conditioning is desired, turn the air conditioning system on.
7. Press the AUTO button in order to convert to full automatic control of the system.



## Convenient features of your vehicle

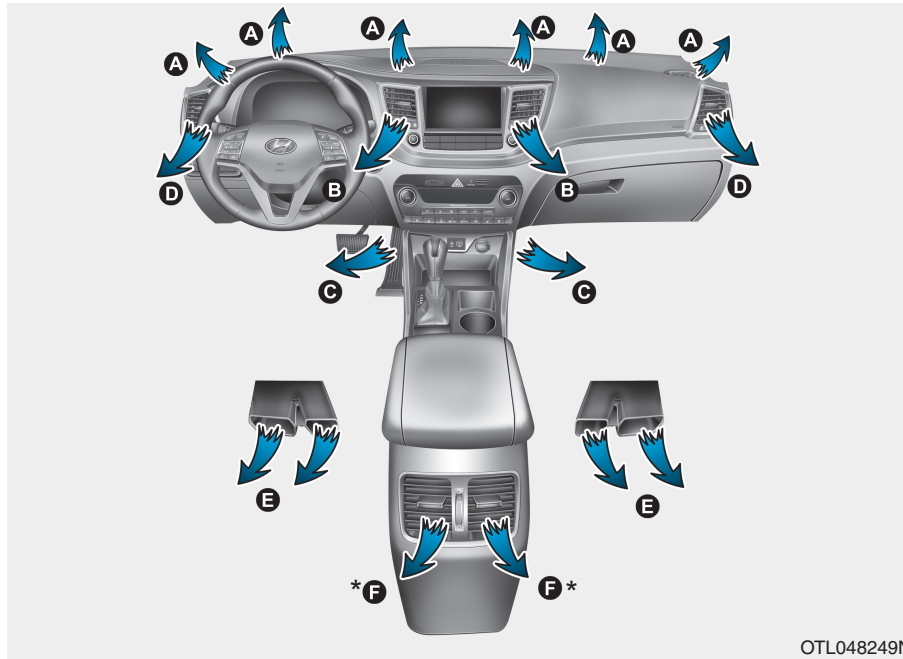

\* : if equipped

## Mode selection

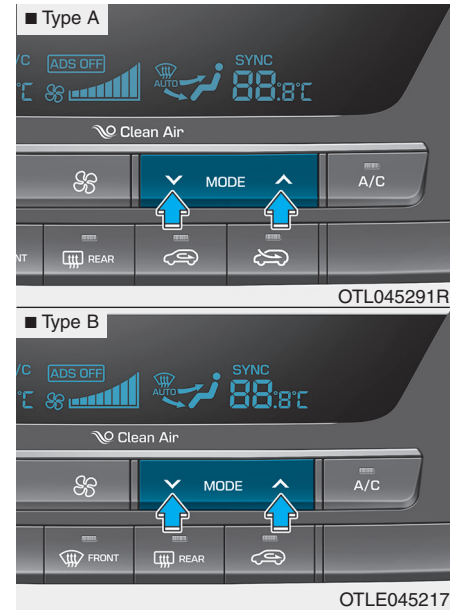

The mode selection button controls the direction of the air flow through the ventilation system.

The air flow outlet direction is cycled as follows:



### Face-Level (B, D, F)

Air flow is directed toward the upper body and face. Additionally, each outlet can be controlled to direct the air discharged from the outlet.

### Bi-Level (B, C, D, E, F)

Air flow is directed towards the face and the floor.

### Floor & Defrost (A, C, D, E, F)

Most of the air flow is directed to the floor and the windshield with a small amount directed to the side window defrosters.

### Floor-Level (A, C, D, E, F)

Most of the air flow is directed to the floor, with a small amount of the air being directed to the windshield and side window defrosters.

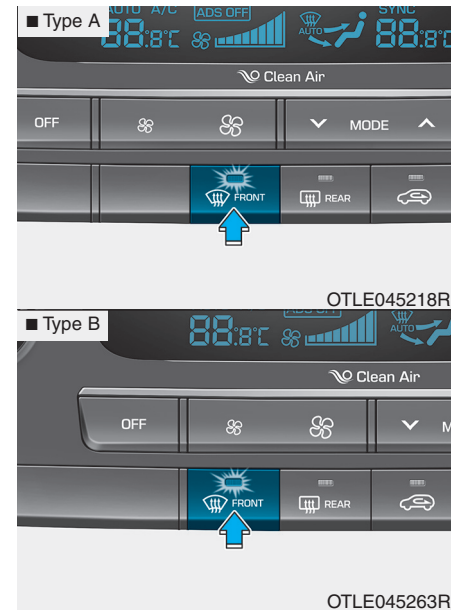

### Defrost-Level (A)

Most of the air flow is directed to the windshield with a small amount of air directed to the side window defrosters.

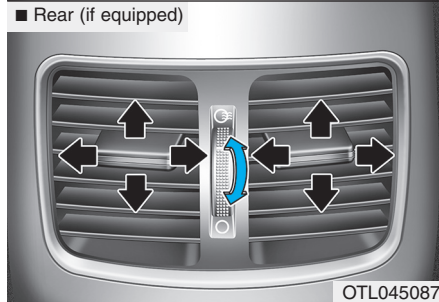
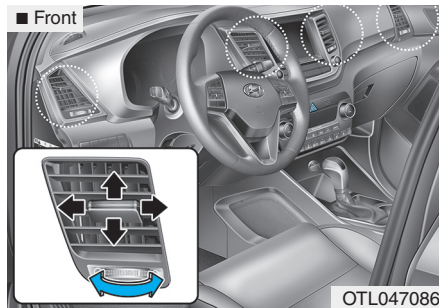

### Instrument panel vents

The outlet vents can be opened (☰) or closed (○) separately using the thumbwheel.

Also, you can adjust the direction of air delivered from these vents using the vent control lever as shown.

## Temperature control

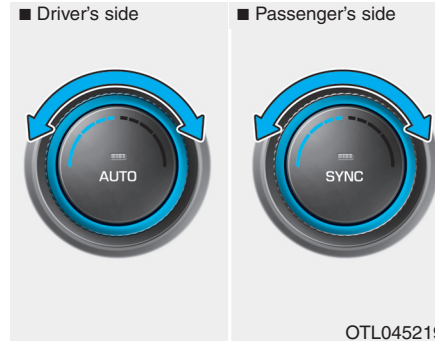

Turn the knob to the right to increase the temperature. Turn the knob to the left to decrease the temperature.

The temperature will increase or decrease by 1°F/0.5°C for each button press. When set to the lowest temperature setting, the air conditioning will operate continuously.



### Adjusting the driver and passenger side temperature equally

- Press the "SYNC" button to operate the driver and passenger side temperature equally.

The passenger side temperature will be set to the same temperature as the driver side temperature.

- Turn the left temperature control knob. The driver and passenger side temperature will be adjusted equally.

### Adjusting the driver and passenger side temperature individually

Press the "SYNC" button again to operate the driver and passenger side temperature individually. The button indicator will turn off.

### Temperature conversion

If the battery has been discharged or disconnected, the temperature mode display will reset to Fahrenheit.

To change the temperature unit from °F to °C or °C to °F:

- On the instrument cluster, go to User Settings Mode → Other Features → Temperature Unit.
- Press the AUTO button for 3 seconds while pressing the OFF button. (Automatic climate control system)

Both the temperature unit on the cluster LCD display and climate control screen will change.

### Air intake control

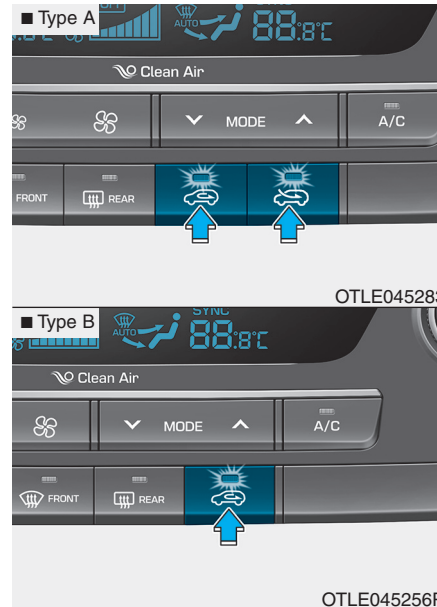

This button is used to select the outside (fresh) air position or recirculated air position.

### Recirculated air position



With the recirculated air position selected, air from the passenger compartment will be drawn through the heating system and heated or cooled according to the function selected.

### Outside (fresh) air position

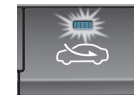

With the outside (fresh) air position selected, air enters the vehicle from outside and is heated or cooled according to the function selected.

### **i** Information

**Prolonged use of the air conditioning with the recirculated air position selected will result in excessively dry air in the passenger compartment.**

**⚠ WARNING**

- Continued use of the climate control system operation in the recirculated air position can cause drowsiness or sleepiness, that may cause loss of vehicle control resulting in an accident. Set the air intake control to the outside (fresh) air position as much as possible while driving.
- Continued use of the climate control system operation in the recirculated air position (without the air conditioning selected) may allow humidity to increase inside the vehicle which may fog the glass and obscure visibility.
- Do not sleep in a vehicle with the air conditioning or heating system on. It may cause serious injury or death due to a drop in the oxygen level and/or body temperature.

**Fan speed control**

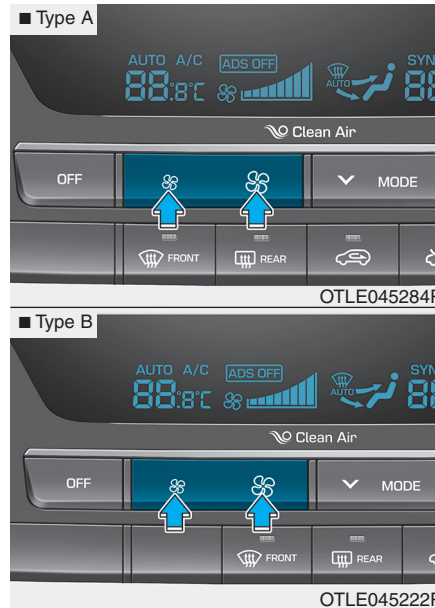

The fan speed can be set to the desired speed by pushing the fan speed control button. Pressing the OFF button turns off the fan.

**i Information**

For better sound quality, fan speed may automatically slow down for a couple of minutes when you activate voice recognition or hands free.

## Air conditioning



OTLE045286R



OTLE045223R

Push the A/C button to manually turn the system on (indicator light will illuminate) and off.

## OFF mode



OTLE045285R



OTLE045224R

Push the OFF button of the front to turn off the air climate control system. You can still operate the mode and air intake buttons as long as the ignition switch is in the ON position.

## System Operation

### Ventilation

1. Select the Face Level  mode.
2. Set the air intake control to the outside (fresh) air position.
3. Set the temperature control to the desired position.
4. Set the fan speed control to the desired speed.

### Heating

1. Select the Floor Level  mode.
2. Set the air intake control to the outside (fresh) air position.
3. Set the temperature control to the desired position.
4. Set the fan speed control to the desired speed.
5. If dehumidified heating is desired, turn the air conditioning system on.

If the windshield fogs up, select the Floor & Defrost  mode or press the Front Defrost  mode.

### Operation Tips

- To keep dust or unpleasant fumes from entering the car through the ventilation system, temporarily set the air intake control to the recirculated air position. Return the control to the fresh air position when the dust or odor has dissipated. This will help keep the driver alert and comfortable.
- To prevent the inside of the windshield from fogging, set the air intake control to the fresh air position and fan speed to the desired position, turn on the air conditioning system, and adjust the temperature control to desired temperature.

### Air conditioning

All HYUNDAI Air Conditioning Systems are filled with environmentally friendly R-134a refrigerant.

1. Start the engine.
2. Push the air conditioning button.
3. Set the mode to the Face Level  mode.
4. Set the air intake control to the recirculated air position. However, prolonged operation of the recirculated air position will excessively dry the air. In this case, switch the air intake control to the outside (fresh) air position.
5. Adjust the fan speed control and temperature control to maintain maximum comfort.

When maximum cooling is desired, rotate the temperature control knob until the temperature display indicates Lo. Then set the fan speed control button to the highest speed.

### NOTICE

**When using the air conditioning system, monitor the engine temperature gauge closely while driving up hills or in heavy traffic when outside temperatures are high. Air conditioning system operation can cause engine overheating. Continue to use the blower fan, but turn the air conditioning system off if the engine temperature gauge indicates engine overheating.**

### Air conditioning system operation tips

- If the vehicle has been parked in direct sunlight during hot weather, open the windows for a short time to let the hot air inside the vehicle escape.
  - After sufficient cooling has been achieved, switch back from the recirculated air to the fresh outside air position.
  - To help reduce moisture inside of the windows on rainy or humid days, decrease the humidity inside the vehicle by operating the air conditioning system with the windows and sunroof closed.
  - Use the air conditioning system every month for a few minutes to ensure maximum system performance.
- If you operate the air conditioner excessively, the difference between the temperature of the outside air and that of the windshield could cause the outer surface of the windshield to fog up, causing loss of visibility. In this case, toggle the mode selection button to the  position and set the fan speed control knob to the lowest speed setting.

## System Maintenance

### Climate control air filter

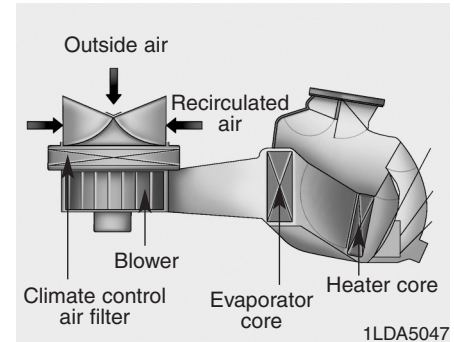

This filter is installed behind the glove box. It filters the dust or other pollutants that enter the vehicle through the heating and air conditioning system.

Have the climate control air filter replaced by an authorized HYUNDAI dealer according to the maintenance schedule. If the car is being driven in severe conditions such as dusty or rough roads, more frequent climate control air filter inspections and changes are required.

If the air flow rate suddenly decreases, the system should be checked at an authorized HYUNDAI dealer.



### **Checking the amount of air conditioner refrigerant and compressor lubricant**

When the amount of refrigerant is low, the performance of the air conditioning is reduced. Overfilling also has a negative influence on the air conditioning system.

Therefore, if abnormal operation is found, have the system inspected by an authorized HYUNDAI dealer.

#### **NOTICE**

**It is important that the correct type and amount of oil and refrigerant is used. Otherwise, damage to the compressor and abnormal system operation may occur.**

**⚠ WARNING**



**Because the refrigerant is at very high pressure, the air conditioning system should only be serviced by trained and certified technicians. It is important that the correct type and amount of oil and refrigerant is used, otherwise damage to the vehicle and personal injury may occur.**

The air conditioning system should be serviced by an authorized HYUNDAI dealer.

### **Air Conditioning refrigerant label**

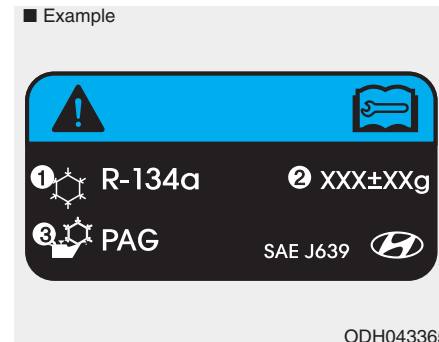

The actual Air Conditioning refrigerant label in the vehicle may differ from the illustration.

The symbols and specifications on the label refer to the following:



1. Classification of refrigerant
2. Amount of refrigerant
3. Classification of Compressor lubricant

Refer to chapter 8 for more detail location of the air conditioning refrigerant label.

## WINDSHIELD DEFROSTING AND DEFOGGING

### ⚠ WARNING

#### Windshield heating

Do not use the  or  position during cooling operation in extremely humid weather. The difference between the temperature of the outside air and that of the windshield could cause the outer surface of the windshield to fog up, causing loss of visibility could cause an accident resulting in serious injury or death. In this case, set the mode selection knob or button to the  position and fan speed control knob or button to a lower speed.

- For maximum windshield defrosting, set the temperature control knob to the highest temperature setting and the fan control knob to the highest fan speed. Select the front defrost button on the climate control display. After the engine warm-up period, warm air will be directed to the front windshield.
- If warm air to the floor is desired while defrosting or defogging, set the mode to the floor-defrost position.
- Before driving, clear all snow and ice from the windshield, rear window, outside rear view mirrors, and all side windows.
- Clear all snow and ice from the hood and air inlet in the cowl grill to improve heater and defroster efficiency and to reduce the probability of fogging up the inside of the windshield.



### NOTICE

If the engine temperature is still cold after starting, then a brief engine warm up period may be required for the vented air flow to become warm or hot.

## Manual Climate Control System

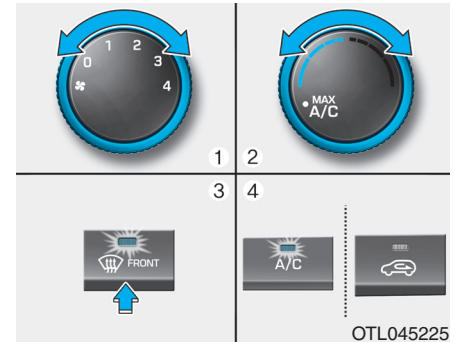
### To defog inside windshield



1. Select any fan speed except "0" position.
2. Select desired temperature.
3. Select the  or  position.
4. The outside (fresh) air will be selected automatically. Additionally, the air conditioning will automatically operate if the mode is selected to the  position.

If the air conditioning and outside (fresh) air position are not selected automatically, press the corresponding button manually.

**To defrost outside windshield**

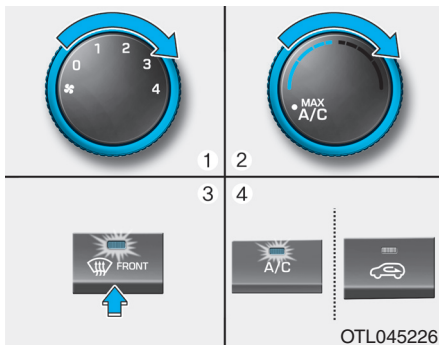

1. Set the fan speed to the highest (extreme right) position.
2. Set the temperature to the extreme hot position.
3. Select the position.
4. The outside (fresh) air and air conditioning will be selected automatically.

**Automatic Climate Control System**

**To defog inside windshield**

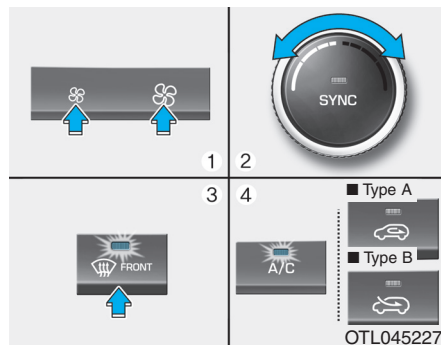

1. Select desired fan speed.
2. Set the temperature to the extreme hot position.
3. Press the defroster button ().
4. The outside (fresh) air position will be selected automatically.

If the outside (fresh) air position is not selected automatically, adjust the corresponding button manually.

If the position is selected, lower fan speed is adjusted to a higher fan speed.

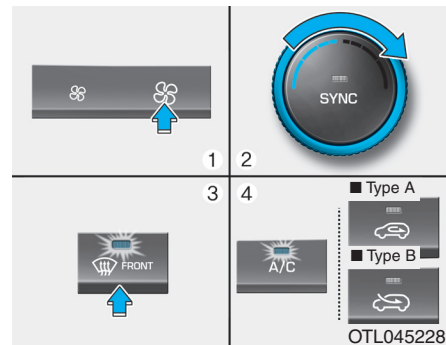

**To defrost outside windshield**



1. Set the fan speed to the highest (extreme right) position.
2. Set the temperature to the extreme hot (HI) position.
3. Press the defroster button ().
4. The outside (fresh) air position will be selected automatically.

If the position is selected, lower fan speed is adjusted to a higher fan speed.

## Defogging logic

To reduce the probability of fogging up the inside of the windshield, the air intake or air conditioning are controlled automatically according to certain conditions such as  or  position. To cancel or return the defogging logic, do the following.

### Manual climate control system

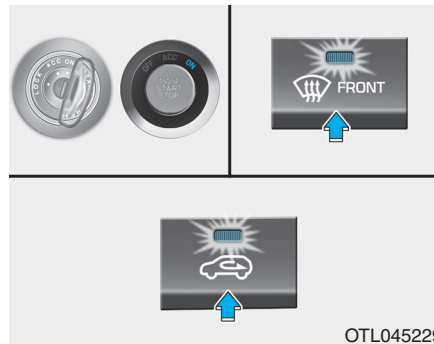



1. Turn the ignition switch to the ON position.
2. Press the defroster button () .
3. While pressing the air conditioning button (A/C), press the air intake control button at least 5 times within 3 seconds.

The indicator on the air intake button blinks 3 times in 0.5 second intervals. This indicates that the defogging logic is cancelled.

If the battery has been discharged or disconnected, the defogging logic will be enabled as the default logic.

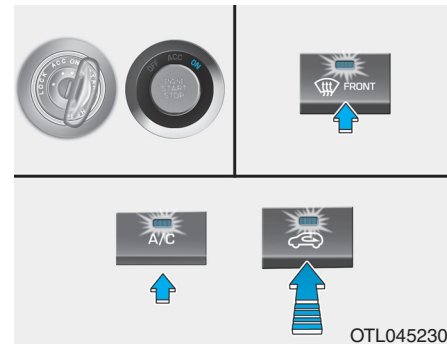
### Automatic climate control system



1. Turn the ignition switch to the ON position.
2. Press the defroster button () .
3. While pressing the air conditioning button (A/C), press the air intake control button at least 5 times within 3 seconds.

The climate control information screen will blink 3 times in 0.5 second intervals. This indicates that the defogging logic is cancelled.

If the battery has been discharged or disconnected, the defogging logic will be enabled as the default logic.

## CLIMATE CONTROL ADDITIONAL FEATURES

### Automatic Ventilation

When the ignition is ON or when the engine is running and the outside temperature is below 59°F (15°C), the automatic ventilation feature will activate if the recirculated air intake position is selected for more than 5 minutes while A/C is off and floor mode is selected. In this condition the air intake position will automatically switch to the outside (fresh) air intake position.

### To cancel or reset the Automatic Ventilation

When the air conditioning system is on, select Face Level  mode and while pressing the A/C button, press the recirculated air position button five times within three seconds.

### Sunroof Inside Air Recirculation

When the heater or air conditioning system is on with the sunroof opened, the outside (fresh) air position will be automatically selected. At this time, if you press the recirculated air position button, the recirculated air position will be selected but will change back to the outside (fresh) air position after 3 minutes.

When the sunroof is closed, the air intake position will return to the original position that was selected.

## STORAGE COMPARTMENT

### ⚠ WARNING

Never store cigarette lighters, propane cylinders, or other flammable/explosive materials in the vehicle. These items may catch fire and/or explode if the vehicle is exposed to hot temperatures for extended periods.

### ⚠ WARNING

**ALWAYS** keep the storage compartment covers closed securely while driving. Items inside your vehicle are moving as fast as the vehicle. If you have to stop or turn quickly, or if you are involved in an accident the items may fly out of the compartment and may cause an injury if they strike the driver or passenger.

### NOTICE

To avoid possible theft, do not leave valuables in the storage compartments.

## Center Console Storage

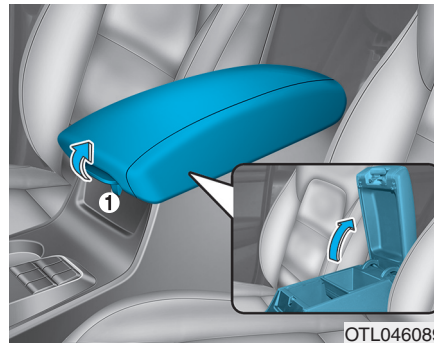

To open :  
Pull the lever (1).

## Glove Box

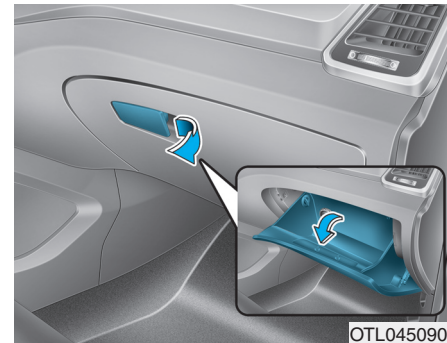

To open the glove box, pull the handle and the glove box will automatically open. Close the glove box after use.

### ⚠ WARNING

**ALWAYS** close the glove box door after use.

An open glove box door can cause serious injury to the passenger in an accident, even if the passenger is wearing a seat belt.

### Sunglass Holder

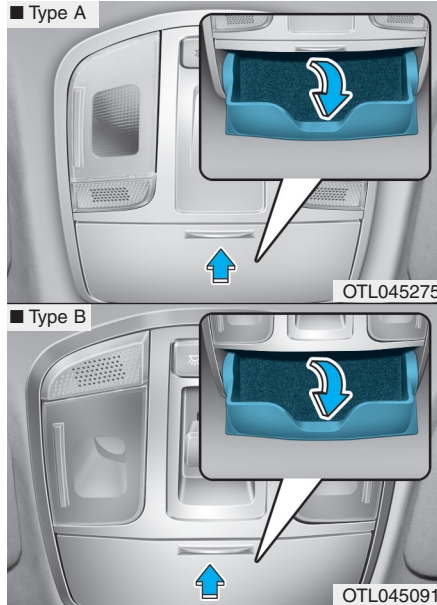

To open:

Press the cover and the holder will slowly open. Place your sunglasses in the compartment door with the lenses facing out.

To close:

Push back into position.

Make sure the sunglass holder is closed while driving.

#### **⚠ WARNING**

- Do not keep objects except sunglasses inside the sunglass holder. Such objects can be thrown from the holder in the event of a sudden stop or an accident, possibly injuring the passengers in the vehicle.
- Do not open the sunglass holder while the vehicle is moving. The rear view mirror of the vehicle can be blocked by an open sunglass holder.
- Do not attempt to force sunglasses into the sunglass holder. If the sunglasses become jammed and you try to open it forcibly, personal injury may occur.

## INTERIOR FEATURES

### Cup Holder

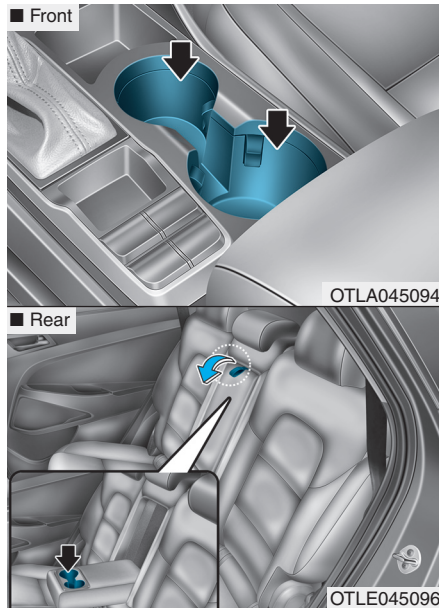

Cups or small beverages cups may be placed in the cup holders.

#### *Rear*

Pull the armrest down to use the cup holders.

#### **⚠ WARNING**

- Avoid abrupt acceleration or braking while driving your vehicle when the cup holder is in use to prevent spilling your drink. If hot liquid spills, you could be burned. Such a burn to the driver could cause loss of vehicle control resulting in an accident.
- Do not place uncovered or unsecured cups, bottles, cans, etc., in the cup holder containing hot liquid while the vehicle is in motion. Injuries may result in the event of sudden stop or collision.

#### **⚠ WARNING**

Keep cans or bottles out of direct sunlight and do not leave them in a hot vehicle. Doing so may cause the can or bottle to overheat and explode.

#### **NOTICE**

- Keep your drinks sealed while driving to prevent spilling your drink. If liquid spills, it may get into the vehicle's electrical/electronic system and damage electrical/electronic parts.
- When cleaning spilled liquids, do not dry the cup holder at high temperature. This may damage the cup holder.



### Sunvisor

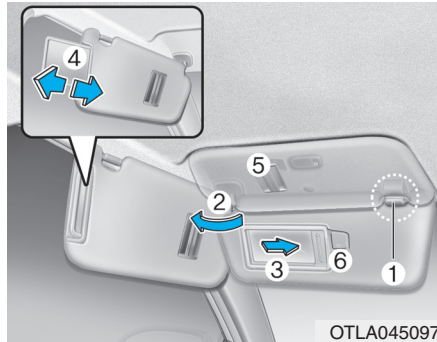

To use the sunvisor, pull it downward.

To use the sunvisor, for a side window, pull it downward, unsnap it from the bracket (1) and swing it to the side (2).

To use the vanity mirror, pull down the sunvisor and slide the mirror cover (3).

Adjust the sunvisor forward or backward (4) as needed. Use the ticket holder (5) to hold tickets.

#### NOTICE

Close the vanity mirror cover securely and return the sunvisor to its original position after use.

#### ⚠ WARNING

For your safety, do not block your view when using the sunvisor.

#### NOTICE

- Do not put several tickets in the ticket holder at one time. This could cause damage to the ticket holder.
- Avoid putting a plastic card such as a credit card in the ticket holder located in the outside of the sunvisor. This could cause damage to the plastic card.

### Power Outlet

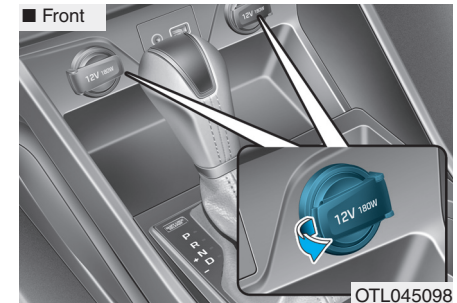

#### ■ Rear (if equipped)



The power outlet is designed to provide power for mobile telephones or other devices designed to operate with vehicle electrical systems. The devices should draw less than 180 W with the engine running.

 **WARNING**

Avoid electrical shocks. Do not place your fingers or foreign objects (pin, etc.) into a power outlet or touch the power outlet with a wet hand.

**NOTICE**

To prevent damage to the Power Outlets :

- Use the power outlet only when the engine is running and remove the accessory plug after use. Using the accessory plug for prolonged periods of time with the engine off could cause the battery to discharge.
- Only use 12V electric accessories which are less than 180 W in electric capacity.
- Adjust the air-conditioner or heater to the lowest operating level when using the power outlet.

(Continued)

(Continued)

- Close the cover when not in use.
- Some electronic devices can cause electronic interference when plugged into a vehicle's power outlet. These devices may cause excessive audio static and malfunctions in other electronic systems or devices used in your vehicle.
- Push the plug in as far as it will go. If good contact is not made, the plug may overheat and the fuse may blow.
- Plug in battery equipped electrical/electronic devices with reverse current protection. The current from the battery may flow into the vehicle's electrical/electronic system and cause system malfunction.

### Clock

You can set the clock by using the AVN (Audio & Navigation).

For more information, refer to the "Multimedia System" in chapter 4 or Navigation System (AVN) Manual that was supplied with your vehicle.

#### WARNING

**Do not adjust the clock while driving, you may lose your steering control and cause an accident that results in severe personal injury or death.**

### Clothes Hanger

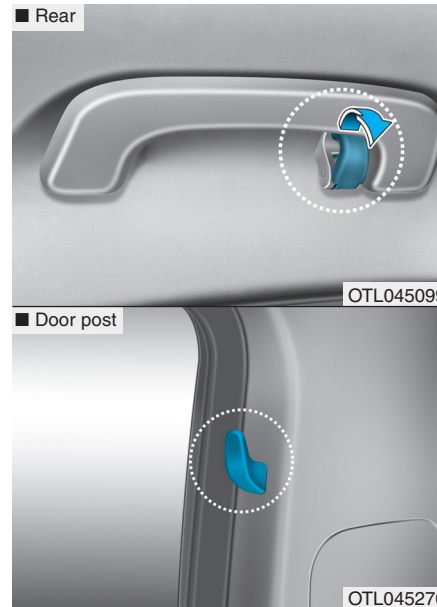

To hang items, pull the hanger down. These hangers are not designed to hold large or heavy items.

#### WARNING

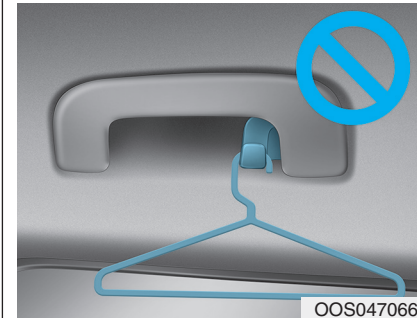

**Do not hang other objects such as hangers or hard objects except clothes. Also, do not put heavy, sharp or breakable objects in the clothes pockets. In an accident or when the curtain air bag is inflated, it may cause vehicle damage or personal injury.**

## Plastic bag hook



To hang a plastic bag, open the tailgate and find a hook attached on rear seat back.

### WARNING

**Do not hang other objects except a plastic bag. In an accident it may cause vehicle damage or personal injury.**

## Floor Mat Anchor(s)

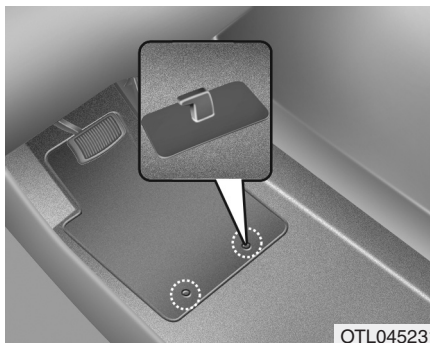

**ALWAYS** use the Floor Mat Anchors to attach the front floor mats to the vehicle. The anchors on the front floor carpet keep the floor mats from sliding forward.

### WARNING

The following must be observed when installing ANY floor mat to the vehicle.

- Ensure that the floor mats are securely attached to the vehicle's floor mat anchor(s) before driving the vehicle.
- Do not use ANY floor mat that cannot be firmly attached to the vehicle's floor mat anchors.
- Do not stack floor mats on top of one another (e.g. all-weather rubber mat on top of a carpeted floor mat). Only a single floor mat should be installed in each position.

**IMPORTANT** - Your vehicle was manufactured with driver's side floor mat anchors that are designed to securely hold the floor mat in place. To avoid any interference with pedal operation, HYUNDAI recommends that the HYUNDAI floor mat designed for use in your vehicle be installed.

### Luggage net (holder)



To keep items from shifting in the cargo area, you can use the four holders located in the cargo area to attach the luggage net.

If your vehicle did not come with a luggage net, contact your authorized HYUNDAI dealer to inquire and obtain one.

### ⚠ CAUTION

To prevent damage to the goods or the vehicle, care should be taken when carrying fragile or bulky objects in the luggage compartment.

### ⚠ WARNING

To avoid eye injury, **DO NOT** overstretch the luggage net. **ALWAYS** keep your face and body out of the luggage net's recoil path. **DO NOT** use the luggage net when the strap has visible signs of wear or damage.

### Cargo security screen (if equipped)

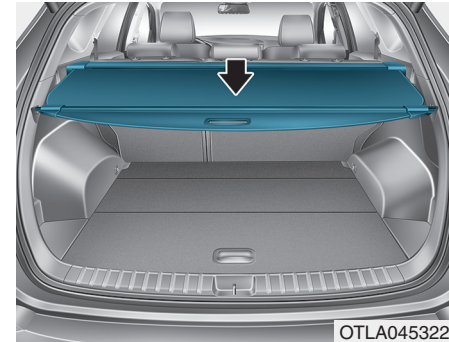

Use the cargo security screen to cover items stored in the cargo area.

### To use the cargo security screen

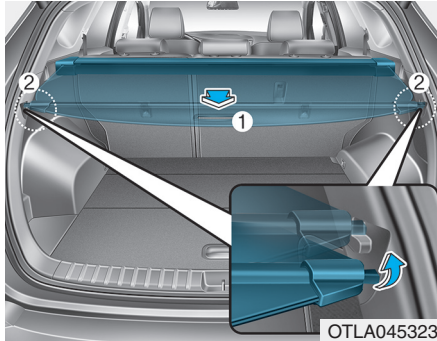

1. Pull the cargo security screen towards the rear of the vehicle by the handle (1).
2. Pull the cargo screen out all the way and then slowly allow the screen to retract back into the mechanism.

When the cargo security screen is not in use:

1. Pull the cargo security screen backward and up to release it from the guides.
2. The cargo security screen will automatically slide back in.

#### NOTICE

The cargo security screen may not automatically slide back in if the cargo security screen is not fully pulled out. Pull the cargo screen out all the way and then slowly allow the screen to retract back into the mechanism.

### To remove the cargo security screen

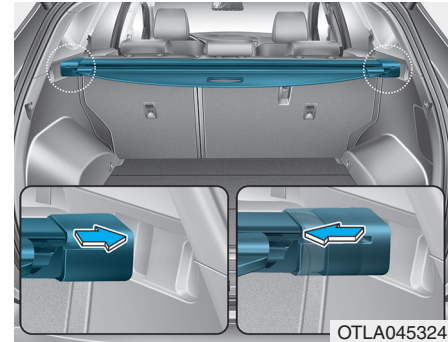

1. Push one side of the cargo screen inward to compress the spring mechanism and release the screen from the vehicle.
2. While the mechanism is compressed, pull out the cargo security screen.

## Convenient features of your vehicle

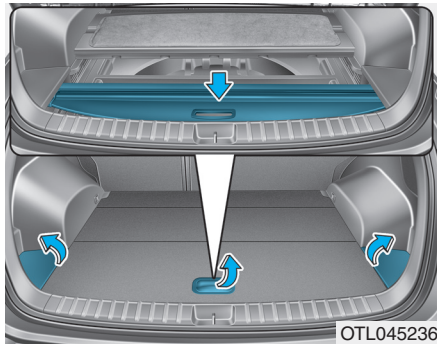

3. Open the luggage tray and keep the cargo security screen in the tray.

**To remove the cargo security screen from the luggage tray**

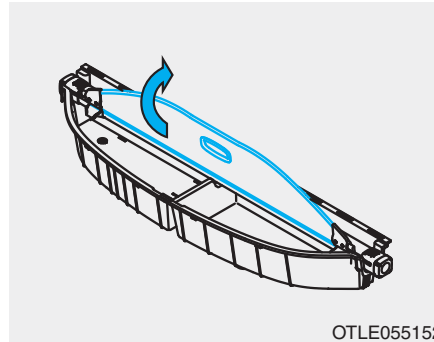

1. Pull up the screen board.

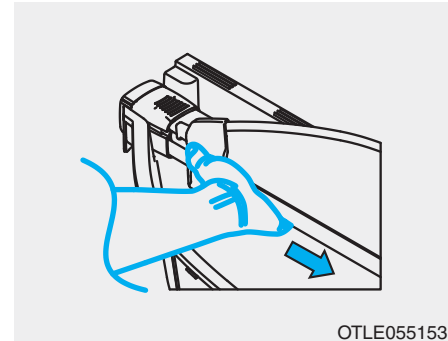

2. Push in the guide pin.



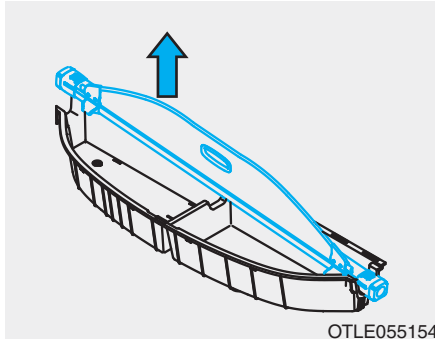

OTLE055154

3. While pushing the guide pin, pull out the cargo security screen.

#### CAUTION

Since the cargo security screen may be damaged or malformed, do not put luggage on it when it is used.

#### WARNING

- Do not place objects on the cargo security screen. Such objects may be thrown about inside the vehicle and possibly injure vehicle occupants during an accident or when braking.
- Never allow anyone to ride in the luggage compartment. It is designed for luggage only.
- Maintain the balance of the vehicle and locate the weight as forward as possible.

#### Luggage tray (if equipped)

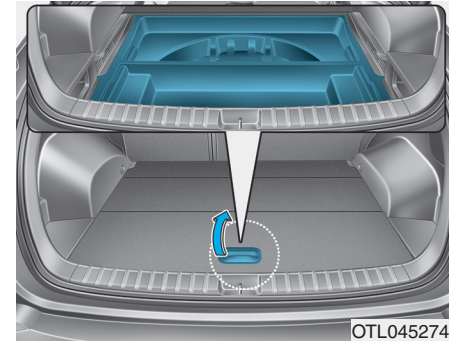

OTL045274

You can place a first aid kit, a reflector triangle, tools, etc. in the box for easy access.

- Grasp the handle on the top of the cover and lift it.



## EXTERIOR FEATURES

### Roof rack (if equipped)

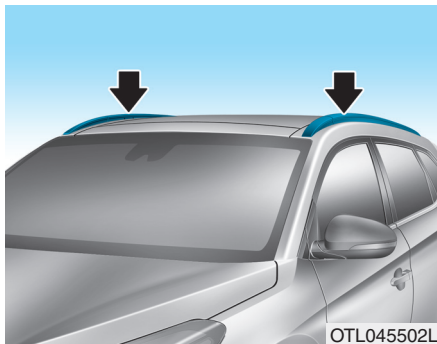

If the vehicle has a roof rack, you can load cargo on top of your vehicle.

#### NOTICE

If the vehicle is equipped with a sunroof or a panorama roof, be sure not to position cargo onto the roof rack in such a way that it could interfere with sunroof or a panorama roof operation.

#### NOTICE

- When carrying cargo on the roof rack, take the necessary precautions to make sure the cargo does not damage the roof of the vehicle.
- When carrying large objects on the roof rack, make sure they do not exceed the overall roof length or width.

#### ⚠ WARNING

- The following specification is the maximum weight that can be loaded onto the roof rack. Distribute the load as evenly as possible onto the roof rack and secure the load firmly. Loading cargo or luggage in excess of the specified weight limit on the roof rack may damage your vehicle.

ROOF RACK	220 lbs. (100 kg) EVENLY DISTRIBUTED
-----------	---

(Continued)

(Continued)

- The vehicle center of gravity will be higher when items are loaded onto the roof rack. Avoid sudden starts, braking, sharp turns, abrupt maneuvers or high speeds that may result in loss of vehicle control or rollover resulting in an accident.
- Always drive slowly and turn corners carefully when carrying items on the roof rack. Severe wind updrafts, caused by passing vehicles or natural causes, can cause sudden upward pressure on items loaded on the roof rack. This is especially true when carrying large, flat items such as wood panels or mattresses. This could cause the items to fall off the roof rack and cause damage to your vehicle or others around you.
- To prevent damage or loss of cargo while driving, check frequently before or while driving to make sure the items on the roof rack are securely fastened.

# Multimedia System

<b>MULTIMEDIA SYSTEM</b> .....	4-3
AUX, USB and iPod® Port .....	4-2
Antenna .....	4-2
Steering Wheel Audio Control.....	4-3
Audio / Video / Navigation System (AVN).....	4-4
<i>Bluetooth</i> ® Wireless Technology Hands-Free.....	4-4
How Vehicle Audio Works .....	4-5
<b>AUDIO (With Touch Screen)</b> .....	4-10
Feature of Your Audio .....	4-11
Radio Mode.....	4-21
Media Mode.....	4-23
Phone Mode .....	4-33
<i>Bluetooth</i> ® Wireless Technology .....	4-34
Voice Recognition Mode .....	4-41
Setup Mode .....	4-46

## MULTIMEDIA SYSTEM

### NOTICE

- If you install an aftermarket HID head lamp, your vehicle's audio and electronic device may malfunction.
- Use caution to keep chemicals such as perfumes, cosmetics, sun screen lotions, hand sanitizers, or air fresheners from contacting any interior components. These chemicals may cause damage or discoloration to the interior materials.

### AUX, USB and iPod® Port

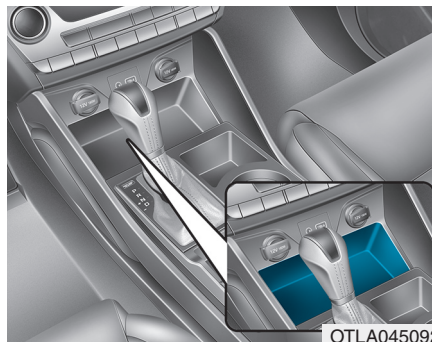

You can use the AUX port to connect audio devices and the USB port to plug in a USB device or iPod®.

### **i** Information

When using a portable audio device connected to the power outlet, noise may occur during playback. If this happens, use the power source of the portable audio device.

\* iPod® is a trademark of Apple Inc.

### Antenna

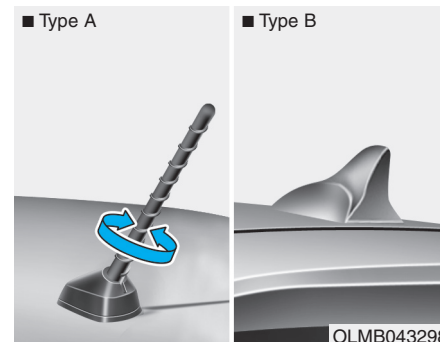

#### **Roof antenna (Type A)**

The roof antenna receives both AM and FM broadcast signals. Rotate the roof antenna in a counterclockwise direction to remove it. Rotate it in a clockwise direction to reinstall it.

#### **Shark fin antenna (Type B)**

The shark fin antenna receives transmitted data. (for example: GPS)

## Steering Wheel Audio Control

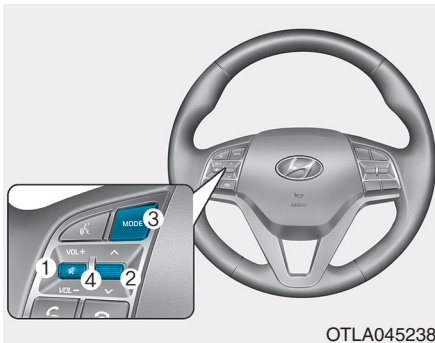

### NOTICE

Do not operate audio remote control buttons simultaneously.

### **VOLUME (VOL + / - ) (1)**

- Move the VOLUME lever up to increase volume.
- Move the VOLUME lever down to decrease volume.

### **SEEK/PRESET ( ^ / ∨ ) (2)**

If the SEEK/PRESET lever is moved up or down and held for 0.8 second or more, it will function in the following modes;

#### **RADIO mode**

It will function as the AUTO SEEK select button. It will SEEK until you release the button.

#### **MEDIA mode**

It will function as the FF/REW button.

If the SEEK/PRESET lever is moved up or down, it will function in the following modes;

#### **RADIO mode**

It will function as the PRESET STATION UP/DOWN button.

#### **MEDIA mode**

It will function as the TRACK UP/DOWN button.

### **MODE (3)**

Press the MODE button to select Radio, Disc\*, or AUX.

\* if equipped

### **i Information**

Detailed information for audio control buttons are described in the following pages in this chapter.

### Audio / Video / Navigation System (AVN)

Detailed information for the AVN system is described in a separately supplied manual.

### Bluetooth® Wireless Technology Hands-Free

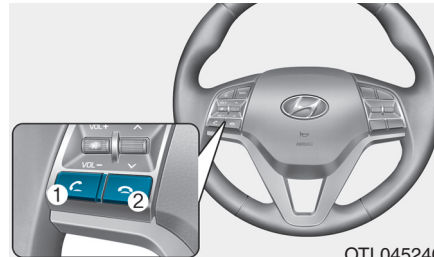

OTL045240

#### ■ Type A



OTL045241

#### ■ Type B



OTL045262

You can use the phone wirelessly by using the *Bluetooth*® Wireless Technology.

- (1) Call / Answer button
- (2) Call end button
- (3) Microphone

Detailed information for the *Bluetooth*® Wireless Technology hands-free is described in the following pages in this chapter or in the manual supplied separately.

## How Vehicle Audio Works

### FM reception

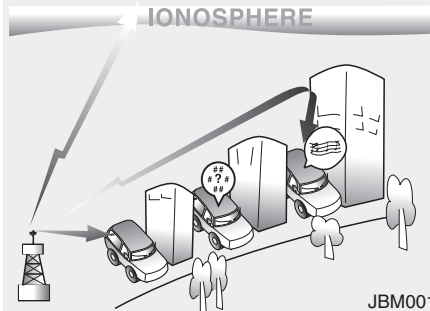

AM and FM radio signals are broadcast from transmitter towers located around your city. They are intercepted by the radio antenna on your vehicle. This signal is then processed by the radio and sent to your vehicle speakers.

When a strong radio signal has reached your vehicle, the precise engineering of your audio system ensures the best possible quality reproduction. However, in some cases the signal coming to your vehicle may not be strong and clear.

This can be due to factors, such as the distance from the radio station, closeness of other strong radio stations or the presence of buildings, bridges or other large obstructions in the area.

### AM reception

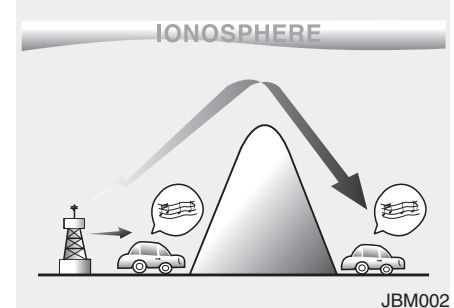

AM broadcasts can be received at greater distances than FM broadcasts. This is because AM radio waves are transmitted at low frequencies. These long distance, low frequency radio waves can follow the curvature of the earth rather than travelling straight. In addition, they curve around obstructions resulting in better signal coverage.

### FM radio station

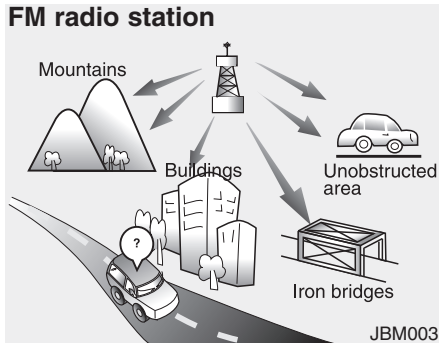

FM broadcasts are transmitted at high frequencies and do not bend to follow the earth's surface. Because of this, FM broadcasts generally begin to fade within short distances from the station. Also, FM signals are easily affected by buildings, mountains, and obstructions. This can lead to undesirable or unpleasant listening conditions which might lead you to believe a problem exists with your radio. The following conditions are normal and do not indicate radio trouble:

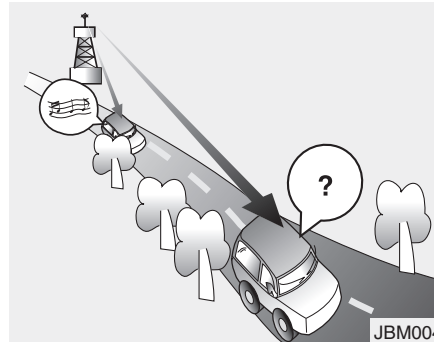

- **Fading** - As your vehicle moves away from the radio station, the signal will weaken and sound will begin to fade. When this occurs, we suggest that you select another stronger station.
- **Flutter/Static** - Weak FM signals or large obstructions between the transmitter and your radio can disturb the signal causing static or fluttering noises to occur. Reducing the treble level may lessen this effect until the disturbance clears.

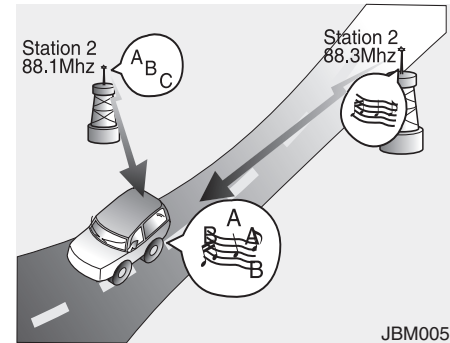

- **Station Swapping** - As an FM signal weakens, another more powerful signal near the same frequency may begin to play. This is because your radio is designed to lock onto the clearest signal. If this occurs, select another station with a stronger signal.
- **Multi-Path Cancellation** - Radio signals being received from several directions can cause distortion or fluttering. This can be caused by a direct and reflected signal from the same station, or by signals from two stations with close frequencies. If this occurs, select another station until the condition has passed.

### ***Using a cellular phone or a two-way radio***

When a cellular phone is used inside the vehicle, noise may be produced from the audio system. This does not mean that something is wrong with the audio equipment. In such a case, try to operate mobile devices as far from the audio equipment as possible.



#### **CAUTION**

When using a communication system such as a cellular phone or a radio set inside the vehicle, a separate external antenna must be fitted. When a cellular phone or a radio set is used with an internal antenna alone, it may interfere with the vehicle's electrical system and adversely affect safe operation of the vehicle.

#### **! WARNING**

##### **Audio System Safety Warnings**

- Do not use a cellular phone while driving. Stop at a safe location to use a cellular phone.
- Do not stare at the screen while driving. Staring at the screen for prolonged periods of time could lead to traffic accidents.
- Do not disassemble, assemble, or modify the audio system. Such acts could result in accidents, fire or electric shock.
- Using the phone while driving may lead to a lack of attention of traffic conditions and increase the likelihood of accidents. Use the phone feature after parking the vehicle.

(Continued)

(Continued)

- Exercise caution not to spill water or introduce foreign objects into the device. Such acts could lead to smoke, fire, or product malfunction.
- Please refrain from use if the screen is blank or no sound can be heard as these signs may indicate product malfunction. Continued use in such conditions could lead to accidents (fires, electric shock) or product malfunctions.
- Do not touch the antenna during thunder or lightning as such acts may lead to lightning induced electric shock.
- Do not stop or park in parking-restricted areas to operate the product. Such acts could lead to traffic accidents.
- Use the system with the vehicle engine turned on. Prolonged use with the ignition turned on only could result in battery discharge.



 **WARNING**

**Distracted Driving**

Driving while distracted can result in a loss of vehicle control that may lead to an accident, severe personal injury, and death. The driver's primary responsibility is in the safe and legal operation of a vehicle, and use of any handheld devices, other equipment, or vehicle systems which take the driver's eyes, attention and focus away from the safe operation of a vehicle or which are not permissible by law should never be used during operation of the vehicle.

**NOTICE**

- Operating the device while driving could lead to accidents due to a lack of attention to external surroundings. First park the vehicle before operating the device.
- Adjust the volume to levels that allow the driver to hear sounds from outside of the vehicle. Driving in a state where external sounds cannot be heard may lead to accidents.
- Pay attention to the volume setting when turning the device on. A sudden output of extreme volume upon turning the device on could lead to hearing impairment. (Adjust the volume to a suitable levels before turning off the device.)
- Turn on the car engine before using this device. Do not operate the audio system for long periods of time only with the ignition turned on as such operations may lead to battery discharge.

(Continued)

(Continued)

- Do not subject the device to severe shock or impact. Direct pressure onto the front side of the monitor may cause damage to the LCD.
- When cleaning the device, make sure to turn off the device and use a dry and smooth cloth. Never use rough materials, chemical cloths, or solvents (alcohol, benzene, thinners, etc.). As such materials may damage the device panel or cause color/quality deterioration.
- Do not place beverages close to the audio system. Spilling beverages may lead to system malfunction.
- In case of product malfunction, please contact your place of purchase or After Service center.
- Placing the audio system within an electromagnetic environment may result in noise interference.
- Prevent caustic solutions such as perfume and cosmetic oil from contacting the dashboard because they may cause damage or discoloration.

---

## iPod®

---

iPod® is a registered trademark of Apple Inc.

---

## Bluetooth® Wireless Technology

---

The Bluetooth® word mark and logos are registered trademarks owned by Bluetooth SIG, Inc. and any use of such marks by HYUNDAI is under license. Other trademarks and trade names are those of their respective owners.

A *Bluetooth®* Wireless Technology enabled cell phone is required to use *Bluetooth®* Wireless Technology. *Bluetooth®* Wireless Technology phone compatibility can be checked by visiting <https://www.hyundaiusa.com/bluetooth>.



## AUDIO (With Touch Screen)



(With *Bluetooth*<sup>®</sup> Wireless Technology)

D3H3H0000EU

## Features of Your Audio



\* The actual image in the vehicle may differ from the illustration.

### (1) **EJECT**

- Ejects the disc.

### (2) **POWER/VOL** knob

- Power: Press to turn power on/off.
- Volume: Turn left/right to control volume.

### (3) **SEEK/TRACK**

- When pressed briefly
  - Radio mode: plays previous/next frequency.
  - Media (CD/USB/iPod®/My Music) modes: changes the track, Song(file).
- When pressed and held
  - Radio mode: continuously changes the frequency. Upon release, plays the current frequency.
  - Media(CD/USB/iPod®/My Music) modes: rewinds or fast forwards the track or file.
  - During a Handsfree call, controls the call volume.

### (4) **PHONE**

- Changes to Phone mode.
- When a phone is not connected, the connection screen is displayed.

### (5) **RADIO**

- Changes to FM/AM mode.
- Each time the button is pressed, the mode is changed in the order of FM1 → FM2 → AM.

### (6) **RESET**

- Shutdown and restart the system.



\* The actual image in the vehicle may differ from the illustration.

### (7) **DISP**

- Turns the monitor display on/off.

### (8) **MEDIA**

- Changes to CD/USB(iPod®)/AUX/My Music/BT(Bluetooth®) Audio mode.
- Each time the button is pressed, the mode is changed in the order of CD → USB(iPod®) → AUX → My Music → BT(Bluetooth®) Audio.

### (9) **CLOCK**

- Move to the Time setting screen.

### (10) **SCAN**

- Radio mode : previews all receivable broadcasts for 5 seconds each.
- Media (CD/USB/My Music) modes: previews each song (file) for 10 seconds each.

### (11) **SETUP**

- Moves to the Display, Sound, Clock, Phone, System setting modes.

### (12) **FOLDER**

- MP3 CD/USB mode : Search Folder.

### (13) **TUNE** knob

- Radio mode: turn to change broadcast frequencies.
- Media (CD/USB/iPod®/My Music) modes: turn to search tracks/channels/ files.

## **i** Information

### - Using Compact Discs

- This device has been manufactured to be compatible with software bearing the following logo marks.
- Do not clean discs with chemical solutions, such as record sprays, antistatic sprays, antistatic liquids, benzene, or thinners.
- After using a disc, put the disc back in its original case to prevent disc scratches.
- Hold discs by their edges or within the center hole to prevent damage to disc surfaces.
- Do not introduce foreign substances into the disc insert/eject slot. Introducing foreign substances could damage the device interior.
- Do not insert two discs simultaneously.
- When using CD-R/CD-RW discs, differences in disc reading and playing times may occur depending on the disc manufacturer, production method and the recording method used.



(Continued)

(Continued)

- Clean fingerprints and dust off the disc surface (coated side) with a soft cloth
- The use of CD-R/CD-RW discs attached with labels may result in disc slot jams or difficulties in disc removal. Such discs may also result in noise while playing.
- Some CD-R/CD-RW discs may not properly operate depending on the disc manufacturer, production method and the recording method used. If problems persist, trying using a different CD as continued use may result in malfunctions.
- The performance of this product may differ depending on the CD-RW Drive Software.
- Copy-protected CDs such as S-type CDs may not function in the device. DATA discs cannot be played. (However, such discs may still operate but will do so abnormally.)

(Continued)

(Continued)

- Do not use abnormally shaped discs (8 cm, heart-shaped, octagon-shaped) as such discs could lead to malfunctions.
- If the disc is straddled on the disc slot without removal for 10 seconds, the disc will automatically be re-inserted into the disc player.
- Only genuine audio CDs are supported. Other discs may result in recognition failure. (e.g. copy CD-R, CDs with labels)

**i** Information

**- Using the USB Devices**

- Connect the USB device after turning on the engine. The USB device may become damaged if it is already connected when the ignition is turned on. The USB device may not operate properly if the car ignition is turned on or off with the USB device connected.
- Be careful for static electricity when connecting/disconnecting USB devices.
- Encoded MP3 Players will not be recognized when connected as an external device.
- When connecting an external USB device, the vehicle's audio system may not recognize the USB depending on what firmware is used by USB device or what files are on the USB.
- Only products formatted with byte/sectors under 64Kbyte will be recognized.

(Continued)

(Continued)

- This device recognizes USB devices formatted in FAT 12/16/32 file formats. This device does not recognize files in NTFS file format.
- Some USB devices may not be supported due to compatibility issues.
- Avoid contact between the USB connector and bodily parts or foreign objects.
- Repeated connecting/disconnecting of USB devices within short periods of time may result in product malfunction.
- A strange noise may occur when disconnecting the USB.
- Make sure to connect/disconnect external USB devices with the audio power turned off.
- The amount of time required to recognize the USB device may differ depending on the type, size or file formats stored on the USB. Such differences in time are not indications of malfunctions.
- The vehicle audio system only supports USB devices designed to play music files.

(Continued)

(Continued)

- USB images and videos are not supported.
- Do not use the USB I/F to charge batteries or USB accessories that generate heat. Doing so may lead to worsened performance or damage to the audio system.
- The audio system may not recognize the USB device if separately purchased USB hubs and extension cables are being used. Connect the USB device directly with the USB port of the vehicle.
- When using mass storage USB devices with separate logical drives, only files saved to the root drive can be played.
- Files may not properly operate if application programs are installed on the USBs.
- The audio system may not operate normally if MP3 Players, cellular phones, digital cameras, or other electronic devices (USB devices not recognized as portable disk drives) are connected with the audio system.

(Continued)

(Continued)

- Charging through the USB may not work for some mobile devices.
- The device may not support normal operation when using a typical USB memory device (miniature, key-chain, etc.). For best results, use a typical USB device that has a metal case.
- The device may not support normal operation when using formats such as HDD Type, CF, or SD Memory.
- The device will not support files locked by DRM (Digital Rights Management.)
- USB memory sticks used by connecting an Adaptor (SD Type or CF Type) may not be properly recognized.
- The device may not operate properly when using USB HDDs or USBs subject to connection failures caused by vehicle vibrations. (e.g. i-stick type)

(Continued)

(Continued)

- Avoid use of USB memory products that can also be used as key chains or mobile phone accessories. Use of such products may cause damage to the USB jack.
- Connecting an MP3 device or phone through various channels, such as AUX/BT or Audio/USB mode may result in pop noises or abnormal operation.



### **i** Information - Using an iPod®

- iPod® is a registered trademark of Apple Inc.
- In order to use the iPod® with your vehicle's audio system, you must use a dedicated iPod® cable. (the cable that is supplied when purchasing iPod®/iPhone® products)
- If the iPod® is connected to the vehicle while it is playing, a high pitch sound could occur for approximately 1-2 seconds immediately after connecting. If possible, connect the iPod® to the vehicle with the iPod® stopped/paused.
- When the vehicle ignition is set to ACC or ON, connecting the iPod® through the iPod® cable will charge the iPod® through the car audio system.
- When connecting with the iPod® cable, make sure to fully insert the jack to prevent communication interference.

(Continued)



**(Continued)**

- When the EQ features of an external device, such as the iPod®, and the audio system are both active, EQ effects could overlap and cause sound deterioration and distortion. Whenever possible, turn off the EQ feature within the external device when it is connected to the audio system.
- Noise may occur when an iPod® or AUX device is connected. When such devices are not being used, disconnect the device for storage.
- When the iPod® or AUX device power is connected to the power jack, playing the external device may result in noise. In such cases, disconnect the power connection before use.
- Skipping or improper operation may occur depending on the characteristics of your iPod®/iPhone® device.

**(Continued)**

**(Continued)**

- If your iPhone® is connected to both the *Bluetooth*® Wireless Technology and USB, the sound may not be properly played. In your iPhone®, select the Dock connector or *Bluetooth*® Wireless Technology to change the sound output (source).
- iPod® mode cannot be operated when the iPod® cannot be recognized due to versions that do not support communication protocols.
- For fifth generation iPod® Nano devices, the iPod® may not be recognized when the battery level is low. Please charge the iPod® for use.
- The search/play orders shown within the iPod® device may differ from the orders shown within the audio system.
- If the iPod® malfunctions due to an iPod® device defect, reset the iPod® and try again. (To learn more, refer to your iPod® manual)

**(Continued)**

**(Continued)**

- Some iPod® products may not sync with the System depending on the version. If the Media is removed before the Media is recognized, then the system may not properly restore the previously operated mode. (iPod® charging is not supported.)
- Use an iPod® cable shorter than 1 meter in length such as the one originally supplied with a new iPod®, longer cables may lead to the audio system not recognizing the iPod®.

**i** Information**- Using the *Bluetooth*<sup>®</sup> Wireless Technology Audio Mode**

- *Bluetooth*<sup>®</sup> Wireless Technology Audio Mode can be used only when a *Bluetooth*<sup>®</sup> Wireless Technology phone has been connected.
- *Bluetooth*<sup>®</sup> Wireless Technology Audio Mode will not be available when connecting mobile phones that do not support this feature.
- If a *Bluetooth*<sup>®</sup> Wireless Technology Phone is being used to play music and receives an incoming or outgoing phone call, then the music will stop.
- Moving the Track up/down while playing *Bluetooth*<sup>®</sup> Wireless Technology audio mode may result in pop noises with some mobile phones.
- *Bluetooth*<sup>®</sup> Wireless Technology streaming audio may not be supported in some mobile phones.

(Continued)

(Continued)

- When returning to *Bluetooth*<sup>®</sup> Wireless Technology Audio mode after ending a call, the mode may not automatically restart in some mobile phones.
- Receiving an incoming call or making an outgoing call while playing *Bluetooth*<sup>®</sup> Wireless Technology Audio may result in audio interference.

**i** Information**- Using the *Bluetooth*<sup>®</sup> Wireless Technology Cellular Phone**

- *Bluetooth*<sup>®</sup> Wireless Technology Handsfree refers to a device which allows the user to conveniently make phone calls with *Bluetooth*<sup>®</sup> Wireless Technology mobile phones through the audio system.
- *Bluetooth*<sup>®</sup> Wireless Technology allows devices to be connected in a short distance, including hands-free devices, stereo headsets, wireless remote controllers, etc. For more information, visit the *Bluetooth*<sup>®</sup> Wireless Technology website at [www.Bluetooth.com](http://www.Bluetooth.com). Before using *Bluetooth*<sup>®</sup> Wireless Technology audio features.
- The *Bluetooth*<sup>®</sup> word mark and logos are registered trademarks owned by *Bluetooth*<sup>®</sup> SIG, Inc. and any use of such marks by HYUNDAI is under license. Other trademarks and trade names are those of their respective owners. A *Bluetooth*<sup>®</sup> enabled cell phone is required to use *Bluetooth*<sup>®</sup> Wireless Technology.

(Continued)

(Continued)

- **Bluetooth®** Wireless Technology features supported within the vehicle are as follows. Some features may not be supported depending on your **Bluetooth®** Wireless Technology device.
  - Answering and placing **Bluetooth®** Wireless Technology Handsfree calls
  - Menu operation during call (Switch to Private, Switch to call waiting, Outgoing volume)
  - Download Call History
  - Download Mobile Phone book
  - Phone book/Call History Auto Download
  - **Bluetooth®** Wireless Technology device auto connection
  - **Bluetooth®** Wireless Technology Audio
- Before using **Bluetooth®** Wireless Technology related features of the audio system, refer your phone's User's Manual for phone-side **Bluetooth®** Wireless Technology operations.

(Continued)

(Continued)

- The phone must be paired to the audio system to use **Bluetooth®** Wireless Technology related features.
- Pairing and connecting a **Bluetooth®** Wireless Technology enabled mobile phone will work only when the **Bluetooth®** Wireless Technology option within your mobile phone has been turned on. (Methods of turning on the **Bluetooth®** Wireless Technology enabled feature may differ depending on the mobile phone.)
- Do not use a cellular phone or perform **Bluetooth®** Wireless Technology settings (e.g. pairing a phone) while driving.
- Even if the phone supports **Bluetooth®** Wireless Technology, the phone will not be found during device searches if the phone has been set to hidden state or the **Bluetooth®** Wireless Technology has been deactivated. Disable the hidden state or activate the **Bluetooth®** Wireless Technology prior to searching/connecting with the car audio system.

(Continued)

(Continued)

- You will not be able to use the hands-free feature when your phone (in the car) is outside of the cellular service area. (e.g. in a tunnel, in an underground area, in a mountainous area, etc.)
- If the cellular phone signal is poor or the vehicles interior noise is too loud, it may be difficult to hear the other person's voice during a call.
- Do not place the phone near or inside metallic objects, otherwise communications with **Bluetooth®** Wireless Technology system or cellular service stations can be disturbed.
- Placing the audio system within an electromagnetic environment may result in noise interference.
- Some cellular phones or other devices may cause interference noise or malfunction to the audio system. In this case, storing the device in a different location may resolve the condition.

(Continued)

(Continued)

- While a phone is connected through *Bluetooth*<sup>®</sup> Wireless Technology your phone may discharge quicker than usual for additional *Bluetooth*<sup>®</sup> Wireless Technology-related operations.
- If Priority is set upon vehicle ignition (IGN/ACC ON), the *Bluetooth*<sup>®</sup> Wireless Technology phone will be automatically connected. Even if you are outside, the *Bluetooth*<sup>®</sup> Wireless Technology phone will be automatically connected once you are in the vicinity of the vehicle. If you do not want to automatically connect your *Bluetooth*<sup>®</sup> Wireless Technology phone, try the following.
  - 1) Turn off the *Bluetooth*<sup>®</sup> Wireless Technology feature in your mobile phone.
  - 2) Turn off the *Bluetooth*<sup>®</sup> Wireless Technology feature in your car audio system.
    - To turn off the *Bluetooth*<sup>®</sup> Wireless Technology feature in your car audio system, press the [SETUP] button ► Select [Phone] and [turn off] the *Bluetooth*<sup>®</sup> Wireless Technology feature.

(Continued)

(Continued)

- *Bluetooth*<sup>®</sup> Wireless Technology connection may become intermittently disconnected in some mobile phones. Follow these steps to try again.
  - 1) Turn the *Bluetooth*<sup>®</sup> Wireless Technology function within the mobile phone off/on and try again.
  - 2) Turn the mobile phone power Off/On and try again.
  - 3) Completely remove the mobile phone battery, reboot, and then try again.
  - 4) Reboot the audio system and try again.
  - 5) Delete all paired devices, pair and try again.
- It is possible to pair up to five *Bluetooth*<sup>®</sup> Wireless Technology devices to the car system.

(Continued)

(Continued)

- Phone contact names should be saved in English or they may not be displayed correctly.
- The Handsfree call volume and quality may differ depending on the mobile phone.
- Only one *Bluetooth*<sup>®</sup> Wireless Technology device can be connected at a time.
- In some mobile phones, starting the ignition while talking through *Bluetooth*<sup>®</sup> Wireless Technology enabled handsfree call will result in the call becoming disconnected. (Switch the call back to your mobile phone when starting the ignition.)
- If the mobile phone is not paired or connected, it is not possible to enter Phone mode. Once a phone is paired or connected, the guidance screen will be displayed.
- *Bluetooth*<sup>®</sup> Handsfree may not be supported in some mobile phones. To learn more about mobile device compatibility, visit <http://www.hyundai.com/us/en/content/owners/bluetooth>.

### **i** Information

**Bluetooth®** Wireless Technology Handsfree is a feature that enables drivers to practice safe driving. Connecting the car audio system with a **Bluetooth®** Wireless Technology phone allows the user to conveniently make calls, receive calls, and manage the phone book. Before using the **Bluetooth®** Wireless Technology, carefully read the contents of this user's manual.

### **!** WARNING

- Excessive use or operations while driving may lead to negligent driving practices and be the cause of accidents.
- Do not operate the device excessively while driving.
- Viewing the screen for prolonged periods of time while driving is dangerous and may lead to accidents.

### **i** Information

Maximum power output of Bluetooth is 3mW.

### **i** Information

#### - Using the Voice Recognition

- When using the voice recognition feature, only commands listed within the user's manual are supported.
- Be aware that during the operation of the voice recognition system, pressing any button other than the [  ] button will terminate voice recognition mode.
- For optimal voice recognition performance, position your head below the microphone above the driver's seat and maintain proper position when speaking voice commands.
- Within the following situations, voice recognition may not function properly due to external sound.
  - When the windows and sunroof are open
  - When the blower AC/heater is set to high
  - When entering and passing through tunnels
  - When driving on rugged and uneven roads
  - During severe rain (heavy rains, windstorms)

(Continued)

(Continued)

- Phone related voice commands can be used only when a *Bluetooth*® Wireless Technology device is connected.
- When making calls by stating a name, the corresponding contact must be downloaded and stored within the audio system.
- After downloading the *Bluetooth*® Wireless Technology phone book, it takes some time to convert the phone book data into voice information. During this time, voice recognition may not properly operate.
- Pronounce the voice commands naturally and clearly as if in a normal conversation.

## Radio Mode

### Radio Mode Display Controls



#### (1) Mode Display

Displays currently operating mode.

#### (2) Frequency

Displays the current frequency.

#### (3) Preset

Displays current preset number [1] ~ [6].

#### (4) Preset Display

Displays preset buttons.

#### (5) A.Store

Automatically saves frequencies with superior reception to Preset buttons.

### With the Radio Mode Button



Pressing the **[RADIO]** button will change the operating mode in the order of FM1 → FM2 → AM.

If [Mode Pop up] is turned on within **[SETUP]** button ► [Display], then pressing the **[RADIO]** button will display the Radio Pop-up Mode screen. Turn the **TUNE** knob to move the focus. Press the knob to select.

### Seek

Press the **[SEEK/TRACK]** button to play the previous/next frequency.

### Tune

Turn the **TUNE** knob to select the desired frequency.

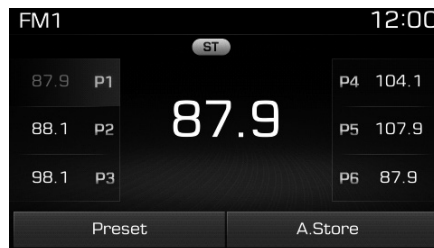

### Selecting Presets/Saving Presets

Select [Preset] to display the broadcast information for the frequency saved to each button.

Select [1] ~ [6] to play the desired preset.

While listening to a frequency you want to save as a preset, press and hold one of the [1] ~ [6] preset buttons to save the current frequency to the selected preset.

### A.Store (Auto Store)

Select [A.Store] to automatically save receivable frequencies to [Preset] button.

### Scan

Press the **[SCAN]** button to preview frequencies with superior reception for 5 seconds each.

Press and hold the **[SCAN]** button to preview presets for 5 seconds each. Once scan is complete, the previous frequency will be restored.

While Scan is operating, pressing the **[SCAN]** button will cancel scanning.

## Media Mode

### With the Radio Mode Button

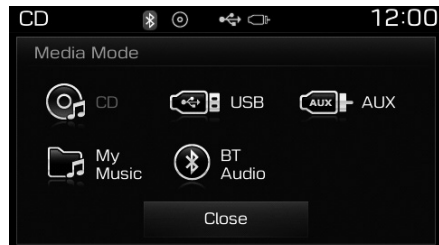

Pressing the **[MEDIA]** button will change the operating mode in the order of CD → USB (iPod®) → AUX → My Music → BT (Bluetooth®) Audio.

If [Mode Pop up] is turned on within **[SETUP]** button ► [Display], then pressing the **[MEDIA]** button will display the Media Pop-up Mode screen.

Turn the **TUNE** knob to move the focus. Press the knob to select.

The media mode pop up screen can be displayed only when there are two or more media modes turned on.

### Mode Display on the Status Bar



When a *Bluetooth®* Wireless Technology, iPod®, USB, or AUX device is connected or a CD is inserted, the corresponding mode icon will be displayed.

Icon	Title
	Bluetooth® Wireless Technology
	CD
	USB (iPod®)
	AUX

## MENU : Audio CD

### Audio CD Mode Display Controls



#### (1) Mode

Displays currently operating mode.

#### (2) Operation State

From Repeat/Shuffle/Scan, displays the currently operating function.

#### (3) Track Info

Displays information about the current track.

#### (4) Play/Pause

Changes the play/pause state.



### (5) Play Time

Displays the current play time.

### (6) Info

Shows detailed information about the current track.

### (7) Shuffle

Turns the Shuffle feature on/off.

### (8) Repeat

Turns the Repeat feature on/off.

### (9) List

Moves to the list screen.

Turn the **TUNE** knob left/right to search for tracks. Once the desired track is displayed, press the **TUNE** knob to select and play.

### *With the Audio CD Mode*

#### Playing/Pausing CD Tracks

Once an audio CD is inserted, the mode will automatically start and begin playing.

While playing, select [II] to pause and select [▶] to play.

Only genuine audio CDs are supported. Other discs may result in recognition failure (e.g. copy CD-R, CDs with labels)

The artist and title information are displayed on the screen if track information is included within the audio CD.

#### Changing Tracks

Press the [SEEK/TRACK] button to move to the previous or next track. Pressing the [SEEK/TRACK √] button after the track has been playing for 2 seconds will start the current track from the beginning.

Pressing the [SEEK/TRACK ∨] button before the track has been playing for 1 second will start the previous track.

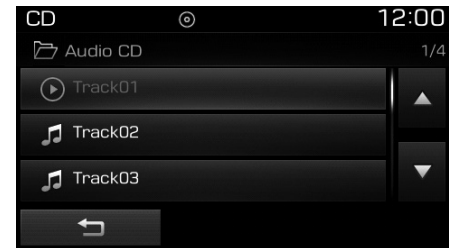

#### Selecting from the List

Turn the **TUNE** knob left/right to search for the desired track.

Once you find the desired track, press the **TUNE** knob to start playing.

#### Rewinding/Fast-forwarding Tracks

While playing, press and hold the [SEEK/TRACK] button to rewind or fast-forward the current track.

#### Scan

Press the [SCAN] button to play the first 10 seconds of each file.

## MENU : MP3 CD

### MP3 CD Mode Display Controls



#### (1) Mode

Displays currently operating mode.

#### (2) Operation State

From Repeat/Shuffle/Scan, displays the currently operating function.

#### (3) File Index

Displays the current file number.

#### (4) File Info

Displays information about the current file.

#### (5) Play/Pause

Changes the play/pause state.

#### (6) Play Time

Displays the current play time.

#### (7) Info

Shows detailed information about the current file.

Select [Info] to display details about the current file.

When the 'Folder File' option is set as the default display within Display setup, the album/artist/file information are displayed as detailed file information.

When the 'Album Artist Song' option is set as the default display, the folder name/file name are displayed as detailed file information.

The title, artist and album info are displayed only when such information is recorded within the MP3 file ID3 tag.

#### (8) Shuffle

Turns the Shuffle feature on/off.

Each time the button is pressed, the feature changes in the order of Shuffle Folder → Shuffle All → Off.

- Shuffle Folder : Plays all files within the current folder in shuffle order.
- Shuffle All : Plays all files in shuffle order.

#### (9) Repeat

Turns the Repeat feature on/off.

Each time the button is pressed, the feature changes in the order of Repeat → Repeat Folder → Off.

- Repeat : Repeats the current file.
- Repeat Folder : Repeats all files within the current Folder.

#### (10) Copy

Copies the current file into My Music. Selecting another feature during copying will display a pop-up asking whether you wish to cancel copying. To cancel, select [Yes].

### (11) List

Moves to the list screen.

Turn the **TUNE** knob left/right to search for files. Once the desired file is displayed, press the **TUNE** knob to select and play.

#### *With the MP3 CD Mode*

##### Playing/Pausing MP3 Files

Once an MP3 disc is inserted the mode will automatically start and being playing.

While playing, select [II] to pause and select [▶] to play.

If there are numerous files and folders within the disc, reading time could take more than 10 seconds and the list may not be displayed or song searches may not operate.

Once loading is complete, try again.

### Changing Files

Press the [**SEEK/TRACK**] button to move to the previous or next file.

Pressing the [**SEEK/TRACK** √] button after the file has been playing for 2 seconds will start the current file from the beginning.

Pressing the [**SEEK/TRACK** √] button before the file has been playing for 1 second will start the previous file.

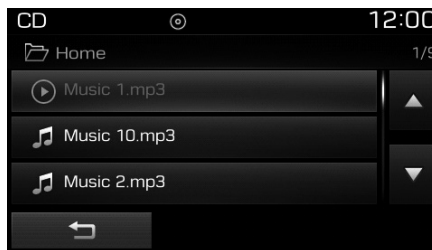

#### Selecting from the List

Turn the **TUNE** knob left/right to search for the desired file.

Once you find the desired file, press the **TUNE** knob to start playing.

### Rewinding/Fast-forwarding Files

While playing, press and hold the [**SEEK/TRACK**] button to rewind or fast-forward the current file.

### Scan

Press the [**SCAN**] button to play the first 10 seconds of each file.

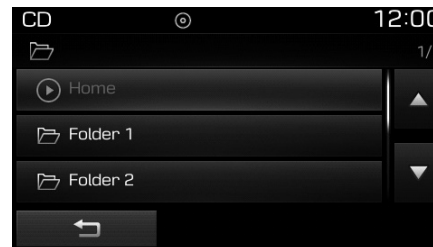

#### Searching Folders

Press the [**FOLDER**] button to select and search folders.

Once the desired folder is displayed, press the **TUNE** knob to select.

The first file within the selected folder will begin playing.

## MENU : USB

### USB Mode Display Controls



#### (1) Mode

Displays currently operating mode.

#### (2) Operation State

From Repeat/Shuffle/Scan, displays the currently operating function.

#### (3) File Index

Displays the current file number.

#### (4) File Info

Displays information about the current file.

#### (5) Play/Pause

Changes the play/pause state.

#### (6) Play Time

Displays the current play time.

#### (7) Info

Displays detailed information for the current file.

When the 'Folder File' option is set as the default display within Display setup, the album/artist/file information are displayed as detailed file information.

When the 'Album Artist Song' option is set as the default display, the folder name/file name are displayed as detailed file information.

The title, artist and album info are displayed only when such information are recorded within the MP3 file ID3 tag.

#### (8) Shuffle

Turns the Shuffle feature on/off.

Each time the button is pressed, the feature changes in the order of Shuffle Folder → Shuffle All → Off.

- Shuffle Folder : Plays all files within the current folder in shuffle order.
- Shuffle All : Plays all files in shuffle order.

#### (9) Repeat

Turns the Repeat feature on/off.

Each time the button is pressed, the feature changes in the order of Repeat → Repeat Folder → Off.

- Repeat : Repeats the current file.
- Repeat : Repeats all files within the current Folder.

#### (10) Copy

Copies the current file into My Music.

Selecting another feature during copying will display a pop-up asking whether you wish to cancel copying.

To cancel, select [Yes].

### (11) List

Moves to the list screen.

Turn the **TUNE** knob left/right to search for files. Once the desired file is displayed, press the **TUNE** knob to select and play.

#### *With the USB Mode*

##### Playing/Pausing USB Files

Once a USB is connected, the mode will automatically start and begin playing a USB file.

While playing, select [II] to pause and select [▶] to play.

Loading may require additional time if there are many files and folders within the USB and may result in faulty list display or file search. Normal operations will resume once loading is complete.

The device may not support normal operation when using a USB memory type besides (Metal Cover Type) USB Memory.

### Changing Files

Press the [**SEEK/TRACK**] button to move to the previous or next file.

Pressing the [**SEEK/TRACK** √] button after the file has been playing for 2 seconds will start the current file from the beginning.

Pressing the [**SEEK/TRACK** √] button before the file has been playing for 1 second will start the previous file.

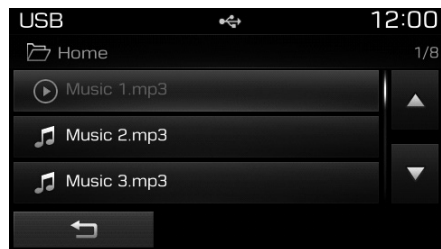

#### Selecting from the List

Turn the **TUNE** knob left/right to search for the desired file.

Once you find the desired file, press the **TUNE** knob to start playing.

### Rewinding/Fast-forwarding Files

While playing, press and hold the [**SEEK/TRACK**] button to rewind or fast-forward the current file.

### Scan

Press the [**SCAN**] button to play the first 10 seconds of each file.

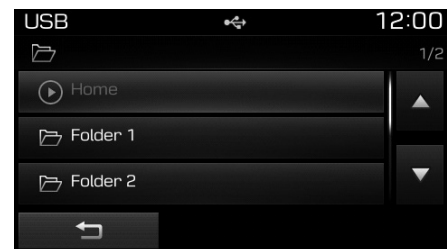

#### Searching Folders

Press the [**FOLDER**] button to select and search folders.

Once the desired folder is displayed, press the **TUNE** knob to select.

The first file within the selected folder will begin playing.

## MENU : iPod®

### Basic Mode Screen



#### (1) Mode

Displays currently operating mode.

#### (2) Operation State

From Repeat/Shuffle, displays the currently operating function.

#### (3) Song Index

Displays the current song/total number of songs.

#### (4) Song Info

Displays information about the current song.

#### (5) Play/Pause

Changes the play/pause state.

#### (6) Play Time

Displays the current play time.

#### (7) Shuffle

Turns the Shuffle feature on/off.

Each time the button is pressed, the feature changes in the order of Shuffle Album → Shuffle All → Off.

- Shuffle Album : Shuffle Album plays album in shuffle order.
- Shuffle All : Plays all songs in shuffle order.

#### (8) Repeat

Turns the Repeat feature on/off.

- Repeat : Repeats the current song.

#### (9) List

Moves to the list screen.

Turn the **TUNE** knob left/right to search for the desired category.

Once you find the desired category, press the **TUNE** knob to select and play.

### With the iPod® Mode

#### Playing/Pausing iPod® Songs

Once an iPod® is connected, the mode will automatically start and begin playing an iPod® song.

While playing, select [II] to pause and select [▶] to play.

iPod®s with unsupported communication protocols may not properly operate in the audio system.

#### Changing Songs

Press the [SEEK/TRACK] button to move to the previous or next song.

Pressing the [SEEK/TRACK V] button after the song has been playing for 2 seconds will start the current song from the beginning.

Pressing the [SEEK/TRACK V] button before the song has been playing for 1 second will start the previous song.

Slight time differences may exist depending your iPod® product.

### Rewinding/Fast-forwarding Songs

While playing, press and hold the **[SEEK/TRACK]** button to rewind or fast-forward the current song.

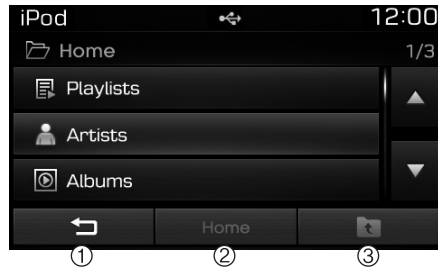

### Selecting from the List

Turn the **TUNE** knob left/right to search for the desired category.

Once you find the desired category, press the **TUNE** knob to select and play.

There are eight categories that can be searched, including Playlists, Artists, Albums, Genres, Songs, Composers, Audiobooks and Podcasts.

### Category Menu

- (1) Displays the play screen.
- (2) Moves to the iPod® root category screen.
- (3) Moves to the previous category.

If the search mode is accessed while playing a song, the most recently searched category is displayed.

Search steps upon initial connection may differ depending on the type of iPod® device.

## MENU : AUX

### AUX Mode Display Controls

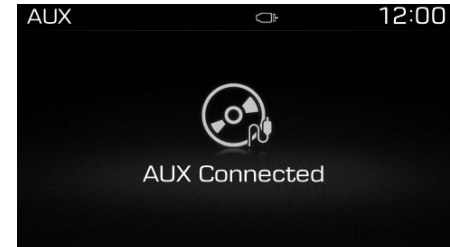

Press the **[MEDIA]** button ► Select **[AUX]**.

An external device can be connected to play music.

### Connecting an External Device

External audio players (Camcorders, car VCR, etc.) can be played through a dedicated cable.

If an external device connector is connected with the AUX terminal, then AUX mode will automatically operate. Once the connector is disconnected, the previous mode will be restored.

AUX mode can be used only when an external audio player (camcorder, car VCR, etc.) has been connected.

The AUX volume can be controlled separately from other audio modes.

Connecting a connector jack to the AUX terminal without an external device will convert the system to AUX mode, but only output noise. When an external device is not being used, also remove the connector jack.

When the external device power is connected to the power jack, playing the external device may output noise. In such cases, disconnect the power connection before use.

Fully insert the AUX cable to the AUX jack upon use.

### MENU : My Music

#### *My Music Mode Display Controls*

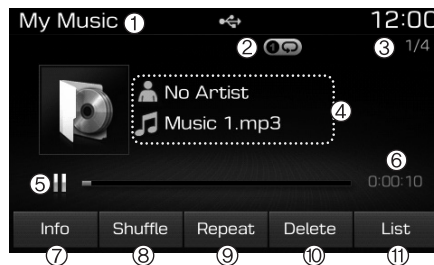

#### (1) Mode

Displays currently operating mode.

#### (2) Operation State

From Repeat/Shuffle/Scan, displays the currently operating function.

#### (3) File Index

Displays the current file/total number of files.

#### (4) File Info

Displays information about the current file.

#### (5) Play/Pause

Changes the play/pause state.

#### (6) Play Time

Displays the current play time.

#### (7) Info

Displays detailed information for the current file.

The title, artist and album info are displayed only when such information is recorded within the MP3 file ID3 tag.

#### (8) Shuffle

Turns the Shuffle feature on/off.

#### (9) Repeat

Turns the Repeat feature on/off.

#### (10) Delete

Deletes the current file.



### (11) List

Moves to the list screen.

Turn the **TUNE** knob left/right to search for files.

Once the desired file is displayed, press the **TUNE** knob to select and play.

#### *With the My Music Mode*

##### Playing/Pausing My Music Files

While playing, select [II] to pause and select [▶] to play.

If there are no files saved within My Music, the [My Music] will be disabled.

##### Changing Songs

Press the [SEEK/TRACK] button to move to the previous or next file.

Pressing the [SEEK/TRACK √] button after the file has been playing for 2 seconds will start the current file from the beginning.

Pressing the [SEEK/TRACK √] button before the file has been playing for 1 second will start the previous file.

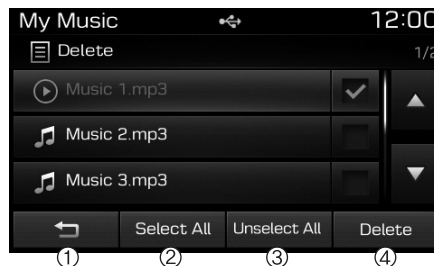

##### Selecting from the List

Turn the **TUNE** knob left/right to search for the desired file.

Once you find the desired category, press the **TUNE** knob to start playing.

From the List screen, it is possible to delete files you previously saved into My Music.

### List Menu

(1) Moves to the previous screen.

(2) Selects all files.

(3) Deselects all selected files.

(4) Deletes selected files.

After selecting the files you want to delete, select [Delete] to delete the selected files.

If there is memory available, up to 6,000 files can be saved. Identical files cannot be copied more than 1,000 times.

To check memory information, press the [SETUP] button ▶ Select [System] ▶ Select [Memory Information].

##### Rewinding/Fast-forwarding Files

While playing, press and hold the [SEEK/TRACK] button to rewind or fast-forward the current file.

##### Scan

Press the [SCAN] button to play the first 10 seconds of each file.

## MENU : Bluetooth® Wireless Technology Audio

### With Bluetooth® Wireless Technology Audio Mode

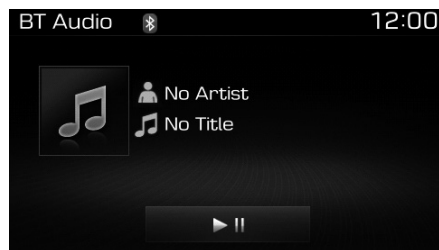

### Playing/Pausing Bluetooth® Wireless Technology Audio

Once a Bluetooth® Wireless Technology device is connected, the mode will automatically start.

While playing, select [▶||] to pause and select [▶||] to play.

The play/pause feature may operate differently depending on the mobile phone.

### Changing Files

Press the [SEEK/TRACK] button to move to the previous or next file.

### Setting Connection

If a Bluetooth® Wireless Technology device has not been connected, press the [SETUP] button ▶ Select [Phone] to display the Bluetooth® Wireless Technology connection screen.

It is possible to use the pair phone, connect/disconnect and delete features from your Bluetooth® Wireless Technology phone.

If music is not yet playing from your mobile device after converting to Bluetooth® Wireless Technology Audio mode, pressing the play button once may start playing the mode.

Check to see that music is playing from the Bluetooth® Wireless Technology device after converting to Bluetooth® Wireless Technology Audio Mode.

## Phone Mode

### Making a call using the Steering wheel controls

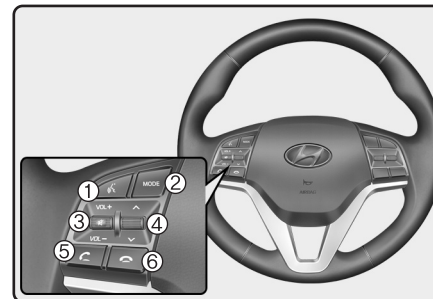

\* The actual image in the vehicle may differ from the illustration.

- (1) When pressed shortly
  - Starts voice recognition.
  - When selecting during a voice prompt, stops the prompt and converts to voice command waiting state.
- When pressed and held
  - Ends voice recognition.

### (2) When pressed shortly

- Radio mode : searches broadcast frequencies saved to pre-sets.
- Media (CD/USB/iPod®/My Music/ BT Audio) modes : changes the track, file or chapter.

### When pressed and held

- Radio mode, automatically searches broadcast frequencies and channels.
- Media (CD/USB/iPod®/My Music) modes, rewinds or fast forwards the track or song (file).
- BT Audio mode may not be supported in some mobile phones.

### (3) Used to control volume.

(4) Each time this button is pressed, the mode is changed in the order of FM1 → FM2 → AM → CD → USB (iPod®) → AUX → My Music → BT Audio.

If the media is not connected or a disc is not inserted, corresponding modes will be disabled.

### (5) When pressed shortly

- When pressed in the phone screen, displays call history screen.
- When pressed in the dial screen, makes a call.
- When pressed in the incoming call screen, answers the call.
- When pressed during call waiting, switches to waiting call. (Call Waiting)

### When pressed and held

- When pressed in the *Bluetooth*® Wireless Technology Handsfree wait mode, redials the last call.
- When pressed during a *Bluetooth*® Wireless Technology Handsfree call, switches call back to mobile phone. (Private)
- When pressed while calling on the mobile phone, switches call back to *Bluetooth*® Wireless Technology Handsfree. (Operates only when *Bluetooth*® Wireless Technology Handsfree is connected)

### (6) Ends phone call.

## *Bluetooth*® Wireless Technology

### *When No Devices have been Paired*

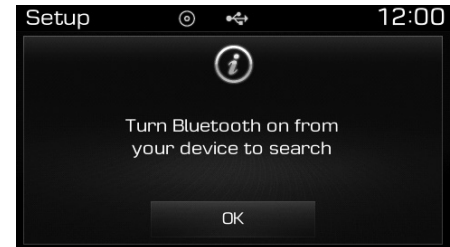

1. Press the **[PHONE]** button or the **[CALL]** button on the steering wheel controls. The following screen is displayed.
2. Select **[OK]** to enter the Pair Phone screen.

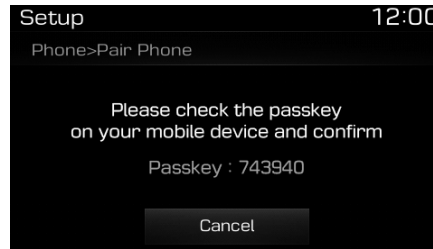

## Information



- Vehicle Name : Name of device as shown when searching from your *Bluetooth*® Wireless Technology device
  - Passkey : Passkey used to pair the device
3. From your *Bluetooth*® Wireless Technology device (i.e. Mobile Phone), search and select your car audio system.

### \* SSP : Secure Simple Pairing

Non SSP supported device :

4. After a few moments, a screen is displayed where the passkey is entered.  
Enter the passkey "0000" to pair your *Bluetooth*® Wireless Technology device with the car audio system.

SSP supported device :

4. After a few moments, a screen is displayed 6 digits passkey.  
Check the passkey on your *Bluetooth*® Wireless Technology device and confirm.
5. Once pairing is complete, the following screen is displayed.

If *Bluetooth*® Wireless Technology devices are paired but none are currently connected, pressing the **[PHONE]** button or the **[CALL]** button on the steering wheel controls the following screen. Select **[Pair]** to pair a new device or select **[Connect]** to connect a previously paired device.

### Pairing through [PHONE] Setup

Press the [SETUP] button ► Select [Phone].

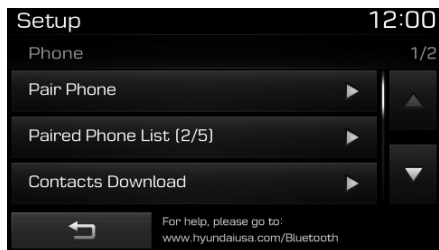

### Pair Phone

The following steps are the same as those described in the section "When No Devices have been Paired" on the previous page.

### Paired Phone List

Press the [SETUP] button ► Select [Phone] ► Select [Paired Phone List].

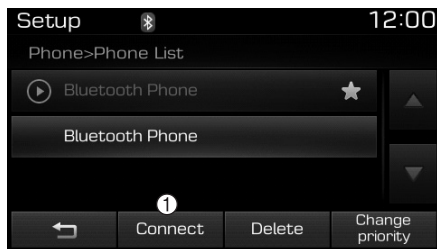

### Connecting a Device

From the paired phone list, select the device you want to connect and select [Connect](1).

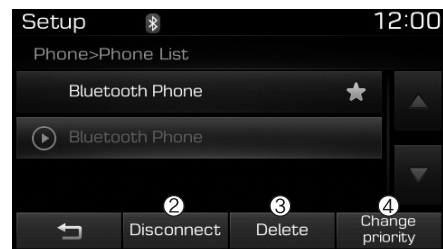

### Disconnecting a Device

From the paired phone list, select the currently connected device and select [Disconnect](2).

### Deleting a Device

From the paired phone list, select the device you want to delete and select [Delete](3).

### **i** Information

- When deleting the currently connected device, the device will automatically be disconnected to proceed with the deleting process.
- If a paired *Bluetooth*® Wireless Technology device is deleted, the device's call history and contacts data will also be deleted.
- To re-use a deleted device, you must pair the device again.

### Changing Priority

It is possible to pair up to five *Bluetooth*® Wireless Technology devices with the car audio system. The "Change Priority" feature is used to set the connection priority of paired phones.

From the paired phone list, select the phone you want to switch to the highest priority, then select [Change priority] (4) from the Menu. The selected device will be changed to the highest priority.

### Phone Menu Screen

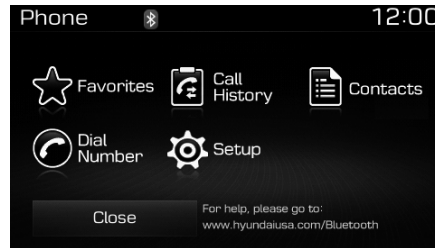

### Phone Menus

With a *Bluetooth*® Wireless Technology device connected, press the [PHONE] button to display the Phone menu screen.

- Favorites : Up to 20 frequently used contacts saved for easy access.
- Call History : Device the call history list screen.
- Contacts : Displays the Contacts list screen.
- Dial Number : Displays the dial screen where numbers can be dialed to make calls.
- Setup : Displays Phone related settings.

### **i** Information

- If you select [Call History] but there is no call history data, a prompt is displayed which asks to download call history data.
- If you select [Contacts] but there is no contacts data stored, a prompt is displayed which asks to download contacts data.
- This feature may not be supported in some mobile phones. For more information on download support, refer to your mobile phone user's manual.

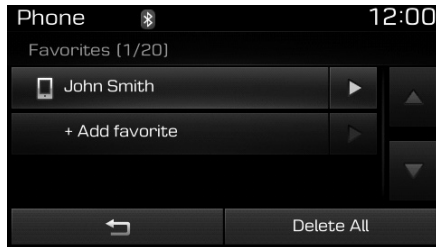

### Favorites

- Saved favorite contact : Connects call upon selection.
- To add favorite : Downloaded contacts be saved as favorite.
- Delete All : Delete all stored favorite contacts.

### **i** Information

- **To save Favorite, contacts should be downloaded.**
- **Contact saved in Favorites will not be automatically updated if the contact has been updated in the phone. To update Favorites, delete the Favorite and create a new Favorite.**

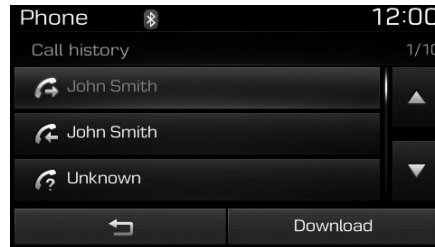

### Call History

A list of incoming, outgoing and missed calls is displayed.

Select [Download] to download the call history.

- Call History :
  - Displays recent calls. (call history)
  - Connects call upon selection.
- Download : Download Recent Call History.
- Call history may not be saved in the call history list in some mobile phones.
- Calls received with hidden caller ID will not be saved in the call history list.

- Calling through the call history is not possible when there is no call history stored or a *Bluetooth®* Wireless Technology phone is not connected.
- Up to 50 received, dialed and missed calls are stored in Call History.
- Time of received/dialed calls and call time information are not saved.

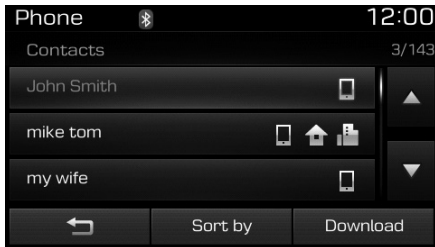
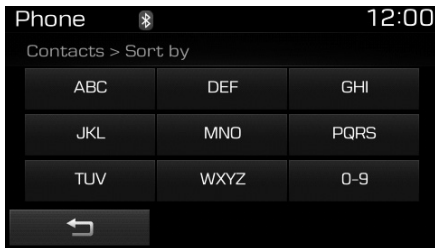

### Contacts

The list of saved phone book entries is displayed. Select [Download] to download the call history.

- Call History :
  - Displays downloaded contacts entries.
  - Connects call upon selection.
- Sort by : Find a contact in an alphabetical order.
- Download :Download contacts entries.

### **i** Information

- Up to 1,000 contacts saved in your *Bluetooth*<sup>®</sup> Wireless Technology phone can be downloaded into the car contacts. Contacts that have been downloaded to the car cannot be edited or deleted on the phone.
- Mobile phone contacts are managed separately for each paired *Bluetooth*<sup>®</sup> Wireless Technology device (max 5 devices x 1,000 contacts each). Previously downloaded data is maintained even if the *Bluetooth*<sup>®</sup> Wireless Technology device has been disconnected. (However, the contacts and call history saved to the phone will be deleted if a paired phone is deleted.)
- It is possible to download contacts during Bluetooth<sup>®</sup> streaming audio.
- When downloading contacts, the icon will be displayed within the status bar.

(Continued)

(Continued)

- It is not possible to begin downloading a contact list when the contact download feature has been turned off within the *Bluetooth*<sup>®</sup> Wireless Technology device. In addition, some devices may require device authorization upon attempting to download contacts. If downloading does not normally occur, check the *Bluetooth*<sup>®</sup> Wireless Technology device settings or the screen state.
- The contacts download feature may not be supported in some mobile phones. For more information of supported Bluetooth<sup>®</sup> devices and function support, refer to your phone's user manual.
- Only supported contacts format can be downloaded and displayed from the *Bluetooth*<sup>®</sup> Wireless Technology device, contacts from some applications will not be included.



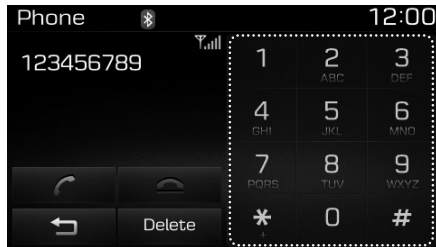

### Calling by Dialing a Number

- Dial Pad : Used to enter phone number.
- Call : If a number has been entered, calls the number. If no number has been entered, switches to call history screen.
- End : Deletes the entered phone number.
- Delete : Deletes entered numbers one digit at a time.

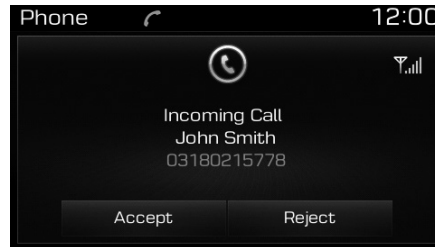

### Answering a Call

Answering a call with a *Bluetooth®* Wireless Technology device connected will display the following screen.

- Caller : Displays the other party's name when the incoming caller is saved within your contacts.
- Incoming Number : Displays the incoming number.
- Accept : Accepts the incoming call.
- Reject : Rejects the incoming call.

### **i** Information

- When an incoming call pop-up is displayed, most Audio and SETUP mode features are disabled. Only the call volume will operate.
- The telephone number may not be properly displayed in some mobile phones.

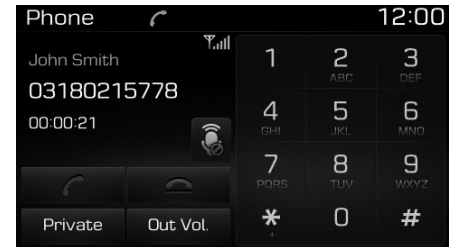

### During a Handsfree Call

- Caller : Displays the other party's name if the incoming caller is saved within your contacts.
- Incoming Number : Displays the incoming number.
- Call time : Displays the call time.
- End : Ends call.
- Private : Converts to Private mode.
- Out Vol. : Sets call volume as heard by the other party.
- Mute : Turns Mic Mute On/Off.

### **i** Information

If the mic is muted, the other party will not be able to hear your voice.

## Voice Recognition Mode

### Using Voice Recognition

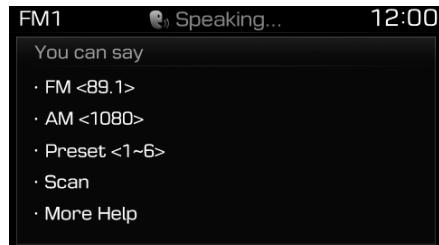

#### Starting Voice Recognition

Shortly press the [🔊] button on the steering wheel remote controller. Say a command.

If prompt feedback is in [ON], then the system will say "Please say a command after the beep (BEEP)"

- If prompt feedback is in [ON] mode, then the system will only say "(BEEP)"
- To change Prompt Feedback [On]/[Off], press the [SETUP] button ► Select [System] ► Select [Prompt Feedback].

For proper recognition, say the command after the voice instruction and beep tone.

### **i** Information

#### Contact List Best Practices

- 1) Do not store single-name entries (e.g., "Bob", "Mom", "Kim", etc.). Instead, always use full names (including first and last names) for all contacts (e.g., use "Jacob Stevenson" instead of "Dad").
- 2) Do not use abbreviations (i.e., use "Lieutenant" instead of "Lt." or "Sergeant" instead of "Sgt.").
- 3) Do not use acronyms (i.e., use "County Finance Department" instead of "CFD").
- 4) Do not use special characters (e.g., "@", "hyphen -", "asterisk \*", "ampersand &").
- 5) If a name is not recognized from the contact list, change it to a more descriptive name (e.g., use "Grandpa Joseph" instead of "Pa Joe").

#### Skipping Prompt Messages

While prompt message is being stated ► Shortly press the [🔊] button on the steering remote controller.

The prompt message is immediately ended and the beep tone will sound. After the "Beep", say the voice command.

#### Skipping Prompt Messages

While system waits for a command ► Shortly press the [🔊] button on the steering remote controller.

The command wait state is immediately ended and the beep tone will sound. After the "Beep", say the voice command.

### Illustration on using Voice Recognition

#### Starting Voice Recognition

Shortly pressing the [  ] button :

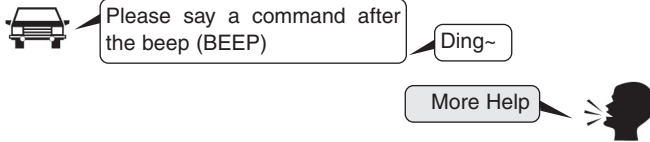

More Help  
Here are some examples of mode commands.  
You can say a radio type like 'FM' or 'AM'.  
You can also say a media source like 'USB', 'My Music', or 'iPod®'.  
Additionally, there are phone commands like 'Contacts', 'Call History', or 'Dial Number'.  
You can find more detailed commands in the user's manual.  
Please say a command after the beep.



More Help  
Here are some examples of mode commands.  
You can say a radio type like 'FM' or 'AM'.  
You can also say a media source like 'USB', 'My Music', or 'iPod®'.  
Additionally, there are phone commands like 'Contacts', 'Call History', or 'Dial Number'.  
You can find more detailed commands in the user's manual.  
Please say a command after the beep.

#### Skipping Voice Recognition

Shortly pressing the [  ] button :



Shortly pressing the [  ] button :



#### Ending Voice Recognition

Shortly pressing the [  ] button :

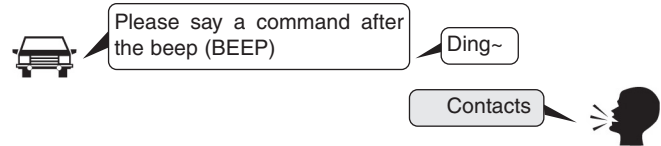

## Voice Command List

### Common Commands

These commands can be used in most operations.

(However a few commands may not be available during certain operations)

Command	Function
More Help	Provides guidance on commands that can be used anywhere in the system.
Help	Provides guidance on commands that can be used within the current mode.
Call<Name>	Calls <Name> saved in Contacts. Ex) Call "John Smith"
Call <Name> on Mobile	Calls <Name> to the number that is saved as "Mobile" in Contacts. Ex) Call "John Smith" on Mobile
Call <Name> in Office	Calls <Name> to the number that is saved as "Office" in Contacts. Ex) Call "John Smith" in Office
Call <Name> at Home	Calls <Name> to the number that is saved as "Home" in Contacts Ex) Call "John Smith" at Home
Call <Name> on Other	Calls <Name> to the number that is saved as "Other" in Contacts Ex) Call "John Smith" on Other
Phone	Provides guidance on Phone related commands. After saying this command, say "Favorites", "Call History", "Contacts" or "Dial Number" execute corresponding functions.
Favorites	Displays the Favorite screen.

Command	Function
Call History	Displays the Call History screen.
Contacts	Displays the Contacts screen. After saying this command, say the name of a contact saved in the Contacts to automatically connect the call.
Dial Number	Displays the Dial number screen. After saying this command, you can say the number that you want to call.
Redial	Connects the last dialed call number.
Tutorial	Provides guidance on how to use voice recognition and Bluetooth® connections
Radio	<ul style="list-style-type: none"> <li>When listening to the radio, displays the next radio screen. (FM1 → FM2 → AM)</li> <li>When listening to a different mode, displays the most recently played radio screen.</li> <li>When currently listening to the FM radio, maintains the current state.</li> <li>When listening to a different mode, displays the most recently played FM screen.</li> </ul>
FM1(FM One)	Displays the FM1 screen.
FM2(FM Two)	Displays the FM2 screen.
AM	Displays the AM screen.

Command	Function
FM Preset 1~6	Plays the most recently played broadcast saved in FM Preset 1~6.
AM Preset 1~6	Plays the broadcast saved in AM Preset 1~6.
FM 87.5~107.9	Plays the FM broadcast of the corresponding frequency.
AM 530~1710	Plays the AM broadcast of the corresponding frequency.
Media	Moves to the most recently played media screen.
CD	Plays music on the CD.
USB	Plays music on the USB device.
iPod®	Plays music on the iPod®.
My Music	Plays music saved in My Music.
AUX (Auxiliary)	Plays the connected external device.
Bluetooth® Audio	Plays the music saved in connected Bluetooth® device.
Mute	Mutes the sound.
Cancel (Exit)	Ends voice command.

### FM/AM Radio Commands

Commands available during FM/AM radio operation.

Command	Function
Preset 1~6	Plays the broadcast station saved in Preset 1~6.
Scan	Scans receivable frequencies from the current broadcast and plays for 10 seconds each.
Preset Scan	Moves to the next preset from the current present and plays for 10 seconds each.
Information	Displays the information of the current broadcast. (This feature can be used when receiving RBDS broadcasts.)

### Audio CD Commands

Commands available during Audio CD operation.

Command	Function
Random	Randomly plays the tracks within the CD.
Random Off	Cancels random play to play tracks in sequential order.
Repeat	Repeats the current track.
Repeat Off	Cancels repeat play to play tracks in sequential order.
Track 1~30	Plays the desired track number.

### MP3 CD/USB Commands

Commands available during MP3 CD/USB operation.

Command	Function
Random	Randomly plays the files within the current folder.
Random Off	Cancels random play to play files in sequential order.
Repeat	Repeats the current file.
Repeat Off	Cancels repeat play to play files in sequential order.
Information	Displays the information screen of the current file.
Next Folder	Plays the first file in the next folder.
Previous Folder	Plays the first file in the previous folder.

### iPod® Commands

Commands available during iPod® operation.

Command	Function
Random	Randomly plays the songs within the current category.
Random Off	Cancels random play to play songs in sequential order.
Repeat	Repeats the current song.
Repeat Off	Cancels repeat play to play songs in sequential order.

### My Music Commands

Commands available during My Music operation

Command	Function
Random	Randomly plays all saved files.
Random Off	Cancels random play to play files in sequential order.
Repeat	Repeats the current file.
Repeat Off	Cancels repeat play to play files in sequential order.
Delete	Deletes the current file. You will bypass an additional confirmation process.

### Bluetooth® Wireless Technology Audio Commands

Commands available during Bluetooth® Wireless Technology audio streaming from mobile phone operation Command Operation.

Command	Function
Play	Plays the currently paused song.
Pause	Pauses the current song.

### Setup Mode

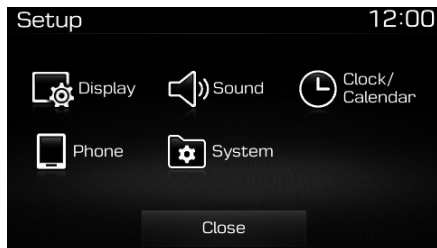

Press the **[SETUP]** button to display the Setup screen.

You can select and control options related to [Display], [Sound], [Clock/Calendar], [Phone] and [System].

#### With the Display Button

Press the **[SETUP]** button ► Select [Display].

You can select and control options related to [Brightness], [Mode Pop up] and [Media Display].



#### Adjusting the Brightness

Use the [Left/Right] to adjust the screen brightness or set the Brightness on Automatic, Day or Night mode.

Select [Default] to reset.

- Automatic : Adjusts the brightness automatically.
- Day : Always maintains the brightness on high.
- Night : Always maintains the brightness on low.

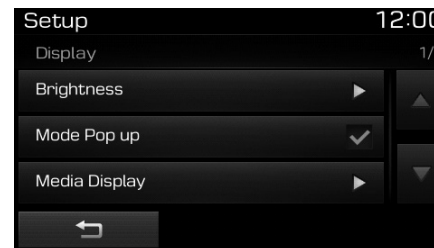

#### Mode Pop-up

This feature is used to display the Mode Pop-up screen when entering radio and media modes.

When this feature is turned on, pressing the **[RADIO]** or **[MEDIA]** button will display the Mode Pop-up screen.

#### **i** Information

**The media Mode Pop-up screen can be displayed only when two or more media modes have been connected.**

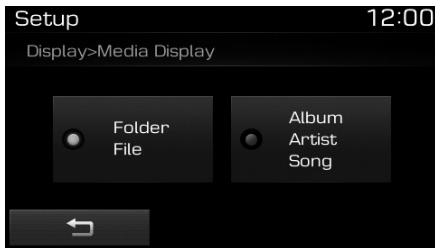

### Media Display

This feature is used to change the information displayed within USB and MP3 CD modes.

- Folder File : Displays file name and folder name.
- Album Artist Song : Displays album name/artist name/song.

### With the Sound Button

Press the **[SETUP]** button ► Select [Sound].

You can select and control options related to [Sound Setting], [Speed Dependent Vol.], [Voice Recognition Vol.] and [Touch Screen Beep].

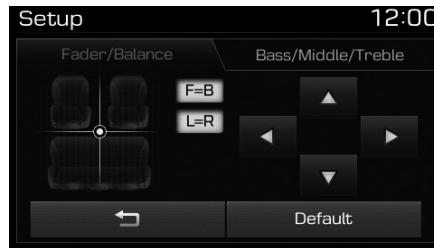

### Sound Setting

Use the [Up/Down/Left/Right] to adjust the Fader/Balance settings.

Use the [Left/Right] to adjust the Bass/Middle/Treble settings.

Select [Default] to reset.



### SDVC (Speed Dependent Volume Control)

The volume level is controlled automatically according to the vehicle speed. SDVC can be set by selecting from On/Off.

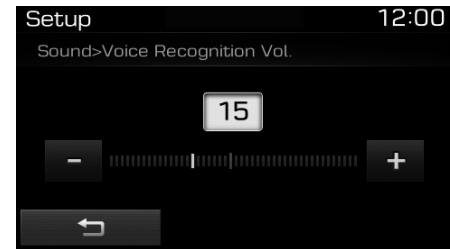

### Voice Recognition Volume

Use the [-], [+] adjust the Voice Recognition volume.



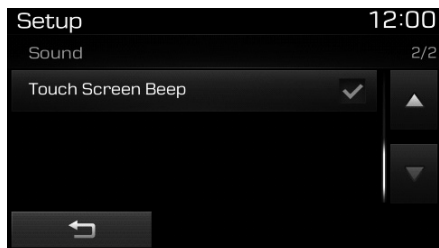

### Touch Screen Beep

This feature is used to turn the touch screen beep on/off.

### With the Clock/Calendar Button

Press the [SETUP] button ► Select [Clock/Calendar].

You can select and control options related to [Clock Settings], [Calendar Settings], [Time Format] and [Clock Display].

### ⚠ WARNING

#### Clock Setting Distraction

**Adjusting the clock setting while driving can result in a loss of vehicle control that may lead to an accident, severe personal injury, and death.**

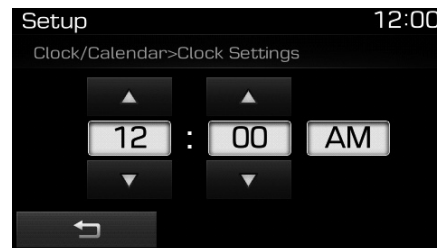

### Clock Settings

Use the [Up/Down] to set the Hour, Minutes setting and select AM/PM.

Press and hold the [CLOCK] button to set the Clock/Calendar screen.

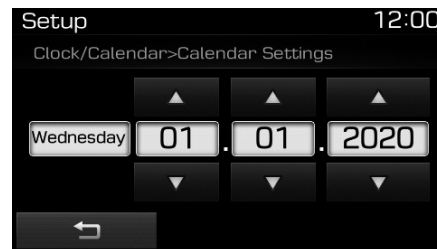

### Calendar Settings

Use the [Up/Down] to set the Day, Month and Year setting.

## Time Format

This feature is used to change the clock format between 12hr or 24hr.

## Clock Display

This feature is used to display a clock on the screen when the audio system is turned off.

## With the Phone Button

Press the [SETUP] button ► Select [Phone].

You can select and control options related to [Pair Phone], [Paired Phone List], [Contacts Download], [Auto Download], [Outgoing Volume] and [Bluetooth System Off].

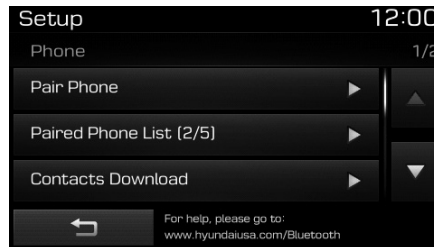

## Pairing a New Device

*Bluetooth*<sup>®</sup> Wireless Technology devices can be paired with the audio system.

For more information, refer to the "Pairing through Phone Setup" section within *Bluetooth*<sup>®</sup> Wireless Technology.



## Viewing Paired Phone List

This feature is used to view mobile phones that have been paired with the audio system. Upon selecting a paired phone, the setup menu is displayed.

For more information, refer to the "Setting *Bluetooth*<sup>®</sup> Wireless Technology Connection" section within *Bluetooth*<sup>®</sup> Wireless Technology.

- (1) Moves to the previous screen.
- (2) Connect/Disconnect Phone : Connect/Disconnects currently selected phone.
- (3) Delete : Deletes the currently selected phone.
- (4) Change priority : Sets currently selected phone to highest connection priority.

### **i** Information

#### **- Before Downloading Contacts**

- Only contacts within connected phones can be downloaded. Also check to see that your mobile phone supports the download feature.
- To learn more about whether your mobile phone supports contacts downloads, refer to your mobile phone user's manual.
- The contacts for only the connected phone can be downloaded.

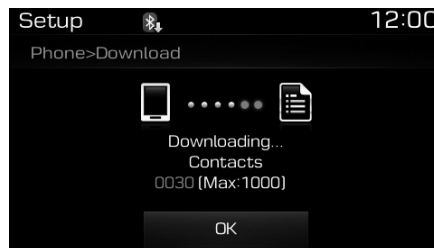

#### **Downloading Contacts**

As the contacts are downloaded from the mobile phone, a download progress bar is displayed.

- Upon downloading phone contacts, the previous corresponding data is deleted.
- This feature may not be supported in some mobile phones.
- Voice Recognition may not operate while contacts are being downloaded.

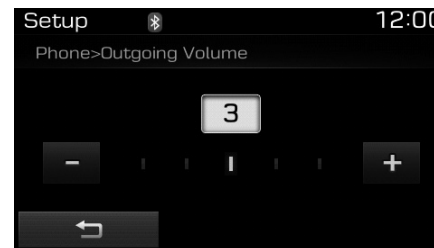

#### **Outgoing Volume**

Use the [-], [+] to adjust the outgoing volume level. While on a call, the volume can be changed by using the **[SEEK/TRACK]** button.

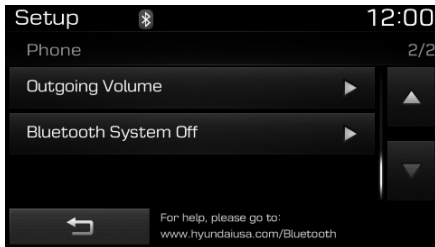

### Turning Bluetooth System Off

Once *Bluetooth*® Wireless Technology is turned off, *Bluetooth*® Wireless Technology related features will not be supported within the audio system.

To turn *Bluetooth*® Wireless Technology back on, press the **[SETUP]** ► Select [Phone] and select [Yes].

### With the System Button

Press the **[SETUP]** button ► Select [System].

You can select and control options related to [Memory Information], [Prompt Feedback] and [Language].

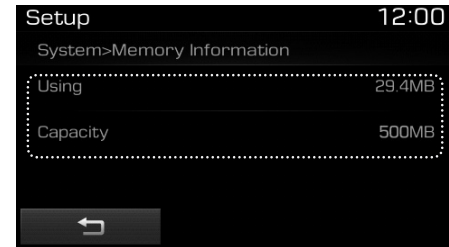
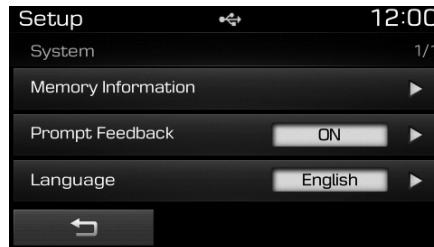

### Memory Information

This feature displays information related to system memory.

- Using : Displays capacity currently in use.
- Capacity : Displays total capacity.

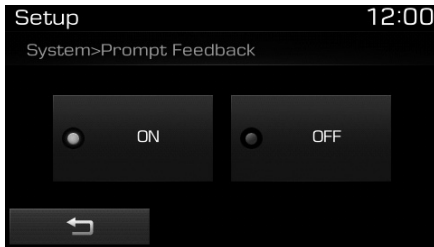

### Prompt Feedback

This feature is used to select the desired prompt feedback option from ON and OFF.

- ON : When using voice recognition, provides detailed guidance prompts.
- OFF : When using voice recognition, omits some guidance prompts.

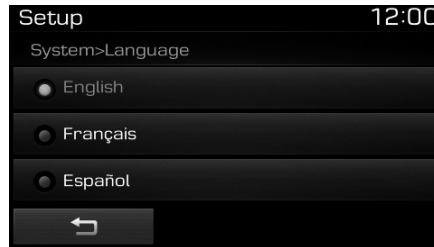

### Language

This feature is used to change the system and voice recognition language.

If the language is changed, the system will restart and apply the selected language.

## ***FCC Warning***

This equipment has been tested and found to comply with the limits for a Class B digital device, pursuant to part 15 of the FCC Rules. These limits are designed to provide reasonable protection against harmful interference in a residential installation.

This equipment generates, uses and can radiate radio frequency energy and, if not installed and used in accordance with the instructions, may cause harmful interference to radio communications. However, there is no guarantee that interference will not occur in a particular installation. If this equipment does cause harmful interference to radio or television reception, which can be determined by turning the equipment off and on, the user is encouraged to try to correct the interference by one or more of the following measures:

- Reorient or relocate the receiving antenna.
- Increase the separation between the equipment and receiver.
- Connect the equipment into an outlet on a circuit different from that to which the receiver is connected.
- Consult the dealer or an experienced radio/TV technician for help

This device complies with part 15 of the FCC Rules. Operation is subject to the following two conditions: (1) This device may not cause harmful interference, and (2) this device must accept any interference received, including interference that may cause undesired operation.

**Caution: Any changes or modifications to this device not expressly approved by the party responsible for compliance could void your authority to operate the equipment.**

This equipment complies with FCC radiation exposure limits set forth for an uncontrolled environment.

This equipment should be installed and operated with minimum 20 cm between the radiator and your body. This transmitter must not be collocated or operating in conjunction with any other antenna or transmitter unless authorized to do so by the FCC.

## Driving your vehicle

<b>Before driving</b> .....	5-4	<b>All wheel drive (AWD)</b> .....	5-40
Before Entering the Vehicle .....	5-4	AWD operation.....	5-41
Before Starting .....	5-4	Emergency precautions.....	5-44
<b>Ignition switch</b> .....	5-6	<b>Drive mode integrated control system</b> .....	5-46
Key Ignition Switch .....	5-6	<b>Blind spot detection system (BSD)</b> .....	5-49
Engine Start/Stop Button.....	5-9	BSD (Blind Spot Detection) /	
<b>Transmission</b> .....	5-14	LCA (Lane Change Assist).....	5-50
Automatic Transmission.....	5-14	RCTA (Rear Cross Traffic Alert) .....	5-53
Ecoshift dual clutch transmission .....	5-18	Limitations of the system .....	5-55
Shift-Lock System .....	5-24	<b>Automatic emergency braking (AEB)</b> .....	5-56
Shift-Lock Release.....	5-24	System setting and activation.....	5-56
Parking.....	5-25	AEB warning message and system control.....	5-58
Good Driving Practices .....	5-25	AEB front radar sensor .....	5-61
<b>Braking system</b> .....	5-27	System malfunction.....	5-62
Power Brakes.....	5-27	Limitations of the system .....	5-63
Disc Brakes Wear Indicator .....	5-28	<b>Lane departure warning system (LDWS)</b> .....	5-67
Parking Brake.....	5-28	LDWS Operation.....	5-68
Anti-lock Brake System (ABS) .....	5-30	Warning Light and Message.....	5-69
Electronic Stability Control (ESC).....	5-32	Limitations of the system .....	5-69
Vehicle Stability Management (VSM).....	5-35	<b>Cruise control</b> .....	5-71
Hill-Start Assist Control (HAC) .....	5-37	Cruise Control operation .....	5-71
Downhill Brake Control (DBC).....	5-37		
Good Braking Practices.....	5-39		

<b>Special driving conditions</b> .....	5-76
Hazardous driving conditions.....	5-76
Rocking the vehicle .....	5-76
Smooth cornering .....	5-77
Driving at night.....	5-77
Driving in the rain.....	5-77
Driving in flooded areas.....	5-78
Highway driving.....	5-78
Reducing the risk of a rollover .....	5-79
<b>Winter driving</b> .....	5-80
Snow or Icy Conditions.....	5-80
Winter Precautions.....	5-82
<b>Trailer towing</b> .....	5-84
If you decide to pull a trailer?.....	5-84
Trailer towing equipment .....	5-86
Driving with a trailer .....	5-87
Maintenance when trailer towing.....	5-91
<b>Vehicle load limit</b> .....	5-92
Tire Loading Information Label .....	5-93



## WARNING

### **Carbon monoxide (CO) gas is toxic. Breathing CO can cause unconsciousness and death.**

Engine exhaust contains carbon monoxide which cannot be seen or smelled.

### **Do not inhale engine exhaust.**

If at any time you smell engine exhaust inside the vehicle, open the windows immediately. Exposure to CO can cause unconsciousness and death by asphyxiation.

### **Be sure the exhaust system does not leak.**

The exhaust system should be checked whenever the vehicle is raised to change the oil or for any other purpose. If you hear a change in the sound of the exhaust or if you drive over something that strikes the underneath side of the vehicle, have the exhaust system checked as soon as possible by an authorized HYUNDAI dealer.

### **Do not run the engine in an enclosed area.**

Letting the engine idle in your garage, even with the garage door open, is a hazardous practice. Run the engine only long enough to start the engine and to move the vehicle out of the garage.

### **Avoid idling the engine for prolonged periods with people inside the vehicle.**

If it is necessary to idle the engine for a prolonged period with people inside the vehicle, be sure to do so only in an open area with the air intake set at "Fresh" and fan control set to high so fresh air is drawn into the interior.

### **Keep the air intakes clear.**

To assure proper operation of the ventilation system, keep the ventilation air intakes located in front of the windshield clear of snow, ice, leaves, or other obstructions.

### **If you must drive with the liftgate open:**

Close all windows.

Open instrument panel air vents.

Set the air intake control at "Fresh", the air flow control at "Floor" or "Face", and the fan control set to high.

 **WARNING**

**CALIFORNIA PROPOSITION 65  
WARNING**

**Engine exhaust and a wide variety of automobile components including components found in the interior furnishings in a vehicle, contain or emit harmful chemicals known to the State of California to cause cancer and birth defects and reproductive harm. In addition, certain fluids contained in vehicles and certain products of components contain or emit chemicals known to the State of California to cause cancer and birth defects or other reproductive harm.**

## BEFORE DRIVING

### Before Entering the Vehicle

- Be sure all windows, outside mirror(s), and outside lights are clean and unobstructed.
- Remove frost, snow, or ice.
- Visually check the tires for uneven wear and damage.
- Check under the vehicle for any sign of leaks.
- Be sure there are no obstacles behind you if you intend to back up.

### Before Starting

- Make sure the hood, the liftgate, and the doors are securely closed and locked.
- Adjust the position of the seat and steering wheel.
- Adjust the inside and outside rearview mirrors.
- Verify all the lights work.
- Fasten your seatbelt. Check that all passengers have fastened their seatbelts.
- Check the gauges and indicators in the instrument panel and the messages on the instrument display when the ignition switch is in the ON position.
- Check that any items you are carrying are stored properly or fastened down securely.

**⚠ WARNING**

To reduce the risk of **SERIOUS INJURY** or **DEATH**, take the following precautions:

- **ALWAYS** wear your seat belt. All passengers must be properly belted whenever the vehicle is moving. For more information, refer to "Seat Belts" in chapter 2.
- Always drive defensively. Assume other drivers or pedestrians may be careless and make mistakes.
- Stay focused on the task of driving. Driver distraction can cause accidents.
- Leave plenty of space between you and the vehicle in front of you.

**⚠ WARNING**

**NEVER** drink or take drugs and drive.

Drinking or taking drugs and driving is dangerous and may result in an accident and **SERIOUS INJURY** or **DEATH**.

Drunk driving is the number one contributor to the highway death toll each year. Even a small amount of alcohol will affect your reflexes, perceptions and judgment. Just one drink can reduce your ability to respond to changing conditions and emergencies and your reaction time gets worse with each additional drink.

Driving while under the influence of drugs is as dangerous or more dangerous than driving under the influence of alcohol.

(Continued)

(Continued)

You are much more likely to have a serious accident if you drink or take drugs and drive. If you are drinking or taking drugs, don't drive. Do not ride with a driver who has been drinking or taking drugs. Choose a designated driver or call a taxi.

## IGNITION SWITCH

### ⚠ WARNING

To reduce the risk of **SERIOUS INJURY** or **DEATH**, take the following precautions:

- **NEVER** allow children or any person who is unfamiliar with the vehicle to touch the ignition switch or related parts. Unexpected and sudden vehicle movement can occur.
- **NEVER** reach through the steering wheel for the ignition switch, or any other control, while the vehicle is in motion. The presence of your hand or arm in this area may cause a loss of vehicle control resulting in an accident.

### Key Ignition Switch



Whenever the front door is opened, the ignition switch will illuminate, provided the ignition switch is not in the ON position. The light will go off immediately when the ignition switch is turned on or go off after about 30 seconds when the door is closed.

### ⚠ WARNING

**NEVER** turn the ignition switch to the LOCK or ACC position while the vehicle is in motion except in an emergency. This will result in the engine turning off and loss of power assist for the steering and brake systems. This may lead to loss of directional control and braking function, which could cause an accident.

**Before leaving the driver's seat, always make sure the shift lever is in P (Park) position, apply the parking brake, and turn ignition switch to the LOCK position.**

**Unexpected vehicle movement may occur if these precautions are not followed.**

### **Key ignition switch positions**

<b>Switch Position</b>	<b>Action</b>	<b>Notice</b>
<b>LOCK</b>	<p>To turn the ignition switch to the LOCK position, push the key in slightly at the ACC position and turn the key towards the LOCK position.</p> <p>The ignition key can be removed in the LOCK position.</p> <p>The steering wheel locks to protect the vehicle from theft. (if equipped)</p>	
<b>ACC</b>	<p>Electrical accessories are usable.</p> <p>The steering wheel unlocks.</p>	
<b>ON</b>	<p>This is the normal key position when the engine has started.</p> <p>All features and accessories are usable.</p> <p>The warning lights can be checked when you turn the ignition switch from ACC to ON.</p>	<p>Do not leave the ignition switch in the ON position when the engine is not running in order to prevent the battery from discharging.</p>
<b>START</b>	<p>To start the engine, turn the ignition switch to the START position. The switch returns to the ON position when you let go of the key.</p>	<p>The engine will crank until you release the key.</p>

### Starting the engine

#### **WARNING**

**Always wear appropriate shoes when operating your vehicle.**

**Unsuitable shoes, such as high heels, ski boots, sandals, flip-flops, etc., may interfere with your ability to use the brake and accelerator pedals.**

1. Make sure the parking brake is applied.
2. Make sure the shift lever is in P (Park).
3. Depress the brake pedal.
4. Turn the ignition switch to the START position. Hold the key (maximum of 10 seconds) until the engine starts and release it.

#### **Information**

- It is best to maintain a moderate engine speed until the vehicle engine comes up to normal operating temperature. Avoid harsh or abrupt acceleration or deceleration while the engine is still cold.
- Whether the engine is cold or warm, always start the vehicle with your foot on the brake pedal. Do not depress the accelerator while starting the vehicle. Do not race the engine while warming it up.

#### **NOTICE**

**To prevent damage to the vehicle:**

- Do not hold the ignition key in the START position for more than 10 seconds. Wait 5 to 10 seconds before trying again.
- Do not push or tow your vehicle to start the engine.

## Engine Start/Stop Button



Whenever the front door is opened, the Engine Start/Stop button will illuminate and will go off 30 seconds after the door is closed.

### **⚠ WARNING**

To reduce risk of serious injury or death, **NEVER** allow children or any person who is unfamiliar with the vehicle to touch the Engine Start/Stop button or related parts. Unexpected and sudden vehicle movement can occur.

### **⚠ WARNING**

To turn the engine off in an emergency:

Press and hold the Engine Start/Stop button for more than two seconds **OR** rapidly press and release the Engine Start/Stop button three times (within three seconds).

If the vehicle is still moving, you can restart the engine without depressing the brake pedal by pressing the Engine Start/Stop button with the shift lever in the **N (Neutral)** position.

### **⚠ WARNING**

- **NEVER** press the Engine Start/Stop button while the vehicle is in motion except in an emergency. This will result in the engine turning off and loss of power assist for the steering and brake systems.



(Continued)

(Continued)



This may lead to loss of directional control and braking function, which could cause an accident.

- Before leaving the driver's seat, always make sure the shift lever is in the **P (Park)** position, set the parking brake, press the Engine Start/Stop button to the **OFF** position, and take the Smart Key with you. Unexpected vehicle movement may occur if these precautions are not followed.
- **NEVER** reach through the steering wheel for the Engine Start/Stop button or any other control while the vehicle is in motion. The presence of your hand or arm in this area may cause a loss of vehicle control resulting in an accident.

**Engine Stop/Start button positions**

Button Position	Action	Notice
<p style="text-align: center;"><b>OFF</b></p>  <p>The image shows a circular button with 'ENGINE START STOP' in the center. The outer ring has 'OFF', 'ACC', and 'ON' markings. The 'OFF' position is highlighted.</p>	<p>To turn off the engine, press the Engine Start/Stop button with shift lever in P (Park). When you press the Engine Start/Stop button without the shift lever in P (Park), the Engine Start/Stop button does not turn to the OFF position, but turns to the ACC position.</p>	
<p style="text-align: center;"><b>ACC</b></p>  <p>The image shows the same button as above, but the 'ACC' position is highlighted.</p>	<p>Press the Engine Start/Stop button when the button is in the OFF position without depressing the brake pedal. Electrical accessories are usable.</p>	<p>If you leave the Engine Start/Stop button in the ACC position for more than one hour, the battery power will turn off automatically to prevent the battery from discharging.</p>



Button Position	Action	Notice
<p data-bbox="254 250 299 274"><b>ON</b></p> 	<p data-bbox="417 257 943 338">Press the Engine Start/Stop button while it is in the ACC position without depressing the brake pedal.</p> <p data-bbox="417 350 943 404">The warning lights can be checked before the engine is started.</p>	<p data-bbox="959 257 1501 338">Do not leave the Engine Start/Stop button in the ON position when the engine is not running to prevent the battery from discharging.</p>
<p data-bbox="232 557 320 581"><b>START</b></p> 	<p data-bbox="417 564 943 675">To start the engine, depress the brake pedal and press the Engine Start/Stop button with the shift lever in the P (Park) or in the N (Neutral) position.</p> <p data-bbox="417 687 943 741">For your safety, start the engine with the shift lever in the P (Park) position.</p>	<p data-bbox="959 564 1501 675">If you press the Engine Start/Stop button without depressing the brake pedal, the engine does not start and the Engine Start/Stop button changes as follows:</p> <p data-bbox="959 687 1290 711"><b>OFF → ACC → ON → OFF</b></p> <p data-bbox="959 723 1501 834">However, the engine may start if you depress the brake pedal within 0.5 second after pressing the Engine Start/Stop button when it is in the OFF position.</p>

### Starting the engine

#### WARNING

- Always wear appropriate shoes when operating your vehicle. Unsuitable shoes, such as high heels, ski boots, sandals, flip-flops, etc., may interfere with your ability to use the brake and accelerator pedals.
- Do not start the vehicle with the accelerator pedal depressed. The vehicle can move and lead to an accident.
- Wait until the engine rpm is normal. The vehicle may suddenly move if the brake pedal is released when the rpm is high.

#### Information

- The engine will start by pressing the Engine Start/Stop button, only when the smart key is in the vehicle.
- Even if the smart key is in the vehicle, if it is far away from the driver, the engine may not start.
- When the Engine Start/Stop button is in the ACC or ON position, if any door is open, the system checks for the smart key. If the smart key is not in the vehicle, the "🚗" indicator will blink and the warning "Key not in vehicle" will come on and if all doors are closed, the chime will also sound for about 5 seconds. Keep the smart key in the vehicle when using the ACC position or if the vehicle engine is ON.

1. Always carry the smart key with you.
2. Make sure the parking brake is applied.
3. Make sure the shift lever is in P (Park).
4. Depress the brake pedal.
5. Press the Engine Start/Stop button.

#### Information

- Do not wait for the engine to warm up while the vehicle remains stationary. Start driving at moderate engine speeds. (Steep accelerating and decelerating should be avoided.)
- Always start the vehicle with your foot on the brake pedal. Do not depress the accelerator while starting the vehicle. Do not race the engine while warming it up.

### NOTICE

To prevent damage to the vehicle:

- If the engine stalls while you are in motion, do not attempt to move the shift lever to the P (Park) position.

If traffic and road conditions permit, you may put the shift lever in the N (Neutral) position while the vehicle is still moving and press the Engine Start/Stop button in an attempt to restart the engine.

- Do not push or tow your vehicle to start the engine.

### NOTICE

To prevent damage to the vehicle:

When the stop lamp fuse is blown, you can't start the engine normally. Replace the fuse with a new one. If you are not able to replace the fuse, you can start the engine by pressing and holding the Engine Start/Stop button for 10 seconds with the Engine Start/Stop button in the ACC position.

Do not press the Engine Start/Stop button for more than 10 seconds except when the stop lamp fuse is blown.

For your safety always depress the brake pedal before starting the engine.

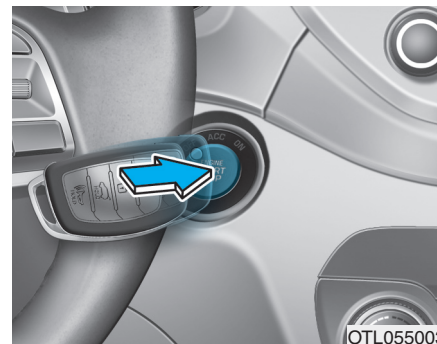



### **i** Information

If the smart key battery is weak or the smart key does not work correctly, you can start the engine by pressing the Engine Start/Stop button with the smart key in the direction of the picture above.

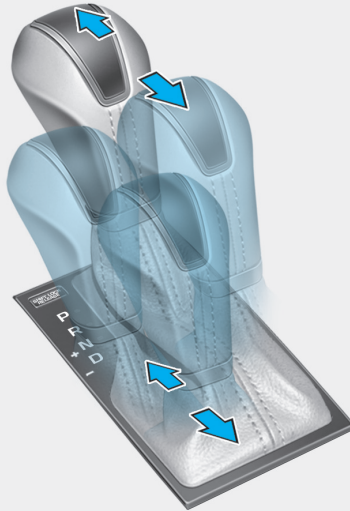
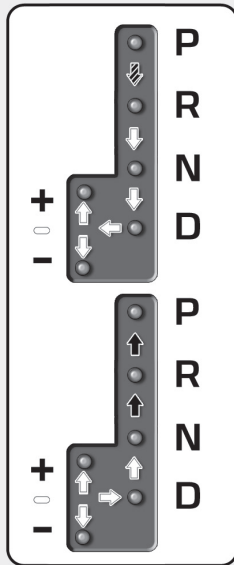
## TRANSMISSION



-  Press the shift button, then move shift lever.
-  Depress the brake pedal, press the shift button, and then move shift lever.
-  Move shift lever.

### Automatic Transmission

#### ***Automatic transmission operation***

The automatic transmission has six forward speeds and one reverse speed.

The individual speeds are selected automatically in the D (Drive) position.

OTL055006

## WARNING

To reduce the risk of serious injury or death:

- **ALWAYS** check the surrounding areas near your vehicle for people, especially children, before shifting a vehicle into D (Drive) or R (Reverse).
- Before leaving the driver's seat, always make sure the shift lever is in the P (Park) position, then set the parking brake, and place the ignition switch in the LOCK/OFF position. Unexpected and sudden vehicle movement can occur if these precautions are not followed.
- Do not use engine braking (shifting from a high gear to lower gear) rapidly on slippery roads. The vehicle may slip causing an accident.

The indicator in the instrument cluster displays the shift lever position when the ignition switch is in the ON position.

### **P (Park)**

Always come to a complete stop before shifting into P (Park).

To shift from P (Park), you must depress firmly on the brake pedal and make sure your foot is off the accelerator pedal.

If you have done all of the above and still cannot shift the lever out of P (Park), see "Shift-Lock Release" in this section.

The shift lever must be in P (Park) before turning the engine off.

## WARNING

- **Shifting into P (Park) while the vehicle is in motion may cause you to lose control of the vehicle.**
- **After the vehicle has stopped, always make sure the shift lever is in P (Park), apply the parking brake, and turn the engine off.**
- **Do not use the P (Park) position in place of the parking brake.**

### R (Reverse)

Use this position to drive the vehicle backward.

#### CAUTION

**Always come to a complete stop before shifting into or out of R (Reverse); you may damage the transmission if you shift into R (Reverse) while the vehicle is in motion.**

### N (Neutral)

The wheels and transmission are not engaged.

Use N (Neutral) if you need to restart a stalled engine, or if it is necessary to stop with the engine ON. Shift into P (Park) if you need to leave your vehicle for any reason.

Always depress the brake pedal when you are shifting from N (Neutral) to another gear.

#### WARNING

**Do not shift into gear unless your foot is firmly on the brake pedal. Shifting into gear when the engine is running at high speed can cause the vehicle to move very rapidly. You could lose control of the vehicle and hit people or objects.**

### D (Drive)

This is the normal driving position. The transmission will automatically shift through a six-gear sequence, providing the best fuel economy and power.

For extra power when passing another vehicle or driving uphill depress the accelerator pedal further until you feel the transmission downshift to a lower gear.

The DRIVE MODE switch, located on the shift lever console, allows the driver to switch from NORMAL mode to SPORT or ECO mode.

**For more information, refer to "Drive Mode Integrated Control System" later in this chapter.**

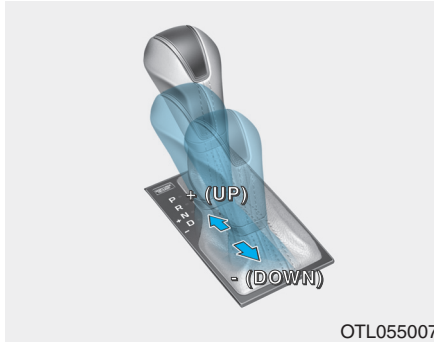

### Manual shift mode

Whether the vehicle is stationary or in motion, manual shift mode is selected by pushing the shift lever from the D (Drive) position into the manual gate. To return to D (Drive) range operation, push the shift lever back into the main gate.

In Manual Shift Mode, moving the shift lever backwards and forwards will allow you to select the desired range of gears for the current driving conditions.

- + (Up) : Push the lever forward once to shift up one gear.
- (Down) : Pull the lever backwards once to shift down one gear.

### **i** Information



- Only the six forward gears can be selected. To reverse or park the vehicle, move the shift lever to the R (Reverse) or P (Park) position as required.
- Downshifts are made automatically when the vehicle slows down. When the vehicle stops, 1<sup>st</sup> gear is automatically selected.
- When the engine rpm approaches the red zone the transmission will upshift automatically.

(Continued)

(Continued)

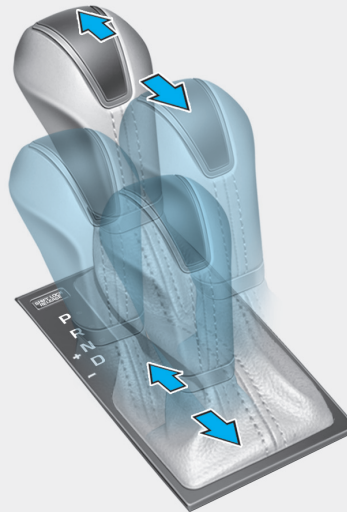
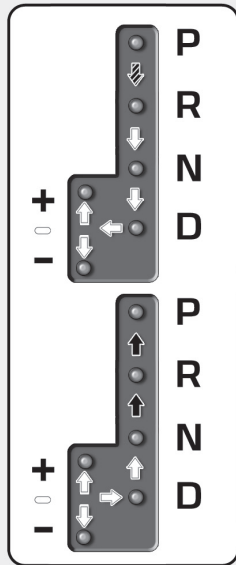
- If the driver presses the lever to + (Up) or - (Down) position, the transmission may not make the requested gear change if the next gear is outside of the allowable engine rpm range. The driver must execute upshifts in accordance with road conditions, taking care to keep the engine rpms below the red zone.
- When accelerating from a stop on a slippery road, push the shift lever forward into the + (Up) position. This allows the transmission to shift into the 2<sup>nd</sup> gear which is better for smooth driving on a slippery road. Push the shift lever to the - (Down) side to shift back to the 1<sup>st</sup> gear.



-  Press the shift button, then move shift lever.
-  Depress the brake pedal, press the shift button, and then move shift lever.
-  Move shift lever.

## Ecoshift dual clutch transmission

### *Ecoshift dual clutch transmission operation*

The Ecoshift dual clutch transmission has seven forward speeds and one reverse speed.

The individual speeds are selected automatically in the D (Drive) position.

OTL055006



## WARNING

To reduce the risk of serious injury or death:

- **ALWAYS check the surrounding areas near your vehicle for people, especially children, before shifting a vehicle into D (Drive) or R (Reverse).**
- **Before leaving the driver's seat, always make sure the shift lever is in the P (Park) position, then set the parking brake, and place the ignition switch in the LOCK/OFF position. Unexpected and sudden vehicle movement can occur if these precautions are not followed.**
- **Do not use engine braking (shifting from a high gear to lower gear) rapidly on slippery roads. The vehicle may slip causing an accident.**

- The Ecoshift dual clutch transmission gives the driving feel of a manual transmission, yet provides the ease of a fully automatic transmission. Unlike a traditional automatic transmission, the gear shifting can sometimes be felt and heard on the Ecoshift dual clutch transmission, as the actuators engage the clutch and the gear is selected.

The Ecoshift dual clutch transmission can be thought of as an automatically shifting manual transmission. When D (Drive) is selected, the transmission will automatically shift through the gears similar to a conventional automatic transmission.

- The Ecoshift dual clutch transmission incorporates a dry-type dual clutch mechanism, which allows for better acceleration performance and increased fuel efficiency while driving. But it differs from a conventional automatic transmission in that it does not incorporate a torque converter. Instead, the transition from one gear to the next is managed by clutch slip, especially at lower speeds.

As a result, shifts are sometimes more noticeable, and a light vibration can be felt as the transmission shaft speed is matched with the engine shaft speed. This is a normal condition of the Ecoshift dual clutch transmission.

- The dry-type clutch transfers torque more directly and provides a direct-drive feeling which may feel different from a conventional automatic transmission. This may be more noticeable when launching the vehicle from a stop or when traveling at low, stop-and-go vehicle speeds.
- When rapidly accelerating from a lower vehicle speed, the engine rpm may increase dramatically as a result of clutch slip as the Ecoshift dual clutch transmission selects the correct gear. This is a normal condition.
- When accelerating from a stop on an incline, press the accelerator smoothly and gradually to avoid any shudder feeling or jerkiness.

- When traveling at a lower vehicle speed, if you release the accelerator pedal quickly, you may feel engine braking before the transmission changes gears. This engine braking feeling is similar to operating a manual transmission at low speed.
- When driving downhill, you may wish to move the gear shift lever to Manual Shift mode and downshift to a lower gear in order to control your speed without using the brake pedal excessively.
- When you turn the engine on and off, you may hear clicking sounds as the system goes through a self test. This is a normal sound for the Ecoshift dual clutch transmission.

### WARNING

**Due to transmission failure, you may not continue to drive and the position indicator (D, R) on the cluster will blink. Contact an authorized HYUNDAI dealer and have the system checked.**

### NOTICE

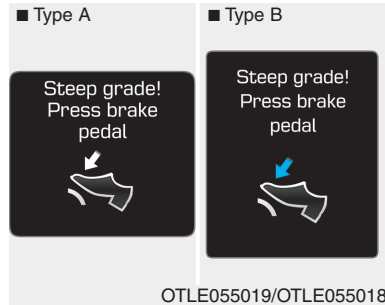

- **To hold the vehicle on a hill use the foot brake or the parking brake. If the vehicle is held by applying the accelerator pedal on a hill the clutch and transmission will be overheated resulting in damage.**

**At this time, a warning message will appear on the LCD display and you may feel a vibration.**

(Continued)

(Continued)

- **If the clutch becomes overheated by excessive use of the clutch to hold on a hill, you may notice a shudder feeling and a blinking display on the instrument cluster. When this occurs, the clutch is disabled until the clutch cools to normal temperatures. If this occurs, pull over to a safe location, shift into P (Park) and apply the foot brake for a few minutes.**
- **If the LCD warning is active, the foot brake must be applied.**
- **Ignoring the warnings can lead to damage to the transmission.**
- **If the display continues to blink, for your safety, contact an authorized HYUNDAI dealer and have the system checked.**

(Continued)

(Continued)

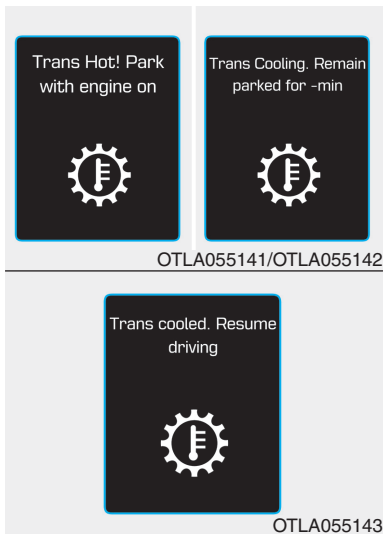

- Under certain conditions, such as repeated stop-and-go launches on steep grades, the transmission clutches may overheat. When the clutches are overheated, the transmission safe protection mode logic is enabled.

(Continued)

(Continued)

If the safe protection mode logic is enabled, the gear position indicator on the cluster blinks with a chime sound. At this time, a warning message will appear on the LCD display and driving may not be smooth. If you ignore this warning, the driving condition may become worse. If this occurs, stop the vehicle, apply the brakes or shift the vehicle to P (Park), and allow the transmission to cool.

- If the Ecoshift dual clutch transmission starts to become overheated, the gear shift characteristics may change. Gear shifts may become more abrupt. If continued operation includes frequent and continuous upshifts and downshifts, the overheat warning message on the cluster LCD display may illuminate. If this occurs, stop the vehicle, apply the brakes or shift the vehicle to (P) Park, and allow the transmission to cool.

(Continued)

(Continued)

When possible, continue to drive the vehicle smoothly while trying to avoid frequent upshifting and downshifting.

- Gear shifts may be more noticeable than a conventional automatic transmission. This is a normal characteristic of this type of Ecoshift dual clutch transmission.
- During the first 1000 miles, you may feel that the vehicle may not be smooth when accelerating at low speed. During this break-in period, the shift quality and performance of your new vehicle is continuously optimized.
- Always come to a complete stop before shifting into D (Drive) or R (Reverse).
- Do not put the shift lever in N (Neutral) while driving.

The indicator in the instrument cluster displays the shift lever position when the ignition switch is in the ON position.

### P (Park)

Always come to a complete stop before shifting into P (Park).

To shift from P (Park), you must depress firmly on the brake pedal and make sure your foot is off the accelerator pedal.

If you have done all of the above and still cannot shift the lever out of P (Park), see "Shift-Lock Release" in this section.

The shift lever must be in P (Park) before turning the engine off.

### WARNING

- **Shifting into P (Park) while the vehicle is in motion may cause you to lose control of the vehicle.**
- **After the vehicle has stopped, always make sure the shift lever is in P (Park), apply the parking brake, and turn the engine off.**
- **Do not use the P (Park) position in place of the parking brake.**

### R (Reverse)

Use this position to drive the vehicle backward.

### CAUTION

**Always come to a complete stop before shifting into or out of R (Reverse); you may damage the transmission if you shift into R (Reverse) while the vehicle is in motion.**

### N (Neutral)

The wheels and transmission are not engaged.

Use N (Neutral) if you need to restart a stalled engine, or if it is necessary to stop with the engine ON. Shift into P (Park) if you need to leave your vehicle for any reason.

Always depress the brake pedal when you are shifting from N (Neutral) to another gear.

### WARNING

**Do not shift into gear unless your foot is firmly on the brake pedal. Shifting into gear when the engine is running at high speed can cause the vehicle to move very rapidly. You could lose control of the vehicle and hit people or objects.**

## D (Drive)

This is the normal driving position. The transmission will automatically shift through a seven-gear sequence, providing the best fuel economy and power.

For extra power when passing another vehicle or driving uphill depress the accelerator pedal further until you feel the transmission downshift to a lower gear.

The DRIVE MODE switch, located on the shift lever console, allows the driver to switch from NORMAL mode to SPORT mode.

**For more information, refer to "Drive Mode Integrated Control System" later in this chapter.**

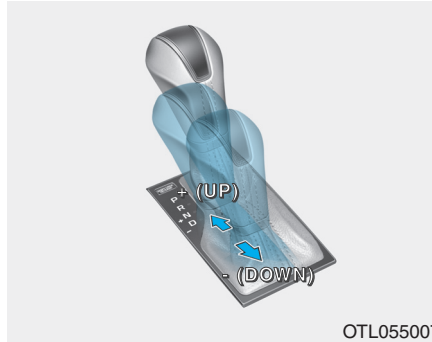

### Manual shift mode

Whether the vehicle is stationary or in motion, manual shift mode is selected by pushing the shift lever from the D (Drive) position into the manual gate. To return to D (Drive) range operation, push the shift lever back into the main gate.

In Manual Shift Mode, moving the shift lever backwards and forwards will allow you to select the desired range of gears for the current driving conditions.

- + (Up) : Push the lever forward once to shift up one gear.
- (Down) : Pull the lever backwards once to shift down one gear.

### **i** Information

- Only the seven forward gears can be selected. To reverse or park the vehicle, move the shift lever to the R (Reverse) or P (Park) position as required.
- Downshifts are made automatically when the vehicle slows down. When the vehicle stops, 1<sup>st</sup> gear is automatically selected.
- When the engine rpm approaches the red zone the transmission will upshift automatically.
- If the driver presses the lever to + (Up) or - (Down) position, the transmission may not make the requested gear change if the next gear is outside of the allowable engine rpm range. The driver must execute upshifts in accordance with road conditions, taking care to keep the engine rpms below the red zone.

### Shift-Lock System

For your safety, the automatic transmission has a shift-lock system which prevents shifting the transmission from P (Park) into R (Reverse) unless the brake pedal is depressed.

To shift the transmission from P (Park) into R (Reverse):

1. Depress and hold the brake pedal.
2. Start the engine or place the ignition switch in the ON position.
3. Move the shift lever.

### Shift-Lock Release

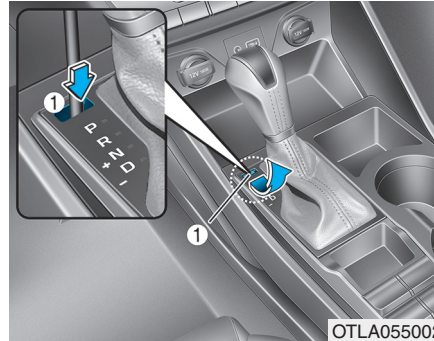

If the shift lever cannot be moved from the P (Park) position into R (Reverse) position with the brake pedal depressed, continue depressing the brake, and then do the following:

1. Place the ignition switch in the LOCK/OFF position.
2. Apply the parking brake.
3. Carefully remove the cap (1) covering the shift-lock release access hole.
4. Insert a tool (e.g. flathead screwdriver) into the access hole and press down on the tool.

5. Move the shift lever.
6. Remove the tool from the shift-lock override access hole then install the cap.

If you need to use the shift-lock release, have your vehicle inspected by an authorized HYUNDAI dealer immediately.

## Parking

Always come to a complete stop and continue to depress the brake pedal. Move the shift lever into the P (Park) position, apply the parking brake, and place the ignition switch in the LOCK/OFF position. Take the Key with you when exiting the vehicle.

### WARNING

**When you stay in the vehicle with the engine running, be careful not to depress the accelerator pedal for a long period of time. The engine or exhaust system may overheat and start a fire.**

**The exhaust gas and the exhaust system are very hot. Keep away from the exhaust system components.**

**Do not stop or park over flammable materials, such as dry grass, paper or leaves. They may ignite and cause a fire.**

## Good Driving Practices

- Never move the shift lever from P (Park) or N (Neutral) to any other position with the accelerator pedal depressed.
- Never move the shift lever into P (Park) when the vehicle is in motion.  
Be sure the vehicle is completely stopped before you attempt to shift into R (Reverse) or D (Drive).
- Do not move the shift lever to N (Neutral) when driving. Doing so may result in an accident because of a loss of engine braking and the transmission could be damaged.
- Do not drive with your foot resting on the brake pedal. Even light, but consistent pedal pressure can result in the brakes overheating, brake wear and possibly even brake failure.
- Depressing both accelerator and brake pedals at the same time can trigger logic for engine power reduction to assure vehicle deceleration. Vehicle acceleration will resume after the brake pedal is released.

- When driving in Manual Shift Mode, slow down before shifting to a lower gear. Otherwise, the lower gear may not be engaged if the engine rpms are outside of the allowable range.
- Always apply the parking brake when leaving the vehicle. Do not depend on placing the transmission in P (Park) to keep the vehicle from moving.
- Exercise extreme caution when driving on a slippery surface. Be especially careful when braking, accelerating or shifting gears. On a slippery surface, an abrupt change in vehicle speed can cause the drive wheels to lose traction and may cause loss of vehicle control resulting in an accident.
- Optimum vehicle performance and economy is obtained by smoothly depressing and releasing the accelerator.

**i** Information - Kickdown Mechanism

Use the kickdown mechanism for maximum acceleration. Depress the accelerator pedal beyond the pressure point. The automatic transmission will shift to a lower gear depending on the engine speed.

**⚠ WARNING**

To reduce the risk of **SERIOUS INJURY or DEATH**:

- **ALWAYS** wear your seatbelt. In a collision, an unbelted occupant is significantly more likely to be seriously injured or killed than a properly belted occupant.
- Avoid high speeds when cornering or turning.
- Do not make quick steering wheel movements, such as sharp lane changes or fast, sharp turns.
- The risk of rollover is greatly increased if you lose control of your vehicle at highway speeds.
- Loss of control often occurs if two or more wheels drop off the roadway and the driver over steers to reenter the roadway.

(Continued)

(Continued)

- In the event your vehicle leaves the roadway, do not steer sharply. Instead, slow down before pulling back into the travel lanes.
- **HYUNDAI** recommends you follow all posted speed limits.



## BRAKING SYSTEM

### Power Brakes

Your vehicle has power-assisted brakes that adjust automatically through normal usage.

If the engine is not running or is turned off while driving, the power assist for the brakes will not work. You can still stop your vehicle by applying greater force to the brake pedal than typical. The stopping distance, however, will be longer than with power brakes.

When the engine is not running, the reserve brake power is partially depleted each time the brake pedal is applied. Do not pump the brake pedal when the power assist has been interrupted.

Pump the brake pedal only when necessary to maintain steering control on slippery surfaces.

### WARNING

**Take the following precautions:**

- **Do not drive with your foot resting on the brake pedal. This will create abnormal high brake temperatures, excessive brake lining and pad wear, and increased stopping distances.**
- **When descending down a long or steep hill, move the gear shift lever to Manual Shift Mode and manually downshift to a lower gear in order to control your speed without using the brake pedal excessively. Applying the brakes continuously will cause the brakes to overheat and could result in a temporary loss of braking performance.**

**(Continued)**

**(Continued)**

- **Wet brakes may impair the vehicle's ability to safely slow down; the vehicle may also pull to one side when the brakes are applied. Applying the brakes lightly will indicate whether they have been affected in this way. Always test your brakes in this fashion after driving through deep water. To dry the brakes, lightly tap the brake pedal to heat up the brakes while maintaining a safe forward speed until brake performance returns to normal. Avoid driving at high speeds until the brakes function correctly.**

### Disc Brakes Wear Indicator

When your brake pads are worn and new pads are required, you will hear a high pitched warning sound from your front or rear brakes. You may hear this sound come and go or it may occur whenever you depress the brake pedal.

Note that some driving conditions or climates may cause a brake squeal when you first apply (or lightly apply) the brakes. This is normal and does not indicate a problem with your brakes.

#### **NOTICE**

**To avoid costly brake repairs, do not continue to drive with worn brake pads.**

#### **i Information**

**Always replace brake pads as complete front or rear axle sets.**

### Parking Brake

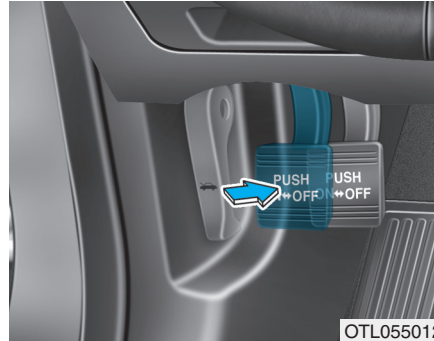

Always set the parking brake before leaving the vehicle. To apply the parking brake:

Firmly depress the brake pedal.

Depress the parking brake pedal down as far as possible.

#### **⚠ WARNING**

**To reduce the risk of SERIOUS INJURY or DEATH, do not operate the parking brake while the vehicle is moving except in an emergency situation. It could damage the brake system and lead to an accident.**



To release:

Firmly depress the brake pedal.

Depress the parking brake pedal down and it will release automatically.

If the parking brake does not release or does not release all the way, have your vehicle checked by an authorized HYUNDAI dealer.

## WARNING

- Whenever leaving the vehicle or parking, always come to a complete stop and continue to depress the brake pedal. Move the shift lever into P (Park) position, then apply the parking brake, and place the ignition switch in the LOCK/OFF position.

Vehicles with the parking brake not fully engaged are at risk for moving inadvertently and causing injury to yourself or others.

- NEVER allow anyone who is unfamiliar with the vehicle to touch the parking brake. If the parking brake is released unintentionally, serious injury may occur.
- Only release the parking brake when you are seated inside the vehicle with your foot firmly on the brake pedal.

## NOTICE

- Do not apply the accelerator pedal while the parking brake is engaged. If you depress the accelerator pedal with the parking brake engaged, warning will sound. Damage to the parking brake may occur.
- Driving with the parking brake on can overheat the braking system and cause premature wear or damage to brake parts. Make sure the parking brake is released and the Brake Warning Light is off before driving.



Check the Parking Brake Warning Light by placing the ignition switch to the ON position (do not start the engine).

This light will be illuminated when the parking brake is applied with the ignition switch in the START or ON position.

Before driving, be sure the parking brake is released and the Brake Warning Light is OFF.

If the Parking Brake Warning Light remains on after the parking brake is released while engine is running, there may be a malfunction in the brake system. Immediate attention is necessary.

If at all possible, cease driving the vehicle immediately. If that is not possible, use extreme caution while operating the vehicle and only continue to drive the vehicle until you can reach a safe location.

## Anti-lock Brake System (ABS)

### WARNING

**An Anti-Lock Braking System (ABS) or an Electronic Stability Control (ESC) system will not prevent accidents due to improper or dangerous driving maneuvers. Even though vehicle control is improved during emergency braking, always maintain a safe distance between you and objects ahead of you. Vehicle speeds should always be reduced during extreme road conditions. The braking distance for cars equipped with ABS or ESC may be longer than for those without these systems in the following road conditions.**

**(Continued)**

(Continued)

- Drive your vehicle at reduced speeds during the following conditions:
- Rough, gravel or snow-covered roads.
- On roads where the road surface is pitted or has different surface height.
- Tire chains are installed on your vehicle.

The safety features of an ABS or ESC equipped vehicle should not be tested by high speed driving or cornering. This could endanger the safety of yourself or others.

ABS is an electronic braking system that helps prevent a braking skid. ABS allows the driver to steer and brake at the same time.

## Using ABS

To obtain the maximum benefit from your ABS in an emergency situation, do not attempt to modulate your brake pressure and do not try to pump your brakes. Depress your brake pedal as hard as possible.

When you apply your brakes under conditions which may lock the wheels, you may hear sounds from the brakes, or feel a corresponding sensation in the brake pedal. This is normal and it means your ABS is active.

ABS does not reduce the time or distance it takes to stop the vehicle.

Always maintain a safe distance from the vehicle in front of you.

ABS will not prevent a skid that results from sudden changes in direction, such as trying to take a corner too fast or making a sudden lane change. Always drive at a safe speed for the road and weather conditions.

ABS cannot prevent a loss of stability. Always steer moderately when braking hard. Severe or sharp steering wheel movement can still cause your vehicle to veer into oncoming traffic or off the road.

On loose or uneven road surfaces, operation of the anti-lock brake system may result in a longer stopping distance than for vehicles equipped with a conventional brake system.

The ABS warning light () will stay on for several seconds after the ignition switch is in the ON position. During that time, the ABS will go through self-diagnosis and the light will go off if everything is normal. If the light stays on, you may have a problem with your ABS. Contact an authorized HYUNDAI dealer as soon as possible

## WARNING

**If the ABS warning light () is on and stays on, you may have a problem with the ABS. Your power brakes will work normally. To reduce the risk of serious injury or death, contact your HYUNDAI dealer as soon as possible.**

**CAUTION**

When you drive on a road having poor traction, such as an icy road, and apply your brakes continuously, the ABS will be active continuously and the ABS warning light (ABS) may illuminate. Pull your car over to a safe place and turn the engine off.

Restart the engine. If the ABS warning light is off, then your ABS system is normal.

Otherwise, you may have a problem with your ABS system. Contact an authorized HYUNDAI dealer as soon as possible.

**i Information**

When you jump start your vehicle because of a drained battery, the ABS warning light (ABS) may turn on at the same time. This happens because of the low battery voltage. It does not mean your ABS is malfunctioning. Have the battery recharged before driving the vehicle.

**Electronic Stability Control (ESC)**

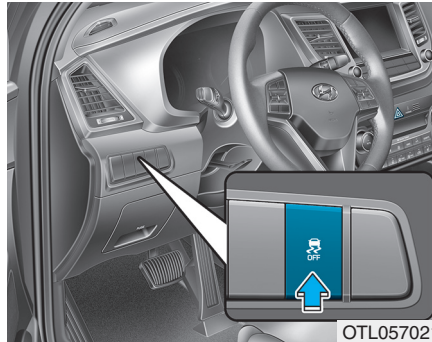

The Electronic Stability Control (ESC) system helps to stabilize the vehicle during cornering maneuvers. ESC checks where you are steering and where the vehicle is actually going. ESC applies braking pressure to any one of the vehicle's brakes and intervenes in the engine management system to assist the driver with keeping the vehicle on the intended path. It is not a substitute for safe driving practices. Always adjust your speed and driving to the road conditions.

**WARNING**

Never drive too fast for the road conditions or too quickly when cornering. The ESC system will not prevent accidents.

Excessive speed in turns, abrupt maneuvers, and hydroplaning on wet surfaces can result in severe accidents.

## ESC operation

### ESC ON condition

When the ignition switch is in the ON position, the ESC and the ESC OFF indicator lights illuminate for approximately three seconds. After both lights go off, the ESC is enabled.

### When operating



When the ESC is in operation, the ESC indicator light blinks:

- When you apply your brakes under conditions which may lock the wheels, you may hear sounds from the brakes, or feel a corresponding sensation in the brake pedal. This is normal and it means your ESC is active.
- When the ESC activates, the engine may not respond to the accelerator as it does under routine conditions.

- If the Cruise Control was in use when the ESC activates, the Cruise Control automatically disengages. The Cruise Control can be reengaged when the road conditions allow. See "Cruise Control System" later in this chapter. (if equipped)
- When moving out of the mud or driving on a slippery road, the engine RPM (revolutions per minute) may not increase even if you press the accelerator pedal deeply. This is to maintain the stability and traction of the vehicle and does not indicate a problem.

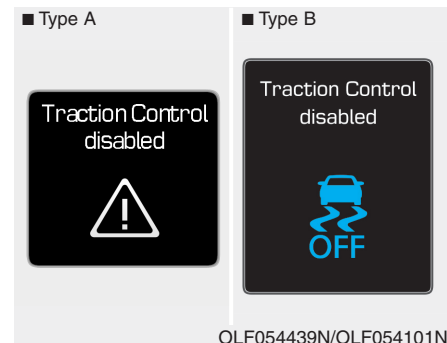

### ESC OFF condition

To cancel ESC operation :

#### • State 1

Press the ESC OFF button briefly. The ESC OFF indicator light and message will illuminate. In this state, the traction control function of ESC (engine management) is disabled, but the brake control function of ESC (braking management) still operates.

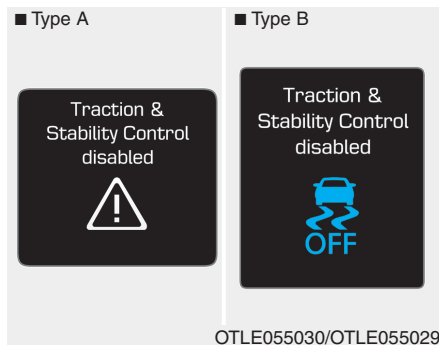

### • State 2

Press the ESC OFF button continuously for more than 3 seconds. The ESC OFF indicator light and message illuminates and a warning chime sounds. In this state, both the traction control function of ESC (engine management) and the brake control function of ESC (braking management) are disabled.

If the ignition switch is placed to the LOCK/OFF position when ESC is off, ESC remains off. Upon restarting the engine, the ESC will automatically turn on again.

### Indicator lights

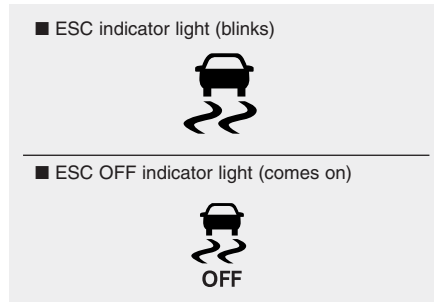

When the ignition switch is placed to the ON position, the ESC indicator light illuminates, then goes off if the ESC system is operating normally.

The ESC indicator light blinks whenever the ESC is operating.

If ESC indicator light stays on, your vehicle may have a malfunction with the ESC system. When this warning light illuminates have your vehicle checked by an authorized HYUNDAI dealer as soon as possible.

The ESC OFF indicator light comes on when the ESC is turned off.

### WARNING

**When the ESC is blinking, this indicates the ESC is active:**

**Drive slowly and NEVER attempt to accelerate. NEVER turn the ESC off while the ESC indicator light is blinking or you may lose control of the vehicle resulting in an accident.**

### NOTICE

**Driving with wheels and tires with different sizes may cause the ESC system to malfunction. Before replacing tires, make sure all four tires and wheels are the same size. Never drive the vehicle with different sized tires and wheels installed.**



## ESC OFF usage

### When Driving

The ESC OFF mode should only be used briefly to help free the vehicle if stuck in snow or mud by temporarily stopping operation of the ESC to maintain wheel torque.

To turn ESC off while driving, press the ESC OFF button while driving on a flat road surface.

### NOTICE

To prevent damage to the transmission:

- **Do not allow wheel(s) of one axle to spin excessively while the ESC, ABS, and parking brake warning lights are displayed. The repairs would not be covered by the vehicle warranty. Reduce engine power and do not spin the wheel(s) excessively while these lights are displayed.**
- **When operating the vehicle on a dynamometer, make sure the ESC is turned off (ESC OFF light illuminated).**

### Information

Turning the ESC off does not affect ABS or standard brake system operation.

## Vehicle Stability Management (VSM)

The Vehicle Stability Management (VSM) is a function of the Electronic Stability Control (ESC) system. It helps ensure the vehicle stays stable when accelerating or braking suddenly on wet, slippery and rough roads where traction over the four tires can suddenly become uneven.

### WARNING

Take the following precautions when using the Vehicle Stability Management (VSM):

- **ALWAYS check the speed and the distance to the vehicle ahead. The VSM is not a substitute for safe driving practices.**
- **Never drive too fast for the road conditions. The VSM system will not prevent accidents. Excessive speed in bad weather, slippery and uneven roads can result in severe accidents.**

### VSM operation

#### VSM ON condition

The VSM operates when:

- The Electronic Stability Control (ESC) is on.
- Vehicle speed is approximately above 9 mph (15 km/h) on curve roads.
- Vehicle speed is approximately above 12 mph (20 km/h) when the vehicle is braking on rough roads.

#### When operating

When you apply your brakes under conditions which may activate the ESC, you may hear sounds from the brakes, or feel a corresponding sensation in the brake pedal. This is normal and it means your VSM is active.

#### NOTICE

**The VSM does not operate when:**

- **Driving on bank road such as gradient or incline.**
- **Driving rearward.**
- **ESC OFF indicator light is on.**
- **EPS (Electric Power Steering) warning light (⊖!) is on.**

#### VSM OFF condition

To cancel VSM operation, press the ESC OFF button. ESC OFF indicator light (  ) will illuminate.

To turn on VSM, press the ESC OFF button again. The ESC OFF indicator light will go out.

#### WARNING

**If ESC indicator light (  ) or EPS warning light ( ⊖! ) stays on, your vehicle may have a malfunction with the VSM system. When the warning light illuminates, have your vehicle checked by an authorized HYUNDAI dealer as soon as possible.**

Driving with wheels and tires with different sizes may cause the ESC system to malfunction. Before replacing tires, make sure all four tires and wheels are the same size. Never drive the vehicle with different sized tires and wheels installed.

## Hill-Start Assist Control (HAC)

The Hill-Start Assist Control (HAC) helps prevent the vehicle from rolling backwards when starting a vehicle from a stop on a hill. The system operates the brakes automatically for approximately 2 seconds and releases the brake after 2 seconds or when the accelerator pedal is depressed.

### WARNING

**Always be ready to depress the accelerator pedal when starting off on a incline. The HAC activates only for approximately 2 seconds.**

### NOTICE

- The HAC does not operate when the shift lever is in P (Park) or N (Neutral)
- The HAC activates even though the ESC (Electronic Stability Control) is off but does not activate when the ESC has malfunctioned.

## Downhill Brake Control (DBC)

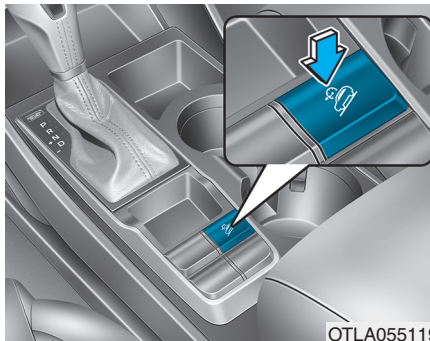

The Downhill Brake Control (DBC) feature assists the driver to descend down a steep hill without having to depress the brake pedal. The system automatically applies the brakes to maintain the vehicle speed below 5 mph (8 km/h) and allows the driver to concentrate on steering the vehicle down hill.





### WARNING

**Always turn off the DBC on normal roads. The DBC might activate inadvertently from the standby mode when driving through speed bumps or making sharp curves.**

### NOTICE

- The DBC defaults to the OFF position whenever the ignition switch is placed in the ON position.
- Noise or vibration may occur from the brakes when the DBC is activated.
- The rear stop light comes on when DBC is activated.

### DBC operation

Mode	Indicator light	Description
<b>Standby</b>	 illuminated	Press the DBC button when vehicle speed is under 25 mph (40 km/h). The DBC system will turn ON and enter the standby mode.  The system does not turn ON if vehicle speed is over 25 mph (40 km/h).
<b>Activated</b>	 blinks	In the standby mode, if vehicle speed is under 22 mph (35 km/h) while driving down a steep hill, the DBC will activate automatically.
<b>Temporarily deactivated</b>	 illuminated	In the activated mode, the DBC will temporarily deactivate under the following conditions: <ul style="list-style-type: none"> <li>• The hill is not steep enough.</li> <li>• The brake pedal or accelerator pedal is depressed.</li> </ul> If the above conditions are not met, the DBC will automatically activate again.
<b>OFF</b>	 not illuminated	The DBC will turn OFF under the following conditions: <ul style="list-style-type: none"> <li>• The DBC button is pressed again.</li> <li>• Vehicle speed is over 38 mph (60 km/h).</li> </ul>

### WARNING

**If the DBC red indicator light illuminates, the system may have overheated or have malfunctioned. When the warning light illuminates even though the DBC system has cooled off, have your vehicle checked by an authorized HYUNDAI dealer as soon as possible.**

### NOTICE

- The DBC may not deactivate on steep inclines even though the brake or accelerator pedal is depressed.
- The DBC does not operate when:
  - The shift lever is in P (Park).
  - The ESC is activated.

## Good Braking Practices

### WARNING

**Whenever leaving the vehicle or parking, always come to a complete stop and continue to depress the brake pedal. Move the shift lever into the P (Park) position, then apply the parking brake, and place the ignition switch in the OFF position.**

**Vehicles parked with the parking brake not applied or not fully engaged may roll inadvertently and may cause injury to the driver and others. ALWAYS apply the parking brake before exiting the vehicle.**

Wet brakes can be dangerous! The brakes may get wet if the vehicle is driven through standing water or if it is washed. Your vehicle will not stop as quickly if the brakes are wet. Wet brakes may cause the vehicle to pull to one side.

To dry the brakes, apply the brakes lightly until the braking action returns to normal, taking care to keep the vehicle under control at all times. If the braking action does not return to normal, stop as soon as it is safe to do so and call an authorized HYUNDAI dealer for assistance.

DO NOT drive with your foot resting on the brake pedal. Even light, but constant pedal pressure can result in the brakes overheating, brake wear, and possibly even brake failure.

If a tire goes flat while you are driving, apply the brakes gently and keep the vehicle pointed straight ahead while you slow down. When you are moving slowly enough for it to be safe to do so, pull off the road and stop in a safe location.

Keep your foot firmly on the brake pedal when the vehicle is stopped to prevent the vehicle from rolling forward.

## ALL WHEEL DRIVE (AWD) (IF EQUIPPED)

The All Wheel Drive (AWD) system delivers engine torque to both the front and rear wheels for extra traction. AWD is useful when maximum traction is required on slippery, muddy, wet, or snow-covered roads.

Occasional off-road use such as established unpaved roads and trails are OK. It is always important that the driver carefully reduces the speed to a level that does not exceed the safe operating speed for those conditions.

### WARNING

To reduce the risk of **SERIOUS INJURY** or **DEATH**:





- Do not drive in conditions that exceed the vehicles intended design such as challenging off-road conditions.
- Avoid high speeds when cornering or turning.
- Do not make quick steering wheel movements, such as sharp lane changes or fast, sharp turns.
- The risk of a rollover is greatly increased if you lose control of your vehicle at highway speeds.
- Loss of control often occurs if two or more wheels drop off the roadway and the driver over steers to reenter the roadway.
- In the event your vehicle leaves the roadway, do not steer sharply. Instead, slow down before pulling back into the travel lanes.

### NOTICE

- Do not drive in water if the level is higher than the bottom of the vehicle.
- Check your brake condition once you are out of mud or water. Depress the brake pedal several times as you move slowly until you feel normal braking return.
- Shorten your scheduled maintenance interval if you drive in off-road conditions such as sand, mud or water (see "Maintenance Under Severe Usage Conditions" in chapter 7).
- Always wash your vehicle thoroughly after off road use, especially the bottom of the vehicle.
- Be sure to equip the vehicle with four tires of the same size and type.
- Make sure that a full time AWD vehicle is towed by a flat bed tow truck.

## AWD operation

### All Wheel Drive (AWD) mode selection

Transfer mode	Selection button	Indicator light	Description
<b>AWD AUTO</b> (AWD LOCK is deactivated)		 (not illuminated)	<p>In the AWD AUTO mode, under normal operating conditions, the vehicle operates similar to conventional 2WD vehicles. If the system determines there is a need for four wheel drive, the engine's driving power is distributed to all four wheels automatically.</p> <p>Use this mode when driving on normal roads.</p>
<b>AWD LOCK</b>		 (illuminated)	<p>In the AWD LOCK mode, the system is deactivated when vehicle speed is over 20 mph (30 km/h) and the mode is shifted to AWD AUTO mode. If the vehicle speed is reduced back down to 20 mph (30 km/h) the system shifts back into AWD LOCK mode.</p> <p>Use this mode when driving up or down steep inclines, driving off-road, driving on sandy and muddy roads, etc. to maximize traction</p>

### WARNING

If AWD warning light (  ) stays on the instrument cluster, your vehicle may have a malfunction with the AWD system. When the AWD warning light (  ) illuminates have your vehicle checked by an authorized HYUNDAI dealer as soon as possible.

 **CAUTION**

**When driving on normal roads, deactivate the AWD LOCK mode by pushing the AWD LOCK button (AWD LOCK indicator light goes off). Driving on normal roads with the AWD LOCK mode, especially, when cornering may cause mechanical noise or vibration. The noise and vibration will disappear when the AWD LOCK mode is deactivated. Prolong driving with the noise and vibration may damage some parts of the power train.**

**NOTICE**

**When the AWD LOCK mode is deactivated, a sensation may be felt as the driving power is delivered entirely to the front wheels.**

***For safe AWD operation***

**Before driving**

- Make sure all passengers are wearing seat belts.
- Sit upright and closer to the steering wheel than usual. Adjust the steering wheel to a position comfortable for you to drive.

**Driving on snow-covered or icy roads**

- Start off slowly by applying the accelerator pedal gently.
- Use snow tires or tire chains.
- Keep sufficient distance between your vehicle and the vehicle in front of you.
- Apply engine braking during deceleration by switching the gear shift lever to Manual Shift Mode and manually selecting a lower gear.
- Avoid speeding, rapid acceleration, sudden brake applications, and sharp turns to prevent skids.

**Driving in sand or mud**

- Maintain slow and constant speed.
- Use tire chains driving in mud if necessary.
- Keep sufficient distance between your vehicle and the vehicle in front of you.
- Reduce vehicle speed and always check the road condition.
- Avoid speeding, rapid acceleration, sudden brake applications, and sharp turns to prevent getting stuck.

 **CAUTION**

**When the vehicle is stuck in snow, sand or mud, place a non-slip material under the drive wheels to provide traction OR Slowly spin the wheels in forward and reverse directions which causes a rocking motion that may free the vehicle. However, avoid running the engine continuously at high rpm, doing so may damage the AWD system.**



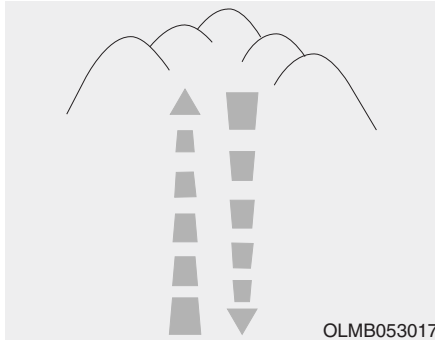

### Driving up or down hills

- Driving uphill
  - Before starting off, check if it is possible to drive uphill.
  - Drive as straight as possible.
- Driving downhill
  - Do not change gear while driving downhill. Select gear before driving downhill.
  - Drive slowly using engine braking while driving downhill.
  - Drive straight as possible.

**⚠ WARNING**

**Exercise extreme caution when driving up or down steep hills. The vehicle may flip over depending on the grade, the terrain, and the trail conditions.**



**⚠ WARNING**

**Do not drive across the contour of steep hills. A slight change in the wheel angle can destabilize the vehicle, or a stable vehicle may lose stability if the vehicle stops its forward motion. Your vehicle may roll over and lead to a serious injury or death.**

### Driving through water

- Try to avoid driving in deep standing water. It may stall your engine and clog your exhaust system.
- If you need to drive in water, stop your vehicle, set the vehicle in AWD LOCK mode and drive under 5 mph (8 km/h).
- Do not change gear while driving in water.

**⚠ CAUTION**

**Always drive slowly in water. If you drive too fast, water may get into the engine compartment and wet the ignition system causing your vehicle to suddenly stop.**

### Additional driving conditions

- Become familiar with the off-road conditions before driving.
- Always pay attention when driving off-road and avoid dangerous areas.
- Drive slowly when driving in heavy wind.
- Reduce vehicle speed when cornering. The center of gravity of AWD vehicles is higher than conventional 2WD vehicles, making them more likely to roll over when you rapidly turn corners.



OTLE055003

- Always hold the steering wheel firmly when you are driving off-road.

#### WARNING

**Do not grab the inside of the steering wheel when you are driving off-road. You may hurt your arm by a sudden steering maneuver or from steering wheel rebound due to an impact with objects on the ground. You could lose control of the steering wheel which may lead to serious injury or death.**

### Emergency precautions

#### *Tires*

Do not use a tire and wheel package with a different size and type from the one originally installed on your vehicle. It can affect the safety and performance of your vehicle, which could lead to steering failure or rollover causing serious injury.

When replacing the tires, be sure to equip all four tires with the tire and wheel of the same size, type, tread, brand and load-carrying capacity. If you equip your vehicle with any tire/wheel combination not recommended by HYUNDAI for off-road driving, you should not use these tires for highway driving.

#### WARNING

**Never start or run the engine while a full-time AWD vehicle is raised on a jack. The vehicle can slip or roll off of a jack causing serious injury or death to you or those nearby.**

## Towing

AWD vehicles must be towed with a wheel lift and dollies or flatbed equipment with all the wheels off the ground. For more information, refer to "Towing" in chapter 6.

## Dynamometer testing

A full-time AWD vehicle must be tested on a special four wheel chassis dynamometer.

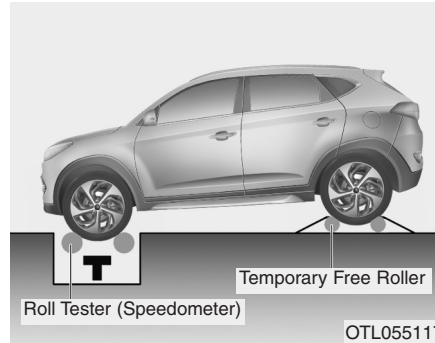

A full-time AWD vehicle should not be tested on a 2WD roll tester. If a 2WD roll tester must be used, perform the following procedure:

1. Check the tire pressures recommended for your vehicle.
2. Place the front wheels on the roll tester for a speedometer test as shown in the illustration.
3. Release the parking brake.
4. Place the rear wheels on the temporary free roller as shown in the illustration.

### CAUTION

- Never engage the parking brake while performing the test.
- When the vehicle is lifted up, do not operate the front and rear wheel separately. All four wheels should be operated.

### WARNING

**Keep away from the front of the vehicle while the vehicle is in gear on the dynamometer. The vehicle can jump forward and cause serious injury or death.**

## DRIVE MODE INTEGRATED CONTROL SYSTEM (IF EQUIPPED)

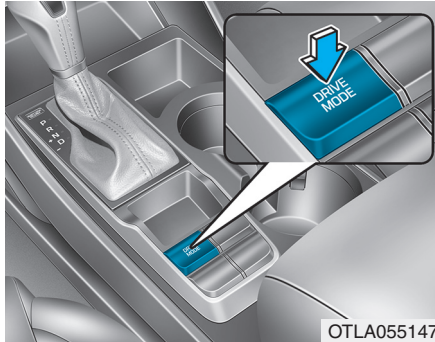

### For Automatic transmission

The drive mode may be selected according to the driver's preference or road condition.

The system resets to be in the NORMAL mode (except for ECO mode), when the engine is restarted.

### **i** Information

**If there is a problem with the instrument cluster, the DRIVE MODE select button may not operate.**

**If this occurs, the vehicle drive mode will default to NORMAL mode.**

The drive mode is selected in the sequence below, whenever the DRIVE MODE button is pressed:

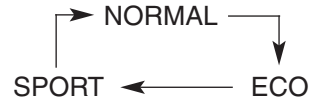

When NORMAL mode is selected, it is not displayed on the instrument cluster.

### **ECO mode**



When the Drive Mode is set to ECO mode, the engine and transmission control logic are changed to maximize fuel efficiency.

- When the ECO mode is selected by pressing the DRIVE MODE button, the ECO indicator (green color) will illuminate.
- If the vehicle is set to ECO mode, when the engine is turned OFF and restarted the Drive Mode setting will remain in ECO mode.

### **i** Information

**Fuel efficiency depends on the driver's driving habit and road condition.**

**When the ECO mode is activated:**

- The acceleration response may be slightly reduced as the accelerator pedal is depressed moderately.
- The air conditioner performance may be limited.
- The shift pattern of the automatic transmission or dual clutch transmission may change.
- The engine noise may get louder.

The above situations are normal conditions when the ECO mode is activated to improve fuel efficiency.

**Limitation of the ECO mode operation:**

If the following conditions occur while the ECO mode is operating, the system operation is limited even though there is no change in the ECO indicator.

- When the coolant temperature is low:  
The system will be limited until engine performance becomes normal.
- When driving up a hill:  
The system will be limited to gain power when driving uphill because engine torque is restricted.
- When driving the vehicle with the automatic transmission or the dual clutch transmission gear shift lever in manual shift mode.  
The system will be limited according to the shift location.

**SPORT mode**

SPORT mode manages the driving dynamics by automatically adjusting the electric power steering and the engine and transmission control logic for enhanced driver performance.

- When SPORT mode is selected by pressing the DRIVE MODE button, the SPORT indicator (yellow color) will illuminate.
- Whenever the engine is restarted, the Drive Mode will revert back to NORMAL mode. If SPORT mode is desired, re-select SPORT mode from the DRIVE MODE button.
- When SPORT mode is activated:
  - The engine rpm will tend to remain raised over a certain length of time even after releasing the accelerator
  - Upshifts are delayed when accelerating

***i* Information**

In SPORT mode, the fuel efficiency may decrease.

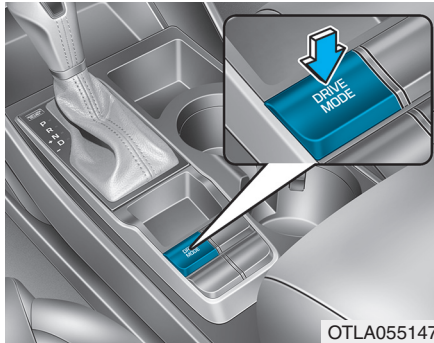

### For EcoShift dual clutch transmission

The drive mode may be selected according to the driver's preference or road condition.

The system resets to be in the NORMAL mode, when the engine is restarted.

#### **i** Information

If there is a problem with the instrument cluster, the DRIVE MODE select button may not operate.

If this occurs, the vehicle drive mode will default to NORMAL mode.

The drive mode is selected in the sequence below, whenever the DRIVE MODE button is pressed:

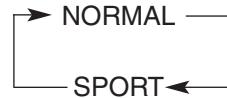

When NORMAL mode is selected, it is not displayed on the instrument cluster.

With the EcoShift dual clutch transmission in NORMAL mode, the engine and transmission control logic are already set to maximize fuel efficiency.

### **SPORT mode**

**SPORT** mode manages the driving dynamics by automatically adjusting the electric power steering and the engine and transmission control logic for enhanced driver performance.

- When SPORT mode is selected by pressing the DRIVE MODE button, the SPORT indicator (yellow color) will illuminate.
- Whenever the engine is restarted, the Drive Mode will revert back to NORMAL mode. If SPORT mode is desired, re-select SPORT mode from the DRIVE MODE button.
- When SPORT mode is activated:
  - The engine rpm will tend to remain raised over a certain length of time even after releasing the accelerator
  - Upshifts are delayed when accelerating

#### **i** Information

In SPORT mode, the fuel efficiency may decrease.

## BLIND SPOT DETECTION SYSTEM (BSD) (IF EQUIPPED)

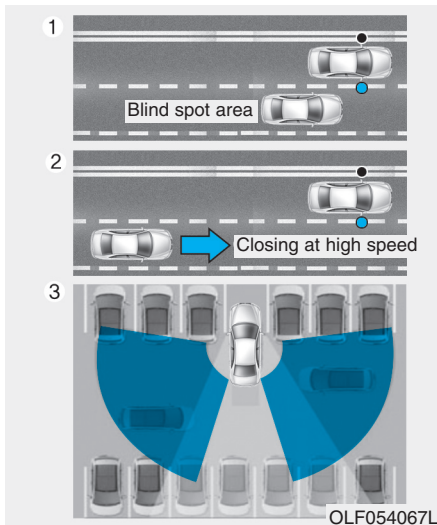

The Blind Spot Detection System (BSD) uses radar sensors in the rear bumper to monitor and warn the driver of an approaching vehicle in the driver's blind spot area.

The system monitors the rear area of the vehicle and provides information to the driver with an audible alert and an indicator on the outside side view mirrors.

### (1) BSD (Blind Spot Detection)

The blind spot detection range varies relative to vehicle speed. Note that if your vehicle is traveling much faster than the vehicles around you, the warning will not occur.

### (2) LCA (Lane Change Assist)

The Lane Change Assist feature will alert you when a vehicle is approaching in an adjacent lane at a high rate of speed. If the driver activates the turn signal when the system detects an oncoming vehicle, the system sounds an audible alert.

### (3) RCTA (Rear Cross Traffic Alert)

The Rear Cross Traffic Alert feature monitors approaching cross traffic from the left and right side of the vehicle when your vehicle is moving in reverse. The feature will operate when the vehicle is moving in reverse below about 6 mph (10 km/h). If oncoming cross traffic is detected a warning chime will sound.

## ⚠ WARNING

- Always be aware of road conditions while driving and be alert for unexpected situations even though the Blind Spot Detection System is operating.
- The Blind Spot Detection System (BSD) is a supplemental system to assist you. Do not entirely rely on the system. Always pay attention, while driving, for your safety.
- The Blind Spot Detection System (BSD) is not a substitute for proper and safe driving. Always drive safely and use caution when changing lanes or backing the vehicle up. The Blind Spot Detection System (BSD) may not detect every object alongside the vehicle.

### BSD (Blind Spot Detection) / LCA (Lane Change Assist)

#### Operating conditions

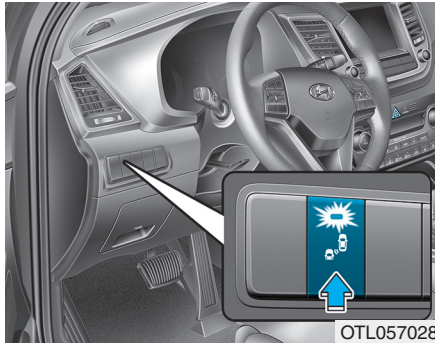

To operate:

Press the BSD switch with the ignition switch in the ON position.

The indicator on the BSD switch will illuminate. When the vehicle speed exceeds 20 mph (30 km/h), the system will be activated.

To cancel:

Press the BSD switch again. The indicator on the switch will go off.

When the system is not used, turn the system off by turning off the switch.

#### **i** Information

- If the Engine Start/Stop button is pressed OFF and then ON again, the BSD system returns to the previous state.
- When the system is turned on, the warning light will illuminate for 3 seconds on the outer side view mirror.

The system will activate when:

1. The system is on.
2. The vehicle speed is above about 20 mph (30 km/h).
3. An oncoming vehicle is detected in the blind spot area.

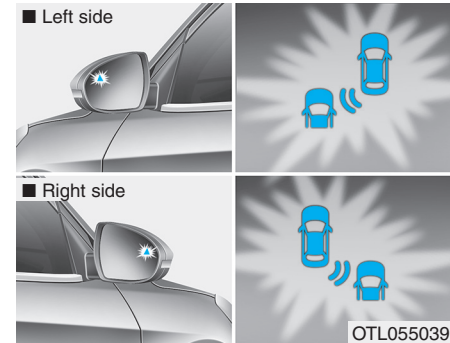

#### First stage alert

If a vehicle is detected within the boundary of the system, a warning light will illuminate on the outer side view mirror.

Once the detected vehicle is no longer within the blind spot area, the warning will turn off according to the driving conditions of the vehicle.



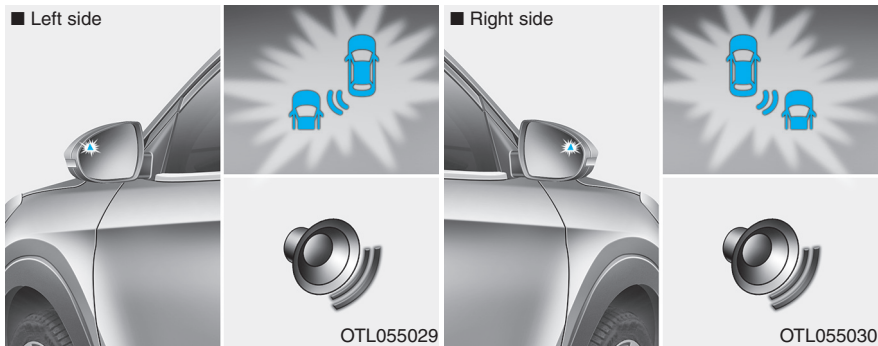

### Second stage alert

A warning chime to alert the driver will activate when:

1. A vehicle has been detected in the blind spot area by the radar system (the warning light will illuminate on the outer side view mirror) AND
2. The turn signal is applied (same side as where the vehicle is being detected).

When this alert is activated, the warning light on the side view mirror will also blink.

If you turn off the turn signal indicator, the warning chime will be deactivated.

### Detecting sensor



The sensors are located inside the rear bumper.

Always keep the rear bumper clean for the proper operation of the system.

### Warning message



- This warning message may appear when :
  - One or both of the sensors on the rear bumper is blocked by dirt or snow or a foreign object
  - Driving in rural areas where the BSD sensor does not detect another vehicle for an extended period of time
  - When there is inclement weather such as heavy snow or rain

If any of these conditions occur, the light on the BSD switch and the system will turn off automatically.

When the BSD cancelled warning message is displayed in the cluster, check to make sure that the rear bumper is free from any dirt or snow in the areas where the sensor is located. Remove any dirt, snow, or foreign material that could interfere with the radar sensors.

After any dirt or debris is removed, the BSD system should operate normally after about 10 minutes of driving the vehicle.

If the system still does not operate normally have your vehicle inspected by an authorized HYUNDAI dealer.

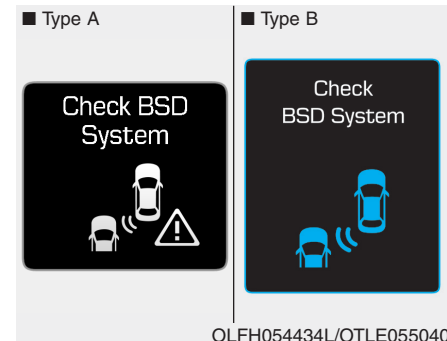

If there is a problem with the BSD system, a warning message will appear and the light on the switch will turn off. The system will turn off automatically. Have your vehicle inspected by an authorized HYUNDAI dealer.

## RCTA (Rear Cross Traffic Alert)

The Rear Cross Traffic Alert feature monitors approaching cross traffic from the left and right side of the vehicle when your vehicle is moving in reverse.

### Operating conditions

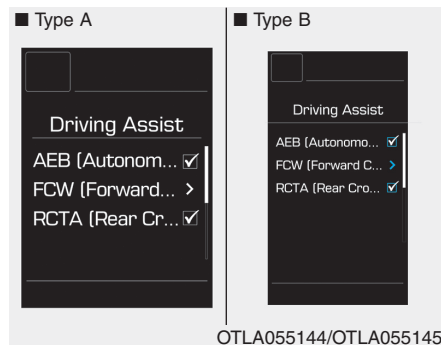

To operate:

Go to the User Settings Mode (Driving Assist) and select RCTA (Rear Cross Traffic Alert) on the LCD display (**For more information, refer to "LCD Display" in chapter 3.**). The system will turn on and standby to activate.

The system will activate when vehicle speed is below 6 mph (10 km/h) with the shift lever in R (Reverse).

### **i** Information

The Rear Cross Traffic Alert (RCTA) detecting range is approximately 1 - 65 ft (0.5 - 20 m). An approaching vehicle will be detected if their vehicle speed is within 2.5 - 22.5 mph (4 - 36 km/h).

Note that the detecting range may vary under certain conditions. As always, use caution and pay close attention to your surroundings when backing your vehicle.

### Warning type

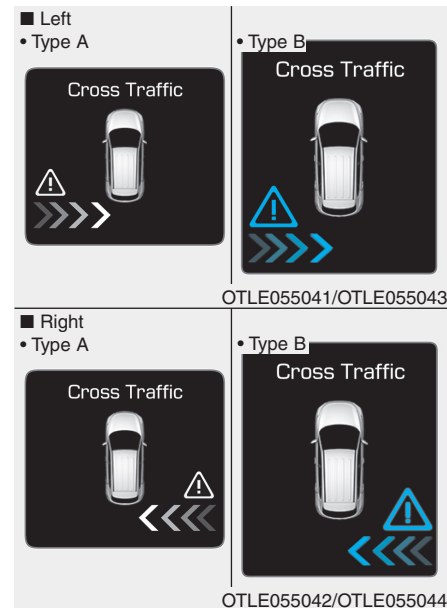

If the vehicle detected by the sensors approaches your vehicle, the warning chime will sound, the warning light on the outer side view mirror will blink and a message will appear on the LCD display.

**i** Information

- The warning chime will turn off when the detected vehicle moves out of the sensing area or if your vehicle is moved away from the detected vehicle.
- The system may not operate properly due to other factors or circumstances. Always pay attention to your surroundings.
- If the sensing area near the rear bumper is blocked by either a wall or barrier or by a parked vehicle, the system sensing area may be reduced.

**⚠ WARNING**

- The warning light on the outer side view mirror will illuminate whenever a vehicle is detected at the rear side by the system.

To avoid accidents, do not focus only on the warning light and neglect to see the surrounding of the vehicle.

(Continued)

(Continued)

- Drive safely even though the vehicle is equipped with a Blind Spot Detection System (BSD) and Rear Cross Traffic Alert (RCTA). Do not solely rely on the system but check your surrounding before changing lanes or backing the vehicle up.

The system may not alert the driver in some conditions so always check your surroundings while driving.

- The Blind Spot Detection System (BSD) and Rear Cross Traffic Alert (RCTA) are not a substitute for proper and safe driving practices. Always drive safely and use caution when changing lanes or backing up your vehicle. The Blind Spot Detection System (BSD) may not detect every object alongside the vehicle.

**NOTICE**

- The system may not work properly when the bumper has been damaged, or if the rear bumper has been replaced or repaired.
- The sensing range differs somewhat according to the width of the road. When the road is narrow, the system may detect other vehicles in the next lane.
- The system may turn off due to strong electromagnetic waves.

***Non-operating condition***

The BSD indicator on the outer side view mirror may not illuminate properly when:

- The outer side view mirror housing is damaged
- The mirror is covered with dirt, snow, or debris
- The window is covered with dirt, snow, or debris
- The window is tinted

## Limitations of the system

The driver must be cautious in the below situations, because the system may not detect other vehicles or objects in certain circumstances.

- The vehicle drives on a curved road or through a tollgate.
- The sensor is polluted with rain, snow, mud, etc.
- The rear bumper where the sensor is located is covered with a foreign object such as a bumper sticker, a bumper guard, a bike stand, etc.
- The rear bumper is damaged, or the sensor is out of the original default position.
- The vehicle height gets lower or higher due to heavy loading in a trunk, abnormal tire pressure, etc.
- The vehicle drives in inclement weather such as heavy rain or snow.
- There is a fixed object near the vehicle, such as a guardrail.
- A big vehicle is near such as a bus or truck.
- A motorcycle or bicycle is near.
- A flat trailer is near.
- If the vehicle has started at the same time as the vehicle next to you and has accelerated.
- When the other vehicle passes at a very fast speed.
- While changing lanes.
- While going down or up a steep road where the height of the lane is different.
- When the other vehicle approaches very close.
- When a trailer or carrier is installed.
- When the temperature near the rear bumper area is high or low.
- When the sensors are blocked by the other vehicles, walls or parking-lot pillars.
- When the detected vehicle also moves back, as your vehicle drives back.
- If there are small objects in the detecting area such as a shopping cart or a baby carriage
- If there is a low height vehicle such as a sports car
- When other vehicles are close to your vehicle
- When the vehicle in the next lane moves two lanes away from you OR when the vehicle two lanes away moves to the next lane from you.
- When driving through a narrow road with many trees or bushes.
- When driving on wet surface.

### Information

**This device complies with Part 15 of the FCC rules.**

**Operation is subject to the following two conditions:**

- 1. This device may not cause harmful interference, and**
- 2. This device must accept any interference received, including interference that may cause undesired operation.**

## AUTOMATIC EMERGENCY BRAKING (AEB) (IF EQUIPPED)

The Automatic Emergency Braking (AEB) system is designed to detect and monitor the vehicle ahead or detect a pedestrian in the roadway through radar signals and camera recognition to warn the driver that a collision is imminent, and if necessary, apply emergency braking.

### ⚠ WARNING

**Take the following precautions when using the Automatic Emergency Braking (AEB):**

- **This system is only a supplemental system and it is not intended to, nor does it replace the need for extreme care and attention of the driver. The sensing range and objects detectable by the sensors are limited. Pay attention to the road conditions at all times.**
- **NEVER drive too fast in accordance with the road conditions or while cornering.**
- **Always drive cautiously to prevent unexpected and sudden situations from occurring. AEB does not stop the vehicle completely and is not a collision avoidance system.**

## System setting and activation

### System setting

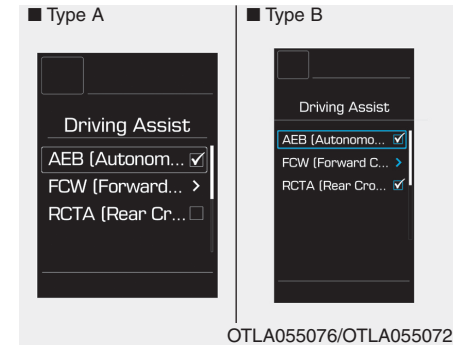

The driver can activate the AEB by placing the ignition switch to the ON position and by selecting 'User Settings', 'Driving Assist', and 'AEB (Autonomous Braking System)'. The AEB deactivates, when the driver cancels the system setting.



The warning light illuminates on the LCD display, when you cancel the AEB system. The driver can monitor the AEB ON/OFF status on the LCD display. If the warning light remains ON when the AEB is activated, have the system checked by an authorized HYUNDAI dealer.

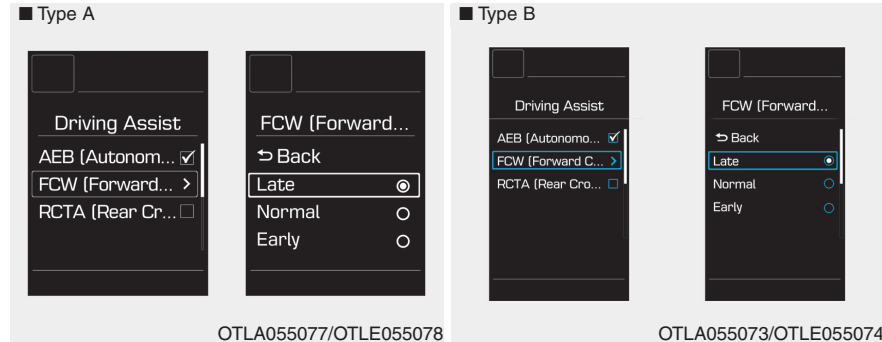

The driver can select the initial warning activation time in the User Settings in the Driver LCD display. The options for the initial Forward Collision Warning include the following:

- **EARLY** - When this condition is selected, the initial Forward Collision Warning is activated earlier than normal. This setting maximizes the amount of distance between the vehicle or pedestrian ahead before the initial warning occurs.
- **NORMAL** - When this condition is selected, the initial Forward Collision Warning is activated normally. This setting allows for a nominal amount of distance between the vehicle or pedestrian ahead before the initial warning occurs.
- **LATE** - When this condition is selected, the initial Forward Collision Warning is activated later than normal. This setting reduces the amount of distance between the vehicle or pedestrian ahead before the initial warning occurs.

### **Prerequisite for activation**

The AEB gets ready to be activated, when the AEB is selected on the LCD display, and when the following prerequisites are satisfied.

- The ESC is activated.
- To enable the system to detect pedestrians ahead, the vehicle driving speed must be between 5 - 40 mph (8 - 65 km/h).
- To enable the system to detect a vehicle ahead, the vehicle driving speed must be between 5 - 110 mph (8 - 180 km/h).

When traveling above 50 mph (80 km/h), the AEB system only initiates partial braking. This is to prevent unintended full braking to stop in the middle of the highway.

### **! WARNING**

- **The AEB automatically activates upon placing the ignition switch to the ON position. The driver can deactivate the AEB by canceling the system setting on the LCD display.**
- **The AEB automatically deactivates upon canceling the ESC. When the ESC is canceled, the AEB cannot be activated on the LCD display.**

### **AEB warning message and system control**

The AEB produces warning messages and warning alarms in accordance with the collision risk levels. Also, it controls the brakes in accordance with the collision risk levels.

### **Forward Warning (1<sup>st</sup> warning)**



This initial warning message appears on the LCD display with a warning chime.

The driver can select the initial warning activation time in the User Settings in the Driver LCD display. The options for the initial Forward Collision Warning include EARLY, NORMAL, or LATE initial warning time.



### **Collision Warning (2<sup>nd</sup> warning)**



- This warning message appears on the LCD display with a warning chime.
- Additionally, some vehicle system intervention occurs by the engine management system to help decelerate the vehicle.
- If the detected vehicle in front is driving slower than 50 mph (80 km/h), your vehicle speed may decelerate sharply to avoid a collision. If the detected vehicle in front is driving faster than 50 mph (80 km/h), your vehicle speed may decelerate moderately.

- If your vehicle is traveling less than 40 mph (65 km/h) and a pedestrian is detected within the Collision Warning (2<sup>nd</sup> warning) stage, your vehicle speed may decelerate sharply to avoid a collision.

### **Emergency braking (3<sup>rd</sup> warning)**



- This warning message appears on the LCD display with a warning alarm.
- Additionally, automatic emergency braking of the vehicle is applied in order to avoid a collision.
- If your vehicle is traveling less than 40 mph (65 km/h) and a pedestrian is detected within the Emergency Braking stage, automatic emergency braking of the vehicle is applied. In this condition, your vehicle speed will decelerate sharply to avoid a collision.

- When your vehicle drives slower than 40 mph (65 km/h) with a passer-by in front, the driving speed may abruptly decrease. When your vehicle drives faster than 70 km/h with a pedestrian in front, the AEB does not operate.

### **Brake operation**

- In an urgent situation, the braking system enters into the ready status for prompt reaction against the driver's depressing the brake pedal.
- The AEB provides additional braking power for optimum braking performance, when the driver depresses the brake pedal.
- The braking control is automatically deactivated, when the driver sharply depresses the brake pedal, or when the driver abruptly operates the steering wheel.
- The braking control is automatically canceled, when risk factors disappear.

### **CAUTION**

**The driver should always use extreme caution while operating the vehicle, whether or not there is a warning message or alarm from the AEB system.**

### **WARNING**

**The braking control cannot completely stop the vehicle nor avoid all collisions. The driver should hold the responsibility to safely drive and control the vehicle.**

### **WARNING**

**The AEB system logic operates within certain parameters, such as the distance from the vehicle or pedestrian ahead, the speed of the vehicle ahead, and the driver's vehicle speed. Certain conditions such as inclement weather and road conditions may affect the operation of the AEB system.**

## AEB front radar sensor



In order for the AEB system to operate properly, always make sure the radar sensor lens cover is clean and free of dirt, snow, and debris. Dirt, snow, or foreign substances on the lens may adversely affect the sensing performance of the radar.

## Warning message and warning light

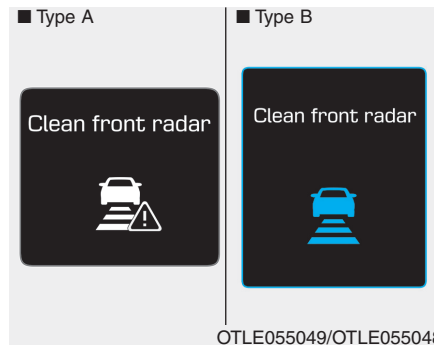

When the sensor lens cover is blocked with dirt, snow, or debris, the AEB system operation may stop temporarily. If this occurs, a warning message will appear on the LCD display. Remove any dirt, snow, or debris and clean the radar sensor lens cover before operating the AEB system.

## NOTICE

- Do not apply foreign objects such as a bumper sticker or a bumper guard near the radar sensor. Doing so may adversely affect the sensing performance of the radar.
- Always keep the radar sensor and lens cover clean and free of dirt and debris.
- Use only a soft cloth to wash the vehicle. Do not spray pressurized water directly on the sensor or sensor cover.
- Be careful not to apply unnecessary force on the radar sensor or sensor cover. If the sensor is forcibly moved out of proper alignment, the AEB system may not operate correctly. In this case, a warning message may not be displayed. Have the vehicle inspected by an authorized HYUNDAI dealer.

(Continued)

(Continued)

- If the front bumper becomes damaged in the area around the radar sensor, the AEB system may not operate properly. Have the vehicle inspected by an authorized HYUNDAI dealer.
- Use only genuine HYUNDAI parts to repair or replace a damaged sensor or sensor cover. Do not apply paint to the sensor cover.

### System malfunction

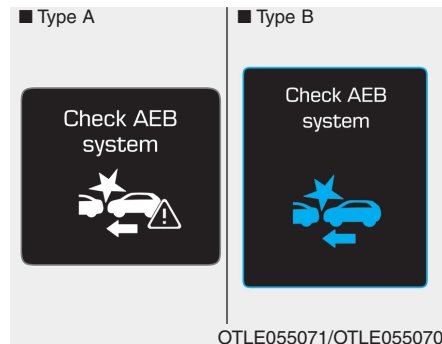

- When the AEB is not working properly, the AEB warning light (🚗) will illuminate and the warning message will appear for a few seconds. After the message disappears, the master warning light (⚠️) will illuminate. In this case, have the vehicle inspected by an authorized HYUNDAI dealer.
- The AEB warning message may appear along with the illumination of the ESC warning light.

### ⚠️ WARNING

- The AEB is only a supplemental system for the driver's convenience. The driver should hold the responsibility to control the vehicle operation. Do not solely depend on the AEB system. Rather, maintain a safe braking distance, and, if necessary, depress the brake pedal to reduce the driving speed.
- In certain instances and under certain driving conditions, the AEB system may activate prematurely. This initial warning message appears on the LCD display with a warning chime.  
Also, in certain instances the front radar sensor or camera recognition system may not detect the vehicle or pedestrian ahead. The AEB system may not activate and the warning message will not be displayed.

(Continued)

(Continued)

- If there is a malfunction with the AEB system, the automatic emergency braking is not applied even though the braking system is operating normally.
- The AEB system operates only to detect vehicles or pedestrians in front of the vehicle.

The AEB system does not operate when the vehicle is in reverse.

The AEB system is not designed to detect other objects on the road such as animals.

The AEB system does not detect cross traffic vehicles that are approaching.

The AEB system cannot detect the driver approaching the side view of a parked vehicle (for example on a dead end street.)

(Continued)

(Continued)

**In these cases, you must maintain a safe braking distance, and if necessary, depress the brake pedal to reduce the driving speed in order to maintain a safe distance.**

### Limitations of the system

The Automatic Emergency Braking (AEB) system is designed to monitor the vehicle ahead or a pedestrian in the roadway through radar signals and camera recognition to warn the driver that a collision is imminent, and if necessary, apply emergency braking.

In certain situations, the radar sensor or the camera may not be able to detect the vehicle or pedestrian ahead. In these cases, the AEB system may not operate normally. The driver must pay careful attention in the following situations where the AEB operation may be limited:

### **Detecting vehicles**

The sensor may be limited when:

- The radar sensor or camera is blocked with a foreign object or debris
- Inclement weather such as heavy rain or snow obscures the field of view of the radar sensor or camera
- There is interference by electromagnetic waves
- There is severe irregular reflection from the radar sensor
- The vehicle in front is too small to be detected by the camera recognition system (for example a motorcycle or a bicycle, etc.)
- The vehicle in front is an oversize vehicle or trailer that is too big to be detected by the camera recognition system (for example a tractor trailer, etc.)
- The driver's field of view is not well illuminated (either too dark or too much reflection or too much back-light that obscures the field of view)

- The vehicle in front does not have their rear lights properly turned ON
- The outside brightness changes suddenly, for example when entering or exiting a tunnel
- The vehicle in front is driving erratically

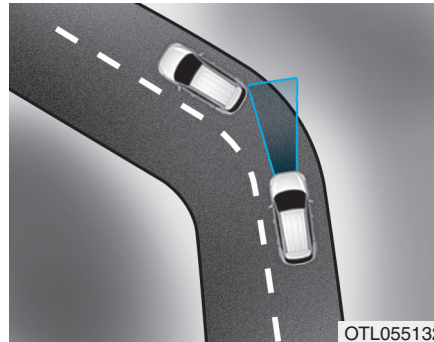

### - Driving on a curve

The performance of the AEB system may be limited when driving on a curved road.

In certain instances on a curved road, the AEB system may activate prematurely.

Also, in certain instances the front radar sensor or camera recognition system may not detect the vehicle traveling on a curved road.

In these cases, the driver must maintain a safe braking distance, and if necessary, depress the brake pedal to reduce your driving speed in order to maintain a safe distance.

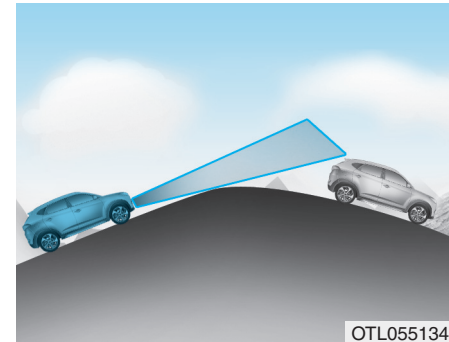

### - Driving on a slope

The performance of the AEB decreases while driving upward or downward on a slope, not recognizing the vehicle in front in the same lane. It may unnecessarily produce the warning message and the warning alarm, or it may not produce the warning message and the warning alarm at all.

When the AEB suddenly recognizes the vehicle in front while passing over a slope, you may experience sharp deceleration.

Always keep your eyes forward while driving upward or downward on a slope, and, if necessary, depress the brake pedal to reduce your driving speed in order to maintain distance.

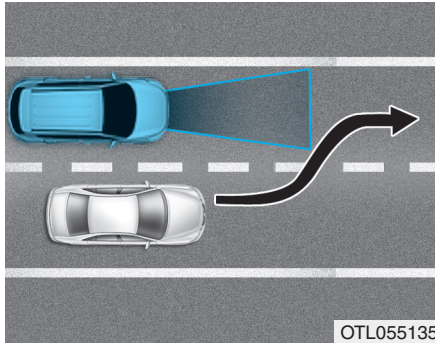

- Changing lanes

When a vehicle changes lanes in front of you, the AEB system may not immediately detect the vehicle, especially if the vehicle changes lanes abruptly. In this case, you must maintain a safe braking distance, and if necessary, depress the brake pedal to reduce your driving speed in order to maintain a safe distance.

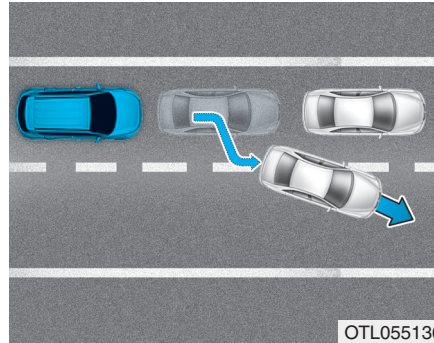

When driving in stop-and-go traffic, and a stopped vehicle in front of you merges out of the lane, the AEB system may not immediately detect the new vehicle that is now in front of you. In this case, you must maintain a safe braking distance, and if necessary, depress the brake pedal to reduce your driving speed in order to maintain a safe distance.

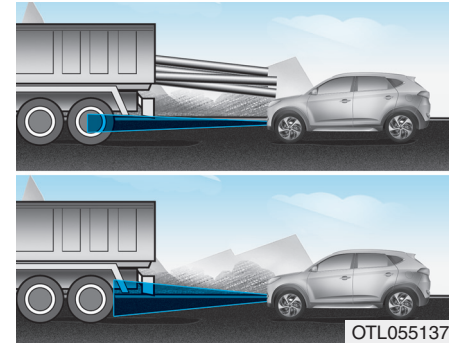

- Detecting the vehicle in front of you

If the vehicle in front of you has cargo that extends rearward from the cab, or when the vehicle in front of you has higher ground clearance, additional special attention is required. The AEB system may not be able to detect the cargo extending from the vehicle. In these instances, you must maintain a safe braking distance from the rearmost object, and if necessary, depress the brake pedal to reduce your driving speed in order to maintain distance.



### ***Detecting pedestrians***

The sensor may be limited when:

- The pedestrian is not fully detected by the camera recognition system, for example, if the pedestrian is leaning over or is not fully walking upright
- The pedestrian is moving very quickly or appears abruptly in the camera detection area  
The pedestrian is wearing clothing that easily blends into the background, making it difficult to be detected by the camera recognition system
- The outside lighting is too bright (e.g. when driving in bright sunlight or in sun glare) or too dark (e.g. when driving on a dark rural road at night)
- It is difficult to detect and distinguish the pedestrian from other objects in the surroundings, for example, when there is a group of pedestrians or a large crowd

### **⚠ WARNING**

- **Do not use the Automatic Emergency Braking system when towing a vehicle. Application of the AEB system while towing may adversely affect the safety of your vehicle or the towing vehicle**
- **Use extreme caution when the vehicle in front of you has cargo that extends rearward from the cab, or when the vehicle in front of you has higher ground clearance.**
- **The AEB system is designed to detect and monitor the vehicle ahead or detect a pedestrian in the roadway through radar signals and camera recognition. It is not designed to detect bicycles, motorcycles, or smaller wheeled objects such as luggage bags, shopping carts, or strollers.**
- **Never try to test the operation of the AEB system. Doing so may cause severe injury or death.**

### ***i* Information**

In some instances, the AEB system may be cancelled when subjected to electromagnetic interference.

### ***i* Information**

This device complies with Part 15 of the FCC rules.

Operation is subject to the following two conditions:

1. This device may not cause harmful interference, and
2. This device must accept any interference received, including interference that may cause undesired operation.



## LANE DEPARTURE WARNING SYSTEM (LDWS) (IF EQUIPPED)

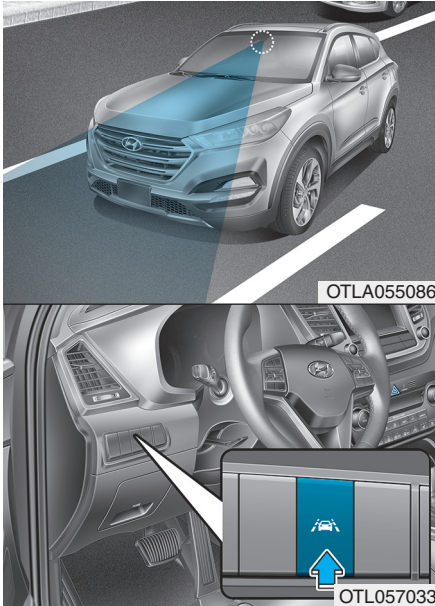

The Lane Departure Warning (LDWS) System feature is designed to monitor the vehicle's position relative to the lane in front of you and detect when the vehicle begins to move out of its lane.

### WARNING

Take the following precautions when using the Lane Departure Warning System (LDWS):

- **ALWAYS** check your surroundings and the road conditions before changing lanes. The LDWS does not control the vehicle to change lanes or to stay in the current lane.
- Do not make abrupt maneuvers or turn the steering wheel suddenly if the LDWS alerts you that the vehicle is departing from the lane.
- If the camera recognition system does not properly detect the lane, the LDWS may not notify you if the vehicle departs from the lane.
- The LDWS does not operate until the vehicle speed reaches approximately 40 mph (64 km/h).

(Continued)

(Continued)

- The LDWS camera recognition system is located in front of the rear view mirror at the center of the front windshield. Do not spray water or any type of liquid near the camera. The system may become damaged.
- Do not attempt to repair the LDWS camera and do not remove any parts.
- Do not place objects on the dashboard that reflects light such as mirrors, white paper, etc. The system may malfunction if the sunlight is reflected.
- Do not place any accessories near the rearview mirror.
- The operation of the LDWS may be affected by several factors including environmental conditions that affect the ability of the camera to detect the lanes in front of you. It is the responsibility of the driver to pay careful attention to the roadway and to maintain the vehicle in its intended lane at all times.

### LDWS Operation

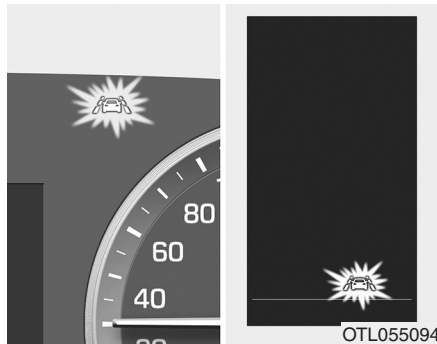

To activate the LDWS:

With the ignition switch in the ON position, press the LDWS button located on the instrument panel on the lower left hand side of the driver. The indicator in the cluster display will initially illuminate white. This indicates the LDWS is in the READY but NOT ENABLED state.

Note that the vehicle speed must be at least approximately 40 mph (64 km/h) to ENABLE the LDWS. The indicator in the cluster display will illuminate green.

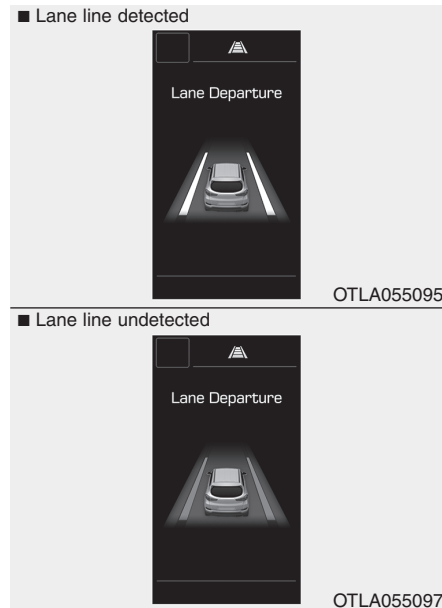

If your vehicle speed exceeds 40 mph (64 km/h) and the LDWS button is ON, the system is enabled. If your vehicle departs from the projected lane in front of you, the LDWS operates as follows:

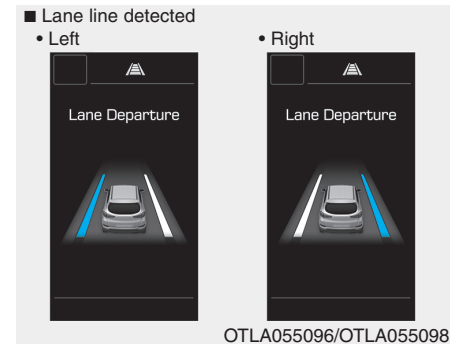

1. A visual warning appears on the cluster LCD display. Either the left lane line or the right lane line in the cluster LCD display will blink depending on which direction the vehicle is veering.
2. An audible warning sounds to alert the driver.

## Warning Light and Message

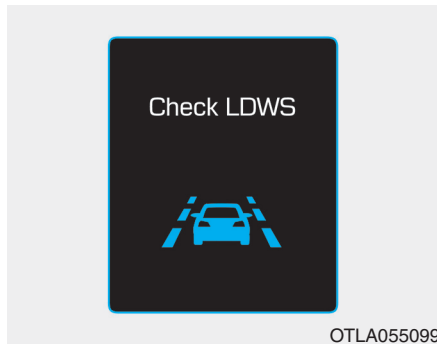

OTLA055099

If there is a malfunction with the LDWS, the indicator on the cluster will illuminate yellow. Additionally, a message that reads, "Check LDWS", will appear on the cluster LCD display. After the message disappears, the master warning light (⚠) will illuminate.

Take your vehicle to an authorized HYUNDAI dealer and have the system checked.

The LDWS does not operate when:

- The driver turns on the turn signal to change lanes or operates the hazard warning flasher.
- The camera recognition system detects that the vehicle is driving on the lane lines.

### **i** Information

**Always operate the turn signal before changing lanes.**

## Limitations of the system

The LDWS may operate prematurely even if the vehicle does not depart from the intended lane, OR, the LDWS may not warn you if the vehicle leaves the intended lane under the following circumstances:

- The lanes ahead are not visible due to rain, snow, water on the road, damaged or stained road surface, or other factors.
- The brightness outside changes suddenly such as when entering or exiting a tunnel.
- The brightness outside is too low such as when the headlamps are not on at night or the vehicle is going through a tunnel.
- It is difficult to distinguish the lane marking from the road surface or the lane marking is faded or not clearly marked.
- Driving on a steep grade or over a hill, or when driving on a curved road.

- When light coming from a street light or an oncoming vehicle is reflected on a wet road surface such as a puddle in the road.
- The windshield or the LDWS camera lens is blocked with dirt or debris.
- The field of view in front is obstructed by sun glare.
- The lanes are incomplete or the area is in a construction zone.
- There are more than two lane lines on the road in front of you.
- The lane markings are not clearly visible from the road.
- The camera recognition system cannot properly detect the lanes due to fog, heavy rain, or snow.
- The lane width differs from standard (either very wide or very narrow).
- The windshield glass is fogged up; a clear view of the road is obstructed.
- There are markings on the road surface that look like a lane line that is inadvertently being detected by the camera.
- There is a boundary structure in the roadway such as a concrete barrier, guardrail and reflector post that is inadvertently being detected by the camera.
- There is not enough distance between you and the vehicle in front to be able to detect the lane line or the vehicle ahead is driving on the lane line.
- The adverse road conditions cause excessive vehicle vibrations while driving.
- The vehicle vibrates heavily due to road conditions.
- Driving on a steep grade or a curve.

## CRUISE CONTROL

### Cruise Control operation

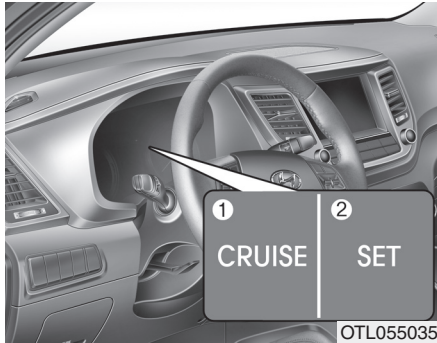

1. CRUISE indicator
2. SET indicator

The Cruise Control system allows you to drive at speeds above 20 mph (30 km/h) without depressing the accelerator pedal.

### WARNING

Take the following precautions:

- If the Cruise Control is left on, ("CRUISE" indicator light in the instrument cluster is illuminated) the Cruise Control can be activated unintentionally. Keep the Cruise Control system off ("CRUISE" indicator light OFF) when the Cruise Control is not in use, to avoid inadvertently setting a speed.
- Use the Cruise Control system only when traveling on open highways in good weather.
- Do not use Cruise Control when towing a trailer.
- Do not use the Cruise Control when it may be unsafe to keep the vehicle at a constant speed:

(Continued)

(Continued)

- When driving in heavy traffic or when traffic conditions make it difficult to drive at a constant speed
- When driving on rainy, icy, or snow-covered roads
- When driving on hilly or windy roads
- When driving in windy areas
- When driving with limited view (possibly due to bad weather such as fog, snow, rain and sandstorm)

### Information

- During normal cruise control operation, when the SET switch is activated or reactivated after applying the brakes, the cruise control will energize after approximately 3 seconds. This delay is normal.
- Before activating the cruise control function, the system will check to verify that the brake switch is operating normally. Depress the brake pedal at least once after turning ON the ignition or starting the engine.

### To set Cruise Control speed

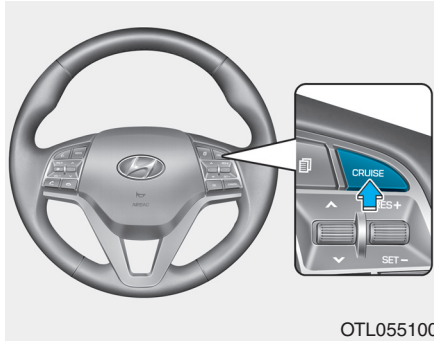

OTL055100

1. Press the CRUISE button on the steering wheel to turn the system on. The "CRUISE" indicator will illuminate.
2. Accelerate to the desired speed, which must be more than 20 mph (30 km/h).

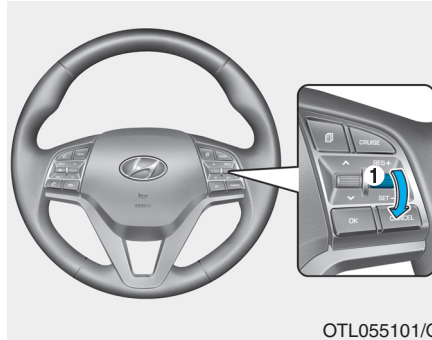

OTL055101/Q

3. Push the toggle switch (1) down (SET-), and release it. The SET indicator light will illuminate.
4. Release the accelerator pedal.

#### **i** Information

**On a steep slope, the vehicle may slightly slow down or speed up, while driving uphill or downhill.**

### To increase Cruise Control speed

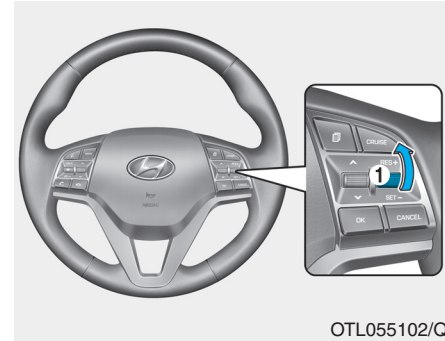

OTL055102/Q

- Push the toggle switch (1) up (RES+) and hold it, while monitoring the SET speed on the instrument cluster. Release the toggle switch when the desired speed is shown and the vehicle will accelerate to that speed.
- Push the toggle switch (1) up (RES+) and release it immediately. The cruising speed will increase 1.0 mph (1.6 km/h) each time the toggle switch is operated in this manner.

- Depress the accelerator pedal. When the vehicle attains the desired speed, push the toggle switch (1) down (SET-).

### **To decrease Cruise Control speed**

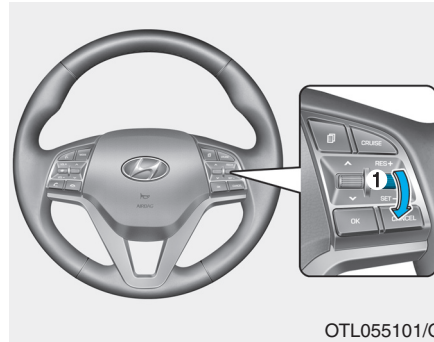

- Push the toggle switch (1) down (SET-) and hold it. Your vehicle will gradually slow down. Release the toggle switch at the speed you want to maintain.
- Push the toggle switch (1) down (SET-) and release it immediately. The cruising speed will decrease 1.0 mph (1.6 km/h) each time the toggle switch is operated in this manner.
- Lightly tap the brake pedal. When the vehicle attains the desired speed, push the toggle switch (1) down (SET-).

### **To temporarily accelerate with the Cruise Control ON**

Depress the accelerator pedal. When you take your foot off the accelerator, the vehicle will return to the previously set speed.

If you push the toggle switch down (SET-) at the increased speed, the Cruise Control will maintain the increased speed.

### ***Cruise Control will be canceled when:***

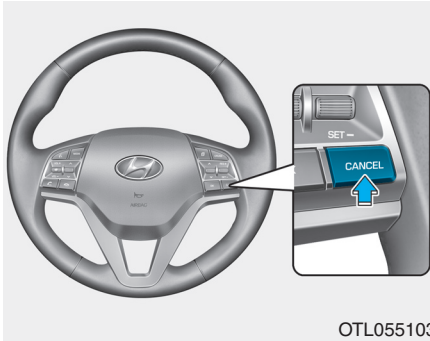

- Depressing the brake pedal.
- Pressing the CANCEL button located on the steering wheel.
- Pressing the CRUISE button. Both the CRUISE indicator and the "SET" indicator will turn OFF.
- Moving the shift lever into N (Neutral).
- Decreasing the vehicle speed to less than approximately 20 mph (30 km/h).

- The ESC (Electronic Stability Control) is operating.
- Downshifting to 2<sup>nd</sup> gear when in Manual Shift mode.

### ***i* Information**

Each of the above actions will cancel Cruise Control operation (the "SET" indicator in the instrument cluster will go off), but only pressing the CRUISE button will turn the system off. If you wish to resume Cruise Control operation, push the lever up (RES+) located on your steering wheel. You will return to your previously preset speed, unless the system was turned off using the CRUISE button.

### ***To resume preset Cruising speed***

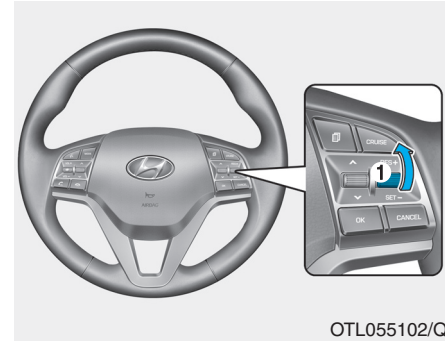

Push the toggle switch (1) up (RES+). If the vehicle speed is over 20 mph (30 km/h), the vehicle will resume the preset speed.



### **To turn Cruise Control off**

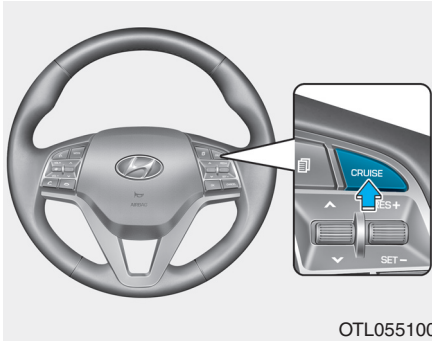

OTL055100

- Press the CRUISE button (the "CRUISE" indicator light will go off).
- Turn the vehicle OFF.

## SPECIAL DRIVING CONDITIONS

### Hazardous driving conditions

When hazardous driving elements are encountered such as water, snow, ice, mud and sand, take the below suggestions:

- Drive cautiously and keep a longer braking distance.
- Avoid abrupt braking or steering.
- When your vehicle is stuck in snow, mud, or sand, use second gear. Accelerate slowly to avoid unnecessary wheel spin.
- Put sand, rock salt, tire chains or other non-slip materials under the wheels to provide additional traction while the vehicle becomes stuck in ice, snow, or mud.

#### WARNING

**Downshifting with an automatic transmission while driving on slippery surfaces can cause an accident. The sudden change in tire speed could cause the tires to skid. Be careful when downshifting on slippery surfaces.**

### Rocking the vehicle

If it is necessary to rock the vehicle to free it from snow, sand, or mud, first turn the steering wheel right and left to clear the area around your front wheels. Then, shift back and forth between R (Reverse) and a forward gear.

Try to avoid spinning the wheels, and do not race the engine.

To prevent transmission wear, wait until the wheels stop spinning before shifting gears. Release the accelerator pedal while shifting, and press lightly on the accelerator pedal while the transmission is in gear. Slowly spinning the wheels in forward and reverse directions causes a rocking motion that may free the vehicle.

#### WARNING

**If the vehicle is stuck and excessive wheel spin occurs, the temperature in the tires can increase very quickly. If the tires become damaged, a tire blow out or tire explosion can occur. This condition is dangerous - you and others may be injured. Do not attempt this procedure if people or objects are anywhere near the vehicle.**

**If you attempt to free the vehicle, the vehicle can overheat quickly, possibly causing an engine compartment fire or other damage. Try to avoid spinning the wheels as much as possible to prevent overheating of either the tires or the engine. DO NOT allow the vehicle to spin the wheels above 35 mph (56 km/h).**

## **i** Information

The ESC system must be turned OFF before rocking the vehicle.

### **NOTICE**

If you are still stuck after rocking the vehicle a few times, have the vehicle pulled out by a tow vehicle to avoid engine overheating, possible damage to the transmission, and tire damage. See "Towing" in chapter 6.

## Smooth cornering

Avoid braking or gear changing in corners, especially when roads are wet. Ideally, corners should always be taken under gentle acceleration.

## Driving at night

Night driving presents more hazards than driving in the daylight. Here are some important tips to remember:

- Slow down and keep more distance between you and other vehicles, as it may be more difficult to see at night, especially in areas where there may not be any street lights.
- Adjust your mirrors to reduce the glare from other driver's headlamps.
- Keep your headlamps clean and properly aimed. Dirty or improperly aimed headlamps will make it much more difficult to see at night.
- Avoid staring directly at the headlamps of oncoming vehicles. You could be temporarily blinded, and it will take several seconds for your eyes to readjust to the darkness.

## Driving in the rain

Rain and wet roads can make driving dangerous. Here are a few things to consider when driving in the rain or on slick pavement:

- Slow down and allow extra following distance. A heavy rainfall makes it harder to see and increases the distance needed to stop your vehicle.
- Turn OFF your Cruise Control.
- Replace your windshield wiper blades when they show signs of streaking or missing areas on the windshield.
- Be sure your tires have enough tread. If your tires do not have enough tread, making a quick stop on wet pavement can cause a skid and possibly lead to an accident. **See "Tire Tread" in chapter 7.**
- Turn on your headlamps to make it easier for others to see you.
- Driving too fast through large puddles can affect your brakes. If you must go through puddles, try to drive through them slowly.

- If you believe your brakes may be wet, apply them lightly while driving until normal braking operation returns.

### **Hydroplaning**

If the road is wet enough and you are going fast enough, your vehicle may have little or no contact with the road surface and actually ride on the water. The best advice is SLOW DOWN when the road is wet.

**The risk of hydroplaning increases as the depth of tire tread decreases, refer to "Tire Tread" in chapter 7.**

### **Driving in flooded areas**

Avoid driving through flooded areas unless you are sure the water is no higher than the bottom of the wheel hub. Drive through any water slowly. Allow adequate stopping distance because brake performance may be reduced.

After driving through water, dry the brakes by gently applying them several times while the vehicle is moving slowly.

### **Highway driving**

#### **Tires**

Adjust the tire inflation, as specified. Under-inflation may overheat or damage the tires.

Do not install worn-out or damaged tires, which may reduce traction or fail the braking operation.

#### **Information**

**Never over-inflate your tires above the maximum inflation pressure, as specified on your tires.**

### ***Fuel, engine coolant and engine oil***

Driving at higher speeds on the highway consumes more fuel and is less efficient than driving at a slower, more moderate speed. Maintain a moderate speed in order to conserve fuel when driving on the highway.

Be sure to check both the engine coolant level and the engine oil before driving.

### ***Drive belt***

A loose or damaged drive belt may overheat the engine.

## Reducing the risk of a rollover

Your multi-purpose passenger vehicle is defined as a Sports Utility Vehicle (SUV). SUV's have higher ground clearance and a narrower track to make them capable of performing in a wide variety of off-road applications. The specific design characteristics give them a higher center of gravity than ordinary vehicles making them more likely to roll over if you make abrupt turns. Utility vehicles have a significantly higher rollover rate than other types of vehicles. Due to this risk, driver and passengers are strongly recommended to buckle their seat belts. In a rollover crash, an unbelted person is significantly more likely to die than a person wearing a seat belt.

There are steps that a driver can make to reduce the risk of a rollover. If at all possible, avoid sharp turns or abrupt maneuvers, do not load your vehicle with heavy cargo on the roof, and never modify your vehicle in any way.

### WARNING

**Utility vehicles have a significantly higher rollover rate than other types of vehicles. To prevent rollovers or loss of control:**

- **Take corners at slower speeds than you would with a passenger vehicle.**
- **Avoid sharp turns and abrupt maneuvers.**
- **Do not modify your vehicle in any way that you would raise the center of gravity.**
- **Keep tires properly inflated.**
- **Do not carry heavy cargo on the roof.**

### WARNING

**In a rollover crash, an unbelted person is significantly more likely to die than a person wearing a seat belt. Make sure all passengers are wearing their seat belts.**

### WINTER DRIVING

The severe weather conditions of winter quickly wear out tires and cause other problems. To minimize winter driving problems, you should take the following suggestions:

#### Snow or Icy Conditions

You need to keep sufficient distance between your vehicle and the vehicle in front of you.

Apply the brakes gently. Speeding, rapid acceleration, sudden brake applications, and sharp turns are potentially very hazardous practices. During deceleration, use engine braking to the fullest extent. Sudden brake applications on snowy or icy roads may cause the vehicle to skid.

To drive your vehicle in deep snow, it may be necessary to use snow tires or to install tire chains on your tires.

Always carry emergency equipment. Some of the items you may want to carry include tire chains, tow straps or chains, a flashlight, emergency flares, sand, a shovel, jumper cables, a window scraper, gloves, ground cloth, coveralls, a blanket, etc.

#### Snow tires

##### WARNING

**Snow tires should be equivalent in size and type to the vehicle's standard tires. Otherwise, the safety and handling of your vehicle may be adversely affected.**

If you mount snow tires on your vehicle, make sure to use radial tires of the same size and load range as the original tires. Mount snow tires on all four wheels to balance your vehicle's handling in all weather conditions. The traction provided by snow tires on dry roads may not be as high as your vehicle's original equipment tires. Check with the tire dealer for maximum speed recommendations.

#### Information

**Do not install studded tires without first checking local, state and municipal regulations for possible restrictions against their use.**

#### Tire chains

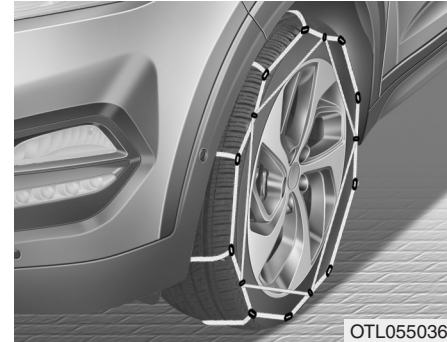

Since the sidewalls of radial tires are thinner than other types of tires, they may be damaged by mounting some types of tire chains on them. Therefore, the use of snow tires is recommended instead of tire chains. Do not mount tire chains on vehicles equipped with aluminum wheels; if unavoidable use a wire type chain. If tire chains must be used, use genuine HYUNDAI parts and install the tire chain after reviewing the instructions provided with the tire chains. Damage to your vehicle caused by improper tire chain use is not covered by your vehicle manufacturer's warranty.

## WARNING

The use of tire chains may adversely affect vehicle handling:

- Drive less than 20 mph (30 km/h) or the chain manufacturer's recommended speed limit, whichever is lower.
- Drive carefully and avoid bumps, holes, sharp turns, and other road hazards, which may cause the vehicle to bounce.
- Avoid sharp turns or locked wheel braking.

## Information

- Install tire chains on the front tires. It should be noted that installing tire chains on the tires will provide a greater driving force, but will not prevent side skids.
- Do not install studded tires without first checking local, state and municipal regulations for possible restrictions against their use.

## Chain installation

When installing tire chains, follow the manufacturer's instructions and mount them as tightly possible. Drive slowly (less than 20 mph (30 km/h)) with chains installed. If you hear the chains contacting the body or chassis, stop and tighten them. If they still make contact, slow down until the noise stops. Remove the tire chains as soon as you begin driving on cleared roads.

When mounting snow chains, park the vehicle on level ground away from traffic. Turn on the vehicle Hazard Warning Flasher and place a triangular emergency warning device behind the vehicle (if available). Always place the vehicle in P (Park), apply the parking brake and turn off the engine before installing snow chains.

### **NOTICE**

- When using tire chains:
- **Wrong size chains or improperly installed chains can damage your vehicle's brake lines, suspension, body and wheels.**
- **Use SAE "S" class or wire chains.**
- **If you hear noise caused by chains contacting the body, retighten the chain to prevent contact with the vehicle body.**
- **To prevent body damage, retighten the chains after driving 0.3~0.6 miles (0.5~1.0 km).**
- **Do not use tire chains on vehicles equipped with aluminum wheels. If unavoidable, use a wire type chain.**
- **Use wire chains less than 0.59 inch (15 mm) wide to prevent damage to the chain's connection.**

### **Winter Precautions**

#### ***Use high quality ethylene glycol coolant***

Your vehicle is delivered with high quality ethylene glycol coolant in the cooling system. It is the only type of coolant that should be used because it helps prevent corrosion in the cooling system, lubricates the water pump and prevents freezing. Be sure to replace or replenish your coolant in accordance with the maintenance schedule in chapter 7. Before winter, have your coolant tested to assure that its freezing point is sufficient for the temperatures anticipated during the winter.

#### ***Change to "winter weight" oil if necessary***

In some climates it is recommended that a lower viscosity "winter weight" oil be used during cold weather. See chapter 8 for recommendations. If you aren't sure what weight oil you should use, consult an authorized HYUNDAI dealer.

#### ***Check battery and cables***

Winter puts additional burdens on the battery system. Visually inspect the battery and cables as described in chapter 7. The level of charge in your battery can be checked by an authorized HYUNDAI dealer or a service station.



***Check spark plugs and ignition system***

Inspect your spark plugs as described in chapter 7 and replace them if necessary. Also check all ignition wiring and components to be sure they are not cracked, worn or damaged in any way.

***Use approved window washer anti-freeze in system***

To keep the water in the window washer system from freezing, add an approved window washer anti-freeze solution in accordance with instructions on the container. Window washer anti-freeze is available from an authorized HYUNDAI dealer and most auto parts outlets. Do not use engine coolant or other types of anti-freeze as these may damage the paint finish.

***Do not let your parking brake freeze***

Under some conditions your parking brake can freeze in the engaged position. This is most likely to happen when there is an accumulation of snow or ice around or near the rear brakes or if the brakes are wet. If there is a risk the parking brake may freeze, apply it only temporarily while you put the gear selector lever in P and block the rear wheels so the car cannot roll. Then release the parking brake.

***Do not let ice and snow accumulate underneath***

Under some conditions, snow and ice can build up under the fenders and interfere with the steering. When driving in severe winter conditions where this may happen, you should periodically check underneath the car to be sure the movement of the front wheels and the steering components is not obstructed.

***Don't place foreign objects or materials in the engine compartment***

Placement of foreign object or materials which prevent cooling of the engine, in the engine compartment, may cause a failure or combustion. The manufacturer is not responsible for the damage caused by such placement.

***To keep locks from freezing***

To keep the locks from freezing, squirt an approved de-icer fluid or glycerine into the key opening. If a lock is covered with ice, squirt it with an approved de-icing fluid to remove the ice. If the lock is frozen internally, you may be able to thaw it out by using a heated key. Handle the heated key with care to avoid injury.

### TRAILER TOWING

If you are considering to tow with your vehicle, you should first check with your state's Department of Motor Vehicles to determine legal requirements. Since laws vary from state to state the requirements for towing trailers, vehicles, or other types of vehicles or apparatus may differ. Ask an authorized HYUNDAI dealer for further details before towing.

Remember that trailering is different than just driving your vehicle by itself. Trailering means changes in handling, durability, and fuel economy. Successful, safe trailering requires correct equipment, and it has to be used properly. Damage to your vehicle caused by improper trailer towing is not covered by your vehicle manufacturer's warranty.

This section contains many time-tested, important trailering tips and safety rules. Many of these are important for your safety and that of your passengers. Please read this section carefully before you pull a trailer.

#### WARNING

##### Take the following precautions:

- **If you don't use the correct towing equipment, or if you drive improperly while towing, you can lose control of the vehicle when pulling a trailer. For example, if the trailer is too heavy, the braking performance may be reduced. You and your passengers could be seriously or fatally injured. Pull a trailer only if you have followed all the steps in this section.**
- **Before towing, make sure the total trailer weight, GCW (Gross Combination Weight), GVW (Gross Vehicle Weight), GAW (Gross Axle Weight ) and trailer tongue load are all within the limits.**

#### If you decide to pull a trailer

Here are some important points if you decide to pull a trailer:

- Consider using a sway control. You can ask a trailer hitch dealer about sway control.
- Do not do any towing with your vehicle during its first 1,200 miles (2,000 km) in order to allow the engine to properly break in. Failure to heed this caution may result in serious engine or transmission damage.
- When towing a trailer, be sure to consult an authorized HYUNDAI dealer for further information on additional requirements such as a towing kit, etc.
- Always drive your vehicle at a moderate speed (less than 60 mph (100 km/h)) or posted towing speed limit.
- On a long uphill grade, do not exceed 45 mph (70 km/h) or the posted towing speed limit, whichever is lower.
- Carefully observe the weight and load limits provided in the following pages.

## Total trailer weight

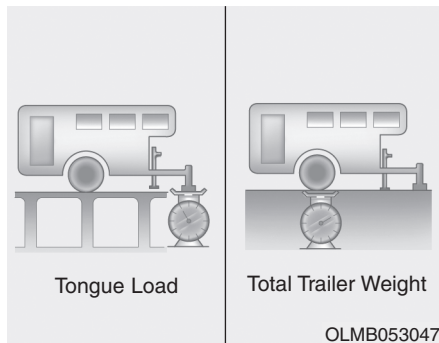

What is the maximum safe weight of a trailer? It should never weigh more than the maximum trailer weight with trailer brakes. But even that can be too heavy. It depends on how you plan to use your trailer. For example, speed, altitude, road grades, outside temperature and how often your vehicle is used to pull a trailer are all important. The ideal trailer weight can also depend on any special equipment that you have on your vehicle.

## Tongue load

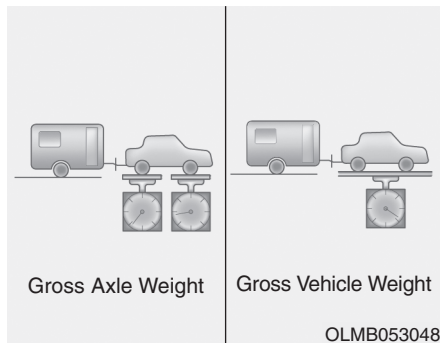

The tongue load is an important weight to measure because it affects the total Gross Vehicle Weight (GVW) of your vehicle. The trailer tongue should weigh a maximum of 10% of the total loaded trailer weight, within the limits of the maximum trailer tongue load permissible.

After you've loaded your trailer, weigh the trailer and then the tongue, separately, to see if the weights are proper. If they aren't, you may be able to correct them simply by moving some items around in the trailer.

## ⚠ WARNING

Take the following precautions:

- Never load a trailer with more weight in the rear than in the front. The front should be loaded with approximately 60% of the total trailer load; the rear should be loaded with approximately 40% of the total trailer load.
- Never exceed the maximum weight limits of the trailer or trailer towing equipment. Improper loading can result in damage to your vehicle and/or personal injury. Check weights and loading at a commercial scale or highway patrol office equipped with scales.

**Reference weight when towing a trailer**

Item		Gasoline Engine					
		1.6 Turbo-GDI		2.0 GDI		2.4 GDI	
		2WD	AWD	2WD	AWD	2WD	AWD
		DCT		A/T		A/T	
Maximum trailer weight lbs (kg)	Without brake system	1,500 (680)		1,650 (748)		1,650 (748)	
	With brake system	1,500 (680)		2,000 (907)		2,000 (907)	
Maximum permissible static vertical load on the coupling device lbs (kg)		220 (100)		220 (100)		220 (100)	

**Trailer towing equipment**

**Hitches**

It's important to have the correct hitch equipment. Crosswinds, large trucks going by, and rough roads are a few reasons why you'll need the right hitch. Here are some rules to follow:

- Do you have to make any holes in the body of your vehicle when you install a trailer hitch? If you do, then be sure to seal the holes later when you remove the hitch. If you don't seal them, carbon monoxide (CO) from your exhaust can get into your vehicle, as well as dirt and water.
- The bumpers on your vehicle are not intended for hitches. Do not attach rental hitches or other bumper-type hitches to them. Use only a frame-mounted hitch that does not attach to the bumper.
- A HYUNDAI trailer hitch accessory is available at an authorized HYUNDAI dealer.

### **Safety chains**

You should always attach chains between your vehicle and your trailer. Cross the safety chains under the tongue of the trailer so that the tongue will not drop to the road if it becomes separated from the hitch. Instructions about safety chains may be provided by the hitch manufacturer or trailer manufacturer. Follow the manufacturer's recommendation for attaching safety chains. Always leave just enough slack so you can turn with your trailer. And, never allow safety chains to drag on the ground.

### **Trailer brakes**

If your trailer is equipped with a braking system, make sure it conforms to federal and/or local regulations and that it is properly installed and operating correctly.

If your trailer weighs more than the maximum trailer weight without trailer brakes loaded, then it needs its own brakes and they must be adequate. Be sure to read and follow the instructions for the trailer brakes so you'll be able to install, adjust and maintain them properly. Do not tap into your vehicle's brake system. Trailer brakes must be applied separately from your vehicle's brake system.

#### **WARNING**

**Do not use a trailer with its own brakes unless you are absolutely certain that you have properly set up the brake system. Use an experienced, competent trailer shop for this work.**

### **Driving with a trailer**

Towing a trailer requires a certain amount of experience. Before setting out for the open road, you must get to know your trailer. Acquaint yourself with the feel of handling and braking with the added weight of the trailer. And always keep in mind that the vehicle you are driving is now longer and not nearly as responsive as your vehicle is by itself.

Before you start, check the trailer hitch and platform, safety chains, electrical connector(s), lights, tires and brakes.

During your trip, occasionally check to be sure that the load is secure, and that the lights and trailer brakes are still working.

### ***Distance***

Stay at least twice as far behind the vehicle ahead as you would when driving your vehicle without a trailer. This can help you avoid situations that require heavy braking and sudden turns.

### ***Passing***

You will need more passing distance up ahead when you're towing a trailer. And, because of the increased vehicle length, you'll need to go much farther beyond the passed vehicle before you can return to your lane.

### ***Backing up***

Hold the bottom of the steering wheel with one hand. Then, to move the trailer to the left, move your hand to the left. To move the trailer to the right, move your hand to the right. Always back up slowly and, if possible, have someone guide you.

### ***Making turns***

When you're turning with a trailer, make wider turns than normal. Do this so your trailer won't strike soft shoulders, curbs, road signs, trees, or other objects. Avoid jerky or sudden maneuvers. Signal well in advance.

### ***Turn signals***

When you tow a trailer, your vehicle has to have a different turn signal flasher and extra wiring. The green arrows on your instrument panel will flash whenever you signal a turn or lane change. Properly connected, the trailer lights will also flash to alert other drivers you're about to turn, change lanes, or stop.

When towing a trailer, the green arrows on your instrument panel will flash for turns even if the bulbs on the trailer are burned out. Thus, you may think drivers behind you are seeing your signals when, in fact, they are not. It's important to check occasionally to be sure the trailer bulbs are still working. You must also check the lights every time you disconnect and then reconnect the wires.

### **WARNING**

**Do not connect a trailer lighting system directly to your vehicle's lighting system. Use an approved trailer wiring harness. Failure to do so could result in damage to the vehicle electrical system and/or personal injury. Consult an authorized HYUNDAI dealer for assistance.**

### **Driving on hills**

Reduce speed and shift to a lower gear before you start down a long or steep downgrade. If you don't shift down, you might have to use your brakes so much that they would get overheated and may not operate efficiently.

On a long uphill grade, shift down and reduce your speed to around 45 mph (70 km/h) to reduce the possibility of engine and transmission overheating.

If your trailer weighs more than the maximum trailer weight without trailer brakes, you should drive in D (Drive) when towing a trailer. Operating your vehicle in D (Drive) when towing a trailer will minimize heat build-up and extend the life of your transmission.

### **NOTICE**

**To prevent engine and/or transmission overheating:**

- **When towing a trailer on steep grades (in excess of 6%) pay close attention to the engine coolant temperature gauge to ensure the engine does not overheat. If the needle of the coolant temperature gauge moves towards "H" (HOT), pull over and stop as soon as it is safe to do so, and allow the engine to idle until it cools down. You may proceed once the engine has cooled sufficiently.**
- **When towing a trailer, your vehicle speed may be much slower than the general flow of traffic, especially when climbing an uphill grade. Use the right hand lane when towing a trailer on an uphill grade. Choose your vehicle speed according to the maximum posted speed limit for vehicles with trailers, the steepness of the grade, and your trailer weight.**

(Continued)

(Continued)

- **For vehicles equipped with the Ecoshift dual clutch transmission, some extra precaution should be taken when towing a trailer. Due to the added load on the transmission when towing a trailer, the clutches may get hot if the vehicle experiences excessive upshifting and downshifting.**

**Under certain conditions, such as repeated stop-and-go launches on steep grades, the transmission clutches may become overheated. When the clutches start to become overheated, the transmission safe protection mode logic is enabled. If the safe protection mode logic is enabled, the gear position indicator on the cluster LCD display blinks, a chime sounds, and a warning message will appear.**

(Continued)

### (Continued)

If the Ecoshift dual clutch transmission starts to become overheated, the gear shift characteristics may change. Gear shifts may become more abrupt. If continued operation while towing a trailer includes frequent and continuous upshifts and downshifts, the overheat warning message on the cluster LCD display may illuminate. If this occurs, stop the vehicle, apply the brakes or shift the vehicle to (P) Park, and allow the transmission to cool.

### ***Parking on hills***

Generally, if you have a trailer attached to your vehicle, you should not park your vehicle on a hill.

However, if you ever have to park your trailer on a hill, here's how to do it:

1. Pull the vehicle into the parking area.  
Turn the steering wheel in the direction of the curb (right if headed down hill, left if headed up hill).
2. Shift the vehicle to P (Park).
3. Set the parking brake and shut off the vehicle.
4. Place wheel chocks under the trailer wheels on the down hill side of the wheels.

5. Start the vehicle, apply the brakes, shift to neutral, release the parking brake and slowly release the brakes until the trailer chocks absorb the load.
6. Reapply the brakes and parking brakes.
7. Move the shift lever to P (Park).
8. Shut off the vehicle and release the vehicle brakes but leave the parking brake set.

### **WARNING**

- **Do not get out of the vehicle without the parking brake firmly set. If you have left the engine running, the vehicle can move suddenly. You and others could be seriously or fatally injured.**
- **Do not apply the accelerator pedal to hold the vehicle on an uphill.**



### ***Driving the vehicle after it has been parked on a hill***

1. With the gear shift lever in P (Park), apply the brakes and hold the brake pedal down while performing the following:
  - Start your engine;
  - Shift into gear; and
  - Release the parking brake.
2. Slowly remove your foot from the brake pedal.
3. Drive slowly until the trailer is clear of the chocks.
4. Stop and have someone pick up and store the chocks.

### **Maintenance when trailer towing**

Your vehicle will need service more often when you regularly pull a trailer. Important items to pay particular attention to include engine oil, automatic transmission fluid, axle lubricant and cooling system fluid. Brake condition is another important item to frequently check. If you're trailering, it's a good idea to review these items before you start your trip. Don't forget to also maintain your trailer and hitch. Follow the maintenance schedule that accompanied your trailer and check it periodically. Preferably, inspect the vehicle and trailer at the start of each day's driving. Inspect the hitch mounting to make sure the hitch is properly secured to the vehicle. Inspect the trailer electrical wiring to make sure brake lights, turn signal lights, running lights, and hazard lights are working properly.

#### **CAUTION**

##### **To prevent vehicle damage:**

- **Due to higher load during trailer usage, overheating might occur on hot days or during uphill driving. If the coolant gauge indicates overheating, switch off the air conditioner and stop the vehicle in a safe area to cool down the engine.**
- **When towing check the automatic transmission fluid more frequently.**

**(Note: This is not applicable for vehicles equipped with the Ecoshift dual clutch transmission.)**

### VEHICLE LOAD LIMIT

Two labels on your driver's door sill show how much weight your vehicle was designed to carry: the Tire and Loading Information Label and the Certification Label.

Before loading your vehicle, familiarize yourself with the following terms for determining your vehicle's weight ratings, from the vehicle's specifications and the Certification Label:

#### **Base Curb Weight**

This is the weight of the vehicle including a full tank of fuel and all standard equipment. It does not include passengers, cargo, or optional equipment.

#### **Vehicle Curb Weight**

This is the weight of your new vehicle when you picked it up from your dealer plus any aftermarket equipment.

#### **Cargo Weight**

This figure includes all weight added to the Base Curb Weight, including cargo and optional equipment.

#### **GAW (Gross Axle Weight)**

This is the total weight placed on each axle (front and rear) - including vehicle curb weight and all payload.

#### **GAWR (Gross Axle Weight Rating)**

This is the maximum allowable weight that can be carried by a single axle (front or rear). These numbers are shown on the Certification Label. The total load on each axle must never exceed its GAWR.

#### **GVW (Gross Vehicle Weight)**

This is the Base Curb Weight plus actual Cargo Weight plus passengers.

#### **GVWR (Gross Vehicle Weight Rating)**

This is the maximum allowable weight of the fully loaded vehicle (including all options, equipment, passengers and cargo). The GVWR is shown on the Certification Label located on the driver's door sill.

## Tire Loading Information Label

### ■ Type A

TIRE AND LOADING INFORMATION RENSEIGNEMENTS SUR LES PNEUS ET LE CHARGEMENT			
SEATING CAPACITY NOMBRE DE PLACES		TOTAL 5	FRONT 2 REAR 3 AVANT 2 ARRIÈRE 3
The combined weight of occupants and cargo should never exceed 440 kg or 970 lbs. Le poids total des occupants et du chargement ne doit jamais dépasser 440 kg ou 970 lbs.			
TIRE PNEU	SIZE DIMENSIONS	COLD TIRE PRESSURE PRESSION DES PNEUS À FROID	SEE OWNER'S MANUAL FOR ADDITIONAL INFORMATION VOIR LE MANUEL DE L'USAGER POUR PLUS DE RENSEIGNEMENTS
FRONT AVANT	225/60R17	240kpa, 35psi	
REAR ARRIÈRE	225/60R17	240kpa, 35psi	
SPARE DE SECOURS	T155/90D16	420kPa, 60psi	

### ■ Type B

TIRE AND LOADING INFORMATION RENSEIGNEMENTS SUR LES PNEUS ET LE CHARGEMENT			
SEATING CAPACITY NOMBRE DE PLACES		TOTAL 5	FRONT 2 REAR 3 AVANT 2 ARRIÈRE 3
The combined weight of occupants and cargo should never exceed 440 kg or 970 lbs. Le poids total des occupants et du chargement ne doit jamais dépasser 440 kg ou 970 lbs.			
TIRE PNEU	SIZE DIMENSIONS	COLD TIRE PRESSURE PRESSION DES PNEUS À FROID	SEE OWNER'S MANUAL FOR ADDITIONAL INFORMATION VOIR LE MANUEL DE L'USAGER POUR PLUS DE RENSEIGNEMENTS
FRONT AVANT	245/45R19	240kpa, 35psi	
REAR ARRIÈRE	245/45R19	240kpa, 35psi	
SPARE DE SECOURS	T155/90D16	420kPa, 60psi	

OTLA058146/OTLA058140

The label located on the driver's door sill gives the original tire size, cold tire pressures recommended for your vehicle, the number of people that can be in your vehicle and vehicle capacity weight.

## Vehicle capacity weight

970 lbs. (440 kg)

Vehicle capacity weight is the maximum combined weight of occupants and cargo. If your vehicle is equipped with a trailer, the combined weight includes the tongue load.

## Seating capacity

Total : 5 persons

(Front seat : 2 persons,  
Rear seat : 3 persons)

Seating capacity is the maximum number of occupants including a driver, your vehicle may carry. However, the seating capacity may be reduced based upon the weight of all of the occupants, and the weight of the cargo being carried or towed. Do not overload the vehicle as there is a limit to the total weight, or load limit including occupants and cargo, the vehicle can carry.

## Towing capacity

Without trailer brakes

1000 lbs (454 kg)

With trailer brakes

1500 lbs (680 kg)

Towing capacity is the maximum trailer weight including its cargo weight that your vehicle can tow.

### ***Cargo capacity***







The cargo capacity of your vehicle will increase or decrease depending on the weight and the number of occupants and the tongue load, if your vehicle is equipped with a trailer.

### ***Steps for determining correct load limit***

1. Locate the statement "The combined weight of occupants and cargo should never exceed XXX kg or XXX lbs." on your vehicle's placard.
2. Determine the combined weight of the driver and passengers that will be riding in your vehicle.
3. Subtract the combined weight of the driver and passengers from XXX kg or XXX lbs.
4. The resulting figure equals the available amount of cargo and luggage load capacity. For example, if the "XXX" amount equals 1400 lbs. and there will be five 150 lb. passengers in your vehicle, the amount of available cargo and luggage load capacity is 650 lbs. (1400 - 750 (5 x 150) = 650 lbs.)
5. Determine the combined weight of luggage and cargo being loaded on the vehicle. That weight may not safely exceed the available cargo and luggage load capacity calculated in Step 4.
6. If your vehicle will be towing a trailer, load from your trailer will be transferred to your vehicle. Consult this manual to determine how this reduces the available cargo and luggage load capacity of your vehicle.

### **WARNING**

**Do not overload the vehicle as there is a limit to the total weight, or load limit, including occupants and cargo, the vehicle can carry. Overloading can shorten the life of the vehicle. If the GVWR or the GAWR is exceeded, parts on the vehicle can break, and it can change the handling of your vehicle. These could cause you to lose control and result in an accident.**

<p><b>Example 1</b></p>	<div style="display: flex; align-items: center; justify-content: center; gap: 20px;"> <div style="text-align: center;"> <div style="background-color: black; color: white; padding: 10px; width: 80px; margin: 0 auto;">Vehicle Capacity</div> <p>Maximum Load (1400 lbs.) (635 kg)</p> </div> <div style="font-size: 2em;">≥</div> <div style="text-align: center;">  <p>Passenger Weight (150 lbs. × 2 = 300 lbs.) (68 kg × 2 = 136 kg)</p> </div> <div style="font-size: 2em;">+</div> <div style="text-align: center;">  <p>Cargo Weight (1100 lbs.) (499 kg)</p> </div> </div>
<p><b>Example 2</b></p>	<div style="display: flex; align-items: center; justify-content: center; gap: 20px;"> <div style="text-align: center;"> <div style="background-color: black; color: white; padding: 10px; width: 80px; margin: 0 auto;">Vehicle Capacity</div> <p>Maximum Load (1400 lbs.) (635 kg)</p> </div> <div style="font-size: 2em;">≥</div> <div style="text-align: center;">  <p>Passenger Weight (150 lbs. × 5 = 750 lbs.) (68 kg × 5 = 340 kg)</p> </div> <div style="font-size: 2em;">+</div> <div style="text-align: center;">  <p>Cargo Weight (650 lbs.) (295 kg)</p> </div> </div>
<p><b>Example 3</b></p>	<div style="display: flex; align-items: center; justify-content: center; gap: 20px;"> <div style="text-align: center;"> <div style="background-color: black; color: white; padding: 10px; width: 80px; margin: 0 auto;">Vehicle Capacity</div> <p>Maximum Load (1400 lbs.) (635 kg)</p> </div> <div style="font-size: 2em;">≥</div> <div style="text-align: center;">  <p>Passenger Weight (172 lbs. × 5 = 860 lbs.) (78 kg × 5 = 390 kg)</p> </div> <div style="font-size: 2em;">+</div> <div style="text-align: center;">  <p>Cargo Weight (540 lbs.) (245 kg)</p> </div> </div>

### Certification label

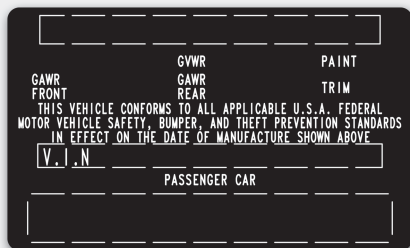

OBH059070

The certification label is located on the driver's door sill at the center pillar and shows the maximum allowable weight of the fully loaded vehicle. This is called the GVWR (Gross Vehicle Weight Rating). The GVWR includes the weight of the vehicle, all occupants, fuel and cargo.

This label also tells you the maximum weight that can be supported by the front and rear axles, called Gross Axle Weight Rating (GAWR).

The total weight of the vehicle, including all occupants, accessories, cargo, and trailer tongue load must not exceed the Gross Vehicle Weight Rating (GVWR) or the Gross Axle Weight Rating (GAWR). To find out the actual loads on your front and rear axles, you need to go to a weigh station and weigh your vehicle. Be sure to spread out your load equally on both sides of the centerline.

#### WARNING

##### Overloading

- **Never exceed the GVWR for your vehicle, the GAWR for either the front or rear axle and vehicle capacity weight. Exceeding these ratings can affect your vehicle's handling and braking ability, and cause an accident.**
- **Do not overload your vehicle. Overloading your vehicle can cause heat buildup in your vehicle's tires and possible tire failure, increased stopping distances and poor vehicle handling—all of which may result in a crash.**

#### **NOTICE**

**Overloading your vehicle may cause damage. Repairs would not be covered by your warranty. Do not overload your vehicle.**

#### WARNING

**If you carry items inside your vehicle (e.g., suitcases, tools, packages, or anything else), they are moving as fast as the vehicle. If you have to stop or turn quickly, or if there is a crash, the items will keep going and can cause an injury if they strike the driver or a passenger.**

- **Put items in the cargo area of your vehicle. Try to spread the weight evenly.**
- **Do not stack items, like suitcases, inside the vehicle above the tops of the seats.**
- **Do not leave an unsecured child restraint in your vehicle.**
- **When you carry something inside the vehicle, secure it.**

## What to do in an emergency

Hazard warning flasher .....	6-2	If you have a flat tire.....	6-14
In case of an emergency while driving .....	6-2	Towing .....	6-21
If the Engine Stalls While Driving .....	6-2	Towing service .....	6-21
If the Engine Stalls at a Crossroad or Crossing.....	6-2	Removable towing hook .....	6-22
If you Have a Flat Tire While Driving .....	6-3	Emergency towing .....	6-23
<b>If the engine will not start .....</b>	<b>6-3</b>	Tie-down hook .....	6-24
If the Engine Doesn't Turn Over or Turns			
Over Slowly.....	6-3		
If the Engine Turns Over Normally but			
Doesn't Start .....	6-3		
<b>Jump starting .....</b>	<b>6-4</b>		
<b>If the engine overheats .....</b>	<b>6-6</b>		
<b>Tire pressure monitoring system (TPMS).....</b>	<b>6-8</b>		
Check Tire Pressure .....	6-8		
Tire Pressure Monitoring System .....	6-9		
Low tire pressure indicator .....	6-10		
Low tire pressure LCD display with position			
indicator.....	6-10		
TPMS (Tire Pressure Monitoring System)			
Malfunction Indicator .....	6-11		
Changing a Tire with TPMS.....	6-12		

## HAZARD WARNING FLASHER

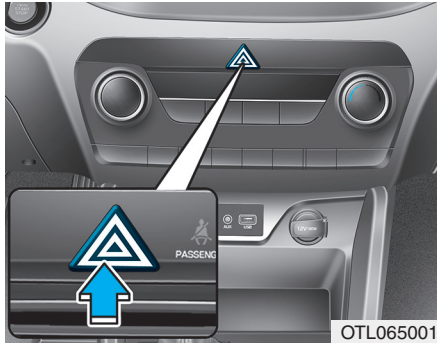

The hazard warning flasher serves as a warning to other drivers to exercise extreme caution when approaching, overtaking, or passing your vehicle.

It should be used whenever emergency repairs are being made or when the vehicle is stopped near the edge of a roadway.

To turn the hazard warning flasher on or off, press the hazard warning flasher button. The button is located in the center fascia panel. Both the left and right turn signal lights will flash simultaneously.

- The hazard warning flasher operates whether your vehicle is running or not.
- The turn signals do not work when the hazard flasher is on.

## IN CASE OF AN EMERGENCY WHILE DRIVING

### If the Engine Stalls While Driving

- Reduce your speed gradually, keeping a straight line. Move cautiously off the road to a safe place.
- Turn on your hazard warning flasher.
- Try to start the engine again. If your vehicle will not start, contact an authorized HYUNDAI dealer or seek other qualified assistance.

### If the Engine Stalls at a Crossroad or Crossing

If the engine stalls at a crossroad or crossing, if safe to do so, move the shift lever to the N (Neutral) position and then push the vehicle to a safe location.



### If you Have a Flat Tire While Driving

If a tire goes flat while you are driving:

- Take your foot off the accelerator pedal and let the vehicle slow down while driving straight ahead. Do not apply the brakes immediately or attempt to pull off the road as this may cause loss of vehicle control resulting in an accident. When the vehicle has slowed to such a speed that it is safe to do so, brake carefully and pull off the road. Drive off the road as far as possible and park on firm, level ground. If you are on a divided highway, do not park in the median area between the two traffic lanes.
- When the vehicle is stopped, press the hazard warning flasher button, move the shift lever into P(Park), and apply the parking brake, and place the ignition switch in the LOCK/OFF position.
- Have all passengers get out of the vehicle. Be sure they all get out on the side of the vehicle that is away from traffic.
- When changing a flat tire, follow the instructions provided later in this chapter.

### IF THE ENGINE WILL NOT START

#### If the Engine Doesn't Turn Over or Turns Over Slowly

- Be sure the shift lever is in N (Neutral) or P (Park). The engine starts only when the shift lever is in N (Neutral) or P (Park).
- Check the battery connections to be sure they are clean and tight.
- Turn on the interior light. If the light dims or goes out when you operate the starter, the battery is drained.

Do not push or pull the vehicle to start it. This could cause damage to your vehicle. See instructions for "Jump Starting" provided in this chapter.



#### CAUTION

**Push or pull starting the vehicle may cause the catalytic converter to overload which can lead to damage to the emission control system.**

#### If the Engine Turns Over Normally but Doesn't Start

Check the fuel level and add fuel if necessary.

If the engine still does not start, have your vehicle checked by an authorized HYUNDAI dealer.

## JUMP STARTING

Jump starting can be dangerous if done incorrectly. Follow the jump starting procedure in this section to avoid serious injury or damage to your vehicle. If in doubt about how to properly jump start your vehicle, we strongly recommend that you have a service technician or towing service do it for you.

### WARNING

To prevent **SERIOUS INJURY** or **DEATH** to you or bystanders, always follow these precautions when working near or handling the battery:



Always read and follow instructions carefully when handling a battery.



Wear eye protection designed to protect the eyes from acid splashes.



Keep all flames, sparks, or smoking materials away from the battery.



Hydrogen is always present in battery cells, is highly combustible, and may explode if ignited.



Keep batteries out of reach of children.

(Continued)

(Continued)



Batteries contain sulfuric acid which is highly corrosive. Do not allow acid to contact your eyes, skin or clothing.

If acid gets into your eyes, flush your eyes with clean water for at least 15 minutes and get immediate medical attention. If acid gets on your skin, thoroughly wash the area. If you feel pain or a burning sensation, get medical attention immediately.

- When lifting a plastic-cased battery, excessive pressure on the case may cause battery acid to leak. Lift with a battery carrier or with your hands on opposite corners.
- Do not attempt to jump start your vehicle if your battery is frozen.
- **NEVER** attempt to recharge the battery when the vehicle's battery cables are connected to the battery.

(Continued)

**(Continued)**

- The electrical ignition system works with high voltage. **NEVER** touch these components with the engine running or when the ignition switch is in the ON position.

**i Information**

An inappropriately disposed battery can be harmful to the environment and human health. Dispose the battery according to your local law(s) or regulations.

**NOTICE**

To prevent damage to your vehicle:

- Only use a 12-volt power supply (battery or jumper system) to jump start your vehicle.
- Do not attempt to jump start your vehicle by push-starting.

***Jump starting procedure***

1. Position the vehicles close enough that the jumper cables will reach, but do not allow the vehicles to touch.
2. Avoid fans or any moving parts in the engine compartment at all times, even when the vehicles are turned off.
3. Turn off all electrical devices such as radios, lights, air conditioning, etc. Put the vehicles in P (Park) and set the parking brakes. Turn both vehicles OFF.

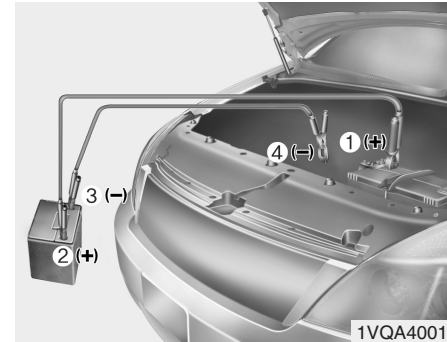

4. Connect the jumper cables in the exact sequence shown in the illustration. First connect one jumper cable to the red, positive (+) jumper terminal of your vehicle (1).
5. Connect the other end of the jumper cable to the red, positive (+) battery/jumper terminal of the assisting vehicle (2).
6. Connect the second jumper cable to the black, negative (-) battery/chassis ground of the assisting vehicle (3).

7. Connect the other end of the second jumper cable to the black, negative (-) chassis ground of your vehicle (4).

Do not allow the jumper cables to contact anything except the correct battery or jumper terminals or the correct ground. Do not lean over the battery when making connections.

8. Start the engine of the assisting vehicle and let it run at approximately 2,000 rpm for a few minutes. Then start your vehicle.

If your vehicle will not start after a few attempts, it probably requires servicing. In this event please seek qualified assistance. If the cause of your battery discharging is not apparent, have your vehicle checked by an authorized HYUNDAI dealer.

Disconnect the jumper cables in the exact reverse order you connected them:

1. Disconnect the jumper cable from the black, negative (-) chassis ground of your vehicle (4).
2. Disconnect the other end of the jumper cable from the black, negative (-) battery/chassis ground of the assisting vehicle (3).
3. Disconnect the second jumper cable from the red, positive (+) battery/jumper terminal of the assisting vehicle (2).
4. Disconnect the other end of the jumper cable from the red, positive (+) jumper terminal of your vehicle (1).

## IF THE ENGINE OVERHEATS

If your temperature gauge indicates overheating, you experience a loss of power, or hear loud pinging or knocking, the engine may be overheating. If this happens, you should:

1. Pull off the road and stop as soon as it is safe to do so.
2. Place the shift lever in P (Park) and set the parking brake. If the air conditioning is ON, turn it OFF.
3. If engine coolant is running out under the vehicle or steam is coming out from the hood, stop the engine. Do not open the hood until the coolant has stopped running or the steaming has stopped. If there is no visible loss of engine coolant and no steam, leave the engine running and check to be sure the engine cooling fan is operating. If the fan is not running, turn the engine off.

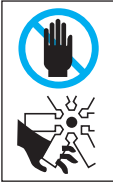
**⚠ WARNING**

While the engine is running, keep hands, clothing and tools away from the moving parts such as the cooling fan and drive belt to prevent serious injury.

4. Check for coolant leaking from the radiator, hoses or under the vehicle. (If the air conditioning had been in use, it is normal for cold water to be draining from it when you stop.)
5. If engine coolant is leaking out, stop the engine immediately and call the nearest authorized HYUNDAI dealer for assistance.

**⚠ WARNING**

Your vehicle is equipped with a pressurized coolant reserve tank. **NEVER** remove the coolant reserve tank cap or the radiator drain plug while the engine and radiator are **HOT**. Hot coolant and steam may blow out under pressure, causing serious injury.

Turn the engine off and wait until the engine cools down. Use extreme care when removing the coolant reserve tank cap. Wrap a towel or thick rag around it, and turn it counter-clockwise slowly to release some of the pressure from the system. Step back while the pressure is released.

When you are sure all the pressure has been released, continue turning the cap counter-clockwise to remove it.

6. If you cannot find the cause of the overheating, wait until the engine temperature has returned to normal. Then, if coolant has been lost, carefully add coolant to the reservoir to bring the fluid level in the reservoir up to the halfway mark.
7. Proceed with caution, keeping alert for further signs of overheating. If overheating happens again, call an authorized HYUNDAI dealer for assistance.

**⚠ CAUTION**

Serious loss of coolant indicates a leak in the cooling system and should be checked as soon as possible by an authorized HYUNDAI dealer.

## TIRE PRESSURE MONITORING SYSTEM (TPMS)

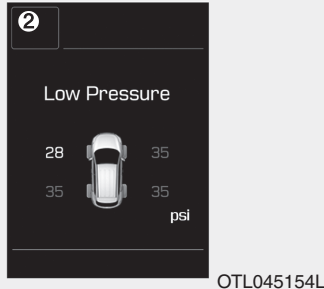

- (1) Low Tire Pressure / TPMS Malfunction Indicator Lamp
- (2) Low Tire Pressure / Tire Pressure Monitor / TPMS Malfunction Display (shown on the cluster LCD display)

### Check Tire Pressure

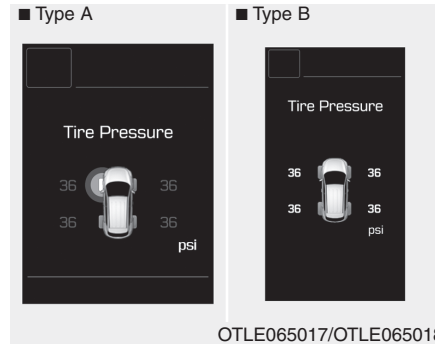

- You can check the tire pressure in the Information Mode on the cluster.
- Refer to the "User Settings Mode" section in chapter 3.**
- Tire pressure is displayed after a few minutes of driving after initial engine start up.
  - If tire pressure is not displayed when the vehicle is stopped, "Drive to display" message will appear. After driving, check the tire pressure.

- The displayed tire pressure values may differ from those measured with a tire pressure gauge.
- You can change the tire pressure unit in the User Settings Mode on the cluster.
  - psi, kpa, bar (**Refer to the "User Settings Mode" section in chapter 3).**)

## Tire Pressure Monitoring System

### WARNING

**Over-inflation or under-inflation can reduce tire life, adversely affect vehicle handling, and lead to sudden tire failure that may cause loss of vehicle control resulting in an accident.**

Each tire, including the spare (if provided), should be checked monthly when cold and inflated to the inflation pressure recommended by the vehicle manufacturer on the vehicle placard or tire inflation pressure label. (If your vehicle has tires of a different size than the size indicated on the vehicle placard or tire inflation pressure label, you should determine the proper tire inflation pressure for those tires.)

As an added safety feature, your vehicle has been equipped with a tire pressure monitoring system (TPMS) that illuminates a low tire pressure telltale when one or more of your tires is significantly under-inflated. Accordingly, when the low tire pressure telltale illuminates, you should stop and check your tires as soon as possible, and inflate them to the proper pressure. Driving on a significantly under-inflated tire causes the tire to overheat and can lead to tire failure.

Under-inflation also reduces fuel efficiency and tire tread life, and may affect the vehicle's handling and stopping ability.

Please note that the TPMS is not a substitute for proper tire maintenance, and it is the driver's responsibility to maintain correct tire pressure, even if under-inflation has not reached the level to trigger illumination of the TPMS low tire pressure telltale.

Your vehicle has also been equipped with a TPMS malfunction indicator to indicate when the system is not operating properly. The TPMS malfunction indicator is combined with the low tire pressure telltale. When the system detects a malfunction, the telltale will flash for approximately one minute and then remain continuously illuminated. This sequence will continue upon subsequent vehicle start-ups as long as the malfunction exists.

When the malfunction indicator is illuminated, the system may not be able to detect or signal low tire pressure as intended. TPMS malfunctions may occur for a variety of reasons, including the installation of replacement or alternate tires or wheels on the vehicle that prevent the TPMS from functioning properly.

Always check the TPMS malfunction telltale after replacing one or more tires or wheels on your vehicle to ensure that the replacement or alternate tires and wheels allow the TPMS to continue to function properly.

### NOTICE

If any of the below happens, have the system checked by an authorized HYUNDAI dealer.

1. The Low Tire Pressure TPMS Malfunction Indicator does not illuminate for 3 seconds when the ignition switch is placed to the ON position or engine is running.
2. The TPMS Malfunction Indicator remains illuminated after blinking for approximately 1 minute.
3. The Low Tire Pressure LCD display remains illuminated



### Low Tire Pressure Telltale

### Low Tire Pressure LCD Display with Position Indicator



When the tire pressure monitoring system warning indicators are illuminated and the warning message is displayed on the cluster LCD display, one or more of your tires is significantly under-inflated. The LCD position indicator will indicate which tire is significantly under-inflated by illuminating the corresponding position light.

If any of your tire pressures are indicated as being low, immediately reduce your speed, avoid hard cornering, and anticipate increased stopping distances. You should stop and check your tires as soon as possible. Inflate the tires to the proper pressure as indicated on the vehicle's placard or tire inflation pressure label located on the driver's side center pillar outer panel.

If you cannot reach a service station or if the tire cannot hold the newly added air, replace the low pressure tire with the spare tire.

The Low Tire Pressure LCD position indicator will remain on and the TPMS Malfunction Indicator may blink for one minute and then remain illuminated until you have the low pressure tire repaired and replaced on the vehicle.

### NOTICE

**The spare tire is not equipped with a tire pressure sensor.**



 **CAUTION**

During winter or cold weather, the TPMS indicator may illuminate if the tire pressures were set when the outside temperature was warm. As the outside air becomes colder, the pressure in the tires will decrease. Similarly, if the outside air becomes warmer, the pressure in the tires will increase. As you drive your vehicle, the temperature of the tires will heat up, therefore the tire pressures will increase. Check and adjust your tire pressures regularly before driving to make sure your vehicle is operating at the correct pressures as designed.

 **WARNING****Low pressure damage**

**Significantly low tire pressure makes the vehicle unstable and can contribute to loss of vehicle control and increased braking distances.**

**Continued driving on low pressure tires can cause the tires to overheat and fail.**

**TPMS Malfunction Indicator**

The TPMS Malfunction Indicator will illuminate after it blinks for approximately one minute when there is a problem with the Tire Pressure Monitoring System.

Have the system checked by an authorized HYUNDAI dealer as soon as possible.

**NOTICE**

**If there is a malfunction with the TPMS, the individual tire pressures in the cluster LCD display will not be available. Have the system checked by an authorized HYUNDAI dealer as soon as possible.**

### NOTICE

The TPMS Malfunction Indicator may illuminate after blinking for one minute if the vehicle is near electric power supply cables or radio transmitters such as police stations, government and public offices, broadcasting stations, military installations, airports, transmitting towers, etc.

Additionally, the TPMS Malfunction Indicator may illuminate if snow chains are used or electronic devices such as computers, chargers, remote starters, navigation, etc. This may interfere with normal operation of the TPMS.

### Changing a Tire with TPMS

If you have a flat tire, the Low Tire Pressure and LCD position indicator will come on. Have the flat tire repaired by an authorized HYUNDAI dealer as soon as possible or replace the flat tire with the spare tire.

#### CAUTION

**Never use a puncture-repairing agent not approved by HYUNDAI dealer to repair and/or inflate a low pressure tire. Tire sealant not approved by HYUNDAI dealer may damage the tire pressure sensor.**

The spare tire does not come with a tire pressure monitoring sensor. When the low pressure tire or the flat tire is replaced with the spare tire, the Low Tire Pressure LCD position indicator will remain on. Also, the TPMS Malfunction Indicator will illuminate after blinking for one minute if the vehicle is driven at speed above 15.5 mph (25 km/h) for approximately 20 minutes.

Once the original tire equipped with a tire pressure monitoring sensor is reinflated to the recommended pressure and reinstalled on the vehicle, the Low Tire Pressure LCD position indicator and TPMS Malfunction Indicator will go off within a few minutes of driving.

If the indicators do not disappear after a few minutes, please visit an authorized HYUNDAI dealer.

Each wheel is equipped with a tire pressure sensor mounted inside the tire behind the valve stem (except for the spare tire). You must use TPMS specific wheels. It is recommended that you always have your tires serviced by an authorized HYUNDAI dealer.

A cold tire means the vehicle has been sitting for 3 hours and driven for less than 1 mile (1.6 km) in that 3 hour period.

Allow the tire to cool before measuring the inflation pressure. Always be sure the tire is cold before inflating to the recommended pressure.

**⚠ WARNING**

- The TPMS cannot alert you to severe and sudden tire damage caused by external factors such as nails or road debris.
- If you feel any vehicle instability, immediately take your foot off the accelerator, apply the brakes gradually with light force, and slowly move to a safe position off the road.

**⚠ WARNING**

Tampering with, modifying, or disabling the Tire Pressure Monitoring System (TPMS) components may interfere with the system's ability to warn the driver of low tire pressure conditions and/or TPMS malfunctions. Tampering with, modifying, or disabling the Tire Pressure Monitoring System (TPMS) components may void the warranty for that portion of the vehicle.

**i Information**

This device complies with Part 15 of the FCC rules.

Operation is subject to the following three conditions:

1. This device may not cause harmful interference.
2. This device must accept any interference received, including interference that may cause undesired operation.
3. Changes or modifications not expressly approved by the party responsible for compliance could void the user's authority to operate the equipment.

## IF YOU HAVE A FLAT TIRE

### WARNING

Changing a tire can be dangerous. Follow the instructions in this section when changing a tire to reduce the risk of serious injury or death.

### CAUTION

Be careful as you use the jack handle to stay clear of the flat end. The flat end has sharp edges that could cause cuts.

### Jack and tools

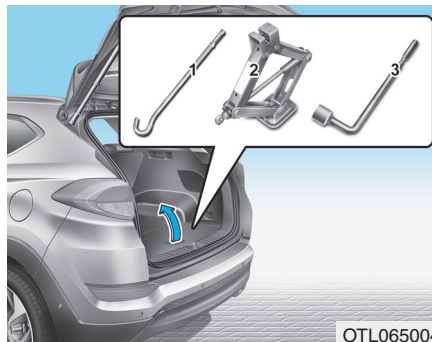

- ① Jack handle
- ② Jack
- ③ Wheel nut wrench

The jack, jack handle, and wheel lug nut wrench are stored in the luggage compartment under the luggage box cover.

The jack is provided for emergency tire changing only.



Turn the winged hold down bolt counterclockwise to remove the spare tire.

Store the spare tire in the same compartment by turning the winged hold down bolt clockwise.

To prevent the spare tire and tools from “rattling,” store them in their proper location.

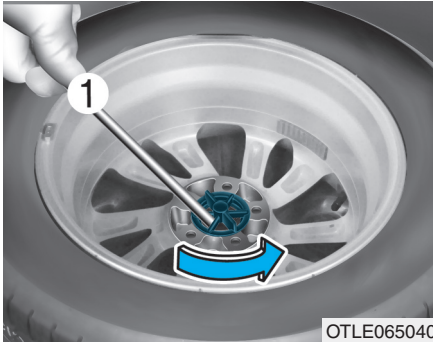

OTLE065040

If it is hard to loosen the tire hold-down wing bolt by hand, you can loosen it easily using the jack handle.

1. Put the jack handle (1) inside of the tire hold-down wing bolt.
2. Turn the tire hold-down wing bolt counterclockwise with the jack handle.

## Changing tires

### ⚠ WARNING

A vehicle can slip or roll off of a jack causing serious injury or death to you or those nearby. Take the following safety precautions:

- Never place any portion of your body under a vehicle that is supported by a jack.
- **NEVER** attempt to change a tire in the lane of traffic. **ALWAYS** move the vehicle completely off the road on level, firm ground away from traffic before trying to change a tire. If you cannot find a level, firm place off the road, call a towing service for assistance.
- Be sure to use the jack provided with the vehicle.

(Continued)

(Continued)

- **ALWAYS** place the jack on the designated jacking positions on the vehicle and **NEVER** on the bumpers or any other part of the vehicle for jacking support.
- Do not start or run the engine while the vehicle is on the jack.
- Do not allow anyone to remain in the vehicle while it is on the jack.
- Keep children away from the road and the vehicle.

## What to do in an emergency

Follow these steps to change your vehicle's tire:

1. Park on a level, firm surface.
2. Move the shift lever into P (Park), apply the parking brake, and place the ignition switch in the LOCK/OFF position.
3. Press the hazard warning flasher button.
4. Remove the wheel lug nut wrench, jack, jack handle, and spare tire from the vehicle.

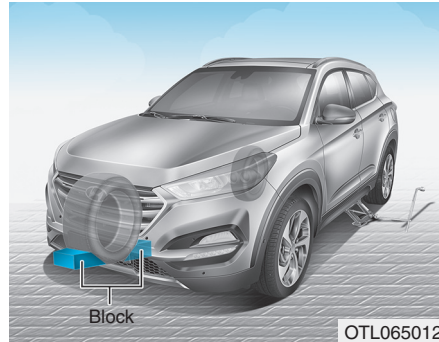

5. Block both the front and rear of the tire diagonally opposite of the tire you are changing.



6. Loosen the wheel lug nuts counterclockwise one turn each in the order shown above, but do not remove any lug nuts until the tire has been raised off of the ground.

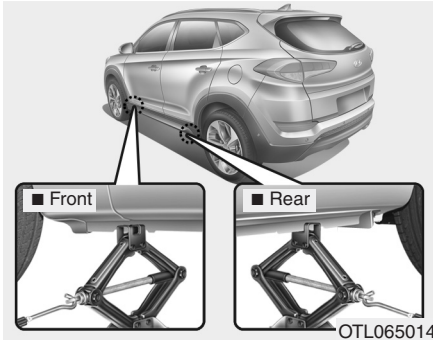

7. Place the jack at the designated jacking position under the frame closest to the tire you are changing. The jacking positions are plates welded to the frame with two notches and two dimples. Never jack any other position or part of the vehicle. Doing so may damage the side seal molding or other parts of the vehicle.

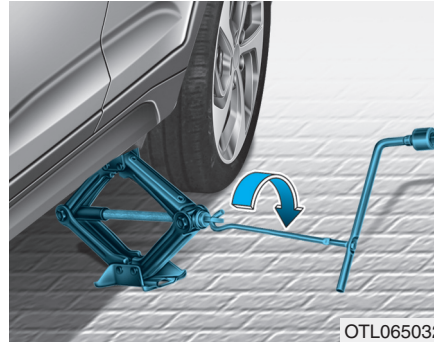

8. Insert the jack handle into the jack and turn it clockwise, raising the vehicle until the tire clears the ground. Make sure the vehicle is stable on the jack.

9. Loosen the lug nuts with the wheel lug nut wrench and remove them with your fingers. Remove the wheel from the studs and lay it flat on the ground out of the way. Remove any dirt or debris from the studs, mounting surfaces, and wheel.
10. Install the spare tire onto the studs of the hub.
11. Tighten the lug nuts with your fingers onto the studs with the smaller end of the lug nuts closest to the wheel.
12. Lower the vehicle to the ground by turning the jack handle counterclockwise.

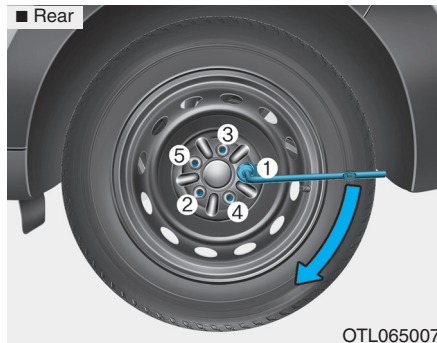

13. Use the wheel lug nut wrench to tighten the lug nuts in the order shown. Double-check each lug nut until they are tight. After changing tires, have an authorized HYUNDAI dealer tighten the lug nuts to their proper torque as soon as possible. **The wheel lug nut should be tightened to 79-94 lbf·ft (11~13 kgf·m).**

If you have a tire gauge, check the tire pressure (see “Tires and Wheels” in chapter 8 for tire pressure instructions.). If the pressure is lower or higher than recommended, drive slowly to the nearest service station and adjust it to the recommended pressure. Always reinstall the valve cap after checking or adjusting tire pressure. If the cap is not replaced, air may leak from the tire. If you lose a valve cap, buy another and install it as soon as possible. After changing tires, secure the flat tire and return the jack and tools to their proper storage locations.

### NOTICE

**Check the tire pressure as soon as possible after installing a spare tire. Adjust it to the recommended pressure.**

### CAUTION

**Your vehicle has metric threads on the studs and lug nuts. Make certain during tire changing that the same nuts that were removed are reinstalled. If you have to replace your lug nuts make sure they have metric threads to avoid damaging the studs and ensure the wheel is properly secured to the hub. Consult an authorized HYUNDAI dealer for assistance.**

If any of the equipment such as the jack, lug nuts, studs, or other equipment is damaged or in poor condition, do not attempt to change the tire and call for assistance.



### Use of compact spare tires

Compact spare tires are designed for emergency use only. Drive carefully on the compact spare tire and always follow the safety precautions.

#### WARNING

**To prevent compact spare tire failure and loss of control possibly resulting in an accident:**

- Use the compact spare tire only in an emergency.
- NEVER operate your vehicle over 50 mph (80 km/h).
- Do not exceed the vehicle's maximum load rating or the load carrying capacity shown on the sidewall of the compact spare tire.
- Do not use the compact spare tire continuously. Repair or replace the original tire as soon as possible to avoid failure of the compact spare tire.

When driving with the compact spare tire mounted to your vehicle:

- Check the tire pressure after installing the compact spare tire. The compact spare tire should be inflated to 60 psi (420 kPa).
- Do not take this vehicle through an automatic car wash while the compact spare tire is installed.
- Do not use the compact spare tire on any other vehicle because this tire has been designed especially for your vehicle.
- The compact spare tire's tread life is shorter than a regular tire. Inspect your compact spare tire regularly and replace worn compact spare tires with the same size and design, mounted on the same wheel.
- Do not use more than one compact spare tire at a time.

#### NOTICE

**When the original tire and wheel are repaired and reinstalled on the vehicle, the lug nut torque must be set correctly. The correct lug nut tightening torque is 79-94 lbf-ft (11~13 kgf·m).**

**CAUTION**

To prevent damaging the compact spare tire and your vehicle:

- Drive slowly enough for the road conditions to avoid all hazards, such as a potholes or debris.
- Avoid driving over obstacles. The compact spare tire diameter is smaller than the diameter of a conventional tire and reduces the ground clearance approximately 1 inch (25 mm).
- Do not use tire chains on the compact spare tire. Because of the smaller size, a tire chain will not fit properly.
- Do not use the compact spare tire on any other wheels, nor should standard tires, snow tires, wheel covers or trim rings be used with the compact spare wheel.

**Jack label**

■ Example

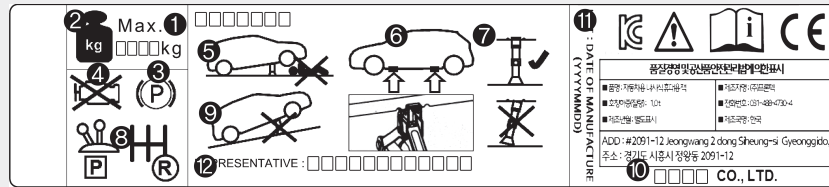

OHYK065011

The actual Jack label in the vehicle may differ from the illustration.

**For more detailed specifications, refer to the label attached to the jack.**

- |  |  |
|--|--|
| <ol style="list-style-type: none"> <li>1. Model Name</li> <li>2. Maximum allowable load</li> <li>3. When using the jack, set your parking brake.</li> <li>4. When using the jack, stop the engine.</li> <li>5. Do not get under a vehicle that is supported by a jack.</li> <li>6. The designated locations under the frame</li> <li>7. When supporting the vehicle, the base plate of jack must be vertical under the lifting point.</li> </ol> | <ol style="list-style-type: none"> <li>8. Shift into Reverse gear on vehicles with manual transmission or move the shift lever to the P (Park) position on vehicles with automatic transmission.</li> <li>9. The jack should be used on firm level ground.</li> <li>10. Jack manufacture</li> <li>11. Production date</li> <li>12. Representative company and address</li> </ol> |
|--|--|

## TOWING

### Towing service

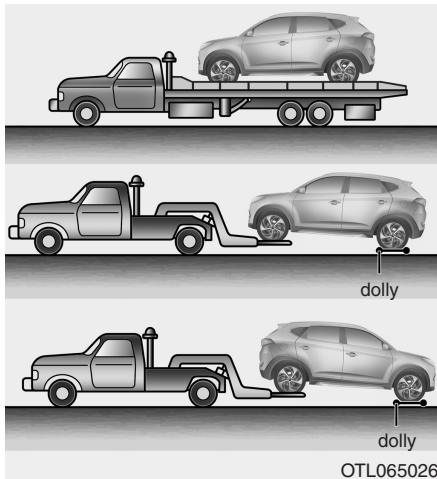

If emergency towing is necessary, we recommend having it done by an authorized HYUNDAI dealer or a commercial tow-truck service. Proper lifting and towing procedures are necessary to prevent damage to the vehicle. The use of wheel dollies or flatbed is recommended.

It is acceptable to tow the vehicle with the rear wheels on the ground (without dollies) and the front wheels off the ground. If any of the loaded wheels or suspension components are damaged or the vehicle is being towed with the front wheels on the ground, use a towing dolly under the front wheels.

When being towed by a commercial tow truck and wheel dollies are not used, the front of the vehicle should always be lifted, not the rear.

If your vehicle is an AWD vehicle, it must be towed with a wheel lift and dollies or flatbed equipment with all the wheels off the ground.

#### CAUTION

**An AWD vehicle should never be towed with the wheels on the ground. This can cause serious damage to the transaxle or the AWD system.**

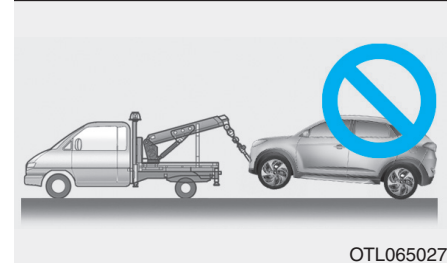
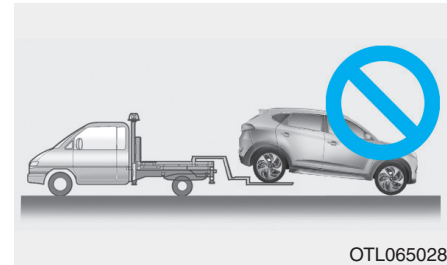

#### CAUTION

- Do not tow the vehicle with the front wheels on the ground as this may cause damage to the vehicle.
- Do not tow with sling-type equipment. Use a wheel lift or flatbed equipment.

### WARNING

If your vehicle is equipped with a rollover sensor, place the ignition switch in the LOCK/OFF or ACC position when the vehicle is being towed. The side impact and curtain air bag may deploy if the sensor detects the situation as a rollover.

When towing your vehicle in an emergency without wheel dollies:

1. Place the ignition switch in the ACC position.
2. Place the shift lever in N (Neutral).
3. Release the parking brake.

### CAUTION

Failure to place the shift lever in N (Neutral) when being towed with the front wheels on the ground can cause internal damage to the transaxle.

## Removable towing hook

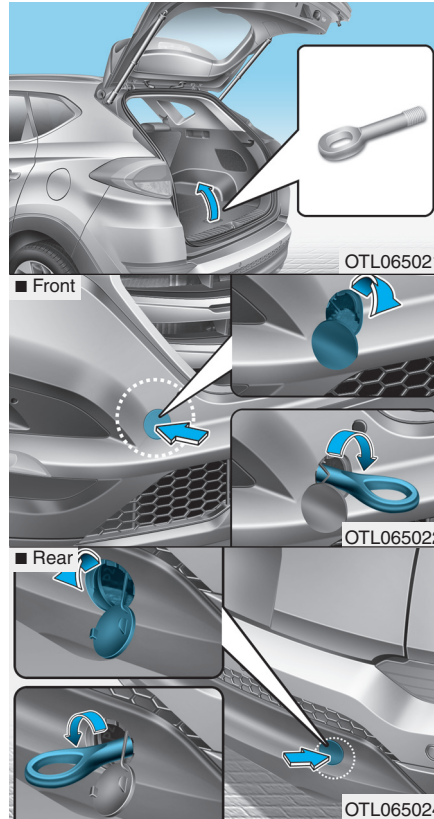

1. Open the tailgate, and remove the towing hook from the tool case.
2. Remove the hole cover pressing the lower part of the cover on the front or rear bumper.
3. Install the towing hook by turning it clockwise into the hole until it is fully secured.
4. Remove the towing hook and install the cover after use.

## Emergency towing

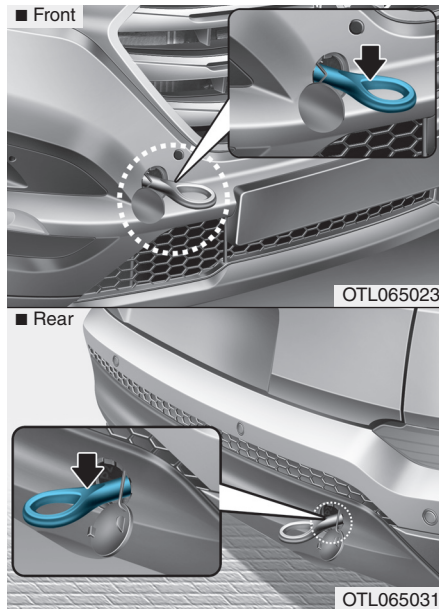

If towing is necessary, we recommend you have it done by an authorized HYUNDAI dealer or a commercial tow truck service.

If towing service is not available in an emergency, your vehicle may be temporarily towed using a cable or chain secured to the emergency towing hook at the front (or rear) of the vehicle.

Use extreme caution when towing the vehicle with a cable or chain. A driver must be in the vehicle to steer it and operate the brakes.

Towing in this manner may be done only on hard-surfaced roads for a short distance and at low speeds. Also, the wheels, axles, power train, steering and brakes must all be in good condition.

Always follow these emergency towing precautions:

- Place the ignition switch in the ACC position so the steering wheel is not locked. (if equipped)
- Place the shift lever in N (Neutral).
- Release the parking brake.
- Depress the brake pedal with more force than normal since you will have reduced braking performance.
- More steering effort will be required because the power steering system will be disabled.
- Use a vehicle heavier than your own to tow your vehicle.
- The drivers of both vehicles should communicate with each other frequently.
- Before emergency towing, check that the hook is not broken or damaged.
- Fasten the towing cable or chain securely to the hook.
- Do not jerk the hook. Apply steady and even force.

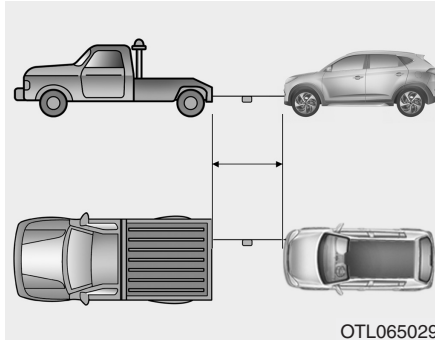

- Use a towing cable or chain less than 16 feet (5 m) long. Attach a white or red cloth (about 12 inch (30 cm) wide) in the middle of the cable or chain for easy visibility.
- Drive carefully so the towing cable or chain remains tight during towing.
- Before towing, check the automatic transaxle for fluid leaks under your vehicle. If the automatic transaxle fluid is leaking, flatbed equipment or a towing dolly must be used.

### CAUTION

To avoid damage to your vehicle and vehicle components when towing:

- Always pull straight ahead when using the towing hooks. Do not pull from the side or at a vertical angle.
- Do not use the towing hooks to pull a vehicle out of mud, sand or other conditions from which the vehicle cannot be driven out under its own power.
- Limit the vehicle speed to 10 mph (15 km/h) and drive less than 1 mile (1.5 km) when towing to avoid serious damage to the automatic transaxle.

### Tie-down hook

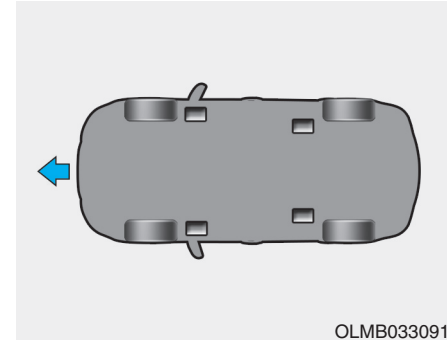

### WARNING

Do not use the tie-down hook(s) for towing purposes. If the tie-down hook(s) are used for towing, the tie-down hook(s) or bumper will be damaged and this could lead to serious injury.

# Maintenance

Engine compartment .....	7-3	Wiper blades .....	7-34
Maintenance services .....	7-5	Blade Inspection .....	7-34
Owner's Responsibility .....	7-5	Blade Replacement .....	7-34
Owner Maintenance Precautions.....	7-5	Battery.....	7-37
Owner maintenance.....	7-6	For Best Battery Service .....	7-38
Owner Maintenance Schedule.....	7-7	Battery Recharging .....	7-38
Scheduled maintenance services.....	7-8	Reset features .....	7-39
Explanation of scheduled maintenance items..	7-19	Tires and wheels .....	7-40
Engine oil .....	7-22	Tire Care.....	7-40
Checking the Engine Oil Level.....	7-22	Recommended Cold Tire Inflation Pressures.....	7-41
Checking the Engine Oil and Filter .....	7-23	Check Tire Inflation Pressure .....	7-42
Engine coolant.....	7-24	Tire Rotation.....	7-42
Checking the Engine Coolant Level.....	7-24	Wheel Alignment and Tire Balance .....	7-43
Changing Engine Coolant.....	7-27	Tire Replacement .....	7-44
Brake fluid .....	7-28	Wheel Replacement .....	7-45
Checking the Brake Fluid Level.....	7-28	Tire Traction .....	7-45
Washer fluid .....	7-29	Tire Maintenance.....	7-45
Checking the Washer Fluid Level.....	7-29	Tire Sidewall Labeling .....	7-45
Parking brake .....	7-29	Tire Terminology and Definitions.....	7-49
Checking the Parking Brake.....	7-29	All Season Tires.....	7-52
Air cleaner .....	7-30	Summer Tires .....	7-52
Filter Replacement.....	7-30	Snow Tires .....	7-53
Climate control air filter .....	7-32	Radial-Ply Tires .....	7-53
Filter Inspection.....	7-32	Low Aspect Ratio Tires.....	7-54

<b>Fuses</b> .....	7-55
Instrument Panel Fuse Replacement.....	7-56
Engine Compartment Panel Fuse Replacement.....	7-57
Fuse/Relay Panel Description.....	7-60
<b>Light bulbs</b> .....	7-68
Headlamp, Parking lamp, Turn signal lamp, side marker and front fog lamp bulb replacement.....	7-69
Side repeater lamp replacement .....	7-79
Rear combination light bulb replacement .....	7-79
High mounted stop lamp replacement.....	7-82
License plate light bulb replacement .....	7-82
Interior light bulb replacement.....	7-83
<b>Appearance care</b> .....	7-85
Exterior Care .....	7-85
Interior Care .....	7-90
<b>Emission control system</b> .....	7-92
Crankcase Emission Control System .....	7-93
Evaporative Emission Control System Including Onboard Refueling Vapor Recovery (ORVR).....	7-93
Exhaust Emission Control System .....	7-94
<b>California perchlorate notice</b> .....	7-96



## ENGINE COMPARTMENT

### ■ Gamma 1.6 Turbo-GDI

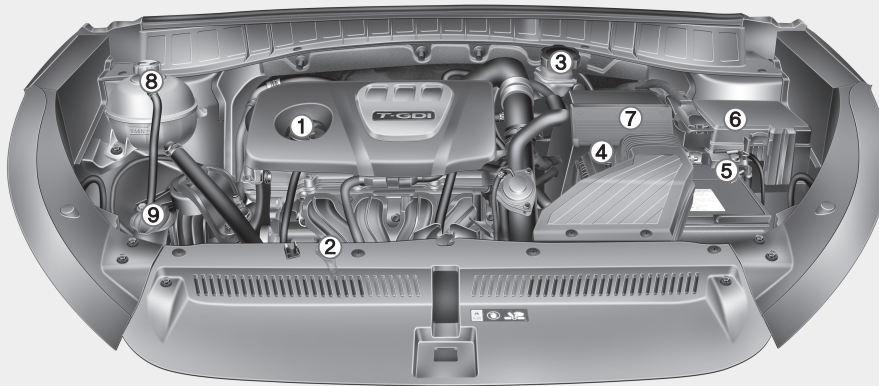

1. Engine oil filler cap
2. Engine oil dipstick
3. Brake fluid reservoir
4. Positive battery terminal
5. Negative battery terminal
6. Fuse box
7. Air cleaner
8. Engine coolant reservoir
9. Windshield washer fluid reservoir

**The actual engine compartment in the vehicle may differ from the illustration.**

### ■ Nu 2.0 GDI

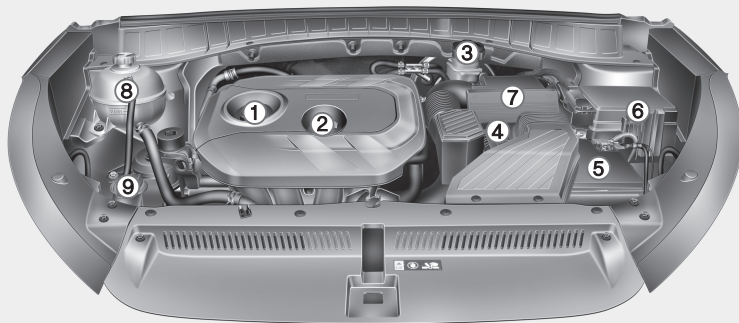

1. Engine oil filler cap
2. Engine oil dipstick
3. Brake fluid reservoir
4. Positive battery terminal
5. Negative battery terminal
6. Fuse box
7. Air cleaner
8. Engine coolant reservoir
9. Windshield washer fluid reservoir

### ■ Theta II 2.4 GDI

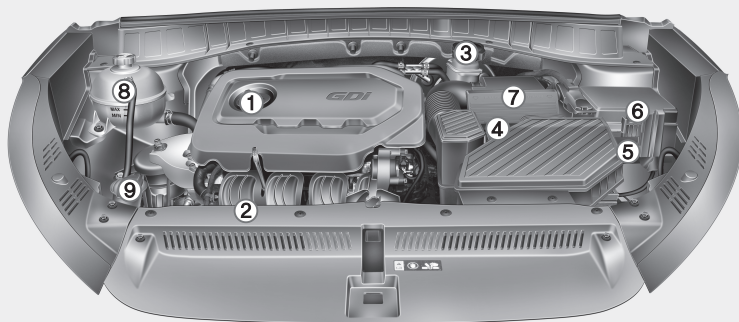

The actual engine compartment in the vehicle may differ from the illustration.

OTLA075001/OTLE075104

## MAINTENANCE SERVICES

You should exercise the utmost care to prevent damage to your vehicle and injury to yourself whenever performing any maintenance or inspection procedures.

We recommend you have your vehicle maintained and repaired by an authorized HYUNDAI dealer. An authorized HYUNDAI dealer meets HYUNDAI's high service quality standards and receives technical support from HYUNDAI in order to provide you with a high level of service satisfaction.

### Owner's Responsibility

Maintenance service and record retention are the owner's responsibility.

You should retain documents that show proper maintenance has been performed on your vehicle in accordance with the scheduled maintenance service charts shown on the following pages. You need this information to establish your compliance with the servicing and maintenance requirements of your vehicle warranties.

Detailed warranty information is provided in your Owner's Handbook & Warranty Information booklet.

Repairs and adjustments required as a result of improper maintenance or a lack of required maintenance are not covered.

### Owner Maintenance Precautions

Inadequate, incomplete or insufficient servicing may result in operational problems with your vehicle that could lead to vehicle damage, an accident, or personal injury. This chapter provides instructions only for the maintenance items that are easy to perform. Several procedures can be done only by an authorized HYUNDAI dealer with special tools.

Your vehicle should not be modified in any way. Such modifications may adversely affect the performance, safety or durability of your vehicle and may, in addition, violate conditions of the limited warranties covering the vehicle.

Certain modifications may also be in violation of regulations established by the U.S. Department of Transportation and other federal or state agencies.

#### NOTICE

**Improper owner maintenance during the warranty period may affect warranty coverage. For details, read the separate Owner's Handbook & Warranty Information booklet provided with the vehicle. If you're unsure about any service or maintenance procedure, have it done by an authorized HYUNDAI dealer.**

## OWNER MAINTENANCE

### WARNING

Performing maintenance work on a vehicle can be dangerous. If you lack sufficient knowledge and experience or the proper tools and equipment to do the work, have it done by an authorized HYUNDAI dealer. ALWAYS follow these precautions for performing maintenance work:

- Park your vehicle on level ground, move the shift lever into the P (Park, for automatic transmission vehicle) position, apply the parking brake, place the ignition switch in the LOCK/OFF position.
- Block the tires (front and back) to prevent the vehicle from moving.

Remove loose clothing or jewelry that can become entangled in moving parts.

(Continued)

(Continued)

- If you must run the engine during maintenance, do so out doors or in an area with plenty of ventilation.
- Keep flames, sparks, or smoking materials away from the battery and fuel-related parts.

The following lists are vehicle checks and inspections that should be performed by the owner or an authorized HYUNDAI dealer at the frequencies indicated to help ensure safe, dependable operation of your vehicle.

Any adverse conditions should be brought to the attention of your dealer as soon as possible.

These Owner Maintenance vehicle checks are generally not covered by warranties and you may be charged for labor, parts and lubricants used.

## Owner Maintenance Schedule

### ***When you stop for fuel:***

- Check the engine oil level.
- Check coolant level in the engine coolant reservoir.
- Check the windshield washer fluid level.
- Check for low or under-inflated tires.

### **WARNING**

**Be careful when checking your engine coolant level when the engine is hot. This may result in coolant being blown out of the opening and cause serious burns and other injuries.**

### ***While operating your vehicle:***

- Note any changes in the sound of the exhaust or any smell of exhaust fumes in the vehicle.
- Check for vibrations in the steering wheel. Notice if there is any increased steering effort or looseness in the steering wheel, or change in its straight-ahead position.
- Notice if your vehicle constantly turns slightly or “pulls” to one side when traveling on smooth, level road.
- When stopping, listen and check for unusual sounds, pulling to one side, increased brake pedal travel or “hard-to-push” brake pedal.
- If any slipping or changes in the operation of your transmission occurs, check the transmission fluid level.
- Check the automatic transmission/ecoshift dual clutch transmission P (Park) function.

- Check the parking brake.
- Check for fluid leaks under your vehicle (water dripping from the air conditioning system during or after use is normal).

### ***At least monthly:***

- Check coolant level in the engine coolant reservoir.
- Check the operation of all exterior lights, including the stoplights, turn signals and hazard warning flashers.
- Check the inflation pressures of all tires including the spare for tires that are worn, show uneven wear, or are damaged.
- Check for loose wheel lug nuts.

### ***At least twice a year: (i.e., every Spring and Fall)***

- Check radiator, heater and air conditioning hoses for leaks or damage.
- Check windshield washer spray and wiper operation. Clean wiper blades with clean cloth dampened with washer fluid.
- Check headlamp alignment.
- Check muffler, exhaust pipes, shields and clamps.
- Check the seat belts for wear and function.

### ***At least once a year:***

- Clean body and door drain holes.
- Lubricate door hinges and hood hinges.
- Lubricate door and hood locks and latches.
- Lubricate door rubber weather strips.
- Check the air conditioning system.
- Inspect and lubricate automatic transmission linkage and controls.
- Clean the battery and terminals.
- Check the brake fluid level.

## **SCHEDULED MAINTENANCE SERVICES**

Follow Normal Maintenance Schedule if the vehicle is usually operated where none of the following conditions apply. If any of the following conditions apply, you must follow the Maintenance Under Severe Usage Conditions.

- Repeated short distance driving.
- Driving in dusty conditions or sandy areas.
- Extensive use of brakes.
- Driving in areas where salt or other corrosive materials are used.
- Driving on rough or muddy roads.
- Driving in mountainous areas.
- Extended periods of idling or low speed operation.
- Driving for a prolonged period in cold temperatures and/or extremely humid climates.
- More than 50% driving in heavy city traffic during hot weather above 90°F (32°C).

For additional information or assistance see your authorized HYUNDAI dealer.

### Normal Maintenance Schedule (Nu 2.0 GDI, Theta 2.4 GDI)

MAINTENANCE ITEM	MAINTENANCE INTERVALS		12	24	36	48	60	72	84	96	108	120	132	144	156	168	180	
	Months	Miles×1,000	7.5	15	22.5	30	37.5	45	52.5	60	67.5	75	82.5	90	97.5	105	112.5	
	Km×1,000		12	24	36	48	60	72	84	96	108	120	132	144	156	168	180	
Drive belts *1	At first, inspect at 60,000 miles or 72 months. Thereafter, inspect every 15,000 miles or 24 months																	
Engine oil and engine oil filter	R	R	R	R	R	R	R	R	R	R	R	R	R	R	R	R	R	
Fuel additives *2	Add fuel additives every 7,500 miles or 12 months																	
Air cleaner filter	I	I	R	I	I	R	I	I	R	I	I	R	I	I	R	I	I	R
Spark plugs	Replace every 97,500 miles																	
Rotate tires	Rotate tires every 7,500 miles																	
Climate control air filter (for evaporator and blower unit)	R	R	R	R	R	R	R	R	R	R	R	R	R	R	R	R	R	
Vacuum hose	I	I	I	I	I	I	I	I	I	I	I	I	I	I	I	I	I	

I : Inspect and if necessary, adjust, correct, clean or replace.

R : Replace or change.

\*1 : The drive belt should be replaced when cracks occur or tension is reduced excessively.

\*2 : If TOP TIER Detergent Gasoline is not available, one bottle of additive is recommended. Additives are available from your authorized HYUNDAI dealer along with information on how to use them. Do not mix other additives.

## Maintenance

### Normal Maintenance Schedule (Nu 2.0 GDI, Theta 2.4 GDI) (CONT)

MAINTENANCE ITEM	MAINTENANCE INTERVALS		12	24	36	48	60	72	84	96	108	120	132	144	156	168	180
	Months	Miles×1,000	7.5	15	22.5	30	37.5	45	52.5	60	67.5	75	82.5	90	97.5	105	112.5
	Km×1,000		12	24	36	48	60	72	84	96	108	120	132	144	156	168	180
Engine coolant	At first, replace at 120,000 miles or 10 years : Thereafter, replace every 30,000 miles or 24 months																
Battery condition	I	I	I	I	I	I	I	I	I	I	I	I	I	I	I	I	I
Brake lines, hoses and connections	I	I	I	I	I	I	I	I	I	I	I	I	I	I	I	I	I
Front brake disc/pads, calipers	I	I	I	I	I	I	I	I	I	I	I	I	I	I	I	I	I
Rear brake disc/pads	I	I	I	I	I	I	I	I	I	I	I	I	I	I	I	I	I
Steering gear box, linkage and boots/ lower arm ball joint, upper arm ball joint	I	I	I	I	I	I	I	I	I	I	I	I	I	I	I	I	I
Driveshaft and boots	I	I	I	I	I	I	I	I	I	I	I	I	I	I	I	I	I
Suspension mounting bolts	I	I	I	I	I	I	I	I	I	I	I	I	I	I	I	I	I
Air conditioner refrigerant	I	I	I	I	I	I	I	I	I	I	I	I	I	I	I	I	I
Air conditioner compressor	I	I	I	I	I	I	I	I	I	I	I	I	I	I	I	I	I
Propeller shaft (AWD)	I	I	I	I	I	I	I	I	I	I	I	I	I	I	I	I	I
Exhaust pipe and muffler	I	I	I	I	I	I	I	I	I	I	I	I	I	I	I	I	I

I : Inspect and if necessary, adjust, correct, clean or replace.

R : Replace or change.



## Normal Maintenance Schedule (Nu 2.0 GDI, Theta 2.4 GDI) (CONT)

MAINTENANCE ITEM	MAINTENANCE INTERVALS		12	24	36	48	60	72	84	96	108	120	132	144	156	168	180
	Months	Miles×1,000	7.5	15	22.5	30	37.5	45	52.5	60	67.5	75	82.5	90	97.5	105	112.5
	Km×1,000	12	24	36	48	60	72	84	96	108	120	132	144	156	168	180	
Automatic transmission fluid	No check, No service required																
Rear axle oil (AWD) * <sup>3</sup>																	
Transfer case oil (AWD) * <sup>3</sup>																	
Vapor hose, fuel filler cap and fuel tank																	
Fuel tank air filter * <sup>4</sup>																	
Fuel filter * <sup>4</sup>																	
Fuel lines, hoses and connections																	
Parking brake																	
Brake fluid																	

I : Inspect and if necessary, adjust, correct, clean or replace.

R : Replace or change.

\*<sup>3</sup> : Transfer case oil and rear axle oil should be changed anytime they have been submerged in water.

\*<sup>4</sup> : Fuel filter & Fuel tank air filter are considered to be maintenance free but periodic inspection is recommended for this maintenance schedule depends on fuel quality. If there are some important safety matters like fuel flow restriction, surging, loss of power, hard starting problem, etc. replace the fuel filter immediately regardless of maintenance schedule and consult an authorized HYUNDAI dealer for details.

### Maintenance Under Severe Usage Conditions (Nu 2.0 GDI, Theta 2.4 GDI)

The following items must be serviced more frequently on cars normally used under severe driving conditions. Refer to the chart below for the appropriate maintenance intervals.

I : Inspect and if necessary, adjust, correct, clean or replace.

R : Replace or change.

Maintenance item	Maintenance operation	Maintenance intervals	Driving condition
Engine oil and filter	R	Every 3,750 miles or 6 months	A, B, C, D, E, F, G, H, I, J, K
Air cleaner filter	R	More frequently	C, E
Spark plugs	R	More frequently	A, B, H, I, K
Automatic transmission fluid	R	Every 60,000 miles	A, C, D, E, F, G, I
Front brake disc/pads, calipers	I	More frequently	C, D, G, H
Rear brake disc/pads	I	More frequently	C, D, G, H
Parking brake	I	More frequently	C, D, G, H

Maintenance item	Maintenance operation	Maintenance intervals	Driving condition
Steering gear box, linkage & boots/ lower arm ball joint, upper arm ball joint	I	More frequently	C, D, E, F, G, H, I
Drive shafts and boots	I	Every 3,750 miles or 6 months	C, D, E, F, G, H, I, J
Climate control air filter (for evaporator and blower unit)	R	More frequently	C, E
Propeller shaft (AWD)	I	Every 7,500 miles or 6 months	C, E
Rear axle oil (AWD)	R	Every 75,000 miles	C, D, E, G, H, I, J
Transfer case oil (AWD)	R	Every 75,000 miles	C, D, E, G, H, I, J

### Severe Driving Conditions

- A - Repeatedly driving short distances of less than 5 miles (8 km) in normal temperature or less than 10 miles (16 km) in freezing temperature
- B - Extensive engine idling or low speed driving for long distances
- C - Driving on rough, dusty, muddy, unpaved, graveled or salt-spread roads
- D - Driving in areas using salt or other corrosive materials or in very cold weather

- E - Driving in sandy areas
- F - Driving in heavy traffic area over 90°F (32°C)
- G - Driving on uphill, downhill, or mountain road
- H - Towing a Trailer, or using a camper, or roof rack
- I - Driving as a patrol car, taxi, other commercial use or vehicle towing
- J - Driving over 106 mph (170 km/h)
- K - Frequently driving in stop-and-go conditions

## Maintenance

### Normal Maintenance Schedule (Gamma 1.6 Turbo-GDI)

MAINTENANCE ITEM	MAINTENANCE INTERVALS		12	24	36	48	60	72	84	96	108	120	132	144	156	168	180	
	Months	Miles×1,000	6	12	18	24	30	36	42	48	54	60	66	72	78	84	90	
	Km×1,000		10	20	30	40	50	60	70	80	90	100	110	120	130	140	150	
Drive belts *1	At first, inspect at 60,000 miles or 72 months. Thereafter, inspect every 12,000 miles or 24 months																	
Engine oil and engine oil filter	R	R	R	R	R	R	R	R	R	R	R	R	R	R	R	R	R	
Intercooler, in/out hose, air intake hose	I	I	I	I	I	I	I	I	I	I	I	I	I	I	I	I	I	
Fuel additives *2	Add fuel additives every 6,000 miles or 12 months																	
Air cleaner filter	I	I	R	I	I	R	I	I	R	I	I	R	I	I	R	I	I	R
Spark plugs	Replace every 42,000 miles																	
Valve clearance *3	Inspect every 60,000 miles or 72 months																	
Rotate tires	Rotate tires every 6,000 miles																	
Climate control air filter (for evaporator and blower unit)	R	R	R	R	R	R	R	R	R	R	R	R	R	R	R	R	R	
Vacuum hose	I	I	I	I	I	I	I	I	I	I	I	I	I	I	I	I	I	

I : Inspect and if necessary, adjust, correct, clean or replace.

R : Replace or change.

\*1 : The drive belt should be replaced when cracks occur or tension is reduced excessively.

\*2 : If TOP TIER Detergent Gasoline is not available, one bottle of additive is recommended. Additives are available from your authorized HYUNDAI dealer along with information on how to use them. Do not mix other additives.

\*3 : Inspect for excessive valve noise and/or engine vibration and adjust if necessary. Have an authorized HYUNDAI dealer perform the operation.

## Normal Maintenance Schedule (Gamma 1.6 Turbo-GDI) (CONT)

MAINTENANCE ITEM	MAINTENANCE INTERVALS	Months	12	24	36	48	60	72	84	96	108	120	132	144	156	168	180
	Miles×1,000	6	12	18	24	30	36	42	48	54	60	66	72	78	84	90	
	Km×1,000	10	20	30	40	50	60	70	80	90	100	110	120	130	140	150	
Engine coolant	At first, replace at 120,000 miles or 10 years : Thereafter, replace every 30,000 miles or 24 months																
Battery condition	I	I	I	I	I	I	I	I	I	I	I	I	I	I	I	I	I
Brake lines, hoses and connections	I	I	I	I	I	I	I	I	I	I	I	I	I	I	I	I	I
Front brake disc/pads, calipers	I	I	I	I	I	I	I	I	I	I	I	I	I	I	I	I	I
Rear brake disc/pads	I	I	I	I	I	I	I	I	I	I	I	I	I	I	I	I	I
Steering gear box, linkage and boots/ lower arm ball joint, upper arm ball joint	I	I	I	I	I	I	I	I	I	I	I	I	I	I	I	I	I
Driveshaft and boots	I	I	I	I	I	I	I	I	I	I	I	I	I	I	I	I	I
Suspension mounting bolts	I	I	I	I	I	I	I	I	I	I	I	I	I	I	I	I	I
Air conditioner refrigerant	I	I	I	I	I	I	I	I	I	I	I	I	I	I	I	I	I
Air conditioner compressor	I	I	I	I	I	I	I	I	I	I	I	I	I	I	I	I	I
Propeller shaft (AWD)	I	I	I	I	I	I	I	I	I	I	I	I	I	I	I	I	I
Exhaust pipe and muffler	I	I	I	I	I	I	I	I	I	I	I	I	I	I	I	I	I

I : Inspect and if necessary, adjust, correct, clean or replace.

R : Replace or change.

### Normal Maintenance Schedule (Gamma 1.6 Turbo-GDI) (CONT)

MAINTENANCE ITEM	MAINTENANCE INTERVALS		12	24	36	48	60	72	84	96	108	120	132	144	156	168	180
	Months	Miles×1,000															
	Km×1,000																
Ecoshift dual clutch transmission fluid						I				I				I			
Rear axle oil (AWD) *4						I				I				I			
Transfer case oil (AWD) *4						I				I				I			
Vapor hose, fuel filler cap and fuel tank			I			I		I		I		I		I		I	
Fuel tank air filter *5			I			I		I		I		I		I		I	
Fuel filter *5			I			I		I		I		I		I		I	
Fuel lines, hoses and connections						I				I				I			
Parking brake			I			I		I		I		I		I		I	
Brake fluid			I			I		I		I		I		I		I	

I : Inspect and if necessary, adjust, correct, clean or replace.

R : Replace or change.

\*4 : Transfer case oil and rear axle oil should be changed anytime they have been submerged in water.

\*5 : Fuel filter & Fuel tank air filter are considered to be maintenance free but periodic inspection is recommended for this maintenance schedule depends on fuel quality. If there are some important safety matters like fuel flow restriction, surging, loss of power, hard starting problem, etc. replace the fuel filter immediately regardless of maintenance schedule and consult an authorized HYUNDAI dealer for details.

### Maintenance Under Severe Usage Conditions (Gamma 1.6 Turbo-GDI)

The following items must be serviced more frequently on cars normally used under severe driving conditions. Refer to the chart below for the appropriate maintenance intervals.

I : Inspect and if necessary, adjust, correct, clean or replace.

R : Replace or change.

Maintenance item	Maintenance operation	Maintenance intervals	Driving condition
Engine oil and filter	R	Every 3,000 miles or 6 months	A, B, C, D, E, F, G, H, I, J, K
Air cleaner filter	R	More frequently	C, E
Spark plugs	R	More frequently	A, B, H, I, K
Ecoshift dual clutch transmission fluid	R	Every 72,000 miles	C, D, E, F, G, H, I, J
Front brake disc/pads, calipers	I	More frequently	C, D, G, H
Rear brake disc/pads	I	More frequently	C, D, G, H
Parking brake	I	More frequently	C, D, G, H

## Maintenance

Maintenance item	Maintenance operation	Maintenance intervals	Driving condition
Steering gear box, linkage & boots/ lower arm ball joint, upper arm ball joint	I	More frequently	C, D, E, F, G, H, I
Drive shafts and boots	I	Every 3,000 miles or 6 months	C, D, E, F, G, H, I, J
Climate control air filter (for evaporator and blower unit)	R	More frequently	C, E
Propeller shaft (AWD)	I	Every 3,000 miles or 6 months	C, E
Rear axle oil (AWD)	R	Every 72,000 miles	C, D, E, G, H, I, J
Transfer case oil (AWD)	R	Every 72,000 miles	C, D, E, G, H, I, J

### Severe Driving Conditions

- A - Repeatedly driving short distances of less than 5 miles (8 km) in normal temperature or less than 10 miles (16 km) in freezing temperature
- B - Extensive engine idling or low speed driving for long distances
- C - Driving on rough, dusty, muddy, unpaved, graveled or salt-spread roads
- D - Driving in areas using salt or other corrosive materials or in very cold weather

- E - Driving in sandy areas
- F - Driving in heavy traffic area over 90°F (32°C)
- G - Driving on uphill, downhill, or mountain road
- H - Towing a Trailer, or using a camper, or roof rack
- I - Driving as a patrol car, taxi, other commercial use or vehicle towing
- J - Driving over 106 mph (170 km/h)
- K - Frequently driving in stop-and-go conditions



## EXPLANATION OF SCHEDULED MAINTENANCE ITEMS

### Engine Oil and Filter

The engine oil and filter should be changed at the intervals specified in the maintenance schedule. If the car is being driven in severe conditions, more frequent oil and filter changes are required.

### Drive Belts

Inspect all drive belts for evidence of cuts, cracks, excessive wear or oil saturation and replace if necessary. Drive belts should be checked periodically for proper tension and adjusted as necessary.

### Fuel Filter

A clogged-up fuel filter may limit the vehicle driving speed, damage the emission system, and cause the hard starting. When a considerable amount of foreign substances are accumulated in the fuel tank, the fuel filter should be replaced.

Upon installing a new fuel filter, operate the diesel engine for several minutes, and check the connections for any leakages. Fuel filters should be installed by an authorized HYUNDAI dealer.

### Fuel Lines, Fuel Hoses and Connections

Check the fuel lines, fuel hoses and connections for leakage and damage. Have an authorized HYUNDAI dealer replace any damaged or leaking parts immediately.

### Vapor Hose and Fuel Filler Cap

The vapor hose and fuel filler cap should be inspected at those intervals specified in the maintenance schedule. Make sure a new vapor hose or fuel filler cap is correctly replaced.

### Vacuum crankcase ventilation hoses (if equipped)

Inspect the surface of hoses for evidence of heat and/or mechanical damage. Hard and brittle rubber, cracking, tears, cuts, abrasions, and excessive swelling indicate deterioration. Particular attention should be paid to examine those hose surfaces nearest to high heat sources, such as the exhaust manifold.

Inspect the hose routing to assure that the hoses do not come in contact with any heat source, sharp edges or moving component which might cause heat damage or mechanical wear. Inspect all hose connections, such as clamps and couplings, to make sure they are secure, and that no leaks are present. Hoses should be replaced immediately if there is any evidence of deterioration or damage.

### Air Cleaner Filter

A genuine HYUNDAI air cleaner filter is recommended when the filter is replaced.

### Spark Plugs

Make sure to install new spark plugs of the correct heat range.

### Valve Clearance (if equipped)

Inspect for excessive valve noise and/or engine vibration and adjust if necessary. Have an authorized HYUNDAI dealer perform the operation.

### Cooling System

Check cooling system components, such as radiator, coolant reservoir, hoses and connections for leakage and damage. Replace any damaged parts.

### Engine Coolant

The coolant should be changed at the intervals specified in the maintenance schedule.

### Automatic Transmission Fluid (if equipped)

Automatic transmission fluid should not be checked under normal usage conditions. But in severe conditions, the fluid should be changed at an authorized HYUNDAI dealer in accordance to the scheduled maintenance at the beginning of this chapter.

#### **NOTICE**

**Automatic transmission fluid color is basically red.**

**As the vehicle is driven, the automatic transmission fluid will begin to look darker. This is a normal condition and you should not judge the need to replace the fluid based upon the changed color.**

#### **CAUTION**

**The use of a non-specified fluid could result in transmission malfunction and failure. Use only the specified automatic transmission fluid (refer to "Recommended Lubricants and Capacities" in chapter 8).**

### Ecoshift dual clutch transmission Fluid (if equipped)

Inspect the Ecoshift dual clutch transmission fluid according to the maintenance schedule.

### Brake Hoses and Lines

Visually check for proper installation, chafing, cracks, deterioration and any leakage. Replace any deteriorated or damaged parts immediately.

### Brake Fluid

Check brake fluid level in the brake fluid reservoir. The level should be between the MIN and the MAX marks on the side of the reservoir. Use only hydraulic brake fluid conforming to DOT 3 or DOT 4 specification.

### **Parking Brake**

Inspect the parking brake system including the parking brake pedal and cables.

### **Brake Discs, Pads, Calipers and Rotors**

Check the pads for excessive wear, discs for run out and wear, and calipers for fluid leakage.

### **Exhaust Pipe and Muffler**

Visually inspect the exhaust pipes, muffler and hangers for cracks, deterioration, or damage. Start the engine and listen carefully for any exhaust gas leakage. Tighten connections or replace parts as necessary.

### **Suspension Mounting Bolts**

Check the suspension connections for looseness or damage. Retighten to the specified torque.

### **Steering Gear Box, Linkage & Boots/Lower Arm Ball Joint**

With the vehicle stopped and the engine off, check for excessive free-play in the steering wheel. Check the linkage for bends or damage. Check the dust boots and ball joints for deterioration, cracks, or damage.

Replace any damaged parts.

### **Drive Shafts and Boots**

Check the drive shafts, boots and clamps for cracks, deterioration, or damage. Replace any damaged parts and, if necessary, repack the grease.

### **Air Conditioning Refrigerant**

Check the air conditioning lines and connections for leakage and damage.

## ENGINE OIL

### Checking the Engine Oil Level

1. Follow all of the oil manufacturer's precautions.
2. Be sure the vehicle is on level ground in P (Park) with the parking brake set and the wheels blocked.
3. Turn the engine on and allow the engine to reach normal operating temperature.
4. Turn the engine off and wait about five minutes for the oil to return to the oil pan.
5. Pull the dipstick out, wipe it clean, and re-insert it fully.

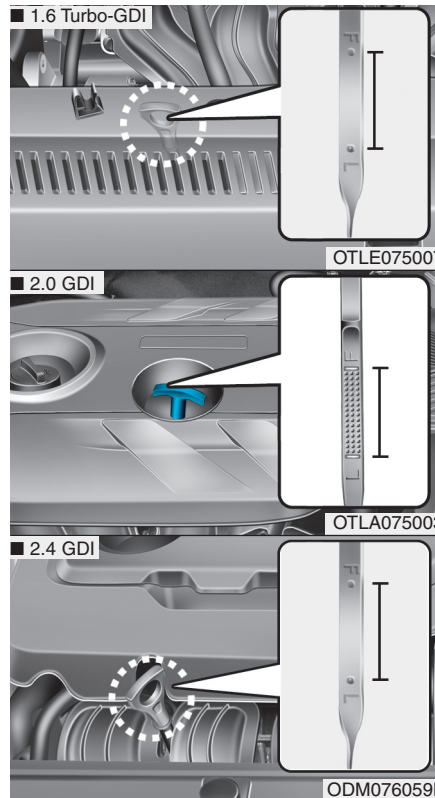

6. Pull the dipstick out again and check the level. The level should be between F and L.
7. If it is near or at L, add enough oil to bring the level to F.

#### **NOTICE**

**To prevent damage to your engine:**

- Do not overfill with engine oil. Add oil in small quantities and recheck level to ensure engine is not overfilled.
- Do not spill engine oil when adding or changing engine oil. Use a funnel to help prevent oil from being spilled on engine components. Wipe off spilled oil immediately.

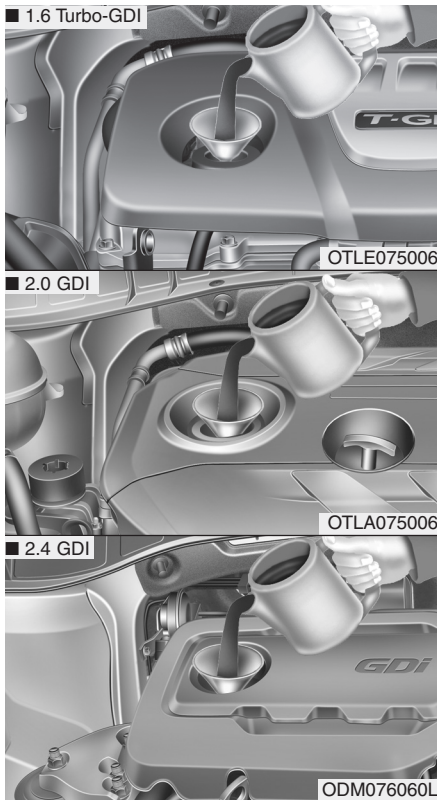

**NOTICE**

Use only the specified engine oil (refer to "Recommended Lubricants and Capacities" in chapter 8).

**Checking the Engine Oil and Filter**



Have engine oil and filter changed by an authorized HYUNDAI dealer according to the Maintenance Schedule at the beginning of this chapter.

**⚠ WARNING**

**CALIFORNIA PROPOSITION 65 WARNING**

Engine oil contains chemicals known to the State of California to cause cancer, birth defects and reproductive harm. Used engine oil may cause irritation or cancer of the skin if left in contact with the skin for prolonged periods of time. Always protect your skin by washing your hands thoroughly with soap and warm water as soon as possible after handling used oil.

### ENGINE COOLANT

The high-pressure cooling system has a reservoir filled with year-round antifreeze coolant. The reservoir is filled at the factory.

Check the antifreeze protection and coolant level at least once a year, at the beginning of the winter season and before traveling to a colder climate.

#### Checking the Engine Coolant Level

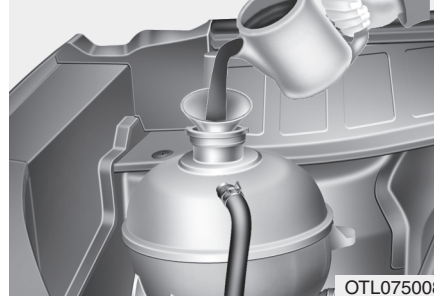
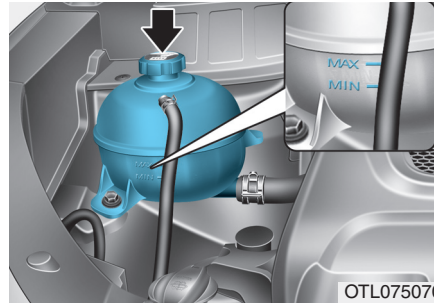

Check the condition and connections of all cooling system hoses and heater hoses. Replace any swollen or deteriorated hoses.

The coolant level should be filled between the MAX and MIN marks on the side of the coolant reservoir when the engine is cool.

If the coolant level is low, add enough distilled (deionized) water to bring the level to the MAX mark, but do not overfill. If frequent additions are required, we recommend that you see an authorized HYUNDAI dealer for a cooling system inspection.

## ⚠ WARNING



Never remove the coolant cap or the drain plug while the engine and radiator are hot. Hot coolant and steam may blow out under pressure, causing serious injury.

Turn the engine off and wait until the engine cools down. Use extreme care when removing the coolant cap. Wrap a thick towel around it, and turn it counterclockwise slowly to the first stop. Step back while the pressure is released from the cooling system. When you are sure all the pressure has been released, press down on the cap, using a thick towel, and continue turning counterclockwise to remove it.

## ⚠ WARNING



The electric motor for the cooling fan may continue to operate or start up when the engine is not running and can cause serious injury. Keep hands, clothing and tools away from the rotating fan blades of the cooling fan.

The electric motor for the cooling fan is controlled by engine coolant temperature, refrigerant pressure and vehicle speed. As the engine coolant temperature decreases, the electric motor will automatically shut off. This is a normal condition. If your vehicle is equipped with GDI, the electric motor for the cooling fan may begin to operate at any time and continue to operate until you disconnect the negative battery cable.

## ⚠ WARNING

Make sure the coolant cap is properly closed after refilling coolant. Otherwise the engine could be overheated while driving.

■ Engine room front view

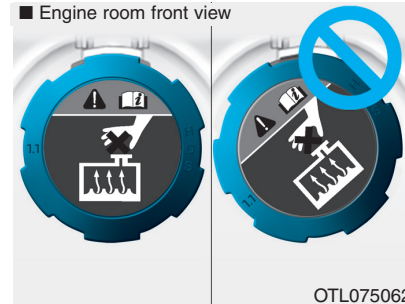

OTL075062

1. Check if the coolant cap label is straight In front.

(Continued)

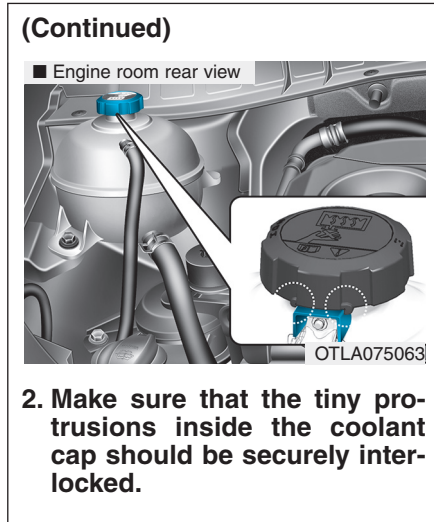

**Recommended engine coolant**

- When adding coolant, use only deionized water, distilled water or soft water for your vehicle and never mix hard water in the coolant filled at the factory.
- An improper coolant mixture can result in severe malfunction or engine damage.
- The engine in your vehicle has aluminum engine parts and must be protected by an phosphate-based ethylene glycol coolant to prevent corrosion and freezing.
- Do not use alcohol or methanol coolant or mix them with the specified coolant.
- Do not use a solution that contains more than 60% antifreeze or less than 35% antifreeze, which would reduce the effectiveness of the solution.

For mixing percentage, refer to the following table:

Ambient Temperature	Mixture Percentage (volume)	
	Antifreeze	Water
5°F (-15°C)	35	65
-13°F (-25°C)	40	60
-31°F (-35°C)	50	50
-49°F (-45°C)	60	40

**i Information**

**If in doubt about the mix ratio, a 50% water and 50% antifreeze mix is the easiest to mix together as it will be the same quantity of each.**

**It is suitable to use for most temperature ranges of -31°F and higher.**



## Changing Engine Coolant

Have coolant changed by an authorized HYUNDAI dealer according to the Maintenance Schedule at the beginning of this chapter.

### WARNING

**Do not use engine coolant or antifreeze in the washer fluid reservoir.**

**Engine coolant can severely obscure visibility when sprayed on the windshield and may cause loss of vehicle control resulting in an accident.**

**Engine coolant may also cause damage to paint and body trim.**

### NOTICE

**To prevent damage to engine parts, put a thick towel around the coolant cap before refilling the coolant to prevent the coolant from overflowing into engine parts, such as the generator.**

## BRAKE FLUID

### Checking the Brake Fluid Level

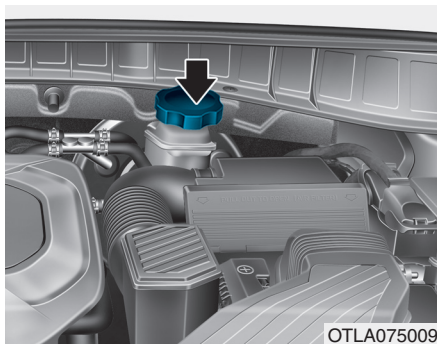

Check the fluid level in the reservoir periodically. The fluid level should be between MAX and MIN marks on the side of the reservoir.

Before removing the reservoir cap and adding brake fluid, clean the area around the reservoir cap thoroughly to prevent brake fluid contamination.

If the level is low, add the specified brake fluid to the MAX level. The level will fall with accumulated mileage. This is a normal condition associated with the wear of the brake linings. If the fluid level is excessively low, have the brake system checked by an authorized HYUNDAI dealer.

#### **⚠ WARNING**

If the brake system requires frequent additions of fluid this could indicate a leak in the brake system. Have the vehicle inspected by an authorized HYUNDAI dealer.

#### **⚠ WARNING**

Do not allow brake fluid to come in contact with your eyes. If brake fluid comes in contact with your eyes, flush your eyes with clean water for at least 15 minutes and get immediate medical attention.

#### **NOTICE**

- Do not allow brake fluid to contact the vehicle's body paint, as paint damage will result.
- Brake fluid, which has been exposed to open air for an extended time should NEVER be used as its quality cannot be guaranteed. It should be disposed of properly.
- Do not use the wrong kind of brake fluid. A few drops of mineral based oil, such as engine oil, in your brake system can damage brake system parts.

#### **i Information**

Use only the specified brake fluid (refer to "Recommended Lubricants and Capacities" in chapter 8).

## WASHER FLUID

### Checking the Washer Fluid Level

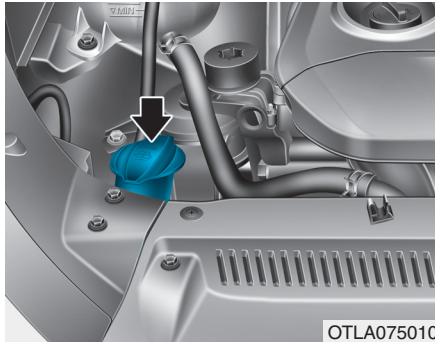

Check the fluid level in the washer fluid reservoir and add fluid if necessary. Plain water may be used if washer fluid is not available. However, use washer solvent with antifreeze characteristics in cold climates to prevent freezing.

### WARNING

To prevent serious injury or death, take the following safety precautions when using washer fluid:

- Do not use engine coolant or antifreeze in the washer fluid reservoir.
- Engine coolant can severely obscure visibility when sprayed on the windshield and may cause loss of vehicle control resulting in an accident or damage to paint and body trim.
- Do not allow sparks or flame to contact the washer fluid or the washer fluid reservoir. Washer fluid may contain alcohol and can be flammable.
- Do not drink washer fluid and avoid contact with skin. Washer fluid is poisonous to humans and animals.
- Keep washer fluid away from children and animals.

## PARKING BRAKE

### Checking the Parking Brake

#### Foot type

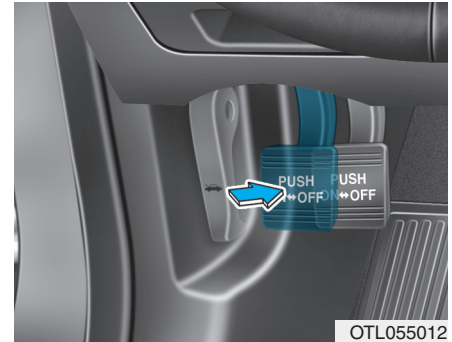

Check whether the stroke is within specification when the parking brake pedal is depressed with 44 lb (20 kg, 196 N) of force. Also, the parking brake alone should securely hold the vehicle on a fairly steep grade. If the stroke is more or less than specified, have the parking brake adjusted by an authorized HYUNDAI dealer.

**Stroke : 3 notch**

## AIR CLEANER

### Filter Replacement

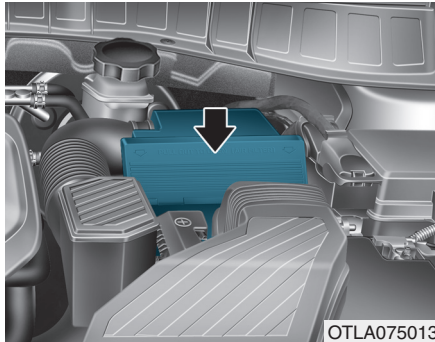

The air cleaner filter can be cleaned for inspection using compressed air.

Do not attempt to wash or to rinse it, as water will damage the filter.

If soiled, the air cleaner filter must be replaced.

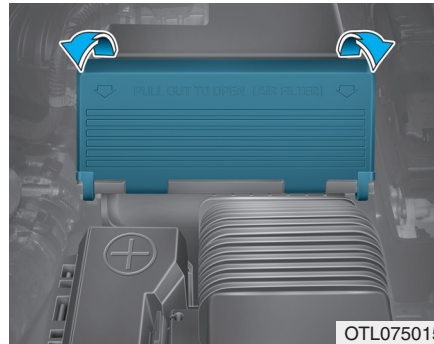

1. Pull down the air cleaner filter cover.
2. Wipe the inside of the air cleaner.

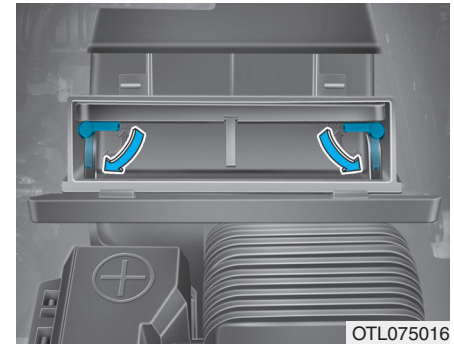

3. Pull down the lever to the UNLOCK position.

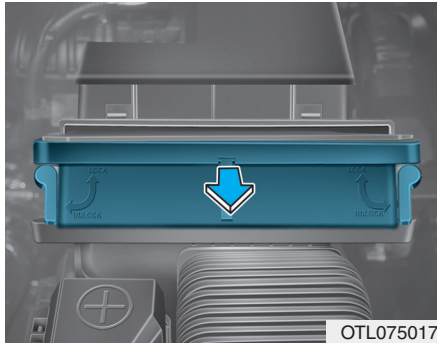

4. Replace the air cleaner filter.

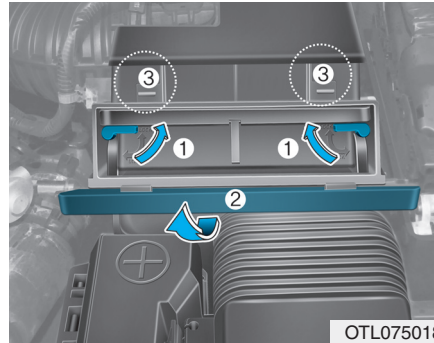

5. Pull up the lever (1) to the LOCK position.
6. Rise up the cover (2) until the hooks on the cover are securely fastened into the latches (3).
7. Check if the cover is firmly installed.

### **i** Information

If the vehicle is operated in extremely dusty or sandy areas, replace the element more often than the usual recommended intervals (refer to "Maintenance Under Severe Usage Conditions" in this chapter).

### **NOTICE**

- Do not drive with the air cleaner filter removed. This will result in excessive engine wear.
- When removing the air cleaner filter, be careful that dust or dirt does not enter the air intake, or damage may result.
- Use HYUNDAI genuine parts, use of non-genuine parts could damage the air flow sensor.

## CLIMATE CONTROL AIR FILTER

### Filter Inspection

The climate control air filter should be replaced according to the Maintenance Schedule. If the vehicle is operated in severely air-polluted cities or on dusty rough roads for a long period, it should be inspected more frequently and replaced earlier. When you replace the climate control air filter, replace it performing the following procedure, and be careful to avoid damaging other components.

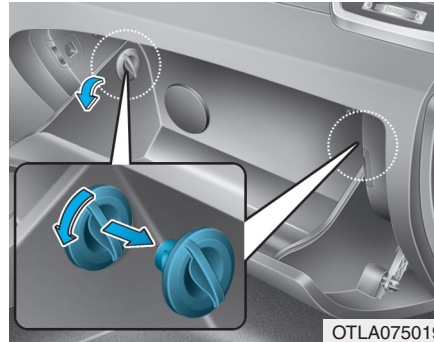

1. With the glove box open, remove the stoppers on both sides to allow the glove box to hang freely on the hinges.

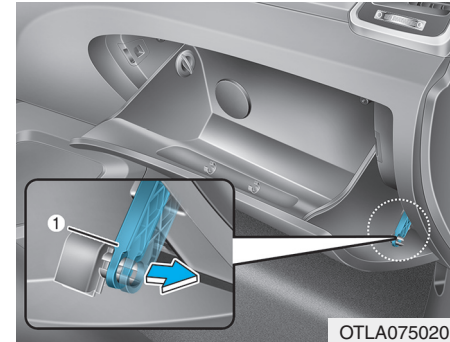

2. Remove the support rod (1).

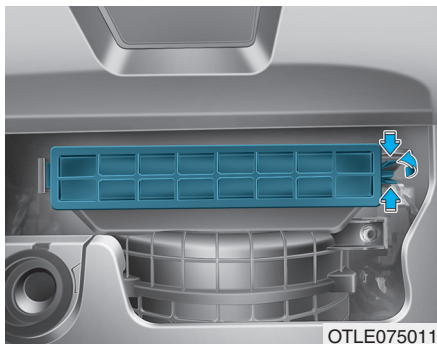

3. Remove the climate control air filter case by pulling out the right side of the cover.

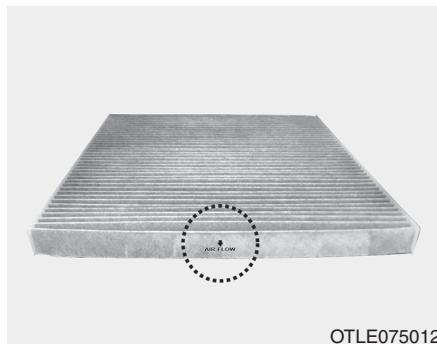

4. Replace the climate control air filter.  
5. Reassemble in the reverse order of disassembly.

**NOTICE**

Install a new climate control air filter in the correct direction with the arrow symbol (↓) facing downwards. Otherwise, the climate control effects may decrease, possibly with a noise.

## WIPER BLADES

### Blade Inspection

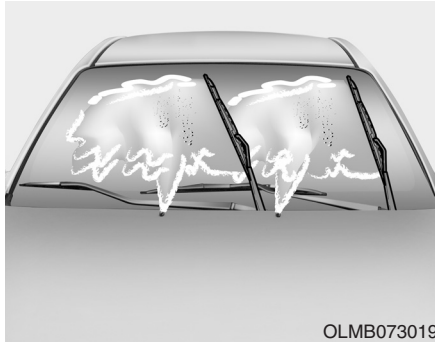

OLMB073019

Contamination of either the windshield or the wiper blades with foreign matter can reduce the effectiveness of the windshield wipers. Common sources of contamination are insects, tree sap, and hot wax treatments used by some commercial car washes. If the blades are not wiping properly, clean both the window and the blades with a clean cloth dampened with washer fluid.

#### **NOTICE**

To prevent damage to the wiper blades, arms or other components, do not:

- Use gasoline, kerosene, paint thinner, or other solvents on or near them.
- Attempt to move the wipers manually.
- Use non-specified wiper blades.

#### **i** Information

Commercial hot waxes applied by automatic car washes have been known to make the windshield difficult to clean.

### Blade Replacement

When the wipers no longer clean adequately, the blades may be worn or cracked, and require replacement.

#### **NOTICE**

To prevent damage to the wiper arms or other components, do not attempt to move the wipers manually.

#### **NOTICE**

The use of a non-specified wiper blade could result in wiper malfunction and failure.



## Front windshield wiper blade

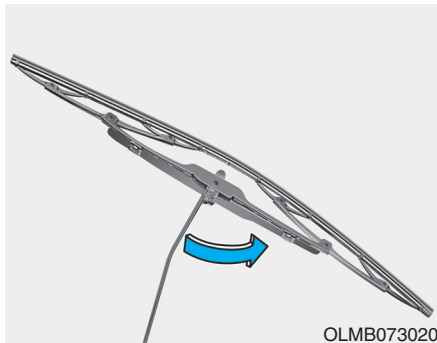

### ■ Type A

1. Raise the wiper arm and slightly rotate the wiper blade assembly to expose the plastic locking clip.

#### CAUTION

**Do not allow the wiper arm to fall against the windshield, since it may chip or crack the windshield.**

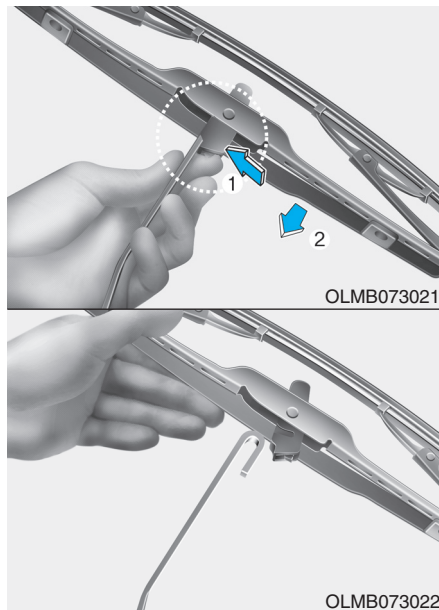

2. Press the clip (1) and slide the blade assembly downward (2).
3. Lift it off the arm.
4. Install the blade assembly in the reverse order of removal.
5. Return the wiper arm on the windshield.

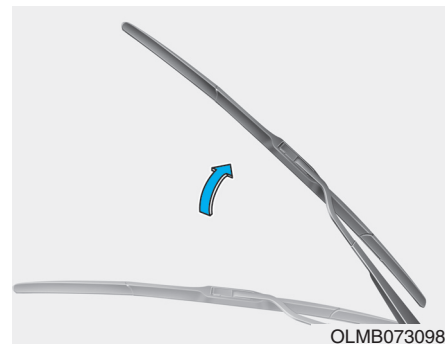

### ■ Type B

1. Raise the wiper arm.

#### CAUTION

**Do not allow the wiper arm to fall against the windshield, since it may chip or crack the windshield.**

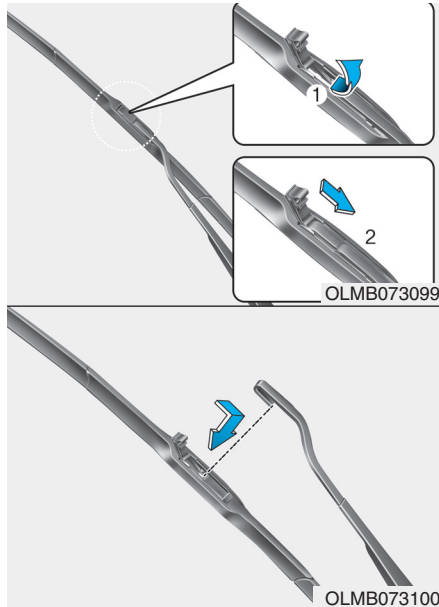

2. Lift up the wiper blade clip (1). Then pull down the blade assembly (2) and remove it.
3. Install the new blade assembly in the reverse order of removal.
4. Return the wiper arm on the windshield.

### Rear windshield wiper blade

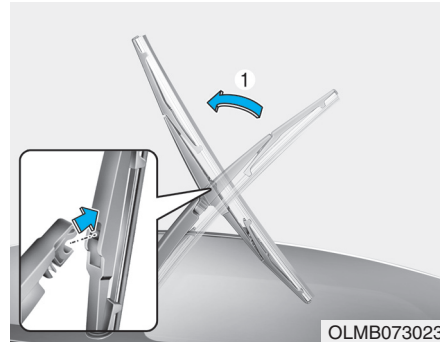

1. Raise the wiper arm.
2. Slightly rotate the wiper blade (1) assembly and pull it out.

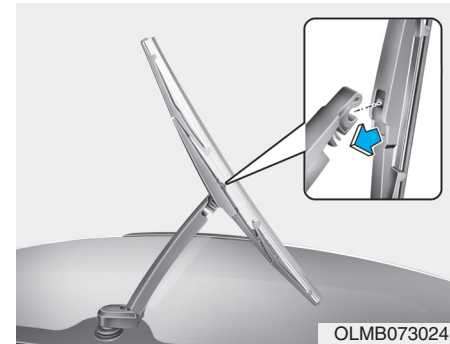

3. Install the new blade assembly by inserting the center part into the slot on the wiper.
4. Make sure the blade assembly is installed firmly by trying to pull it slightly.

### CAUTION

To prevent damage to the wiper arms or other components, have an authorized HYUNDAI dealer replace the wiper blade.

## BATTERY

### WARNING

To prevent **SERIOUS INJURY** or **DEATH** to you or bystanders, always follow these precautions when working near or handling the battery:



Always read and follow instructions carefully when handling a battery.



Wear eye protection designed to protect the eyes from acid splashes.



Keep all flames, sparks, or smoking materials away from the battery.



Hydrogen is always present in battery cells, is highly combustible, and may explode if ignited.



Keep batteries out of reach of children.

(Continued)

(Continued)



Batteries contain sulfuric acid which is highly corrosive. Do not allow acid to contact your eyes, skin or clothing.

If acid gets into your eyes, flush your eyes with clean water for at least 15 minutes and get immediate medical attention. If acid gets on your skin, thoroughly wash the area. If you feel pain or a burning sensation, get medical attention immediately.

- When lifting a plastic-cased battery, excessive pressure on the case may cause battery acid to leak. Lift with a battery carrier or with your hands on opposite corners.
- Do not attempt to jump start your vehicle if your battery is frozen.

(Continued)

(Continued)

- **NEVER** attempt to recharge the battery when the vehicle's battery cables are connected to the battery.
- The electrical ignition system works with high voltage. **NEVER** touch these components with the engine running or when the Engine Start/Stop button is in the ON position.

**⚠ WARNING**

**CALIFORNIA PROPOSITION 65  
WARNING**

Battery posts, terminals, and related accessories contain lead and lead compounds, chemicals known to the State of California to cause cancer, birth defects and reproductive harm. Batteries also contain other chemicals known to the State of California to cause cancer. Wash hands after handling.

**NOTICE**

- When you do not use the vehicle for a long time in a low temperature area, disconnect the battery and keep it indoors.
- Always charge the battery fully to prevent battery case damage in low temperature areas.

**For Best Battery Service**

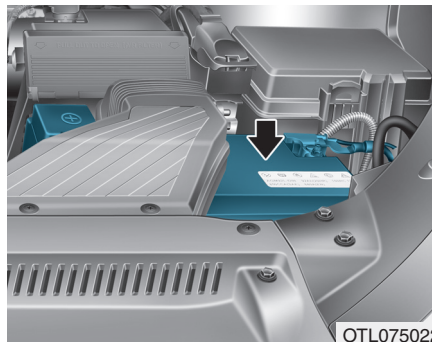

- Keep the battery securely mounted.
- Keep the battery top clean and dry.
- Keep the terminals and connections clean, tight, and coated with petroleum jelly or terminal grease.
- Rinse any spilled acid from the battery immediately with a solution of water and baking soda.

**Battery Recharging**

**⚠ WARNING**

Always follow these instructions when recharging your vehicle's battery to avoid the risk of **SERIOUS INJURY** or **DEATH** from explosions or acid burns:

- Before performing maintenance or recharging the battery, turn off all accessories and place the ignition switch to the **LOCK/OFF** position.
- Keep all flames, sparks, or smoking materials away from the battery.
- Always work outdoors or in an area with plenty of ventilation.
- Wear eye protection when checking the battery during charging.
- The battery must be removed from the vehicle and placed in a well ventilated area.

(Continued)

(Continued)

- **Watch the battery during charging, and stop or reduce the charging rate if the battery cells begin boiling violently.**
- **The negative battery cable must be removed first and installed last when the battery is disconnected. Disconnect the battery charger in the following order:**
  - (1) **Turn off the battery charger main switch.**
  - (2) **Unhook the negative clamp from the negative battery terminal.**
  - (3) **Unhook the positive clamp from the positive battery terminal.**
- **Always use a genuine HYUNDAI approved battery when you replace the battery.**

### ***By jump starting***

After a jump start from a good battery, drive the vehicle for 20-30 minutes before it is shutoff. The vehicle may not restart if you shut it off before the battery had a chance to adequately recharge. See "Jump Starting" in chapter 6 for more information on jump starting procedures.

### ***i* Information**



**An inappropriately disposed battery can be harmful to the environment and human health.**

**Dispose the battery according to your local law(s) or regulation.**

### **Reset features**

Some items need to be reset after the battery has been discharged or the battery has been disconnected. See chapter 3 for:

- Power Windows
- Trip Computer
- Climate Control System
- Clock
- Audio System
- Sunroof
- Integrated Memory System

## TIRES AND WHEELS

### WARNING

Tire failure may cause loss of vehicle control resulting in an accident. To reduce risk of **SERIOUS INJURY** or **DEATH**, take the following precautions:

- Inspect your tires monthly for proper inflation as well as wear and damage.
- The recommended cold tire pressure for your vehicle can be found in this manual and on the tire label located on the driver's side center pillar. Always use a tire pressure gauge to measure tire pressure. Tires with too much or too little pressure wear unevenly causing poor handling.
- Check the pressure of the spare every time you check the pressure of the other tires on your vehicle.

(Continued)

(Continued)

- Replace tires that are worn, show uneven wear, or are damaged. Worn tires can cause loss of braking effectiveness, steering) control, or traction.
- **ALWAYS** replace tires with the same size as each tire that was originally supplied with this vehicle. Using tires and wheels other than the recommended sizes could cause unusual handling characteristics, poor vehicle control, or negatively affect your vehicle's Anti-Lock Brake System (ABS) resulting in a serious accident.

### Tire Care

For proper maintenance, safety, and maximum fuel economy, you must always maintain recommended tire inflation pressures and stay within the load limits and weight distribution recommended for your vehicle.

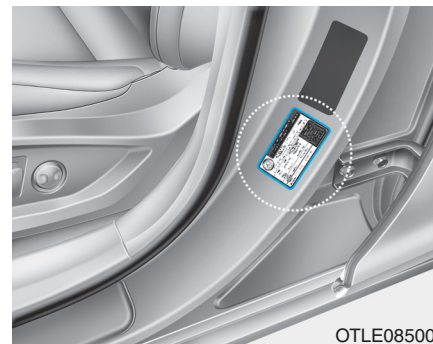

All specifications (sizes and pressures) can be found on a label attached to the driver's side center pillar.

## Recommended Cold Tire Inflation Pressures

All tire pressures (including the spare) should be checked when the tires are cold. "Cold tires" means the vehicle has not been driven for at least three hours or driven less than one mile (1.6 km).

Warm tires normally exceed recommended cold tire pressures by 4 to 6 psi (28 to 41 kPa). Do not release air from warm tires to adjust the pressure or the tires will be under-inflated. For recommended inflation pressure, refer to "Tire and Wheels" in chapter 8.

### WARNING

**Recommended pressures must be maintained for the best ride, vehicle handling, and minimum tire wear.**

**Over-inflation or under-inflation can reduce tire life, adversely affect vehicle handling, and lead to sudden tire failure that could result in loss of vehicle control resulting in an accident.**

**Severe under-inflation can lead to severe heat build-up, causing blowouts, tread separation and other tire failures that can result in the loss of vehicle control resulting in an accident. This risk is much higher on hot days and when driving for long periods at high speeds.**

### CAUTION

- **Under-inflation results in excessive wear, poor handling and reduced fuel economy. Wheel deformation is also possible. Keep your tire pressures at the proper levels. If a tire frequently needs refilling, have it checked by an authorized HYUNDAI dealer.**
- **Over-inflation produces a harsh ride, excessive wear at the center of the tire tread, and a greater possibility of damage from road hazards.**

### Check Tire Inflation Pressure

Check your tires, including the spare tire, once a month or more.

#### ***How to check***

Use a good quality tire pressure gauge to check tire pressure. You can not tell if your tires are properly inflated simply by looking at them. Radial tires may look properly inflated when they are under-inflated.

Remove the valve cap from the tire valve stem. Press the tire gauge firmly onto the valve to get a pressure measurement. If the cold tire inflation pressure matches the recommended pressure on the tire and loading information label, no further adjustment is necessary. If the pressure is low, add air until you reach the recommended pressure. Make sure to put the valve caps back on the valve stems. Without the valve cap, dirt or moisture could get into the valve core and cause air leakage. If a valve cap is missing, install a new one as soon as possible.

If you overfill the tire, release air by pushing on the metal stem in the center of the tire valve. Recheck the tire pressure with the tire gauge. Be sure to put the valve caps back on the valve stems. Without the valve cap, dirt or moisture could get into the valve core and cause air leakage. If a valve cap is missing, install a new one as soon as possible.

### Tire Rotation

To equalize tread wear, HYUNDAI recommends that the tires be rotated every 7,500 miles (12,000 km) or sooner if irregular wear develops.

During rotation, check the tires for correct balance.

When rotating tires, check for uneven wear and damage. Abnormal wear is usually caused by incorrect tire pressure, improper wheel alignment, out-of-balance wheels, severe braking or severe cornering. Look for bumps or bulges in the tread or side of tire. Replace the tire if you find either of these conditions. Replace the tire if fabric or cord is visible. After rotation, be sure to bring the front and rear tire pressures to specification and check lug nut tightness (proper torque is 79-94 lb.ft [11-13 kg.m]).



■ Without a spare tire

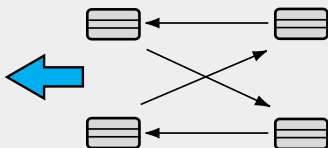

ODH073802

Disc brake pads should be inspected for wear whenever tires are rotated.

### **i** Information

Tires that are asymmetrical or directional can only be installed on the wheel in one direction. The outside and inside of an asymmetrical tire is not easily distinguishable. Pay careful attention to the markings on the sidewalls of the tires, noting the "outside" marking and also the rotating direction before installing them on the vehicle.

### **⚠** WARNING

- Do not use the compact spare tire for tire rotation.
- Do not mix bias ply and radial ply tires under any circumstances. This may cause unusual handling characteristics that may cause loss of vehicle control resulting in an accident.

## Wheel Alignment and Tire Balance

The wheels on your vehicle were aligned and balanced carefully at the factory to give you the longest tire life and best overall performance.

In most cases, you will not need to have your wheels aligned again. However, if you notice unusual tire wear or your vehicle pulling one way or the other, the alignment may need to be reset.

If you notice your vehicle vibrating when driving on a smooth road, your wheels may need to be rebalanced.

### **NOTICE**

Improper wheel weights can damage your vehicle's aluminum wheels. Use only approved wheel weights.

## Tire Replacement



If the tire is worn evenly, a tread wear indicator will appear as a solid band across the tread. This shows there is less than 1/16 inch (1.6 mm) of tread left on the tire. Replace the tire when this happens.

Do not wait for the band to appear across the entire tread before replacing the tire.

### **⚠ WARNING**

**To reduce the risk of DEATH or SERIOUS INJURY:**

- Replace tires that are worn, show uneven wear, or are damaged. Worn tires can cause loss of braking effectiveness, steering control, and traction.
- Always replace tires with the same size as each tire that was originally supplied with this vehicle. Using tires and wheels other than the recommended sizes could cause unusual handling characteristics, poor vehicle control, or negatively affect your vehicle's Anti-Lock Brake System (ABS) resulting in a serious accident.

(Continued)

(Continued)

- When replacing tires (or wheels), it is recommended to replace the two front or two rear tires (or wheels) as a pair. Replacing just one tire can seriously affect your vehicle's handling.
- Tires degrade over time, even when they are not being used. Regardless of the remaining tread, HYUNDAI recommends that tires be replaced after six (6) years of normal service.
- Heat caused by hot climates or frequent high loading conditions can accelerate the aging process. Failure to follow this warning may cause sudden tire failure, which could lead to a loss of vehicle control resulting in an accident.

### **Compact spare tire replacement**

A compact spare tire has a shorter tread life than a regular size tire. Replace it when you can see the tread wear indicator bars on the tire. The replacement compact spare tire should be the same size and design tire as the one provided with your new vehicle and should be mounted on the same compact spare tire wheel. The compact spare tire is not designed to be mounted on a regular size wheel, and the compact spare tire wheel is not designed for mounting a regular size tire.

#### **⚠ WARNING**

**The original tire should be repaired or replaced as soon as possible to avoid failure of the spare and loss of vehicle control resulting in an accident. The compact spare tire is for emergency use only. Do not operate your vehicle over 50 mph (80 km/h) when using the compact spare tire.**

### **Wheel Replacement**

When replacing the metal wheels for any reason, make sure the new wheels are equivalent to the original factory units in diameter, rim width and offset.

### **Tire Traction**

Tire traction can be reduced if you drive on worn tires, tires that are improperly inflated or on slippery road surfaces. Tires should be replaced when tread wear indicators appear. To reduce the possibility of losing control, slow down whenever there is rain, snow or ice on the road.

### **Tire Maintenance**

In addition to proper inflation, correct wheel alignment helps to decrease tire wear. If you find a tire is worn unevenly, have your dealer check the wheel alignment.

When you have new tires installed, make sure they are balanced. This will increase vehicle ride comfort and tire life. Additionally, a tire should always be rebalanced if it is removed from the wheel.

### **Tire Sidewall Labeling**

This information identifies and describes the fundamental characteristics of the tire and also provides the tire identification number (TIN) for safety standard certification. The TIN can be used to identify the tire in case of a recall.

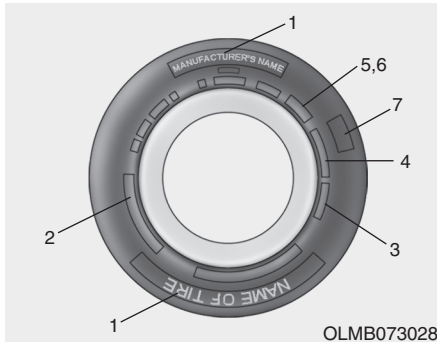

### **1. Manufacturer or brand name**

Manufacturer or brand name is shown.

### **2. Tire size designation**

A tire's sidewall is marked with a tire size designation. You will need this information when selecting replacement tires for your car. The following explains what the letters and numbers in the tire size designation mean.

Example tire size designation:

(These numbers are provided as an example only; your tire size designator could vary depending on your vehicle.)

**225/60R17 99H**

225 - Tire width in millimeters.

60 - Aspect ratio. The tire's section height as a percentage of its width.

R - Tire construction code (Radial).

17 - Rim diameter in inches.

99 - Load Index, a numerical code associated with the maximum load the tire can carry.

H - Speed Rating Symbol. See the speed rating chart in this section for additional information.

### **Wheel size designation**

Wheels are also marked with important information that you need if you ever have to replace one. The following explains what the letters and numbers in the wheel size designation mean.

Example wheel size designation:

**7.0J X 17**

7.0 - Rim width in inches.

J - Rim contour designation.

17 - Rim diameter in inches.

### Tire speed ratings

The chart below lists many of the different speed ratings currently being used for passenger car tires. The speed rating is part of the tire size designation on the sidewall of the tire. This symbol corresponds to that tire's designed maximum safe operating speed.

Speed Rating Symbol	Maximum Speed
S	112 mph (180 km/h)
T	118 mph (190 km/h)
H	130 mph (210 km/h)
V	149 mph (240 km/h)
W	168 mph (270 km/h)
Y	186 mph (300 km/h)

### 3. Checking tire life (TIN : Tire Identification Number)

Any tires that are over six years old, based on the manufacturing date, (including the spare tire) should be replaced by new ones. You can find the manufacturing date on the tire sidewall (possibly on the inside of the wheel), displaying the DOT Code. The DOT Code is a series of numbers on a tire consisting of numbers and English letters. The manufacturing date is designated by the last four digits (characters) of the DOT code.

#### DOT : XXXX XXXX OOOO

The front part of the DOT means a plant code number, tire size and tread pattern and the last four numbers indicate week and year manufactured.

For example:

DOT XXXX XXXX 1618 represents that the tire was produced in the 16th week of 2018.

### 4. Tire ply composition and material

The number of layers or plies of rubber-coated fabric in the tire. Tire manufacturers also must indicate the materials in the tire, which include steel, nylon, polyester, and others. The letter "R" means radial ply construction; the letter "D" means diagonal or bias ply construction; and the letter "B" means belted-bias ply construction.

### 5. Maximum permissible inflation pressure

This number is the greatest amount of air pressure that should be put in the tire. Do not exceed the maximum permissible inflation pressure. Refer to the Tire and Loading Information label for recommended inflation pressure.

### **6. Maximum load rating**

This number indicates the maximum load in kilograms and pounds that can be carried by the tire. When replacing the tires on the vehicle, always use a tire that has the same load rating as the factory installed tire.

### **7. Uniform tire quality grading**

Quality grades can be found where applicable on the tire sidewall between tread shoulder and maximum section width.

For example:

TREAD wear 200

TRACTION AA

TEMPERATURE A

### **Tread wear**

The tread wear grade is a comparative rating based on the wear rate of the tire when tested under controlled conditions on a specified government test course. For example, a tire graded 150 would wear one-and-a-half times ( $1\frac{1}{2}$ ) as well on the government course as a tire graded 100.

The relative performance of tires depends upon the actual conditions of their use, however, and may depart significantly from the norm due to variations in driving habits, service practices and differences in road characteristics and climate.

These grades are molded on the sidewalls of passenger vehicle tires. The tires available as standard or optional equipment on your vehicle may vary with respect to grade.

### **Traction - AA, A, B & C**

The traction grades, from highest to lowest, are AA, A, B and C. Those grades represent the tire's ability to stop on wet pavement as measured under controlled conditions on specified government test surfaces of asphalt and concrete. A tire marked C may have poor traction performance.

#### **WARNING**

**The traction grade assigned to this tire is based on straight-ahead braking traction tests, and does not include acceleration, cornering, hydroplaning, or peak traction characteristics.**

## Temperature - A, B & C

The temperature grades are A (the highest), B and C representing the tire's resistance to the generation of heat and its ability to dissipate heat when tested under controlled conditions on a specified indoor laboratory test wheel.

Sustained high temperature can cause the material of the tire to degenerate and reduce tire life, and excessive temperature can lead to sudden tire failure. Grade C responds to a level of performance which all passenger car tires must meet under the Federal Motor Vehicle Safety Standard No. 109. Grades B and A represent higher levels of performance on the laboratory test wheel than the minimum required by law.

### WARNING

**The temperature grade for this tire is established for a tire that is properly inflated and not overloaded. Excessive speed, under-inflation, over-inflation, or excessive loading, either separately or in combination, can cause heat build-up and possible sudden tire failure. This may cause loss of vehicle control resulting in an accident.**

## Tire Terminology and Definitions

### ***Air Pressure***

The amount of air inside the tire pressing outward on the tire. Air pressure is expressed in pounds per square inch (psi) or kilopascal (kPa).

### ***Accessory Weight***

This means the combined weight of optional accessories. Some examples of optional accessories are automatic transmission, power seats, and air conditioning.

### ***Aspect Ratio***

The relationship of a tire's height to its width.

### ***Belt***

A rubber coated layer of cords that is located between the plies and the tread. Cords may be made from steel or other reinforcing materials.

### ***Bead***

The tire bead contains steel wires wrapped by steel cords that hold the tire onto the rim.

### ***Bias Ply Tire***

A pneumatic tire in which the plies are laid at alternate angles less than 90 degrees to the centerline of the tread.

### ***Cold Tire Pressure***

The amount of air pressure in a tire, measured in pounds per square inch (psi) or kilopascals (kPa) before a tire has built up heat from driving.

### ***Curb Weight***

This means the weight of a motor vehicle with standard and optional equipment including the maximum capacity of fuel, oil and coolant, but without passengers and cargo.

### ***DOT Markings***

A code molded into the sidewall of a tire signifying that the tire is in compliance with the U.S. Department of Transportation motor vehicle safety standards. The DOT code includes the Tire Identification Number (TIN), an alphanumeric designator which can also identify the tire manufacturer, production plant, brand and date of production.

7-50

### ***GVWR***

Gross Vehicle Weight Rating

### ***GAWR FRT***

Gross Axle Weight Rating for the Front Axle.

### ***GAWR RR***

Gross Axle Weight Rating for the Rear axle.

### ***Intended Outboard Sidewall***

The side of an asymmetrical tire, that must always face outward when mounted on a vehicle.

### ***Kilopascal (kPa)***

The metric unit for air pressure.

### ***Light truck(LT) tire***

A tire designated by its manufacturer as primarily intended for use on light-weight trucks or multipurpose passenger vehicles.

### ***Load ratings***

The maximum load that a tire is rated to carry for a given inflation pressure.

### ***Load Index***

An assigned number ranging from 1 to 279 that corresponds to the load carrying capacity of a tire.

### ***Maximum Inflation Pressure***

The maximum air pressure to which a cold tire may be inflated. The maximum air pressure is molded onto the sidewall.

### ***Maximum Load Rating***

The load rating for a tire at the maximum permissible inflation pressure for that tire.

### ***Maximum Loaded Vehicle Weight***

The sum of curb weight; accessory weight; vehicle capacity weight; and production options weight.



**Normal Occupant Weight**

The number of occupants a vehicle is designed to seat multiplied by 150 pounds (68 kg).

**Occupant Distribution**

Designated seating positions.

**Outward Facing Sidewall**

An asymmetrical tire has a particular side that faces outward when mounted on a vehicle. The outward facing sidewall bears white lettering or bears manufacturer, brand, and/or model name molding that is higher or deeper than the same moldings on the inner facing sidewall.

**Passenger (P-Metric) tire**

A tire used on passenger cars and some light duty trucks and multipurpose vehicles.

**Ply**

A layer of rubber-coated parallel cords

**Pneumatic tire**

A mechanical device made of rubber, chemicals, fabric and steel or other materials, that, when mounted on an automotive wheel provides the traction and contains the gas or fluid that sustains the load.

**Pneumatic options weight**

The combined weight of installed regular production options weighing over 5 lb. (2.3 kg) in excess of the standard items which they replace, not previously considered in curb weight or accessory weight, including heavy duty breaks, ride levelers, roof rack, heavy duty battery, and special trim.

**Recommended Inflation Pressure**

Vehicle manufacturer's recommended tire inflation pressure as shown on the tire placard.

**Radial Ply Tire**

A pneumatic tire in which the ply cords that extend to the beads are laid at 90 degrees to the centerline of the tread.

**Rim**

A metal support for a tire and upon which the tire beads are seated.

**Sidewall**

The portion of a tire between the tread and the bead.

**Speed Rating**

An alphanumeric code assigned to a tire indicating the maximum speed at which a tire can operate.

**Traction**

The friction between the tire and the road surface. The amount of grip provided.

### **Tread**

The portion of a tire that comes into contact with the road.

### **Treadwear Indicators**

Narrow bands, sometimes called "wear bars", that show across the tread of a tire when only 1/16 inch of tread remains.

### **UTQGS**

Uniform Tire Quality Grading Standards is a tire information system that provides consumers with ratings for a tire's traction, temperature and treadwear. Ratings are determined by tire manufacturers using government testing procedures. The ratings are molded into the sidewall of the tire.

### **Vehicle Capacity Weight**

The number of designated seating positions multiplied by 150 lbs. (68 kg) plus the rated cargo and luggage load.

### **Vehicle Maximum Load on the Tire**

Load on an individual tire due to curb and accessory weight plus maximum occupant and cargo weight.

### **Vehicle Normal Load on the Tire**

Load on an individual tire that is determined by distributing to each axle its share of the curb weight, accessory weight, and normal occupant weight and dividing by 2.

### **Vehicle Placard**

A label permanently attached to a vehicle showing the original equipment tire size and recommended inflation pressure.

### **All Season Tires**

HYUNDAI specifies all season tires on some models to provide good performance for use all year round, including snowy and icy road conditions. All season tires are identified by ALL SEASON and/or M+S (Mud and Snow) on the tire sidewall. Snow tires have better snow traction than all season tires and may be more appropriate in some areas.

### **Summer Tires**

HYUNDAI specifies summer tires on some models to provide superior performance on dry roads. Summer tire performance is substantially reduced in snow and ice. Summer tires do not have the tire traction rating M+S (Mud and Snow) on the tire side wall. If you plan to operate your vehicle in snowy or icy conditions, HYUNDAI recommends the use of snow tires or all season tires on all four wheels.

## Snow Tires

If you equip your car with snow tires, they should be the same size and have the same load capacity as the original tires. Snow tires should be installed on all four wheels; otherwise, poor handling may result. Snow tires should carry 4 psi (28 kPa) more air pressure than the pressure recommended for the standard tires on the tire label on the driver's side of the center pillar, or up to the maximum pressure shown on the tire sidewall, whichever is less. Do not drive faster than 75 mph (120 km/h) when your vehicle is equipped with snow tires.

## Radial-Ply Tires

Radial-ply tires provide improved tread life, road hazard resistance and smoother high speed ride. The radial-ply tires used on this vehicle are of belted construction, and are selected to complement the ride and handling characteristics of your vehicle. Radial-ply tires have the same load carrying capacity, as bias-ply or bias belted tires of the same size, and use the same recommended inflation pressure. Mixing of radial-ply tires with bias-ply or bias belted tires is not recommended. Any combinations of radial-ply and bias-ply or bias belted tires when used on the same vehicle will seriously deteriorate vehicle handling. The best rule to follow is: Identical pairs of radial-ply tires should always be used as a set for the front tires and a set for the rear tires.

Longer wearing tires can be more susceptible to irregular tread wear. It is very important to follow the tire rotation interval in this chapter to achieve the tread life potential of these tires. Cuts and punctures in radial-ply tires are repairable only in the tread area, because of sidewall flexing. Consult your tire dealer for radial-ply tire repairs.

### WARNING

**Do not mix bias ply and radial ply tires under any circumstances. This may cause unusual handling characteristics that may cause loss of vehicle control resulting in an accident.**

### Low Aspect Ratio Tires

Low aspect ratio tires, the aspect ratio is lower than 50, are provided for sporty looks.

Because low aspect ratio tires are optimized for handling and braking, their sidewall is a little stiffer than a standard tire. Also low aspect ratio tires tend to be wider and consequently have a greater contact patch with the road surface. In some instances they may generate more road noise compared with standard tires.

#### CAUTION

**Because the sidewall of a low aspect ratio tire is shorter than a standard tire, the rim of the wheel and the tire itself is more easily susceptible to damage. Use caution when driving and follow the guidelines below to help minimize damage to the wheel and tire:**

- **When driving on a rough road or off road, drive cautiously because tires and wheels may be damaged. And after driving, inspect tires and wheels.**
- **When passing over a pothole, speed bump, manhole, or curb stone, drive slowly so that the tires and wheels are not damaged.**
- **If the tire is subjected to a severe impact, have the tire and wheel inspected by an authorized HYUNDAI dealer.**
- **Inspect the tire condition and pressure every 1,800 miles (3,000km).**

#### CAUTION

- **It is not easy to recognize tire damage with your own eyes. But if there is the slightest hint of tire damage, have the tire checked or replaced because the tire damage may cause air leakage from the tire.**
- **If the tire is damaged by driving on a rough road, off road, pothole, manhole, or curb stone, it will not be covered by the warranty.**

## FUSES

### ■ Blade type



Normal



Blown

### ■ Cartridge type



Normal



Blown

### ■ Multi fuse

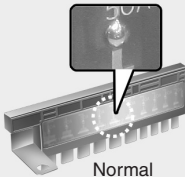

Normal

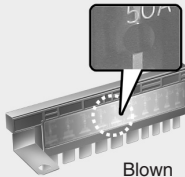

Blown

### ■ Battery fuse terminal

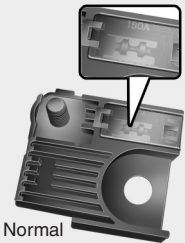

Normal

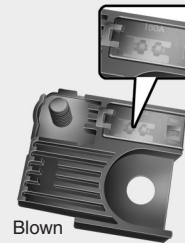

Blown

OLF074075

A vehicle's electrical system is protected from electrical overload damage by fuses.

This vehicle has 2 (or 3) fuse panels, one located in the driver's side panel bolster, the other in the engine compartment near the battery.

If any of your vehicle's lights, accessories, or controls do not work, check the appropriate circuit fuse. If a fuse has blown, the element inside the fuse will be melted or broken.

If the electrical system does not work, first check the driver's side fuse panel. Before replacing a blown fuse, turn the engine and all switches off, and then disconnect the negative battery cable. Always replace a blown fuse with one of the same rating.

If the replacement fuse blows, this indicates an electrical problem. Avoid using the system involved and immediately consult an authorized HYUNDAI dealer.

## Information

Four kinds of fuses are used : blade type For lower amperage rating, cartridge type/Multi fuse/Battery fuse terminal for higher amperage ratings

## WARNING

**NEVER** replace a fuse with anything but another fuse of the same rating.

- A higher capacity fuse could cause damage and possibly cause a fire.
- Do not install a wire or aluminum foil instead of the proper fuse - even as a temporary repair. It may cause extensive wiring damage and possibly a fire.

## CAUTION

Do not use a screwdriver or any other metal object to remove fuses because it may cause a short circuit and damage the system.

### Instrument Panel Fuse Replacement

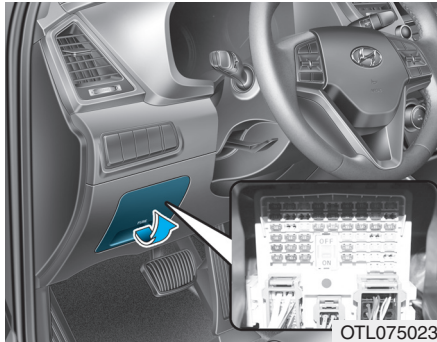

1. Turn the engine off.
2. Turn all other switches OFF.
3. Open the fuse panel cover.
4. Refer to the label on the inside of the fuse panel cover to locate the suspected fuse location.

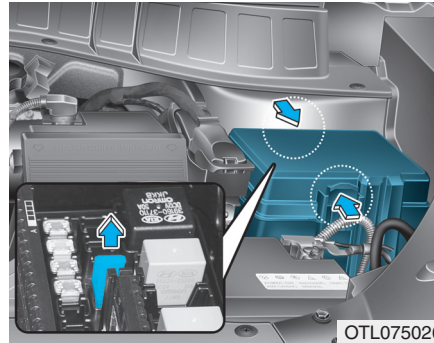

5. Pull the suspected fuse straight out. Use the removal tool provided in the engine compartment fuses panel.
6. Check the removed fuse; replace it if it is blown. Spare fuses are provided in the instrument panel fuse panels (or in the engine compartment fuse panel).
7. Push in a new fuse of the same rating, and make sure it fits tightly in the clips. If it fits loosely, consult an authorized HYUNDAI dealer.

In an emergency, if you do not have a spare fuse, use a fuse of the same rating from a circuit you may not need for operating the vehicle, such as the cigarette lighter fuse.

If the headlamps or other electrical components do not work and the fuses are OK, check the fuse panel in the engine compartment. If a fuse is blown, it must be replaced with the same rating.

## Fuse switch

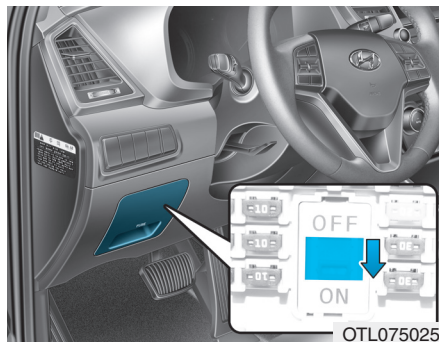

Always, place the fuse switch to the ON position.

If you move the switch to the OFF position, some items such as the audio system and digital clock must be reset and the smart key may not work properly.

## Information

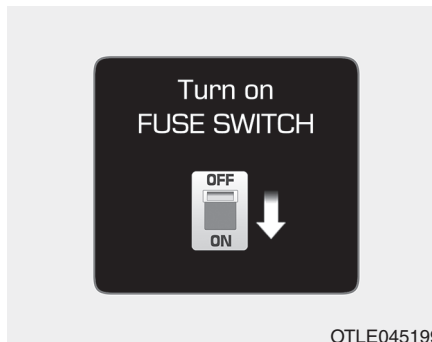

If the fuse switch is OFF, the above message will appear.

### **NOTICE**

- **Always place the fuse switch in the ON position while driving the vehicle.**
- **Do not move the fuse switch repeatedly. The fuse switch may be damaged.**

## Engine Compartment Panel Fuse Replacement

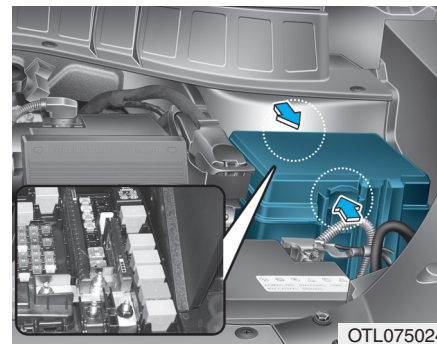

1. Turn the engine off.
2. Turn all other switches OFF.
3. Remove the fuse panel cover by pressing the tap and pulling up.
4. Check the removed fuse; replace it if it is blown. To remove or insert the fuse, use the fuse puller in the engine compartment fuse panel.
5. Push in a new fuse of the same rating, and make sure it fits tightly in the clips. If it fits loosely, consult an authorized HYUNDAI dealer.

### CAUTION

After checking the fuse box in the engine compartment securely close the fuse box cover inside the engine compartment, until it clicks.

If the fuse box is not closed properly, water may leak in side, possibly causing a malfunction with the electrical system.

### Main fuse

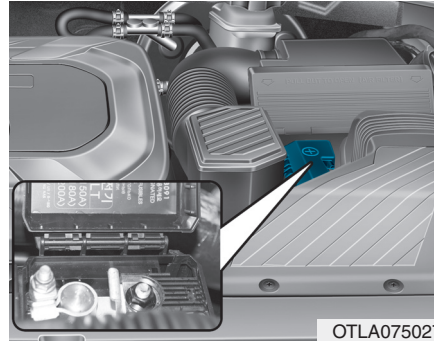

If the main fuse is blown, it must be removed as follows:

1. Turn off the engine.
2. Disconnect the negative battery cable.
3. Remove the fuse panel cover by pressing the tab and pulling it up.
4. Remove the nuts shown in the picture above.
5. Replace the fuse with a new one of the same rating.
6. Reinstall in the reverse order of removal.

### Information

If the main fuse is blown, consult an authorized HYUNDAI dealer.



## Multi fuse

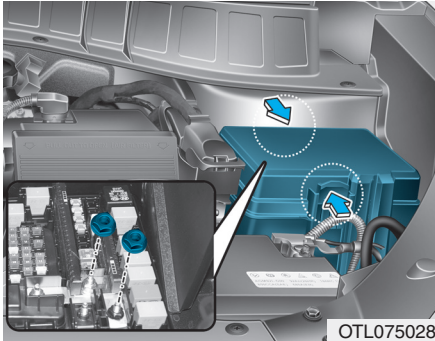

If the multi fuse is blown, it must be removed as follows:

1. Turn off the engine.
2. Disconnect the negative battery cable.
3. Remove the fuse panel cover by pressing the tab and pulling it up.
4. Remove the nuts shown in the picture above.
5. Replace the fuse with a new one of the same rating.
6. Reinstall in the reverse order of removal.

## **i** Information

If the multi fuse is blown, consult an authorized HYUNDAI dealer.

## Fuse/Relay Panel Description

### Instrument panel fuse panel



OTL075067

Inside the fuse/relay box cover, you can find the fuse/relay label describing fuse/relay name and capacity.

### **i** Information

Not all fuse panel descriptions in this manual may be applicable to your vehicle; the information is accurate at the time of printing. When you inspect the fuse box on your vehicle, refer to the fuse box label.

USE THE DESIGNATED FUSE ONLY

1 A/CON 7.5A	WIPER RR 15A	6 MODULE 10A	WASHER 15A	5 MODULE 7.5A	AIR BAG 15A	1 MODULE 10A	START 10A	
7 MODULE 7.5A			HEATED STEERING 15A	8 MODULE 7.5A	4 MODULE 7.5A	A/BAG IND 7.5A	3 MODULE 10A	
1 SMART KEY 15A		4WD 20A	TAILGATE OPEN 10A	S/HEATER RR 15A	MDPS 7.5A	3 SMART KEY 7.5A	CLUSTER 7.5A	SPARE 15A
2 SMART KEY 10A	MULTIMEDIA 15A	INTERIOR LAMP 10A	<b>FUSE SWITCH</b>		DOOR LOCK 20A	2 SUNROOF 20A		POWER OUTLET 20A
BRAKE SWITCH 7.5A	2 MEMORY 10A	1 MEMORY 10A			P/SEAT (PASS) 30A	S/HEATER FRT 20A	1 SUNROOF 20A	2 MODULE 20A
SPARE 10A	2 A/CON 7.5A	HEATED MIRROR 10A			P/SEAT (DRV) 30A	SAFETY P/WINDOW 25A	P/WINDOW RH 25A	
						P/WINDOW LH 25A	AMP 25A	

91941-D3620

OTLA075031

## Instrument panel fuse panel

Fuse Name	Fuse rating	Circuit Protected
A/CON1	7.5A	A/C Control Module, Cluster Ionizer (Auto A/C), E/R Junction Block (Blower Relay)
WIPER RR	15A	ICM Relay Box (Rear Wiper Relay), Rear Wiper Motor
MODULE6	10A	BCM, Smart Key Control Module
WASHER	15A	Multifunction Switch (Washer Switch)
MODULE5	7.5A	Crash Pad Switch, Parking Assist Buzzer, BCM, ATM Shift Lever, 4WD ECM, AEB Sensor, Console Switch, Blind Spot Detection Radar LH/RH, Lane Departure Warning Control Module, Lane Keeping Assist Control Module
AIR BAG	15A	SRS Control Module, Passenger Occupant Detection Sensor
MODULE1	10A	BCM, Smart Key Control Module, AUDIO, A/V & Navigation Head Unit, TMU Module, AMP, Power Outside Mirror Switch, PCB Block (Power Outlet Relay)
START	10A	ICM Relay Box (Burglar Alarm Relay), Transaxle Range Switch
MODULE7	7.5A	Front Air Ventilation Seat Control Module, Front Seat Warmer Control Module, Rear Seat Warmer
HEATED STEERING	15A	BCM
MODULE8	7.5A	Driver/Passenger Power Outside Mirror, Center Facia Switch, Key Solenoid, AEB Sensor
MODULE4	7.5A	Data Link Connector, A/C Control Module, Head Lamp LH/RH, A/V & Navigation Head Unit, Electro Chromic Mirror, TMU Module, Front Air Ventilation Seat Control Module, Front Seat Warmer Control Module, Rear Seat Warmer
A/BAG IND	7.5A	Instrument Cluster, Center Facia Switch
MODULE3	10A	BCM, ATM Shift Lever, IPS Control Module (ON/START Input)
SMART KEY1	15A	Smart Key Control Module
4WD	20A	4WD ECM

### Instrument panel fuse panel

Fuse Name	Fuse rating	Circuit Protected
TAILGATE OPEN	10A	Tail Gate Open Relay
S/HEATER RR	15A	Rear Seat Warmer
MDPS	7.5A	MDPS Unit
SMART KEY3	7.5A	Smart Key Control Module, Immobilizer Module
CLUSTER	7.5A	Instrument Cluster (IG1 Power), ATM Shift Lever ILL.
SMART KEY2	10A	Smart Key Control Module, Start/Stop Button Switch, Immobilizer Module
MULTIMEDIA	15A	Audio, A/V & Navigation Head Unit, TMU Module
INTERIOR LAMP	10A	Ignition Key Ill. & Door Warning Switch, Luggage Lamp, Glove Box Lamp, Overhead Console Lamp, Front Vanity Lamp LH/RH, Room Lamp, Rear Personal Lamp LH/RH
DOOR LOCK	20A	Door Lock Relay, Door Unlock Relay, ICM Relay Box (Two Turn Unlock Relay)
SUNROOF2	20A	Panorama Sunroof
POWER OUTLET	20A	Front Power Outlet & Cigarette Lighter
BRAKE SWITCH	7.5A	Smart Key Control Module, Stop Lamp Switch
MEMORY2	10A	Data Link Connector, BCM, Instrument Cluster, A/C Control Module, Auto Light & Photo Sensor, Electro Chromic Mirror, ICM Relay Box (Outside Mirror Folding/Unfolding Relay)
P/SEAT (PASS)	30A	Passenger Seat Manual Switch
S/HEATER FRT	20A	Front Air Ventilation Seat Control Module, Front Seat Warmer Control Module
SUNROOF1	20A	Panorama Sunroof
MODULE2	20A	PCB Block (Fuse - ABS3, ECU6, TCU2, MODULE1, MODULE2)
A/CON2	7.5A	A/C Control Module
HEATED MIRROR	10A	Driver/Passenger Power Outside Mirror, A/C Control Module, ECM (G4FJ)

## Instrument panel fuse panel

Fuse Name	Fuse rating	Circuit Protected
P/SEAT (DRV)	30A	Driver Seat Manual Switch
SAFETY P/WINDOW	25A	Driver Safety Power Window Module
P/WINDOW RH	25A	Power Window Main Switch, Passenger Power Window Switch
P/WINDOW LH	25A	Power Window Main Switch
AMP	25A	AMP

### Engine compartment fuse panel

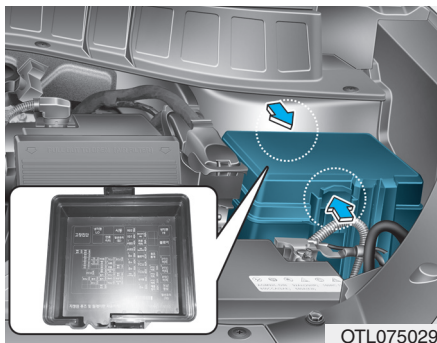

OTL075029

Inside the fuse/relay box cover, you can find the fuse/relay label describing fuse/relay name and capacity.

#### **i** Information

Not all fuse panel descriptions in this manual may be applicable to your vehicle; the information is accurate at the time of printing. When you inspect the fuse panel in your vehicle, refer to the fuse panel label.

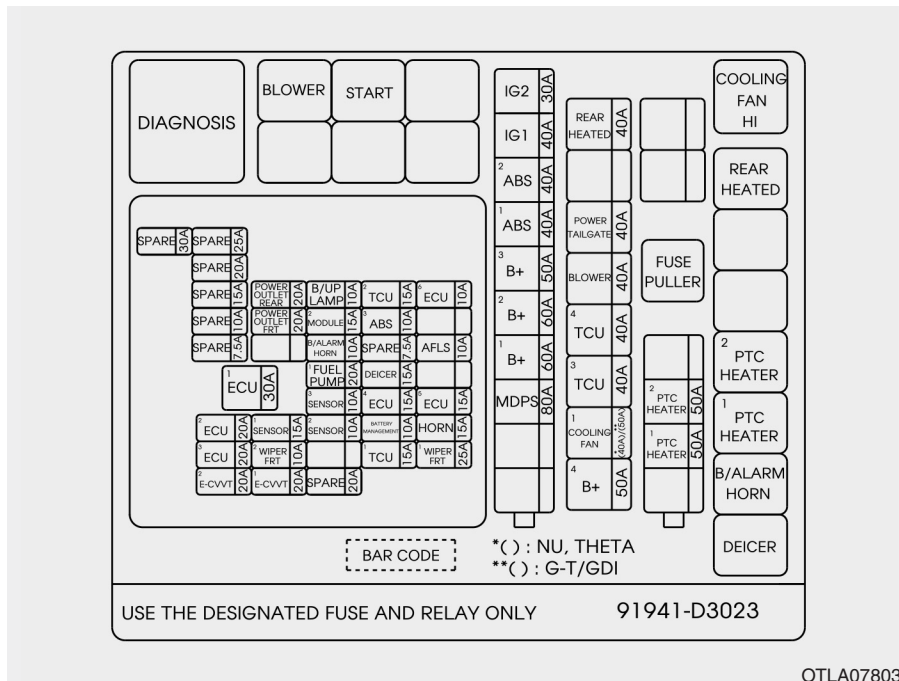

OTLA078030

## Engine compartment main fuse panel

	Fuse Name	Fuse rating	Protected Component
MULTI FUSE	MDPS	80A	MDPS Unit
	B+1	60A	Smart Junction Block (ARISU-LT IPS 1, IPS 2, IPS 3, IPS 4, Fuse - AMP)
	B+2	60A	Smart Junction Block (ARISU-LT IPS 5, IPS 6, IPS 7, IPS 8, Fuse - SMART KEY1, SMART KEY2, BRAKE SWITCH)
	B+3	50A	Smart Junction Block (Fuse - SUNROOF1, SUNROOF2, S/HEATER FRT, S/HEATER RR, SAFETY P/WINDOW, Power Window Relay (Fuse - P/WINDOW LH, P/WINDOW RH)
	ABS1	40A	ESC Module, Multipurpose Check Connector
	ABS2	40A	ESC Module, Multipurpose Check Connector
	IG1	40A	Ignition Switch (W/O Smart Key), PCB Block (PDM (IG1)/PDM (ACC) Relay - With Smart Key)
	IG2	30A	Start Relay, Ignition Switch (W/O Smart Key), PCB Block (PDM (IG2) Relay - With Smart Key)
FUSE	B+4	50A	Smart Junction Block (Fuse - MODULE8, 4WD, P/SEAT (DRV), P/SEAT (PASS), TAILGATE OPEN, DOOR LOCK, Leak Current Autocut Device - Fuse Switch, INTERIOR LAMP, MULTIMEDIA, MEMORY2)
	COOLING FAN1	40A	[G4NC] Cooling Fan High Relay
		50A	[G4FJ] Cooling Fan High Relay
	TCU3	40A	[G4FJ - 7DCT] TCM
	TCU4	40A	[G4FJ - 7DCT] TCM
	BLOWER	40A	Blower Relay
	POWER TAILGATE	40A	Power Tail Gate Module
REAR HEATED	40A	Rear Defogger Relay	

### Engine compartment main fuse panel

Fuse Name	Fuse rating	Circuit Protected
WIPER FRT1	25A	Ignition Switch (W/O Smart Key), PDM (IG2) Relay (With Smart Key)
TCU1	15A	[G4FJ] TCM (7DCT)
WIPER FRT2	10A	BCM
ECU3	20A	PCM (G4NC) / ECM (G4FJ)
HORN	15A	Horn Relay
BATTERY MANAGEMENT	10A	Battery Sensor
SENSOR2	10A	[G4NC] Oil Control Valve #1/#2, Camshaft Position Sensor #1/#2, Purge Control Solenoid Valve, Variable Intake Solenoid Valve, Canister Close Valve, Fuel Pump Relay [G4FJ] Oil Control Valve #1/#2, Purge Control Solenoid Valve, Canister Close Valve, Fuel Pump Relay
SENSOR1	15A	[G4NC] PCM, Oxygen Sensor (Up)/(Down) [G4FJ] ECM, Oxygen Sensor (Up)/(Down)
ECU2	20A	IGNITION COIL #1/#2/#3/#4, Condenser (G4NC)
ECU5	15A	PCM (G4NC) / ECM (G4FJ)
ECU4	15A	PCM (G4NC) / ECM (G4FJ)
SENSOR3	10A	[G4NC] E/R Junction Block (Cooling Fan High Relay) [G4FJ] Brake Vacuum Switch, RCV Control Solenoid Valve, E/R Junction Block (Cooling Fan High Relay)
DEICER	15A	E/R Junction Block (Front Deicer Relay)
FUEL PUMP1	20A	Fuel Pump Relay
MODULE1	7.5A	O/S Mirror Switch
B/ALARM HORN	10A	E/R Junction Block (B/Alarm Horn Relay)
ABS3	10A	ESC Module
AFLS	10A	Adaptive Front Light System
PCT Heater1	50A	PCT Heater 1
PCT Heater2	50A	PCT Heater 2



## Engine compartment main fuse panel

Fuse Name	Fuse rating	Circuit Protected
MODULE2	10A	[G4FJ] Vacuum Pump
POWER OUTLER FRT	20A	Front Power Outlet & Cigarette Lighter
ECU6	10A	PCM (G4NC) / ECM (G4FJ)
TCU2	15A	Transaxle Range Switch, TCM (G4FJ - 7DCT)
B/UP LAMP	10A	PCM (G4NC) / TCM (G4FJ), Transaxle Range Switch, Audio, A/V & Navigation Head Unit, Electro Chromic Mirror, Rear Combination Lamp (IN) LH/RH
POWER OUTLER REAR	20A	Rear Power Outlet
ECU1	30A	Engine Control Relay
E-CVVT1	20A	PCM (G4NC) / ECM (G4FJ)
E-CVVT2	20A	PCM (G4NC) / ECM (G4FJ)

### LIGHT BULBS

Consult an authorized HYUNDAI dealer to replace most vehicle light bulbs. It is difficult to replace vehicle light bulbs because other parts of the vehicle must be removed before you can get to the bulb. This is especially true for removing the headlamp assembly to get to the bulb(s).

Removing/installing the headlamp assembly can result in damage to the vehicle.

#### **i** Information

After heavy driving, rain or washing, headlamp and trunk lenses could appear frosty. This condition is caused by the temperature difference between the lamp inside and the outside temperature. This is similar to the condensation on your windows inside your vehicle during the rain and doesn't indicate a problem with your vehicle. If the water leaks into the lamp bulb circuitry, have your vehicle checked by an authorized HYUNDAI dealer.

#### **i** Information - Desiccant (if equipped)

This vehicle is equipped with desiccant to reduce fogging inside the headlamp due to moisture.

The desiccant is consumable and its performance may change based on the used period or environment.

If fogging inside the headlamp due to moisture continues for a long time, have your vehicle checked by an authorized HYUNDAI dealer.

After inspection, you may receive proper service according to the warranty policy.

#### **⚠** WARNING

- Prior to replacing a lamp, depress the foot brake, move the shift lever into P (Park) apply the parking brake, place the ignition switch to the LOCK/OFF position, and take the key with you when leaving the vehicle to avoid sudden movement of the vehicle and to prevent possible electric shock.
- Be aware the bulbs may be hot and may burn your fingers.

## Headlamp, Parking lamp, Turn signal lamp, side marker and front fog lamp bulb replacement

### Type A – Halogen Headlamps (Low/High beam)



- (1) Headlamp (Low)
- (2) Headlamp (High)
- (3) Turn signal lamp
- (4) Parking lamp
- (5) Side marker lamp
- (6) Daytime running lamp (DRL)
- (7) Fog lamp

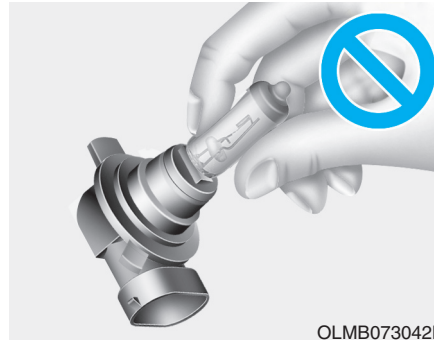

Headlamp (Halogen bulb)

#### **⚠ WARNING**

- **Handle halogen bulbs with care. Halogen bulbs contain pressurized gas that will produce flying pieces of glass that could cause injuries if broken.**
- **Wear eye protection when changing a bulb. Allow the bulb to cool down before handling it.**

- Always handle them carefully, and avoid scratches and abrasions. If the bulbs are lit, avoid contact with liquids.
- Never touch the glass with bare hands. Residual oil may cause the bulb to overheat and burst when lit.
- A bulb should be operated only when installed in a headlamp.
- If a bulb becomes damaged or cracked, replace it immediately and carefully dispose of it.

### ■ High/Low beam

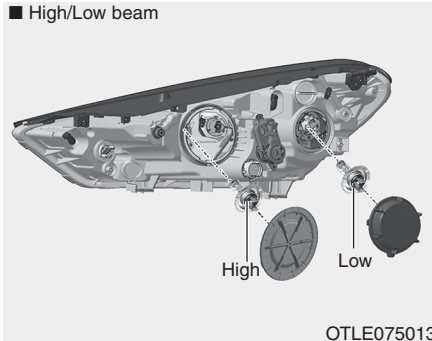

1. Open the hood.
2. Disconnect the negative battery cable.
3. Remove the headlamp bulb cover by turning it counterclockwise.
4. Disconnect the headlamp bulb socket-connector.
5. Unsnap the headlamp bulb retaining wire by pressing the end and pushing it upward.
6. Remove the bulb from the headlamp assembly.
7. Install a new headlamp bulb and snap the headlamp bulb retaining wire into position by aligning the wire with the groove on the bulb.

8. Connect the headlamp bulb socket-connector.
9. Install the headlamp bulb cover by turning it clockwise.

### **i** Information

The headlamp aiming should be adjusted after an accident or after the headlamp assembly is reinstalled at an authorized HYUNDAI dealer.

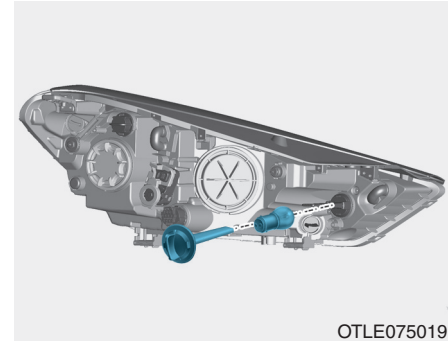

### Turn signal lamp

1. Open the hood.
2. Disconnect the negative battery cable.
3. Remove the socket from the assembly by turning the socket counterclockwise until the tabs on the socket align with the slots on the assembly.
4. Remove the bulb from the socket by pressing it in and rotating it counterclockwise until the tabs on the bulb align with the slots in the socket. Pull the bulb out of the socket.

5. Install a new bulb by inserting it into the socket and rotating it until it locks into place.
6. Install the socket in the assembly by aligning the tabs on the socket with the slots in the assembly.
7. Push the socket into the assembly and turn the socket clockwise.

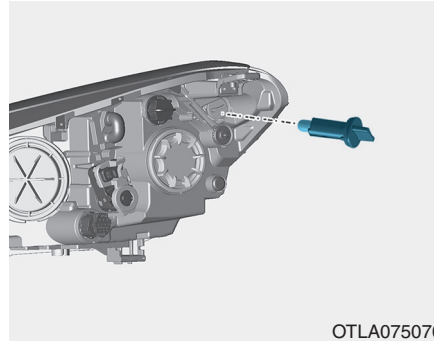

#### Side marker lamp

1. Open the hood.
2. Disconnect the negative battery cable.
3. Remove the socket from the assembly by turning the socket counterclockwise until the tabs on the socket align with the slots on the assembly.
4. Remove the bulb from the socket by pulling out the bulb.
5. Insert a new bulb.

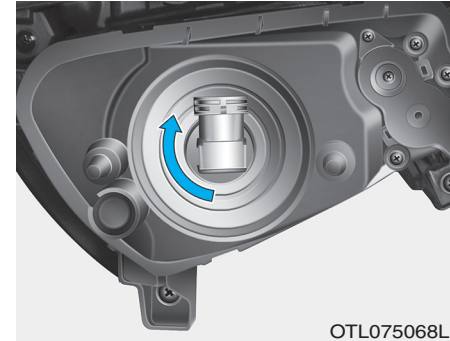

#### Front fog lamp

1. Remove the front bumper under cover.
2. Reach your hand into the back of the front bumper.
3. Disconnect the power connector from the socket.
4. Remove the bulb-socket from the housing by turning the socket counterclockwise until the tabs on the socket align with the slots on the housing.

### Parking lamp/Daytime running lamp (LED type)

Your vehicle is equipped with LED lamps. LED lamps do not have replaceable bulbs. If the LED lamp does not operate, have the vehicle checked by an authorized HYUNDAI dealer.

### Type B – HID Headlamp (Low beam)



- (1) Headlamp (Low)
- (2) Headlamp (High)
- (3) Turn signal lamp
- (4) Parking lamp
- (5) Side marker lamp
- (6) Daytime running lamp (DRL)
- (7) Fog lamp

### Headlamp (Low, HID type)

#### WARNING

#### HID Headlamp low beam

**Do not attempt to replace or inspect the low beam (XENON bulb) due to electric shock danger. If the low beam (XENON bulb) is not working, have your vehicle checked by an authorized HYUNDAI Dealer.**

### **i** Information

If your vehicle is equipped with High Intensity Discharge (HID) headlamps, these headlamps contain mercury. So if you need to have your vehicle disposed, you should remove the HID Headlamps before disposal. The removed HID headlamps should be recycled, re-used or disposed as hazardous waste.

If the light bulb does not operate, have the vehicle checked by an authorized HYUNDAI dealer.

### **i** Information

HID lamps have superior performance vs. halogen bulbs.

HID lamps are estimated by the manufacturer to last twice as long or longer than halogen bulbs depending on their frequency of use. They will probably require replacement at some point in the life of the vehicle. Cycling the headlamps on and off more than typical use will shorten HID lamps life. HID lamps do not fail in the same manner as halogen incandescent lamps. If a headlamp goes out after a period of operation but will immediately relight when the headlamp switch is cycled it is likely the HID lamp needs to be replaced. HID lighting components are more complex than conventional halogen bulbs thus have higher replacement cost.

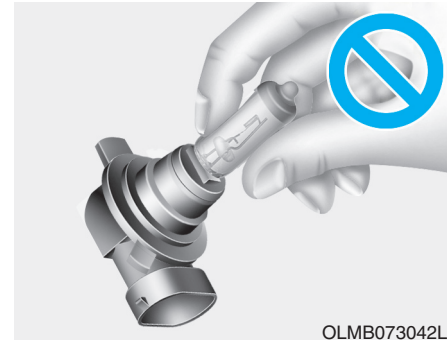

OLMB073042L

Headlamp (High, Halogen type)

#### **⚠ WARNING**

- Handle halogen bulbs with care. Halogen bulbs contain pressurized gas that will produce flying pieces of glass that could cause injuries if broken.
- Wear eye protection when changing a bulb. Allow the bulb to cool down before handling it.

- Always handle them carefully, and avoid scratches and abrasions. If the bulbs are lit, avoid contact with liquids.
- Never touch the glass with bare hands. Residual oil may cause the bulb to overheat and burst when lit.
- A bulb should be operated only when installed in a headlamp.
- If a bulb becomes damaged or cracked, replace it immediately and carefully dispose of it.

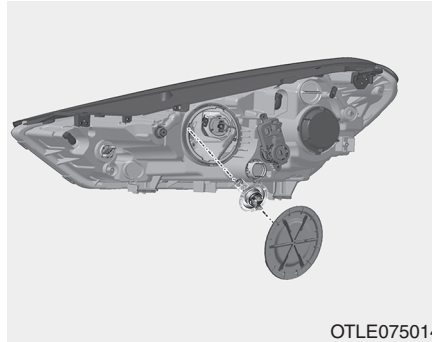

1. Open the hood.
2. Disconnect the negative battery cable.
3. Remove the headlamp bulb cover by turning it counterclockwise.
4. Disconnect the headlamp bulb socket-connector.
5. Unsnap the headlamp bulb retaining wire by pressing the end and pushing it upward.
6. Remove the bulb from the headlamp assembly.
7. Install a new headlamp bulb and snap the headlamp bulb retaining wire into position by aligning the wire with the groove on the bulb.

8. Connect the headlamp bulb socket-connector.
9. Install the headlamp bulb cover by turning it clockwise.

### **i** Information

**The headlamp aiming should be adjusted after an accident or after the headlamp assembly is reinstalled at an authorized HYUNDAI dealer.**



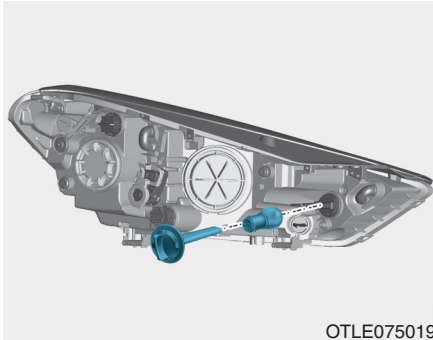

### Turn signal lamp

1. Open the hood.
2. Disconnect the negative battery cable.
3. Remove the socket from the assembly by turning the socket counterclockwise until the tabs on the socket align with the slots on the assembly.
4. Remove the bulb from the socket by pressing it in and rotating it counterclockwise until the tabs on the bulb align with the slots in the socket. Pull the bulb out of the socket.

5. Install a new bulb by inserting it into the socket and rotating it until it locks into place.
6. Install the socket in the assembly by aligning the tabs on the socket with the slots in the assembly.
7. Push the socket into the assembly and turn the socket clockwise.

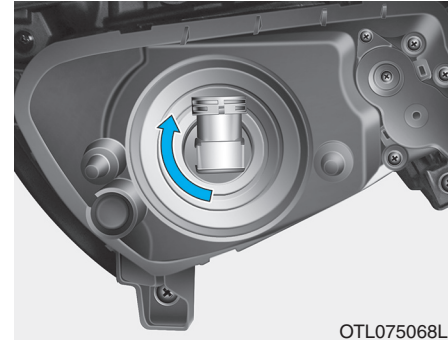

### Front fog lamp

1. Remove the front bumper under cover.
2. Reach your hand into the back of the front bumper.
3. Disconnect the power connector from the socket.
4. Remove the bulb-socket from the housing by turning the socket counterclockwise until the tabs on the socket align with the slots on the housing.

### Parking lamp/Side marker lamp/ Daytime running lamp (LED type)

Your vehicle is equipped with LED lamps. LED lamps do not have replaceable bulbs. If the LED lamp does not operate, have the vehicle checked by an authorized HYUNDAI dealer.

### Type C – LED Headlamp (Low beam)



- (1) Headlamp (Low)
- (2) Headlamp (High)
- (3) Turn signal lamp
- (4) Parking lamp
- (5) Side marker lamp
- (6) Daytime running lamp (DRL)
- (7) Fog lamp

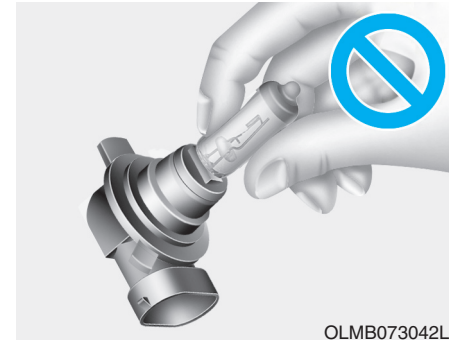

Headlamp (High, Halogen type)

### **⚠ WARNING**

- Handle halogen bulbs with care. Halogen bulbs contain pressurized gas that will produce flying pieces of glass that could cause injuries if broken.
- Wear eye protection when changing a bulb. Allow the bulb to cool down before handling it.

- Always handle them carefully, and avoid scratches and abrasions. If the bulbs are lit, avoid contact with liquids.
- Never touch the glass with bare hands. Residual oil may cause the bulb to overheat and burst when lit.
- A bulb should be operated only when installed in a headlamp.
- If a bulb becomes damaged or cracked, replace it immediately and carefully dispose of it.

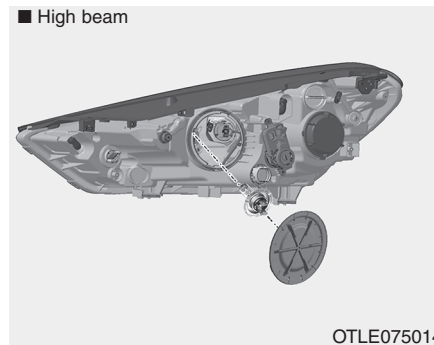

1. Open the hood.
2. Disconnect the negative battery cable.
3. Remove the headlamp bulb cover by turning it counterclockwise.
4. Disconnect the headlamp bulb socket-connector.
5. Unsnap the headlamp bulb retaining wire by pressing the end and pushing it upward.
6. Remove the bulb from the headlamp assembly.
7. Install a new headlamp bulb and snap the headlamp bulb retaining wire into position by aligning the wire with the groove on the bulb.

8. Connect the headlamp bulb socket-connector.
9. Install the headlamp bulb cover by turning it clockwise.

### **i** Information

**The headlamp aiming should be adjusted after an accident or after the headlamp assembly is reinstalled at an authorized HYUNDAI dealer.**

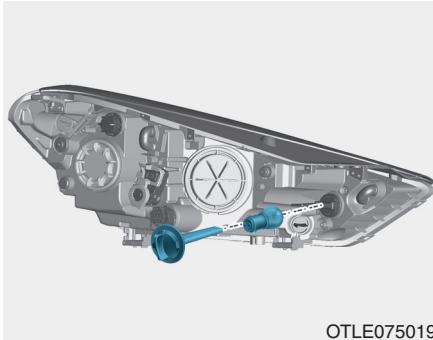

### Turn signal lamp

1. Open the hood.
2. Disconnect the negative battery cable.
3. Remove the socket from the assembly by turning the socket counterclockwise until the tabs on the socket align with the slots on the assembly.
4. Remove the bulb from the socket by pressing it in and rotating it counterclockwise until the tabs on the bulb align with the slots in the socket. Pull the bulb out of the socket.

5. Install a new bulb by inserting it into the socket and rotating it until it locks into place.
6. Install the socket in the assembly by aligning the tabs on the socket with the slots in the assembly.
7. Push the socket into the assembly and turn the socket clockwise.

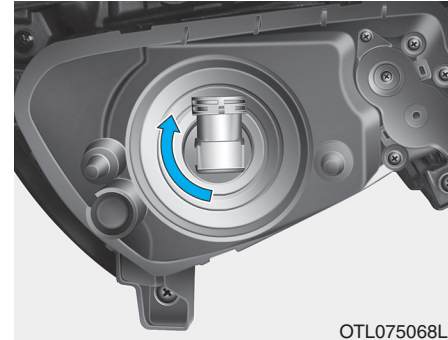

### Front fog lamp

1. Remove the front bumper under cover.
2. Reach your hand into the back of the front bumper.
3. Disconnect the power connector from the socket.
4. Remove the bulb-socket from the housing by turning the socket counter clockwise until the tabs on the socket align with the slots on the housing.

### Headlamp (Low)/Parking lamp/ Side marker lamp/Daytime running lamp (LED type)

Your vehicle is equipped with LED lamps. LED lamps do not have replaceable bulbs. If the LED lamp does not operate, have the vehicle checked by an authorized HYUNDAI dealer.

### Side repeater lamp replace- ment

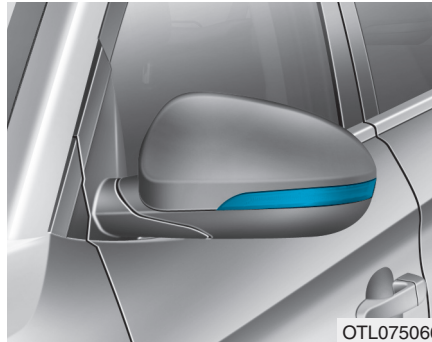

If the light bulb does not operate,  
have the vehicle checked by an  
authorized HYUNDAI dealer.

### Rear combination light bulb replacement

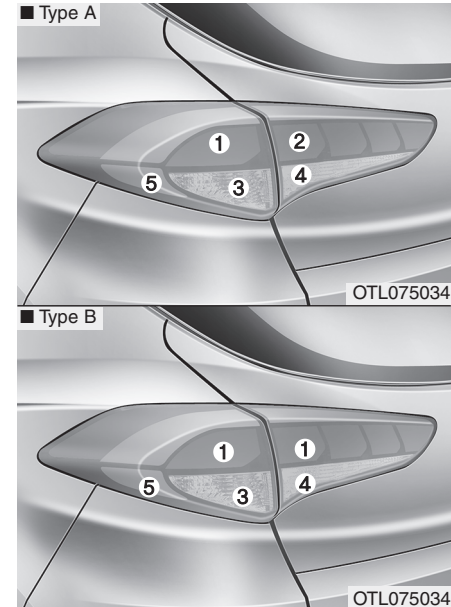

- (1) Stop/tail lamp
- (2) Tail lamp
- (3) Rear turn signal lamp
- (4) Back-up lamp
- (5) Side marker

### Outside lamp

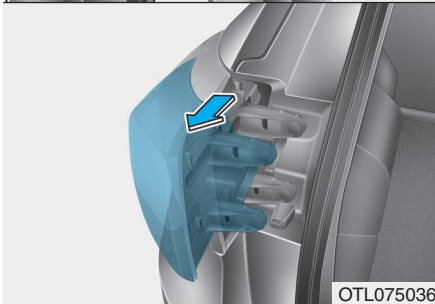
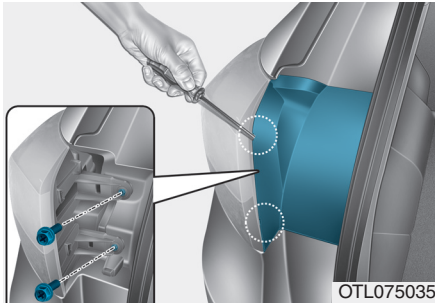

### Stop/tail Lamp, Turn signal Lamp and Side marker lamp

1. Turn off the engine.
2. Open the liftgate.

3. Loosen the lamp assembly retaining screws with a cross-tip screwdriver.
4. Remove the rear combination lamp assembly from the body of the vehicle.

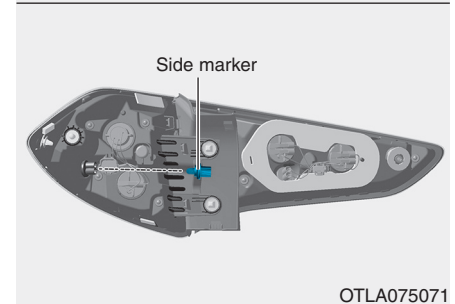
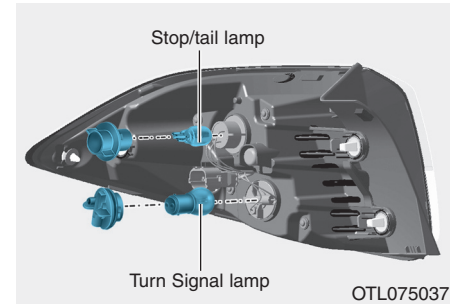

5. Remove the socket from the assembly by turning the socket counterclockwise until the tabs on the socket align with the slots on the assembly.

6. Remove the bulb from the socket by pressing it in and rotating it counterclockwise until the tabs on the bulb align with the slots in the socket. Pull the bulb out of the socket.
7. Insert a new bulb by inserting it into the socket and rotating it until it locks into place.
8. Install the socket in the assembly by aligning the tabs on the socket with the slots in the assembly. Push the socket into the assembly and turn the socket clockwise.
9. Reinstall the lamp assembly to the body of the vehicle.

### Stop/tail lamp and Side marker lamp (LED type)

If the LED lamp does not operate, have the vehicle checked by an authorized HYUNDAI dealer.

### Inside lamp



### Tail lamp/Back-up lamp

1. Turn off the engine.
2. Open the liftgate.
3. Remove the service cover using a flat-blade screwdriver.

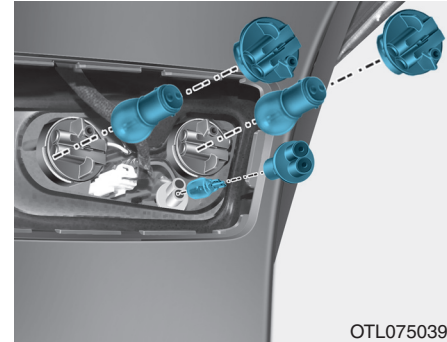

4. Remove the socket from the assembly by turning the socket counterclockwise until the tabs on the socket align with the slots on the assembly.
5. Pull the bulb out of the socket.
6. Insert a new bulb into the socket.
7. Install the socket into the assembly by aligning the tabs on the socket with the slots on the assembly and turning the socket clockwise.
8. Reinstall the lamp assembly to the body of the vehicle.

### Stop and tail lamp (LED type)

If the LED lamp does not operate, have the vehicle checked by an authorized HYUNDAI dealer.

### High mounted stop lamp replacement

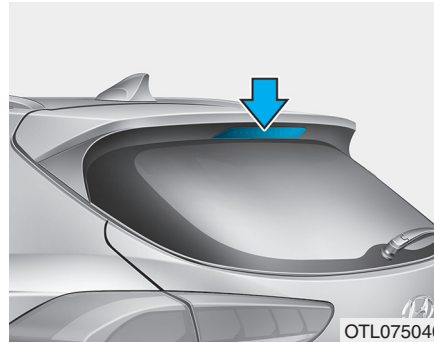

1. Open the liftgate.
2. Gently remove the center cover of the rear tailgate trim.
3. Disconnect the electrical connector.
4. Remove the plug.
5. Loosen the retaining nuts and remove the spoiler.
6. Remove the high mounted stop light assembly after loosening the nuts and washer nozzle.
7. Reinstall a new light assembly in the reverse order of removal.

### License plate light bulb replacement

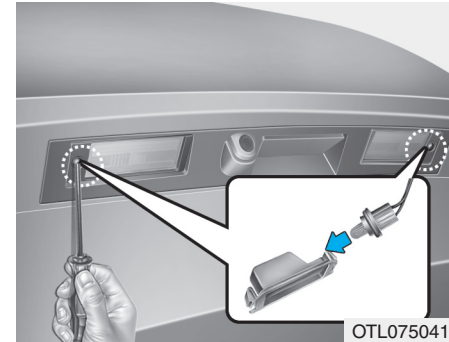

1. Loosen the lens retaining screws with a screwdriver.
2. Remove the lens.
3. Remove the bulb by pulling it straight out.
4. Install a new bulb.
5. Reinstall the lens securely with the lens retaining screws.



## Interior light bulb replacement

### Map lamp, Room lamp, Vanity mirror lamp, Tailgate room lamp and glove box lamp

■ Map lamp - with sunroof



■ Map lamp - without sunroof

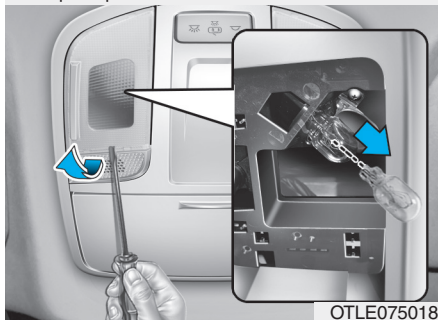

■ Vanity mirror lamp

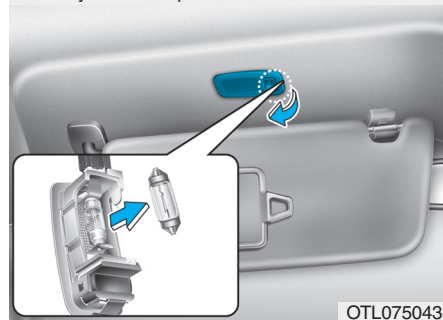

■ Room lamp - with sunroof

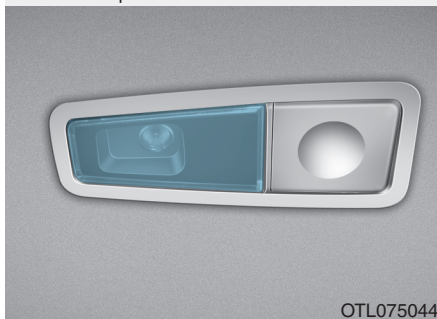

■ Room lamp - without sunroof

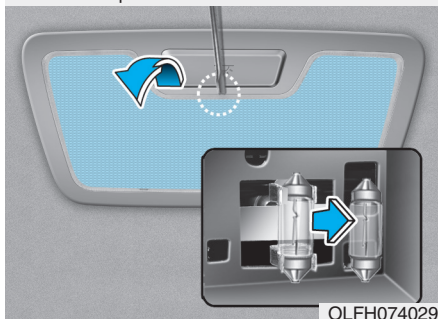

■ Tailgate room lamp

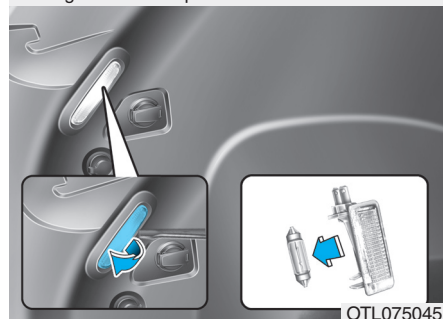

If the LED lamp does not operate, have the vehicle checked by an authorized HYUNDAI dealer.

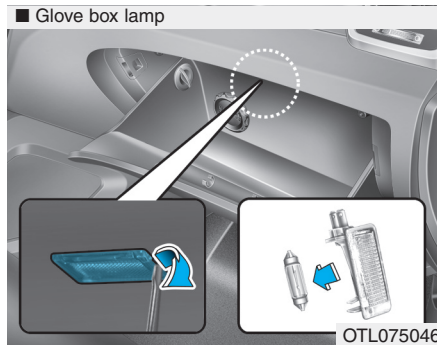

### **NOTICE**

**Use care not to dirty or damage lenses, lens tabs, and plastic housings.**

1. Using a flat-head screwdriver, gently pry the lens from the interior light housing.
2. Remove the bulb by pulling it straight out.
3. Install a new bulb in the socket.
4. Align the lens tabs with the interior light housing notches and snap the lens into place.

If the lamps do not operating, have the vehicle checked by an authorized HYUNDAI dealer.

## APPEARANCE CARE

### Exterior Care

#### *Exterior general caution*

It is very important to follow the label directions when using any chemical cleaner or polish. Read all warning and caution statements that appear on the label.

#### *High-pressure washing*

- When using high-pressure washers, make sure to maintain sufficient distance from the vehicle. Insufficient clearance or excessive pressure can lead to component damage or water penetration.
- Do not spray the camera, sensors or its surrounding area directly with a high pressure washer. Shock applied from high pressure water may cause the device to not operate normally.
- Do not bring the nozzle tip close to boots (rubber or plastic covers) or connectors as they may be damaged if they come into contact with high pressure water.

#### *Protecting your vehicle's finish*

##### Washing

To help protect your vehicle's finish from rust and deterioration, wash it thoroughly and frequently at least once a month with lukewarm or cold water.

If you use your vehicle for off-road driving, you should wash it after each off-road trip. Pay special attention to the removal of any accumulation of salt, dirt, mud, and other foreign materials. Make sure the drain holes in the lower edges of the doors and rocker panels are kept clear and clean.

Insects, tar, tree sap, bird droppings, industrial pollution and similar deposits can damage your vehicle's finish if not removed immediately.

Even prompt washing with plain water may not completely remove all these deposits. A mild soap, safe for use on painted surfaces, should be used.

After washing, rinse the vehicle thoroughly with lukewarm or cold water. Do not allow soap to dry on the finish.

### WARNING

**After washing the vehicle, test the brakes while driving slowly to see if they have been affected by water before getting on the road. If braking performance is impaired, dry the brakes by applying them lightly while maintaining a slow forward speed.**

### CAUTION

- **Do not use strong soap, chemical detergents or hot water, and do not wash the vehicle in direct sunlight or when the body of the vehicle is warm.**
- **Be careful when washing the side windows of your vehicle. Especially, with high-pressure water, water may leak through the windows and wet the interior.**
- **To prevent damage to the plastic parts, do not clean with chemical solvents or strong detergents.**



### CAUTION

- **Water washing in the engine compartment including high pressure water washing may cause the failure of electrical circuits located in the engine compartment.**
- **Never allow water or other liquids to come in contact with electrical/electronic components inside the vehicle as this may damage them.**

### Waxing

A good coat of wax provides a barrier between your paint and environmental contamination.

Keeping a good coat of wax on your vehicle will help protect it.

Wax the vehicle when water will no longer bead on the paint.

Always wash and dry the vehicle before waxing. Use a good quality liquid or paste wax, and follow the manufacturer's instructions. Wax all metal trim to protect it and to maintain its luster.

Removing oil, tar, and similar materials with a spot remover will usually strip the wax from the finish. Be sure to re-wax these areas even if the rest of the vehicle does not yet need waxing.

### CAUTION

- **Wiping dust or dirt off the body with a dry cloth will scratch the finish.**
- **Do not use steel wool, abrasive cleaners, or strong detergents containing highly alkaline or caustic agents on chrome-plated or anodized aluminum parts. This may result in damage to the protective coating and cause discoloration or paint deterioration.**

### ***Repairing your vehicle's finish***

Deep scratches or stone chips in the painted surface must be repaired promptly. Exposed metal will quickly rust and may develop into a major repair expense.

#### **NOTICE**

**If your vehicle is damaged and requires any metal repair or replacement, be sure the body shop applies anti-corrosion materials to the parts repaired or replaced.**

### ***Bright-metal maintenance***

- To remove road tar and insects, use a tar remover, not a scraper or other sharp object.
- To protect the surfaces of bright-metal parts from corrosion, apply a coating of wax or chrome preservative and rub to a high luster.
- During winter weather or in coastal areas, cover the bright metal parts with a heavier coating of wax or preservative. If necessary, coat the parts with non-corrosive petroleum jelly or other protective compound.

### ***Underbody maintenance***

Corrosive materials used for ice and snow removal and dust control may collect on the underbody. If these materials are not removed, accelerated rusting can occur on underbody parts such as the fuel lines, frame, floor pan and exhaust system, even though they have been treated with rust protection.

Thoroughly flush the vehicle underbody and wheel openings with luke-warm or cold water once a month, after off-road driving and at the end of each winter. Pay special attention to these areas because it is difficult to see all the mud and dirt. It will do more harm than good to wet down the road grime without removing it. The lower edges of doors, rocker panels, and frame members have drain holes that should not be allowed to clog with dirt; trapped water in these areas can cause rusting.

#### **⚠ WARNING**

**After washing the vehicle, test the brakes while driving slowly to see if they have been affected by water. If braking performance is impaired, dry the brakes by applying them lightly while maintaining a slow forward speed.**

### **Aluminum wheel maintenance**

The aluminum wheels are coated with a clear protective finish.

#### **CAUTION**

- **Do not use abrasive cleaner, polishing compound, solvent, or wire brushes on aluminum wheels.**
- **Clean the wheel when it has cooled.**
- **Use only a mild soap or neutral detergent, and rinse thoroughly with water. Also, clean the wheels after driving on salted roads.**
- **Do not wash the wheels with high-speed car wash brushes.**
- **Do not use any cleaners containing acid or alkaline detergents.**

### **Corrosion protection**

#### **Protecting your vehicle from corrosion**

By using the most advanced design and construction practices to combat corrosion, HYUNDAI produces cars of the highest quality. However, this is only part of the job. To achieve the long-term corrosion resistance your vehicle can deliver, the owner's cooperation and assistance is also required.

#### **Common causes of corrosion**

The most common causes of corrosion on your vehicle are:

- Road salt, dirt and moisture that is allowed to accumulate underneath the vehicle.
- Removal of paint or protective coatings by stones, gravel, abrasion or minor scrapes and dents which leave unprotected metal exposed to corrosion.

### **High-corrosion areas**

If you live in an area where your vehicle is regularly exposed to corrosive materials, corrosion protection is particularly important. Some of the common causes of accelerated corrosion are road salts, dust control chemicals, ocean air and industrial pollution.

### Moisture breeds corrosion

Moisture creates the conditions in which corrosion is most likely to occur. For example, corrosion is accelerated by high humidity, particularly when temperatures are just above freezing. In such conditions, the corrosive material is kept in contact with the car surfaces by moisture that is slow to evaporate.

Mud is particularly corrosive because it is slow to dry and holds moisture in contact with the vehicle. Although the mud appears to be dry, it can still retain the moisture and promote corrosion.

High temperatures can also accelerate corrosion of parts that are not properly ventilated so the moisture can be dispersed. For all these reasons, it is particularly important to keep your vehicle clean and free of mud or accumulations of other materials. This applies not only to the visible surfaces but particularly to the underside of the vehicle.

### To help prevent corrosion

#### *Keep your car clean*

The best way to prevent corrosion is to keep your vehicle clean and free of corrosive materials. Attention to the underside of the vehicle is particularly important.

- If you live in a high-corrosion area — where road salts are used, near the ocean, areas with industrial pollution, acid rain, etc.—, you should take extra care to prevent corrosion. In winter, hose off the underside of your vehicle at least once a month and be sure to clean the underside thoroughly when winter is over.
- When cleaning underneath the vehicle, pay particular attention to the components under the fenders and other areas that are hidden from view. Do a thorough job; just dampening the accumulated mud rather than washing it away will accelerate corrosion rather than prevent it. Water under high pressure and steam are particularly effective in removing accumulated mud and corrosive materials.

- When cleaning lower door panels, rocker panels and frame members, be sure that drain holes are kept open so that moisture can escape and not be trapped inside to accelerate corrosion.

#### *Keep your garage dry*

Don't park your car in a damp, poorly ventilated garage. This creates a favorable environment for corrosion. This is particularly true if you wash your vehicle in the garage or drive it into the garage when it is still wet or covered with snow, ice or mud. Even a heated garage can contribute to corrosion unless it is well ventilated so moisture is dispersed.

#### *Keep paint and trim in good condition*

Scratches or chips in the finish should be covered with "touch-up" paint as soon as possible to reduce the possibility of corrosion. If bare metal is showing through, the attention of a qualified body and paint shop is recommended.

Bird droppings are highly corrosive and may damage painted surfaces in just a few hours. Always remove bird droppings as soon as possible. 7-89



### Interior Care

#### *Interior general precautions*

Prevent caustic solutions such as perfume and cosmetic oil, from contacting the interior parts because they may cause damage or discoloration. If they do contact the interior parts, wipe them off immediately. See the instructions for the proper way to clean vinyl.



#### **CAUTION**

- **Never allow water or other liquids to come in contact with electrical/electronic components inside the vehicle as this may damage them.**
- **When cleaning leather products (steering wheel, seats etc.), use neutral detergents or low alcohol content solutions. If you use high alcohol content solutions or acid/alkaline detergents, the color of the leather may fade or the surface may get stripped off.**

#### *Cleaning the upholstery and interior trim*

##### **Vinyl (if equipped)**

Remove dust and loose dirt from vinyl with a whisk broom or vacuum cleaner. Clean vinyl surfaces with a vinyl cleaner.

##### **Fabric (if equipped)**

Remove dust and loose dirt from fabric with a whisk broom or vacuum cleaner. Clean with a mild soap solution recommended for upholstery or carpets. Remove fresh spots immediately with a fabric spot cleaner. If fresh spots do not receive immediate attention, the fabric can be stained and its color can be affected. Also, its fire-resistant properties can be reduced if the material is not properly maintained.



#### **CAUTION**

**Using anything but recommended cleaners and procedures may affect the fabric's appearance and fire-resistant properties.**

##### **Leather (if equipped)**

##### • Feature of Seat Leather

- Leather is made from the outer skin of an animal, which goes through a special process to be available for use. Since it is a natural object, each part differs in thickness or density. Wrinkles may appear as a natural result of stretching and shrinking depending on the temperature and humidity.
- The seat is made of stretchable fabric to improve comfort.
- The parts contacting the body are curved and the side supporting area is high which provides driving comfort and stability.
- Wrinkles may appear naturally from usage. It is not a fault of the product.



 **CAUTION**

- **Wrinkles or abrasions which appear naturally from usage are not covered by warranty.**
- **Belts with metallic accessories, zippers or keys inside the back pocket may damage the seat fabric.**
- **Make sure not to wet the seat. It may change the nature of natural leather.**
- **Jeans or clothes which could bleach may contaminate the surface of the seat covering fabric.**

• **Caring for the leather seats**

- Vacuum the seat periodically to remove dust and sand on the seat. It will prevent abrasion or damage of the leather and maintain its quality.
- Wipe the natural leather seat cover often with dry or soft cloth.
- Use of a proper leather protective may prevent abrasion of the cover and helps maintain the color. Be sure to read the instructions and consult a specialist when using leather coating or protective agents.
- Light colored (beige, cream beige) leather is easily contaminated and the stain is noticeable. Clean the seats frequently.
- Avoid wiping with wet cloth. It may cause the surface to crack.

• **Cleaning the leather seats**

- Remove all contaminations instantly. Refer to instructions below for removal of each contaminant.
- Cosmetic products (sunscreen, foundation, etc.)  
Apply cleansing cream on a cloth and wipe the contaminated spot. Wipe off the cream with a wet cloth and remove water with a dry cloth.
- Beverages (coffee, soft drink, etc.)  
Apply a small amount of neutral detergent and wipe until contaminations do not smear.
- Oil  
Remove oil instantly with absorbable cloth and wipe with stain remover used only for natural leather.
- Chewing gum  
Harden the gum with ice and remove gradually.

### ***Cleaning the seat belt webbing***

Clean the belt webbing with any mild soap solution recommended for cleaning upholstery or carpet. Follow the instructions provided with the soap. Do not bleach or re-dye the webbing because this may weaken the seat belt.

### ***Cleaning the interior window glass***

If the interior glass surfaces of the vehicle become fogged (that is, covered with an oily, greasy or waxy film), they should be cleaned with glass cleaner. Follow the directions on the glass cleaner container.



### **CAUTION**

**Do not scrape or scratch the inside of the rear window. This may result in damage to the rear window defroster grid.**

## **EMISSION CONTROL SYSTEM**

The emission control system of your vehicle is covered by a written limited warranty. Please see the warranty information contained in the Owner's Handbook & Warranty Information booklet in your vehicle.

Your vehicle is equipped with an emission control system to meet all applicable emission regulations. There are three emission control systems, as follows.

- (1) Crankcase emission control system
- (2) Evaporative emission control system
- (3) Exhaust emission control system

In order to assure the proper function of the emission control systems, it is recommended that you have your vehicle inspected and maintained by an authorized HYUNDAI dealer in accordance with the maintenance schedule in this manual.



### **CAUTION**

**For the Inspection and Maintenance Test (With Electronic Stability Control (ESC) system)**

- To prevent the vehicle from misfiring during dynamometer testing, turn the Electronic Stability Control (ESC) system off by pressing the ESC switch (ESC OFF light illuminated).
- After dynamometer testing is completed, turn the ESC system back on by pressing the ESC switch again.

### 1. Crankcase Emission Control System

The positive crankcase ventilation system is employed to prevent air pollution caused by blow-by gases being emitted from the crankcase. This system supplies fresh filtered air to the crankcase through the air intake hose. Inside the crankcase, the fresh air mixes with blow-by gases, which then pass through the PCV valve into the induction system.

### 2. Evaporative Emission Control System Including Onboard Refueling Vapor Recovery (ORVR)

The Evaporative Emission Control System is designed to prevent fuel vapors from escaping into the atmosphere. The ORVR system is designed to allow the vapors from the fuel tank to be loaded into a canister while refueling at the gas station, preventing the escape of fuel vapors into the atmosphere.

#### **Canister**

Fuel vapors generated inside the fuel tank are absorbed and stored in the onboard canister. When the engine is running, the fuel vapors absorbed in the canister are drawn into the surge tank through the purge control solenoid valve.

#### **Purge Control Solenoid Valve (PCSV)**

The purge control solenoid valve is controlled by the Engine Control Module (ECM); when the engine coolant temperature is low during idling, the PCSV closes so that evaporated fuel is not taken into the engine. After the engine warms-up during ordinary driving, the PCSV opens to introduce evaporated fuel to the engine.

### 3. Exhaust Emission Control System

The Exhaust Emission Control System is a highly effective system which controls exhaust emissions while maintaining good vehicle performance.

When the engine starts or fails to start, excessive attempts to restart the engine may cause damage to the emission system.

#### **Vehicle modifications**

- This vehicle should not be modified. Modification of your vehicle could affect its performance, safety or durability and may even violate governmental safety and emissions regulations.

In addition, damage or performance problems resulting from any modification may not be covered under warranty.

- If you use unauthorized electronic devices, it may cause the vehicle to operate abnormally, wire damage, battery discharge and fire. For your safety, do not use unauthorized electronic devices.

### ***Engine exhaust (carbon monoxide) precautions***

- Carbon monoxide can be present with other exhaust fumes. If you smell exhaust fumes of any kind in your vehicle, drive with all the windows fully open. Have your vehicle checked and repaired immediately.

#### **⚠ WARNING**

**Engine exhaust gases contain carbon monoxide (CO). Though colorless and odorless, it is dangerous and could be lethal if inhaled. Follow the instructions on this page to avoid CO poisoning.**

#### **⚠ WARNING**

#### **CALIFORNIA PROPOSITION 65 WARNING**

**Engine exhaust and a wide variety of automobile components and parts, including components found in the interior furnishings in a vehicle, contain or emit chemicals known to the State of California to cause cancer and birth defects and reproductive harm. In addition, certain fluids contained in vehicles and certain products of component wear contain or emit chemicals known to the State of California to cause cancer and birth defects or other reproductive harm.**

- Do not operate the engine in confined or closed areas (such as garages) any more than what is necessary to move the vehicle in or out of the area.
- When the vehicle is stopped in an open area for more than a short time with the engine running, adjust the ventilation system (as needed) to draw outside air into the vehicle.
- Never sit in a parked or stopped vehicle for any extended time with the engine running.
- When the engine stalls or fails to start, excessive attempts to restart the engine may cause damage to the emission control system.

### ***Operating precautions for catalytic converters (if equipped)***

#### **⚠ WARNING**

The exhaust system and catalytic converter are very hot during and immediately after the engine has been running. To avoid **SERIOUS INJURY** or **DEATH**:

- Do not park, idle, or drive the vehicle over or near flammable objects, such as grass, vegetation, paper, leaves, etc. A hot exhaust system can ignite flammable items under your vehicle.
- Keep away from the exhaust system and catalytic converter or you may get burned.

Also, Do not remove the heat sink around the exhaust system, do not seal the bottom of the vehicle, and do not coat the vehicle for corrosion control. It may present a fire risk under certain conditions.

Your vehicle is equipped with a catalytic converter emission control device.

To prevent damage to the catalytic converter and to your vehicle, take the following precautions:

#### **⚠ CAUTION**

- Use only **UNLEADED FUEL** for gasoline engines.
- Do not operate the vehicle when there are signs of engine malfunction, such as misfire or a noticeable loss of performance.
- Do not misuse or abuse the engine. Examples of misuse are coasting with the engine off and descending steep grades in gear with the engine off.
- Do not operate the engine at high idle speed for extended periods (5 minutes or more).

(Continued)

(Continued)

- Do not modify or tamper with any part of the engine or emission control system. All inspections and adjustments must be made by an authorized HYUNDAI dealer.
- Avoid driving with extremely low fuel level. If you run out of gasoline, it could cause the engine to misfire and result in excessive loading of the catalytic converter.

## **CALIFORNIA PERCHLORATE NOTICE**

Perchlorate Material-special handling may apply, See: [www.dtsc.ca.gov/hazardouswaste/perchlorate](http://www.dtsc.ca.gov/hazardouswaste/perchlorate).

Notice to California Vehicle Dismantlers:

Perchlorate containing materials, such as air bag inflators, seatbelt pretensioners and keyless remote entry batteries, must be disposed of according to Title 22 California Code of Regulations Section 67384.10 (a).

# Specifications, Consumer information and Reporting safety defects

Engine .....	8-2
Dimensions .....	8-2
Gross vehicle weight .....	8-3
Luggage volume .....	8-3
Bulb Wattage .....	8-4
Tires and Wheels .....	8-6
Air Conditioning System.....	8-7
Recommended Lubricants and Capacities .....	8-8
Recommended SAE Viscosity Number .....	8-10
Vehicle Identification Number (VIN) .....	8-11
Vehicle Certification Label .....	8-11
Tire Specification and Pressure Label .....	8-12
Engine Number .....	8-12
Refrigerant Label.....	8-13
Consumer Information.....	8-14
Reporting Safety Defects .....	8-15

## DIMENSIONS

Items		in (mm)
Overall length		176.18 (4,475)
Overall width		72.83 (1,850)
Overall height		64.76 (1,645) / 66.34 (1,650) *1
Front tread	225/60 R17	63.31 (1,608)
	245/45 R19	63.15 (1,604)
Rear tread	225/60 R17	63.78 (1,620)
	245/45 R19	63.58 (1,615)
Wheelbase		105.12 (2,670)

\*1 : with roof rack

## ENGINE

Items	Gamma 1.6 Turbo-GDI	Nu 2.0 GDI	Theta 2.4 GDI
Displacement cu. in (cc)	97.09 (1,591)	121.99 (1,999)	143.96 (2,359)
Bore x Stroke in. (mm)	3.03X3.36 (77X85.4)	3.19X3.81 (81X97)	3.46X3.78 (88X96)
Firing order	1-3-4-2	1-3-4-2	1-3-4-2
No. of cylinders	4, In-line	4, In-line	4, In-line



## GROSS VEHICLE WEIGHT

lbs (kg)

Item	Gamma 1.6 Turbo-GDI		Nu 2.0 GDI		Theta 2.4 GDI	
	2WD	AWD	2WD	AWD	2WD	AWD
	Dual clutch transmission		Automatic transmission		Automatic transmission	
5-passenger	4,652 (2,110)	4,784 (2,170)	4,586 (2,080)	4,740 (2,150)	4,718 (2,140)	4,850 (2,200)

## LUGGAGE VOLUME

Item		5-passenger	
		When the rear cargo adjustable shelf is installed in the upper position:	When the rear cargo adjustable shelf is installed in the lower position:
SAE*	Front row	57 cu ft (1,614 l)	61.94 cu ft (1,754 l)
	Second row	28.11 cu ft (796 l)	30.97 cu ft (877 l)

\* : Society of Automotive Engineers

## BULB WATTAGE

Light Bulb			Bulb type	Wattage	
Front	Headlamp	Low	Type A	H7	55
			Type B	D3S	35
			Type C	LED	LED
			High	H7	55
	Turn signal lamp			PY28/8W	28
	Parking Lamp			LED	LED
	Side Marker Lamp	Type A		W5W	5
		Type B, C		LED	LED
	Fog lamp*			H8	35
Daytime running lamp (DRL)*			LED	LED	
Side Repeater lamp (Outside mirror)			LED	LED	
Rear	Rear combination lamp	Type A	Stop/Tail	P28/8W	28/8
			Tail	P21/5W	10
			Turn signal	PY27W	27
			Back up	W16W	16
		Side marker	W5W	5	
		Type B	Stop/Tail	LED	LED
			Turn signal	PY27W	27
			Back up	W16W	16
	Side marker		LED	LED	
	High mounted stop lamp			LED	LED
License plate lamp			W5W	5	

(Continued)

\* If equipped

(Continued)

Light Bulb		Bulb type	Wattage
Interior	Map lamp	with sunroof*	LED
		without sunroof	WEDGE
	Room lamp	with sunroof*	LED
		without sunroof	FESTOON
	Vanity mirror lamp	FESTOON	5
	Tailgate room lamp	FESTOON	10
Glove box lamp	W5W	5	
ETC	Puddle lamp	LED	LED

\* If equipped

## TIRES AND WHEELS

Items	Tire Size	Wheel Size	Inflation pressure kPa (psi)				Wheel lug nut torque kgf·m (lbf·ft, N·m)
			Normal Load		Maximum Load		
			Front	Rear	Front	Rear	
Full size tire	225/60 R17	7.0J X 17	240 (35)	240 (35)	240 (35)	240 (35)	11~13 (79~94, 107~127)
	245/45 R19	7.5J X 19					
Compact spare tire	T155/90 D16	4.0T X 16	420 (60)	420 (60)	420 (60)	420 (60)	

### NOTICE

- It is permissible to add 3 psi (20 kPa) to the standard tire pressure specification if colder temperatures are expected soon. Tires typically loose 1 psi (7 kPa) for every 12°F (7°C) temperature drop. If extreme temperature variations are expected, recheck your tire pressure as necessary to keep them properly inflated.
- An air pressure generally decreases, as you drive up to a high-altitude area above sea level. Thus, if you plan to drive a high-altitude area, check the tire pressures in advance. If necessary, inflate them to a proper level (Air inflation per altitude: +2.4 psi/1 mile (+10 kPa/1 km).

### CAUTION

When replacing tires, use the same size originally supplied with the vehicle.  
Using tires of a different size can damage the related parts or not work properly.

## AIR CONDITIONING SYSTEM

Items	Weight of Volume	Classification
Refrigerant oz. (g)	19.4±0.88 (550±25)	R-134a
Compressor lubricant oz. (cc)	4.23±0.35 (120±10)	PAG 30

Contact an authorized HYUNDAI dealer for more details.

## RECOMMENDED LUBRICANTS AND CAPACITIES

To help achieve proper engine and powertrain performance and durability, use only lubricants of the proper quality. The correct lubricants also help promote engine efficiency that results in improved fuel economy.

Lubricant		Volume	Classification
Engine oil *1 *2 (drain and refill) Recommends 	1.6 Turbo-GDI	4.76 US qt (4.5 l)	ACEA A5*3 (or above)
	2.0 GDI	4.23 US qt. (4.0 l)	API SM*4 & ILSAC GF-4 (or above) ACEA A5*3 (or above)
	2.4 GDI	5.07 US qt. (4.8 l)	
Automatic transmission fluid	2.0 GDI	7.71 US qt. (7.3 l)	MICHANG ATF SP-IV, SK ATF SP-IV, NOCA ATF SP-IV, HYUNDAI genuine ATF SP-IV
	2.4 GDI	7.08 US qt. (6.7 l)	
Ecoshift dual clutch transmission fluid	1.6 Turbo-GDI	2.01~2.11 US qt. (1.9~2.0 l)	HK MTF 70W (SK) SPIRAX S6 GHME 70W (H.K.SHELL) GS MTF HD 70W (GS CALTEX) (API GL-4, SAE 70W)
Engine Coolant	1.6 Turbo-GDI	7.5 US qt. (7.1 l)	Mixture of antifreeze and water (Phosphate-based Ethylene glycol coolant for aluminum radiator)
	2.0 GDI	7.93 US qt. (7.5 l)	
	2.4 GDI	8.14 US qt. (7.7 l)	

Lubricant		Volume	Classification
Brake fluid		0.74~0.85 US qt. (0.7~0.8 l)	FMVSS116 DOT-3 or DOT-4
Rear differential oil (AWD)		0.56~0.67 US qt. (0.53~0.63 l)	HYPOID GEAR OIL API GL-5, SAE75W/90 (SHELL HD AXLE OIL 75W90 or equivalent)
Transfer case oil (AWD)	1.6 Turbo-GDI	0.51~0.55 US qt. (0.48~0.52 l)	
	2.0 GDI	0.36~0.38 US qt. (0.34~0.36 l)	
	2.4 GDI		
Fuel		16.38 US gal. (62 l)	Refer to "Fuel requirements" in foreword section

\*1 : Refer to the recommended SAE viscosity numbers on the next page.

\*2 : Engine oils labeled Energy Conserving Oil are now available. Along with other additional benefits, they contribute to fuel economy by reducing the amount of fuel necessary to overcome engine friction. Often, these improvements are difficult to measure in everyday driving, but in a year's time, they can offer significant cost and energy savings.

\*3 : If the ACEA A5 engine oil is not available in your country, you are able to use ILSAC GF-3 (or above) or ACEA A3 (or above).

\*4 : If the API service SM engine oil is not available in your country, you are able to use API service SL.

## Recommended SAE viscosity number

### CAUTION

**Always be sure to clean the area around any filler plug, drain plug, or dipstick before checking or draining any lubricant. This is especially important in dusty or sandy areas and when the vehicle is used on unpaved roads. Cleaning the plug and dipstick areas will prevent dirt and grit from entering the engine and other mechanisms that could be damaged.**

Engine oil viscosity (thickness) has an effect on fuel economy and cold weather operating (engine start and engine oil flowability). Lower viscosity engine oils can provide better fuel economy and cold weather performance, however, higher viscosity engine oils are required for satisfactory lubrication in hot weather. Using oils of any viscosity other than those recommended could result in engine damage. When choosing an oil, consider the range of temperature your vehicle will be operated in before the next oil change. Proceed to select the recommended oil viscosity from the chart.

		Temperature Range for SAE Viscosity Numbers								
Temperature	°C	-30	-20	-10	0	10	20	30	40	50
	(°F)	-10	0	20	40	60	80	100	120	
1.6 Turbo-GDI *1								20W-50		
								15W-40		
								10W-30		
								5W-30, 5W-40		
2.0 GDI, 2.4 GDI *2								10W-30		
								5W-20, 5W-30		

\*1 : For better fuel economy, it is recommended to use the engine oil of a viscosity grade 5W-30 (ACEA A5 or above). However, if the engine oil is not available in your country, select the proper engine oil using the engine oil viscosity chart.

\*2 : For better fuel economy, it is recommended to use the engine oil of a viscosity grade SAE 5W-20 (API SM / ILSAC GF-4 / ACEA A5 or above). However, if the engine oil is not available in your country, select the proper engine oil using the engine oil viscosity chart.





## VEHICLE IDENTIFICATION NUMBER (VIN)

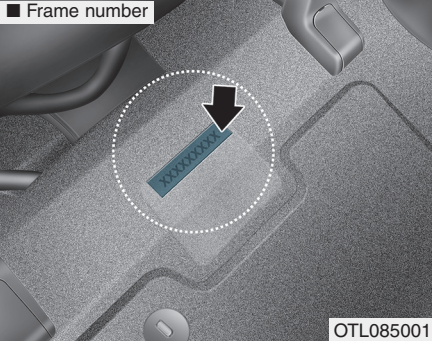

The vehicle identification number (VIN) is the number used in registering your car and in all legal matters pertaining to its ownership, etc. The number is punched on the floor under the passenger seat. To check the number, open the cover.

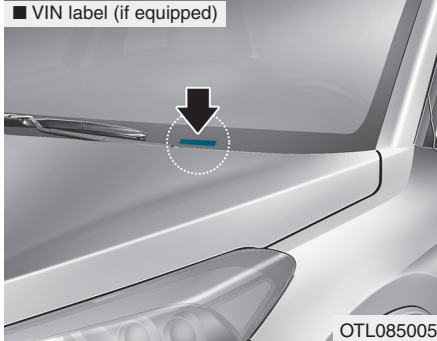

The VIN is also on a plate attached to the top of the dashboard. The number on the plate can easily be seen through the windshield from outside.

## VEHICLE CERTIFICATION LABEL

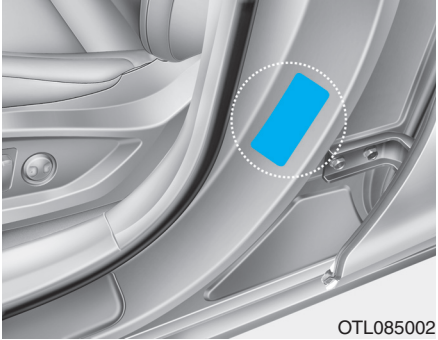

The vehicle certification label attached on the driver's side center pillar gives the Vehicle Identification Number (VIN).

## TIRE SPECIFICATION AND PRESSURE LABEL

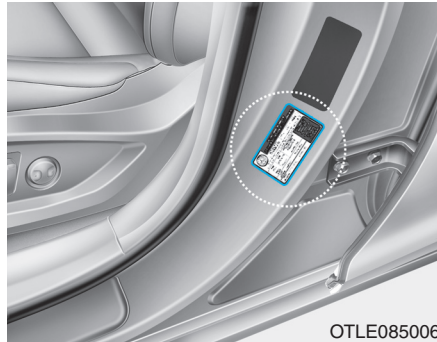

The tires supplied on your new vehicle are chosen to provide the best performance for normal driving.

The tire label located on the driver's side center pillar gives the tire pressures recommended for your car.

## ENGINE NUMBER

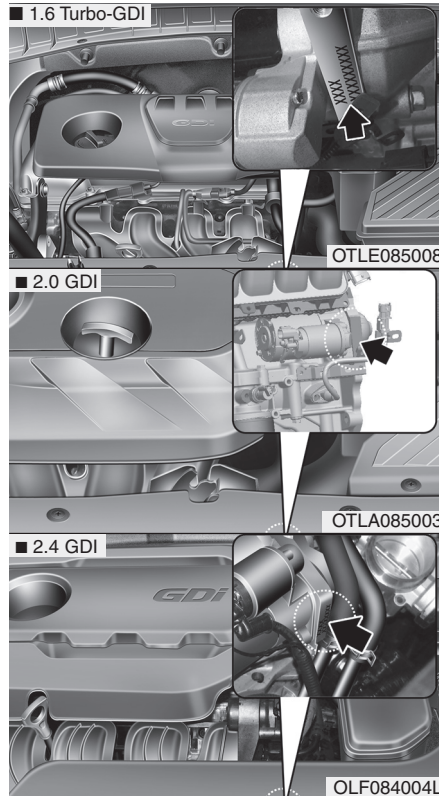

The engine number is stamped on the engine block as shown in the drawing.

## REFRIGERANT LABEL (IF EQUIPPED)

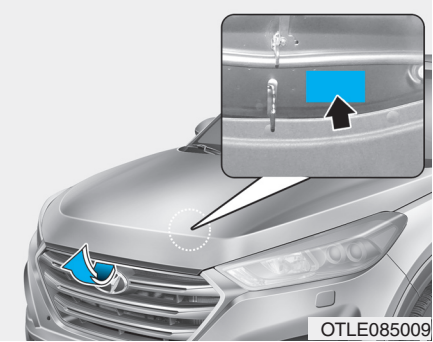

The refrigerant label provides information such as refrigerant type and amount.

The label is located on the underside of the hood.

## CONSUMER INFORMATION

This consumer information has been prepared in accordance with regulations issued by the National Highway Traffic Safety Administration of the U.S. Department of Transportation. Your HYUNDAI dealer will help answer any questions you may have as you read this information.

HYUNDAI motor vehicles are designed and manufactured to meet or exceed all applicable safety standards.

For your safety, however, we strongly urge you to read and follow all directions in this Owner's Manual, particularly the information under the headings "**NOTICE**", "**CAUTION**" and "**WARNING**".

If, after reading this manual, you have any questions regarding the operation of your vehicle, please contact your nearest HYUNDAI Motor America Regional Office as listed in the following:

### **Eastern Region:**

Connecticut, Delaware,  
Maine, Massachusetts, New  
Hampshire, New Jersey, New York,  
Pennsylvania, Rhode Island,  
Vermont.

Eastern Region  
1122 Cranbury South River Road  
Jamesburg, NJ 08831  
(800) 633-5151

### **Southern Region:**

Florida, Georgia, Maryland, North  
Carolina, South Carolina, Virginia,  
West Virginia.

Southern Region  
3025 Chastain Meadows Parkway  
Suite 100 Marietta, GA 30066  
(800) 633-5151

### **South Central Region:**

Alabama, Arkansas, Louisiana,  
Mississippi, New Mexico, Oklahoma,  
Tennessee, Texas.

South Central Region  
1421 South Beltline Road, Suite 400  
Coppell, TX 75019  
(800) 633-5151

### **Central Region:**

Illinois, Indiana, Iowa, Kentucky,  
Michigan, Minnesota, Nebraska,  
North Dakota, South Dakota, Ohio,  
Wisconsin, Kansas, Missouri.

Central Region  
2 Trans Am Plaza Dr #500 Oakbrook  
Terrace, IL 60181  
(800) 633-5151

### **Western Region:**

Alaska, Hawaii, Arizona, California,  
Colorado, Idaho, Montana, Nevada,  
Oregon, Utah, Washington,  
Wyoming.

Western Region  
10550 Talbert Avenue P.O.Box  
20850 Fountain Valley, California  
92728-0850  
(800) 633-5151

## REPORTING SAFETY DEFECTS

If you believe that your vehicle has a defect which could cause a crash or could cause injury or death, you should immediately inform the National Highway Traffic Safety Administration (NHTSA) in addition to notifying HYUNDAI MOTOR AMERICA.

To contact NHTSA, you may call the Vehicle Safety Hotline toll-free at 1-888- 327-4236 (TTY: 1-800-424-9153); go to <http://www.safercar.gov>; download the SaferCar mobile application; or write to: Administrator, NHTSA  
1200 New Jersey Ave, SE,  
West Building Washington, D.C. 20590.

You can also obtain other information about motor vehicle safety from <http://www.safercar.gov>.

If NHTSA receives similar complaints, it may open an investigation, and if it finds that a safety defect exists in a group of vehicles, it may order a recall and remedy campaign. However, NHTSA cannot become involved in individual problems between you, your dealer, or HYUNDAI MOTOR AMERICA.

# Index

**A**

Air bag warning labels.....	2-69
Air bags.....	2-46
Additional safety precautions.....	2-68
Air bag warning labels.....	2-69
Do not install a child restraint on the front passenger seat.....	2-61
How does the air bags system operate?.....	2-51
Occupant Classification System (OCS).....	2-56
SRS Care.....	2-67
What to expect after an air bag inflates.....	2-56
Where are the air bags?.....	2-48
Why didn't my air bag go off in a collision.....	2-62
Air cleaner.....	7-38
Airconditioning system	
Automatic climate control system.....	3-137
Manual climate control system.....	3-127
Airventilation seat.....	2-18
All wheel drive (AWD).....	5-40
Antenna.....	4-2
Anti-lock brake system (ABS).....	5-30
Audio.....	4-10
Auto light position.....	3-107

Automatic climate control system.....	3-137
Air conditioning.....	3-145
Automatic heating and air conditioning.....	3-138
Climate control air filter.....	3-147
Manual heating and air conditioning.....	3-139
Automatic emergency braking (AEB).....	5-56
Automatic transmission.....	5-14
Shift lock system.....	5-24
AUX, USB and iPod port.....	4-2

**B**

Battery.....	7-45
Before driving.....	5-4
Blind spot detection system (BSD).....	5-49
Blind zone mirror.....	3-36
<i>Bluetooth</i> <sup>®</sup> Wireless Technology Hands-Free.....	4-4
Brake system.....	5-27
Anti-lock brake system (ABS).....	5-30
Downhill brake control (DBC).....	5-37
Electronic stability control (ESC).....	5-32
Hill-start assist control (HAC).....	5-37
Parking brake (Manual).....	5-28
Power brakes.....	5-27
Vehicle stability management (VSM).....	5-35
Brakes fluid.....	7-28
Bulb replacement.....	7-68
Bulb wattage.....	8-4
Button start/stop, see engine start/stop button.....	5-9

## C

California perchlorate notice .....	7-96
Capacities (Lubricants) .....	8-8
Care	
Exterior care .....	7-85
Interior care .....	7-90
Tire care .....	7-40
Cargo security screen .....	3-160
Center console storage .....	3-153
Central door lock switch .....	3-16
Certification label .....	8-11
Chains	
Tire chains .....	5-80
Checking tire inflation pressure .....	7-42
Child restraint system (CRS) .....	2-35
Children always in the rear .....	2-35
Installing a Child Restraint System (CRS) .....	2-39
Selecting a Child Restraint System (CRS) .....	2-37
Child-protector rear door lock .....	3-18
Climate control air filter .....	3-135, 7-32
Clock .....	3-158
Clothes hanger .....	3-158
Combined instrument, see instrument cluster .....	3-63
Compact spare tire .....	6-19
Compass with Electric chromic mirror .....	3-28
Consumer information .....	8-14

Coolant .....	7-24
Cooling fluid, see engine coolant .....	7-24
Crankcase emission control system .....	7-93
Cruise control system .....	5-71
Cup holder .....	3-155

## D

Dashboard illumination, see instrument panel illumination .....	3-64
Dashboard, see instrument cluster .....	3-63
Day/night rearview mirror .....	3-23
Daytime running light .....	3-112
Defogging (Windshield) .....	3-149
Defroster (Rear window) .....	3-126
Defrosting (Windshield) .....	3-149
Dimensions .....	8-2
Display illumination, see instrument panel illumination .....	3-64
Displays, see instrument cluster .....	3-63
Do not install a child restraint on the front passenger seat .....	2-61
Door locks .....	3-14
Central door lock switch .....	3-16
Child-protector rear door lock .....	3-18
Downhill brake control (DBC) .....	5-37
Drinks holders, see cup holders .....	3-155
Drive mode integrated control system .....	5-46



Driver assist system .....	3-121
Rear parking assist system .....	3-122
Rear view camera .....	3-121
Driving at night .....	5-77
Driving in flooded areas .....	5-78
Driving in the rain .....	5-77

## E

Ecoshift dual clutch transmission .....	5-18
Electric chromic mirror (ECM) with homelink .....	3-24
Electric chromic mirror (ECM) with homelink and compass .....	3-28
Electric power steering .....	3-20
Electronic stability control (ESC) .....	5-32
Emergency towing .....	6-23
Emission control system .....	7-92
Crankcase emission control system .....	7-92
Evaporative emission control System .....	7-93
Exhaust emission control system .....	7-94
Engine .....	8-2
Engine compartment .....	1-6, 7-3
Engine coolant .....	7-24
Engine Coolant Temperature gauge .....	3-65
Engine number .....	8-12
Engine oil .....	7-22
Engine start/stop button .....	5-9
Evaporative emission control System .....	7-93

Exhaust emission control system .....	7-94
Explanation of scheduled maintenance items .....	7-19
Exterior care .....	7-85
Exterior features .....	3-46, 3-164
Fuel filler door .....	3-47
Hood .....	3-46
Roof rack .....	3-164
Exterior lights .....	3-107
Exterior overview .....	1-2

## F

Flat tire (with spare tire) .....	6-14
Changing tires .....	6-15
Compact spare tire .....	6-19
Jack and tools .....	6-14
Removing and storing the spare tire .....	6-15
Floor mat anchor(s) .....	3-159
Fluid	
Brakes fluid .....	7-28
Washer fluid .....	7-29
Fog lamp (front) .....	3-110
Folding the outside rearview mirror .....	3-37
Front fog lamp replacement .....	7-71, 7-75, 7-78
Front lamps (interior) .....	3-114
Front seat .....	2-6
Fuel Economy .....	3-91

Fuel filler door .....	3-47
Fuel Gauge .....	3-66
Fuel requirements .....	F-7
Fuse switch .....	7-57
Fuses .....	7-55
Fuse switch .....	7-57
Fuse/relay panel description .....	7-60
Instrument panel fuse .....	7-56
Main fuse .....	7-58
Multi fuse .....	7-59

## G

Gauges .....	3-65
Glove box .....	3-153
Glove box lamp .....	3-117
Gross vehicle weight .....	8-3

## H

Hazard warnig flasher .....	6-2
Hazardous driving conditions .....	5-76
Head restraint .....	2-14
Headlamp replacement .....	7-69, 7-72, 7-76
Heated steering wheel .....	3-21
Heater	
Automatic climate control system .....	3-137
Manual climate control system .....	3-127
Highbeam operation .....	3-109
High mounted stop lamp replacement .....	7-82
Hill-start assist control (HAC) .....	5-37
Hood .....	3-46
Horn .....	3-22
How to use this manual .....	F-6
How vehicle audio works .....	4-5

<b>I</b>	
If the engine overheats.....	6-6
If the engine stalls at a crossroad or crossing.....	6-2
If the engine stalls while driving.....	6-2
If the engine will not start.....	6-3
If you have a flat tire.....	6-14
If you have a flat tire while driving.....	6-3
Ignition switch.....	5-6
Engine Start/Stop button.....	5-9
Key ignition switch.....	5-6
Immobilizer System.....	3-12
Important safety precautions.....	2-2
Air bag hazards.....	2-2
Always wear your seat belt.....	2-2
Control your speed.....	2-3
Driver distraction.....	2-2
Keep your vehicle in safe condition.....	2-3
Restrain all children.....	2-2
In case of emergency while driving.....	6-2
Indicator light.....	3-94
Information Mode.....	3-73
Inside rearview mirror.....	3-23
Instrument cluster.....	3-63
Gauges.....	3-65
Instrument panel illumination.....	3-64
LCD Display Control.....	3-64
Transmission Shift Indicator.....	3-68

Instrument panel fuse.....	7-56
Instrument panel overview.....	1-5
Interior care.....	7-90
Interior features.....	3-155
Cargo security screen.....	3-160
Clock.....	3-158
Clothes hanger.....	3-158
Cup holder.....	3-155
Floor mat anchor(s).....	3-159
Luggage net (holder).....	3-160
Luggage tray.....	3-163
Plastic bag hook.....	3-159
Power outlet.....	3-156
Sunvisor.....	3-156
Interior lamp AUTO cut.....	3-114
Interior light.....	3-114
Front lamps.....	3-114
Glove box lamp.....	3-117
Interior lamp AUTO cut.....	3-114
Room lamp.....	3-114
Tailgate room lamp.....	3-116
Vanity mirror lamp.....	3-117
Interior light bulb replacement.....	7-83
Interior overview.....	1-4

## J

Jack and tools.....	6-14
Jack label.....	6-20
Jump starting.....	6-4

## K

Keys .....	3-4
------------	-----

## L

Label	
Refrigerant label.....	8-13
Tire sidewall labeling.....	7-45
Tire specification and pressure label.....	8-12
Vehicle certification label.....	8-11
Lane Change Assist.....	5-50
Lane departure warning system(LDWS).....	5-67
LCD display.....	3-70
Information Mode .....	3-73
LCD modes .....	3-70
User Settings Mode.....	3-75
Warning Messages.....	3-81
LCD Display Control.....	3-64
LCD modes .....	3-70
License plate light bulb replacement.....	7-82

Lighting.....	3-107
Auto light position.....	3-107
Daytime running light .....	3-112
Exterior lights .....	3-107
Front fog lamp .....	3-110
Highbeam operation .....	3-109
Interior lights .....	3-114
Turn signals .....	3-110
Welcome system.....	3-113
Low tire pressure telltale .....	6-10
Lubricants and capacities.....	8-8
Luggage net (holder).....	3-160
Luggage tray .....	3-163
Luggage volume .....	8-3

## M

Main fuse .....	7-58
Maintenance	
Explanation of scheduled maintenance items .....	7-19
Maintenance services .....	7-5
Owner maintenance.....	7-6
Scheduled maintenance service.....	7-8
Tire maintenance .....	7-45
Maintenance schedule.....	7-8
Maintenance services.....	7-5

Manual climate control system.....	3-127
Air conditioning .....	3-132
Climate control air filter.....	3-135
Heating and air conditioning.....	3-128
Mirrors .....	3-23
Blind zone mirror .....	3-36
Day/night rearview mirror.....	3-23
Electric chromic mirror (ECM) with homelink .....	3-24
Electric chromic mirror (ECM) with homelink and compass .....	3-28
Folding the outside rearview mirror.....	3-37
Inside rearview mirror.....	3-23
Outside rearview mirror .....	3-35
Outside rearview mirror control.....	3-37
Moonroof, see panorama sunroof.....	3-42
Multi fuse.....	7-59
Multimedia system.....	4-2
Antenna .....	4-2
AUX, USB and iPod port.....	4-2
Steering wheel audio control.....	4-3

**N**

Non-powered tailgate (liftgate).....	3-51
--------------------------------------	------

**O**

Odometer.....	3-67
Oil (Engine) .....	7-22
Outside rearview mirror.....	3-35
Outside rearview mirror control .....	3-37
Owner maintenance .....	7-6

**P**

Panorama sunroof .....	3-42
Parking brake .....	7-29
Parking brake (Manual) .....	5-28
Plastic bag hook.....	3-159
Power brakes.....	5-27
Power liftgate.....	3-53
Power outlet .....	3-156
Power window lock button .....	3-41

## R

Rear combination light bulb replacement.....	7-79
Rear parking assist system.....	3-122
Rear seat.....	2-11
Rear view camera .....	3-121
Rear window wiper and washer .....	3-120
Recommended cold tire inflation pressures .....	7-41
Recommended lubricants and capacities .....	8-8
Recommended SAE viscosity number.....	8-10
Reducing the risk of a rollover .....	5-79
Refrigerant label .....	8-13
Remote key .....	3-4
Reporting safety defects .....	8-15
Rocking the vehicle .....	5-76
Roof rack.....	3-164
Room lamp.....	3-114
Rotation (Tire) .....	7-42

## S

Scheduled maintenance service .....	7-8
Seat belts.....	2-22
Additional seat belt safety precautions .....	2-32
Care of seat belts.....	2-34
Seat belt restraint system.....	2-24
Seat belt safety precautions.....	2-22
Seat belt warning light .....	2-23

Seat warmers.....	2-18
Seats .....	2-4
Airventilation seat .....	2-18
Front seat .....	2-6
Head restraint .....	2-14
Rear seat .....	2-11
Safety precautions .....	2-5
Seat warmers .....	2-18
Shift lock system.....	5-24
Side marker replacement.....	7-71, 7-76, 7-79
Side repeater lamp replacement.....	7-79
Smart key .....	3-8
Smart tailgate (liftgate).....	3-59
Smooth cornering.....	5-77
Spare tire	
Changing tires .....	6-15
Compact spare tire.....	6-19
Removing and storing the spare tire .....	6-15
Special driving conditions .....	5-76
Driving at night .....	5-77
Driving in flooded areas.....	5-78
Driving in the rain .....	5-77
Hazardous driving conditions .....	5-76
Highway driving.....	5-78
Reducing the risk of a rollover.....	5-79
Rocking the vehicle.....	5-76
Smooth cornering .....	5-77
Speedometer.....	3-65

Starting difficulties, see engine will not start .....	6-3
Steering wheel.....	3-20
Electric power steering.....	3-20
Heated steering wheel .....	3-21
Horn.....	3-22
Tilt steering/Telescope steering.....	3-21
Steering wheel audio control .....	4-3
<i>Bluetooth</i> <sup>®</sup> Wireless Technology Hands-Free .....	4-4
Storage compartment .....	3-153
Center console storage .....	3-153
Glove box .....	3-153
Sunglass holder .....	3-154
Sunglass holder .....	3-154
Sunroof, see panorama sunroof .....	3-42
Sunvisor .....	3-156

**T**

Tachometer.....	3-65
Tailgate (Liftgate)	
Non-powered tailgate (liftgate).....	3-51
Power tailgate (liftgate).....	3-53
Smart tailgate(liftgate).....	3-59
Tailgate room lamp .....	3-116
Theft-alarm system .....	3-19
Tilt steering/Telescope steering .....	3-21
Tire chains.....	5-85
Tire pressure monitoring system (TPMS) .....	6-8
Low tire pressure telltale.....	6-10
Tire rotation .....	7-42
Tire specification and pressure label .....	8-12
Tires and wheels .....	7-40
Checking tire inflation pressure .....	7-42
Recommended cold tire inflation pressures .....	7-41
Tire care.....	7-40
Tire maintenance .....	7-45
Tire replacement.....	7-44
Tire rotation.....	7-42
Tire sidewall labeling .....	7-45
Tire traction .....	7-45
Wheel alignment and tire balance.....	7-43
Wheel Replacement.....	7-44
Tires and wheels specification.....	8-6

Towing .....	6-23
Trailer towing.....	5-84
Transmission	
Automatic transmission.....	5-14
Ecoshift dual clutch transmission .....	5-18
Transmission Shift Indicator.....	3-68
Trip A/B .....	3-90
Trip computer.....	3-89
Fuel Economy .....	3-91
Trip A/B.....	3-90
Turn signal lamp replacement.....	7-70, 7-75, 7-78
Turn signals.....	3-110

## U

User Settings Mode.....	3-75
-------------------------	------

## V

Vanity mirror lamp.....	3-117
Vehicle break-in process.....	F-9
Vehicle certification label .....	8-11
Vehicle data collection and event data recorders .....	F-10
Vehicle identification number (VIN).....	8-11
Vehicle load limit.....	5-92
Vehicle stability management (VSM).....	5-35

## W

Warning light .....	3-94
Warning Messages - LCD display.....	3-81
Washer fluid.....	7-29
Welcome system .....	3-113
Wheel alignment and tire balance .....	7-43
Wheel replacement .....	7-44
Windows .....	3-38
Power window lock button .....	3-41
Windshield defrosting and defogging.....	3-149
Windshield washers (Front).....	3-118
Windshield wipers (Front) .....	3-118
Winter driving.....	5-80
Tire chains .....	5-80
Wiper blades .....	7-34
Wipers and washers .....	3-118
Rear window wiper and washer.....	3-120
Windshield washers (Front) .....	3-118
Windshield wipers (Front).....	3-118