

WALK THE CUSTOMER THROUGH EACH OF THE FOLLOWING KEY DELIVERY FEATURES

Tire Pressure Monitoring System (TPMS) - Page 33



LOW TIRE PRESSURE INDICATOR: Illuminates if one or more of your tires is significantly under-inflated. Safely park the vehicle and check your tires as soon as possible, and inflate them to proper pressure.

NOTE: Tire pressure may vary in colder temperatures causing the low tire pressure light to illuminate. Inflate tires according to the tire pressure label located on the driver's side door pillar.

TPMS MALFUNCTION INDICATOR: Illuminates when there is a malfunction with the TPMS system. Have the system checked by an authorized Dealer of Genesis Brand Products as soon as possible.



LOW TIRE PRESSURE POSITION INDICATOR: Indicates which tire is significantly under-inflated by illuminating the corresponding position.

NOTE: TPMS is not a substitute for proper tire maintenance. It is the driver's responsibility to maintain correct tire pressure, even if under-inflation has not reached the level to trigger illumination of the low tire pressure indicator. Refer to the Owner's Manual for further information.

Wiper / Washer - Page 09

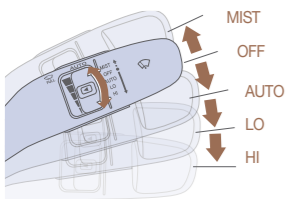

- To activate wipers move the switch down to one of three positions (AUTO, LO, HI)
- To adjust "AUTO" speed rotate dial
- To spray washer fluid, pull lever toward you
- Push lever up for a single wiper pass

Genesis Connected Services - Page 15-16

- Assist with creating a Genesis Owners account
- Assist with Genesis Connected Services enrollment
- Show Genesis Connected Services Users Manual
- Encourage customers to press the Genesis Connected Services button 

Explain Smart Drive Mode Function including SMART Icon Color Changes - Page 37

MAINTENANCE

Scheduled Maintenance (Normal Usage)		3.3T		5.0L
Engine Oil & Filter	Replace	6,000 or 12 mos.	Replace	7,500 or 12 mos.
Fuel Additives	Add	6,000 or 12 mos.	Add	7,500 or 12 mos.
Tire Rotation	Perform	6,000 or 12 mos.	Perform	7,500 or 12 mos.
Vacuum Hose				
Air Conditioning Refrigerant				
Brake Hoses & Lines				
Drive Shafts & Boots				
Exhaust Pipe & Muffler				
Front Brake Disc/Pads, Calipers	Inspect	6,000 or 12 mos.	Inspect	7,500 or 12 mos.
Rear Brake Disc/Pads				
Steering Gear Box, Linkage & Boots, Lower Arm Ball Joint, Upper Arm Ball Joint				
Suspension Mounting Bolts				
Propeller Shaft				
Air Cleaner Filter	Inspect	6,000 or 12 mos.	Inspect	7,500 or 12 mos.
	Replace	18,000 or 36 mos.	Replace	22,500 or 36 mos.
Climate Control Air Filter (For Evaporator and Blower Unit)	Inspect	6,000 or 12 mos.	Replace	7,500 or 12 mos.
Fuel Tank Air Filter				
Vapor Hose, Fuel Tank Cap, Fuel Tank				
Brake Fluid		12,000 or 24 mos.	Inspect	15,000 or 24 mos.
Parking Brake				
Fuel Filter				
Fuel Lines, Fuel Hoses & Connections	Inspect	24,000 or 48 mos.	Inspect	30,000 or 48 mos.
Front(AWD)/Rear Differential Oil				
Valve Clearance	Inspect	60,000 or 72 mos.	-	-
Drive Belts	Inspect	First 60,000 or 72 mos. Subsequent, every 12,000 or 24 mos.	Inspect	First 60,000 or 72 mos. Subsequent, every 15,000 or 24 mos.
Spark Plugs (Iridium Coated)	Replace	42,000	Replace	105,000
Coolant	Replace	First 120,000 or 120 mos. Subsequent, every 30,000 or 24 mos.	Replace	First 120,000 or 120 mos. Subsequent, every 30,000 or 24 mos.
Automatic Transmission Fluid	No check or services required for Normal Usage driving.			
*See Owner's Manual for details.				

Looking for more detailed information? This Quick Reference Guide does not replace your vehicle's Owner's Manual. If you require additional information or are unsure of a specific item, you should always refer to the vehicle's Owner's Manual or contact your authorized Dealer of Genesis Brand Products.

The information contained in this Quick Reference Guide was correct at the time of printing; however, specifications and equipment can change without notice. No warranty or guarantee is being extended in this Quick Reference Guide, and Genesis Motors USA reserves the right to change product specifications and equipment at any time without incurring obligations. Some vehicles are shown with optional equipment. Specifications apply to U.S. vehicles only. Please contact your Dealer of Genesis Brand Products for current vehicle specifications.

GENESIS G90

QUICK REFERENCE GUIDE



GENESIS BRANDED VEHICLE OWNER PRIVACY POLICY

Your Genesis Branded vehicle may be equipped with technologies and services that use information collected, generated, recorded or stored by the vehicle. We have created a Vehicle Owner Privacy Policy to explain how these technologies and services collect, use, and share this information.

You may read our Vehicle Owner Privacy Policy on the GenesisMotorsUSA.com website at <http://www.genesismotorsusa.com/privacy-policy.html>. If you would like to receive a hard copy of our Vehicle Owner Privacy Policy, please contact Customer Care at:

Genesis Customer Care
P.O. Box 20850
Fountain Valley, CA 92728
844-340-9741
CustomerCare@genesismotorsusa.com

Genesis Customer Care representatives are available Monday through Friday, between the hours of 5:00 AM and 7:00 PM PST and Saturday and Sunday between 6:30 AM and 3:00 PM PST (English). For Customer Care assistance in Spanish or Korean, representatives are available Monday through Friday between 6:30 AM and 3:00 PM PST.

Roadside Assistance: **1-844-340-9742**
SiriusXM® Radio: **1-800-967-2346**
Genesis Customer Care &
Connected Services: **1-844-340-9741**
www.MyGenesisusa.com

Table of contents

GETTING STARTED

Driver position memory system	03
Front seat adjustment	04
Headrest	05
Seat belt adjustment	02
Smart key	02

FEATURES AND CONTROLS

Adaptive front lighting system (AFLS)	09
Automatic climate control	20-21
Child-protector rear door lock	14
Driver's main controls	07
Fuel filler door	06
Head-up display	19
Headlights	08
Heated steering wheel	06
Honmlink wireless garagecontrol system	15
Instrument cluster	16-17
Instrument panel illumination	17
Interior lights	11
LCD display control	18
LCD display modes	18
Multi-view camera system	22
Parking assist system (PAS)	23
Power trunk	12
Rear door window curtain	07
Rearview camera	22
Rear window curtain	07
Seat warmer and cooler	14
Smart trunk	13
Steering wheel adjustments	06
Sunroof	10
Trunk lid control button	13
Wiper and washer	09
Wireless cellular phone charging system	23

MULTIMEDIA

Aux and USB port	31
Genesis connected services	27-28
Bluetooth operational tips	24
Bluetooth phone operation	26
Bluetooth phone pairing	26
Navigation	30-31
Steering wheel audio control	24
Voice recognition tips	25

DRIVING

Advanced smart cruise control system	39
Audio mode	30
Auto hold	32
Automatic transmission	34
Assist emergency braking (AEB)	35
Blind spot detection system (BSD)	38
Drive mode integrated control system	37
Driver attention alert system	36
Electric parking brake (EPB)	32
Electronic stability control (ESC)	36
Lane departure warning system (LDWS)	38
Paddle shifter	35
Tire pressure monitoring system (TPMS)	33

*Some vehicles may not be equipped with all the listed features.

Fuel filler door Page 06	Headlights Page 08	Instrument cluster Pages 16-17
Driver's main controls Page 07	Trunk release Page 13	Steering wheel adjustments Page 06

Advanced smart cruise control system Page 39	Wiper and washer Page 09	Automatic climate control Pages 20-21
Steering wheel audio control Page 24	Automatic transmission Page 34	AUX and USB port Page 31

Use this Quick Reference Guide to learn about the features that will enhance your enjoyment of your Genesis. More detailed information about these features are available in your Owner's Manual.

⚠ WARNING!

To reduce the risk of serious injury to yourself and others, read and understand the important SAFETY INFORMATION in your Owner's Manual.

SMART KEY

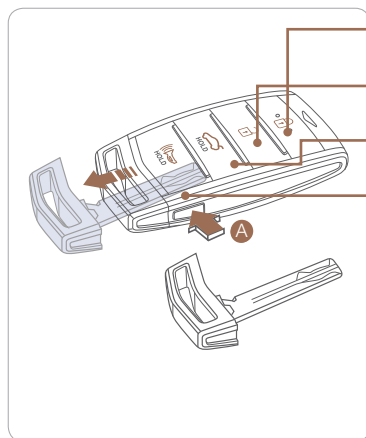

- Lock
- Unlock
- Trunk Open
- Panic

Mechanical key

Press and hold the release button **A** and remove the key.

NOTE:

User-selectable option; see the Owner's Manual for more details.

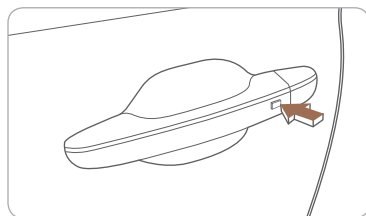

Door Lock/Unlock

Smart key must be within range

Insert hand into door handle:
 Once – Unlock driver's door
 Twice – Unlock all doors
 Press the button to lock all doors.

SEAT BELT ADJUSTMENT (Front seat)

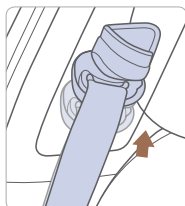
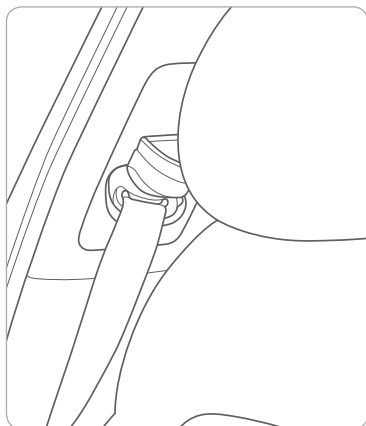

Pull up to raise.

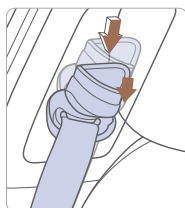

Press button and push down to lower.

DRIVER MEMORY SYSTEM

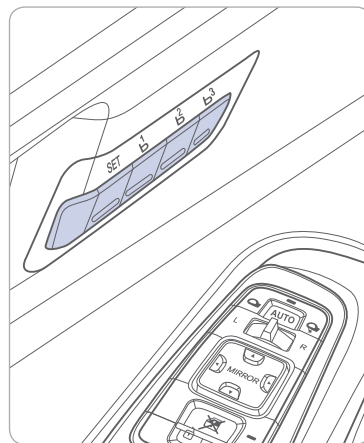

Vehicle must be in Park.

Setting seat position

1. Adjust the position of the driver's seat, outer side view mirror, steering wheel, instrument panel illumination and head-up display.
2. Press the SET button. The system will beep once.
3. Press one of the memory buttons (1, 2 or 3) within 4 seconds.

Recalling

Press the desired memory button (1, 2 or 3). The system will beep once.

FRONT SEAT ADJUSTMENT

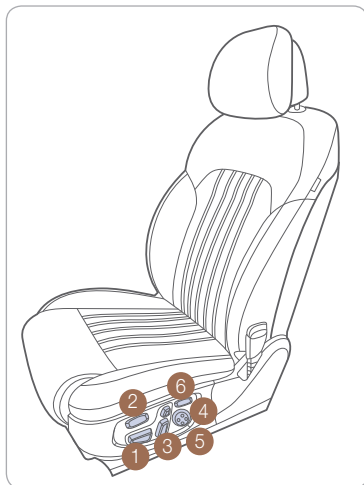

Forward and rearward ¹



Seat cushion length (for driver's seat) ²



Seatback angle ³



Seat cushion height and tilt ¹



Lumbar support ⁴

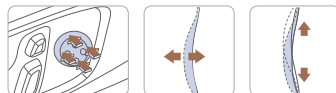

Seat bolster adjustment ⁵

(for driver's seat, if equipped)

Rotate outer ring to adjust seat bolster

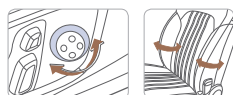

Seat shoulder adjustment ⁶

(for driver's seat, if equipped)

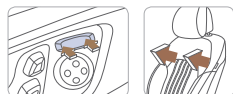

HEAD RESTRAINTS (Front seat)

Forward and rearward adjustment Up and down adjustment

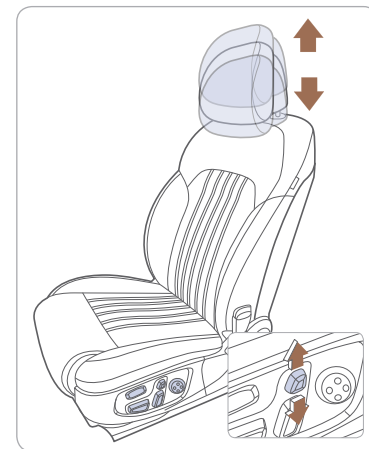
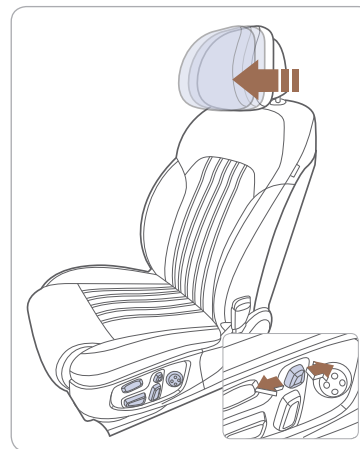

HEAD RESTRAINTS (Rear seat)

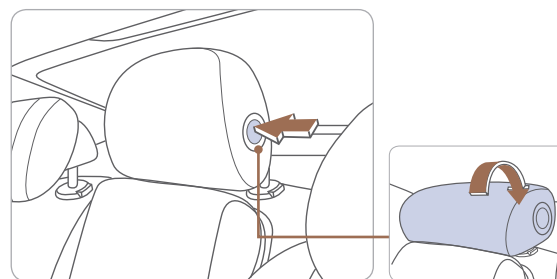

Folding the center head restraint (if equipped)

To fold the center head restraint:

- When the rear-center head restraint is not used, manually fold back the rear-center head restraint while pressing the button (1) on the side. To use the rear-center head restraint again, manually pull up the rear-center head restraint, until it is securely latched.
- You can remove the rear-center head restraint by manually pulling up the rear-center head restraint, while pressing the release button.

STEERING WHEEL ADJUSTMENTS

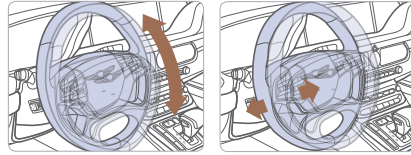
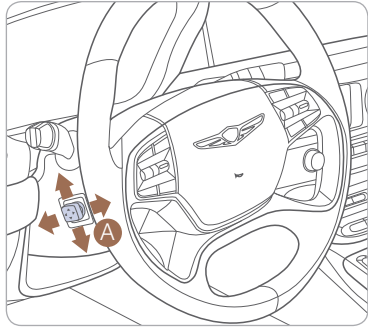

Tilt

Telescope

NOTE:

Do not adjust while driving.
Toggle switch **A** to adjust steering wheel.

HEATED STEERING WHEEL

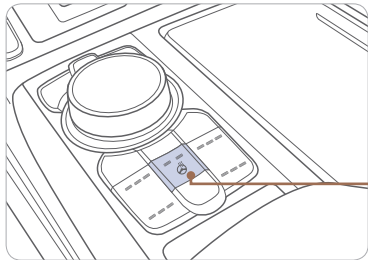

Pressing the heated steering wheel button warms the steering wheel. The indicator on the button is illuminated.



Heated steering wheel button.

NOTE:

Heated steering wheel includes Smart Logic that automatically adjust setting. Please refer to your Owner's Manual for further information.

FUEL FILLER DOOR

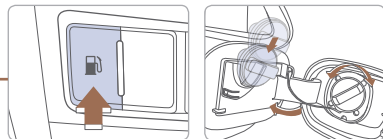
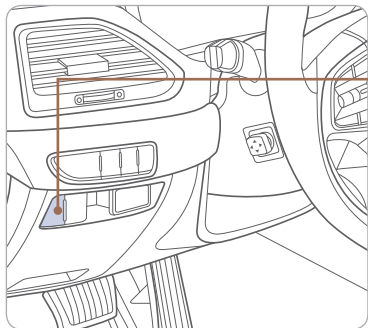

NOTE:

After adding fuel, always reinstall the fuel cap onto the filler neck by rotating it clockwise until it clicks one time.

DRIVER'S MAIN CONTROLS

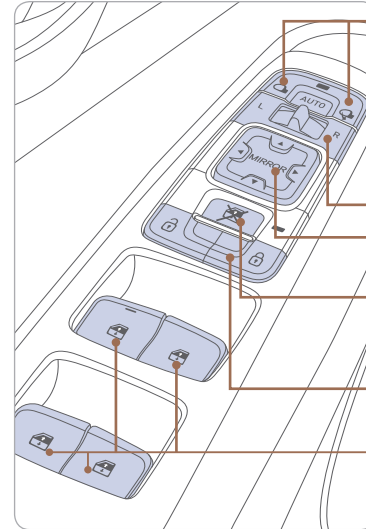

Folding outside mirrors

Press to fold/unfold mirrors. Press the lock or unlock button on the smart key, and the mirrors will be folded or unfolded.

Outer side view mirror

- Press the L or R button.
- Adjust the mirror by using the directional switch.

Power window lock switch

Disables the power window switches on the passenger doors.

Door lock

Locks/unlocks all doors.

Window switches

- Front doors power window switches.
- Rear doors power window switches.

REAR DOOR WINDOW CURTAIN

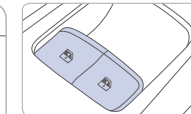
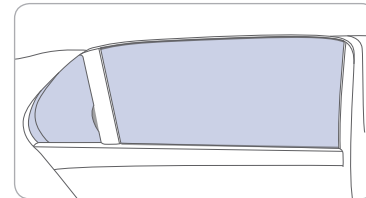

(Driver's door) (Rear doors)

With windows closed, pull up to raise or push down to lower the rear door window curtain.

REAR WINDOW CURTAIN

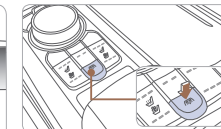
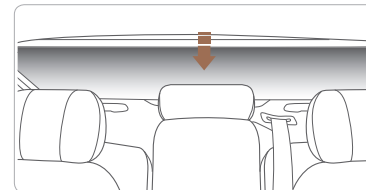

Press to raise and lower the rear window curtain.

NOTE:

When Reverse is engaged, curtain will lower automatically. Curtain will raise automatically when (forward) speeds reach 12 mph.

HEADLIGHTS

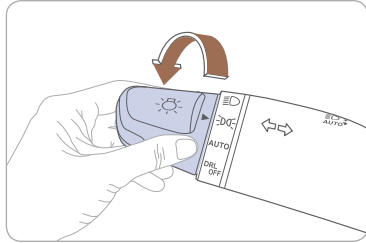

- Headlights on
- Parking lights on
- Auto headlights on
- DRL off

Headlight delay

Headlights may stay on for 15 seconds after exiting and locking up the vehicle. Press the remote lock button twice to turn the headlights off. Please refer to your Owner's Manual for further information.

Turn signals **A** and lane change **B** signals

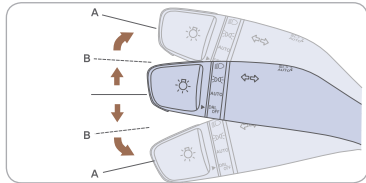

High beam

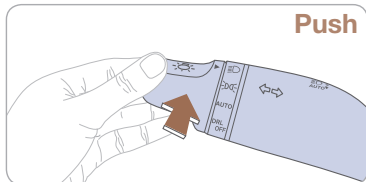

NOTE:

To turn off the high beam, pull the lever towards you.

Flashing headlights

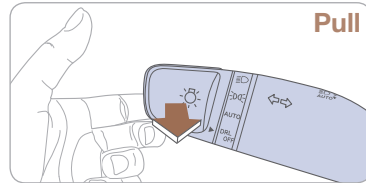

Smart high beam

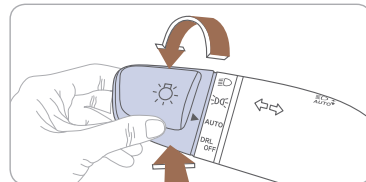

Smart high beam function

1. Select the AUTO position on stalk.
2. Push the lever forward to engage the Auto high beam.
3. Push the lever forward again to disengage.

DYNAMIC BENDING LIGHT (DBL)

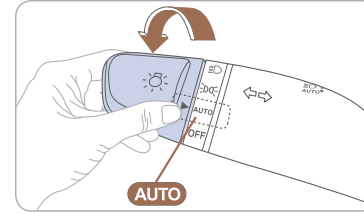

DBL uses the steering angle and vehicle speed to help keep your field of vision wide by swiveling and leveling the headlamp.

- To turn DBL on, turn the knob to the AUTO position.

NOTE:

DBL is not active unless vehicle is moving.

WIPER AND WASHER

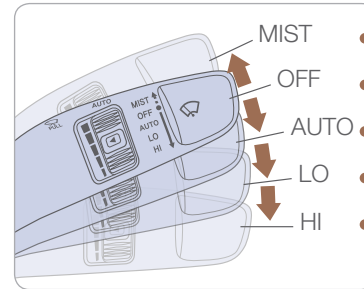

- MIST** - Single wipe
- OFF**
- AUTO** - Auto wipe
- LO** - Low wiper speed
- HI** - High wiper speed

Auto control wipe interval adjustment

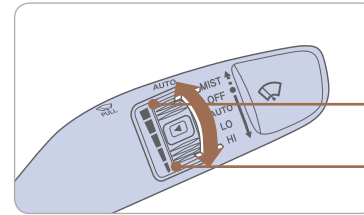

- Fast wiper speed
- Slow wiper speed

Front windshield wash with brief wipes

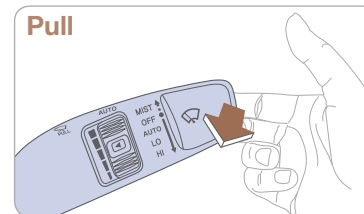

SUNROOF

Sliding the sunroof

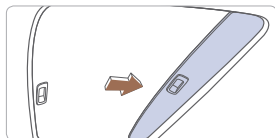
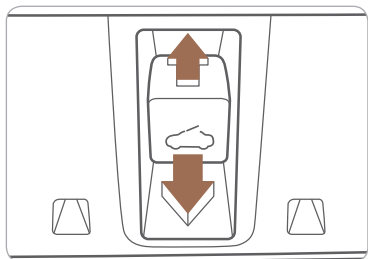

To open
Press the switch rearward and past the detent to open completely.

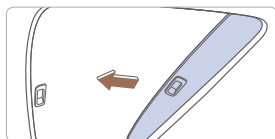

To close
Press the switch forward past the detent to close completely.

Tilting the sunroof

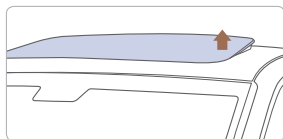
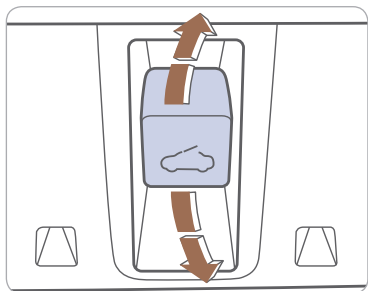

To tilt
Press the switch up.

To close
Pull the switch forward.

INTERIOR LIGHTS

Front lamps

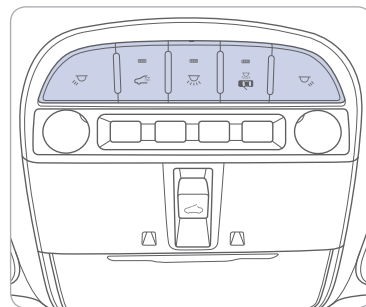

Turns the map lamp on or off



The front or rear room lamp will illuminate when the doors are open or unlocked with the smart key.



Turns the room lamp on or off



Turns all front lamps on or off

Rear room lamps

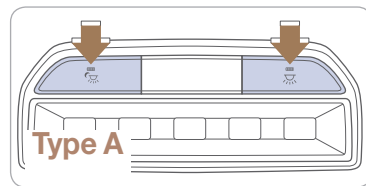

Turns all rear room lamps on or off



Turns room lamp on or off

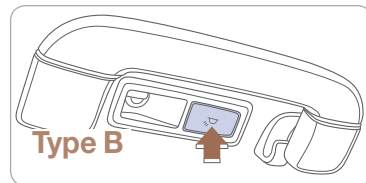

Turns the rear map lamp and the door handle lamps on or off

POWER TRUNK

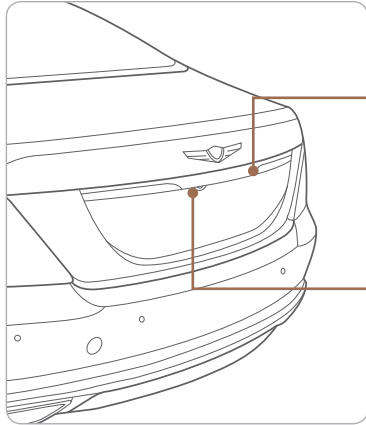

Power trunk open button

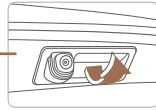

Press to open.
Smart key needs to be within the range.

Power trunk open button on the smart key

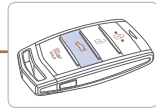

Press and hold.

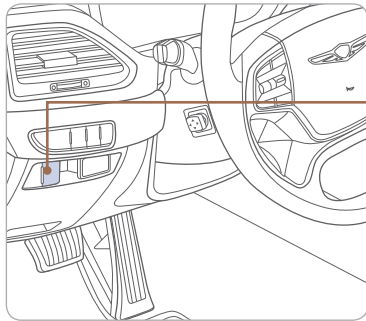

Power trunk main control button

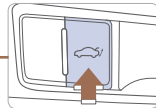

Press to open.
Press and hold to close.

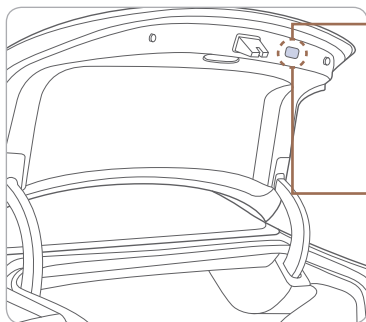

Power trunk close button

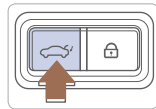

Press to close.

Power trunk lock button

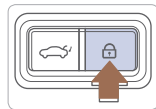

Press to lock the trunk and all doors will lock.
Smart key needs to be within range.

TRUNK LID CONTROL BUTTON

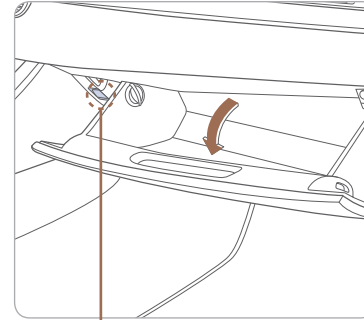

The trunk lid control button is used to prevent unauthorized access to the trunk.

1. Open the glove box.
2. Press the trunk lid control button. In this LOCK position, the trunk can only be opened with the mechanical key.
3. Close and lock the glove box with the mechanical key.

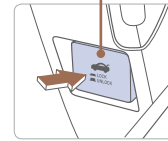

NOTE:

Without the mechanical key, the smart key can only start the engine and operate door locks.

SMART TRUNK

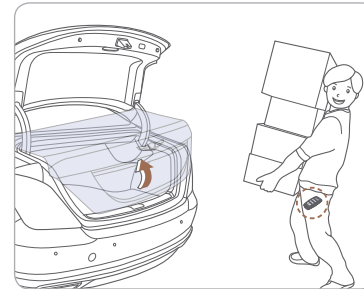

Smart Trunk

When smart key is within range for 3 seconds, the trunk will automatically open.

To enable Smart Trunk function:
Vehicle must be in P (Park) to adjust the settings in the User Settings mode.

1. Select "Door" in the User Settings in the instrument cluster.
2. Check "Smart Trunk".

NOTE:

Function is active after 15 seconds when all doors are closed and locked. The vehicle will also provide an audible and visual alarm while activating. Please refer to your Owner's Manual for further information.

SEAT WARMER AND COOLER

Front seat

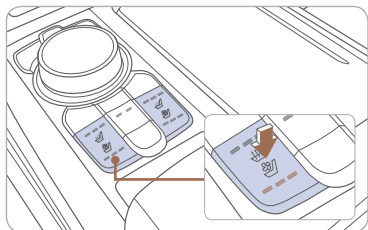

Rear seat

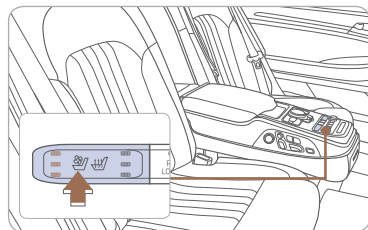

Push desired switch to warm or cool the seat.

OFF → HIGH → MEDIUM → LOW



Defaults to the OFF position when the vehicle is restarted.

NOTE:

Seat warmer includes Smart Logic that automatically adjust setting. Please refer to your Owner's Manual for further information.

CHILD-PROTECTOR REAR DOOR LOCK

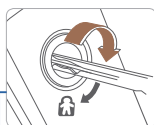
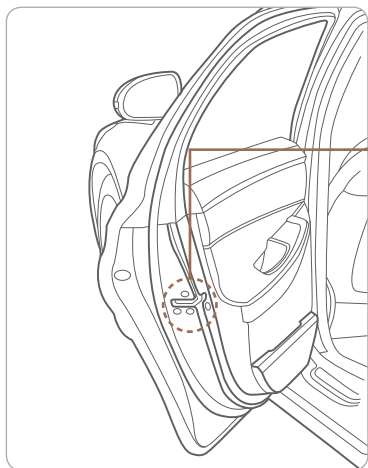

Lock

Insert a key into the hole and turn it towards the lock position .

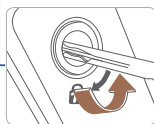

Unlock

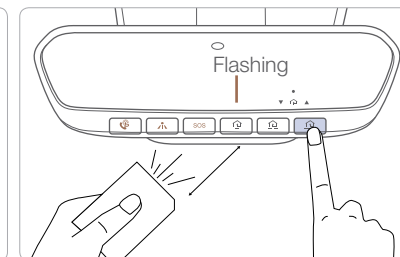
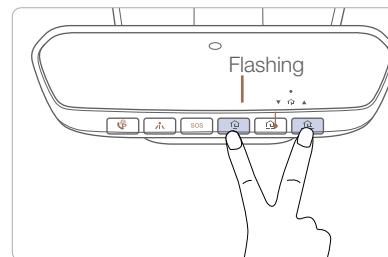

Insert a key into the hole and turn away from the lock position .

HOMELINK WIRELESS GARAGE CONTROL SYSTEM



Standard Programming

To train most devices, follow these instructions:

1. For first-time programming, press and hold the two outside buttons. ( , ), HomeLink® Channel 1 and Channel 3, until the indicator light begins to flash (after 10 seconds). Release both buttons. Do not hold the buttons for longer than 20 seconds.
2. Position the end of your hand-held transmitter 1-3 inches (2-8 cm) away from the homeLink® button you wish to program while keeping the indicator light in view.
3. Simultaneously press and hold both the HomeLink® and hand-held transmitter buttons until the HomeLink® indicator light changes from a slow to a rapid blinking light. Now you may release both the HomeLink® and hand-held transmitter buttons.

INSTRUMENT CLUSTER

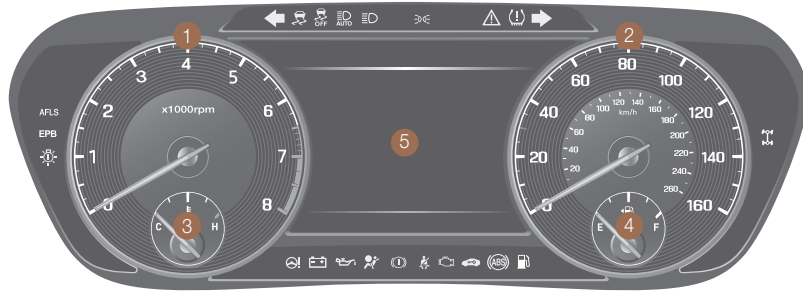

- 1 Tachometer
- 2 Speedometer
- 3 Engine coolant temperature gauge
- 4 Fuel gauge
- 5 LCD display (including trip computer)

WARNINGS AND INDICATORS

Air bag warning light	Seat belt warning light	Parking brake & brake fluid warning light
ABS warning light	Electronic Brake Force Distribution (EBD) System warning light	
Malfunction Indicator Lamp (MIL)	Charging system warning light	Motor-Driven Power Steering (MDPS) warning light
Engine oil pressure warning light	Low fuel level warning light	Low Tire Pressure warning light
EPB Electric Parking Brake (EPB) warning light	Automatic Emergency Braking (AEB) warning light	AFLS Adaptive Front Lighting System (AFLS) warning light
All Wheel Drive (AWD) warning light	Master warning light	Electronic Stability Control (ESC) indicator
Electronic Stability Control (ESC) OFF indicator	Immobilizer indicator	Turn signal indicator
High beam indicator	Light ON indicator	Smart high beam indicator
SPORT mode drive indicator	SMART mode drive indicator	ECO mode drive indicator
INDIVIDUAL mode indicator	AUTO HOLD indicator	Lane Keeping Assist System (LKAS) indicator

INSTRUMENT PANEL ILLUMINATION

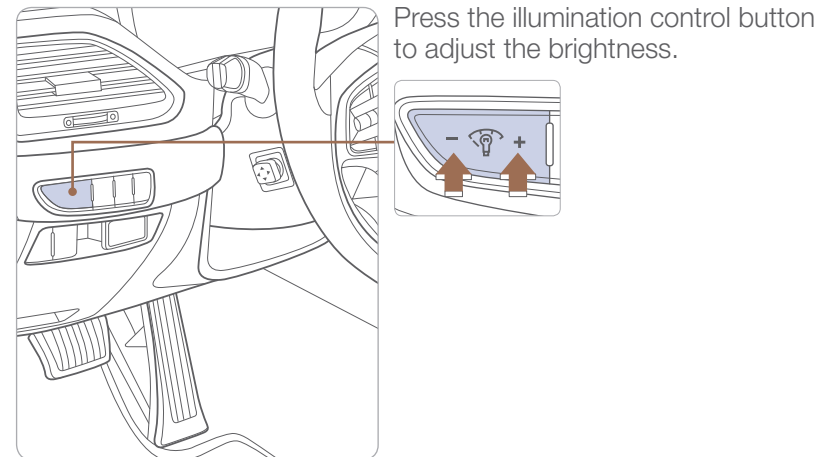

LCD DISPLAY CONTROL

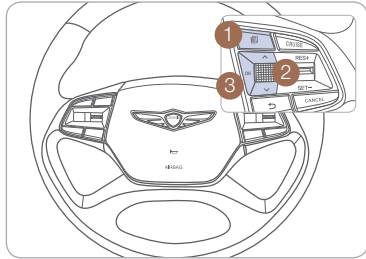

- 1 : **MODE button**
Press to change modes.
- 2 : **MOVE switch**
Rotate to change items.
- 3 **OK** : **OK button**
Push button for setting or resetting the selected item.

LCD DISPLAY MODES

Modes	Symbol	Description
Trip Computer		This mode displays driving information such as tripmeter, fuel economy, etc.
Turn By Turn (TBT) (if equipped)		This mode displays the state of the navigation.
Assist		This mode displays the state of the Smart Cruise Control (SCC) and Lane Keeping Assist System (LKAS), Driver Attention Alert (DAA), and Tire Pressure Monitoring System (TPMS).
User Settings		Changes settings.
Warning		Displays warning messages.

HEAD-UP DISPLAY

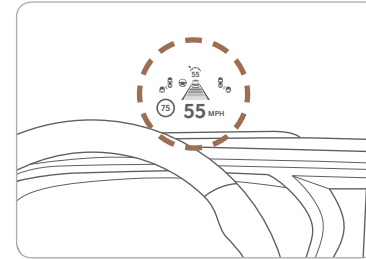

The Head-Up Display is a transparent display which projects a shadow of information of the instrument cluster and navigation on the windshield glass.

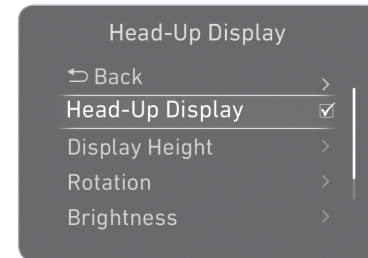

To activate the head-up display, select “Head-Up Display” on the User Settings mode in the cluster.

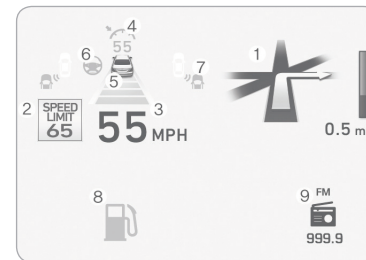

Head-Up Display information

1. Turn-by-turn (TBT) navigation information
2. Road information
3. Driving speed information
4. Cruise control system set speed information
5. Advanced smart cruise information
6. Lane Keeping Assist System (LKAS) information
7. Blind spot detection warnings
8. Warning lights
9. Multimedia information

AUTOMATIC CLIMATE CONTROL

Front

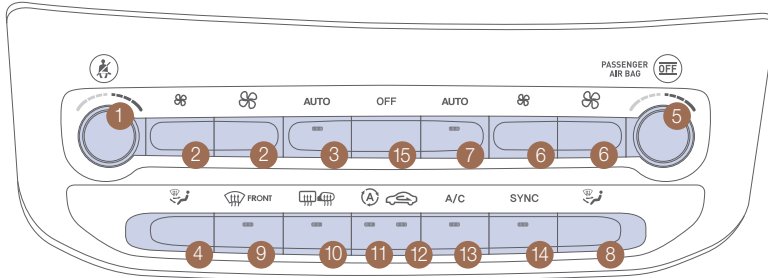

- 1 Driver's temperature control knob
- 2 Driver's fan speed control button
- 3 Driver's AUTO button
- 4 Driver's mode selection button
- 5 Passenger's temperature control knob
- 6 Passenger's fan speed control button
- 7 Passenger's AUTO button
- 8 Passenger's mode selection button
- 9 Front windshield defroster button
- 10 Rear window defroster button
- 11 AQS (Air quality system) button
- 12 Air intake control button
- 13 Air conditioning button
- 14 SYNC button
- 15 OFF button

Rear

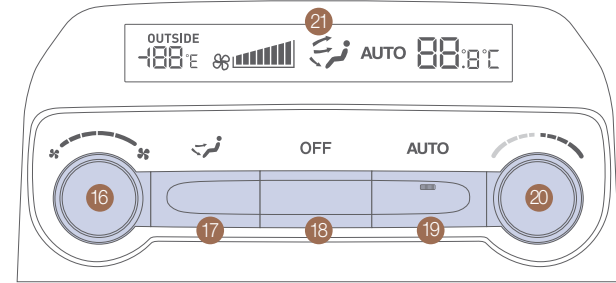

- 16 Rear fan speed control knob
- 17 Rear mode selection button
- 18 Rear OFF button
- 19 Rear AUTO button
- 20 Rear temperature control knob
- 21 LCD display

DEFOGGING/DEFROSTING

1. Set the temperature control to the desired setting.
2. Press the front windshield defrost button.
3. Set the fan speed to the highest setting.

NOTE:

To reduce the tendency of the glass fogging and also to improve visibility, keep the interior surface of the windshield clean by wiping it with a clean cloth and glass cleaner. In addition, select air intake control to the outside (fresh) air position whenever possible while operating the vehicle.

SYSTEM OFF

Pressing the OFF button will place the system to the OFF mode.

- Blower will turn off.
- Outside (fresh) air position will be selected.
- Vented air will be at last set temperature.

MODE SELECTION

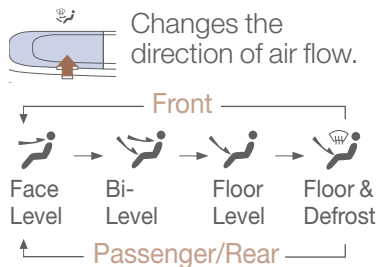

AIR INTAKE CONTROL

- Recirculated air position
- Outside (fresh) air position
- AQS activated (auto air intake control)

SYNC BUTTON

- Press the SYNC button to adjust the driver and front/rear passenger side temperature and air flow direction equally.

AUTOMATIC HEATING/ AIR CONDITIONING

1. Press the AUTO button.
 2. Set the temperature control to the desired setting.
- The modes, fan speeds, air intake, and air-conditioning will adjust automatically according to the temperature setting.

REAR WINDOW DEFROSTER

- Press to activate/deactivate the rear window and outside mirrors defroster.

REARVIEW CAMERA

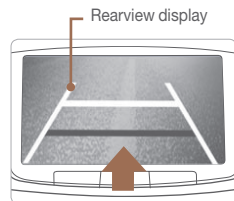
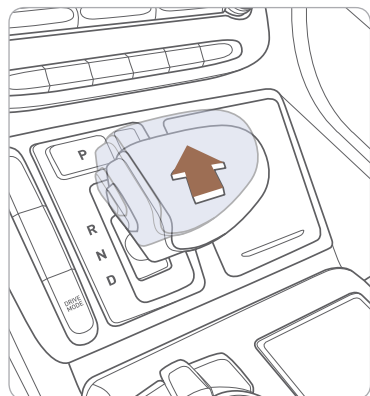

The rearview camera will activate when the engine is running and the shift lever is in the R (Reverse) position.

NOTE:
Rearview display is selectable, see Owner's Manual for further details.

MULTI-VIEW CAMERA SYSTEM

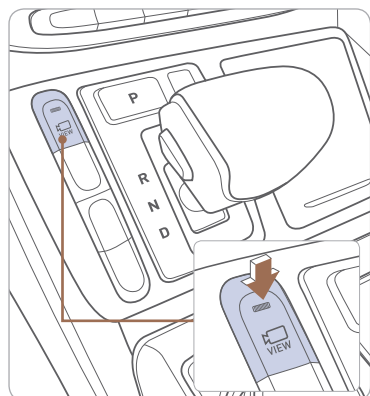

This parking support system displays an all-around view of the vehicle when parking. Press the switch to activate/deactivate the system.

Operating conditions

When the shift lever is in R position, the system is always turned ON, but when it is in N or D position, the switch has to be turned ON and the vehicle speed is less than 9 mph.

NOTE:
Multi-view display is selectable, see Owner's Manual for further details.

PARKING ASSIST SYSTEM (PAS)

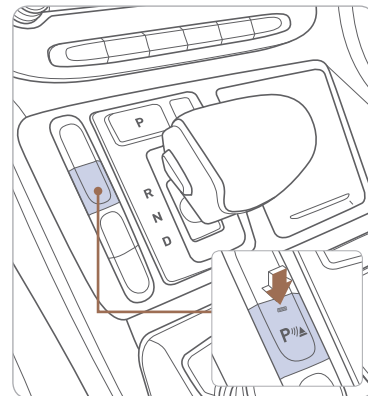

The parking assist system assists the driver during movement of the vehicle by chiming if any object is sensed within the distance of 3.3 ft in front and 4 ft behind the vehicle.

PAS ON/OFF

To turn the PAS off, press the ON/OFF button. To turn on the PAS, press it again.

If you move the shift lever to R with the engine Start/Stop button in ON and the parking assist system in OFF, the parking assist system will operate automatically.

NOTE:
The parking assist system is not active when vehicle speed exceeds 12 mph.

WIRELESS CELLULAR PHONE CHARGING SYSTEM

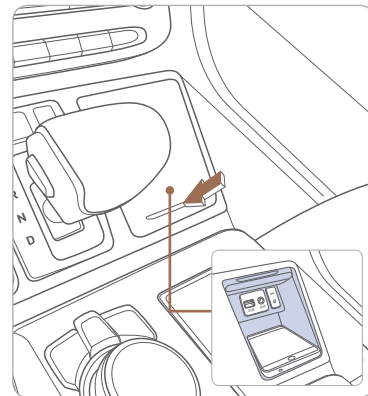

The system operates when all doors are closed, and the Engine Start/Stop button is in the ACC/ON position. When the charging process is completed, the indicator color changes to green from orange. If there is a malfunction, the indicator blinks in orange for 10 seconds. In this case, temporarily stop the charging process, by removing the phone from the charge pad then placing it back on the pad. The wireless charging function can be turned ON or OFF in the user settings mode on the instrument cluster.

NOTE:
The wireless cellular phone charging system supports only the Qi-enabled cellular phones (Qi).

STEERING WHEEL AUDIO CONTROL

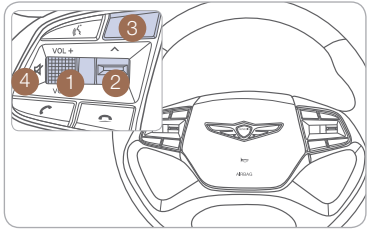

- 1 **VOLUME**
Raises or lowers the volume.
- 2 **PRESET / SEEK**
- Short press: PRESET
- Long press: SEEK
- 3 **MODE**
Press and hold to turn audio ON/OFF.
- 4 **MUTE**
Press to mute or activate the sound.

BLUETOOTH® OPERATIONAL TIPS

In the following situations you or the other party may have difficulty hearing each other:

1. When the Bluetooth® volume is too high. High level volume may result in distortion and echo.
2. When driving on a rough road, high speeds and / or with the window open.
3. When the air conditioning vents are facing the microphone.

Steering wheel Bluetooth® control

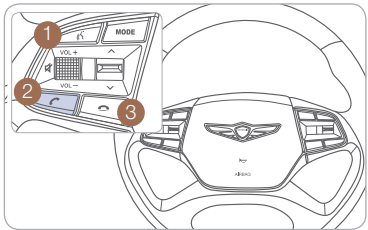

- 1 **TALK**
Activates voice recognition.
- 2 **CALL**
Places and transfers calls.
- 3 **END**
Ends calls or cancels functions.

To Answer a Call:

- Press the button on the steering wheel.

To Reject a Call:

- Press the button on the steering wheel.

To Adjust Ring Volume:

- Use the VOLUME buttons on the steering wheel.

To Transfer a Call to the Phone

(Private call on handset – do not use while driving):

- Press and hold the button on the steering wheel until the audio system transfers a call to the phone.

To Finish a Call:

- Press the button on the steering wheel.

Making a call using voice recognition:

The menu tree identifies available voice recognition Bluetooth® functions.

Calling by Name:

1. Press button.
2. Say the following command:
 - “Call <John>”: Connects the call to John.
 - “Call <John> on <Mobile/Home/Office>”:
Connects the call to John’s Mobile, Home, or Office phone number.

Dialing by Number:

1. Press the button.
2. Say “Dial Number”.
3. Say the desired phone numbers.

For complete list of commands, please refer to your Owner’s Manual.

VOICE RECOGNITION TIPS

Your vehicle is equipped with Voice Recognition technology which allows drivers to operate their phones without having to take their eyes off the road to minimize distractions.

Voice recognition performance may be affected if driving with windows and sun roof open; when the heating-cooling system is on; when passing in a tunnel or when driving on rugged and uneven roads.

To start a voice command, press the button, the following phone commands are available:

Command	Function
Call	Displays downloaded Contacts.
Calls <Name>	Calls <Name> saved in Contacts.
Dial Number	Displays a screen when you can say a phone number to dial.
Dial <Phone number>	You can directly say the number to call. ex) Dial 111 555 1234
Redial	Directly calls at the number that you have last dialed.
Call History	Displays your Call History.

NOTE:

For complete list of commands, please refer to your Owner’s Manual.

BLUETOOTH® PHONE OPERATION

NOTE: Vehicle must be parked to complete the pairing process.

1. Press the PHONE button on the navigation or  button on the steering wheel remote controller.

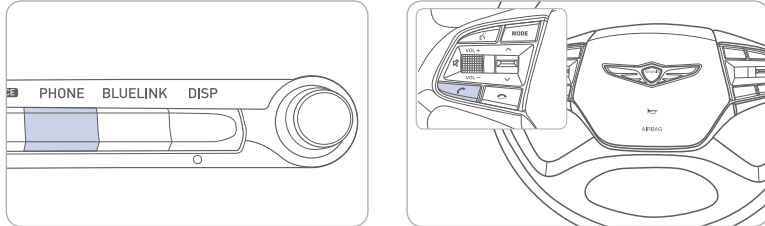

2. Once the Bluetooth® Connection screen is displayed, press [Add New Device].
3. Within the Bluetooth® pairing screen in your Bluetooth® device, search and select the vehicle name. The default vehicle name is “GENESIS G90”.
4. Verify the passkey and proceed with pairing from your Bluetooth® device. The default passkey is “0000”.
5. Connect Bluetooth®.

NOTE: You can add/delete additional phones in the main home screen. Home-Setup-Bluetooth – Bluetooth Connection.

Please refer to your Owner’s Manual for further information.

GENESIS CONNECTED SERVICES

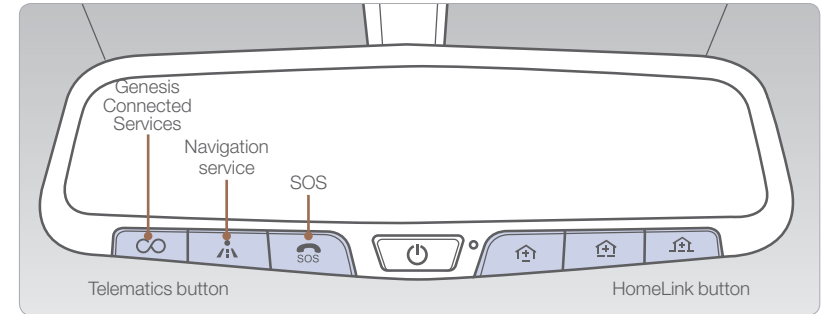

Genesis Connected Services subscription is required. To enroll, please visit your dealership or MyGenesisUSA.com.

Press the  button for access to the voice-response menu of services.

- You can say:

Roadside Assistance

Service Link

Account Assistance

Press the  button for Destination Search Powered by Google™.

Press the **SOS** button for SOS Emergency Assistance.

Visit MyGenesisUSA.com for more information or refer to your Genesis Connected Services User’s Manual for detailed information on system operation.

For immediate assistance with subscription services, please call 1-844-340-9741.

Google™ is a registered trademark of Google, Inc.

Genesis Intelligent Assistant App



You can download the Genesis Intelligent Assistant App to your compatible smart phone from the following sites:

- iPhone® — Apple® App Store
- Android™ — Google Play™

Remote Start

Remote Start enables you to remotely start your vehicle virtually from anywhere. For vehicles equipped with full-automatic temperature control, you can also enable climate control remotely and turn on the front window defroster, ensuring a warm or cool car is ready to go when you are.

-  To use this feature, you must have a Genesis Connected Services Personal Identification Number (PIN). To create or change your PIN, log in to MyGenesisUSA.com.

Remember:

- Remote Start will automatically shut off after 10 minutes or after selected engine timer runs out in navigation vehicles.
- While this feature is active, the parking lights will blink until the vehicle is turned off or when vehicle is in operation.
- To continue to operate the vehicle, the proximity key must be inside the vehicle with the driver, prior to pressing the brake and being able to move the gearshift from the P (Park) position.

Preconditions:

- Ignition is OFF
- Alarm is armed (i.e., vehicle locked by key fob Remote Door Lock)
- Gearshift level is in the P (Park) position
- Brake pedal is not depressed
- Engine hood is securely closed
- All the doors are closed and locked
- The tailgate or trunk lid is closed
- The security / panic system is not activated
- The proximity key is not inside the vehicle
- The battery power is not low
- Vehicle is located in an open area
- It has been less than 4 days since last vehicle ignition off
- Vehicle located in area with good cell reception

Remote Start will terminate:

- After 10 minutes or after selected engine timer runs out in navigation vehicles
- Brake is pressed without the proximity key inside the vehicle
- Alarm is triggered without the proximity key inside the vehicle
- Door / trunk is opened from inside the vehicle

Notice: Laws in some communities may restrict the use of the features that remotely start the engine. For example, some laws may require a person using the remote start feature to have the vehicle in view when doing so, or limit the length of time a vehicle engine may idle. Please check local and state regulations for any requirements and restrictions on remote starting of vehicles and engine idling time.

WARNING!

Do not remote start vehicle in an enclosed environment (i.e., closed garage). Prolonged operation of a motor vehicle in an enclosed environment can cause a harmful build-up of carbon monoxide. Carbon monoxide is harmful to your health. Exposure to high levels of carbon monoxide can cause headaches, dizziness or in extreme cases unconsciousness and / or death. Do not leave children or animals unattended in a vehicle while using the remote start function.

CAUTION!

If the vehicle's windshield wipers are left on when the vehicle was last driven, then the wipers will turn on if the remote start function is activated. To avoid damage to the wiper blades (i.e., due to heavy ice or snow accumulated on the windshield), please always turn the vehicle's windshield wipers off when parking the vehicle.

NAVIGATION

AUDIO MODE

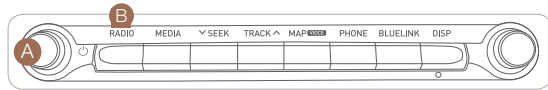

1. Press POWER button **A** to turn on the radio.
2. Press the RADIO **B** on the navigation unit. Or press HOME **C** on the controller then, select [Radio]. The most recently played channel will start.
3. Each press of the RADIO **B** will change the mode in order of FM → AM → SiriusXM → FM.
4. Select the channel you wish to listen to.

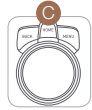

NOTE: A clear view of the southern sky is recommended to ensure XM[®] radio reception.

Basic features on the map screen

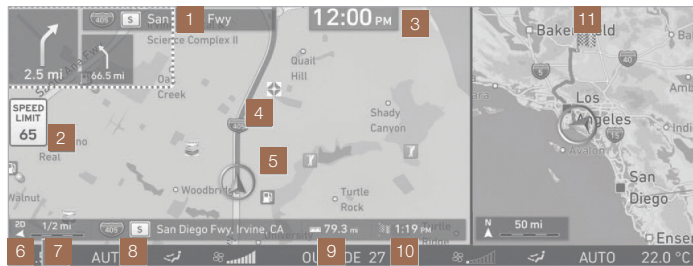

- 1 Preliminary guidance: Provides distance, direction guidance at turn points and directions within the set route.
- 2 Speed limit information: Provides speed limit information for the current route.
- 3 Current time: Displays the current time.
- 4 Route: Displays the route from the current position to the set destination.
- 5 Car position mark: Displays the current car position and traveling direction.
- 6 Map screen mode: Displays the current map screen mode.
- 7 Map scale : Adjusts the map scale.
- 8 Current location: Displays the address or name of the current location.
- 9 Remaining distance: Displays the remaining distance to reach the destination.
- 10 ETA/Remaining time: Displays the ETA (estimated time of arrival) or the remaining time to reach the destination.
- 11 Assistant window: Displays map, intersection zoom and turn list information.

Destination search screen

Press “HOME” → [Navigation] → [Destination].

Or in the map screen, press “MENU” → [Destination].

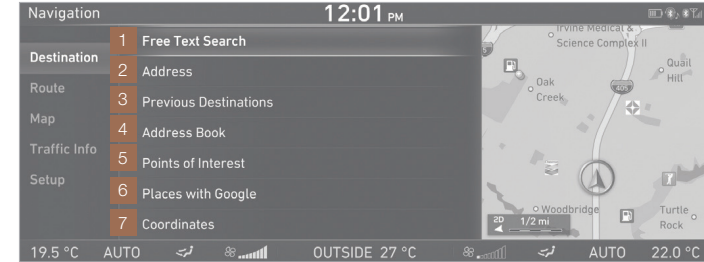

- 1 Free Text Search: Uses keywords to search for destinations.
- 2 Address: Uses addresses to search for destinations.
- 3 Previous Destinations: Uses previous destinations (recent searches, recent destinations) for use as destinations.
- 4 Address Book: Searches for destinations within the Address Book.
- 5 Points of Interest: Searches POIs by keyword, Along the Route, Near Destination, In a Different City, or category for use as destinations.
- 6 Places with Google: Searches for places to set as destinations. (available only when Blue Link is activated)
- 7 Coordinates: Uses coordinates to search for destinations.

AUX AND USB PORT

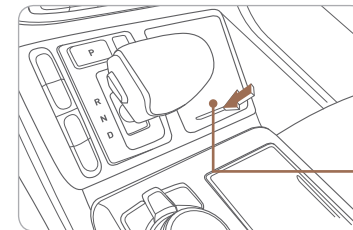

Use the jack to connect an external audio device and listen to it through the audio speakers in your vehicle.



ELECTRIC PARKING BRAKE (EPB)

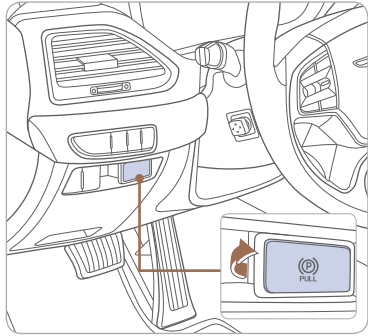

Applying
Depress the brake pedal and then pull the EPB switch.

Releasing
Press and hold the EPB switch with the brake pedal depressed or shift the shift lever from P to R or D.

AUTO HOLD

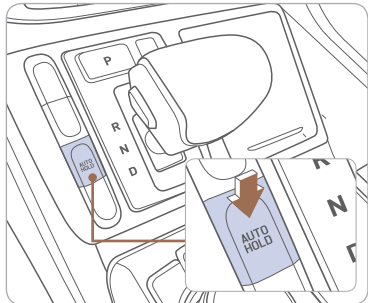

The Auto Hold feature assists in hill areas. It applies the brake until the accelerator pedal is pressed.

- WHITE AUTO HOLD** 1. Press the AUTO HOLD switch.
- GREEN AUTO HOLD** 2. Stop the vehicle by pressing the brake pedal. The brake will remain engaged even if the brake pedal is released.
- WHITE AUTO HOLD** 3. The AUTO HOLD will be released when the accelerator pedal is pressed with the shift lever in D (Drive) or R (Reverse).

To cancel the AUTO HOLD operation, press the switch again with the brake pedal depressed.

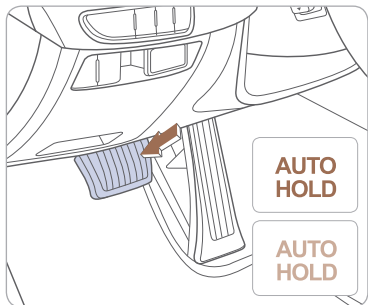

TIRE PRESSURE MONITORING SYSTEM (TPMS)

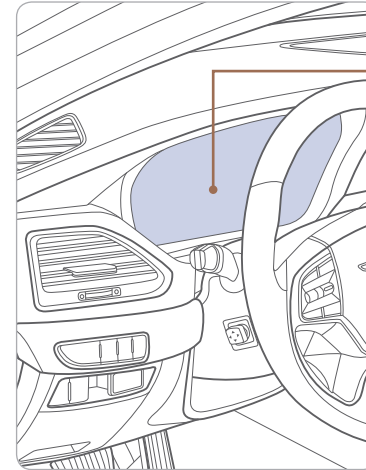

Low Tire Pressure Indicator / TPMS Malfunction Indicator

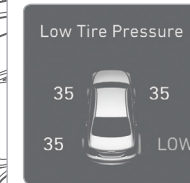

Low Tire Pressure / Tire Pressure Monitor / TPMS Malfunction Display (shown on the cluster LCD display)

LOW TIRE PRESSURE INDICATOR

Illuminates if one or more of your tires is significantly under-inflated.

TPMS MALFUNCTION INDICATOR

Blinks for approximately one minute, then remains illuminated when there is a malfunction with the TPMS. Inspect all tires and adjust tire pressure to specification. If the lamp remains illuminated, have the system checked by an authorized Dealer of Genesis Brand Products as soon as possible.

LOW TIRE PRESSURE POSITION INDICATOR AND TIRE PRESSURE INDICATOR (LCD DISPLAY)

Tire pressures will display after driving a short distance. If a tire pressure drops lower than predetermined specification the Low Tire Pressure Indicator will illuminate and the LCD display will indicate tire(s) requiring air.

AUTOMATIC TRANSMISSION

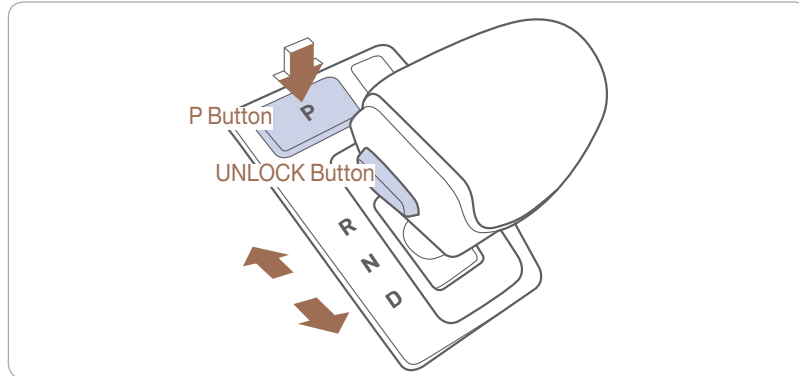

When you move the shift lever, depress the brake pedal while pressing the UNLOCK button.

The automatic transmission has eight forward speeds and one reverse speed. The individual speeds are selected automatically in the D (Drive) position.

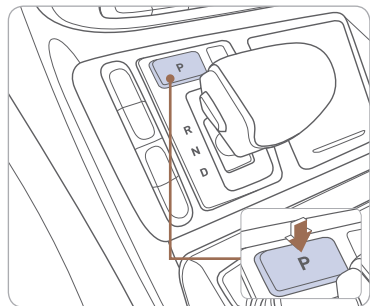

P (Park)

Always stop completely before shifting into P (Park). To shift the gear from R (Reverse), N (Neutral), D (Drive) or Manual mode to P (Park), press the [P] button while depressing the brake pedal.

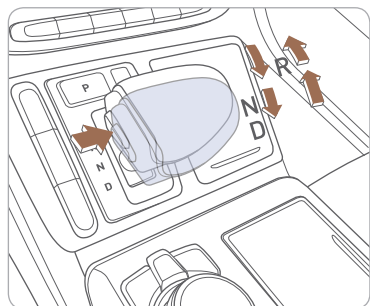

R (Reverse) / N (Neutral) / D (Drive)

To select gear, press the [UNLOCK] button while depressing the brake pedal and then move the shift lever forward (R side) or backward (D side).

PADDLE SHIFTER (Manual Mode)

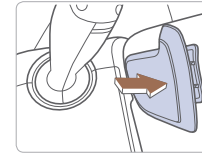

Press (-) to downshift

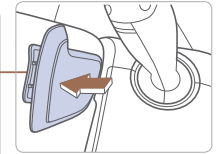
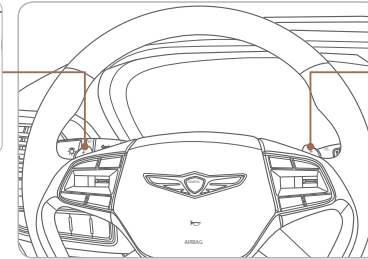

Press (+) to upshift

The paddle shifter is available when the shift lever is in the D (Drive) position. Press the [+] or [-] paddle shifter once to shift up or down one gear.

NOTE:

To disengage Manual mode (and engage Auto mode), press and hold [+] paddle shifter.

ASSIST EMERGENCY BRAKING (AEB)

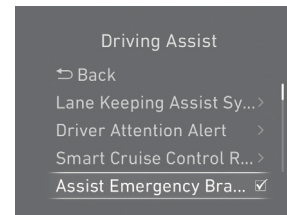

The Assist Emergency Braking (AEB) system is designed to help detect and monitor the vehicle ahead or detect a pedestrian in the roadway through radar signals and camera recognition to warn the driver of potential collision, and if necessary, apply emergency braking.

To activate the system, select 'User Settings → Driving Assist → Assist Emergency Braking' on the LCD display. The system deactivates, when the system setting is cancelled.

ELECTRONIC STABILITY CONTROL (ESC)

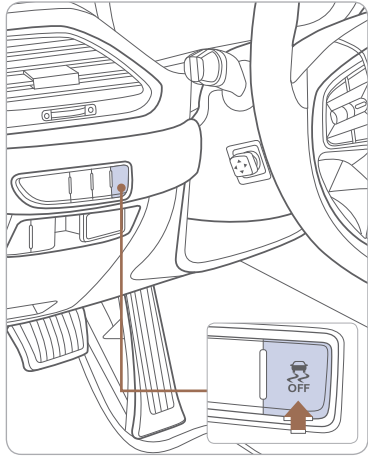

The ESC system is an electronic system designed to help the driver maintain vehicle control under adverse conditions.

ESC automatically selects the ON position when the engine is started.

To turn off the Traction Control
Press the ESC OFF button.

To turn off the Traction and Stability Control
Press and hold the ESC OFF button for more than 3 seconds.

DRIVER ATTENTION ALERT SYSTEM

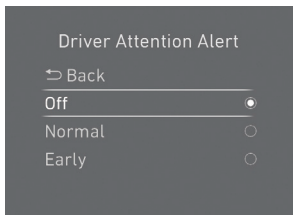

The Driver Attention Alert (DAA), system is to warn the driver with any hazardous driving situations upon detecting the driver's fatigue level or inattentive driving practices.

To turn ON the Driver Attention Alert system, turn on the engine, and then select 'User Settings → Driving Assist → Driver Attention Alert → Normal / Early' on the LCD Display.

The Driver Attention Alert system is operable, when driving speed is between 40 mph and 110 mph.

NOTE:

To display DAA on LCD, select Assist Mode-Attention Level.

DRIVE MODE INTEGRATED CONTROL SYSTEM

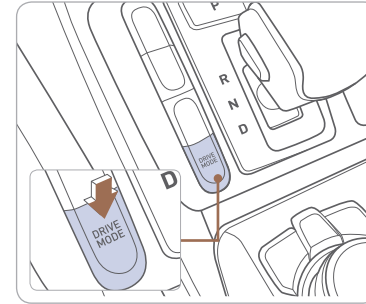

Press the DRIVE MODE switch to select the preferred drive mode.

The mode displayed on the instrument cluster changes as below.

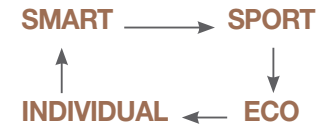

SMART mode

SMART mode selects the proper driving mode among ECO, NORMAL, and SPORT by judging the driver's driving habits (i.e. mild or dynamic).

SMART ICON located in instrument cluster will change colors depending on adjustment setting.



Green SMART ICON:
ECO mode setting, mild driving.



White SMART ICON:
Normal mode setting, normal driving.



Orange SMART ICON :
Sport mode setting, dynamic driving.

SPORT mode

Focuses on dynamic driving by automatically controlling the steering wheel, engine, and transmission systems.

ECO mode

Improves fuel efficiency for eco-friendly driving.

INDIVIDUAL mode

The driver can separately adjust modes of each driving system.

NOTE:

Individual mode setting are available in the main home menu. Select "Home-Setup-Drive mode."

Please refer to your Owner's Manual for more information.

LANE KEEPING ASSIST SYSTEM (LKA)

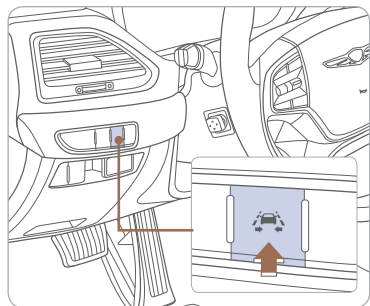

The Lane Keeping Assist system detects lane markers on the road, and assists the driver's steering to help keep the vehicle between the lanes.

To activate, press the LKA button with the Engine Start/Stop button in the ON position. LKA operates only when the vehicle speed is between 40 mph and 110 mph.

NOTE:

To adjust LKA settings, select user settings in the Instrument Cluster LCD display control, "User Settings-Driving Assist-Lane Keeping Assist System."

Please refer to your Owner's Manual for more information.

BLIND SPOT DETECTION SYSTEM (BSD)

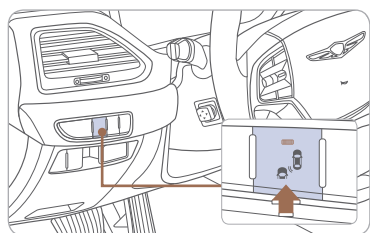

The BSD system monitors the rear area of the vehicle and provides information to the driver. Press the BSD switch. If vehicle speed exceeds 20 mph the system will activate. Press the switch again to deactivate the system.

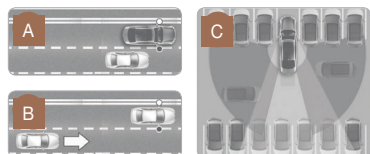

- A** BSD (Blind Spot Detection) Warning range is dependent on your vehicle speed. If your vehicle speed is much faster than other vehicles, the warning is not active.
- B** LCA (Lane Change Assist) When the vehicle is approaching at high speed, the warning is active.
- C** RCTA (Rear Cross-Traffic Alert) When your vehicle moves (below 6 mph) in Reverse, the sensor detects the approaching vehicles and the warning is active.

ADVANCED SMART CRUISE CONTROL SYSTEM

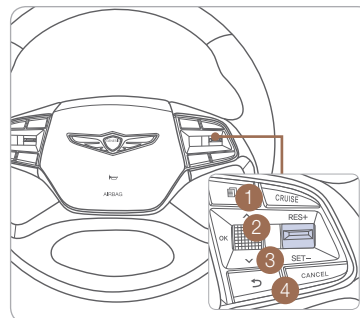

The Advanced Smart Cruise Control System allows you to program the vehicle to maintain constant speed and distance detecting the vehicle ahead without depressing the accelerator/brake pedal.

- 1** To turn On/Off the Cruise Control.
- 2** To Resume or Increase the Cruise Control speed.
- 3** To Set or Decrease the Cruise Control speed.
- 4** To Cancel the Cruise Control.

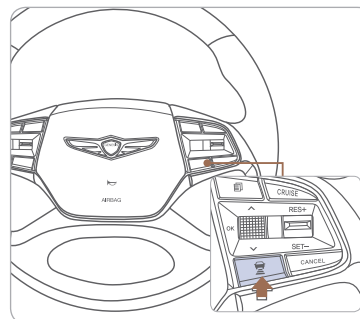

Setting vehicle distance

Press the button to set and maintain the vehicle-to-vehicle distance without pressing the accelerator or brake pedal.

The vehicle-to-vehicle distance **1** will automatically activate when you set the cruise speed **2**.

Each time the button is pressed, the vehicle-to-vehicle distance changes as follows:

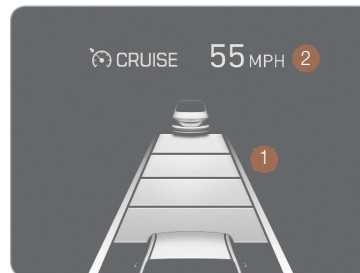

Program Coverage Summary

The Genesis Service Valet Program is included for the first 3 years or 36,000 miles, whichever comes first.				
Complimentary Services	Service Valet	Complimentary Rental Vehicle	Maintenance	Wear Items
Original Owner or Lessee	Yes	Yes	Yes	Yes
Subsequent Owner or Lessee	Warranty Only	Warranty Only	No	No

See below for program terms and conditions.

SERVICE VALET

Service Valet is available while your vehicle is receiving complimentary maintenance, wear items, or warranty repairs by an authorized Genesis retailer. Simply contact your authorized Genesis retailer's Service Experience Manager or contact the Customer Care Center at 844-340-9741 to make your appointment. The retailer will work with you to arrange your pickup and delivery time and location.

- Valet appointments must be made at least 2 business days in advance.
- Valet area of coverage is valid only within an estimated 1 hour drive time distance (based on traffic, weather, and road conditions) from the participating retailer location to the pickup/delivery location.
- Valet pickup and delivery must occur during normal business hours. After-hours pickup and delivery are at the discretion of your participating retailer.
- You must notify your Genesis Service Experience Manager 1 business day in advance if location or time of valet services changes. If a change or cancellation is not made at least 1 business day in advance, you may be charged a fee, or Service Valet may be cancelled.
- You will be charged a fee if you elect to extend the use of the courtesy replacement vehicle or delay the delivery of your vehicle.
- Prior to or at the time of pickup, you will need to provide your valet with the following information if a courtesy replacement vehicle is needed:
 - Insurance company name, policy number, and expiration date
 - Driver's license number, state, expiration, and birth date
 - Credit card number and expiration date (standard requirement for rental car use)
 - The above information for any additional drivers

Genesis brand vehicle owner must provide the valet with the Genesis brand vehicle that is currently registered in compliance with local and state laws. Road tolls incurred during the Service Valet may be charged to the vehicle owner.

COMPLIMENTARY RENTAL VEHICLE

We come to you and provide you with alternative transportation. While your vehicle is being serviced under this program, qualified drivers will be provided a courtesy replacement Genesis brand vehicle at no additional cost. You must be at least 25 years of age (in most states) with a valid driver's license to drive a replacement vehicle. Please provide your Service Advocate with the following information:

- Insurance company name, policy number, and expiration date
- Driver's license number, state, expiration and birth date
- Credit card number and expiration date (standard requirement for rental car use)
- The above information for any additional drivers

COMPLIMENTARY MAINTENANCE AND WEAR COVERAGE

Vehicle Eligibility

For original retail owners of the Genesis vehicle, all factory-recommended scheduled maintenance and normal wear parts replacement are covered for the first 3 years or 36,000 miles, whichever comes first. The Service Valet Program is applicable to all 2017 and 2018 model year Genesis brand vehicle United States specification vehicles purchased in the United States from authorized Genesis retailers. The program is not in effect outside of the United States.

- Vehicle coverage begins on the date of first retail sale. Fleet vehicles are excluded from this program.
- If the vehicle becomes damaged (such as by accident, fire, act of nature, etc.) and is subsequently titled salvaged, flooded, or reconstructed, it is no longer eligible for the benefits of the Genesis G90 complimentary maintenance Program.

Guidelines for Scheduling Maintenance

The Service Valet Program covers factory-recommended scheduled maintenance for the first 3 years or 36,000 miles, whichever comes first. Severe use maintenance intervals are not covered by this program. Covered maintenance costs include all labor and parts necessary to complete the factory recommended service. Having your vehicle serviced at the specified time/mile intervals is critical in maintaining long-term durability. Failure to have your vehicle serviced at the specified interval may invalidate the warranty under certain circumstances.

If for any reason a service is missed, the authorized Genesis retailer will perform the next or missed major service.

Some owners may wish to have their oil changed more frequently. The customer must pay for any additional services performed on the vehicle. Service procedures not specifically referenced in the Genesis Customer Care Quick Reference Guide must be preauthorized by a District Service Manager.

COMPLIMENTARY MAINTENANCE AND WEAR COVERAGE (continued)

Guidelines for Normal Wear

The Genesis Maintenance Program includes coverage for specific items that may wear out under normal use (see below) for the first 3 years or 36,000 miles, whichever comes first. To qualify for replacement, the wear limit must be at or below the minimum service limits as specified by technical reference manuals. Tires are excluded from this program.

Items covered under normal wear include:

- Front and rear brake pads
- Front and rear brake discs
- Windshield wiper blade inserts

Exclusions from Coverage

The following items, without limitation, are not covered :

- Gasoline and gasoline additives
- State inspections
- Wear and tear of soft trim, including seats, carpets, door casings, wood veneer, headliner, and all chrome trim
- Wear and tear or damage to exterior body panels, trim, and glass
- Damage due to poor fuel quality, misuse, abuse, neglect, fire, accident, flood, or installation of unapproved parts and accessories
- Vehicles used in competitive events
- Vehicles with an unreadable/tampered VIN, or where true mileage cannot be determined
- Repairs and maintenance not performed at an Authorized Genesis G90 Dealership
- Repairs covered under the Hyundai New Vehicle Limited Warranty
- Required maintenance and covered wear parts replacement on United States specification vehicles operating outside the United States

Transfer of Coverage

The described coverage only applies to the original retail purchaser or original lessee of a Genesis Brand vehicle. The coverage is not transferable to subsequent owners, with the exception of immediate family members. Immediate family members include the following:

- Spouses or registered domestic partners
- Parents
- Children or stepchildren

Dealerships will verify that the owner/customer is the original owner/lessee. Certain limitations and exclusions apply to this program. Please refer to your New Vehicle Limited Warranty for warranty details.

Guest

Date

