



owner.ford.com (U.S.)



ford.ca (Canada)

December 2017
First Printing
Owner's Manual
GT
Litho in U.S.A.



JPHJ19A321 AA



2018 FORD GT OWNER'S MANUAL



The information contained in this publication was correct at the time of going to print. In the interest of continuous development, we reserve the right to change specifications, design or equipment at any time without notice or obligation. No part of this publication may be reproduced, transmitted, stored in a retrieval system or translated into any language in any form by any means without our written permission. Errors and omissions excepted.

© Ford Motor Company 2017

All rights reserved.

Part Number: 201711 20171113184048

Table of Contents

Introduction

About This Manual.....	5
Symbols Glossary.....	5
Data Recording.....	7
California Proposition 65.....	9
Perchlorate.....	9
Replacement Parts Recommendation.....	10
Special Notices.....	10
Mobile Communications Equipment.....	11
Ford Performance.....	12

Environment

Protecting the Environment.....	13
---------------------------------	----

At a Glance

Instrument Panel Overview.....	14
Unique Features.....	15

Child Safety

General Information.....	17
Installing Child Restraints.....	18
Booster Seats.....	22
Child Restraint Positioning.....	24

Seatbelts

Principle of Operation.....	26
Fastening the Seatbelts.....	26
Seatbelt Warning Lamp and Indicator Chime.....	28
Seatbelt Reminder.....	29
Child Restraint and Seatbelt Maintenance.....	31
Seatbelt Extension.....	31

Personal Safety System™

Personal Safety System™.....	32
------------------------------	----

Supplementary Restraints System

Principle of Operation.....	33
Driver and Passenger Airbags.....	34
Front Passenger Sensing System.....	35
Side Airbags.....	37
Driver and Passenger Knee Airbags.....	37
Crash Sensors and Airbag Indicator.....	38
Airbag Disposal.....	39

Keys and Remote Controls

General Information on Radio Frequencies.....	40
Remote Control.....	41
Replacing a Lost Key or Remote Control.....	45

Doors and Locks

Locking and Unlocking.....	46
Opening the Doors.....	48
Emergency Door Release.....	49

Security

Passive Anti-Theft System.....	50
Anti-Theft Alarm.....	51

Steering Wheel

Adjusting the Steering Wheel.....	52
Audio Control.....	53
Voice Control.....	53
Cruise Control.....	53
Information Display Control.....	54
Drive Mode Control.....	54
Wiper and Washer Control.....	54
Lighting Control.....	54

Pedals

Adjusting the Pedals.....	56
---------------------------	----

Table of Contents

Wipers and Washers

Windshield Wipers.....	57
Windshield Washers.....	57

Lighting

General Information.....	58
Lighting Control.....	58
Autolamps.....	59
Instrument Lighting Dimmer.....	59
Daytime Running Lamps.....	59
Direction Indicators.....	60
Interior Lamps.....	60

Windows and Mirrors

Power Windows.....	61
Global Opening.....	61
Exterior Mirrors.....	62
Interior Mirror.....	62

Instrument Cluster

Gauges.....	63
Warning Lamps and Indicators.....	65
Audible Warnings and Indicators.....	69

Information Displays

General Information.....	70
Information Messages.....	73

Climate Control

Manual Climate Control.....	80
Automatic Climate Control.....	81
Hints on Controlling the Interior Climate.....	83
Cabin Air Filter.....	85

Seats

Sitting in the Correct Position.....	86
Manual Seats.....	86

Auxiliary Power Points

Auxiliary Power Points.....	88
-----------------------------	----

Storage Compartments

Cup Holders.....	89
Map Pockets.....	89
Under Seat Storage.....	89

Starting and Stopping the Engine

General Information.....	90
Keyless Starting.....	90
Steering Wheel Lock.....	91
Starting the Engine.....	91

Fuel and Refueling

Safety Precautions.....	94
Fuel Quality.....	94
Fuel Filler Funnel Location.....	95
Running Out of Fuel.....	95
Refueling.....	96
Fuel Consumption.....	98
Emission Control System.....	99

Engine Emission Control

Emission Law.....	102
Catalytic Converter.....	103

Transmission

Automatic Transmission.....	106
-----------------------------	-----

Brakes

General Information.....	111
Hints on Driving With Anti-Lock Brakes.....	111
Electric Parking Brake.....	112
Hill Start Assist.....	114

Table of Contents

Stability Control

Principle of Operation.....	115
Using Stability Control.....	116

Parking Aids

Rear View Camera.....	119
-----------------------	-----

Cruise Control

Principle of Operation.....	121
Using Cruise Control.....	121

Driving Aids

Steering.....	122
Drive Mode Control.....	122

Load Carrying

Rear Under Hatch Storage.....	128
Load Limit.....	128

Towing

Towing a Trailer.....	133
Towing the Vehicle on Four Wheels.....	133

Driving Hints

Breaking-In.....	134
Driving Through Water.....	134
Floor Mats.....	135

Roadside Emergencies

Roadside Assistance.....	136
Hazard Flashers.....	136
Fuel Shutoff.....	136
Jump Starting the Vehicle.....	137
Post-Crash Alert System.....	138
Transporting the Vehicle.....	138
Towing Points.....	139

Customer Assistance

Getting the Services You Need.....	140
------------------------------------	-----

In California (U.S. Only).....	141
The Better Business Bureau (BBB) Auto Line Program (U.S. Only).....	141
Utilizing the Mediation/Arbitration Program (Canada Only).....	142
Getting Assistance Outside the U.S. and Canada.....	143
Ordering Additional Owner's Literature.....	144
Reporting Safety Defects (U.S. Only).....	144
Reporting Safety Defects (Canada Only).....	145

Fuses

Fuse Specification Chart.....	146
Changing a Fuse.....	155

Maintenance

General Information.....	157
Opening and Closing the Hood.....	157
Under Hood Overview.....	160
Engine Oil Dipstick.....	161
Engine Oil Check.....	161
Engine Coolant Check.....	162
Automatic Transmission Fluid Check.....	166
Brake Fluid Check.....	166
Power Steering Fluid Check.....	167
Washer Fluid Check.....	167
Fuel Filter.....	167
Changing the 12V Battery.....	168
Checking the Wiper Blades.....	169
Changing the Wiper Blades.....	169
Adjusting the Headlamps.....	170
Changing a Bulb.....	171
Changing the Engine Air Filter.....	171

Vehicle Care

General Information.....	172
Cleaning Products.....	172

Table of Contents

Cleaning the Exterior.....	172
Waxing.....	174
Cleaning the Engine.....	174
Cleaning the Windows and Wiper Blades.....	175
Cleaning the Interior.....	175
Cleaning the Instrument Panel and Instrument Cluster Lens.....	176
Cleaning Leather Seats.....	176
Repairing Minor Paint Damage.....	177
Cleaning the Wheels.....	177
Vehicle Storage.....	178

Wheels and Tires

Tire Sealant and Inflator Kit.....	180
Tire Care.....	186
Using Summer Tires.....	198
Using Snow Chains.....	198
Tire Pressure Monitoring System.....	198
Changing a Road Wheel.....	202
Driving at High Speed.....	202
Technical Specifications.....	203

Capacities and Specifications

Engine Specifications.....	204
Motorcraft Parts.....	205
Vehicle Dimensions.....	206
Vehicle Identification Number.....	207
Vehicle Certification Label.....	208
Transmission Code Designation.....	208
Capacities and Specifications.....	209

Audio System

Audio Unit.....	212
USB Port.....	212

SYNC™ 3

General Information.....	213
Home Screen.....	223

Using Voice Recognition.....	224
Entertainment.....	230
Phone.....	234
Navigation.....	239
Apps.....	247
Settings.....	248
SYNC™ 3 Troubleshooting.....	259

Accessories

Accessories.....	273
------------------	-----

Scheduled Maintenance

General Maintenance Information.....	274
Normal Scheduled Maintenance.....	275
Special Operating Conditions Scheduled Maintenance.....	276
Scheduled Maintenance Record.....	277

Appendices

End User License Agreement.....	288
---------------------------------	-----

Introduction

ABOUT THIS MANUAL

Thank you for choosing Ford Performance. If you have owned a Ford Performance vehicle before, welcome back. If this is your first Ford Performance vehicle, welcome to the family. We are confident that our dedication to performance, quality, craftsmanship and customer service will provide you with many miles of exhilarating, safe and comfortable driving.

We strive to build engaging vehicles that involve the driver in every aspect of the driving experience. Although performance is at the heart of every Ford Performance vehicle, we go further. Our goal is to deliver a comprehensive, complete vehicle, paying close attention to the smallest details such as the sound of the exhaust, the quality of the interior materials and the functionality and the comfort of the seats, to make sure that you enjoy not only exceptional performance but an outstanding driving environment as well. In this vehicle, we express this philosophy through the use of lightweight materials, a sophisticated powertrain and outstanding chassis dynamics and aerodynamics.

This manual provides information specific to your Ford GT. By referring to this manual, you can identify those features, controls and specifications unique to your new Ford GT.

To assist you with any questions or concerns regarding your vehicle, we established the Ford GT Concierge. Contact your Ford GT Concierge at the number listed if you need assistance.

Ford GT Concierge Phone Numbers

Market	Phone number
Austria	0800-802632
Belgium	0800-795-45
Canada	1-800-210-5795
China	400-120-9152
France	0805-080272
Germany	0800-182-4992
Ireland	1-800-901-591
Italy	800-789-771
Macau	+853-62621460
Mexico	1-800-210-5795
Netherlands	0-800-022-2286
Saudi Arabia	800-844-7834
Spain	900-839249
Sweden	020-889-877
Switzerland	0800-890-079
United Arab Emirates	8000-35703061
United Kingdom	0800-014-8400
United States	1-800-210-5795

All other countries should use 001-313-427-8617.

Note: Please be advised that international calls may be subject to carrier fees.

SYMBOLS GLOSSARY

These are some of the symbols you may see on your vehicle.

Introduction



Air conditioning system



Anti-lock braking system



Avoid smoking, flames or sparks



Battery



Brake fluid - non petroleum based



Brake system



Carbon Ceramic Brakes



Cabin air filter



Child seat tether anchor



Cruise control



Do not open when hot



Engine air filter



Engine coolant



Engine coolant temperature



Engine oil



Explosive gas



Fan warning



Fasten seatbelt



Flammable



Front airbag



Fuse compartment



Hazard warning flashers



Keep out of reach of children



Lighting control



Low tire pressure warning



Maintain correct fluid level



Note operating instructions



Panic alarm



Parking brake



Power steering fluid

Introduction



Requires registered technician



Safety alert



See Owner's Manual



See Service Manual



Service engine soon



Side airbag



Shield the eyes



Stability control



Windshield wash and wipe

DATA RECORDING

Service Data Recording

Service data recorders in your vehicle are capable of collecting and storing diagnostic information about your vehicle. This potentially includes information about the performance or status of various systems and modules in the vehicle, such as engine, throttle, steering or brake systems. In order to properly diagnose and service your vehicle, Ford Motor Company (Ford of Canada in Canada), and service and repair facilities may access or share among them vehicle diagnostic information received through a direct connection to your vehicle when

diagnosing or servicing your vehicle. Additionally, Ford Motor Company (Ford of Canada, in Canada) may, where permitted by law, use vehicle diagnostic information for vehicle improvement or with other information we may have about you, (for example, your contact information), to offer you products or services that may interest you. Data may be provided to our service providers such as part suppliers that may help diagnose malfunctions, and who are similarly obligated to protect data. We retain this data only as long as necessary to perform these functions or to comply with law. We may provide information where required in response to official requests to law enforcement or other government authorities or third parties acting with lawful authority or court order, and such information may be used in legal proceedings. For U.S. only (if equipped), if you choose to use connected apps and services, such as SYNC Vehicle Health Report or MyFord Mobile App, you consent that certain diagnostic information may also be accessed electronically by Ford Motor Company and Ford authorized service facilities, and that the diagnostic information may be used to provide services to you, personalizing your experience, troubleshoot, and to improve products and services and offer you products and services that may interest you, where permitted by law. For Canada only, for more information, please review the Ford of Canada privacy policy at www.ford.ca, including our U.S. data storage and use of service providers in other jurisdictions who may be subject to legal requirements in Canada, the United States and other countries applicable to them, for example, lawful requirements to disclose personal information to governmental authorities in those countries. See **SYNC™ 3** (page 213).

Introduction

Event Data Recording

This vehicle is equipped with an event data recorder. The main purpose of an event data recorder is to record, in certain crash or near crash-like situations, such as an airbag deployment or hitting a road obstacle; this data will assist in understanding how a vehicle's systems performed. The event data recorder is designed to record data related to vehicle dynamics and safety systems for a short period of time, typically 30 seconds or less.

The event data recorder in this vehicle is designed to record such data as:

- How various systems in your vehicle were operating;
- Whether or not the driver and passenger safety belts were buckled/fastened;
- How far (if at all) the driver was depressing the accelerator and/or the brake pedal; and
- How fast the vehicle was traveling; and
- Where the driver was positioning the steering wheel.

This data can help provide a better understanding of the circumstances in which crashes and injuries occur.

Note: *Event data recorder data is recorded by your vehicle only if a non-trivial crash situation occurs; no data is recorded by the event data recorder under normal driving conditions and no personal data or information (e.g., name, gender, age, and crash location) is recorded (see limitations regarding 911 Assist and Traffic, directions and Information privacy below). However, parties, such as law enforcement, could combine the event data recorder data with the type of personally identifying data routinely acquired during a crash investigation.*

To read data recorded by an event data recorder, special equipment is required, and access to the vehicle or the event data recorder is needed. In addition to the vehicle manufacturer, other parties, such as law enforcement, that have such special equipment, can read the information if they have access to the vehicle or the event data recorder. Ford Motor Company and Ford of Canada do not access event data recorder information without obtaining consent, unless pursuant to court order or where required by law enforcement, other government authorities or other third parties acting with lawful authority. Other parties may seek to access the information independently of Ford Motor Company and Ford of Canada.

Introduction

Note: *Including to the extent that any law pertaining to Event Data Recorders applies to SYNC or its features, please note the following: Once 911 Assist (if equipped) is enabled (set ON), 911 Assist may, through any paired and connected cell phone, disclose to emergency services that the vehicle has been in a crash involving the deployment of an airbag or, in certain vehicles, the activation of the fuel pump shut-off. Certain versions or updates to 911 Assist may also be capable of being used to electronically or verbally provide to 911 operators the vehicle location (such as latitude and longitude), and/or other details about the vehicle or crash or personal information about the occupants to assist 911 operators to provide the most appropriate emergency services. If you do not want to disclose this information, do not activate the 911 Assist feature. See SYNC™ 3 (page 213).*

Additionally, when you connect to Traffic, Directions and Information (if equipped, U.S. only), the service uses GPS technology and advanced vehicle sensors to collect the vehicle's current location, travel direction, and speed ("vehicle travel information"), only to help provide you with the directions, traffic reports, or business searches that you request. If you do not want Ford or its vendors to receive this information, do not activate the service. For more information, see Traffic, Directions and Information, Terms and Conditions. See SYNC™ 3 (page 213).

CALIFORNIA PROPOSITION 65

WARNINGS



Some constituents of engine exhaust, certain vehicle components, certain fluids contained in vehicles and certain products of component wear contain or emit chemicals known to the State of California to cause cancer and birth defects or other reproductive harm.



Battery posts, terminals and related accessories contain lead and lead compounds, chemicals known to the State of California to cause cancer and reproductive harm. Batteries also contain other chemicals known to the State of California to cause cancer. Wash your hands after handling.

PERCHLORATE

Certain components in your vehicle such as airbag modules, seatbelt pretensioners and remote control batteries may contain perchlorate material. Special handling may apply for service or vehicle end of life disposal.

Introduction

For more information visit:

Web Address
www.dtsc.ca.gov/hazardouswaste/perchlorate

REPLACEMENT PARTS RECOMMENDATION

We have built your vehicle to the highest standards using quality parts. We recommend that you demand the use of genuine Ford and Motorcraft parts whenever your vehicle requires scheduled maintenance or repair. You can clearly identify genuine Ford and Motorcraft parts by looking for the Ford, FoMoCo or Motorcraft branding on the parts or their packaging.

Scheduled Maintenance and Mechanical Repairs

One of the best ways for you to make sure that your vehicle provides years of service is to have it maintained in line with our recommendations using parts that conform to the specifications detailed in this Owner's Manual. Genuine Ford and Motorcraft parts meet or exceed these specifications.

Collision Repairs

We hope that you never experience a collision, but accidents do happen. Genuine Ford replacement collision parts meet our stringent requirements for fit, finish, structural integrity, corrosion protection and dent resistance. During vehicle development we validate that these parts deliver the intended level of protection as a whole system. A great way to know for sure you are getting this level of protection is to use genuine Ford replacement collision parts.

Warranty on Replacement Parts

Genuine Ford and Motorcraft replacement parts are the only replacement parts that benefit from a Ford Warranty. The Ford Warranty may not cover damage caused to your vehicle as a result of failed non-Ford parts. For additional information, refer to the terms and conditions of the Ford Warranty.

SPECIAL NOTICES

New Vehicle Limited Warranty

For a detailed description of what your vehicle's New Vehicle Limited Warranty covers, see the Ford GT Warranty Guide provided to you along with your Owner's Manual.

Additional Warranty Information

Your vehicle's warranty information is covered in its entirety in the Ford GT Warranty Guide. You can obtain warranty service for your vehicle at a certified Ford GT Service dealer. If you need assistance locating an authorized dealer, please contact your Ford GT Concierge at **1-800-210-5795**.

We design and build our vehicles for our customers to drive as delivered from the factory. The Ford GT Warranty Guide discusses vehicle use and the installation of aftermarket parts and their effect on warranty coverage. See the Ford GT Warranty Guide for complete information.

Special Instructions

WARNINGS



You risk death or serious injury to yourself and others if you do not follow the instruction highlighted by the warning symbol. Failure to follow the specific warnings and instructions could result in personal injury.

Introduction

WARNINGS



NEVER use a rearward facing child restraint on a seat protected by an ACTIVE AIRBAG in front of it, DEATH or SERIOUS INJURY to the CHILD can occur.

For your added safety, your vehicle is fitted with sophisticated electronic controls.

On Board Diagnostics Data Link Connector

WARNING



Do not connect wireless plug-in devices to the data link connector. Unauthorized third parties could gain access to vehicle data and impair the performance of safety related systems. Only allow repair facilities that follow our service and repair instructions to connect their equipment to the data link connector.

Your vehicle has an OBD Data Link Connector (DLC) that is used in conjunction with a diagnostic scan tool for vehicle diagnostics, repairs and reprogramming services. Installing an aftermarket device that uses the DLC during normal driving for purposes such as remote insurance company monitoring, transmission of vehicle data to other devices or entities, or altering the performance of the vehicle, may cause interference with or even damage to vehicle systems. We do not recommend or endorse the use of aftermarket plug-in devices unless approved by Ford. The vehicle Warranty will not cover damage caused by an aftermarket plug-in device.

Certified Ford GT Service Dealer

All occurrences of authorized dealer in this manual are references to dealers who are certified to work on the Ford GT. Not all dealers have this certification. To locate a certified Ford GT Service dealer, contact your Ford GT Concierge at 1-800-210-5795.

MOBILE COMMUNICATIONS EQUIPMENT

WARNING



Driving while distracted can result in loss of vehicle control, crash and injury. We strongly recommend that you use extreme caution when using any device that may take your focus off the road. Your primary responsibility is the safe operation of your vehicle. We recommend against the use of any hand-held device while driving and encourage the use of voice-operated systems when possible. Make sure you are aware of all applicable local laws that may affect the use of electronic devices while driving.

Using mobile communications equipment is becoming increasingly important in the conduct of business and personal affairs. However, you must not compromise your own or others' safety when using such equipment. Mobile communications can enhance personal safety and security when appropriately used, particularly in emergency situations. Safety must be paramount when using mobile communications equipment to avoid negating these benefits. Mobile communication equipment includes, but is not limited to, cellular phones, pagers, portable email devices, text messaging devices and portable two-way radios.

Introduction

FORD PERFORMANCE

Welcome to the Ford Performance family!

Performance and racing are deeply embedded in Ford's DNA, dating back to October 10, 1901 when Henry Ford won his first race against Alexander Winton, America's greatest racer at the time. Henry Ford founded Ford Motor Company 18 months later with capital raised on the back of this remarkable upset victory.

Today, that spirit of passion, innovation and performance lives on through Ford Performance. Established in 2015, the company's performance teams -- Ford Special Vehicle Team (United States), Team RS (Europe), Ford Performance

(Australia) and Ford Racing (United States) – have unified under the mission to create the world's leading performance vehicles, parts, accessories and experiences for enthusiasts. This includes accelerating the development of advanced aerodynamics, lightweighting, electronics, powertrain performance, fuel efficiency and other technologies that can be applied across Ford's product portfolio.

We are proud and passionate about what we do and we look forward to a long and exciting relationship with you. Thank you for choosing Ford Performance!



E211570

Environment

PROTECTING THE ENVIRONMENT

You should play your part in protecting the environment. Correct vehicle usage and the authorized disposal of waste, cleaning and lubrication materials are significant steps toward this aim.

For details about Ford Motor Company's sustainability progress and initiatives visit:

Web Address
www.sustainability.ford.com

At a Glance

INSTRUMENT PANEL OVERVIEW

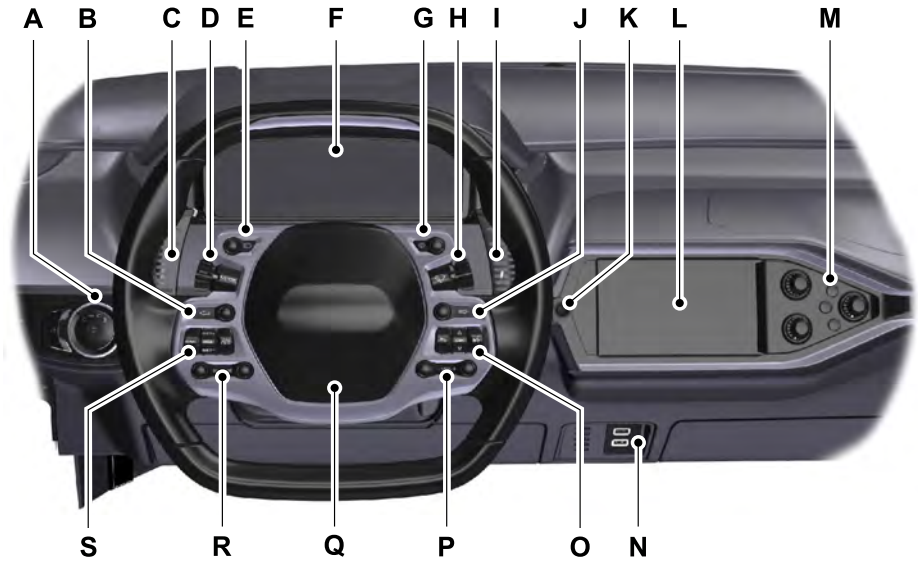

E243664

- A Lighting control. See **Lighting Control** (page 58).
- B Left direction indicator. See **Direction Indicators** (page 60).
- C Left paddle shifter. See **Automatic Transmission** (page 106).
- D Drive mode control. See **Drive Mode Control** (page 122).
- E High beam switch. See **Lighting Control** (page 58).
- F Instrument cluster. See **Gauges** (page 63).
- G Windshield washers. See **Windshield Washers** (page 57).
- H Windshield wipers. See **Windshield Wipers** (page 57).
- I Right paddle shifter. See **Automatic Transmission** (page 106).
- J Right direction indicator. See **Direction Indicators** (page 60).
- K Audio on and off button. See **Audio Unit** (page 212).
- L SYNC 3. See **General Information** (page 213).

At a Glance

- M Climate controls. See **Automatic Climate Control** (page 81). See **Manual Climate Control** (page 80).
- N Media hub. See **USB Port** (page 212).
- O Menu and voice control. See **Voice Control** (page 53).
- P Audio control. See **Audio Control** (page 53).
- Q Horn.
- R Audio control. See **Audio Control** (page 53).
- S Cruise control. See **Using Cruise Control** (page 121).

UNIQUE FEATURES



E236793

Vehicle Structure

- Carbon fiber tub and body shell.
- Aluminum structure fore and aft of tub.
- Steel roll cage integrated into the tub.

Powertrain

- Mid-engine 3.5L Twin Turbo EcoBoost V6.
- 7-speed dual clutch automated manual transmission.

Chassis

- Electronic/hydraulic controlled torsion bar front and rear suspension systems with ride height varied depending on drive mode.
- Front end lift feature for driveway approaches and speed bumps.
- Independent front and rear suspension with unequal length upper and lower control arms.
- Carbon ceramic brake discs.
- Brembo 6-piston front and 4-piston rear calipers.

At a Glance

- 20 in. x 8.5 in. forged alloy front wheels with 245/35R20 Michelin Pilot Sport Cup 2 tires.
- 20 in. x 11.5 in. forged alloy rear wheels with 325/30R20 Michelin Pilot Sport Cup 2 tires.
- Carbon fiber wheels available as an option.

Electronics and Vehicle Controls

- Vehicle drive mode control with five settings.
- Full LCD instrument cluster with customer selectable features.
- Race inspired steering wheel with stalkless steering column.
- Paddle shifters.
- SYNC 3 including navigation system.
- Single zone automatic temperature control.
- ABS, ESC (electronic stability control) and launch control.
- Passive entry/passive start key system.

Exterior

- Carbon fiber body panels including undertrays.
- Active aerodynamic rear wing and front splitter.
- LED headlamps and tail lamps.

Interior

- Fixed seating positions.
- Independently adjustable steering column and pedals.
- Carbon fiber, leather, and Alcantara interior surfaces.

Child Safety

GENERAL INFORMATION

See the following sections for directions on how to properly use safety restraints for children.

WARNINGS



Always make sure your child is secured properly in a device that is appropriate for their height, age and weight. Child safety restraints must be bought separately from your vehicle. Failure to follow these instructions and guidelines may result in an increased risk of serious injury or death to your child.



All children are shaped differently. The recommendations for safety restraints are based on probable child height, age and weight thresholds from the National Highway Traffic Safety Administration and other safety organizations, or are the minimum requirements of law. We recommend checking with a NHTSA Certified Child

WARNINGS

Passenger Safety Technician (CPST) and consult your pediatrician to make sure your child seat is appropriate for your child, and is compatible with and properly installed in your vehicle. To locate a child seat fitting station and CPST, contact NHTSA toll free at 1-888-327-4236 or go to <http://www.nhtsa.dot.gov>. In Canada, contact Transport Canada toll free at 1-800-333-0371 or go to www.tc.gc.ca to find a Child Car Seat Clinic in your area. Failure to properly restrain children in safety seats made especially for their height, age, and weight may result in an increased risk of serious injury or death to your child.



On hot days, the temperature inside the vehicle can rise very quickly. Exposure of people or animals to these high temperatures for even a short time can cause death or serious heat related injuries, including brain damage. Small children are particularly at risk.

Child Safety

Recommendations for Safety Restraints for Children

Child	Child size, height, weight, or age	Recommended restraint type
Infants or toddlers	Children weighing 40 lb (18 kg) or less (generally age four or younger).	Use a child safety seat (sometimes called an infant carrier, convertible seat, or toddler seat).
Small children	Children who have outgrown or no longer properly fit in a child safety seat (generally children who are less than 4 ft. 9 in. (1.45 m) tall, are greater than age four and less than age 12, and between 40 lb (18 kg) and 80 lb (36 kg) and upward to 100 lb (45 kg) if recommended by your child restraint manufacturer).	Use a belt-positioning booster seat.
Larger children	Children who have outgrown or no longer properly fit in a belt-positioning booster seat (generally children who are at least 4 ft. 9 in. (1.45 m) tall or greater than 80 lb (36 kg) or 100 lb (45 kg) if recommended by child restraint manufacturer).	Use a vehicle seatbelt having the lap belt snug and low across the hips, shoulder belt centered across the shoulder and chest, and seat back upright.

- You are required by law to properly use safety seats for infants and toddlers in the United States and Canada.
- Many states and provinces require that small children use approved booster seats until they reach age eight, a height of 4 feet 9 inches (1.45 meters) tall, or 80 pounds (36 kilograms). Check your local and state or provincial laws for specific requirements about the safety of children in your vehicle.

INSTALLING CHILD RESTRAINTS

Child Seats



E142594

Child Safety

Use a child safety seat (sometimes called an infant carrier, convertible seat, or toddler seat) for infants, toddlers, or children weighing 35 lb (16 kg) or less (generally age four or younger).

Using Lap and Shoulder Belts

WARNINGS



NEVER use a rearward facing child restraint on a seat protected by an ACTIVE AIRBAG in front of it, DEATH or SERIOUS INJURY to the CHILD can occur.



Depending on where you secure a child restraint, and depending on the child restraint design, you may block access to certain seatbelt buckle assemblies and LATCH lower anchors, rendering those features potentially unusable. To avoid risk of injury, make sure occupants only use seating positions where they are able to be properly restrained.

When installing a child safety seat with combination lap and shoulder belts:

- Use the correct seatbelt buckle for that seating position.
- Insert the belt tongue into the proper buckle until you hear a snap and feel it latch. Make sure the tongue is securely fastened in the buckle.
- Keep the buckle release button pointing up and away from the safety seat, with the tongue between the child restraint and the release button, to prevent accidental unbuckling.
- Place the vehicle seat upon which the child restraint will be installed in the upright position.
- Put the seatbelt in the automatic locking mode. See Step 5. This vehicle does not require the use of a locking clip.

Perform the following steps when installing the child restraint with combination lap and shoulder belts:

Note: Although the child restraint illustrated is a forward facing child restraint, the steps are the same for installing a rear facing child restraint.



E142528

1. Position the child safety seat in a seat with a combination lap and shoulder belt.



E142529

2. Pull down on the shoulder belt and then grasp the shoulder belt and lap belt together.

Child Safety



E142530

3. While holding the shoulder and lap belt portions together, route the tongue through the child restraint according to the child restraint manufacturer's instructions. Be sure the belt webbing is not twisted.



E142875

5. To put the retractor in the automatic locking mode, grasp the shoulder portion of the belt and pull downward until you pull the entire belt out.

Note: The automatic locking mode is available on the front passenger seat. This vehicle does not require the use of a locking clip.

6. Allow the belt to retract to remove slack. The belt clicks as it retracts to indicate it is in the automatic locking mode.
7. Try to pull the belt out of the retractor to make sure the retractor is in the automatic locking mode (you should not be able to pull more belt out). If the retractor is not locked, unbuckle the belt and repeat Steps 5 and 6.

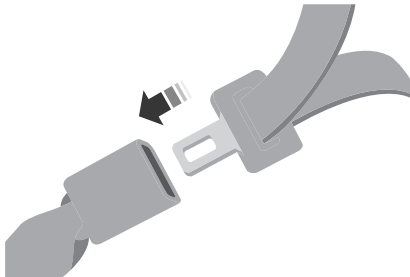

E142531

4. Insert the belt tongue into the proper buckle (the buckle closest to the direction the tongue is coming from) for that seating position until you hear a snap and feel the latch engage. Make sure the tongue is latched securely by pulling on it.



E142533

Child Safety

- Remove remaining slack from the belt. Force the seat down with extra weight, for example, by pressing down or kneeling on the child restraint while pulling up on the shoulder belt in order to force slack from the belt. This is necessary to remove the remaining slack that will exist once the extra weight of the child is added to the child restraint. It also helps to achieve the proper snugness of the child restraint to your vehicle. Sometimes, a slight lean toward the buckle will additionally help to remove remaining slack from the belt.
- Attach the tether strap (if the child restraint is equipped).

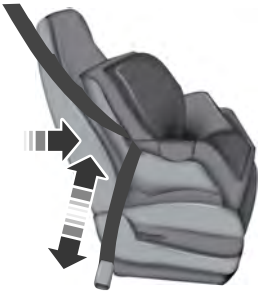

E142534

- Before placing the child in the seat, forcibly move the seat forward and back to make sure the seat is securely held in place. To check this, grab the seat at the belt path and attempt to move it side to side and forward and back. There should be no more than 1 in (2.5 cm) of movement for proper installation.

We recommend checking with a NHTSA Certified Child Passenger Safety Technician to make certain the child restraint is properly installed. In Canada, check with Transport Canada for referral to a Child Car Seat Clinic.

Using Tether Straps



Many forward-facing child safety seats include a tether strap which extends from the back of the child safety seat and hooks to an anchoring point called the top tether anchor. Tether straps are available as an accessory for many older safety seats.

Contact the manufacturer of your child restraint for information about ordering a tether strap, or to obtain a longer tether strap if the tether strap on your safety seat does not reach the appropriate top tether anchor in your vehicle.

Once the child safety seat has been installed using the seatbelt, you can attach the top tether strap.

The tether strap anchor in your vehicle is in the following position (shown from top view):

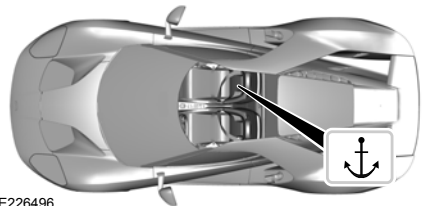

E226496

Perform the following steps to install a child safety seat with tether anchors:

Child Safety

BOOSTER SEATS

WARNING

 Do not put the shoulder section of the seatbelt or allow the child to put the shoulder section of the seatbelt under their arm or behind their back. Failure to follow this instruction could reduce the effectiveness of the seatbelt and increase the risk of injury or death in a crash.

Use a belt-positioning booster seat for children who have outgrown or no longer properly fit in a child safety restraint (generally children who are less than 57 in (1.45 m) tall, are greater than age 4 and less than age 12, and between 40 lb (18 kg) and 80 lb (36 kg) and upward to 100 lb (45 kg) if recommended by your child restraint manufacturer). Many state and provincial laws require that children use approved booster seats until they reach age eight, a height of 57 in (1.45 m) tall, or 80 lb (36 kg).

Booster seats should be used until you can answer YES to ALL of these questions when seated without a booster seat:

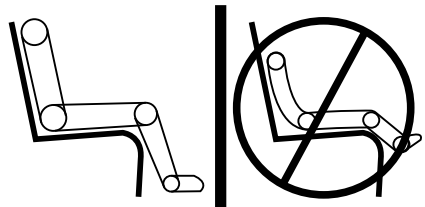

E142595

- Can the child sit all the way back against their vehicle seat backrest with knees bent comfortably at the edge of the seat cushion?
- Can the child sit without slouching?



E225883

1. Route the tether strap through either opening in the seatback as shown.
2. Locate the anchor behind the passenger seat on the floor.
3. Clip the tether strap to the anchor.
4. Tighten the child safety seat tether strap according to the manufacturer's instructions. If your child restraint system has a tether strap, and the child restraint manufacturer recommends its use, we also recommend its use.

If the safety seat is not anchored properly, the risk of a child being injured in a crash greatly increases.

Child Safety

- Does the lap belt rest low across the hips?
- Is the shoulder belt centered on the shoulder and chest?
- Can the child stay seated like this for the whole trip?

Always use booster seats in conjunction with your vehicle lap and shoulder belt.

Types of Booster Seats



E68924

- Backless booster seats

If your backless booster seat has a removable shield, remove the shield. If a vehicle seating position has a low seat backrest or no head restraint, a backless booster seat may place your child's head (as measured at the tops of the ears) above the top of the seat. In this case, move the backless booster to another seating position with a higher seat backrest or head restraint and lap and shoulder belts, or consider using a high back booster seat.



E70710

- High back booster seats

If, with a backless booster seat, you cannot find a seating position that adequately supports your child's head, a high back booster seat would be a better choice.

Children and booster seats vary in size and shape. Choose a booster that keeps the lap belt low and snug across the hips, never up across the stomach, and lets you adjust the shoulder belt to cross the chest and rest snugly near the center of the shoulder. The following drawings compare the ideal fit (center) to a shoulder belt uncomfortably close to the neck and a shoulder belt that could slip off the shoulder. The drawings also show how the lap belt should be low and snug across the child's hips.

Child Safety



E142596



E142597

If the booster seat slides on the vehicle seat upon which it is being used, placing a rubberized mesh sold as shelf or carpet liner under the booster seat may improve this condition. Do not introduce any item thicker than this under the booster seat. Check with the booster seat manufacturer's instructions.

CHILD RESTRAINT POSITIONING

WARNINGS



NEVER use a rearward facing child restraint on a seat protected by an ACTIVE AIRBAG in front of it, DEATH or SERIOUS INJURY to the CHILD can occur.

WARNINGS



Always carefully follow the instructions and warnings provided by the manufacturer of any child restraint to determine if the restraint device is appropriate for your child's size, height, weight, or age. Follow the child restraint manufacturer's instructions and warnings provided for installation and use in conjunction with the instructions and warnings provided by your vehicle manufacturer. A safety seat that is improperly installed or utilized, is inappropriate for your child's height, age, or weight or does not properly fit the child may increase the risk of serious injury or death.

Child Safety

WARNINGS



Never let a passenger hold a child on his or her lap while the vehicle is moving. The passenger cannot protect the child from injury in a crash.



Do not use pillows, books or towels to boost your child's height.



Always restrain an unoccupied child seat or booster seat. They may become projectiles in a crash or sudden stop, which may increase the risk of serious injury.

WARNINGS



Do not put the seatbelt under your child's arm or behind its back.



Do not leave children or pets unattended in your vehicle. Failure to follow this instruction could result in personal injury or death.

Recommendations for attaching child safety restraints for children

Restraint Type	Combined weight of child and child restraint	Use any attachment method as indicated below by X	
		Seatbelt and top tether anchor	Seatbelt only
Forward facing child restraint	Up to 65 lb (29.5 kg)	X	
Forward facing child restraint	Over 65 lb (29.5 kg)	X	

Note: *The child restraint must rest tightly against the vehicle seat upon which it is installed.*

Seatbelts

PRINCIPLE OF OPERATION

WARNINGS



Always drive and ride with your seatback upright and the lap belt snug and low across the hips.



Children must always be properly restrained.



Never let a passenger hold a child on his or her lap while the vehicle is moving. The passenger cannot protect the child from injury in a crash.



All occupants of your vehicle, including the driver, should always properly wear their seatbelts, even when an airbag supplemental restraint system is provided. Failure to properly wear your seatbelt could seriously increase the risk of injury or death.



In a rollover crash, an unbelted person is significantly more likely to die than a person wearing a seatbelt.



Each seating position in your vehicle has a specific seatbelt assembly made up of one buckle and one tongue designed to be used as a pair. Use the shoulder belt on the outside shoulder only. Never wear the shoulder belt under the arm. Never use a single seatbelt for more than one person.



Seatbelts and seats may be hot in a vehicle that is in the sunshine. The hot seatbelts or seats may burn a small child. Check seat covers and buckles before you place a child anywhere near them.

All seating positions in your vehicle have lap and shoulder seatbelts. All occupants of the vehicle should always properly wear their seatbelts, even when an airbag supplemental restraint system is provided.

The seatbelt system consists of:

- Lap and shoulder seatbelts.
- Seatbelt pretensioner at the front outboard seating positions.
- Belt tension sensor at the front outboard passenger seating position.



• Seatbelt warning light and chime.



• Crash sensors and monitoring system with readiness indicator.

The seatbelt pretensioners at the front seating positions are designed to tighten the seatbelts when activated. In frontal and near-frontal crashes, the seatbelt pretensioners may be activated alone or, if the crash is of sufficient severity, together with the front airbags.

FASTENING THE SEATBELTS

The safety restraints in the vehicle are combination lap and shoulder belts.



E224747

Seatbelts



E142587

1. Insert the belt tongue into the proper buckle (the buckle closest to the direction the tongue is coming from) until you hear a click and feel it latch. Make sure you securely fasten the tongue in the buckle.

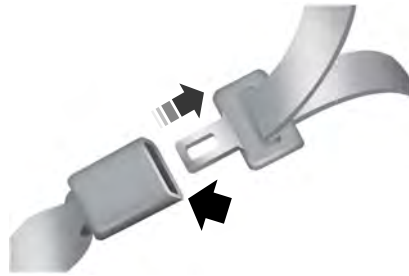

E142588

2. To unfasten, press the release button and remove the tongue from the buckle.

Using Seatbelts During Pregnancy

WARNING

 Always ride and drive with your seatback upright and properly fasten your seatbelt. Fit the lap portion of the seatbelt snugly and low across the hips. Position the shoulder portion of the seatbelt across your chest. Pregnant women must follow this practice. See the following figure.

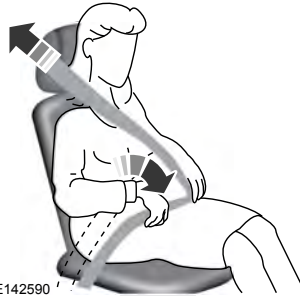

E142590

Pregnant women should always wear their seatbelt. Position the lap belt portion of a combination lap and shoulder belt low across the hips below the belly and worn as tight as comfort allows. Position the shoulder belt to cross the middle of the shoulder and the center of the chest.

Seatbelt Locking Modes

WARNING

 If your vehicle is involved in a crash, have the seatbelts and associated components inspected as soon as possible. Failure to follow this instruction could result in personal injury or death.

All safety restraints in the vehicle are combination lap and shoulder belts and have vehicle sensitive locking mode. In addition, the front outboard passenger seatbelts have the automatic locking mode.

Seatbelts

Vehicle Sensitive Mode

This is the normal retractor mode, which allows free shoulder belt length adjustment to your movements and locking in response to vehicle movement. For example, if the driver brakes suddenly or turns a corner sharply, or the vehicle receives an impact of about 5 mph (8 km/h) or more, the combination seatbelts lock to help reduce forward movement of the driver and passenger.

In addition, the retractor is designed to lock if you pull the webbing out too quickly. If the seatbelt retractor locks, slowly lower the height adjuster to allow the seatbelt to retract. If the retractor does not unlock, pull the seatbelt out slowly then feed a small length of webbing back toward the stowed position.

Automatic Locking Mode

In this mode, the shoulder belt automatically pre-locks. The belt still retracts to remove any slack in the shoulder belt. The automatic locking mode is not available on the driver seatbelt.

When to Use the Automatic Locking Mode

Use this mode any time a child safety seat, except a booster, is installed in the passenger front seating position. See **Child Safety** (page 17).

How to Use the Automatic Locking Mode

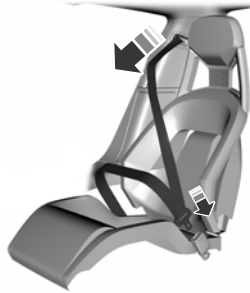

E243129

1. Buckle the combination lap and shoulder belt.
2. Grasp the shoulder portion and pull downward until you pull the entire belt out.
3. Allow the belt to retract. As the belt retracts, you will hear a clicking sound. This indicates the seatbelt is now in the automatic locking mode.

How to Disengage the Automatic Locking Mode

Unbuckle the combination lap and shoulder belt and allow it to retract completely to disengage the automatic locking mode and activate the vehicle sensitive (emergency) locking mode.

SEATBELT WARNING LAMP AND INDICATOR CHIME



This lamp illuminates and an audible warning will sound if the driver seatbelt has not been fastened when the vehicle's ignition is turned on.

Seatbelts

Conditions of operation

If	Then
The driver seatbelt is not buckled before the ignition switch is turned to the on position...	The seatbelt warning light illuminates and the warning chime sounds for a few seconds.
The driver seatbelt is buckled while the indicator light is illuminated and the warning chime is sounding...	The seatbelt warning light and warning chime turn off.
The driver seatbelt is buckled before the ignition switch is turned to the on position...	The seatbelt warning light and indicator chime remain off.

SEATBELT REMINDER

Belt-Minder™

This feature supplements the seatbelt warning function by providing additional reminders that intermittently sound a tone and illuminate the seatbelt warning light when you are in the driver seat or you have a front seat passenger and a seatbelt is unbuckled.

The system uses information from the front passenger sensing system to determine if a front seat passenger is present and therefore potentially in need of a warning. To avoid activating the Belt-Minder feature for objects you place in the front passenger seat, only the front seat passengers receive warnings as determined by the front passenger sensing system.

If the Belt-Minder warnings expire (warnings for about five minutes) for one passenger (driver or front passenger), the other passenger can still cause the Belt-Minder feature to turn on.

Seatbelts

If	Then
You and the front seat passenger buckle your seatbelts before you switch the ignition on or less than 1-2 minutes elapse after you switch the ignition on...	The Belt-Minder feature will not activate.
You or the front seat passenger do not buckle your seatbelts before your vehicle reaches at least 6 mph (9.7 km/h) and 1-2 minutes elapse after you switch the ignition on...	The Belt-Minder feature activates, the seatbelt warning light illuminates and a warning tone sounds for 6 seconds every 25 seconds, repeating for about 5 minutes or until you and the front seat passenger buckle your seatbelts.
The seatbelt for the driver or front passenger is unbuckled for about 1 minute while the vehicle is traveling at least 6 mph (9.7 km/h) and more than 1-2 minutes elapse after you switch the ignition on...	The Belt-Minder feature activates, the seatbelt warning light illuminates and a warning tone sounds for 6 seconds every 25 seconds, repeating for about 5 minutes or until you and the front seat passenger buckle your seatbelts.

Deactivating and Activating the Belt-Minder Feature

WARNING



While the system allows you to switch it off, this system is designed to improve your chances of being safely belted and surviving a crash. We recommend you leave the system switched on. To reduce the risk of injury, do not switch the system on or off while driving your vehicle.

Note: *The driver and front passenger warnings switch on and off independently. When you perform this procedure for one seating position, do not buckle the other position as this terminates the process.*

Read Steps 1 - 4 thoroughly before proceeding with the programming procedure.

Before following the procedure, make sure that:

- The parking brake is set.
 - The transmission is in park (P).
 - The ignition is off.
 - The driver and front passenger seatbelts are unbuckled.
1. Switch the ignition on. Do not start the vehicle.
 2. Wait until the seatbelt warning light turns off (about one minute). After Step 2, wait an additional 5 seconds before proceeding with Step 3. Once you start Step 3, you must complete the procedure within 30 seconds.
 3. For the seating position you are switching off, buckle then unbuckle the seatbelt three times at a moderate speed, ending in the unbuckled state. After Step 3, the seatbelt warning light turns on.

Seatbelts

4. While the seatbelt warning light is on, buckle and then unbuckle the seatbelt. After Step 4, the seatbelt warning light flashes for confirmation.
 - This will switch the feature off for that seating position if it is currently on.
 - This will switch the feature on for that seating position if it is currently off.

CHILD RESTRAINT AND SEATBELT MAINTENANCE

Inspect the vehicle safety belts and child safety seat systems periodically to make sure they work properly and are not damaged. Inspect the vehicle and child seat safety belts to make sure there are no nicks, tears or cuts. Replace if necessary. All vehicle safety belt assemblies, including retractors, buckles, front safety belt buckle assemblies, buckle support assemblies (slide bar-if equipped), shoulder belt height adjusters (if equipped), shoulder belt guide on seat back (if equipped), child safety seat LATCH and tether anchors, and attaching hardware, should be inspected after a crash. Read the child restraint manufacturer's instructions for additional inspection and maintenance information specific to the child restraint.

Ford Motor Company recommends that all safety belt assemblies in use in vehicles involved in a crash be replaced. However, if the crash was minor and an authorized dealer finds that the belts do not show damage and continue to operate properly, they do not need to be replaced. Safety belt assemblies not in use during a crash should also be inspected and replaced if either damage or improper operation is noted.

Properly care for safety belts. See **Vehicle Care** (page 172).

SEATBELT EXTENSION

WARNINGS



Persons who fit into the vehicle's seatbelt should not use an extension. Unnecessary use could result in serious personal injury in the event of a crash.



Only use extensions provided free of charge by Ford Motor Company dealers. The dealer will provide an extension designed specifically for this vehicle, model year and seating position. The use of an extension intended for another vehicle, model year or seating position may not offer you the full protection of your vehicle's seatbelt restraint system.



Never use seatbelt extensions to install child restraints.



Do not use extensions to change the way the seatbelt fits across the torso, over the lap or to make the seatbelt buckle easier to reach.

If, because of body size or driving position, it is not possible to properly fasten the seatbelt over your lap and shoulder, an extension that is compatible with the seatbelts is available free of charge from Ford Motor Company dealers. Only Ford seatbelt extensions made by the original equipment seatbelts manufacturer should be used with Ford seatbelts. Ask your authorized dealer if your extension is compatible with your Ford vehicle restraint system.

Personal Safety System™

The Personal Safety System provides an improved overall level of frontal crash protection to front seat occupants and is designed to help further reduce the risk of airbag-related injuries. The system analyzes different occupant conditions and crash severity before activating the appropriate safety devices to help better protect a range of occupants in a variety of frontal crash situations.

The vehicle Personal Safety System consists of:

- Driver and passenger dual-stage airbag supplemental restraints.
- Seatbelts, energy management retractors and seatbelt usage sensors.
- Front passenger sensing system.
- Passenger airbag off and on indicator lamp.
- Front crash severity sensors.
- Restraints control module with impact and safing sensors.
- Restraint system warning light and backup tone.
- The electrical wiring for the airbags, crash sensors, front seatbelt usage sensors, front passenger sensing system and indicator lights.

How Does the Personal Safety System Work?

The Personal Safety System can adapt the deployment strategy of the safety devices according to crash severity and occupant conditions. A collection of crash and occupant sensors provides information to the restraints control module. During a crash, the restraints control module may deploy one or both stages of the dual-stage airbags based on crash severity and occupant conditions.

Supplementary Restraints System

PRINCIPLE OF OPERATION

WARNINGS

 Airbags do not inflate slowly or gently, and the risk of injury from a deploying airbag is the greatest close to the trim covering the airbag module.

 All occupants of your vehicle, including the driver, should always properly wear their seatbelts, even when an airbag supplemental restraint system is provided. Failure to properly wear your seatbelt could seriously increase the risk of injury or death.

 Always use appropriate child restraints. Failure to follow this could seriously increase the risk of injury or death.

 Never place your arm over the airbag module as a deploying airbag can result in serious arm fractures or other injuries.

 Airbags can kill or injure a child in a child restraint. Never place a rear-facing child restraint in front of an active airbag.

 Do not attempt to service, repair, or modify the airbag supplemental restraint systems or its fuses as you could be seriously injured or killed. Contact your authorized dealer as soon as possible.

 Several airbag system components get hot after inflation. To reduce the risk of injury, do not touch them after inflation.

 If the airbag has deployed, the airbag will not function again and must be replaced immediately. If the airbag is not replaced, the unrepaired area will increase the risk of injury in a crash.

The airbags are a supplemental restraint system and are designed to work with the seatbelts to help protect the driver and right front passenger from certain upper body injuries. Airbags do not inflate slowly; there is a risk of injury from a deploying airbag.

Note: *You will hear a loud bang and see a cloud of harmless powdery residue if an airbag deploys. This is normal.*

The airbags inflate and deflate rapidly upon activation. After airbag deployment, it is normal to notice a smoke-like, powdery residue or smell the burnt propellant. This may consist of cornstarch, talcum powder (to lubricate the bag) or sodium compounds (for example, baking soda) that result from the combustion process that inflates the airbag. Small amounts of sodium hydroxide may be present which may irritate the skin and eyes, but none of the residue is toxic.

Though the system is designed to help reduce serious injuries, contact with a deploying airbag may also cause abrasions or swelling. Temporary hearing loss is also a possibility as a result of the noise associated with a deploying airbag. Because airbags must inflate rapidly and with considerable force, there is the risk of death or serious injuries such as fractures, facial and eye injuries or internal injuries, particularly to occupants who are not properly restrained or are out of position at the time of airbag deployment. It is extremely important that occupants are properly restrained as far away from the airbag module as possible while maintaining vehicle control.

Routine maintenance of the airbags is not required.

Supplementary Restraints System

DRIVER AND PASSENGER AIRBAGS

WARNINGS



Never place your arm over the airbag module as a deploying airbag can result in serious arm fractures or other injuries.



NEVER use a rearward facing child restraint on a seat protected by an ACTIVE AIRBAG in front of it, DEATH or SERIOUS INJURY to the CHILD can occur.

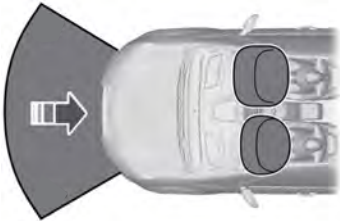

E151127

The driver and front passenger airbags deploy during significant frontal and near frontal crashes.

The driver and passenger front airbag system consists of:

- Driver and passenger airbag modules.
- Front passenger sensing system.



• Crash sensors and monitoring system with readiness indicator. See **Crash Sensors and Airbag Indicator** (page 38).

Proper Driver and Front Passenger Seating Adjustment

WARNING



National Highway Traffic Safety Administration (NHTSA) recommends a minimum distance of at least 10 in (25 cm) between an occupant's chest and the driver airbag module.

After all occupants put on seatbelts, it is very important that they continue to sit properly. A properly seated occupant sits upright, leaning against the seatback, and is centered on the seat cushion, with their feet comfortably extended on the floor. Sitting improperly can increase the chance of injury in a crash event. For example, if an occupant slouches, lies down, turns sideways, sits forward, leans forward or sideways, or puts one or both feet up, the chance of injury during a crash greatly increases.

Children and Airbags

WARNING



NEVER use a rearward facing child restraint on a seat protected by an ACTIVE AIRBAG in front of it, DEATH or SERIOUS INJURY to the CHILD can occur.



E142846

Supplementary Restraints System

FRONT PASSENGER SENSING SYSTEM

WARNINGS



Sitting improperly, out of position or with the seatback reclined too far can take weight off the seat cushion and affect the decision of the passenger sensing system, resulting in serious injury or death in the event of a crash. Always sit upright against your seat back, with your feet on the floor.



Any alteration or modification to the front passenger seat may affect the performance of the front passenger sensing system. This could seriously increase the risk of injury or death.

This system works with sensors that are part of the front passenger seat and seatbelt to detect the presence of a properly-seated occupant and determine if the front passenger frontal airbag should be enabled (may inflate) or not.



E179527

The front passenger sensing system uses a passenger airbag off indicator which illuminates and stays lit to remind you that the front passenger frontal airbag is disabled.

The indicator lamp is on the overhead console.

Note: When you first switch the ignition on, the indicator lamp illuminates for a short period of time to confirm it is functional.

The front passenger sensing system is designed to disable (will not inflate) the front passenger frontal airbag when it detects a rear facing infant seat, a forward-facing child restraint, or a booster seat. The sensor turns off the passenger front airbag and side airbag when the passenger seat is empty.

- When the front passenger sensing system disables (will not inflate) the front passenger frontal airbag, the indicator lamp illuminates and stays lit to remind you that the front passenger frontal airbag is disabled.
- If you install the child restraint and the indicator lamp is not lit, switch the vehicle off, remove the child restraint from the vehicle and reinstall the restraint following the child restraint manufacturer's instructions.

The front passenger sensing system is designed to enable (may inflate) the front passenger frontal airbag anytime the system senses that a person of adult size is sitting properly in the front passenger seat.

- When the front passenger sensing system enables the front passenger frontal airbag (may inflate), the indicator lamp will be unlit and stays unlit.

Supplementary Restraints System

If a person of adult size is sitting in the front passenger seat, but the airbag off indicator lamp is lit, it is possible that the person is not sitting properly in the seat. If this happens:

- Switch the vehicle off and ask the person to place the seatback in the full upright position.

- Have the person sit upright in the seat, centered on the seat cushion, with the person's legs comfortably extended.
- Restart the vehicle and have the person remain in this position for about two minutes. This allows the system to detect that person and enable the passenger front airbag.

Occupant	Passenger Airbag OFF Indicator	Passenger Airbag
Empty	Lit	Disabled
Child	Lit	Disabled
Adult	Unlit	Enabled

Note: When the passenger airbag off light illuminates, the passenger side airbag (near the B-pillar) may be disabled to avoid the risk of airbag deployment injuries.

After all occupants put on seatbelts, it is very important that they continue to sit properly. A properly seated occupant sits upright, leaning against the seatback, and centered on the seat cushion, with their feet comfortably extended on the floor. Sitting improperly can increase the chance of injury in a crash event. For example, if an occupant slouches, lies down, turns sideways, sits forward, leans forward or sideways, or puts one or both feet up, the chance of injury during a crash greatly increases.

If you think that the status of the passenger airbag off indicator lamp is incorrect, check for the following:

- Objects between the seat cushion and the center console.
- Objects hanging off the seatback.
- Objects placed on the occupant's lap.
- Cargo interference with the seat.

The conditions listed above may cause the weight of a properly seated occupant to be incorrectly interpreted by the front passenger sensing system. The person in the front passenger seat may appear heavier or lighter due to the conditions described in the list above.



Make sure the front passenger sensing system is operating properly. See **Crash Sensors and Airbag Indicator** (page 38).

If the airbag readiness light is lit, do the following:

The driver and adult passenger should check for objects interfering with the seat.

If there are objects interfering with the seat, take the following steps to remove the obstruction:

- Pull the vehicle over.
- Switch the ignition off.
- Driver and adult passenger should check for any objects interfering with the seat.
- Remove the obstruction(s) (if found).
- Restart the vehicle.

Supplementary Restraints System

- Wait at least two minutes and verify that the airbag readiness light is no longer illuminated.
- If the airbag readiness light remains illuminated, this may or may not be a problem due to the front passenger sensing system.

Do not attempt to repair or service the system. Take your vehicle immediately to an authorized dealer.

If it is necessary to modify an advanced front airbag system to accommodate a person with disabilities, contact the Ford GT Concierge.

SIDE AIRBAGS

WARNINGS



To reduce risk of injury, do not obstruct or place objects in the deployment path of the airbag.



Do not lean your head on the door. The side airbag could injure you as it deploys from the B-pillar.



Do not attempt to service, repair, or modify the airbag supplemental restraint systems or its fuses on a vehicle containing air bags as you could be seriously injured or killed. Contact your authorized dealer as soon as possible.



If the side airbag has deployed, the airbag will not function again. The side airbag system (including the seat) must be inspected as soon as possible. If the airbag is not replaced, the unrepaired area will increase the risk of injury in a crash.

The side airbags are near the B-pillar. In certain sideways crashes, the airbag on the side affected by the crash will be inflated. The airbag was designed to inflate between the door panel and occupant to further enhance the protection provided occupants in side impact crashes.

The system consists of the following:

- An embossed side panel indicating that side airbags are on your vehicle.
- Side airbags near the B-pillar.
- Front passenger sensing system.



• Crash sensors and monitoring system with readiness indicator. See **Crash Sensors and Airbag Indicator** (page 38).

Note: *The passenger sensing system will deactivate the passenger side airbag (near the B-pillar) if it detects an empty, unbuckled passenger seat.*

The design and development of the side airbag system included recommended testing procedures that were developed by a group of automotive safety experts known as the Side Airbag Technical Working Group. These recommended testing procedures help reduce the risk of injuries related to the deployment of side airbags.

DRIVER AND PASSENGER KNEE AIRBAGS

WARNING



To reduce risk of injury, do not obstruct or place objects in the deployment path of the knee airbag.

Supplementary Restraints System

The knee airbags are under or within the instrument panel. During a crash, the restraints control module may activate the driver and passenger knee airbags based on crash severity and occupant conditions. Under certain crash and occupant conditions, the driver and passenger knee airbag may deploy, but the driver front airbag may not activate. As with front and side airbags, it is important to be properly seated and restrained to reduce the risk of death or serious injury.



Make sure the knee airbags are operating properly. See **Crash Sensors and Airbag Indicator** (page 38).

CRASH SENSORS AND AIRBAG INDICATOR

WARNING



Modifying or adding equipment to the front end of your vehicle (including hood, bumper system, frame, front end body structure, tow hooks and hood pins) may affect the performance of the airbag system, increasing the risk of injury. Do not modify or add equipment to the front end of your vehicle.

Your vehicle has a collection of crash and occupant sensors which provide information to the restraints control module. The restraints control module deploys (activates) the front seatbelt pretensioners, driver airbag, passenger airbag, knee airbag(s) and side airbags. Based on the type of crash, the restraints control module deploys the appropriate safety devices.

The restraints control module monitors the readiness of the safety devices and the crash and occupant sensors. The readiness of the safety system is indicated by a warning indicator light in the instrument cluster or by a backup tone if the warning light is not working. Routine maintenance of the airbag is not required.

A difficulty with the system is indicated by one or more of the following:



The readiness light does not illuminate immediately after you switch the ignition on.

- The readiness light either flashes or stays lit.
- The system has five tones that repeat periodically until the problem, the light or both are repaired.

If you experience any of these events, even intermittently, have a qualified technician service the supplemental restraint system immediately. If it is not serviced, the system may not function properly in a crash.

The design of the seatbelt pretensioners and the front airbag supplemental restraint system is to activate when the vehicle sustains frontal deceleration sufficient to cause the restraints control module to deploy a safety device.

Supplementary Restraints System

If the seatbelt pretensioners or front airbags do not activate for both front seat occupants in a crash, it does not mean that something is wrong with the system. Rather, it means the restraints control module determined the accident conditions (crash severity, belt usage) were not appropriate to activate these safety devices.

- The design of the front airbags is to activate only in frontal and near-frontal crashes (not rollovers, side impacts or rear impacts unless the crash causes sufficient frontal deceleration).
- The design of the seatbelt pretensioners is to activate in frontal, near-frontal and side crashes and rollovers.
- The knee airbag(s) may deploy based on crash severity and occupant conditions.
- The design of the side airbags is to inflate in certain side crashes. Side airbags may activate in other types of crashes if the vehicle experiences sufficient sideways motion or deformation.

AIRBAG DISPOSAL

Contact your authorized dealer as soon as possible. Airbags must be disposed of by qualified personnel.

Keys and Remote Controls

GENERAL INFORMATION ON RADIO FREQUENCIES

This device complies with Part 15 of the FCC Rules and with Industry Canada license-exempt RSS standard(s). Operation is subject to the following two conditions: (1) This device may not cause harmful interference, and (2) This device must accept any interference received, including interference that may cause undesired operation.

Note: *Changes or modifications not expressly approved by the party responsible for compliance could void the user's authority to operate the equipment. The term **IC** before the radio certification number only signifies that Industry Canada technical specifications were met.*

The typical operating range for your transmitter is approximately 33 ft (10 m).

One of the following could cause a decrease in operating range:

- weather conditions
- nearby radio towers
- structures around the vehicle
- other vehicles parked next to your vehicle

Other short-distance radio transmitters, such as amateur radios, medical equipment, wireless headphones, remote controls and alarm systems may operate on the same frequency as your remote control. If other transmitters are operating on those frequencies, you may not be able to use your remote control. Using your remote control near some types of electronic equipment, such as USB devices, computers or cell phones can interfere with remote operation. Operating your remote control near metal or metallic-finished purses, bags or clothing can interfere with remote operation.

Note: *Make sure to lock your vehicle before leaving it unattended.*

Note: *If you are in range, the remote control will operate if you press any button unintentionally.*

Intelligent Access

The system uses a radio frequency signal to communicate with your vehicle and authorize your vehicle to unlock when one of the following conditions are met:

- You push the exterior door release panel within 3 ft (1 m) proximity of an intelligent access key.
- You press a button on the transmitter.

If excessive radio frequency interference is present in the area or if the transmitter battery is low, you may need to mechanically unlock your door. You can use the mechanical key blade in your intelligent access key to open the engine cover to access a pull strap to manually unlock the driver door in this situation. See **Remote Control** (page 41).

Keys and Remote Controls

REMOTE CONTROL

Intelligent Access Key



E234662

Your intelligent access keys operate the power locks. The key must be in your vehicle to activate the push-button start system.

Removable Key Blade

The intelligent access key also contains a removable mechanical key blade that you can use to unlock the rear hatch and release the driver door.



E234661

Slide the release on the back of the remote control and pivot the cover off to access the key blade.



E151795

Note: Your vehicle's backup keys came with a security tag that provides important vehicle key cut information. Keep the tag in a safe place for future reference.

Keys and Remote Controls

Competition Series



E252158

The competition series intelligent access key does not have a hatch release button or a removable key. In addition to the competition series intelligent access key, a provided separate key unlocks the competition series hatch.

Using the Key Blade

Intelligent Access Key

A manual driver door release is located in the engine compartment.

To access the door release:

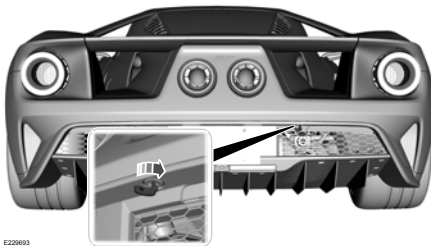

E22903

1. Open the rear hatch using the key blade.

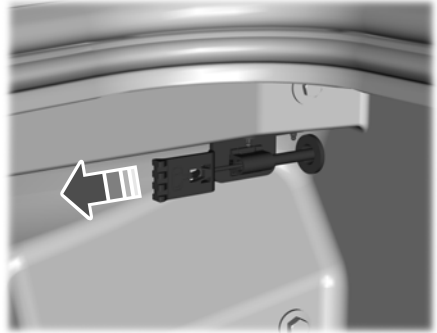

E229694

2. Pull the release located on the left side of the storage box under the rear hatch.

Competition Series

1. Unlock rear hatch using your key.

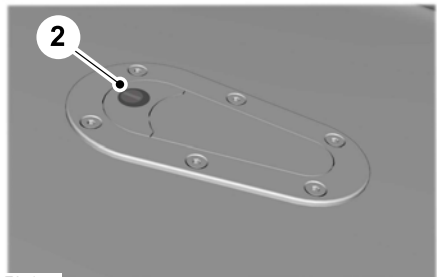

E251577

2. Push the button to release the handle.

Keys and Remote Controls

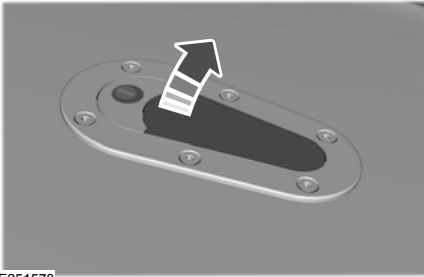

E251578

3. Pull the handle up until you feel a click.
4. Push down on the hatch until you feel a click.



E251630

5. Lift the hatch and remove the two-piece prop rod from the storage area.



E251629

6. Assemble the prop rod and use it to prop open rear hatch.

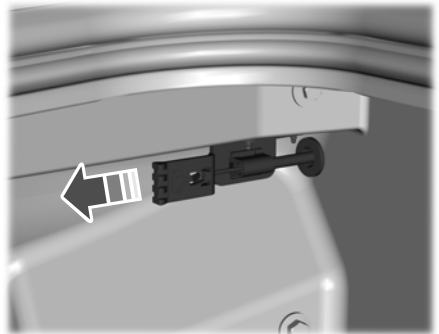

E229694

7. Pull the release located on the left side of the storage box under the rear hatch.

Replacing the Battery

Note: Refer to local regulations when disposing of transmitter batteries.

Keys and Remote Controls

Note: Do not wipe off any grease on the battery terminals or on the back surface of the circuit board.

Note: Replacing the battery will not delete the transmitter from the vehicle. The transmitter should operate normally.

A message will appear in the information display when the remote control battery is low. See **Information Messages** (page 73).

Intelligent Access Transmitter

The remote control uses one coin-type three-volt lithium battery CR2032 or equivalent.



E234661

1. Push the release button and pull the key blade out.



E234660

2. Twist a thin coin under the tab hidden behind the key blade head to remove the battery cover.

Keys and Remote Controls

REPLACING A LOST KEY OR REMOTE CONTROL

Replacement keys or remote controls can be purchased from an authorized dealer. Authorized dealers can program remote controls for your vehicle. See **Passive Anti-Theft System** (page 50).



E218402

3. Insert a suitable tool, for example a screwdriver, in the position shown and carefully remove the battery.
4. Install a new battery with the + facing upward.
5. Reinstall the battery cover and the key blade.

Car Finder



Press the button twice within three seconds. The horn sounds and the turn signals flash. We recommend you use this method to locate your vehicle, rather than using the panic alarm.

Sounding a Panic Alarm

Note: *The panic alarm will only operate when the ignition is off.*



Press the button to activate the alarm. Press the button again or switch the ignition on to deactivate.

Doors and Locks

LOCKING AND UNLOCKING

You can use the power door lock control or the remote control to lock and unlock your vehicle.

Power Door Locks

The power door lock control is on the driver and front passenger door panels.

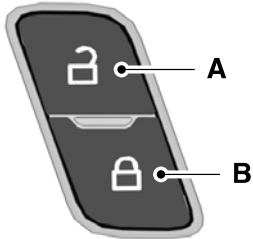

E196954

- A Unlock.
- B Lock.

Door Lock Indicator

An LED in the door lock switch lights when you lock the door. It remains lit for up to 10 minutes after you switch off the ignition.

Remote Control

You can use the remote control at any time.

Unlocking the Doors (Two-Stage Unlock)



Press the button to unlock the driver door.

Press the button again within three seconds to unlock all doors. The directional indicators flash.

Press and hold both the lock and unlock buttons on the remote control for three seconds to change between driver-door or all-door unlock mode. The direction indicators flash twice to indicate a change to the unlocking mode. Driver-door unlock mode only unlocks the driver door when you press the unlock button once. All-door unlock mode unlocks all doors with one press of the unlock button. The unlocking mode applies to the remote control and intelligent access. You can also change the mode in the information display. See **General Information** (page 70).

Locking the Doors



Press the button to lock all the doors. The direction indicators flash. Press the button again within three seconds to confirm that all the doors are closed and locked. The doors lock again, the horn sounds and the direction indicators flash if all the doors are closed and locked.

Mislock

If any door or engine compartment is open, or if the hood is open, the horn sounds twice and the directional indicators do not flash.

Activating Intelligent Access

You must have the intelligent access key within 3 ft (1 m) of your vehicle.

At a Door

Push the door release panel to unlock and release the door. Move your fingers behind the edge of the door to lift the door open.

Note: *Doors open upward and outward. Make sure there is enough room to open the door both upward and outward.*

Doors and Locks

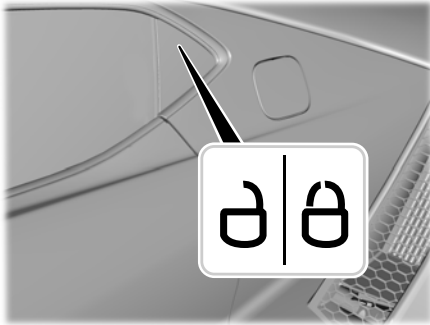

E269486

Touch and hold the red lock indicator on the rear quarter window to lock the door. The indicator behind the quarter window shows if your vehicle is locked or unlocked. There is a brief delay before you can unlock your vehicle again.

Smart Unlocks for Intelligent Access Keys

This feature helps to prevent you from locking your intelligent access key inside your vehicle's passenger compartment.

If you attempt to lock your vehicle with the intelligent access key inside, all of the doors immediately unlock and a tone sounds, indicating that a key is inside. The system searches for an intelligent access key inside the vehicle after you lock the door, the transmission is in park (P) and the ignition is off.

You can override the smart unlock feature and intentionally lock the intelligent access key inside your vehicle.

To do this, lock your vehicle after you have closed all the doors by:

- Pressing the lock button on another intelligent access key.
- Touching the locking area on the door panel with another intelligent access key in your hand.

When you open one of the front doors and lock your vehicle using the power door lock control, all doors lock then unlock if:

- The ignition is on.
- The ignition is off and your vehicle is not in park (P).

Autolock (If Equipped)

Autolock locks all the doors when:

- All doors are closed.
- The ignition is on.
- You shift into any gear putting your vehicle in motion.
- Your vehicle reaches a speed greater than 12 mph (20 km/h).

Autolock repeats when:

- You open then close any door while the ignition is on and your vehicle speed is 9 mph (15 km/h) or lower.
- Your vehicle reaches a speed greater than 12 mph (20 km/h).

Autounlock

Autounlock unlocks all the doors when:

- Your vehicle has been moving at a speed greater than 12 mph (20 km/h).
- All doors are closed.
- The ignition is on.
- The vehicle comes to a stop and you switch the ignition off or to the accessory position.
- You open the driver door within 10 minutes of switching the ignition off or to accessory.

Doors and Locks

Note: The doors will not autounlock if you electronically lock your vehicle after you switch the ignition off and before you open the driver door.

Enabling or Disabling Autolock and Autounlock

Note: You can switch autounlock and autolock on or off independently of each other.

Autolock is not configurable in all markets. If the autolock settings are not available in your information display, then the system is not configurable. See **General Information** (page 70).

Illuminated Entry (If Equipped)

The interior lamp illuminates when you unlock the doors with the remote entry system.

The illuminated entry system turns off the lights if:

- The ignition is on.
- You press the remote control lock button.
- After 25 seconds of illumination.

The light does not turn off if:

- You switch them on with the lamp control.
- Any door is open.

Illuminated Exit (If Equipped)

The interior lamp illuminates when all doors are closed and you switch the ignition off.

The lamp turns off if all the doors remain closed and:

- 25 seconds elapse.
- You press the push button ignition switch.

Battery Saver

If you leave on the courtesy lamps, dome lamps or headlamps, the battery saver turns them off 10 minutes after you switch the ignition off.

Accessory Mode Battery Saver for Intelligent Access Keys

If you leave your vehicle switched on, it shuts off when it detects a certain amount of battery drain, or after 45 minutes.

OPENING THE DOORS

Note: While your vehicle is in motion, the door release buttons only function if you press the interior unlock button and door interior release button within two seconds.

Opening the Doors from Inside



Press the door release button located on the arm rest to release the door. Push the door out and up to open the door. The hydraulic lift cylinder assists in the door movement once you start to open the door.

Doors and Locks

EMERGENCY DOOR RELEASE

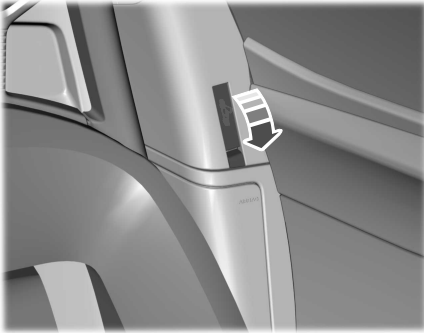

E232493

Your doors can be manually opened from the inside of the car when the door release button is not functioning or if there is a low battery or other electrical concerns. Grab the emergency door release pull strap located on the B-pillar trim beside the seat and pull it up and out to release the door. There is an emergency release pull strap for each door.

PASSIVE ANTI-THEFT SYSTEM

Note: *The system is not compatible with non-Ford aftermarket remote start systems. Use of these systems may result in vehicle starting problems and a loss of security protection.*

Note: *Metallic objects, electronic devices or a second coded key on the same key chain may cause vehicle starting problems if they are too close to the key when starting your vehicle. Prevent these objects from touching the coded key while starting your vehicle. Switch the ignition off, move all objects on the key chain away from the coded key and restart your vehicle if a problem occurs.*

Note: *Do not leave a duplicate coded key in your vehicle. Always take your keys and lock all doors when leaving your vehicle.*

SecuriLock

The system helps prevent your vehicle from starting unless you use a coded key programmed to your vehicle. Using the wrong key may prevent your vehicle from starting. A message may appear in the information display.

If you are unable to start your vehicle with a correctly coded key, it is not operating properly. A message may appear in the information display.

Automatic Arming

Your vehicle arms immediately after switching the ignition off.

Automatic Disarming

Switching the ignition on with a coded key disarms your vehicle.

Replacement Keys

Note: *Your vehicle comes equipped with two intelligent access keys.*

The intelligent access key functions as a programmed key that operates the driver door lock and activates the intelligent access with push button start system, as well as a remote control.

If your programmed transmitters are lost or stolen and you do not have an extra coded key, contact the Ford GT concierge to have your Ford GT transported to your Certified Ford GT Service Dealership to erase the key codes from your vehicle and program new coded keys. See **About This Manual** (page 5).

Store an extra programmed key away from your vehicle in a safe place to help prevent any inconveniences. See your authorized dealer to purchase additional spare or replacement keys.

Programming a Spare Intelligent Access Key

Note: *You can program a maximum of four intelligent access keys to your vehicle.*

You must have two previously programmed intelligent access keys inside your vehicle and the new unprogrammed intelligent access keys readily accessible. See an authorized dealer to have the spare key programmed if two previously programmed keys are not available.

Make sure that your vehicle is off before beginning this procedure. Make sure that you close all the doors before beginning and that they remain closed throughout the procedure. Perform all steps within 30 seconds of starting the sequence. Stop and wait for at least one minute before starting again if you perform any steps out of sequence.

Read and understand the entire procedure before you begin.

Security

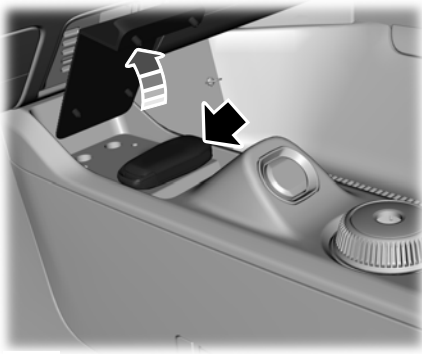

E228717

1. Remove the rubber mat from the console. Place the first programmed key on the flat surface under the mat where indicated, then press the push button ignition switch.
2. Wait five seconds and then press the push button ignition switch again.
3. Remove the intelligent access key.
4. Within 10 seconds, place a second programmed intelligent access key on the flat surface under the mat where indicated. Press the push button ignition switch.
5. Wait five seconds and then press the push button ignition switch again.
6. Remove the intelligent access key.
7. Place the unprogrammed intelligent access key on the flat surface under the mat where indicated and press the push button ignition switch.

Programming is now complete. Verify the remote control functions operate and your vehicle starts with the new intelligent access key.

If programming was not successful, wait 10 seconds and repeat Steps 1 through 7. If you are still unsuccessful, take your vehicle to your authorized dealer.

ANTI-THEFT ALARM

The system will warn you of an unauthorized entry to your vehicle. If a person opens any door, the rear hatch or the hood without using the remote, it triggers the alarm.

The direction indicators will flash and the horn will sound if unauthorized entry is attempted while the alarm is armed.

Take all remote controls to an authorized dealer if there is any potential alarm problem with your vehicle.

Arming the Alarm

The alarm is ready to arm when there is not a key in your vehicle. Electronically lock your vehicle to arm the alarm.

Disarming the Alarm

Disarm the alarm by any of the following actions:

- Unlock the doors or rear hatch with the remote control.
- Switch your vehicle on or start your vehicle.

Note: If your remote control comes equipped with a panic button, pressing the panic button on the remote control will stop the horn and signal indicators, but will not disarm the system.

Steering Wheel

ADJUSTING THE STEERING WHEEL

WARNING

 Do not adjust the steering wheel when your vehicle is moving.

Note: Make sure that you are sitting in the correct position. See **Sitting in the Correct Position** (page 86).

Note: There are two steering column adjustment levers on the steering column. The left lever is for the telescope adjustment. The right lever is for the tilt and small telescope adjustments.



E232042

1. Use the left lever to unlock the steering column.

Note: You have to hold the lever down to make adjustments.

2. Adjust the steering wheel to the desired telescope position.



E232043

3. Lock the steering column.

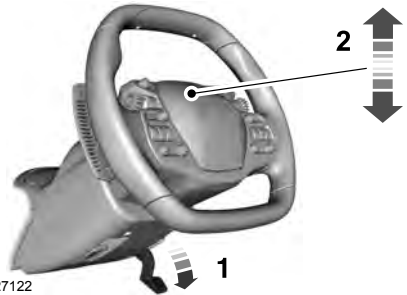

E227122

1. Use the right lever to unlock the steering column.
2. Adjust the steering wheel to the desired tilt and telescope position.



E227240

3. Lock the steering column.

Steering Wheel

AUDIO CONTROL (If Equipped)

You can operate the following functions with the control:



E227115

- A Volume down.
- B Volume up.



E227117

- A Seek down.
- B Seek up.

Seek, Next or Previous

Press the seek button to:

- Tune the radio to the next or previous stored preset.
- Play the next or the previous track.

Press and hold the seek button to:

- Tune the radio to the next station up or down the frequency band.
- Seek or fast forward through a track.

VOICE CONTROL (If Equipped)



E227121

See your SYNC information.

CRUISE CONTROL



E227119

See **Cruise Control** (page 121).

Steering Wheel

INFORMATION DISPLAY CONTROL



E227121

See **Information Displays** (page 70).

DRIVE MODE CONTROL



E227821

See **Driving Aids** (page 122).

WIPER AND WASHER CONTROL

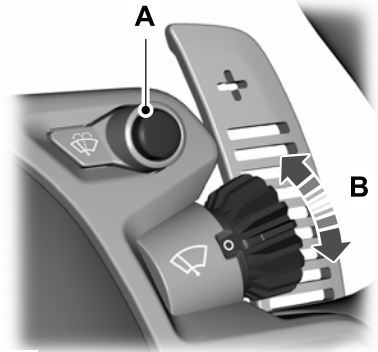

E227822

- A Windshield Washers.
- B Windshield Wipers.

See **Wipers and Washers** (page 57).

LIGHTING CONTROL

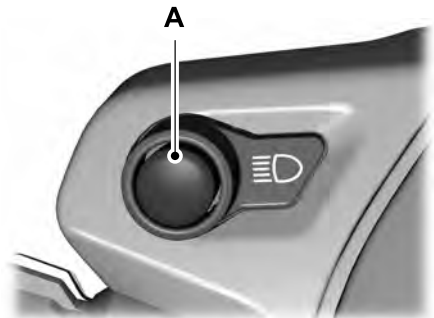

E227823

- A Highbeam control.

Steering Wheel

See **Lighting** (page 58).

Pedals

ADJUSTING THE PEDALS

WARNING



Never use the pedal adjustment controls when your feet are on the accelerator or brake pedal when the vehicle is moving.

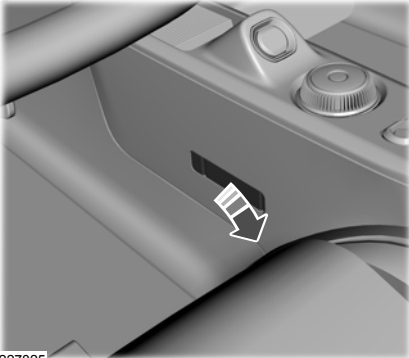

E227825

You can find the adjustment strap on the left side of the center console.

Note: Adjust the pedals only when your vehicle is in **P** (Park) and the engine is off.

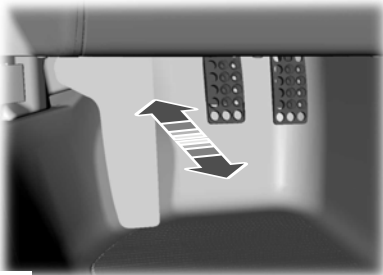

E227824

Note: The brake and accelerator pedals will move together during the adjustment procedure.

1. Position yourself comfortably in the seat.
2. Pull the pedal adjustment strap to release the pedal module. The pedals will automatically move toward the drivers feet.
3. Place your foot on the foot rest and move the pedals to a comfortable position.
4. Release the adjustment strap to lock the pedals in position. Reinstall the strap into the recessed pocket after the adjustment is complete.
5. Test the application of the brake and accelerator pedals.
6. If needed perform the pedal adjustment over until the pedals are at a distance that is both comfortable and safe to operate.

Wipers and Washers

WINDSHIELD WIPERS

Note: Fully defrost the windshield before you switch the windshield wipers on.

Note: If streaks or smears appear on the windshield, clean the windshield and the wiper blades. If that does not resolve the issue, install new wiper blades.

Note: Do not operate the wipers on a dry windshield. This may scratch the glass, damage the wiper blades or cause the wiper motor to burn out. Always use the windshield washers before wiping a dry windshield.

Rotate the knob to switch on the windshield wipers.



E226966

- Off.
- I Intermittent - long interval.
- II Intermittent - short interval.
- III Normal wipe.
- IIII High-speed wipe.

WINDSHIELD WASHERS

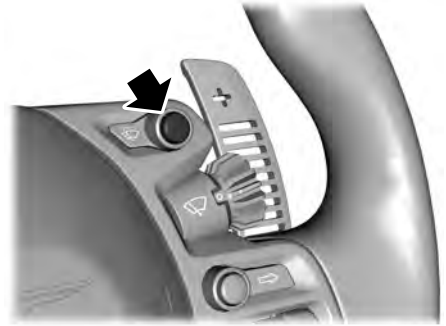

E226967

Note: Do not operate the washers when the washer reservoir is empty. This may cause the washer pump to overheat.

Press and hold the button to spray windshield washer fluid and switch on the wipers. When you release the button, the wipers turn on for three additional wipes and then turn off.

Note: Briefly pressing the washer button causes a single wipe without washer fluid.

When you use the washers, there is a courtesy wipe after a short delay to clear away any drops on the windshield. You can switch this feature on or off. See **Information Displays** (page 70).

Lighting

GENERAL INFORMATION

Condensation in the Exterior Front Lamps and Rear Lamps

Exterior front lamps and rear lamps have vents to accommodate normal changes in air pressure.

Condensation can be a natural by-product of this design. When moist air enters the lamp assembly through the vents, there is a possibility that condensation can occur when the temperature is cold. When normal condensation occurs, a fine mist can form on the interior of the lens. The fine mist eventually clears and exits through the vents during normal operation.

Clearing time may take as long as 48 hours under dry weather conditions.

Examples of acceptable condensation are:

- The presence of a fine mist (no streaks, drip marks or large droplets).
- A fine mist covers less than 50% of the lens.

Examples of unacceptable condensation are:

- A water puddle inside the lamp.
- Streaks, drip marks or large droplets present on the interior of the lens.

If you see any unacceptable condensation, have your vehicle checked by an authorized dealer.

LIGHTING CONTROL

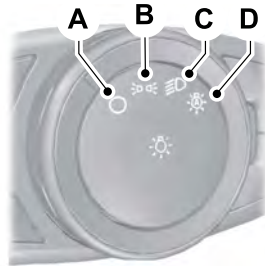

E252122

- A Off.
- B Parking lamps, instrument panel lamps, license plate lamps and rear lamps.
- C Headlamps.
- D Autolamps.

High Beams

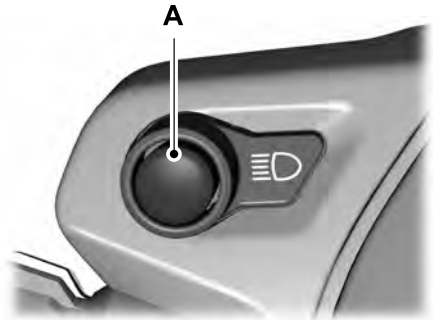

E227823

- A High beam control.

Press the button briefly to flash the high beams.

Lighting

Press and hold to switch the high beams on.

Press and hold again to switch the high beams off.

AUTOLAMPS

WARNING



The system does not relieve you of your responsibility to drive with due care and attention. You may need to override the system if it does not turn the headlamps on in low visibility conditions, for example daytime fog.

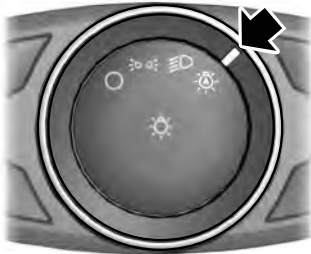

E142451

When the lighting control is in the autolamps position, the headlamps turn on in low light situations, or when the wipers turn on.

The headlamps remain on for a period of time after you switch the ignition off. Use the information display controls to adjust the period of time that the headlamps remain on.

Note: If you switch on the autolamps, you cannot switch the high beams on until the system turns the low beams on.

INSTRUMENT LIGHTING DIMMER

Note: If you disconnect the battery or it becomes discharged, the illuminated components turn to the maximum setting.



E236438

- A Press repeatedly or press and hold to brighten.
- B Press repeatedly or press and hold to dim.

DAYTIME RUNNING LAMPS

WARNING



The daytime running lamps system does not activate the rear lamps and may not provide adequate lighting during low visibility driving conditions. Make sure you switch the headlamps on, as appropriate, during all low visibility conditions. Failure to do so may result in a crash.

Lighting

To switch the system on:

- For vehicles sold in the United States, the lighting control must be in the autolamps position. The lamps turn on in daylight and turn the headlamps on when ambient light is low. You can enable this feature in the information display. See **Information Displays** (page 70).
- For vehicles sold in Canada, daytime running lamps turn on in both off and autolamps position. You cannot disable this feature.

The lamps turn on under the following conditions:

- You open any door.
- You press the panic button on the remote control.
- You press the lamp button.



E187345

DIRECTION INDICATORS



E229691

- A Left direction indicator.
- B Right direction indicator.

Note: The direction indicator buttons are on the steering wheel.

Press and hold the button briefly to use the direction indicators.

Press the button briefly to flash the indicator three times.

INTERIOR LAMPS (If Equipped)

Note: The interior lamp switch is on the overhead console.

Windows and Mirrors

POWER WINDOWS

WARNINGS



Do not leave children unattended in your vehicle and do not let them play with the power windows. Failure to follow this instruction could result in personal injury.



When closing the power windows, verify they are free of obstruction and make sure that children and pets are not in the proximity of the window openings.



E146043

Note: You may hear a pulsing noise when just one of the windows is open. Lower the opposite window slightly to reduce this noise.

Press the switch to open the window.

Lift the switch to close the window.

One-Touch Down

Press the switch fully and release it. Press again or lift it to stop the window.

One-Touch Up

Lift the switch fully and release it. Press or lift it again to stop the window.

Bounce-Back

The window will stop and reverse some distance if it detects an obstacle while closing.

Overriding the Bounce-Back Feature

WARNING



If you override bounce-back, the window does not reverse if it detects an obstacle. Take care when closing the windows to avoid personal injury or damage to your vehicle.

Pull up the window switch and hold within two seconds of the window reaching the bounce-back position. The window will travel up with no bounce-back protection. The window will stop if you release the switch before the window is fully closed.

Accessory Delay

You can use the window switches for several minutes after you switch the ignition off or until you open either front door.

GLOBAL OPENING

You can use the remote control to open the windows with the ignition off.

Note: You can enable or disable this feature in the information display, or see an authorized dealer. See **General Information** (page 70).

Note: To operate this feature, accessory delay must not be active.

Windows and Mirrors

Remote Control Front Windows

You can open the windows for a short time after you unlock your vehicle with the remote control. After you unlock your vehicle, press and hold the remote control unlock button to open the windows. Release the button once movement starts. Press the lock or unlock button to stop movement.

EXTERIOR MIRRORS

Power Exterior Mirrors

WARNING



Do not adjust the mirrors when your vehicle is moving. This could result in the loss of control of your vehicle, serious personal injury or death.

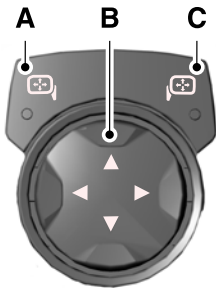

E176804

- A Left-hand mirror
- B Adjustment control
- C Right-hand mirror

To adjust a mirror:

1. Select the mirror you want to adjust. The control will illuminate.
2. Adjust the position of the mirror.
3. Press the mirror switch again.

Fold-Away Exterior Mirrors

Push the mirror toward the door window glass. Make sure that you fully engage the mirror in its support when returning it to its original position.

INTERIOR MIRROR

WARNING



Do not adjust the mirrors when your vehicle is moving. This could result in the loss of control of your vehicle, serious personal injury or death.

Note: Do not clean the housing or glass of any mirror with harsh abrasives, fuel or other petroleum or ammonia-based cleaning products.

You can adjust the interior mirror to your preference. This mirror has a second pivot point, which lets you move the mirror head up or down and from side to side.

Pull the tab below the mirror toward you to reduce glare at night.

Instrument Cluster

GAUGES

Note: Cluster shown in standard measure. Metric clusters are similar.

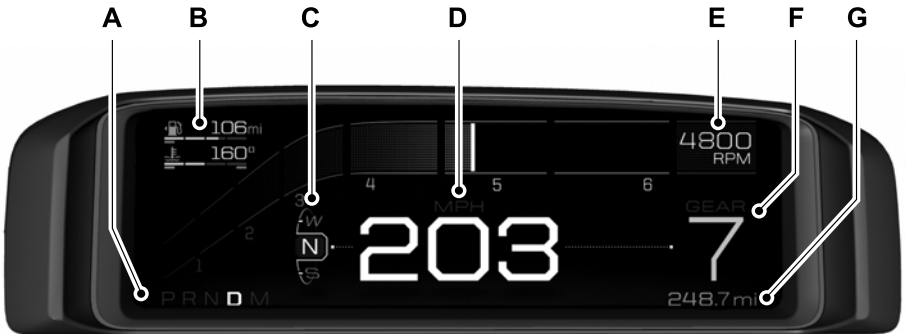

E227915

- A Transmission Gear Position.
- B Left Information Display.
- C Drive Mode.
- D Center Information Display.
- E Tachometer.
- F Right Information Display.
- G Odometer.

Information Display

Left Information Display

Varies depending on drive mode.

Normal, Wet and Sport Mode:

- Fuel Level.
- Engine Coolant Temperature.

Track Mode:

- Speedometer.

V-Max Mode:

- Fuel Level.

Drive Mode

See **Drive Mode Control** (page 122).

Center Information Display

Varies depending on drive mode.

Normal, Wet and V-Max Mode:

- Speedometer.

Sport and Track Mode:

- Gear.

Right Information Display

Varies depending on drive mode.

Instrument Cluster

Normal and Wet Mode:

- Gear.

Sport Mode:

- Speedometer.

Track Mode:

- Engine Coolant Temperature.
- Engine Oil Temperature.
- Transmission Temperature.
- Fuel Level.

V-Max Mode:

- Engine Coolant Temperature.
- Engine Oil Temperature.
- Engine Oil Pressure.
- Turbo Boost Pressure.

Trip Computer

The trip computer functions only operate when the engine is running. See **General Information** (page 70).

Fuel Gauge

Note: *The fuel gauge may vary slightly when your vehicle is moving or on a slope.*

Switch the ignition on. The fuel gauge will indicate approximately how much fuel is left in the fuel tank. The arrow adjacent to the fuel pump symbol indicates on which side of your vehicle the fuel filler door is located.

Variations

Note: *The low fuel warning and distance-to-empty warning can appear at different fuel gauge positions depending on fuel economy conditions. This variation is normal.*

The gauge is divided into four segments and moves towards the right when you refuel your vehicle. If the gauge remains in the far left segment after adding fuel, this indicates your vehicle needs service soon.

After refueling, some variability in gauge position is normal:

- It may take a short time for the gauge to reach full after leaving the gas station. This is normal and depends upon the slope of pavement at the gas station.
- The fuel amount dispensed into the tank is a little less or more than the gauge indicated. This is normal and depends upon the slope of pavement at the gas station.
- If the gas station nozzle shuts off before the tank is full, try a different gas pump nozzle.

Low Fuel Reminder

A low fuel reminder triggers when the distance to empty value reaches 50 mi (80 km) to empty, with additional warnings at 25 mi (40 km), 10 mi (20 km) and 0 mi (0 km) to empty if the message is cleared each time.

In Track Mode, the distance to empty warnings appear at 10 mi (20 km) and 0 mi (0 km) to empty if the message is cleared each time.

After extended periods of performance driving, your distance to empty value may display low even after refueling. Drive your vehicle under normal operating conditions to recalibrate the distance to empty.

Instrument Cluster

Driving Type (Fuel Economy Conditions)	Distance to Empty	Fuel Gauge Position
Highway driving.	50 mi (80 km)	1/8 tank.
Performance driving or extended idle.	50 mi (80 km)	1/4 tank.

Engine Coolant Temperature Gauge

WARNING



Do not remove the coolant reservoir cap when the cooling system is hot. Wait 10 minutes for the cooling system to cool down. Cover the coolant reservoir cap with a thick cloth to prevent the possibility of scalding and slowly remove the cap. Failure to follow this instruction could result in personal injury.

At normal operating temperature, the engine coolant temperature will be in the middle range of the gauge. If the engine coolant temperature exceeds the normal range, the gauge will be highlighted. Stop your vehicle as soon as safely possible, switch off the engine and let it cool.

Engine Oil Temperature Gauge

If the engine oil temperature exceeds the normal range, the engine is overheating. Reduce engine speed as soon as safely possible to allow the engine to cool. If you continue to operate the engine at high engine speeds, the engine speed reduces automatically to prevent engine damage.

Engine Oil Pressure Gauge

Oil pressure varies with engine speed. The pressure rises as engine speed rises and drops as engine speed drops.

If the pressure drops below the normal range of the gauge, a warning lamp illuminates and a message appears in the information display. Stop your vehicle as soon as it is safe to do so and switch the engine off. Check the engine oil level.

Gauge Mode

On the right side of the instrument cluster, you can configure which gauges are displayed.

WARNING LAMPS AND INDICATORS

The following warning lamps and indicators alert you to a vehicle condition that may become serious. Some lamps illuminate when you start your vehicle to make sure they work. If any lamps remain on after starting your vehicle, refer to the respective system warning lamp for further information.

Note: *Some warning indicators appear in the information display and operate the same as a warning lamp but do not illuminate when you start your vehicle.*

Anti-Lock Braking System



If it illuminates when you are driving, this indicates a malfunction. You will continue to have the normal braking system (without ABS) unless the brake system warning lamp is also illuminated. Have the system checked by your authorized dealer.

Instrument Cluster

Battery



If it illuminates while driving, it indicates a malfunction. Switch off all unnecessary electrical equipment and have the system checked by your authorized dealer immediately.

Brake System

WARNING



Driving your vehicle with the warning lamp on is dangerous. A significant decrease in braking performance may occur. It may take you longer to stop your vehicle. Have your vehicle checked as soon as possible. Driving extended distances with the parking brake engaged can cause brake failure and the risk of personal injury.



It will illuminate when you engage the parking brake with the ignition on.

If it illuminates when you are driving, check that the parking brake is not engaged. If the parking brake is not engaged, this indicates low brake fluid level or a brake system malfunction. Have the system checked immediately by your authorized dealer.

Carbon Ceramic Brake



It illuminates when the brake pads are worn and require replacement.

Cruise Control



It illuminates when you switch the system on.

See **Using Cruise Control** (page 121).

Damper Comfort Mode



It illuminates when you switch this feature on. See **Drive Mode Control** (page 122).

Direction Indicator



Illuminates when the left or right turn signal or the hazard warning flasher is turned on. If the indicators stay on or flash faster, check for an inoperative bulb. See **Maintenance** (page 157).

Door Ajar



Displays when the ignition is on and any door is not completely closed.

Electric Park Brake



It illuminates or flashes when the electric parking brake has a malfunction. See **Electric Parking Brake** (page 112).

Engine Coolant Temperature



Illuminates when the engine coolant temperature is high. Stop the vehicle as soon as possible, switch off the engine and let cool. See **Engine Coolant Check** (page 162).

Engine Oil



If it illuminates with the engine running or when you are driving, this indicates a malfunction. Stop your vehicle as soon as it is safe to do so and switch the engine off. Check the engine oil level.

See **Engine Oil Check** (page 161).

Instrument Cluster

Note: Do not resume your journey if it illuminates despite the level being correct. Have the system checked by your authorized dealer immediately.

Fasten Seatbelt



It illuminates and a chime sounds until you fasten the seatbelts.

Front Airbag



If it fails to illuminate when you start your vehicle, continues to flash or remains on, it indicates a malfunction. Have the system checked by your authorized dealer.

Front Lift Mode Active



Illuminates when you switch this feature on. See **Drive Mode Control** (page 122).

Frost Warning Lamp

WARNING



Even if the temperature rises to above 39°F (4°C) there is no guarantee that the road is free of hazards caused by inclement weather.



It illuminates when the outside air temperature is 39°F (4°C) or below.

Hatch Ajar



Displays when the ignition is on and the hatch is not completely closed.

High Beam



It illuminates when you switch the high beam headlamps on or use the headlamp flasher.

Hood Ajar



Displays when the ignition is on and the hood is not completely closed.

Hydraulic System Fault



Illuminates when there is an issue with your vehicle's hydraulic system. Have the system checked by your authorized dealer immediately.

Launch Control



Illuminates when you switch this feature on. See **Using Stability Control** (page 116).

Low Beam Malfunction Warning Lamp



It illuminates when there is a malfunction with a low beam headlamp bulb.

Low Fuel Level



It will illuminate when the fuel level is low or the fuel tank is nearly empty. Refuel as soon as possible.

Low Tire Pressure Warning



It will illuminate when your tire pressure is low. If the lamp remains on with the engine running or when driving, check your tire pressures as soon as possible.

Instrument Cluster

It will also illuminate momentarily when you switch the ignition on to confirm the lamp is functional. If it does not illuminate when you switch the ignition on, or begins to flash at any time, have the system checked by your authorized dealer.

Parking Lamps



It will illuminate when you switch the parking lamps on.

Powertrain Fault



Illuminates when a powertrain fault has been detected. Have the system checked as soon as possible.

Rear Fog Lamp (If Equipped)



It illuminates when you switch the rear fog lamps on.

Ride Height System Fault



Illuminates when there is an issue with the ride height system.

Service Engine Soon



If it illuminates when the engine is running this indicates a malfunction. The On Board Diagnostics system has detected a malfunction of the vehicle emission control system.

If it flashes, engine misfire may be occurring. Increased exhaust gas temperatures could damage the catalytic converter or other vehicle components. Drive in a moderate fashion (avoid heavy acceleration and deceleration) and have your vehicle immediately serviced.

It also illuminates momentarily when you switch the ignition on prior to engine start to confirm the lamp is functional and to indicate whether your vehicle is ready for Inspection and Maintenance (I/M) testing.

Normally, it illuminates until the engine is cranked and automatically turns off if no malfunctions are present. However, if after 15 seconds it flashes eight times, this indicates that your vehicle is not ready for Inspection and Maintenance (I/M) testing. See **Emission Control System** (page 99).

Stability Control



Flashes during operation.

If it does not illuminate when you switch the ignition on, or remains on when the engine is running, this indicates a malfunction. Have your vehicle checked as soon as possible.

Note: *The system automatically turns off if there is a malfunction.*

See **Using Stability Control** (page 116).

Stability Control Off



It illuminates when you switch the system off.

Transmission Fault



Illuminates when there is a malfunction with your transmission. Have the system checked by your authorized dealer immediately.

Instrument Cluster

AUDIBLE WARNINGS AND INDICATORS

Keyless Warning Alert

The horn will sound twice when you exit your vehicle with the intelligent access key and your vehicle is in ON, indicating your vehicle is still on. The horn will also sound twice when you exit your vehicle and attempt to lock the doors manually while the intelligent access key is still in the vehicle. The doors will not lock if the intelligent access key remains in the vehicle.

Headlamps On Warning Chime

Sounds when you remove the key from the vehicle and you have left the headlamps or parking lamps on.

Information Displays

GENERAL INFORMATION

WARNING



Driving while distracted can result in loss of vehicle control, crash and injury. We strongly recommend that you use extreme caution when using any device that may take your focus off the road. Your primary responsibility is the safe operation of your vehicle. We recommend against the use of any hand-held device while driving and encourage the use of voice-operated systems when possible. Make sure you are aware of all applicable local laws that may affect the use of electronic devices while driving.

Various systems on your vehicle can be controlled using the information display controls on the steering wheel. Corresponding information is displayed in the information display.

Note: Some options may appear slightly different or not at all if the items are optional.

Information Display Controls



E227121

- Press the return arrow button to enter the menu.
- Use the center toggle control to scroll through and highlight the options within a menu.
- Press the **OK** button to enter a sub-menu.
- Press the **OK** button to choose and confirm settings or messages.
- Press the return arrow button to exit a menu.

You can switch some features on or off by pressing the **OK** button.

Main Menu

Menu
Launch Control
Information
Navigation - Cancel Route
Rear Wing Deployment
Display Settings
Vehicle Settings

Note: You cannot switch on Launch Control in Wet Mode.

Information Displays

Information	
None	
Trip/Fuel Economy	
Tire Pressure	
Navigation	
Speedometer km/h	
Gauges ¹	
Configure Gauges ²	Coolant Temperature
	Oil Temperature
	Transmission Temperature
	Oil Pressure
	Inlet Air Temperature
	Turbo Boost Pressure
	Voltage
	Confirm and Exit

¹ In order to provide real-time values, some gauges may display more value fluctuation than other gauges during normal operation.

² You can display information for up to four gauges.

Note: The information you select for the on demand screen appears on the right-hand side of the cluster.

Note: Navigation only appears if you have a route active in your navigation.

Rear Wing Deployment
Choose your applicable setting.

Note: You cannot switch on Rear Wing Deployment in V-Max or Track Modes.

Note: If you deploy the rear wing, the system cannot lower it until you switch your setting to **Auto** and drive over a certain speed. See **Drive Mode Control** (page 122).

Information Displays

Display Settings	
Distance	Choose your applicable setting.
Temperature	Choose your applicable setting.
Tire Pressure	Choose your applicable setting.
Language	Choose your applicable setting.

Note: Changing the Distance setting also affects other gauge values.

Vehicle Settings		
Performance Shift Indicator	Choose your applicable setting.	
Lighting	Autolamp Delay	
	Daytime Lights	
Locks	Autolock	
	Autounlock	
	Mislock	
	Remote Unlock	Choose your applicable setting.
Remote Start	Duration	Choose your applicable setting.
	System	
Tire Monitor	Hold OK to Reset	
Windows	Remote Open	
Wipers	Courtesy Wipe	

Information Displays

INFORMATION MESSAGES



E227121

Press the **OK** button to acknowledge and remove some messages from the information display. The information display automatically removes other messages after a short time.

You need to confirm certain messages before you can access the menus.

AdvanceTrac™

Message	Action
Service AdvanceTrac	The system detects a condition that requires service. Have the system checked as soon as possible.
AdvanceTrac OFF	The driver has switched on or switched off the AdvanceTrac system.
AdvanceTrac ON	
AdvanceTrac PERFORMANCE	Displays if you switch on PERFORMANCE mode. See Using Stability Control (page 116).
AdvanceTrac PERFORMANCE +	Displays if you switch on PERFORMANCE+ mode. See Using Stability Control (page 116).
AdvanceTrac Change Request Not Available in Current Drive Mode	Displays if the current drive mode does not allow adjustments to the AdvanceTrac system. See Using Stability Control (page 116).

Alarm

Message	Action
Vehicle Alarm To Stop Alarm, Start Vehicle.	Alarm triggered due to unauthorized entry. See Anti-Theft Alarm (page 51).

Information Displays

Battery and Charging System

Message	Action
Charging System Service Soon	The charging system needs servicing. If the warning stays on or continues to come on, contact an authorized dealer as soon as possible.
Charging System Service Now	The charging system needs servicing. Contact an authorized dealer as soon as possible.
Battery State of Charge Low	The battery management system determines that the battery is at a low state of charge. Turn your ignition off as soon as possible to protect the battery. This message clears once you restart your vehicle and the battery state of charge has recovered.

Doors and Locks

Message	Action
X Door Ajar	The door(s) listed is not completely closed.
Hood Ajar	The hood is not completely closed.
Hatch Ajar	The hatch is not completely closed.
Door Unlocked	Displays when the door lock turns off.
Door Fault Pull Release Strap Over Shoulder	Indicates a door fault that requires manually opening the door by the pull strap on the B-pillar. Contact an authorized dealer.
Door Fault Service Required	Indicates a fault with the electronic door system. Contact an authorized dealer.

Engine

Message	Action
Engine Coolant Over Temperature	The engine coolant temperature is excessively high.
Power Reduced to Lower Engine Temp	The engine is overheating and the power has been reduced to assist in lowering the temperature. Stop in a safe place as soon as it is possible.
Vehicle is On	The engine is on and a door is open.

Information Displays

Fuel

Message	Action
Check Fuel Fill Inlet	The fuel fill inlet may not be properly closed.
Fuel Level Low XX Miles to Empty	An early reminder of a low fuel condition showing the estimated distance until tank is empty.
Fuel Level Low XX km to Empty	

Hill Start Assist

Message	Action
Hill Start Assist Not Available	Displays when hill start assist is not available. Contact your authorized dealer.

Keys and Intelligent Access

Message	Action
No Key Detected	The system does not detect a key in your vehicle. See Keyless Starting (page 90).
Restart Now or Key is Needed	You pressed the start/stop button to switch off the engine and your vehicle does not detect your intelligent access key inside your vehicle.
Starting System Fault	There is a problem with your vehicle's starting system. See an authorized dealer for service.
Key Program Successful	You have successfully programmed an intelligent access key to the system.
Key Program Failure	You have failed to program an intelligent access key to the system.
Max Number of Keys Learned	You have programmed the maximum number of keys to the system.
Not Enough Keys Learned	You have not programmed enough keys to the system.
Key Battery Low Replace Soon	The key battery is low. Change the battery as soon as possible.

Information Displays

Maintenance

Message	Action
Low Engine Oil Pressure	Stop your vehicle as soon as safely possible and turn off the engine. Check the oil level. If the warning stays on or continues to come on with your engine running, contact an authorized dealer as soon as possible.
Brake Fluid Level Low	The brake fluid level is low, inspected the brake system immediately. See Brake Fluid Check (page 166).
Check Brake System	The brake system needs servicing. Stop your vehicle in a safe place. Contact an authorized dealer.
Ceramic Brakes Replace All Brake Pads	The brake pads need replacement. Contact an authorized dealer.
Transport Mode Contact Dealer	Your vehicle is still in Transport or Factory mode. This may not allow some features to operate properly. See an authorized dealer.
Factory Mode Contact Dealer	

Park Brake

Message	Action
To Release: Press Brake and Switch	Displays if you attempt to release the electric parking brake manually without pressing the brake pedal.
Park Brake Use Switch to Release	Displays if you must manually release the electric parking brake.
Park Brake Not Applied	Displays if you have not fully applied the electric parking brake.
Park Brake Not Released	Displays if you have not fully released the electric parking brake.
Park Brake Maintenance Mode	Displays if the electric parking brake system enters a special mode used to allow service of the rear brakes. Contact an authorized dealer.

Information Displays

Message	Action
Park Brake Limited Function Service Required	Displays if the electric park brake system detects a condition that requires service. Some functionality may still be available. See an authorized dealer.
Park Brake Malfunction Service Now	Displays if the electric parking brake system detects a condition that requires service. See an authorized dealer.
Park Brake On	Displays if the parking brake is set, the engine is running and you drive the vehicle more than 3 mph (5 km/h). If the warning stays on after you release the parking brake, contact an authorized dealer.

Remote Start

Message	Action
To Drive: Press Brake and Start Button	A reminder to apply the brake and push the start button to drive your vehicle after a remote start.

Starting System

Message	Action
Starting System Fault	There is a problem with your vehicle's starting system. See an authorized dealer for service.

Steering System

Message	Action
Steering Lock Malfunction Service Now	The steering lock system has detected a condition that requires service. See an authorized dealer.
Steering Col. Lock Turn Wheel while Starting vehicle	You need to turn your steering wheel when starting your vehicle to unlock your steering column.

Information Displays

Tire Pressure Monitoring System

Message	Action
Tire Pressure Low	One or more tires on your vehicle has low tire pressure. See Tire Pressure Monitoring System (page 198).
Tire Pressure Monitor Fault	The tire pressure monitoring system is malfunctioning. If the warning stays on or continues to come on, contact an authorized dealer. See Tire Pressure Monitoring System (page 198).
Tire Pressure Sensor Fault	A tire pressure sensor is malfunctioning or your spare tire is in use. See Tire Pressure Monitoring System (page 198). If the warning stays on or continues to come on, contact an authorized dealer as soon as possible.

Transmission

Message	Action
Transmission Limited Function See Manual	The transmission has limited functionality. See an authorized dealer.
Transmission Not in Park	Displays as a reminder to shift into park. This message may also display after reconnecting or recharging the battery until you cycle the ignition on. See Changing the 12V Battery (page 168).
Transmission Not in Park. Park Engages in xx:xx	Stay in neutral mode is engaged. Transmission automatically shifts into park when timer reaches zero.
Transmission Adjusted	Displays when the transmission has adjusted the shift strategy.
Transmission Adapt-Mode	Displays when the transmission is adjusting the shift strategy.
Transmission Indicat-Mode Lockup On	Displays when the transmission shift selector is locked and unable to select gears.
Transmission Indicat-Mode Lockup Off	Displays when the transmission shift selector is unlocked and free to select gears.
Invalid Gear Selection	Displays if you cannot shift to the selected gear because of current vehicle conditions.

Information Displays

Message	Action
Stay in Neutral Mode Engaged	Displays when neutral hold is active. See Automatic Transmission (page 106).
Park will engage at Low Speed	Displays if the vehicle will shift to park (P) after it reaches a certain speed or slower.
Select M to Confirm Stay in Neutral Mode	Displays when you need to press manual (M) to enter neutral hold. See Automatic Transmission (page 106).
SHIFT SYS FAULT Confirm Park Brake Apply Before Exiting the Vehicle	Displays when there is a fault with the transmission gear selection. See an authorized dealer.
Transmission Clutch Fluid Over Temperature	The transmission clutch fluid temperature is excessively high.

Climate Control

MANUAL CLIMATE CONTROL (If Equipped)

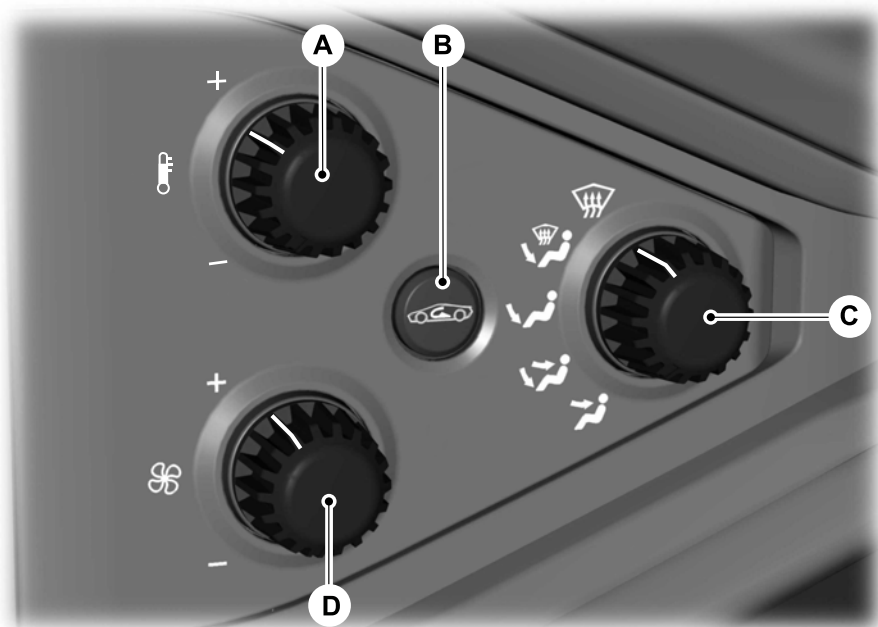

E252115

- A **Temperature control:** Adjusts the temperature of the air circulated in your vehicle.
- B **Recirculated air:** Press to switch between outside air and recirculated air. The air currently in the passenger compartment recirculates.
- C **Air distribution control:** Turn to switch airflow from the windshield, instrument panel or footwell vents on or off. You can distribute air through any combination of these vents.
- D **Fan speed control:** Adjusts the volume of air circulated in the vehicle.

Climate Control

AUTOMATIC CLIMATE CONTROL (If Equipped)

Type One - Standard Measurement

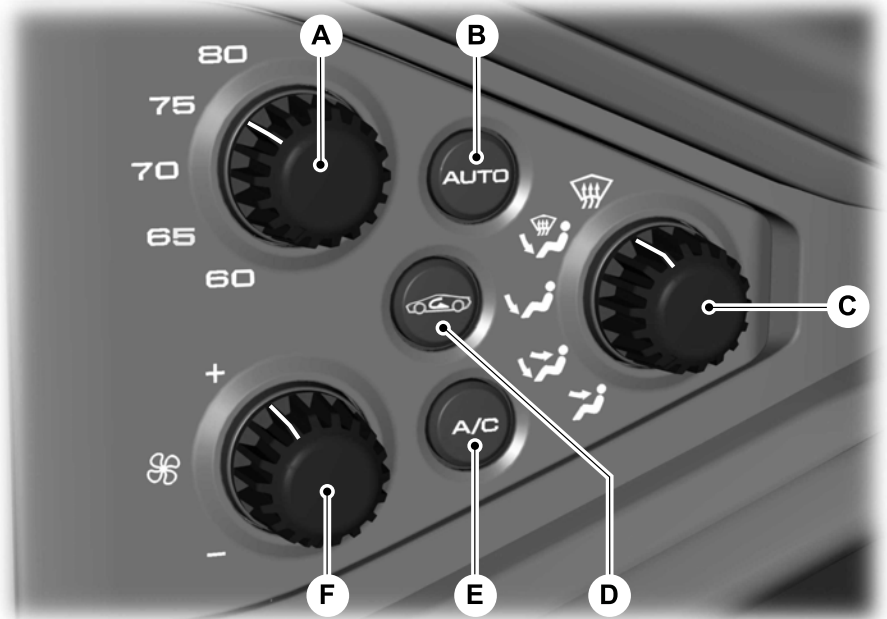

E243068

Climate Control

Type Two - Metric Measurement



E243069

- A **Temperature control:** Adjusts the temperature of the air circulated in your vehicle.
- B **AUTO:** Press to switch on automatic operation. Turn to select the desired temperature and air distribution. Fan speed and air conditioning automatically adjusts to heat or cool the vehicle to maintain the desired temperature.
- C **Air distribution control:** Turn to switch airflow from the windshield, instrument panel, or footwell vents on or off.
- D **Recirculated air:** Press to switch between outside air and recirculated air. The air currently in the passenger compartment recirculates. This may reduce the time needed to cool the interior (when used with A/C) and reduce unwanted odors from entering your vehicle.

Climate Control

- E **A/C:** Press to switch the air conditioning on or off. Use A/C with recirculated air to improve performance and efficiency.
- F **Fan speed control:** Adjusts the volume of air circulated in the vehicle.

HINTS ON CONTROLLING THE INTERIOR CLIMATE

General Hints

Note: Prolonged use of recirculated air may cause the windows to fog up.

Note: You may feel a small amount of air from the footwell air vents regardless of the air distribution setting.

Note: To reduce humidity build-up inside your vehicle, do not drive with the system switched off or with recirculated air always switched on.

Note: To improve the time to reach a comfortable temperature in hot weather, drive with the windows open until you feel cold air through the air vents.

Manual Climate Control

Note: To reduce fogging of the windshield during humid weather, adjust the air distribution control to the windshield air vents position.

Automatic Climate Control

Note: Adjusting the settings when your vehicle interior is extremely hot or cold is not necessary.

Note: The system adjusts to heat or cool the interior to the temperature you select as quickly as possible.

Note: For the system to function efficiently, the instrument panel and side air vents should be fully open.

Note: If you select **AUTO** during cold outside temperatures, the fan may run at a slower speed until the engine warms up.

Quickly Heating the Interior

	Manual climate control	Automatic climate control
1	Adjust the fan speed to the highest setting.	Press AUTO .
2	Adjust the temperature control to the full heat setting.	Adjust the temperature control to the desired setting.
3	Direct air to the footwell using the air distribution buttons.	Direct air to the position you desire.

Climate Control

Recommended Settings for Heating

	Manual climate control	Automatic climate control
1	Adjust the fan speed to the center setting.	Press AUTO .
2	Adjust the temperature control to the midway point of the hot settings.	Adjust the temperature control to the desired setting. Use 72°F (22°C) as a starting point, then adjust the setting as necessary.
3	Direct air to the footwell using the air distribution buttons.	Direct air to the footwell and windshield using the air distribution controls.

Recommended Settings for Cooling

	Manual climate control	Automatic climate control
1	Adjust the fan speed to the center setting.	Press AUTO .
2	Adjust the temperature control to the midway point of the cold settings.	Adjust the temperature control to the desired setting. Use 72°F (22°C) as a starting point, then adjust the setting as necessary.
3	Direct air to the instrument panel using the air distribution buttons.	Direct air to the position you desire.

Defogging the Side Windows in Cold Weather

	Manual climate control	Automatic climate control
1	Direct air to the windshield using the air distribution buttons.	Adjust the temperature control to the desired setting. Use 72°F (22°C) as a starting point, then adjust the setting as necessary.
2	Adjust the temperature control to the desired setting.	
3	Adjust the fan speed to the highest setting.	

CABIN AIR FILTER

Your vehicle is equipped with a cabin air filter, which gives you and your passengers the following benefits:

- It improves your driving comfort by reducing particle concentration.
- It improves the interior compartment cleanliness.
- It protects the climate control components from particle deposits.

You can locate the cabin air filter under the front hood.

Note: *Make sure you have a cabin air filter installed at all times. This prevents foreign objects from entering the system. Running the system without a filter in place could result in degradation or damage to the system.*

Replace the filter at regular intervals. See **Scheduled Maintenance** (page 274).

For additional cabin air filter information, or to replace the filter, see a qualified technician.

Seats

SITTING IN THE CORRECT POSITION

WARNINGS



Sitting improperly, out of position or with the seatback reclined too far can take weight off the seat cushion and affect the decision of the passenger sensing system, resulting in serious injury or death in the event of a crash. Always sit upright against your seat back, with your feet on the floor.



Do not place any objects on a folded seat. Hard objects may become projectiles in a crash or sudden stop, which may increase the risk of serious personal injury.

We recommend that you follow these guidelines:

- Sit in an upright position with the base of your spine as far back as possible.
- Keep sufficient distance between yourself and the steering wheel. We recommend a minimum of 10 in (25 cm) between your breastbone and the airbag cover.
- Hold the steering wheel with your arms slightly bent.
- Bend your legs slightly so that you can press the pedals fully.
- Position the shoulder strap of the seatbelt over the center of your shoulder and position the lap strap tightly across your hips.

Make sure that your driving position is comfortable and that you can maintain full control of your vehicle.

MANUAL SEATS

WARNING



Do not adjust the driver seat when your vehicle is moving.

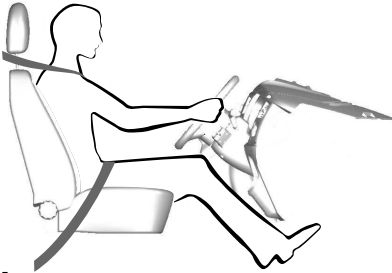

E68595

When you use them properly, the seat, head restraint, seatbelt and airbags will provide optimum protection in a crash.

Seats



E224746

To adjust the seatback:

1. Lean forward and pull the lever up.
2. With the seatback released, lean back to a comfortable position while holding the lever up.
3. Release the lever and let the seat lock into position.

Auxiliary Power Points

12 Volt DC Power Point

WARNING



Incorrect use of the power points can cause damage not covered by the vehicle warranty, and can result in fire or serious injury.

Note: *When you switch the ignition on, you can use the socket to power 12 volt appliances with a maximum current rating of 12.5 amps.*

Note: *You can only use the power supply with the ignition on.*

Note: *Do not hang any accessory from the accessory plug.*

Note: *Do not use the power point over the vehicle capacity of 12 volt DC 180 watts or a fuse may blow.*

Note: *Always keep the power point cap closed when not in use.*

Do not insert objects other than an accessory plug into the power point. This damages the power point and may blow the fuse.

Run the vehicle for full capacity use of the power point.

To prevent the battery from running out of charge:

- Do not use the power point longer than necessary when the vehicle is not running.

Location

The power point is on the right side of the center floor console.

Storage Compartments

CUP HOLDERS

Note: Do not place hot drinks in the cup holders when your vehicle is moving.

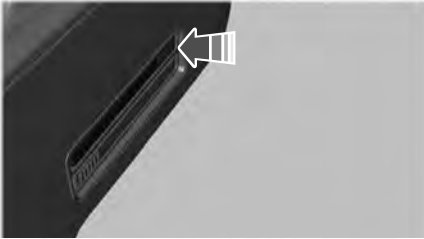

E247860

Press the button to access the cup holders. The cup holders extend independently.

MAP POCKETS

You can access the storage pockets on the back of the front seats by folding the seats forward.

UNDER SEAT STORAGE

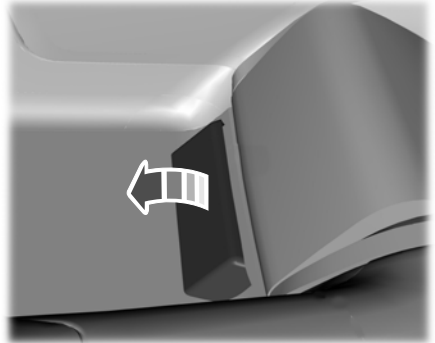

E227957

1. Press the center of the door to release the latch.
2. Pull the door down to access the storage bin.

Starting and Stopping the Engine

GENERAL INFORMATION

WARNINGS



Extended idling at high engine speeds can produce very high temperatures in the engine and exhaust system, creating the risk of fire or other damage.



Do not park, idle or drive your vehicle on dry grass or other dry ground cover. The emission system heats up the engine compartment and exhaust system, creating the risk of fire.



Do not start the engine in a closed garage or in other enclosed areas. Exhaust fumes can be toxic. Always open the garage door before you start the engine.



Exhaust leaks may result in entry of harmful and potentially lethal fumes into the passenger compartment. If you smell exhaust fumes inside your vehicle, have your vehicle inspected immediately. Do not drive if you smell exhaust fumes.

If you disconnect the battery, your vehicle may exhibit some unusual driving characteristics for approximately 5 mi (8 km) after you reconnect it. This is because the engine management system must realign itself with the engine. You can disregard any unusual driving characteristics during this period.

The powertrain control system meets all Canadian interference-causing equipment standard requirements regulating the impulse electrical field or radio noise.

When you start the engine, avoid pressing the accelerator pedal before and during operation. Only use the accelerator pedal when you have difficulty starting the engine.

KEYLESS STARTING

Note: The keyless starting system may not function if the key is close to metal objects or electronic devices such as cellular phones.

Note: A valid key must be located inside your vehicle to switch the ignition on and start the engine.

Ignition Modes



E243665

The keyless starting system has three modes:

Off: Turns the ignition off.

- Without applying the brake pedal, press and release the button once when the ignition is in the on mode, or when the engine is running but the vehicle is not moving.

On: All electrical circuits are operational and the warning lamps and indicators illuminate.

- Without applying the brake pedal, press and release the button once.

Start: Starts the engine.

- Press the brake pedal and then press the button for any length of time.

Starting and Stopping the Engine

STEERING WHEEL LOCK

The steering wheel locks automatically when you leave your vehicle and take the intelligent access key with you. The steering wheel unlocks automatically when you enter your vehicle with the intelligent access key.

Note: You may need to turn the steering wheel left or right if the wheel does not unlock completely. This may happen in certain situations, such as parking your vehicle on a steep grade.

STARTING THE ENGINE

When you start the engine, the idle speed increases. This helps to warm up the engine. If the engine idle speed does not slow down automatically, have your vehicle checked by an authorized dealer.

Note: You can crank the engine for a total of 60 seconds, without the engine starting, before the starting system temporarily disables. The 60 seconds does not have to be all at once. For example, you can crank the engine three times for 20 seconds each, without the engine starting, to reach the 60 second time limit. If you exceed the cranking time, you cannot attempt to start the engine for at least 15 minutes. After 15 minutes, you have a 15 second time limit to crank the engine. You need to wait 60 minutes before you crank the engine again for 60 seconds.

Before starting the engine, check the following:

- Make sure all occupants fasten their seatbelts.
- Make sure the headlamps and electrical accessories are off.
- Make sure the parking brake is on.
- Move the transmission selector into park (P).

Note: Do not touch the accelerator pedal.

Note: You must have your intelligent access key in the vehicle in order to shift the transmission out of park (P).



E24366

1. Fully press the brake pedal.
2. Press the Engine START/STOP button.

The system does not function if:

- The key frequencies are jammed.
- The key battery has no charge.

If you are unable to start the engine, do the following:

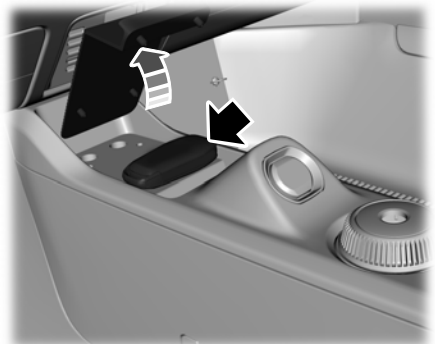

E228717

1. Place the key fob under the rubber mat in front of the Engine START/STOP button.

Starting and Stopping the Engine

2. With the key in this position, press the brake pedal and then the Engine START/STOP button to switch the ignition on and start your vehicle.

Note: If the vehicle fails to start, replace the key fob battery.

Fast Restart

The fast restart feature allows you to restart the engine within 20 seconds of switching it off, even if a valid key is not present.

Within 20 seconds of switching the engine off, press the brake pedal and press the START/STOP button. After 20 seconds have expired, you can no longer restart the engine without the key present inside your vehicle.

Once the engine has started, it remains running until you press the START/STOP button, even if the system does not detect a valid key. If you open and close a door while the engine is running, the system searches for a valid key. You cannot restart the engine if the system does not detect a valid key within 20 seconds.

Failure to Start

If you cannot start the engine after three attempts, wait 10 seconds and follow this procedure:

1. Fully press the brake pedal.
2. Move the transmission selector to the park (P) position.
3. Fully press the accelerator pedal and hold it there.
4. Press the START/STOP button once.

Stopping the Engine When Your Vehicle is Stationary

1. Move the transmission selector to the park (P) position.
2. Press the START/STOP button once.

3. Apply the parking brake.

Note: This switches off the ignition, all electrical circuits, warning lamps and indicators.

Stopping the Engine When Your Vehicle is Moving

WARNING



Switching off the engine when your vehicle is still moving results in a significant decrease in braking assistance. Higher effort is required to apply the brakes and to stop your vehicle. A significant decrease in steering assistance could also occur. The steering does not lock, but higher effort could be required to steer your vehicle. When you switch the ignition off, some electrical circuits, for example airbags, also turn off. If you unintentionally switch the ignition off, shift into neutral (N) and restart the engine.

1. Move the transmission selector to the neutral position and use the brakes to bring your vehicle to a safe stop.
2. When your vehicle has stopped, park (P) will engage automatically.
3. Press and hold the START/STOP button for one second, or press it three times within two seconds.
4. Apply the parking brake.

Guarding Against Exhaust Fumes

WARNING



Exhaust leaks may result in entry of harmful and potentially lethal fumes into the passenger compartment. If you smell exhaust fumes inside your vehicle, have your vehicle inspected immediately. Do not drive if you smell exhaust fumes.

Starting and Stopping the Engine

Important Ventilating Information

If you stop your vehicle and leave the engine idling for long periods, we recommend that you do one of the following:

- Open the windows at least 1 in (2.5 cm).
- Set your climate control to outside air.

Fuel and Refueling

SAFETY PRECAUTIONS

WARNINGS



Do not overfill the fuel tank. The pressure in an overfilled tank may cause leakage and lead to fuel spray and fire.



The fuel system may be under pressure. If you hear a hissing sound near the fuel filler inlet, do not refuel until the sound stops. Otherwise, fuel may spray out, which could cause serious personal injury.



Fuels can cause serious injury or death if misused or mishandled.



Fuel may contain benzene, which is a cancer-causing agent.



When refueling always shut the engine off and never allow sparks or open flames near the fuel tank filler valve. Never smoke or use a cell phone while refueling. Fuel vapor is extremely hazardous under certain conditions. Avoid inhaling excess fumes.

Follow these guidelines when refueling:

- Extinguish all smoking materials and any open flames before refueling your vehicle.
- Always switch the engine off before refueling.
- Automotive fuels can be harmful or fatal if swallowed. Fuel is highly toxic and if swallowed can cause death or permanent injury. If fuel is swallowed immediately call a physician, even if no symptoms are immediately apparent. The toxic effects of fuel may not be apparent for hours.

- Avoid inhaling fuel vapors. Inhaling fuel vapor can lead to eye and respiratory tract irritation. In severe cases, excessive or prolonged breathing of fuel vapor can cause serious illness and permanent injury.
- Avoid getting fuel in your eyes. If you splash fuel in your eyes, immediately remove contact lenses (if worn), flush with water for 15 minutes and seek medical attention. Failure to seek proper medical attention could lead to permanent injury.
- Fuels can be harmful if absorbed through the skin. If you splash fuel on your skin, clothing or both, promptly remove contaminated clothing and thoroughly wash your skin with soap and water. Repeated or prolonged skin contact causes skin irritation.
- Be particularly careful if you are taking Antabuse or other forms of Disulfiram for the treatment of alcoholism. Breathing fuel vapors could cause an adverse reaction, serious personal injury or sickness. Immediately call a physician if you experience any adverse reactions.

FUEL QUALITY

Choosing the Right Fuel

Use only premium unleaded gasoline with a minimum pump (R+M)/2 octane rating of 91. For optimal performance, use premium unleaded gasoline with an octane rating of 93 or higher.

Fuel and Refueling

The use of the correct fuel is an important part of the proper maintenance of your vehicle, and a condition of the vehicle Warranty. For this vehicle, the use of gasoline with an octane level of 91 or higher is required. The use of gasoline with an octane rating lower than 91 will invalidate the vehicle Warranty. It can degrade vehicle performance and lead to severe mechanical damage.

Note: *Use of any fuel other than those recommended can impair the emission control system and cause a loss of vehicle performance.*

Do not use:

- Diesel fuel.
- Fuels containing kerosene or paraffin.
- Fuel containing more than 15% ethanol or E85 fuel.
- Fuels containing methanol.
- Fuels containing metallic-based additives, including manganese-based compounds.
- Fuels containing the octane booster additive, methylcyclopentadienyl manganese tricarbonyl (MMT).
- Leaded fuel (using leaded fuel is prohibited by law).

The use of fuels with metallic compounds such as methylcyclopentadienyl manganese tricarbonyl (commonly known as MMT), which is a manganese-based fuel additive, will impair engine performance and affect the emission control system.

Do not be concerned if the engine sometimes knocks lightly. However, if it knocks heavily under most driving conditions while you are using fuel with the recommended octane rating, contact an authorized dealer to prevent any engine damage.

FUEL FILLER FUNNEL LOCATION

The fuel filler funnel is located in the storage compartment under the rear hatch.

RUNNING OUT OF FUEL

Running out of fuel can cause damage not covered by the vehicle Warranty.

If your vehicle runs out of fuel:

- Add a minimum of 1.3 gal (5 L) of fuel to restart the engine.
- You may need to switch the ignition from off to on several times after refueling to allow the fuel system to pump the fuel from the tank to the engine. When restarting, cranking time takes a few seconds longer than normal.

Note: *If your vehicle is on a steep slope, more fuel may be required.*

Filling a Portable Fuel Container

WARNING



Flow of fuel through a fuel pump nozzle can produce static electricity. This can cause a fire if you are filling an ungrounded fuel container.

Use the following guidelines to avoid electrostatic charge build-up, which can produce a spark, when filling an ungrounded fuel container:

- Only use an approved fuel container to transfer fuel to your vehicle. Place the container on the ground when filling it.
- Do not fill a fuel container when it is inside your vehicle (including the cargo area).

Fuel and Refueling

- Keep the fuel pump nozzle in contact with the fuel container when filling it.
- Do not use a device that holds the fuel pump nozzle lever in the fill position.

Adding Fuel From a Portable Fuel Container

WARNINGS

 Do not insert the nozzle of a fuel container or an aftermarket funnel into the fuel filler neck. This may damage the fuel system filler neck or its seal and cause fuel to run onto the ground.

 Do not try to pry open or push open the capless fuel system with foreign objects. This could damage the fuel system and its seal and cause injury to you or others.

 Do not dispose of fuel in the household refuse or the public sewage system. Use an authorized waste disposal facility.

When refueling the vehicle fuel tank from a fuel container, use the fuel filler funnel included with your vehicle. See **Fuel Filler Funnel Location** (page 95).

Note: Do not use aftermarket funnels as they may not work with the capless fuel system and can damage it.

When refueling the vehicle fuel tank from a fuel container, do the following:

1. Fully open the fuel filler door.
2. Fully insert the fuel filler funnel into the fuel filler inlet.



E157452

3. Add fuel to your vehicle from the fuel container.
4. Remove the fuel filler funnel.
5. Fully close the fuel filler door.
6. Clean the fuel filler funnel and place it back in your vehicle or correctly dispose of it.

Note: Extra funnels can be purchased from an authorized dealer if you choose to dispose of the funnel.

REFUELING

WARNINGS

 Do not overfill the fuel tank. The pressure in an overfilled tank may cause leakage and lead to fuel spray and fire.

 Do not try to pry open or push open the capless fuel system with foreign objects. This could damage the fuel system and its seal and cause injury to you or others.

 Do not remove the fuel pump nozzle from its fully inserted position when refueling.

Fuel and Refueling

WARNINGS

 When refueling always shut the engine off and never allow sparks or open flames near the fuel tank filler valve. Never smoke or use a cell phone while refueling. Fuel vapor is extremely hazardous under certain conditions. Avoid inhaling excess fumes.

 Wait at least 10 seconds before removing the fuel pump nozzle to allow any residual fuel to drain into the fuel tank.

 Stop refueling when the fuel pump nozzle automatically shuts off for the first time. Failure to follow this will fill the expansion space in the fuel tank and could lead to fuel overflowing.

Note: Your vehicle does not have a fuel filler cap.

Note: You must unlock your vehicle before opening and closing the fuel tank filler door.

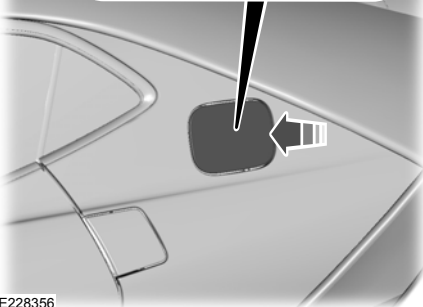
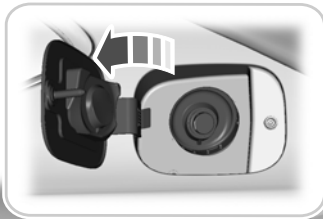

E228356

1. Fully open the fuel tank filler door until it engages.

Note: When you insert the correct size fuel pump nozzle a spring loaded inhibitor will open.

2. Insert the fuel pump and keep it resting on the cover of the fuel tank filler pipe opening.

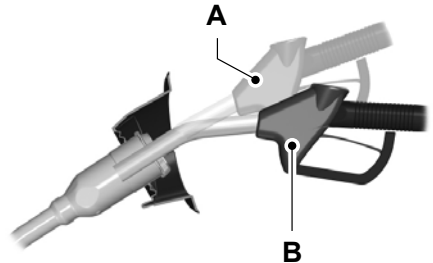

E139203

3. Hold the fuel pump nozzle in position B when refueling. Holding the fuel nozzle in position A can affect the flow of fuel and shut off the fuel nozzle before the fuel tank is full.

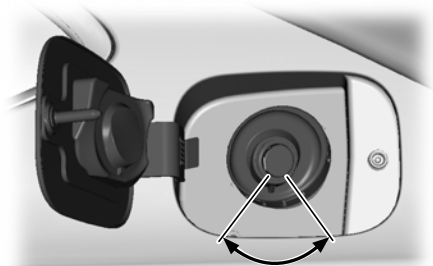

E228357

4. Operate the fuel pump nozzle within the area shown.

Fuel and Refueling



E119081

5. Slightly raise the fuel pump nozzle and then slowly remove it.
6. Fully close the fuel tank filler door.

Note: Do not attempt to start the engine if you have filled the fuel tank with incorrect fuel. Incorrect fuel use can cause damage not covered by the vehicle Warranty. Have your vehicle checked immediately.

System Warnings (If Equipped)

If the fuel filler inlet does not fully close a warning message appears in the information display.

1. Stop your vehicle as soon as it is safe to do so and switch the engine off.
2. Shift into park (P) or neutral (N). Apply the parking brake.
3. Fully open the fuel filler door.
4. Check the fuel filler inlet and the area around it for any items or debris that may be obstructing its movement.
5. Fully insert a fuel pump nozzle or the fuel filler funnel provided with your vehicle into the fuel filler inlet. This action should dislodge any debris that may be preventing the fuel filler inlet from fully closing.
6. Fully close the fuel filler door.

Note: If this action corrects the problem the message may not immediately reset. If the message remains and a warning lamp illuminates, have your vehicle checked as soon as possible.

FUEL CONSUMPTION

The advertised capacity is the indicated capacity and the empty reserve combined. Indicated capacity is the difference in the amount of fuel in the fuel tank and when the fuel gauge indicates empty.

See **Capacities and Specifications** (page 204).

Note: The amount of fuel in the empty reserve varies and should not be relied upon to increase driving range.

Note: When refueling your vehicle after the fuel gauge indicates empty, you might not be able to refuel the full amount of the advertised capacity due to the empty reserve still present in the fuel tank.

Filling the Fuel Tank

For consistent results when refueling:

- Always switch the ignition off before refueling. If you leave the engine running, you will get an inaccurate reading.
- Use the same fill rate each time you fill the tank.

Results are most accurate when the filling method is consistent.

Calculating Fuel Economy

Do not measure fuel economy during the first 1,000 mi (1,600 km) of driving (this is your engine's break-in period). A more accurate measurement is obtained after 2,000 mi (3,200 km) to 3,000 mi (4,800 km). Also, fuel expense, frequency of fill ups or fuel gauge readings are not accurate ways to measure fuel economy.

1. Fill the fuel tank completely and record the initial odometer reading.
2. Each time you fill the fuel tank, record the amount of fuel added.

Fuel and Refueling

3. After at least three fill ups, fill the fuel tank and record the current odometer reading.
4. Subtract your initial odometer reading from the current odometer reading.
5. To calculate L/100 km (liters per 100 kilometers) fuel consumption, multiply the liters used by 100, then divide by kilometers traveled. To calculate MPG (miles per gallon) fuel consumption, divide miles traveled by gallons used.

Keep a record for at least one month and record the type of driving (city or highway). This provides an accurate estimate of your vehicle's fuel economy under current driving conditions.

Conditions

- Heavily loading your vehicle reduces fuel economy.
- Carrying unnecessary weight in your vehicle may reduce fuel economy.
- Adding certain accessories to your vehicle may reduce fuel economy.
- Using fuel blended with alcohol may lower fuel economy.
- Fuel economy may decrease with lower temperatures.
- Fuel economy may decrease when driving short distances.
- You will get better fuel economy when driving on flat terrain than when driving on hilly terrain.

EMISSION CONTROL SYSTEM

WARNINGS



Do not park, idle, or drive your vehicle in dry grass or other dry ground cover. The emission system heats up the engine compartment and exhaust system, which can start a fire.

WARNINGS



Exhaust leaks may result in entry of harmful and potentially lethal fumes into the passenger compartment. If you smell exhaust fumes inside your vehicle, have your dealer inspect your vehicle immediately. Do not drive if you smell exhaust fumes.

Your vehicle is equipped with various emission control components and a catalytic converter that will enable your vehicle to comply with applicable exhaust emission standards.

To make sure that the catalytic converter and other emission control components continue to work properly:

- Use only the specified fuel listed.
- Avoid running out of fuel.
- Do not turn off the ignition while your vehicle is moving, especially at high speeds.
- Have the items listed in scheduled maintenance information performed according to the specified schedule.

The scheduled maintenance items listed in scheduled maintenance information are essential to the life and performance of your vehicle and to its emissions system.

If you use anything other than Ford, Motorcraft or Ford-authorized parts for maintenance replacements or for service of components affecting emission control, such non-Ford parts should be equivalent to genuine Ford Motor Company parts in performance and durability.

Illumination of the service engine soon indicator, charging system warning light or the temperature warning light, fluid leaks, strange odors, smoke or loss of engine power could indicate that the emission control system is not working properly.

Fuel and Refueling

An improperly operating or damaged exhaust system may allow exhaust to enter the vehicle. Have a damaged or improperly operating exhaust system inspected and repaired immediately.

Do not make any unauthorized changes to your vehicle or engine. By law, vehicle owners and anyone who manufactures, repairs, services, sells, leases, trades vehicles, or supervises a fleet of vehicles are not permitted to intentionally remove an emission control device or prevent it from working. Information about your vehicle's emission system is on the Vehicle Emission Control Information Decal located on or near the engine. This decal also lists engine displacement.

Please consult your warranty information for complete details.

On-Board Diagnostics (OBD-II)

Your vehicle has a computer known as the on-board diagnostics system (OBD-II) that monitors the engine's emission control system. The system protects the environment by making sure that your vehicle continues to meet government emission standards. The OBD-II system also assists a service technician in properly servicing your vehicle.



When the service engine soon indicator illuminates, the OBD-II system has detected a malfunction. Temporary malfunctions may cause the service engine soon indicator to illuminate. Examples are:

1. Your vehicle has run out of fuel—the engine may misfire or run poorly.
2. Poor fuel quality or water in the fuel—the engine may misfire or run poorly.
3. The fuel fill inlet may not have closed properly. See **Refueling** (page 96).

4. Driving through deep water—the electrical system may be wet.

You can correct these temporary malfunctions by filling the fuel tank with good quality fuel, properly closing the fuel fill inlet or letting the electrical system dry out. After three driving cycles without these or any other temporary malfunctions present, the service engine soon indicator should stay off the next time you start the engine. A driving cycle consists of a cold engine startup followed by mixed city and highway driving. No additional vehicle service is required.

If the service engine soon indicator remains on, have your vehicle serviced at the first available opportunity. Although some malfunctions detected by the OBD-II may not have symptoms that are apparent, continued driving with the service engine soon indicator on can result in increased emissions, lower fuel economy, reduced engine and transmission smoothness and lead to more costly repairs.

Readiness for Inspection and Maintenance (I/M) Testing

Some state and provincial and local governments may have Inspection/Maintenance (I/M) programs to inspect the emission control equipment on your vehicle. Failure to pass this inspection could prevent you from getting a vehicle registration.



If the service engine soon indicator is on or the bulb does not work, your vehicle may need service. See On-Board Diagnostics.

Fuel and Refueling

Your vehicle may not pass the I/M test if the service engine soon indicator is on or not working properly (bulb is burned out), or if the OBD-II system has determined that some of the emission control systems have not been properly checked. In this case, the vehicle is not ready for I/M testing.

If the vehicle's engine or transmission has just been serviced, or the battery has recently run down or been replaced, the OBD-II system may indicate that the vehicle is not ready for I/M testing. To determine if the vehicle is ready for I/M testing, turn the ignition key to the on position for 15 seconds without cranking the engine. If the service engine soon indicator blinks eight times, it means that the vehicle is not ready for I/M testing; if the service engine soon indicator stays on solid, it means that your vehicle is ready for I/M testing.

The OBD-II system checks the emission control system during normal driving. A complete check may take several days.

If the vehicle is not ready for I/M testing, you can perform the following driving cycle consisting of mixed city and highway driving:

1. 15 minutes of steady driving on an expressway or highway followed by 20 minutes of stop-and-go driving with at least four 30-second idle periods.
2. Allow your vehicle to sit for at least eight hours with the ignition off. Then, start the vehicle and complete the above driving cycle. The vehicle must warm up to its normal operating temperature. Once started, do not turn off the vehicle until the above driving cycle is complete.

If the vehicle is still not ready for I/M testing, you need to repeat the above driving cycle.

Engine Emission Control

EMISSION LAW

WARNING



Do not remove or alter the original equipment floor covering or insulation between it and the metal floor of the vehicle. The floor covering and insulation protect occupants of the vehicle from the engine and exhaust system heat and noise. On vehicles with no original equipment floor covering insulation, do not carry passengers in a manner that permits prolonged skin contact with the metal floor. Failure to follow these instructions may result in fire or personal injury.

U.S. federal laws and certain state laws prohibit removing or rendering inoperative emission control system components. Similar federal or provincial laws may apply in Canada. We do not approve of any vehicle modification without first determining applicable laws.



Tampering with emissions control systems including related sensors or the Diesel Exhaust Fluid system can result in reduced engine power and the illumination of the service engine soon light.

Tampering With a Noise Control System

Federal laws prohibit the following acts:

- Removal or rendering inoperative by any person other than for purposes of maintenance.
- Repair or replacement of any device or element of the design incorporated into a new vehicle for the purpose of noise control prior to its sale or delivery to the ultimate purchaser or while it is in use.
- The use of the vehicle after any person removes or renders inoperative any device or element of the design.

The U.S. Environmental Protection Agency may presume to constitute tampering as follows:

- Removal of hood blanket, fender apron absorbers, fender apron barriers, underbody noise shields or acoustically absorptive material.
- Tampering or rendering inoperative the engine speed governor, to allow engine speed to exceed manufacturer specifications.

If the engine does not start, runs rough, experiences a decrease in engine performance, experiences excess fuel consumption or produces excessive exhaust smoke, check for the following:

- A plugged or disconnected air inlet system hose.
- A plugged engine air filter element.
- Water in the fuel filter and water separator.
- A clogged fuel filter.
- Contaminated fuel.
- Air in the fuel system, due to loose connections.
- An open or pinched sensor hose.
- Incorrect engine oil level.

Engine Emission Control

- Incorrect fuel for climatic conditions.
- Incorrect engine oil viscosity for climactic conditions.

Note: *Some vehicles have a lifetime fuel filter that is integrated with the fuel tank. Regular maintenance or replacement is not needed.*

Note: *If these checks do not help you correct the concern, have your vehicle checked as soon as possible.*

Noise Emissions Warranty, Prohibited Tampering Acts and Maintenance

On January 1, 1978, Federal regulation became effective governing the noise emission on trucks over 10,000 lb (4,536 kg) Gross Vehicle Weight Rating (GVWR). The preceding statements concerning prohibited tampering acts and maintenance, and the noise warranty found in the Warranty Guide, are applicable to complete chassis cabs over 10,000 lb (4,536 kg) GVWR.

CATALYTIC CONVERTER

WARNINGS



Do not park, idle or drive your vehicle on dry grass or other dry ground cover. The emission system heats up the engine compartment and exhaust system, creating the risk of fire.



The normal operating temperature of the exhaust system is very high. Never work around or attempt to repair any part of the exhaust system until it has cooled. Use special care when working around the catalytic converter. The catalytic converter heats up to a very high temperature after only a short period of engine operation and stays hot after the engine is switched off.

WARNINGS



Exhaust leaks may result in entry of harmful and potentially lethal fumes into the passenger compartment. If you smell exhaust fumes inside your vehicle, have your vehicle inspected immediately. Do not drive if you smell exhaust fumes.

Your vehicle has various emission control components and a catalytic converter that enables it to comply with applicable exhaust emission standards.

To make sure that the catalytic converter and other emission control components continue to work properly:

- Do not crank the engine for more than 10 seconds at a time.
- Do not run the engine with a spark plug lead disconnected.
- Do not push-start or tow-start your vehicle. Use booster cables. See **Jump Starting the Vehicle** (page 137).
- Use only the specified fuel listed.
- Do not switch the ignition off when your vehicle is moving.
- Avoid running out of fuel.
- Have the items listed in scheduled maintenance information performed according to the specified schedule.

Note: *Resulting component damage may not be covered by the vehicle Warranty.*

The scheduled maintenance items listed in scheduled maintenance information are essential to the life and performance of your vehicle and to its emissions system.

If you use anything other than Ford, Motorcraft or Ford-authorized parts for maintenance replacements or for service of components affecting emission control, such non-Ford parts should be equivalent to genuine Ford Motor Company parts in performance and durability.

Engine Emission Control

Illumination of the service engine soon indicator, charging system warning light or the temperature warning light, fluid leaks, strange odors, smoke or loss of engine power could indicate that the emission control system is not working properly.

An improperly operating or damaged exhaust system may allow exhaust to enter the vehicle. Have a damaged or improperly operating exhaust system inspected and repaired immediately.

Do not make any unauthorized changes to your vehicle or engine. By law, vehicle owners and anyone who manufactures, repairs, services, sells, leases, trades vehicles, or supervises a fleet of vehicles are not permitted to intentionally remove an emission control device or prevent it from working. Information about your vehicle's emission system is on the Vehicle Emission Control Information Decal located on or near the engine. This decal also lists engine displacement.

Please consult your warranty information for complete details.

On-Board Diagnostics (OBD-II)

Your vehicle has a computer known as the on-board diagnostics system (OBD-II) that monitors the engine's emission control system. The system protects the environment by making sure that your vehicle continues to meet government emission standards. The OBD-II system also assists a service technician in properly servicing your vehicle.



When the service engine soon indicator illuminates, the OBD-II system has detected a malfunction. Temporary malfunctions may cause the service engine soon indicator to illuminate. Examples are:

1. Your vehicle has run out of fuel—the engine may misfire or run poorly.
2. Poor fuel quality or water in the fuel—the engine may misfire or run poorly.
3. The fuel fill inlet may not have closed properly. See **Refueling** (page 96).
4. Driving through deep water—the electrical system may be wet.

You can correct these temporary malfunctions by filling the fuel tank with good quality fuel, properly closing the fuel fill inlet or letting the electrical system dry out. After three driving cycles without these or any other temporary malfunctions present, the service engine soon indicator should stay off the next time you start the engine. A driving cycle consists of a cold engine startup followed by mixed city and highway driving. No additional vehicle service is required.

If the service engine soon indicator remains on, have your vehicle serviced at the first available opportunity. Although some malfunctions detected by the OBD-II may not have symptoms that are apparent, continued driving with the service engine soon indicator on can result in increased emissions, lower fuel economy, reduced engine and transmission smoothness and lead to more costly repairs.

Readiness for Inspection and Maintenance (I/M) Testing

Some state and provincial and local governments may have Inspection/Maintenance (I/M) programs to inspect the emission control equipment on your vehicle. Failure to pass this inspection could prevent you from getting a vehicle registration.



If the service engine soon indicator is on or the bulb does not work, your vehicle may need service. See On-Board Diagnostics.

Engine Emission Control

Your vehicle may not pass the I/M test if the service engine soon indicator is on or not working properly (bulb is burned out), or if the OBD-II system has determined that some of the emission control systems have not been properly checked. In this case, the vehicle is not ready for I/M testing.

If the vehicle's engine or transmission has just been serviced, or the battery has recently run down or been replaced, the OBD-II system may indicate that the vehicle is not ready for I/M testing. To determine if the vehicle is ready for I/M testing, turn the ignition key to the on position for 15 seconds without cranking the engine. If the service engine soon indicator blinks eight times, it means that the vehicle is not ready for I/M testing; if the service engine soon indicator stays on solid, it means that your vehicle is ready for I/M testing.

The OBD-II system checks the emission control system during normal driving. A complete check may take several days.

If the vehicle is not ready for I/M testing, you can perform the following driving cycle consisting of mixed city and highway driving:

1. 15 minutes of steady driving on an expressway or highway followed by 20 minutes of stop-and-go driving with at least four 30-second idle periods.
2. Allow your vehicle to sit for at least eight hours with the ignition off. Then, start the vehicle and complete the above driving cycle. The vehicle must warm up to its normal operating temperature. Once started, do not turn off the vehicle until the above driving cycle is complete.

If the vehicle is still not ready for I/M testing, you need to repeat the above driving cycle.

Transmission

AUTOMATIC TRANSMISSION

WARNINGS



Always fully apply the parking brake. Make sure you shift into park (P) for vehicles with an automatic transmission. Switch the ignition off and remove the key whenever you leave your vehicle.



Do not apply the brake pedal and accelerator pedal simultaneously. Applying both pedals simultaneously for more than a few seconds will limit engine performance, which may result in difficulty maintaining speed in traffic and could lead to serious injury.

Your Ford GT vehicle is equipped with a 7-speed, dual clutch automatic transmission. In drive (D), the transmission shifts automatically, or you can shift with the paddle shifters. In manual mode, you must shift the transmission with the paddle shifters.

Understanding the Positions of Your Automatic Transmission



E227917

1. Fully press down the brake pedal.
2. Move the selector to the desired gear.

Park (P)

With the transmission in park (P), your vehicle locks the transmission and prevents the wheels from turning. Always come to a complete stop before putting your vehicle into park (P).

Automatic Return to Park

Note: This feature does not operate when your vehicle is in Stay in Neutral mode.

Your vehicle has a feature that automatically shifts your vehicle into park (P) when any of the following conditions occur:

- You turn the vehicle off.
- You open the driver's door with your seatbelt unlatched.
- Your seatbelt is unlatched when the driver's door is open.

If you turn your vehicle off when moving, your vehicle first shifts into neutral (N) until it slows down enough to shift into park (P) automatically.

Note: If you have waited an extended period of time (2-15 minutes) before starting your vehicle, unlatching your seatbelt causes this feature to activate, even with the driver's door closed.

Note: This feature may not work properly if the door ajar switch is malfunctioning. If your door ajar indicator does not illuminate when you open the driver's door or the indicator illuminates with the driver's door closed, see your authorized dealer.

Reverse (R)

With the selector in reverse (R), your vehicle moves backward. Always come to a complete stop before shifting into and out of reverse (R).

Transmission

Neutral (N)

With the selector in neutral (N), your vehicle can be started and is free to roll. Hold the brake pedal down when in this position.

Stay in Neutral Mode

Stay in Neutral mode allows your vehicle to stay in neutral when you exit your vehicle. Your vehicle must be stationary to enter this mode.

To enter Stay in Neutral mode:

- With the engine running.
- Release the parking brake if applied, press down the brake pedal and press the parking brake release switch on the center console.
- Press down the brake pedal and move the transmission selector to neutral (N).
- A message appears in your display screen.
- Press the manual (M) button to enter Stay in Neutral mode.
- Another message appears in your display screen confirming Neutral mode is engaged.
- Stay in Neutral mode remains engaged as long as the engine is running. If the engine is turned off, a 30 minute timer starts and appears in your display screen.

To exit Stay in Neutral mode, press down the brake pedal and select a different gear.

Drive (D)

Drive (D) is the normal driving position for the best fuel economy. In the drive (D) position, the transmission automatically shifts through gears one through seven.

Manual (M)

To select manual (M), place the transmission selector in drive (D) and press "M" button in the middle of the selector. Once you select manual (M), you must use the paddle shifters to upshift or downshift the transmission.

To exit manual (M) and return to drive (D), press the "M" button again.

SelectShift™ Automatic Transmission

Your vehicle is equipped with a SelectShift Automatic transmission, which gives you the ability to change gears up or down as desired.

In order to prevent the engine from running at too low an RPM, which may cause it to stall, SelectShift still automatically makes some downshifts if it has determined that you have not downshifted in time. Although SelectShift makes some downshifts for you, it still allows you to downshift at any time as long as SelectShift determines that no damage occurs to the engine from over-revving.

Note: *Engine damage may occur if you maintain excessive engine revving without shifting.*

SelectShift does not automatically upshift, even if the engine is approaching the RPM limit. It must be shifted manually by use of the upshift (+) paddle. When using Manual (M) shift mode, pay attention to the shift indicator on the top rim of the steering wheel and the RPM indicator in the instrument cluster.

Use the paddles on the steering wheel to shift.

- Pull the right paddle (+) to upshift.
- Pull the left paddle (-) to downshift.

Transmission



E243776

SelectShift in drive (D):

- Provides a temporary manual mode for performing more demanding maneuvers where extra control of gear selection is required (for example, when overtaking). This mode holds a selected gear for a temporary period of time dependent on driver inputs (for example, steering or accelerator pedal input).

SelectShift in manual (M):

- Provides a permanent manual gear selection where full control of gear selection is required.

The instrument cluster displays your currently selected gear. If a gear is requested but not available due to vehicle conditions (low speed, too high engine speed for requested gear selection), the current gear flashes two times.

Upshift to the recommended shift speeds according to this following chart:

Upshifts When Accelerating (Recommended for Best Fuel Economy)	
Shift from:	
1 - 2	15 mph (24 km/h)
2 - 3	25 mph (40 km/h)
3 - 4	40 mph (64 km/h)

Upshifts When Accelerating (Recommended for Best Fuel Economy)

4 - 5	45 mph (72 km/h)
5 - 6	50 mph (80 km/h)
6 - 7	55 mph (88 km/h)

Brake-Shift Interlock

WARNINGS

 When doing this procedure, you need to take the transmission out of park (P) which means your vehicle can roll freely. To avoid unwanted vehicle movement, always fully apply the parking brake prior to doing this procedure. Use wheels chocks if appropriate.

 If the parking brake is fully released, but the brake warning lamp remains illuminated, the brakes may not be working properly. Have your vehicle checked as soon as possible.

Note: *You should only use this procedure in the event that your vehicle is disabled and you cannot start the engine in order to shift into Neutral (N) to move it. Use the provided Transmission Park Override tool to release the transmission park mechanism and allow the rear tires to roll freely.*

Note: *See your authorized dealer as soon as this procedure is used.*

Note: *Do not drive your vehicle until you verify that the brake lamps are working.*

Your vehicle is equipped with a brake-shift interlock feature that prevents moving the selector from park (P) when the ignition is in the on position and the brake pedal is not pressed.

Transmission

If you cannot move the selector out of park (P) position with the ignition in the on position and the brake pedal pressed, a malfunction may have occurred. It is possible that a fuse has blown or your vehicle's brake lamps are not operating properly. See **Fuse Specification Chart** (page 146).

If the fuse is good and the brake lamps are functioning, then there may be a fault in the system. To roll the car or to allow the vehicle to be transported for repair, use the following procedure to place the transmission into neutral (N) manually. To place the transmission into neutral (N) in the event of a battery failure, or other electrical fault that prevents the shifter from working, use this procedure.

Manually Placing the Transmission in Park Override

The transmission park override tool is in the storage compartment under the rear hatch.

It requires two people to perform this procedure properly. One person seated in the driver's seat, that must remain in control of vehicle steering, brakes and parking brake at all times. For instructions on releasing the parking brake in the event of a loss of vehicle battery power. See **Electric Parking Brake** (page 112). If you do not have battery power, chock the wheels so the car does not roll forward or backward when not intended.

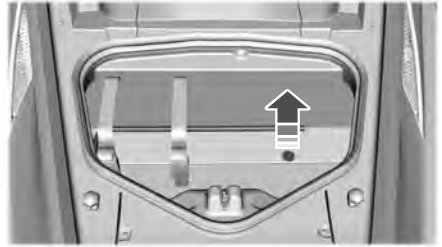

E241995

1. Remove the plug from the bottom right side of the storage compartment to access the park override shaft.

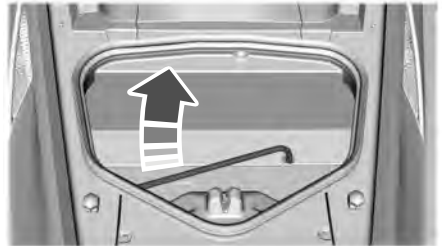

E249885

2. Insert the park override tool onto the shaft. Hold the tool in the rotated position to maintain park override when you move the vehicle.
3. To return the transmission to normal park function, remove the park override tool.
4. Re-install the plug and return the tool to the storage position.

If Your Vehicle Gets Stuck In Mud or Snow

If your vehicle is stuck in mud or snow, reducing the stability and traction control may be beneficial as this allows the wheels to spin. You can reduce the stability and traction control by switching to Sport mode and adjusting the AdvanceTrac setting. See **Using Stability Control** (page 116).

Brakes

GENERAL INFORMATION

Note: Occasional brake noise is normal. If a metal-to-metal, continuous grinding or continuous squeal sound is present, the brake linings may be worn-out. Have the system checked by an authorized dealer. If your vehicle has continuous vibration or shudder in the steering wheel while braking, have it checked by an authorized dealer.

Note: Brake dust may accumulate on the wheels, even under normal driving conditions. Some dust is inevitable as the brakes wear and does not contribute to brake noise. See **Cleaning the Wheels** (page 177).



See **Warning Lamps and Indicators** (page 65).

Wet brakes result in reduced braking efficiency. Gently press the brake pedal a few times after washing the car.

Carbon Ceramic Brake Discs

Your vehicle has carbon ceramic brake discs. When cleaning your wheels and tires, use care not to get any wheel cleaner or tire dressing on the brake discs.



This lamp illuminates when your brakes pads are worn and require replacement. See an authorized dealer for replacement.

Brake Over Accelerator

In the event the accelerator pedal becomes stuck or entrapped, apply steady and firm pressure to the brake pedal to slow the vehicle and reduce engine power. If you experience this condition, apply the brakes and bring your vehicle to a safe

stop. Move the transmission to park (P), switch the engine off and apply the parking brake. Inspect the accelerator pedal for any interferences. If none are found and the condition persists, have your vehicle towed to the nearest authorized dealer.

Brake Assist

Brake assist detects when you brake rapidly by measuring the rate at which you press the brake pedal. It provides maximum braking efficiency as long as you press the pedal, and can reduce stopping distances in critical situations.

Anti-lock Brake System

This system helps you maintain steering control during emergency stops by keeping the brakes from locking.



This lamp momentarily illuminates when you switch the ignition on. If the light does not illuminate during start up, remains on or flashes, the system may be disabled. Have the system checked by an authorized dealer. If the anti-lock brake system is disabled, normal braking is still effective.



If the brake warning lamp remains illuminated after you release the parking brake, have the system checked by an authorized dealer.

HINTS ON DRIVING WITH ANTI-LOCK BRAKES

The anti-lock braking system does not eliminate the risks when:

- You drive too closely to the vehicle in front of you.
- Your vehicle is hydroplaning.
- You take corners too fast.
- The road surface is poor.

Brakes

Note: If the system activates, the brake pedal may pulse and may travel further. Maintain pressure on the brake pedal. You may also hear a noise from the system. This is normal.

ELECTRIC PARKING BRAKE

WARNING



Always set the parking brake and leave your vehicle with the transmission in park (P).

The electric parking brake operates with the switch in the center console.

Note: When you apply the electric parking brake in certain conditions, for example, on a steep hill, the electric parking brake may reapply the brakes within three to ten minutes.

Note: You may notice various noises when you apply and release the electric parking brake. This is normal and no cause for concern.

Applying the Electric Parking brake

WARNINGS



Applying the electric parking brake while moving will result in the engagement of the anti-lock braking system. Do not use the electric parking brake system when the vehicle is moving unless the normal brake system is unable to stop the vehicle.



With the exception of emergency conditions (for example, the brake pedal is broken or is blocked), do not apply the electric parking brake while the vehicle is moving. On bends, or poor road surfaces or weather conditions, emergency braking can cause the vehicle to skid out of control or off the road.

Note: The brake system warning lamp lights during an electric parking brake apply. If the brake system warning lamp flashes and continues to flash, there could be a problem with your electric parking brake. See your authorized dealer.

Note: The brake system warning lamp illuminates for ten seconds if you switch the ignition off after you apply the electric parking brake, or you apply the electric parking brake after you switch the ignition off.

Note: When you switch the engine off, the electric parking brake applies.



E227395

Pull the switch up to apply the electric parking brake.

The brake system warning lamp flashes for about two seconds and then illuminates to confirm that you have applied the electric parking brake. See **Information Displays** (page 70).

If you apply the electric parking brake when your vehicle is moving, the brake system warning lamp illuminates and a warning chime sounds. See **Information Displays** (page 70).

If your vehicle speed is above 4 mph (6 km/h), the braking force is applied as long as you pull the switch. Releasing or pressing the switch or pressing the accelerator pedal will stop the braking force.

Brakes

Releasing the Electric Parking Brake



E227515

You can release the electric parking brake either manually by pressing the switch or automatically by pressing the accelerator pedal.

Manual release

WARNING



If the brake system warning light remains illuminated or flashes for more than four seconds after you have released the parking brake, there could be a problem with your braking system. Have your vehicle checked as soon as possible.

You can manually release the electric parking brake by:

1. Switching the ignition on.
2. Pressing the brake pedal.
3. Pressing the electric parking brake switch.

When you release the electric parking brake, the brake system warning lamp turns off.

Automatic release - drive away release

Your vehicle automatically releases the parking brake if all of the following conditions exist:

- You close the driver door.
- You put on your seatbelt.
- You press the accelerator pedal.
- The system does not detect any faults in the parking brake system.

Note: *If the electric parking brake warning lamp stays illuminated, the electric parking brake will not automatically release. You must release the electric parking brake using the electric parking brake switch.*

The brake system warning lamp turns off to confirm that you released the electric parking brake.

Note: *The electric parking brake drive away release makes starting on a hill easier. This feature releases the parking brake automatically when the vehicle has sufficient drive force to move up the hill. To assure drive away release when starting uphill, press the accelerator pedal quickly.*

Battery With No Charge

WARNING



You will not be able to apply or release the electric parking brake if the battery is low or has no charge.

If the battery is low or has no charge, use jumper cables and a booster battery.

After connecting the booster battery, you should be able to apply or release the electric parking brake.

Brakes

HILL START ASSIST

WARNINGS



The system does not replace the parking brake. When you leave your vehicle, always apply the parking brake.



You must remain in your vehicle when the system turns on. At all times, you are responsible for controlling your vehicle, supervising the system and intervening, if required. Failure to take care may result in the loss of control of your vehicle, serious personal injury or death.



The system turns off if there is a malfunction or if you excessively rev the engine.

The system makes it easier to pull away when your vehicle is on a slope without the need to use the parking brake.

When the system is active, your vehicle remains stationary on the slope for two to three seconds after you release the brake pedal. This allows you time to move your foot from the brake to the accelerator pedal. The brakes release automatically once the engine develops sufficient torque to prevent your vehicle from rolling down the slope. The system activates automatically on any slope that causes significant vehicle rollback.

Note: *There is no warning lamp to indicate the system is either on or off.*

Using Hill Start Assist

1. Press the brake pedal to bring your vehicle to a complete standstill. Keep the brake pedal pressed.
2. If the sensors detect that your vehicle is on a slope, the system activates automatically.
3. When you remove your foot from the brake pedal, your vehicle will remain on the slope without rolling away for about two or three seconds. This hold time automatically extends if you are in the process of driving off.
4. Drive off in the normal manner. The brakes release automatically.

Stability Control

PRINCIPLE OF OPERATION

WARNINGS



Vehicle modifications involving braking system, aftermarket roof racks, suspension, steering system, tire construction and wheel and tire size may change the handling characteristics of your vehicle and may adversely affect the performance of the electronic stability control system. In addition, installing any stereo loudspeakers may interfere with and adversely affect the electronic stability control system. Install any aftermarket stereo loudspeaker as far as possible from the front center console, the tunnel, and the front seats in order to minimize the risk of interfering with the electronic stability control sensors. Reducing the effectiveness of the electronic stability control system could lead to an increased risk of loss of vehicle control, vehicle rollover, personal injury and death.



Remember that even advanced technology cannot defy the laws of physics. It's always possible to lose control of a vehicle due to inappropriate driver input for the conditions. Aggressive driving on any road condition can cause you to lose control of your vehicle increasing the risk of personal injury or property damage. Activation of the electronic stability control system is an indication that at least some of the tires have exceeded their ability to grip the road; this could reduce the operator's ability to control the vehicle potentially resulting in a loss of vehicle control, vehicle rollover, personal injury and death. If your electronic stability control system activates, SLOW DOWN.

WARNINGS



The stability and traction control light illuminates steadily if the system detects a failure. Make sure you did not manually disable the traction control system using the information display controls or the switch. If the stability control and traction control light is still illuminating steadily, have the system serviced by an authorized dealer immediately. Operating your vehicle with the traction control disabled could lead to an increased risk of loss of vehicle control, vehicle rollover, personal injury and death.

The stability and traction control systems help you to avoid drive wheel spin and loss of traction. The system automatically turns on each time you switch the ignition on.

If a fault occurs in either the stability control or the traction control system, you may experience the following conditions:

- The stability and traction control light illuminates steadily.
- The stability control and traction control systems do not enhance your vehicle's ability to maintain traction of the wheels.

If a driving condition activates either the stability control or the traction control system you may experience the following conditions:

- The stability and traction control light flashes.
- Your vehicle slows down.
- Reduced engine power.
- A vibration in the brake pedal.
- The brake pedal is stiffer than usual.
- If the driving condition is severe and your foot is not on the brake, the brake pedal may move as the system applies higher brake force.

Stability Control

The stability and traction control systems have several features built into it to help you maintain control of your vehicle:

AdvanceTrac™ Electronic Stability Control

The system enhances your vehicle's ability to prevent skids or lateral slides by applying brakes to one or more of the wheels individually and, if necessary, reducing engine power.

Traction Control

The system enhances your vehicle's ability to maintain traction of the wheels by detecting and controlling wheel spin. Traction control settings on your vehicle are integrated into the AdvanceTrac Stability Control system.

The following chart describes how much you can change the functionality of stability control and traction control in each Drive Mode:

Drive Mode	Available Setting(s)	Operation	How to Select
Normal, Wet and V-Max.	On.	Normal.	No input required.
Sport and Track.	On.	Normal.	No input required.
	Performance.	Stability control is reduced, traction control remains on.	Press the ESC button once.
	Performance+.	Stability control is reduced, traction control is disabled.	Press the ESC button twice within 0.5 seconds.
	Off.	Stability and traction control is disabled.	Press the ESC button for 5 seconds.

If the stability or traction control system has been reduced or disabled, press the stability and traction control button once to return to the normal on setting.

USING STABILITY CONTROL

AdvanceTrac™ Electronic Stability Control

The system automatically turns on each time you switch the ignition on. You can also use the stability control button on the center console to adjust the operation of the AdvanceTrac stability control system.

AdvanceTrac electronic stability control is disabled when the transmission is in reverse (R).

The amount of change you can make to the AdvanceTrac stability control system depends on the Drive Mode you have selected.

Note: Do not use Track or V-Max modes on public roadways.

Note: Messages appear in the instrument cluster when you make changes to the AdvanceTrac system.

Stability Control

Note: When you start your vehicle, AdvanceTrac turns on for all drive modes. It does not remember the previous setting.

Traction Control

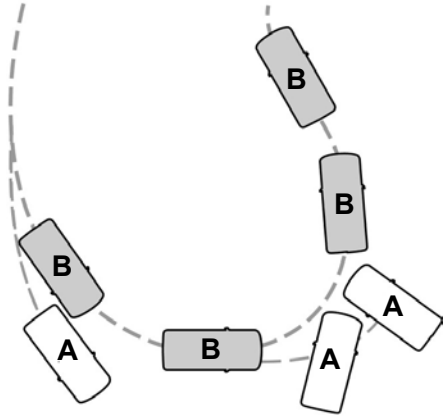

E72903

- A Vehicle without stability control skidding off its intended route.
- B Vehicle with stability control maintaining control on a slippery surface.

If your vehicle begins to slide, the system applies the brakes to individual wheels and, when needed, reduces engine power at the same time. If the wheels spin when accelerating on slippery or loose surfaces, the system reduces engine power in order to increase traction.

System Indicator Lights and Messages



The stability and traction control light temporarily illuminates on engine start-up and flashes:

- When a driving condition activates either of the systems.
- If a problem occurs in either of the systems.



The stability and traction control off light temporarily illuminates on engine start-up and stays on when you adjust the operation of the AdvanceTrac stability control system. The amount of change you can make to the AdvanceTrac stability control system depends on the drive mode you have selected. The chart found earlier in this section shows how much you can change the stability control and traction control for each drive mode.

Launch Control

Note: Only use this feature in a controlled environment, such as a track. Launch control is not for use in normal driving.

Note: Launch control is not available when in the Wet drive mode.

Your vehicle has a launch control feature that uses clutch and engine controls to reduce wheel spin or slip on a hard acceleration from a standing start.

To operate launch control, your vehicle must meet the following conditions:

- You must be in any drive mode other than Wet drive mode.
- You must close the doors, front hood and rear hatch.
- Your vehicle should be on a level surface.
- You must disengage the electric park brake.
- You must be at a complete stop with the brake pedal applied and the transmission selector in drive (D).

Stability Control

- Transmission clutch fluid temperature must be in the normal operating temperature range.
- No powertrain or brake system warning indicators are active.

Launch Control remains active until:

- You switch the feature off through the display screen.
- Your vehicle no longer meets the conditions required for launch control to operate.

Using Launch Control

To use Launch Control:

- Activate the launch control feature through the display screen. See **General Information** (page 70).
- When activated, the LC icon appears in white inside the information cluster.
- With your vehicle at a complete stop, hold the brake pedal firmly and press the accelerator pedal to wide open throttle.
- When the engine reaches the required RPM and your vehicle meets all other system requirements, the LC icon turns from white to green and the vehicle is ready to launch.
- Quickly release the brake pedal and carefully steer your vehicle when it accelerates from a stop. The launch control feature controls wheel spin as you accelerate.
- After completing the run and stopping, the LC icon returns to white.
- If any operating conditions are not within specification, the LC icon turns grey with a strikethrough.
- You can switch launch control off through the display screen. See **General Information** (page 70).

Parking Aids

REAR VIEW CAMERA

WARNINGS

 The rear view camera system is a reverse aid supplement device that still requires the driver to use it in conjunction with the interior and exterior mirrors for maximum coverage.

 Objects that are close to either corner of the bumper or under the bumper, might not be seen on the screen due to the limited coverage of the camera system.

 Use caution when turning camera features on or off when the transmission is not in park (P). Make sure your vehicle is not moving.

The rear view camera system provides a video image of the area behind your vehicle.

During operation, lines appear in the display which represent your vehicle's proximity to objects behind your vehicle.

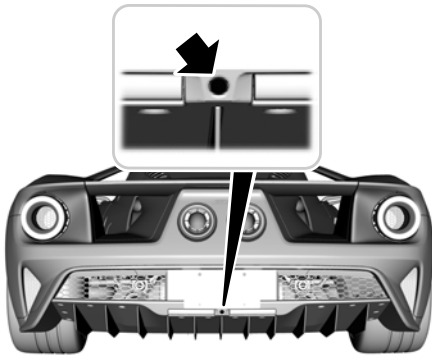

E236446

The camera is located below the license plate.

Using the Rear View Camera System

The rear view camera system displays what is behind your vehicle when you place the transmission in reverse (R).

The system uses fixed guidelines to help you see what is behind your vehicle. Fixed guidelines show the path your vehicle is moving while reversing in a straight line. This can be helpful when backing into a parking space.

The camera may not operate correctly under the following conditions:

- Nighttime or dark areas if the reverse lamps are not operating.
- Mud, water or debris obstructs the camera's view. Clean the lens with a soft, lint-free cloth and non-abrasive cleaner.
- The camera is misaligned due to damage to the rear of your vehicle.

Camera Guidelines

Note: Fixed guidelines are only available when the transmission is in reverse (R).

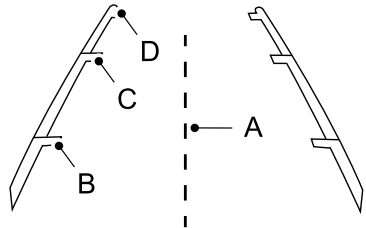

E243771

- A Centerline
- B Fixed guideline: Red Zone
- C Fixed guideline: Yellow zone
- D Fixed guideline: Green zone

Parking Aids

Always use caution while reversing. Objects in the red zone are closest to your vehicle and objects in the green zone are farther away. Objects are getting closer to your vehicle as they move from the green zone to the yellow or red zones. Use the side view mirrors and rear view mirror to get better coverage on both sides and rear of the vehicle.

Manual Zoom

WARNING



When manual zoom is on, the full area behind your vehicle may not show. Be aware of your surroundings when using the manual zoom feature.

Note: *Manual zoom is only available when the transmission is in reverse (R).*

Selectable settings for this feature are Zoom in (+) and Zoom out (-). Press the symbol in the camera screen to change the view. The default setting is Zoom OFF.

This feature allows you to get a closer view of an object behind your vehicle. The zoom is only active while the transmission is in reverse (R). When the transmission shifts out of reverse (R), the feature automatically turns off and must be reset when it is used again.

Rear Camera Delay

You can select to have the rear camera continue to display after shifting from reverse (R). See **Settings** (page 248).

Cruise Control

PRINCIPLE OF OPERATION

Cruise control lets you maintain a set speed without keeping your foot on the accelerator pedal. You can use cruise control when your vehicle speed is greater than 20 mph (30 km/h).

USING CRUISE CONTROL

WARNINGS



Do not use cruise control on winding roads, in heavy traffic or when the road surface is slippery. This could result in loss of vehicle control, serious injury or death.



When you are going downhill, your vehicle speed could increase above the set speed. The system does not apply the brakes.

Note: *Cruise control disengages if the vehicle speed decreases more than 10 mph (16 km/h) below the set speed when driving uphill.*



E227119

The cruise controls are on the steering wheel.

Switching Cruise Control On

Press **ON**.



The indicator appears in the information display.

Setting the Cruise Speed

1. Drive to desired speed.
2. Toggle **SET+** or **SET-**.
3. Take your foot off the accelerator pedal.

Note: *The indicator changes color.*

Changing the Set Speed

Note: *If you accelerate by pressing the accelerator pedal, the set speed will not change. When you release the accelerator pedal, your vehicle returns to the speed that you previously set.*

- Toggle **SET+** or **SET-** to change the set speed in small increments.
- Press the accelerator or brake pedal until you reach the desired speed. Toggle **SET+** or **SET-**.
- Toggle and hold **SET+** or **SET-**. Release the control when you reach the desired speed.

Canceling the Set Speed

Press **CAN** or tap the brake pedal. The set speed does not erase.

Resuming the Set Speed

Press **RES**.

Switching Cruise Control Off

Note: *You erase the set speed when you switch the system off.*

Press **OFF** when the system is in standby mode, or switch the ignition off.

Driving Aids

STEERING

To help prevent damage to the power steering system:

- Never hold the steering wheel at its furthest turning points (until it stops) for more than three to five seconds when the engine is running.
- Do not operate the vehicle with a low hydraulic fluid level. See **Power Steering Fluid Check** (page 167).
- Some noise is normal during operation. If excessive, check for low hydraulic fluid level before seeking service by your dealer.
- Heavy or uneven efforts may be caused by low hydraulic fluid. Check for low hydraulic fluid level before seeking service by your dealer.
- Do not over fill the hydraulic fluid as this may result in leaks from the reservoir. See **Power Steering Fluid Check** (page 167).

If the power steering system breaks down (or if the engine is off), you can manually steer the vehicle, but it takes more effort.

If the steering wanders or pulls, check for:

- An improperly inflated tire.
- Uneven tire wear.
- Loose or worn suspension components.
- Loose or worn steering components.
- Improper vehicle alignment.

A high crown in the road or high crosswinds may also make the steering seem to wander or pull.

DRIVE MODE CONTROL

Drive Mode Selection

Your vehicle has five selectable drive modes that deliver an enhanced driving experience through a suite of sophisticated electronic vehicle systems. In response to vehicle use and driving conditions, the selection of the drive mode optimizes handling and powertrain response. This provides a single location to control multiple systems performance settings.

Using Selectable Drive Modes



E227821

To change the drive mode setting, use the rotary switch on the left side of the steering wheel.

Note: To engage or disengage Track or V-Max Drive Modes, the car must be at a stop with the transmission in park (P) and the engine running. This is necessary since the vehicle ride height changes. You can change between Normal, Wet and Sport Drive Modes while the vehicle is in motion.

Driving Aids

Modes:

- Normal (N) – Use for normal driving in dry conditions.
 - AdvanceTrac Stability Control is active and cannot be adjusted.
 - Ride height is set to High and suspension damping is set to Normal.
 - Comfort damping can be selected with the console switch.
 - Launch control is available.
 - Transmission automatic shift calibration is set to Normal.
 - Rear wing deploys at speeds above 90 mph (145 km/h) and retracts when the speed drops below 81 mph (130 km/h).
 - Air brake activates at speeds above 75 mph (121 km/h) when the brakes are applied with moderate force.
- Sport (S) – Use for sport driving in dry conditions.
 - AdvanceTrac Stability Control is active but can be adjusted by use of the Stability Control button on the console.
 - Ride height is set to High and suspension damping is set to Sport.
 - Comfort damping cannot be selected.
 - Launch control is available.
 - Transmission automatic shift calibration is set to Sport.
 - Turbocharger anti-lag calibration is active.
 - Rear wing deploys at speeds above 70 mph (113 km/h) and retracts when the speed drops below 45 mph (72 km/h).
 - Air brake activates at speeds above 75 mph (121 km/h) when the brakes are applied with moderate force.
- Wet (W) – Use for driving in wet conditions.
 - AdvanceTrac Stability Control is active and cannot be adjusted.
 - Ride height is set to High and suspension damping is set to Normal.
 - Comfort damping can be selected with the console switch.
 - Launch control is not available.
 - Transmission automatic shift calibration is set to Normal.
 - Rear wing deploys at speeds above 90 mph (145 km/h) and retracts when the speed drops below 81 mph (130 km/h).
 - Air brake activates at speeds above 75 mph (121 km/h) when the brakes are applied with moderate force.

Driving Aids

- Track (T) – Optimized settings for track handling performance. The Track drive mode should only be used in a track environment, not on the street, due to the low ride height. This setting can only be selected while your vehicle is in park (P) with the engine running, and you need to confirm the selection.
 - AdvanceTrac Stability Control is active but can be adjusted by use of the Stability Control button on the console.
 - Ride height is set to Low and suspension damping is set to Track.
 - Comfort damping cannot be selected due to low ride height.
 - Launch control is available.
 - Transmission automatic shift calibration is set to Sport.
 - Turbocharger anti-lag calibration is active.
 - Rear wing deploys and remains deployed while in Track mode. When you change to another mode, the wing lowers once you start to drive your vehicle, not while it is stopped.
 - Air brake activates at speeds above 75 mph (121 km/h) when the brakes are applied with moderate force.
- V-Max (V) – Optimized settings for achieving maximum velocity (top speed). The V-Max mode should only be used in a controlled track environment, not on the street, due to the low ride height. This setting can only be selected while your vehicle is in park (P) with the engine running, and you need to confirm the selection.
 - AdvanceTrac Stability Control is active and cannot be adjusted.
 - Ride height is set to Low and suspension damping is set to Track.
 - Comfort damping cannot be selected due to low ride height.
 - Launch control is available.
 - Transmission automatic shift calibration is set to Sport.
 - Rear wing does not deploy.
 - Air brake activates at speeds above 75 mph (121 km/h) when the brakes are applied with moderate force.

Note: *When you shut down your vehicle in V-Max or Track mode, the vehicle returns to the Normal ride height. When you restart your vehicle in V-Max or Track mode, you need to re-acknowledge the drive mode selection in the information display in order for the drive mode to reactivate. If you do not make a selection, the vehicle returns to the previously selected drive mode.*

Driving Aids

Drive Mode	Wet	Normal	Sport	Track	V-Max
Use	Driving in wet conditions	Normal driving in dry conditions	Sport driving in dry conditions	Optimized settings for track use (not for street use). Must be in park (P) to select this mode	Optimized settings for achieving maximum velocity (not for street use). Must be in park (P) to select this mode
AdvanceTrac Stability Control	Active, cannot be adjusted	Active, cannot be adjusted	Active, but can be adjusted	Active, but can be adjusted	Active, cannot be adjusted
Launch control	Not Available	Available			
Ride height and suspension damping	High with normal damping	High with normal damping	High with sport damping	Low with track damping	Low with track damping
Comfort damping	Available	Available	Not Available	Not Available	Not Available
Automatic transmission	Normal	Normal	Sport	Sport	Sport
Turbocharger anti-lag	Inactive	Inactive	Active	Active	Inactive
Rear wing	Active above 90 mph (145 km/h)	Active above 90 mph (145 km/h)	Active above 70 mph (113 km/h)	Always deployed	Does not deploy
Air brake	Activates above 75 mph (121 km/h) with moderate braking				

Note: *Selectable driving modes has diagnostic checks that continuously monitor the system to ensure proper operation. If a selected mode is unavailable due to a system fault or change in gear shifter position, the selected mode defaults to Normal.*

Driving Aids

Front Lift

WARNING



Before using front lift, make sure the area around your vehicle is free from obstruction. Failure to follow this instruction could result in personal injury or death.

Your vehicle has a front lift system to provide additional front end clearance when approaching a speed bump, driveway ramp or another similar surface where front end clearance could be a concern.

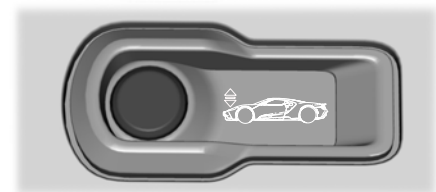

E229612

The front lift button is located on the center console. Press the button to lift the front end of your vehicle. Press the button again to return to normal ride height. A warning indicator illuminates in the display screen when the system is on. When you shut the engine off, the car returns to normal ride height. Remember to use the front lift again when needed, for example when backing out of a driveway.

Note: The front lift feature only operates if your vehicle is traveling under 25 mph (40 km/h). If your vehicle exceeds this speed, the system automatically returns your vehicle to normal ride height.

Note: The front lift feature does not function when in Track (T) or V-Max (V) drive modes.

Damper Comfort Mode



E229613

You can change the feel of the suspension by pressing the damper comfort button on the center console. An indicator illuminates in the display screen when the system is active. The comfort mode operates at speeds up to 85 mph (137 km/h).

Pressing the damper comfort button softens the suspension. Pressing the button again returns the suspension to the normal setting.

Note: The comfort mode selection does not function when in Sport (S), Track (T) or V-Max (V) drive modes.

Active Aerodynamics

The rear wing is a tri-state device designed to operate automatically in either a low-drag (down), high downforce (up) or airbrake mode depending on the vehicle demands.

The rear wing works in harmony with the bi-state front splitter. The front splitter has a raised leading edge so that the surfaces underneath and immediately downstream of it create a Venturi effect and lower the air pressure creating downforce on the front wheels. In normal (low-drag) operation, the Venturi effect draws air through ducts that connect the upper surface of the splitter just below the radiator intake. This reduces drag and eliminates unnecessary front downforce. When the rear wing moves out of the low-drag position, and to compensate for

Driving Aids

the increase in grip capability from the rear tires, the front splitter automatically compensates by closing off airflow through the ducts causing an increase in front downforce. The operation of this system is entirely automatic and is dependent on the rear-wing state and the drive mode selected.

For information on raising the rear wing for cleaning, See **Vehicle Care** (page 172).

Load Carrying

REAR UNDER HATCH STORAGE

Your vehicle has a storage compartment under the rear hatch.

Note: Avoid placing items in the storage compartment that could be affected by temperature, as this area is subject to both high and low temperatures.

LOAD LIMIT

Vehicle Loading - with and without a Trailer

This section guides you in the proper loading of your vehicle, trailer, or both. Keep your loaded vehicle weight within its design rating capability, with or without a trailer. Properly loading your vehicle provides maximum return of vehicle design performance. Before you load your vehicle, become familiar with the following terms for determining your vehicle's weight rating, with or without a trailer, from the vehicle's Tire and Loading Information label or Safety Compliance Certification label.

Tire and Loading Label Information Example:

TIRE AND LOADING INFORMATION

SEATING CAPACITY TOTAL: 5 FRONT: 2 REAR: 3

The combined weight of occupants and cargo should never exceed: **385 kg or 850 lbs.**

TIRE	SIZE	COLD TIRE PRESSURE
FRONT	235/45R18 94V	235 KPA, 34 PSI
REAR	235/45R18 94V	235 KPA, 34 PSI
SPARE	NONE	NONE

SEE OWNERS MANUAL FOR ADDITIONAL INFORMATION

TIRE AND LOADING INFORMATION
RENSEIGNEMENTS SUR LES PNEUS ET LE CHARGEMENT

SEATING CAPACITY / NOMBRE DE PLACES TOTAL 5 FRONT AVANT 2 REAR ARRIERE 3

The combined weight of occupants and cargo should never exceed 396 kg or 875 lbs. / Le poids total des occupants et du chargement ne doit jamais dépasser 396 kg ou 875 lb.

TIRE / PNEU	SIZE / DIMENSIONS	COLD TIRE PRESSURE / PRESION DES PNEUS A FROID
FRONT AVANT	235/40R19 96V	255 KPA, 37 PSI
REAR ARRIERE	235/40R19 96V	255 KPA, 37 PSI
SPARE / SECOURS	T125/80R16 97M	415 KPA, 60 PSI

SEE OWNER'S MANUAL FOR ADDITIONAL INFORMATION / VOIR LE MANUEL DE L'USAGER POUR PLUS DE RENSEIGNEMENTS

E198719

Payload



E24628

Payload is the combined weight of cargo and passengers that your vehicle is carrying. The maximum payload for your vehicle appears on the Tire and Loading label. The label is either on the B-pillar or the edge of the driver door. Vehicles exported outside the US and Canada may not have a tire and

Load Carrying

loading label. Look for “The combined weight of occupants and cargo should never exceed XXX kg OR XXX lb” for maximum payload. The payload listed on the Tire and Loading Information label is the maximum payload for your vehicle as built by the assembly plant. If you install any additional equipment on your vehicle, you must determine the new payload. Subtract the weight of the equipment from the payload listed on the Tire and Loading label. When towing, trailer tongue weight or king pin weight is also part of payload.

Note: *Your Ford GT is not designed for trailer towing. Never tow a trailer with your Ford GT.*

WARNING



The appropriate loading capacity of your vehicle can be limited either by volume capacity (how much space is available) or by payload capacity (how much weight the vehicle should carry). Once you have reached the maximum payload of your vehicle, do not add more cargo, even if there is space available. Overloading or improperly loading your vehicle can contribute to loss of vehicle control and vehicle rollover.

GAWR (Gross Axle Weight Rating)

GAWR is the maximum allowable weight that a single axle (front or rear) can carry. These numbers are on the Safety Compliance Certification label. The label is located on the door hinge pillar, door-latch post, or the door edge that meets the door-latch post, next to the driver seating position.

The total load on each axle must never exceed its Gross Axle Weight Rating.

GVWR (Gross Vehicle Weight Rating)

GVWR is the maximum allowable weight of the fully loaded vehicle. This includes all options, equipment, passengers and cargo. It appears on the Safety Compliance Certification label. The label is located on the door hinge pillar, door-latch post, or the door edge that meets the door-latch post, next to the driver seating position.

The gross vehicle weight must never exceed the Gross Vehicle Weight Rating.

Load Carrying

Safety Compliance Certification Label Example:

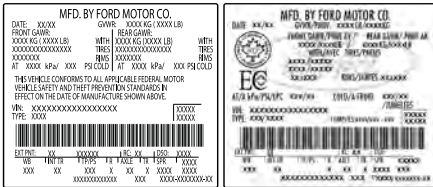

6198228

WARNING



Exceeding the Safety Compliance Certification label vehicle weight limits can adversely affect the performance and handling of your vehicle, cause vehicle damage and can result in the loss of control of your vehicle, serious personal injury or death.

Maximum Loaded Trailer Weight

Note: *Your Ford GT is not designed for trailer towing. Never tow a trailer with your Ford GT.*

GCWR (Gross Combined Weight Rating)

GCWR is the maximum allowable weight of the vehicle and the loaded trailer, including all cargo and passengers, that the vehicle can handle without risking damage.

The gross combined weight must never exceed the Gross Combined Weight Rating.

Note: *Your Ford GT is not designed for trailer towing. Never tow a trailer with your Ford GT.*

WARNINGS



Do not exceed the GVWR or the GAWR specified on the certification label.



Do not use replacement tires with lower load carrying capacities than the original tires because they may lower your vehicle's GVWR and GAWR limitations. Replacement tires with a higher limit than the original tires do not increase the GVWR and GAWR limitations.



Exceeding any vehicle weight rating can adversely affect the performance and handling of your vehicle, cause vehicle damage and can result in the loss of control of your vehicle, serious personal injury or death.

Steps for determining the correct load limit:

1. Locate the statement "The combined weight of occupants and cargo should never exceed XXX kg or XXX lb." on your vehicle's placard.
2. Determine the combined weight of the driver and passengers that will be riding in your vehicle.
3. Subtract the combined weight of the driver and passengers from XXX kg or XXX lb.

Load Carrying

- The resulting figure equals the available amount of cargo and luggage load capacity. For example, if the “XXX” amount equals 1,400 lb. and there will be five 150 lb. passengers in your vehicle, the amount of available cargo and luggage load capacity is 650 lb. $(1400 - 750) (5 \times 150) = 650 \text{ lb.}$
- Determine the combined weight of luggage and cargo being loaded on the vehicle. That weight may not safely exceed the available cargo and luggage load capacity calculated in Step 4.
- If your vehicle will be towing a trailer, load from your trailer will be transferred to your vehicle. Consult this manual to determine how this reduces the available cargo and luggage load capacity of your vehicle.

Helpful examples for calculating the available amount of cargo and luggage load capacity

Suppose your vehicle has a 1400-pound (635-kilogram) cargo and luggage capacity. You decide to go golfing. Is there enough load capacity to carry you, four of your friends and all the golf bags? You and four friends average 220 pounds (99 kilograms) each and the golf bags weigh approximately 30 pounds (13.5 kilograms) each. The calculation would be: $1400 - (5 \times 220) - (5 \times 30) = 1400 - 1100 - 150 = 150 \text{ pounds.}$ Yes, you have

enough load capacity in your vehicle to transport four friends and your golf bags. In metric units, the calculation would be: $635 \text{ kilograms} - (5 \times 99 \text{ kilograms}) - (5 \times 13.5 \text{ kilograms}) = 635 - 495 - 67.5 = 72.5 \text{ kilograms.}$

Suppose your vehicle has a 1400-pound (635-kilogram) cargo and luggage capacity. You and one of your friends decide to pick up cement from the local home improvement store to finish that patio you have been planning for the past two years. Measuring the inside of the vehicle with the rear seat folded down, you have room for twelve 100-pound (45-kilogram) bags of cement. Do you have enough load capacity to transport the cement to your home? If you and your friend each weigh 220 pounds (99 kilograms), the calculation would be: $1400 - (2 \times 220) - (12 \times 100) = 1400 - 440 - 1200 = -240 \text{ pounds.}$ No, you do not have enough cargo capacity to carry that much weight. In metric units, the calculation would be: $635 \text{ kilograms} - (2 \times 99 \text{ kilograms}) - (12 \times 45 \text{ kilograms}) = 635 - 198 - 540 = -103 \text{ kilograms.}$ You will need to reduce the load weight by at least 240 pounds (104 kilograms). If you remove three 100-pound (45-kilogram) cement bags, then the load calculation would be: $1400 - (2 \times 220) - (9 \times 100) = 1400 - 440 - 900 = 60 \text{ pounds.}$ Now you have

Load Carrying

the load capacity to transport the cement and your friend home. In metric units, the calculation would be: 635 kilograms - (2 x 99 kilograms) - (9 x 45 kilograms) = 635 - 198 - 405 = 32 kilograms.

The above calculations also assume that the loads are positioned in your vehicle in a manner that does not overload the front or the rear gross axle weight rating specified for your vehicle on the Safety Compliance Certification label.

Towing

TOWING A TRAILER

Note: *Your Ford GT is not designed for trailer towing. Never tow a trailer with your Ford GT.*

TOWING THE VEHICLE ON FOUR WHEELS

Emergency Towing

You can release the steering wheel lock by starting the engine or by pressing the START/STOP button with your foot off the brake.

If your Ford GT must be transported, whenever possible, use an enclosed trailer, an open car trailer, or a roll back car carrier. If you must move the car on its wheels, install the recovery hook provided in the rear hatch storage. This recovery hook should be screwed into the receptacle located in the right corner of the front grille. Once installed, use the recovery hook to pull the car.

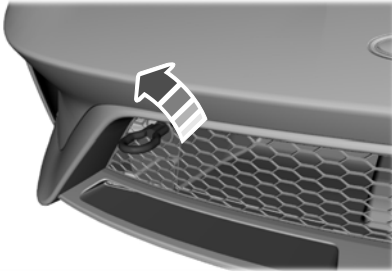

E233260

Driving Hints

BREAKING-IN

You need to break in new tires for approximately 300 mi (480 km). During this time, your vehicle may exhibit some unusual driving characteristics.

You should not drive your Ford GT aggressively for the first 600 mi (1,000 km) of vehicle operation. This will allow for proper break in of the powertrain and braking systems.

For the first 600 miles (1,000 km):

- Do not apply high load at low engine speed.
- Do not drive the vehicle at a sustained high-speed, high load.
- Avoid driving the vehicle at full throttle.
- Drive the vehicle at varying road and engine speeds.
- Do not drive in competition and race track conditions.
- Do not use launch control.
- If you are going to use the vehicle on the race track right after break in, change the oil after break in.

Cold Engine Operation

The design of your Ford GT restricts engine power and RPM when the engine is cold. The engine RPM and power output will be reduced until the engine reaches full operating temperature.

Hot Engine Shut down

You should allow your Ford GT engine to cool down for a few minutes prior to shut down after high speed or high performance driving. Allowing the engine to run at light loads and or idle for a few minutes will reduce overall engine oil and coolant temperatures.

DRIVING THROUGH WATER

WARNING



Do not drive through flowing or deep water as you may lose control of your vehicle.

Note: *Driving through standing water can cause vehicle damage.*

Note: *Engine damage can occur if water enters the air filter.*

Before driving through standing water, check the depth. Never drive through water that is higher than the sidewall of the front tire. If the water is up onto the wheel, do not proceed. When driving through a puddle, drive slowly to avoid splashing the water into the engine air intake.



E232273

When driving through standing water, drive very slowly and do not stop your vehicle. Your brake performance and traction may be limited.

After driving through water and as soon as it is safe to do so:

- Lightly press the brake pedal to dry the brakes and to check that they work.
- Check that the horn works.

Driving Hints

- Check that the exterior lights work.
- Turn the steering wheel to check that the steering power assist works.

FLOOR MATS

WARNINGS

 Use a floor mat designed to fit the footwell of your vehicle that does not obstruct the pedal area. Failure to follow this instruction could result in the loss of control of your vehicle, personal injury or death.

 Pedals that cannot move freely can cause loss of vehicle control and increase the risk of serious personal injury.

 Secure the floor mat to both retention devices so that it cannot slip out of position and interfere with the pedals. Failure to follow this instruction could result in the loss of control of your vehicle, personal injury or death.

 Do not place additional floor mats or any other covering on top of the original floor mats. This could result in the floor mat interfering with the operation of the pedals. Failure to follow this instruction could result in the loss of control of your vehicle, personal injury or death.

 Always make sure that objects cannot fall into the driver foot well while your vehicle is moving. Objects that are loose can become trapped under the pedals causing a loss of vehicle control.



To install the floor mats, position the floor mat eyelet over the retention post and press down to lock in position. Make sure the hook and loop fastener is properly attached to the floor at the front edge of the driver side floor mat.

To remove the floor mat, reverse the installation procedure.

Note: Regularly check the floor mats to make sure they are secure.

Roadside Emergencies

ROADSIDE ASSISTANCE

Vehicles Sold in the United States: Getting Roadside Assistance

To fully assist you should you have a vehicle concern, Ford Motor Company offers a complimentary roadside assistance program. This program is separate from the New Vehicle Limited Warranty.

The service is available:

- 24 hours a day, seven days a week.
- The coverage period is three years from the date of purchase.

Roadside Assistance covers:

- Assistance with a flat tire.
- Battery jump start.
- Lock-out assistance (key replacement cost is the customer's responsibility).
- Assistance if your vehicle runs out of fuel.
- Winch out — available if your vehicle is stuck.
- Towing — Ford dealership or independent service contractors, if not prohibited by state, local or municipal law, shall tow your vehicle to the nearest Certified Ford GT Dealership.

Vehicles Sold in the United States: Using Roadside Assistance

United States Ford GT customers who require Roadside Assistance, call the Ford GT Concierge at 800-210-5795.

If you need to arrange roadside assistance for yourself, Ford Motor Company reimburses a reasonable amount for towing to the nearest authorized dealership. To obtain reimbursement information, contact the Ford GT Concierge at 800-210-5795.

For assistance outside of the United States, refer to the complete list of Ford GT Concierge phone numbers. See **About This Manual** (page 5).

HAZARD FLASHERS

Note: *The hazard flashers operate when the ignition is in any position. If used when the vehicle is not running, the battery loses charge. As a result, there may be insufficient power to restart your vehicle.*



The hazard flasher control is on the floor console. Use your hazard flashers when your vehicle is creating a safety hazard for other motorists.

- Press the flasher control and all front and rear direction indicators flash.
- Press the button again to switch them off.

FUEL SHUTOFF

WARNING



If your vehicle has been involved in a crash, have the fuel system checked. Failure to follow this instruction could result in fire, personal injury or death.

Note: *When you try to restart your vehicle after a fuel shutoff, the vehicle makes sure that various systems are safe to restart. Once the vehicle determines the systems are safe, then the vehicle allows you to restart.*

Note: *In the event that your vehicle does not restart after your third attempt, contact a qualified technician.*

The fuel pump shutoff stops the flow of fuel to the engine in the event of a moderate to severe crash. Not every impact causes a shutoff.

Roadside Emergencies

Should your vehicle shut off after a crash, you may restart your vehicle.

1. Press **START/STOP** to switch off your vehicle.
2. Press the brake pedal and **START/STOP** to switch on your vehicle.
3. Remove your foot from the brake pedal and press **START/STOP** to switch off your vehicle.
4. You can attempt to start the vehicle by pressing the brake pedal and **START/STOP**, or press **START/STOP** without pressing the brake pedal.

Note: Both methods re-enable the fuel system.

JUMP STARTING THE VEHICLE

WARNINGS



Do not use fuel lines, engine valve covers, windshield wiper arms, the intake manifold, or hood latch as ground points.



Use only adequately sized cables with insulated clamps.

Preparing Your Vehicle

Note: Attempting to push-start a vehicle with an automatic transmission may cause transmission damage.

Note: Use only a 12-volt supply to start your vehicle.

Note: Do not disconnect the battery of the disabled vehicle as this could damage the vehicle's electrical system.

Park the booster vehicle close to the hood of the disabled vehicle, making sure the two vehicles do not touch.

Connecting the Jumper Cables

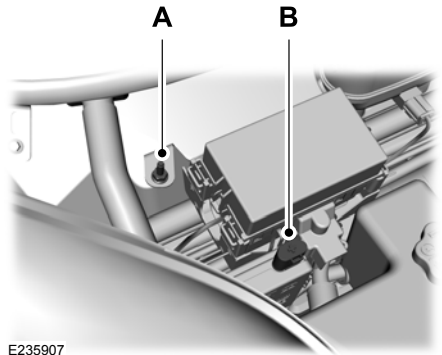

E235907

1. Switch off all accessories.
2. Remove the red cap over the positive (B) post of the disabled vehicle.
3. Connect the positive (+) jumper cable to the positive (B) post of the disabled vehicle.
4. Connect the other end of the positive (+) cable to the positive terminal of the booster vehicle battery.
5. Connect the negative (-) jumper cable to the negative (A) post of the disabled vehicle.
6. Connect the other end of the negative (-) cable to the negative terminal of the booster vehicle battery.

Grounding Stud Location

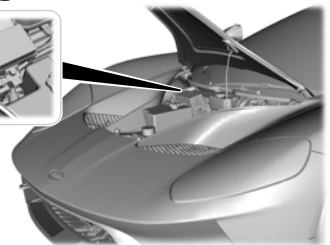
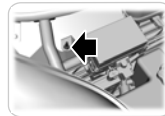

E22889

Roadside Emergencies

Jump Starting

1. Start the engine of the booster vehicle and rev the engine moderately, or press the accelerator gently to keep your engine speed between 2000 and 3000 RPM, as shown in your tachometer.
2. Start the engine of the disabled vehicle.
3. Once the disabled vehicle has been started, run both vehicle engines for an additional three minutes before disconnecting the jumper cables.

Removing the Jumper Cables

Remove the jumper cables in the reverse order that they were connected.

1. Remove the jumper cable from the negative (-) terminal of the booster vehicle battery.
2. Remove the jumper cable from the negative (A) post of the disabled vehicle.
3. Remove the jumper cable from the positive (+) terminal of the booster vehicle battery.
4. Remove the jumper cable from the positive (B) post of the disabled vehicle.
5. Allow the engine to idle for at least one minute.

POST-CRASH ALERT SYSTEM

The system flashes the direction indicators and sounds the horn (intermittently) in the event of a serious impact that deploys an airbag (front and side) or the safety belt pretensioners.

The horn and indicators will turn off when:

- You press the hazard control button.
- You press the panic button on the remote entry transmitter (if equipped).
- Your vehicle runs out of power.

TRANSPORTING THE VEHICLE

If you need to transport your vehicle, please contact the Ford GT Concierge at 800-210-5795.

You can only transport your vehicle in an enclosed trailer or on a roll back flatbed truck. The ramp angle / angle of approach on Ford GT is 9 degrees. Below are some ramp lengths required to achieve this angle depending on trailer / bed entrance height.

Height	Ramp Length
20 inches	130 inches
18 inches	115 inches
16 inches	105 inches
14 inches	90 inches
12 inches	80 inches

Your vehicle has a front end lift feature that uses the electronically controlled suspension hydraulics to lift the front of the car. You can use this feature for driveway approaches and speed bumps. If there is power to this system, use it to lift the front when loading the car onto a trailer or a roll back. To operate the front lift, use the switch in the console.

Note: *The ground clearance on the car at standard ride height is only 5 in (12 cm). Use care when moving or loading the car to make sure it does not bottom out.*

Note: *The vehicle doors swing both upward and outward. At the full open position, the top edge of the door is 67 in (170 cm) from the ground and swings outward 26 in (66 cm). Make sure you have the clearance you need prior to opening the door.*

The full undertrays of the vehicle are carbon fiber, there are no tie down slots. Use only over the tire straps to tie the car down for transport.

Roadside Emergencies

Getting the Transmission in Neutral

If the battery loses charge, the transmission will be in park (P). You can use the transmission tool to place the car into Neutral (N). See **Automatic Transmission** (page 106).

TOWING POINTS

Recovery Hook Location

Your vehicle comes with a screw-in recovery hook, it is in the storage compartment under the rear hatch.

Installing the Recovery Hook

Note: *The screw-in recovery hook has a left-hand thread. Turn it counterclockwise to install it. Make sure that the recovery hook is fully tightened.*

The installation point for the recovery hook is the receptacle in the right corner of the front grille.

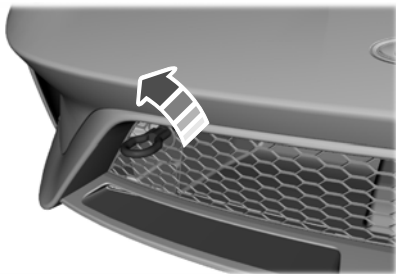

E233260

Customer Assistance

GETTING THE SERVICES YOU NEED

Warranty repairs to your vehicle must be performed by an authorized dealer. If you need assistance in identifying a Ford GT Service Dealership or would like assistance in scheduling a repair, please contact the Ford GT Concierge. See **About This Manual** (page 5).

A reasonable time must be allowed to perform a repair after taking your vehicle to the authorized dealer. Repairs will be made using Ford or Motorcraft® parts, or remanufactured or other parts that are authorized by Ford.

Away From Home

If you are away from home when your vehicle needs service, contact the Ford GT Concierge and they will arrange repairs at the nearest Certified Ford GT Service Dealership.

Website
www.owner.ford.com

These are some of the items that can be found online:

- Owner Manuals.
- Maintenance Schedules.
- Recalls.
- Ford Genuine Accessories.

In Canada:

Website
www.ford.ca

Additional Assistance

If you have questions or concerns, or are unsatisfied with the service you are receiving, follow these steps:

1. Contact your Ford GT Concierge or Service Advisor at your selling or servicing authorized dealer.
2. If your inquiry or concern remains unresolved, contact the Sales Manager, Service Manager or Customer Relations Manager.
3. If you require assistance or clarification on Ford Motor Company policies, please contact the Ford Customer Relationship Center.

In order to help us serve you better, please have the following information available when contacting a Customer Relationship Center:

- Vehicle Identification Number.
- Your telephone number (home and business).
- The name of the authorized dealer and city where located.
- The vehicle's current odometer reading.

In some states within the United States, you must directly notify Ford in writing before pursuing remedies under your state's warranty laws, and Ford is also allowed a final repair attempt.

Additionally, in some states within the United States, a consumer has the option of submitting a warranty dispute to the BBB Auto Line before taking action under the Magnuson-Moss Warranty Act, or to the extent allowed by state law, before pursuing replacement or repurchase

Customer Assistance

remedies provided by certain state laws. This dispute handling procedure is not required prior to enforcing state created rights or other rights which are independent of the Magnuson-Moss Warranty Act or state replacement or repurchase laws.

IN CALIFORNIA (U.S. ONLY)

California Civil Code Section 1793.2(d) requires that, if a manufacturer or its representative is unable to repair a motor vehicle to conform to the vehicle's applicable express warranty after a reasonable number of attempts, the manufacturer shall be required to either replace the vehicle with one substantially identical or repurchase the vehicle and reimburse the buyer in an amount equal to the actual price paid or payable by the consumer (less a reasonable allowance for consumer use). The consumer has the right to choose whether to receive a refund or replacement vehicle.

California Civil Code Section 1793.22(b) presumes that the manufacturer has had a reasonable number of attempts to conform the vehicle to its applicable express warranties if, within the first 18 months of ownership of a new vehicle or the first 18,000 mi (29,000 km), whichever occurs first:

1. Two or more repair attempts are made on the same non-conformity likely to cause death or serious bodily injury OR
2. Four or more repair attempts are made on the same nonconformity (a defect or condition that substantially impairs the use, value or safety of the vehicle) OR
3. The vehicle is out of service for repair of nonconformities for a total of more than 30 calendar days (not necessarily all at one time).

In the case of 1 or 2 above, the consumer must also notify the manufacturer of the need for the repair of the nonconformity at the following address:

Ford Motor Company
16800 Executive Plaza Drive
Mail Drop 3NE-B
Dearborn, MI 48126

You are required to submit your warranty dispute to BBB AUTO LINE before asserting in court any rights or remedies conferred by California Civil Code Section 1793.22(b). You are also required to use BBB AUTO LINE before exercising rights or seeking remedies created by the Federal Magnuson-Moss Warranty Act, 15 U.S.C. sec. 2301 et seq. If you choose to seek redress by pursuing rights and remedies not created by California Civil Code Section 1793.22(b) or the Magnuson-Moss Warranty Act, resort to BBB AUTO LINE is not required by those statutes.

THE BETTER BUSINESS BUREAU (BBB) AUTO LINE PROGRAM (U.S. ONLY)

Your satisfaction is important to Ford Motor Company and to your dealer. If a warranty concern has not been resolved using the three-step procedure outlined earlier in this chapter in the Getting the Services you need section, you may be eligible to participate in the BBB AUTO LINE program.

The BBB AUTO LINE program consists of two parts – mediation and arbitration. During mediation, a representative of the BBB will contact both you and Ford Motor Company to explore options for settlement of the claim. If an agreement is not reached during mediation or you do not want to participate in mediation, and if your claim is eligible, you may participate in the

Customer Assistance

arbitration process. An arbitration hearing will be scheduled so that you can present your case in an informal setting before an impartial person. The arbitrator will consider the testimony provided and make a decision after the hearing.

Disputes submitted to the BBB AUTO LINE program are usually decided within forty days after you file your claim with the BBB. You are not bound by the decision, and may reject the decision and proceed to court where all findings of the BBB Auto Line dispute, and decision, are admissible in the court action. Should you choose to accept the BBB AUTO LINE decision, Ford is then bound by the decision, and must comply with the decision within 30 days of receipt of your acceptance letter.

BBB AUTO LINE Application: Using the information provided below, please call or write to request a program application. You will be asked for your name and address, general information about your new vehicle, information about your warranty concerns, and any steps you have already taken to try to resolve them. A Customer Claim Form will be mailed that will need to be completed, signed and returned to the BBB along with proof of ownership. Upon receipt, the BBB will review the claim for eligibility under the Program Summary Guidelines.

You can get more information by calling BBB AUTO LINE at 1-800-955-5100, or writing to:

**BBB AUTO LINE
3033 Wilson Boulevard, Suite 600
Arlington, Virginia 22201**

BBB AUTO LINE applications can also be requested by calling the Ford Motor Company Customer Relationship Center at 1-800-392-3673.

Note: *Ford Motor Company reserves the right to change eligibility limitations, modify procedures, or to discontinue this process at any time without notice and without obligation.*

UTILIZING THE MEDIATION/ARBITRATION PROGRAM (CANADA ONLY)

For vehicles delivered to authorized Canadian dealers. In those cases where you continue to feel that the efforts by Ford of Canada and the authorized dealer to resolve a factory-related vehicle service concern have been unsatisfactory, Ford of Canada participates in an impartial third party mediation/arbitration program administered by the Canadian Motor Vehicle Arbitration Plan (CAMVAP).

The CAMVAP program is a straight forward and relatively speedy alternative to resolve a disagreement when all other efforts to produce a settlement have failed. This procedure is without cost to you and is designed to eliminate the need for lengthy and expensive legal proceedings.

In the CAMVAP program, impartial third-party arbitrators conduct hearings at mutually convenient times and places in an informal environment. These impartial arbitrators review the positions of the parties, make decisions and, when appropriate, render awards to resolve disputes. CAMVAP decisions are fast, fair, and final as the arbitrator's award is binding on both you and Ford of Canada.

CAMVAP services are available in all Canadian territories and provinces. For more information, without charge or obligation, call your CAMVAP Provincial Administrator directly at 1-800-207-0685 or visit www.camvap.ca.

Customer Assistance

GETTING ASSISTANCE OUTSIDE THE U.S. AND CANADA

Before exporting your vehicle to a foreign country, contact the appropriate foreign embassy or consulate. These officials can inform you of local vehicle registration regulations and where to find unleaded fuel or petrol/gas engines or the proper sulfur fuel for diesel engines.

If you cannot find the proper fuel recommended for your vehicle, contact our Customer Relationship Center.

The use of improper fuels in your vehicle without proper conversion may damage the effectiveness of your emission control system and may cause engine knocking or serious engine damage. Ford Motor Company or Ford of Canada is not responsible for any damage caused by use of improper fuel. Using improper fuels may also result in difficulty importing your vehicle back into the United States.

If your vehicle must be serviced while you are traveling or living in Asia-Pacific Region, Sub-Saharan Africa, U.S. Virgin Islands and/or Puerto Rico, Central America, the Caribbean, and Israel and the Middle East, contact the nearest authorized dealer. If the authorized dealer cannot help you, contact the corresponding Ford Customer Assistance Center:

FORD MOTOR COMPANY

Customer Relationship Centers in:

Customer Relationship Center	Phone	Fax	E-mail
Asia Pacific	N/A	N/A	apemcrc@ford.com
Caribbean and Central America	+1 313 594 4857	-	expcac@ford.com
Middle East	Ford 80004443673	971 4 3327 266	menacac@ford.com
	Lincoln 80004441067		
	UAE 80004441066		
	Saudi Arabia 8008443673		
	Mobily and Zain cell phone users in Saudi 800850078		

Customer Assistance

Customer Relationship Center	Phone	Fax	E-mail
Puerto Rico and U.S. Virgin Islands	+1-800-841-3673	N/A	prcac@ford.com
Sub-Saharan Africa	+1-313-594-4857	N/A	ssacrc@ford.com
South Korea	+82-02-1600-6003	N/A	infokr1@ford.com or infokr@lincoln.com

If you buy your vehicle in North America and then relocate to any of the above locations, register your vehicle identification number (VIN) and new address with Ford Global Trade Services by emailing, expcso@ford.com.

If you are in another foreign country, contact the nearest authorized dealer. In the event your inquiry is unresolved, communicate your concern with the dealership's Sales Manager, Service Manager or Customer Relations Manager. If you require additional assistance or clarification, please contact the respective Customer Relationship Center as previously listed.

Customers in the U.S. should call 1-800-392-3673.

ORDERING ADDITIONAL OWNER'S LITERATURE

To order the publications in this portfolio, contact the Ford GT Concierge at 1-800-210-5795.

REPORTING SAFETY DEFECTS (U.S. ONLY)



E142557

If you believe that your vehicle has a defect which could cause a crash or could cause injury or death, you should immediately inform the National Highway Traffic Safety Administration (NHTSA) in addition to notifying Ford Motor Company.

If NHTSA receives similar complaints, it may open an investigation, and if it finds that a safety defect exists in a group of vehicles, it may order a recall and remedy campaign. However, NHTSA cannot become involved in individual problems between you, your dealer, or Ford Motor Company.

To contact NHTSA, you may call the Vehicle Safety Hotline toll-free at 1-888-327-4236 (TTY: 1-800-424-9153); go to <http://www.safercar.gov>; or write to:

Administrator
1200 New Jersey Avenue,
Southeast
Washington, D.C. 20590

Customer Assistance

You can also obtain other information about motor vehicle safety from <http://www.safercar.gov>.

REPORTING SAFETY DEFECTS (CANADA ONLY)

If you believe that your vehicle has a defect which could cause a crash or could cause injury or death, you should immediately inform Transport Canada and Ford of Canada.

Transport Canada Contact Information	
Website	http://www.tc.gc.ca/eng/motorvehiclesafety/reporting-defects-motor-vehicles.html (English)
Website	http://www.tc.gc.ca/fra/secureiteautomobile/signaler-defauts-vehicules-automobiles.html (French)
Phone	1-800-333-0510

Ford of Canada Contact Information	
Website	www.ford.ca
Phone	1-800-565-3673

Fuses

FUSE SPECIFICATION CHART

Front Power Distribution Box

WARNINGS



Always disconnect the battery before servicing high current fuses.



To reduce risk of electrical shock, always replace the cover to the power distribution box before reconnecting the battery or refilling fluid reservoirs.

The front power distribution box is under the front hood. See **Under Hood Overview** (page 160). It has high-current fuses that protect your vehicle's main electrical systems from overloads. There are also high-current fuses next to the front power distribution box. If replacement of these high-current fuses is required, see an authorized dealer.

If you disconnect and reconnect the battery, you will need to reset some features. See **Changing the 12V Battery** (page 168).

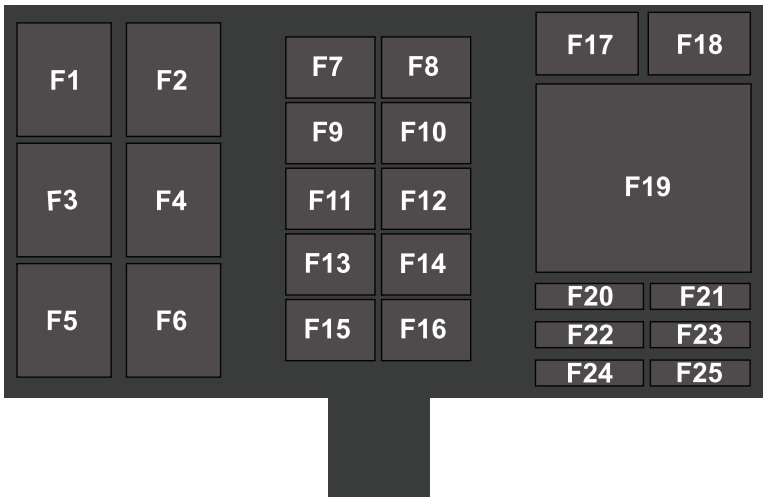

E235532

Fuse or Relay Number	Fuse Rating	Protected Components
1	—	Vehicle dynamics module relay.
2	—	Radiator fan 1 relay.
3	—	HVAC blower relay.
4	—	Wipers relay.

Fuses

Fuse or Relay Number	Fuse Rating	Protected Components
5	—	Radiator fan 2 relay.
6	—	Horn relay.
7	50A ¹	Body control module.
8	—	Shunt.
9	40A ¹	Vacuum pump.
10	25A ¹	Wiper.
11	40A ¹	Radiator fan 2.
12	50A ¹	Body control module.
13	60A ¹	Body control module.
14	40A ¹	Radiator fan 1.
15	40A ¹	HVAC Blower.
16	40A ¹	Antilock brake system.
17	40A ¹	Antilock brake system.
18	30A ¹	Body control module.
19	—	Vacuum pump relay.
20	5A ²	Vehicle dynamics module.
21	20A ²	Left headlamp.
22	5A ²	Antilock brake system.
23	20A ²	Horn.

Fuses

Fuse or Relay Number	Fuse Rating	Protected Components
24	20A ²	Electronic door system.
25	20A ²	Right headlamp.

¹ J-case low profile fuse.

² Mini fuse.

Rear Power Distribution Box 1

The rear power distribution box is in the engine compartment. See **Under Hood Overview** (page 160). It has high-current fuses that protect your vehicle's main electrical systems from overloads. These are in the right side of the engine compartment behind an access door in the engine surround panel. If replacement of these high-current fuses is required, see an authorized dealer.

If you disconnect and reconnect the battery, you will need to reset some features. See **Changing the 12V Battery** (page 168).

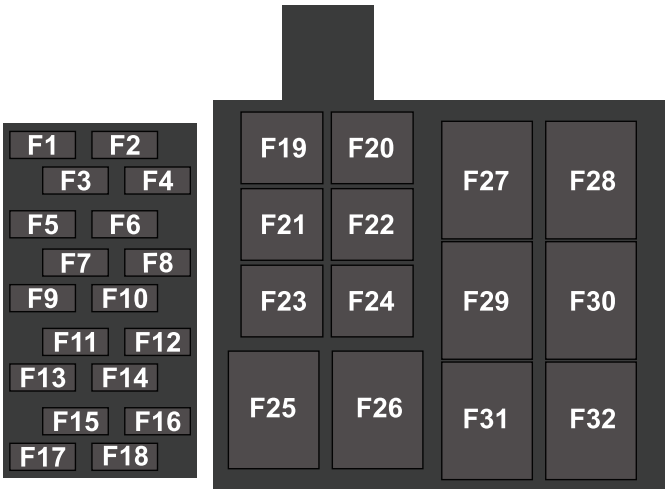

E235533

Fuses

Fuse or Relay Number	Fuse Rating	Protected Components
1	15A ¹	Vehicle power 3.
2	5A ¹	Mass airflow.
3	10A ¹	Engine control module.
4	5A ¹	Transmission control module.
5	20A ¹	Vehicle power 1.
6	5A ¹	Keep alive power.
7	—	Not used.
8	5A ¹	Rear video camera.
9	—	Not used.
10	10A ¹	Alternator sense.
11	10A ¹	Air conditioner.
12	10A ¹	Damper.
13	15A ¹	Vehicle power 4.
14	—	Not used.
15	5A ¹	Battery backup sounder.
16	5A ¹	Engine control module. Run/start.
17	20A ¹	Vehicle power 2.
18	15A ¹	Injector.
19	30A ²	Fuel pump 1.
20	30A ²	Fuel pump 2.
21	30A ²	Transmission control module.

Fuses

Fuse or Relay Number	Fuse Rating	Protected Components
22	30A ²	Starter.
23	30A ²	Charge air cooler fan.
24	—	Shunt.
25	—	Charge air cooler fan relay.
26	—	Not used.
27	—	Fuel pump 1 relay.
28	—	AC clutch relay.
29	—	Starter relay.
30	—	Fuel injection relay.
31	—	Fuel pump 2 relay.
32	—	Engine control module relay.

¹ Mini fuse.

² J-case low profile fuse.

Rear Power Distribution Box 2

The rear power distribution box is in the engine compartment. See **Under Hood Overview** (page 160). It has high-current fuses that protect your vehicle's main electrical systems from overloads. These are in the right side of the engine compartment behind an access door in the engine surround panel. If replacement of these high-current fuses is required, see an authorized dealer.

If you disconnect and reconnect the battery, you will need to reset some features. See **Changing the 12V Battery** (page 168).

Fuses



E270327

Fuse or Relay Number	Fuse Rating	Protected Components
1	—	Transmission gear fluid cooler fan relay.
2	—	Engine oil cooler fan relay.
3	—	Transmission clutch fluid cooler fan relay.
4	—	Not used.
5	—	Not used.
6	—	Not used.
7	20A ¹	Engine oil cooler fan.
8	30A ¹	Transmission clutch fluid cooler fan.
9	20A ¹	Transmission gear fluid cooler fan.
10	—	Not used.

¹J-case low profile fuse.

Passenger Compartment Fuse Panel

The fuse panel is in the passenger footwell behind the toeboard panel.

Fuses

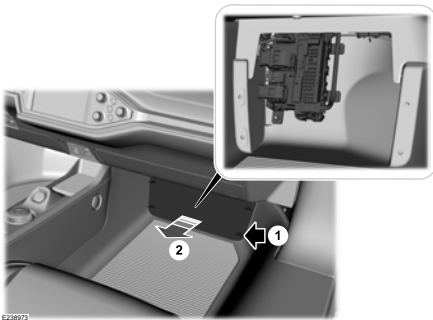

To remove the toeboard panel, rotate each of the four fasteners, and then pull the toeboard panel toward you. Once you remove this panel, you can access the fuse panel. After replacing a fuse, reinstall the toeboard panel and rotate the fasteners back to their original position.

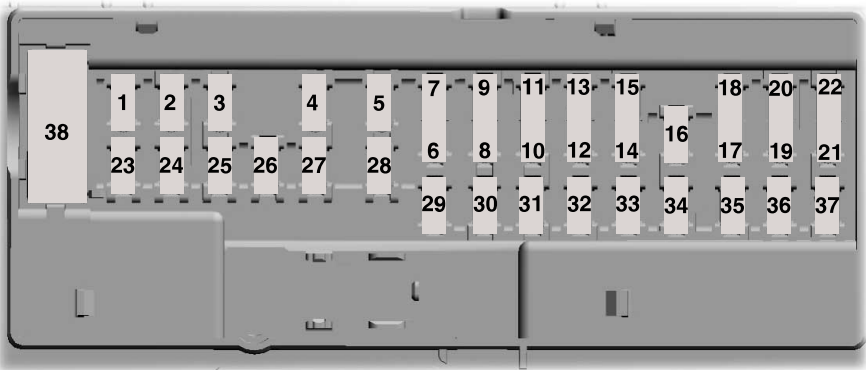

E145984

Fuse or Relay Number	Fuse Rating	Protected Components
1	—	Not used.
2	7.5A ¹	Not used (spare).
3	20A ¹	Driver unlock relay. Double lock relay.
4	5A ¹	Not used (spare).

Fuses

Fuse or Relay Number	Fuse Rating	Protected Components
5	20A ¹	Not used (spare).
6	10A ²	Not used (spare).
7	10A ²	Not used (spare).
8	10A ²	Not used (spare).
9	10A ²	Brake on/off (BOO) switch.
10	5A ²	Push button start switch.
11	5A ²	Right and left exterior door locks and handles.
12	7.5A ²	RF transceiver module (RTM).
13	7.5A ²	Steering column control module logic. Smart datalink connector logic. Instrument cluster.
14	10A ²	Extended power mode (EPM) module.
15	10A ²	Smart datalink connector (SDLC) power.
16	15A ¹	Decklid release relay.
17	5A ²	Combined sensor module.
18	5A ²	Telematics control unit (TCU)- Modem.
19	7.5A ²	Not used (spare).
20	7.5A ²	Front damper controllers.
21	5A ²	Shift indicator module (HUD). Interior temperature sensor.
22	5A ²	Extended power mode module.
23	10A ¹	Right window switch illumination. Right door lock switch illumination. Left door lock switch illumination.

Fuses

Fuse or Relay Number	Fuse Rating	Protected Components
		Power mirror/window switch (motor). Right smart window motor (logic). Left smart window motor (logic).
24	20A ¹	Central lock relay. Central unlock relay.
25	30A ¹	Left smart window motor.
26	30A ¹	Right smart window motor.
27	30A ¹	Not used (spare).
28	20A ¹	Electronic steering column lock (relay supply).
29	30A ¹	Not used (spare).
30	30A ¹	Not used (spare).
31	15A ¹	Not used (spare).
32	10A ¹	SYNC. Audio on/off switch. Gear shift module (GSM). HVAC ECU power.
33	20A ¹	Audio control module (ACM).
34	30A ¹	Run-start relay (R12).
35	5A ¹	Steering angle sensor (SSAM).
36	15A ¹	Auxiliary power point.
37	20A ¹	Battery junction box (BJB) F60, F62, F64, F66, F65.
38	—	Not used.

¹Micro 2 fuse.

²Micro 3 fuse.

Fuses

CHANGING A FUSE

Fuses

WARNING



Always replace a fuse with one that has the specified amperage rating. Using a fuse with a higher amperage rating can cause severe wire damage and could start a fire.



E217331

If electrical components in the vehicle are not working, a fuse may have blown. Blown fuses are identified by a broken wire within the fuse. Check the appropriate fuses before replacing any electrical components.

Fuse Types

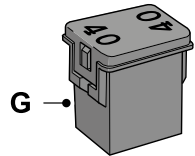
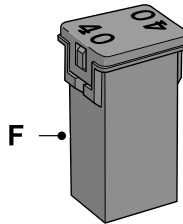
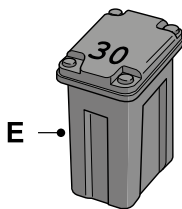
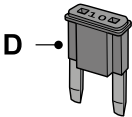
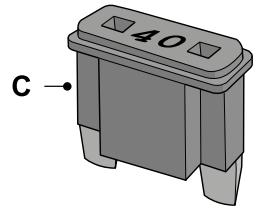
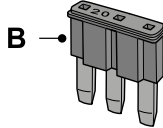
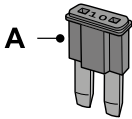

E207206

Callout	Fuse Type
A	Micro 2
B	Micro 3
C	Maxi
D	Mini

Fuses

Callout	Fuse Type
E	M Case
F	J Case
G	J Case Low Profile

Maintenance

GENERAL INFORMATION

Have your Ford GT serviced regularly to help maintain its roadworthiness and resale value. There is a network of Ford GT service dealers that are certified to help you with their professional servicing expertise. We believe that their specially trained technicians are best qualified to service your vehicle properly and expertly. They are supported by a range of highly specialized tools developed specifically for servicing the Ford GT.

If your vehicle requires professional service, an authorized dealer can provide the necessary parts and service. Check your warranty information to find out which parts and services are covered.

Use only recommended fuels, lubricants, fluids and service parts conforming to specifications. Motorcraft® parts are designed and built to provide the best performance in your vehicle.

Precautions

- Do not work on a hot engine.
- Make sure that nothing gets caught in moving parts.
- Do not work on a vehicle with the engine running in an enclosed space, unless you are sure you have enough ventilation.
- Keep all open flames and other burning material (such as cigarettes) away from the battery and all fuel related parts.

Working with the Engine Off

1. Set the parking brake and shift to park (P).
2. Switch off the engine.
3. Block the wheels.

Working with the Engine On

WARNING



To reduce the risk of vehicle damage and personal burn injuries, do not start your engine with the air cleaner removed and do not remove it while the engine is running.

1. Set the parking brake and shift to park (P).
2. Block the wheels.

OPENING AND CLOSING THE HOOD

Opening the Front Hood



E229939

Maintenance

1. Inside the vehicle, pull the hood release handle located on the left side panel left of the pedals.
2. Slightly lift the hood.

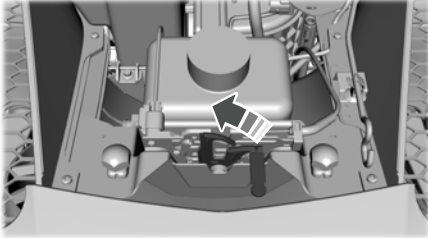

E233210

3. Release the hood latch by pulling up on the secondary release lever.

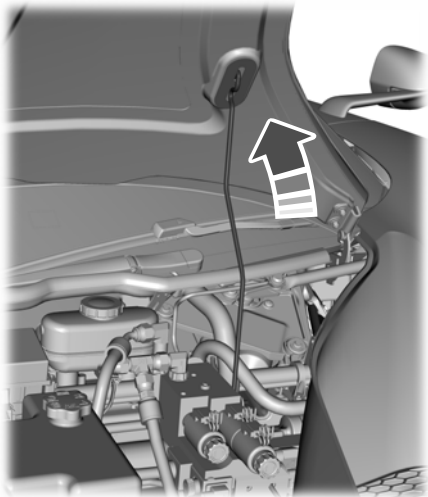

E233828

4. Open the hood and support it with the prop rod.

Closing the Front Hood

1. Remove the hood prop rod from the under hood slot and securely place it back in its holder.
2. Lower the hood and lightly press down until closed.

Note: If you do not close the front hood correctly, an indicator lamp displays in the instrument cluster. See **Warning Lamps and Indicators** (page 65).

Opening the Rear Hatch

Production Model

You can open the rear hatch by three different methods:

- A button on your remote control. See **Remote Control** (page 41).
- In the case of a dead battery or other electrical concerns, use the key blade in your remote control. See **Remote Control** (page 41).



A button on the lighting control switch.

After you release the rear hatch latch, lift the rear hatch into the open position.

A hydraulic cylinder holds the rear hatch open.

Competition Model

Use the following procedure to open the rear hatch on your competition model GT.

1. Unlock rear hatch using your key.

Maintenance

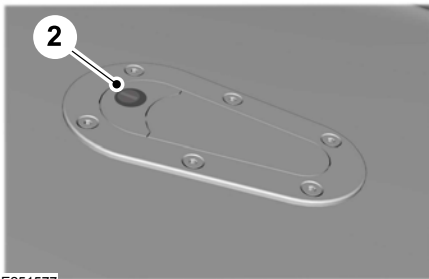

E251577

2. Push the button to release the handle.

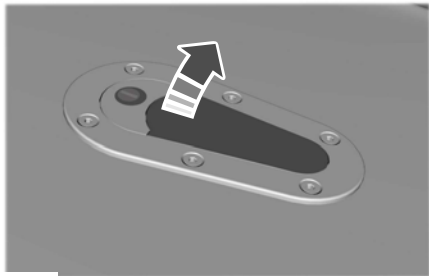

E251578

3. Pull the handle up until you feel a click.
4. Push down on the hatch until you feel a click.



E251630

5. Lift the hatch and remove the two-piece prop rod from the storage area.



E251629

6. Assemble the prop rod and use it to prop open rear hatch.

Closing the Rear Hatch

Production Model

1. Pull down the rear hatch.
2. Lightly press the hatch into position so the latch fully engages.

Competition Model

1. Lift hatch to remove prop rod.
2. Disassemble prop rod and place in storage area.
3. Lower rear hatch all the way down and press till it clicks.
4. Re-engage the latch fully and re-lock it.

Maintenance

UNDER HOOD OVERVIEW

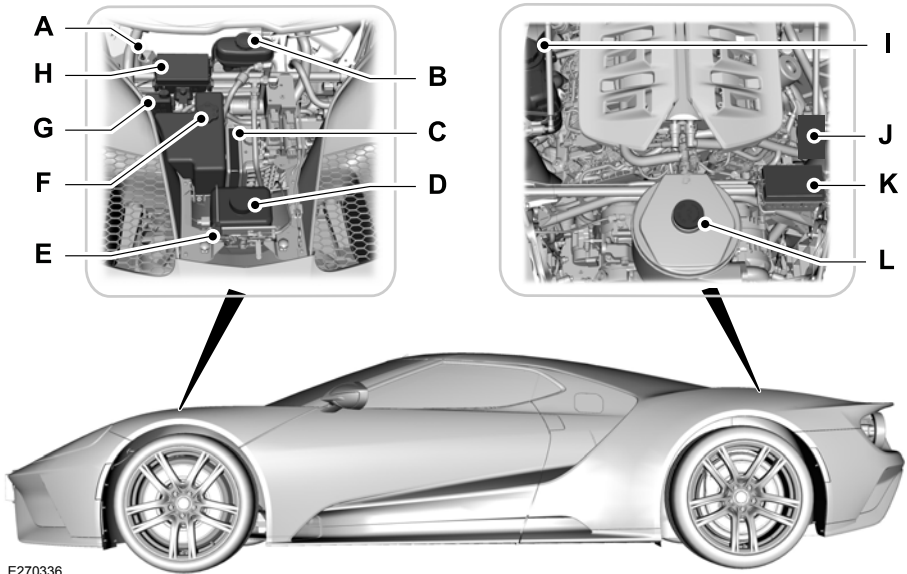

E270336

- A. Negative jump start post. See **Jump Starting the Vehicle** (page 137).
- B. Brake fluid reservoir. See **Brake Fluid Check** (page 166).
- C. Cabin air filter access door. See **Cabin Air Filter** (page 85).
- D. Washer fluid reservoir. See **Windshield Washers** (page 57).
- E. Front hood sensor. See **Warning Lamps and Indicators** (page 65).
- F. Hydraulic fluid reservoir for power steering, active aero and active suspension. See **Power Steering Fluid Check** (page 167).
- G. Positive jump start post. See **Jump Starting the Vehicle** (page 137).
- H. Front power distribution box. See **Fuse Specification Chart** (page 146).
- I. Engine coolant reservoir. See **Engine Coolant Check** (page 162).
- J. Rear power distribution box 2. See **Fuse Specification Chart** (page 146).
- K. Rear power distribution box 1. See **Fuse Specification Chart** (page 146).
- L. Oil cap, reservoir and dipstick. See **Engine Oil Dipstick** (page 161).

Maintenance

ENGINE OIL DIPSTICK

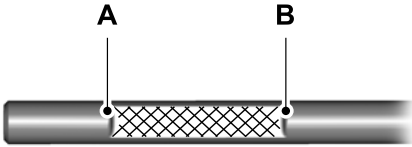

E230019

- A MIN
- B MAX

ENGINE OIL CHECK

Note: Use a thick cloth to protect your hand when removing the oil tank cap and dipstick.

To check the engine oil level consistently and accurately, do the following:

1. Make sure the parking brake is on. Make sure the transmission is in park (P) or neutral (N).
2. Run the engine until it reaches normal operating temperature (Coolant temperature of 190°F (87.7°C) or higher).
3. Turn the engine off and wait two to three minutes.
4. Make sure that your vehicle is on level ground.
5. Open the rear hatch. See **Opening and Closing the Hood** (page 157).
6. Unscrew the oil tank cap to remove the dipstick and wipe it with a clean, lint-free cloth. See **Under Hood Overview** (page 160).

7. Replace the cap and dipstick and remove it again to check the oil level. See **Engine Oil Dipstick** (page 161).
8. Make sure that the oil level is between the minimum and the maximum marks. If the oil level is at the minimum mark, add oil immediately. See **Capacities and Specifications** (page 204).
9. If the oil level is correct, replace the cap and dipstick and make sure it is fully tightened.

Note: Do not remove the dipstick when the engine is running.

Note: If the oil level is between the maximum and minimum marks, the oil level is acceptable. Do not add oil.

Note: The oil consumption of new engines reaches its normal level after approximately 3,000 mi (5,000 km).

Note: High performance vehicles tend to be driven in such a way the engine experiences high speed and high load. As a result, some oil consumption could occur between oil changes. We recommend that you check the oil level on a regular basis.

Adding Engine Oil

WARNINGS



Do not remove the filler cap when the engine is running.



Do not add engine oil when the engine is hot. Hot engine oil can burn you badly.

Note: Use a thick cloth to protect your hand when removing the oil tank cap and dipstick.

Do not use supplemental engine oil additives because they are unnecessary and could lead to engine damage that may not be covered by the vehicle Warranty.

To top up the engine oil level do the following:

Maintenance

1. Unscrew the oil tank cap.
2. Add engine oil by pouring oil that meets Ford specifications into the oil tank. See **Capacities and Specifications** (page 204). You may have to use a funnel to pour the engine oil into the opening.
3. Recheck the oil level.
4. If the oil level is correct, replace the cap and the dipstick and make sure it is fully tightened.





Note: Do not add oil further than the maximum mark. Oil levels above the maximum mark may cause engine damage.

Note: Make sure you install the oil tank cap and dipstick correctly.

Note: Soak up any spillage with an absorbent cloth immediately.

ENGINE COOLANT CHECK

WARNINGS

-  Never remove the coolant reservoir cap when the engine is running or hot.
-  Do not put coolant in the windshield washer reservoir. If sprayed on the windshield, coolant could make it difficult to see through the windshield.
-  To reduce the risk of personal injury, make sure the engine is cool before unscrewing the coolant pressure relief cap. The cooling system is under pressure. Steam and hot liquid can come out forcefully when you loosen the cap slightly.
-  Do not add coolant further than the **MAX** mark.

Check the concentration and level of the coolant only when the engine is cold at the intervals listed in the scheduled maintenance information. See **Scheduled Maintenance** (page 274).

Note: Make sure that the coolant level is between the **MIN** and **MAX** marks on the coolant reservoir when the engine is cold.

Note: Coolant expands when it is hot. The level may extend beyond the **MAX** mark.

The coolant reservoir is behind an access panel on the left side of the of the engine compartment. The cold MIN / MAX are located on the front inboard corner of the coolant reservoir. MAX is located just below where the black top meets the translucent reservoir lower. MIN is located 3/4 inch (20 mm) below the black top.



E244128

Maintain coolant concentration within 48% to 50%, which equates to a freeze point between -30°F (-34°C) and -34°F (-37°C). Coolant concentration should be checked using a refractometer. We do not recommend the use of hydrometers or coolant test strips for measuring coolant concentration.

Adding Coolant

WARNING

-  Never remove the coolant reservoir cap when the engine is running or hot.

Maintenance

Note: *Automotive fluids are not interchangeable. Do not use coolant or windshield washer fluid outside of its specified function and vehicle location.*

Note: *Do not use stop leak pellets, cooling system sealants or additives as they can cause damage to the engine cooling or heating systems. Resulting component damage may not be covered by the vehicle Warranty.*

It is very important to use prediluted coolant meeting the correct specification in order to avoid plugging the small passageways in the engine cooling system. See **Capacities and Specifications** (page 204). Do not mix different colors or types of coolant in your vehicle. Mixing of engine coolants or using an incorrect coolant may harm the engine or cooling system components and may not be covered by the vehicle Warranty.

Note: *Coolants marketed for all makes and models may not meet Ford specifications and may cause damage to the cooling system. Resulting component damage may not be covered by the vehicle Warranty.*

If the coolant level is at or below the minimum mark, add prediluted coolant immediately. Only check the coolant level or add coolant when the system is cold.

To top up the coolant level do the following:

1. Unscrew the cap slowly. Any pressure escapes as you unscrew the cap.
2. Add prediluted coolant meeting the correct specification. See **Capacities and Specifications** (page 204).
3. Add enough prediluted coolant to reach the correct level.
4. Replace the coolant reservoir cap, turn it clockwise until you feel a strong resistance.

5. Check the coolant level in the coolant reservoir the next few times you drive your vehicle. If necessary, add enough prediluted engine coolant to bring the coolant level to the correct level.

If you have to add more than 1.1 qt (1 L) of engine coolant per month, have your vehicle checked as soon as possible. Operating an engine with a low level of coolant can result in engine overheating and possible engine damage.

Note: *During normal vehicle operation, the coolant may change color from orange to pink or light red. As long as the coolant is clear and uncontaminated, this color change does not indicate the coolant has degraded nor does it require the coolant to be drained, the system to be flushed, or the coolant to be replaced.*

Note: *In case of emergency, you can add a large amount of water without coolant in order to reach a vehicle service location. Water alone, without coolant, can cause engine damage from corrosion, overheating or freezing.*

Do not use the following as a coolant substitute:

- Alcohol.
- Methanol.
- Brine.
- Any coolant mixed with alcohol or methanol antifreeze.

Alcohol and other liquids can cause engine damage from overheating or freezing.

Do not add extra inhibitors or additives to the coolant. These can be harmful and compromise the corrosion protection of the coolant.

Recycled Coolant

We do not recommend the use of recycled coolant as an approved recycling process is not yet available.

Maintenance

Dispose of used engine coolant in an appropriate manner. Follow your community's regulations and standards for recycling and disposing of automotive fluids.

Severe Climates

If you drive in extremely cold climates:

- It may be necessary to increase the coolant concentration above 50%.
- A coolant concentration of 60% provides improved freeze point protection. Coolant concentrations above 60% decrease the overheat protection characteristics of the coolant and may cause engine damage.

If you drive in extremely hot climates:

- It may be necessary to decrease the coolant concentration to 40%.
- A coolant concentration of 40% provides improved overheat protection. Coolant concentrations below 40% decrease the freeze and corrosion protection characteristics of the coolant and may cause engine damage.

Vehicles driven year-round in non-extreme climates should use prediluted coolant for optimum cooling system and engine protection.

Coolant Change

At specific mileage intervals, as listed in the scheduled maintenance information, the coolant should be changed. Add prediluted coolant meeting the correct specification. See **Capacities and Specifications** (page 204).

Fail-Safe Cooling

Fail-safe cooling allows you to temporarily drive your vehicle before any incremental component damage occurs. The fail-safe distance depends on ambient temperature, vehicle load and terrain.

How Fail-Safe Cooling Works

If the engine begins to overheat, the coolant temperature gauge moves toward the red zone:



A warning lamp illuminates and a message may appear in the information display.



If the engine reaches a preset over-temperature condition, the engine automatically switches to alternating cylinder operation. Each disabled cylinder acts as an air pump and cools the engine.

When this occurs, your vehicle still operates, however:

- Engine power is limited.
- The air conditioning system turns off.

Continued operation increases the engine temperature, causing the engine to completely shut down. Your steering and braking effort increases in this situation.

When the engine temperature cools, you can re-start the engine. Have your vehicle checked as soon as possible to minimize engine damage.

When Fail-Safe Mode Is Activated

WARNINGS



Fail-safe mode is for use during emergencies only. Operate your vehicle in fail-safe mode only as long as necessary to bring your vehicle to rest in a safe location and seek immediate repairs. When in fail-safe mode, your

Maintenance

WARNINGS

vehicle will have limited power, will not be able to maintain high-speed operation, and may completely shut down without warning, potentially losing engine power, power steering assist, and power brake assist, which may increase the possibility of a crash resulting in serious injury.



Never remove the coolant reservoir cap when the engine is running or hot.

Your vehicle has limited engine power when in the fail-safe mode, drive your vehicle with caution. Your vehicle does not maintain high-speed operation and the engine may operate poorly.

Remember that the engine is capable of automatically shutting down to prevent engine damage. In this situation:

1. Pull off the road as soon as safely possible and switch the engine off.
2. Contact the Ford GT Concierge to obtain assistance. See **About This Manual** (page 5).
3. If this is not possible, wait a short period for the engine to cool.
4. Check the coolant level. If the coolant level is at or below the minimum mark, add prediluted coolant immediately.
5. When the engine temperature cools, you can re-start the engine. Have your vehicle checked as soon as possible to minimize engine damage.

Note: *Driving your vehicle without repair increases the chance of engine damage.*

Engine Coolant Temperature Management

WARNING



To reduce the risk of crash and injury, be prepared that the vehicle speed may reduce and the vehicle may not be able to accelerate with full power until the coolant temperature reduces.

At this time, you may notice the coolant temperature gauge moves toward the red zone and a message may appear in the information display.

You may notice a reduction in vehicle speed caused by reduced engine power in order to manage the engine coolant temperature. Your vehicle may enter this mode if certain high-temperature and high-load conditions take place. The amount of speed reduction depends on vehicle loading, grade and ambient temperature. If this occurs, there is no need to pull off the road. You can continue to drive your vehicle.

The air conditioning may automatically turn on and off during severe operating conditions to protect the engine from overheating. When the coolant temperature decreases to the normal operating temperature, the air conditioning turns on.

If the coolant temperature gauge moves fully into the red zone, or if the coolant temperature warning or service engine soon messages appear in your information display, do the following:

1. Pull off the road as soon as safely possible and shift the transmission into park (**P**).

Maintenance

2. Leave the engine running until the coolant temperature gauge needle returns to the normal position. After several minutes, if the temperature does not drop, follow the remaining steps.
3. Switch the engine off and wait for it to cool. Check the coolant level.
4. If the coolant level is at or below the minimum mark, add prediluted coolant immediately.
5. If the coolant level is normal, restart the engine and continue.

AUTOMATIC TRANSMISSION FLUID CHECK

If required, have an authorized dealer check and change the transmission fluid at the correct service interval. See **Scheduled Maintenance** (page 274).





The automatic transmission does not have a transmission fluid dipstick.

Refer to your scheduled maintenance information for scheduled intervals for fluid checks and changes. Your transmission does not consume fluid. However, if the transmission slips, shifts slowly or if you notice a sign of leaking fluid, contact an authorized dealer.

Do not use supplemental transmission fluid additives, treatments or cleaning agents. The use of these materials may affect transmission operation and result in damage to internal transmission components.

BRAKE FLUID CHECK

WARNINGS

-  Do not use any fluid other than the recommended brake fluid as this will reduce brake efficiency. Use of incorrect fluid could result in the loss of vehicle control, serious personal injury or death.
-  Only use brake fluid from a sealed container. Contamination with dirt, water, petroleum products or other materials may result in brake system damage or failure. Failure to adhere to this warning could result in the loss of vehicle control, serious personal injury or death.
-  Do not allow the fluid to touch your skin or eyes. If this happens, rinse the affected areas immediately with plenty of water and contact your physician.
-  A fluid level between the **MAX** and **MIN** lines is within the normal operating range and there is no need to add fluid. A fluid level not in the normal operating range could compromise the performance of the system. Have your vehicle checked immediately.



E244129

Maintenance

To avoid fluid contamination, the reservoir cap must remain in place and fully tight, unless you are adding fluid.

Only use fluid that meets Ford specifications. See **Capacities and Specifications** (page 204).

POWER STEERING FLUID CHECK

The hydraulic fluid reservoir is under the hood. The fluid is used for power steering, active aerodynamics and the active hydraulic suspension. Keep the fluid level between MIN and MAX marks as shown on the reservoir.

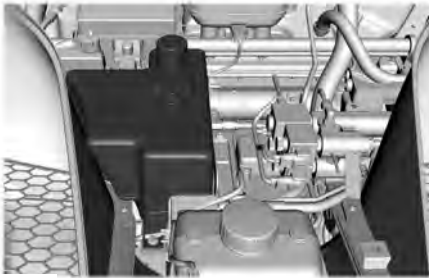

E248557

Note: *This procedure must be followed to prevent over filling of the reservoir.*

1. Start the engine and make sure that the steering wheel is at the straight ahead position. Do not move the steering wheel after this time.
2. Allow the engine to idle in Park for 2 minutes then shut the engine off.
3. After the engine has been off for 5 minutes, check the hydraulic fluid level in the reservoir.
4. The MIN / MAX marks are on the front face of the reservoir. If the level is above the MIN line on the reservoir DO NOT add fluid.
5. If the level is below the MIN line, add only enough fluid to bring the level to a point between the MIN and MAX lines.
6. DO NOT add fluid past the MAX line.

WASHER FLUID CHECK

WARNING



If you operate your vehicle in temperatures below 40°F (5°C), use washer fluid with antifreeze protection. Failure to use washer fluid with antifreeze protection in cold weather could result in impaired windshield vision and increase the risk of injury or accident.

Add fluid to fill the reservoir if the level is low. Only use a washer fluid that meets Ford specifications. See **Capacities and Specifications** (page 204).

State or local regulations on volatile organic compounds may restrict the use of methanol, a common windshield washer antifreeze additive. Washer fluids containing non-methanol antifreeze agents should be used only if they provide cold weather protection without damaging the vehicle's paint finish, wiper blades or washer system.

FUEL FILTER

Your vehicle is equipped with a lifetime fuel filter that is integrated with the fuel tank. Regular maintenance or replacement is not needed.

Maintenance

CHANGING THE 12V BATTERY

WARNING



Battery posts, terminals and related accessories contain lead and lead compounds. Wash hands after handling.

The Ford GT uses a lithium Ion battery.

The battery is located inside the right front fender. For battery maintenance or replacement, contact an authorized dealer.

When a battery replacement is required, you must use a recommended replacement battery that matches the electrical requirements of the vehicle.

Note: *If you add electrical accessories or components to the vehicle, it may adversely affect the low voltage battery performance and durability. This may also affect the performance of other electrical systems in the vehicle.*

Because your vehicle's engine is electronically controlled by a computer, some control conditions are maintained by power from the battery. When the battery is disconnected or a new battery is installed, the engine must relearn its idle and fuel trim strategy for optimum driveability and performance.

To restore the settings, do the following:

1. Apply the parking brake.
2. Shift into park (P) or neutral (N).
3. Switch off all accessories.
4. Press the brake pedal and start your vehicle.

5. Run the engine until it reaches normal operating temperature. While the engine is warming up, complete the following: Reset the clock. See **Audio System** (page 212). Reset the radio station presets. See **Audio System** (page 212).
6. Allow the engine to idle for at least one minute.
7. Drive the vehicle at least 10 mi (16 km) to completely relearn the idle trim and fuel trim strategy.

Note: *If you do not allow the engine to relearn the idle and fuel trim strategy, the idle quality of your vehicle may be adversely affected until the engine computer eventually relearns the idle trim and fuel trim strategy.*

Make sure that you dispose of old batteries in an environmentally friendly way. Seek advice from your local authority about recycling old batteries.

Battery Charger and Maintainer

If you plan to have your GT parked for more than two weeks without driving it, connect the battery charger and maintainer provided. This charger connects simply to the jump start (+) and (-) posts as shown in the illustration below.

Maintenance

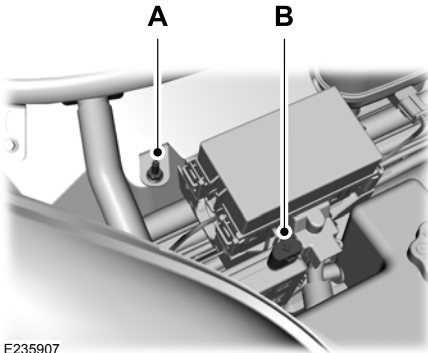

E235907

1. Connect the positive (+) red cable to the positive (B) post.
2. Connect the negative (-) black cable to the negative (A) post.

The battery charger and maintainer charges the battery to a full charge and then monitor the charge as the car sits. If the battery charge level drops, the maintainer turns on to keep the battery fully charged. You can keep the car stored with the charger and maintainer attached. For further information on the charger, see the instructions provided with the charger.

Note: *If the battery state of charge has dropped below 10.5 volts, the battery will have gone into its under voltage protection mode. If this has occurred, connect the charger and press the reset button on the charger for 10 seconds. this will wake up the battery to allow it to receive a charge.*

Note: *The GT battery charger and maintainer is designed for the Lithium battery used on Ford GT. Use only this device. A charger designed for a lead acid battery may damage the lithium battery in your GT.*

Battery Management System (if Equipped)

The battery management system monitors battery conditions and takes actions to extend battery life. If excessive battery drain is detected, the system temporarily disables the electrical systems to protect the battery.

Use the charger to bring the battery back to full charge.

Electrical Accessory Installation

Note: *If you add electrical accessories or components to the vehicle, it may adversely affect battery performance and durability. This may also affect the performance of other electrical systems in the vehicle.*

CHECKING THE WIPER BLADES



E142463

Run the tip of your fingers over the edge of the blade to check for roughness.

Clean the wiper blades with washer fluid or water applied with a soft sponge or cloth.

CHANGING THE WIPER BLADES

Replacement blades are available at your Ford dealer.

Maintenance

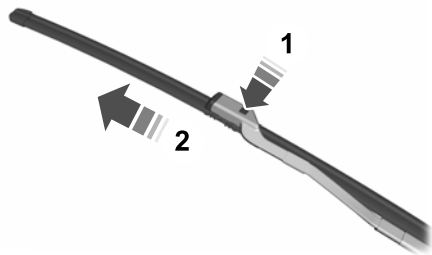

E233208

Note: To avoid damaging the windshield, lift the wiper blade a few inches off the glass and place a cloth on the windshield under the blade.

Note: Manually move the wiper blades to the midway position.

Note: The windshield wiper blades are different in length. The longer blade is on the driver's side.

1. Disconnect the washer pipe from the wiper arm.
2. Press the release button on the top of the wiper arm where the blade assembly attaches to the arm.
3. Pull the blade assembly away from the arm, while rocking it from side to side to help release it.
4. Keep the cloth in place to avoid the arm from hitting the windshield glass.
5. Install the new blade assembly and reconnect the washer pipe.
6. When complete, switch on the wipers and they will cycle back to the park position when you switch them off.

Replace wiper blades at least once per year for optimum performance.

ADJUSTING THE HEADLAMPS

Headlamp Aim Target

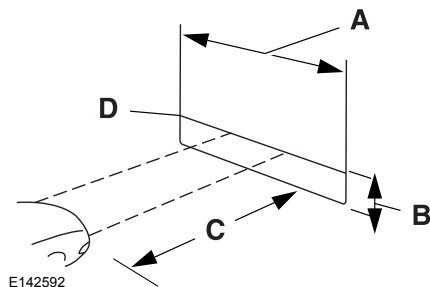

E142592

- A 8 ft (2.4 m).
- B Center height of lamp to ground.
- C 25 ft (7.6 m).
- D Horizontal reference line.

Vertical Aim Adjustment

1. Park your vehicle on a level surface approximately 25 ft (7.6 m) away from a vertical wall or screen.
2. Apply the parking brake.
3. Measure the height from the center of the headlamp to the ground.

Note: There may be an identifying mark on the lens to help you locate the center of the headlamp bulb.

4. Mark a horizontal reference line on the vertical wall or screen that is a minimum of 8 ft (2.4 m) long.
5. Switch the low beam headlamps on.

Maintenance

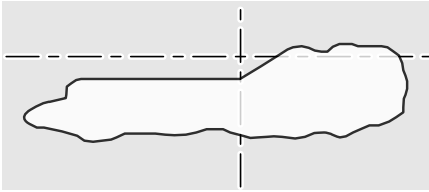

E209825

6. There is a distinct change from light to dark in the left-hand portion of the headlamp beam pattern. Position the top edge of this cut-off 2 in (5 cm) below the horizontal reference line.

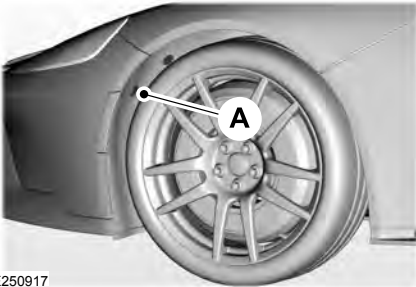

E250917

7. Locate and remove the plug in the front of the wheel liner. Place wheels in the straight ahead position. Use a 1/2 inch socket wrench to adjust vertical alignment (A).

Note: To see a clearer light pattern while adjusting one headlamp, block the light from the other headlamp.

8. Switch the low beam headlamps off.

CHANGING A BULB

LED Lamps

All exterior and interior lamps on the GT are LED.

These lamps operate at a high voltage. Contact an authorized dealer if they fail.

CHANGING THE ENGINE AIR FILTER

Please see an authorized dealer.

Vehicle Care

GENERAL INFORMATION

Your authorized dealer has many quality products available to clean your vehicle and protect its finishes.

CLEANING PRODUCTS

Materials

For best results, use the following products or products of equivalent quality:

Name	Specification
Motorcraft® Bug and Tar Remover, ZC-42 (U.S. & Canada)	
Motorcraft® Custom Bright Metal Cleaner, ZC-15 (U.S. & Canada)	ESR-M5B194-B
Motorcraft® Detail Wash, ZC-3-A (U.S. & Canada)	ESR-M14P4-A
Motorcraft® Engine Shampoo and Degreaser, ZC-20 (U.S.)	ESR-M14P3-A
Motorcraft® Engine Shampoo, CXC-66-A (Canada)	
Motorcraft® Premium Leather and Vinyl Cleaner, ZC-56 (U.S. & Canada)	WSS-M99P43-B
Motorcraft® Multi-Purpose Cleaner, CXC-101 (Canada)	
Motorcraft® Premium Windshield Wash Concentrate with Bitterant, ZC-32-B2 (U.S.)	WSS-M14P19-A
Motorcraft® Premium Quality Windshield Washer Fluid, CXC-37-A/B/D/F (Canada)	WSS-M14P19-A
Motorcraft® Professional Strength Carpet & Upholstery Cleaner, ZC-54 (U.S. & Canada)	
Motorcraft® Premium Glass Cleaner, CXC-100 (Canada)	ESR-M14P5-A
Motorcraft® Spot and Stain Remover, ZC-14 (U.S.)	
Motorcraft® Ultra-Clear Spray Glass Cleaner, ZC-23 (U.S.)	ESR-M14P5-A
Motorcraft® Wheel and Tire Cleaner, ZC-37-A (U.S. & Canada)	

CLEANING THE EXTERIOR

Note: Never drive your vehicle through an automated, commercial car wash due to the vehicle's low ground clearance. Always wash your vehicle by hand. Never use a power washer or high pressure wand to clean your vehicle.

Note: Suntan lotions and insect repellents can damage painted surfaces. If these substances come in contact with your vehicle, wash the affected area as soon as possible.

Note: Use a separate wash mitt and soap bucket to clean the wheels to prevent brake dust from scratching the paint finish.

Vehicle Care

Note: Do not spray cleaning products on the brake discs. Any resulting damage is not covered by your vehicle warranty.

Note: Always follow the instructions included in this manual when cleaning your vehicle and do not use abrasive cleaning products.

Standard Paint Finish

If your vehicle has a matte paint finish, see **Matte Paint Finish** in this chapter.

Wash your vehicle regularly with cool or lukewarm water and a neutral pH shampoo, we recommend Motorcraft®™ Detail Wash.

- Never use strong household detergents or soap, for example dish washing or laundry liquid. These products can discolor and spot painted surfaces.
- Never wash your vehicle when it is hot to the touch, or during strong or direct sunlight.
- Dry your vehicle with a chamois or soft terry cloth towel to eliminate water spotting.
- Immediately remove fuel spillages, bird droppings, insect deposits and road tar. These may cause damage to your vehicle's paintwork or trim over time. We recommend Motorcraft® Bug and Tar Remover.

Matte Paint Finish (if Equipped)

Prepare the following before washing your vehicle:

- Use a no shine, matte car wash soap that does not contain fillers or silicone.
- Use high quality, soft lamb's wool mitts and wash each mitt thoroughly after each car wash.

- Wash your vehicle's painted surfaces in the shade with two buckets of water, one for soap and the other for clean water.
- Add a plastic grit guard to the bottom of the soap bucket so that dirt settles at the bottom of the bucket and does not contaminate the wash mitt.

To wash your vehicle:

1. Rinse your vehicle to remove as much dirt and debris as possible.
2. Wet the wash mitt in the soap bucket and apply the soapy water to your vehicle in a gentle back-and-forth motion.

Note: Do not rub the wash mitt in circles or rub the paint surface aggressively. Rubbing too hard in circles leaves permanent swirl marks in the paint finish.

3. Rinse the wash mitt in clean water before inserting the mitt back into the soap bucket to prevent dirt from contaminating the soapy water.
4. Rinse the vehicle with clean water and dry it with a clean, damp cloth.

Note: Do not use automotive waxes, detail sprays or abrasive polishes or glazes on your vehicle. Improper use of cleaning products can cause damage to your vehicle not covered by your vehicle warranty.

Immediately remove fuel spillages, bird droppings, insect deposits and road tar. Use a wet microfiber towel and an alcohol-based window cleaner, a matte paint finish cleaner or a 50/50 mix of alcohol and deionized water.

Note: Always soak a microfiber towel or wash mitt with water before cleaning. Using a dry towel or mitt on a matte paint finish creates a permanent glossy spot in the paint finish.

Vehicle Care

Raising the Rear Wing

For routine cleaning, raise the wing.

Using the information display select the following:

1. Rear wing deployment.
2. Select Raised.

After you have cleaned your vehicle, to return the wing to the lowered position you must drive the car at 15 mph (25 km/h) or above. The wing will return to the lowered position.

Note: *You cannot lower the wing when your vehicle is stationary.*

Exterior Plastic Parts

For routine cleaning we recommend Motorcraft® Detail Wash. If tar or grease spots are present, we recommend Motorcraft® Bug and Tar Remover.

Under Hood

For removing black rubber marks from under the hood we recommend Motorcraft® Wheel and Tire Cleaner or Motorcraft® Bug and Tar Remover.

WAXING

Note: *If your vehicle has a matte paint finish, do not wax your vehicle.*

Regular waxing is necessary to protect your car's paint from the elements. We recommend that you wash and wax the painted surface once or twice a year.

When washing and waxing, park your vehicle in a shaded area out of direct sunlight. Always wash your vehicle before applying wax.

- Use a quality wax that does not contain abrasives.
- Follow the manufacturer's instructions to apply and remove the wax.

- Apply a small amount of wax in a back-and-forth motion, not in circles.
- Do not allow wax to come in contact with any non-body (low-gloss black) colored trim. The wax will discolor or stain the parts over time.
- Do not apply wax to glass areas.
- After waxing, your car's paint should feel smooth, and be free of streaks and smudges.

CLEANING THE ENGINE

Engines are more efficient when they are clean because grease and dirt buildup keep the engine warmer than normal.

When washing:

- Do not spray a hot engine with cold water to avoid cracking the engine block or other engine components.
- Spray Motorcraft® Engine Shampoo and Degreaser on all parts that require cleaning and pressure rinse clean. In Canada, use Motorcraft Engine Shampoo.
- Never wash or rinse the engine while it is hot or running; water in the running engine may cause internal damage.
- Never wash or rinse any ignition coil, spark plug wire or spark plug well, or the area in and around these locations.
- Never spray water on electrical components such as modules, connectors and fuse boxes. Cover all electrical components before cleaning to prevent water damage.

Vehicle Care

CLEANING THE WINDOWS AND WIPER BLADES

Dirty windshield and wipers will result in poor windshield wiper operation. Keep the windshield and wiper blades clean to maintain windshield wiper performance.

To clean exterior glass surfaces and wiper blades:

- Clean the exterior surface of the windshield with a non-abrasive glass cleaner.
- For windshields contaminated with tree sap, chemicals, wax or bugs, clean the outside surface of the windshield with Motorcraft Bug and Tar Remover.
- Clean the wiper blades with isopropyl rubbing alcohol or windshield washer concentrate.

The interior glass surface of the windshield and engine cover glass, and both the inner and outer surface of the bulkhead glass, have a laminate coating that requires special care.

To clean interior glass surfaces:

- When cleaning the inside of the windshield, avoid getting any glass cleaner on the instrument panel or door panels. Wipe any excess cleaner off these surfaces immediately.
- Use a microfiber towel and plain water, or a mixture of one-half water and one-half white vinegar, to clean the interior glass surfaces.

Note: *Never use alcohol or ammonia based cleaners, aerosol sprays or abrasive compounds to clean the interior glass surfaces of your vehicle. Using improper cleaning products can cause damage to your vehicle.*

CLEANING THE INTERIOR

WARNING



Do not use cleaning solvents, bleach or dye on the vehicle's seatbelts, as these actions may weaken the belt webbing.

Clean safety belts with water applied with a soft sponge. Let them dry naturally, away from artificial heat.

Wipe carbon fiber surfaces with a clean, damp and soft cloth to remove dust. Then use a clean, dry and soft cloth to dry these areas.

Cleaning Alcantara Microfiber Cloth

Note: *Some models have Alcantara microfiber cloth fabric on the seats, headliner, instrument panel and door panels.*

Use a soft brush, a clean, dry cloth or vacuum cleaner to remove dust and loose dirt from Alcantara cloth surfaces. Gently wipe the cloth surfaces with a clean, damp cotton cloth.

Note: *Alcantara microfiber cloth fabric are made of polyester microfiber with micro-porous polyurethane. Using commercially available fabric cleaners can cause permanent damage.*

Note: *Do not use commercially available leather and vinyl cleaning products on Alcantara cloth fabric.*

Depending on the type of stain, use water, lemon juice or pure ethyl alcohol when cleaning. For cleaning Alcantara microfiber cloth, refer to the following chart:

Vehicle Care

Type of Stain	Cleaning Procedure
Fruit juice, jam, jelly, syrup or ketchup.	Use lukewarm water and rinse by dabbing with clean water.
Blood, egg, excrement or urine.	Use cold water and rinse by dabbing with clean water. Avoid warm water because it makes these substances coagulate.
Liquor, alcoholic beverages, wine, beer, cola and tea.	Use lukewarm water. If the color remains, treat with lemon juice and then rinse.
Indelible pencil, cocoa, chocolate, pastry with cream or chocolate, ice cream or mustard.	Use lukewarm water and rinse by dabbing with clean water.
Vinegar, hair gel, tomato sauce or coffee with sugar.	Use lemon juice, wipe with lukewarm water and rinse by dabbing with clean water.
Dye transfer and all other stains.	Use ethyl alcohol, then dab with water.

CLEANING THE INSTRUMENT PANEL AND INSTRUMENT CLUSTER LENS

WARNING



Do not use chemical solvents or strong detergents when cleaning the steering wheel or instrument panel to avoid contamination of the airbag system.

Note: Follow the same procedure as cleaning leather seats for cleaning leather interior trim surfaces. See **Cleaning Leather Seats** (page 176).

Note: If your vehicle has Alcantara or Miko microfiber cloth trim, follow the cleaning instructions in this chapter. See **Cleaning the Interior** (page 175).

Clean the carbon fiber portions of the instrument panel and cluster lens with a clean, damp and soft cloth, then use a clean, dry and soft cloth to dry these areas.

- Do not use any household cleaning products or glass cleaners as these may damage the finish of the instrument panel, interior trim and cluster lens.
- Wash or wipe your hands clean if you have been in contact with certain products such as insect repellent and suntan lotion to avoid possible damage to the interior painted surfaces.
- Do not allow air fresheners and hand sanitizers to spill onto interior surfaces. If a spill occurs, wipe off immediately. Your warranty may not cover these damages.

CLEANING LEATHER SEATS (if Equipped)

If your vehicle has Alcantara or Miko microfiber cloth trim, follow the cleaning instructions in this chapter. See **Cleaning the Interior** (page 175).

Vehicle Care

Note: Follow the same procedure as cleaning leather seats for cleaning leather interior trim surfaces.

For routine cleaning, wipe the surface with a soft, damp cloth and a mild soap and water solution. Dry the area with a clean, soft cloth.

For cleaning and removing stains such as dye transfer, use Motorcraft™ Premium Leather and Vinyl Cleaner or a commercially available leather cleaning product for automotive interiors.

Note: Test any cleaner or stain remover on an inconspicuous area.

You should:

- Remove dust and loose dirt with a vacuum cleaner.
- Clean and treat spills and stains as soon as possible.

Do not use the following products as these may damage the leather:

- Oil and petroleum or silicone-based leather conditioners.
- Household cleaners.
- Alcohol solutions.
- Solvents or cleaners intended specifically for rubber, vinyl and plastics.

REPAIRING MINOR PAINT DAMAGE

See your authorized dealer to obtain touch-up paint for the exterior color of your vehicle. The color code is included on the Safety Compliance Certification label on the driver's door-latch post. Follow the instructions on the paint bottle.

CLEANING THE WHEELS

This information applies to alloy and carbon fiber wheels.

Note: Do not apply a cleaning chemical to warm or hot wheels.

Note: Do not drive your vehicle through an automated, commercial car wash. Automated car washes can damage your vehicle.

Note: Do not use industrial-strength or heavy-duty cleaners in combination with brush agitation to remove brake dust and dirt.

Note: Do not use hydrofluoric acid-based or high caustic-based wheel cleaners, steel wool, fuels or strong household detergents.

Note: Do not spray wheel cleaning products on any part of the braking system. Use a mild soap and water solution only.

Alloy and carbon fiber wheels are coated with a paint finish. To maintain their condition we recommend that you:

- Clean the wheels weekly using Motorcraft Wheel and Tire Cleaner or a gentle soap solution. Apply to the wheel only using manufacturer's instructions.
- Use a soft sponge to remove deposits of dirt and brake dust accumulation.
- Rinse thoroughly with a strong stream of water when you have completed the cleaning process.
- To remove tar and grease, use Motorcraft Bug and Tar Remover.

Vehicle Care

VEHICLE STORAGE

At Ford, we fully understand that many Ford Performance vehicles will see only occasional operation and that many of the vehicles, especially in northern climates, may be stored for an extended period during the winter months. If you plan on storing your vehicle for 30 days or more, read the following maintenance recommendations to make sure your vehicle stays in good operating condition.

We engineer and test all motor vehicles and their components for reliable, regular driving. Under various conditions, long-term storage may lead to degraded engine performance or failure unless you use specific precautions to preserve engine components.

General

Note: *Do not park your vehicle in facilities that use parking platforms or elevators that lift your vehicle. The vehicle Warranty may not cover damage caused to your vehicle as a result of using this type of equipment.*

- Store all vehicles inside a garage or building in a dry, ventilated place.
- Protect from sunlight, if possible. Use a soft, breathable vehicle cover.

Body

- Wash your vehicle thoroughly to remove dirt, grease, oil, tar or mud from exterior surfaces, rear-wheel housing and the underside of front fenders.
- Lubricate all hood, door and luggage compartment hinges and latches with a light grade oil.
- Cover interior trim to prevent fading.
- Keep all rubber parts free from oil and solvents.

Engine

- Change the engine oil and filter prior to storage because used engine oil contains contaminants which may cause engine damage.
- Start the engine every 15 days for a minimum of 15 minutes. Run at fast idle with the climate controls set to defrost until the engine reaches normal operating temperature.
- With your foot on the brake, shift through all the gears while the engine is running.
- If your vehicle is stored for more than a few months, we recommend that you change the engine oil before you use your vehicle again.

Fuel system

- Fill the fuel tank with high-quality fuel until the first automatic shutoff of the fuel pump nozzle and add commercially available fuel stabilizer. Run the engine for a minimum of one minute to ensure that treated fuel has circulated through the system.

Cooling system

- Protect against freezing temperatures.
- When removing your vehicle from storage, check coolant fluid level. Confirm that there are no cooling system leaks and that fluid is at the recommended level.

Battery

- Connect your vehicle to the battery charger/maintainer provided with your vehicle whenever you store your vehicle for more than 2 weeks.
- Connect the wires as shown in the illustration. See **Changing the 12V Battery** (page 168).

Vehicle Care

Brakes

- Make sure the brakes and parking brake release fully.

Tires

- To minimize flat spots on the tires, inflate all four tires to the recommended cold pressures listed on the Safety Compliance Certification label or Tire Label. When the vehicle is taken out of storage, reset the tire pressures as necessary to the recommended levels listed on the Safety Compliance Certification label or Tire Label affixed to your vehicle.

Note: *If you store your vehicle in a location with low ambient temperatures, follow the instructions for care of summer tires. See **Using Summer Tires** (page 198).*

Miscellaneous

- Move vehicles at least 25 ft (7.5 m) every 15 days to lubricate working parts and prevent flat spots in the tires.

Removing Vehicle From Storage

When your vehicle is ready to come out of storage, do the following:

- Wash your vehicle to remove any dirt or grease film build-up on window surfaces.
- Check windshield wipers for any deterioration.
- Check under the hood and engine cover for any foreign material that may have collected during storage such as mice or squirrel nests.
- Check the exhaust for any foreign material that may have collected during storage.
- Check tire pressures and set tire inflation per the Tire Label.

- Check brake pedal operation. Drive your vehicle 15 ft (4.5 m) back and forth with the brake lightly applied.
- Check fluid levels (including coolant, oil and gas) to make sure there are no leaks, and fluids are at recommended levels.

See an authorized dealer if you have any concerns or issues.

Wheels and Tires

TIRE SEALANT AND INFLATOR KIT

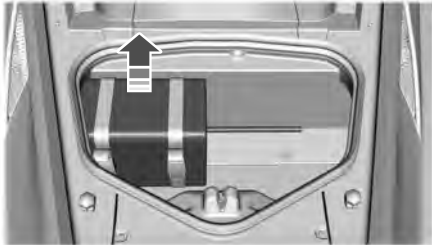

E244127

The kit is located in the storage compartment under the rear hatch, forward of the rear wing. The kit consists of an air compressor to re-inflate the tire and a canister of sealing compound that will effectively seal most punctures caused by nails or similar objects. This kit provides a temporary tire repair, allowing you to drive your vehicle up to 120 mi (200 km) at a maximum speed of 50 mph (80 km/h) to reach a tire service location.

Note: *The temporary mobility kit contains enough sealant compound in the canister for one tire repair only. See an authorized Ford dealer for replacement sealant canisters.*

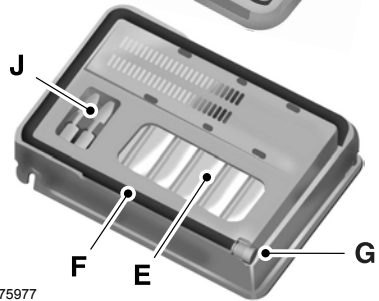
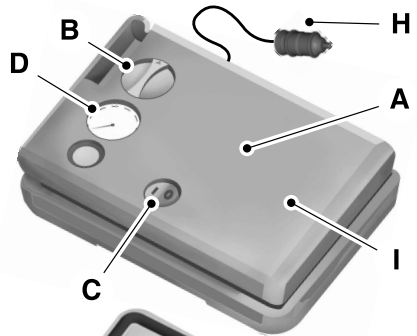

E175977

- A Air compressor (inside).
- B Selector switch.
- C On and off button.
- D Air pressure gauge.
- E Sealant bottle and canister.
- F Dual purpose hose: air and repair.
- G Tire valve connector.
- H Accessory power plug.
- I Casing/housing.
- J Bike/raft/sports ball adapters.

Wheels and Tires

General Information

WARNING



Failure to follow these guidelines could result in an increased risk of loss of vehicle control, injury or death.

Note: Do not use the kit if you have severely damaged a tire. Only seal punctures located within the tire tread with the kit.

Do not attempt to repair punctures larger than ¼ inch (6 millimeters) or damage to the tire's sidewall. The tire may not completely seal.

Loss of air pressure may adversely affect tire performance. For this reason:

Note: Do not drive the vehicle above 50 mph (80 km/h).

Note: Do not drive further than 120 mi (200 km). Drive only to the closest authorized Ford dealer or tire repair shop to have your tire inspected.

- Drive carefully and avoid abrupt steering maneuvers.
- Periodically monitor tire inflation pressure in the affected tire; if the tire is losing pressure, have the vehicle towed on a flat bed.
- Read the information in the Tips for Use of the Kit section to make sure safe operation of the kit and your vehicle.

Tips for Use of the Kit

To ensure safe operation of the kit:

- Read all instructions and cautions fully.
- Before operating the kit, make sure your vehicle is safely off the road and away from moving traffic. Switch on the hazard lights.
- Always set the parking brake to ensure the vehicle does not move unexpectedly.

- Do not remove any foreign objects, such as nails or screws, from the tire.
- When using the kit, leave the engine running (only if the vehicle is outdoors or in a well-ventilated area) so the compressor does not drain the vehicle's battery.
- Do not allow the compressor to operate continuously for more than 15 minutes. This will help prevent the compressor from overheating.
- Never leave the kit unattended during operation.
- Sealant compound contains latex. Those with latex sensitivities should use appropriate precautions to avoid an allergic reaction.
- Keep the kit away from children.
- Only use the kit when the ambient temperature is between -22°F (-30°C) and 158°F (70°C).
- Only use the sealing compound before the use-by date. The use-by date is on a label on the sealant canister, which you can see through the rectangular viewing window on the bottom of the compressor. Check the use-by date regularly and replace the canister after four years of non-use.
- Do not store the kit unsecured inside the passenger compartment of the vehicle as it may cause injury during a sudden stop or crash. Always store the kit in its original location.
- After sealant use, an authorized Ford dealer must replace the tire pressure monitoring system sensor and valve stem on the wheel.
- Operating the kit could cause an electrical disturbance in radio operation.

Wheels and Tires



* When inflation only is required for a tire or other objects, the selector must be in the Air position.



What to do When a Tire Is Punctured

You can repair a tire puncture within the tire's tread area in two stages with the kit.

- In the first stage, inflate the tire with a sealing compound and air. After you inflate the tire, you will need to drive the vehicle a short distance (about 4 mi (6 km) to distribute the sealant in the tire.
- In the second stage, check the tire pressure and adjust, if necessary, to the vehicle's specified tire inflation pressure.

First Stage: Inflating the Tire with Sealing Compound and Air

WARNINGS

-  Do not stand directly over the kit while inflating the tire. If you notice any unusual bulges or deformations in the tire's sidewall during inflation, stop and call roadside assistance.
-  If the tire does not inflate to the recommended tire pressure within 15 minutes, stop and call roadside assistance.
-  Do not run the engine when operating the air compressor unless the vehicle is outdoors or in a well-ventilated area.

Preparation: Park the vehicle in a safe, level and secure area, away from moving traffic.

Switch the hazard lights on. Apply the parking brake and switch the engine off. Inspect the flat tire for visible damage.

Sealant compound contains latex. Use appropriate precautions to avoid any allergic reactions.

Do not remove any foreign object that has pierced the tire. If a puncture is located in the tire sidewall, stop and call roadside assistance.

1. Remove the valve cap from the tire valve.
2. Unwrap the dual purpose hose (black tube) from the back of the compressor housing.
3. Fasten the hose to the tire valve by turning the connector clockwise. Tighten the connection securely.

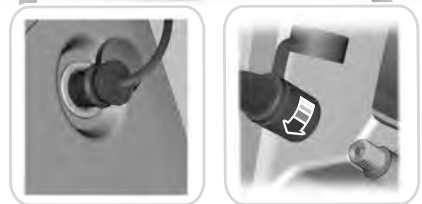
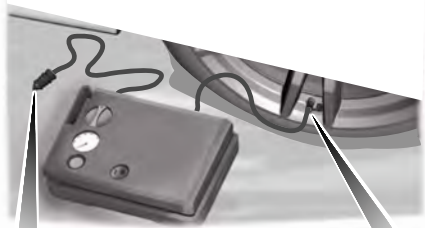

E252191

4. Plug the power cable into the 12-volt power point located on the right side of the floor console.
5. Remove the warning sticker found on the casing/housing and place it on the top of the instrument panel or the center of the dash.

Wheels and Tires

6. Start the vehicle and leave the engine running so the compressor does not drain the vehicle's battery.

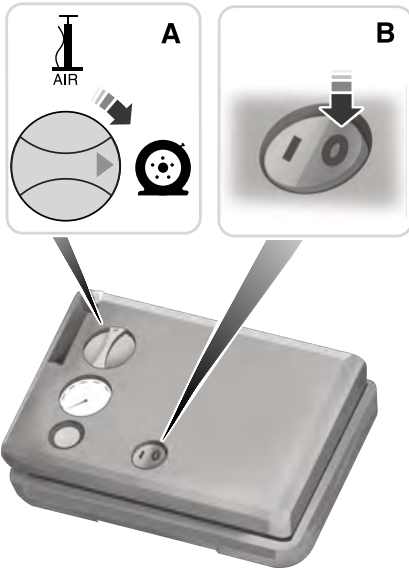

E175981

7. Turn dial (A) clockwise to the sealant position. Switch the kit on by pressing the on/off button (B).
8. Inflate the tire to the pressure listed on the tire label located on the driver's door or the door jamb area. The initial air pressure gauge reading may indicate a value higher than the label pressure while you pump the sealing compound into the tire. This is normal and should be no reason for concern. The pressure gauge reading will indicate the tire inflation pressure after about 30 seconds of operation. You should check the final tire pressure with the compressor turned OFF in order to get an accurate pressure reading.

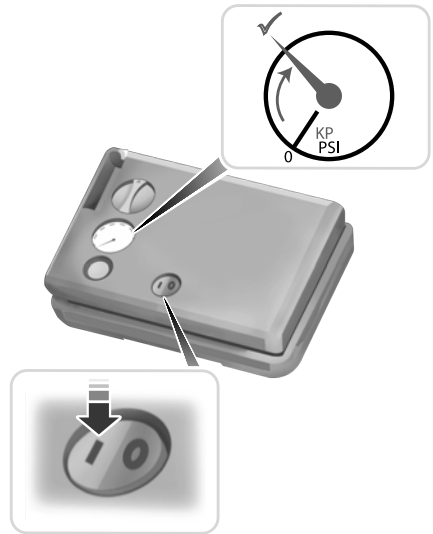

E175982

9. When the tire reaches the recommended tire pressure, switch off the kit, unplug the power cable, and disconnect the hose from the tire valve. Re-install the valve cap on the tire valve and return the kit to the stowage area.
10. Immediately and cautiously, drive the vehicle 4 mi (6 km) to distribute the sealant evenly inside the tire. Do not exceed 50 mph (80 km/h).
11. After 4 mi (6 km), stop and check the tire pressure. See Second Stage: Checking Tire Pressure.

Wheels and Tires

Note: *If you experience any unusual vibration, ride disturbance or noise while driving, reduce your speed until you can safely pull off to the side of the road to call for roadside assistance. Note: Do not proceed to the second stage of this operation.*

Second Stage: Checking Tire Pressure

WARNING



The power plug may get hot after use and should be handled carefully when unplugging.

If you are proceeding from the First Stage: Re-inflating the Tire with Sealing Compound and Air section and have injected sealant in the tire and the pressure is below 20 psi (1.4 bar), continue to the next step.

Check the air pressure of your tires as follows:



E175983

1. Remove the valve cap from the tire valve.
2. Firmly screw the air compressor hose onto the valve stem by turning clockwise.
3. Push and turn the dial clockwise to the air position.

4. If required, switch on the compressor and adjust the tire to the recommended inflation pressure shown on the tire label located on the driver's door or door jamb area. You should check the tire pressure with the compressor turned OFF in order to get an accurate pressure reading.
5. Unplug the hoses, re-install the valve cap on the tire and return the kit to the stowage area.

What to Do After the Tire has Been Sealed

After using the kit to seal your tire, you will need to replace the sealant canister. You can obtain sealant canisters and spare parts at an authorized Ford dealer. You can dispose of empty sealant canisters at home. However, you should dispose of canisters still containing liquid sealant through your local authorized Ford dealer or tire dealer, or in accordance with local waste disposal regulation.

Note: *After you use the sealing compound, the maximum vehicle speed is 50 mph (80 km/h) and the maximum driving distance is 120 mi (200 km). You should inspect the sealed tire immediately.*

You can check the tire pressure any time within the 120 mi (200 km) by performing the steps listed previously in the Second Stage: Checking Tire Pressure procedure.

Wheels and Tires

Removal of the sealant canister from the kit

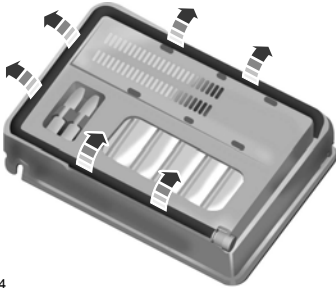

E175984

1. Unwrap the dual purpose hose (black tube) from the compressor housing.

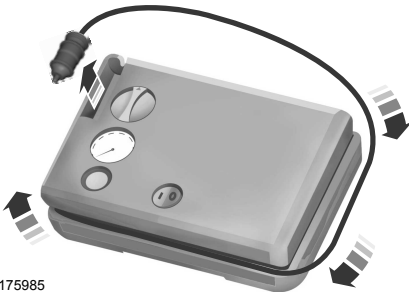

E175985

2. Unwrap the power cord.



E175986

3. Remove the back cover.



E175987

4. Rotate the sealant canister up 90 degrees and pull away from casing/housing to remove.

Installation of the sealant canister to the kit

1. With the canister held perpendicular to the housing, insert the canister nozzle into the connector and push until seated.
2. Rotate the canister 90 degrees down into the housing/casing.



E175988

3. Snap the back cover back into place.

Wheels and Tires

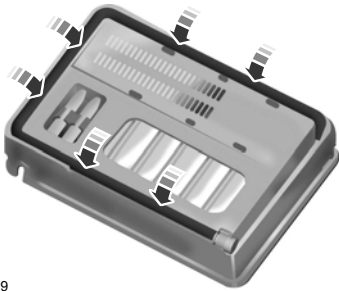

E175989

4. Wrap the dual purpose hose (black tube) around the channel on the bottom of the housing/casing.



E175990

5. Wrap the power cord around the housing and stow the accessory power plug into its storage area.

Note: *If you experience any difficulties with the removal or installation of the sealant canister, consult an authorized Ford dealer for assistance.*

Make sure you check the sealant compound's use-by date regularly. The use-by date is on a label located on the sealant canister, which you can see through the rectangular viewing window on the bottom of the kit. You should replace the sealant canister after four years of non-use.

TIRE CARE

Information About Uniform Tire Quality Grading



E142542

Tire Quality Grades apply to new pneumatic passenger car tires. The Quality grades can be found where applicable on the tire sidewall between tread shoulder and maximum section width. For example: **Treadwear 200 Traction AA Temperature A.**

These Tire Quality Grades are determined by standards that the United States Department of Transportation has set.

Tire Quality Grades apply to new pneumatic passenger car tires. They do not apply to deep tread, winter-type snow tires, space-saver or temporary use spare tires, light truck or LT type tires, tires with nominal rim diameters of 10 to 12 inches or limited production tires as defined in Title 49 Code of Federal Regulations Part 575.104 (c)(2).

Wheels and Tires

U.S. Department of Transportation Tire quality grades: The U.S. Department of Transportation requires Ford Motor Company to give you the following information about tire grades exactly as the government has written it.

Treadwear

The treadwear grade is a comparative rating based on the wear rate of the tire when tested under controlled conditions on a specified government test course. For example, a tire graded 150 would wear 1 ½ times as well on the government course as a tire graded 100. The relative performance of tires depends upon the actual conditions of their use, however, and may depart significantly from the norm due to variations in driving habits, service practices, and differences in road characteristics and climate.

Traction AA A B C

WARNING

 The traction grade assigned to this tire is based on straight-ahead braking traction tests, and does not include acceleration, cornering, hydroplaning or peak traction characteristics.

The traction grades, from highest to lowest are AA, A, B, and C. The grades represent the tire's ability to stop on wet pavement as measured under controlled conditions on specified government test surfaces of asphalt and concrete. A tire marked C may have poor traction performance.

Temperature A B C

WARNING

 The temperature grade for this tire is established for a tire that is properly inflated and not overloaded. Excessive speed, underinflation, or excessive loading, either separately or in combination, can cause heat buildup and possible tire failure.

The temperature grades are A (the highest), B and C, representing the tire's resistance to the generation of heat and its ability to dissipate heat when tested under controlled conditions on a specified indoor laboratory test wheel. Sustained high temperature can cause the material of the tire to degenerate and reduce tire life, and excessive temperature can lead to sudden tire failure. The grade C corresponds to a level of performance which all passenger car tires must meet under the

Wheels and Tires

Federal Motor Vehicle Safety Standard No. 139. Grades B and A represent higher levels of performance on the laboratory test wheel than the minimum required by law.

Glossary of Tire Terminology

***Tire label:** A label showing the original equipment tire sizes, recommended inflation pressure and the maximum weight the vehicle can carry.

***Tire Identification Number (TIN):** A number on the sidewall of each tire providing information about the tire brand and manufacturing plant, tire size and date of manufacture. Also referred to as DOT code.

***Inflation pressure:** A measure of the amount of air in a tire.

***Standard load:** A class of P-metric or Metric tires designed to carry a maximum load at set pressure. For example: For P-metric tires 35 psi (2.4 bar) and for Metric tires 36 psi (2.5 bar). Increasing the inflation pressure beyond this pressure will not increase the tire capability.

***Extra load:** A class of P-metric or Metric tires designed to carry a heavier maximum load at 42 psi (2.9 bar). Increasing the inflation pressure beyond this pressure will not increase the tire's load carrying capability.

***kPa:** Kilopascal, a metric unit of air pressure.

***PSI:** Pounds per square inch, a standard unit of air pressure.

***Cold tire pressure:** The tire pressure when the vehicle has been stationary and out of direct sunlight for an hour or more and prior to the vehicle being driven for 1 mi (1.6 km).

***Recommended inflation pressure:** The cold inflation pressure found on the Safety Compliance Certification Label (affixed to either the door hinge pillar, door-latch post, or the door edge that meets the door-latch post, next to the driver's seating position), or Tire Label located on the B-Pillar or the edge of the driver's door.

***B-pillar:** The structural member at the side of the vehicle behind the front door.

***Bead area of the tire:** Area of the tire next to the rim.

***Sidewall of the tire:** Area between the bead area and the tread.

***Tread area of the tire:** Area of the perimeter of the tire that contacts the road when mounted on the vehicle.

***Rim:** The metal support (wheel) for a tire or a tire and tube assembly upon which the tire beads are seated.

Wheels and Tires

Information Contained on the Tire Sidewall

Both United States and Canada Federal regulations require tire manufacturers to place standardized information on the sidewall of all tires. This information identifies and describes the fundamental characteristics of the tire and also provides a U.S. DOT Tire Identification Number for safety standard certification and in case of a recall.

Information on P Type Tires

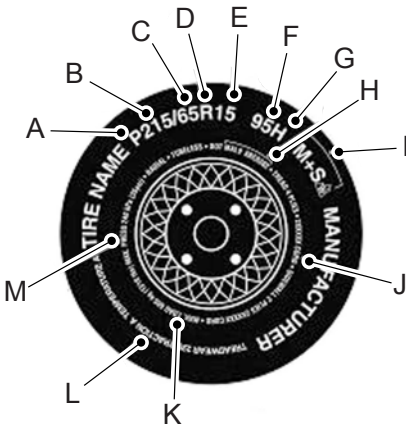

E142543

P215/65R15 95H is an example of a tire size, load index and speed rating. The definitions of these items are listed below. (Note that the tire size, load index and speed rating for your vehicle may be different from this example.)

A. P: Indicates a tire, designated by the Tire and Rim Association, that may be used for service on cars, sport utility vehicles, minivans and light trucks. **Note:** If your tire size does not begin with a letter this may mean it is designated by either the European Tire and Rim Technical Organization or the Japan Tire Manufacturing Association.

B. 215: Indicates the nominal width of the tire in millimeters from sidewall edge to sidewall edge. In general, the larger the number, the wider the tire.

C. 65: Indicates the aspect ratio which gives the tire's ratio of height to width.

D. R: Indicates a radial type tire.

E. 15: Indicates the wheel or rim diameter in inches. If you change your wheel size, you will have to purchase new tires to match the new wheel diameter.

F. 95: Indicates the tire's load index. It is an index that relates to how much weight a tire can carry. You may find this information in your owner's manual. If not, contact a local tire dealer.

Note: You may not find this information on all tires because it is not required by federal law.

Wheels and Tires

G. H: Indicates the tire's speed rating. The speed rating denotes the speed at which a tire is designed to be driven for extended periods of time under a standard condition of load and inflation pressure. The tires on your vehicle may operate at different conditions for load and inflation pressure. These speed ratings may need to be adjusted for the difference in conditions. The ratings range from 81 mph (130 km/h) to 186 mph (299 km/h). These ratings are listed in the following chart.

Note: You may not find this information on all tires because it is not required by federal law.

Letter rating	Speed rating
M	81 mph (130 km/h)
N	87 mph (140 km/h)
P	93 mph (150 km/h)
Q	99 mph (160 km/h)
R	106 mph (170 km/h)
S	112 mph (180 km/h)
T	118 mph (190 km/h)
U	124 mph (200 km/h)
H	130 mph (210 km/h)
V	149 mph (240 km/h)
W	168 mph (270 km/h)

Letter rating	Speed rating
Y	186 mph (300 km/h)
ZR	>186 mph (300 km/h)

Note: For tires with a maximum speed capability over 149 mph (240 km/h), tire manufacturers sometimes use the letters ZR. For those with a maximum speed capability over 186 mph (299 km/h), tire manufacturers always use the letters ZR.

H. U.S. DOT Tire Identification Number (TIN): This begins with the letters DOT and indicates that the tire meets all federal standards. The next two numbers or letters are the plant code designating where it was manufactured, the next two are the tire size code and the last four numbers represent the week and year the tire was built. For example, the numbers 317 mean the 31st week of 1997. After 2000 the numbers go to four digits. For example, 2501 means the 25th week of 2001. The numbers in between are identification codes used for traceability. This information is used to contact customers if a tire defect requires a recall.

I. M+S or M/S: Mud and Snow, or
AT: All Terrain, or
AS: All Season.

Wheels and Tires

J. Tire Ply Composition and Material Used: Indicates the number of plies or the number of layers of rubber-coated fabric in the tire tread and sidewall. Tire manufacturers also must indicate the ply materials in the tire and the sidewall, which include steel, nylon, polyester, and others.

K. Maximum Load: Indicates the maximum load in kilograms and pounds that can be carried by the tire. See the Safety Compliance Certification Label (affixed to either the door hinge pillar, door-latch post, or the door edge that meets the door-latch post, next to the driver's seating position), for the correct tire pressure for your vehicle.

L. Treadwear, Traction and Temperature Grades:

***Treadwear** The treadwear grade is a comparative rating based on the wear rate of the tire when tested under controlled conditions on a specified government test course. For example, a tire graded 150 would wear one and one-half times as well on the government test course as a tire graded 100.

***Traction:** The traction grades, from highest to lowest are AA, A, B, and C. The grades represent the tire's ability to stop on wet pavement as measured under controlled conditions on specified government test surfaces of asphalt and concrete. A tire marked C may have poor traction performance.

***Temperature:** The temperature grades are A (the highest), B and C, representing the tire's resistance to the generation of heat and its ability to dissipate heat when tested under controlled conditions on a specified indoor laboratory test wheel.

M. Maximum Inflation Pressure: Indicates the tire manufacturers' maximum permissible pressure or the pressure at which the maximum load can be carried by the tire. This pressure is normally higher than the vehicle manufacturer's recommended cold inflation pressure which can be found on the Safety Compliance Certification Label (affixed to either the door hinge pillar, door-latch post, or the door edge that meets the door-latch post, next to the driver's seating position), or Tire Label which is located on the B-Pillar or the edge of the driver's door. The cold inflation pressure should never be set lower than the recommended pressure on the vehicle label.

Wheels and Tires

The tire suppliers may have additional markings, notes or warnings such as standard load or radial tubeless.

Location of the Tire Label

You will find a Tire Label containing tire inflation pressure by tire size and other important information located on the driver's side door opening.

Inflating Your Tires

Safe operation of your vehicle requires that your tires are properly inflated. Remember that a tire can lose up to half of its air pressure without appearing flat.

Every day before you drive, check your tires. If one looks lower than the others, use a tire gauge to check pressure of all tires and adjust if required.

At least once a month and before long trips, inspect each tire and check the tire pressure with a tire gauge (including spare, if equipped). Inflate all tires to the inflation pressure recommended by Ford Motor Company.

You are strongly urged to buy a reliable tire pressure gauge, as automatic service station gauges may be inaccurate. Ford recommends the use of a digital or dial-type tire pressure gauge rather than a stick-type tire pressure gauge.

Use the recommended cold inflation pressure for optimum tire performance and wear. Under-inflation or over-inflation may cause uneven treadwear patterns.

WARNING



Under-inflation is the most common cause of tire failures and may result in severe tire cracking, tread separation or blowout, with unexpected loss of vehicle control and increased risk of injury. Under-inflation increases sidewall flexing and rolling resistance, resulting in heat buildup and internal damage to the tire. It also may result in unnecessary tire stress, irregular wear, loss of vehicle control and accidents. A tire can lose up to half of its air pressure and not appear to be flat!

Always inflate your tires to the Ford recommended inflation pressure even if it is less than the maximum inflation pressure information found on the tire. The Ford recommended tire inflation pressure is found on the Safety Compliance Certification Label (affixed to either the door hinge pillar, door-latch post, or the door edge that meets the door-latch post, next to the driver's seating position), or Tire Label which is located on the B-Pillar or the edge

Wheels and Tires

of the driver's door. Failure to follow the tire pressure recommendations can cause uneven treadwear patterns and adversely affect the way your vehicle handles.

Maximum Inflation Pressure is the tire manufacturer's maximum permissible pressure and the pressure at which the maximum load can be carried by the tire. This pressure is normally higher than the manufacturer's recommended cold inflation pressure which can be found on the Safety Compliance Certification Label (affixed to either the door hinge pillar, door-latch post, or the door edge that meets the door-latch post, next to the driver's seating position), or Tire Label which is located on the B-Pillar or the edge of the driver's door. The cold inflation pressure should never be set lower than the recommended pressure on the Safety Compliance Certification Label or Tire Label.

When weather temperature changes occur, tire inflation pressures also change. A 43°F (6°C) temperature drop can cause a corresponding drop of 1 psi (7 kPa) in inflation pressure. Check your tire pressures frequently and adjust them to the proper pressure which can be found on the Safety Compliance Certification Label or Tire Label.

To check the pressure in your tire(s):

1. Make sure the tires are cool, meaning they are not hot from driving even a mile.

Note: *If you are checking tire pressure when the tire is hot, (for example, driven more than 1 mi (1.6 km)), never bleed or reduce air pressure. The tires are hot from driving and it is normal for pressures to increase above recommended cold pressures. A hot tire at or below recommended cold inflation pressure could be significantly under-inflated.*

Note: *If you have to drive a distance to get air for your tire(s), check and record the tire pressure first and add the appropriate air pressure when you get to the pump. It is normal for tires to heat up and the air pressure inside to go up as you drive.*

2. Remove the cap from the valve on one tire, then firmly press the tire gauge onto the valve and measure the pressure.
3. Add enough air to reach the recommended air pressure.

Note: *If you overfill the tire, release air by pressing on the metal stem in the center of the valve. Then recheck the pressure with your tire gauge.*

4. Replace the valve cap.
5. Repeat this procedure for each tire, including the spare.

Wheels and Tires

6. Visually inspect the tires to make sure there are no nails or other objects embedded that could poke a hole in the tire and cause an air leak.
7. Check the sidewalls to make sure there are no gouges, cuts or bulges.

Inspecting Your Tires and Wheel Valve Stems

Periodically inspect the tire treads for uneven or excessive wear and remove objects such as stones, nails or glass that may be wedged in the tread grooves. Check the tire and valve stems for holes, cracks, or cuts that may permit air leakage and repair or replace the tire and replace the valve stem. Inspect the tire sidewalls for cracking, cuts, bruises and other signs of damage or excessive wear. If internal damage to the tire is suspected, have the tire demounted and inspected in case it needs to be repaired or replaced. For your safety, tires that are damaged or show signs of excessive wear should not be used because they are more likely to blow out or fail.

Improper or inadequate vehicle maintenance can cause tires to wear abnormally. Inspect all your tires, including the spare, frequently, and replace them if one or more of the following conditions exist:

Tire Wear



E142546

When the tread is worn down to one sixteenth of an inch (2 mm), tires must be replaced to help prevent your vehicle from skidding and hydroplaning. Built-in treadwear indicators, or wear bars, which look like narrow strips of smooth rubber across the tread will appear on the tire when the tread is worn down to one sixteenth of an inch (2 mm).

When the tire tread wears down to the same height as these wear bars, the tire is worn out and must be replaced.

Damage

Periodically inspect the tire treads and sidewalls for damage (such as bulges in the tread or sidewalls, cracks in the tread groove and separation in the tread or sidewall). If damage is observed or suspected have the tire inspected by a tire professional.

Wheels and Tires

Age

WARNINGS



Tires degrade over time depending on many factors such as weather, storage conditions, and conditions of use (load, speed, inflation pressure) the tires experience throughout their lives.



In general, tires should be replaced after six years regardless of tread wear. However, heat caused by hot climates or frequent high loading conditions can accelerate the aging process and may require tires to be replaced more frequently.

U.S. DOT Tire Identification Number

Both United States and Canada Federal regulations require tire manufacturers to place standardized information on the sidewall of all tires. This information identifies and describes the fundamental characteristics of the tire and also provides a U.S. DOT Tire Identification Number for safety standard certification and in case of a recall.

This begins with the letters DOT and indicates that the tire meets all federal standards. The next two numbers or letters are the plant code designating where it was manufactured, the next two are the tire size code and the last four numbers represent the week and year the tire was built. For example, 2501 means the 25th week of 2001. The numbers in between are identification codes used for traceability. This information is used to contact customers if a tire defect requires a recall.

Tire Replacement Requirements

Your vehicle is equipped with tires designed to provide a safe ride and handling capability.

WARNINGS





Only use replacement tires and wheels that are the same size, load index, speed rating and type (such as P-metric versus LT-metric or all-season versus all-terrain) as those originally provided by Ford. The recommended tire and wheel size may be found on either the Safety Compliance Certification Label (affixed to either the door hinge pillar, door-latch post, or the door edge that meets the door-latch post, next to the driver's seating position), or the Tire Label which is located on the B-Pillar or edge of the driver's door. If this information is not found on these

Wheels and Tires

WARNINGS

labels, then you should contact your authorized dealer as soon as possible. Use of any tire or wheel not recommended by Ford can affect the safety and performance of your vehicle, which could result in an increased risk of loss of vehicle control, vehicle rollover, personal injury and death.

 The use of non-recommended tires and wheels could cause steering, suspension, axle, transfer case or power transfer unit failure. If you have questions regarding tire replacement, contact your authorized dealer as soon as possible.

 To reduce the risk of serious injury, when mounting replacement tires and wheels, you should not exceed the maximum pressure indicated on the sidewall of the tire to set the beads without additional precautions listed below. If the beads do not seat at the maximum pressure indicated, re-lubricate and try again.

 When inflating the tire for mounting pressures up to 20 psi (1.38 bar) greater than the maximum pressure on the tire sidewall, the following precautions must be taken to protect the person mounting the tire:

- Make sure that you have the correct tire and wheel size.
- Lubricate the tire bead and wheel bead seat area again.
- Stand at a minimum of 12 ft (3.66 m) away from the wheel and tire assembly.
- Use both eye and ear protection.

WARNINGS

 For a mounting pressure more than 20 psi (1.38 bar) greater than the maximum pressure, a Ford dealer or other tire service professional should do the mounting.

 Always inflate steel carcass tires with a remote air fill with the person inflating standing at a minimum of 12 ft (3.66 m) away from the wheel and tire assembly.

Important: Remember to replace the wheel valve stems when the road tires are replaced on your vehicle.

It is recommended that the two front tires or two rear tires generally be replaced as a pair.

The tire pressure sensors mounted in the wheels (originally installed on your vehicle) are not designed to be used in aftermarket wheels.

Wheels and Tires

The use of wheels or tires not recommended by Ford Motor Company may affect the operation of your tire pressure monitoring system.

If the tire pressure monitoring system indicator is flashing, your system is malfunctioning. Your replacement tire might be incompatible with your tire pressure monitoring system, or some component of the system may be damaged.

Safety Practices

WARNINGS



If your vehicle is stuck in snow, mud or sand, do not rapidly spin the tires; spinning the tires can tear the tire and cause an explosion. A tire can explode in as little as three to five seconds.



Do not spin the wheels at over 34 mph (55 km/h). The tires may fail and injure a passenger or bystander.

Driving habits have a great deal to do with your tire mileage and safety.

- *Observe posted speed limits.
- *Avoid fast starts, stops and turns.
- *Avoid potholes and objects on the road.
- *Do not run over curbs or hit the tire against a curb when parking.

Highway Hazards

No matter how carefully you drive there's always the possibility that you may eventually have a flat tire on the highway. Drive slowly to the closest safe area out of traffic. This may further damage the flat tire, but your safety is more important.

If you feel a sudden vibration or ride disturbance while driving, or you suspect your tire or vehicle has been damaged, immediately reduce your speed. Drive with caution until you can safely pull off the road. Stop and inspect the tires for damage. If a tire is under-inflated or damaged, see the instructions on use of the tire sealant and inflater kit at the beginning of this section. If the kit cannot provide a temporary tire inflation, contact an authorized dealer.

Tire and Wheel Alignment

A bad jolt from hitting a curb or pothole can cause the front end of your vehicle to become misaligned or cause damage to your tires. If your vehicle seems to pull to one side when you're driving, the wheels may be out of alignment. Have an authorized dealer check the wheel alignment periodically.

Wheels and Tires

Wheel misalignment in the front or the rear can cause uneven and rapid treadwear of your tires and should be corrected by an authorized dealer. Front-wheel drive vehicles and those with an independent rear suspension (if equipped) may require alignment of all four wheels.

The tires should also be balanced periodically. An unbalanced tire and wheel assembly may result in irregular tire wear.

USING SUMMER TIRES

Your Ford GT was built with Michelin Pilot Sport Cup 2 tires which are a summer tire. Summer tires provide superior performance on wet and dry roads. Summer tires do not have the Mud and Snow (M+S or M/S) tire traction rating on the tire side wall. Since summer tires do not have the same traction performance as All-season or Snow tires, we do not recommend using summer tires when temperatures drop to about 45°F (7°C) or below (depending on tire wear and environmental conditions) or in snow and ice conditions. Like any tire, summer tire performance is affected by tire wear and environmental conditions. If you must drive in those conditions, we recommend using Mud and Snow (M+S, M/S), All-season or Snow tires.

Always store your summer tires indoors at temperatures above 19°F (-7°C). The rubber compounds used in these tires lose flexibility and may develop surface cracks in the tread area at temperatures below 19°F (-7°C). If the tires have been subjected to 19°F (-7°C) or less, warm them in a heated space to at least 41°F (5°C) for at least 24 hours before installing them on a vehicle, or moving the vehicle

with the tires installed, or checking tire inflation. Do not place tires near heaters or heating devices used to warm the room where the tires are stored. Do not apply heat or blow heated air directly on the tires. Always inspect the tires after storage periods and before use.

USING SNOW CHAINS

WARNINGS



If you choose to install snow tires on your vehicle, they must be the same size, construction, and load range as the original tires listed on the tire placard, and they must be installed on all four wheels. Mixing tires of different size or construction on your vehicle can adversely affect your vehicle's handling and braking, and may lead to loss of vehicle control.



Do not use snow chains or cables on this vehicle as they may cause damage to your vehicle which may lead to loss of vehicle control.

Snow chains have not been approved for use on your vehicle.

TIRE PRESSURE MONITORING SYSTEM

WARNINGS



The tire pressure monitoring system is not a substitute for manually checking tire pressures. You should periodically check tire pressures using a pressure gauge. Failure to correctly maintain tire pressures could increase the risk of tire failure, loss of control, vehicle rollover and personal injury.



Do not use tire sealants as they may damage the tire pressure monitoring system.

Wheels and Tires

WARNINGS



If the tire pressure monitor sensor becomes damaged it may not function.



Each tire should be checked monthly when cold and inflated to the inflation pressure recommended by the vehicle manufacturer on the vehicle placard or tire inflation pressure label. (If your vehicle has tires of a different size than the size indicated on the vehicle placard or tire inflation pressure label, you should determine the proper tire inflation pressure for those tires.)

As an added safety feature, your vehicle has been equipped with a Tire Pressure Monitoring System (TPMS) that illuminates a low tire pressure telltale when one or more of your tires is significantly under-inflated. Accordingly, when the low tire pressure telltale illuminates, you should stop and check your tires as soon as possible, and inflate them to the proper pressure. Driving on a significantly under-inflated tire causes the tire to overheat and can lead to tire failure. Under-inflation also reduces fuel efficiency and tire tread life, and may affect the vehicle's handling and stopping ability.

Please note that the TPMS is not a substitute for proper tire maintenance, and it is the driver's responsibility to maintain correct tire pressure, even if under-inflation has not reached the level to trigger illumination of the TPMS low tire pressure telltale.

Your vehicle has also been equipped with a TPMS malfunction indicator to indicate when the system is not operating properly. The TPMS malfunction indicator is combined with the low tire pressure telltale. When the system detects a malfunction, the telltale flashes for approximately one minute and then remains illuminated. This sequence continues upon subsequent vehicle start-ups as long as the malfunction exists.

When the malfunction indicator is illuminated, the system may not be able to detect or signal low tire pressure as intended. TPMS malfunctions may occur for a variety of reasons, including the installation of replacement or alternate tires or wheels on the vehicle that prevent the TPMS from functioning properly. Always check the TPMS malfunction telltale after replacing one or more tires or wheels on your vehicle to ensure that the replacement or alternate tires and wheels allow the TPMS to continue to function properly.

This device complies with Part 15 of the FCC Rules and with Licence exempt RSS Standards of Industry Canada. Operation is subject to the following two conditions:

- This device may not cause harmful interference, and
- This device must accept any interference received, including interference that may cause undesired operation.

WARNING



Changes or modifications not expressly approved by the party responsible for compliance could void the user's authority to operate the equipment. The term "IC:" before the radio certification number only signifies that Industry Canada technical specifications were met.

Wheels and Tires

Changing Tires With a Tire Pressure Monitoring System



E142549

Note: Each road tire is equipped with a tire pressure sensor located inside the wheel and tire assembly cavity. The pressure sensor is attached to the valve stem. The pressure sensor is covered by the tire and is not visible unless the tire is removed. Take care when changing the tire to avoid damaging the sensor

You should always have your tires serviced by an authorized dealer.

Check the tire pressure periodically (at least monthly) using an accurate tire gauge. See **Inflating Your Tires** in this chapter.

Understanding Your Tire Pressure Monitoring System



E250820

The tire pressure monitoring system measures pressure in your road tires and sends the tire pressure readings to your vehicle. You can view the tire pressure readings through the information display. See **General Information** (page 70). The low tire pressure warning light turns on if the tire pressure is significantly low. Once the light is illuminated, your tires are under-inflated and need to be inflated to the manufacturer's recommended tire pressure. Even if the light turns on and a short time later turns off, your tire pressure still needs to be checked.

When You Believe Your System is Not Operating Properly

The main function of the tire pressure monitoring system is to warn you when your tires need air. It can also warn you in the event the system is no longer capable of functioning as intended. See the following chart for information concerning your tire pressure monitoring system:

Wheels and Tires

Low tire pressure warning light	Possible cause	Customer action required
Solid warning light	Tire(s) under-inflated	Make sure tires are at the proper pressure. See Inflating your tires in this chapter. After inflating your tires to the manufacturer's recommended pressure as shown on the Tire Label (located on the edge of driver's door or the B-Pillar), the vehicle must be driven for at least two minutes over 20 mph (32 km/h) before the light turns off.
	TPMS malfunction	If the tires are properly inflated and the light remains on, contact your authorized dealer as soon as possible.
Flashing warning light	TPMS malfunction	If the tires are properly inflated and the light remains on, contact your authorized dealer as soon as possible.

When Inflating Your Tires

Note: Do not use the tire pressure display screen as a tire pressure gauge, this can result in over or under inflation of a tire.

When putting air into your tires (such as at a gas station or in your garage), the tire pressure monitoring system may not respond immediately to the air added to your tires.

It may take up to two minutes of driving over 20 mph (32 km/h) for the light to turn off after you have filled your tires to the recommended inflation pressure.

How Temperature Affects Your Tire Pressure

The tire pressure monitoring system monitors tire pressure in each pneumatic tire. When driving in a normal manner, a typical passenger tire inflation pressure may increase about 2–4 psi (14–28 kPa) from a cold start situation. If the vehicle is stationary overnight with the outside

temperature significantly lower than the daytime temperature, the tire pressure may decrease about 3 psi (21 kPa) for a drop of 30°F (17°C) in ambient temperature. This lower pressure value may be detected by the tire pressure monitoring system as being significantly lower than the recommended inflation pressure and activate the system warning light for low tire pressure. If the low tire pressure warning light is on, visually check each tire to verify that no tire is flat. If one or more tires are flat, repair as necessary. Check the air pressure in the road tires. If any tire is under-inflated, carefully drive the vehicle to the nearest location where air can be added to the tires. Inflate all the tires to the recommended inflation pressure.

Wheels and Tires

CHANGING A ROAD WHEEL

Important Information for Lifting or Jacking

A vehicle jack is not included with your vehicle. If you are on the road and need to change a wheel, it is recommended that you contact the Ford GT Concierge to obtain roadside assistance. See **Special Notices** (page 10).

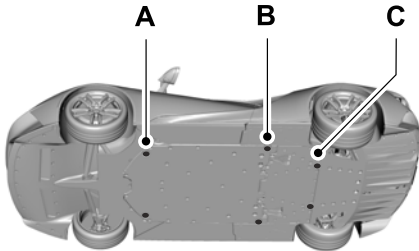

E228623

- A Front lift points
- B Middle lift points
- C Rear lift points

To avoid damage to your vehicle, use a low profile hydraulic jack when removing a road wheel. Only place the jack on one of the alloy lifting posts when lifting your vehicle. Do not lift your vehicle on the carbon fiber panels.

Note: *It is recommended that an interface be used between the alloy lifting point and the vehicle jack (for example, a hockey puck or dense rubber pad).*

DRIVING AT HIGH SPEED

Tire Pressure - Speeds Greater Than 165 mph (265 km/h)

WARNING



Always re-inflate tires to recommended tire pressures before the vehicle is operated on-road. The recommended pressure is located on the tire label or safety certification label, located on the B-pillar, inside the driver's door.

Note: *When driving over 165 mph (265 km/h), be sure to check and adjust your tire pressures accordingly.*

Note: *If you are not sure about the proper tire inflation pressures, contact an authorized dealer or service center.*

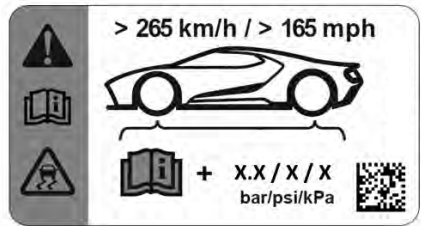

E247515

Your tires may require additional inflation pressure for operation at speeds greater than 165 mph (265 km/h). If this label is present on your vehicle, you must adjust the tire pressure accordingly.

Wheels and Tires

TECHNICAL SPECIFICATIONS

Wheel Lug Nut Torque Specifications

WARNING



When you install a wheel, always remove any corrosion, dirt or foreign materials present on the mounting surfaces of the wheel or the surface of the wheel hub, brake drum or brake disc that contacts the wheel. Make sure to secure any fasteners that attach the rotor to the hub so they do not interfere with the mounting surfaces of the wheel. Installing wheels without correct metal-to-metal contact at the wheel mounting surfaces can cause the wheel nuts to loosen and the wheel to come off while your vehicle is in motion, resulting in loss of vehicle control, personal injury or death.

Bolt size	lb-ft (Nm)*
M14 X 1.5	150 lb.ft (204 Nm)

*Torque specifications are for nut and bolt threads free of dirt and rust. Use only Ford recommended replacement fasteners.

Retighten the lug nuts to the specified torque within 100 miles (160 kilometers) after any wheel disturbance (such as tire rotation, changing a flat tire, wheel removal).



E145950

A Wheel pilot bore

Inspect the wheel pilot bore and mounting surface prior to installation. Remove any visible corrosion or loose particles.

Note: The wheel stud length differs depending on the wheels equipped. The hub on carbon fiber wheels require longer wheel studs due to a thicker hub. If changing wheel types between alloy and carbon fiber, in either direction, you must also change the wheel studs to match the length required for that wheel type. Also use the longer studs for the carbon fiber wheels and then use open lug nuts if putting alloy wheels back on the car.

Capacities and Specifications

ENGINE SPECIFICATIONS

Measurement	Specification
Engine model.	3.5L GTDI
Engine displacement.	213 in ³ (3,490 cm ³)
Bore.	3.6 in (92.5 mm)
Stroke.	3.4 in (86.7 mm)
Compression ratio.	9:1
Normal engine idling speed.	800 RPM
Maximum engine speed.*	7000 RPM
Firing order.	1-4-2-5-3-6
Ignition system.	Coil on plug.
Spark plug gap.	0.030 in (0.75 mm)
Compression ratio.	9:1
Fuel quality.	Premium fuel only.

* As the engine reaches normal operating temperature, the allowable maximum engine speed (redline) increases.

Capacities and Specifications

MOTORCRAFT PARTS

Component	Part Number
Air filter element.	FA-1912-A*
Oil filter.	HG7Z-6731-A**
Battery.	HG7Z-10655-A**
Spark plugs.	SP-542*
Cabin air filter.	FP-70*
Windshield wipers.	HG7Z-17528-A (right-hand side)** HG7Z-17528-B (left-hand side)**

*Motorcraft® part number

**Ford part number

We recommend Ford and Motorcraft® replacement parts available at your Ford dealer or at fordparts.com for scheduled maintenance. These parts meet or exceed Ford Motor Company's specifications and are engineered for your vehicle. Use of other parts may impact vehicle performance, emissions and durability. Your warranty may be void for any damage related to use of other parts.

For spark plug replacement, contact an authorized dealer. Replace the spark plugs at the appropriate intervals.

Capacities and Specifications

VEHICLE DIMENSIONS

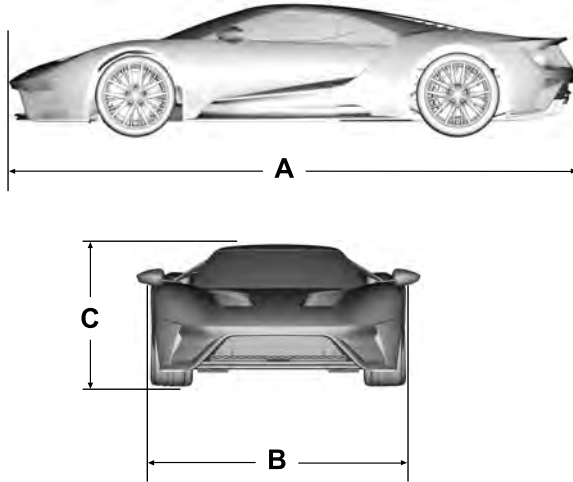

E257130

Item	Dimension	Specification
A	Overall length.	187.5 in (4,763 mm)
B	Overall width excluding exterior mirrors.	78.9 in (2,004 mm)
B	Overall width with mirrors folded.	83.2 in (2,113 mm)
B	Overall width with mirrors extended.	88.1 in (2,237.7 mm)
C	Overall height without options (Normal drive mode).	43.7 in (1,109 mm)

Capacities and Specifications

VEHICLE IDENTIFICATION NUMBER

You can find the vehicle identification number at the following locations.

On the vehicle certification label inside the driver's door opening.

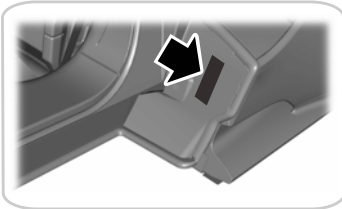
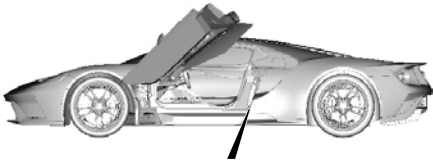

E227109

On the left-hand side of the instrument panel.

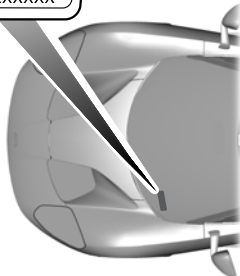
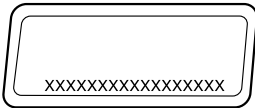

E252123

Please note that in the graphic, XXXX is representative of your vehicle identification number.

The Vehicle Identification Number contains the following information:

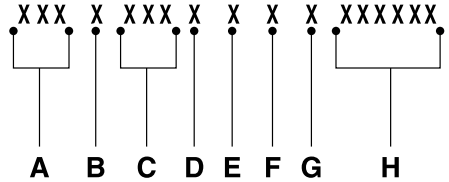

E142477

- A World manufacturer identifier
- B Brake system, Gross Vehicle Weight Rating, Restraint Devices and their locations
- C Make, vehicle line, series, body type
- D Engine type
- E Check digit
- F Model year
- G Assembly plant
- H Production sequence number

Capacities and Specifications

VEHICLE CERTIFICATION LABEL

MFD. BY FORD MOTOR CO.

DATE: XX/XX GVWR: XXXX KG (XXXX LB)
 FRONT GAWR: XXXX KG (XXXX LB) REAR GAWR: XXXX KG (XXXX LB)

THIS VEHICLE CONFORMS TO ALL APPLICABLE FEDERAL MOTOR VEHICLE SAFETY AND THEFT PREVENTION STANDARDS IN EFFECT ON THE DATE OF MANUFACTURE SHOWN ABOVE.

VIN: XXXXXXXXXXXXXXXXXXXX TYPE: XXXX
 MAXIMUM LOAD = OCCUPANTS + LUGGAGE = XXXKG/XXXLB
 OCCUPANTS = X TOTAL; X FRONT, X REAR

TIRE (FR): XXX/XXXXXX XXX RIMS (FR): XX-X XX
 (RR): XXX/XXXXXX XXX (RR): XX-X XX
 PRESSURE (FR): XXX kPa/ XX PSI COLD (RR): XX kPa/ XX PSI COLD



XXXXXXXXXXXXXXXXXXXX

TRAILER TOWING - SEE OWNER GUIDE

EXT PNT:	RC:	DSO:	XXXXX XXXXX
INT TR	TP/PS	TR	AXLE
		TR	SPR

XXX XXXX-XXXXXX-XX

E245288

The National Highway Traffic Safety Administration Regulations require that a Safety Compliance Certification Label be affixed to a vehicle and prescribe where the Safety Compliance Certification Label may be located. The Safety Compliance Certification Label shall be affixed to either the door hinge pillar, the door latch post, or the edge of the door near the door latch, next to the driver's seating position.

TRANSMISSION CODE DESIGNATION

MFD. BY FORD MOTOR CO.

DATE: XX/XX GVWR: XXXX KG (XXXX LB)
 FRONT GAWR: REAR GAWR:
 XXXX KG (XXXX LB) WITH XXXX KG (XXXX LB) WITH
 XXXXXXXXXXXXXXXXXXXX TIRES XXXXXXXXXXXXXXXXXXXX TIRES
 XXXXXX RIMS XXXXXX RIMS
 AT XXXX kPa/ XXX PSI COLD AT XXXX kPa/ XXX PSI COLD

THIS VEHICLE CONFORMS TO ALL APPLICABLE FEDERAL MOTOR VEHICLE SAFETY AND THEFT PREVENTION STANDARDS IN EFFECT ON THE DATE OF MANUFACTURE SHOWN ABOVE.

VIN: XXXXXXXXXXXXXXXXXXXX XXXXX
 TYPE: XXXX XXXXX



EXT PNT:	XX	XXXXXX	RC:	XX	DSO:	XXXX
WB	INT TR	TP/PS	TR	AXLE	TR	SPR
XXX	XX	XXX	X	XX	X	XXXX
		XXXXXXXXXXXX				XXXX-XXXXXX-XX

E167814

The transmission code is on the Safety Compliance Certification Label. The following table shows the transmission code along with the transmission description.

Description	Code
Seven-speed DCT transmission	F

Capacities and Specifications

CAPACITIES AND SPECIFICATIONS

Capacities

WARNING



The air conditioning refrigerant system contains refrigerant under high pressure. Only qualified personnel should service the air conditioning refrigerant system. Opening the air conditioning refrigerant system can cause personal injury.

Item	Capacity
Engine oil with oil filter (dry fill capacity).	15.3 qt (14.5 L)
Engine oil with oil filter (oil change refill capacity).	13.7 qt (13 L)
Engine coolant.	20.1 qt (19 L)
Brake fluid.	1.1 qt (1.04 L)
Hydraulic fluid (power steering, active suspension, active aero).	6.3 qt (6 L)
Transmission fluid.	4.1 qt (3.9 L)
Wet Clutch fluid.	8.5 qt (8 L)
Fuel tank.	15.2 gal (57.54 L)
Windshield washer fluid.	0.5 gal (1.89 L)
A/C Refrigerant.	1.5 lb (0.68 kg)
A/C Refrigerant Compressor Oil.	4.7 fl oz (140 ml)

Capacities and Specifications

Specifications

Materials

Name	Specification
Recommended motor oil: Castrol Edge® Supercar SAE 5W-50 Full Synthetic Motor Oil (U.S. & Canada)	WSS-M2C931-C
Engine coolant: Motorcraft® Orange Prediluted Antifreeze/Coolant VC-3DIL-B (U.S.) CVC-3DIL-B (Canada)	WSS-M97B44-D2
Brake fluid: Motorcraft® DOT 4 Low Viscosity (LV) High Performance Motor Vehicle Brake Fluid PM-20 (U.S. & Canada)	WSS-M6C65-A2
Hydraulic Fluid Motorcraft® MERCON LV XT-10-QLVC	WSS-M2C938-A
Gear/Transmission Fluid: Motorcraft® Ford GT Supercar Transaxle Lubricant XT-75W90-QSC	-
Clutch Fluid: Motorcraft® Ford GT Supercar Clutch Fluid XL-20	-
Windshield washer fluid: Motorcraft® Premium Windshield Wash Concentrate with Bitterant ZC-32-B2 (U.S.) CXC-37-A/B/D/F (Canada)	WSS-M14P19-A
A/C refrigerant (U.S. and Mexico): R-1234yf Refrigerant YN-33-A	WSS-M17B21-A
A/C refrigerant (Canada): R-1234yf Refrigerant HS7Z-19B519-BA	WSS-M17B21-A

Capacities and Specifications

Name	Specification
A/C refrigerant compressor oil: Motorcraft® R-1234yf PAG Refrigerant Compressor Oil YN-35	WSS-M2C300-A2
Multi-purpose grease: Motorcraft® Multi-Purpose Grease Spray XL-5-A (U.S. & Canada)	ESB-MIC93-B
Lock cylinders: Penetrating and Lock Lubricant XL-1 (U.S.) CXC-51-A (Canada)	-

If you use oil and fluids that do not meet the defined specification and viscosity grade, this may lead to:

- Component damage, which the vehicle warranty does not cover.
- Longer engine cranking periods.
- Increased emission levels.
- Reduced engine performance.
- Reduced fuel economy.
- Reduced brake performance.

Only use fluid that meets Ford specifications.



We recommend Castrol Edge Supercar 5W-50 motor oil for your Ford GT. If this oil is not available, use motor oils of the recommended viscosity grade that meet the Ford specification of WSS-M2C931-C such as Motorcraft® 5W-50.

Do not use oil labeled with API SN service category unless the label also displays the API certification mark.

Do not use supplemental engine oil additives because they are unnecessary and could lead to engine damage that may not be covered by your vehicle warranty.

Note: Ford recommends using DOT 4 Low Viscosity (LV) High Performance Brake Fluid or equivalent meeting WSS-M6C65-A2. Use of any fluid other than the recommended fluid may cause degraded brake performance and not meet the Ford performance standards. Keep brake fluid clean and dry. Contamination with dirt, water, petroleum products or other materials may result in brake system damage and possible failure.

Audio System

AUDIO UNIT

WARNING



Driving while distracted can result in loss of vehicle control, crash and injury. We strongly recommend that you use extreme caution when using any device that may take your focus off the road. Your primary responsibility is the safe operation of your vehicle. We recommend against the use of any hand-held device while driving and encourage the use of voice-operated systems when possible. Make sure you are aware of all applicable local laws that may affect the use of electronic devices while driving.

You can access your audio features with the touchscreen and steering wheel controls. See your SYNC information.

The power button is to the left of the display screen.

USB PORT (If Equipped)

The USB port is on the bottom of the instrument panel.

The USB port allows you to plug in media playing devices, memory sticks and charge devices (if supported). See your SYNC information.

SYNC™ 3 (If Equipped)

GENERAL INFORMATION

WARNING



Driving while distracted can result in loss of vehicle control, crash and injury. We strongly recommend that you use extreme caution when using any device that may take your focus off the road. Your primary responsibility is the safe operation of your vehicle. We recommend against the use of any hand-held device while driving and encourage the use of voice-operated systems when possible. Make sure you are aware of all applicable local laws that may affect the use of electronic devices while driving.

Getting to Know Your System

The SYNC 3 system allows you to interact with a variety of features using the touchscreen and voice commands. By integrating with your Bluetooth-enabled phone, the touchscreen provides easy interaction with audio, multimedia, navigation and your phone's SYNC 3 compatible apps.

Using the Touchscreen

To operate the touchscreen, you can simply touch the item or option that you want to select. The button changes color when you select it.

The SYNC 3 layout allows you to quickly select the feature you wish to use.



E207614

E

SYNC™ 3 (If Equipped)

Item	Menu Item	Action and Description
A	Status Bar	This bar displays icons and messages pertaining to current system activities including voice commands and phone functions such as text messages.
B	Home	This button is available on the main screens. Pressing it takes you to the home screen view.
C	Clock	This shows the current time. You can set the clock manually or have it controlled by the vehicle's GPS location. See Settings (page 248).
D	Outside Temperature	This displays the current outside temperature.
E	Feature Bar	You can touch any of the buttons on this bar to select a feature.

The touchscreen allows you quick access to all of your comfort, navigation, communication and entertainment options. Using the status and feature bar you can quickly select the feature you want to use.

Note: *Your system is equipped with a feature that allows you to access and control audio features for 10 minutes after you switch the ignition off (and no doors open).*

The Status Bar

Additional icons also display in the status bar depending on market, vehicle options and current operation. If a feature is not active, the icon does not display. Certain icons may move to the left or right depending on what options are active.

SYNC™ 3 (If Equipped)

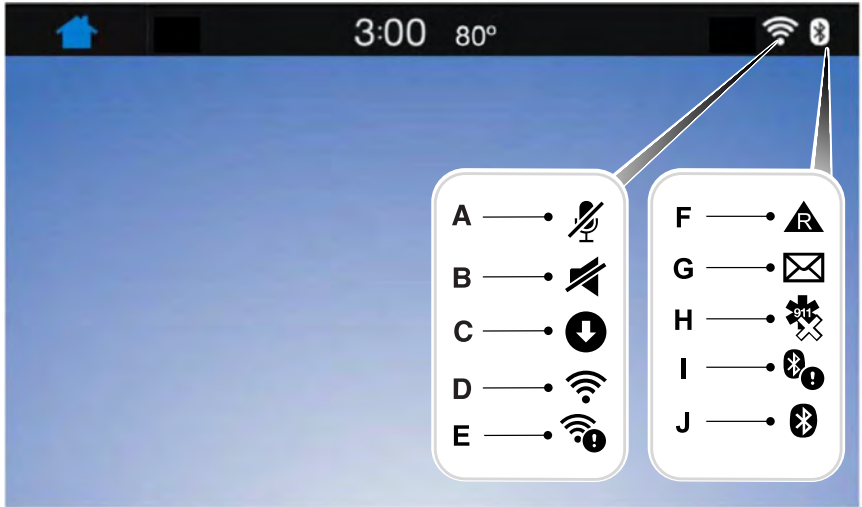

E223058

Callout	Item	Description
A	Microphone Mute	This icon displays when your phone's microphone is muted. A caller cannot hear you.
B	Mute	This icon displays when the audio system is muted.
C	Download	This icon displays when SYNC 3 has received a software update. Pressing the icon will show more details about the new software.
D	Wi-Fi	This icon appears if a Wi-Fi network is connected.
E	Wi-Fi in Range	This icon displays when an available Wi-Fi network is within range.
F	Roaming	This icon displays when your cell phone is roaming.
G	Text Message	This icon displays when you receive a text message on your phone.

SYNC™ 3 (If Equipped)

Callout	Item	Description
H	911 Assist Off	This icon displays when 911 Assist is set to off and your phone is connected to SYNC.
I	Bluetooth Alert	This icon displays when there is an active Bluetooth alert.
J	Bluetooth	This icon displays to show an active Bluetooth connection.

Messages may also appear in the status bar to provide you with notifications. You can select the message to view the associated feature.

Feature Bar

Feature Bar Item	Functions
Audio	Allows you to control the media playing in your vehicle. You can control all audio features including AM, FM radio, and media streaming over a Bluetooth device or through a USB connection.
Phone	Allows you to make calls, receive calls, and access the phonebook of your connected device.
Navigation	Allows you to see your vehicle's location on a virtual road map, get driving directions to your destination and find points of interest along your route.
Apps	Connect and control SYNC 3 compatible apps running on your iPhone or Android device.
Settings	You can customize your system with various settings for the touchscreen display, feature preferences, and how you want to interact with your vehicle.

Cleaning the Touchscreen

You can remove fingerprints with a dry, clean, soft cloth.

If dirt or fingerprints are still on the screen, apply a small amount of alcohol to the cloth and try to clean it again.

Note: Do not use detergent or any type of solvent to clean the touchscreen.

Note: Do not pour or spray alcohol onto the touchscreen.

Using Voice Recognition

Using voice commands allows you to keep your hands on the wheel and focus on what is in front of you. The system provides feedback through audible tones, prompts, questions and spoken confirmations depending on the situation and the chosen level of interaction (voice settings).

The system also asks short questions (confirmation prompts) when it is not sure of your request or when there are multiple possible responses to your request.

When using voice commands, words and icons may appear in the status bar indicating the status of the voice command session. See **Using Voice Recognition** (page 224).

Using the Steering Wheel Controls

You can use different controls on your steering wheel to interact with the touchscreen system in different ways.

VOL: Control the volume of audio output.

Voice: Press to start a voice session. Press again to stop the voice prompt and immediately begin speaking. Press and hold to end a voice session.

SEEK NEXT:

- While in radio mode, press to seek between memory presets.
- While in USB or Bluetooth Audio, press to seek between songs or press and hold to fast seek.

SEEK PREVIOUS:

- While in radio mode, press to seek between memory presets.
- While in USB or Bluetooth Audio, press to seek between songs or press and hold to fast seek.

See **Steering Wheel** (page 52).

Using Your Bezel Controls

- **Power:** Switch the audio system on and off.
- **DISP:** Switch the display on or off. You can also touch the screen to switch the display back on.

911 Assist

WARNINGS



Unless the 911 Assist setting is set on before a crash, the system will not dial for help which could delay response time, potentially increasing the risk of serious injury or death after a crash.



Do not wait for 911 Assist to make an emergency call if you can do it yourself. Dial emergency services immediately to avoid delayed response time which could increase the risk of serious injury or death after a crash. If you do not hear 911 Assist within five seconds of the crash, the system or phone may be damaged or non-functional.



Always place your phone in a secure location in your vehicle so it does not become a projectile or get damaged in a crash. Failure to do so may cause serious injury to someone or damage the phone which could prevent 911 Assist from working properly.

Note: The SYNC 911 Assist feature must be set on before the incident.

SYNC™ 3 (If Equipped)

Note: The SYNC 911 Assist feature only operates in the U.S., Canada or in a territory in which 911 is the emergency number.

Note: Before setting this feature on, make sure that you read the 911 Assist Privacy Notice later in this section for important information.

Note: If any user sets 911 Assist to on or off, that setting applies for all paired phones. If 911 Assist is switched off and the phone is connected to SYNC, an icon displays on the status bar.

Note: Every phone operates differently. While SYNC 911 Assist works with most cellular phones, some may have trouble using this feature.

If a crash deploys an airbag (excluding knee airbags and rear inflatable safety belts [if equipped]) or activates the fuel pump shut-off, your SYNC-equipped vehicle may be able to contact emergency services by dialing 911 through a paired and connected Bluetooth-enabled phone. You can learn more about the 911 Assist feature, by visiting:

Website
www.owner.ford.com www.syncmyride.ca www.syncmaroute.ca

For important information about airbag deployment and the fuel pump shut-off please see the Supplementary Restraints and Roadside Emergencies sections of your owner manual.

To switch 911 Assist on and off please view the settings information. See **Settings** (page 248).

To make sure that 911 Assist works correctly:

- SYNC must be powered and working properly at the time of the incident and throughout feature activation and use.
- The 911 Assist feature must be set on before the incident.
- You must pair and connect a Bluetooth-enabled and compatible cell phone to SYNC.
- A connected Bluetooth-enabled phone must have the ability to make and maintain an outgoing call at the time of the incident.
- A connected Bluetooth-enabled phone must have adequate network coverage, battery power and signal strength.
- The vehicle must have battery power and be located in the U.S., Canada or in a territory in which 911 is the emergency number.

In the Event of a Crash

Not all crashes will deploy an airbag or activate the fuel pump shut-off (the triggers for 911 Assist). If a connected cell phone sustains damage or loses its connection to SYNC during a crash, SYNC will search for and try to connect to a previously paired cell phone; SYNC will then attempt to call the emergency services.

Before making the call:

- SYNC provides a short window of time (about 10 seconds) to cancel the call. If you fail to cancel the call, SYNC attempts to dial 911.
- SYNC says the following, or a similar message: "SYNC will attempt to call 911, to cancel the call, press Cancel on your screen or press and hold the phone button on your steering wheel."

If you do not cancel the call, and SYNC makes a successful call, a pre-recorded message plays for the 911 operator, and then the occupant(s) in your vehicle is able to talk with the operator. Be prepared to provide your name, phone number and location immediately, because not all 911 systems are capable of receiving this information electronically.

911 Assist May Not Work If

- Your cellular phone or 911 Assist hardware sustains damage in a crash.
- The vehicle's battery or the SYNC system has no power.
- The phone(s) thrown from your vehicle are the ones paired and connected to the system.

911 Assist Privacy Notice

When you switch on 911 Assist, it may disclose to emergency services that your vehicle has been in a crash involving the deployment of an airbag or activation of the fuel pump shut-off. Certain versions or updates to 911 Assist may also be capable of electronically or verbally disclosing to 911 operators your vehicle location or other details about your vehicle or crash to assist 911 operators to provide the most appropriate emergency services. If you do not want to disclose this information, do not switch the feature on.

Safety Information

WARNING



Driving while distracted can result in loss of vehicle control, crash and injury. We strongly recommend that you use extreme caution when using any device that may take your focus off the road. Your primary responsibility is the safe operation of your vehicle. We recommend against the use of any hand-held device while driving and encourage the use of voice-operated systems when possible. Make sure you are aware of all applicable local laws that may affect the use of electronic devices while driving.

- Do not attempt to service or repair the system. Have an authorized dealer check your vehicle.
- Do not operate playing devices if the power cords or cables are broken, split or damaged. Place cords and cables out of the way, so they do not interfere with the operation of pedals, seats, compartments or safe driving abilities.
- Do not leave playing devices in your vehicle during extreme conditions as it could cause them damage. See your device's user guide for further information.
- For your safety, some SYNC 3 functions are speed-dependent. Their use is limited to when your vehicle is traveling at speeds under 3 mph (5 km/h). Make sure that you review your device's manual before using it with SYNC 3.

Speed-restricted Features

Some features of this system may be too difficult to use while your vehicle is moving so they are restricted from use unless your vehicle is stationary.

SYNC™ 3 (If Equipped)

- Screens crowded with information, such as Point of Interest reviews and ratings, movie times or ski conditions.
 - Any action that requires you to use a keyboard is restricted, such as entering a navigation destination or editing information.
 - All lists are limited so the user can view fewer entries (such as phone contacts or recent phone call entries).
- See the following chart for more specific examples.

Restricted features	
Cellular Phone	Pairing a Bluetooth phone.
	Browsing of list entries is limited for phone contacts and recent phone calls.
System Functionality	Enabling Valet Mode.
	Editing settings for the rear view camera.
Wi-Fi	Editing Wi-Fi settings.
	Editing the list of wireless networks.
	Connecting to a new Wi-Fi network.
Text Messages	Viewing received text messages.
Navigation	Using the keyboard to enter a destination.
	Adding or editing Navigation Favorites entries or Avoid Areas.

Creating a SYNC Owner Account

Why do I need a SYNC owner account?

- Essential for keeping up with the latest software and connected features.
- Access to customer support for any questions you may have.
- Maintain account permissions.

Visit the website to sign up and register.

Website
www.owner.ford.com www.syncmyride.ca

Website

www.syncmaroute.ca

Updating Your System

You can choose to download the update onto a USB drive or use Wi-Fi to deliver automatic updates.

USB Updates

To use the USB update you need to log into your owner account and visit the SYNC software update page.

SYNC™ 3 (If Equipped)

Website
www.owner.ford.com www.syncmyride.ca www.syncmaroute.ca

The website notifies you if an update is available. You can then select to download the update.

You will need an empty USB drive. Please check the website for minimum requirements. Once you have inserted the USB drive into your computer, choose to start the download. Follow the instructions provided to download the files to the USB drive.

The installation of most files occurs in the background, and does not interrupt your use of the system. Navigation updates cannot be installed in the background, because the files are too large.

To install the update in your vehicle, remove anything that is plugged in the USB ports on the media hub and plug in the USB drive containing the update. When the USB drive is plugged in, the installation should begin immediately. After a successful installation, the update is available the next time the vehicle is started.

Please refer to the website for any further actions.

Updating Over Wi-Fi

To update your System over Wi-Fi your vehicle must be within the range of a Wi-Fi access point. Data rates may apply.

To connect your system to Wi-Fi, select:

Menu Item	
Settings	
Wi-Fi	
Available Wi-Fi Networks	You can then select your Wi-Fi network. You may have to enter the security code if the network is secured. The system confirms when it has connected to the network.

You must also give the system permission to update automatically. Upon vehicle delivery, the System asks you if you would like to use the automatic update feature. If you agree to automatic updates, you can press OK to confirm. If this selection does not appear upon vehicle delivery you can access it through the General Settings. See **Settings** (page 248). You can also perform a master reset. See **SYNC™ 3 Troubleshooting** (page 259).

If you would like to switch this feature on later, select:

Menu Item	
Settings	
General	
Automatic System Updates	From this menu, you can enable automatic updates. If you have not done so already, the system prompts you to set up a Wi-Fi connection when you enable this feature.

When Wi-Fi and automatic updates are enabled, your system checks for software updates periodically. If a new version is available, it downloads at that time. Software downloads can take place for up to 30 minutes after you have switched your vehicle off. The updates do not interrupt the normal use of your SYNC 3 system. If a download does not complete for any reason, the download continues where it left off at the next Wi-Fi connected opportunity. Upon activation of an update, a banner displays on the touchscreen indicating the system update. Select the icon to see more detail. This icon displays for two ignition cycles.

To switch this feature off:

Menu Item	
Settings	
General	
Automatic System Updates	In this menu selection, you can change the selection for automatic updates to OFF.

Support

The SYNC support team is available to help you with any questions you are not able to answer on your own.

Monday-Saturday, 8:30am-8:00pm EST.

United States: 1-800-392-3673.

Canada: 1-800-565-3673.

Times are subject to change due to holidays.

Privacy Information

When you connect a cellular phone to SYNC 3, the system creates a profile within your vehicle that links to that cellular phone. This profile helps in offering you more cellular features and operating more efficiently. Among other things, this profile may contain data about your cellular phone book, text messages (read and unread), and call history, including history of calls when your cell phone was not connected to the system. In addition, if you connect a media device, the system creates and retains an index of supported media content. The system also records a short diagnostic log of approximately 10 minutes of all recent system activity. The log profile and other system data may be used to improve the system and help diagnose any problems that may occur.

The cellular profile, media device index, and diagnostic log remain in your vehicle unless you delete them and are generally accessible only in your vehicle when the cellular phone or media player is connected.

If you no longer plan to use the system or your vehicle, we recommend you perform a Master Reset to erase all stored information. You can find more information about the Master Reset in General Settings. See **Settings** (page 248). System data cannot be accessed without special equipment and access to your vehicle's SYNC 3 module. Ford Motor Company and Ford of Canada do not access the system data for any purpose other than as described absent consent, a court order, or where required by law enforcement, other government authorities, or other third parties acting with lawful authority. Other parties may seek to access the information independently of Ford Motor Company and Ford of Canada.

HOME SCREEN



E207616

Item	Title	Home screen display
A	Audio	Shows the active media source.
B	Phone	The name of the connected phone appears on the screen. The status of the phone features also appear. This includes signal strength, battery charge, 911 assist setting state (On or Off), text messaging and roaming.
C	Navigation	This map displays your current location or current route in real time. When you have navigation active, you also see the next turn and the length of time and distance to your destination.

You can touch any of the feature displays to access that feature.

Anytime you select the home button, the system returns you to this screen.

SYNC™ 3 (If Equipped)

USING VOICE RECOGNITION

The SYNC 3 system allows you to use voice commands, to control features like audio. By using voice commands, you can keep your hands on the wheel and your eyes on the road.

You can access each feature controlled by SYNC 3 through a variety of commands.



To activate the SYNC 3 voice commands push the voice button on the steering wheel and wait for the prompt.

___ is a dynamic listing, meaning that it can be the name of anything, such as artist, the name of contact or number. The context and the description of the command tell you what to say for this dynamic option.

There are some commands that work for every feature, these commands are:

Voice Command	Action and Description
Main Menu	Brings you to the main menu.
Go back	Returns you to the previous screen.
Cancel	Ends the voice session.
List of Commands	Gives you a list of possible voice commands.
___ List of Commands	You can name any feature and the system gives a list of commands available for the feature. For example, you could say: Phone List of Commands Navigation List of Commands
Next Page	You can use this command to view the next page of options on any screen where multiple pages of choices are given.
Previous Page	You can use this command to view the previous page of options on any screen where multiple pages of choices are given.
Help	Gives you available commands you can use on the current screen.

Included here are some of the most popular commands for each SYNC 3 feature.

Audio Voice Commands

___ is a dynamic listing, meaning that for audio voice commands it can be a radio frequency number or the name of a artist, album, song or a genre.

SYNC™ 3 (If Equipped)

To control the media features, press the voice button and when prompted, say:

Voice command	Description
AM ____ FM ____	Allows you to tune to a specific FM or AM frequency such as "88.7 FM" or "1580 AM".
FM ____ HD ____ *	Allows you to tune to a specific HD frequency such as "88.7 FM HD 1".
Bluetooth Audio	Allows you to listen to music on your Bluetooth-connected device.
USB	Allows you to listen to music on your USB connected device.
Play Genre ____ Play Playlist ____ Play Artist ____ Play Album ____ Play Podcast ____ Play Song ____ Play Audiobook ____	For USB audio only, you can say the name of an artist, album, song or a genre to listen to that selection. Your system must finish indexing before this option is available. For example, you could say "Play artist, The Beatles" or "Play song, Penny Lane".
Browse ____	For USB audio only, you can say the name of an artist, album, or a genre to browse by that selection. Your system must finish indexing before this option is available. For example you can say "Browse The Beatles" or "Browse folk".

* This option may not be available in all markets or may require a subscription.

Phone Voice Commands

Pairing a Phone

You can use voice commands to connect your Bluetooth-enabled phone to the system.

SYNC™ 3 (If Equipped)

To pair your phone, press the voice button and when prompted, say:

Voice command	Description
Pair Phone	Follow the on-screen instructions to complete the pairing process. See Settings (page 248).

Making Calls

___ is a dynamic listing, meaning that for phone voice commands it can be the name of the contact you wish to call or the digits you want to dial.

Press the voice button and say a command similar to the following:

Voice command	Description
Call ___	Allows you to call a specific contact from your phonebook such as "Call Jenny".
Call ___ at ___	Allows you to call a specific contact from your phonebook at a specific location such as "Call Jenny at Home".
Dial ___	Allows you to dial a specific number such as "Dial 867-5309".

Please make sure that you are saying the contact name exactly as it appears in your contact list.

Once you have provided the digits of the phone number, you can say the following commands:

Voice Command	Description
<0-9>	If the full number was not entered with the first command, you can continue saying the number.
Dial	Tells SYNC 3 to make the phone call.
Delete	Tells SYNC 3 to erase the last block of digits stated.
Clear	Tells SYNC 3 to erase the entire number.

SYNCTM 3 (If Equipped)

Text Message Voice Commands

To access text message options, press the voice button and say:

Voice command	Description
Listen to Message	
Listen to text message ___	You can say the number of the message you would like to hear.
Reply to Message	

Navigation Voice Commands

___ is a dynamic listing, meaning that for navigation voice commands it can be a POI category or an address.

Setting a Destination

You can use any of the following commands to set a destination or find a point of interest.

You can find an address, a point of interest (POI), or search for points of interest by category:

Voice command	Description
Find an Address	Allows you to enter the address search functionality.
Find a ___	State the name of the POI category you would like to search for such as "Find restaurants".
Find POI	Allows you to enter the POI search functionality.
Find Intersection	Allows you to enter the intersection search functionality.
Destination Nearest ___	State the name of the POI category you would like to search for nearby such as "Destination nearest restaurants".
Destination Previous Destination	Allows you to see a list of your previous destinations.
Destination Home	Allows you to route to your home address.

SYNC™ 3 (If Equipped)

In addition, you can say these commands when a route is active:

Voice command	Description
Cancel Route	Cancels the current route.
Detour	Allows you to select an alternate route.
Repeat Instruction	Repeats the last guidance prompt.
Show Route	Repeats the last guidance prompt.
Where Am I	Provides current location.
Zoom in	Allows you to zoom in on the map.
Zoom out	Allows you to zoom out from the map.

Mobile App Voice Commands (If Equipped)

The following voice commands are always available:

Voice command	Description
Mobile Apps	SYNC 3 will prompt you to say the name of an app to start it on SYNC 3.
List Mobile Apps	SYNC 3 will list all of the currently available Mobile Apps.
Find New Apps	SYNC 3 will search and connect to compatible app(s) running on your mobile device.

There are also voice commands that you can use when app(s) are connected to SYNC 3:

Voice command	Description
Say the name of an app	At any time, you can say the name of a mobile app to start the mobile app on SYNC 3.
Say the name of an app, followed by help	SYNC 3 will list the available voice commands for the specified app if the app is running on SYNC 3.

Voice Settings Commands

You can say the following commands to access the voice settings:

Voice command	Description
Voice Settings	Allows you to enter the voice settings functionality.
Interaction Mode Standard	Sets standard prompting with longer prompts.
Interaction Mode Advanced	Sets advanced prompting with shorter prompts.
Phone Confirmation On	Allows the system to confirm before making a phone call.
Phone Confirmation Off	The system does not confirm before placing a call.
Voice Command Lists On	The system displays a short list of available commands.
Voice Command Lists Off	The system does not display the list of commands.

You can use the volume control to adjust the volume of the system voice prompts. While prompt is active, adjust the volume control up or down to your desired setting.

ENTERTAINMENT

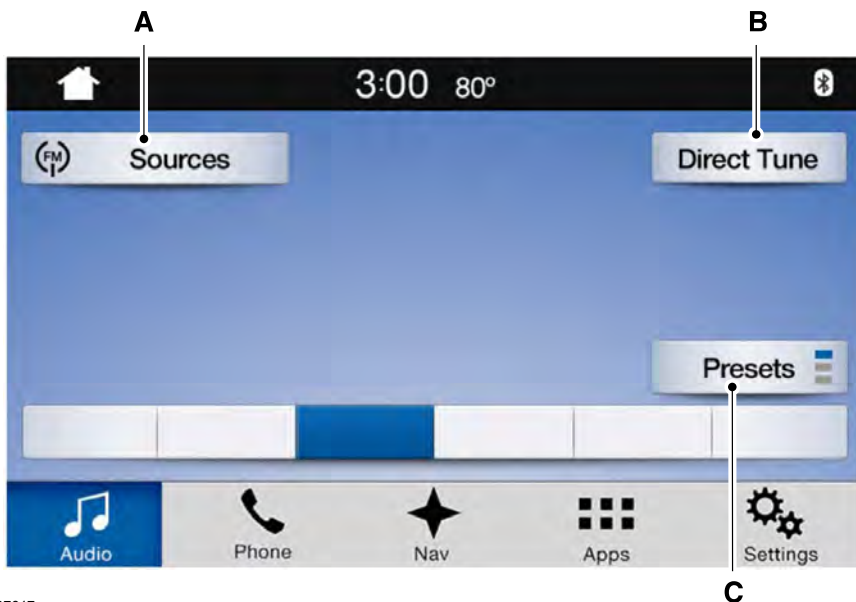

E207617

Message	Message and description
A	Sources
B	Direct Tune
C	Presets

You can access these options using the touchscreen or voice commands.

Sources

Press this button to select the source of media you want to listen to.

Menu item	
AM	
FM	
USB	The name of the USB that is plugged in displays here.

SYNC™ 3 (If Equipped)

Menu item	
Bluetooth Stereo	
Apps	If you have SYNC 3 compatible apps on your connected smart phone, they display here as individual source selections.

* This feature may not be available in all markets and requires an active subscription.

AM/FM Radio

Tuning a Station

You can use the tune or seek controls on the radio bezel to select a station.

To tune a station using the touchscreen, select:

Menu item
Direct Tune

A pop up appears, allowing you to type in the frequency of a station. You can only enter a valid station for the source you are currently listening to.

You can press the backspace button to delete the previously entered number.

Once you have entered the station's call numbers, you can select:

Menu item	Action and description
Enter	Press to begin playing the station you have entered.
Cancel	Press to exit without changing the station.

Presets

To set a new preset, tune to the station and then press and hold one of the memory preset buttons. The audio mutes briefly while the system saves the station and then returns.

There are two preset banks available for AM and three banks for FM. To access additional presets, tap the preset button. The indicator on the preset button shows which bank of presets you are currently viewing.

Bluetooth Stereo or USB

Bluetooth Stereo and USB allow you to access media that you store on your Bluetooth device or USB device such as music, audio books or podcasts.

SYNC™ 3 (If Equipped)

The following buttons are available for Bluetooth and USB:

Button	Function
Repeat	Pressing the repeat button toggles the repeat setting through three modes: repeat off (button not highlighted), repeat all (button highlighted) and repeat track (button highlighted with a small number one).
Shuffle	Play the tracks in random order.

You can use the forward, reverse, pause or play buttons to control the audio playback.

To get more information about the currently playing track, press the cover art or Info button.

For some devices, SYNC 3 is able to provide 30-second skip buttons when you listen to audio books or podcasts. These buttons allow you to skip forward or backward within a track.

While playing audio from a USB device you can look for certain music by selecting the following:

Button	Function
Browse	If available, displays the list of tracks in the Now Playing playlist.
New Search	This option, which is available under browse, allows you to play all tracks or to filter the available media into one of the below categories.
	Play All
	Playlists
	Artist
	Albums
	Songs
	Genres
	Podcasts
Audiobooks	

SYNC™ 3 (If Equipped)

Button	Function
	Composers
A-Z Jump	This button allows you to choose a specific letter to view within the category you are browsing.
Explore Device	If available, this allows you to browse the folders and files on your USB device.

USB Ports



E244044

The USB ports are in the lower center of the instrument panel, just above the floor console.

This feature allows you to plug in USB media devices, memory sticks, flash drives or thumb drives, and charge devices if they support this feature.

Select this option to play audio from your USB device.

Apps

The system supports the use of certain audio apps such as Pandora or iHeartRadio through a USB or Bluetooth-enabled device.

Each app gives you different on-screen options depending on the app's content. See **Apps** (page 247).

Supported Media Players, Formats and Metadata Information

The system is capable of hosting nearly any digital media player, including iPod, iPhone, and most USB drives.

Supported audio formats include MP3, WMA, WAV, AAC, and FLAC.

Supported audio file extensions include MP3, WMA, WAV, M4A, M4B, AAC, and FLAC.

Supported USB file systems include: FAT, exFAT, and NTFS.

SYNC 3 is also able to organize the media from your USB device by metadata tags. Metadata tags, which are descriptive software identifiers embedded in the media files, provide information about the file.

SYNC™ 3 (If Equipped)

If your indexed media files contain no information embedded in these metadata tags, SYNC 3 may classify the empty metadata tags as unknown.

SYNC 3 is capable of indexing up to 50,000 songs per USB device, for up to 10 devices.

PHONE

WARNING



Driving while distracted can result in loss of vehicle control, crash and injury. We strongly recommend that you use extreme caution when using any device that may take your focus off the road. Your primary responsibility is the safe operation of your vehicle. We recommend against the use of any hand-held device while driving and encourage the use of voice-operated systems when possible. Make sure you are aware of all applicable local laws that may affect the use of electronic devices while driving.

Hands-free calling is one of the main features of the system. Once you pair your cell phone, you can access many options using the touchscreen or voice commands. While the system supports a variety of features, many are dependent on your cell phone's functionality.

Pairing Your Cell Phone for the First Time

Pair your Bluetooth enabled phone with the system before using the functions in hands-free mode.

Switch on Bluetooth on your device to begin pairing. See your phone's manual if necessary.

To add a phone, select:

Menu Item
Add Phone

1. Follow the on-screen instructions.
2. A prompt alerts you to search for the system on your phone.
3. Select your vehicle's make and model as it displays on your phone.
4. Confirm that the six-digit number appearing on your phone matches the six-digit number on the touchscreen.
5. The touchscreen indicates when the pairing is successful.
6. Your phone may prompt you to give the system permission to access information. To check your phone's compatibility, see your phone's manual or visit the website.

Alternatively, to add a phone, select:

Menu Item
Add Phone
Then select:
Discover Other Bluetooth Devices

1. Follow the on-screen instructions.
2. Select your phone's name when it appears on the touchscreen.
3. Confirm that the six-digit number appearing on your phone matches the six-digit number on the touchscreen.
4. The touchscreen indicates when the pairing is successful.
5. Your phone may prompt you to give the system permission to access information. To check your phone's compatibility, see your phone's manual or visit the website.

SYNCTM 3 (If Equipped)

At a minimum, most cell phones with Bluetooth wireless technology support the following functions:

- Answering an incoming call.
- Ending a call.
- Dialing a number.
- Call waiting notification.
- Caller identification.

Other features, such as text messaging using Bluetooth and automatic phonebook download, are phone-dependent features.

To check your phone's compatibility, see your phone's manual or visit the website:

Websites
owner.ford.com www.syncmyride.ca www.syncmaroute.ca

Phone Menu

This menu becomes available after pairing a phone.

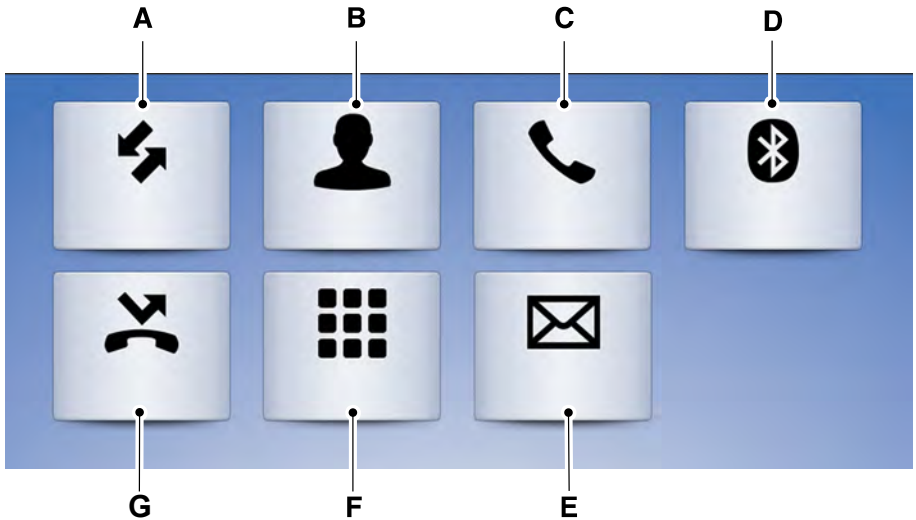

E251249

Item	Menu Item	Action and Description
A	Recent Call List	Displays your recent calls. You can place a call by selecting an entry from this list.

SYNC™ 3 (If Equipped)

Item	Menu Item	Action and Description			
		You can also sort the calls by selecting the drop down menu at the top of the screen. You can choose:			
		All	Incoming	Outgoing	Missed
B	Contacts	All of your contacts from your phone display in alphabetical order.			
		A-Z Jump		Selecting this button allows you to choose a specific letter to view.	
C	Phone Settings	Displays the name of your phone and takes you to the phone settings options. From this menu, you can pair subsequent devices, set ring tones and alerts.			
D	Change Device	Gives you access to the list of paired or connected Bluetooth devices allowing you to change or select a device.			
E	Text Messages	Displays all recent text messages.			
F	Phone Keypad	Use this keypad to dial in a phone number. Use the backspace button to delete numbers.			
		Call		Press this button to begin a call.	
G	Do Not Disturb	Touch this button to reject all incoming calls automatically. Text message notifications do not display on the screen. All ringtones and alerts are set to silent.			

Users with phones having voice services may see a button to access the feature. For example, iPhone users see a Siri button. A press and hold of the voice button on the steering wheel also accesses this feature.

Making Calls

There are many ways to make calls from the SYNC 3 system, including using voice commands. See **Using Voice Recognition** (page 224). You can use the touchscreen to place calls as well.

To call a number in your contacts, select:

Menu Item	Action and Description
Contacts	You can then select the name of the contact you want to call. Any numbers stored for that contact display along with any stored contact photos. You can then select the number that you want to call. The system begins the call.

To call a number from your recent calls, select:

Menu Item	Action and Description
Recent Call List	You can then select an entry that you want to call. The system begins the call.

To call a number that is not stored in your phone, select:

Menu Item	Action and Description
Phone Keypad	Select the digits of the number you wish to call.
Call	The system begins the call.

Pressing the backspace button deletes the last digit you typed.

Receiving Calls

During an incoming call, an audible tone sounds. Caller information appears in the display if it is available.

To accept the call, select:

Menu Item
Accept

Note: You can also accept the call by pressing the phone button on the steering wheel.

To reject the call, select:

Menu Item
Reject

Note: You can also reject the call by pressing the phone button on the steering wheel.

Ignore the call by doing nothing. SYNC 3 logs it as a missed call.

During a Phone Call

During a phone call, the contacts name and number display on the screen along with the call duration.

The phone status items are also visible:

- Signal Strength.
- Battery.
- 911 Assist (United States and Canada only). See **Settings** (page 248).

You can select any of the following during an active phone call:

SYNC™ 3 (If Equipped)

Item	
End Call	Immediately end a phone call. You can also press the button on the steering wheel.
Keypad	Press this to access the phone keypad.
Mute	You can switch the microphone off so the caller does not hear you.

Item	
Privacy	Transfer the call to the cell phone or back to SYNC 3.

Text Messaging

Note: *Downloading and sending text messages using Bluetooth are cell phone-dependent features.*

Note: *Certain features in text messaging are speed-dependent and not available when your vehicle is traveling at speeds over 3 mph (5 km/h).*

Receiving a Text Message

When a new message arrives, an audible tone sounds and the screen displays a pop-up with the caller name and ID, if supported by your cell phone. You can select:

Menu Item	Action and Description
Hear It	Have SYNC 3 read the message to you.
View	View the text on the touchscreen.
Call	To call the sender.
Reply	You can select from 15 preset messages. Press the message that you would like to use and confirm to send the message. SYNC 3 confirms when the message is sent successfully.
Close	To exit the screen.

Smartphone Connectivity (If Equipped)

SYNC 3 allows you to use Apple CarPlay and Android Auto to access your phone.

When you use Apple CarPlay or Android Auto, you can:

- Make calls.
- Send and receive messages.
- Listen to music.
- Use your phone's voice assistant.

Apple CarPlay and Android Auto disable some SYNC 3 features.

Most Apple CarPlay and Android Auto features use mobile data.

Apple CarPlay

Apple CarPlay requires an iPhone 5 or newer with iOS 7.1 or newer. Updating to the latest iOS version is recommended.

1. Plug your phone into a USB port. See **USB Port** (page 212).

SYNC™ 3 (If Equipped)

- Follow the prompts on the touchscreen.
- Follow the prompts that appear on your phone to allow access to Apple CarPlay.

After completing the setup, your phone connects to CarPlay automatically when plugged into a USB port.

To disable this feature from the Settings screen, select:

Menu Item
Apple CarPlay Preferences
Your device is listed if SYNC detects Apple CarPlay. Select the name of your device and select:
Disable

To return to SYNC 3, go to the Apple CarPlay home screen and select the SYNC app.

Note: Contact Apple for Apple CarPlay support.

Android Auto

Android Auto is compatible with most devices with Android 5.0 or newer.

- Download the Android Auto app to your device from Google Play to prepare your device (this may require mobile data usage).

Note: The Android Auto App may not be available within your current market.

- Plug your device into a USB port. See **USB Port** (page 212).
- To switch this feature on from the Settings screen, scroll left on the screen and select:

Menu Item
Android Auto Preferences
Enable Android Auto

Note: Android Auto must be switched on after plugging in your device.

To disable this feature from the Settings screen, select:

Menu Item
Android Auto Preferences
Your device is listed if SYNC detects Android Auto. Select the name of your device and select:
Disable

Note: You may need to slide your Settings screen to the left to select **Apple CarPlay Preferences** or **Android Auto Preferences**.

To return to SYNC 3, select the speedometer icon in the Android Auto menu bar at the bottom of the touchscreen, and then touch the option to return to SYNC.

Note: Contact Google for Android Auto support.

NAVIGATION

Your navigation system is comprised of two main features, destination mode and map mode.

Map Mode

Map mode shows advanced viewing comprised of 2D city maps, 3D landmarks and 3D city models (when available). 2D city maps show detailed outlines of buildings, visible land use, landscape features, and detailed railroad infrastructure for the most essential cities around the globe.

3D landmarks appear as clear, visible objects that are typically recognizable and have a certain tourism value.

3D city models are complete 3D models of entire city areas including navigable roads, parks, rivers and rendered buildings. 3D landmarks and city models appear in 3D map mode only. Coverage of these varies and improves with updated map releases.



Select the zoom in icon to see a closer view of the map.



Select the zoom out icon to see a farther away view of the map.

You can adjust the view in preset increments. You can also pinch to zoom in or out of the map.

The information bar tells you the names of streets, cities or landmarks as you hover over them with the crosshair cursor.

You can change your view of the map by tapping on the location indicator icon on the right hand side of the screen. You can choose from the following options:



Heading up (2D map) This always shows the direction of forward travel to be upward on the screen. This view is available for map scales up to 3 mi (5 km).



North up (2D map) always shows the northern direction to be upward on the screen.



3D map mode provides an elevated perspective of the map. Adjust this viewing angle and rotate the map 180 degrees by touching the map twice, and then dragging your finger along the shaded bar with arrows at the bottom of the map.



Re-center the map by pressing this icon whenever you scroll the map away from your vehicle's current location.



Points of Interest (POI) grouping icon:

You can choose up to three POI icons to display on the map. If the chosen POIs are located close together or are

at the same location a box is used to display a single category icon instead of repeating the same icon, in order to reduce clutter. When you select the box on the map, a pop-up appears indicating how many POIs are in this location. Select the pop up to see a list of the available POIs. You can scroll through and select POIs from this list.

If your vehicle is low on charge or fuel, station icons automatically display on the map.

You can choose to display traffic icons on the map representing twelve different types of incidents. See **Settings** (page 248).

You can set a destination by hovering above a location and selecting:

Button
Start

SYNCTM 3 (If Equipped)

Destination Mode

To set a destination, press:

Menu Item	Description
Destination	
Enter a navigation destination in any of the following formats:	
Search	Street Address (number, street, city, state) For example "12 Mainstreet Dearborn MI"
	Partial Address (number, street) if searching in current state (number, street and zip code (or postal code in Canada)) if searching out of state You can enter unique addresses that contain door number prefixes with or without the prefix. For example, you could enter "6N340 Fairway Lane" or "340 Fairway Lane".
	City (name or zip code)
	Point of Interest (name or category)
	Intersection (street 1 / street 2) (street 1 and street 2) (street 1 & street 2) (street 1 @ street 2) (street 1 at street 2)
	Latitude and Longitude (##.##### , ##.#####) This is in a decimal degrees format, one to six decimal places are accepted.
	You are given autocomplete options below the address bar to select as you type. If you do not give an exact destination, a menu displays with your possible selections.
Previous Destinations	Collections of your last 40 navigation destinations display here. You can select any option from the list to select it as your destination.

SYNC™ 3 (If Equipped)

Menu Item	Description	
	Delete All	Select this option to remove all previous destinations.
Home	Select to navigate to your set Home destination. The time it takes to travel from your current location to Home displays. To set your Home, press:	
	Home	A prompt appears asking if you would like to create a favorite for home. Select:
	Yes	Enter a location into the search bar and press:
	Save	
Work	Select to navigate to your set Work destination. The time it takes to travel from your current location to Work displays. To set your Work:	
	Work	A prompt appears asking if you would like to create a favorite for work. Select:
	Yes	Enter a location into the search bar and press:
	Save	
Favorites	Favorites include any location you have previously saved. To add Favorites:	
	Add a Favorite	Select this button and enter a location into the destination bar.
	Search	Select this option to have the system locate the address you have entered.
	Save	Select this button when the address you have entered appears on the screen.
	The address saves as a favorite and you see the favorites screen. You can now select this address from the favorites screen.	
Point of Interest (POI) Categories	POI categories that may display (based on market and vehicle configuration):	
	Food	
	Fuel	
	Hotel	
	ATM	

SYNCTM 3 (If Equipped)

Menu Item	Description	
	See All	Press to view additional categories. Once you have selected a category, follow the menus to find what you are looking for.
	Inside of these categories you can search by:	
	Nearby	
	Along Route	
	Near Destination	
	In a City	

Once you have chosen your destination, press:

Menu Item	Action and Description	
Save	This saves the destination to your favorites.	
Start	This shows you a map of your entire route. You can then choose your route from three different options.	
	Fastest	Uses the fastest moving roads possible.
	Shortest	Uses the shortest distance possible.
	Economical Route	Uses the most fuel-efficient route.
	The time and distance for each route also displays.	
Cancel	On the route screen, you can choose to cancel the current navigation. The system asks for confirmation then returns you to the map mode screen.	

Once you have chosen you destination, press:

Menu Item	Action and Description
Start	The system uses a variety of screens and prompts to guide you to your destination. During Route guidance, you can press the maneuver arrow icon on the map if you want the system to repeat route guidance instructions. When the system repeats the last guidance instruction, it updates the distance to the next guidance instruction, since it detects that the vehicle is moving.

SYNC™ 3 (If Equipped)

Menu Item	Action and Description
	The navigation map shows your estimated time of arrival, remaining travel time and the distance to your destination. SYNC 3 may not always announce vehicle arrival at the exact point of your destination and you may have to cancel a route manually.

Navigation Menu

In map mode and during active navigation you can access the navigation menu.

During active navigation, touch the bottom of the screen to view the menu and other buttons.

To access the Navigation menu, press:

Button		
Menu		
You can then select:		
Screen View	Full Map	A full screen map displays during navigation.
	Highway Exit Info	Highway exit information displays on the right hand side of the screen during navigation. Points of interest icons display for restaurants, hotels, fuel stations and ATMs when they are present at the exit. You can select the POI icons to receive a listing of specific locations. You can select the POI location as a waypoint or destination if desired.
	Turn List	Only available during an active route. Displays all of the turns on the current route. You can choose to avoid any road on the turn list by selecting the road from the list. A screen then appears and you can press:
		Avoid
Navigation Settings	Press this button to adjust your preferences. See Settings (page 248).	
Where Am I?	Provides your current location city and the nearest road.	
The following are only available on the menu during an active navigation route:		
Cancel Route	The system asks for confirmation and then returns you to the map mode screen.	

SYNC™ 3 (If Equipped)

Button	
Mute Guidance	Selecting this option switches off the audio navigation guidance. Press the button again to un-mute guidance.
View Route	Press this to see a map of the full route.
Detour	An alternate route displays in comparison with the current route.
Edit Waypoints	Only available if you have an active waypoint on your route. See Waypoints later in this section for information on how to set waypoints.
	Use this button to re-order or remove your waypoints.
	You can also have the system set the order for you by pressing:
To return to your route press:	Go

Waypoints

You can add a waypoint to a navigation route as a destination along your route.

To add a waypoint:

1. Select the search icon (magnifying glass) while on an active route. This brings up the destination menu.
2. Set your destination using any of the given methods. Once the destination has been selected, the screen allows you to set the destination as a waypoint by selecting:

Menu Item	
Add Waypoint	The waypoint list then appears and you are able to re-order all of your waypoints by selecting the menu icon on the right hand side of the location. You can select up to five waypoints.
You can also have the system set the order for you by pressing:	Optimize Order
To return to your route, press:	Go

SYNC™ 3 (If Equipped)

cityseeker (If Equipped)

Note: cityseeker point of interest (POI) information is limited to approximately 1110 cities (1049 in the United States, 36 in Canada and 15 in Mexico).



E225487

cityseeker, when available, is a service that provides more information about certain points of interest such as restaurants, hotels and attractions.

When you have selected a point of interest, the location and information appear, such as address, phone number and a star rating.

Press **More Information** to see a photo, a review, a list of services and facilities, the average room or meal price and the web address. This screen displays the point of interest icons.

For restaurants, cityseeker can provide information such as star rating, average cost, review, handicap access, hours of operation, and website address.

For hotels, cityseeker can provide information such as star rating, price category, review, check-in and checkout times, hotel service icons and website address. Hotel service icons include:

- Restaurant
- Business center
- Handicap facilities
- Laundry
- Refrigerator
- 24 hour room service

- Fitness center
- Internet access
- Pool
- Wi-Fi

Attractions include nearby landmarks, amusement parks, historic buildings and more. cityseeker can provide information such as star rating, reviews, hour of operation and admission price.

Navigation Map Updates

Annual navigation map updates are available for purchase through your dealership, by calling 1-866-462-8837 in the United States and Canada or 01-800-557-5539 in Mexico. You can also visit:

Website
www.navigation.com/sync

You need to specify the make and model of your vehicle to determine if there is an update available.

HERE is the digital map provider for the navigation application. If you find map data errors, you may report them directly to HERE by going to www.here.com/mapcreator. HERE evaluates all reported map errors and responds with the result of their investigation by e-mail.

Map coverage includes the USA (including Puerto Rico and the US Virgin Islands), Canada and Mexico.

SYNC™ 3 (If Equipped)

APPS

The system enables voice, steering wheel, and touch screen control of SYNC 3 AppLink enabled smartphone apps. Once an app is running through AppLink, you can control main features of the app through voice commands and steering wheel controls.

Note: Available AppLink enabled apps will vary by market.

Note: You must pair and connect your smartphone via Bluetooth to SYNC 3 to access AppLink.

Note: iPhone users need to connect the phone to the USB port.

Note: For information on available apps, supported smartphone devices and troubleshooting tips please visit:

Websites
owner.ford.com www.syncmyride.ca www.syncmaroute.ca

Note: Make sure you have an active account for the app that you have downloaded. Some apps will work automatically with no setup. Other apps will want you to configure your personal settings and personalize your experience by creating stations or favorites. We recommend you do this at home or outside of your vehicle.

Note: We encourage you to review the smartphone app's terms of service and privacy policies because Ford is not responsible for your app or its use of data.

Note: AppLink is a native SYNC system feature. Accessing mobile apps through AppLink is only possible when Android Auto or Apple CarPlay are disabled. Some apps may only be accessible in the car through AppLink and others only through Android Auto or Apple CarPlay. Please refer to the Smartphone Connectivity information to disable Android Auto or Apple CarPlay.

Note: In order to use an app with SYNC 3, the App needs to be running in the background of your phone. If you shut down the app on your phone, it shuts down the app on SYNC 3 as well.

Note: If a SYNC 3 AppLink compatible app is not shown in the Apps Domain, make sure the required app is running on the mobile device.

Menu Item	Action and Description
Connect Mobile Apps	SYNC 3 will search and connect to compatible app(s) running on your mobile device.

Enabling SYNC 3 Mobile Apps

In order to enable mobile apps, SYNC 3 requires user consent to send and receive app authorization information and updates using the data plan associated with the connected device.

The connected device sends data to Ford in the United States. The information is encrypted and includes your VIN, SYNC 3 module number, odometer, usage statistics and debugging information. We retain this data for only as long as necessary to provide this service, troubleshoot, and improve products and services and to offer you products and services that may interest you where allowed by law.

SYNC™ 3 (If Equipped)

Note: You must enable mobile apps for each connected device the first time you select a mobile app using the system.

Note: Ford reserves the right to limit functionality or deactivate mobile apps at any time.

Note: Standard data rates apply. Ford is not responsible for any additional charges you may receive from your service provider, when your vehicle sends or receives data through the connected device. This includes any additional charges incurred due to driving in areas when roaming out of a home network.

You can enable and disable apps through settings. See **Settings** (page 248).

App Permissions

The system organizes the App permissions into groups. You can grant these group permissions individually. You can change a permission group status any time when not driving, by using the settings menu. While in the settings menu, you can also see the data included in each group.

When you launch an app using SYNC 3, the system may ask you to grant certain permissions, for example Vehicle information, Driving characteristics, GPS and Speed, and/or Push notifications. You can enable all groups or none of them during the initial app permissions prompts. The settings menu offers individual group permission control.

Note: You are only prompted to grant permissions the first time you use an app with SYNC 3.

Note: If you disable group permissions, apps will still be enabled to work with SYNC 3 unless you deactivate All Apps in the settings menu.

SETTINGS

Under this menu, you can access and adjust the settings for many of the system features. To access additional settings, swipe the screen left or right.

Sound

Pressing this button allows you to adjust the following:

Sound Settings	
Reset All	Returns Treble, Midrange, and Bass sound settings to factory levels.
Treble	Adjusts the high frequency level.
Midrange	Adjusts the middle frequency level.
Bass	Adjusts the low frequency level.
Balance	Adjusts the sound ratio from side to side.
Speed Compensated Vol.	Adjusts the amount the audio system volume increases with speed, or turns the feature off.
Occupancy Mode	Optimizes the sound based on the location of the listeners.

SYNC™ 3 (If Equipped)

Sound Settings	
Sound Settings	Stereo
	Surround

Your vehicle might not have all of these features.

Media Player

This button is available when a media device such as a Bluetooth Stereo or USB device is the active audio source. Pressing the button allows you to access the following options for active devices only.

Menu Item	Action and Description		
Podcast Speed	For some Apple devices, SYNC 3 can adjust the playback speed of podcasts. When a podcast is playing, you can choose:		
	Slower	Normal	Faster
Audiobook Speed	For some Apple devices, SYNC 3 can adjust the playback speed of audiobooks. When an audiobook is playing, you can choose:		
	Slower	Normal	Faster
Cover Art Priority	Media Player	Cover art displays from your device's music files. If no cover art for the files exists on the device, then the Gracenote Database provides cover art.	
	Gracenote®	The Gracenote Database supplied cover art is used for your music files. This overrides any cover art from your device.	
Gracenote® Management	Switches on an off Gracenote® to provide metadata information such as genre, artist, album.		
Gracenote® Database Info	This allows you to view the version level of the Gracenote Database.		
Device Information	This allows you to view the manufacturer and model number of your media device.		
Update Media Index	Erase the stored in media information in order to re-index.		

SYNC™ 3 (If Equipped)

Clock

To adjust the time, select the up and down arrows on either side of the screen. The

arrows on the left adjust the hour and arrows on the right adjust the minute. You can then select AM or PM.

You can adjust the following features:

Menu Item	Action and Description
Clock Format	Select how time displays.
Auto Time Zone Update	When active, the clock adjusts to time zone changes. This feature is only available in vehicles with navigation.
Reset Clock to GPS Time	When selected, the vehicle clock resets to GPS satellite time.

The system automatically saves any updates you make to the settings.

Bluetooth

Pressing this button allows you to access the following:

Menu Item	Action
Bluetooth	Turning Bluetooth off disconnects all devices and does not permit new connections.

You must activate Bluetooth to pair a Bluetooth-enabled device.

The processes of pairing a Bluetooth device is the same as pairing a phone. **See Pairing a Device** in Phone settings for how to pair a device and the available options.

Phone

Pair your Bluetooth-enabled phone with the system before using the functions in hands-free mode.

Switch on Bluetooth on your device to begin pairing. See your phone's manual if necessary.

To add a phone, select:

Menu Item
Add Phone

1. Follow the on-screen instructions.
2. A prompt alerts you to search for the system on your phone.
3. Select your vehicle's make and model as it displays on your phone.
4. Confirm that the six-digit number appearing on your phone matches the six-digit number on the touchscreen.
5. The touchscreen indicates when the pairing is successful.

SYNC™ 3 (If Equipped)

- Your phone may prompt you to give the system permission to access information. To check your phone's compatibility, see your phone's manual or visit the website.

Alternatively, to add a phone, select:

Menu Item
Add Phone
Then select:
Discover Other Bluetooth Devices

- Follow the on-screen instructions.
- Select your phone's name when it appears on the touchscreen.
- Confirm that the six-digit number appearing on your phone matches the six-digit number on the touchscreen.

- The touchscreen indicates when the pairing is successful.
- Your phone may prompt you to give the system permission to access information. To check your phone's compatibility, see your phone's manual or visit the website.

Other features, such as text messaging using Bluetooth and automatic phonebook download, are phone-dependent features.

To check your phone's compatibility, see your phone's manual or visit the website:

Website
owner.ford.com www.syncmyride.ca www.syncmaroute.ca

Once you have paired a device you can adjust the following options.

Menu Item	Action and Description
View Devices	
You can then select:	
Add a Bluetooth Device	You can add a Bluetooth-enabled device by following the steps in the previous table.
You can select a phone by touching the name of the phone on the screen. You then have the following options:	
Connect	Depending on the status of the device, you can select either of these options to interact with the selected device.
Disconnect	
Device Information	Allows you to see phone and device information.
Make Primary	Allows you to select this device to be your preferred device.
Delete	Removes the selected device from the system.

SYNC™ 3 (If Equipped)

Menu Item	Action and Description	
Manage Contacts		
You can then select:		
Auto-Download Contacts	Enable this option to have SYNC 3 periodically re-download your phonebook to keep your contact list up to date.	
Sort By:	Choose how you would like the system to display your contacts. You can choose:	
	<table border="1" style="width: 100%; border-collapse: collapse;"> <tr> <td style="width: 50%; text-align: center;">First Name</td> <td style="width: 50%; text-align: center;">Last Name</td> </tr> </table>	First Name
First Name	Last Name	
Re-download Contacts	Select this option to re-download your contact list manually.	
Delete Contacts	Select this option to delete the in vehicle contact list. Deleting the in vehicle list does not erase the contact list on the connected phone.	

Menu Item	Action and Description
Set Phone Ringtone	
You can then select:	
No Ringtone	No sound plays when a call comes to your phone.
Use Phone Ringtone	The currently selected ringtone on your phone plays when you receive a call. This option may not be available for all phones. If this option is available, it is the default setting.
You can also select one of the three available ringers.	

Menu Item	Action and Description
Text Messaging	
You can then select:	
No Alert (Silence)	No sound plays when a message comes to your phone.
You can select one of the three available notification sounds.	
Voice Readout	When enabled, a voice prompt alerts you when you receive a new message.

SYNCTM 3 (If Equipped)

You can enable and disable the following options as well:

Menu Item	Action and Description
Mute Audio in Privacy	When enabled, vehicle audio (such as radio or apps) is muted for the duration of the phone call even when the phone call is in privacy.
Roaming Warning	When enabled, an alert displays that your phone is roaming when you attempt to place a call.
Low Battery Notification	When enabled, a message displays when the battery on your phone is running low.

911 Assist

Note: This service is only available in the United States and Canada.

Select this button to modify the on or off setting for this feature. If the mobile phone's contacts have been downloaded, you can adjust the following option:

Menu Item	Action and Description
Set Emergency Contacts	You can select up to two numbers from your mobile device's phone-book as emergency contacts for quick access at the end of the 911 Assist call process.

Radio

This button is available if a Radio source such as AM or FM is the active media source. Pressing the button allows you to access the following features:

Menu Item	Action and Description
Radio Text	This feature is available when FM Radio is your active media source. Activate this feature to have the system display radio text.
Autoset Presets (AST)	Refresh
	Selecting this option stores the six strongest stations in your current location to the last preset bank of the currently tuned source.

Navigation

You can adjust many of the Navigation preferences by selecting the following menus.

SYNC™ 3 (If Equipped)

Map Preferences

Menu Item	Action and Description
Map Preferences	
Then select any of the following:	
3D City Model	When this option is active, the system shows 3D renderings of buildings.
Breadcrumbs	When enabled, your vehicle's previously traveled route displays with white dots.
POI Icons	Enable this feature to display up to 3 POI icons on the navigation map.
	Once this feature is activated you can select the icons you want displayed by selecting:
Incident Map Icons	This menu allows you to choose which incident icons you would like to have displayed on the navigation map.

Route Preferences

Menu Item	Second Level Messages, Actions and Descriptions	
Route Preferences		
Then select any of the following:		
Preferred Route	Choose to have the system display your chosen route type.	
	Shortest	Fastest
Always Use ___ Route	Bypass route selection in destination programming. The system only calculates one route based on your preferred route setting. When activated, the system uses your selected route type to calculate only one route to the desired destination.	
Use HOV Lanes	The system selects High Occupancy Vehicle or car pool lanes when providing route guidance.	
Automatically Find Parking	The system searches for and displays available parking locations as you approach your destination.	
Eco Time Penalty	Select a level of cost for the calculated Eco Route. The higher the setting, the longer the time allotment is for the route.	

SYNC™ 3 (If Equipped)

Menu Item	Second Level Messages, Actions and Descriptions
Dynamic Route Guidance	Enable or disable considering traffic information when planning a route. The system can find a faster route based on heavy traffic flow information or detect a Road Closed incident and find a detour route if possible.
Avoid Freeways	If selected, SYNC 3 avoids freeways when computing a navigation route.
Avoid Toll Roads	If selected, SYNC 3 avoids Toll Roads when computing a navigation route.
Avoid Ferries/Car Trains	If selected, SYNC 3 avoids the use of Ferries or Trains when computing a navigation route.

Navigation Preferences

Menu Item	Action and Description
Navigation Preferences	
Guidance Prompts	You can adjust how the system provides prompts.
Then select any of the following:	
Voice and Tones	A tone sounds followed by voice instructions.
Voice Only	Only voice instructions are given.
Tones Only	Only a tone sounds to prompt you.

Mobile Apps

You can enable the control of compatible mobile apps running on your Bluetooth or USB device on SYNC 3. In order to enable mobile apps, SYNC 3 requires user consent to send and receive app authorization information and updates using the data plan associated with the connected device.

The connected device sends data to Ford in the United States. The encrypted information includes your VIN, SYNC 3 module number, anonymous usage statistics and debugging information. Updates may take place automatically.

Note: *All Mobile Apps may not be compatible with the system.*

SYNC™ 3 (If Equipped)

Note: Standard data rates will apply. Ford is not responsible for any additional charges you may receive from your service provider, when your vehicle sends or receives data through the connected device. This includes any additional charges incurred due to driving in areas when roaming out of a home network.

Menu Item	Action and Description		
Mobile Apps	Enable or disable the use of mobile apps on SYNC 3. Disabling mobile apps in the settings menu disables automatic updates and the use of mobile apps on SYNC 3.		
	You can view the status of mobile app permissions in the settings menu.		
Once Mobile Apps is enabled, you have the following options:			
Update Mobile Apps	This provides information on the current state of available app updates.		
	There are three possible statuses:		
	Update Needed	Up-To-Date	Updating Mobile Apps...
	The system has detected a new app requiring authorization or a general permissions update is required.	No update is required.	The system is trying to receive an update.
	Request Update		Select this button if an update is required and you want to request this update manually. For example, when your mobile device is connected to a Wi-Fi hotspot, select:

SYNC™ 3 (If Equipped)

Menu Item	Action and Description
	Request Update
All Apps	Grant or deny permissions to all apps at once.
There may also be SYNC 3 enabled apps listed under these options.	Grant or deny an individual app particular permissions. App permissions are organized into groups. By pressing the info book icon, you can see which signals are included in each group.

Note: Ford is not responsible or liable for any damages or loss of privacy relating to usage of an app, or dissemination of any vehicle data that you approve Ford to provide to an app.

General

Access and adjust the system settings, voice features, as well as phone, navigation and wireless settings.

Menu Item	
Language	Select to have the touchscreen display in English, Spanish or French.
Distance	Select to display units in kilometers or miles.
Temperature	Select to display units in Celsius or Fahrenheit.
Touch Screen Beep	Select to have the system beep to confirm choices made through the touchscreen.
Automatic System Updates	When you activate this option, the system automatically updates when you have an available Internet connection through a Wi-Fi network or mobile connection.
About	Information pertaining to the system and its software.
Software Licenses	Documentation of the software license for the system.
Master Reset	Select to restore factory defaults. This erases all personal settings and personal data.

Wi-Fi

You can adjust the following:

SYNC™ 3 (If Equipped)

Menu Item	Action and Description
Wi-Fi	Enable this option to connect to Wi-Fi for SYNC 3 vehicle software updates.
View Available Networks	This provides you with a list of available Wi-Fi networks within range.
	Clicking on a network from the list allows you to connect or disconnect from that network. The system may require a security code to connect.
	When you click the information button next to a network, more information about the network displays such as the signal strength, connection status and security type.
Wi-Fi Available Notifications	The system alerts you when your vehicle is parked and a Wi-Fi network is within range if SYNC is not already connected.

Camera Settings

To make adjustments using the touchscreen, select:

Message	Action and Description
Camera Settings	
Then select from the following:	
Rear Camera Delay	You can enable or disable this option using the slider.

You can find more information on the rear-view camera system in the parking aids chapter of your owner manual.

Display

To make adjustments using the touchscreen, select:

Menu Item	Action and Description	
Brightness	Make the screen display brighter or dimmer.	
Mode	You can select:	
	Auto	The screen automatically switches between day and night modes based on the outside light level.
	Day	The screen displays with a light background to enhance daytime viewing.

SYNC™ 3 (If Equipped)

Menu Item	Action and Description	
	Night	The screen displays with a darker background to make nighttime viewing easier.
	Off	The screen goes black and does not display anything. To switch the screen back on, simply tap the screen.
Auto Dim	Enable this option to automatically dim the display brightness based on ambient lighting conditions.	

Voice Control

You can adjust the voice control settings by selecting the following options.

Menu Item	
Advanced Mode	Enable this option to remove additional voice prompts and confirmations.
Phone Confirmation	Enable this option to have the system confirm a contacts name with you before making a call.
Voice Command List	Enable this option to have the system display a list of available voice commands when the voice button is pressed.

Valet Mode

Valet mode allows you to lock the system. No information is accessible until the system is unlocked with the correct PIN.

When you select valet mode a pop up appears informing you that a four digit code must be entered to enable and disable valet mode. You can use any PIN you chose but you must use the same PIN to disable valet mode. The system asks you to input the code.

Note: *If the system is locked and you cannot remember the PIN, please contact the Customer Relationship Center.*

United States: 1-800-392-3673

Canada: 1-800-565-3673

To enable valet mode, enter your chosen PIN. The system then asks to confirm your PIN by reentering it. The system then locks.

To unlock the system, enter the same pin number. The system reconnects to your phone and all of your options are available again.

SYNC™ 3 TROUBLESHOOTING

Your SYNC 3 system is easy to use. However, should questions arise, please refer to the tables below.

To check your cell phone's compatibility, refer to the regional Ford or Lincoln website.

SYNC™ 3 (If Equipped)

Cell phone issues		
Issue	Possible cause	Possible solution
There is background noise during a phone call.	The audio control settings on your cell phone may be affecting SYNC 3 performance.	Refer to your device's manual about audio adjustments.
During a call, I can hear the other person but they cannot hear me.	Possible cell phone malfunction.	Try switching your cell phone off, resetting it or removing the battery, then try again.
		Make sure that the microphone for SYNC 3 is not set to off. Look for the microphone icon on the phone screen.
During a call, I cannot hear the other person and they cannot hear me.	The system may need to be restarted.	To restart your system, shut down the engine, open and close the door, and then lock the door and wait for 2-3 minutes. Make sure that your SYNC 3 screen is black and the lighted USB port is off.
SYNC 3 is not able to download my phonebook.	This is a cell phone-dependent feature.	Check your cell phone's compatibility.
	Possible cell phone malfunction.	Make sure you allow SYNC 3 to retrieve contacts from your phone. Refer to your cell manual.
		You must switch on your cell phone and the automatic phonebook download feature on SYNC 3.
Try switching your cell phone off, resetting it or removing the battery, then try again.		
The system says "Phonebook downloaded" but my SYNC 3 phonebook is empty or is missing contacts.	Limitations on your cell phone's capability.	Make sure you allow SYNC 3 to retrieve contacts from your phone. Refer to your cell manual.
		If the missing contacts are stored on your SIM card, move them to your cell phone's memory.
		You must switch on your cell phone and the automatic phonebook download feature on SYNC 3.

SYNC™ 3 (If Equipped)

Cell phone issues		
Issue	Possible cause	Possible solution
I am having trouble connecting my cell phone to SYNC 3.	This is a cell phone-dependent feature.	Check your cell phone's compatibility.
	Possible cell phone malfunction.	Try switching your cell phone off, resetting it or removing the battery, then try again.
		Try deleting your device from SYNC 3 and deleting SYNC from your device, then trying again.
		Always check the security and auto accept prompt settings relative to the SYNC 3 Bluetooth connection on your cell phone.
		Update your cell phone's firmware.
		Switch the auto download setting off.
Text messaging is not working on SYNC 3.	This is a cell phone-dependent feature.	Check your cell phone's compatibility.
	Possible cell phone malfunction.	Try switching your cell phone off, resetting it or removing the battery, then try again.
	iPhone	<ul style="list-style-type: none"> • Go to your cell phone's Settings. • Go to the Bluetooth Menu. • Press the blue circle to the right of the device named with your vehicle make and model to enter the next menu. • Turn Show Notifications on. • Disconnect then reconnect your iPhone from the SYNC 3 system to activate this settings update. <p>Your iPhone is now set up to forward incoming text messages to SYNC 3. Repeat these steps for every other SYNC 3 vehicle that you connect. Your iPhone will only forward incoming text messages to SYNC 3 if the iPhone is not unlocked in the messaging application. Replying to text messages using SYNC 3 is not supported by iPhone.</p>

SYNC™ 3 (If Equipped)

Cell phone issues		
Issue	Possible cause	Possible solution
		Text messages from WhatsApp and Facebook Messenger are not supported.
Audible text messages do not work on my cell phone.	This is a cell phone-dependent feature.	Your cell phone must support downloading text messages through Bluetooth to receive incoming text messages.
	This is a cell phone limitation.	Because each cell phone is different, refer to your device's manual for the specific cell phone you are pairing. In fact, there can be differences between cell phones due to brand, model, service provider and software version.

USB and Bluetooth Stereo issues		
Issue	Possible cause	Possible solution
I am having trouble connecting my device.	Possible device malfunction.	Disconnect the device from SYNC 3. Try switching your device off, resetting it or removing the battery, then reconnect it to SYNC 3.
		Make sure you are using the manufacturer's cable.
		Make sure to correctly insert the USB cable into the device and your vehicle's USB port.
	Make sure that the device does not have an auto-install program or active security settings.	
	The device has a lock screen enabled.	Make sure your device is unlocked before connecting it to SYNC 3.
SYNC 3 does not recognize my device when I start my vehicle.	This is a device limitation.	Make sure you are not leaving the device in your vehicle during very hot or cold temperatures.
Bluetooth audio does not stream.	This is a device-dependent feature.	Make sure you connect the device to SYNC 3 and that you have started the media player on your device.

SYNC™ 3 (If Equipped)

USB and Bluetooth Stereo issues		
Issue	Possible cause	Possible solution
	The device is not connected.	
	The device is in a bad state.	Try switching your device off, resetting it or removing the battery, then reconnect it to SYNC 3.
SYNC 3 does not recognize music that is on my device.	Your music files may not contain the correct artist, song title, album or genre information.	Make sure that all song details are populated.
	The file may be corrupted.	Try replacing the corrupt file with a new version.
	The song may have copyright protection that does not allow it to play.	Some devices require you to change the USB settings from mass storage to media transfer protocol class.
	The file format is not supported by SYNC 3.	Convert the file to a supported format. See Entertainment (page 230).
	The device needs to be re-indexed.	Update media index. See Settings (page 248).
	The device has a lock screen enabled.	Make sure your device is unlocked before connecting it to SYNC 3.
When I connect my device, I sometimes do not hear any sound.	This is a device limitation.	Disconnect the device from SYNC 3. Try switching your device off, resetting it or removing the battery, then connect it back to SYNC 3.
		To listen to Apple devices through USB, select AirPlay from the devices Control Center, then select Dock Connector.
		To listen to Apple devices through Bluetooth Stereo, select AirPlay from the devices Control Center, then select SYNC.
SYNC 3 does not display the song information, repeat, or shuffle buttons.	The device or media player is incompatible.	Connect a compatible device or media player.

SYNC™ 3 (If Equipped)

Wi-Fi Issues		
Issue	Possible cause	Possible solution
Failed connection.	Password error.	Verify password.
	Weak signal.	Check for a poor Wi-Fi signal.
	Multiple Access points within range with the same SSID.	Use a unique name for your SSID, don't use the default name unless it contains a unique identifier, such as part of the MAC address.
Disconnecting after successful connection.	Weak signal probably due to distance from the hotspot, obstruction or high interference.	Position the vehicle close to the hotspot with the front of the vehicle facing the hotspot direction and remove obstacles if possible. Other Wi-Fi, Bluetooth, microwave and cordless phones may cause interference.
Poor signal seen by SYNC 3 despite being near a hotspot.	There may be an obstruction between SYNC 3 and the hotspot.	If the vehicle is equipped with heated windshield, try positioning the vehicle so that the windshield is not facing the hotspot. If you have metallic window tinting but not on the windshield, position the vehicle to face the hotspot. If all windows are tinted, you can open the windows in the direction of the hotspot if that is feasible. Try to remove other obstructions that may impact signal quality such as opening the garage door.
A hotspot is not listed in the list of available networks.	The hotspot was defined as a hidden network.	Please set the network to visible and try again.

SYNC™ 3 (If Equipped)

Wi-Fi Issues		
Issue	Possible cause	Possible solution
SYNC 3 is not seen when searching for Wi-Fi networks from your phone or other devices.	SYNC 3 does not currently provide a hotspot.	SYNC 3 currently does not provide a hotspot.
Software download takes too long.	Poor signal strength, too far from the hotspot, hotspot is supporting multiple connections, slow Internet connection or other problems.	Check the signal quality (under network details), if SYNC 3 indicates good or excellent, test with another high-speed equipped hotspot where the environment is more predictable.
SYNC 3 seems to connect with a hotspot and the signal strength is excellent but the software is not being updated.	It is possible that there is no new software. The connected hotspot may be a managed one and it requires either a subscription or agreeing to the terms and conditions.	Test the connection with another device, if the hotspot requires a subscription, you may contact the service provider.

SYNC™ 3 (If Equipped)

AppLink issues		
Issue	Possible cause(s)	Possible solution(s)
AppLink Mobile Applications: When I select "Find Mobile Apps," SYNC 3 does not find any applications.	You did not connect an AppLink Compatible phone to SYNC 3.	Make sure you have a compatible smart-phone; an Android with OS 2.3 or higher or an iPhone 3GS or newer with iOS 5.0 or higher. Additionally, make sure you pair and connect your phone to SYNC 3 in order to find AppLink-capable apps on your device. iPhone users must also connect to a USB port with an Apple USB cable.
My phone is connected, but I still cannot find any apps.	AppLink-enabled apps are not installed and running on your mobile device.	Make sure you have downloaded and installed the latest version of the app from your phone's app store. Make sure the app is running on your phone. Some apps require you to register or login to the app on the phone before using them with AppLink. Also, some may have a "Ford SYNC" setting, so check the app's settings menu on the phone.
My phone is connected, my app(s) are running, but I still cannot find any apps.	Sometimes apps do not properly close and re-open their connection to SYNC 3, over ignition cycles, for example.	Closing and restarting apps may help SYNC 3 find the application if you cannot discover it inside the vehicle. On an Android device, if apps have an 'Exit' or 'Quit' option, then select it and restart the app. If the app does not have that option, select the phone's settings menu and select 'Apps', then find the particular app and choose 'Force stop.' Do not forget to restart the app afterward, then select "Find Mobile Apps" on SYNC 3.
		On an iPhone with iOS7+, to force close an app, double tap the home button then swipe up on the app to close it. Tap the home button again, then select the app again to restart it. After a few seconds, the app should then appear in SYNC 3's Mobile App's Menu.

SYNC™ 3 (If Equipped)

AppLink issues		
Issue	Possible cause(s)	Possible solution(s)
My Android phone is connected, my app(s) are running, I restarted them, but I still cannot find any apps.	There is a Bluetooth issue on some older versions of the Android operating system that may cause apps that were found on your previous vehicle drive to not be found again if you did not switch Bluetooth off.	Switch Bluetooth off and then on to reset it on your phone. If you are in your vehicle, SYNC 3 should be able to automatically reconnect to your phone if you press the "Phone" button.
My iPhone is connected, my app is running, I restarted the app but I still cannot find it on SYNC 3.	You may need to reset the USB connection to SYNC 3.	Unplug the USB cable from the phone, wait a moment, and plug the USB cable back in to the phone. After a few seconds, the app should appear in SYNC 3's Mobile Apps Menu. If not, "Force Close" the application and restart it.
I have an Android phone. I found and started my media app on SYNC 3, but there is no sound or the sound is very low.	The Bluetooth volume on the phone may be low.	Increase the Bluetooth volume of the device by using the device's volume control buttons which are most often found on the side of the device.
I can only see some of the AppLink apps running on my phone listed in the SYNC 3 Mobile Apps Menu.	Some Android devices have a limited number of Bluetooth ports that apps can use to connect. If you have more AppLink apps on your phone than the number of available Bluetooth ports, you will not see all of your apps listed in the SYNC 3 mobile apps menu.	Force close or uninstall the apps you do not want SYNC 3 to find. If the app has a "Ford SYNC" setting, disable that setting in the app's settings menu on the phone.

SYNC™ 3 (If Equipped)

Voice command issues		
Issue	Possible cause	Possible solution
SYNC 3 does not understand what I am saying.	You may be using the wrong voice commands.	Review the cell phone voice commands and the media voice commands at the beginning of their respective sections. Refer to the audio display during an active voice session to find a list of voice commands there.
	You may be speaking too soon or at the wrong time.	Wait for the system to prompt you before you state your command.
SYNC 3 does not understand the name of a song or artist.	You may be using the wrong voice commands.	Review the media voice commands at the beginning of the media section.
	You may not be saying the name exactly as it appears on your device.	Say the song or artist name exactly as it is displayed on your device. For example, say "Play Artist Prince" or "Play song Purple Rain".
		Make sure you are saying the complete title such as "California remix featuring Jennifer Nettles".
	If there are any abbreviations in the name, like ESPN or CNN, you have to spell those: "E-S-P-N" or "C-N-N".	
The song or artist name may have some special characters that are not being recognized by SYNC 3.	Make sure that song titles, artists, album, and playlists names do not have any special characters like *, - or +.	
SYNC 3 does not understand or is calling the wrong contact when I want to make a call.	You may not be saying the name exactly as it appears on your phone-book.	Make sure that you are saying the name exactly as it appears on your phone. For example, if your contact is "Joe Wilson", say "Call Joe Wilson". If your contact name is "Mom", say "Call Mom".
	The contact name may contain special characters.	Make sure that your contact names do not have any special characters like *, - or +.

SYNC™ 3 (If Equipped)

Voice command issues		
Issue	Possible cause	Possible solution
The SYNC 3 voice control system is having trouble recognizing foreign names stored on my cell phone.	You may not be saying the name exactly as it appears on your phonebook.	SYNC 3 applies the phonetic pronunciation rules of the selected language to the contact names stored on your cell phone.
		Helpful Hint: You can select your contact manually. Press PHONE . Select the option for phonebook and then contact name. Press the soft-key option to hear it. SYNC 3 will read the contact name to you, giving you some idea of the pronunciation it is expecting.
The SYNC 3 voice control system is having trouble recognizing foreign tracks, artists, albums, genres and playlist names from my media player or USB flash drive.	You may be saying the foreign names using the currently selected language for SYNC 3.	SYNC 3 applies the phonetic pronunciation rules of the selected language to the names stored on your media player or USB flash drive. It is able to make some exceptions for very popular artist names (for example, U2) such that you can always use the English pronunciation for these artists.
The system generates voice prompts and the pronunciation of some words may not be accurate for my language.	SYNC 3 uses text-to-speech voice prompt technology.	SYNC 3 uses a synthetically generated voice rather than pre-recorded human voice.
		SYNC 3 offers several new voice control features for a wide range of languages. Dialing a contact name directly from the phonebook without pre-recording (for example, "call John Smith") or selecting a track, artist, album, genre or playlist directly from your media player (for example, "play artist Madonna").

SYNC™ 3 (If Equipped)

Personal Profiles	
Issue	Possible cause and solution
I cannot create a profile.	Personal Profiles have not been set up.
	An invalid profile name was entered.
	A memory button was not selected when prompted.
	The vehicle's ignition was not On and in Park or was shifted out of Run or Park while creating a profile.
	Personal Profiles is turned off.
I cannot link a keyfob.	The lock button was not selected on a keyfob when prompted.
	The keyfob selected was already associated to another profile and an overwrite was declined.
	A profile recall was performed while linking a keyfob.
	The vehicle's ignition was not On and in Park, or was shifted out of Run or Park while linking a keyfob.
	The old linking method is used.
My personalized settings do not save.	The unsaved setting is not supported by Personal Profiles.
	A different Personal Profile is active than expected.
	Another user has changed settings for the wrong Personal Profile.
My profile will not recall.	A Personal Profile has not been created.
	Personal Profiles is turned off.
	The requested profile is already active.
	The memory button being used is not linked to a profile.

SYNCTM 3 (If Equipped)

Personal Profiles	
Issue	Possible cause and solution
	The keyfob being used is not linked to a profile.
	The wrong keyfob is being used.
	A button other than unlock or remote start is being pressed on a linked keyfob.
	The Personal Profile was deleted.
My preset positions recall but my profile does not.	Personal Profiles is turned off.
My profile recalls but my preset positions do not.	The vehicle is in motion.
	The preset positions are the same as the Guest or previously active profile.
I lost a keyfob.	Unlink and relink your keyfob in the Personal Profiles menu. You may need to see your authorized dealer.
I lost all profiles.	Keyfobs had been erased and reprogramed. This could happen if you let dealership add a new keyfob to replace lost one.
	Master Reset had been performed without your acknowledgement.

SYNC™ 3 (If Equipped)

General		
Issue	Possible cause	Possible solution
<p>The language selected for the instrument cluster and information and entertainment display does not match the SYNC 3 language (phone, USB, Bluetooth audio, voice control and voice prompts).</p>	<p>SYNC 3 does not support the currently selected language for the instrument cluster and information and entertainment display.</p>	<p>SYNC 3 only supports four languages in a single module for text display, voice control and voice prompts. The country where you bought your vehicle dictates the four languages based on the most popular languages spoken. If the selected language is not available, SYNC 3 remains in the current active language.</p>
		<p>SYNC 3 offers several new voice control features for a wide range of languages. Dialing a contact name directly from the phonebook without pre-recording (for example, "call John Smith") or selecting a track, artist, album, genre or playlist directly from your media player (for example, "play artist Madonna").</p>

SYNC 3 System Reset
<p>The system has a System Reset feature that can be performed if the function of a SYNC 3 feature is lost. This reset is intended to restore functionality and will not erase any information previously stored in the system (such as paired devices, phonebook, call history, text messages, or user settings). To perform a System Reset, press and hold the Seek Up (>>) button while pressing and holding the Radio Power button. After approximately 5 seconds the screen will go black. Allow 1-2 minutes for the system reset to complete. You may then resume using the SYNC 3 system.</p>

For additional assistance with SYNC 3 troubleshooting, refer to the regional Ford or Lincoln website.

Accessories

For a complete listing of Ford GT Accessories and Ford GT Licensed Products, contact the Ford GT Concierge at 1-800-210-5795. The Ford GT Concierge has the latest information on the offerings available.

Scheduled Maintenance

GENERAL MAINTENANCE INFORMATION

Why Maintain Your Vehicle?

Carefully following the maintenance schedule helps protect against major repair expenses resulting from neglect or inadequate maintenance and may help to increase the value of your vehicle when you sell or trade it. Keep all receipts for completed maintenance with your vehicle and record the maintenance in the pages that follow in this section.

We have established regular maintenance intervals for your vehicle based upon rigorous testing. It is important that you have your vehicle serviced at the proper times. Remember that time is just as important as miles driven. These intervals are based on both time and distance driven. Since cars like the Ford GT do not get driven daily in most cases, your maintenance intervals may be more based on time than distance driven.

It is your responsibility to have all scheduled maintenance performed and to make sure that the materials used meet the specifications identified in this owner's manual. See **Capacities and Specifications** (page 204).

Failure to perform scheduled maintenance invalidates warranty coverage on parts affected by the lack of maintenance.

Why Maintain Your Vehicle at Your Certified Ford GT Service Dealership?

Factory-Trained Technicians

Service technicians participate in extensive factory-sponsored certification training to help them become experts on the operation of your Ford GT.

Genuine Ford and Motorcraft™ Replacement Parts

Certified Ford GT Service Dealerships stock the Ford and Motorcraft parts needed to maintain your Ford GT. These parts meet or exceed our specifications. Parts installed at your dealership carry a nationwide 24-month or unlimited mile (kilometer) parts and labor limited warranty.

If you do not use Ford authorized parts they may not meet our specifications and depending on the part, it could affect emissions compliance.

Convenience

The Ford GT Concierge will be happy to assist you in scheduling your maintenance visits and will work with your Certified Ford GT Service Dealership to make these arrangements.

Road Course Maintenance

If your Ford GT is subjected to dedicated road course use, we recommend additional maintenance. See **Special Operating Conditions Scheduled Maintenance** (page 276).

Protecting Your Investment

Additives and Chemicals

This owner's manual and the Ford Workshop Manual list the recommended additives and chemicals for your vehicle. We do not recommend using chemicals or additives not approved by us as part of your vehicle's normal maintenance. Please consult your warranty information.

Scheduled Maintenance

Oils and Fluids

In many cases, fluid discoloration is a normal operating characteristic and, by itself, does not necessarily indicate a concern or that the fluid needs to be changed. However, a qualified expert, such as the factory-trained technicians at your

dealership, should inspect discolored fluids that also show signs of overheating or foreign material contamination immediately.

Make sure to change your vehicle's oils and fluids at the specified intervals or in conjunction with a repair.

NORMAL SCHEDULED MAINTENANCE

Normal Maintenance Intervals

Annually or Every 5,000 mi (8,000 km)
Change oil and filter.
Inspect tires and check tire pressures.
Inspect the brake pads, rotors, hoses, brake cooling duct hoses and check parking brake function. Check brake fluid level.
Inspect the engine cooling system strength and hoses. Check coolant level.
Inspect the exhaust system and heat shields.
Inspect the accessory drive belts.
Inspect the steering linkage, ball joints, suspension and tie-rod ends.
Inspect the wiper blades. Check washer fluid level.
Inspect hinges and latches. Lubricate if needed.
Inspect vehicle battery and state of charge.
Check the hydraulic fluid level.
Check operation of all lights.
Check operation of warning indicators inside the instrument cluster.
Check for any fluid leaks.

Scheduled Maintenance

Other maintenance items ¹	
Every 2 Years or 10,000 mi (16,000 km)	Change brake fluid.
Every 2 Years or 10,000 mi (16,000 km)	Replace cabin air filter.
Every 3 Years or 15,000 mi (24,000 km)	Replace engine air filters.
Every 6 Years or 30,000 mi (48,000 km)	Change transmission fluid.
Every 45,000 mi (72,000 km)	Replace spark plugs.
Every 10 Years or 60,000 mi (100,000 km)	Change hydraulic fluid.
Every 10 Years or 60,000 mi (100,000 km)	Change engine coolant. ²
Every 10 Years or 100,000 mi (160,000 km)	Replace front and rear accessory drive belts.
Every 24 Years	Replace Hydraulic Accumulator Bottle.

¹ Do not exceed the designated distance or mileage for the interval.

² Initial replacement at 10 years or 60,000 mi (100,000 km), then every six years or 30,000 mi (48,000 km).

SPECIAL OPERATING CONDITIONS SCHEDULED MAINTENANCE

Hot Climate Oil Change Intervals

Vehicles operating in the Middle East, North Africa, Sub-Saharan Africa or locations with similar climates using an American Petroleum Institute (API) Certified for Gasoline Engines (Certification mark) oil of SM or SN quality, the normal oil change interval is 2,500 mi (4,000 km).

Engine Air Filter and Cabin Air Filter Replacement

The life of the engine air filter and cabin air filter is dependent on exposure to dusty and dirty conditions. Vehicles operated in these conditions require frequent inspection and replacement of the engine air filter and cabin air filter.

Operating at High Speeds and Track Days

Your vehicle is capable of sustained high speeds and track day driving. Your GT has electronic controls to reduce power and limit the RPM to reduce powertrain temperatures if operating temperatures are exceeded.

Scheduled Maintenance

Before Operating Your Vehicle at High Speeds:

- Verify your tires have the correct pressures. See **Technical Specifications** (page 203).
- Inspect wheels and tires for wear and damage. Replace any damaged wheels and tires.
- Check and set lug nut torque. See **Technical Specifications** (page 203).
- Verify fluid levels for oil, coolant, brake, and hydraulic fluid. See **Maintenance** (page 157).
- Change the oil and filter prior to use on the track.

After Operating Your vehicle at High Speeds and Track Day Driving, Do the Following:

- Set tire pressures to specification.
- Check and set lug nut torque. See **Technical Specifications** (page 203).
- Check all fluid levels.
- If you drive your car for an extended period of time at high speed or on the track for an extended time, change the oil and filter.

SCHEDULED MAINTENANCE RECORD

<input type="radio"/> Repair Order #:	<p>Dealer stamp</p>
<input type="radio"/> Distance:	
<input type="radio"/> Engine hours (optional):	
<input type="radio"/> Multi-point inspection (recommended): <input type="checkbox"/>	
<input type="radio"/> Signature:	

Scheduled Maintenance

<input type="radio"/> Repair Order #:	Dealer stamp
<input type="radio"/> Distance:	
<input type="radio"/> Engine hours (optional):	
<input type="radio"/> Multi-point inspection (recommended): <input type="checkbox"/>	
<input type="radio"/> Signature:	

<input type="radio"/> Repair Order #:	Dealer stamp
<input type="radio"/> Distance:	
<input type="radio"/> Engine hours (optional):	
<input type="radio"/> Multi-point inspection (recommended): <input type="checkbox"/>	
<input type="radio"/> Signature:	

Scheduled Maintenance

<input type="radio"/> Repair Order #:	Dealer stamp
<input type="radio"/> Distance:	
<input type="radio"/> Engine hours (optional):	
<input type="radio"/> Multi-point inspection (recommended): <input type="checkbox"/>	
<input type="radio"/> Signature:	

<input type="radio"/> Repair Order #:	Dealer stamp
<input type="radio"/> Distance:	
<input type="radio"/> Engine hours (optional):	
<input type="radio"/> Multi-point inspection (recommended): <input type="checkbox"/>	
<input type="radio"/> Signature:	

Scheduled Maintenance

<input type="radio"/> Repair Order #:	<p>Dealer stamp</p>
<input type="radio"/> Distance:	
<input type="radio"/> Engine hours (optional):	
<input type="radio"/> Multi-point inspection (recommended): <input type="checkbox"/>	
<input type="radio"/> Signature:	

<input type="radio"/> Repair Order #:	<p>Dealer stamp</p>
<input type="radio"/> Distance:	
<input type="radio"/> Engine hours (optional):	
<input type="radio"/> Multi-point inspection (recommended): <input type="checkbox"/>	
<input type="radio"/> Signature:	

Scheduled Maintenance

<input type="radio"/> Repair Order #:	Dealer stamp
<input type="radio"/> Distance:	
<input type="radio"/> Engine hours (optional):	
<input type="radio"/> Multi-point inspection (recommended): <input type="checkbox"/>	
<input type="radio"/> Signature:	

<input type="radio"/> Repair Order #:	Dealer stamp
<input type="radio"/> Distance:	
<input type="radio"/> Engine hours (optional):	
<input type="radio"/> Multi-point inspection (recommended): <input type="checkbox"/>	
<input type="radio"/> Signature:	

Scheduled Maintenance

<input type="radio"/> Repair Order #:	<p>Dealer stamp</p>
<input type="radio"/> Distance:	
<input type="radio"/> Engine hours (optional):	
<input type="radio"/> Multi-point inspection (recommended): <input type="checkbox"/>	
<input type="radio"/> Signature:	

<input type="radio"/> Repair Order #:	<p>Dealer stamp</p>
<input type="radio"/> Distance:	
<input type="radio"/> Engine hours (optional):	
<input type="radio"/> Multi-point inspection (recommended): <input type="checkbox"/>	
<input type="radio"/> Signature:	

Scheduled Maintenance

<input type="radio"/> Repair Order #:	Dealer stamp
<input type="radio"/> Distance:	
<input type="radio"/> Engine hours (optional):	
<input type="radio"/> Multi-point inspection (recommended): <input type="checkbox"/>	
<input type="radio"/> Signature:	

<input type="radio"/> Repair Order #:	Dealer stamp
<input type="radio"/> Distance:	
<input type="radio"/> Engine hours (optional):	
<input type="radio"/> Multi-point inspection (recommended): <input type="checkbox"/>	
<input type="radio"/> Signature:	

Scheduled Maintenance

<input type="radio"/> Repair Order #:	Dealer stamp
<input type="radio"/> Distance:	
<input type="radio"/> Engine hours (optional):	
<input type="radio"/> Multi-point inspection (recommended): <input type="checkbox"/>	
<input type="radio"/> Signature:	

<input type="radio"/> Repair Order #:	Dealer stamp
<input type="radio"/> Distance:	
<input type="radio"/> Engine hours (optional):	
<input type="radio"/> Multi-point inspection (recommended): <input type="checkbox"/>	
<input type="radio"/> Signature:	

Scheduled Maintenance

<input type="radio"/> Repair Order #:	Dealer stamp
<input type="radio"/> Distance:	
<input type="radio"/> Engine hours (optional):	
<input type="radio"/> Multi-point inspection (recommended): <input type="checkbox"/>	
<input type="radio"/> Signature:	

<input type="radio"/> Repair Order #:	Dealer stamp
<input type="radio"/> Distance:	
<input type="radio"/> Engine hours (optional):	
<input type="radio"/> Multi-point inspection (recommended): <input type="checkbox"/>	
<input type="radio"/> Signature:	

Scheduled Maintenance

<input type="radio"/> Repair Order #:	<p>Dealer stamp</p>
<input type="radio"/> Distance:	
<input type="radio"/> Engine hours (optional):	
<input type="radio"/> Multi-point inspection (recommended): <input type="checkbox"/>	
<input type="radio"/> Signature:	

<input type="radio"/> Repair Order #:	<p>Dealer stamp</p>
<input type="radio"/> Distance:	
<input type="radio"/> Engine hours (optional):	
<input type="radio"/> Multi-point inspection (recommended): <input type="checkbox"/>	
<input type="radio"/> Signature:	

Scheduled Maintenance

<input type="radio"/> Repair Order #:	<p>Dealer stamp</p>
<input type="radio"/> Distance:	
<input type="radio"/> Engine hours (optional):	
<input type="radio"/> Multi-point inspection (recommended): <input type="checkbox"/>	
<input type="radio"/> Signature:	

Appendices

END USER LICENSE AGREEMENT

VEHICLE SOFTWARE END USER LICENSE AGREEMENT (EULA)

- You ("You" or "Your" as applicable) have acquired a vehicle having several devices, including SYNC ® and various control modules, ("DEVICES") that include software licensed or owned by Ford Motor Company and its affiliates ("FORD MOTOR COMPANY"). Those software products of FORD MOTOR COMPANY origin, as well as associated media, printed materials, and "online" or electronic documentation ("SOFTWARE") are protected by international intellectual property laws and treaties. The SOFTWARE is licensed, not sold. All rights reserved.
- The SOFTWARE may interface with and/or communicate with, or may be later upgraded to interface with and/or communicate with additional software and/or systems provided by FORD MOTOR COMPANY.

IF YOU DO NOT AGREE TO THIS END USER LICENSE AGREEMENT ("EULA") DO NOT USE THE DEVICES OR COPY THE SOFTWARE. ANY USE OF THE SOFTWARE, INCLUDING BUT NOT LIMITED TO USE ON THE DEVICES, WILL CONSTITUTE YOUR AGREEMENT TO THIS EULA (OR RATIFICATION OF ANY PREVIOUS CONSENT).

GRANT OF SOFTWARE LICENSE: This EULA grants you the following license:

- You may use the SOFTWARE as installed on the DEVICES and as otherwise interfacing with systems and/or services provide by or through FORD MOTOR COMPANY or its third party software and service providers.

Description of Other Rights and Limitations

- **Speech Recognition:** If the SOFTWARE includes speech recognition component(s), you should understand that speech recognition is an inherently statistical process and that recognition errors are inherent in the process. Neither FORD MOTOR COMPANY nor its suppliers shall be liable for any damages arising out of errors in the speech recognition process. It is your responsibility to monitor any speech recognition functions included in the system.
- **Limitations on Reverse Engineering, Decompilation and Disassembly:** You may not reverse engineer, decompile, translate, disassemble or attempt to discover any source code or underlying ideas or algorithms of the SOFTWARE nor permit others to reverse engineer, decompile or disassemble the SOFTWARE, except and only to the extent that such activity is expressly permitted by applicable law notwithstanding this limitation or to the extent as may be permitted by the licensing terms governing use of any open source components included with the SOFTWARE.
- **Limitations on Distributing, Copying, Modifying and Creating Derivative Works:** You may not distribute, copy, make modifications to or create derivative works based on the SOFTWARE, except and only to the extent that such activity is expressly permitted by applicable law notwithstanding this limitation or to the extent as may be permitted by the licensing terms governing use of any open source components included with the SOFTWARE.

Appendices

- **Single EULA:** The end user documentation for the DEVICES and related systems and services may contain multiple EULAs, such as multiple translations and/or multiple media versions (e.g., in the user documentation and in the software). Even if you receive multiple EULAs, you are licensed to use only one (1) copy of the SOFTWARE.
- **SOFTWARE Transfer:** You may permanently transfer your rights under this EULA only as part of a sale or transfer of the DEVICES, provided you retain no copies, you transfer all of the SOFTWARE (including all component parts, the media and printed materials, any upgrades, and, if applicable, the Certificate(s) of Authenticity), and the recipient agrees to the terms of this EULA. If the SOFTWARE is an upgrade, any transfer must include all prior versions of the SOFTWARE.
- **Termination:** Without prejudice to any other rights, FORD MOTOR COMPANY may terminate this EULA if you fail to comply with the terms and conditions of this EULA.
- **Internet-Based Services Components:** The SOFTWARE may contain components that enable and facilitate the use of certain Internet-based services. You acknowledge and agree that FORD MOTOR COMPANY, third party software and service suppliers, its affiliates and/or its designated agent may automatically check the version of the SOFTWARE and/or its components that you are utilizing and may provide upgrades or supplements to the SOFTWARE that may be automatically downloaded to your DEVICES.
- **Additional Software/Services:** The SOFTWARE may permit FORD MOTOR COMPANY, third party software and service suppliers, its affiliates and/or its designated agent to provide or make available to you SOFTWARE updates, supplements, add-on components, or Internet-based services components of the SOFTWARE after the date you obtain your initial copy of the SOFTWARE ("Supplemental Components".) SOFTWARE updates may cause you to incur additional charges from your wireless service provider. If FORD MOTOR COMPANY or third party software and services suppliers provide or make available to you Supplemental Components and no other EULA terms are provided along with the Supplemental Components, then the terms of this EULA shall apply. FORD MOTOR COMPANY, its affiliates and/or its designated agent reserve the right to discontinue without liability any Internet-based services provided to you or made available to you through the use of the SOFTWARE.

Appendices

- **Links to Third Party Sites:** The SOFTWARE may provide you with the ability to link to third party sites. The third party sites are not under the control of FORD MOTOR COMPANY, its affiliates and/or its designated agent. Neither FORD MOTOR COMPANY nor its affiliates nor its designated agent are responsible for (i) the contents of any third party sites, any links contained in third party sites, or any changes or updates to third party sites, or (ii) webcasting or any other form of transmission received from any third party sites. If the SOFTWARE provides links to third party sites, those links are provided to you only as a convenience, and the inclusion of any link does not imply an endorsement of the third party site by FORD MOTOR COMPANY, its affiliates and/or its designated agent.
- **Obligation to Drive Responsibly:** You recognize your obligation to drive responsibly and keep attention on the road. You will read and abide with the DEVICES operating instructions particularly as they pertain to safety and you agree to assume any risk associated with the use of the DEVICES.

UPGRADES AND RECOVERY MEDIA:

If the SOFTWARE is provided by FORD MOTOR COMPANY separate from the DEVICES on media such as a ROM chip, CD ROM disk(s) or via web download or other means, and is labeled "For Upgrade Purposes Only" or "For Recovery Purposes Only" you may install one (1) copy of such SOFTWARE onto the DEVICES as a replacement copy for the existing SOFTWARE, and use it in accordance with this EULA, including any additional EULA terms accompanying the upgrade SOFTWARE.

INTELLECTUAL PROPERTY RIGHTS:

All title and intellectual property rights in and to the SOFTWARE (including but not limited to any images, photographs, animations, video, audio, music, text and "applets" incorporated into the SOFTWARE), the accompanying printed materials, and any copies of the SOFTWARE, are owned by FORD MOTOR COMPANY, or its affiliates or suppliers. The SOFTWARE is licensed, not sold. You may not copy the printed materials accompanying the SOFTWARE. All title and intellectual property rights in and to the content which may be accessed through use of the SOFTWARE is the property of the respective content owner and may be protected by applicable copyright or other intellectual property laws and treaties. This EULA grants you no rights to use such content outside its intended use. All rights not specifically granted under this EULA are reserved by FORD MOTOR COMPANY, its affiliates, and third party software and service providers and suppliers. Use of any on-line services which may be accessed through the SOFTWARE may be governed by the respective terms of use relating to such services. If this SOFTWARE contains documentation that is provided only in electronic form, you may print one copy of such electronic documentation.

EXPORT RESTRICTIONS: You acknowledge that the SOFTWARE is subject to U.S. and European Union export jurisdiction. You agree to comply with all applicable international and national laws that apply to the SOFTWARE, including the U.S. Export Administration Regulations, as well as end-user, end-use and destination restrictions issued by U.S. and other governments.

Appendices

TRADEMARKS: This EULA does not grant you any rights in connection with any trademarks or service marks of FORD MOTOR COMPANY, its affiliates, and third party software and service providers.

PRODUCT SUPPORT: Please refer to FORD MOTOR COMPANY instructions provided in the documentation for the DEVICES product support, such as the vehicle owner guide.

Should you have any questions concerning this EULA, or if you desire to contact FORD MOTOR COMPANY for any other reason, please refer to the address provided in the documentation for the DEVICES.

No Liability for Certain Damages: EXCEPT AS PROHIBITED BY LAW, FORD MOTOR COMPANY, ANY THIRD PARTY SOFTWARE OR SERVICES SUPPLIERS, AND THEIR AFFILIATES SHALL HAVE NO LIABILITY FOR ANY INDIRECT, SPECIAL, CONSEQUENTIAL OR INCIDENTAL DAMAGES ARISING FROM OR IN CONNECTION WITH THE USE OR PERFORMANCE OF THE SOFTWARE. THIS LIMITATION SHALL APPLY EVEN IF ANY REMEDY FAILS OF ITS ESSENTIAL PURPOSE. THERE ARE NO WARRANTIES OTHER THAN THOSE THAT MAY BE EXPRESSLY PROVIDED FOR YOUR NEW VEHICLE.

SYNC® Automotive Important Safety Information Read and follow instructions:

- Before using your SYNC® system, read and follow all instructions and safety information provided in this end user manual ("Owner Guide".) Not following precautions found in the Owner Guide can lead to an accident or other serious injuries.

General Operation

- **Voice Command Control:** Certain functions within the SYNC® system may be accomplished using voice commands. Using voice commands while driving helps you to operate the system without removing your hands from the wheel or eyes from the road.
- **Prolonged Views of Screen:** Do not access any function requiring a prolonged view of the screen while you are driving. Pull over in a safe and legal manner before attempting to access a function of the system requiring prolonged attention.
- **Volume Setting:** Do not raise the volume excessively. Keep the volume at a level where you can still hear outside traffic and emergency signals while driving. Driving while unable to hear these sounds could cause an accident.
- **Navigation Features:** Any navigation features included in the system are intended to provide turn by turn instructions to get you to a desired destination. Please make certain all persons using this system carefully read and follow instructions and safety information fully.
- **Distraction Hazard:** Any navigation features may require manual (non-verbal) setup. Attempting to perform such set-up or insert data while driving can distract your attention and could cause an accident or other serious injury. Stop the vehicle in a safe and legal manner before attempting these operations.
- **Let Your Judgment Prevail:** Any navigation features are provided only as an aid. Make your driving decisions based on your observations of local conditions and existing traffic regulations. Any such feature is not a

Appendices

substitute for your personal judgment. Any route suggestions made by this system should never replace any local traffic regulations or your personal judgment or knowledge of safe driving practices.

- **Route Safety:** Do not follow the route suggestions if doing so would result in an unsafe or illegal maneuver, if you would be placed in an unsafe situation, or if you would be directed into an area that you consider unsafe. The driver is ultimately responsible for the safe operation of the vehicle and therefore, must evaluate whether it is safe to follow the suggested directions.
- **Potential Map Inaccuracy:** Maps used by this system may be inaccurate because of changes in roads, traffic controls or driving conditions. Always use good judgment and common sense when following the suggested routes.
- **Emergency Services:** Do not rely on any navigation features included in the system to route you to emergency services. Ask local authorities or an emergency services operator for these locations. Not all emergency services such as police, fire stations, hospitals and clinics are likely to be contained in the map database for such navigation features.

Your Responsibilities and Assumptions of Risk

- You agree to each of the following:(a) Any use of the SOFTWARE while driving an automobile or other vehicle in violation of applicable law or otherwise driving in an unsafe manner presents a significant risk of distracted driving and should not be attempted under any circumstances;(b) Use of the SOFTWARE at excessive volume poses a significant risk of hearing damage and should not be attempted under any circumstances;(c) The SOFTWARE may not be compatible with new or different versions of an operating system, third party software, or third party services, and the SOFTWARE may potentially cause a critical failure of an operating system, third party software, or third party service.(d) Any third party service accessed by or third party software used with the SOFTWARE (i) may charge an additional fee for access, (ii) may not work correctly, on an uninterrupted basis, or error free, (iii) may change streaming formats or discontinue operation, (iv) may contain adult, profane or offensive content; and (v) may contain inaccurate, false or misleading traffic, weather, financial or safety information or other content; and (e) Use of the SOFTWARE may cause you to incur additional charges from your wireless service provider (WSP) and any data or minute calculators that may be included in the software program are for reference only, are not warranted in any way and should not be relied upon in anyway.
- When using the SOFTWARE, you agree to be responsible for and assume the entire risk to the items set forth in Section (a) – (e) above.

Appendices

Disclaimer of Warranty

YOU EXPRESSLY ACKNOWLEDGE AND AGREE THAT USE OF THE DEVICES AND SOFTWARE IS AT YOUR SOLE RISK AND THAT THE ENTIRE RISK AS TO SATISFACTORY QUALITY, PERFORMANCE, COMPATIBILITY, ACCURACY AND EFFORT IS WITH YOU. TO THE MAXIMUM EXTENT PERMITTED BY APPLICABLE LAW, THE SOFTWARE AND ANY THIRD PARTY SOFTWARE OR THIRD-PARTY SERVICES ARE PROVIDED "AS IS" AND "AS AVAILABLE", WITH ALL FAULTS AND WITHOUT WARRANTY OF ANY KIND, AND FORD MOTOR COMPANY HEREBY DISCLAIMS ALL WARRANTIES AND CONDITIONS WITH RESPECT TO THE SOFTWARE, THIRD PARTY SOFTWARE, AND THIRD-PARTY SERVICES, EITHER EXPRESS, IMPLIED OR STATUTORY, INCLUDING, BUT NOT LIMITED TO, THE IMPLIED WARRANTIES AND/OR CONDITIONS OF MERCHANTABILITY, OF SATISFACTORY QUALITY, OF FITNESS FOR AN PARTICULAR PURPOSE, OF ACCURACY, OF QUIET ENJOYMENT, AND NON-INFRINGEMENT OF THIRD-PARTY RIGHTS. FORD MOTOR COMPANY DOES NOT WARRANT (a) AGAINST INTERFERENCE WITH YOUR ENJOYMENT OF THE SOFTWARE, THIRD PARTY SOFTWARE, OR THIRD-PARTY SERVICES, (b) THAT THE SOFTWARE, THIRD PARTY SOFTWARE, OR THIRD-PARTY SERVICES WILL MEET YOUR REQUIREMENTS, (c) THAT THE OPERATION OF THE SOFTWARE, THIRD PARTY SOFTWARE, OR THIRD-PARTY SERVICES WILL BE UNINTERRUPTED OR ERROR-FREE, (d) OR THAT DEFECTS IN THE SOFTWARE, THIRD PARTY SOFTWARE, OR THIRD-PARTY SERVICES WILL BE CORRECTED. NO ORAL OR WRITTEN INFORMATION OR ADVICE GIVEN BY FORD MOTOR COMPANY OR ITS AUTHORIZED REPRESENTATIVE SHALL

CREATE A WARRANTY. SHOULD THE SOFTWARE, THIRD PARTY SOFTWARE, OR THIRD-PARTY SERVICES PROVE DEFECTIVE, YOU ASSUME THE ENTIRE COST OF ALL NECESSARY SERVICING, REPAIR OR CORRECTION. SOME JURISDICTIONS DO NOT ALLOW THE DISCLAIMER OF IMPLIED WARRANTIES OR LIMITATIONS ON APPLICABLE STATUTORY RIGHTS OF A CONSUMER, SO THE ABOVE DISCLAIMER MAY NOT FULLY APPLY TO YOU. THE SOLE WARRANTY PROVIDED BY FORD MOTOR COMPANY SHALL BE FOUND IN THE WARRANTY INFORMATION INCLUDING WITH YOUR OWNER GUIDE. TO THE EXTENT THAT THERE IS ANY CONFLICT BETWEEN THE TERMS OF THIS SECTION AND THE WARRANTY BOOKLET, THE WARRANTY BOOKLET SHALL CONTROL.

Applicable Law, Venue, Jurisdiction

- The laws of the State of Michigan govern this EULA and Your use of the SOFTWARE. Your use of the SOFTWARE may also be subject to other local, state, national, or international laws. Any litigation arising out of or related to this EULA shall be brought and maintained exclusively in a court of the State of Michigan located in Wayne County or in the United States District Court for the Eastern District of Michigan. You hereby consent to submit to the personal jurisdiction of a court in the State of Michigan located in Wayne County and the United States District Court for the Eastern District of Michigan for any dispute arising out of or relating to this EULA.

Appendices

Binding Arbitration and Class Action Waiver

(a) Application. This Section applies to any dispute EXCEPT IT DOES NOT INCLUDE A DISPUTE RELATING TO COPYRIGHT INFRINGEMENT, OR TO THE ENFORCEMENT OR VALIDITY OF YOUR, FORD MOTOR COMPANY, OR ANY OF FORD MOTOR COMPANY'S LICENSORS' INTELLECTUAL PROPERTY RIGHTS. Dispute means any dispute, action, or other controversy between You and FORD MOTOR COMPANY, other than the exceptions listed above, concerning the SOFTWARE (including its price) or this EULA, whether in contract, warranty, tort, statute, regulation, ordinance, or any other legal or equitable basis.

(b) Notice of Dispute. In the event of a Dispute, You or FORD MOTOR COMPANY must give the other a "Notice of Dispute", which is a written statement of the name, address, and contact information of the party giving it, the facts giving rise to the dispute, and the relief requested. You and FORD MOTOR COMPANY will attempt to resolve any dispute through informal negotiation within 60 days from the date the Notice of Dispute is sent. After 60 days, You or FORD MOTOR COMPANY may commence arbitration.

(c) Small claims court. You may also litigate any dispute in small claims court in your county of residence or FORD MOTOR COMPANY'S principal place of business, if the dispute meets all requirements to be heard in the small claims court. You may litigate in small claims court whether or not You negotiated informally first.

(d) Binding arbitration. If You and FORD MOTOR COMPANY, do not resolve any dispute by informal negotiation or in small claims court, any other effort to resolve the dispute will be conducted exclusively by binding arbitration. You are giving up

the right to litigate (or participate in as a party or class member) all disputes in court before a judge or jury. Instead, all disputes will be resolved before a neutral arbitrator, whose decision will be final except for a limited right of appeal under the Federal Arbitration Act. Any court with jurisdiction over the parties may enforce the arbitrator's award.

(e) Class action waiver. Any proceedings to resolve or litigate any dispute in any forum will be conducted solely on an individual basis. Neither you nor FORD MOTOR COMPANY, will seek to have any dispute heard as a class action, as a private attorney general action, or in any other proceeding in which any party acts or proposes to act in a representative capacity. No arbitration or proceeding will be combined with another without the prior written consent of all parties to all affected arbitrations or proceedings.

(f) Arbitration procedure. Any arbitration will be conducted by the American Arbitration Association (the "AAA"), under its Commercial Arbitration Rules. If You are an individual and use the SOFTWARE for personal or vehicle use, or if the value of the dispute is \$75,000 or less whether or not You are an individual or how You use the SOFTWARE, the AAA Supplementary Procedures for Consumer-Related Disputes will also apply. To commence arbitration, submit a Commercial Arbitration Rules Demand for Arbitration form to the AAA. You may request a telephonic or in-person hearing by following the AAA rules. In a dispute involving \$10,000 or less, any hearing will be telephonic unless the arbitrator finds good cause to hold an in-person hearing instead. For more information, see adr.org or call 1-800-778-7879. You agree to commence arbitration only in your county of residence or FORD MOTOR COMPANY'S principal place of business. The arbitrator

Appendices

may award the same damages to You individually as a court could. The arbitrator may award declaratory or injunctive relief only to You individually, and only to the extent required to satisfy Your individual claim.

(g) Arbitration fees and incentives.

- I. Disputes involving \$75,000 or less. FORD MOTOR COMPANY will promptly reimburse your filing fees and pay the AAA's and arbitrator's fees and expenses. If you reject FORD MOTOR COMPANY'S last written settlement offer made before the arbitrator was appointed ("last written offer"), your dispute goes all the way to an arbitrator's decision (called an "award"), and the arbitrator awards you more than the last written offer, FORD MOTOR COMPANY will give you three incentives: (1) pay the greater of the award or \$1,000; (2) pay twice your reasonable attorney's fees, if any; and (3) reimburse any expenses (including expert witness fees and costs) that your attorney reasonably accrues for investigating, preparing, and pursuing your claim in arbitration. The arbitrator will determine the amounts.
- ii. Disputes involving more than \$75,000. The AAA rules will govern payment of filing fees and the AAA's and arbitrator's fees and expenses.
- iii. Disputes involving any amount. In any arbitration you commence, FORD MOTOR COMPANY will seek its AAA or arbitrator's fees and expenses, or Your filing fees it reimbursed, only if the arbitrator finds the arbitration frivolous or brought for an improper purpose. In any arbitration FORD MOTOR COMPANY commences, it will pay all

filing, AAA, and arbitrator's fees and expenses. It will not seek its attorney's fees or expenses from you in any arbitration. Fees and expenses are not counted in determining how much a dispute involves.

(h) Claims or disputes must be filed within one year. To the extent permitted by law, any claim or dispute under this EULA to which this Section applies must be filed within one year in small claims court (Section c) or in arbitration (Section d). The one-year period begins when the claim or dispute first could be filed. If such a claim or dispute is not filed within one year, it is permanently barred.

(i) Severability. If the class action waiver (Section e) is found to be illegal or unenforceable as to all or some parts of a dispute, then that portion of Section e will not apply to those parts. Instead, those parts will be severed and proceed in a court of law, with the remaining parts proceeding in arbitration. If any other provision of that portion Section e is found to be illegal or unenforceable, that provision will be severed with the remainder of Section e remaining in full force and effect.

Telenav Software End User License Agreement

Please read these terms and conditions carefully before you use the TeleNav Software. Your use of the TeleNav Software indicates that you accept these terms and conditions. If you do not accept these terms and conditions, do not break the seal of the package, launch, or otherwise use the TeleNav Software. TeleNav may revise this Agreement and the privacy policy at any time, with or without notice to you. You agree to visit <http://www.telenav.com> from time to time to review the then current version of this Agreement and of the privacy policy.

Appendices

1. Safe and Lawful Use

You acknowledge that devoting attention to the TeleNav Software may pose a risk of injury or death to you and others in situations that otherwise require your undivided attention, and you therefore agree to comply with the following when using the TeleNav Software:

- (a) observe all traffic laws and otherwise drive safely;
- (b) use your own personal judgment while driving. If you feel that a route suggested by the TeleNav Software instructs you to perform an unsafe or illegal maneuver, places you in an unsafe situation, or directs you into an area that you consider to be unsafe, do not follow such instructions;
- (c) do not input destinations, or otherwise manipulate the TeleNav Software, unless your vehicle is stationary and parked;
- (d) do not use the TeleNav Software for any illegal, unauthorized, unintended, unsafe, hazardous, or unlawful purposes, or in any manner inconsistent with this Agreement;
- (e) arrange all GPS and wireless devices and cables necessary for use of the TeleNav Software in a secure manner in your vehicle so that they will not interfere with your driving and will not prevent the operation of any safety device (such as an airbag).

You agree to indemnify and hold TeleNav harmless against all claims resulting from any dangerous or otherwise inappropriate use of the TeleNav Software in any moving vehicle, including as a result of your failure to comply with the directions above.

2. Account Information

You agree: (a) when registering the TeleNav Software, to provide TeleNav with true, accurate, current, and complete information about yourself, and (b) to inform TeleNav promptly of any changes to such information, and to keep it true, accurate, current and complete.

3. Software License

- Subject to your compliance with the terms of this Agreement, TeleNav hereby grants to you a personal, non-exclusive, non-transferable license (except as expressly permitted below in connection with your permanent transfer of the TeleNav Software license), without the right to sublicense, to use the TeleNav Software (in object code form only) in order to access and use the TeleNav Software. This license shall terminate upon any termination or expiration of this Agreement. You agree that you will use the TeleNav Software only for your personal business or leisure purposes, and not to provide commercial navigation services to other parties.

3.1 License Limitations

- **(a)** reverse engineer, decompile, disassemble, translate, modify, alter or otherwise change the TeleNav Software or any part thereof; **(b)** attempt to derive the source code, audio library or structure of the TeleNav Software without the prior express written consent of TeleNav; **(c)** remove from the TeleNav Software, or alter, any of TeleNav's or its suppliers' trademarks, trade names, logos, patent or copyright notices, or other notices or markings; **(d)**

Appendices

distribute, sublicense or otherwise transfer the TeleNav Software to others, except as part of your permanent transfer of the TeleNav Software; or **(e)** use the TeleNav Software in any manner that

- i. infringes the intellectual property or proprietary rights, rights of publicity or privacy or other rights of any party,
- ii. violates any law, statute, ordinance or regulation, including but not limited to laws and regulations related to spamming, privacy, consumer and child protection, obscenity or defamation, or
- iii. is harmful, threatening, abusive, harassing, tortuous, defamatory, vulgar, obscene, libelous, or otherwise objectionable; and (f) lease, rent out, or otherwise permit unauthorized access by third parties to the TeleNav Software without advanced written permission of TeleNav.

4. Disclaimers

- To the fullest extent permissible pursuant to applicable law, in no event will TeleNav, its licensors and suppliers, or agents or employees of any of the foregoing, be liable for any decision made or action taken by you or anyone else in reliance on the information provided by the TeleNav Software. TeleNav also does not warrant the accuracy of the map or other data used for the TeleNav Software. Such data may not always reflect reality due to, among other things, road closures, construction, weather, new roads and other changing conditions. You are responsible for the entire risk arising out of your use of the TeleNav Software. For example but without limitation, you agree not to rely on the TeleNav Software for critical navigation in areas where the well-being or survival of you or others

is dependent on the accuracy of navigation, as the maps or functionality of the TeleNav Software are not intended to support such high risk applications, especially in more remote geographical areas.

- TELENAV EXPRESSLY DISCLAIMS AND EXCLUDES ALL WARRANTIES IN CONNECTION WITH THE TELENAV SOFTWARE, WHETHER STATUTORY, EXPRESS OR IMPLIED, INCLUDING ALL WARRANTIES WHICH MAY ARISE FROM COURSE OF DEALING, CUSTOM OR TRADE AND INCLUDING, BUT NOT LIMITED TO, THE IMPLIED WARRANTIES OF MERCHANTABILITY, FITNESS FOR A PARTICULAR PURPOSE AND NON-INFRINGEMENT OF THIRD PARTY RIGHTS WITH RESPECT TO THE TELENAV SOFTWARE.
- Certain jurisdictions do not permit the disclaimer of certain warranties, so this limitation may not apply to you.

5. Limitation of Liability

- TO THE EXTENT PERMITTED UNDER APPLICABLE LAW, UNDER NO CIRCUMSTANCES SHALL TELENAV OR ITS LICENSORS AND SUPPLIERS BE LIABLE TO YOU OR TO ANY THIRD PARTY FOR ANY INDIRECT, INCIDENTAL, CONSEQUENTIAL, SPECIAL OR EXEMPLARY DAMAGES (INCLUDING IN EACH CASE, BUT NOT LIMITED TO, DAMAGES FOR THE INABILITY TO USE THE EQUIPMENT OR ACCESS DATA, LOSS OF DATA, LOSS OF BUSINESS, LOSS OF PROFITS, BUSINESS INTERRUPTION OR THE LIKE) ARISING OUT OF THE USE OF OR INABILITY TO USE THE TELENAV SOFTWARE, EVEN IF TELENAV HAS BEEN ADVISED OF THE POSSIBILITY OF SUCH DAMAGES. NOTWITHSTANDING ANY DAMAGES THAT YOU MIGHT INCUR FOR ANY

Appendices

REASON WHATSOEVER (INCLUDING, WITHOUT LIMITATION, ALL DAMAGES REFERENCED HEREIN AND ALL DIRECT OR GENERAL DAMAGES IN CONTRACT, TORT (INCLUDING NEGLIGENCE) OR OTHERWISE), THE ENTIRE LIABILITY OF TELENAV AND OF ALL OF TELENAV'S SUPPLIERS SHALL BE LIMITED TO THE AMOUNT ACTUALLY PAID BY YOU FOR THE TELENAV SOFTWARE. SOME STATES AND/OR JURISDICTIONS DO NOT ALLOW THE EXCLUSION OR LIMITATION OF INCIDENTAL OR CONSEQUENTIAL DAMAGES, SO THE ABOVE LIMITATIONS OR EXCLUSIONS MAY NOT APPLY TO YOU.

6. Arbitration and Governing Law

- You agree that any dispute, claim or controversy arising out of or relating to this Agreement or the TeleNav Software shall be settled by independent arbitration involving a neutral arbitrator and administered by the American Arbitration Association in the County of Santa Clara, California. The arbitrator shall apply the Commercial Arbitration Rules of the American Arbitration Association, and the judgment upon the award rendered by the arbitrator may be entered by any court having jurisdiction. Note that there is no judge or jury in an arbitration proceeding and the decision of the arbitrator shall be binding upon both parties. You expressly agree to waive your right to a jury trial. This Agreement and performance hereunder will be governed by and construed in accordance with the laws of the State of California, without giving effect to its conflict of law provisions. To the extent judicial action is necessary in connection with the binding arbitration, both TeleNav and you agree to submit

to the exclusive jurisdiction of the courts of the County of Santa Clara, California. The United Nations Convention on Contracts for the International Sale of Goods shall not apply.

7. Assignment

- You may not resell, assign, or transfer this Agreement or any of your rights or obligations, except in totality, in connection with your permanent transfer of the TeleNav Software, and expressly conditioned upon the new user of the TeleNav Software agreeing to be bound by the terms and conditions of this Agreement. Any such sale, assignment or transfer that is not expressly permitted under this paragraph will result in immediate termination of this Agreement, without liability to TeleNav, in which case you and all other parties shall immediately cease all use of the TeleNav Software. Notwithstanding the foregoing, TeleNav may assign this Agreement to any other party at any time without notice, provided the assignee remains bound by this Agreement.

8. Miscellaneous

8.1

This Agreement constitutes the entire agreement between TeleNav and you with respect to the subject matter hereof.

8.2

Except for the limited licenses expressly granted in this Agreement, TeleNav retains all right, title and interest in and to the TeleNav Software, including without limitation all related intellectual property rights. No licenses or other rights which are not expressly granted in this Agreement are intended to, or shall be, granted or

Appendices

conferred by implication, statute, inducement, estoppel or otherwise, and TeleNav and its suppliers and licensors hereby reserve all of their respective rights other than the licenses explicitly granted in this Agreement.

8.3

By using the TeleNav Software, you consent to receive from TeleNav all communications, including notices, agreements, legally required disclosures or other information in connection with the TeleNav Software (collectively, "Notices") electronically. TeleNav may provide such Notices by posting them on TeleNav's Website or by downloading such Notices to your wireless device. If you desire to withdraw your consent to receive Notices electronically, you must discontinue your use of the TeleNav Software.

8.4

TeleNav's or your failure to require performance of any provision shall not affect that party's right to require performance at any time thereafter, nor shall a waiver of any breach or default of this Agreement constitute a waiver of any subsequent breach or default or a waiver of the provision itself.

8.5

If any provision herein is held unenforceable, then such provision will be modified to reflect the intention of the parties, and the remaining provisions of this Agreement will remain in full force and effect.

8.6

The headings in this Agreement are for convenience of reference only, will not be deemed to be a part of this Agreement, and will not be referred to in connection with the construction or interpretation of this Agreement. As used in this Agreement, the words "include" and "including" and variations thereof, will not be deemed to be terms of limitation, but rather will be deemed to be followed by the words "without limitation".

9. Other Vendors Terms and Conditions

- The Telenav Software utilizes map and other data licensed to Telenav by third party vendors for the benefit of you and other end users. This Agreement includes end-user terms applicable to these companies (included at the end of this Agreement), and thus your use of the Telenav Software is also subject to such terms. You agree to comply with the following additional terms and conditions, which are applicable to Telenav's third party vendor licensors::

9.1 End User Terms Required by HERE North America, LLC

The data ("Data") is provided for your personal, internal use only and not for resale. It is protected by copyright, and is subject to the following terms and conditions which are agreed to by you, on the one hand, and Telenav ("Telenav") and its licensors (including their licensors and suppliers) on the other hand.

© 2013 HERE. All rights reserved.

The Data for areas of Canada includes information taken with permission from Canadian authorities, including: © Her Majesty the Queen in Right of Canada, © Queen's Printer for Ontario, © Canada Post Corporation, GeoBase®, © Department of Natural Resources Canada.

Appendices

HERE holds a non-exclusive license from the United States Postal Service® to publish and sell ZIP+4® information.

©United States Postal Service® 2014. Prices are not established, controlled or approved by the United States Postal Service®. The following trademarks and registrations are owned by the USPS: United States Postal Service, USPS, and ZIP+4

The Data for Mexico includes certain data from Instituto Nacional de Estadística y Geografía.

9.2 End User Terms Required by NAV2 (Shanghai) Co., Ltd

The data (“Data”) is provided for your personal, internal use only and not for resale. It is protected by copyright, and is subject to the following terms and conditions which are agreed to by you, on the one hand, and NAV2 (Shanghai) Co., Ltd (“NAV2”) and its licensors (including their licensors and suppliers) on the other hand. 20xx. All rights reserved

Terms and Conditions

Permitted Use. You agree to use this Data together with the Telenav Software solely for the internal business and personal purposes for which you were licensed, and not for service bureau, time-sharing or other similar purposes. Accordingly, but subject to the restrictions set forth in the following paragraphs, you agree not to otherwise reproduce, copy, modify, decompile, disassemble, create any derivative works of, or reverse engineer any portion of this Data, and may not transfer or distribute it in any form, for any purpose, except to the extent permitted by mandatory laws.

Restrictions. Except where you have been specifically licensed to do so by Telenav, and without limiting the preceding paragraph, you may not use this Data (a) with any products, systems, or applications installed or otherwise connected to or in communication with vehicles, capable of vehicle navigation, positioning, dispatch, real time route guidance, fleet management or similar applications; or (b) with or in communication with any positioning devices or any mobile or wireless-connected electronic or computer devices, including without limitation cellular phones, palmtop and handheld computers, pagers, and personal digital assistants or PDAs.

Warning. The Data may contain inaccurate or incomplete information due to the passage of time, changing circumstances, sources used and the nature of collecting comprehensive geographic data, any of which may lead to incorrect results.

No Warranty. This Data is provided to you “as is,” and you agree to use it at your own risk. Telenav and its licensors (and their licensors and suppliers) make no guarantees, representations or warranties of any kind, express or implied, arising by law or otherwise, including but not limited to, content, quality, accuracy, completeness, effectiveness, reliability, fitness for a particular purpose, usefulness, use or results to be obtained from this Data, or that the Data or server will be uninterrupted or error-free.

Disclaimer of Warranty: TELENAV AND ITS LICENSORS (INCLUDING THEIR LICENSORS AND SUPPLIERS) DISCLAIM ANY WARRANTIES, EXPRESS OR IMPLIED, OF QUALITY, PERFORMANCE, MERCHANTABILITY, FITNESS FOR A

Appendices

PARTICULAR PURPOSE OR NON-INFRINGEMENT. Some States, Territories and Countries do not allow certain warranty exclusions, so to that extent the above exclusion may not apply to you.

Disclaimer of Liability: TELENV AND ITS LICENSORS (INCLUDING THEIR LICENSORS AND SUPPLIERS) SHALL NOT BE LIABLE TO YOU: IN RESPECT OF ANY CLAIM, DEMAND OR ACTION, IRRESPECTIVE OF THE NATURE OF THE CAUSE OF THE CLAIM, DEMAND OR ACTION ALLEGING ANY LOSS, INJURY OR DAMAGES, DIRECT OR INDIRECT, WHICH MAY RESULT FROM THE USE OR POSSESSION OF THE INFORMATION; OR FOR ANY LOSS OF PROFIT, REVENUE, CONTRACTS OR SAVINGS, OR ANY OTHER DIRECT, INDIRECT, INCIDENTAL, SPECIAL OR CONSEQUENTIAL DAMAGES ARISING OUT OF YOUR USE OF OR INABILITY TO USE THIS INFORMATION, ANY DEFECT IN THE INFORMATION, OR THE BREACH OF THESE TERMS OR CONDITIONS, WHETHER IN AN ACTION IN CONTRACT OR TORT OR BASED ON A WARRANTY, EVEN IF TELENV OR ITS LICENSORS HAVE BEEN ADVISED OF THE POSSIBILITY OF SUCH DAMAGES. Some States, Territories and Countries do not allow certain liability exclusions or damages limitations, so to that extent the above may not apply to you.

Export Control. You shall not export from anywhere any part of the Data or any direct product thereof except in compliance with, and with all licenses and approvals required under, applicable export laws, rules and regulations, including but not limited to the laws, rules and regulations administered by the Office of Foreign Assets Control of the U.S. Department of Commerce and the Bureau of Industry and Security of the U.S. Department of Commerce. To the extent that any such

export laws, rules or regulations prohibit HERE from complying with any of its obligations hereunder to deliver or distribute Data, such failure shall be excused and shall not constitute a breach of this Agreement.

Entire Agreement. These terms and conditions constitute the entire agreement between Telenav (and its licensors, including their licensors and suppliers) and you pertaining to the subject matter hereof, and supersedes in their entirety any and all written or oral agreements previously existing between us with respect to such subject matter.

Governing Law. The above terms and conditions shall be governed by the laws of the State of Illinois [insert "Netherlands" where European HERE Data is used], without giving effect to (i) its conflict of laws provisions, or (ii) the United Nations Convention for Contracts for the International Sale of Goods, which is explicitly excluded. You agree to submit to the jurisdiction of the State of Illinois [insert "The Netherlands" where European HERE Data is used] for any and all disputes, claims and actions arising from or in connection with the Data provided to you hereunder.

Government End Users. If the Data is being acquired by or on behalf of the United States government or any other entity seeking or applying rights similar to those customarily claimed by the United States government, this Data is a "commercial item" as that term is defined at 48 C.F.R. ("FAR") 2.101, is licensed in accordance with these End-User Terms, and each copy of Data delivered or otherwise furnished shall be marked and embedded as appropriate with the following "Notice of Use," and shall be treated in accordance with such Notice:

Appendices

NOTICE OF USE

CONTRACTOR (MANUFACTURER/
SUPPLIER) NAME: HERE

CONTRACTOR (MANUFACTURER/
SUPPLIER) ADDRESS: c/o Nokia, 425
West Randolph Street, Chicago, Illinois
60606

This Data is a commercial item as
defined in FAR 2.101 and is subject to
these End-User Terms under which this
Data was provided.

© 1987 – 2014 HERE – All rights reserved.

If the Contracting Officer, federal government agency, or any federal official refuses to use the legend provided herein, the Contracting Officer, federal government agency, or any federal official must notify HERE prior to seeking additional or alternative rights in the Data.

I. US/Canada Territory

A. United States Data. The End-User Terms for any Application containing Data for the United States shall contain the following notices:

“HERE holds a non-exclusive license from the United States Postal Service® to publish and sell ZIP+4® information.”

“©United States Postal Service® 20XX. Prices are not established, controlled or approved by the United States Postal Service®. The following trademarks and registrations are owned by the USPS: United States Postal Service, USPS, and ZIP+4.”

B. Canada Data. The following provisions apply to the Data for Canada, which may include or reflect data from third party licensors (“Third Party Data”), including Her Majesty the Queen in Right of Canada (“Her Majesty”), Canada Post Corporation (“Canada Post”) and the Department of Natural Resources of Canada (“NRCan”):

1. Disclaimer and Limitation: Client agrees that its use of the Third Party Data is subject to the following provisions:

a. Disclaimer: The Third Party Data is licensed on an “as is” basis. The licensors of such data, including Her Majesty, Canada Post and NRCan, make no guarantees, representations or warranties respecting such data, either express or implied, arising by law or otherwise, including but not limited to, effectiveness, completeness, accuracy or fitness for a particular purpose.

b. Limitation on Liability: The Third Party Data licensors, including Her Majesty, Canada Post and NRCan, shall not be liable: (i) in respect of any claim, demand or action, irrespective of the nature of the cause of the claim, demand or action alleging any loss, injury or damages, direct or indirect, which may result from the use or possession of such Data; or (ii) in any way for loss of revenues or contracts, or any other consequential loss of any kind resulting from any defect in the Data.

Appendices

2. Copyright Notice: In connection with each copy of all or any portion of the Data for the Territory of Canada, Client shall affix in a conspicuous manner the following copyright notice on at least one of: (i) the label for the storage media of the copy; (ii) the packaging for the copy; or (iii) other materials packaged with the copy, such as user manuals or end user license agreements: "This data includes information taken with permission from Canadian authorities, including © Her Majesty the Queen in Right of Canada, © Queen's Printer for Ontario, © Canada Post Corporation, GeoBase®, © The Department of Natural Resources Canada. All rights reserved!"

3. End-User Terms: Except as otherwise agreed by the parties, in connection with the provision of any portion of the Data for the Territory of Canada to End-Users as may be authorized under the Agreement, Client shall provide such End-Users, in a reasonably conspicuous manner, with terms (set forth with other end user terms required to be provided under the Agreement, or as otherwise may be provided, by Client) which shall include the following provisions on behalf of the Third Party Data licensors, including Her Majesty, Canada Post and NRCan:

The Data may include or reflect data of licensors, including Her Majesty the Queen in the Right of Canada ("Her Majesty"), Canada Post Corporation ("Canada Post") and the Department of Natural Resources Canada ("NRCan"). Such data is licensed on an "as is" basis. The licensors, including Her Majesty, Canada Post and NRCan, make no guarantees, representations or warranties respecting such data,

either express or implied, arising by law or otherwise, including but not limited to, effectiveness, completeness, accuracy or fitness for a particular purpose. The licensors, including Her Majesty, Canada Post and NRCan, shall not be liable in respect of any claim, demand or action, irrespective of the nature of the cause of the claim, demand or action alleging any loss, injury or damages, direct or indirect, which may result from the use or possession of the data or the Data. The licensors, including Her Majesty, Canada Post and NRCan, shall not be liable in any way for loss of revenues or contracts, or any other consequential loss of any kind resulting from any defect in the data or the Data.

End User shall indemnify and save harmless the licensors, including Her Majesty, Canada Post and NRCan, and their officers, employees and agents from and against any claim, demand or action, irrespective of the nature of the cause of the claim, demand or action, alleging loss, costs, expenses, damages or injuries (including injuries resulting in death) arising out of the use or possession of the data or the Data.

4. Additional Provisions: The terms contained in this Section are in addition to all of the rights and obligations of the parties under the Agreement. To the extent that any of the provisions of this Section are inconsistent with, or conflict with, any other provisions of the Agreement, the provisions of this Section shall prevail.

Appendices

II. Mexico. The following provision applies to the Data for Mexico, which includes certain data from the Instituto Nacional de Estadística y Geografía (“INEGI”):

A. Any and all copies of the Data and/or packaging containing Data for Mexico shall contain the following notice: “Fuente: INEGI (Instituto Nacional de Estadística y Geografía)”

III. Latin America Territory

A. Third Party Notices. Any and all copies of the Data and/or packaging relating thereto shall include the respective Third Party Notices set forth below and used as described below corresponding to the Territory (or portion thereof) included in such copy:

Territory Notice

Ecuador “INSTITUTO GEOGRAFICO MILITAR DEL ECUADOR AUTORIZACION N° IGM-2011-01- PCO-01 DEL 25 DE ENERO DE 2011”
“source: © IGN 2009 - BD TOPO ®”

Guade-
loupe,
French
Guiana
and
Marti-
nique
Mexico “Fuente: INEGI (Instituto Nacional de Estadística y Geografía)”

IV. Middle East Territory

A. Third Party Notices. Any and all copies of the Data and/or packaging relating thereto shall include the respective Third Party Notices set forth below and used as described below corresponding to the Territory (or portion thereof) included in such copy:

Country Notice

Jordan “© Royal Jordanian Geographic Centre”. The foregoing notice requirement for Jordan Data is a material term of the Agreement. If Client or any of its permitted sublicensees (if any) fail to meet such requirement, HERE shall have the right to terminate Client’s license with respect to the Jordan Data.

B. Jordan Data. Client and its permitted sublicensees (if any) are restricted from licensing and/or otherwise distributing HERE’s database for the country of Jordan (“Jordan Data”) for use in Enterprise Applications to (i) non-Jordanian entities for use of the Jordan Data solely in Jordan or (ii) Jordan-based customers. In addition, Client, its permitted sublicensees (if any) and End-Users are restricted from using the Jordan Data in Enterprise Applications if such party is (i) a non-Jordanian entity using the Jordan Data solely in Jordan or (ii) a Jordan-based customer. For purposes of the foregoing, “Enterprise Applications” shall mean Geomarketing applications, GIS applications, mobile business asset management applications, call center applications, telematics applications, public organization Internet applications or for providing geocoding services.

Appendices

V. Europe Territory

A. Use of Certain Traffic Codes in Europe

1. General Restrictions Applicable to Traffic Codes. Client acknowledges and agrees that in certain countries of the Europe Territory, Client will need to obtain rights directly from third party RDS-TMC code providers to receive and use the Traffic Codes in the Data and to deliver to End-Users Transactions in any way derived from or based on such Traffic Codes. For such countries, HERE shall deliver the Data incorporating Traffic Codes to Client only after receiving certification from Client of its having obtained such rights.

2. Display of Third Party Rights Legends for Belgium. Client shall, for each Transaction that uses Traffic Codes for Belgium, provide the following notice to the End-User: "Traffic Codes for Belgium are provided by the Ministerie van de Vlaamse Gemeenschap and the Ministère de l'Équipement et des Transports."

B. Paper Maps. With respect to any license granted to Client relating to making, selling or distributing paper maps (i.e., a map fixed on a paper or paper-like medium): (a) such license with respect to Data for the Territory of Great Britain is conditioned on Client's entering into and complying with a separate written agreement with the Ordnance Survey ("OS") to create and sell paper maps, Client's paying to the OS any and all applicable paper map royalties, and Client's complying with the OS copyright notice requirements; (b) such license for selling or otherwise distributing for charge with respect to Data for the Territory of Czech Republic

is conditioned on Client's obtaining prior written consent from Kartografie a.s.; (c) such license for selling or distributing with respect to Data for the Territory of Switzerland is conditioned on Client's obtaining a permit from Bundesamt für Landestopografie of Switzerland; (d) Client is restricted from using Data for the Territory of France to create paper maps with a scale between 1:5,000 and 1:250,000; and (e) Client is restricted from using any Data to create, sell or distribute paper maps that are the same or substantially similar, in terms of data content and specific use of color, symbols and scale, to paper maps published by the European national mapping agencies, including without limitation, Landvermessungämter of Germany, Topografische Dienst of the Netherlands, Nationaal Geografisch Instituut of Belgium, Bundesamt für Landestopografie of Switzerland, Bundesamt für Eich-und Vermessungswesen of Austria, and the National Land Survey of Sweden.

C. OS Enforcement. Without limiting Section IV(B) above, with respect to Data for the Territory of Great Britain, Client acknowledges and agrees that the Ordnance Survey ("OS") may bring a direct action against Client to enforce compliance with the OS copyright notice (see Section IV(D) below) and paper map requirements (see Section IV(B) above) contained in this Agreement.

D. Third Party Notices. Any and all copies of the Data and/or packaging relating thereto shall include the respective Third Party Notices set forth below and used as described below corresponding to the Territory (or portion thereof) included in such copy:

Country(ies) Notice

Appendices

Austria	“© Bundesamt für Eich- und Vermessungswesen”	Spain	“Información geográfica propiedad del CNIG”
Croatia		Sweden	“Based upon electronic data © National Land Survey Sweden.”
Cyprus,		Switzerland	“Topografische Grundlage: © Bundesamt für Landestopographie.
Estonia,			
Latvia,			
Lithuania,			
Moldova,			
Poland,			
Slovenia			
and/or			
Ukraine	“© EuroGeographics”		
France	“source: © IGN 2009 – BD TOPO ®”		
Germany	“Die Grundlagendaten wurden mit Genehmigung der zuständigen Behörden entnommen”		
Great Britain	“Contains Ordnance Survey data © Crown copyright and database right 2010 Contains Royal Mail data © Royal Mail copyright and database right 2010”		
Greece	“Copyright Geomatics Ltd.”		
Hungary	“Copyright © 2003; Top-Map Ltd.”		
Italy	“La Banca Dati Italiana è stata prodotta usando quale riferimento anche cartografia numerica ed al tratto prodotta e fornita dalla Regione Toscana.”		
Norway	“Copyright © 2000; Norwegian Mapping Authority”		
Portugal	“Source: IgeoE – Portugal”		

E. Respective Country Distribution. Client acknowledges that HERE has not received approvals to distribute map data for the following countries in such respective countries: Albania, Belarus, Kyrgyzstan, Moldova and Uzbekistan. HERE may update such list from time to time. The license rights granted to Client under this TL with respect to the Data for such countries are contingent upon Client’s compliance with all applicable laws and regulations, including, without limitation, any required licenses or approvals to distribute the Application incorporating such Data in such respective countries.

VI. Australia Territory

A. Third Party Notices. Any and all copies of the Data and/or packaging relating thereto shall include the respective Third Party Notices set forth below and used as described below corresponding to the Territory (or portion thereof) included in such copy:

Copyright. Based on data provided under license from PSMA Australia Limited (www.pasma.com.au).

Appendices

Product incorporates data which is © 20XX Telstra Corporation Limited, GM Holden Limited, Intelomatics Australia Pty Ltd and Continental Pty Ltd.

B. Third Party Notices for Australia. In addition to the foregoing, the End-User Terms for any Application containing RDS-TMC Traffic Codes for Australia shall contain the following notice: “Product incorporates traffic location codes which is © 20XX Telstra Corporation Limited and its licensors.”

AT&T Vehicle Network Carrier Telematics Disclosure

END USER FOR PURPOSES OF THIS SECTION MEANS YOU AND YOUR HEIRS, EXECUTORS, LEGAL PERSONAL REPRESENTATIVES AND PERMITTED ASSIGNS. FOR PURPOSES OF THIS SECTION “UNDERLYING WIRELESS SERVICE CARRIER” INCLUDES ITS AFFILIATES AND CONTRACTORS AND THEIR RESPECTIVE OFFICERS, DIRECTORS, EMPLOYEES, SUCCESSORS AND ASSIGNS. END USER HAS NO CONTRACTUAL RELATIONSHIP WITH THE UNDERLYING WIRELESS SERVICE CARRIER AND END USER IS NOT A THIRD PARTY BENEFICIARY OF ANY AGREEMENT BETWEEN FORD AND UNDERLYING CARRIER. END USER UNDERSTANDS AND AGREES THAT THE UNDERLYING CARRIER HAS NO LEGAL, EQUITABLE, OR OTHER LIABILITY OF ANY KIND TO END USER. IN ANY EVENT, REGARDLESS OF THE FORM OF THE ACTION, WHETHER FOR BREACH OF CONTRACT, WARRANTY, NEGLIGENCE, STRICT LIABILITY IN TORT OR OTHERWISE, END USER’S EXCLUSIVE REMEDY FOR CLAIMS ARISING IN ANY WAY IN CONNECTION WITH THIS AGREEMENT, FOR ANY CAUSE WHATSOEVER, INCLUDING BUT NOT LIMITED TO ANY FAILURE OR

DISRUPTION OF SERVICE PROVIDED HEREUNDER, IS LIMITED TO PAYMENT OF DAMAGES IN AN AMOUNT NOT TO EXCEED THE AMOUNT PAID BY END USER FOR THE SERVICES DURING THE TWO-MONTH PERIOD PRECEDING THE DATE THE CLAIM AROSE.

(ii) END USER AGREES TO INDEMNIFY AND HOLD HARMLESS THE UNDERLYING WIRELESS SERVICE CARRIER AND ITS OFFICERS, EMPLOYEES, AND AGENTS AGAINST ANY AND ALL CLAIMS, INCLUDING WITHOUT LIMITATION CLAIMS FOR LIBEL, SLANDER, OR ANY PROPERTY DAMAGE, PERSONAL INJURY OR DEATH, ARISING IN ANY WAY, DIRECTLY OR INDIRECTLY, IN CONNECTION WITH THIS AGREEMENT OR THE USE, FAILURE TO USE, OR INABILITY TO USE THE DEVICE EXCEPT WHERE THE CLAIMS RESULT FROM THE UNDERLYING CARRIER’S GROSS NEGLIGENCE OR WILLFUL MISCONDUCT. THIS INDEMNITY WILL SURVIVE THE TERMINATION OF THE AGREEMENT.

(iii) END USER HAS NO PROPERTY RIGHT IN ANY NUMBER ASSIGNED TO THE DEVICE.

(iv) END USER UNDERSTANDS THAT FORD AND THE UNDERLYING CARRIER CANNOT GUARANTEE THE SECURITY OF WIRELESS TRANSMISSIONS, AND WILL NOT BE LIABLE FOR ANY LACK OF SECURITY RELATING TO THE USE OF THE SERVICES

THE SERVICE IS FOR [END USER’S] USE ONLY AND END USER MAY NOT RESELL THE SERVICE TO ANY OTHER PARTY END USER UNDERSTANDS THAT THE UNDERLYING CARRIER DOES NOT GUARANTEE ANY END USER UNINTERRUPTED SERVICE OR COVERAGE. THE UNDERLYING CARRIER DOES NOT WARRANT THAT END USERS CAN OR WILL BE LOCATED USING THE SERVICE. THE UNDERLYING CARRIER

Appendices

MAKES NO WARRANTY, EXPRESS OR IMPLIED, OF MERCHANTABILITY OR FITNESS FOR A PARTICULAR PURPOSE, SUITABILITY, OR PERFORMANCE REGARDING ANY SERVICES OR GOODS, AND IN NO EVENT SHALL AT&T BE LIABLE, WHETHER OR NOT DUE TO ITS OWN NEGLIGENCE, FOR ANY: (A) ACT OR OMISSION OF A THIRD PARTY; (B) MISTAKES, OMISSIONS, INTERRUPTIONS, ERRORS, FAILURES TO TRANSMIT, DELAYS, OR DEFECTS IN THE SERVICE PROVIDED BY OR THROUGH THE UNDERLYING CARRIER; (C) DAMAGE OR INJURY CAUSED BY SUSPENSION OR TERMINATION BY THE UNDERLYING CARRIER; OR (D) DAMAGE OR INJURY CAUSED BY A FAILURE OR DELAY IN CONNECTING A CALL TO ANY ENTITY, INCLUDING 911 OR ANY OTHER EMERGENCY SERVICE. TO THE FULL EXTENT ALLOWED BY LAW, THE END USER RELEASES, INDEMNIFIES AND HOLDS THE UNDERLYING CARRIER HARMLESS FROM AND AGAINST ANY AND ALL CLAIMS OF ANY PERSON OR ENTITY FOR DAMAGES OF ANY NATURE ARISING IN ANY WAY FROM OR RELATING TO, DIRECTLY OR INDIRECTLY, SERVICES PROVIDED BY THE UNDERLYING CARRIER OR ANY PERSON'S USE THEREOF, INCLUDING CLAIMS ARISING IN WHOLE OR IN PART FROM THE ALLEGED NEGLIGENCE OF THE UNDERLYING CARRIER.

VII. China Territory

Personal Use Only

You agree to use this Data together with [insert name of Client Application] for the solely personal, non-commercial purposes for which you were licensed, and not for service bureau, time-sharing or other similar purposes. Accordingly, but subject to the restrictions set forth in the following paragraphs, you may copy this Data only as necessary for your personal use to (i)

view it, and (ii) save it, provided that you do not remove any copyright notices that appear and do not modify the Data in any way. You agree not to otherwise reproduce, copy, modify, decompile, disassemble or reverse engineer any portion of this Data, and may not transfer or distribute it in any form, for any purpose, except to the extent permitted by mandatory laws.

Restrictions

Except where you have been specifically licensed to do so by NAV2, and without limiting the preceding paragraph, you may not (a) use this Data with any products, systems, or applications installed or otherwise connected to or in communication with vehicles, capable of vehicle navigation, positioning, dispatch, real time route guidance, fleet management or similar applications; or (b) with or in communication with any positioning devices or any mobile or wireless-connected electronic or computer devices, including without limitation cellular phones, palmtop and handheld computers, pagers, and personal digital assistants or PDAs. You agree to cease using this Data if you fail to comply with these terms and conditions.

Limited Warranty

NAV2 warrants that (a) the Data will perform substantially in accordance with the accompanying written materials for a period of ninety (90) days from the date of receipt, and (b) any support services provided by NAV2 shall be substantially as described in applicable written materials provided to you by NAV2, and NAV2's support engineers will make commercially reasonable efforts to solve any problem issues.

Appendices

***rig*Customer Remedies**

NAV2 and its suppliers' entire liability and your exclusive remedy shall be, at NAV2's sole discretion, either (a) return of the price paid, if any, or (b) repair or replacement of the Data that do not meet NAV2's Limited Warranty and that are returned to NAV2 with a copy of your receipt. This Limited Warranty is void if failure of the Data has resulted from accident, abuse, or misapplication. Any replacement Data will be warranted for the remainder of the original warranty period or thirty (30) days, whichever is longer. Neither these remedies nor any product support services offered by NAV2 are available without proof of purchase from an authorized international source.

No Other Warranty:

EXCEPT FOR THE LIMITED WARRANTY SET FORTH ABOVE AND TO THE EXTENT PERMITTED BY APPLICABLE LAW, NAV2 AND ITS LICENSORS (INCLUDING THEIR LICENSORS AND SUPPLIERS) DISCLAIM ANY WARRANTIES, EXPRESS OR IMPLIED, OF QUALITY, PERFORMANCE, MERCHANTABILITY, FITNESS FOR A PARTICULAR PURPOSE, OWNERSHIP OR NON-INFRINGEMENT. Certain warranty exclusions may not be permitted under applicable law, so to that extent the above exclusion may not apply to you.

Limited Liability:

TO THE EXTENT PERMITTED BY APPLICABLE LAW, NAV2 AND ITS LICENSORS (INCLUDING THEIR LICENSORS AND SUPPLIERS) SHALL NOT BE LIABLE TO YOU: IN RESPECT OF ANY CLAIM, DEMAND OR ACTION, IRRESPECTIVE OF THE NATURE OF THE CAUSE OF THE CLAIM, DEMAND OR ACTION ALLEGING ANY LOSS, INJURY OR DAMAGES, DIRECT OR INDIRECT, WHICH MAY RESULT FROM THE USE OR POSSESSION OF THE INFORMATION; OR

FOR ANY LOSS OF PROFIT, REVENUE, CONTRACTS OR SAVINGS, OR ANY OTHER DIRECT, INDIRECT, INCIDENTAL, SPECIAL OR CONSEQUENTIAL DAMAGES ARISING OUT OF YOUR USE OF OR INABILITY TO USE THIS INFORMATION, ANY DEFECT IN THE INFORMATION, OR THE BREACH OF THESE TERMS OR CONDITIONS, WHETHER IN AN ACTION IN CONTRACT OR TORT OR BASED ON A WARRANTY, EVEN IF NAV2 OR ITS LICENSORS HAVE BEEN ADVISED OF THE POSSIBILITY OF SUCH DAMAGES. UNDER NO CIRCUMSTANCES SHALL NAV2'S OR ITS SUPPLIERS' LIABILITY HEREUNDER EXCEED THE PRICE PAID. Certain liability exclusions may not be permitted under applicable law, so to that extent the above exclusion may not apply to you.

Export Control

You agree not to export to anywhere any part of the Data provided to you or any direct product thereof except in compliance with, and with all licenses and approvals required under, applicable export laws, rules and regulations.

IP Protection

The Data are owned by NAV2 or its suppliers and are protected by applicable copyright and other intellectual property law and treaties. The Data are provided solely on the basis of a license to use, not sale.

Entire Agreement

These terms and conditions constitute the entire agreement between NAV2 (and its licensors, including their licensors and suppliers) and you pertaining to the subject matter hereof, and supersedes in their entirety any and all written or oral agreements previously existing between us with respect to such subject matter.

Appendices

Governing Law.

The above terms and conditions shall be governed by the laws of the People's Republic of China, without giving effect to (i) its conflict of laws provisions, or (ii) the United Nations Convention for Contracts for the International Sale of Goods, which is explicitly excluded. Any dispute arising from or in connection with the Data provided to you hereunder shall be submitted to the Shanghai International Economic and Trade Arbitration Commission for arbitration.

Gracenote® Copyright

CD and music-related data from Gracenote, Inc., copyright©

2000-2007 Gracenote. Gracenote Software, copyright © 2000-2007 Gracenote. This product and service may practice one or more of the following U.S. Patents 5,987,525; 6,061,680; 6,154,773; 6,161,132; 6,230,192; 6,230,207; 6,240,459; 6,330,593 and other patents issued or pending. Some services supplied under license from Open Globe, Inc. for U.S. Patent 6,304,523.

Gracenote and CDDB are registered trademarks of Gracenote. The Gracenote logo and logotype, and the "Powered by Gracenote™" logo are trademarks of Gracenote.

Gracenote® End User License Agreement (EULA)

This device contains software from Gracenote, Inc. of 2000 Powell Street Emeryville, California 94608 ("Gracenote").

The software from Gracenote (the "Gracenote Software") enables this device to do disc and music file identification and obtain music-related information, including name, artist, track, and title information ("Gracenote Data") from online servers

("Gracenote Servers"), and to perform other functions. You may use Gracenote Data only by means of the intended End User functions of this device. This device may contain content belonging to Gracenote's providers. If so, all of the restrictions set forth herein with respect to Gracenote Data shall also apply to such content and such content providers shall be entitled to all of the benefits and protections set forth herein that are available to Gracenote. You agree that you will use the content from Gracenote ("Gracenote Content"), Gracenote Data, the Gracenote Software, and Gracenote Servers for your own personal, non-commercial use only. You agree not to assign, copy, transfer or transmit the Gracenote Content, Gracenote Software or any Gracenote Data (except in a Tag associated with a music file) to any third party. YOU AGREE NOT TO USE OR EXPLOIT GRACENOTE CONTENT, GRACENOTE DATA, THE GRACENOTE SOFTWARE, OR GRACENOTE SERVERS, EXCEPT AS EXPRESSLY PERMITTED HEREIN.

You agree that your non-exclusive licenses to use the Gracenote Content, Gracenote Data, the Gracenote Software, and Gracenote Servers will terminate if you violate these restrictions. If your licenses terminate, you agree to cease any and all use of the Gracenote Content, Gracenote Data, the Gracenote Software, and Gracenote Servers.

Gracenote, respectively, reserve all rights in Gracenote Data, the Gracenote Software, and the Gracenote Servers and Gracenote Content, including all ownership rights. Under no circumstances will either Gracenote become liable for any payment to you for any information that you provide,

Appendices

including any copyrighted material or music file information. You agree that Gracenote may enforce its respective rights, collectively or separately, under this agreement against you, directly in each company's own name.

Gracenote uses a unique identifier to track queries for statistical purposes. The purpose of a randomly assigned numeric identifier is to allow Gracenote to count queries without knowing anything about who you are. For more information, see the web page at www.gracenote.com for the Gracenote Privacy Policy.

THE GRACENOTE SOFTWARE, EACH ITEM OF GRACENOTE DATA AND THE GRACENOTE CONTENT ARE LICENSED TO YOU "AS IS". NEITHER GRACENOTE MAKES ANY REPRESENTATIONS OR WARRANTIES, EXPRESS OR IMPLIED, REGARDING THE ACCURACY OF ANY GRACENOTE DATA FROM THE GRACENOTE SERVERS OR GRACENOTE CONTENT. GRACENOTE COLLECTIVELY AND SEPARATELY RESERVE THE RIGHT TO DELETE DATA AND/OR CONTENT FROM THE COMPANIES' RESPECTIVE SERVERS OR, IN THE CASE OF GRACENOTE, CHANGE DATA CATEGORIES FOR ANY CAUSE THAT GRACENOTE DEEMS SUFFICIENT. NO WARRANTY IS MADE THAT EITHER GRACENOTE CONTENT OR THE GRACENOTE SOFTWARE OR GRACENOTE SERVERS ARE ERROR-FREE OR THAT THE FUNCTIONING OF THE GRACENOTE SOFTWARE OR GRACENOTE SERVERS WILL BE UNINTERRUPTED. GRACENOTE IS NOT OBLIGATED TO PROVIDE YOU WITH ANY ENHANCED OR ADDITIONAL DATA TYPES THAT GRACENOTE MAY CHOOSE TO PROVIDE IN THE FUTURE AND IS FREE TO DISCONTINUE ITS ONLINE SERVICES AT ANY TIME. GRACENOTE DISCLAIM ALL WARRANTIES EXPRESS OR IMPLIED, INCLUDING, BUT NOT LIMITED TO,

IMPLIED WARRANTIES OF MERCHANTABILITY, FITNESS FOR A PARTICULAR PURPOSE, TITLE, AND NON-INFRINGEMENT. NEITHER GRACENOTE WARRANTS THE RESULTS THAT WILL BE OBTAINED BY YOUR USE OF THE GRACENOTE SOFTWARE OR ANY GRACENOTE SERVER. IN NO CASE WILL GRACENOTE BE LIABLE FOR ANY CONSEQUENTIAL OR INCIDENTAL DAMAGES OR FOR ANY LOST PROFITS OR LOST REVENUES FOR ANY REASON WHATSOEVER. © Gracenote 2007.

Radio Frequency Statement

FCC ID: ACJ-SYNCG3-L

IC: 216B-SYNCG3-L

This device complies with Part 15 of the FCC Rules and with RSS-210 of Industry Canada. Operation is subject to the following two conditions:

- (1)** This device may not cause harmful interference, and
- (2)** this device must accept any interference received, including interference that may cause undesired operation.

WARNING



Changes or modifications not expressly approved by the party responsible for compliance could void the user's authority to operate the equipment. The term "IC:" before the radio certification number only signifies that Industry Canada technical specifications were met.

The antenna used for this transmitter must not be co-located or operating in conjunction with any other antenna or transmitter.

Appendices

Taiwan Territory

Note: In accordance with the management approach of low-power radio wave radiation motors:

Article 12: For approved and certified low-power radiation motor models, companies, firms or users must not alter the frequency, increase the power or change the characteristics and functions of the original design without authorization.

Article 14: The usage of low-power radio-frequency motors must not affect aviation safety and interfere with legal telecommunications. Should interference be detected, immediately stop using the device and only resume usage after ensuring that there is no longer any interference. For the legal telecommunication and wireless telecommunication of the telco, the low-power radio frequency motor must be able to tolerate legal limits of interference from telecommunication, industrial, scientific and radio wave equipment.

SUNA TRAFFIC CHANNEL – TERMS AND CONDITIONS

By activating, using and/or accessing the SUNA Traffic Channel, SUNA Predictive or other content or material provided by Intelematics (together, **SUNA Products and/or Services**), you must accept certain terms and conditions. The following is a brief summary of the terms and conditions that apply to you. To view the full terms and conditions relevant to your use of the SUNA Products and/or Services, please consult:

Website
www.sunatrafic.com.au/termsandconditions/

1. Acceptance

By using SUNA Products and/or Services, you will be deemed to have accepted and agreed to be bound by the terms and conditions fully detailed at:

Website
www.sunatrafic.com.au/termsandconditions/

2. Intellectual Property

SUNA Products and/or Services are for your personal use. You may not record, or retransmit the content, nor use the content in association with any other traffic information or route guidance service or device not approved by Intelematics. You obtain no right of ownership in any Intellectual Property Rights (including copyright) in the data that is used to provide SUNA Products and/or Services.

3. Appropriate Use

SUNA Products and/or Services are intended as an aid to personal motoring and travel planning, and do not provide comprehensive or accurate information on all occasions. On occasions, you may experience additional delay as a result of using SUNA Products and/or Services. You acknowledge that it is not intended, or suitable, for use in applications where time of arrival or driving directions may impact the safety of the public or yourself.

4. Use of SUNA Products and Services while driving

You, and other authorised drivers of the vehicle in which SUNA Products and/or Services are available or installed and active, remain at all times responsible for observing all relevant laws and codes of safe driving. In particular, you agree to only actively operate SUNA Products and/or Services when the Vehicle is at a complete stop and it is safe to do so.

Appendices

5. Service Continuity and Reception of the SUNA Traffic Channel

We will use reasonable endeavours to provide the SUNA Traffic Channel 24 hours a day, 365 days a year. The SUNA Traffic Channel may occasionally be unavailable for technical reasons or for planned maintenance. We will try to perform maintenance at times when congestion is light. We reserve the right to withdraw SUNA Products and/or Services at any time.

Also, we cannot assure the uninterrupted reception of the SUNA Traffic Channel RDS-TMC signal at any particular location.

6. Limitation of Liability

Neither Intelematics (nor its suppliers or the manufacturer of your device (the “**Suppliers**”)) shall be liable to you or to any third party for any damages either direct, indirect, incidental, consequential or otherwise arising out of the use of or inability to use SUNA Products and/or Services even if Intelematics or a Supplier has been advised of the possibility of such damages. You also acknowledge that the neither Intelematics nor any Supplier guarantees nor make any warranties that relate to the availability, accuracy or completeness of SUNA Products and/or Services, and to the extent which it is lawful to do so, both Intelematics and each Supplier excludes any warranties which might otherwise be implied by any State or Federal legislation in relation to SUNA Products and/or Services.

7. Please Note

Great care has been taken in preparing this manual. Constant product development may mean that some information is not entirely up-to-date. The information in this document is subject to change without notice.

WARNING



Driving while distracted can result in loss of vehicle control, crash and injury. We strongly recommend that you use extreme caution when using any device that may take your focus off the road. Your primary responsibility is the safe operation of your vehicle. We recommend against the use of any hand-held device while driving and encourage the use of voice-operated systems when possible. Make sure you are aware of all applicable local laws that may affect the use of electronic devices while driving.

Index

A

A/C	
See: Climate Control.....	80
About This Manual.....	5
Ford GT Concierge Phone Numbers.....	5
ABS	
See: Brakes.....	111
ABS driving hints	
See: Hints on Driving With Anti-Lock Brakes.....	111
Accessories.....	273
Accessories	
See: Replacement Parts Recommendation.....	10
Adjusting the Headlamps.....	170
Headlamp Aim Target.....	170
Adjusting the Pedals.....	56
Adjusting the Steering Wheel.....	52
Airbag Disposal.....	39
Air Conditioning	
See: Climate Control.....	80
Air Filter	
See: Changing the Engine Air Filter.....	171
Alarm	
See: Anti-Theft Alarm.....	51
Anti-Theft Alarm.....	51
Arming the Alarm.....	51
Disarming the Alarm.....	51
Appendices.....	288
Apps.....	247
.....	247
At a Glance.....	14
Audible Warnings and Indicators.....	69
Headlamps On Warning Chime.....	69
Keyless Warning Alert.....	69
Audio Control.....	53
Seek, Next or Previous.....	53
Audio System.....	212
Audio Unit.....	212
Autolamps.....	59
Automatic Climate Control.....	81
Automatic Transmission.....	106
Brake-Shift Interlock.....	108
If Your Vehicle Gets Stuck In Mud or Snow.....	110
SelectShift™ Automatic Transmission.....	107

Understanding the Positions of Your Automatic Transmission.....	106
Automatic Transmission Fluid Check.....	166
Auxiliary Power Points.....	88
12 Volt DC Power Point.....	88
Location.....	88

B

Battery	
See: Changing the 12V Battery.....	168
Bonnet Lock	
See: Opening and Closing the Hood.....	157
Booster Seats.....	22
Types of Booster Seats.....	23
Brake Fluid Check.....	166
Brakes.....	111
General Information.....	111
Breaking-In.....	134
Cold Engine Operation.....	134
Hot Engine Shut down.....	134

C

Cabin Air Filter.....	85
California Proposition 65.....	9
Capacities and Specifications.....	209
Specifications.....	210
Car Wash	
See: Cleaning the Exterior.....	172
Catalytic Converter.....	103
On-Board Diagnostics (OBD-II).....	104
Readiness for Inspection and Maintenance (I/M) Testing.....	104
Changing a Bulb.....	171
LED Lamps.....	171
Changing a Fuse.....	155
Fuses.....	155
Changing a Road Wheel.....	202
Important Information for Lifting or Jacking.....	202
Changing the 12V Battery.....	168
Battery Charger and Maintainer.....	168
Battery Management System.....	169
Changing the Engine Air Filter.....	171
Changing the Wiper Blades.....	169
Checking the Wiper Blades.....	169

Index

Child Restraint and Seatbelt	
Maintenance.....	31
Child Restraint Positioning.....	24
Child Safety.....	17
General Information.....	17
Cleaning Leather Seats.....	176
Cleaning Products.....	172
Materials.....	172
Cleaning the Engine.....	174
Cleaning the Exterior.....	172
Exterior Plastic Parts.....	174
Matte Paint Finish.....	173
Raising the Rear Wing.....	174
Standard Paint Finish.....	173
Under Hood.....	174
Cleaning the Instrument Panel and	
Instrument Cluster Lens.....	176
Cleaning the Interior.....	175
Cleaning Alcantara Microfiber Cloth.....	175
Cleaning the Wheels.....	177
Cleaning the Windows and Wiper	
Blades.....	175
Climate Control.....	80
Coolant Check	
See: Engine Coolant Check.....	162
Crash Sensors and Airbag Indicator.....	38
Cruise Control.....	53
Principle of Operation.....	121
Cruise control	
See: Using Cruise Control.....	121
Cup Holders.....	89
Customer Assistance.....	140
D	
Data Recording.....	7
Event Data Recording.....	8
Service Data Recording.....	7
Daytime Running Lamps.....	59
Direction Indicators.....	60
Doors and Locks.....	46
Drive Mode Control.....	54
Active Aerodynamics	126
Damper Comfort Mode.....	126
Drive Mode Selection.....	122
Front Lift.....	126
Driver and Passenger Airbags.....	34
Children and Airbags.....	34
Proper Driver and Front Passenger Seating	
Adjustment.....	34
Driver and Passenger Knee Airbags.....	37
Driving Aids.....	122
Driving at High Speed.....	202
Tire Pressure - Speeds Greater Than	
.....	202
Driving Hints.....	134
Driving Through Water.....	134
DRL	
See: Daytime Running Lamps.....	59
E	
Electric Parking Brake.....	112
Applying the Electric Parking brake.....	112
Battery With No Charge.....	113
Releasing the Electric Parking Brake.....	113
Emergency Door Release.....	49
Emission Control System.....	99
On-Board Diagnostics (OBD-II).....	100
Readiness for Inspection and Maintenance	
(I/M) Testing.....	100
Emission Law.....	102
Noise Emissions Warranty, Prohibited	
Tampering Acts and Maintenance.....	103
Tampering With a Noise Control	
System.....	102
End User License Agreement.....	288
VEHICLE SOFTWARE END USER LICENSE	
AGREEMENT (EULA)	288
Engine Coolant Check.....	162
Adding Coolant.....	162
Coolant Change.....	164
Engine Coolant Temperature	
Management.....	165
Fail-Safe Cooling.....	164
Recycled Coolant.....	163
Severe Climates.....	164
Engine Emission Control.....	102
Engine Immobilizer	
See: Passive Anti-Theft System.....	50
Engine Oil Check.....	161
Adding Engine Oil.....	161
Engine Oil Dipstick.....	161
Engine Specifications.....	204
Entertainment.....	230
AM/FM Radio.....	231

Index

Apps.....	233	Engine Oil Temperature Gauge.....	65
Bluetooth Stereo or USB.....	231	Fuel Gauge.....	64
Sources.....	230	Gauge Mode.....	65
Supported Media Players, Formats and Metadata Information.....	233	Information Display.....	63
USB Ports.....	233	Trip Computer.....	64
Environment.....	13	Gearbox	
EPB		See: Transmission.....	106
See: Electric Parking Brake.....	112	General Information on Radio	
Event Data Recording		Frequencies.....	40
See: Data Recording.....	7	Intelligent Access.....	40
Exterior Mirrors.....	62	General Maintenance Information.....	274
Fold-Away Exterior Mirrors.....	62	Protecting Your Investment.....	274
Power Exterior Mirrors.....	62	Road Course Maintenance.....	274
		Why Maintain Your Vehicle?.....	274
		Why Maintain Your Vehicle at Your Certified Ford GT Service Dealership?.....	274
F		Getting Assistance Outside the U.S. and Canada.....	143
Fastening the Seatbelts.....	26	Getting the Services You Need.....	140
Seatbelt Locking Modes.....	27	Away From Home.....	140
Using Seatbelts During Pregnancy.....	27	Global Opening.....	61
Flat Tire Inflation		Remote Control Front Windows.....	62
See: Tire Sealant and Inflator Kit.....	180		
Floor Mats.....	135	H	
Foot Pedals		Hazard Flashers.....	136
See: Adjusting the Pedals.....	56	Headlamp Adjusting	
Ford Performance.....	12	See: Adjusting the Headlamps.....	170
Front Passenger Sensing System.....	35	Heating	
Fuel and Refueling.....	94	See: Climate Control.....	80
Fuel Consumption.....	98	Hill Start Assist.....	114
Calculating Fuel Economy.....	98	Using Hill Start Assist.....	114
Filling the Fuel Tank.....	98	Hints on Controlling the Interior	
Fuel Filler Funnel Location.....	95	Climate.....	83
Fuel Filter.....	167	Defogging the Side Windows in Cold Weather.....	84
Fuel Quality.....	94	General Hints.....	83
Choosing the Right Fuel.....	94	Quickly Heating the Interior.....	83
Fuel Shutoff.....	136	Recommended Settings for Cooling.....	84
Fuses.....	146	Recommended Settings for Heating.....	84
Fuse Specification Chart.....	146	Hints on Driving With Anti-Lock Brakes.....	111
Front Power Distribution Box.....	146	Home Screen.....	223
Passenger Compartment Fuse Panel.....	151	Hood Lock	
Rear Power Distribution Box 1.....	148	See: Opening and Closing the Hood.....	157
Rear Power Distribution Box 2.....	150		
G			
Gauges.....	63		
Engine Coolant Temperature Gauge.....	65		
Engine Oil Pressure Gauge.....	65		

Index

I

In California (U.S. Only).....	141
Information Display Control.....	54
Information Displays.....	70
General Information.....	70
Information Messages.....	73
AdvanceTrac™.....	73
Alarm.....	73
Battery and Charging System.....	74
Doors and Locks.....	74
Engine.....	74
Fuel.....	75
Hill Start Assist.....	75
Keys and Intelligent Access.....	75
Maintenance.....	76
Park Brake.....	76
Remote Start.....	77
Starting System.....	77
Steering System.....	77
Tire Pressure Monitoring System.....	78
Transmission.....	78
Installing Child Restraints.....	18
Child Seats.....	18
Using Lap and Shoulder Belts.....	19
Using Tether Straps.....	21
Instrument Cluster.....	63
Instrument Lighting Dimmer.....	59
Instrument Panel Overview.....	14
Interior Lamps.....	60
Interior Mirror.....	62
Introduction.....	5

J

Jump Starting the Vehicle.....	137
Connecting the Jumper Cables.....	137
Jump Starting.....	138
Preparing Your Vehicle.....	137
Removing the Jumper Cables.....	138

K

Keyless Starting.....	90
Ignition Modes.....	90
Keys and Remote Controls.....	40

L

Lighting Control.....	54
High Beams.....	58
Lighting.....	58
General Information.....	58
Load Carrying.....	128
Load Limit.....	128
Vehicle Loading - with and without a Trailer.....	128
Locking and Unlocking.....	46
Activating Intelligent Access.....	46
Autolock.....	47
Battery Saver.....	48
Illuminated Entry.....	48
Illuminated Exit.....	48
Power Door Locks.....	46
Remote Control.....	46
Smart Unlocks for Intelligent Access Keys.....	47
Lug Nuts See: Changing a Road Wheel.....	202

M

Maintenance.....	157
General Information.....	157
Manual Climate Control.....	80
Manual Seats.....	86
Map Pockets.....	89
Message Center See: Information Displays.....	70
Mirrors See: Windows and Mirrors.....	61
Mobile Communications Equipment.....	11
Motorcraft Parts.....	205

N

Navigation.....	239
cityseeker.....	246
Destination Mode.....	241
Map Mode.....	240
Navigation Map Updates.....	246
Navigation Menu.....	244
Waypoints.....	245
Normal Scheduled Maintenance.....	275
Normal Maintenance Intervals.....	275

Index

O

Oil Check	
See: Engine Oil Check.....	161
Opening and Closing the Hood.....	157
Closing the Front Hood.....	158
Closing the Rear Hatch.....	159
Opening the Front Hood.....	157
Opening the Rear Hatch.....	158
Opening the Doors.....	48
Opening the Doors from Inside.....	48
Ordering Additional Owner's Literature.....	144

P

Parking Aids.....	119
Passive Anti-Theft System.....	50
SecuriLock.....	50
PATS	
See: Passive Anti-Theft System.....	50
Pedals.....	56
Perchlorate.....	9
Personal Safety System™.....	32
How Does the Personal Safety System Work?.....	32
Phone.....	234
During a Phone Call.....	237
Making Calls.....	236
Pairing Your Cell Phone for the First Time.....	234
Phone Menu.....	235
Receiving Calls.....	237
Smartphone Connectivity.....	238
Text Messaging.....	238
Post-Crash Alert System.....	138
Power Door Locks	
See: Locking and Unlocking.....	46
Power Steering Fluid Check.....	167
Power Windows.....	61
Accessory Delay.....	61
Bounce-Back.....	61
One-Touch Down.....	61
One-Touch Up.....	61
Protecting the Environment.....	13

R

Rear Under Hatch Storage.....	128
Rear View Camera.....	119
Using the Rear View Camera System.....	119
Rear View Camera	
See: Rear View Camera.....	119
Refueling.....	96
System Warnings.....	98
Remote Control.....	41
Car Finder.....	45
Intelligent Access Key.....	41
Replacing the Battery.....	43
Sounding a Panic Alarm.....	45
Using the Key Blade.....	42
Repairing Minor Paint Damage.....	177
Replacement Parts	
Recommendation.....	10
Collision Repairs.....	10
Scheduled Maintenance and Mechanical Repairs.....	10
Warranty on Replacement Parts.....	10
Replacing a Lost Key or Remote Control.....	45
Reporting Safety Defects (Canada Only).....	145
Reporting Safety Defects (U.S. Only).....	144
Roadside Assistance.....	136
Vehicles Sold in the United States: Getting Roadside Assistance.....	136
Vehicles Sold in the United States: Using Roadside Assistance.....	136
Roadside Emergencies.....	136
Running-In	
See: Breaking-In.....	134
Running Out of Fuel.....	95
Adding Fuel From a Portable Fuel Container.....	96
Filling a Portable Fuel Container.....	95

S

Safety Precautions.....	94
Scheduled Maintenance Record.....	277
Scheduled Maintenance.....	274
Seatbelt Extension.....	31

Index

Seatbelt Reminder.....	29	Stability Control.....	115
Belt-Minder™.....	29	Principle of Operation.....	115
Seatbelts.....	26	Starting and Stopping the Engine.....	90
Principle of Operation.....	26	General Information.....	90
Seatbelt Warning Lamp and Indicator		Starting the Engine.....	91
Chime.....	28	Failure to Start.....	92
Conditions of operation.....	29	Fast Restart.....	92
Seats.....	86	Guarding Against Exhaust Fumes.....	92
Security.....	50	Important Ventilating Information.....	93
Settings.....	248	Stopping the Engine When Your Vehicle is	
911 Assist.....	253	Moving.....	92
Bluetooth.....	250	Stopping the Engine When Your Vehicle is	
Camera Settings.....	258	Stationary.....	92
Clock.....	250	Steering.....	122
Display.....	258	Steering Wheel Lock.....	91
General.....	257	Steering Wheel.....	52
Media Player.....	249	Storage Compartments.....	89
Mobile Apps.....	255	Supplementary Restraints System.....	33
Navigation.....	253	Principle of Operation.....	33
Phone.....	250	Symbols Glossary.....	5
Radio.....	253	SYNC™ 3.....	213
Sound.....	248	General Information.....	213
Valet Mode.....	259	SYNC™ 3 Troubleshooting.....	259
Voice Control.....	259		
Wi-Fi.....	257	T	
Side Airbags.....	37	Technical Specifications	
Sitting in the Correct Position.....	86	See: Capacities and Specifications.....	204
Snow Chains		The Better Business Bureau (BBB) Auto	
See: Using Snow Chains.....	198	Line Program (U.S. Only).....	141
Spare Wheel		Tire Care.....	186
See: Changing a Road Wheel.....	202	Glossary of Tire Terminology.....	188
Special Notices.....	10	Information About Uniform Tire Quality	
Additional Warranty Information.....	10	Grading.....	186
Certified Ford GT Service Dealer.....	11	Information Contained on the Tire	
New Vehicle Limited Warranty.....	10	Sidewall.....	189
On Board Diagnostics Data Link		Temperature A B C.....	187
Connector.....	11	Traction AA A B C.....	187
Special Instructions.....	10	Treadwear.....	187
Special Operating Conditions Scheduled		Tire Inflation When Punctured	
Maintenance.....	276	See: Tire Sealant and Inflator Kit.....	180
Engine Air Filter and Cabin Air Filter		Tire Pressure Monitoring System.....	198
Replacement.....	276	Changing Tires With a Tire Pressure	
Hot Climate Oil Change Intervals.....	276	Monitoring System.....	200
Operating at High Speeds and Track		Understanding Your Tire Pressure	
Days.....	276	Monitoring System.....	200
Speed Control		Tire Repair Kit	
See: Cruise Control.....	121	See: Tire Sealant and Inflator Kit.....	180

Index

Tire Sealant and Inflator Kit.....	180	Utilizing the Mediation/Arbitration Program (Canada Only).....	142
First Stage: Inflating the Tire with Sealing Compound and Air.....	182	V	
General Information.....	181	Vehicle Care.....	172
Second Stage: Checking Tire Pressure.....	184	General Information.....	172
Tips for Use of the Kit.....	181	Vehicle Certification Label.....	208
What to Do After the Tire has Been Sealed.....	184	Vehicle Dimensions.....	206
What to do When a Tire Is Punctured.....	182	Vehicle Identification Number.....	207
Tires		Vehicle Storage.....	178
See: Wheels and Tires.....	180	Battery.....	178
Towing a Trailer.....	133	Body.....	178
Towing Points.....	139	Brakes.....	179
Installing the Recovery Hook.....	139	Cooling system.....	178
Recovery Hook Location.....	139	Engine.....	178
Towing the Vehicle on Four Wheels.....	133	Fuel system.....	178
Emergency Towing.....	133	General.....	178
Towing.....	133	Miscellaneous.....	179
Transmission Code Designation.....	208	Removing Vehicle From Storage.....	179
Transmission.....	106	Tires.....	179
Transporting the Vehicle.....	138	Ventilation	
Getting the Transmission in Neutral.....	139	See: Climate Control.....	80
U		VIN	
Under Hood Overview.....	160	See: Vehicle Identification Number.....	207
Under Seat Storage.....	89	Voice Control.....	53
Unique Features.....	15	W	
USB Port.....	212	Warning Lamps and Indicators.....	65
Using Cruise Control.....	121	Anti-Lock Braking System.....	65
Switching Cruise Control Off.....	121	Battery.....	66
Switching Cruise Control On.....	121	Brake System.....	66
Using Snow Chains.....	198	Carbon Ceramic Brake.....	66
Using Stability Control.....	116	Cruise Control.....	66
AdvanceTrac™ Electronic Stability Control	116	Damper Comfort Mode.....	66
Launch Control.....	117	Direction Indicator.....	66
Traction Control.....	117	Door Ajar.....	66
Using Summer Tires.....	198	Electric Park Brake.....	66
Using Voice Recognition.....	224	Engine Coolant Temperature.....	66
Audio Voice Commands.....	224	Engine Oil.....	66
Mobile App Voice Commands.....	228	Fasten Seatbelt.....	67
Navigation Voice Commands.....	227	Front Airbag.....	67
Phone Voice Commands.....	225	Front Lift Mode Active.....	67
Voice Settings Commands.....	229	Frost Warning Lamp.....	67
		Hatch Ajar.....	67
		High Beam.....	67
		Hood Ajar.....	67

Index

Hydraulic System Fault.....	67
Launch Control.....	67
Low Beam Malfunction Warning Lamp.....	67
Low Fuel Level.....	67
Low Tire Pressure Warning.....	67
Parking Lamps.....	68
Powertrain Fault.....	68
Rear Fog Lamp.....	68
Ride Height System Fault.....	68
Service Engine Soon.....	68
Stability Control.....	68
Stability Control Off.....	68
Transmission Fault.....	68
Washer Fluid Check.....	167
Washers See: Cleaning the Exterior.....	172
See: Wipers and Washers.....	57
Waxing.....	174
Wheel Nuts See: Changing a Road Wheel.....	202
Wheels and Tires.....	180
Technical Specifications.....	203
Windows and Mirrors.....	61
Windshield Washers.....	57
Windshield Wipers.....	57
Wiper and Washer Control.....	54
Wiper Blades See: Checking the Wiper Blades.....	169
Wipers and Washers.....	57