

WALK THE CUSTOMER THROUGH EACH OF THE FOLLOWING KEY DELIVERY FEATURES

□ TIRE PRESSURE MONITORING SYSTEM (TPMS) – page 34

Explain TPMS function to customer.

- When illuminated, one or more tires are under-inflated.
- Blinks for approximately one minute then remains illuminated when there is a malfunction with the TPMS.



□ WINDSHIELD WIPER / WASHER – page 19

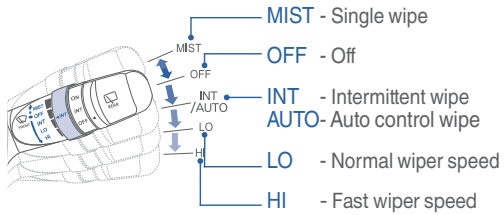

MAINTENANCE

Scheduled Maintenance	Normal Usage		Severe Usage*	
Hydrogen system				
Hydrogen system (Check for hydrogen leaks)	Inspect	6,500 or 12 months	Inspect	More Frequently
FCEV cleaner filter	Replace	6,500	Replace	More Frequently
Traction motor coolant	1st Replace 130,000 or 120 months After that, replace every 26,000 or 24 months		Replace	More Frequently
Fuel cell stack coolant	Replace	38,000 or 36 months	Replace	More Frequently
Ion filter	Replace	6,500	Replace	More Frequently
Reduction gear fluid	No check, No service required		Replace	78,000
Brake hoses and lines	Inspect	13,000 or 12 months	Inspect	Same as normal
Drive shafts and boots	Inspect	13,000 or 12 months	Inspect	7,500
Front brake disc/pads, calipers	Inspect	13,000 or 12 months	Inspect	More Frequently
Rear brake disc/pads	Inspect	13,000 or 12 months	Inspect	More Frequently
Steering gear box, linkage & boots/lower arm ball joint, upper arm ball joint	Inspect	13,000 or 12 months	Inspect	More Frequently
Suspension mounting bolts	Inspect	13,000 or 12 months	Inspect	Same as normal
Climate control air filter	Replace	13,000 or 12 months	Replace	More Frequently
Brake fluid	Inspect	26,000 or 24 months	Inspect	More Frequently
Parking brake	Inspect	26,000 or 24 months	Inspect	More Frequently
Climate Control Air Filter (for Evaporator and Blower Unit)	Replace	13,000 or 12 months	Replace	More Frequently
Air Conditioning System Operation	Inspect	13,000 or 12 months	Inspect	Same As Normal
Disc Brake and Pads	Inspect	13,000 or 12 months	Inspect	More Frequently

*See Owner's Manual for details.

Looking for more detailed information? This Quick Reference Guide does not replace your vehicle's Owner's Manual. If you require additional information or are unsure of a specific issue, you should always refer to the vehicle's Owner's Manual or contact your authorized Hyundai dealer. The information contained in this Quick Reference Guide was correct at the time of printing; however, specifications and equipment can change without notice. No warranty or guarantee is being extended in this Quick Reference Guide, and Hyundai reserves the right to change product specifications and equipment at any time without incurring obligations. Some vehicles are shown with optional equipment. Please contact your Hyundai dealer for current vehicle specifications and optional equipment.

NP150-T2015-FC
(Rev 02/14/17)
Printing 02/17/17



HYUNDAI Tucson Fuel Cell

Quick Reference Guide

www.hyundai.com



Roadside Assistance: **1-800-243-7766**
 Consumer Affairs: **1-800-633-5151**
 XM® Radio: **1-800-967-2346**

Table of Contents

GETTING STARTED

Before driving theCell Tucson Fuel	02-04
Emergency while driving	06-09
Engine Start / Stop Button	14
Front seat adjustment(Power)	15
Fuel Cell Electric Vehicle Components	10-11
Headrest adjustment	15
Hydrogen Gas Detection Sensors	12
Main Indicator for safety in cluster for using Tucson Fuel Cell	05
Rear seat folding	15
Remote keyless entry	14
Safety Plug	12
Virtual Engine Sound System (VESS)	13

FEATURES AND CONTROLS

Automatic climate control	24-25
Central door lock switch	17
Child-protector rear door lock	16
Driver's main controls	17
Fuel filler Door	17
Headlights and fog lights	18
Instrument cluster	20-21
Instrument panel illumination	21
Interior lights	26
LCD display warning messages	23
Seat belt adjustment	16
Seat Warmer	26
Steering wheel audio control	27
Steering wheel – Tilt and telescopic	16
Trip computer	22
Wiper and washer	19

MULTIMEDIA

AUX, USB and iPod® port	31
Bluetooth® operational tips	29-30
Bluetooth® phone pairing	28
Clock adjustment	33
Navigation	31-33

DRIVING

Electronic Stability Control (ESC)	35
Gear Shift Lever	36
Tire Pressure Monitoring System (TPMS)	34
Rearview camera	34

* Some vehicles may not be equipped with all the listed features.

Frequently Asked Questions

- Pair phone to your vehicle. Refer to page 28 and 29.

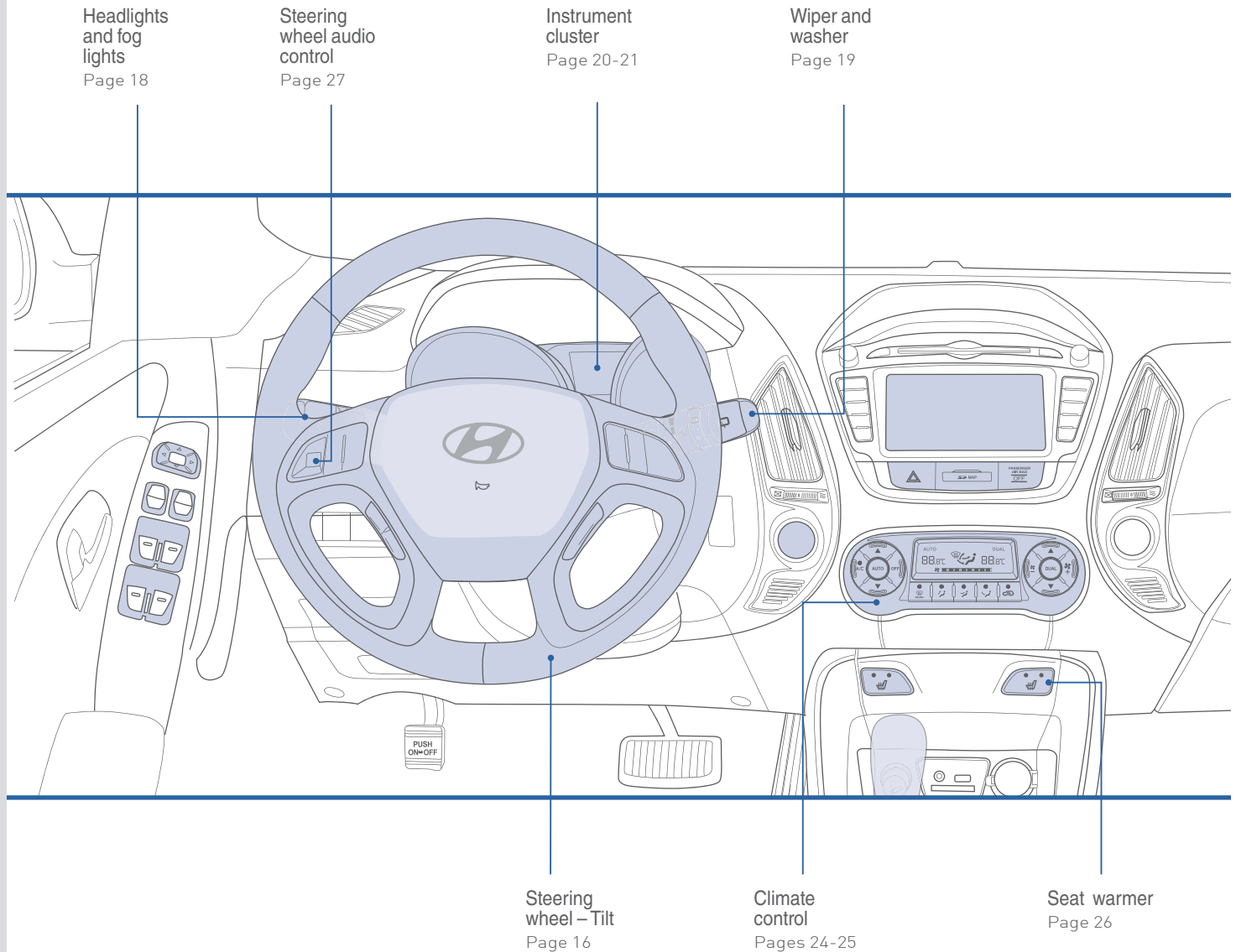

Use this Quick Reference Guide to learn about the features that will enhance your enjoyment of your Hyundai. More detailed information about these features are available in your Owner's Manual.

WARNING!

To reduce the risk of serious injury to yourself and others, read and understand the important SAFETY INFORMATION in your Owner's Manual.

BEFORE DRIVING THE TUCSON FUEL CELL

The Tucson Fuel Cell vehicle is a unique vehicle that operates using a fuel cell stack to convert hydrogen and oxygen into electrical energy. Because of its unique characteristics, the vehicle operation differs slightly from a conventional vehicle, and taking certain precautions will help to ensure a safe and enjoyable driving experience. We recommend that you review the following warning and caution notices before proceeding with this Quick Reference Guide.

Main warning for using Tucson Fuel Cell (High voltage system)

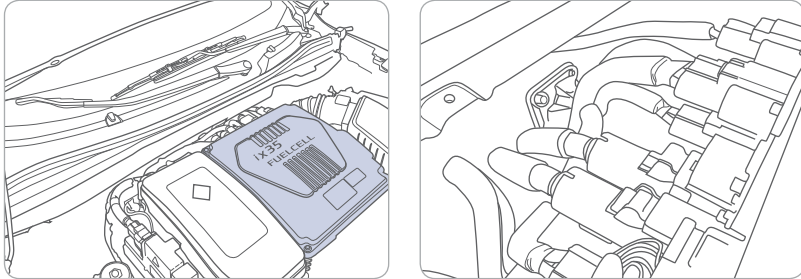

- Never touch the orange or high voltage labeled components including wires, cables, and connections. If the insulators or covers are damaged or removed, severe injury or death from electrocution may occur.
- The power cell module located in the engine compartment generates high voltage and distributes the voltage to the electric traction motor and to various electrical systems. Never touch any of the electrical components in the engine compartment. Contact with high voltage electrical components without proper safety equipment can lead to serious injury or death.
- Special precaution should be taken to avoid contact with engine compartment fluids such as the traction motor coolant or the fuel cell stack coolant. Contact with the skin or eyes may cause severe irritation. If contact should occur, flush the affected area with water and see a doctor if necessary.

Main warning for using Tucson Fuel Cell (Hydrogen fuel tank system)

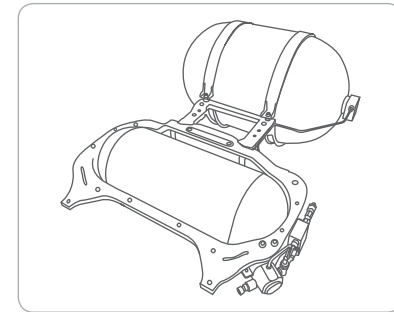
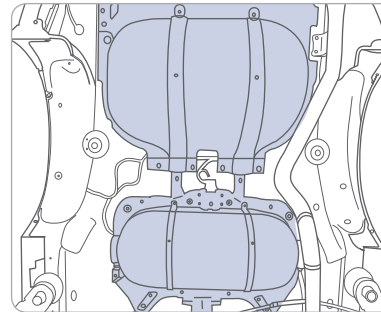

- The hydrogen storage system is comprised of two separate tanks that are interconnected and filled with hydrogen gas. The tanks contain hydrogen gas under high pressure. Serious injury or death can result from improper installation, lack of maintenance, or over pressurization. Always have your vehicle serviced by an authorized Hyundai Fuel Cell dealer.

Main caution for using Tucson Fuel Cell

- The Tucson Fuel Cell vehicle operates on high voltage electrical power. Do not spray water in the engine compartment to prevent water intrusion and a possible short circuit of the high voltage components.

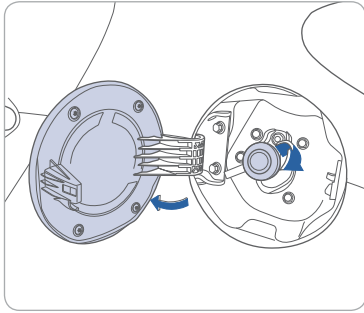

- Make sure the ignition is turned OFF before opening the fuel filler door.
- After refueling, always check that the receptacle boot is installed and that the fuel filler door is securely closed. If the fuel filler door is not closed, a warning will illuminate in the cluster. The vehicle will not start until the fuel filler door is closed.

Main notice for using Tucson Fuel Cell

- The Tucson Fuel Cell system contains many electronic components. High voltage components like cables and other parts may cause electromagnetic interference with other electronic devices.
- If you park the vehicle for a long time, the 12V auxiliary battery may discharge. If this occurs, the vehicle may not start and might need to be jump started. Jump starting a vehicle can be dangerous if not done properly. If you are unaware of how to jump start a vehicle, contact your authorized Tucson Fuel Cell dealer.

Hyundai recommends to make sure the vehicle is driven at least several times per month to maintain charging of the auxiliary battery. Driving for at least 10 minutes or 2 miles will help to keep the vehicle operating correctly

- Always start the vehicle with the gear shift lever in the “P” or “N” position, and wait for the “READY” lamp to illuminate in the cluster before driving the vehicle.
- Always move the gear shift lever to the “P” position and engage the parking brake before turning OFF the ignition and exiting the vehicle.

MAIN INDICATORS FOR SAFETY IN CLUSTER FOR USING TUCSON FUEL CELL



Service Lamp

This warning light illuminates:

When the fuel cell electric vehicle control system is not working properly. If the warning light remains on, have the vehicle inspected by an authorized HYUNDAI Tucson Fuel Cell dealer.



Hydrogen Gas Leak Warning Light

This warning light illuminates:

- [Red] When a hydrogen leak is detected by one of the four hydrogen sensors in the vehicle.

If this occurs, the vehicle will revert to “EV mode,” which will allow the vehicle to be driven solely on the high voltage battery system. EV mode is limited to only about 1 mile of driving range, therefore it is important to pull over to the side of the road as soon as it is reasonably safe to do so. When the vehicle has stopped, turn OFF the ignition and contact an authorized Hyundai Tucson Fuel Cell dealer immediately.

- [Yellow] When there is a malfunction with one of the hydrogen leakage detection sensors.

If this occurs, have the vehicle inspected by an authorized Hyundai Tucson Fuel Cell dealer as soon as possible.



High Voltage Warning Light

This warning light illuminates:

When there is a malfunction with the high voltage circuit. If the warning light continuously remains on when the vehicle is in “READY” state, or comes on during driving, have the vehicle inspected by an authorized HYUNDAI Tucson Fuel Cell dealer.



Power Down Warning Light

This warning light illuminates:

When the vehicle power should be limited due to a malfunction with fuel cell stack. If the warning light continuously remains on when the vehicle is in “READY” state, or comes on during driving, this indicates that there may be a malfunction with the fuel cell stack. If this occurs, have the vehicle inspected by an authorized HYUNDAI Tucson Fuel Cell dealer.



Motor Overheat Warning Light

This warning light illuminates:

When the motor or inverter is overheated. Do not continue driving with an overheated motor or inverter. If this occurs, have the vehicle inspected by an authorized HYUNDAI Tucson Fuel Cell dealer.



Fuel Cell Stack Temperature Warning Light

This warning light illuminates:

When the fuel cell stack is overheated. Do not continue driving with an overheated fuel cell stack. If this occurs, have the vehicle inspected by an authorized HYUNDAI Tucson Fuel Cell dealer.

EMERGENCY WHILE DRIVING

If an accident occurs

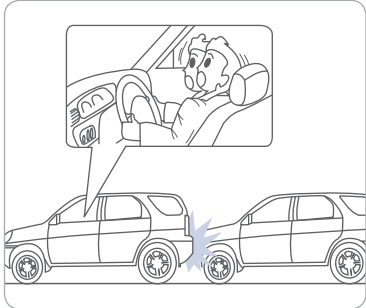

1. Stop the vehicle, move the shift lever to the P (Park) position turn on your hazard flashers, depress the parking brake, and turn the vehicle OFF.
2. Evacuate to the safety place.
3. Call emergency services for help and let them know the vehicle is a Fuel Cell Electric Vehicle.

If a fire occurs

1. Stop the vehicle, move the shift lever to the P (Park) position, depress the parking brake, and turn the vehicle OFF.

If a fire occurs, evacuate from the vehicle, call the fire department, and let them know the vehicle is a Fuel Cell Electric Vehicle. Do not come close to the vehicle until the fire is totally extinguished.

Emergency venting of hydrogen gas

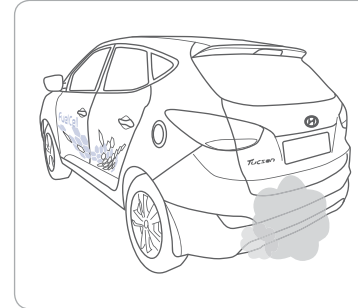

If the temperature near the safety valve located underneath at the rear of the vehicle is over 230°F caused by a fire or other reasons, the safety valve will open to vent hydrogen gas. Venting the hydrogen gas makes a loud noise because the venting speed is very fast. For your safety, stay well away from the vehicle until the hydrogen gas in the tank is completely discharged.

If a submersion in water occurs

If your vehicle was flooded and has soaked carpeting or water on the flooring, you should not try to start the vehicle by pressing the POWER button.

We recommend that you call an authorized HYUNDAI Tucson Fuel Cell dealer.

EMERGENCY WHILE DRIVING

If you have a flat tire while driving

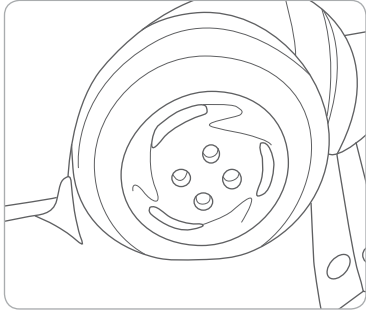

If a tire goes flat while you are driving:

1. Take your foot off the accelerator pedal and let the vehicle slow down while driving straight ahead. Do not apply the brakes immediately or attempt to pull off the road as this may cause a loss of control. When the vehicle has slowed to such a speed that it is safe to do so, brake carefully and pull off the road. Drive off the road as far as possible and park on firm, level ground. If you are on a divided highway, do not park in the median area between the two traffic lanes.
2. When the vehicle is stopped, turn on your emergency hazard flashers, set the parking brake and move the shift lever to the P(Park) position.
3. Have all passengers get out of the vehicle. Be sure they all get out on the side of the vehicle that is away from traffic.
4. When repairing a flat tire, refer to your Owner's manual.

If the vehicle stalls while driving

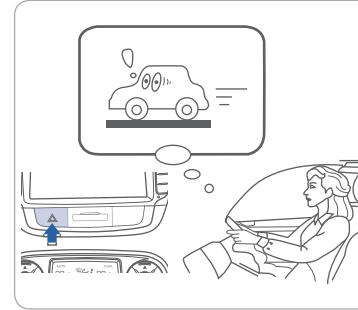

1. Reduce your speed gradually, keeping a straight line. Move cautiously off the road to a safe place.
2. Turn on your emergency flashers.
3. Try to start the vehicle again. If your vehicle will not start, contact an authorized HYUNDAI Tucson Fuel Cell dealer.

FUEL CELL ELECTRIC VEHICLE COMPONENTS

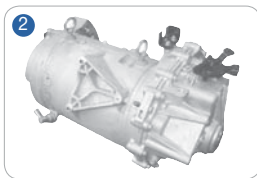
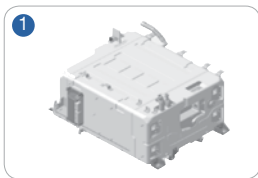
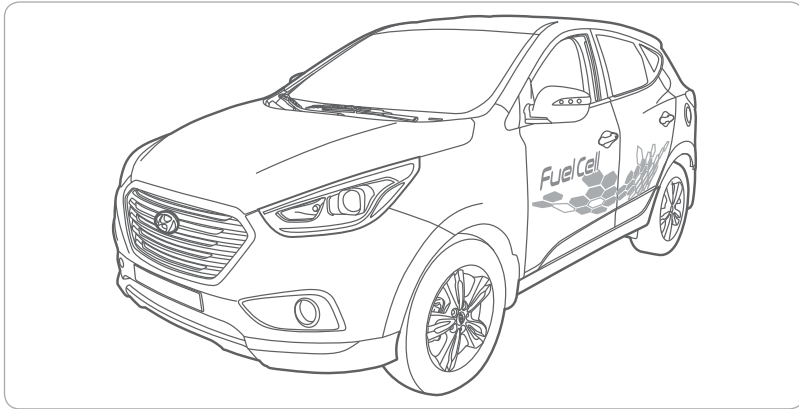

- 1 Fuel Cell Stack
- 2 Motor
- 3 Hydrogen Tanks
- 4 Battery System

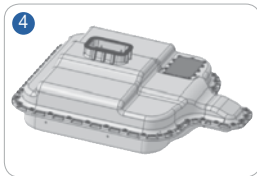
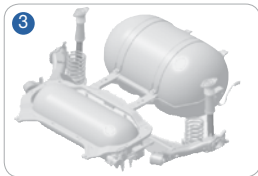

Electrical power in the Tucson Hydrogen Fuel Cell vehicle is generated by the fuel cell stack and by the regenerative braking system. Energy is stored in the high voltage battery.

The electrical power generated by the fuel cell stack flows to the high voltage junction box and then to a DC/AC power inverter. AC current is then used to drive the traction motor which drives the vehicle.

During normal driving, the fuel cell supplies electrical power to the traction motor. Some electrical power is supplied back to the high voltage battery system.

When additional power is needed, such as during acceleration or driving uphill, both the fuel cell and the high voltage battery supply electrical power to the traction motor.

During braking or downhill driving, the rotational energy of the traction motor is converted to electrical energy. This is called regenerative braking mode.

The electrical energy is used to charge the high voltage battery and the 12V auxiliary battery.

High voltage battery

The Tucson Hydrogen Fuel Cell vehicle has a high voltage battery module which is connected to the fuel cell stack. Energy from the fuel cell stack and from the regenerative braking system is stored in the high voltage battery module.

Fuel Cell Stack

A fuel cell is a device that converts the chemical energy from a fuel into electricity through a chemical reaction with oxygen. Fuel cells are different from batteries in that they require a constant source of fuel and oxygen to run, but they can produce electricity continually for as long as these inputs are supplied. Hydrogen gas is the fuel source for the Tucson Fuel Cell vehicle.

High pressure hydrogen storage tanks

The hydrogen storage system is comprised of two tanks which are filled with hydrogen gas. Each tank is made of an aluminum liner wrapped in carbon fiber. When the tanks are full the corresponding tank pressure is approximately 10,000 psi (700 bar, 70 MPa). A pressure regulator is used to reduce the pressure before the hydrogen is supplied to the fuel cell stack.

High Voltage Cables

The high voltage which is generated from the fuel cell stack and stored in the high voltage battery system is distributed to various components through high voltage cables. Most of the high voltage cables are routed near the bulkhead in the engine room and underneath the vehicle. These high voltage cables are sufficiently insulated and can easily be identified by their bright orange color. Special precautions must be taken before handling the high voltage cables.

12V Battery

A conventional 12V battery is located in the rear compartment on the driver side of the vehicle (underneath the plastic cover). The auxiliary battery power is used to initiate the fuel cell stack during startup (prior to "READY" mode). The auxiliary battery is also used to supply power to the headlamps, the audio system, and other low voltage electrical components in the vehicle.

WARNING

Warning labels are attached to high voltage components and cables in the vehicle. Never touch any of these components or cables without Personal Protection Equipment (PPE) like insulating gloves, safety glasses, etc. Without proper protection, severe injury or death from electrocution may occur.

The fuel cell power module in the engine compartment generates high voltage that is distributed to the electric traction motor and to other components. The high voltage battery system can be very dangerous. Never touch the fuel cell power module without Personal Protection Equipment (PPE) like insulating gloves, safety glasses, etc. Without proper protection, severe injury or death from electrocution may occur.

HYDROGEN GAS DETECTION SENSORS

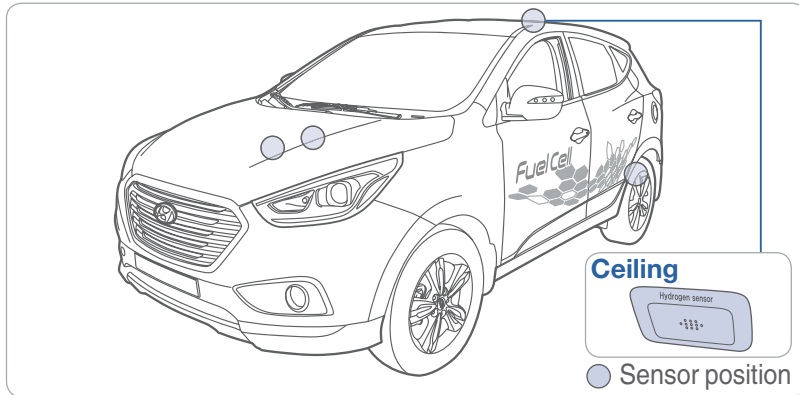

There are four hydrogen gas detectors located in the vehicle. If one of these sensors detects a leak while driving, the hydrogen gas leak warning lamp will illuminate on the cluster display. The sensors will trigger at concentrations below the minimum flammability limit of hydrogen. However, when the sensor is triggered, the hydrogen fuel cell system will be shut down. At that time, the vehicle will revert to “EV mode,” which will allow the vehicle to be driven solely on the high voltage battery system. EV mode is limited to only about 1 mile of driving range, therefore it is important to pull over to the side of the road as soon as it is reasonably safe to do so. When the vehicle has stopped, turn OFF the ignition and contact an authorized Hyundai Tucson Fuel Cell dealer immediately.

SAFETY PLUG

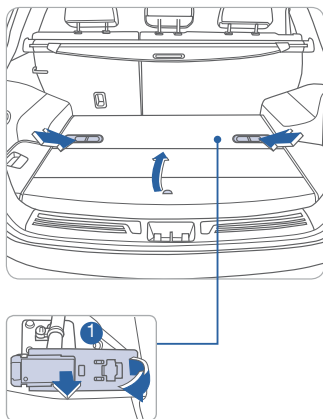

A safety plug located in the rear trunk is applied to be able to disconnect the high voltage system from the fuel cell stack.

IMPORTANT : This equipment is for trained personnel only.

DANGER

There are special procedures required for removing the safety plug from the vehicle. Do not attempt to remove the safety plug by yourself. This device is for a trained service technician at an authorized Hyundai Fuel Cell dealer or for first responders in the event of an emergency with the vehicle. Emergency responders have received special instructions on how to disconnect the high voltage system using the safety plug.

VIRTUAL ENGINE SOUND SYSTEM (VESS)

Because the Tucson Fuel Cell vehicle is an electric vehicle, it is very quiet and produces no audible noise from the engine compartment when the vehicle is in motion. In order to alert pedestrians that a vehicle is near, a Virtual Engine Sound System (VESS) is implemented.

The Tucson Fuel Cell vehicle emits a warning chime to pedestrians when the vehicle is operating in the forward direction at low speeds (from 1 to 13 mph), and whenever the vehicle is shifted into reverse.



REMOTE KEYLESS ENTRY

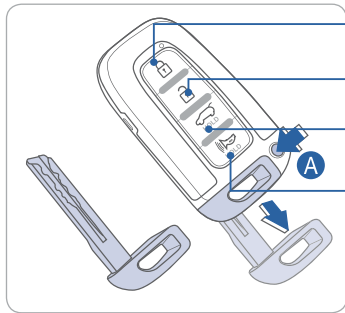

- Lock
- Unlock
- Tailgate unlock (no popping up)
- Panic



Mechanical key **A**

Press and hold the release button and remove the key.

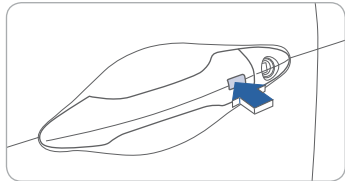

Driver's door Lock / Unlock

Smart key must be within 28~40 in. from the outside door handle.

Unlocking doors:

1. Carry the Smart Key.
2. Press the door handle button.
3. Press the door handle button again
4. seconds to unlock all doors.

Locking doors:

1. Press the door handle button.

ENGINE START/STOP BUTTON

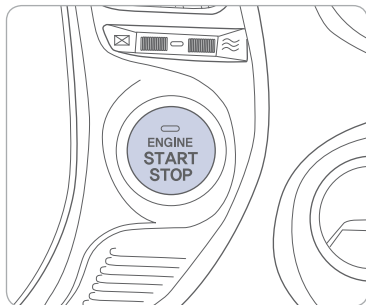

With the ignition OFF, press the engine start/stop button:

- Once for ACC (Accessory) mode.
- Twice for ON mode.
- Three times for OFF.

To start the engine, press the start/stop button while depressing the brake pedal. To shut engine OFF, shift to P (Park) and press the start/stop button.

Emergency situations

Shut off engine while driving:

- Press engine start/stop button for more than 2 seconds or press it 3 times consecutively within 3 seconds.

Restart engine while driving

- Press engine start/stop button with shift lever in N (Neutral).

FRONT SEAT ADJUSTMENT

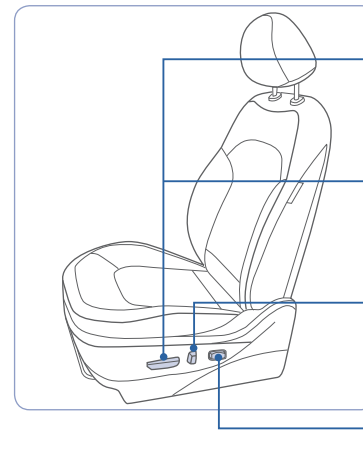

Forward and backward

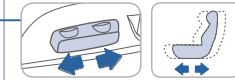

Seat cushion height (for driver's seat)

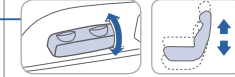

Seatback angle

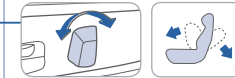

Lumbar support (for driver's seat)



HEADREST ADJUSTMENT

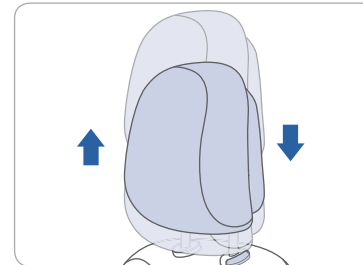

To Raise Headrest:

Pull headrest up.

To Lower Headrest:

Press lock button while pressing down on headrest.

REAR SEAT FOLDING



To fold the rear seat

Pull on the seatback folding lever, then fold the seat toward.

To unfold the rear seat

Lift and pull the seatback backward. Pull the seatback firmly until it clicks into place.

* Never use while driving for your safety.



SEAT BELT ADJUSTMENT (Front seat)

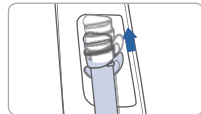
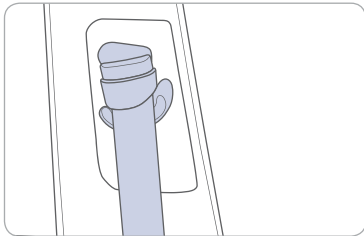

Pull up to raise.

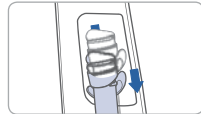

Press button and push down to lower.

STEERING WHEEL - TILT AND TELESCOPIC

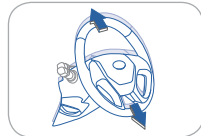
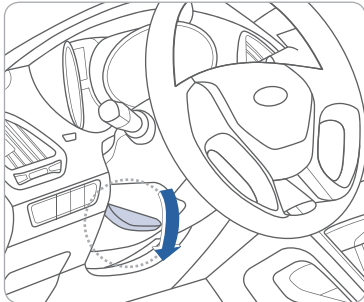

Tilt and telescopic

NOTE: Do not adjust while driving.

1. Pull down the lever.
2. Set the angle and height
3. Pull up the lever.

CHILD-PROTECTOR REAR DOOR LOCK

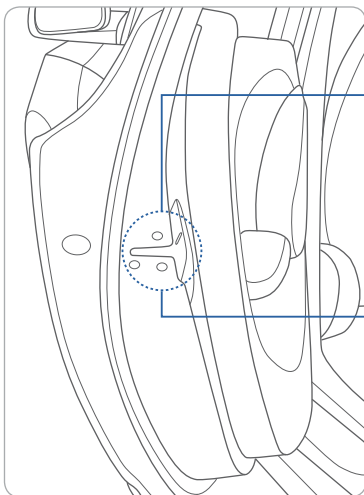

Lock (🔒)



Unlock (➡)

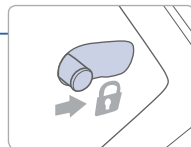

DRIVER'S MAIN CONTROLS

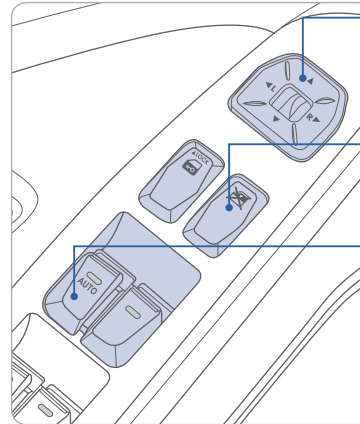

Outside Rearview Mirrors

Press L (left) or R (right) on the switch. Adjust the mirror by using the directional switch.

Power Window Lock Switch

Disables the power window switches on the passenger doors.

Window Auto down/up (driver's side only)

Press past detent to fully open/close window.

CENTRAL DOOR LOCK SWITCH

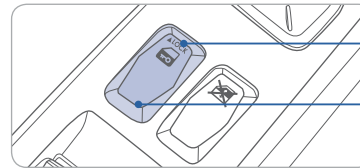

All doors will lock.

All doors will unlock.

FUEL FILLER DOOR

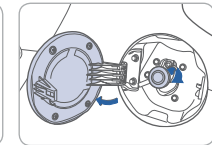
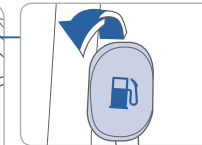
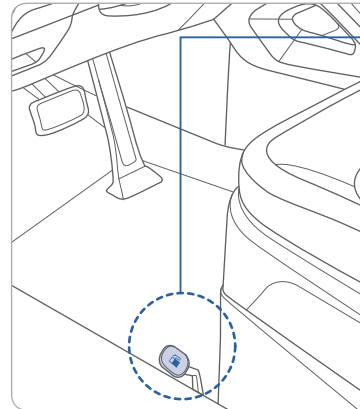

NOTE

- Make sure the ignition is turned OFF before opening the fuel filler door.
- After refueling, always check that the receptacle boot is installed and that the fuel filler door is securely closed. If the fuel filler door is not closed, a warning will illuminate in the cluster. The vehicle will not start until the fuel filler door is closed.



HEADLIGHTS AND FOG LIGHTS

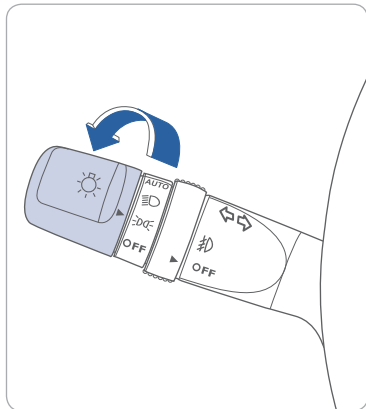

- ▶ | **OFF** OFF position
- ▶ | Parking light position
- ▶ | Headlight position
- ▶ | **AUTO** Auto light position

Escort Function

Head lights may stay on for 15 seconds after exiting and locking vehicle. Press remote lock button twice to turn headlights off. See Owner's Manual for more detail.

Turn signals and lane change signals

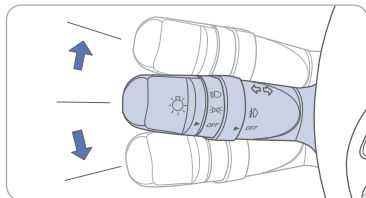

High beams

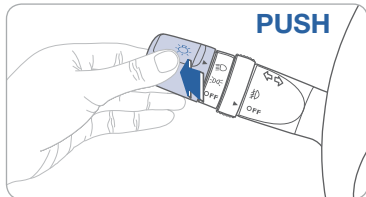

Flashing headlights

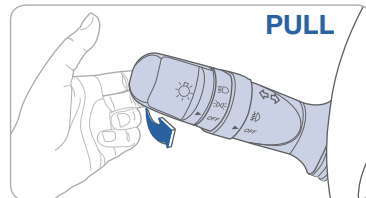

Fog lights

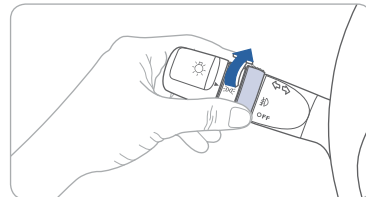

WIPER AND WASHER

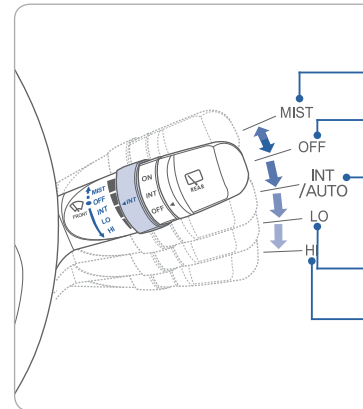

- MIST - Single wipe
- OFF - Off
- INT - Intermittent wipe
- AUTO - Auto control wipe
- LO - Normal wiper speed
- HI - Fast wiper speed

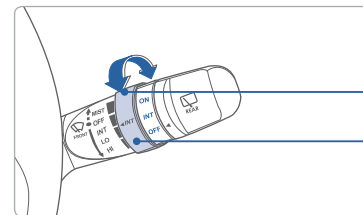

Intermittent wipe time adjustment

- Faster intervals between wipes
- Slower intervals between wipes

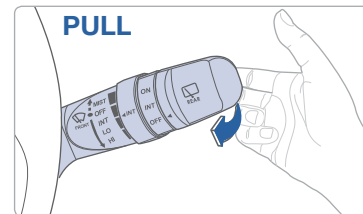

Wash with brief wipes

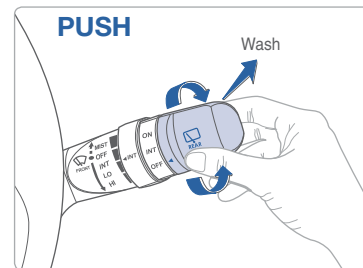

Rear wiper/washer control

- ON - Normal wiper operation
- INT - Intermittent wiper operation
- OFF - Wiper is not in operation

- Push away for rear wash





FEATURES AND CONTROLS

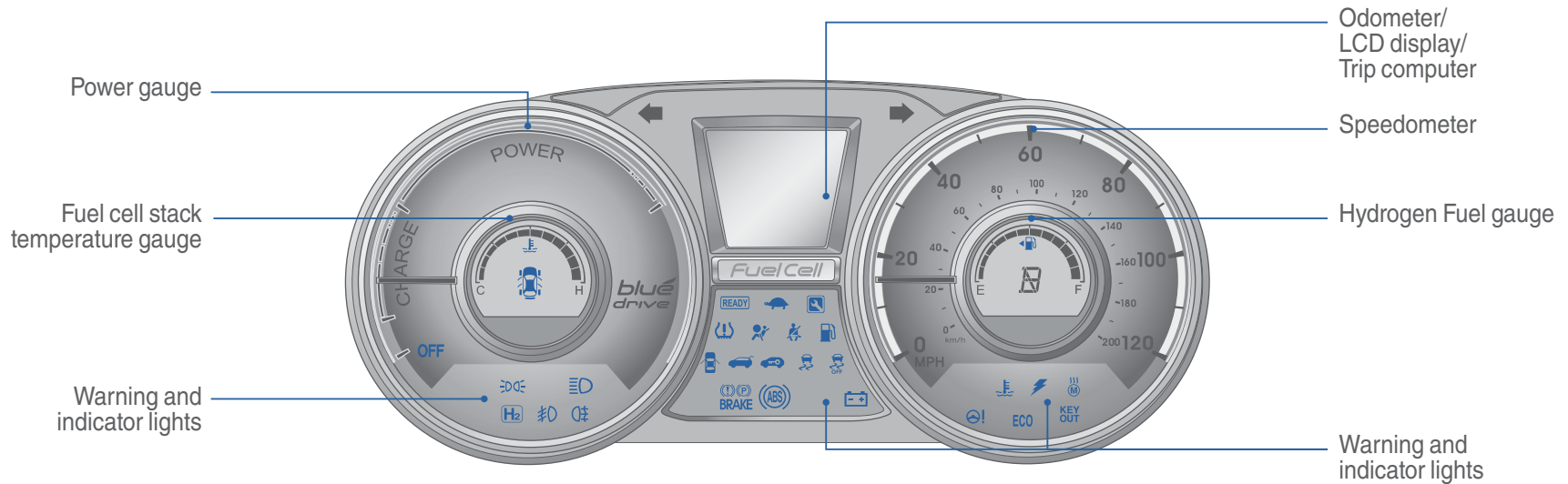

WARNING AND INDICATORS

Air bag warning light	Seat belt warning light	Parking brake & Brake fluid warning light
ABS warning light	Electronic Brake force Distribution (EBD) System warning light	
Electronic Power Steering system warning light	Charging system warning light	Fuel cell stack temp. warning light
Low fuel level warning light	Low Tire Pressure warning light	Door ajar warning light
Tailgate open warning light	Service lamp	Power down warning light
Hydrogen gas leak warning light	Motor overheat warning light	High voltage warning light
Electronic Stability Control(ESC) indicator	Electronic Stability Control (ESC) OFF indicator	Reduction Gear Shift Indicator
ECO indicator light	Immobilizer indicator light	Key out indicator light
Turn signal indicator light	High beam indicator light	Light ON indicator light
Front fog light indicator light	READY indicator light	

Power gauge



This gauge indicates the power consumption amount of the traction motor or charging amount of the high voltage battery.

Hydrogen fuel gauge



This gauge indicates the approximate amount of fuel remaining in the fuel tank (The fuel tank capacity is given in chapter 8 of the owner's Manual). The fuel gauge is supplemented by a low fuel warning light which will illuminate when the fuel tank is nearly empty.

INSTRUMENT PANEL ILLUMINATION

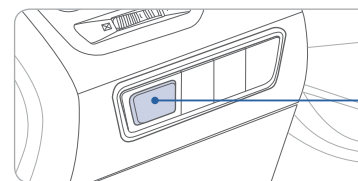

Press the control button "+" or "-" to adjust the brightness.

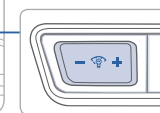



TRIP COMPUTER

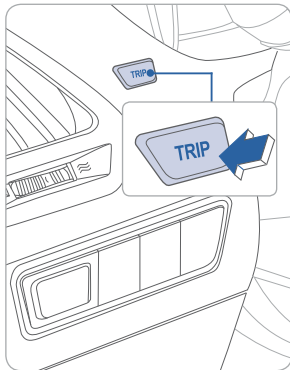

Press the TRIP button for less than 1 second to select function as follows:

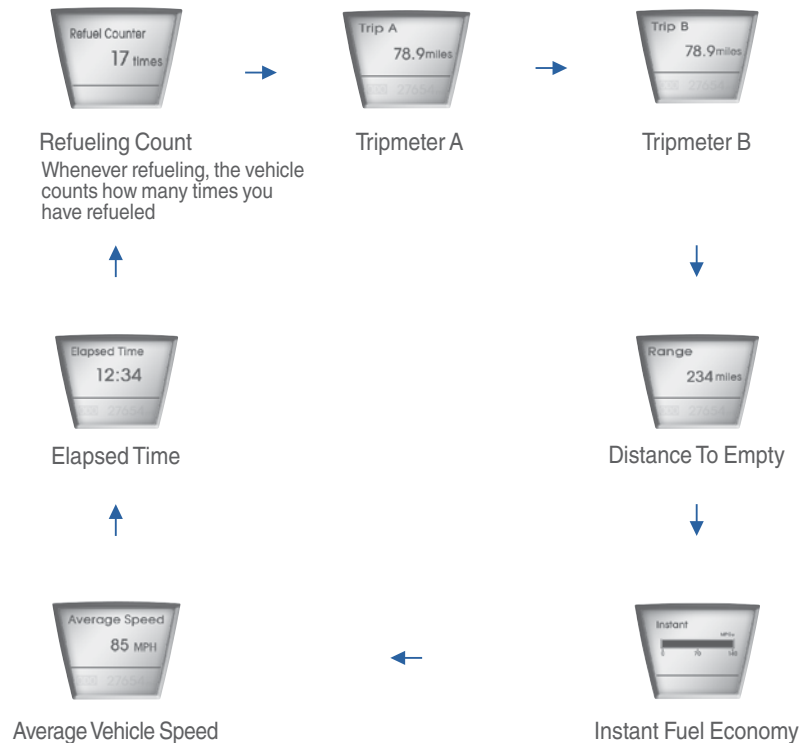

LCD DISPLAY WARNING MESSAGES

Starting



This message illuminates while you are starting the vehicle.

Go!



This message illuminates if you have started the vehicle properly and the vehicle has completed its functional system check. (Also, the READY indicator light comes on together).

Cold Start. Please wait



When you start the vehicle in cold weather, some additional time is needed to allow the fuel cell stack to warm up. This allows the fuel cell stack to operate at its optimum temperature.

Powering down. Please wait



When you turn off the vehicle, a blower in the engine compartment turns on for a minute to purge any excess water which is expelled out the tailpipe.

Stop vehicle and check power system



This warning message illuminates if a severe malfunction is detected on your vehicle. At that time, park the vehicle cautiously as soon as possible, turn off the vehicle, and then try to start the vehicle again. After that, if this warning message remains, have the vehicle inspected by an authorized HYUNDAI Tucson Fuel Cell dealer.

Refuel to prevent hydrogen system damage



This warning message illuminates if the remaining hydrogen fuel is empty. If this warning message appears, move the vehicle to a safe location and turn off the vehicle. Have the vehicle towed to the closest hydrogen fueling station or to a qualified HYUNDAI Tucson Fuel Cell dealer.

Close fuel door



When the fuel filler door is not closed securely, this warning message illuminates. Note that the vehicle will not start if the fuel door is open. After refueling, be sure to close the fuel filler door prior to starting the vehicle.

Check fuel cell coolant

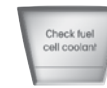

This warning message illuminates if the coolant level in the fuel cell stack coolant reservoir is low. To refill the coolant, we recommend that you consult an authorized HYUNDAI Tucson Fuel Cell dealer. For more details, refer to "Fuel Cell Stack Coolant" in chapter 7 of owner's manual.

Check fuel cell coolant filter



This warning message illuminates if the ion filter needs to be checked. We recommend that you have the vehicle inspected by an authorized HYUNDAI Tucson Fuel Cell dealer.

Checking hydrogen system



This warning message illuminates for about 10 seconds and then disappears if a malfunction is detected on the sensor for the fuel filler door. Note that while this message is displayed, the vehicle will not start. If this warning message appears, experienced this warning message, we recommend that you have the vehicle inspected by an authorized HYUNDAI Tucson Fuel Cell dealer.

Check brakes



This warning message illuminates if the brake system needs to be checked. We recommend that you have the vehicle inspected by an authorized HYUNDAI Tucson Fuel Cell dealer.



FEATURES AND CONTROLS

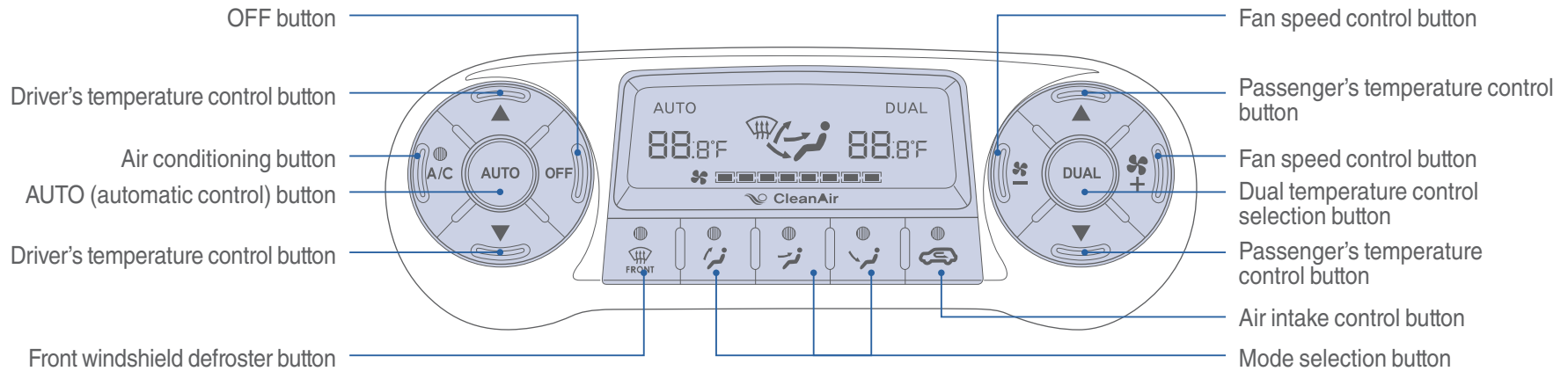

DEFROSTING / DEFOGGING



1. Press the front windshield defrost control.



2. Set the temperature control to the warmest setting.



3. Set the fan speed to the highest setting.

SYSTEM OFF MODE

Pressing the OFF button will place the system in the off mode.

- Front blower will turn off.
- Outside (fresh) air position is selected.
- Vented air will be at last set temperature.

AIR INTAKE CONTROL

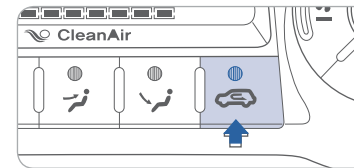

- Recirculated air position
- Outside (fresh) air position

DUAL BUTTON

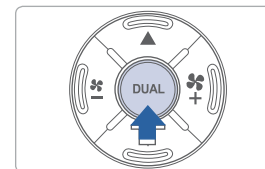

Press the DUAL button to toggle between operating the driver's and passenger's side temperature individually.

MODE SELECTION

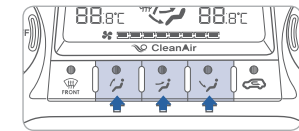

Change the direction of the air flow as follows.

- Defrost Level
- Face Level
- Floor Level

Select 2~3 modes at the same time.



REAR WINDOW DEFROSTER

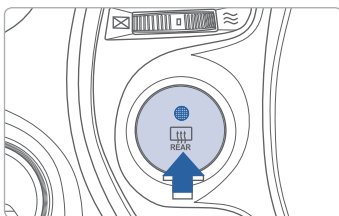

Press to activate/deactivate the rear defroster.



SEAT WARMER

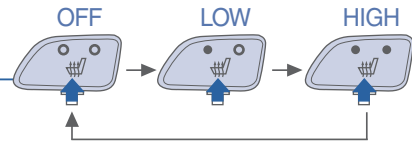
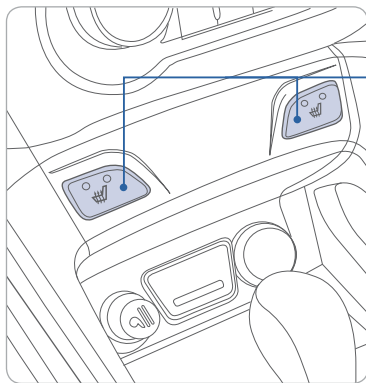

Push desired switch to warm the seat.

INTERIOR LIGHTS

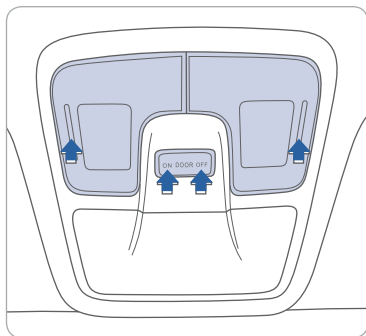

ON

Map and dome light.

DOOR

Map and dome light will turn on when any door is open except tailgate.

OFF

The lights stay off at all times except when individually turned on.

STEERING WHEEL AUDIO CONTROL

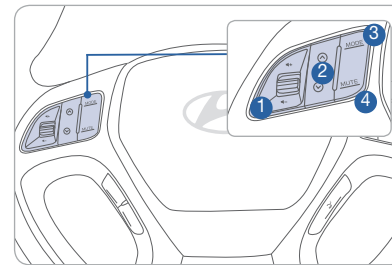

- 1 **VOLUME**
Raises or lowers speaker volume.
- 2 **SEEK/PRESET**
Change station.
- 3 **MODE**
Change the audio source.
- 4 **MUTE**
Mute the sound.

Please refer to your Owner's Manual for more detailed information on how to use your audio system.

Bluetooth Control

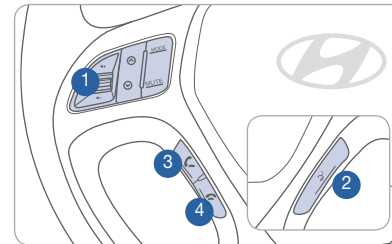

- 1 **VOLUME**
Raises or lowers speaker volume.
- 2 **TALK**
Activates voice recognition.
- 3 **CALL**
Places and transfers calls.
- 4 **END**
Ends calls or cancels functions.

To redial previously dialed number, press and hold 3.

* Bluetooth is a wireless technology that allows multiple devices to be connected in a short range, low powered devices like hands-free, stereo headset, wireless remocom, etc. For more information, visit the website at www.bluetooth.com



BLUETOOTH PHONE PAIRING

Pairing tutorials, phone compatibility and Operational tips can be found through the Smart QR code using the QR reader application on your Smartphone.



Phone Setup (Pairing phone) with Navigation

Vehicle must be in park to complete pairing process.

1. Press the call  button on the steering wheel remote controller.
4. Input the Passkey.
(The initial passkey is 0000.)

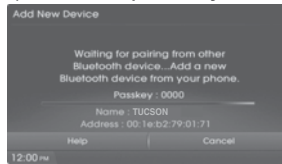
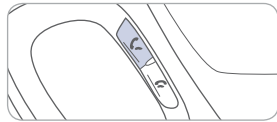

2. Press Yes button on the screen.
5. Bluetooth® becomes connected.

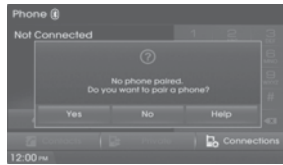

3. Search for the car name and pair the device.

BLUETOOTH OPERATIONAL TIPS

In the following situations you or the other party may have difficulty hearing each other:

1. Keep the Bluetooth volume to a low level. High level volume may result in distortion and echo.
2. When driving on a rough road, high speeds and/or with the window open.
3. When the air conditioning vents are facing the microphone and/or when the air conditioning fan is at the max speed.

Steering wheel bluetooth control

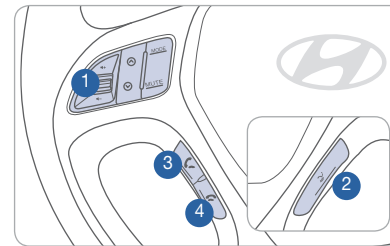

- 1 VOLUME**
Raises or lowers speaker volume.
- 2 TALK**
Activates voice recognition.
- 3 CALL**
Places and transfers calls.
- 4 END**
Ends calls or cancels functions.

To redial previously dialed number, press and hold **3**

To Answer a Call:

- Press  button on the steering wheel.

To Reject a Call:

- Press  button on the steering wheel.

To Adjust Ring Volume:

- Use the VOLUME buttons on the steering wheel.

To Transfer a Call to the Phone (Secret Call):

- Press and hold  button on the steering wheel until the audio system transfers a call to the phone.

To Finish a Call:

- Press  button on the steering wheel.



MULTIMEDIA

Making a call using voice recognition:

The menu tree identifies available voice recognition Bluetooth® functions.

Calling by Name:

1. Press button.
2. Say the following command:
 - “Call <John>”: Connects the call to John.
 - “Call <John> on <Mobile/Home/Office>”: Connects the call to John’s Mobile, Home, or Office phone number.

Dialing by Number:

1. Press button.
2. Say “Dial”.
3. Say desired phone numbers when prompted.
4. Say “Dial” to complete the number and make a call.

For complete list of commands, refer to your Owner’s Manual.

VOICE RECOGNITION TIPS

Your vehicle is equipped with Voice Recognition technology which allows drivers to operate their phones without having to take their eyes off the road to minimize distractions.

Voice recognition performance may be affected if driving with windows and sun roof open; when the heating-cooling system is on; when passing in a tunnel or when driving on rugged and uneven roads.

Quick reference on using voice commands

To start voice command. Press the key, the following commands are available:

Command	Function
Help	Displays the main Help screen
Destination Help	Displays the Destination related command list
Map Help	Displays the Map related command list
radio Help	Displays the FM/AM radio related command list
XM Help	Displays the XM radio related command list
DISC Help	Displays the DISC mode related command list for the disc inserted in the CD player
iPod Help	Displays the iPod related command list
USB Help	Displays the USB related command list
Phone Help	Displays the Phone related command list



NAVIGATION

Audio mode



Press **POWER** button **A** to turn radio on.

TUNING/LISTENING TO CHANNELS

1. Press **FM/AM** **B** or **SAT** (Converts to XM mode) : **XM** **C**.
2. Rotate **Audio Control knob** **D** to desired channel.

NOTE A clear view of the southern sky helps to ensure XM® radio reception.

SETTING PRESET MEMORY BUTTONS (FM/AM/XM®)

Press and hold any preset button (1-6) **E** until audible beep is heard to store current channel.

ADJUSTING THE SOUND CONTROL

1. Press **INFO SETUP** **F** button and press the **SETUP** and press the **SOUND** to display the Sound Settings screen.
2. Touch on-screen arrows to adjust desired setting.

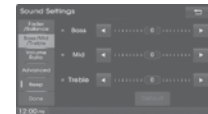

AUX, USB AND iPod PORT

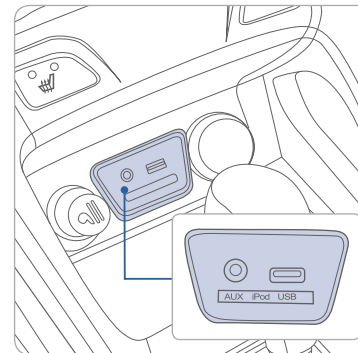

Use the jack to connect an external audio device and listen to it through the audio system speakers in your vehicle.

iPod® is a trademark of Apple, Inc.



MULTIMEDIA



NAVIGATION

Map position

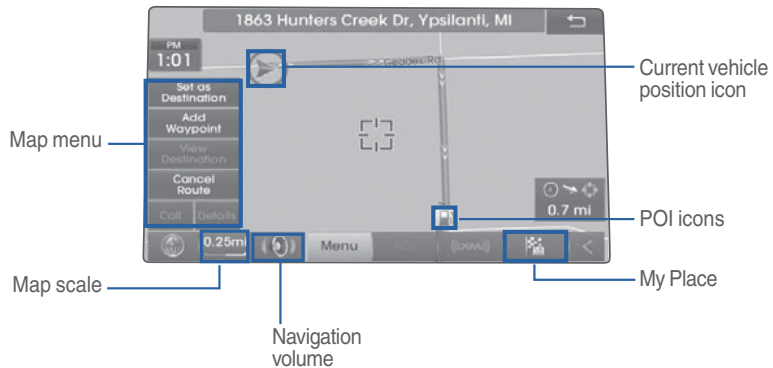

Destination menu



Quick Menu

Press the button on the left side of the map screen to display the Quick Menu.

1. Quick Menu – Display/hide Quick Menus
2. Quick Menu Bar – Menus added to the Quick Menu (possible to set up to 6 menus)
3. Edit - Add/Delete Quick Menus
4. Current Quick Menus – Shows list of current Quick Menus
5. Add/Remove – Add or remove Quick Menus
6. Quick Menu Categories – List of categories that can be added to Quick Menus

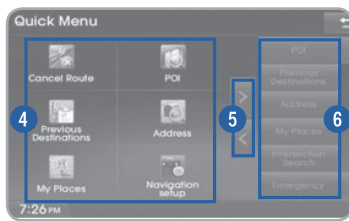

Destination menu

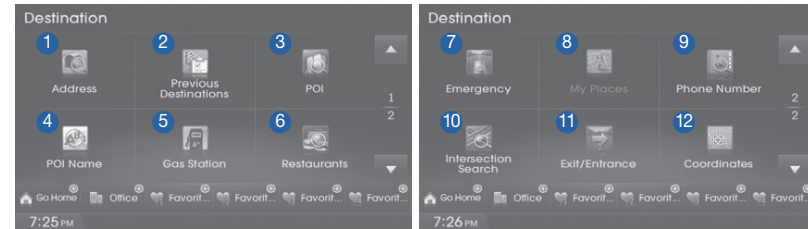

Name	Description
1 Address	Used to search destinations by selecting specific states/cities/roads
2 Previous Destinations	Used for route guidance to recently set destinations
3 Point of Interest	Used to search for neighboring POIs near current position/near scroll position/near destination/near city center
4 POI Name	Used to search for POIs by name
5 Gas Station	Used to search for gas stations
6 Restaurants	Used to search for restaurants
7 Emergency	Used to make emergency related searches
8 My Places	Displays list of saved My Places
9 Phone Number	Used to search destinations by entering POI phone numbers
10 Intersection Search	Used to search destinations by selecting street intersections
11 EXIT/Entrance	Used to search destinations by searching for expressway exits/entrances
12 Coordinates	Used to search destinations by entering the Lat/ Long coordinates

CLOCK ADJUSTMENTS



With Navigation:

Press and hold **CLOCK** . GPS Time time received from the GPS will be displayed automatically. Time Format: When the clock type is digital, it converts the time display between 12 hour and 24 hour format.

REARVIEW CAMERA

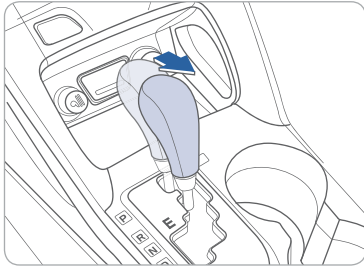

The rearview camera will activate when the ignition switch is ON and the shift lever is in the R (Reverse) position.

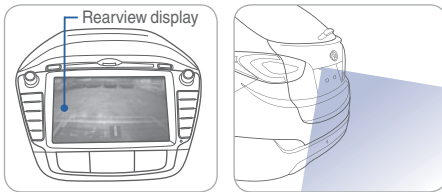

TIRE PRESSURE MONITORING SYSTEM (TPMS)



Low Tire Pressure Indicator / TPMS Malfunction Indicator

LOW TIRE PRESSURE INDICATOR

Illuminates if one or more of your tires is significantly under-inflated.

TPMS MALFUNCTION INDICATOR

Blinks for approximately one minute, then remains illuminated when there is a malfunction with the TPMS. Inspect all tires and adjust tire pressure to specification. If the lamp remains illuminated, have the system checked by an authorized Hyundai dealer as soon as possible.

ELECTRONIC STABILITY CONTROL (ESC)

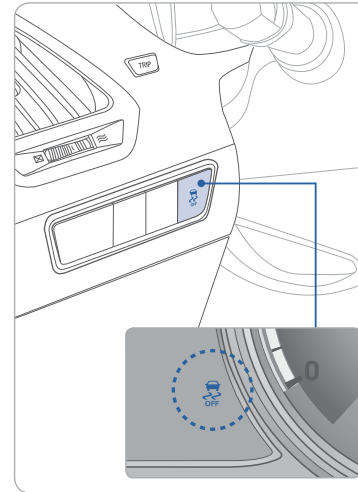

The ESC system is an electronic system designed to help the driver maintain vehicle control under adverse conditions.

This car has 2 kinds of ESC off states. If the power button is turned to the LOCK position when ESC is off, ESC remains off. Upon restarting the vehicle, the ESC will automatically turn on again.

- To turn ESC on, press it again.
- ESC off state 1
To cancel ESC operation, press the ESC OFF button (ESC OFF) shortly (ESC OFF indicator light (ESC OFF) illuminates).
- ESC off state 2
To cancel ESC operation, press the ESC OFF button (ESC OFF) for more than 3 seconds. ESC OFF indicator light (ESC OFF) illuminates and ESC OFF warning chime will sound.



DRIVING

GEAR SHIFT LEVER

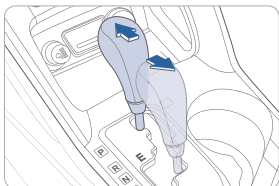

P (Park) : Press the brake pedal to move the shift lever from P.

R (Reverse)

: Gears disengaged.

N (Neutral)

: The Gear Shift lever will shift through the gears automatically.

D (Drive)



E (Economic) : High efficiency mode

L (Low)

: Use for uphill or a steep grade.

A series of horizontal lines for taking notes.

TUCSON FUEL CELL CUSTOMER DELIVERY CHECKLIST

HYUNDAI OWNER	DEALERSHIP NAME
SALES CONSULTANT	DATE
VIN	PREVIOUS VEHICLE

BEFORE DELIVERY

- CONFIRM "GOOD BATTERY" USING GR8 AND STAPLE TEST TICKET HERE
- SET TIRE PRESSURE LF___ RF___ RR___ LR___
- VERIFY VEHICLE IS CLEAN, IN GOOD CONDITION, FREE OF CHIPS AND SCRATCHES - CLEAN WINDSHIELD AND BACK WINDOW
- ENSURE FLOORMATS ARE SNAPPED INTO PLACE

Sales Consultant Date Sales Manager Date

Customer @ Date

Email