

WALK THE CUSTOMER THROUGH EACH OF THE FOLLOWING KEY DELIVERY FEATURES

How to Defrost - page 26

- 1 Press the front defrost button.
- 2 Set to the warmest temperature setting.
- 3 Set to the highest fan speed.

Tire Pressure Monitoring System (TPMS) - page 43



LOW TIRE PRESSURE INDICATOR / TPMS MALFUNCTION INDICATOR

NOTE: Tire pressure may vary in colder temperatures causing the low tire pressure indicator  to illuminate. Inflate tires according to the Tire Pressure Label located on the driver's side door pillar.

Windshield Wiper / Washer - page 12

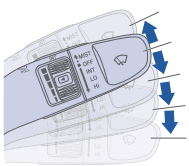

- To activate wipers, move the switch down to one of the three positions (INT, LO, HI)
- To adjust "INT" speed, move switch
- To spray the washer fluid pull lever toward you
- Push the lever up for a single wiper pass

Unlocking Vehicle - page 02

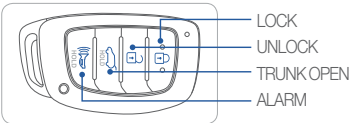

Blue Link - pages 31-33

- Assist with creating MyHyundai.com account
- Assist with Blue Link enrollment
- Show Blue Link Users Manual & tear out Voice Commands/Quick Tip Card
- Encourage customers to press the Blue link button 

MAINTENANCE

Scheduled Maintenance	Normal Usage	Severe Usage*
Engine Oil and Filter*	Replace 7,500 or 12 mos.	Replace 3,750 or 6 mos.
Fuel Additive	Add 7,500 or 12 mos.	Add Same as Normal
Tire Rotation	Perform 7,500	Perform 7,500
Air Cleaner Filter	Inspect 7,500 Replace 30,000	Inspect Same As Normal Replace More Frequently
Vacuum Hose	Inspect 7,500	Inspect Same As Normal
Climate Control Air Filter (for Evaporator and Blower Unit)	Replace 15,000	Replace More Frequently
Air Conditioning Refrigerant	Inspect 15,000	Inspect Same As Normal
Brake Hoses & Lines	Inspect 15,000	Inspect Same As Normal
Drive Shafts & Boots	Inspect 15,000	Inspect 7,500
Exhaust Pipe & Muffler	Inspect 15,000	Inspect Same As Normal
Front Disc Brake / Pads, Calipers & Rotors	Inspect 15,000	Inspect More Frequently
Rear Brake Disc / Pads	Inspect 15,000	Inspect More Frequently
Steering Gear Box, Linkage & Boots / Lower Arm Ball Joint, Upper Arm Ball Joint	Inspect 15,000	Inspect More Frequently
Suspension Mounting Bolts	Inspect 15,000	Inspect Same As Normal
Brake Fluid	Inspect 30,000	Inspect Same As Normal
Crankcase Ventilation Hose	Inspect 30,000	Inspect Same As Normal
Fuel Filter	Inspect 30,000	Inspect Same As Normal
Fuel Lines, Fuel Hoses and Connections	Inspect 30,000	Inspect Same As Normal
Fuel Tank Air Filter	Inspect 30,000	Inspect Same As Normal
Parking Brake	Inspect 30,000	Replace More Frequently
Vapor Hose, Fuel Tank & Fuel Filler Cap	Inspect 30,000	Replace Same As Normal
Spark Plugs	Replace 105,000	Replace More Frequently
Engine Coolant	1st Replace 120,000 or 120 mos. Add'l Replace 30,000 or 24 mos.	Replace Same As Normal
Inverter Coolant	1st Replace 120,000 or 120 mos. Add'l Replace 30,000 or 24 mos.	Replace Same As Normal
Hybrid Starter Generator (HSG) Belt	Inspect 7,500 or 12 mos Replace 60,000 or 48 mos	Inspect 3,750 or 6 mos Replace 30,000 or 24 mos
Automatic Transmission Fluid	No check, No service required	Replace 60,000

*Check the engine oil regularly between recommended oil change. Hyundai recommends Quaker State oil.
*See Owner's Manual for details.

Looking For more detailed information? This Quick Reference Guide does not replace your vehicle's Owner's Manual. If you require additional information or are unsure of a specific issue, we recommend that you always refer to the vehicle's Owner's Manual or contact your authorized Hyundai dealer. The information contained in this Quick Reference Guide is correct at the time of printing; however, specifications and equipment can change without notice. No warranty or guarantee is being extended in this Quick Reference Guide, and Hyundai reserves the right to change product specifications and equipment at any time without incurring obligations. Some vehicles are shown with optional equipment.

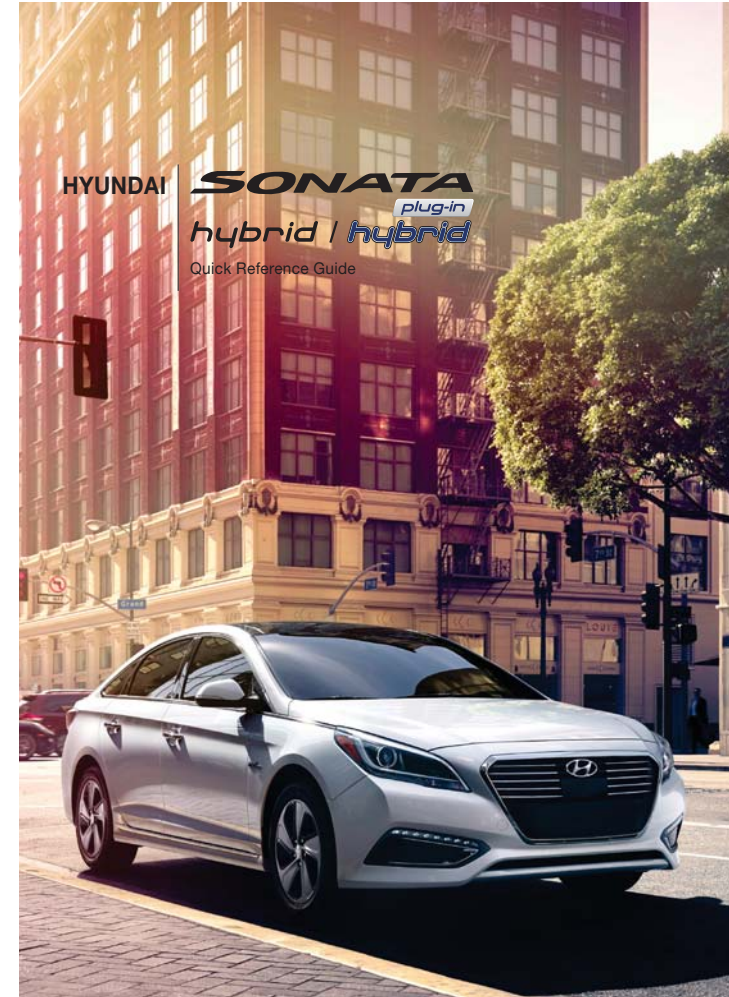

HYUNDAI **SONATA** plug-in hybrid | hybrid

Quick Reference Guide

www.hyundai.com

 **HYUNDAI**
NEW THINKING.
NEW POSSIBILITIES.

Roadside Assistance: 1-800-243-7766
Consumer Affairs: 1-800-633-5151
XM®Radio: 1-800-967-2346
Blue Link: 1-855-2BLUELINK
(1-855-225-8354)

NP150-C2017-A
(Rev 08/02/16)
Printing 08/05/16

Table of Contents

GETTING STARTED

Charging the Vehicle	08-10
Driver Position Memory System	05
Front Seat Adjustment	03
Headrest Adjustment	04
Seat Belt Adjustment	04
Smart Key	02
Vehicle Start / Stop Button	05

FEATURES AND CONTROLS

Air Ventilation Seats	16
Automatic Climate Control	26-27
Child - Protector Rear Door Lock	14
Clock Adjustment	17
Driver's Main Controls	06
Fuel Filler Lid	07
Headlights	11
Heated Steering Wheel	07
Homelink Wireless Control System	15
Hybrid Battery Vent	16
Hybrid System Modes	25
Instrument Cluster	18-21
Instrument Panel Illumination	23
Interior Lights	12
LCD Display Control	22
LCD Display Modes	22
Plug-in Hybrid Mode Indicator	24
Rearview Camera	15
Rear Parking sensors	17
Seat Warmer	16
Smart Trunk	13
Steering Wheel Adjustment	06
Steering Wheel Audio Control	28
Trunk Opening	13
Wipers and Washer	12

MULTIMEDIA

AUX, USB and iPod Port	35
Blue Link Telematics System	31-33
Bluetooth Operational Tips	28
Bluetooth Phone Operation	30
Bluetooth Phone Pairing	30
Navigation	34
Remote Start	30-31
Steering Wheel Audio Control	28
Voice Recognition Tips	29

DRIVING

Android Auto	36-37
Apple carplay™	38-41
Auto Hold	42
Automatic Transmission	44
Blind Spot Detection (BSD) System	46
Cruise Control / Smart Cruise Control	48
Drive Mode Integrated Control System	47
Electric Parking Brake (EPB)	42
Electronic Stability Control (ESC)	45
Hybrid Driving Tips	49
Lane Departure Warning System (LDWS)	45
Tire Pressure Monitoring System (TPMS)	43
Virtual Engine Sound System (VESS)	44

* Some vehicles may not be equipped with all the listed features.

Frequently Asked Questions

- Pair phone to your vehicle. Refer to page 30



Driver Position Memory System
Page 05

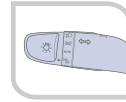

Headlights
Page 11



Instrument Cluster
Page 18-21

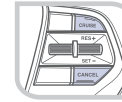

Cruise control/ Smart Cruise Control
Page 48



Vehicle Start/ Stop Button
Page 05



Navigation
Page 34

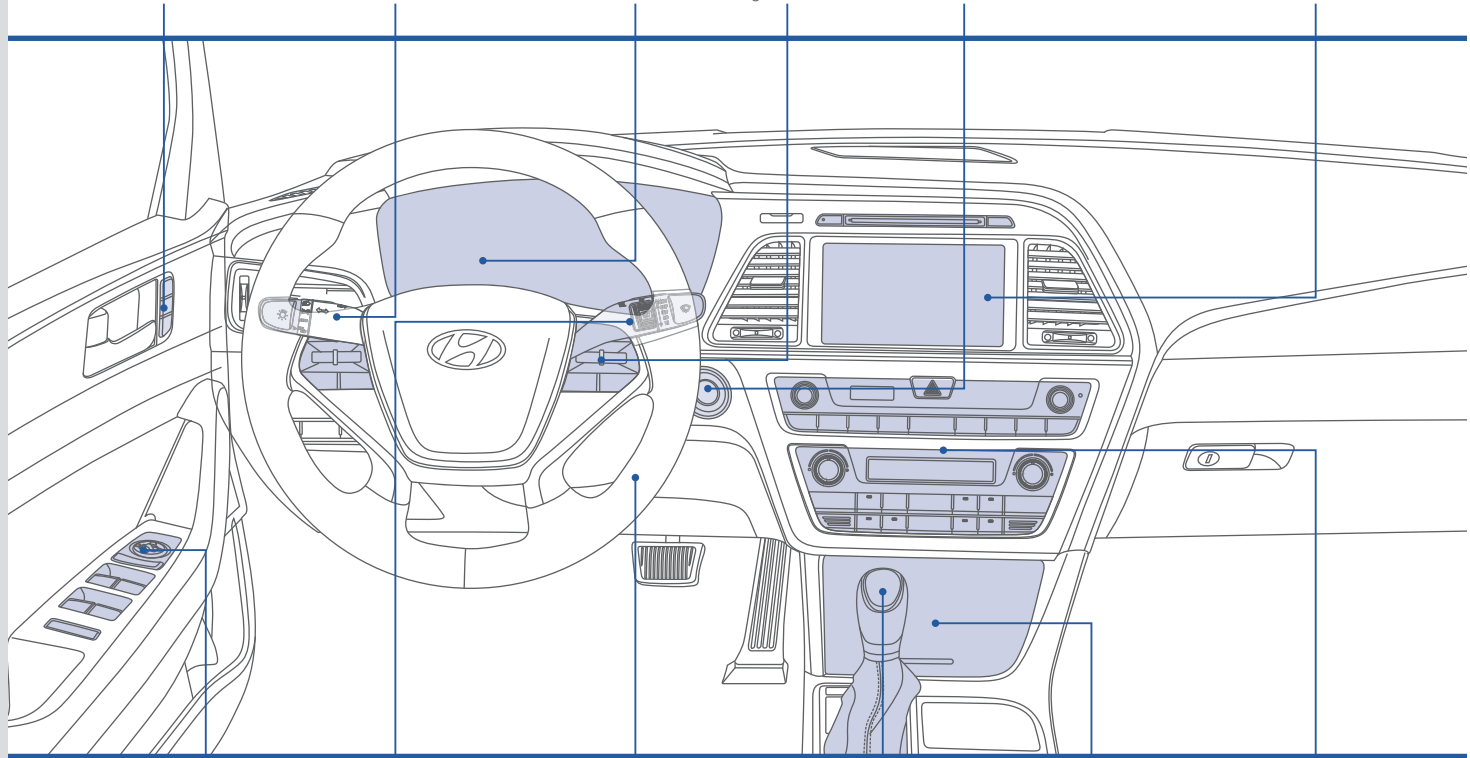

Driver's Main Controls
Page 06

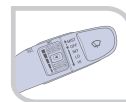

Wiper and Washer
Page 12



Steering Wheel Adjustment
Page 06

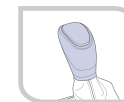

Automatic Transmission
Page 44



AUX, USB and iPod
Page 35



Automatic Climate Control
Page 26-27

Use this Quick Reference Guide to learn about the features that will enhance your enjoyment of your Hyundai. More detailed information about these features are available in your Owner's Manual.

WARNING!

To reduce the risk of serious injury to yourself and others, read and understand the important SAFETY INFORMATION in your Owner's Manual.

GETTING STARTED

SMART KEY

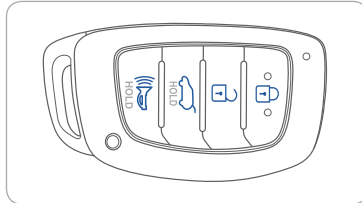

- Lock
- Unlock
- Trunk Open
- Alert

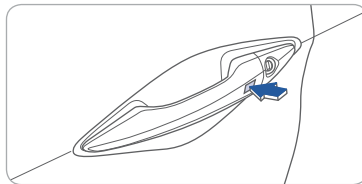

Driver's Door Lock / Unlock
Smart key must be within 28~40in. from the outside door handle.
Press: Once – Unlock driver door
Twice – Unlock all doors
Third – Lock all doors

NOTE:
For the User Selectable Option, please refer to your Owner's Manual for further information.

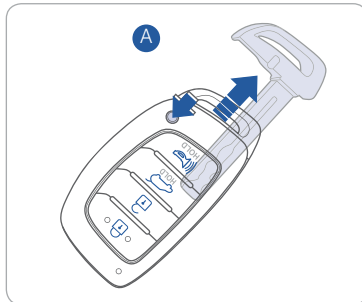

Removing the Mechanical Key
Press and hold the release button (A) to remove the mechanical key.

FRONT SEAT ADJUSTMENT



Forward and Backward ①

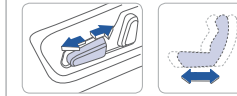

Seat Cushion Height

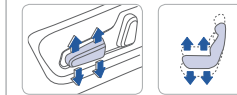

Seatback Angle ②

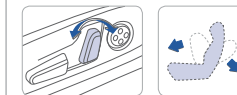

Lumbar Support (for driver's seat) ③

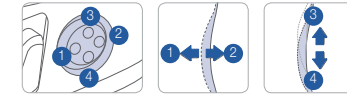

GETTING STARTED

HEADREST ADJUSTMENT

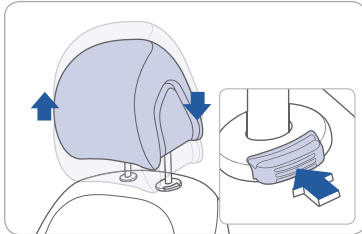

To Raise the Headrest:
Pull the headrest up.

To Lower the Headrest:
Press the lock button while pressing down on the headrest.

VEHICLE START / STOP BUTTON

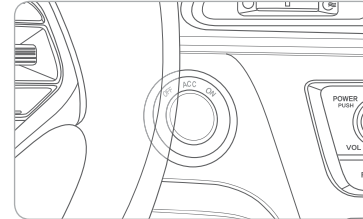

With the ignition OFF and foot OFF of brake pedal, press the Vehicle Start / Stop button.

- Once for ACC (Accessory) mode.
- Twice for ON mode.
- Third for OFF.

To start the vehicle in any mode (including OFF), press the Vehicle Start / Stop button while pressing down on the brake pedal.

To shut the vehicle OFF, place the shift lever in P (Park) and press the Vehicle Start / Stop button again.

Emergency Situations

Shutting off the hybrid system while driving

Press Vehicle Start / Stop button for more than 2 seconds or 3 times consecutively within 3 seconds.

Restarting the hybrid system while driving

Press Vehicle Start / Stop button with shift lever in N (Neutral).

SEAT BELT ADJUSTMENT (Front seat)

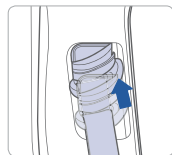
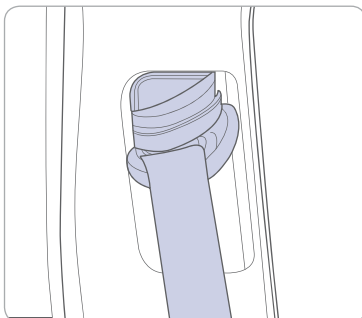

Pull up to raise.

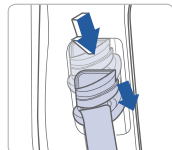

Press the button and push down to lower.

DRIVER POSITION MEMORY SYSTEM

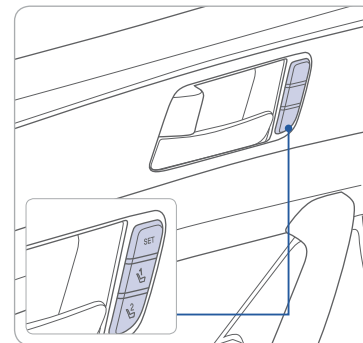

Storing

1. Adjust the driver's seat position, outside rearview mirror position and instrument panel illumination intensity.
2. Press the SET button. The system will beep once.
3. Press one of the memory buttons (1 or 2) within 5 seconds. The system will beep twice.

NOTE:

Transmission must be in P (Park).

Recalling

Press the desired memory button (1 or 2). The system will beep once.

FEATURES AND CONTROLS

STEERING WHEEL ADJUSTMENTS

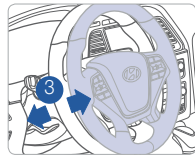
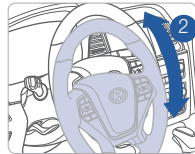
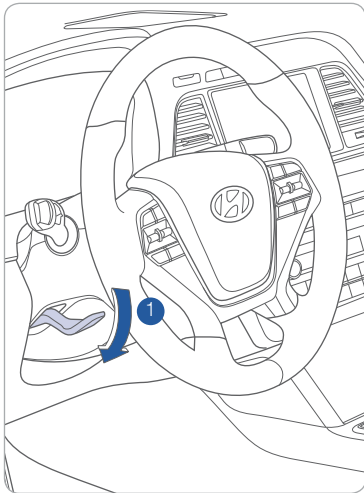

NOTE: Do not adjust while driving.

1. Pull the lever **1** down.
2. Set the angle **2** and the distance **3**.
3. Pull the lever **1** up to lock position.

DRIVER'S MAIN CONTROLS

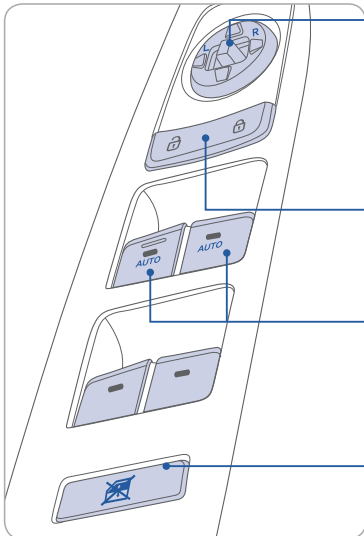

Outside Rearview Mirror

Move the lever towards L (left) or R (right) on the switch. Adjust the mirror by using the mirror adjustment control switch.

Door Lock

Locks / unlocks all doors.

Window Auto Down / Up (if equipped)

Press past detent to fully open / close the window.

Power Window Lock Button

Disables the power window switches on the rear passenger doors.

HEATED STEERING WHEEL

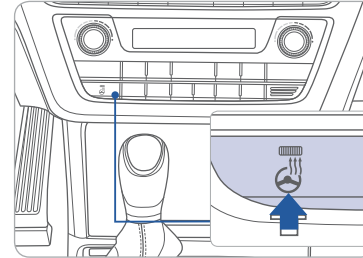

Press the heated steering wheel button to warm up the steering wheel. The indicator on the button will be illuminated. Press the button again to turn it off.

FUEL FILLER LID

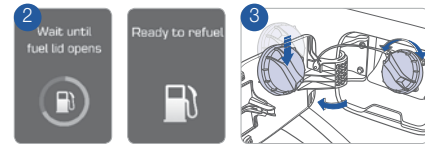
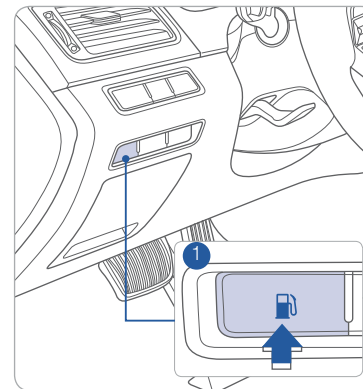

1. Push the fuel filler door opener button **1**.
2. Wait until the fuel tank is depressurized.
It may take up to 20 seconds to open the fuel filler door (for Plug-in hybrid) **2**.
3. Remove the fuel tank cap **3**.

NOTE:

Tighten the fuel filler cap until one click is heard.

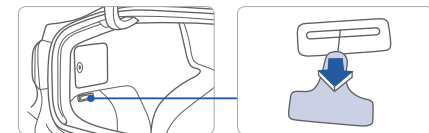

Emergency fuel filler door release

Pull the handle of the release located on the left side of the luggage compartment.

GETTING STARTED

CHARGING THE VEHICLE

240V (Level 2 Charger)

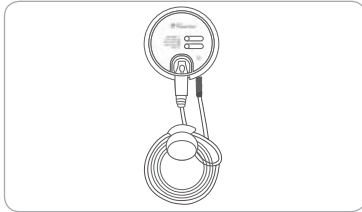

You can charge your vehicle by using a public charger at an electricity charging station.

NOTE: You can also have a Level 2 charger installed in your garage by a qualified manufacturer to your local electrical codes.

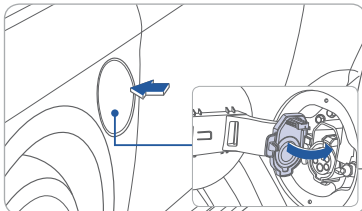

1. Move the shift lever to P (Park), turn off all switches, and turn OFF the vehicle.
2. Open the charging door, and the charging inlet cover (to open the cover, driver door must be unlocked).

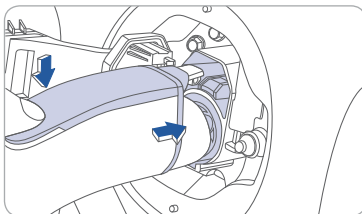

3. Insert the charging connector into the charging inlet until you hear a clicking sound.
4. Check if the charging cable connection indicator in the instrument cluster is turned ON.

Emergency Charging Door Release

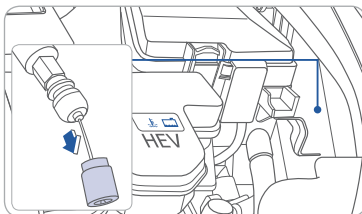

Open the hood and slightly pull the emergency cable.

Charging indicator (on dash)

When Charger is plugged in:

Green Light ON: Charging in progress

Green Light OFF: Charging is complete

Green Light Blinking: Scheduled charge time is programmed, but currently not charging

Red Light Blinking: Charging malfunction.

Please visit your local Hyundai dealership

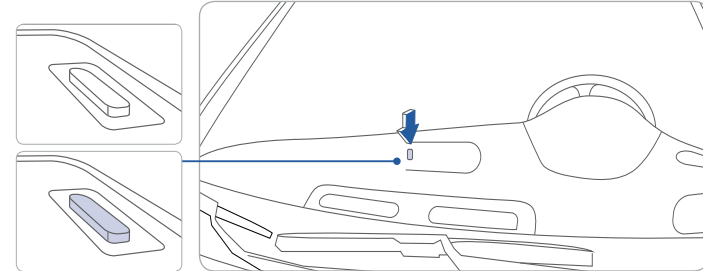

Scheduled Charging

Scheduled charging times can be programmed from the PHEV menu in the audio screen.

Scheduled charging will occur when the charging cable connected to the charging port.



GETTING STARTED

120V (Level 1 Charger)

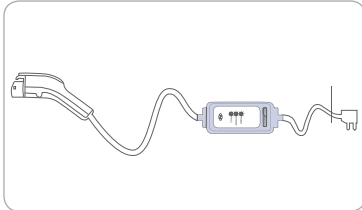

120V charger (supplied with vehicle) can be used if Level 2 Charger is unavailable.

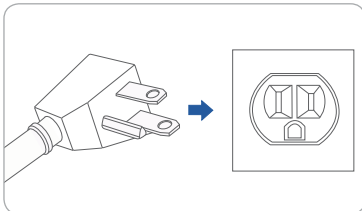

1. Move the shift lever to P (Park), turn off all switches, and turn OFF the vehicle.
2. Connect the plug to a household electric outlet.

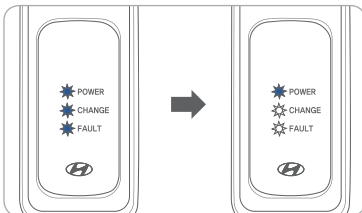

3. Check if all LED lamps blink for 0.5 seconds then, the power lamp ON.

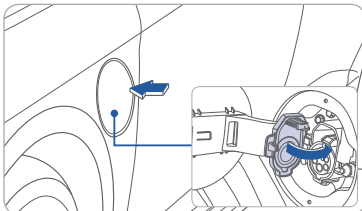

4. Open the charging door, and the charging inlet cover (to open the cover, all vehicle doors must be unlocked).

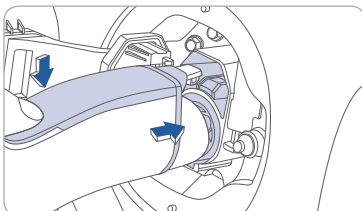

5. Insert the charging connector into the charging inlet until you hear a clicking sound.
6. Check if the charging cable connection indicator in the instrument cluster is turned ON.



FEATURES AND CONTROLS

HEADLIGHTS

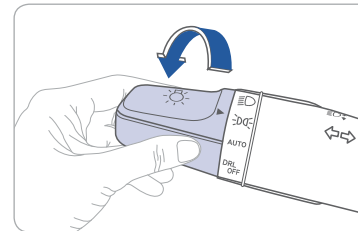

- Headlight Position
- Parking Light Position
- Auto Light Position
- DRL OFF Position

Headlight Delay

Headlights may stay on for 15 seconds after exiting and locking up the vehicle. Press the remote lock button twice to turn the headlights off. Please refer to your Owner's Manual for further information.

Turn Signals and Lane Change Signals

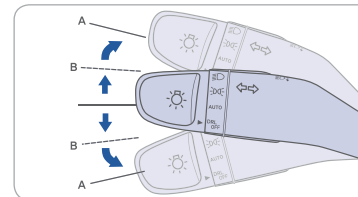

Flashing the Headlights

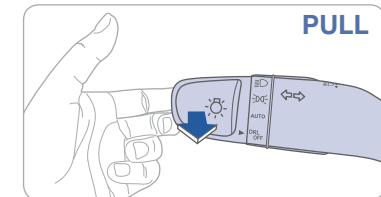

High Beams

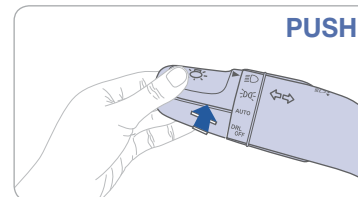

Smart High Beams

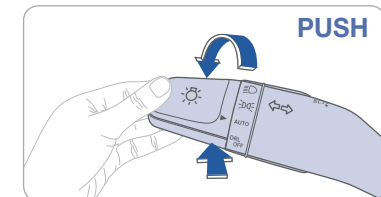

NOTE: To turn off the high beam, pull the lever towards you.

Smart High Beam Function

1. Select the AUTO position on stalk.
 2. Push the lever forward to engage the Auto High Beam.
 3. Push the lever forward again to disengage.
- Please refer to your Owner's Manual for further information.



FEATURES AND CONTROLS

WIPERS AND WASHER

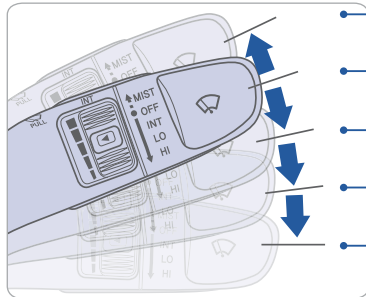

- MIST - Single wipe
- OFF
- INT - Intermittent wipe
- LO - Low wiper speed
- HI - High wiper speed

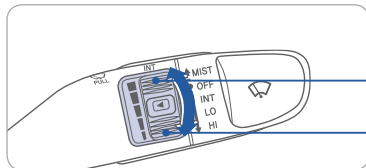

Intermittent Wipe Time Adjustment

Move the control switch.

Fast wiper speed

Slow wiper speed

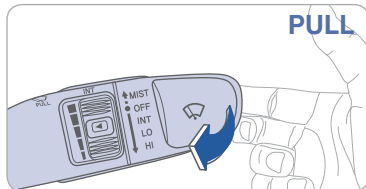

PULL

Windshield Washer

Pull the lever gently toward you to spray the washer fluid on the windshield and to run the wipers 1-3 cycles.

INTERIOR LIGHTS

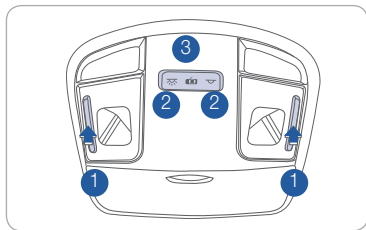

Front Map Lamp ①

Press the switch to turn on / off the map lamp.

Front Room Lamp (☀️) ② (Type A)

Press the switch to turn on / off the room lamp (overhead lamp).

Front Room Lamp (☀️) ② (Type B)

Press the switch to turn on / off the room lamp (overhead lamp).

Front Door Lamp (🚪) ③ (Type B)

Lights will turn on when any door is open.

TRUNK OPENING

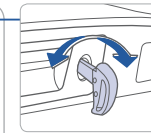
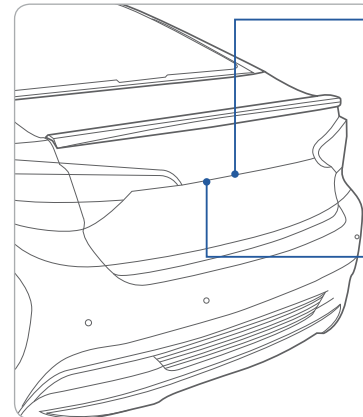

Use the mechanical key.

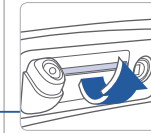

Press to open. Smart key needs to be within the range.



Press and hold.

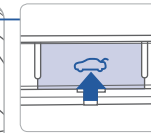
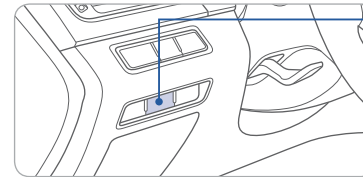

Press the release button in the vehicle.

SMART TRUNK

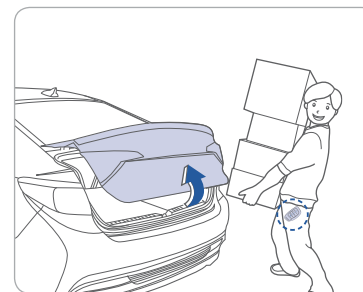

Smart Trunk

Trunk will open automatically when detecting smart key within the range near the trunk for over 3 seconds.

To enable Smart Trunk function:

Vehicle must be in P (Park) to adjust the settings in the User Setting mode.

1. Select "Door / Trunk" in the User Settings in the instrument cluster.
2. Check "Smart Trunk".

NOTE:

Function is active after 15 seconds when all doors are closed and locked. The vehicle will also provide an audible and visual alarm while activating. Please refer to your Owner's Manual for further information.

FEATURES AND CONTROLS

CHILD-PROTECTOR REAR DOOR LOCK

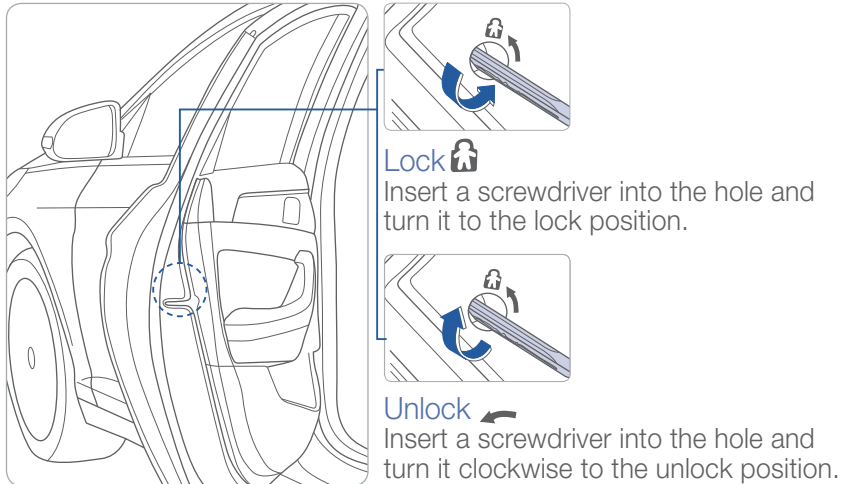

HOMELINK WIRELESS CONTROL SYSTEM

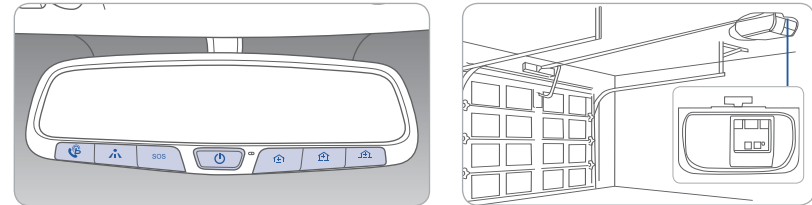

Standard Programming

To train most devices, follow these instructions:

1. For the first-time programming, press and hold the two outside buttons, HomeLink® Channel 1 and Channel 3 buttons, until the indicator light begins to flash (after 10 seconds). Release both buttons. Do not hold the buttons for over 20 seconds.
2. Position the end of your hand-held transmitter 1-3in. (2-8cm) away from the HomeLink® buttons while keeping the indicator light in view.
3. Simultaneously press and hold both the HomeLink® and the hand-held transmitter button. DO NOT release the buttons until step 4 has been completed.
4. While continuing to hold the buttons, the red indicator Status LED will flash slowly and then rapidly after HomeLink® successfully trains to the frequency signal from the hand-held transmitter. Release both buttons.

For more detailed information, please refer to your Owner's Manual, or visit www.homelink.com or call (800) 355-3515.

REARVIEW CAMERA

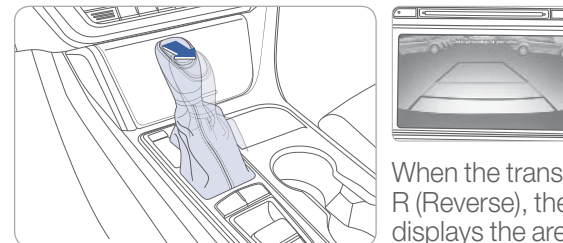

When the transmission is shifted into R (Reverse), the rearview camera displays the area behind the vehicle.



FEATURES AND CONTROLS

SEAT WARMER (front seats)

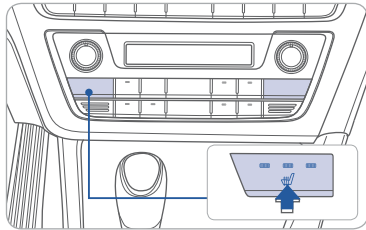

Each time you push the button, the setting is changed as follows:

OFF → HIGH → MIDDLE → LOW



If you want to turn it off immediately, press and hold the button.

AIR VENTILATION SEATS (front seats)

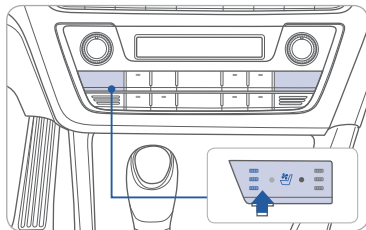

Each time you press the button, the setting is changed as following:

OFF → HIGH → MIDDLE → LOW



If you want to turn it off immediately, press and hold the button.

HYBRID BATTERY VENT

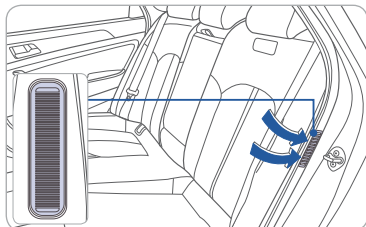

The Hybrid battery air intake vent is located at the left side of the rear seat. Do not cover the air vent or spill liquid.

REAR PARKING SENSORS

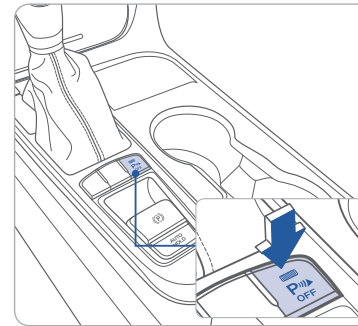

The rear parking sensors assists the driver during reverse movement of the vehicle by chiming if any object is sensed within the distance of 50 in. behind the vehicle.

Push the button to turn off the rear parking sensors. The indicator light on the button will turn on.

CLOCK ADJUSTMENT

With Standard Radio

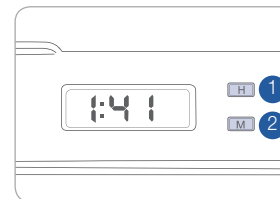

1. Hour
Press the ① button to adjust the Hour.
2. Minute
Press the ② button to adjust the Minute.

NOTE: Press and hold ① and ② to switch between 12 or 24 hours.

With Navigation

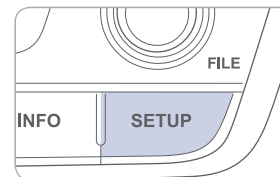

1. Press the SETUP button.
2. Touch the "Clock" button on the screen.
3. Select GPS Time to On.

FEATURES AND CONTROLS

INSTRUMENT CLUSTER

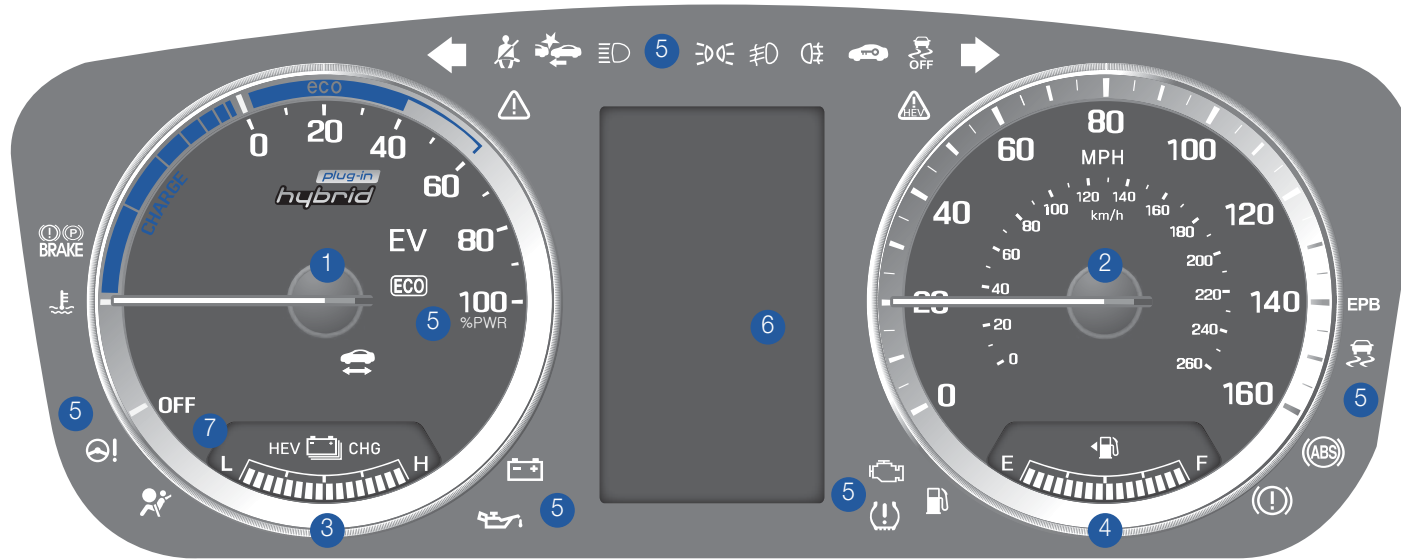

- ① Hybrid System Gauge
- ② Speedometer
- ③ Battery SOC (State of Charge) Gauge
- ④ Fuel Gauge
- ⑤ Warning and Indicator Lights
- ⑥ LCD Display (including Trip Computer)
- ⑦ Plug-in Hybrid Mode Indicator



FEATURES AND CONTROLS

WARNINGS AND INDICATORS

Ready Indicator	Service Warning Light	EV Mode Indicator
Charging Cable Connection Indicator*	Air Bag Warning Light	Seat Belt Warning Light
Parking Brake & Brake Fluid Warning Light	Regenerative Brake Warning Light	Anti-Lock Brake System (ABS) Warning Light
Electronic Brake Force Distribution (EBD) System Warning Light	Electric Parking Brake (EPB) Warning Light	
Malfunction Indicator Lamp (MIL)	Charging System Warning Light	Engine Oil Pressure Warning Light
Low Fuel Level Warning Light	Low Tire Pressure Warning Indicator/TPMS Malfunction Lamp	Master Warning Light
Electronic Stability Control (ESC) Indicator	Electronic Stability Control (ESC) OFF Indicator	Electric Power Steering (EPS) Warning Light
Immobilizer Indicator	Turn Signal Indicator	High Beam Indicator
Light ON Indicator	Cruise Indicator	Cruise SET Indicator
AUTO HOLD Indicator	SPORT Mode Indicator	ECO Mode Indicator
Forward Collision Warning System (FCWS) Warning Light	Lane Departure Warning System (LDWS) Indicator	

* : Plug-in hybrid



Ready Mode

When the vehicle is on, the READY indicator is illuminated. Even if the gasoline engine is off, you can drive the vehicle.



EV Mode

This is an indicator to let the driver know that the vehicle is operating fully in EV Mode (Electric Vehicle Mode).



Eco Guide

This is an indicator gauge to display the ECO driving status.



Hybrid Service Indicator

If there is a problem with the Hybrid System, the service indicator light will illuminate. Have an authorized Hyundai dealer fix the problem as soon as possible.

FEATURES AND CONTROLS

LCD DISPLAY CONTROL

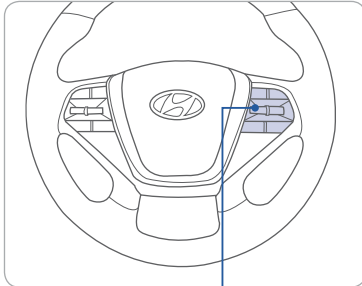

- ① : MODE button for changing modes
- ② : MOVE switch for changing items
- ③ : SELECT / RESET button for setting or resetting the selected item

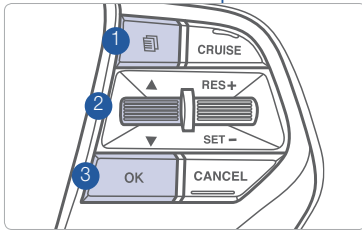

INSTRUMENT PANEL ILLUMINATION

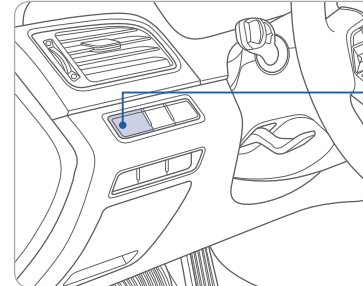

Press - or + to adjust the instrument cluster illumination brightness.

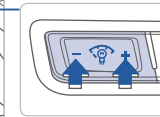

LCD DISPLAY MODES

Modes	Symbol	Explanation
Trip Computer		This mode displays driving information like the tripmeter, fuel economy, and so on.
Turn By Turn (TBT) (if equipped)		This mode displays the state of the navigation.
SCC / LDWS (if equipped)		This mode displays the state of the Smart Cruise Control (SCC) and Lane Departure Warning System (LDWS).
A / V (if equipped)		This mode displays the state of the A / V (Audio Visual) system.
Information	or or	Displays service interval and warning messages.
User Settings		Changes settings.



FEATURES AND CONTROLS

PLUG-IN HYBRID MODE INDICATOR

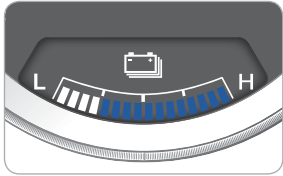

CD (Charge Depleting, Electric) Mode
The high-voltage (hybrid) battery is used to drive the vehicle.

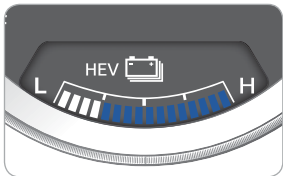

CS (Charge Sustaining, Hybrid) Mode
The high-voltage (hybrid) battery and gasoline engine is used to drive the vehicle.

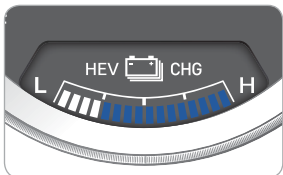

HEV-Charging Mode
Gasoline engine is used to drive the vehicle and charge the high-voltage (hybrid) battery.

HYBRID SYSTEM MODES

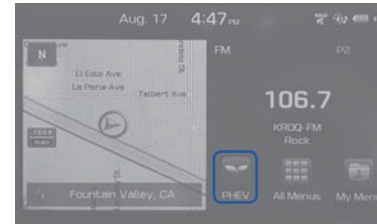

Press the INFO button in the head unit.
Press the PHEV button to select one of the screens.



ECO Driving
This screen displays if the vehicle is driven economically. The display will change according to the ECO Level bars. The level increases as your driving becomes more economical.



Energy Information
This screen displays the Battery Information and Energy Flow Mode.



Energy Flow Mode
This screen displays the energy flow from the engine and battery.



Fuel Economy Mode
This screen displays average fuel economy. The graph shows fuel economy for the last 30 minutes and it is updated every 2 minutes and 30 seconds.

FEATURES AND CONTROLS

AUTOMATIC CLIMATE CONTROL

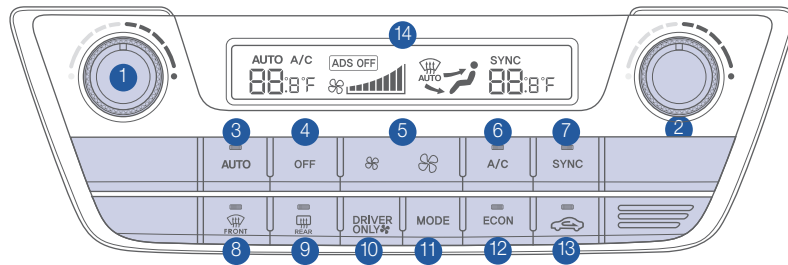

- 1 Driver's Temperature Control Knob
- 2 Passenger's Temperature Control Knob
- 3 AUTO (Automatic Control) Button
- 4 OFF Button
- 5 Fan Speed Control Button
- 6 Air Conditioning Button
- 7 SYNC Button
- 8 Front Windshield Defrost Button
- 9 Rear Window Defrost Button
- 10 DRIVER ONLY Button
- 11 Mode Selection Button
- 12 ECON (Economy Air Conditioning) Button
- 13 Air Intake Control Button
- 14 Climate Control Information Screen

DEFOGGING/DEFROSTING

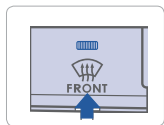

1. Press the defrost button.

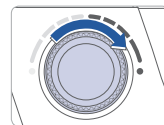

2. Select the warmest temperature.

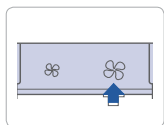

3. Set the fan speed to the highest speed.

SYSTEM OFF

Pressing the OFF button will place the system to the OFF mode.

- Climate control fan will turn off.
- Outside (fresh) air position will be selected.
- Vented air will be at last set temperature.

NOTE:

To reduce the tendency of the glass fogging and also improve the visibility, keep the interior surface of the windshield clean by wiping it with a clean cloth and glass cleaner. In addition, select air intake control to the outside (fresh) air position whenever possible while operating the vehicle.

AIR INTAKE CONTROL

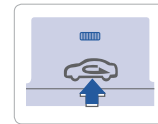

Recirculated air position

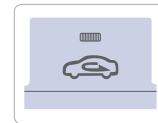

Outside (fresh) air position

AUTOMATIC HEATING / AIR CONDITIONING

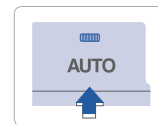

Controls the modes, fan speeds, air intake and air-conditioning automatically.

MODE SELECTION

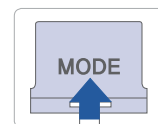

Changes the direction of the air flow as following:



MULTIMEDIA

STEERING WHEEL AUDIO CONTROL

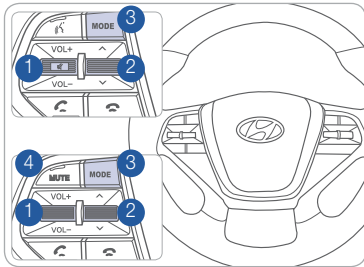

- 1 **VOLUME**
Raises or lowers the speaker volume.
- 2 **SEEK / PRESET**
Change station.
- 3 **MODE**
Change the audio source.
- 4 **MUTE**
Mute the sound.

BLUETOOTH® OPERATIONAL TIPS

In the following situations you or the other party may have difficulty hearing each other:

1. Keep the Bluetooth® volume low. High level volume may result in distortion and echo.
2. When driving on a rough road, high speeds and / or with the window open.
3. When the air conditioning vents are facing the microphone and / or when the air conditioning fan is at the max speed.

Steering wheel bluetooth® control

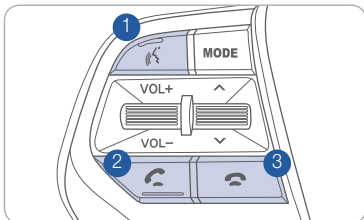

- 1 **TALK**
Activates voice recognition.
- 2 **CALL**
Places and transfers calls.
- 3 **END**
Ends calls or cancels functions.

To Answer a Call:

- Press the button on the steering wheel.

To Reject a Call:

- Press the button on the steering wheel.

To Adjust Ring Volume:

- Use the VOLUME buttons on the steering wheel.

To Transfer a Call to the Phone

(Private call on handset – do not use while driving):

- Press and hold the button on the steering wheel until the audio system transfers a call to the phone.

To Finish a Call:

- Press the button on the steering wheel.

Making a call using voice recognition:

The menu tree identifies available voice recognition Bluetooth® functions.

Calling by Name:

1. Press button.
2. Say the following command:
 - “Call <John Smith>”: Connects the call to John.
 - “Call <John Smith> on <on Mobile / in Office / at Home>”: Connects the call to John’s Mobile, Home, or Office phone number.

Dialing by Number:

1. Press the button.
2. Say “Dial Number.”
3. Say the desired phone number.

For the complete list of commands, please refer to your Owner’s Manual.



MULTIMEDIA



BLUETOOTH PHONE PAIRING

Phone setup (pairing phone) with Audio

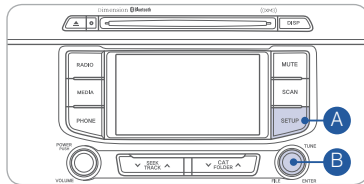

NOTE: Vehicle must be parked to complete the pairing process.

1. Press the SETUP **A** button.
2. Select "Phone" by turning and pressing the TUNE / ENTER **B** knob.
3. Select "Pair Phone" by turning and pressing the TUNE / ENTER knob.
4. Search for the device name as displayed on your mobile phone and connect.
5. Input the passkey displayed on the Audio screen.
6. Pairing is complete.

Phone setup (pairing phone) with Navigation

1. Press the PHONE button in the head unit or the button in the steering wheel remote control.

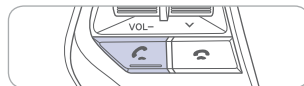
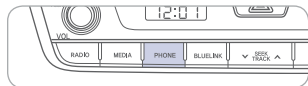

2. Press <YES> to search for Bluetooth phones.
3. Pair your car after your mobile phone detects the Bluetooth device.
4. Enter the passkey or accept the authorization popup. (The default passkey is 0000).
5. Connect Bluetooth.



NOTE: Vehicle must be parked to complete the pairing process.

BLUE LINK TELEMATICS SYSTEM

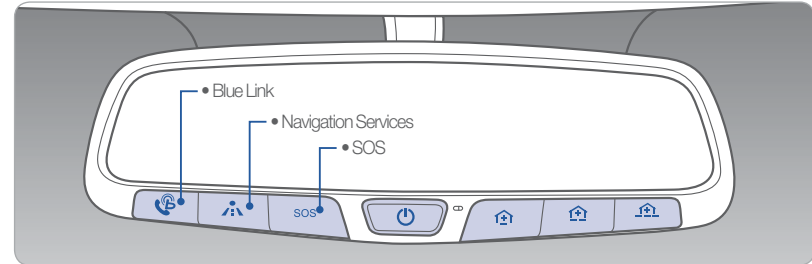

Blue Link subscription is required. To enroll, please visit your dealership or MyHyundai.com.

Press the button for access to the voice-response menu of services.

You can say:

- "Service Link" to schedule a service appointment.
- "Roadside Assistance" for roadside services.
- "Blue Link Account Services" for help with your Blue Link subscription.

- Press the button for Destination Search Powered by Google®.

- Press the **SOS** button for SOS Emergency Assistance.

- Refer to your Blue Link User's Manual for detailed information on system operation.

- For immediate assistance with subscription services, please call 1-855-2BLUELINK (1-855-225-8354).

Google® is a registered trademark of Google Inc.

MULTIMEDIA

Remote, Start Remote Climate Control, Battery Charge Status

Remote Start



You can download the Blue Link mobile app to your compatible smart phone from the following sites:

- iPhone® — Apple® App Store
- Android® — Google Play



Scan to download the app.

Remote Start enables you to remotely start your vehicle from virtually anywhere. You can also enable climate control remotely and turn on the windshield defroster, ensuring a warm or cool car is ready to go when you are.

- To use this feature, you must have a Blue Link Personal Identification Number (PIN). To create or change your PIN, log on to www.MyHyundai.com.

Remember:

- Remote Start with Climate Control will automatically shut off after 10 minutes or after selected engine timer runs out.
- While this feature is active, the parking lights will blink until vehicle is turned off or when vehicle is in operation.
- To continue operation of the vehicle, the proximity key must be inside the vehicle with the driver prior to pressing the brake and being able to move the gearshift from the P (Park) position.

Preconditions:

- Ignition is OFF
- Alarm is armed (i.e., vehicle locked by key fob Remote Door Lock)
- Vehicle is not connected to a charger.
- Gearshift level is in the P (Park) position
- Brake pedal is not depressed
- Engine hood is securely closed
- All the doors are closed and locked
- The tailgate or trunk lid is closed
- The security/panic system is not activated
- The proximity key is not inside the vehicle
- The battery power is not low
- Vehicle is located in an open area
- It has been less than 4 days since last vehicle ignition off
- Vehicle located in area with good cell reception

Remote Start will terminate:

- After 10 minutes or after selected engine timer runs out.
- Brake is pressed without proximity key inside vehicle
- Alarm is triggered without proximity key inside vehicle
- Door/trunk is opened from inside the vehicle

Notice: Laws in some communities may restrict the use of the features that remotely start the engine. For example, some laws may require a person using the remote start feature to have the vehicle in view when doing so or limit the length of time a vehicle engine may idle. Please check local and state regulations for any requirements and restrictions on remote starting of vehicles and engine idling time.

WARNING!

Do not remote start vehicle in an enclosed environment (i.e., closed garage). Prolonged operation of a motor vehicle in an enclosed environment can cause a harmful build-up of carbon monoxide. Carbon monoxide is harmful to your health. Exposure to high levels of carbon monoxide can cause headaches, dizziness or in extreme cases unconsciousness and/or death. Do not leave children or animals unattended in a vehicle while using the remote start function.

CAUTION!

If the vehicle's windshield wipers are left on when the vehicle was last driven, then the wipers will turn on if the remote start function is activated. To avoid damage to the wiper blades (i.e., due to heavy ice or snow accumulated on the windshield), please always turn the vehicle's windshield wipers off when parking the vehicle.



MULTIMEDIA



NAVIGATION

Basic features on the map screen

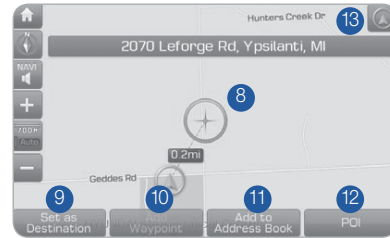

- 1 Move to the Home Screen.
- 2 Change the map view mode.
- 3 Voice Guidance On / Off.
- 4 Zoom in the map.
- 5 Set the zoom level automatically according to the guidance.
- 6 Zoom out the map.
- 7 Quick and easy selection of a destination and options.
- 8 Touch to scroll the map.
- 9 Quick and easy selection of a destination from the map screen.
- 10 Set a waypoint to the current route.
- 11 Save frequently used address to the address book.
- 12 Find a POI (Point Of Interest) around the current position.
- 13 View the vehicle's current position on the map screen.

Basic features on the map screen



- 1 Set destination by address search.
- 2 Select from previously inputted addresses and POI's.
- 3 Runs Google Local Search.
- 4 Select the desired item in the sub-categories.
- 5 Search and select the desired destination among the searched items.
- 6 Search and select the desired destination among the searched items.
- 7 Search and select the desired destination among the searched items.
- 8 Search the destination with the address book.
- 9 Search destination by phone number.
- 10 Type freeway name and exit / entrance to search.
- 11 Type the Street name, the State, and city name to search.
- 12 Type coordinates to search.

AUX, USB AND iPod / iPhone PORT

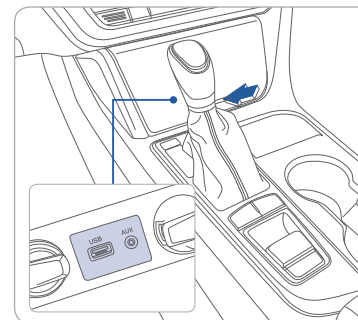

Use the input jack to connect an external audio device and listen to it through the audio system in your vehicle.



MULTIMEDIA

ANDROID AUTO™

REQUIREMENTS:

- Micro USB cable
- OS Android™ 5.0 or higher
- Compatible Android Phone
- Data and wireless plan for applicable features

BEFORE YOU BEGIN:

- Android Auto features may operate differently than on your phone.
- Message and data charges may apply when using Android Auto.
- Android Auto relies on the performance of your phone. If you experience performance issues:
 - Close all apps and then restart them or
 - Disconnect and then reconnect your phone
- Using the micro USB cable that was provided with your phone is recommended.
- When Android Auto is active, your in-vehicle voice recognition system is disabled and you will be using talk to Google™ to make your requests.

ANDROID AUTO SUPPORT



<https://support.google.com/androidauto/>

PHONE SETUP

Turn on the Bluetooth® on your phone and connect the micro USB cable to your phone and the USB port on the vehicle.

Phone will prompt you to download the Android Auto app and update other needed apps (i.e. Google Maps™, Google Play Music™, Google Now™).

NOTE: Vehicle must be parked.

- Location mode setting should be set to High accuracy.
- Vehicle and phone setup should be completed in one sitting. If phone setup needs to be resumed, we recommend to Force Stop the Android Auto app on the Phone then reopen the app and accept the Disclaimer notifications.

CAR SETUP

1. Press the SETUP button.
2. Touch the “Connectivity” icon on the screen.
3. Select “On” for Android Auto.
4. Connect your Android phone to the vehicle USB port. Agree to the notification and disclaimers on your phone then the “Android Auto” icon will appear confirming the setup.

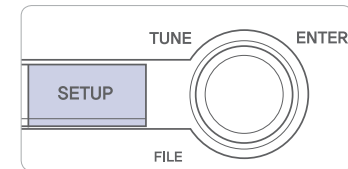

For more detailed information on how to operate Android Auto, please refer to your navigation manual.

For additional Android Auto support, please refer to the Android Auto Support Website

<https://support.google.com/androidauto/>

Android Auto, Google Play, Android, and other marks are trademarks of Google Inc.



MULTIMEDIA

APPLE CARPLAY™

REQUIREMENTS

- Apple Lightning® cable
- Latest iOS
- iPhone® 5 or above
- Data and wireless plan for applicable features

BEFORE YOU BEGIN

- Apple® CarPlay features may operate differently than on our phone.
- Message and data charges may apply when using Apple CarPlay.
- Apple CarPlay relies on the performance of your phone. If you experience performance issues:
 - Close all apps and then restart them or
 - Disconnect and then reconnect your phone
- Using the Apple Lightning cable that was provided with your phone is recommended.
- When Apple CarPlay is active, your voice recognition system is disabled and you will be using Siri® to make your requests.

PHONE SETUP

On your phone, go to Settings > General > Restrictions > CarPlay to allow CarPlay access.

On your phone, go to Settings > General > Siri and ensure Siri is turned ON.

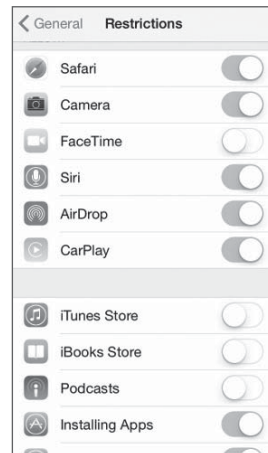

CAR SETUP

1. Press the SETUP button.
2. Touch the “Connectivity” icon on the screen.
3. Touch “iOS” on the Connectivity Settings screen then touch “On” to enable Apple CarPlay.
4. Connect your Apple iPhone to the vehicle USB port then touch ‘OK’ when the pop-up message appears. The Apple CarPlay icon will now appear on the vehicle Home screen confirming the setup.

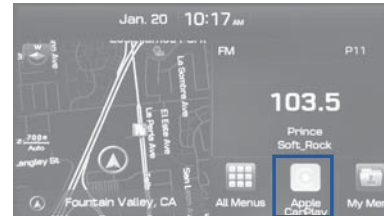

Apple CarPlay, Apple, and other marks are trademarks of Apple Inc.



MULTIMEDIA



CarPlay Home Screen

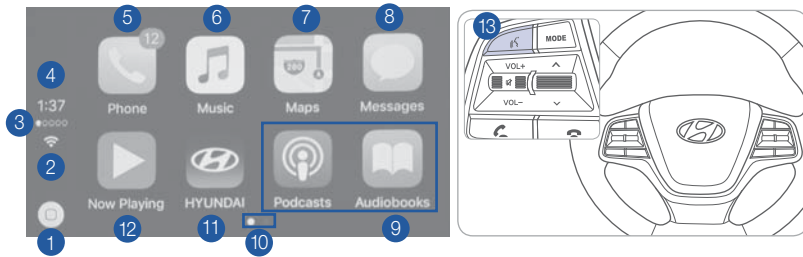

- | | |
|-------------------------|----------------------------------|
| 1 HOME ICON | 7 APPLE MAPS |
| 2 WIRELESS CONNECTIVITY | 8 MESSAGES |
| 3 CELLULAR SIGNAL | 9 3RD PARTY APPS |
| 4 PHONE TIME | 10 SCREEN PAGE INDICATOR |
| 5 PHONE | 11 EXIT TO HYUNDAI |
| 6 APPLE MUSIC™ | 12 CURRENT CARPLAY AUDIO PLAYING |

SIRI

Apple CarPlay uses Siri to perform many actions like sending messages, placing calls, and looking up/setting POI/Destinations. A Siri session can be initiated on any screen by:

1. Touch and holding the HOME icon 1 on the CarPlay screen or
2. Press the steering wheel VOICE RECOGNITION 13 button.

Note: Ensure Siri feature is set to ON in your phone (Go to Settings > General > Siri).

3. Say any of the following commands;
 - “Text <John Smith> ‘Call you later’” to send a text message.
 - “Read text messages” to read available text message.
 - “Call <John Smith>” to make a phone call.
 - “Find <POI/Destination>” to locate a POI/Destination.

PHONE

Touch the PHONE 5 icon to access the Phone screen. Siri will automatically asks ‘Who you would like to call’ when the PHONE 5 icon is selected.

NOTE: Phone call sound quality is dependent on the wired connection. Using the Lightning cable that came with the phone is recommended.

APPLE MUSIC

Touch the APPLE MUSIC 6 icon to access the Apple Music screen.

APPLE MAPS

Touch the APPLE MAPS 7 icon to access the Apple Map screen.

MESSAGES

Touch the MESSAGES 8 icon to access the Message screen. Siri will automatically asks ‘To hear unread messages or create a new one’ when the MESSAGE icon is selected.

3rd PARTY APPS

Supported CarPlay apps that are downloaded on your phone will appear on the CarPlay screen. Touch the apps icons to access those supported apps.

NOTE: A list of the supported CarPlay supported apps can be found at <http://www.apple.com/ios/carplay/>

Ensure phone has latest version of the 3rd Party Apps.

DRIVING

ELECTRIC PARKING BRAKE (EPB)

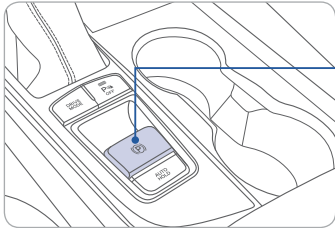

Applying



Stop the vehicle then pull up the EPB switch.

Releasing

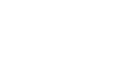

Move the shift lever from P to R or D while depressing the brake pedal.

or

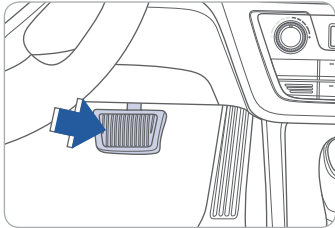

Press the EPB switch while depressing the brake pedal.

NOTE:

If necessary, emergency braking is possible by pulling and holding the EPB switch.

AUTO HOLD

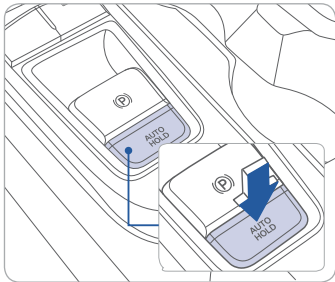

When the vehicle reaches a stop, Auto Hold keeps the vehicle stopped even when the brake pedal is released. The brakes are released automatically when the accelerator pedal is depressed.

**WHITE
AUTO
HOLD**

1. Press the AUTO HOLD switch.

**GREEN
AUTO
HOLD**

2. Stop the vehicle by depressing the brake pedal. The brake will remain engaged even if the brake pedal is released.

**WHITE
AUTO
HOLD**

3. The brake pedal will release when the accelerator pedal is depressed with transmission in D, R or manual mode.

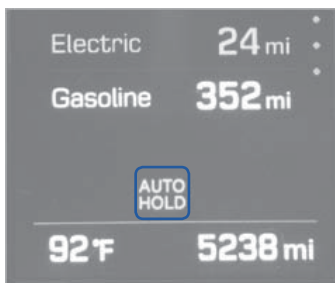

To cancel the AUTO HOLD operation, press the AUTO HOLD switch again.

TIRE PRESSURE MONITORING SYSTEM (TPMS)



Low Tire Pressure Indicator /
TPMS Malfunction Indicator



Low Tire Pressure Position Indicator
and Tire Pressure Indicator
(Shown on the LCD display)

LOW TIRE PRESSURE INDICATOR

Illuminates if one or more of your tires is significantly under-inflated.

TPMS MALFUNCTION INDICATOR

Blinks for approximately one minute, then remains illuminated when there is a malfunction with the TPMS. Inspect all tires and adjust the tire pressure to specification. If the lamp remains illuminated, have the system checked by an authorized Hyundai dealer as soon as possible.

LOW TIRE PRESSURE POSITION INDICATOR AND TIRE PRESSURE INDICATOR (LCD DISPLAY)

Tire pressures will display after driving a short distance. If a tire pressure drops lower than predetermined specification, the Low Tire Pressure Indicator (🚗) will illuminate and the LCD (📺) display will indicate tire(s) requiring air.

DRIVING

AUTOMATIC TRANSMISSION

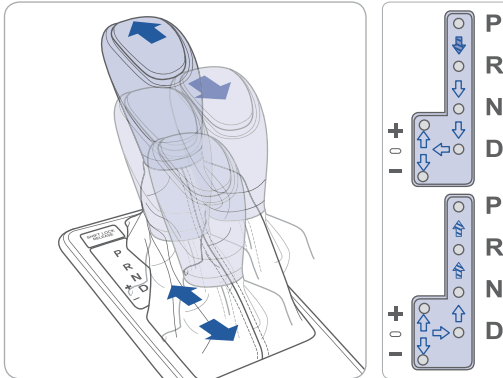

- (➡) : Press the shift button while moving the shift lever.
- (⏪) : Depress the brake pedal and press the shift button while moving the shift lever.
- (➡) : The shift lever can freely operate.

Shiftronic

Move the shift lever from D (Drive) into the manual gate to select.
Move the shift lever forward (+) to up shift or rearward (-) to downshift.

VIRTUAL ENGINE SOUND SYSTEM (VESS)

The Virtual Engine Sound System generates an artificial sound to alert pedestrians of the vehicle approaching due to the silent nature of the vehicle when it is operating in EV mode.

ELECTRONIC STABILITY CONTROL (ESC)

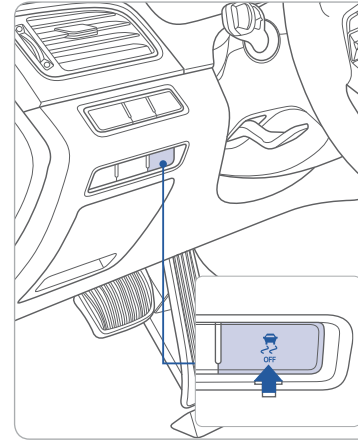

The ESC system is an electronic system designed to help the driver maintain vehicle control under adverse conditions.

ESC automatically selects the ON position when the engine is started.

To turn off the Engine Control
Press the ESC OFF button shortly.

To turn off the Engine and Traction Control
Press the ESC OFF button for more than 3 seconds.

LANE DEPARTURE WARNING SYSTEM (LDWS)

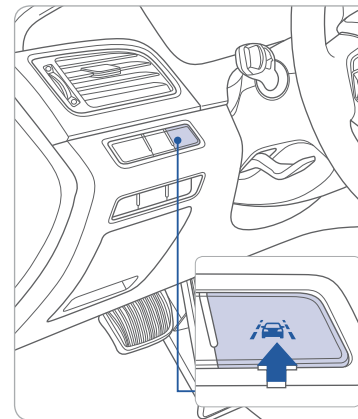

The Lane Departure Warning System detects the lane on the road and warns the driver if the vehicle leaves the lane when the vehicle speed is over 40mph.

- To turn on the LDWS, press the LDWS switch.
- To turn off the LDWS, press the switch again.

The indicator on the instrument cluster is green when the system detects lanes but is white when the lane is not detected.



DRIVING

BLIND SPOT DETECTION SYSTEM (BSD)

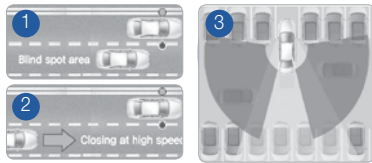

The BSD (Blind Spot Detection) system uses a radar sensor to alert the driver while driving. It monitors the rear area of the vehicle and provides information to the driver.

- 1 Blind Spot Detection
- 2 Lane Change Assist
- 3 Rear Cross Traffic Alert

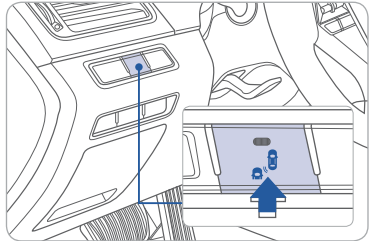

- To turn the BSD on, press the BSD button (indicator illuminated).
- To turn the BSD off, press the BSD button again.

The system will activate if vehicle speed exceeds 20 mph.

Rear Cross Traffic Alert

When the transmission is put in R (Reverse), the system provides an alert if a vehicle is approaching from the sides.

DRIVE MODE INTEGRATED CONTROL SYSTEM

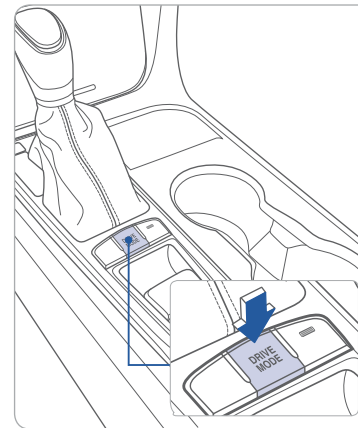

You can select the drive mode according to your preference or the road condition. The system defaults back to ECO mode when the vehicle is restarted.

Each time you press the button, the drive mode is changed as follows :

Plug-in hybrid

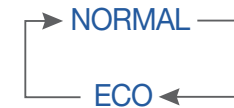

Normal mode is not displayed on the instrument cluster.

ECO mode

Eco mode system helps to improve fuel efficiency. When the Eco mode system is activated, the vehicle acceleration and gear shift points and will be reduced to conserve the fuel consumption.



DRIVING

CRUISE CONTROL / SMART CRUISE CONTROL

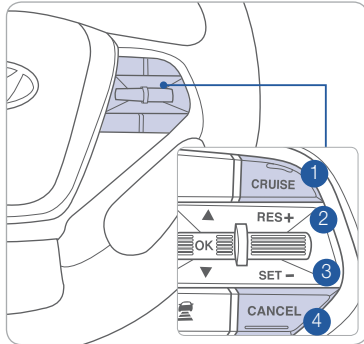

The Cruise Control system allows you to program the vehicle to maintain a constant speed without holding the accelerator pedal.

- 1 To turn On / Off the Cruise Control.
- 2 To Resume or Increase the Cruise Control speed.
- 3 To Set or Decrease the Cruise Control speed.
- 4 To Cancel the Cruise Control.

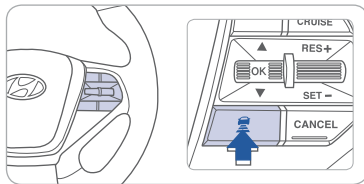

Setting Vehicle Distance (Advanced Smart Cruise Control only)

This system assist you in setting the distance from the vehicle ahead and will maintain the selected distance without you depressing the accelerator or the brake pedal.

The vehicle to vehicle distance 5 will automatically activate when you set the cruise speed 6.

Each time the vehicle distance set button is pressed, the vehicle to vehicle distance changes as follows:

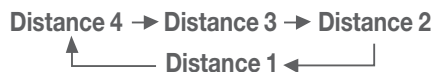
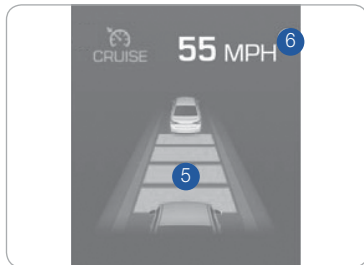

If your vehicle is equipped with Advanced Smart Cruise Control and you wish to eliminate the vehicle distance function, you can change cruise control setting to a standard setting.

Press the Cruise Control button on the steering wheel to turn on the Cruise Control. Then press and hold the vehicle distance button for more than 2 seconds to toggle between the Smart Cruise Control (SCC) and Cruise Control (CC) mode.

Please refer to your Owner's Manual for more information.

HYBRID DRIVING TIPS

The following tips may help benefit you to maximizing fuel economy and experience Hybrid driving.

Common practice:

- Check tire pressure
- Roll windows up when driving
- Properly maintain your vehicle
- Turn the Climate Control system off during cold start.



Set headlight switch to AUTO or OFF when not in use. This will help preserve Hybrid battery charge.



Set climate control to ECON mode.



Try to drive in the ECO zone and maintain EV Mode indicator to illuminate as much as possible.

Driving suggestions to improve fuel economy:

- Drive smoothly.
- Accelerate at moderate speed.
- Try to maintain your speed with traffic to prevent unnecessary speed adjustments.
- Always maintain a safe driving distance from the vehicle in front of you so you can avoid unnecessary braking.

HYUNDAI VEHICLE OWNER PRIVACY POLICY

Your Hyundai vehicle may be equipped with technologies and services that use information collected, generated, recorded or stored by the vehicle. Hyundai has created a Vehicle Owner Privacy Policy to explain how these technologies and services collect, use, and share this information.

You may read our Vehicle Owner Privacy Policy on the Hyundaiusa.com website at <https://www.hyundaiusa.com/owner-privacy-policy.aspx>. If you would like to receive a hard copy of our Vehicle Owner Privacy Policy, please contact our Customer Connect Center at:

Hyundai Motor America
Hyundai Customer Connect Center
P.O. Box 20850
Fountain Valley, CA 92728-0850
800-633-5151 consumeraffairs@hmausa.com

Hyundai's Customer Connect Center representatives are available Monday through Friday, between the hours of 5:00 AM and 7:00 PM PST and Saturday and Sunday between 6:30 AM and 3:00 PM PST (English). For Customer Connect Center assistance in Spanish or Korean, representatives are available Monday through Friday between 6:30 AM and 3:00 PM PST.

SONATA CUSTOMER DELIVERY CHECK LIST

HYUNDAI OWNER	DEALERSHIP NAME
SALES CONSULTANT	DATE
VIN	PREVIOUS VEHICLE

BEFORE DELIVERY

- SET TIRE PRESSURE LF ___ RF ___ RR ___ LR ___
- VERIFY VEHICLE IS CLEAN, IN GOOD CONDITION, FREE OF CHIPS AND SCRATCHES - CLEAN WINDSHIELD AND BACK WINDOW
- ENSURE FLOORMATS ARE SNAPPED INTO PLACE

Sales Consultant	Date	Sales Manager	Date
Customer			Date
Email			