

## WALK THE CUSTOMER THROUGH EACH OF THE FOLLOWING KEY DELIVERY FEATURES

- DRIVE MODE INTEGRATED CONTROL SYSTEM– pages 36
  - Explain each drive mode
- BLUETOOTH – pages 20-21
  - Show phone compatibility website: [www.hyundaiusa.com/bluetooth](http://www.hyundaiusa.com/bluetooth)
  - Make a test call using Bluetooth with the customer’s phone
  - Demonstrate Voice Recognition (VR)
- BLUE LINK – page 23-25
  - Assist with creating MyHyundai.com account
  - Assist with Blue Link enrollment
  - Show Blue Link Users Manual & tear out Voice Commands/Quick Tip Card
  - Encourage customers to press the Blue link button 
- TIRE PRESSURE MONITORING SYSTEM (TPMS) – page 35
  - Explain TPMS function to customer
  - When illuminated, one or more tires are under-inflated.
  - Blinks for approximately one minute then remains illuminated when there is a malfunction with the TPMS
- VEHICLE SETTINGS – pages 12– 15 and 27-29
  - Demonstrate vehicle settings in instrument cluster
  - Demonstrate navigation use, enter dealer address
  - Show radio presets
- CLOCK – pages 32
  - Demonstrate how to set clock (including daylight savings setting for Navigation equipped vehicles)



## MAINTENANCE

Scheduled Maintenance	Normal Usage		Severe Usage*	
Engine Oil and Filter*	Replace	7,500 or 12 mos.	Replace	3,750 or 6 mos.
Fuel Additives	Add	At every Oil and Filter Service	Add	Same As Normal
Tire Rotation	Perform	7,500	Perform	7,500
Fuel System Cleaner Additive	Inspect Replace	7,500 30,000	Inspect Replace	Same As Normal More Frequently
Battery Condition	Inspect	7,500	Inspect	Same As Normal
Vacuum Hose	Inspect	7,500	Inspect	Same As Normal
Climate Control Air Filter	Replace	15,000	Replace	More Frequently
Brake Hoses and Lines	Inspect	15,000	Inspect	Same As Normal
Drive Shafts and Boots	Inspect	15,000	Inspect	7,500 or 6 mos.
Exhaust Pipe and Muffler	Inspect	15,000	Inspect	Same As Normal
Front Brake Disc/Pads, Callipers	Inspect	15,000	Inspect	More Frequently
Rear Brake Disc/Pads	Inspect	15,000	Inspect	More Frequently
Steering Gear Box, Linkage & Boots, Lower/Upper Arm Ball Joint	Inspect	15,000	Inspect	More Frequently
Suspension Mounting Bolts	Inspect	15,000	Inspect	Same As Normal
Propeller Shaft (AWD)	Inspect	15,000	Inspect	7,500 or 6 mos.
Brake Fluid	Inspect	30,000	Inspect	Same As Normal
Fuel Filter	Inspect	30,000	Inspect	Same As Normal
Fuel Lines, Fuel Hoses, and Connections	Inspect	30,000	Inspect	Same As Normal
Fuel Tank Air Filter	Inspect	30,000	Inspect	Same As Normal
Parking Brake	Inspect	30,000	Inspect	More Frequently
Vapor Hose and Fuel Filler Cap, Fuel Tank	Inspect	30,000	Inspect	Same As Normal
Transfer Case Oil (AWD)	Inspect	37,500	Replace	75,000
Rear Axle Oil (AWD)	Inspect	37,500	Replace	75,000
Valve Clearance	Inspect	60,000	Inspect	Same As Normal
Drive Belts	Inspect	1st: 60,000 or 72 mos. Addtl.: 15,000 or 24 mos.	Inspect	Same As Normal
Coolant	Replace	1st: 120,000 or 60 mos. Addtl.: 30,000 or 24 mos.	Replace	Same As Normal
Spark Plugs	Replace	105,000 or 120 mos.	Replace	More Frequently
Automatic Transaxle Fluid	No Check, No Service required		Replace	60,000

\*Check the engine oil regularly between recommended oil change. Hyundai recommends Quaker State oil.

\*See Owner's Manual for details.

Looking for more detailed information? This Quick Reference Guide does not replace your vehicle's Owner's Manual. If you require additional information or are unsure of a specific issue, you should always refer to the vehicle's Owner's Manual or contact your authorized Hyundai dealer.

The information contained in this Quick Reference Guide was correct at the time of printing; however, specifications and equipment can change without notice. No warranty or guarantee is being extended in this Quick Reference Guide, and Hyundai reserves the right to change product specifications and equipment at any time without incurring obligations. Some vehicles are shown with optional equipment. Specifications apply to U.S. vehicles only. Please contact your Hyundai dealer for current vehicle specifications.

NP150-72017  
(Rev 02/01/16)  
Printing 02/03/16



[www.hyundai.com](http://www.hyundai.com)



Roadside Assistance: **1-800-243-7766**  
 Consumer Affairs: **1-800-633-5151**  
 XM® Radio: **1-800-967-2346**  
 Blue Link: **1-855-2BLUELINK (1-855-225-8354)**

# Table of contents

## GETTING STARTED

Folding key	02
Front seat adjustment	03
Headrest adjustment	04
Rear seat folding	04
Remote keyless entry	02
Seat belt adjustment	04

## FEATURES AND CONTROLS

AC 115V plug	38
Auto hold	37
Blind Spot Detection system (BSD)	40
Central door lock switch	06
Child-proof rear door lock	33
Climate control	16-17
Clock adjustments	32
Cruise control / Smart cruise control	18
Drive mode integrated control system	36
Driver position memory system	05
Driver Selectable Steering Mode	35
Driver's main controls	06
Electronic parking brake (EPB)	37
Electronic Stability Control (ESC)	36
Fuel filler lid	05
Headlights and foglights	07
HomeLink® integrated transceiver	11
Instrument cluster	12-15
Instrument panel illumination	13 & 15
Interior lights	10
Lane Departure Warning System (LDWS)	39
Multi-view camera system	38
Power liftgate	09
Rearview camera	40
Seat warmer and ventilated system	33
Steering wheel adjustments	05
Steering wheel functions	18-19
Sunroof	09
Tire Pressure Monitoring System (TPMS)	35
Transmission	34
Trip computer	13 & 15
Wiper and washer	08

## MULTIMEDIA

Android Auto	34-35
Audio	26
AUX, USB, and iPod® Port	26
Blue Link Telematics System	23-25
Bluetooth operational tips	20-21
Bluetooth phone operation	22
Bluetooth phone pairing	22
Navigation	27-29

\*Some vehicles may not be equipped with all the listed features.

## Frequently Asked Questions

1. Pair phone to your vehicle. Refer to pages 22.
2. Program HomeLink. Refer to page 11.
3. Getting started with Blue Link. Refer to page 23.

**Type A**      **Type B**  
 Headlights and fog lights Page 07      Trip computer Pages 13 & 15      Cruise control system Page 20      Wiper and washer Page 08      Navigation Pages 27-29  
 Driver's main controls Page 06      Steering wheel adjustments Page 05      Instrument cluster Pages 12-15      Transmission Page 34      AUX, USB and iPod® port Page 26      Climate control Pages 16-17  
 Automatic      Manual

**⚠ WARNING!**  
 To reduce the risk of serious injury to yourself and others, read and understand the important SAFETY INFORMATION in your Owner's Manual.

## REMOTE KEYLESS ENTRY

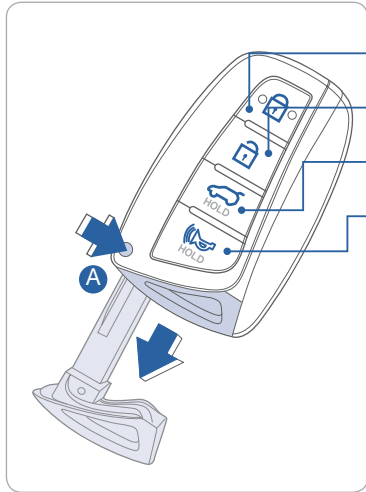

- Lock
- Unlock
- Tailgate unlock (Press and Hold)
- Alarm



### Mechanical key

Press and hold the release **A** button and remove the key.

### NOTE

User selectable option see Owner's Manual for more detail.

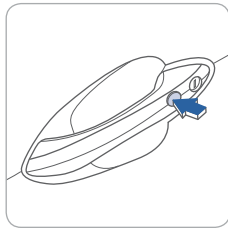

**Driver's door Lock / Unlock**  
Smart key must be within range.

### Press:

- Once – Unlock driver door
- Twice – Unlock all doors
- Third – Lock all doors

## FOLDING KEY



**Unfolding key**  
Press button **A** to unfold key.

- Lock
- Unlock
- Tailgate unlock (Press and Hold)
- Alarm

## FRONT SEAT ADJUSTMENT (Manual)

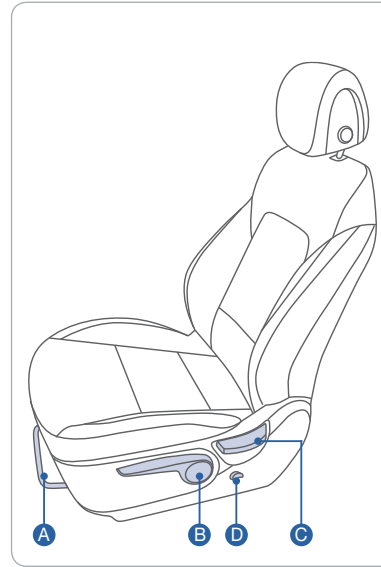

Forward/backward



Seat cushion height (for driver's seat)



Seatback angle



Lumbar support



## FRONT SEAT ADJUSTMENT (POWER)



Forward / backward

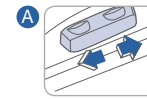

Seat cushion height

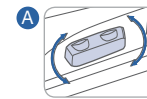

Seatback angle



Lumbar support (for driver's seat)

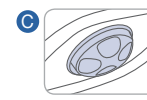



### REAR SEAT FOLDING

2<sup>nd</sup> row seat

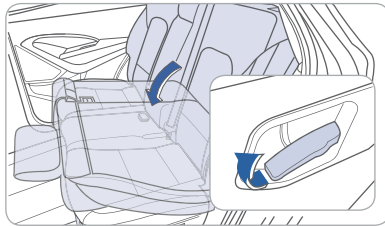

From cargo area (2<sup>nd</sup> row seat)

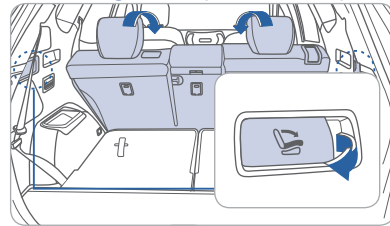

3<sup>rd</sup> row seat

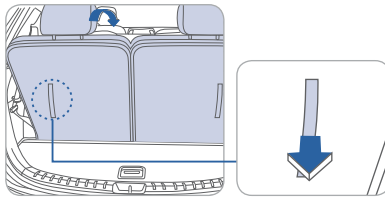

Rear center seatback (2<sup>nd</sup> row seat)

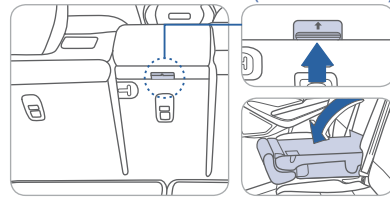

### HEADREST ADJUSTMENT

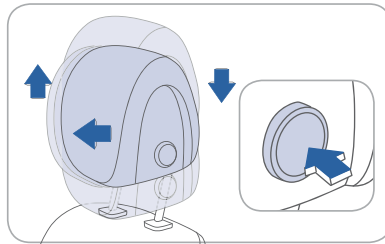

To Raise Headrest:

Pull headrest up.

To Lower Headrest:

Press lock button while pressing down on headrest.

To Adjust Headrest Forward:

Pull forward to 1 of 3 positions

To Adjust Backward:

Press lock button and push headrest backwards.

### SEAT BELT ADJUSTMENT (Front seat)

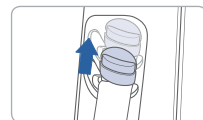
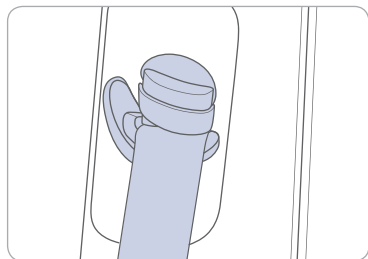

Pull up to raise.

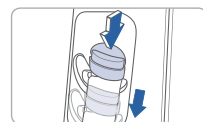

Press button and push down to lower.



### STEERING WHEEL ADJUSTMENTS

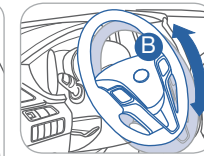
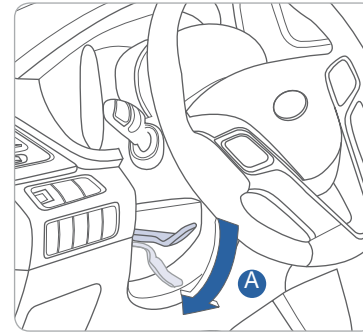

Tilt

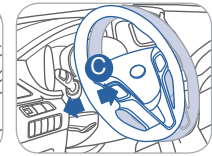

Telescopic

**NOTE** Do not adjust while driving.

1. Pull the lever **A** down to release.
2. Set the angle **B** and distance **C**
3. Pull the lever **A** up to lock.

### FUEL FILLER LID

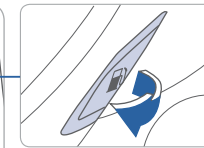
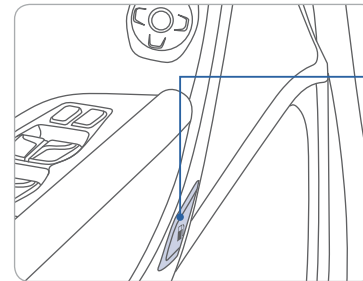

**NOTE**

After adding fuel, always reinstall the fuel cap onto the filler neck by rotating it clockwise until it clicks one time.

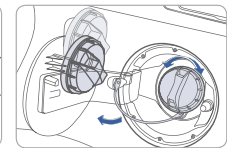

Check the engine oil regularly between recommended oil changes.

### DRIVER POSITION MEMORY SYSTEM

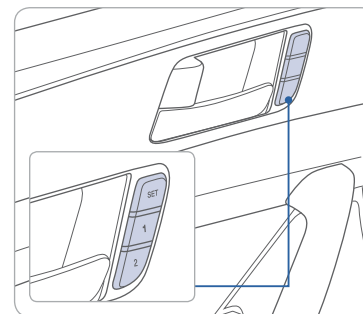

**Storing**

1. Adjust the driver's seat position, outside rearview mirror position and instrument panel illumination intensity.
2. Press the SET button. The system will beep once.
3. Press one of the memory buttons (1 or 2) within 5 seconds. The system will beep twice.

**NOTE** Transmission must be in P (Park).

**Recalling**

Press the desired memory button(1 or 2). The system will beep once.



### DRIVER'S MAIN CONTROLS

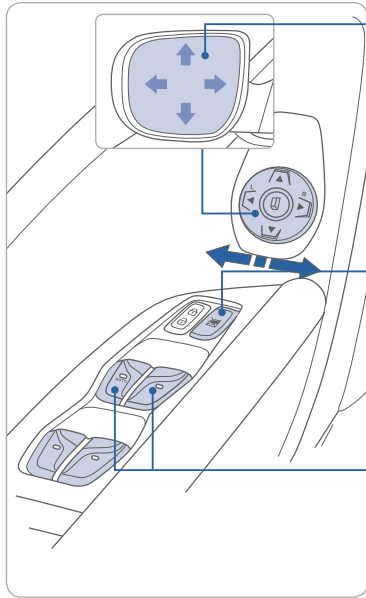

**Outside rearview mirrors**  
Press L (left) or R (right) on the switch. Then adjust the mirror by using the directional switch (↕).

**Power window lock switch**  
Disables the power window switches on the rear passenger doors only.

**Window auto down/up**  
Press past detent to fully open/close window.

### CENTRAL DOOR LOCK SWITCH

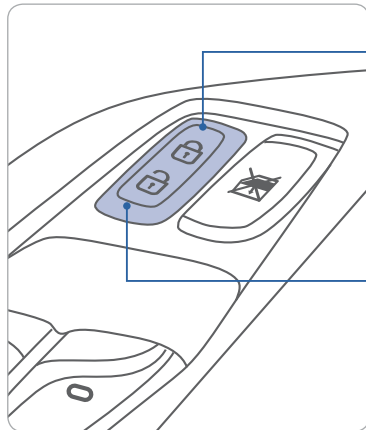

All doors will lock

All doors will unlock

### HEADLIGHTS AND FOG LIGHTS

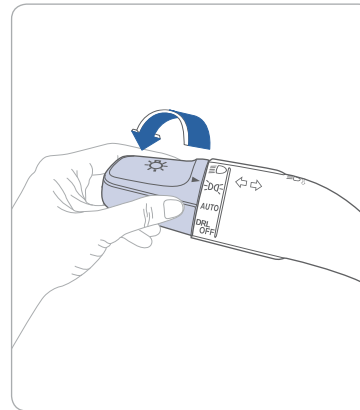

- ▶ | Headlight position
- ▶ | Parking light position
- ▶ | **AUTO** Auto light position
- ▶ | **DRL OFF** DRL OFF position

#### Headlight delay

Headlights may stay on for 15 seconds after exiting and locking vehicle. Press remote lock button twice to turn headlights off. See Owner's Manual for more detail.

#### Turn signals and lane change signals    Flashing headlights

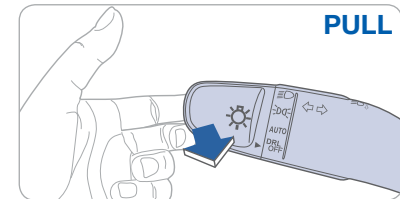
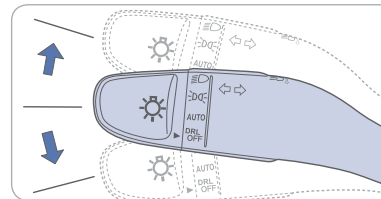

#### High beam / Smart high beam

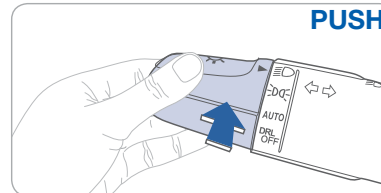

#### Fog light

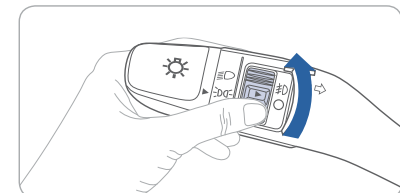

#### NOTE

To turn off high beam, pull the lever towards you.

#### Smart High Beam Function

1. Select auto position on stalk.
2. Push lever forward to engage Auto High beam.
3. Push lever forward again to disengage.



## FEATURES AND CONTROLS

### WIPER AND WASHER

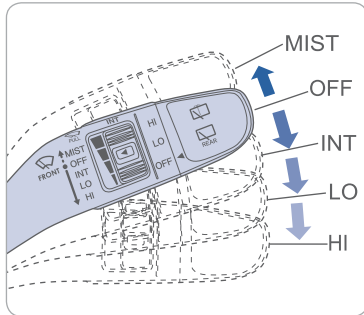

- MIST - Single wipe
- OFF - Off
- INT - Intermittent wipe
- LO - Normal wiper speed
- HI - Fast wiper speed

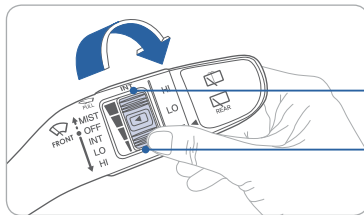

#### Intermittent wipe time adjustment

- Fast wiper speed
- Slow wiper speed

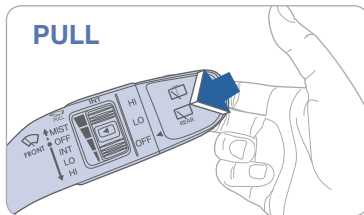

#### PULL

#### Front windshield wash with brief wipes

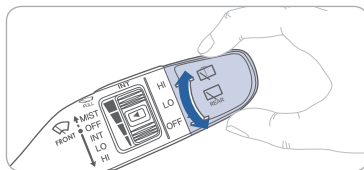

#### Rear wiper/washer control

- HI - Fast wiper speed
- LO - Normal wiper speed
- OFF - Off

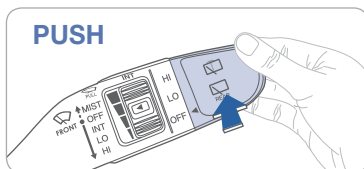

#### PUSH

#### Rear window wash with brief wipes



### SUNROOF

#### Sliding the sunroof

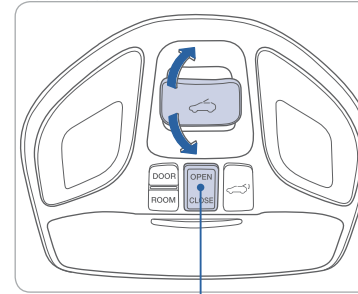

Sunshade open/close button

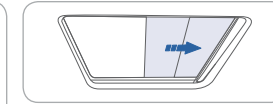

**To Open**  
Slide switch rearward.

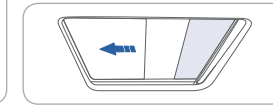

**To Close**  
Slide switch forward.



#### NOTE

To operate the sunshade, press open or close button.

#### Tilting the sunroof

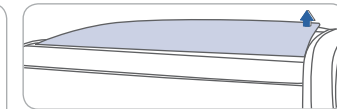
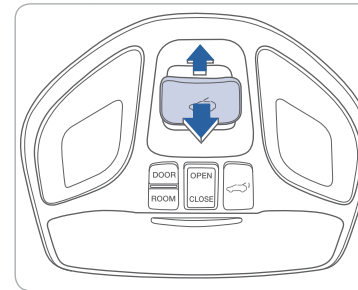

**To Tilt**  
Press the switch up.

**To Close**  
Slide the switch forward or pull the switch down.

### POWER LIFTGATE

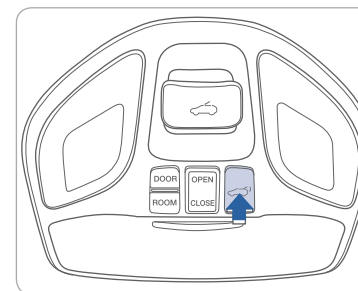

#### Options for opening liftgate

- Press exterior liftgate soft-touch switch.
- Press and hold key fob liftgate button.
- Press front seat overhead console button. (must be in P (park) to operate.)

#### Options for closing liftgate

- Press button on edge of open liftgate.
- Press front seat overhead console button.

#### Smart Liftgate

Refer to Owner's Manual for more information on operating Smart Liftgate feature.



## FEATURES AND CONTROLS



### INTERIOR LIGHTS

#### Map lamp

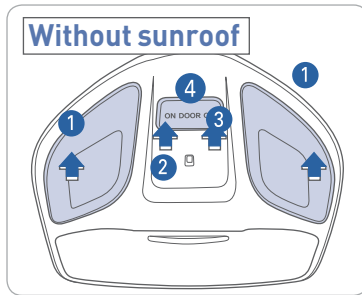

Push the lens **1** to turn the map lamp on or off.

**ON 2**  
Map lamp and room lamp will turn on.

**OFF 3**  
The lights stay off.

**DOOR 4**  
Map lamp and room lamp comes on when any door is opened.

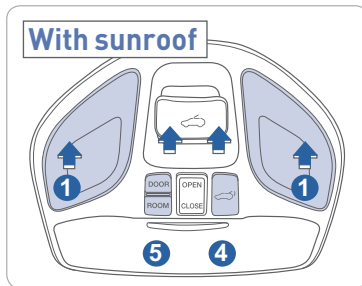

**ROOM 5**  
Map lamp and room lamp come on.

#### Room lamp

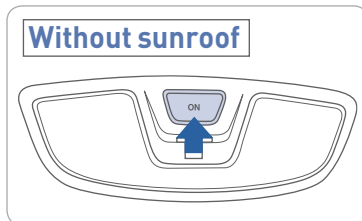

Press the switch to turn the light on or off.

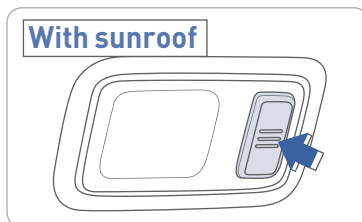

### HOMELINK WIRELESS CONTROL SYSTEM

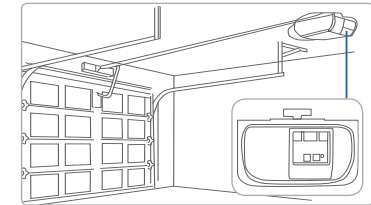
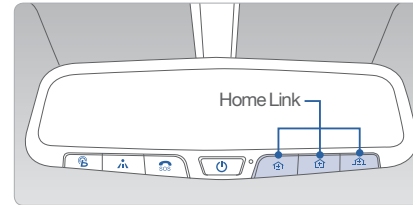

#### Standard Programming

To train most devices, follow these instructions:

1. For first-time programming, press and hold the two outside buttons, HomeLink® Channel 1 and Channel 3 Buttons, until the indicator light begins to flash (after 20 seconds). Release both buttons. Do not hold the buttons for longer than 30 seconds.
2. Position the end of your hand-held transmitter 1-3 inches (2-8 cm) away from the HomeLink® buttons while keeping the indicator light in view.
3. Simultaneously press and hold both the HomeLink® and hand-held transmitter button. DO NOT release the buttons until step 4 has been completed.
4. While continuing to hold the buttons the red indicator Status LED will flash slowly and then rapidly after HomeLink® successfully trains to the frequency signal from the hand-held transmitter. Release both buttons.

For detail instructions, refer to your Owner's Manual or visit [www.homelink.com](http://www.homelink.com).



## FEATURES AND CONTROLS

### Type A

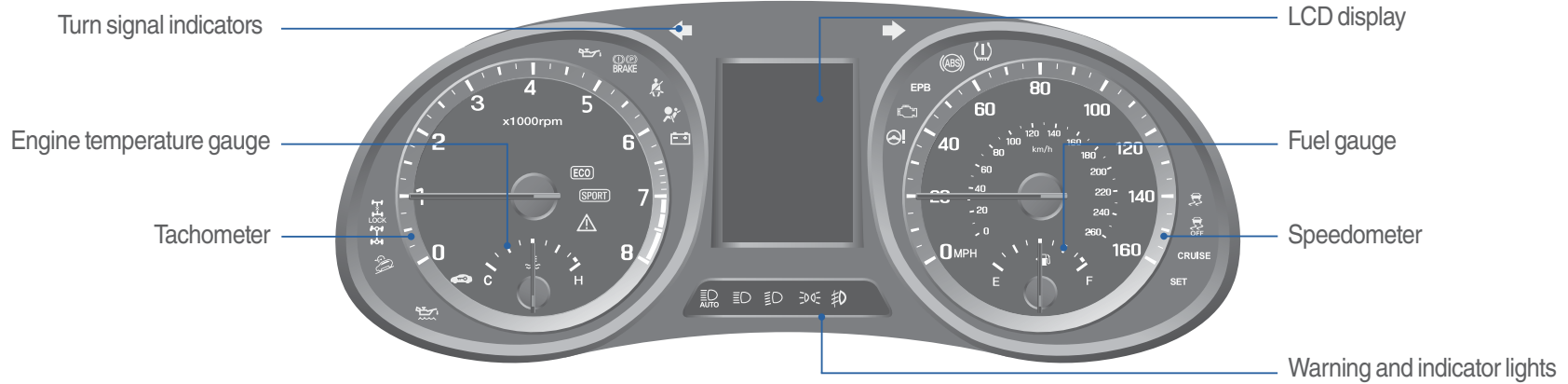

### WARNINGS AND INDICATORS

Airbag warning light	Seat belt warning light	Parking brake & Brake fluid warning light
ABS warning light	Electronic Brake force Distribution (EBD) System warning light	
Electric Power Steering (EPS) warning light	Malfunction Indicator Lamp (MIL)	Charging system warning light
Engine coolant temperature warning light	Engine oil pressure warning light	Low fuel level warning light
Low Tire Pressure Warning Light/TPMS system malfunction light	Electronic Stability Control (ESC) indicator	Electronic Stability Control (ESC) OFF indicator
AWD warning light	Immobilizer indicator	Turn signal indicator
ECO indicator	Light ON indicator	Front fog light indicator
High beam indicator	Cruise ON indicator	Cruise SET indicator
AWD LOCK indicator	Downhill Brake Control (DBC) indicator	AUTO HOLD indicator Light (if equipped)
SPORT Mode indicator Light (if equipped)		

### INSTRUMENT PANEL ILLUMINATION

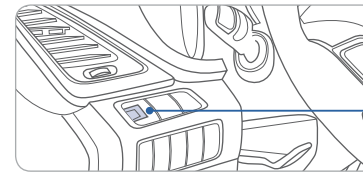

Move the control knob left or right to adjust the brightness.

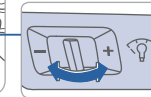

### TRIP COMPUTER

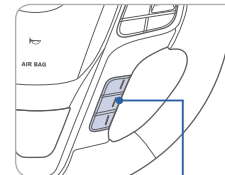

Select "Trip Computer" mode by pressing the MODE button

To change the trip mode as follows, press the MOVE button .

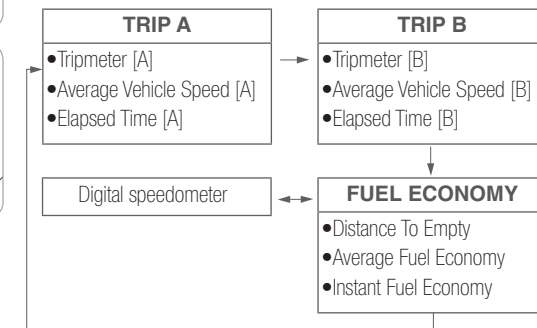





## FEATURES AND CONTROLS

### Type B

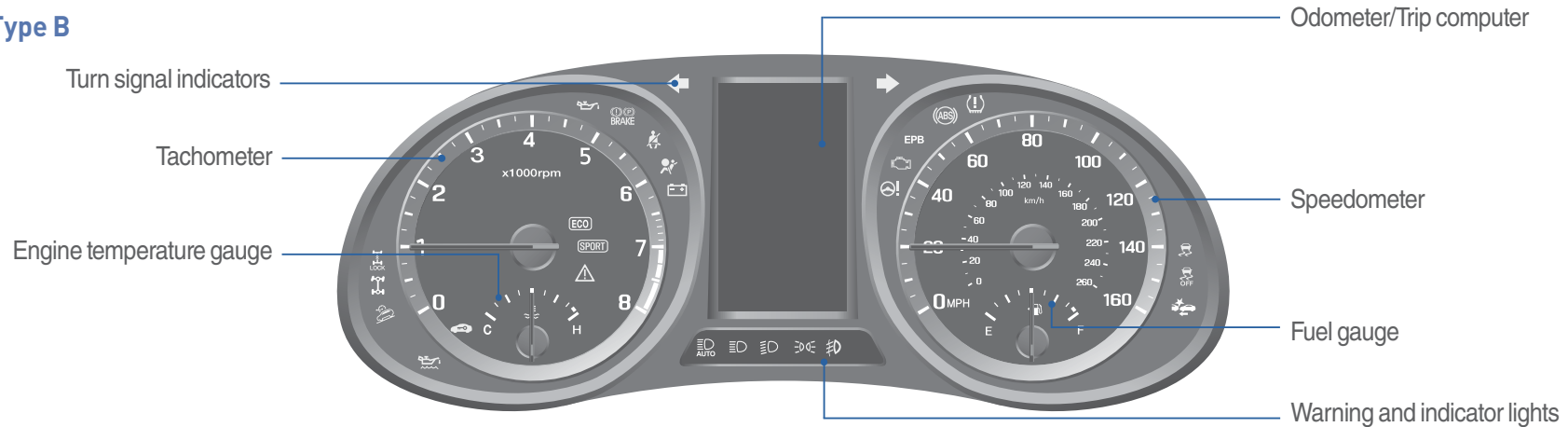

### WARNINGS AND INDICATORS

Airbag warning light	Seat belt warning light	Parking brake & Brake fluid warning light
ABS warning light	Electronic Brake force Distribution (EBD) System warning light	
Electric Power Steering (EPS) warning light	Malfunction Indicator Lamp (MIL)	Charging system warning light
Engine coolant temperature warning light	Engine oil pressure warning light	Low fuel level warning light
Low Tire Pressure Warning Light/TPMS system malfunction light	Electronic Stability Control (ESC) indicator	Electronic Stability Control (ESC) OFF indicator
AWD warning light	Immobilizer indicator	Turn signal indicator
ECO indicator	Light ON indicator	Front fog light indicator
High beam indicator	Cruise ON indicator	Cruise SET indicator
AWD LOCK indicator	Smart high beam indicator (if equipped)	Electric Parking Brake (EPB) warning light (if equipped)
Downhill Brake Control (DBC) indicator	Automatic Emergency Braking (AEB) warning light (if equipped)	AUTO HOLD indicator Light (if equipped)
SPORT Mode indicator Light (if equipped)		

### INSTRUMENT PANEL ILLUMINATION

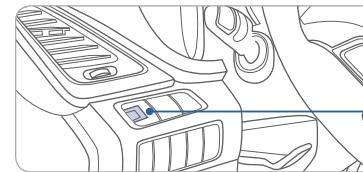

Move the control knob left or right to adjust the brightness.

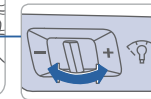

### TRIP COMPUTER

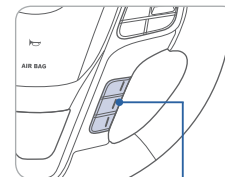

Select "Trip Computer" mode by pressing the MODE button .

To change the trip mode as follows, press the MOVE button .

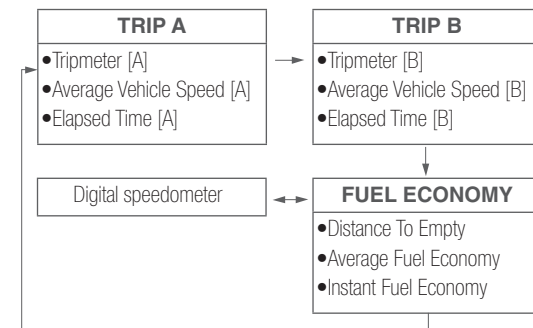



## MULTIMEDIA

### Type A,B

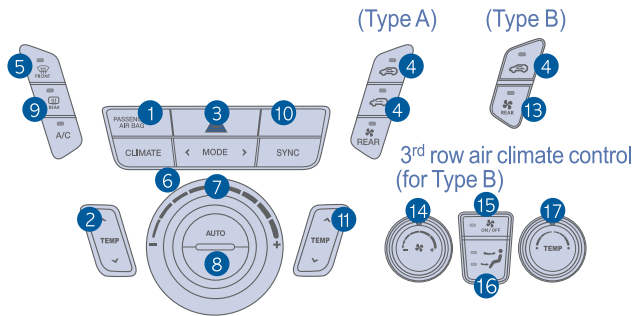

- 1 Air conditioning button
- 2 Driver's temperature control button
- 3 Mode selection button
- 4 Air intake control buttons
- 5 Front windshield defrost button
- 6 Fan speed control knob
- 7 AUTO (automatic control button)
- 8 OFF button
- 9 Rear window defrost button
- 10 Sync temperature control selection button
- 11 Passenger's temperature control button
- 12 Climate control information screen selection button
- 13 3<sup>rd</sup> row blower climate control ON/OFF button
- 14 3<sup>rd</sup> row fan speed control knob
- 15 3<sup>rd</sup> row blower ON/OFF button
- 16 3<sup>rd</sup> row mode selection button
- 17 3<sup>rd</sup> row temperature control knob

### AUTOMATIC HEATING AND COOLING



1. Press the AUTO button.



2. Set the driver's temperature control to the desired setting.

The modes, fan speeds, air intake, and air-conditioning will be controlled automatically according to the temperature setting.

#### NOTE

To reduce tendency of the glass fogging and also improve visibility, keep the interior surface of the windshield clean by wiping it with a clean cloth and glass cleaner. In addition, select air intake control to the outside (fresh) air position whenever possible while operating the vehicle.

### SYSTEM OFF MODE

Pressing the OFF button will place the system in the off mode.

- Front blower will turn off.
- Outside (fresh) air position selected.
- Vented air at last set temperature.

### DEFROSTING / DEFOGGING



1. Press the front windshield defrost button.



2. Set the temperature control towards warmer setting.



3. Set the fan speed to the highest setting.



### Type C

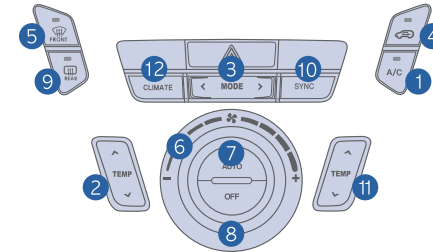

- 10 Sync temperature control selection button
- 11 Passenger's temperature control button
- 12 Climate control information screen selection button
- 13 3<sup>rd</sup> row blower climate control ON/OFF button
- 14 3<sup>rd</sup> row fan speed control knob
- 15 3<sup>rd</sup> row blower ON/OFF button
- 16 3<sup>rd</sup> row mode selection button
- 17 3<sup>rd</sup> row temperature control knob

### AUTO DEFOGGING SYSTEM



The auto defogging system automatically controls moisture of the windshield inside while the climate control system is operating. This indicator illuminates when the auto defogging system senses the moisture of inside the windshield and has activated.

### AIR INTAKE CONTROL

#### Type A

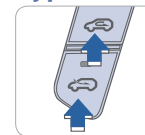

Recirculated air position

#### Type B



Outside (fresh) air position

### SYNC BUTTON

#### Type A

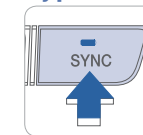

#### Type B

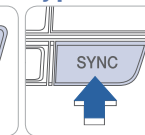

Press the SYNC button to operate the driver and passenger side temperature individually.

### REAR WINDOW DEFROSTER

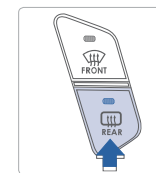

Press to activate/deactivate the rear defroster.

### MODE SELECTION

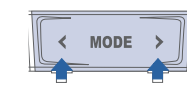

Changing the direction of the air flow as follows:

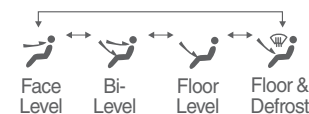



## CRUISE CONTROL/SMART CRUISE CONTROL

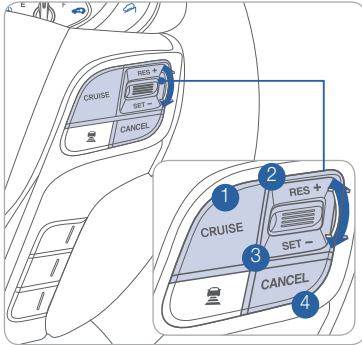

The Cruise Control system allows you to program the vehicle to maintain a constant speed without holding the accelerator pedal.

- 1 Turn On/Off the Cruise Control.
- 2 Resume or Increase the Cruise Control speed.
- 3 Set or Decrease the Cruise Control speed.
- 4 Cancel the Cruise Control.

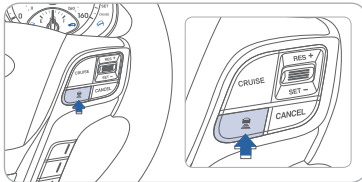

### Setting Vehicle Distance (Smart Cruise Control only)

This system assist you in setting the distance from the vehicle ahead and will maintain the selected distance without you depressing the accelerator or the brake pedal.

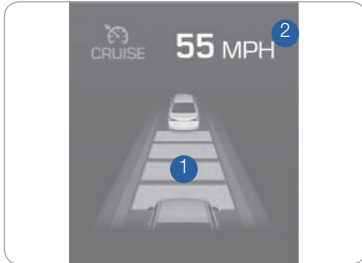

The vehicle to vehicle distance 1 will automatically activate when you set the cruise speed 2.

Each time the vehicle distance set button is pressed, the vehicle to vehicle distance changes as follows:

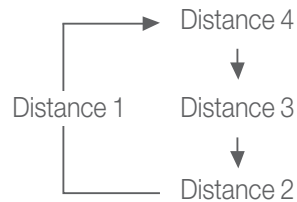

If your vehicle is equipped with Advanced Smart Cruise Control and you wish to eliminate the vehicle distance function, you can change cruise control setting to a standard setting.

Press the Cruise Control button on the steering wheel to turn on Cruise Control. Then press and hold the vehicle distance button for more than 2 seconds to toggle between Smart Cruise Control (SCC) and Cruise Control (CC) mode.

Please refer to your Owner's Manual for more information.

## Audio control

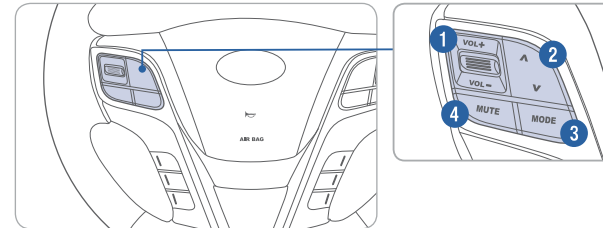

- 1 **VOLUME**  
Raises or lowers speaker volume.
- 2 **SEEK/PRESET**  
Press to change presets. Press and hold to seek stations.
- 3 **MODE**  
Change the audio source. Hold to turn Audio power on/off.
- 4 **MUTE**  
Mute the sound. Turn off the microphone during a call.

## Bluetooth control

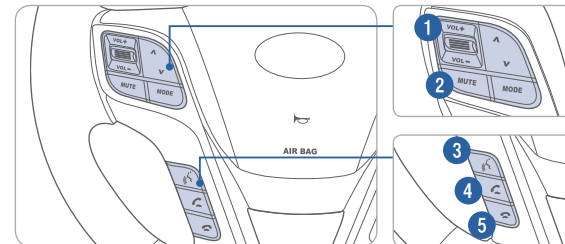

- 1 **VOLUME**  
Raises or lowers speaker volume.
- 2 **MUTE**  
Mute the sound.
- 3 **TALK**  
Activates voice recognition.
- 4 **CALL**  
Places and transfers calls.
- 5 **END**  
Ends calls or cancels functions.

## BLUETOOTH OPERATIONAL TIPS

In the following situations you or the other party may have difficulty hearing each other:

1. Keep the Bluetooth volume to a low level. High level volume may result in distortion and echo.
2. When driving on a rough road, high speeds and/or with the window open.
3. When the air conditioning vents are facing the microphone and/or when the air conditioning fan is at the max speed.

### Steering wheel bluetooth control

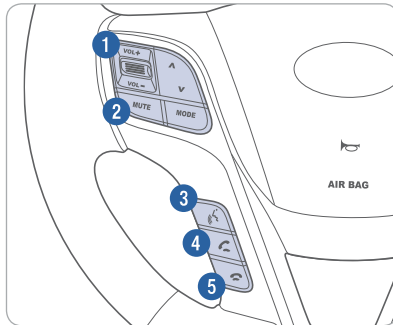

- 1 VOLUME**  
Raises or lowers speaker volume.
- 2 MUTE**  
Mute the microphone during a call.
- 3 TALK**  
Activates voice recognition.
- 4 CALL**  
Places and transfers calls.
- 5 END**  
Ends calls or cancels functions.

To redial previously dialed number, press and hold **3**.

#### To Answer a Call:

- Press button on the steering wheel.

#### To Reject a Call:

- Press button on the steering wheel.

#### To Adjust Ring Volume:

- Use the VOLUME buttons on the steering wheel.

#### To Transfer a Call to the Phone

##### (Private Call):

- Press and hold button on the steering wheel until the audio system transfers a call to the phone.

#### To Finish a Call:

- Press button on the steering wheel.

## VOICE RECOGNITION TIPS

Your vehicle is equipped with Voice Recognition technology which allows drivers to operate their phones without having to take their eyes off the road to minimize distractions.

Voice recognition performance may be affected if driving with windows and sun roof open; when the heating-cooling system is on; when passing in a tunnel or when driving on rugged and uneven roads.





## MULTIMEDIA

### BLUETOOTH PHONE PAIRING

Pairing tutorials, phone compatibility and Operational tips can be found through the Smart QR code using the QR reader application on your Smartphone.



### BLUETOOTH PHONE OPERATION

Vehicle must be in Park to complete the pairing process.

#### Phone setup (Pairing phone) with Display Audio and Navigation

1. Press PHONE button.

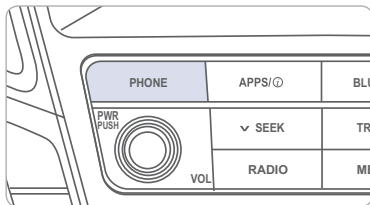

2. Search for car name from the bluetooth list from your phone and pair device.
3. Input the passkey.  
(The initial passkey is 0000.)



4. Bluetooth® becomes connected.

#### NOTE

After pairing is completed, transfer of the contact list to the audio system will begin (if your phone is supported).



### BLUE LINK TELEMATICS SYSTEM

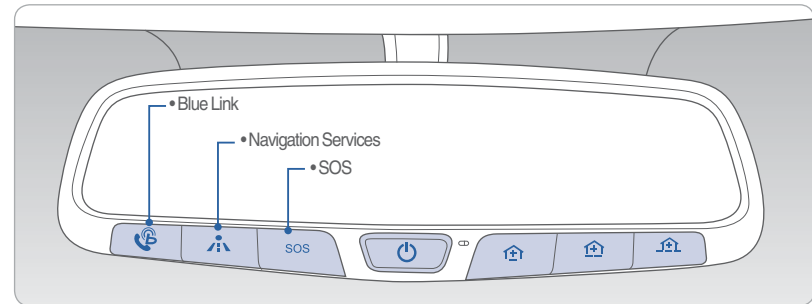

Blue Link subscription is required. To enroll, please visit your dealership or MyHyundai.com.

Press the  button for access to the voice-response menu of services.

- You can say:  
Service Link  
Roadside Assistance  
Blue Link Account Services  
Help  
Cancel

Press the  button for Destination Search Powered by Google™.

- For vehicle equipped with factory-installed navigation systems.

Press the **SOS** button for SOS Emergency Assistance.

Visit HyundaiBlueLink.com for more information or refer to your Blue Link User's Manual for detailed information on system operation.

For immediate assistance with subscription services, please call 1-855-2BLUELINK (1-855-225-8354).

Google™ is a registered trademark of Google, Inc.

## Blue Link Mobile App



You can download the Blue Link mobile app to your compatible smart phone from the following sites:

- iPhone® — Apple® App Store
- Android™ — Google Play™

Visit [HyundaiBlueLink.com](http://HyundaiBlueLink.com) FAQs to see a list of compatible devices.



Scan to see list of compatible devices and to download the app.

## Remote Start

Remote Start enables you to remotely start your vehicle from virtually anywhere. For vehicles equipped with full-automatic temperature control, you can also enable climate control remotely and turn on the front window defroster, ensuring a warm or cool car is ready to go when you are.

- To use this feature, you must have a Blue Link Personal Identification Number (PIN). To create or change your PIN, log on to [www.MyHyundai.com](http://www.MyHyundai.com).

### Remember:

- Remote Start will automatically shut off after 10 minutes or after selected engine timer runs out.
- While this feature is active, the parking lights will blink until vehicle is turned off or when vehicle is in operation.
- To continue operation of the vehicle, the proximity key must be inside the vehicle with the driver prior to pressing the brake and being able to move the gearshift from the P (Park) position.

**NOTE** Remote Start is not available on all models. Remote Start is only available for Push Start equipped vehicle with an Automatic Transmission.

## Preconditions:

- Ignition is OFF
- Alarm is armed (i.e., vehicle locked by key fob Remote Door Lock)
- Gearshift level is in the P (Park) position
- Brake pedal is not depressed
- Engine hood is securely closed
- All the doors are closed and locked
- The tailgate or trunk lid is closed
- The security/panic system is not activated
- The proximity key is not inside the vehicle
- The battery power is not low
- Vehicle is located in an open area
- It has been less than 4 days since last vehicle ignition off
- Vehicle located in area with good cell reception

## Remote Start will terminate:

- After 10 minutes or after selected engine timer runs out
- Brake is pressed without proximity key inside vehicle
- Alarm is triggered without proximity key inside vehicle
- Door/trunk is opened from inside the vehicle

Notice: Laws in some communities may restrict the use of the features that remotely start the engine. For example, some laws may require a person using the remote start feature to have the vehicle in view when doing so or limit the length of time a vehicle engine may idle. Please check local and state regulations for any requirements and restrictions on remote starting of vehicles and engine idling time.

### ⚠ WARNING!

Do not remote start vehicle in an enclosed environment (i.e., closed garage). Prolonged operation of a motor vehicle in an enclosed environment can cause a harmful build-up of carbon monoxide. Carbon monoxide is harmful to your health. Exposure to high levels of carbon monoxide can cause headaches, dizziness or in extreme cases unconsciousness and/or death. Do not leave children or animals unattended in a vehicle while using the remote start function.

### ⚠ CAUTION!

If the vehicle's windshield wipers are left on when the vehicle was last driven, then the wipers will turn on if the remote start function is activated. To avoid damage to the wiper blades (i.e., due to heavy ice or snow accumulated on the windshield), please always turn the vehicle's windshield wipers off when parking the vehicle.

## AUDIO

### Display Audio

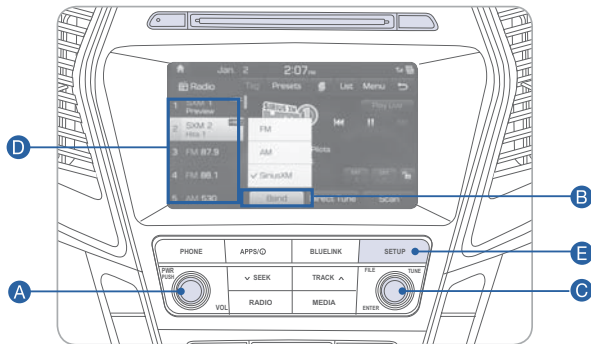

Press POWER button **A** to turn radio on.

#### • TUNING/LISTENING TO CHANNELS

1. Press BAND button **B** on screen to select FM/AM/SiriusXM®.
2. ROTATE TUNE knob **C** to desired channel.

**NOTE** A clear view of the southern sky helps ensure SiriusXM® radio reception.

#### • SETTING PRESET MEMORY BUTTONS

Press and hold any preset button **D** on the screen until an audible beep is heard to store current channel.

#### • ADJUSTING THE SOUND CONTROL

1. Press the SETUP button **E** and press the SOUND button on screen to display the Sound Settings screen.
2. Touch on-screen arrows to adjust desired setting.

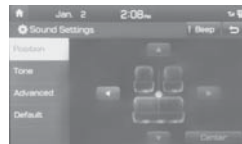

## AUX, USB, AND iPod® PORT

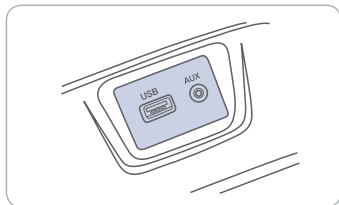

Use the jack to connect an external audio device and listen to it through the audio system speakers in your vehicle.



## NAVIGATION

### Audio mode

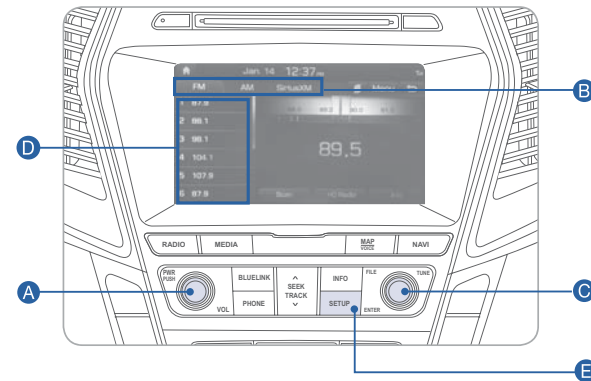

Press POWER button **A** to turn radio on.

#### • TUNING/LISTENING TO CHANNELS

1. Press BAND button **B** on screen to select FM/AM/SiriusXM®.
2. ROTATE TUNE knob **C** to desired channel.

**NOTE** A clear view of the southern sky helps ensure SiriusXM® radio reception.

#### • SETTING PRESET MEMORY BUTTONS

Press and hold any preset button **D** on the screen until an audible beep is heard to store current channel.

#### • ADJUSTING THE SOUND CONTROL

1. Press the SETUP button **E** and press the SOUND button on screen to display the Sound Settings screen.
2. Touch on-screen arrows to adjust desired setting.

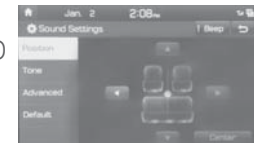

## NAVIGATION

### Basic features on the map screen



- 1 Move to the Home Screen
- 2 Change the map view mode
- 3 Voice Guidance On/Off
- 4 Zoom in the map
- 5 Set the zoom level automatically according to the guidance
- 6 Zoom out the map
- 7 Quick and easy selection of a destination and options
- 8 Touch to scroll the map
- 9 Quick and easy selection of a destination from the map screen
- 10 Set a waypoint to the current route
- 11 Save frequently used address to address book
- 12 Find a POI (Point Of Interest) around the current position
- 13 View the vehicle's current position on the map screen

### Basic features on the map screen



- 1 Set destination by address search.
- 2 Select from previously inputted addresses and POI's.
- 3 Search POI Name to search the destination.
- 4 Runs Google Local Search.
- 5 Select the desired item in the sub-categories.
- 6 Search and select the desired destination among the searched items.
- 7 Search and select the desired destination among the searched items.
- 8 Search and select the desired destination among the searched items.
- 9 Search the destination with the address book.
- 10 Search destination by phone number.
- 11 Type freeway name and exit/entrance to search.
- 12 Type the Street name, the State, and city name to search.
- 13 Type coordinates to search.





## ANDROID AUTO™

### REQUIREMENTS:

- Micro USB cable
- OS Android™ 5.0 or higher
- Compatible Android Phone
- Data and wireless plan for applicable features

### BEFORE YOU BEGIN:

- Android Auto features may operate differently than on your phone.
- Message and data charges may apply when using Android Auto.
- Android Auto relies on the performance of your phone. If you experience performance issues:
  - Close all apps and then restart them or
  - Disconnect and then reconnect your phone
- Using the micro USB cable that was provided with your phone is recommended.
- When Android Auto is active, your in-vehicle voice recognition system is disabled and you will be using talk to Google™ to make your requests.

### ANDROID AUTO SUPPORT



<https://support.google.com/androidauto/>

## PHONE SETUP

Turn on Bluetooth® on your phone and connect the micro USB cable to your phone and the USB port on the vehicle.

Phone will prompt you to download the Android Auto app and update other needed apps (i.e. Google Maps™, Google Play Music™, Google Now™).

**NOTE** Vehicle must be parked.

- Location mode setting should be set to High accuracy.
- Car and phone setup should be completed in one sitting. If phone setup needs to be resumed, recommend to Force Stop the Android Auto app on the Phone then reopen the app and accept the Disclaimer notifications.

## CAR SETUP

1. Press the SETUP button on the radio.
2. Touch the “Connectivity” icon on screen.
3. Select “On” for Android Auto.
4. Connect your Android phone to the vehicle USB port. Agree to the notification and disclaimers on your phone then the “Android Auto” icon will appear confirming the setup.

For more detailed information on how to operate Android Auto, please refer to your navigation manual.

For additional Android Auto support, please refer to the Android Auto Support Website  
<https://support.google.com/androidauto/>

Android Auto, Google Play, Android, and other marks are trademarks of Google Inc.



## CLOCK ADJUSTMENTS

### With Display Audio

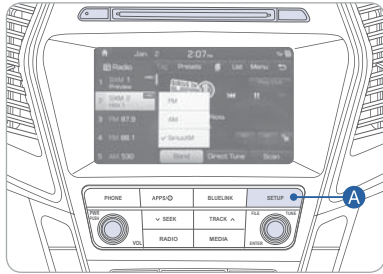

Press SETUP button **A** and press the on-screen CLOCK button. Press on-screen arrows to adjust the time and date.

### With Navigation



Press SETUP button **A** and press the on-screen CLOCK button. Enable GPS Time and the time and date will automatically set

## SEAT WARMER AND VENTILATED SYSTEM

### Front seat

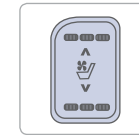
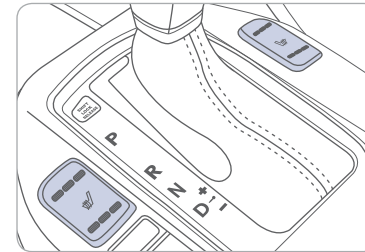

Push the upper portion of the switch to warm or the lower portion to cool.

HIGH (-----) → MIDDLE (-----) → LOW (-----)

↑ OFF ↓

### Rear seat

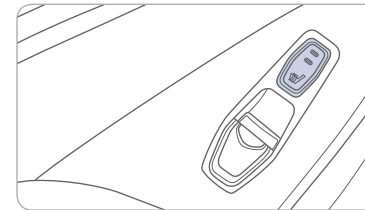

Push the switch to warm the rear seat.

OFF → HIGH (-----) → LOW (-----)

↑ ↓

## CHILD-PROOF REAR DOOR LOCK

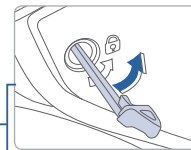
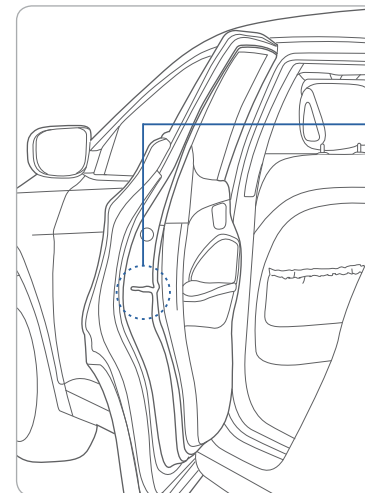

### Lock (🔒)

Insert a key into the hole and turn it to the lock (🔒) position.

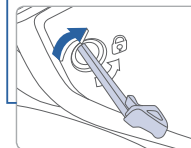

### Unlock

Insert a key into the hole and turn it counter clockwise to unlock position.

## AUTOMATIC TRANSMISSION

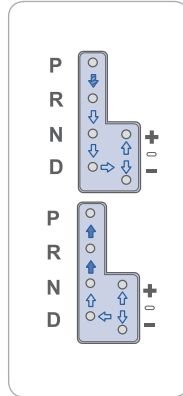
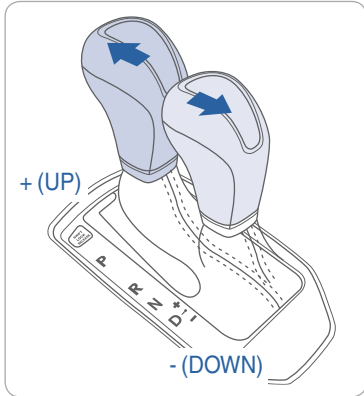

- : Depress the brake pedal and the lock release button when shifting.
- : The lock release button must be pressed while moving the shift lever.
- : The shift lever can be shifted without pressing the lock release button.

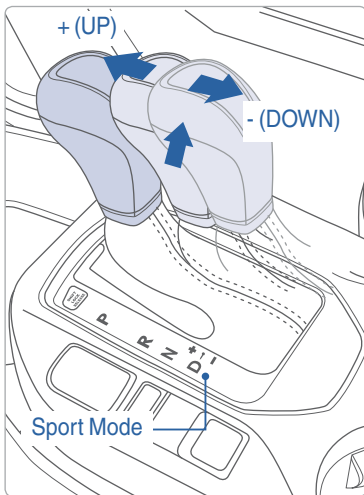

### Sport mode

Move the shift lever from D (Drive) into the manual gate to select.

Move the shift lever forward (+) to upshift or rearward (-) to downshift.

## TIRE PRESSURE MONITORING SYSTEM (TPMS)

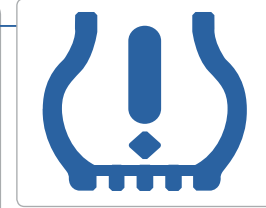
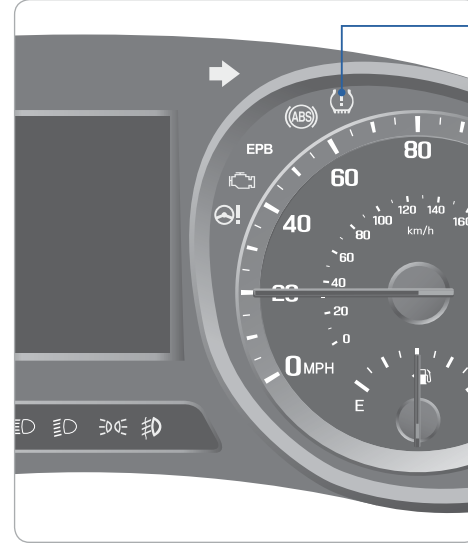

Low Tire Pressure Indicator / TPMS Malfunction Indicator

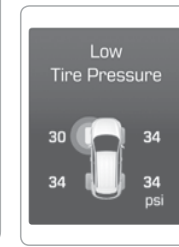

### LOW TIRE PRESSURE INDICATOR

Illuminates if one or more of your tires is significantly under-inflated.

### TPMS MALFUNCTION INDICATOR

Blinks for approximately one minute, then remains illuminated when there is a malfunction with the TPMS system. Have the system checked by an authorized Hyundai dealer.

### NOTE

When the low tire pressure indicator is illuminated, inflate tire to proper tire pressure as soon as possible. Tire pressure may vary in colder temperatures, causing the low tire pressure indicator to illuminate.

### ELECTRONIC STABILITY CONTROL (ESC)

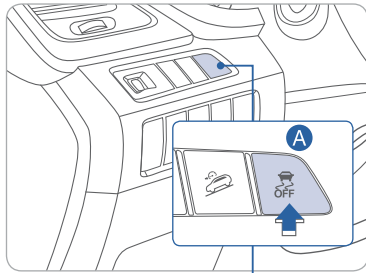

The ESC system is an electronic system designed to help the driver maintain vehicle control under adverse conditions.

Press **A** to turn ESC on/off.

#### NOTE

It is recommended to always have the ESC system ON.

### DRIVE MODE INTEGRATED CONTROL SYSTEM

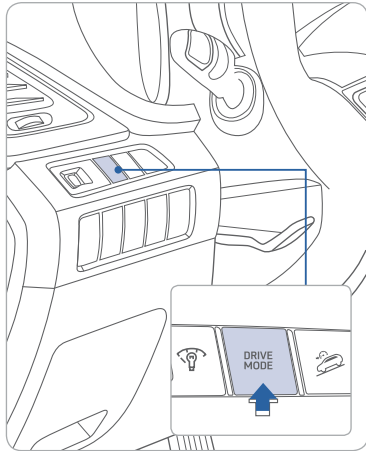

You can select the drive mode according to your preference or the road condition.

The system initializes to the NORMAL mode (except ECO mode) after the engine has been turned off and on.

Each time you press the button, the drive mode is changed as follows :

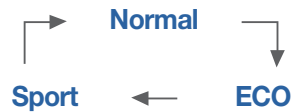

Normal mode is not displayed on the instrument cluster.

#### ECO mode

Eco mode system helps to improve fuel efficiency. When the Eco mode system is activated, the vehicle acceleration, gear shift points and air conditioning performance will be reduced to conserve the fuel consumption.

#### Sport mode

Sport mode focuses on engaging driving dynamics by adjusting the steering feel along with the responsiveness of the engine and transmission.

### ELECTRIC PARKING BRAKE (EPB)

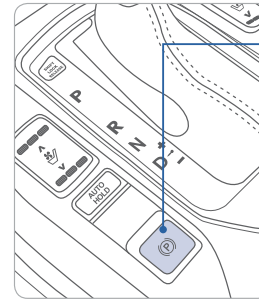

#### Applying

Stop the vehicle then pull the EPB switch.

#### Releasing

Move shift lever from P to R, N or D while depressing the brake pedal.  
or

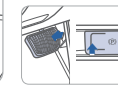

Press the EPB switch while depressing the brake pedal.

NOTE: If necessary, emergency braking is possible by pulling and holding the EPB switch.

### AUTO HOLD

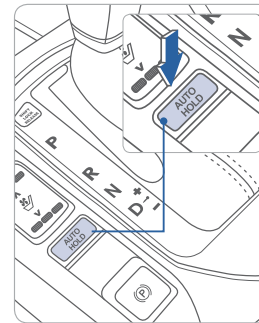

The Auto Hold feature assists in steep hill areas. It holds the brake until the accelerator pedal is pressed.

#### WHITE AUTO HOLD

1. Press the AUTO HOLD switch.

#### GREEN AUTO HOLD

2. Stop the vehicle by pressing the brake pedal. The brakes will remain engaged even if the brake pedal is released.

#### WHITE AUTO HOLD

3. The brakes will release when the accelerator pedal is pressed with transmission in D, R or manual mode.

To cancel the AUTO HOLD operation, press the AUTO HOLD switch again.

#### To improve your fuel efficiency:

- Drive smoothly and accelerate at a moderate rate.
- Avoid heavy acceleration.
- Maintain steady cruising speed.
- Adjust the vehicle speed to the traffic condition and avoid speed changes.
- Avoid unnecessary braking.
- Keep the tires inflated to the recommended tire pressure.
- Don't idle the engine longer than necessary.



## FEATURES AND CONTROLS

### AC 115V PLUG

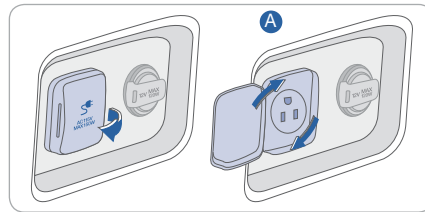
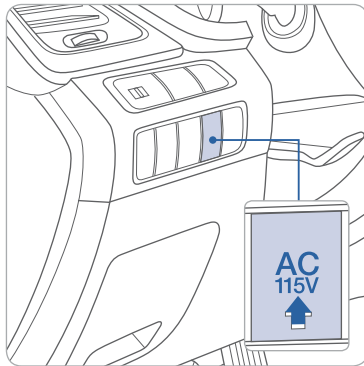

1. Dashboard button must be switched on to use cargo area AC115V plug. Engine should be running when AC 115V plug is in use.
2. Rotate safety plate **A** on outlet for use.

### MULTI-VIEW CAMERA SYSTEM

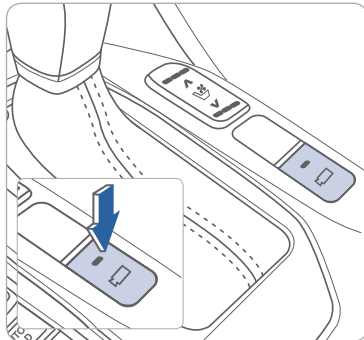

This parking support system displays an all-around view of the vehicle when parking. Press the switch to activate/deactivate the system.

#### Operating conditions

The shift lever is in D, N, or R position with the ignition ON

The vehicle speed is less than 12.4 mph

### LANE DEPARTURE WARNING SYSTEM (LDWS)

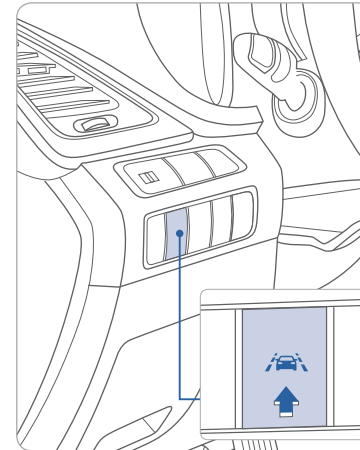

The Lane Departure Warning System detects the lane on the road and warns the driver if the vehicle leaves the lane when the vehicle speed is over 37mph.

- To turn LDWS on, press the LDWS switch
- To turn LDWS off, press the switch again.

### AUTONOMOUS EMERGENCY BRAKING (AEB)

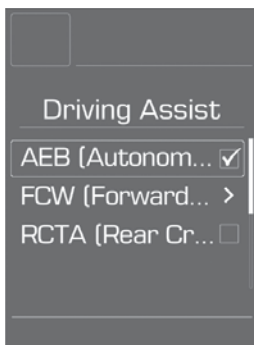

The Autonomous Emergency Braking (AEB) system is designed to detect and monitor the vehicle ahead or detect a pedestrian in the roadway and warn the driver if a collision is imminent.

To operate the system, select the AEB (Autonomous Emergency Braking) in the LCD cluster display under User Settings. Please refer to your Owner's Manual for further information.



FEATURES AND CONTROLS



REARVIEW CAMERA

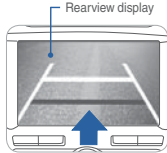
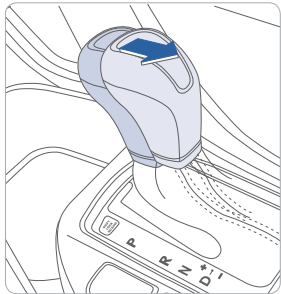

The rearview camera will activate when the ignition switch is ON and the shift lever is in the R (Reverse) position.

BLIND SPOT DETECTION SYSTEM (BSD)

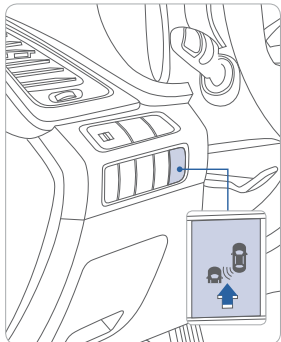

The BSD system sensor senses the rear side territory of the vehicle and provides information to the driver. Press the BSD switch. If vehicle speed exceeds 9mph the system will activate. Press the switch again to deactivate the system.

**A Blind spot detection (BSD)**  
Warning range is dependent on your vehicle speed. However, if your vehicle speed differences is 9 mph above other vehicles, the warning is not active.

**B Lane change assist (LCA)**  
When a vehicle is approaching at high speed, the warning is not active.



**C Rear Cross-traffic Alert (RCTA)**  
When your vehicle moves (below 6mph) in Reverse, the sensor detects the approaching vehicles and the warning is active.

Key Websites:

- Hyundai website - [www.hyundai.com](http://www.hyundai.com)
- Hyundai owner website - [www.myhyundai.com](http://www.myhyundai.com)
- Bluetooth phone compatibility - [www.hyundaiusa.com/bluetooth](http://www.hyundaiusa.com/bluetooth)
- Blue Link - [www.MyHyundai.com](http://www.MyHyundai.com)

HYUNDAI VEHICLE OWNER PRIVACY POLICY

Your Hyundai vehicle may be equipped with technologies and services that use information collected, generated, recorded or stored by the vehicle. Hyundai has created a Vehicle Owner Privacy Policy to explain how these technologies and services collect, use, and share this information.

You may read our Vehicle Owner Privacy Policy on the Hyundaiusa.com website at <https://www.hyundaiusa.com/owner-privacy-policy.aspx> If you would like to receive a hard copy of our Vehicle Owner Privacy Policy, please contact our Customer Connect Center at:

Hyundai Motor America  
Hyundai Customer Connect Center  
P.O. Box 83835  
Phoenix, AZ 85071-3835  
800-633-5151  
[consumeraffairs@hmasua.com](mailto:consumeraffairs@hmasua.com)

Hyundai's Customer Connect Center representatives are available Monday through Friday, between the hours of 5:00 AM and 7:00 PM PST and Saturday and Sunday between 6:30 AM and 3:00 PM PST (English). For Customer Connect Center assistance in Spanish or Korean, representatives are available Monday through Friday between 6:30 AM and 3:00 PM PST.

SANTA FE CUSTOMER DELIVERY CHECK LIST

HYUNDAI OWNER	DEALERSHIP NAME
SALES CONSULTANT	DATE
VIN	PREVIOUS VEHICLE

BEFORE DELIVERY

- CONFIRM "GOOD BATTERY" USING GR8 AND STAPLE TEST TICKET HERE
- SET TIRE PRESURE LF \_\_\_ RF \_\_\_ RR \_\_\_ LR \_\_\_
- VERIFY VEHICLE IS CLEAN, IN GOOD CONDITION, FREE OF CHIPS AND SCRATCHES · CLEAN WINDSHIELD AND BACK WINDOW
- ENSURE FLOORMATS ARE SNAPPED INTO PLACE

_____ Sales Consultant	_____ Date	_____ Sales Manager	_____ Date
_____ Customer		_____ Date	
_____ Email			