

WALK THE CUSTOMER THROUGH EACH OF THE FOLLOWING KEY DELIVERY FEATURES

- DEMONSTRATE HOW TO SET THE CLOCK - page 29
- DEMONSTRATE AUTOMATIC CLIMATE CONTROL - page 18 – 19

□ HOW TO DEFROST

- 1 Press the front defrost button.
- 2 Set to warmest temperature setting.
- 3 Set to highest fan speed.

□ GENESIS CONNECTED SERVICES – page 21-23

- Assist with creating a Genesis Owners account
- Show Genesis Connected Services Users Manual
- Encourage customers to press the Genesis Connected Services button 

□ TIRE PRESSURE MONITORING SYSTEM (TPMS)- page 35

Low tire pressure indicator / TPMS malfunction indicator



NOTE: Tire pressure may vary in colder temperatures causing the low tire pressure indicator  to illuminate. Inflate tires according to the Tire Pressure Label located on the driver's side door pillar.

□ WINDSHIELD WIPER / WASHER - page 09

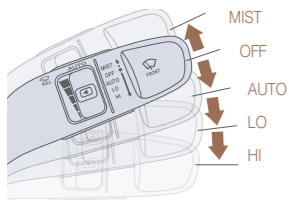

- To activate wipers move the switch down to one of the three positions (AUTO, LO, HI)
- To adjust "AUTO" speed move switch
- To spray washer fluid pull lever toward you
- Push lever up for a single wiper pass

□ PARKING ASSIST SYSTEM (PAS) - page 33

If the PAS is OFF, it will automatically turn ON when in Reverse. PAS will automatically turn OFF when driving forward and speed is over 6 mph.

MAINTENANCE

Scheduled Maintenance	Normal Usage		Severe Usage*	
Engine Oil And Filter*	Replace	7,500 or 12 mos.	Replace	3,750 or 6 mos.
Fuel Additives	Add	Every 7,500 or 12 mos.		
Tire Rotation	Perform	7,500	Perform	7,500
Air Cleaner Filter	Inspect Replace	7,500 30,000	Inspect Replace	More Frequently Same As Normal
Fuel Tank Air Filter	Inspect	30,000	Inspect Replace	Same As Normal More Frequently
Vacuum Hose	Inspect	7,500	Inspect	Same As Normal
Fuel Lines, Fuel Hoses And Connections	Inspect	30,000	Inspect	Same As Normal
Vapor Hose & Fuel Filler Cap, Fuel tank	Inspect	30,000	Inspect	Same As Normal
Climate Control Air Filter (For Evaporator And Blower Unit)	Replace	15,000	Replace	More Frequently
Air Conditioning Refrigerant	Inspect	15,000	Inspect	Same As Normal
Brake Hoses & Lines	Inspect	15,000	Inspect	Same As Normal
Drive Shafts & Boots	Inspect	15,000	Inspect	7,500 or 6 mos.
Exhaust Pipe & Muffler	Inspect	15,000	Inspect	Same As Normal
Front Brake Disc/Pads, Calipers	Inspect	15,000	Inspect	More Frequently
Rear Brake Disc/Pads	Inspect	15,000	Inspect	More Frequently
Steering Gear Box, Linkage & Boots/ Lower Arm Ball Joint, Upper Arm Ball Joint	Inspect	15,000	Inspect	More Frequently
Suspension Mounting Bolts	Inspect	15,000	Inspect	Same As Normal
Propeller Shaft	Inspect	15,000	Inspect	7,500 or 6 mos.
Brake Fluid	Inspect	30,000	Inspect	Same As Normal
Parking Brake	Inspect	30,000	Inspect	More Frequently
Front(AWD)/Rear Differential Oil	Inspect	37,500	Replace	75,000
Fuel Filter	Inspect	30,000	Inspect	Same As Normal
Valve Clearance (3.8L)	Inspect	60,000	Inspect	Same As Normal
Drive Belt	1st Inspect 60,000 or 72 mos. Add. Inspect 15,000 or 24 mos.		Inspect	Same As Normal
Spark Plugs (Iridium Coated)	Replace	105,000	Replace	More Frequently
Coolant	1st Replace 120,000 or 120 mos. Add. Replace 30,000 or 24 mos.		Replace	Same As Normal
Automatic Transmission Fluid	No, Check, No service required		Replace	60,000

*Check the engine oil regularly between recommended oil change. We recommend Quaker State oil.
*See Owner's Manual for details.

Looking For more detailed information? This Quick Reference Guide does not replace your vehicle's Owner's Manual. If you require additional information or are unsure of a specific issue, we recommend that you always refer to the vehicle's Owner's Manual or contact your authorized retailer of Genesis Branded Products. The information contained in this Quick Reference Guide is correct at the time of printing; however, specifications and equipment can change without notice. No warranty or guarantee is being extended in this Quick Reference Guide, and Genesis Brand reserves the right to change product specifications and equipment at any time without incurring obligations. Some vehicles are shown with optional equipment.



GENESIS G80

Quick Reference Guide

www.GenesisMotorsUSA.com

Roadside Assistance: **1-844-340-9742**
 SiriusXM® Radio: **1-800-967-2346**
 Genesis Customer Care & Connected Services: **1-844-340-9741**



GENESIS

Table of contents

Automatic Emergency Braking (AEB)	35
Auto Hold	34
AUX, USB and iPod port	27
Blind Spot Detection system (BSD)	38
Bluetooth operational tips	24
Bluetooth phone pairing	20
Child - protector rear door lock	12
Climate control	18-19
Climate control system seat & seat warmer	31
Clock adjustment	29
Cruise control/Advance smart cruise control	40
Driver Information System (DIS)	28
Drive mode integrated control system	39
Driver position memory system	05
Driver's main controls	07
Electronic Stability Control (ESC)	37
Electronic Parking Brake (EPB)	34
Engine start/stop button	05
Front seat adjustment	03
Fuel filler door	07
Genesis Connected Services	21-23
Headlights and fog lights	08
Headrest adjustment	04
Head up display	17
Heated steering wheel	32
HomeLink wireless garage control system	13
Instrument cluster	14-15
Interior lights	10
Lane Keeping Assist System (LKAS)	37
LCD display control/modes	16
Navigation	26
Panoramic Sunroof	10
Parking assist system (PAS)	33
Parking Guide system	33
Rearview camera	32
Rear window curtain	30
Seat belt adjustment	04
Smart key	02
Steering wheel adjustment	06
Steering wheel audio control	24
Tire Pressure Monitoring System (TPMS)	35
Transmission/paddle shifter	36
Trunk	11
Voice recognition tips	25
Wipers and washer	09



Driver position memory system
Page05

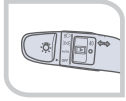

Head lights and fog lights
Page08

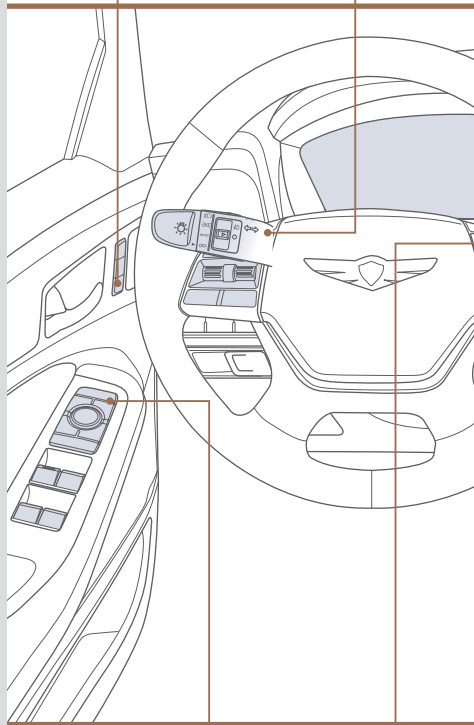



Driver's main controls
Page07



Wiper and washer
Page09

FREQUENTLY ASKED QUESTIONS

- Pair phone to your vehicle. Refer to page 20.



Instrument cluster
Page14-15



Cruise control/Advanced smart cruise control
Page40



Engine start/stop button
Page05



Navigation
Page26

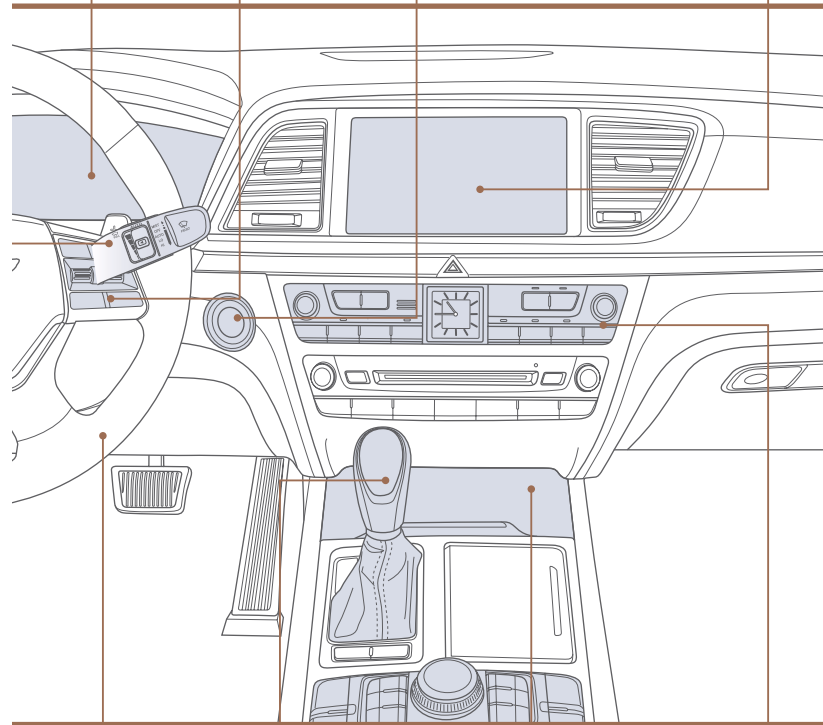

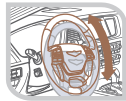



Steering wheel adjustment
Page06



Transmission
Page36



AUX, USB and iPod
Page27



Climate control
Page18-19

Use this Quick Reference Guide to learn about the features that will enhance your enjoyment of your Genesis Branded vehicle. More detailed information about these features are available in your Owner's Manual.





*Some vehicles may not be equipped with all the listed features.

⚠ WARNING!

To reduce the risk of serious injury to yourself and others, read and understand the important SAFETY INFORMATION in your Owner's Manual.

SMART KEY



-  Lock
-  Unlock
-  Trunk unlock
-  Panic

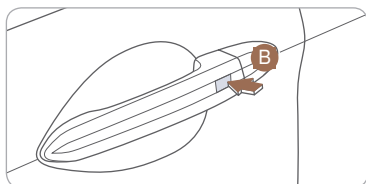

Driver's door Lock / Unlock
Smart key must be within 28~40 in. from the outside door handle.

Press: Once – Unlock driver door
Twice – Unlock all doors
Third – Lock all doors

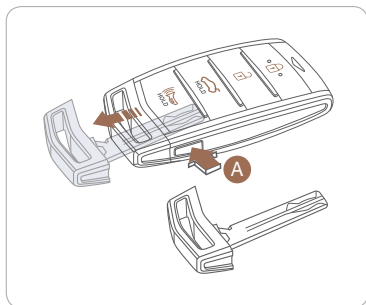

Remove mechanical key.

Press and hold the release button **A** to remove the mechanical key.

NOTE: The key hole is located under the key hole cover **B**.

FRONT SEAT ADJUSTMENT

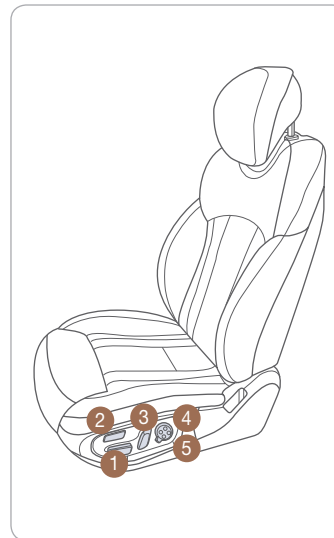

Forward and backward ①



Seat cushion length (for driver's seat) ②



Seatback angle ③



Seat cushion height ①

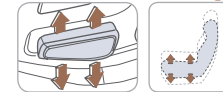

Lumbar support ④

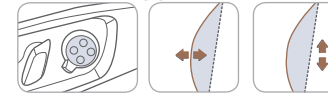

Seat bolster adjustment (for driver's seat) ⑤

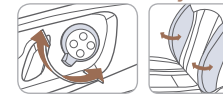

HEADREST ADJUSTMENT

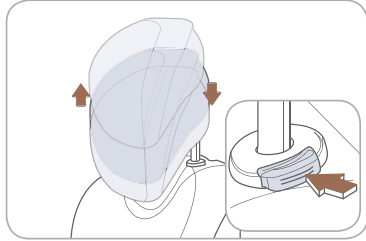

To Raise Headrest:
Pull headrest up.

To Lower Headrest:
Press lock button while pressing down on headrest.

To adjust headrest forward:
Pull forward to 1 of 3 positions.

To adjust backward:
Pull it fully forward to the farthest position and release it.

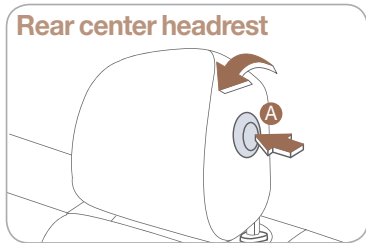

Rear center headrest

To Raise Center Headrest:
Rotate headrest forward.
Lift headrest up.

To Lower Center Headrest:
Press lock button while pressing down on headrest.
Press button **A** to rotate headrest down.

SEAT BELT ADJUSTMENT (Front seat)

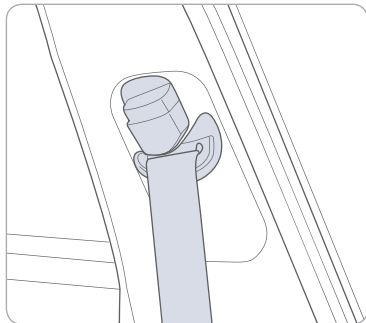

Pull up to raise.

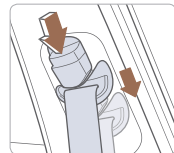

Press button and push down to lower.

ENGINE START/STOP BUTTON

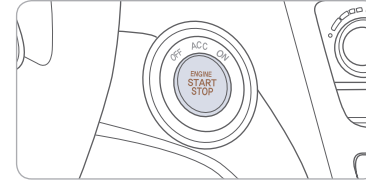

With the ignition OFF and foot OFF of brake pedal, press the engine start / stop button.

- Once for ACC(Accessory) mode.
- Twice for ON mode.
- Three times for OFF.

To start the engine in any mode(including OFF), press the engine start/stop button while pressing the brake pedal.

To shut the engine OFF, place shift lever in P(Park) and press the engine start/stop button again.

Emergency situations

Shut off engine while driving

Press and hold engine start/stop button for more than 2 seconds or press 3 times consecutively within 3 seconds.

Restart engine while driving

Press engine start/stop button with shift lever in N(Neutral).

DRIVER POSITION MEMORY SYSTEM

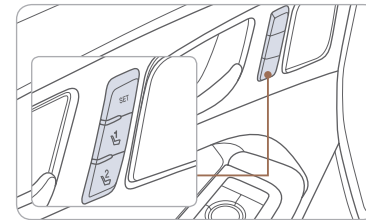

NOTE: For resetting, please see Owner's Manual for procedure.

Storing

1. Adjust the driver's seat, outside rearview mirrors, steering wheel, instrument panel illumination and head up display.
2. Press the SET button. The system will beep once.
3. Press one of the memory buttons (1 or 2) within 5 seconds. The system will beep twice.

NOTE: Transmission must be in P(Park).

Recalling

Press the desired memory button (1 or 2). The system will beep once.

STEERING WHEEL ADJUSTMENTS

Power tilt and telescopic

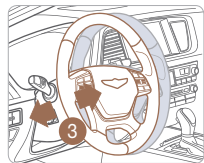
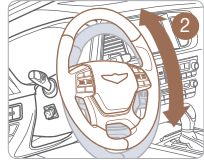
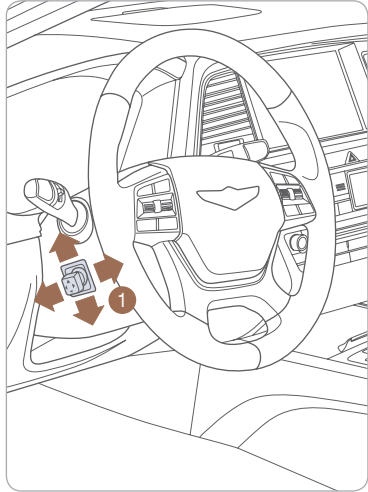

NOTE: Do not adjust while driving.

Set the angle ② and distance ③ with the switch ①.

Manual tilt and telescopic

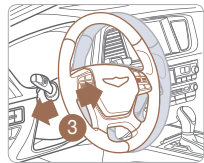
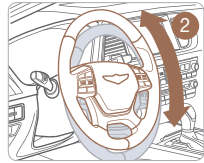
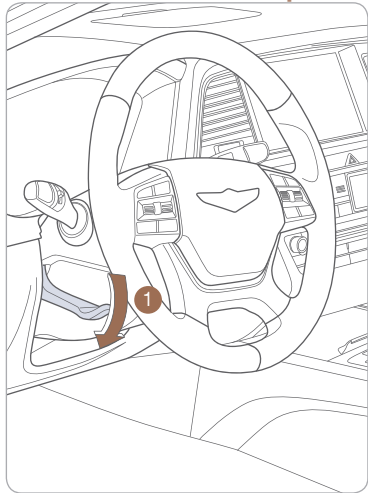

NOTE: Do not adjust while driving.

1. Move the lever downward ①.
2. Set the angle ② and distance ③.
3. Pull the lever up.

FUEL FILLER DOOR

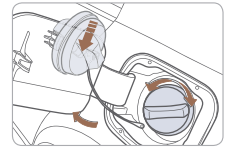
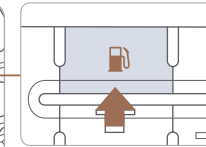
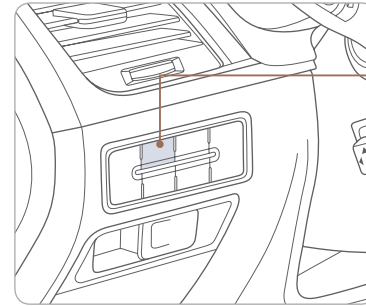

NOTE: Tighten fuel cap until one click is heard.

Failure to do this may result in the Check Engine Light illuminating.

DRIVER'S MAIN CONTROLS

Driver's door

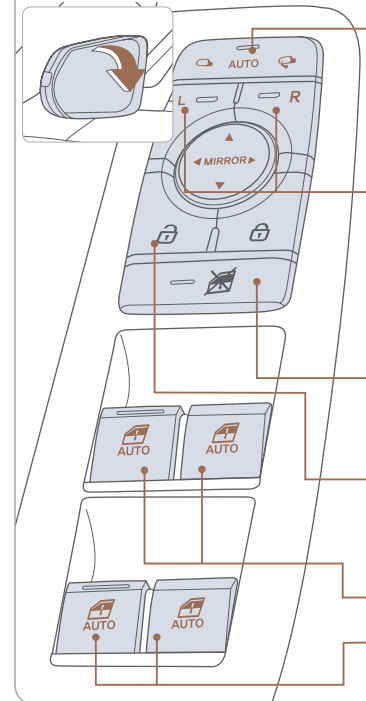

Outside Rearview Mirror

- Press switch left/right to unfold/fold mirrors.

Press the lock or unlock button on the smart key, and the mirrors will be folded or unfolded when AUTO is set.

- Press the L or R button to adjust the mirror by using the directional switch. If L or R button is still selected, both mirrors will tilt downward when reversing. Deselect L or R will disable the auto tilt down feature.

Power window lock button

Disables the power window switches on the rear passenger doors.

Door Lock

Locks/unlocks all doors.

Window Switches

- Front power window switches.
- Rear power window switches.

HEADLIGHTS AND FOG LIGHTS

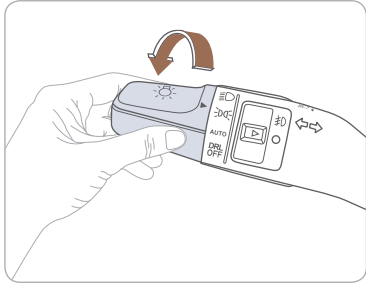

- Headlight position
- Parking light position
- AUTO** Auto light position
- DRL OFF** DRL OFF position

Headlight delay

Headlights may stay on for 15 seconds after exiting and locking vehicle. Press the remote lock button twice to turn headlights off.

This feature can be enabled/disabled under the Lights menu in the User Settings of the instrument cluster.

See Owner's Manual for more detail.

Turn signals and lane change signals

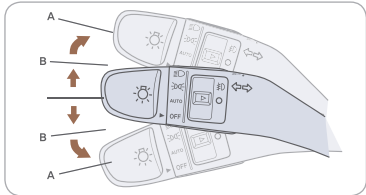

High beam

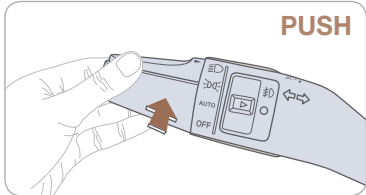

Smart High Beam Function

1. Select auto position on stalk.
2. Push lever forward to engage Auto High beam.
3. Push lever forward again to disengage.

See Owner's Manual for more details.

Flashing high beam

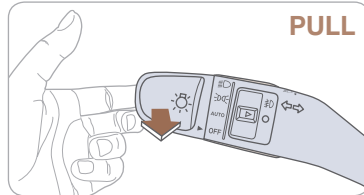

Fog light

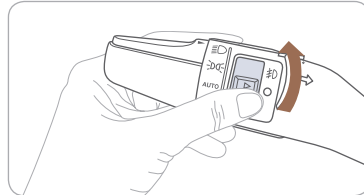

WIPERS AND WASHER

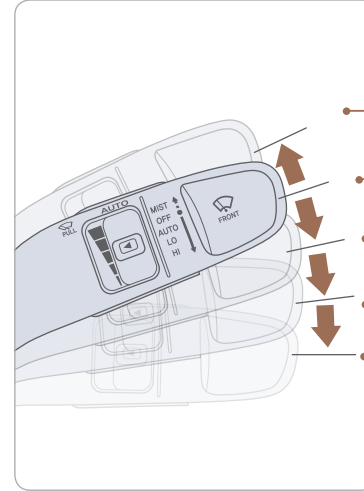

- MIST** - Single wipe
- OFF**
- AUTO** - Auto control wipe
- LO** - Low wiper speed
- HI** - High wiper speed

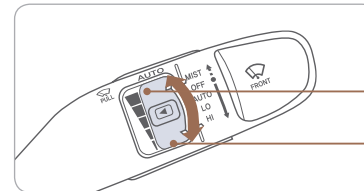

Auto control wiper interval adjustment
Adjust the control knob.

- Fast wiper speed
- Slow wiper speed

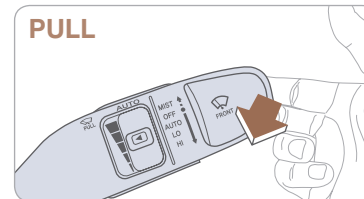

Windshield washer

Pull the lever gently toward you to spray washer fluid on the windshield and to run the wipers 1-3 cycles.

Headlamp washer

Fluid will spray on headlamp assemblies when headlamps are turned ON. Will activate only once for every ignition key cycle or only once every 15 minutes.

PANORAMIC SUNROOF

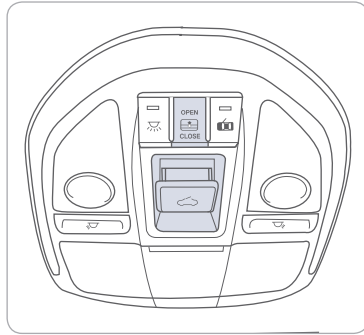

Sunshade

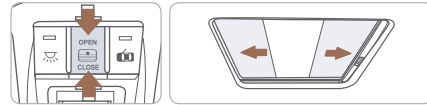

Sliding the sunroof



Tilting the sunroof

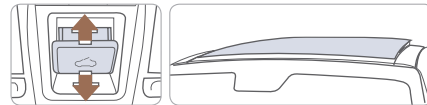

INTERIOR LIGHTS

Type A

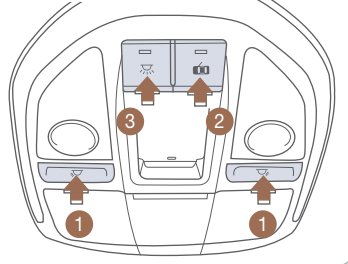

Front Map Lamp (☀️) ①

Push the switch to turn the map lamp on or off.

Front Door Lamp (🚪) ②

Lights will turn on when any door is open.

Front Room Lamp (☀️) ③

Push the switch to turn the room lamp on or off.

Type B

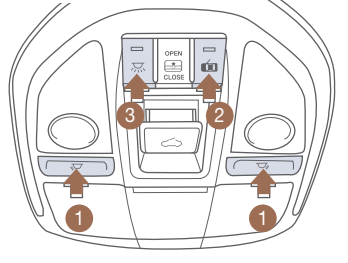

TRUNK

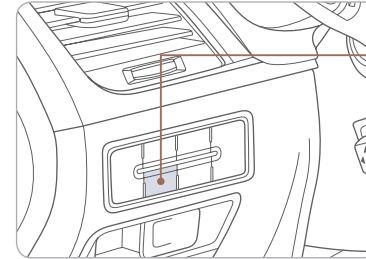

Trunk main control button

Press the button to open the trunk.

Power trunk:
To close, press and hold until trunk is fully closed.

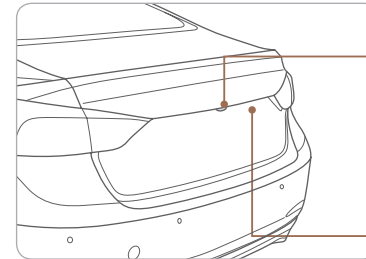
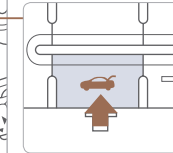

Trunk open button

Press to open.
Smart key needs to be within range.

Use the mechanical key.

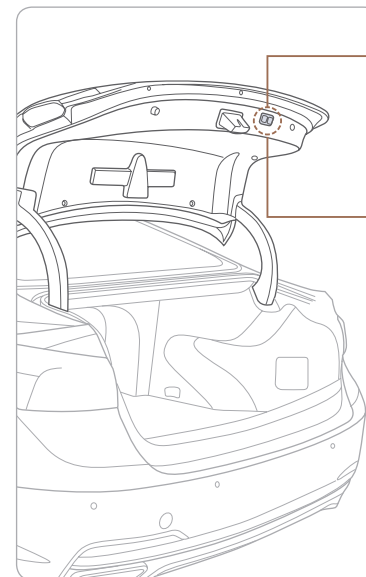
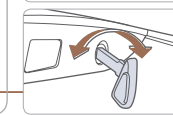
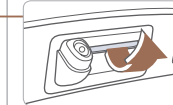

Power trunk close button

Pressing the button closes the power trunk automatically.



Power trunk lock button

Pressing the button with the smart key in proximity locks all the doors and closes the power trunk automatically.

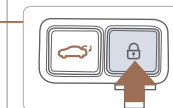

Trunk open button on the smart key

Pressing the button for more than 1 second opens the power trunk automatically.





Smart Trunk

Trunk will open automatically when detecting smart key within range near the trunk for more than 3 seconds.

To enable Smart Trunk function:

Vehicle must be in P (Park) to adjust settings in the User Setting mode.

1. Select "Door/Trunk" in the User Settings in the instrument cluster.
2. Check "Smart Trunk".



NOTE: Function is active after 15 seconds when all doors are closed and locked. The vehicle will also provide an audible and visual alarm while activating. For more details, refer to Owner's Manual. Factory setting defaults Smart Trunk in OFF position.

CHILD-PROTECTOR REAR DOOR LOCK

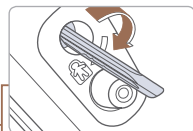
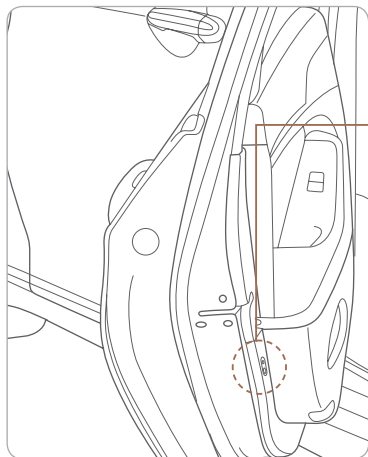

Lock

Insert a key into the hole and turn it towards the lock position .

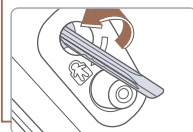

Unlock

Insert a key into the hole and turn away from the lock position .

HOMELINK WIRELESS GARAGE CONTROL SYSTEM

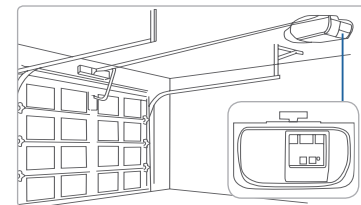
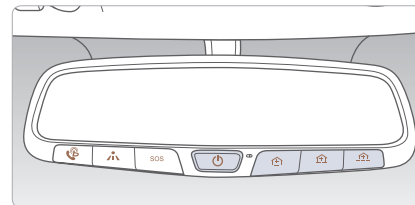

Standard Programming

To program most devices, follow these instructions:

1. For first-time programming, press and hold the two outside buttons, HomeLink® Channel 1 and Channel 3 Buttons, until the indicator light begins to flash (after 10 seconds). Release both buttons. Do not hold the buttons for longer than 20 seconds.
2. Position the end of your hand-held transmitter 1-3 inches (2-8 cm) away from the HomeLink® buttons while keeping the indicator light in view.
3. Simultaneously press and hold both the HomeLink® and hand-held transmitter button. DO NOT release the buttons until step 4 has been completed.
4. While continuing to hold the buttons the red indicator Status LED will flash slowly and then rapidly after HomeLink® successfully trains to the frequency signal from the hand-held transmitter. Release both buttons.

For detail instructions and list of compatible products, refer to your Owner's Manual or visit www.homelink.com.

Type A with 4.3" LCD Display

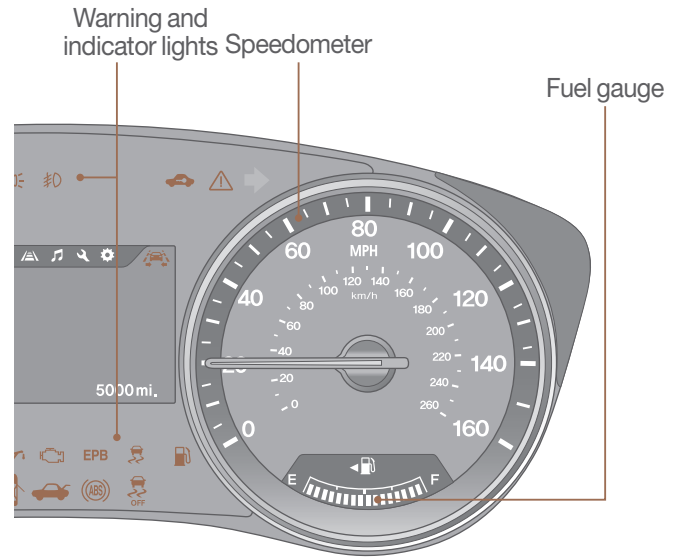
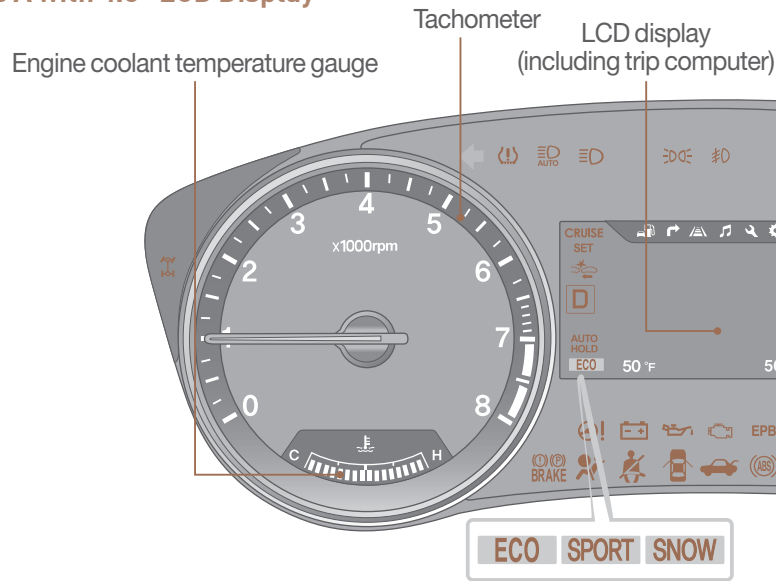

Type B with 7" LCD Display

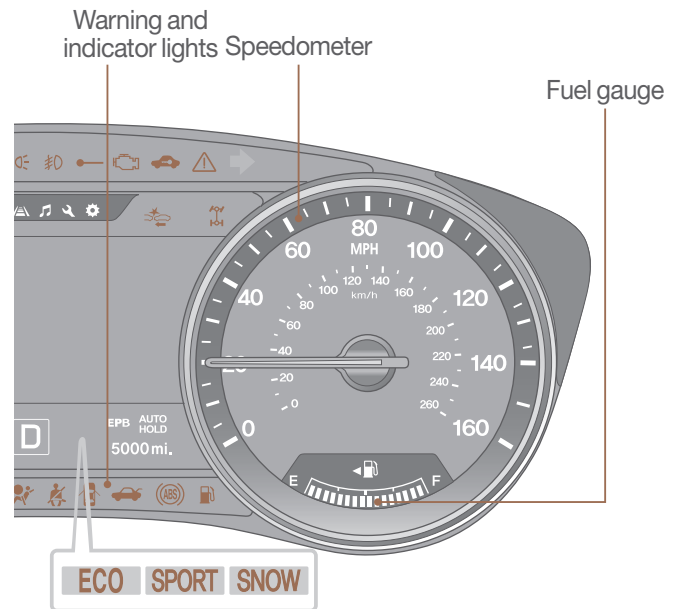
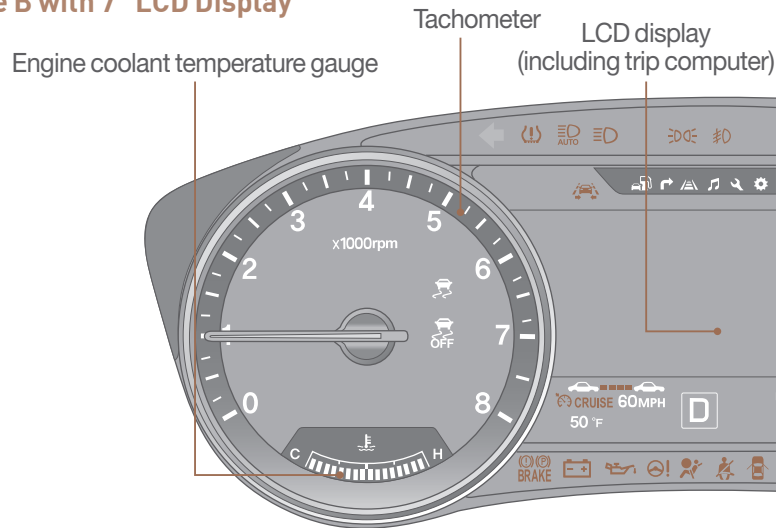

LCD DISPLAY MODES

Modes	Symbol	Explanation
Trip Computer		This mode displays driving information like the tripmeter, fuel economy, and so on.
Turn By Turn (TBT) (if equipped)		This mode displays the navigation turn by turn guidance.
ASCC/LKAS (if equipped)		This mode displays the state of the Advanced Smart Cruise Control (ASCC) and Lane Keeping Assist System (LKAS).
AV		This mode displays the state of the AV system.
Information		Display service internal warning messages and tire pressures.
User Settings		Changes settings.

LCD DISPLAY CONTROL

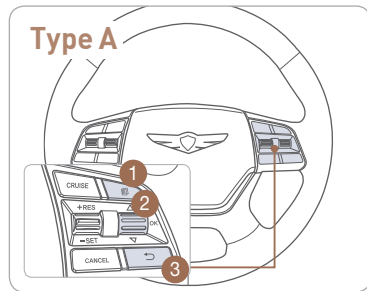

- 1 : MODE button for changing modes
- 2 : MOVE switch for changing items
- OK (Press) : SELECT/RESET button for setting or resetting the selected item
- 3 : BACK button for moving to upper level menu (if equipped)

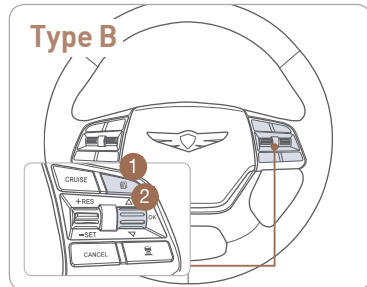

WARNINGS AND INDICATORS

Air bag warning light	Seat belt warning	Parking brake & Brake fluid warning light
Anti-lock Brake System (ABS) warning light	Electronic Brake Force Distribution (EBD) system warning light	
Electric Power Steering (EPS) warning light	Malfunction Indicator Lamp (MIL)	Charging system warning light
Engine coolant temperature warning light	Engine oil pressure warning light	Low fuel level warning light
Low tire pressure warning light	Door open warning light	Trunk open warning light
AWD warning light	Electric Parking Brake (EPB) warning light	Automatic Emergency Braking (AEB) warning light
Master warning light	Electronic Stability Control (ESC) indicator	Electronic Stability Control (ESC) OFF indicator
Immobilizer indicator	Turn signal indicator	Low beam indicator
High beam indicator	Light ON indicator	Smart high beam indicator
Front fog light indicator	Cruise indicator	Cruise SET indicator
AUTO HOLD indicator	SPORT mode indicator	SNOW mode indicator
ECO indicator	Lane Keeping Assistant System (LKAS) indicator	

HEAD UP DISPLAY

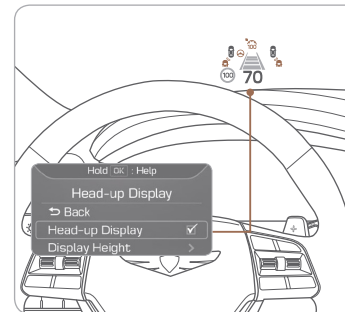

The head up display is a transparent display which projects an image of selected information of the instrument cluster and navigation on the windshield glass.

To activate the head up display, select "Head-up Display" on the "User Settings Mode" in the LCD display. Adjust "Head-up Display" height until in view.

NOTE: See Owner's Manual for more details on selecting content to display on the Head Up Display.

Front

Type A

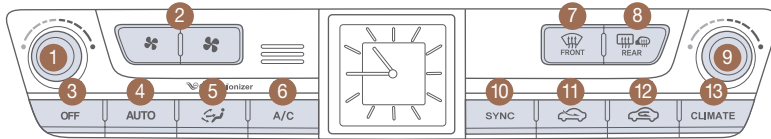

Type B

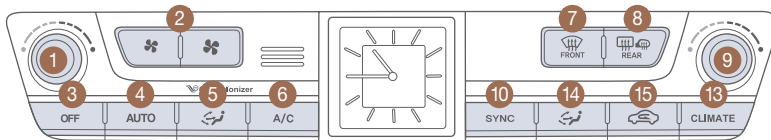

- 1 Driver's temperature control knob
- 2 Fan speed control button
- 3 OFF button
- 4 AUTO (automatic control) button
- 5 Mode selection button (Driver)
- 6 Air conditioning button
- 7 Front windshield defrost button
- 8 Rear window defrost button
- 9 Passenger's temperature control knob

DEFOGGING/DEFROSTING

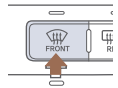

1. Press the front defrost button.

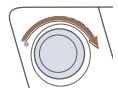

2. Select warmest temperature.

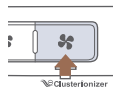

3. Set the fan speed to the highest speed.

SYSTEM OFF

Pressing the OFF button will place the system in the OFF mode.

- Front blower will turn off.
- Outside (fresh) air position will be selected.
- Vented air will be at last set temperature.

NOTE: To reduce the glass fogging and improve visibility, keep the interior surface of the windshield clean by wiping it with a clean cloth and glass cleaner. In addition, select air intake control to the outside (fresh) air position whenever possible while operating the vehicle.

MODE SELECTION



Changing the direction of the air flow as follow.



Rear

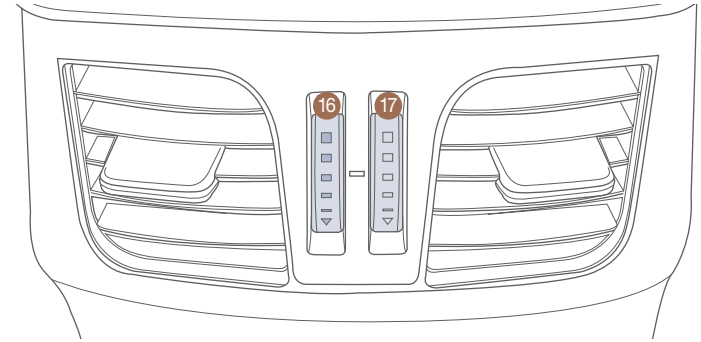

- 10 SYNC button (sync driver and passenger front air temperature)
- 11 Air intake control button (Outside air)
- 12 Air intake control button (Recirculated air)
- 13 Climate information screen selection button
- 14 Mode selection button (Passenger)
- 15 Air intake control button
- 16 Rear temperature control thumbwheel
- 17 Rear vent ON/OFF thumbwheel

AIR INTAKE CONTROL



Recirculated air position



Outside(fresh) air position (type A)



Outside(fresh) air position (type B) (light off)

AUTOMATIC HEATING / AIR CONDITIONING



Automatically controls the modes, fan speeds, air intake and air-conditioning functions.

SMART VENT

When cabin humidity and carbon dioxide levels increase while Climate Control is off, fresh air will be circulated into the cabin.

Please refer to the Owner's Manual for more information.

BLUETOOTH PHONE PAIRING

Pairing a new device

NOTE: Vehicle must be in (P) Park to complete pairing process.

1. Press the PHONE button in the head unit(or DIS navigation system) or  button in the steering wheel remote control.

Standard AVN

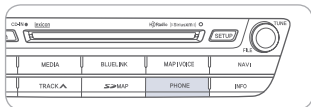

DIS navigation system

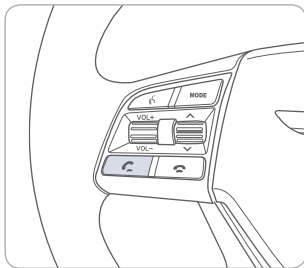
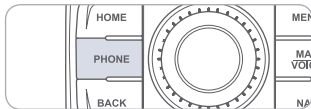

2. Press <YES> to search for Bluetooth phones.
3. Pair your car after your mobile phone detects the Bluetooth device.
4. Enter the passkey or accept the authorization popup. (The default passkey is 0000.)
5. Connect Bluetooth.

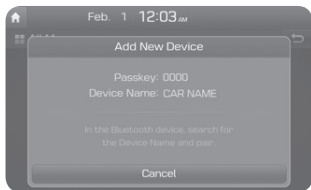

GENESIS CONNECTED SERVICES

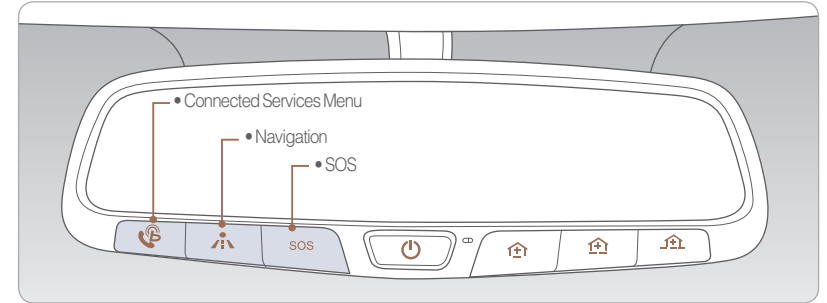

Press the  button for access to the voice-response menu of services.

You can say:

- "Service Link" to schedule a service appointment.
- "Roadside Assistance" for roadside services.
- "Genesis Account Services" for help with your Blue Link subscription.
- Press the  button for Destination Search Powered by Google®.
- Press the **SOS** button for SOS Emergency Assistance.
- Refer to your Genesis Connected Services Menu User's Manual for detailed information on system operation.
- For immediate assistance with subscription services, please call 1-844-340-9741.

Google® is a registered trademark of Google Inc.

Remote Features

Genesis Intelligent Assistance App



You can download the Genesis Mobile App to your compatible smart phone from the following sites:

- iPhone® — Apple® App Store
- Android® — Google Play



Remote Start with Climate Control

This feature enables you to remotely start your vehicle and set an engine timer (1-10 minutes) from virtually anywhere. You can also set the climate control temperature and turn on the rear-window defroster, ensuring a warm or cool car is ready to go when you are.

- To use this feature, you must have a Genesis Connected Services Personal Identification Number (PIN). To create or change your PIN, log on to www.GenesisMotorsUSA.com/Owners.

Remember...

- Remote Start with Climate Control will automatically shut off after 10 minutes or after selected engine timer runs out.
- While this feature is active, the parking lights will blink until vehicle is turned off or when vehicle is in operation.
- To continue operation of the vehicle, the proximity key must be inside the vehicle with the driver prior to pressing the brake and being able to move the gearshift from the "P" (park) position.

Please note: Remote Services are subject to adequate cellular coverage and signal strength, and only available in the 50 United States.

Remote Start Preconditions:

- Ignition is OFF
- Alarm is armed (i.e., vehicle locked by key fob Remote Door Lock)
- Gearshift level is in the "P" (park) position
- Brake pedal is not depressed
- Engine hood is securely closed
- All the doors are closed and locked
- The tailgate or trunk lid is closed
- The security/panic system is not activated
- The proximity key is not inside the vehicle
- The battery power is not low
- Vehicle is located in an open area
- It has been less than 4 days since last vehicle ignition off
- Vehicle located in area with good cell reception

Remote Start with Climate will terminate...

- After 10 minutes or after selected engine timer runs out
- Brake is pressed without proximity key inside vehicle
- Alarm is triggered without proximity key inside vehicle
- Door/trunk is opened from inside the vehicle

Notice: Laws in some communities may restrict the use of the features that remotely start the engine. For example, some laws may require a person using the remote start feature to have the vehicle in view when doing so or limit the length of time a vehicle engine may idle. Please check local and state regulations for any requirements and restrictions on remote starting of vehicles and engine idling time.

⚠ WARNING!

Do not remote start vehicle in an enclosed environment (i.e., closed garage). Prolonged operation of a motor vehicle in an enclosed environment can cause a harmful build-up of carbon monoxide. Carbon monoxide is harmful to your health. Exposure to high levels of carbon monoxide can cause headaches, dizziness or in extreme cases unconsciousness and/or death. Do not leave children or animals unattended in a vehicle while using the remote start function.

⚠ CAUTION!

If the vehicle's windshield wipers are left on when the vehicle was last driven, then the wipers will turn on if the remote start function is activated. To avoid damage to the wiper blades (i.e., due to heavy ice or snow accumulated on the windshield), please always turn the vehicle's windshield wipers off when parking the vehicle.

STEERING WHEEL AUDIO CONTROL

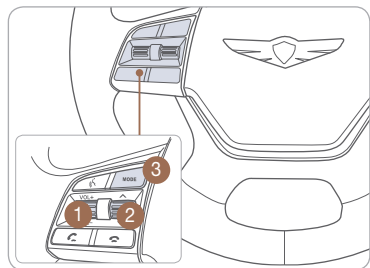

- 1 **VOLUME/MUTE**
Scroll up or down to adjust the volume.
Press to mute or unmute the sound.
- 2 **SEEK/PRESET**
Change station.
- 3 **MODE**
Change the audio source.

BLUETOOTH OPERATIONAL TIPS

In the following situations you or the other party may have difficulty hearing each other:

1. When Bluetooth volume is set too high. It may result in distortion and echo.
2. When driving on a rough road, high speeds and/or with the window open.
3. When the air conditioning vents are facing the microphone and/or when the air conditioning fan is at the max speed.

Steering wheel bluetooth control

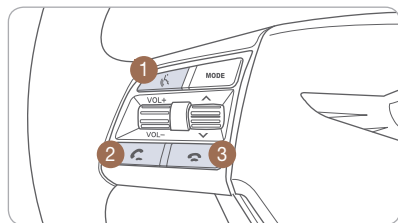

- 1 **TALK**
Activates voice recognition.
- 2 **CALL**
Places and transfers calls.
- 3 **END**
Ends calls or cancels functions.

To Answer a Call:

- Press button on the steering wheel.

To Reject a Call:

- Press button on the steering wheel.

To Adjust Ring Volume:

- Use the VOLUME buttons on the steering wheel.

To Transfer a Call to the Phone

(Private Call):

- Press and hold button on the steering wheel until the audio system transfers a call to the phone.

To Finish a Call:

- Press button on the steering wheel.

Making a call using voice recognition:

The menu tree identifies available voice recognition Bluetooth® functions.

Calling by Name:

1. Press button.
2. Say the following command **after** the Voice Recognition beep:
 - “Call <John Smith>”: Connects the call to John Smith.
 - “Call <John Smith> on <on Mobile/in Office/at Home>”: Connects the call to John Smith’s Mobile, Home, or Office phone number.

Dialing by Number:

1. Press button.
2. Say “Dial Number” **after** the Voice Recognition beep.
3. Say desired phone number. For complete list of commands, refer to your Owner’s Manual.

VOICE RECOGNITION TIPS

Your vehicle is equipped with Voice Recognition technology which allows drivers to operate their phones without having to take their eyes off the road to minimize distractions.

Voice recognition performance may be affected if speaking before Voice Recognition beep is heard, driving with windows and sun roof open; when the heating-cooling system is on; when passing in a tunnel or when driving on rugged and uneven roads.

Quick reference on using voice commands

To start voice command. Press the key, the following commands are available:

Command	Function
Call	Displays downloaded Contacts.
Call <Name>	Calls <Name> saved in Contacts.
Dial Number	Displays a screen where you can say a phone number to dial.
Dial <Phone #>	You can directly say the number to call. ex) Dial 111 555 1234
Redial	Directly calls at the number that you last dialed.
Call History	Displays your Call History.

NAVIGATION

Map position

Standard AVN



- 1 Move to the Home Screen
- 2 Change the map view mode
- 3 Navigation Voice Guidance On/Off
- 4 + Zoom in the map
- 5 Map scale display
- 6 - Zoom out the map



- 7 [MENU] button
- 8 Touch to scroll the map
- 9 Quick and easy selection of a destination from the map screen
- 10 Set a waypoint to the current route
- 11 Save frequently used address to address book
- 12 Find a POI(Point Of Interest) around the current position
- 13 Vehicle position

North Up/Heading Up.

- Displays the current map mode to reflect the position in reference to the screen. The map mode can be switched between North Up and Heading Up.
- Each time the button is pressed, the screen will switch in the order shown below.
 - Heading Up ➡ North Up ➡ Heading Up ➡
 - Map Scale: Increases or decreases the map size.
 - Map Scale indicator: shows the scale of the map.
 - Map Voice Key: Activate/deactivate the voice guidance.

DIS Navigation system



- 1 Clock display
- 2 Move to the Home Screen
- 3 Change the map view mode
- 4 Navigation voice guidance on/off
- 5 + Zoom in the map
- 6 Map scale display
- 7 - Zoom out the map

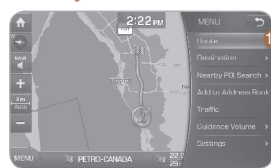

- 8 [MENU] button
- 9 Route guidance
- 10 Vehicle position
- 11 Current position and Destination
- 12 Remaining distance display/ Remaining time
- 13 Cancel Route
- 14 [Route] button

AUX, USB AND iPod PORT

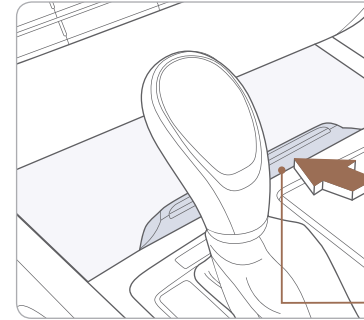

Use the input jack to connect an external audio device and listen to it through the audio system in your vehicle.

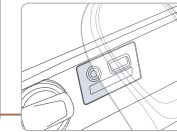

NOTE: To operate your iPod® through the vehicle's audio system, connect your Apple supplied USB cable to the USB port.

iPod® is a trademark of Apple Inc.

DRIVER INFORMATION SYSTEM (DIS)

The central control panel is located in the vehicle center console. It comprises the controller and the main function buttons.

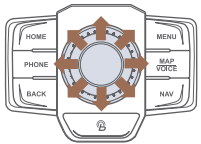
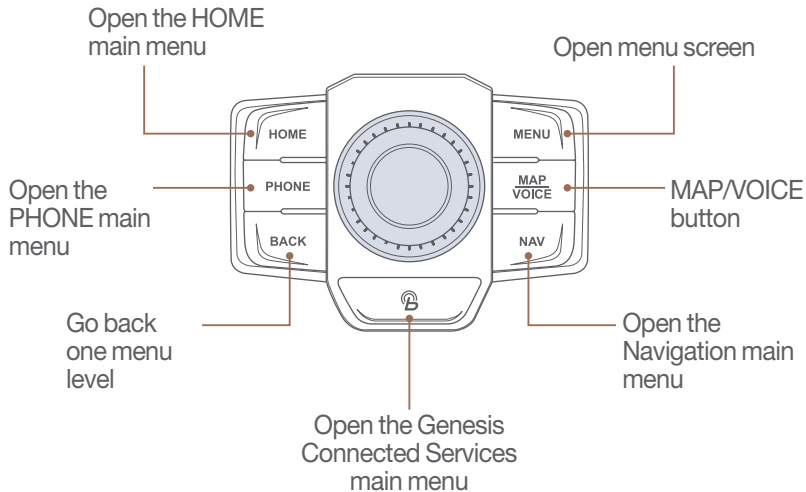

Scrolling through Controller

Move the focus or scroll through the navigation map.

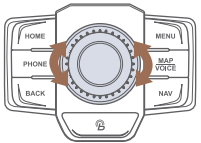

Turning the controller

Move the focus, or zoom in/out the navigation map.

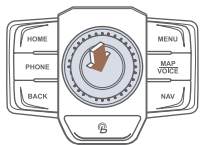

Pressing the controller

Start/Select the focused feature.

CLOCK ADJUSTMENT

With DIS Touch System

1. Press "HOME" button.

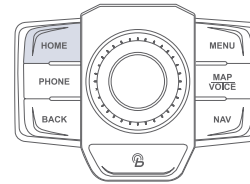

2. Press "Settings" icon on the screen, then press "Clock".

3. To set your preferred Time Setting:

- Check "GPS Time" to adjust the time automatically.
- Press "Time Setting" to adjust the clock manually. GPS Time must not be selected.
- If "Daylight Savings Time" is selected, the clock will be adjusted forward by one hour.

With Touch Screen System

1. Press the "SETUP" button.

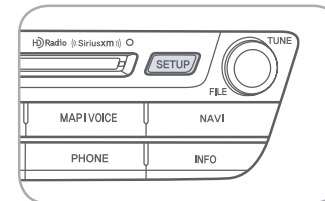

2. Press "Clock" icon on the screen.

3. To set your preferred Time Setting:

- Check "GPS Time" to adjust the time automatically.
- Press "Date/Time Setting" to adjust the clock manually. GPS Time must not be selected.
- If "Daylight Savings Time" is selected, the clock will be adjusted forward by one hour.

NOTE: Once the digital clock is adjusted, the analog clock will be updated accordingly.



REAR WINDOW CURTAIN

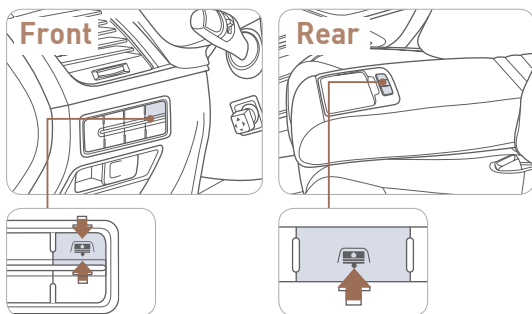
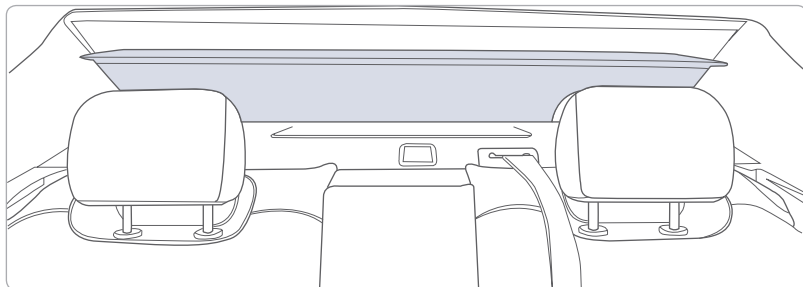

Press the button to lower.
Press the button again to raise.

NOTE: If curtain is in up position, curtain will move downward automatically when shifting into Reverse. Curtain will raise automatically when shifter is in Drive and vehicle speed is above 10 mph.

SEAT WARMER (front seats)

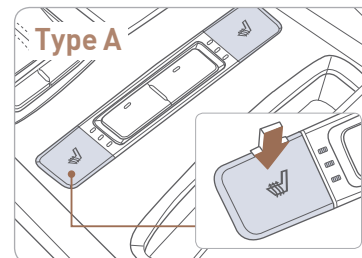

Each time you push the button, the setting is changed as follows:

OFF → HIGH → MIDDLE → LOW



If you want to turn it off immediately, press and hold the button.

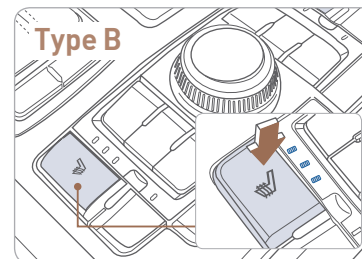

CLIMATE CONTROL SYSTEM SEAT (front seats)

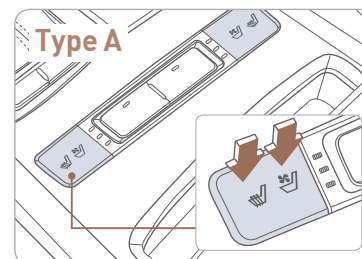

- Heat
- Cool

Each time you push the button, the setting is changed as follows:

OFF → HIGH → MIDDLE → LOW



If you want to turn it off immediately, press and hold the button.

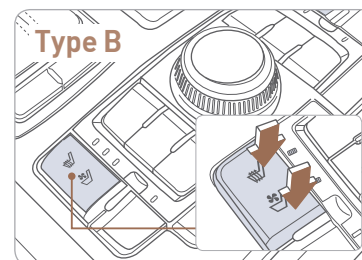

HEATED STEERING WHEEL

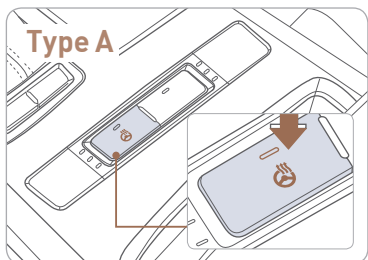

Pressing the heated steering wheel button warms the steering wheel. The indicator on the button is illuminated.

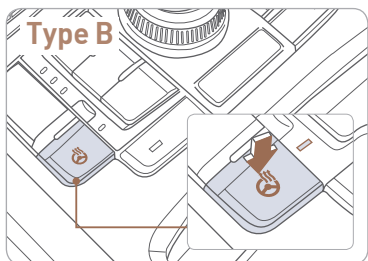

REARVIEW CAMERA

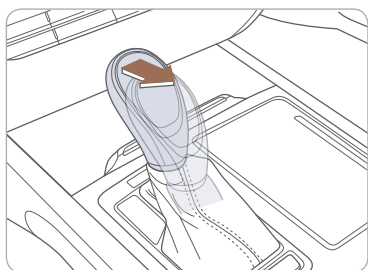

When transmission is shifted into R (Reverse), rearview camera displays the area behind the vehicle.

To switch view, press "Top View" button on screen.

PARKING GUIDE SYSTEM



The parking guide system will activate when the back-up light is ON and the shift lever in the R (Reverse) position.

PARKING ASSIST SYSTEM (PAS)

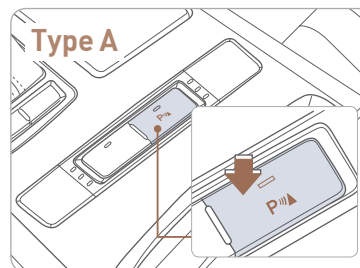

The parking assist system assists the driver during movement of the vehicle by chiming if any object is sensed within the distance of 39.5 inches in front and 47.2 inches in behind the vehicle.

PAS ON/OFF

To turn the PAS off, press the ON/OFF button. To turn the PAS on, press it again.

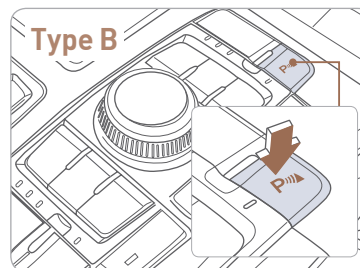

If you move the shift lever to R with the engine start/stop button in ON and the parking assist system in OFF, the parking assist system will turn ON automatically.

The system will automatically turn off when vehicle is driven forward at a speed above 6 mph.

ELECTRONIC PARKING BRAKE (EPB)

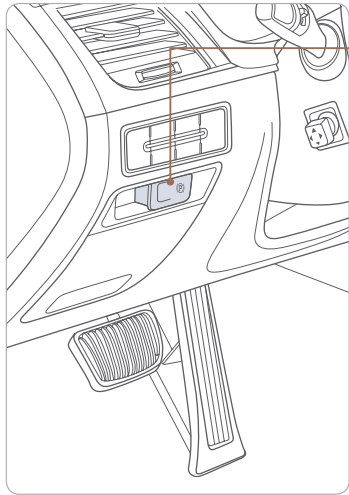

Applying

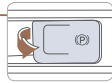

Stop the vehicle then pull the EPB switch.

Releasing



Move shift lever from P to R, N or D while depressing the brake pedal.
or

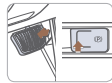

Press the EPB switch while depressing the brake pedal.

NOTE: If necessary, emergency braking is possible by pulling and holding the EPB switch.

AUTO HOLD

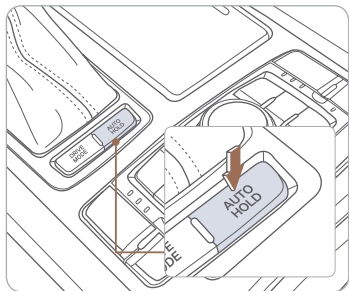

The Auto Hold feature assists in steep hill areas. It holds the brake until the accelerator pedal is pressed.

WHITE AUTO HOLD

1. Press the AUTO HOLD switch.

GREEN AUTO HOLD

2. Stop the vehicle by pressing the brake pedal. The brakes will remain engaged even if the brake pedal is released.

WHITE AUTO HOLD

3. The brakes will release when the accelerator pedal is pressed with transmission in D, R or manual mode.

To cancel the AUTO HOLD operation, press the AUTO HOLD switch again.

AUTOMATIC EMERGENCY BRAKING (AEB)



The Automatic Emergency Braking (AEB) helps avoid accidents by identifying critical situations early and warning the driver.

Also, the system helps reduce the severity of crashes which cannot be avoided by lowering the speed of collision and, in some cases, by preparing the vehicle and restraint systems for impact.

NOTE: System can be Enabled/ Disabled in the User Settings page of the instrument cluster under Driving Assist.

TIRE PRESSURE MONITORING SYSTEM (TPMS)

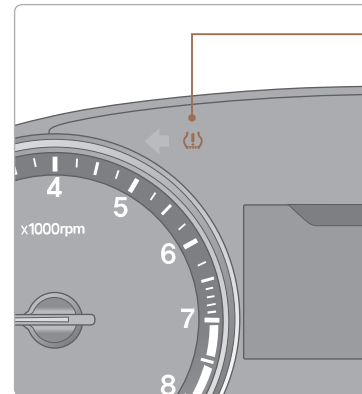

Low Tire Pressure Indicator / TPMS Malfunction Indicator



Low Tire Pressure Position Telltale and Tire Pressure Telltale (Shown on the LCD display)

NOTE: Vehicle must be driven for accurate tire pressure reading.

LOW TIRE PRESSURE INDICATOR

Illuminates if one or more of your tires is significantly under-inflated.

TPMS MALFUNCTION INDICATOR

Blinks for approximately one minute, then remains illuminated when there is a malfunction with the TPMS. Inspect all tires and adjust tire pressure to specification. If the lamp remains illuminated, have the system checked by authorized retailer of Genesis Branded Products as soon as possible.

NOTE: Units can be changed in the User Settings page of the instrument cluster under Other Features.

AUTOMATIC TRANSMISSION

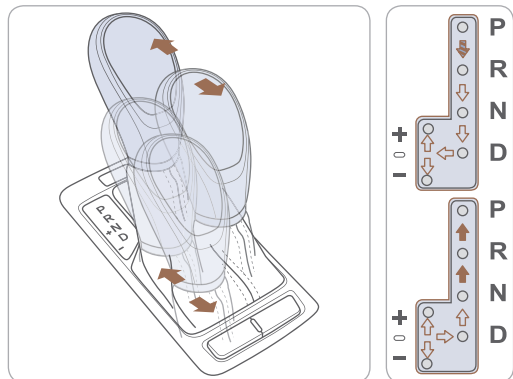

(➡): Press the shift button, then move shift lever.

(⚡➡): Depress the brake pedal, then move shift lever.

(⇨): Move shift lever.

Manual shift mode

Move the shift lever from D (Drive) into the manual gate to select.

Move the shift lever forward (+) to up shift or rearward (-) to downshift.

PADDLE SHIFTER

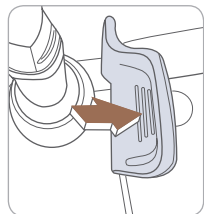

Press (-) to downshift

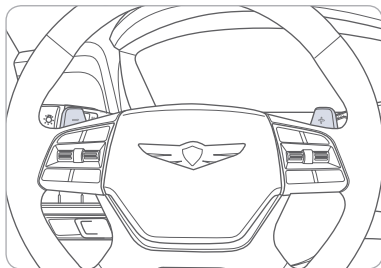

The Paddle shifter is available when the shift lever is in the D position or the manual shift mode.

Pull the [+] or [-] paddle shifter once to shift up or down one gear.

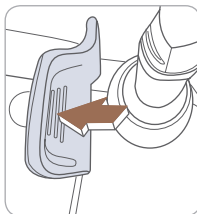

Press (+) to upshift

ELECTRONIC STABILITY CONTROL (ESC)

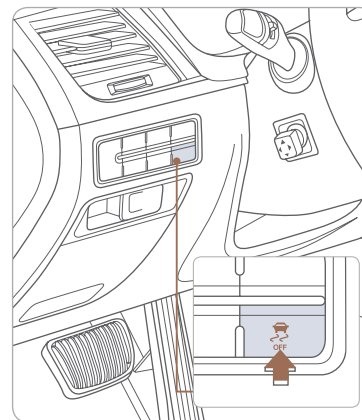

The ESC system is an electronic system designed to help the driver maintain vehicle control under adverse conditions.

ESC automatically selects the ON position when the engine is started.

To turn off Traction Control
Press the ESC OFF button once.

To turn off Traction and Stability Control
Press and hold the ESC OFF button for more than 3 seconds.

LANE KEEPING ASSIST SYSTEM (LKAS)

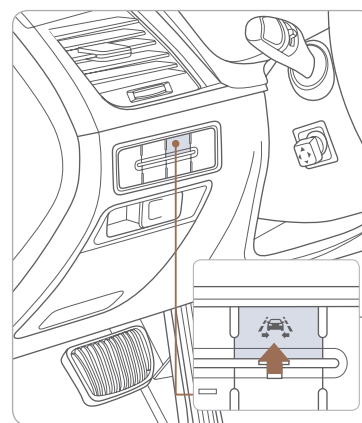

The Lane Keeping Assist System detects lane markers on the road, and assists the driver's steering to help keep the vehicle between lanes.

- To turn LKAS on, press the LKAS switch.
- To turn LKAS off, press the switch again.

NOTE: LKAS operates only when the vehicle speed is above 38 mph and when the LKAS indicator is green displayed in the instrument cluster.

Refer to the Owner's Manual for more detailed information.

NOTE: LKAS Settings can be adjusted in the User Settings page of the instrument cluster under Driving Assist.

BLIND SPOT DETECTION SYSTEM (BSD)

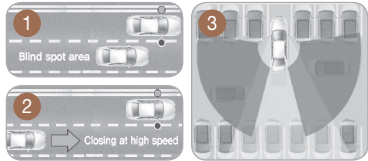

The BSD (Blind spot detection) system uses a radar sensor to alert the driver while driving. It senses the rear side territory of the vehicle and provides information to the driver.

- 1 Blind spot detection
- 2 Lane change assist
- 3 Rear cross traffic alert

- To turn the BSD on, press the BSD button. (indicator illuminated)
- To turn the BSD off, press the BSD button again.

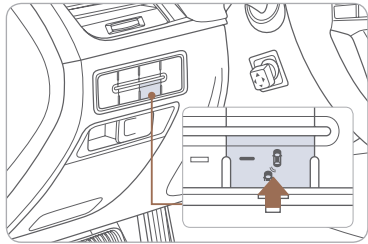

The BSD system will activate once vehicle speed exceeds 20 mph.

The rear cross traffic alert will activate, if vehicle is in reverse at speeds below 6 mph and BSD is activated.

DRIVE MODE INTEGRATED CONTROL SYSTEM

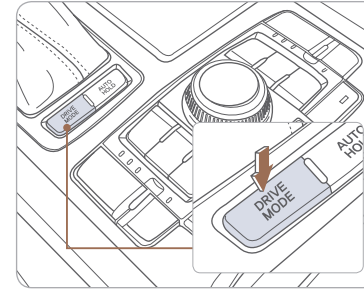

You can select the drive mode according to your preference or the road condition. The drive mode defaults to the Normal mode whenever the engine start/stop button is turned to the ON position.

Each time you press the button, the drive mode is changed as follows :

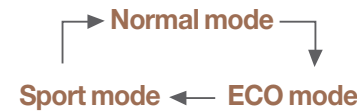

Normal mode

Normal mode is not displayed on the instrument cluster.

ECO mode

Active ECO helps improve fuel efficiency by controlling certain engine and transmission system operating parameters.

Sport mode

Sport mode focuses on dynamic driving by automatically controlling the steering wheel, engine and transmission system.

Snow mode

Snow mode helps you to drive more effectively on the slippery road such as snowy or muddy road.

Press and hold the drive mode button to select the Snow mode. Press the button again to return to previous mode.

CRUISE CONTROL/ADVANCED SMART CRUISE CONTROL

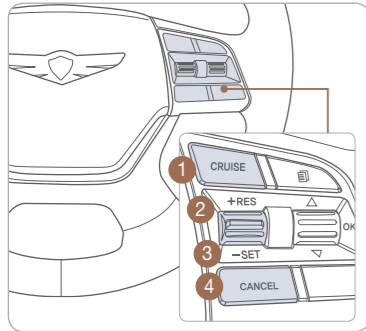

The cruise control system allows you to program the vehicle to maintain a constant speed without holding the accelerator pedal.

- 1 To On/Off the cruise control.
- 2 To Resume or Increase the cruise control speed.
- 3 To Set or Decrease the cruise control speed.
- 4 To Cancel the cruise control.

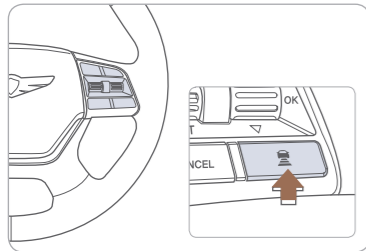

Setting vehicle distance (Advanced smart cruise control only)

This system assist you in setting the distance from the vehicle ahead and will maintain the selected distance without you depressing the accelerator or the brake pedal.

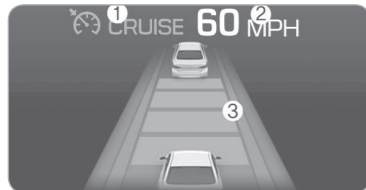

The vehicle to vehicle distance will automatically activate when you set the cruise speed.

Each time the vehicle distance set button is pressed, the vehicle to vehicle distance changes as follows:

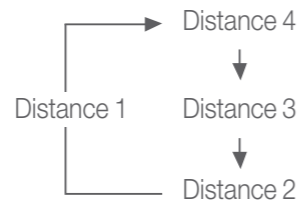

If your vehicle is equipped with Advanced smart cruise control and you wish to eliminate the vehicle distance function, you can change cruise control setting to a standard setting.

Press the Cruise Control button on the steering wheel to turn on Cruise Control. Then press and hold the vehicle distance button for more than 2 seconds to toggle between Smart Cruise Control (SCC) and Cruise Control (CC) mode.

Please refer to your Owner's Manual for more information.

GENESIS BRANDED VEHICLE OWNER PRIVACY POLICY

Your Genesis Branded vehicle may be equipped with technologies and services that use information collected, generated, recorded or stored by the vehicle. We have created a Vehicle Owner Privacy Policy to explain how these technologies and services collect, use, and share this information.

You may read our Vehicle Owner Privacy Policy on the GenesisMotorsUSA.com website at <http://www.genesismotorsusa.com/privacy-policy.html> If you would like to receive a hard copy of our Vehicle Owner Privacy Policy, please contact Customer Care at:

Genesis Customer Care
 P.O. Box 20850
 Fountain Valley, CA 92728
 844-340-9741
 CustomerCare@genesismotorsusa.com

Genesis Customer Care representatives are available Monday through Friday, between the hours of 5:00 AM and 7:00 PM PST and Saturday and Sunday between 6:30 AM and 3:00 PM PST (English). For Customer Care assistance in Spanish or Korean, representatives are available Monday through Friday between 6:30 AM and 3:00 PM PST.

GENESIS CUSTOMER DELIVERY CHECKLIST

GENESIS BRAND OWNER	RETAILER NAME
SALES CONSULTANT	DATE
VIN	PREVIOUS VEHICLE

BEFORE DELIVERY

- SET TIRE PRESURE LF ___ RF ___ RR ___ LR ___
- VERIFY VEHICLE IS CLEAN, IN GOOD CONDITION, FREE OF CHIPS AND SCRATCHES · CLEAN WINDSHIELD AND BACK WINDOW
- ENSURE FLOORMATS ARE SNAPPED INTO PLACE

Sales Consultant	Date	Sales Manager	Date
Customer			Date
Email		@	