

HYUNDAI



OWNER'S MANUAL

**Operation
Maintenance
Specifications**

All information in this Owner's Manual is current at the time of publication. However, Hyundai reserves the right to make changes at any time so that our policy of continual product improvement may be carried out.

This manual applies to all of this vehicle and includes descriptions and explanations of optional as well as standard equipment. As a result, you may find material in this manual that does not apply to your specific vehicle.

CAUTION: MODIFICATIONS TO YOUR HYUNDAI

Your Hyundai should not be modified in any way. Such modifications may adversely affect the performance, safety or durability of your Hyundai and may, in addition, violate conditions of the limited warranties covering the vehicle. Certain modifications may also be in violation of regulations established by the U.S. Department of Transportation and other federal or state agencies.

TWO-WAY RADIO OR CELLULAR TELEPHONE INSTALLATION

Your vehicle is equipped with electronic fuel injection and other electronic components. It is possible for an improperly installed/adjusted two-way radio or cellular telephone to adversely affect electronic systems. For this reason, we recommend that you carefully follow the radio manufacturer's instructions or consult your Hyundai dealer for precautionary measures or special instructions if you choose to install one of these devices.

SAFETY AND VEHICLE DAMAGE WARNING

This manual includes information titled as WARNING, CAUTION and NOTICE.
These titles indicate the following:

WARNING

This indicates that a condition may result in harm, serious injury or death to you or other persons if the warning is not heeded. Follow the advice provided with the warning.

CAUTION

This indicates that a condition may result in damage to your vehicle or its equipment if the caution is not heeded. Follow the advice provided with the caution.

*** NOTICE**

This indicates that interesting or helpful information is being provided.

FOREWORD

Thank you for choosing Hyundai. We are pleased to welcome you to the growing number of discerning people who drive Hyundais. The advanced engineering and high-quality construction of each Hyundai we build is something of which we're very proud.

Your Owner's Manual will introduce you to the features and operation of your new Hyundai. It is suggested that you read it carefully because the information it contains can contribute greatly to the satisfaction you receive from your new car.

The manufacturer also recommends that all service and maintenance on your car be performed by an authorized Hyundai dealer. Hyundai dealers are prepared to provide high-quality service, maintenance and any other assistance that may be required.

HYUNDAI MOTOR AMERICA

Note : Because future owners will also need the information included in this manual, if you sell this Hyundai, please leave the manual in the vehicle for their use. Thank you.

CAUTION

Severe engine and transaxle damage may result from the use of poor quality fuels and lubricants that do not meet Hyundai specifications. You must always use high quality fuels and lubricants that meet the specifications listed on Page 8-6 and 8-7 in the Vehicle Specifications and consumer information section of the Owner's Manual.

Copyright 2015 Hyundai Motor America. All rights reserved. No part of this publication may be reproduced, stored in any retrieval system or transmitted in any form or by any means without the prior written permission of Hyundai Motor America.

Guide to Hyundai Genuine Parts

1. What are Hyundai Genuine Parts?

Hyundai Genuine Parts are the same parts used by Hyundai Motor Company to manufacture vehicles. They are designed and tested for the optimum safety, performance, and reliability to our customers.

2. Why should you use genuine parts?

Hyundai Genuine Parts are engineered and built to meet rigid manufacturing requirements.

Damage caused by using imitation, counterfeit or used salvage parts is not covered under the Hyundai New Vehicle Limited Warranty or any other Hyundai warranty.

In addition, any damage to or failure of Hyundai Genuine Parts caused by the installation or failure of an imitation, counterfeit or used salvage part is not covered by any Hyundai Warranty.

3. How can you tell if you are purchasing Hyundai Genuine Parts?

Look for the Hyundai Genuine Parts Logo on the package (see below).

Hyundai Genuine Parts for export are packaged with labels written only in English.

Hyundai Genuine Parts are only sold through authorized Hyundai Dealerships.

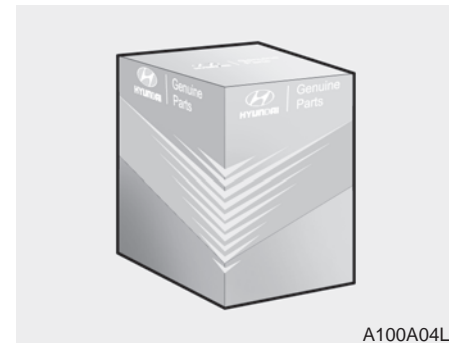
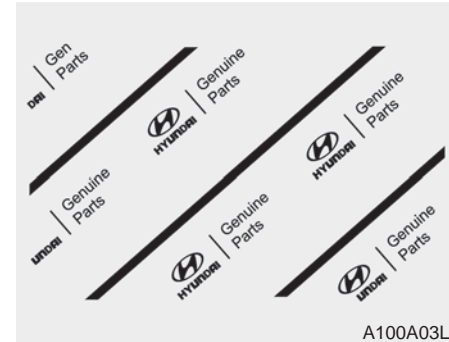



TABLE OF CONTENTS

Introduction

How to use this manual / Fuel requirements / Vehicle break-in process / Vehicle handling instructions / Vehicle data collection and event data recorders

1

Your vehicle at a glance

Exterior overview / Interior overview / Instrument panel overview / Engine compartment

2

Safety features of your vehicle

Seats / Seat belts / Child restraint system / Air bag

3

Features of your vehicle

Keys / Door locks / Tailgate / Windows / Hood / Fuel filler lid / Panoramic sunroof / Steering wheel / Mirrors / Instrument cluster / Lighting / Wipers & Washers / Climate control system / Multimedia system / Etc.

4

Driving your vehicle

Before driving / Engine start/stop button / Transaxle / All Wheel Drive (AWD) / Brake system / Cruise control system / Blind Spot Detection System / Active ECO system / Winter driving / Vehicle load limit / Etc.

5

What to do in an emergency

Road warning / Emergency while driving / Emergency starting / Engine overheat / TPMS / Flat tire / Towing / Etc.

6

Maintenance

Engine compartment / Maintenance service / Engine oil / Engine coolant / Brake fluid / Washer fluid / Parking brake / Air cleaner / Wiper blades / Battery / Tire and wheels / Fuses / Light bulbs / Etc.

7

Specifications, Consumer information and Reporting safety defects

8

Index

I

Introduction

How to use this manual 1-2
Fuel requirements 1-3
• Gasoline containing alcohol and methanol 1-3
• Other fuels 1-4
• Gasoline containing MMT 1-4
• Do not use methanol 1-4
• Fuel Additives 1-4
Vehicle break-in process 1-5
Vehicle handling instructions 1-5
Vehicle data collection and event data recorders . 1-6

HOW TO USE THIS MANUAL

We want to help you get the greatest possible driving experience from your vehicle. Your Owner's Manual can assist you in many ways. We strongly recommend that you read the entire manual. In order to minimize the chance of death or injury, you must read the **WARNING** and **CAUTION** sections in the manual.

Illustrations complement the text in this manual to best explain how to use your vehicle. By reading your manual, you will learn about features, important safety information, and driving tips under various road conditions.

The general layout of the manual is provided in the Table of Contents. A good place to start is the index; it has an alphabetical listing of all information in your manual.

Sections: This manual has eight sections plus an index. Each section begins with a brief list of contents so you can tell at a glance if that section has the information you want.

You will find various **WARNINGS**, **CAUTIONS**, and **NOTICES** in this manual. These **WARNINGS** were prepared to enhance your personal safety. You should carefully read and follow **ALL** procedures and recommendations provided in these **WARNINGS**, **CAUTIONS** and **NOTICES**.

Symbols used in this manual *Warnings, Cautions and Notices*

WARNING

A WARNING indicates that a condition may result in harm, serious bodily injury or death if the warning is ignored.

CAUTION

A CAUTION indicates that a condition may result in damage to your vehicle if the caution is ignored.

*** NOTICE**

A NOTICE indicates interesting or helpful information is being provided.

Safety symbol in illustrations



The symbol means to "Avoid" or "Do not do something".

FUEL REQUIREMENTS

Your new vehicle is designed to obtain maximum performance with UNLEADED FUEL, as well as minimize exhaust emissions and spark plug fouling.

Your new vehicle is designed to use only unleaded fuel having a pump octane number $((R+M)/2)$ of 87 (Research Octane Number 91) or higher. (Do not use methanol blended fuels.)

Never add any fuel system cleaning agents to the fuel tank other than what has been specified. (Consult an authorized HYUNDAI dealer for details.)

⚠ WARNING - Refueling

- Do not "top off" after the nozzle automatically shuts off when refueling. Attempts to force more fuel into the tank can cause fuel overflow onto you and the ground causing a risk of fire.
- Always check that the fuel cap is installed securely to prevent fuel spillage in the event of an accident.

Gasoline containing alcohol and methanol

Gasohol, a mixture of gasoline and ethanol (also known as grain alcohol), and gasoline or gasohol containing methanol (also known as wood alcohol) are being marketed along with or instead of leaded or unleaded gasoline.

Do not use gasohol containing more than 10% ethanol, and do not use gasoline or gasohol containing any methanol. Either of these fuels may cause drivability problems and damage to the fuel system, engine control system and emission control system.

Discontinue using gasohol of any kind if drivability problems occur.

Vehicle damage or drivability problems may not be covered by the manufacturer's warranty if they result from the use of:

1. Gasohol containing more than 10% ethanol.
2. Gasoline or gasohol containing methanol.
3. Leaded fuel or leaded gasohol.

"E85" fuel is an alternative fuel comprised of 85 percent ethanol and 15 percent gasoline, and is manufactured exclusively for use in Flexible Fuel Vehicles. "E85" is not compatible with your vehicle. Use of "E85" may result in poor engine performance and damage to your vehicle's engine and fuel system. HYUNDAI recommends that customers do not use fuel with an ethanol content exceeding 10 percent.

*** NOTICE**

Your New Vehicle Limited Warranty does not cover damage to the fuel system or any performance problems caused by the use of "E85" fuel.

Other fuels

Using fuels such as;

- Silicone (Si) contained fuel,
- Ferrocene (Fe) contained fuel, and
- Other metallic additives contained fuels,

may cause vehicle and engine damage or cause plugging, misfiring, poor acceleration, engine stalling, catalyst melting, abnormal corrosion, life cycle reduction, etc.

Also, the Malfunction Indicator Lamp (MIL) may illuminate.

*** NOTICE**

Damage to the fuel system or performance problem caused by the use of these fuels may not be covered by your New Vehicle Limited Warranty.

Gasoline containing MMT

Some gasoline contains harmful manganese-based fuel additives such as MMT (Methylcyclopentadienyl Manganese Tricarbonyl).

HYUNDAI does not recommend the use of gasoline containing MMT.

This type of fuel can reduce vehicle performance and affect your emission control system.

The malfunction indicator lamp on the cluster may come on.

Do not use methanol

Fuels containing methanol (wood alcohol) should not be used in your vehicle. This type of fuel can reduce vehicle performance and damage components of the fuel system, engine control system and emission control system.

*** NOTICE**

Your New Vehicle Limited Warranty may not cover damage to the fuel system and any performance problems that are caused by the use of fuels containing methanol.

Fuel Additives

HYUNDAI recommends that you use good quality gasolines treated with detergent additives such as TOP TIER Detergent Gasoline, which help prevent deposit formation in the engine.

These gasolines will help the engine run cleaner and enhance performance of the Emission Control System. For more information on TOP TIER Detergent Gasoline, please go to the website (www.toptiergas.com)

For customers who do not use TOP Tier Detergent Gasoline regularly, and have problems starting their vehicle or the engine does not run smoothly, additives that you can buy separately may be added to the gasoline.

If TOP TIER Detergent Gasoline is not available, one bottle of additive added to the fuel tank at every 7,500mile or every engine oil change is recommended. Additives are available from your authorized HYUNDAI dealer along with information on how to use them. Do not mix other additives.

Operation in foreign countries

If you are going to drive your vehicle in another country, be sure to:

- Observe all regulations regarding registration and insurance.
- Determine that acceptable fuel is available.

VEHICLE BREAK-IN PROCESS

No special break-in period is needed. By following a few simple precautions for the first 600 miles (1,000 km) you may add to the performance, economy and life of your vehicle.

- Do not race the engine.
- While driving, keep your engine speed (rpm, or revolutions per minute) between 2,000 rpm and 4,000 rpm.
- Do not maintain a single speed for long periods of time, either fast or slow. Varying engine speed is needed to properly break-in the engine.
- Avoid hard stops, except in emergencies, to allow the brakes to seat properly.

⚠ CALIFORNIA PROPOSITION 65 WARNING

Items contained in motor vehicles or emitted from them are known to the State of California to cause cancer and birth defects or reproductive harm. These include:

- Gasoline and its vapors
- Engine exhaust
- Used engine oil
- Interior passenger compartment components and materials
- Component parts which are subject to heat and wear

In addition, battery posts, terminals and related accessories contain lead, lead compounds and other chemicals known to the State of California to cause cancer and reproductive harm.

VEHICLE HANDLING INSTRUCTIONS

As with other vehicles of this type, failure to operate this vehicle correctly may result in loss of control, an accident or vehicle rollover.

Specific design characteristics (higher ground clearance, track, etc.) give this vehicle a higher center of gravity than other types of vehicles. It is not designed for cornering at the same speeds as a conventional 2-wheel drive sedans or sports coupe. Avoid sharp turns or abrupt maneuvers. Failure to operate this vehicle correctly may result in loss of control, an accident or vehicle rollover. **Be sure to read the “Reducing the risk of a rollover” driving guidelines, in section 5 of this manual.**

VEHICLE DATA COLLECTION AND EVENT DATA RECORDERS

This vehicle is equipped with an event data recorder (EDR). The main purpose of an EDR is to record, in certain crash or near crash-like situations, such as an air bag deployment or hitting a road obstacle, data that will assist in understanding how a vehicle's systems performed. The EDR is designed to record data related to vehicle dynamics and safety systems for a short period of time, typically 30 seconds or less. The EDR in this vehicle is designed to record such data as:

- How various systems in your vehicle were operating;
- Whether or not the driver and passenger safety belts were buckled/fastened;
- How far (if at all) the driver was depressing the accelerator and/or brake pedal; and,
- How fast the vehicle was traveling.

These data can help provide a better understanding of the circumstances in which crashes and injuries occur. **NOTE:** EDR data are recorded by your vehicle only if a non-trivial crash situation occurs; no data are recorded by the EDR under normal driving conditions and no personal data (e.g., name, gender, age, and crash location) are recorded. However, other parties, such as law enforcement, could combine the EDR data with the type of personally identifying data routinely acquired during a crash investigation.

To read data recorded by an EDR, special equipment is required, and access to the vehicle or the EDR is needed. In addition to the vehicle manufacturer, other parties, such as law enforcement, that have the special equipment, can read the information if they have access to the vehicle or the EDR.

Your vehicle at a glance

Exterior overview	2-2
Interior overview (I)	2-4
Interior overview (II)	2-5
Instrument panel overview	2-6
Engine compartment	2-7

EXTERIOR OVERVIEW

■ Front view

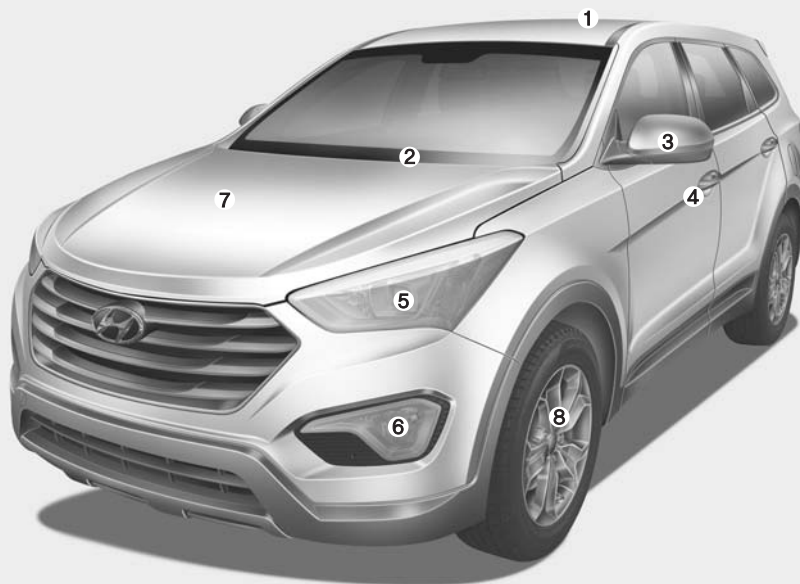

- 1. Panoramic sunroof4-47
- 2. Front windshield wiper blades7-43
- 3. Outside rearview mirror.....4-67
- 4. Door locks4-21
- 5. Headlight7-75
- 6. Front fog light.....4-116
- 7. Hood.....4-41
- 8. Tires and wheels7-48 / 8-4

* The actual shape may differ from the illustration.

ONCEIN2001

■ Rear view

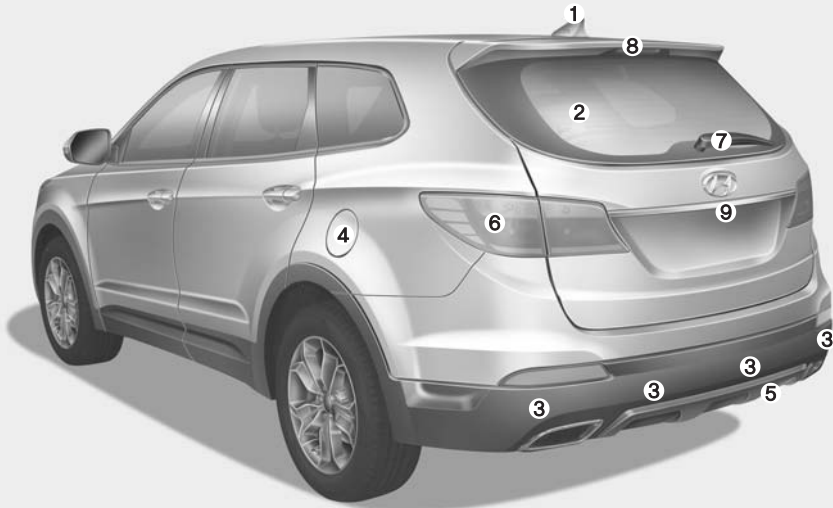

- 1. Antenna4-161
- 2. Defroster.....4-124
- 3. Parking assist system.....4-105
- 4. Fuel filler door4-43
- 5. Towing hook.....6-31
- 6. Rear combination lamp7-79
- 7. Rear window wiper blade7-44
- 8. High mounted stop lamp7-81
- 9. Rearview camera4-109

* The actual shape may differ from the illustration.

INTERIOR OVERVIEW (I)

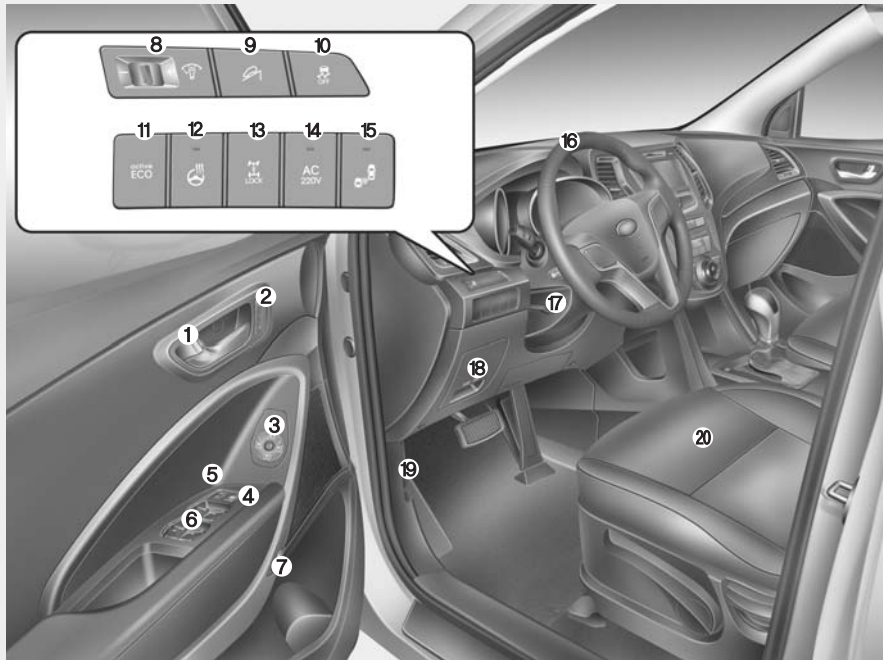

1. Inside door handle.....4-23
2. Driver position memory system.....3-8
3. Outside rearview mirror control4-67
4. Power window lock button4-40
5. Central door lock switch4-23
6. Power window switch.....4-36
7. Fuel-filler door opener4-43
8. Instrument panel illumination control knob.....4-72
9. DBC button.....5-40
10. ESC OFF button.....5-35
11. Active ECO button.....5-56
12. Heated steering wheel button4-53
13. AWD LOCK button5-22
14. AC inverter button4-153
15. BSD on/off button.....5-50
16. Steering wheel.....4-53
17. Tilt and telescopic steering control lever4-54
18. Inner panel fuse7-63
19. Hood release lever4-41
20. Seat3-2

* The actual shape may differ from the illustration.

ONCNIN3003

INTERIOR OVERVIEW (II)

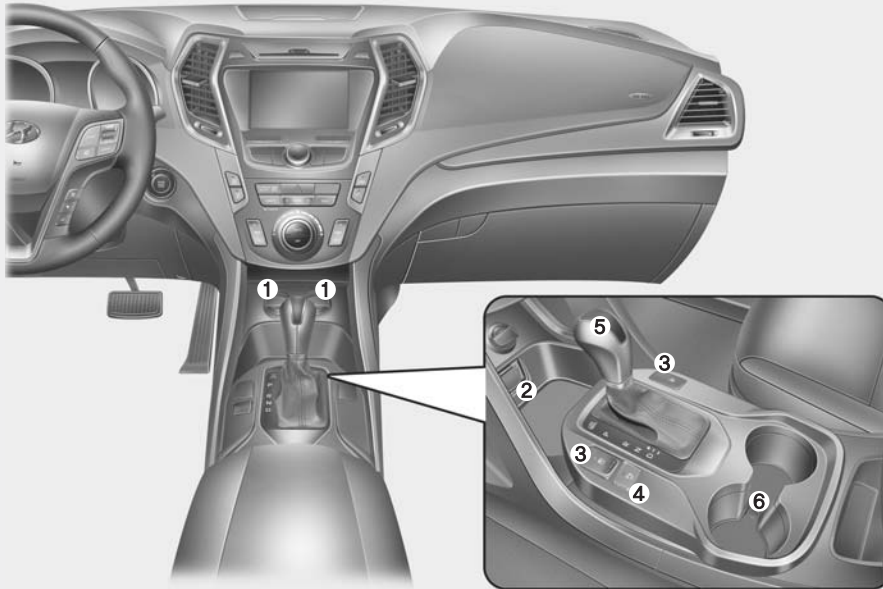

- 1. Power outlet.....4-152
- 2. Aux, USB and iPod®4-156
- 3. Seat warmer/
Air ventilation seat button3-13/3-14
- 4. Parking assist system button.....4-105
- 5. Transaxle shift lever5-14
- 6. Cup holder4-150

* The actual shape may differ from the illustration.

INSTRUMENT PANEL OVERVIEW

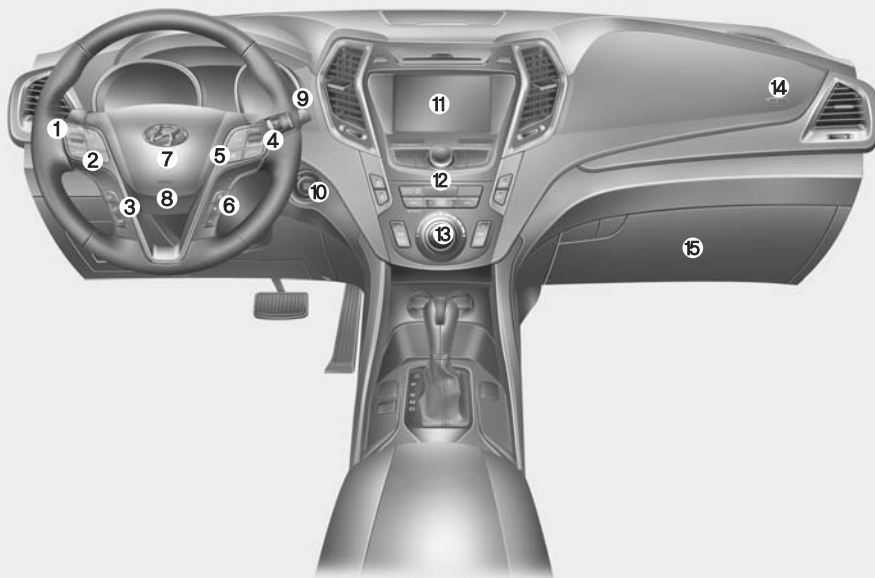

1. Lighting control lever4-112
2. Audio remote control buttons4-161
3. Bluetooth hands-free buttons4-196 / 4-247
4. Cruise control button5-46
5. Driver selectable steering mode button ..4-55
6. LCD display control buttons4-72
7. Horn.....4-54
8. Driver's front air bag.....3-62
9. Wiper and washer control lever.....4-117
10. Ignition switch/
Engine start/stop button.....5-6 / 5-9
11. Audio4-161
12. Hazard warning flasher4-110
13. Climate control system4-125 / 4-135
14. Passenger's front air bag3-62
15. Glove box4-147

* The actual shape may differ from the illustration.

OANNIN2004

ENGINE COMPARTMENT

■ Gasoline 3.3L GDI



- 1. Engine coolant reservoir7-33
- 2. Engine oil filler cap7-30
- 3. Brake fluid reservoir7-35
- 4. Air cleaner7-38
- 5. Fuse box.....7-63
- 6. Negative battery terminal7-45
- 7. Positive battery terminal.....7-45
- 8. Radiator cap7-34
- 9. Engine oil dipstick.....7-30
- 10. Windshield washer fluid reservoir.....7-37

* The actual engine room in the vehicle may differ from the illustration.

ONCEIN2007

Safety features of your vehicle

Seats	3-2	• Curtain air bag	3-68
• Front seat adjustment - Manual	3-5	• SRS Care	3-75
• Front seat adjustment - Power	3-6	• Additional safety precautions	3-76
• Driver position memory system	3-8	• Air bag warning label	3-77
• Rear seat adjustment	3-15		
Seat belts	3-27		
• Seat belt restraint system	3-27		
• Pre-tensioner seat belt	3-33		
• Seat belt precautions	3-36		
• Care of seat belts	3-39		
Child restraint system	3-40		
• Using a child restraint system	3-42		
• Tether Anchor system	3-45		
• Securing a child restraint seat with child seat lower anchor system	3-47		
Air bag - supplemental restraint system	3-49		
• How does the air bag system operate	3-50		
• Do not Installing a child restraint on a front passenger's seat	3-51		
• Air bag warning light	3-52		
• SRS components and functions	3-52		
• Occupant classification system	3-56		
• Main components of occupant classification system	3-57		
• Driver's and passenger's front air bag	3-62		
• Side impact air bag	3-67		

SEATS

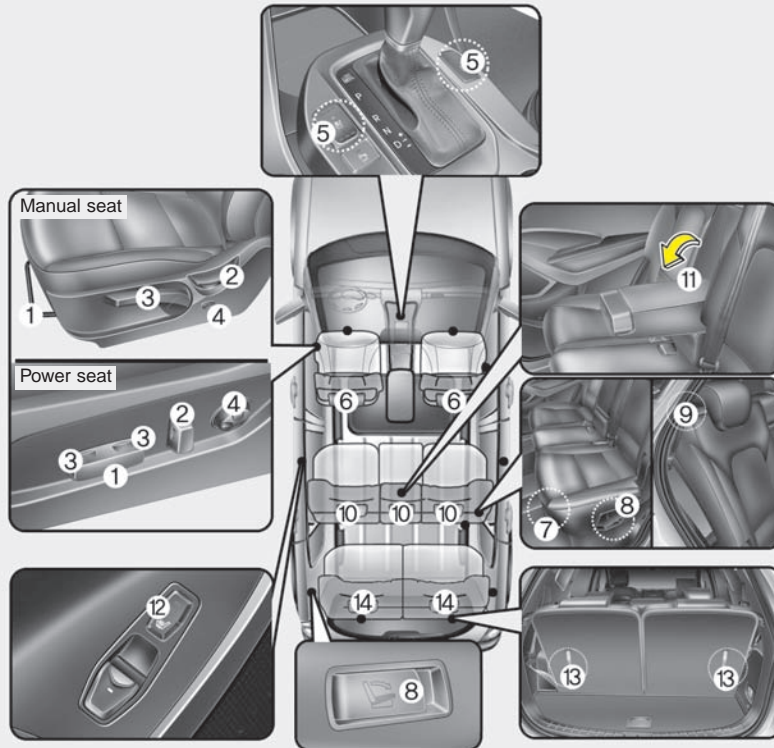

ONCNSA3001

Front seat

- (1) Forward and backward
- (2) Seatback angle
- (3) Seat cushion height (Driver's seat)
- (4) Lumbar support (Driver's seat)*
- (5) Seat warmer* /
Air ventilation seat*
- (6) Headrest

2nd row seat

- (7) Forward and backward
- (8) Seatback angle and folding
- (9) Walk-in seat lever
- (10) Headrest
- (11) Armrest
- (12) Seat warmer*

3rd row seat

- (13) Seatback folding
- (14) Headrest

* if equipped

※ The actual feature in the vehicle may differ from the illustration.

⚠ WARNING - Loose objects

Loose objects in the driver's foot area could interfere with the operation of the foot pedals, possibly causing an accident. Do not place anything under the front seats.

⚠ WARNING - Uprighting seat

When you return the seatback to its upright position, hold the seatback and return it slowly and be sure there are no other occupants around the seat. If the seatback is returned without being held and controlled, the back of the seat could spring forward resulting in accidental injury to a person struck by the seatback.

⚠ WARNING - Driver responsibility for passengers

Riding in a vehicle with the seatback reclined could lead to serious or fatal injury in an accident. If a seat is reclined during an accident, the occupant's hips may slide under the lap portion of the seat belt, applying great force to the unprotected abdomen. Serious or fatal internal injuries could result. The driver must advise the passenger to keep the seatback in an upright position whenever the vehicle is in motion.

⚠ WARNING

Occupants should never sit on seat cushions. The passenger's hips may slide under the lap portion of the seat belt during an accident or a sudden stop. Serious or fatal internal injuries could result because the seat belt cannot operate normally.

⚠ WARNING - Driver's seat

To avoid serious injury or death:

- Never attempt to adjust the seat while the vehicle is moving. This could result in loss of control, and an accident causing death, serious injury, or property damage.
- Do not allow anything to interfere with the normal position of the seatback. Storing items against a seatback or in any other way interfering with proper locking of a seatback could result in serious or fatal injury in a sudden stop or collision.
- In order to avoid unnecessary and perhaps severe air bag injuries, always sit as far back as possible from the steering wheel while maintaining comfortable control of the vehicle. We recommend that your chest be at least 10 inches (250 mm) away from the steering wheel.

⚠ WARNING - Rear seatbacks

- The rear seatback must be securely latched. If not, passengers and objects could be thrown forward resulting in serious injury or death in the event of a sudden stop or collision.
- No passenger should ride in the cargo area or sit or lie on folded seatbacks while the vehicle is moving. All passengers must be properly seated in seats and restrained properly while riding.
- When resetting the seatback to the upright position, make sure it is securely latched by pushing it forward and rearwards.
- To avoid the possibility of burns, do not remove the carpet in the cargo area. Emission control devices beneath this floor generate high temperatures.

(Continued)

(Continued)

- Luggage and other cargo should be laid flat in the cargo area or on the folded rear seatback. If objects are large, heavy, or must be piled, they must be secured. Under no circumstances should cargo be piled higher than the seatbacks. Failure to follow these warnings could result in serious injury or death in the event of a sudden stop, collision or rollover.

⚠ WARNING

After adjusting the seat, always check that it is securely locked into place by attempting to move the seat forward or reverse without using the lock release lever. Sudden or unexpected movement of the driver's seat could cause you to lose control of the vehicle resulting in an accident.

⚠ WARNING

- Do not adjust the seat while wearing seat belts. Moving the seat cushion forward may cause strong pressure on the abdomen.
- Use extreme caution so that hands or other objects are not caught in the seat mechanisms while the seat is moving.
- Do not place a cigarette lighter on the floor or seat. When you operate the seat, gas may exit out of the lighter and cause a fire.
- Use extreme caution when picking small objects trapped under the seats or between the seat and the center console. Your hands might be cut or injured by the sharp edges of the seats mechanism.

Front seat adjustment - Manual (if equipped)

Forward and rearward

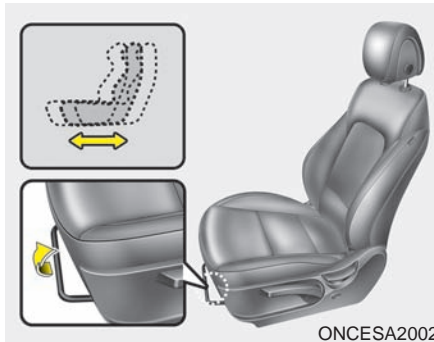

To move the seat forward or rearward:

1. Pull the seat slide adjustment lever up and hold it.
2. Slide the seat to the position you desire.
3. Release the lever and make sure the seat is locked in place.

Adjust the seat before driving, and make sure the seat is locked securely by trying to move forward and rearward without using the lever. If the seat moves, it is not locked properly.

Seatback angle

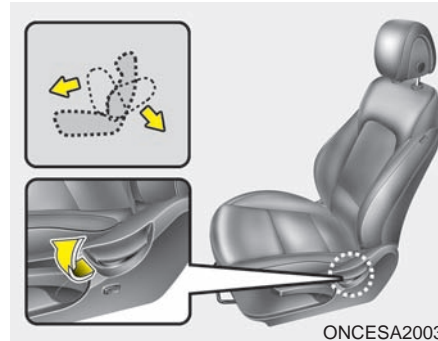

To recline the seatback:

1. Lean forward slightly and lift up the seatback recline lever.
2. Carefully lean back on the seat and adjust the seatback of the seat to the position you desire.
3. Release the lever and make sure the seatback is locked in place. (The lever **MUST** return to its original position for the seatback to lock.)

Seat cushion height (for driver's seat) (if equipped)

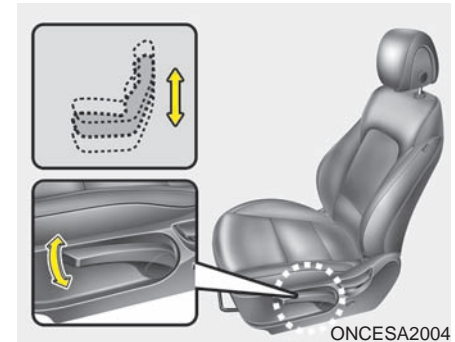

To change the height of the seat cushion, push the lever upwards or downwards.

- To lower the seat cushion, push the lever down several times.
- To raise the seat cushion, pull the lever up several times.

2-way lumbar support (for driver's seat)

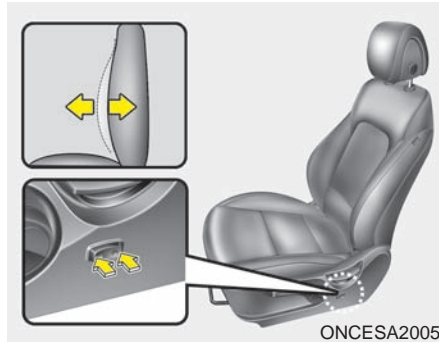

1. Press the front portion of the switch to increase support or the rear portion of the switch to decrease support.
2. Release the switch once it reaches the desired position.

Front seat adjustment - power (if equipped)

The front seat can be adjusted by using the control knobs located on the outside of the seat cushion. Before driving, adjust the seat to the proper position so as to easily control the steering wheel, pedals and switches on the instrument panel.

⚠ WARNING

**The power seat is operable with the ignition OFF.
Therefore, children should never be left unattended in the vehicle.**

⚠ CAUTION

- *The power seat is driven by an electric motor. Stop operating once the adjustment is completed. Excessive operation may damage the electrical equipment.*
- *When in operation, the power seat consumes a large amount of electrical power. To prevent unnecessary battery drain, don't adjust the power seat longer than necessary while the engine is not running.*
- *Do not operate two or more power seat control knobs at the same time. Doing so may result in power seat motor or electrical component malfunction.*

Forward and backward

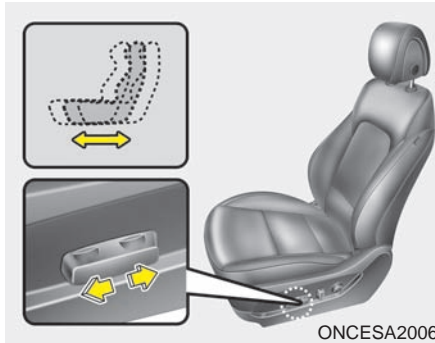

1. Push the control switch forward or backward to move the seat to the desired position.
2. Release the switch once the seat reaches the desired position.

Seatback angle

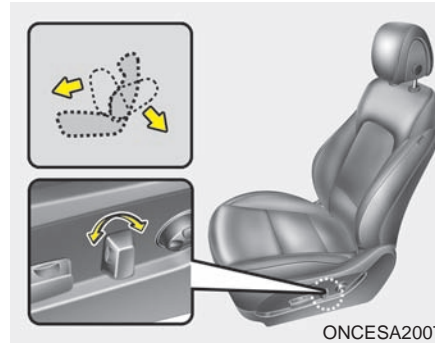

1. Push the control switch forward or backward to move the seatback to the desired angle.
2. Release the switch once the seat reaches the desired position.

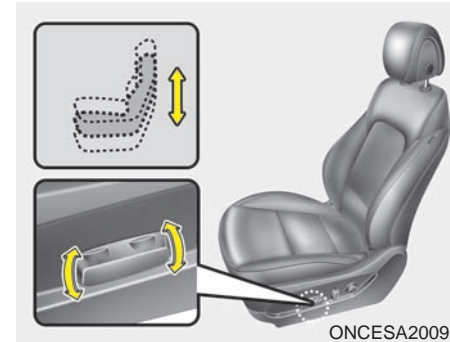

Seat height (for driver's seat)

1. Pull the front portion of the control switch up to raise or down to lower the front part of the seat cushion. Pull the rear portion of the control switch up to raise or down to lower the seat cushion.
2. Release the switch once the seat reaches the desired position.

4-way lumbar support (for driver's seat, if equipped)

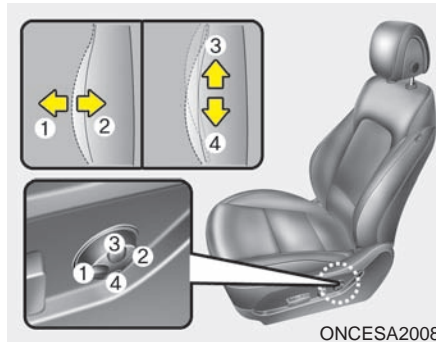

The lumbar support can be adjusted by pressing the switch.

1. Press the front portion (1) of the switch to increase support, or the rear portion (2) of the switch, to decrease support.
2. Release the switch once it reaches the desired position.
3. Press the upper portion (3) of the switch to move the support position up, or press the lower portion (4) of the switch, to move the support position down.
4. Release the switch once it reaches the desired position.

Driver position memory system (if equipped, for power seat)

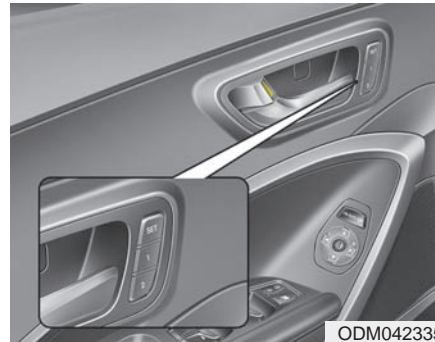

A driver position memory system is provided to store and recall the driver seat and outside rearview mirror position with a simple button operation. By saving the desired position into the system memory, different drivers can reposition the driver seat based upon their driving preference. If the battery is disconnected, the position memory will be erased and the driving position should be restored in the system.

⚠ WARNING

Never attempt to operate the driver position memory system while the vehicle is moving.

This could result in loss of control, and an accident causing death, serious injury, or property damage.

Storing positions into memory using the buttons on the door

Storing driver's seat positions

1. Shift the shift lever into P or N while the engine start/stop button is ON or ignition switch ON.
2. Adjust the driver's seat and outside rearview mirror to a position that is comfortable for the driver.
3. Press SET button on the control panel. The system will beep once.
4. Press one of the memory buttons (1 or 2) within 5 seconds after pressing the SET button. The system will beep twice when memory has been successfully stored.

Recalling positions from memory

The position in memory will be recalled when:

1. The shift lever is in P or N with one of the condition below:
 - The ignition switch in the ON position or engine running.
 - The ignition switch in the LOCK/OFF or ACC position while the driver's door is opened.
2. Press the desired memory button (1 or 2). The system will beep once, then the driver's seat will automatically adjust to the stored position.

Adjusting the control switch for the driver's seat while the system is recalling the stored position will cause the movement to stop and move in the direction that the control switch is moved.

⚠ WARNING

Use caution when recalling the adjustment memory while sitting in the vehicle. Push the seat position control switch to the desired position immediately if the seat moves too far in any direction.

Easy access function (if equipped)

The system will move the driver's seat automatically as follows:

- Without smart key system
 - It will move the driver's seat rearward when the ignition key is removed and front driver's door is opened.
 - It will move the driver's seat forward when the ignition key is inserted.
- With smart key system
 - It will move the driver's seat rearward when the engine start/stop button is changed to the OFF position and front driver's door is opened.
 - It will move the driver's seat forward when the engine start/stop button is changed to the ACC or START position.

You can activate or deactivate this feature. Refer to "User settings" in section 4.

Headrest

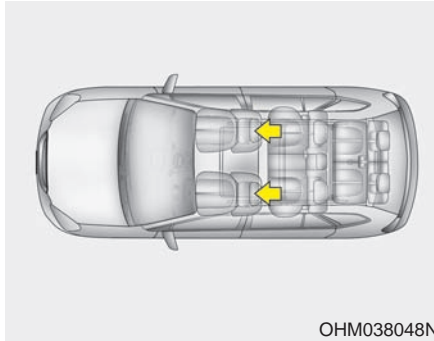

The driver's and front passenger's seats are equipped with a headrest for the occupant's safety and comfort. The headrest not only provides comfort for the driver and front passenger, but also helps to protect the head and neck in the event of a collision.

⚠ WARNING - Headrest adjustment

- For maximum effectiveness in case of an accident, the headrest should be adjusted so the middle of the headrest is at the same height as the center of gravity of an occupant's head. Generally, the center of gravity of most people's head is similar with the height of the top of their eyes.

Also adjust the headrest as close to your head as possible. For this reason, the use of a cushion that holds the body away from the seatback is not recommended.

- Do not operate the vehicle with the headrests removed. Severe injury to an occupant may occur in the event of an accident. Headrests may provide protection against severe neck injuries when properly adjusted.
- Do not adjust the headrest position of the driver's seat while the vehicle is in motion.

Forward and backward adjustment

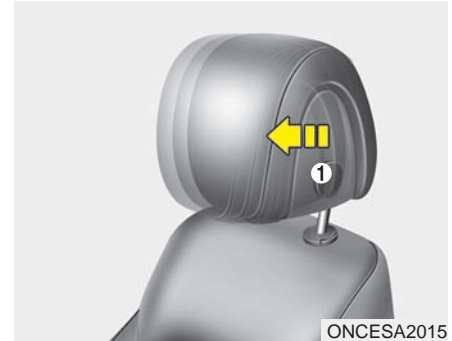

The headrest may be adjusted forward to 4 different positions by pulling the headrest forward to the desired detent. To adjust the headrest to backwards position, press and hold the release button (1), and adjust position of the headrest. Adjust the headrest so that it properly supports the head and neck.

Adjusting the height up and down

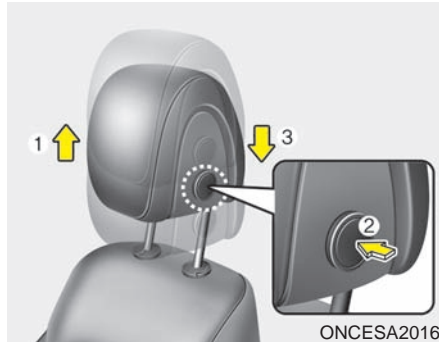

To raise the headrest :

1. Pull it up to the desired position (1).

To lower the headrest :

1. Push and hold the release button (2) on the headrest support
2. Lower the headrest to the desired position (3).

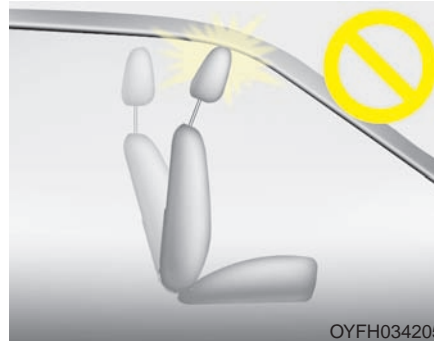

⚠ CAUTION

If you recline the seatback towards the front with the headrest and seat cushion raised, the headrest may come in contact with the sunvisor or other parts of the vehicle.

Removal and installation

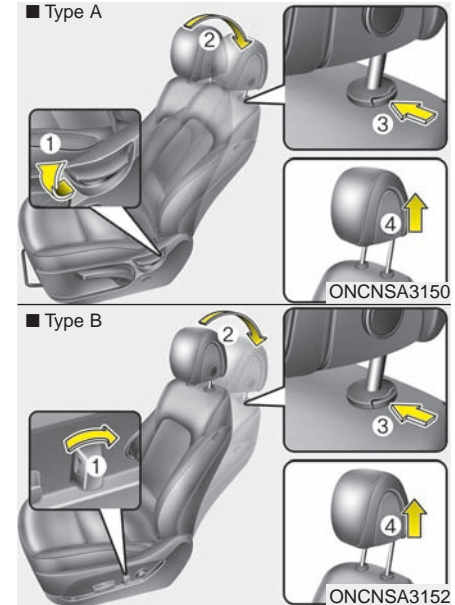

To remove the headrest:

1. Recline the seatback (2) with the recline lever or switch (1).
2. Raise headrest as far as it can go.

3. Press the headrest release button (3) while pulling the headrest up (4).

⚠ WARNING

NEVER allow anyone to ride in a seat with the headrest removed.

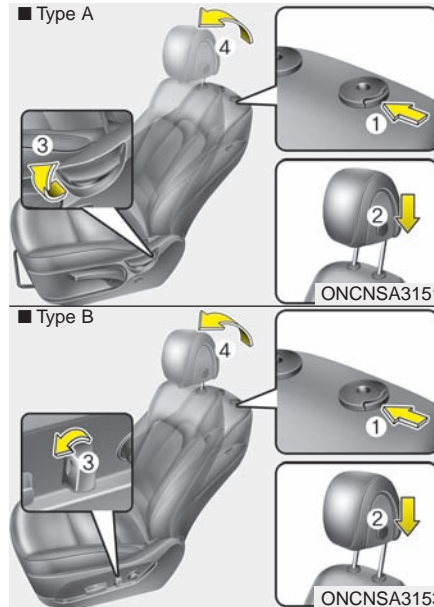

3. Adjust the headrest to the appropriate height.

⚠ WARNING

Always make sure the headrest locks into position after re-installing and adjusting it properly.

To reinstall the headrest :

1. Put the headrest poles (2) into the holes while pressing the release button (1).
2. Recline the seatback (4) with the recline lever or switch (3).

Seat warmer (if equipped)

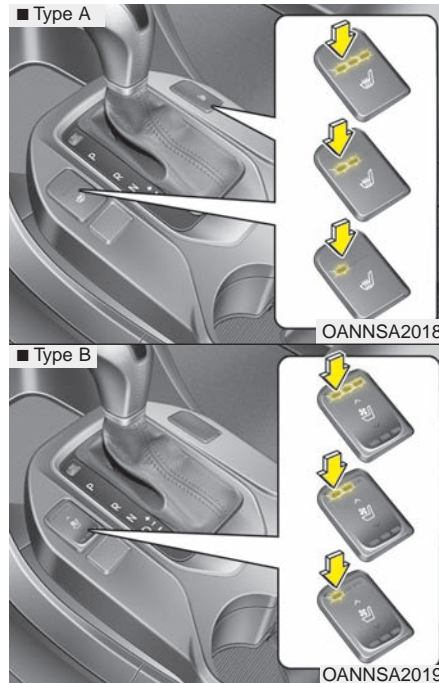

With the ignition switch in the ON position, push either of the switches (red color) to warm the driver's seat or the front passenger's seat.

During mild weather or under conditions where the operation of the seat warmer is not needed, keep the switches in the OFF position.

- Each time you push the button, the temperature setting of the seat is changed as follows :

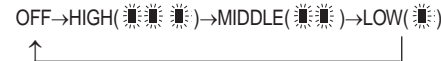

- The seat warmer defaults to the OFF position whenever the ignition switch is turned on.
- With the seat warmer switch in the ON position, the heating system in the seat turns off or on automatically depending on the seat temperature.

The seat warmer is provided to warm the front seats during cold weather.

⚠ CAUTION

- *When cleaning the seats, do not use an organic solvent such as thinner, benzene, alcohol and gasoline. Doing so may damage the surface of the heater or seats.*
- *To prevent overheating the seat warmer, do not place anything on the seats that insulates against heat, such as blankets, cushions or seat covers while the seat warmer is in operation.*
- *Do not place heavy or sharp objects on seats equipped with seat warmers. Damage to the seat warming components could occur.*

⚠ WARNING - Seat warmer burns

Never allow passengers who may not be able to take care of themselves to be exposed to the risk of seat warmer burns.

These include:

1. Infants, children, elderly or disabled persons, or hospital outpatients
2. Persons with sensitive skin or those that burn easily
3. Fatigued individuals
4. Intoxicated individuals
5. Individuals taking medication that can cause drowsiness or sleepiness (sleeping pills, cold tablets, etc.)

Air ventilation seat (if equipped)

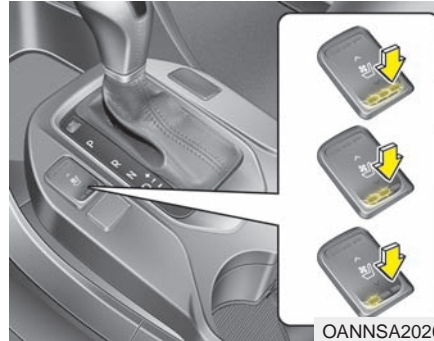

The air ventilation seat is provided to cool the front seats during hot weather by blowing air through small vent holes on the surface of the seats. While the engine is running, press the cooling portion (blue color) of the switch to cool the driver's seat or the front passenger's seat.

When the operation of the seat cooler is not needed, keep the switches in the OFF position.

- Each time you press the button, the airflow will change as follows:

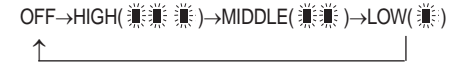

- The air ventilation seat defaults to the OFF position whenever the ignition switch is turned on.

Seatback pocket



⚠ WARNING

For proper operation of the occupant classification system:

- Do not place any items cumulatively weighing over 2.2 lbs (1 kg) in the seatback pocket or on the seat.

⚠ WARNING - Seatback pockets

Do not put heavy or sharp objects in the seatback pocket. An occupant could contact such objects in a crash. Heavy objects in the front passenger seatback could also interfere with the occupant sensing system.

Rear seat adjustment

Forward and backward
(if equipped)

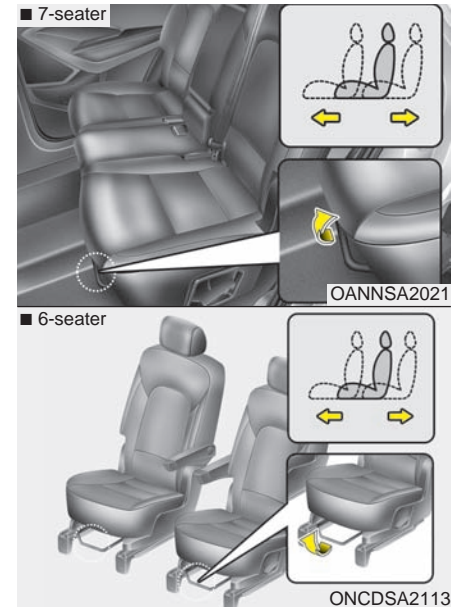

To move the seat forward or backward:

1. Pull the seat slide adjustment lever up and hold it.

2. Slide the seat to the position you desire.
3. Release the lever and make sure the seat is locked in place.

Adjust the seat before driving, and make sure the seat is locked securely by trying to move forward and backward without using the lever. If the seat moves, it is not locked properly.

Seatback angle

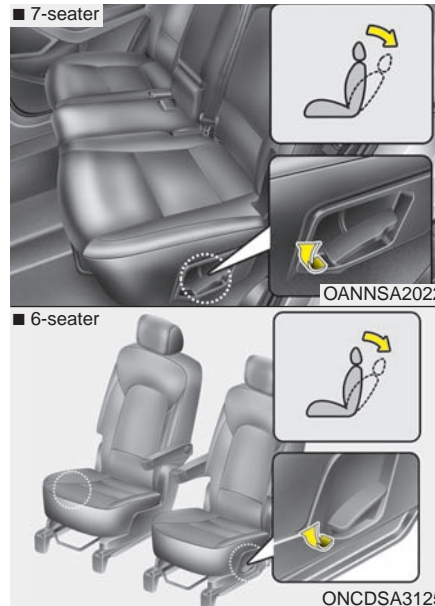

3. Release the lever and make sure the seatback is locked in place. (The lever **MUST** return to its original position for the seatback to lock.)

To recline the seatback:

1. Pull up the seatback recline lever.
2. Hold the lever and adjust the seatback of the seat to the position you desire.

Headrest (for rear seat)

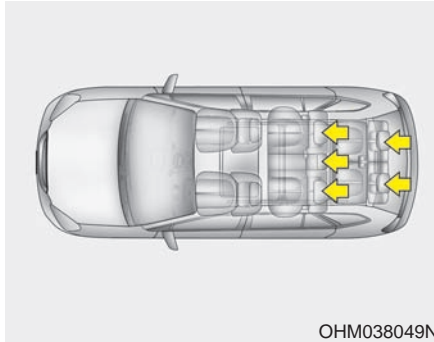

OHM038049N

The rear seat(s) is equipped with headrests in all the seating positions for the occupant's safety and comfort. The headrest not only provides comfort for passengers, but also helps to protect the head and neck in the event of a collision.

⚠ WARNING - Headrest adjustment



(Continued)

(Continued)

- For maximum effectiveness in case of an accident, the headrest should be adjusted so the middle of the headrest is at the same height as the center of gravity of an occupant's head. Generally, the center of gravity of most people's head is similar with the height of the top of their eyes. Also adjust the headrest as close to your head as possible. For this reason, the use of a cushion that holds the body away from the seatback is not recommended.
- Do not operate the vehicle with the headrests removed. Severe injury to an occupant may occur in the event of an accident. Headrests may provide protection against severe neck injuries when properly adjusted.
- Do not adjust the headrest height while the vehicle is in motion.

Adjusting the height up and down - 2nd row

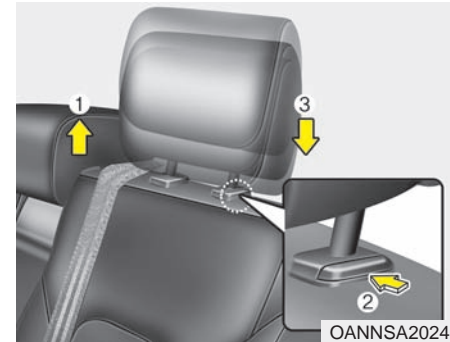

OANNSA2024

To raise the headrest :

1. Pull it up to the desired position (1).

To lower the headrest :

1. Push and hold the release button (2) on the headrest support
2. Lower the headrest to the desired position (3).

Removal and installation - 2nd row

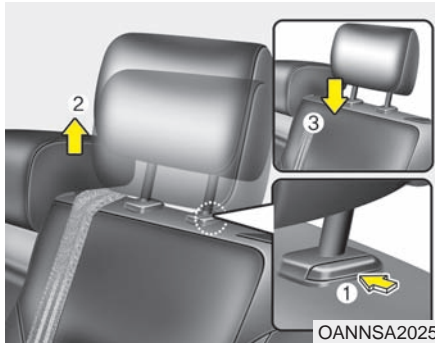

To remove the headrest :

1. Raise it as far as it can go then press the release button (1) while pulling the headrest up (2).

To reinstall the headrest :

1. Put the headrest poles (3) into the holes while pressing the release button (1).
2. Adjust it to the appropriate height.

⚠ WARNING

- Make sure the headrest locks in position after adjusting it to properly protect the occupants.
- After installing the headrest, make sure that it is installed in the right direction.
A headrest installed reversely could increase whiplash injury during rear impact.

Fold the headrest - 3rd row

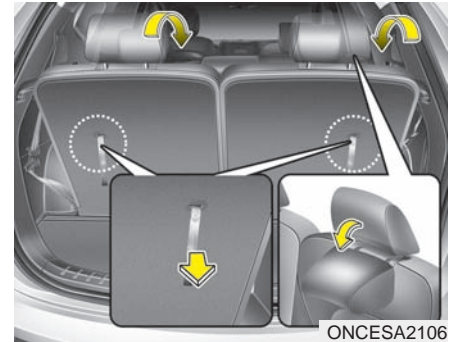

To fold the headrest :
Pull the strap.

Unfold the headrest - 3rd row

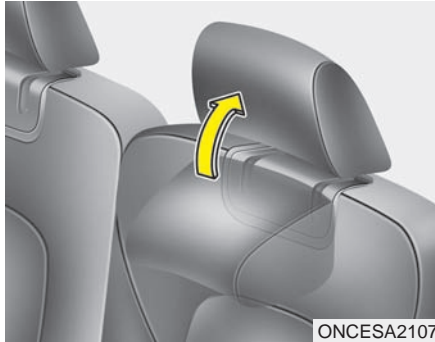

To unfold the headrest :
Raise the headrest manually.

Armrest

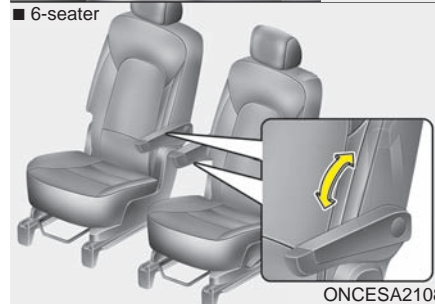

To use the armrest, pull it forward from the seatback.

Seat warmer (for rear seat, if equipped)

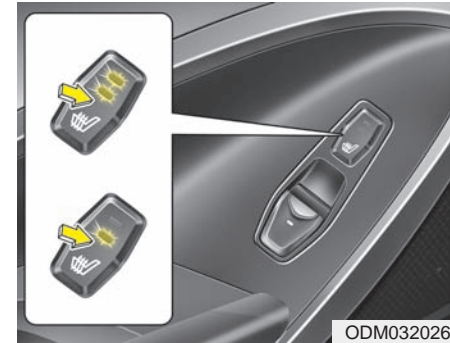

The seat warmer is provided to warm the rear seats during cold weather. With the ignition switch in the ON position, push either of the switches to warm the rear seats.

During mild weather or under conditions where the operation of the seat warmer is not needed, keep the switches in the OFF position.

Safety features of your vehicle

- Each time you push the button, the temperature setting of the seat is changed as follows :

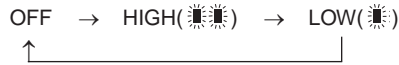

- The seat warmer defaults to the OFF position whenever the ignition switch is turned on.
- With the seat warmer switch in the ON position, the heating system in the seat turns off or on automatically depending on the seat temperature.

CAUTION

- *When cleaning the seats, do not use an organic solvent such as thinner, benzene, alcohol and gasoline. Doing so may damage the surface of the heater or seats.*
- *To prevent overheating the seat warmer, do not place anything on the seats that insulates against heat, such as blankets, cushions or seat covers while the seat warmer is in operation.*
- *Do not place heavy or sharp objects on seats equipped with seat warmers. Damage to the seat warming components could occur.*

WARNING - Seat warmer burns

Never allow passengers who may not be able to take care of themselves to be exposed to the risk of seat warmer burns.

These include:

1. Infants, children, elderly or disabled persons, or hospital outpatients
2. Persons with sensitive skin or those that burn easily
3. Fatigued individuals
4. Intoxicated individuals
5. Individuals taking medication that can cause drowsiness or sleepiness (sleeping pills, cold tablets, etc.)

**Walk-in seat
(2nd row seat, if equipped)**

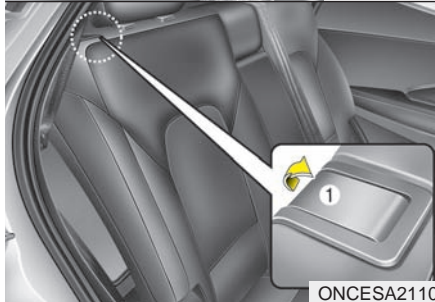
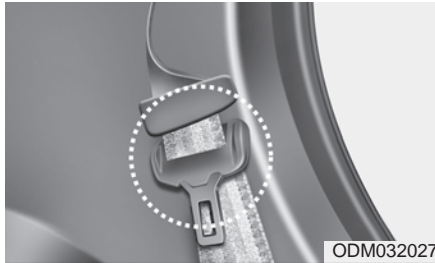

To get in or out of the 3rd row seat,

1. Route the seat belt webbing through the rear seat belt guide clip. After inserting the seat belt, tighten the belt webbing by pulling it up.
2. Pull up the walk-in lever (1) on the 2nd row seatback.

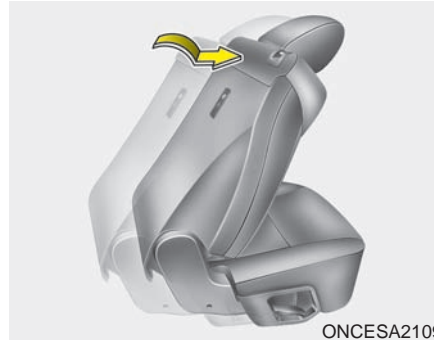

3. The 2nd row seatback will be folded and push the seat to the farthest forward position.

After getting in or out, slide the 2nd row seat to the farthest rearward position and pull the seatback firmly backward until it clicks into place. Make sure that the seat is locked in place.

⚠ WARNING

Never attempt to adjust while the vehicle is moving or while the 2nd row seat is occupied as the seat may suddenly move and cause the seated passenger to be injured.

Folding the rear seat

The rear seatbacks can be folded to facilitate carrying long items or to increase the luggage capacity of the vehicle.

⚠ WARNING

- **Never allow passengers to sit on top of the folded down seatback while the vehicle is moving. This is not a proper seating position and no seat belts are available for use. This could result in serious injury or death in case of an accident or sudden stop.**
- **Objects carried on the folded down seatback should not extend higher than the top of the front seatbacks. Doing this could allow cargo to slide forward and cause injury or damage during sudden stops.**

■ 2nd row seat

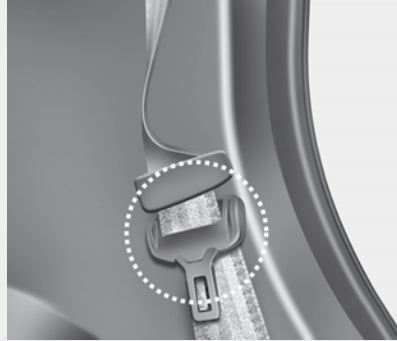
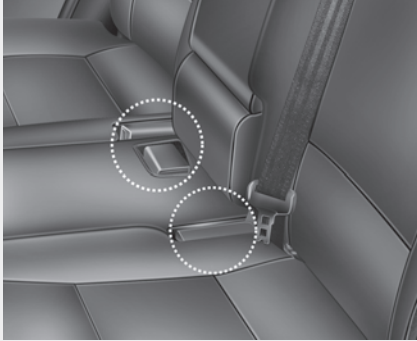

■ 3rd row seat

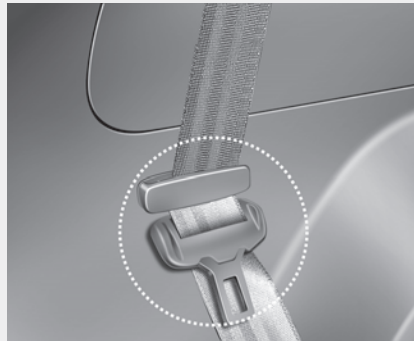
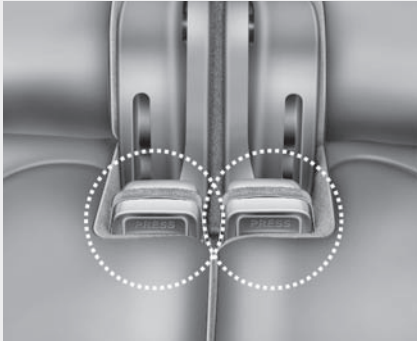

ODM032034/OXM039030/ODM032027/ODM032035

To fold down the rear seatback

1. Insert the rear seat belt buckle in the pocket between the rear seatback and cushion, and insert the rear seat belt webbing in the guide to prevent the seat belt from being damaged.
2. Set the front seatback to the upright position and if necessary, slide the front seat forward.
3. Lower the rear headrests to the lowest position.

■ 2nd row seat

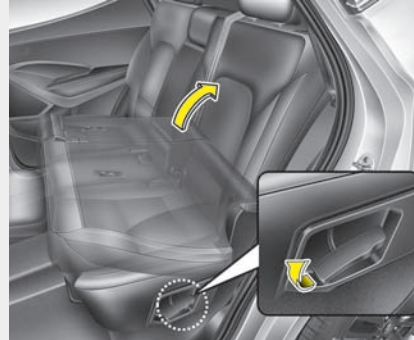
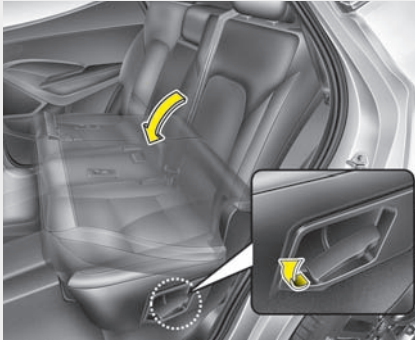

■ 3rd row seat

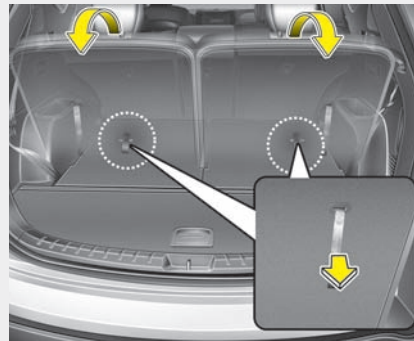
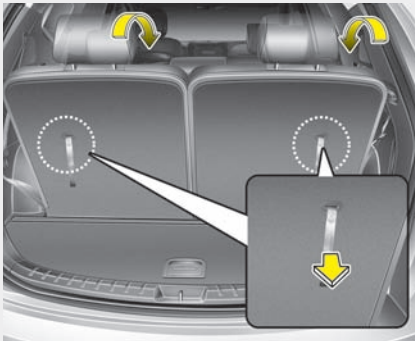

OANNSA2026/ONCESA2100/OANNSA2027/ONCESA2102

4. Pull on the seatback folding lever, then fold the seat toward the front of the vehicle. When you return the seatback to its upright position, always be sure it has locked into position by pushing on the top of the seatback.

5. To use the rear seat, lift and pull the seatback backward by pulling on the folding lever (2nd row) or strap (3rd row).

Pull the seatback firmly until it clicks into place.

Make sure the seatback is locked in place.

6. Return the rear seat belt to the proper position.

**2nd row seat folding
(from outside, if equipped)**

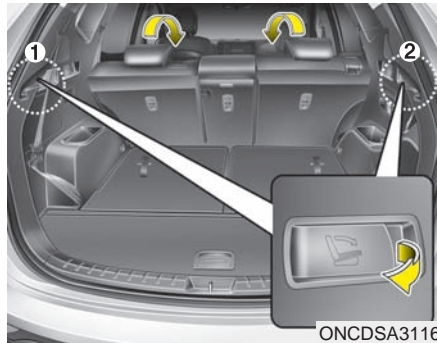

Pull the 2nd row seat back folding lever out.

The 2nd row seat back will be folded.

If you pull the left side lever (1) out, left side seat back and center seat back will be folded.

If you pull the right side lever (2) out, right side seat back will be folded.

⚠ WARNING - Rear seat folding

Do not fold the rear seats (2nd & 3rd row seats), if passengers, pets or luggage are in the rear seats.

It may cause injury or damage to passengers, pets or luggage.

To fold down the rear center seat-back (for 2nd row seat)

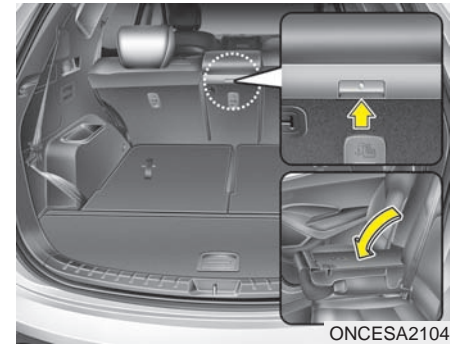

1. Lower the rear headrests to the lowest position.

2. Push the center seatback folding lever up, then fold the seat toward the front of the vehicle.

When you return the seatback to its upright position, always be sure it has locked into position by pushing on the top of the seatback.

⚠ WARNING - 2nd row center seat folding



- Do not fold the 2nd row center seat, if occupants are seated in the 3rd row seats, it may cause injury to occupants by the seat device.

If occupants are seated in the 3rd row seats, fix the upright position of the 2nd row center seat.

- The 2nd row center seat back does not fix when it is folded. If you use the 2nd row center seat back folding function to carry long objects, you should fix the long object to prevent it from being thrown about the vehicle in a collision and causing injury to vehicle occupants.

⚠ WARNING - Uprighting seat

When you return the seatback to its upright position, hold the seatback and return it slowly. If the seatback is returned without holding it, the back of the seat could spring forward resulting in injury caused by being struck by the seatback.

⚠ WARNING - 2nd row LH seat folding

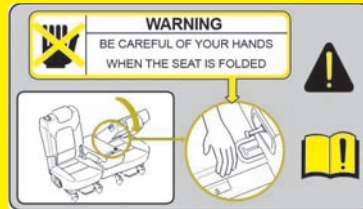

Be careful when you fold the 2nd row LH seat, if the center seat is folded. It may cause the injury to you by the seat device.

⚠ CAUTION - Damaging rear seat belt buckles

When you fold the rear (2nd and/or 3rd row) seatback, insert the buckle in the pocket between the rear seatback and cushion. Doing so can prevent the buckle from being damaged by the rear seatback.

⚠ CAUTION - Rear seat belts

When returning the rear (2nd and/or 3rd row) seatbacks to the upright position, remember to return the rear shoulder belts to their proper position. Routing the seat belt webbing through the rear seat belt guides will help keep the belts from being trapped behind or under the seats.

⚠ WARNING - Cargo

Cargo should always be secured to prevent it from being thrown about the vehicle in a collision and causing injury to the vehicle occupants. Do not place objects in the rear (2nd and/or 3rd row) seats, since they cannot be properly secured and may hit the front seat occupants in a collision.

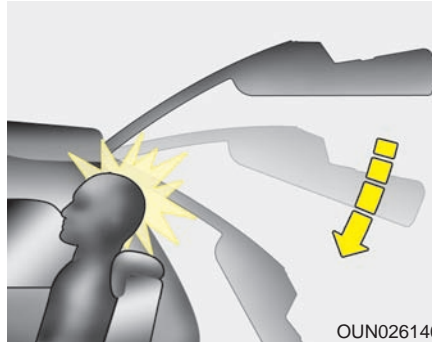

⚠ WARNING - Cargo loading

Make sure the engine is off, the automatic transaxle is in P (Park) and the parking brake is securely applied whenever loading or unloading cargo. Failure to take these steps may allow the vehicle to move if the shift lever is inadvertently moved to another position.

⚠ WARNING

If the liftgate (tailgate) is pushed down to close it when a passenger's head is not against a properly adjusted headrest or a tall person is seated, the liftgate (tailgate) may hit the occupant's head, which could cause injury.

SEAT BELTS

Seat belt restraint system

WARNING

- For maximum restraint system protection, the seat belts must always be used whenever the car is moving.
- Seat belts are most effective when seatbacks are in the upright position.
- Children age 12 and younger must always be properly restrained in the rear seat. Never allow children to ride in the front passenger seat. If a child over 12 must be seated in the front seat, he/she must be properly belted and the seat should be moved as far back as possible.

(Continued)

(Continued)

- Never wear the shoulder belt under your arm or behind your back. An improperly positioned shoulder belt can cause serious injuries in a crash. The shoulder belt should be positioned midway over your shoulder across your collarbone.
- Always wear both the shoulder portion and lap portion of the lap/shoulder belt.
- Avoid wearing twisted seat belts. A twisted belt can't do its job as well. In a collision, it could even cut into you. Be sure the belt webbing is straight and not twisted.
- Be careful not to damage the belt webbing or hardware. If the belt webbing or hardware is damaged, replace it.

WARNING

Seat belts are designed to bear upon the bony structure of the body, and should be worn low across the front of the pelvis, chest and shoulders, as applicable; wearing the lap section of the belt across the abdominal area must be avoided.

Seat belts should be adjusted as firmly as possible, consistent with comfort, to provide the protection for which they have been designed.

A slack belt will greatly reduce the protection afforded to the occupant.

(Continued)

(Continued)

Care should be taken to avoid contamination of the webbing with polishes, oils and chemicals and particularly battery acid. Cleaning may safely be carried out using mild soap and water. The belt should be replaced if webbing becomes frayed, contaminated or damaged. It is essential to replace the entire assembly after it has been worn in a severe impact even if damage to the assembly is not obvious. Belts should not be worn with straps twisted. Each seat belt assembly must only be used by one occupant; it is dangerous to put a belt around a child being carried on the occupant's lap.

⚠ WARNING

- No modifications or additions should be made by the user which will either prevent the seat belt adjusting devices from operating to remove slack, or prevent the seat belt assembly from being adjusted to remove slack.
- When you fasten the seat belt, be careful not to latch the seat belt in the buckles of another. It's very dangerous and you may not be protected by the seat belt properly.
- Do not unfasten the seat belt and do not fasten and unfasten the seat belt repeatedly while driving. This could result in loss of control, and an accident causing death, serious injury, or property damage.
- Make sure there is nothing in the buckle. The seat belt may not be fastened securely.

Seat belt warning (for driver's seat)



The driver's seat belt warning light and chime will activate to the following table when the ignition switch is in "ON" position.

Conditions		Warning Pattern	
Seat Belt	Vehicle Speed	Light-Blink	Chime-Sound
Unbuckled		6 seconds	
Buckled		6 seconds	None
Buckled → Unbuckled	Below 3 mph (5 km/h)	6 seconds	None
	3 mph~ 6 mph	6 seconds	
	Above 6 mph (10 km/h)	6 sec. on / 24 sec. off (11 times)	
Unbuckled	Above 6 mph (10 km/h)	6 seconds *1	
	↓ Below 3 mph (5 km/h)	↓ Stop *2	

*1 Warning pattern repeats 11 times with an interval of 24 seconds. If the driver's seat belt is buckled, the light will stop within 6 seconds and chime will stop immediately.

*2 The light will stop within 6 seconds and chime will stop immediately.

Seat belt - Driver's and passenger's 3-point system with emergency locking retractor

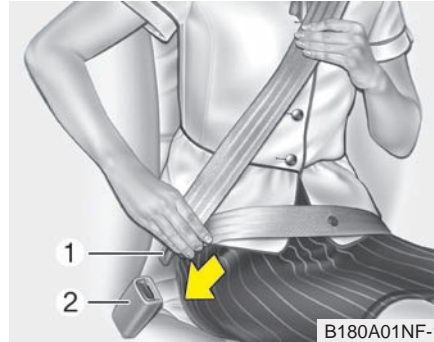

To fasten your seat belt:

To fasten your seat belt, pull it out of the retractor and insert the metal tab (1) into the buckle (2). There will be an audible "click" when the tab locks into the buckle.

The seat belt automatically adjusts to the proper length only after the lap belt portion is adjusted manually so that it fits snugly around your hips. If you lean forward in a slow, easy motion, the belt will extend and let you move around. If there is a sudden stop or impact, however, the belt will lock into position. It will also lock if you try to lean forward too quickly.

If you are not able to pull out the seat belt from the retractor, firmly pull the belt out and release it. Then you will be able to pull the belt out smoothly.

Height adjustment (Front)

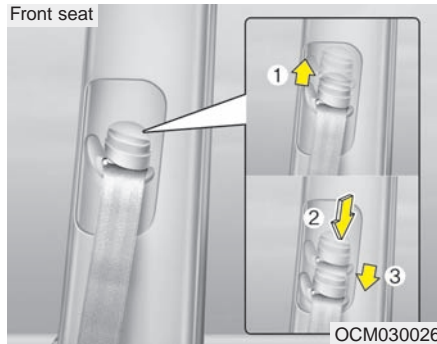

You can adjust the height of the shoulder belt anchor to one of 4 positions for maximum comfort and safety.

The shoulder portion should be adjusted so that it lies across your chest and midway over your shoulder nearest the door and not your neck.

The height of the adjusting seat belt should not be too near your neck.

To adjust the height of the seat belt anchor, lower or raise the height adjuster into an appropriate position.

To raise the height adjuster, pull it up (1). To lower it, push it down (3) while pressing the height adjuster button (2). Release the button to lock the anchor into position. Try sliding the height adjuster to make sure that it has locked into position.

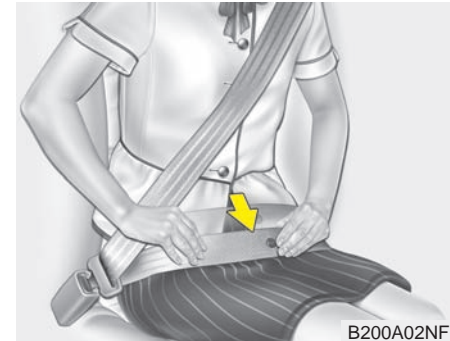

⚠ WARNING

Improperly positioned seat belts may increase the risk of serious injury in an accident. Take the following precautions when adjusting the seat belt:

- **Position the lap portion of the seat belt as low as possible across your hips, not on your waist, so that it fits snugly.**

(Continued)

(Continued)

- **Position one arm under the shoulder belt and the other over the belt, as shown in the illustration.**
- **Always position the shoulder belt anchor into the locked position at the appropriate height.**
- **Never position the shoulder belt across your neck or face.**

Seat belts - Rear seat 3-point system with combination locking retractor

To fasten your seat belt:

Combination retractor type seat belts are installed in the rear seat positions to help accommodate the installation of child restraint systems. Although a combination retractor is also installed in the front passenger seat position, it is strongly recommended that children always be seated in the rear seat. NEVER place any infant restraint system in the front seat of the vehicle.

This type of seat belt combines the features of both an emergency locking retractor seat belt and an automatic locking retractor seat belt. To fasten your seat belt, pull it out of the retractor and insert the metal tab into the buckle. There will be an audible "click" when the tab locks into the buckle. When not securing a child restraint, the seat belt operates in the same way as the driver's seat belt (Emergency Locking Retractor Type). It automatically adjusts to the proper length only after the lap belt portion of the seat belt is adjusted manually so that it fits snugly around your hips.

When the seat belt is fully extended from the retractor to allow the installation of a child restraint system, the seat belt operation changes to allow the belt to retract, but not to extend (Automatic Locking Retractor Type). Refer to "Using a child restraint system" in this section.

To convert from the automatic locking feature to the emergency locking operation mode, allow the unbuckled seat belt to fully retract.

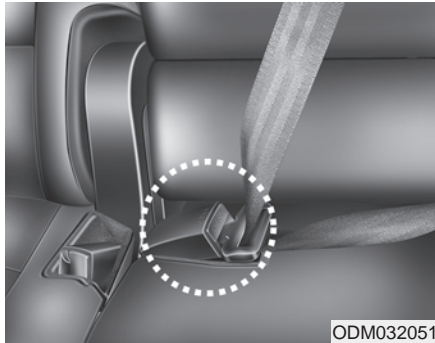

When using the rear center seat belt, the buckle with the "CENTER" mark must be used.

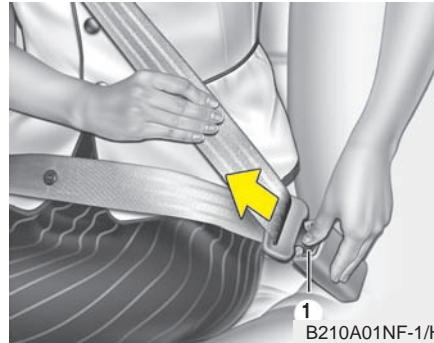

To release the seat belt:

The seat belt is released by pressing the release button (1) in the locking buckle. When it is released, the belt should automatically draw back into the retractor.

If this does not happen, check the belt to be sure it is not twisted, then try again.

Stowing the rear seat belt

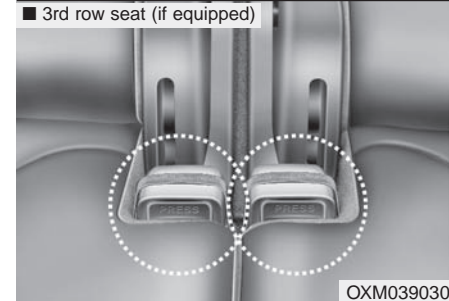
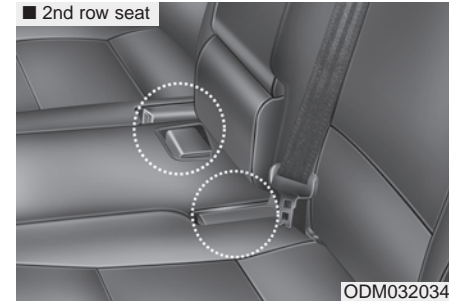

- The rear seat belt buckles can be stowed in the pocket between the rear seatback and cushion when not in use.

■ 2nd row seat

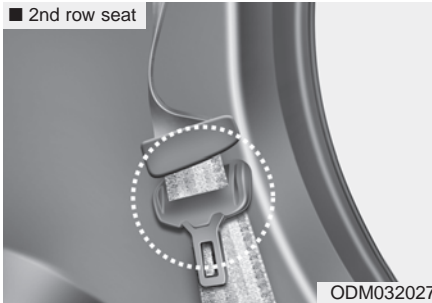

■ 3rd row seat (if equipped)

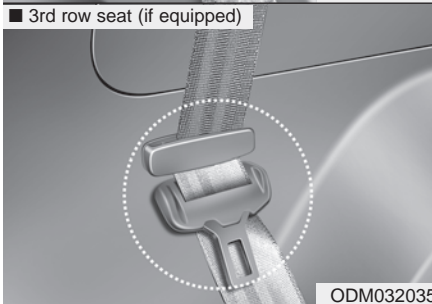

⚠ CAUTION

When using the seat belt, use it after taking it out of the guides. If you pull the seat belt when it is stored in the guides, it may damage the guides and/or belt webbing.

Pre-tensioner seat belt



Your vehicle is equipped with pre-tensioner seatbelts in the front seating positions (driver side with retractor pre-tensioner, passenger side with retractor and EFD (Emergency Fastening Device)).

The pre-tensioner seat belts can be activated, where the frontal collisions (or side collisions or rollovers) are severe enough, together with the air bags.

- Routing the seat belt webbing through the rear seat belt guides will help keep the belts from being trapped behind or under the seats. After inserting the seat belt, tighten the belt webbing by pulling it up.

When the vehicle stops suddenly, or if the occupant tries to lean forward too quickly, the seat belt retractor will lock into position. In certain frontal collisions (or side collisions or rollovers), the pre-tensioner will activate and pull the seat belt into tighter contact against the occupant's body.

(1) Retractor Pretensioner

The purpose of the retractor pre-tensioner is to make sure that the shoulder belts fit in tightly against the occupant's upper body in certain frontal collisions (or side collisions or rollovers).

(2) EFD (Emergency Fastening Device)

The purpose of the EFD is to make sure that the pelvis belts fit in tightly against the occupant's lower body in certain frontal collisions (or rollovers). (for passenger's side)

If the system senses excessive tension on the driver or passenger's seat belt when the pre-tensioner system activates, the load limiter inside the retractor pre-tensioner will release some of the pressure on the affected seat belt.

⚠ WARNING

- **Do not put anything near the buckle. Placing objects near the buckle may increase the risk of personal injury in the event of a collision.**
- **For your safety, be sure that the belt webbing is not loose or twisted and always sit properly on your seat.**

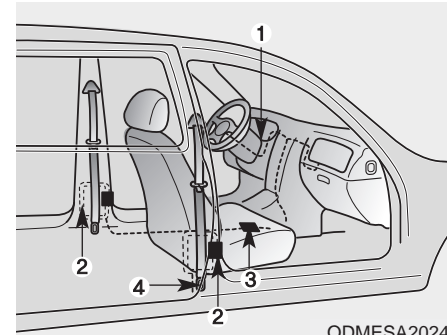

ODMESA2024

The seat belt pre-tensioner system consists mainly of the following components. Their locations are shown in the illustration:

1. SRS air bag warning light
2. Retractor pre-tensioner assembly
3. SRS control module
4. Emergency fastening device (EFD)

⚠ WARNING

To obtain maximum benefit from a pre-tensioner seat belt:

1. The seat belt must be worn correctly and adjusted to the proper position. Please read and follow all of the important information and precautions about your vehicle's occupant safety features – including seat belts and air bags – that are provided in this manual.
2. Be sure you and your passengers always wear seat belts properly.

*** NOTICE**

- Both the driver's and front passenger's seat belt pre-tensioner system may be activated not only in certain frontal collision but also in certain side collision or rollover, if the vehicle is equipped with a side or curtain air bag.
- When the pre-tensioner seat belts are activated, a loud noise may be heard and fine dust, which may appear to be smoke, may be visible in the passenger compartment. These are normal operating conditions and are not hazardous.
- Although it is harmless, the fine dust may cause skin irritation and should not be breathed for prolonged periods. Wash all exposed skin areas thoroughly after an accident in which the pre-tensioner seat belts were activated.
- Because the sensor that activates the SRS air bag is connected with the pre-tensioner seat belt, the SRS air bag warning light  on the instrument panel will illuminate for approximately 6 seconds after the ignition switch has been turned to the ON position, and then it should turn off.

⚠ CAUTION

If the pre-tensioner seat belt system are not working properly, this warning light will illuminate even if there is no malfunction of the SRS air bag. If the SRS air bag warning light blinks or does not illuminate when the ignition switch is turned ON, or if it remains illuminated after illuminating for approximately 6 seconds, or if it illuminates while the vehicle is being driven, have an authorized HYUNDAI dealer inspect the pre-tensioner seat belt and SRS air bag system as soon as possible.

⚠ WARNING

- Pre-tensioner seatbelt systems are designed to operate only one time. After activation, pre-tensioner seat belts must be replaced. All seat belts, of any type, should always be replaced after they have been worn during a collision.
- The pre-tensioner seat belt assembly mechanisms become hot during activation. Do not touch the pre-tensioner seat belt assemblies for several minutes after they have been activated.
- Do not attempt to inspect or replace the pre-tensioner seat belts yourself. This must be done by an authorized HYUNDAI dealer.
- Do not strike the pre-tensioner seat belt assemblies.
- Do not attempt to service or repair the pre-tensioner seat belt system in any manner.

(Continued)

(Continued)

- Improper handling of the pre-tensioner seat belt assemblies, and failure to heed the warnings not to strike, modify, inspect, replace, service or repair the pre-tensioner seat belt assemblies may lead to improper operation or inadvertent activation and serious injury.
- Always wear the seat belts when driving or riding in a motor vehicle.
- If the vehicle or pre-tensioner seat belt must be discarded, contact an authorized HYUNDAI dealer.

Seat belt precautions

⚠ WARNING

All occupants of the vehicle must wear their seat belts at all times. Seat belts and child restraints reduce the risk of serious or fatal injuries for all occupants in the event of a collision or sudden stop. Without a seat belt, occupants could be shifted too close to a deploying air bag, strike the interior structure or be thrown from the vehicle. Properly worn seat belts greatly reduce these hazards.

Even with advanced air bags, unbelted occupants can be severely injured by a deploying air bag.

Always follow the precautions about seat belts, air bags and occupant seating contained in this manual.

Infant or small child

All 50 states have child restraint laws. You should be aware of the specific requirements in your state. Child and/or infant seats must be properly placed and installed in the rear seat. For more information about the use of these restraints, refer to “Child restraint system” in this section.

⚠ WARNING

Every person in your vehicle needs to be properly restrained at all times, including infants and children. Never hold a child in your arms or lap when riding in a vehicle. The violent forces created during a crash will tear the child from your arms and throw the child against the interior. Always use a child restraint appropriate for your child's height and weight.

*** NOTICE**

Small children are best protected from injury in an accident when properly restrained in the rear seat by a child restraint system that meets the requirements of the Federal Motor Vehicle Safety Standards. Before buying any child restraint system, make sure that it has a label certifying that it meets Federal Motor Vehicle Safety Standard 213. The restraint must be appropriate for your child's height and weight. Check the label on the child restraint for this information. Refer to “Child restraint system” in this section.

Larger children

Children who are too large for child restraint systems should always occupy the rear seat and use the available lap/shoulder belts. The lap portion should be fastened snug on the hips and as low as possible. Check belt fit periodically. A child's squirming could put the belt out of position. Children are afforded the most safety in the event of an accident when they are restrained by a proper restraint system in the rear seat. If a larger child (over age 12) must be seated in the front seat, the child should be securely restrained by the available lap/shoulder belt and the seat should be placed in the rear-most position. Children age 12 and under should be restrained securely in the rear seat. NEVER place a child age 12 and under in the front seat. NEVER place a rear facing child seat in the front seat of a vehicle.

If the shoulder belt portion slightly touches the child's neck or face, try placing the child closer to the center of the vehicle. If the shoulder belt still touches their face or neck they need to be returned to a child restraint system.

⚠ WARNING - Shoulder belts on small children

- Never allow a shoulder belt to be in contact with a child's neck or face while the vehicle is in motion.
- If seat belts are not properly worn and adjusted on children, there is a risk of death or serious injury.

Pregnant women

The use of a seat belt is recommended for pregnant women to lessen the chance of injury in an accident. When a seat belt is used, the lap belt portion should be placed as low and snugly as possible on the hips, not across the abdomen. For specific recommendations, consult a physician.

⚠ WARNING - Pregnant women

Pregnant women must never place the lap portion of the safety belt over the area of the abdomen where the unborn child is located or above the abdomen where the belt could seriously injure or even cause the death of the unborn child during an impact.

Injured person

A seat belt should be used when an injured person is being transported. When this is necessary, you should consult a physician for recommendations.

One person per belt

Two people (including children) should never attempt to use a single seat belt. This could increase the severity of injuries in case of an accident.

Do not lie down

To reduce the chance of injuries in the event of an accident and to achieve maximum effectiveness of the restraint system, all passengers should be sitting up and the front and rear seats should be in an upright position when the car is moving. A seat belt cannot provide proper protection if the person is lying down in the rear seat or if the seats are in a reclined position.

⚠ WARNING

Riding with a reclined seatback increases your chance of serious or fatal injuries in the event of a collision or sudden stop. The protection of your restraint system (seat belts and air bags) is greatly reduced by reclining your seat. Seat belts must be snug against your hips and chest to work properly. The more the seatback is reclined, the greater the chance that an occupant's hips will slide under the lap belt causing serious internal injuries or the occupant's neck could strike the shoulder belt. Drivers and passengers should always sit well back in their seats, properly belted, and with the seatbacks upright.

Care of seat belts

Seat belt systems should never be disassembled or modified. In addition, care should be taken to assure that seat belts and belt hardware are not damaged by seat hinges, doors or other abuse.

⚠ WARNING - Pinched seat belt

Make sure that the webbing and/or buckle does not get caught or pinched in the rear seat when returning the rear seatback to its upright position. A caught or pinched webbing/buckle may become damaged and could fail during a collision or sudden stop resulting in serious injury or death.

Periodic inspection

All seat belts should be inspected periodically for wear or damage of any kind. Any damaged parts should be replaced as soon as possible.

Keep belts clean and dry

Seat belts should be kept clean and dry. If belts become dirty, they can be cleaned by using a mild soap solution and warm water. Bleach, dye, strong detergents or abrasives should not be used because they may damage and weaken the fabric.

When to replace seat belts

Entire in-use seat belt assembly or assemblies should be replaced if the vehicle has been involved in an accident. This should be done even if no damage is visible. Additional questions concerning seat belt operation should be directed to an authorized HYUNDAI dealer.

CHILD RESTRAINT SYSTEM

Children riding in the car should sit in the rear seat and must always be properly restrained to minimize the risk of injury in an accident, sudden stop or sudden maneuver. According to accident statistics, children are safer when properly restrained in the rear seats than in the front seat. Larger children not in a child restraint should use one of the seat belts provided.

You should be aware of the specific requirements in your state. Child and/or infant safety seats must be properly placed and installed in the rear seat. You must use a commercially available child restraint system that meets the requirements of the Federal Motor Vehicle Safety Standards (FMVSS).

Child restraint systems are designed to be secured in vehicle seats by lap belts or the lap belt portion of a lap/shoulder belt, or by a LATCH system (if equipped).

Children could be injured or killed in a crash if their restraints are not properly secured. For small children and babies, a child seat or infant seat must be used. Before buying a particular child restraint system, make sure it fits your car seat and seat belts, and fits your child. Follow all the instructions provided by the manufacturer when installing the child restraint system.

WARNING

- **A child restraint system must be placed in the rear seat. Never install a child or infant seat on the front passenger's seat. Should an accident occur and cause the passenger-side air bag to deploy, it could severely injure or kill an infant or child seated in an infant or child seat. Thus only use a child restraint in the rear seat of your vehicle.**

(Continued)

(Continued)

- **A seat belt or child restraint system can become very hot if it is left in a closed vehicle on a sunny day, even if the outside temperature does not feel hot. Be sure to check the seat cover and buckles before placing a child there.**
- **When the child restraint system is not in use, store it in the luggage area or fasten it with a seat belt so that it will not be thrown forward in the case of a sudden stop or an accident.**
- **Children may be seriously injured or killed by an inflating air bag. All children, even those too large for child restraints, must ride in the rear seat.**

⚠ WARNING

To reduce the chance of serious or fatal injuries:

- Children of all ages are safer when restrained in the rear seat. A child riding in the front passenger seat can be forcefully struck by an inflating air bag resulting in serious or fatal injuries.
- Always follow the child restraint system manufacturer's instructions for installation and use of the child restraint.
- Always make sure the child seat is secured properly in the car and your child is securely restrained in the child seat.
- Never hold a child in your arms or lap when riding in a vehicle. The violent forces created during a crash will tear the child from your arms and throw the child against the car's interior.

(Continued)

(Continued)

- Never put a seat belt over yourself and a child. During a crash, the belt could press deep into the child causing serious internal injuries.
- Never leave children unattended in a vehicle – not even for a short time. The car can heat up very quickly, resulting in serious injuries to children inside. Even very young children may inadvertently cause the vehicle to move, entangle themselves in the windows, or lock themselves or others inside the vehicle.
- Never allow two children, or any two persons, to use the same seat belt.
- Children often squirm and reposition themselves improperly. Never let a child ride with the shoulder belt under their arm or behind their back. Always properly position and secure children in the rear seat.

(Continued)

(Continued)

- Never allow a child to stand-up or kneel on the seat or floor of a moving vehicle. During a collision or sudden stop, the child can be violently thrown against the vehicle's interior, resulting in serious injury.
- Never use an infant carrier or a child safety seat that "hooks" over a seatback, it may not provide adequate security in an accident.
- Seat belts can become very hot, especially when the car is parked in direct sunlight. Always check seat belt buckles before fastening them over a child.
- After an accident, have an authorized HYUNDAI dealer check the child restraint system, seat belt, tether anchor and lower anchor.
- If there is not enough space to place the child restraint system because of the driver's seat, install the child restraint system in the rear right seat.

Using a child restraint system

Rearward-facing child restraint system

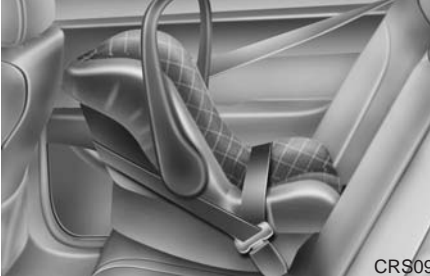

CRS09

Forward-facing child restraint system



OANNSA2032

For small children and babies, the use of a child seat or infant seat is required. This child seat or infant seat should be of appropriate size for the child and should be installed in accordance with the manufacturer's instructions.

For safety reasons, we recommend that the child restraint system be used in the rear seats.

⚠ WARNING

Never place a rear-facing child restraint in the front passenger seat, because of the danger that an inflating passenger-side air bag could impact the rear-facing child restraint and kill the child.

Since all passenger seat belts move freely under normal conditions and only lock under extreme or emergency conditions (emergency locking mode), you must manually change these seat belts to the automatic locking mode to secure a child restraint.

⚠ WARNING - Child seat installation

- **A child can be seriously injured or killed in a collision if the child restraint is not properly anchored to the vehicle and the child is not properly restrained in the child restraint.**

(Continued)

(Continued)

Before installing the child restraint system, read the instructions supplied by the child restraint system manufacturer.

- **If the seat belt does not operate as described in this section, have the system checked immediately by your authorized HYUNDAI dealer.**
- **Failure to observe this manual's instructions regarding child restraint systems and the instructions provided with the child restraint system could increase the chance and/or severity of injury in an accident.**
- **If the vehicle headrest prevents proper installation of a child seat, the headrest of the respective seating position shall be readjusted or entirely removed.**

Placing a passenger seat belt into the automatic locking mode

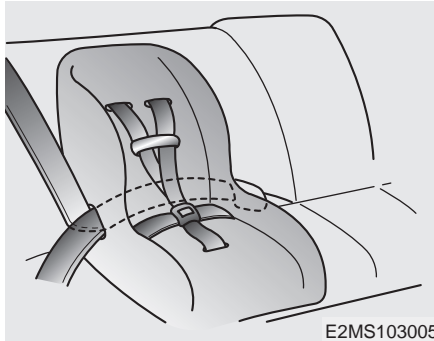

The automatic locking mode will help prevent the normal movement of the child in the vehicle from causing the seat belt to loosen and compromise the child restraint system. To secure a child restraint system, use the following procedure.

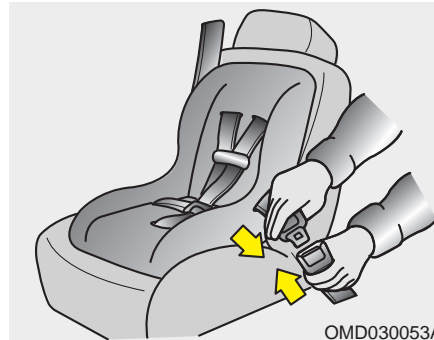

To install a child restraint system on the outboard or center rear seats, do the following:

1. Place the child restraint system in the seat and route the lap/shoulder belt around or through the restraint, following the restraint manufacturer's instructions. Be sure the seat belt webbing is not twisted.
2. Fasten the lap/shoulder belt latch into the buckle. Listen for the distinct "click" sound.

Position the release button so that it is easy to access in case of an emergency.



3. Pull the shoulder portion of the seat belt all the way out. When the shoulder portion of the seat belt is fully extended, it will shift the retractor to the "Automatic locking" (child restraint) mode.



4. Slowly allow the shoulder portion of the seat belt to retract and listen for an audible “clicking” or “ratchet-ing” sound. This indicates that the retractor is in the “automatic locking” mode. If no distinct sound is heard, repeat steps 3 and 4.



5. Remove as much slack from the belt as possible by pushing down on the child restraint system while feeding the shoulder belt back into the retractor.
6. Push and pull on the child restraint system to confirm that the seat belt is holding it firmly in place. If it is not, release the seat belt and repeat steps 2 through 6.
7. Double check that the retractor is in the “Automatic locking” mode by attempting to pull more of the seat belt out of the retractor. If you cannot, the retractor is in the “Automatic locking” mode.

To remove the child restraint, press the release button on the buckle and then pull the lap/shoulder belt out of the restraint and allow the seat belt to retract fully.

⚠ WARNING - Automatic locking mode

The lap/shoulder belt automatically returns to the “emergency lock mode” whenever the belt is allowed to retract fully. Therefore, the preceding seven steps must be followed each time a child restraint is installed. If the retractor is not in the Automatic Locking mode, the child restraint can move when your vehicle turns or stops suddenly. A child can be seriously injured or killed if the child restraint is not properly anchored to the car, including setting the retractor to the Automatic Locking mode.

When the seat belt is allowed to retract to its fully stowed position, the retractor will automatically switch from the “Automatic locking” mode to the emergency lock mode for normal adult usage.

Securing a child restraint seat with “Tether Anchor” system

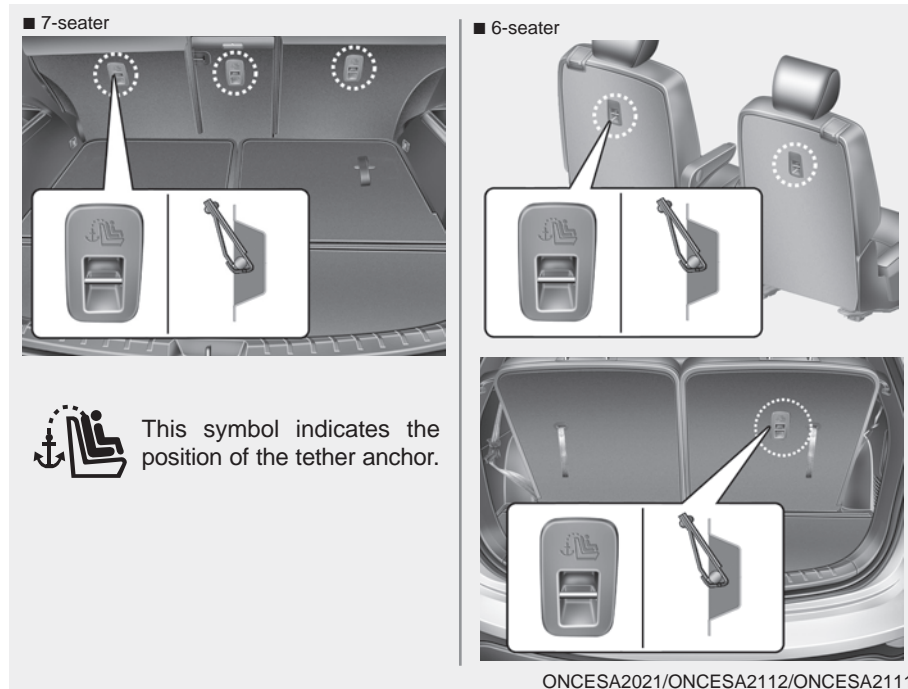

Child restraint hooks (tether anchors) are located on the rear of the seat backs.

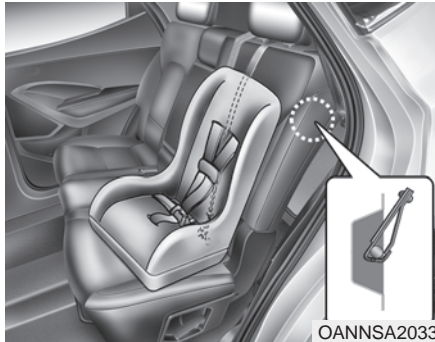

1. Route the child restraint seat strap over the seatback.

For vehicles with adjustable headrests, route the tether strap under the headrest and between the headrest posts, otherwise route the tether strap over the top of the seatback.

※ Refer to "Adjusting the height up and down - 2nd row" in this chapter.

2. Connect the tether strap hook to the appropriate child restraint hook holder and tighten to secure the child restraint seat.

⚠ WARNING

- When using the vehicle's "Tether Anchor" system to install a child restraint system in the rear seat, all unused vehicle rear seat belt metal latch plates or tabs must be latched securely in their seat belt buckles and the seat belt webbing must be retracted behind the child restraint to prevent the child from reaching and taking hold of unretracted seat belts. Unlatched metal latch plates or tabs may allow the child to reach the unretracted seat belts which may result in strangulation and a serious injury or death to the child in the child restraint.

- Do not place anything around the lower anchors. Also make sure that the seat belt is not caught in the lower anchors.

⚠ WARNING

A child can be seriously injured or killed in a collision if the child restraint is not properly anchored to the car and the child is not properly restrained in the child restraint. Always follow the child seat manufacturer's instructions for installation and use.

⚠ WARNING - Tether strap

Never mount more than one child restraint to a single tether anchor or to a single lower anchorage point. The increased load caused by multiple seats may cause the tethers or anchorage points to break, causing serious injury or death.

⚠ WARNING - Child restraint check

Check that the child restraint system is secure by pushing and pulling it in different directions. Incorrectly fitted child restraints may swing, twist, tip or separate causing death or serious injury.

⚠ WARNING - Child restraint anchorage

- Child restraint anchorages are designed to withstand only those loads imposed by correctly fitted child restraints. Under no circumstances are they to be used for adult seat belts or harnesses or for attaching other items or equipment to the vehicle.
- The tether strap may not work properly if attached somewhere other than the correct tether anchor.

Securing a child restraint seat with child seat lower anchor system

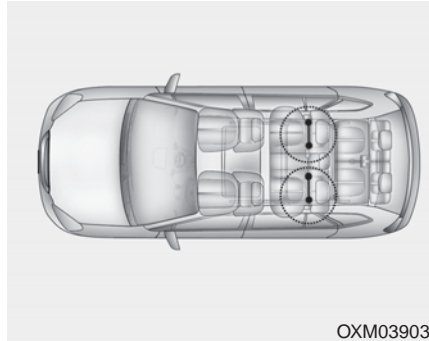

OXM039035

Some child seat manufacturers make child restraint seats that are labeled as LATCH or LATCH-compatible child restraint seats. LATCH stands for "Lower Anchors and Tethers for Children". These seats include two rigid or webbing mounted attachments that connect to two LATCH anchors at specific seating positions in your vehicle. This type of child restraint seat eliminates the need to use seat belts to attach the child seat in the rear seats.

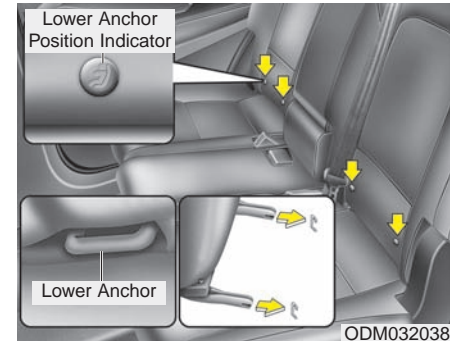

ODM032038

Child restraint symbols are located on the left and right rear seat backs to indicate the position of the lower anchors for child restraints.

⚠ WARNING - Unused rear seatbelts

Always fasten the seatbelts behind the child restraint seat when they are not used to secure the child seat. Failure to do so may result in child strangulation.

⚠ WARNING

Do not place anything around the lower anchors. Also make sure that the seat belt is not caught in the lower anchors.

LATCH anchors have been provided in your vehicle. The LATCH anchors are located in the left and right outboard seating positions of the second row. Their locations are shown in the illustration. There is no LATCH anchors provided for the second center and the third seating positions.

The LATCH anchors are located between the seatback and the seat cushion of the rear seat left and right outboard seating positions.

Follow the child seat manufacturer's instructions to properly install child restraint seats with LATCH or LATCH-compatible attachments.

Once you have installed the LATCH child restraint, assure that the seat is properly attached to the LATCH and tether anchors.

Also, test the child restraint seat before you place the child in it. Tilt the seat from side to side. Also try to tug the seat forward. Check to see if the anchors hold the seat in place.

⚠ CAUTION

Do not allow the rear seat belt webbing to get scratched or pinched by the child-seat latch and LATCH anchor during the installation.

⚠ WARNING

If the child restraint is not anchored properly, the risk of a child being seriously injured or killed in a collision greatly increases.

⚠ WARNING - LATCH lower anchors

LATCH lower anchors are only to be used with the left and right outboard seating positions of the second row. Never attempt to attach a LATCH equipped seat in the the second center and the third seating positions.

You may damage the anchors or the anchors may fail and break in a collision.

*** NOTICE**

The recommended weight for the LATCH system is under 65 lb (30 kg).

How to calculate the child restraint weight :

**Child restraint weight =
65 lb (30 kg) - Child weight**

AIR BAG - ADVANCED SUPPLEMENTAL RESTRAINT SYSTEM

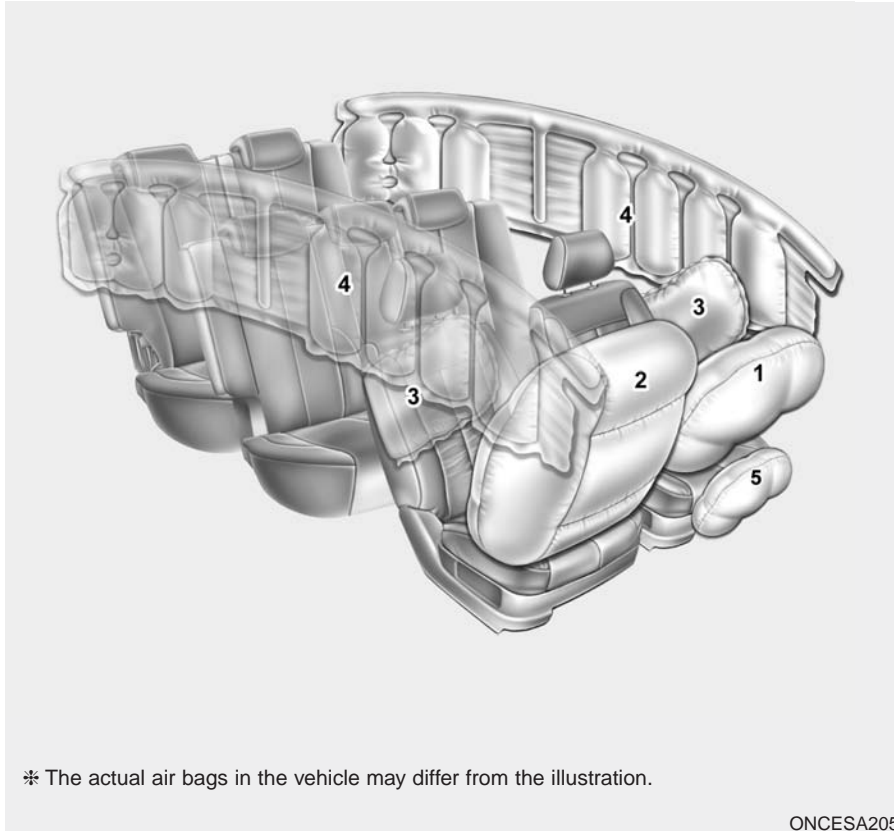

- (1) Driver's front air bag
- (2) Passenger's front air bag
- (3) Side impact air bag
- (4) Curtain air bag
- (5) Driver's knee air bag

⚠ WARNING

Even in vehicles with air bags, you and your passengers must always wear the seat belts provided in order to minimize the risk and severity of injury in the event of a collision or rollover.

* The actual air bags in the vehicle may differ from the illustration.

ONCESA2052

How does the air bag system operate

- Air bags are activated (able to inflate if necessary) only when the ignition switch is turned to the ON or START position.
- The appropriate air bags inflate instantly in the event of serious frontal or side collision in order to help protect the occupants from serious physical injury.
- There is no single speed at which the air bags will inflate.

Generally, air bags are designed to inflate by the severity of a collision and its direction. These two factors determine whether the sensors send out an electronic deployment/inflation signal.

- Air bag deployment depends on a number of factors including vehicle speed, angles of impact and the density and stiffness of the vehicles or objects which your vehicle hits in the collision. Though, factors are not limited to those mentioned above.

- The front air bags will completely inflate and deflate in an instant.

It is virtually impossible for you to see the air bags inflate during an accident.

It is much more likely that you will simply see the deflated air bags hanging out of their storage compartments after the collision.

- In addition to inflating in serious side collisions, side and/or curtain air bags will inflate if the sensing system detects a rollover.
- When a rollover is detected, side and/or curtain air bags will remain inflated longer to help provide protection from ejection, especially when used in conjunction with the seat belts.
- In order to help provide protection, the air bags must inflate rapidly. The speed of air bag inflation is a consequence of the extremely short time in which to inflate the air bag between the occupant and the vehicle structures before the occupant impacts those structures.

This speed of inflation reduces the risk of serious or life-threatening injuries and is thus a necessary part of air bag design.

However, air bag inflation can also cause injuries which normally can include facial abrasions, bruises and broken bones because the inflation speed also causes the air bags to expand with a great deal of force.

- **There are even circumstances under which contact with the air bag can cause fatal injuries, especially if the occupant is positioned excessively close to the air bag.**

WARNING

- **To avoid severe personal injury or death caused by deploying air bags in a collision, the driver should sit as far back from the steering wheel air bag as possible (at least 10 inches (250 mm) away). The front passengers should always move their seats as far back as possible and sit back in their seat.**

(Continued)

(Continued)

- Air bags inflate instantly in the event of collision, and passengers may be injured by the air bag expansion force if they are not in proper position.
- Air bag inflation may cause injuries which normally include facial or bodily abrasions, injuries from broken glasses or burns by the air bag inflation gasses.

Noise and smoke

When the air bags inflate, they make a loud noise and they leave smoke and powder in the air inside of the vehicle. This is normal and is a result of the ignition of the air bag inflator. After the air bag inflates, you may feel substantial discomfort in breathing due to the contact of your chest with both the seat belt and the air bag, as well as from breathing the smoke and powder. **Open your doors and/or windows as soon as possible after impact in order to reduce discomfort and prevent prolonged exposure to the smoke and powder.**

Though the smoke and powder are non-toxic, they may cause irritation to the skin (eyes, nose and throat, etc). If this is the case, wash and rinse with cold water immediately and consult a doctor if the symptom persists.

⚠ WARNING - Hot components

Do not touch the air bag storage area's internal components immediately after air bag inflation. The air bag related parts in the steering wheel, instrument panel and the roof rails above the front and rear doors are very hot. Hot components can result in burn injuries.

Do not install a child restraint on the front passenger's seat.



Never place a rear-facing child restraint in the front passenger's seat. If the air bag deploys, it would impact the rear-facing child restraint, causing serious or fatal injury.

In addition, do not place front-facing child restraints in the front passenger's seat either. If the front passenger air bag inflates, it could cause serious or fatal injuries to the child.

⚠ WARNING - Air bag deployment

When children are seated in the rear outboard seats of a vehicle equipped with side and/or curtain air bags, install the child restraint system as far away from the door side as possible. Inflation of the side and/or curtain air bags could cause serious injury or death to an infant or child.

Air bag warning light



The purpose of the air bag warning light in your instrument panel is to alert you of a potential problem with your airbag system, which includes side and/or curtain airbags used for rollover protection.

When the ignition switch is turned ON, the indicator light should illuminate for approximately 6 seconds, then go off.

SRS components and functions

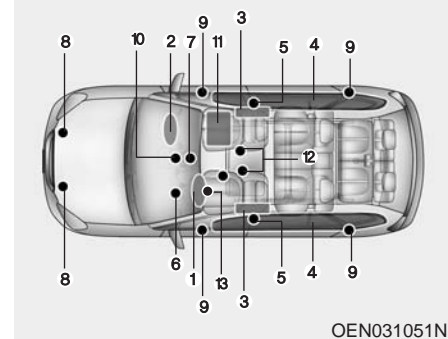

The SRS consists of the following components:

1. Driver's front air bag module
2. Passenger's front air bag module
3. Side impact air bag modules
4. Curtain air bag modules
5. Retractor pre-tensioner assemblies
6. Air bag warning light
7. SRS control module (SRSCM)/ Rollover sensor
8. Front impact sensors
9. Side impact sensors

10. "PASSENGER AIR BAG OFF" indicator (Front passenger's seat only)
11. Occupant classification system (Front passenger's seat only)
12. Driver's and front passenger's seat belt buckle sensors
13. Driver's knee air bag module

The SRSCM continually monitors all SRS components while the ignition switch is ON to determine if a crash impact is severe enough to require air bag deployment or pre-tensioner seat belt deployment.



W7-147

The SRS air bag warning light "🚗" on the instrument panel will illuminate for about 6 seconds after the ignition switch is turned to the ON position, after which the SRS air bag warning light "🚗" should go out.

⚠ WARNING

If any of the following conditions occurs, this indicates a malfunction of the SRS. Have an authorized HYUNDAI dealer inspect the air bag system as soon as possible.

- The light does not turn on briefly when you turn the ignition ON.
- The light stays on after illuminating for approximately 6 seconds.
- The light comes on while the vehicle is in motion.
- The light blinks when the ignition switch is in ON position.

Safety features of your vehicle

Driver's front air bag (1)



OHM039102N

The front air bag modules are located in the center of the steering wheel, in the front passenger's panel above the glove box and in the driver's side knee bolster. When the SRSCM detects a sufficiently severe impact to the front of the vehicle, it will automatically deploy the front air bags.

Driver's front air bag (2)



OHM039103N

Upon deployment, tear seams molded directly into the pad covers will separate under pressure from the expansion of the air bags. Further opening of the covers then allows full inflation of the air bags.

Driver's front air bag (3)



OHM039104N

A fully inflated air bag, in combination with a properly worn seat belt, slows the driver's or the passenger's forward motion, reducing the risk of head and chest injury.

After complete inflation, the air bag immediately starts deflating, enabling the driver to maintain forward visibility and the ability to steer or operate other controls.

Passenger's front air bag

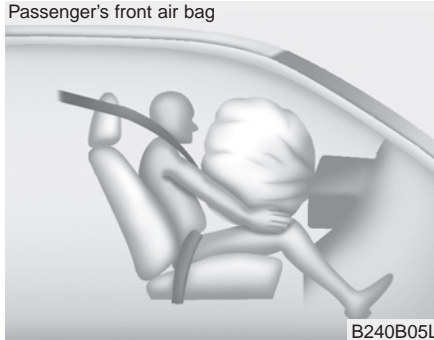

B240B05L

⚠ WARNING

- Do not install or place any accessories (drink holder, CD or discs holder, sticker, etc.) on the front passenger's panel above the glove box in a vehicle with a passenger's air bag. Such objects may become dangerous projectiles and cause injury if the passenger's air bag inflates.

(Continued)

(Continued)

- When installing a container of liquid air freshener inside the vehicle, do not place it near the instrument cluster nor on the instrument panel surface. It may become a dangerous projectile and cause injury if the passenger's air bag inflates.

⚠ WARNING

- If an air bag deploys, there may be a loud noise followed by a fine dust released in the vehicle. These conditions are normal and are not hazardous - the air bags are packed in this fine powder. The dust generated during air bag deployment may cause skin or eye irritation as well as aggravate asthma for some persons. Always wash all exposed skin areas thoroughly with lukewarm water and a mild soap after an accident in which the air bags were deployed.
- The SRS can function only when the ignition switch is in the ON position.

(Continued)

(Continued)

If the SRS air bag warning light "🚗" does not illuminate, or continuously remains on after illuminating for about 6 seconds or blinks when the ignition switch is turned to the ON position, or after the engine is started, comes on while driving, the SRS is not working properly. If this occurs, have your vehicle immediately inspected by an authorized HYUNDAI dealer.

- Before you replace a fuse or disconnect a battery terminal, turn the ignition switch to the LOCK position and remove the ignition key for ignition key, and turn the engine start/stop button to the OFF position for smart key. Never remove or replace the air bag related fuse(s) when the ignition switch is in the ON position. Failure to heed this warning will cause the SRS air bag warning light to illuminate.

Occupant classification system

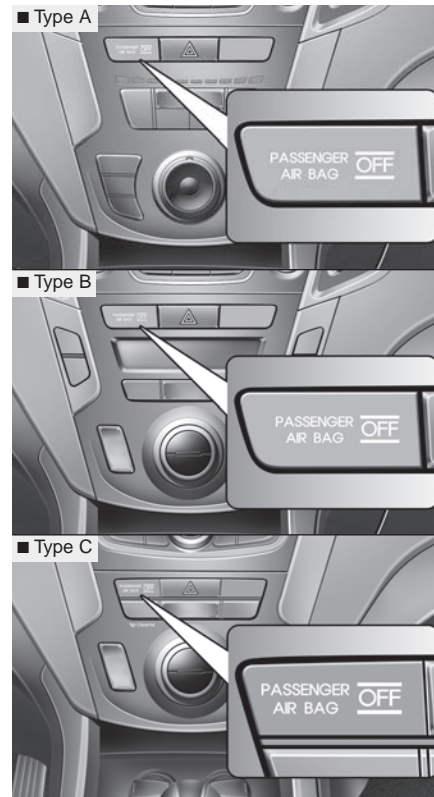

OANNSA2003/OANNSA2002/OANNSA2004

Your vehicle is equipped with an occupant classification system in the front passenger's seat.

The occupant classification system is designed to detect the presence of a properly-seated front passenger and determine if the passenger's front air bag should be enabled (may inflate) or not. The driver's front air bag is not affected or controlled by the occupant classification system.

Main components of occupant classification system

- A detection device located within the front passenger seat cushion.
- Electronic system to determine whether the front passenger air bag system should be activated or deactivated.
- An indicator light located on the instrument panel which illuminates the words PASSENGER AIR BAG "OFF" indicating the front passenger air bag system is deactivated.
- The instrument panel air bag indicator light is interconnected with the occupant classification system.

If the front passenger seat is occupied by a person that the system determines to be of adult size, and he/she sits properly (sitting upright with the seatback in an upright position, centered on the seat cushion with their seat belt on, legs comfortably extended and their feet on the floor), the PASSENGER AIR BAG "OFF" indicator will be turned off and the front passenger's air bag will be able to inflate, if necessary, in frontal crashes.

You will find the PASSENGER AIR BAG "OFF" indicator on the center facia panel. This system detects the conditions 1~4 in the following table and activates or deactivates the front passenger air bag based on these conditions.

Always be sure that you and all vehicle occupants are seated and restrained properly (sitting upright with the seat in an upright position, centered on the seat cushion, with the person's legs comfortably extended, feet on the floor, and wearing the safety belt properly) for the most effective protection by the air bag and the safety belt.

- The OCS may not function properly if the passenger takes actions which can affect the classification system. These include:
 - (1) Failing to sit in an upright position.
 - (2) Leaning against the door or center console.
 - (3) Sitting towards the sides or the front of the seat.
 - (4) Putting legs on the dashboard or resting them on other locations which reduce the passenger weight on the front seat.
 - (5) Improperly wearing the safety belt.
 - (6) Reclining the seat back.
 - (7) Wearing a thick cloth like ski wear or hip protection wear.
 - (8) Put on the seat an additional thick cushion.

Condition and operation in the front passenger occupant classification system

Condition detected by the occupant classification system	Indicator/Warning light		Devices
	PASSENGER AIR BAG "OFF" indicator light	SRS warning light	Front passenger air bag
1. Adult *1 or child age 13 and up*2	Off	Off	Activated
2. Infant or child restraint system with 12 months old*3 *4	On	Off	Deactivated
3. Unoccupied	On	Off	Deactivated
4. Malfunction in the system	Off	On	Activated

*1 The system judges a person of adult size as an adult. When a smaller adult sits in the front passenger seat, the system may recognize him/her as a child depending on his/her physique and posture.

*2 Do not allow children to ride in the front passenger seat. When a larger child who has outgrown a child restraint system sits in the front passenger seat, the system may recognize him/her as an adult depending upon his/her physique or sitting position.

*3 Never install a child restraint system on the front passenger seat.

*4 The PASSENGER AIR BAG "OFF" indicator may turn on or off when a child above 12 months to 12 years old (with or without child restraint system) sits in the front passenger seat. This is a normal condition.

⚠ WARNING - OCS system
Riding in an improper position adversely affects the occupant classification system (OCS) and may result in the deactivation of front passenger air bag. It is important for the driver to instruct the passenger as to the proper seating instructions as contained in this manual.
(Continued)

(Continued)



- Never put a heavy load, an active electronic device or blanket in the front passenger seat or seatback pocket.



- Never sit with hips shifted towards the front of the seat.



- Never place feet on the dashboard.



- Never sit on the front passenger seat with anything attached such as a blanket or cushion.

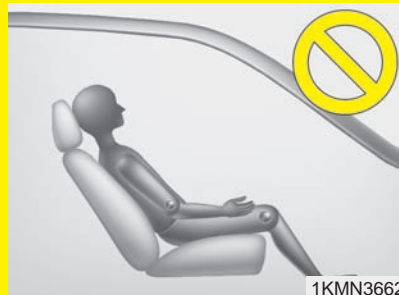

- Never excessively recline the front passenger seatback.



- Never lean on the door or center console.
- Never sit on one side of the front passenger seat.

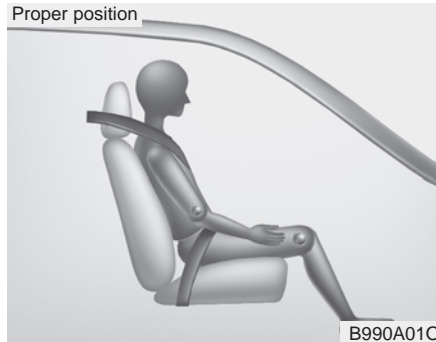

When an adult is seated in the front passenger seat, if the PASSENGER AIR BAG "OFF" indicator is on, turn the ignition switch to the LOCK or OFF position and ask the passenger to sit properly (sitting upright with the seat back in an upright position, centered on the seat cushion with their seat belt on, legs comfortably extended and their feet on the floor). Restart the engine and have the person remain in that position. This will allow the system to detect the person and to enable the passenger air bag.

If the PASSENGER AIR BAG "OFF" indicator is still on, ask the passenger to move to the rear seat.

⚠ WARNING - AIR BAG "OFF" light

Do not allow an adult passenger to ride in the front seat when the PASSENGER AIR BAG "OFF" indicator is illuminated, because the air bag will not deploy in the event of a crash. The driver must instruct the passenger to reposition himself in the seat. Failure to properly position yourself may lead to air bag deactivation resulting in air bag non-deployment in a collision. If the PASSENGER AIR BAG "OFF" indicator remains illuminated after the passenger repositions themselves properly and the vehicle is restarted, it is recommended the passenger move to the rear seat because the passenger's front air bag will not deploy.

*** NOTICE**

The PASSENGER AIR BAG "OFF" indicator illuminates for about 4 seconds after the ignition switch is turned to the ON position or after the engine is started. If the front passenger seat is occupied, the occupant classification sensor will then classify the front passenger after several more seconds.

⚠ WARNING

Do not hang onto the front passenger seat. Do not hang any items, such as a seatback table or entertainment system, on the front passenger seatback. Do not place feet on the front passenger seatback. Do not place any items under the front passenger seat. Any of these could interfere with proper sensor operation.

⚠ WARNING

- Even though your vehicle is equipped with the occupant classification system, never install a child restraint system in the front passenger's seat. A deploying air bag can forcefully strike a child resulting in serious injuries or death. Any child age 12 and under should ride in the rear seat. Children too large for child restraints should use the available lap/shoulder belts. No matter what type of crash, children of all ages are safer when restrained in the rear seat.
- The occupant classification system may not work properly if water, coffee or any other liquid on the front passenger seat. Keep the front seat dry at all times.

(Continued)

(Continued)

- If the PASSENGER AIR BAG "OFF" indicator is illuminated when the front passenger's seat is occupied by an adult and he/she sits properly (sitting upright with the seatback in an upright position, centered on the seat cushion with their seat belt on, legs comfortably extended and their feet on the floor), have that person sit in the rear seat.
- Do not modify or replace the front passenger seat. Don't place anything on or attach anything such as a blanket or seat heater to the front passenger seat. This can adversely affect the occupant classification system.
- Do not sit on sharp objects such as tools when occupying the front passenger seat. This can adversely affect the occupant classification system.

(Continued)

(Continued)

- Do not use accessory seat covers on the front seats.
- Accident statistics show that children are safer if they are restrained in the rear, as opposed to the front seat. It is recommended that child restraints be secured in a rear seat, including an infant riding in a rear-facing infant seat, a child riding in a forward-facing child seat and an older child riding in a booster seat.
- Air bags can only be used once – have an authorized HYUNDAI dealer replace the air bag immediately after deployment.

(Continued)

(Continued)

- A smaller-stature adult in the front passenger' seat who is not seated correctly (for example: seat excessively reclined, leaning on the door or center console, or hips shifted forward in the seat) can cause a condition where the occupant classification system senses less weight than if the occupant were seated properly (sitting upright with the seatback in an upright position, centered on the seat cushion with their seat belt on, legs comfortably extended and their feet on the floor).

This condition can result in an adult potentially being misclassified as a child and illumination of the PASSENGER AIR BAG "OFF" indicator.

⚠ WARNING

If the occupant classification system is not working properly, the SRS air bag warning light  on the instrument panel will illuminate because the passenger's front air bag is connected with the occupant classification system. If there is a malfunction of the occupant classification system, the PASSENGER AIR BAG "OFF" indicator will not illuminate and the passenger's front air bag will inflate in frontal impact crashes even if there is no occupant in the front passenger's seat. If the SRS air bag warning light does not illuminate when the ignition switch is turned to the ON position, remains illuminated after approximately 6 seconds or blinks when the ignition switch is turned to the ON position, or if it illuminates while the vehicle is being driven, have an authorized HYUNDAI dealer inspect the occupant classification system and the SRS air bag system as soon as possible.

Driver's and passenger's front air bag

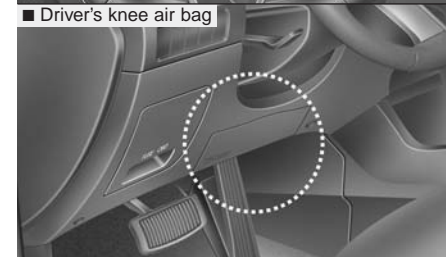

ODM032040/ODM032041/ODM032042

Your vehicle is equipped with a Supplemental Restraint (Air Bag) System and the lap/shoulder belts at both the driver and passenger seating positions.

The front air bags are designed to supplement the three-point seat belts. For these air bags to provide protection, the seat belts must be worn at all times when driving.

The indications of the system's presence are the letters "SRS AIR BAG" embossed on the air bag pad cover in the steering wheel, on the knee bolster below the steering wheel column and the passenger's side front panel pad above the glove box.

The SRS consists of air bags installed under the pad covers in the center of the steering wheel, in the knee bolster below the steering wheel column and the passenger's side front panel above the glove box.

The purpose of the SRS is to provide the vehicle's driver and/or the front passenger with additional protection than that offered by the seat belt system alone in case of a frontal impact of sufficient severity.

The seat belt buckle sensors determine if the driver and front passenger's seat belts are fastened. These sensors provide the ability to control the SRS deployment based on whether or not the seat belts are fastened, and how severe the impact is.

The advanced SRS offers the ability to control the air bag inflation within two levels. A first stage level is provided for moderate-severity impacts. A second stage level is provided for more severe impacts.

According to the impact severity and seat belt usage, the SRSCM (SRS Control Module) controls the air bag inflation. Failure to properly wear seat belts can increase the risk or severity of injury in an accident.

Additionally, your vehicle is equipped with an occupant classification system in the front passenger's seat. The occupant classification system detects the presence of a passenger in the front passenger's seat and will turn off the front passenger's air bag under certain conditions. For more detail, see "Occupant classification system" in this section.

⚠ WARNING

Do not place any objects underneath the front seats as they could interfere with the occupant classification system.

⚠ WARNING

If you are considering modification of your vehicle due to a disability, please contact the Hyundai Customer Assistance Center at 1-800-633-5151.

*** NOTICE**

- Be sure to read information about the SRS on the labels provided on the sun visor.
- Advanced air bags are combined with pre-tensioner seat belts to help provide enhanced occupant protection in frontal crashes. Front air bags are not intended to deploy in collisions in which protection can be provided by the pre-tensioner seat belt.

⚠ WARNING

Always use seat belts and child restraints – every trip, every time, everyone! Air bags inflate with considerable force and in the blink of an eye. Seat belts help keep occupants in proper position to obtain maximum benefit from the air bag. Even with advanced air bags, improperly and unbelted occupants can be severely injured when the air bag inflates.

Always follow the precautions about seat belts, air bags and occupant safety contained in this manual. To reduce the chance of serious or fatal injuries and receive the maximum safety benefit from your restraint system:

- Never place a child in any child or booster seat in the front seat.
- ABC – Always Buckle Children in the back seat. It is the safest place for children of any age to ride.

(Continued)

(Continued)

- Front and side air bags can injure occupants improperly positioned in the front seats.
- Move your seat as far back as practical from the front air bags, while still maintaining control of the vehicle.
- You and your passengers should never sit or lean unnecessarily close to the air bags. Improperly positioned driver and passengers can be severely injured by inflating air bags.
- Never lean against the door or center console – always sit in an upright position.
- Do not allow a passenger to ride in the front seat when the PASSENGER AIR BAG "OFF" indicator is illuminated, because the air bag will not deploy in the event of a moderate or severe frontal crash.

(Continued)

(Continued)

- No objects should be placed over or near the air bag modules on the steering wheel, instrument panel, and the front passenger's panel above the glove box, because any such object could cause harm if the vehicle is in a crash severe enough to cause the air bags to deploy.
- Never place covers, blankets or seat warmers on the passenger seat as these may interfere with the occupant classification system.
- Do not tamper with or disconnect SRS wiring or other components of the SRS system. Doing so could result in injury, due to accidental deployment of the air bags or by rendering the SRS inoperative.

(Continued)

(Continued)

- If the SRS air bag warning light remains illuminated while the vehicle is being driven, have an authorized HYUNDAI dealer inspect the air bag system as soon as possible.
- Air bags can only be used once – have an authorized HYUNDAI dealer replace the air bag immediately after deployment.
- The SRS is designed to deploy the front air bags only when frontal impact is sufficiently severe and when the impact angle is toward from the forward longitudinal axis of the vehicle. Additionally, the air bags will only deploy once. Seat belts must be worn at all times.
- Front air bags are not intended to deploy in side-impact, rear-impact or rollover crashes. In addition, front air bags will not deploy in frontal crashes below the deployment threshold.

(Continued)

(Continued)

- Even though your vehicle is equipped with the occupant classification system, do not install a child restraint system in the front passenger seat position. A child restraint system must never be placed in the front seat. The infant or child could be severely injured or killed by an air bag deployment in case of an accident.
- Children age 12 and under must always be properly restrained in the rear seat. Never allow children to ride in the front passenger seat. If a child over 12 must be seated in the front seat, he or she must be properly belted and the seat should be moved as far back as possible.

(Continued)

(Continued)

- For maximum safety protection in all types of crashes, all occupants including the driver should always wear their seat belts whether or not an air bag is also provided at their seating position to minimize the risk of severe injury or death in the event of a crash. Do not sit or lean unnecessarily close to the air bag while the vehicle is in motion.
- Sitting improperly or out of position can result in serious or fatal injury in a crash. All occupants should sit upright with the seatback in an upright position, centered on the seat cushion with their seat belt on, legs comfortably extended and their feet on the floor until the vehicle is parked and the ignition key is removed.

(Continued)

(Continued)

- The SRS air bag system must deploy very rapidly to provide protection in a crash. If an occupant is out of position because of not wearing a seat belt, the air bag may forcefully contact the occupant causing serious or fatal injuries.

Side impact air bag

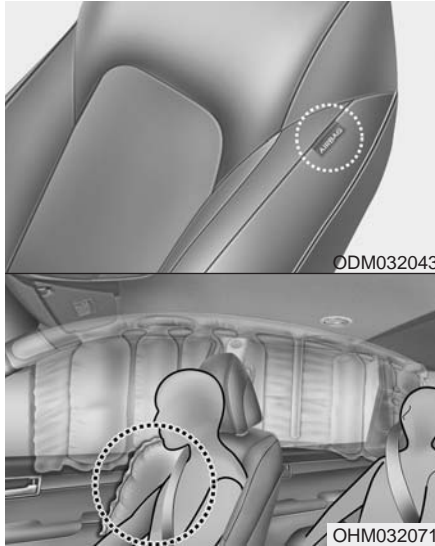

* The actual air bags in the vehicle may differ from the illustration.

Your vehicle is equipped with a side impact air bag in each front seat. The purpose of the air bag is to provide the vehicle's driver and/or the front passenger with additional protection than that offered by the seat belt alone.

The side impact air bags are designed to deploy only during certain side-impact collisions, depending on the crash severity, angle, speed and point of impact. The side impact air bags are not designed to deploy in all side impact situations or rollover situations.

The side impact air bags do not only deploy on the side of the impact but also on the opposite side.

The side and/or curtain air bags on both sides of the vehicle may deploy if a rollover or possible rollover is detected.

⚠ WARNING

Do not allow the passengers to lean their heads or bodies onto doors, put their arms on the doors, stretch their arms out of the window, or place objects between the doors and passengers when they are seated on seats equipped with side and/or curtain air bags.

⚠ WARNING

- **The side impact air bag is supplemental to the driver's and the passenger's seat belt systems and is not a substitute for them. Therefore your seat belts must be worn at all times while the vehicle is in motion. The air bags deploy only in certain side impact conditions severe enough to cause significant injury to the vehicle occupants.**
- **For best protection from the side impact air bag system and to avoid being injured by the deploying side impact air bag, both front seat occupants should sit in an upright position with the seat belt properly fastened. The driver's hands should be placed on the steering wheel at the 9:00 and 3:00 positions. The passenger's arms and hands should be placed on their laps.**

(Continued)

(Continued)

- Do not use any accessory seat covers.
- Use of seat covers could reduce or prevent the effectiveness of the system.
- Do not install any accessories on the side or near the side air bag.
- Do not place any objects over the air bag or between the air bag and yourself.
- Do not place any objects (an umbrella, bag, etc.) between the front door and the front seat. Such objects may become dangerous projectiles and cause injury if the supplemental side air bag inflates.
- To prevent unexpected deployment of the side impact air bag that may result in personal injury, avoid impact to the side impact sensor when the ignition switch is on.

(Continued)

(Continued)

- If the seat or seat cover is damaged, have the vehicle checked and repaired by an authorized HYUNDAI dealer because your vehicle is equipped with side impact air bags and an occupant classification system.

Curtain air bag

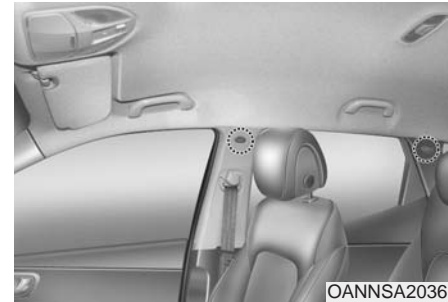

* The actual air bags in the vehicle may differ from the illustration.

Curtain air bags are located along both sides of the roof rails above the front and rear doors.

They are designed to help protect occupants in certain side impacts and to help prevent them from ejecting out of the vehicle as a result of a rollover, especially when the seatbelts are also in use.

- The curtain air bags are designed to deploy during certain side impact collisions, depending on the crash severity, angle, speed and point of impact.
- The curtain air bags do not only deploy on the side of the impact but also on the opposite side.
- Also, the curtain air bags on both sides of the vehicle will deploy in certain rollover situations.
- The curtain air bags are not designed to deploy in all side impact or rollover situations.

⚠ WARNING

- **In order for side and curtain air bags to provide the best protection, front seat occupants and outboard rear occupants should sit in an upright position with the seat belts properly fastened.**

Importantly, children should sit in a proper child restraint system in the rear seat.

- **When children are seated in the rear outboard seats, they must be seated in the proper child restraint system. Make sure to put the child restraint system as far away from the door side as possible, and secure the child restraint system in a locked position.**

(Continued)

(Continued)

- **Do not allow the passengers to lean their heads or bodies onto doors, put their arms out of the doors, stretch their arms out of the window, or place objects between the doors and passengers when they are seated on seats equipped with side and/or curtain air bags.**
- **Never try to open or repair any components of the side curtain air bag system. This should only be done by an authorized HYUNDAI dealer.**

Failure to follow the above instructions can result in injury or death to the vehicle occupants in an accident.

Why didn't my air bag go off in a collision? (Inflation and non-inflation conditions of the air bag)

There are many types of accidents in which the air bag would not be expected to provide additional protection.

These include rear impacts, second or third collisions in multiple impact accidents, as well as low speed impacts.

Air bag collision sensors

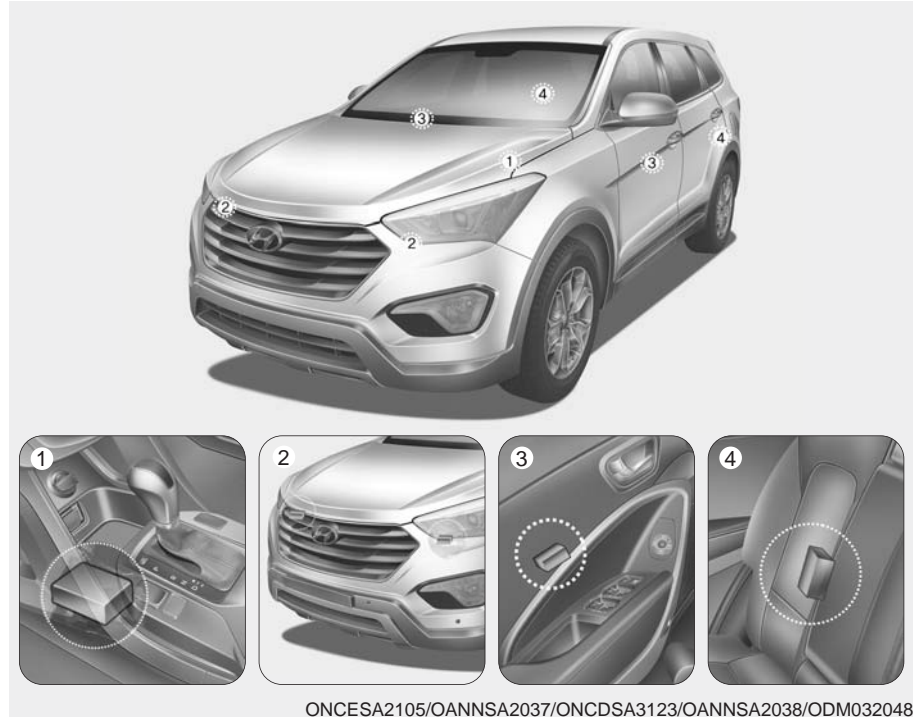

- (1) SRS control module / Rollover sensor
- (2) Front impact sensor

- (3) Side impact sensor
- (4) Side impact sensor

⚠ WARNING - Air bag sensors

- Do not hit or allow any objects to impact the locations where air bags or sensors are installed.

This may cause unexpected air bag deployment, which could result in serious personal injury or death.

- If the installation location or angle of the sensors is altered in any way, the air bags may deploy when they should not or they may not deploy when they should, causing severe injury or death.

Therefore, do not try to perform maintenance on or around the air bag sensors. Have the vehicle checked and repaired by an authorized HYUNDAI dealer.

- Problems may arise if the sensor installation angles are changed due to the deformation of the front bumper, body or C pillars or front door where side collision sensors are installed. Have the vehicle checked and repaired by an authorized HYUNDAI dealer.
- Your vehicle has been designed to absorb impact and deploy the air bag(s) in certain collisions. Installing bumper guards or side steppers or replacing a bumper with non-genuine parts may adversely affect your vehicle's collision and air bag deployment performance.

Air bag inflation conditions



Front air bags

Front air bags are designed to inflate in a frontal collision depending on the intensity, speed or angles of impact of the front collision.



* The actual air bags in the vehicle may differ from the illustration.

Side impact and curtain air bags

Side impact and curtain air bags are designed to inflate when an impact is detected by side collision sensors depending on the strength, speed or angles of impact resulting from a side impact collision.

Also, the side impact and curtain air bags are designed to inflate when a rollover is detected by the rollover sensor.

Although the front air bags (driver's front, knee and front passenger's air bags) are designed to inflate in frontal collisions, they also may inflate in other types of collisions if the front impact sensors detect a sufficient frontal force in another type of impact. Side impact and curtain air bags are designed to inflate in certain side impact collisions. They may inflate in other type of collisions where a side force is detected by the sensors.

Side air bag and/or curtain air bags may also inflate where rollover sensors indicate the possibility of a rollover occurring (even if none actually occurs) or in other situations, including when the vehicle is tilted while being towed. Even where side and/or curtain air bags would not provide impact protection in a rollover, however, they will deploy to prevent ejection of occupants, especially those who are restrained with seat belts.

If the vehicle chassis is impacted by bumps or objects on unimproved roads, the air bags may deploy. Drive carefully on unimproved roads or on surfaces not designed for vehicle traffic to prevent unintended air bag deployment.

Air bag non-inflation conditions



- In certain low-speed collisions the air bags may not deploy. The air bags are designed not to deploy in such cases because they may not provide benefits beyond the protection of the seat belts in such collisions.

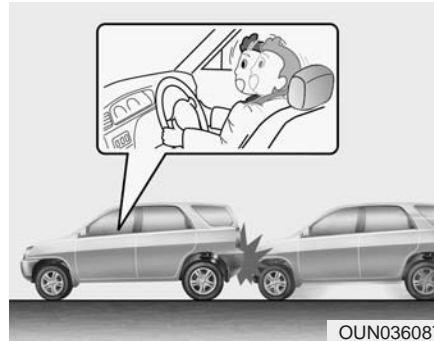

- Air bags are not designed to inflate in rear collisions, because occupants are moved backward by the force of the impact. In this case, inflated air bags would not be able to provide any additional benefit.



- Front air bags may not inflate in side impact collisions, because occupants move to the direction of the collision, and thus in side impacts, frontal air bag deployment would not provide additional occupant protection.

However, side impact and curtain air bags may inflate depending on the intensity, vehicle speed and angles of impact.

Safety features of your vehicle

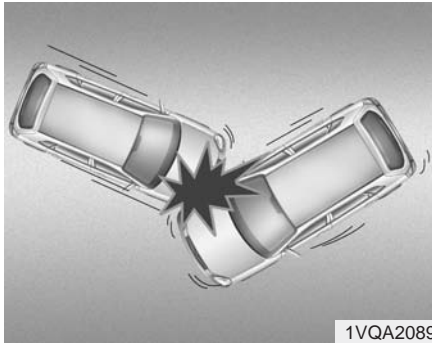

- In an angled collision, the force of impact may direct the occupants in a direction where the air bags would not be able to provide any additional benefit, and thus the SRS may not deploy any air bags.

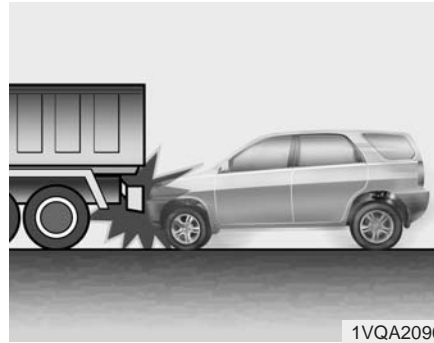

- Just before impact, drivers often brake heavily. Such heavy braking lowers the front portion of the vehicle causing it to "ride" under a vehicle with a higher ground clearance. Air bags may not inflate in this "under-ride" situation because forces that are detected by sensors may be reduced by such "under-ride" collisions.

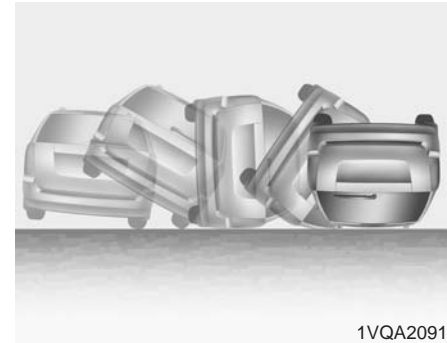

- Front air bags may not inflate in rollover accidents where the SRSCM indicates that the SRSCM indicates that the front air bag deployment would not provide additional occupant protection.

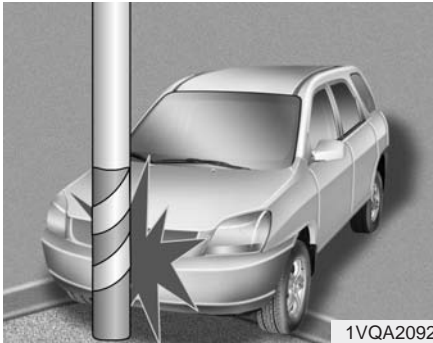

1VQA2092

- Air bags may not inflate if the vehicle collides with objects such as utility poles or trees.

SRS Care

The SRS is virtually maintenance-free and so there are no parts you can safely service by yourself. If the SRS air bag warning light "⚠" does not illuminate, when you turn the ignition on, or continuously remains on, or continuously blinks have your vehicle immediately inspected by an authorized HYUNDAI dealer.

Any work on the SRS system, such as removing, installing, repairing, or any work on the steering wheel, the front passenger's panel, front seats and roof rails must be performed by an authorized HYUNDAI dealer. Improper handling of the SRS system may result in serious personal injury.

To clean the air bag pad covers, use only a soft, dry cloth or one which has been moistened with plain water. Solvents or cleaners could adversely affect the air bag covers and proper deployment of the system.

⚠ WARNING

- **Modification to SRS components or wiring, including the addition of any kind of badges to the pad covers or modifications to the body structure, can adversely affect SRS performance and lead to possible injury.**
- **Not only the modification of the parts where the SRS sensors are but also the modification of other parts of the vehicle may affect the SRS performance and lead to possible injury.**
- **No objects should be placed over or near the air bag modules on the steering wheel, instrument panel, and the front passenger's panel above the glove box, because any such object could cause harm if the vehicle is in a crash severe enough to cause the air bags to inflate.**

(Continued)

(Continued)

- If the air bags inflate, they must be replaced by an authorized HYUNDAI dealer.
- Do not tamper with or disconnect SRS wiring, or other components of the SRS system. Doing so could result in injury, due to accidental inflation of the air bags or by rendering the SRS inoperative.
- If your car was flooded and has soaked carpeting or water on the flooring, you shouldn't try to start the engine; have the car towed to an authorized HYUNDAI dealer.

If components of the air bag system must be discarded, or if the vehicle must be scrapped, certain safety precautions must be observed. An authorized HYUNDAI dealer knows these precautions and can give you the necessary information. Failure to follow these precautions and procedures could increase the risk of personal injury.

Additional safety precautions

- **Never let passengers ride in the cargo area or on top of a folded-down back seat.** All occupants should sit upright, fully back in their seats with their seat belts on and their feet on the floor.
- **Passengers should not move out of or change seats while the vehicle is moving.** A passenger who is not wearing a seat belt during a crash or emergency stop can be thrown against the inside of the vehicle, against other occupants, or out of the vehicle.
- **Each seat belt is designed to restrain one occupant.** If more than one person uses the same seat belt, they could be seriously injured or killed in a collision.
- **Do not use any accessories on seat belts.** Devices claiming to improve occupant comfort or reposition the seat belt can reduce the protection provided by the seat belt and increase the chance of serious injury in a crash.
- **Passengers should not place hard or sharp objects between themselves and the air bags.** Carrying hard or sharp objects on your lap or in your mouth can result in injuries if an air bag inflates.
- **Keep occupants away from the air bag covers.** All occupants should sit upright, fully back in their seats with their seat belts on and their feet on the floor. If occupants are too close to the air bag covers, they could be injured if the air bags inflate.
- **Do not attach or place objects on or near the air bag covers.** Any object attached to or placed on the front or side air bag covers could interfere with the proper operation of the air bags.
- **Do not modify the front seats.** Modification of the front seats could interfere with the operation of the supplemental restraint system sensing components or side air bags.
- **Do not place items under the front seats.** Placing items under the front seats could interfere with the operation of the supplemental restraint system sensing components and wiring harnesses.

- **Never hold an infant or child on your lap.** The infant or child could be seriously injured or killed in the event of a crash. All infants and children should be properly restrained in appropriate child safety seats or seat belts in the rear seat.

⚠ WARNING

- **Sitting improperly or out of position can cause occupants to be shifted too close to a deploying air bag, strike the interior structure or be thrown from the vehicle resulting in serious injury or death.**
- **Always sit upright with the seatback in an upright position, centered on the seat cushion with your seat belt on, legs comfortably extended and your feet on the floor.**

(Continued)

(Continued)

- **Always have the ignition OFF when the vehicle is being towed or where it may otherwise be tilted, since the side and/or curtain air bags may inflate if the sensors interpret those tilt angles as a potential rollover.**
- **Be careful not to cause impact to the doors when the ignition is ON. The air bags may inflate.**

Adding equipment to or modifying your air bag-equipped vehicle

If you modify your vehicle by changing your vehicle's frame, bumper system, front end or side sheet metal or ride height, this may affect the operation of your vehicle's air bag system.

Air bag warning label

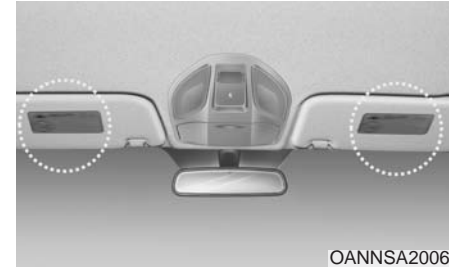

Air bag warning labels, some required by the U.S. National Highway Traffic Safety Administration (NHTSA), are attached to alert the driver and passengers of potential risks of the air bag system.

Features of your vehicle

Folding key	4-4	• Smart liftgate (Smart tailgate)	4-32
• Record your key number	4-4	• Emergency liftgate (tailgate) safety release	4-35
• Key operations	4-4	Windows	4-36
• Precautions	4-6	• Power windows	4-37
• Battery replacement	4-7	Hood	4-41
• Immobilizer system	4-8	• Opening the hood	4-41
Smart key	4-10	• Closing the hood	4-42
• Record your key number	4-10	Fuel filler lid	4-43
• Smart key function	4-10	• Opening the fuel filler lid	4-43
• Loss of the smart key	4-13	• Closing the fuel filler lid	4-43
• Precautions	4-14	• Emergency fuel filler lid release	4-46
• Smart key immobilizer system	4-14	Panoramic sunroof	4-47
• Battery replacement	4-16	• Sunroof open warning	4-47
Theft-alarm system	4-17	• Sunshade	4-48
• Armed stage	4-17	• Sliding the sunroof	4-49
• Theft-alarm stage	4-19	• Tilting the sunroof	4-50
• Disarmed stage	4-19	• Closing the sunroof	4-50
Door locks	4-21	• Resetting the sunroof	4-52
• From outside	4-21	Steering wheel	4-53
• From inside	4-23	• Electronic power steering	4-53
• Impact sensing door unlock system	4-25	• Tilt & telescopic steering	4-54
• Child-protector rear door lock	4-25	• Heated steering wheel	4-55
Liftgate (Tailgate)	4-26	• Horn	4-55
• Non-Powered liftgate (tailgate)	4-26	• Driver selectable steering mode	4-56
• Power liftgate (Power tailgate)	4-27		

Mirrors	4-59	Rear parking assist system	4-105
• Inside rearview mirror	4-59	• Operation	4-105
• Blue Link® center	4-67	• Non-operational conditions	4-106
• Outside rearview mirror	4-67	• Self-diagnosis	4-108
• Blind zone mirror (BZM)	4-70	Rearview camera	4-109
Instrument cluster	4-71	Hazard warning flasher	4-110
• Instrument Cluster Control	4-72	Lighting	4-111
• LCD Display Control	4-72	• Battery saver function	4-111
• Gauges	4-73	• Headlamp delay function	4-111
• Transaxle Shift Indicator	4-76	• Daytime running light	4-112
LCD display	4-77	• Lighting control	4-112
• LCD Modes	4-77	• High - beam operation	4-114
• Service Mode	4-78	• Turn signals and lane change signals	4-115
• User Settings Mode	4-79	• Front fog light	4-116
• A/V Mode	4-82	Wipers and washers	4-117
• Turn By Turn Mode	4-82	• Windshield wipers (front)	4-117
• Warning Messages	4-82	• Windshield washers (front)	4-118
Trip computer	4-89	• Rear window wiper and washer switch	4-119
• Overview	4-89	Interior light	4-120
• Trip A/B	4-90	• Automatic turn off function	4-120
• Fuel Economy	4-91	• Map lamp	4-120
Warning and indicator sights	4-93	• Room lamp	4-121
• Warning lights	4-93	• Luggage room lamp	4-122
• Indicator Lights	4-101	• Vanity mirror lamp	4-122
		• Glove box lamp	4-122

Welcome system	4-123	Interior features	4-150
• Headlamp welcome	4-123	• Cigarette lighter	4-150
• Interior light	4-123	• Cup holder	4-150
• Pocket lamp	4-123	• Sunvisor	4-151
Defroster	4-124	• Power outlet	4-152
• Rear window defroster	4-124	• AC inverter	4-153
• Front wiper deicer	4-124	• Clothes hanger	4-155
Manual climate control system	4-125	• Floor mat anchor(s)	4-155
• Heating and air conditioning	4-126	• Aux, USB and iPod® port	4-156
• 3rd row climate control	4-131	• Luggage net (holder)	4-157
• System operation	4-131	• Cargo security screen	4-157
• Climate control air filter	4-133	• Side curtain	4-159
Automatic climate control system	4-135	Exterior features	4-160
• Automatic heating and air conditioning	4-137	• Roof rack	4-160
• Manual heating and air conditioning	4-137	Audio system	4-161
• 3rd row climate control	4-143	• Antenna	4-161
Windshield defrosting and defogging	4-144	• Audio remote control	4-161
• Manual climate control system	4-144		
• Automatic climate control system	4-145		
Storage compartment	4-147		
• Center console storage	4-147		
• Glove box	4-147		
• Multi box	4-148		
• Sunglass holder	4-148		
• Luggage tray	4-149		

FOLDING KEY

Record your key number



The key code number is stamped or printed on the key code tag attached to the key set. Should you lose your keys,

this number will enable an authorized HYUNDAI dealer to duplicate the keys easily. Remove the key code tag and store it in a safe place. Also, record the key code number and keep it in a safe and handy place, but not in the vehicle.

Key operations



- Used to start the engine.
- Used to lock and unlock the doors.
- Used to lock and unlock the glove box.
- To unfold the key, press the release button then the key will unfold automatically. To fold the key, fold the key manually while pressing the release button.

CAUTION

Do not fold the key without pressing the release button. This may damage the key.

WARNING

Use only HYUNDAI original parts for the ignition key in your vehicle. If an aftermarket key is used, the ignition switch may not return to ON after START. If this happens, the starter will continue to operate causing damage to the starter motor and possible fire due to excessive current in the wiring.

⚠ WARNING - Ignition key

Leaving children unattended in a vehicle with the ignition key is dangerous even if the key is not in the ignition switch in ACC or ON position. Children copy adults and they could place the key in the ignition switch.

The ignition key would enable children to operate power windows or other controls, or even make the vehicle move, which could result in serious bodily injury or even death. Never leave the keys in your vehicle with unsupervised children, when the engine is running.

Door Lock (1)

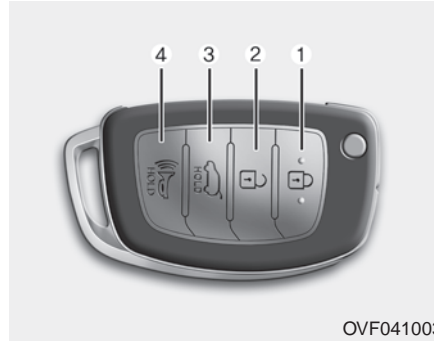

OVF041003

1. Close all doors, engine hood and liftgate (tailgate).
2. Press the lock button(1).
3. All doors and liftgate (tailgate) will lock. The hazard warning lights will blink once.
4. If the lock button is pressed once more within 4 seconds, the hazard warning lights will blink and the horn will sound once (Horn Feedback function).
5. Make sure that doors are locked by checking the door lock button inside or pulling the outside door handle.

Door Unlock (2)

1. Press the unlock button(2).
2. The driver's door will unlock. The hazard warning lights will blink two times.
3. Press the unlock button(2) twice within 4 seconds and all doors and liftgate (tailgate) will unlock. The hazard warning lights will blink two times.

*** NOTICE**

You can activate or deactivate the **Two Turn Unlock and Horn Feedback function**. Refer to "User settings" in this section.

Liftgate (Tailgate) unlock (3)

The liftgate (tailgate) is unlocked if the button is pressed for more than 1 second.

Also, once the liftgate (tailgate) is opened and then closed, the liftgate (tailgate) will be locked automatically.

Panic (4)

The horn sounds and hazard warning lights flash for about 30 seconds if this button is pressed for more than 1 second. To stop the horn and lights, press any button on the transmitter.

Transmitter precautions

*** NOTICE**

The transmitter will not work if any of following occur:

- The ignition key is in the ignition switch.
- You exceed the operating distance limit (about 90 feet [30 m]).
- The battery in the transmitter is weak.
- Other vehicles or objects may be blocking the signal.
- The weather is extremely cold.
- The transmitter is close to a radio transmitter such as a radio substation or an airport which can interfere with normal operation of the transmitter.

When the transmitter does not work correctly, open and close the door with the ignition key. If you have a problem with the transmitter, contact an authorized HYUNDAI dealer.

(Continued)

(Continued)

- If the transmitter is in close proximity to your mobile phone, the signal could be blocked by your mobile phones normal operational signals. This is especially important when the phone is active such as making and receiving calls, text messaging, and/or sending/receiving emails. Avoid placing the transmitter and your mobile phone in the same pants or jacket pocket and always try to maintain an adequate distance between the two devices.

CAUTION

Keep the transmitter away from water or any liquid and fire.

If the inside of the transmitter gets damp (due to drinks or moisture), or is heated, internal circuit may malfunction, excluding the car from the warranty.

Battery replacement

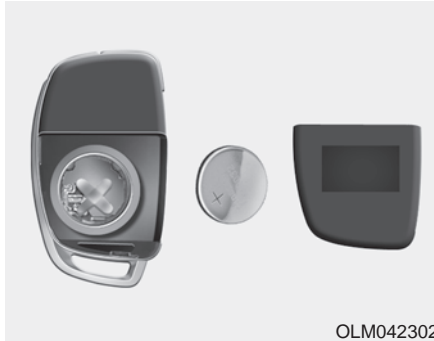

OLM042302

The transmitter uses a 3 volt lithium battery which will normally last for several years. When replacement is necessary, use the following procedure.

1. Insert a slim tool into the slot and gently pry open the transmitter center cover.
2. Replace the battery with a new battery (CR2032). When replacing the battery, make sure the battery position.
3. Install the battery in the reverse order of removal.

For replacement transmitters, see an authorized HYUNDAI dealer for transmitter reprogramming.

- The transmitter is designed to give you years of trouble-free use, however it can malfunction if exposed to moisture or static electricity. If you are unsure how to use your transmitter or replace the battery, contact an authorized HYUNDAI dealer.
- Using the wrong battery can cause the transmitter to malfunction. Be sure to use the correct battery.
- To avoid damaging the transmitter, don't drop it, get it wet, or expose it to heat or sunlight.



An inappropriately disposed battery can be harmful to the environment and may cause human health. Dispose the battery according to your local law(s) or regulation.



CAUTION - Transmitter damage

Do not drop, wet or expose the keyless entry system transmitter to heat or sunlight.

Immobilizer system (if equipped)

Your vehicle is equipped with an electronic engine immobilizer system to reduce the risk of unauthorized vehicle use.

Your immobilizer system is comprised of a small transponder in the ignition key and electronic devices inside the vehicle.

With the immobilizer system, whenever you insert your ignition key into the ignition switch and turn it to ON, it checks and determines and verifies if the ignition key is valid.

If the key is determined to be valid, the engine will start.

If the key is determined to be invalid, the engine will not start.

To activate the immobilizer system:

Turn the ignition key to the OFF position. The immobilizer system activates automatically. Without a valid ignition key for your vehicle, the engine will not start.

To deactivate the immobilizer system:

Insert the ignition key into the key cylinder and turn it to the ON position.

WARNING

In order to prevent theft of your vehicle, do not leave spare keys anywhere in your vehicle. Your Immobilizer password is a customer unique password and should be kept confidential. Do not leave this number anywhere in your vehicle.

*** NOTICE**

When starting the engine, do not use the key with other immobilizer keys around. Otherwise the engine may not start or may stop soon after it starts. Keep each key separate in order to avoid a starting malfunction.

CAUTION

Do not put metal accessories near the ignition switch.

Metal accessories may interrupt the transponder signal and may prevent the engine from being started.

*** NOTICE**

If you need additional keys or lose your keys, contact an authorized HYUNDAI dealer.

 **CAUTION**

The transponder in your ignition key is an important part of the immobilizer system. It is designed to give years of trouble-free service, however you should avoid exposure to moisture, static electricity and rough handling. Immobilizer system malfunction could occur.

 **CAUTION**

Do not change, alter or adjust the immobilizer system because it could cause the immobilizer system to malfunction and should only be serviced by an authorized HYUNDAI dealer.

Malfunctions caused by improper alterations, adjustments or modifications to the immobilizer system are not covered by your vehicle manufacturer warranty.

This device complies with Part 15 of the FCC rules.

Operation is subject to the following two conditions:

1. This device may not cause harmful interference, and
2. This device must accept any interference received, including interference that may cause undesired operation.

 **CAUTION**

Changes or modifications not expressly approved by the party responsible for compliance could void the user's authority to operate the equipment. If the keyless entry system is inoperative due to changes or modifications not approved by the party responsible for compliance, it will not be covered by your manufacturer's vehicle warranty.

SMART KEY

Record your key number



The key code number is stamped or printed on the key code tag attached to the key set. Should you lose your keys,

this number will enable an authorized HYUNDAI dealer to duplicate the keys easily. Remove the key code tag and store it in a safe place. Also, record the key code number and keep it in a safe and handy place, but not in the vehicle.

Smart key function



To remove the mechanical key, press and hold the release button(1) and remove the mechanical key (2).

To reinstall the mechanical key, put the key into the hole and push it until a click sound is heard.

With a smart key, you can lock or unlock a door (and Liftgate (Tailgate)) and start the engine.

Refer to the following for more details.

⚠ WARNING - Smart key

Leaving children unattended in a vehicle with the smart key is dangerous even if the Engine Start/Stop Button is in the ACC or ON position. Children copy adults and they could press the Engine Start/Stop Button.

The smart key would enable children to operate power windows or other controls, or even make the vehicle move, which could result in serious bodily injury or even death. Never leave the keys in your vehicle with unsupervised children, when the Engine is running.

Door Lock

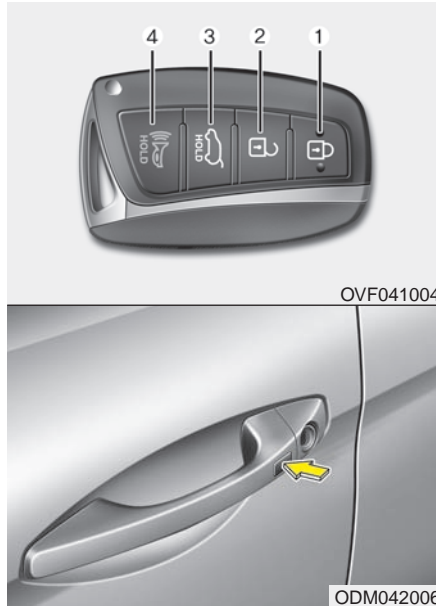

3. Press the button of the outside door handle.
4. The hazard warning lights will blink and the chime will sound once.
5. Make sure that doors are locked by pulling the outside door handle.

* NOTICE

- The button will only operate when the smart key is within 28~40in. (0.7~1m) from the outside door handle.
- Even though you press the outside door handle button, the doors will not lock and the chime will sound for 3 seconds if any of following occur:
 - The smart key is in the vehicle.
 - The engine start/stop button is in ACC or ON position.
 - Any door is open.

Using the button on the smart key

- 1 Close all doors, engine hood and liftgate (tailgate).
2. Press the lock button(1).
3. The hazard warning lights will blink and the chime will sound once.
4. Make sure that doors are locked by pulling the outside door handle.

Using the door handle button

1. Carry the smart key.
2. Close all doors, engine hood and liftgate (tailgate).

Unlocking

Using the door handle button

1. Carry the smart key.
 2. Press the button of the driver's outside door handle.
 3. The driver's door will unlock. The hazard warning lights will blink and the chime will sound two times.
 4. Press the button twice within 4 seconds and all doors and the liftgate (tailgate) will unlock and the hazard warning lights will blink and the chime will sound two times.
- * If you press the button of the front passenger's outside door handle while carrying the smart key, all doors will unlock.

*** NOTICE**

- The button will only operate when the smart key is within 28~40in. (0.7~1m) from the outside door handle.
- When the smart key is recognized in the area of 28~40in. (0.7~1m) from the front outside door handle, other people can also unlock the doors by pressing the button of the front outside door handle.
- After unlocking the driver's door or all doors, the door(s) will lock automatically unless the door is opened.

Using the button on the smart key

1. Press the unlock button(2) of the smart key.
2. The driver's door will unlock. The hazard warning lights will blink and the chime will sound two times.
3. Press the unlock button(2) twice within 4 seconds and all doors and the liftgate (tailgate) will unlock. The hazard warning lights will blink and the chime will sound two times.

*** NOTICE**

After pressing the button, the doors will lock automatically unless any door is opened within 30 seconds.

*** NOTICE**

You can activate or deactivate the Two Turn Unlock function. Refer to "User settings" in this section.

Liftgate (Tailgate) unlocking

Using the liftgate (tailgate) handle button

1. Carry the smart key.
2. Press the liftgate (tailgate) handle button.
3. When all doors are locked, the hazard warning lights will blink two times.

Once the liftgate (tailgate) is opened and then closed, the liftgate (tailgate) will lock automatically.

*** NOTICE**

The button will only operate when the smart key is within 28~40in. (0.7~1m) from the liftgate (tailgate) handle.

Using the button on the smart key

1. Press the liftgate (tailgate) unlock button(3) for more than 1 second.
2. When all doors are locked, the hazard warning lights will blink two times.

Panic

1. Press the panic button(4) for more than 1 second.
2. The horn sounds and hazard warning light flash for about 30 seconds.

*** NOTICE**

To stop the horn and lights, press any button on the smart key.

Start-up

You can start the engine without inserting the key. For detailed information refer to the “Engine start/stop button” in section 5.

Loss of the smart key

A maximum of 2 smart keys can be registered to a single vehicle.

If you happen to lose your smart key, you will not be able to start the engine. You should immediately take the vehicle and remaining key to your authorized HYUNDAI dealer(tow the vehicle, if necessary) to protect it from potential theft.

Smart key precautions

- The smart key will not work if any of the following occur:
 - The smart key is close to a radio transmitter such as a radio station or an airport which can interfere with normal operation of the smart key.
 - The smart key is near a mobile two way radio system or a cellular phone.
 - Another vehicle's smart key is being operated close to your vehicle.
- When the smart key does not work correctly, open and close the door with the mechanical key and contact an authorized HYUNDAI dealer.

- If the smart key is in close proximity to your cell phone or smart phone, the signal from the smart key could be blocked by normal operation of your cell phone or smart phone. This is especially important when the phone is active such as making a call, receiving calls, text messaging, and/or sending/receiving emails. Avoid placing the smart key and your cell phone or smart phone in the same pants or jacket pocket and maintain adequate distance between the two devices.

CAUTION

Keep the smart key away from water or any liquid and fire. If the inside of the smart key gets damp (due to drinks or moisture), or is heated, internal circuit may malfunction, excluding the car from the warranty.

Smart key immobilizer system

Your vehicle is equipped with an electronic engine immobilizer system to reduce the risk of unauthorized vehicle use.

Your immobilizer system is comprised of a small transponder in the smart key and electronic devices inside the vehicle.

With the immobilizer system, whenever you turn the engine start/stop button to the ON position by pressing the button while carrying the smart key, it checks and determines and verifies if the smart key is valid or not.

If the key is determined to be valid, the engine will start.

If the key is determined to be invalid, the engine will not start.

To deactivate the immobilizer system:

Turn the engine start/stop button to the ON position by pressing the button while carrying the smart key.

To activate the immobilizer system:

Turn the engine start/stop button to the OFF position. The immobilizer system activates automatically.

Without a valid smart key for your vehicle, the engine will not start.

 CAUTION

In order to prevent theft of your vehicle, do not leave spare keys anywhere in your vehicle. Your Immobilizer password is a customer unique password and should be kept confidential. Do not leave this number anywhere in your vehicle.

*** NOTICE**

When starting the engine, do not use the key with other immobilizer keys around. Otherwise the engine may not start or may stop soon after it starts. Keep each key separate in order to avoid a starting malfunction.

 CAUTION

Do not put metal accessories near the smart key.

The engine may not start because the metal accessories may interrupt the transponder signal from transmitting normally.

*** NOTICE**

If you need additional keys or lose your keys, contact an authorized HYUNDAI dealer.

 CAUTION

The transponder in your smart key is an important part of the immobilizer system. It is designed to give years of trouble-free service, however you should avoid exposure to moisture, static electricity and rough handling. Immobilizer system malfunction could occur.

 CAUTION

Do not change, alter or adjust the immobilizer system because it could cause the immobilizer system to malfunction and should only be serviced by an authorized HYUNDAI dealer.

Malfunctions caused by improper alterations, adjustments or modifications to the immobilizer system are not covered by your vehicle manufacturer warranty.

This device complies with Part 15 of the FCC rules.

Operation is subject to the following two conditions:

1. This device may not cause harmful interference, and
2. This device must accept any interference received, including interference that may cause undesired operation.

⚠ WARNING

Changes or modifications not expressly approved by the party responsible for compliance could void the user's authority to operate the equipment. If the keyless entry system is inoperative due to changes or modifications not expressly approved by the party responsible for compliance, it will not be covered by your manufacturer's vehicle warranty.

Battery replacement

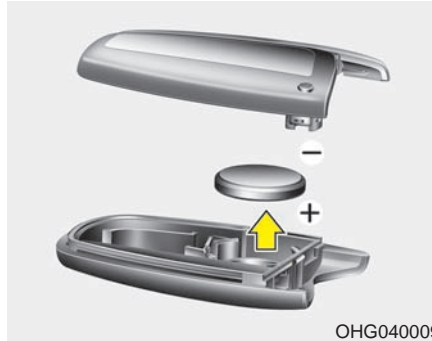

A smart key battery should last for several years, but if the smart key is not working properly, try replacing the battery with a new one. If you are unsure how to use your smart key or replace the battery, contact an authorized HYUNDAI dealer.

1. Remove the mechanical key.
2. Pry open the rear cover.
3. Replace the battery with a new battery (CR2032). When replacing the battery, make sure the battery position.

4. Install the battery in the reverse order of removal.

- The smart key is designed to give you years of trouble-free use, however it can malfunction if exposed to moisture or static electricity. If you are unsure how to use or replace the battery, contact an authorized HYUNDAI dealer.
- Using the wrong battery can cause the smart key to malfunction. Be sure to use the correct battery.
- To avoid damaging the smart key, don't drop it, get it wet, or expose it to heat or sunlight.
-  An inappropriately disposed battery can be harmful to the environment and human health. Dispose the battery according to your local law(s) or regulation.

⚠ CAUTION - Smart key damage

Do not drop, get wet or expose the smart key to heat or sunlight, or it will be damaged.

THEFT-ALARM SYSTEM (IF EQUIPPED)

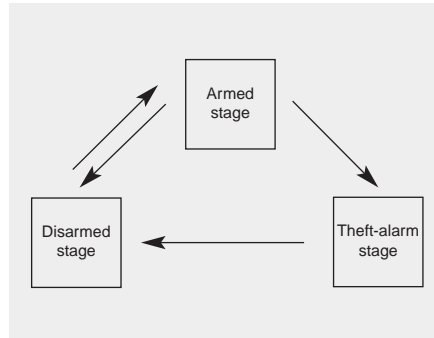

This system is designed to provide protection from unauthorized entry into the vehicle. This system is operated in three stages: the first is the "Armed" stage, the second is the "Theft-alarm" stage, and the third is the "Disarmed" stage. If triggered, the system provides an audible alarm with blinking of the hazard warning lights.

Armed stage

Using the smart key (if equipped)

Park the vehicle and stop the engine. Arm the system as described below.

1. Turn off the engine.
2. Make sure that all doors, the engine hood and liftgate (tailgate) lid are closed and latched.
3. • Lock the doors by pressing the button of the front outside door handle with the smart key in your possession.

After completion of the steps above, the hazard warning lights and chime will operate once to indicate that the system is armed.

If any door remains open, the doors won't lock and the chime will sound for 3 seconds. Close the door and try again to lock the doors.

If the liftgate (tailgate) hatch or the engine hood remains open, the hazard warning lights and the chime won't operate, and the theft alarm will not arm. After you close the liftgate (tailgate) and engine hood, the hazard warning lights blink once.

- Lock the doors by pressing the lock button on the smart key.

After completion of the steps above, the hazard warning lights and chime will operate once to indicate that the system is armed.

If any door, liftgate (tailgate) or engine hood remains open, the hazard warning lights and chime won't operate and the theft-alarm will not arm. After you close the liftgate (tailgate) and engine hood, the hazard warning lights blink once.

Using the transmitter (if equipped)

Park the vehicle and stop the engine. Arm the system as described below.

1. Turn off the engine and remove the ignition key from the ignition switch.
2. Make sure that all doors, the engine hood and liftgate (tailgate) are closed and latched.
3. Lock the doors by pressing the lock button on the transmitter.

After completion of the steps above, the hazard warning lights will blink once to indicate that the system is armed.

If any door, liftgate (tailgate) or engine hood remains open, the hazard warning lights won't operate and theft-alarm will not arm. After you close all doors, liftgate (tailgate) and engine hood, the hazard warning lights blink once.

Using the mechanical key

Park the vehicle and stop the engine. Arm the system as described below.

1. Turn off the engine and remove the key from the ignition switch(if equipped).
2. Make sure that all doors, the engine hood and liftgate (tailgate) are closed and latched.
3. Lock the doors by inserting the key into the key hole on the front outside door handle and turning the key toward the rear of the vehicle.

If any door, liftgate (tailgate) or engine hood remains open, the theft-alarm will not arm.

*** NOTICE**

If you lock or unlock the doors by using the mechanical key, the hazard warning light won't operate.

Do not arm the system until all passengers have left the vehicle. If the system is armed while a passenger(s) remains in the vehicle, the alarm may be activated when the remaining passenger(s) leave the vehicle. If any door (or trunk) or engine hood is opened within 30 seconds after the system enters the armed stage, the system is disarmed to prevent an unnecessary alarm.

Theft-alarm stage

The alarm will be activated if any of the following occurs while the system is armed.

- A door is opened without using the transmitter, smart key or mechanical key.
- The liftgate (tailgate) is opened without using the transmitter or smart key.
- The engine hood is opened.

The horn will sound and the hazard warning lights will blink continuously for approximately 30 seconds. The alarm will repeat once more unless the system is disarmed. To turn off the system, unlock the doors with the mechanical key or transmitter or smart key.

Disarmed stage

Using the smart key (if equipped)

The system will be disarmed when the doors are unlocked by pressing the unlock button on the smart key or pressing the lock/unlock button of the front outside door handle with the smart key in your possession.

After unlocking the doors, the hazard warning lights and chime will operate twice to indicate that the system is disarmed.

After unlocking the doors, if any door is not opened within 30 seconds, the system will be rearmed.

Using the transmitter (if equipped)

The system will be disarmed when the doors are unlocked by pressing the unlock button on the transmitter.

After unlocking the doors, the hazard warning lights will blink twice to indicate that the system is disarmed.

After unlocking the doors, if any door is not opened within 30 seconds, the system will be rearmed.

Using the mechanical key

The system will be disarmed when the doors are unlocked with the mechanical key.

*** NOTICE**

If you lock or unlock the doors by using the mechanical key, the hazard warning light and chime sound won't operate.

* NOTICE

- Avoid trying to start the engine while the alarm is activated. The vehicle starting motor is disabled during the theft-alarm stage.
- If you lose your keys, contact your authorized HYUNDAI dealer.

CAUTION

Do not change, alter or adjust the theft-alarm system because it could cause the theft-alarm system to malfunction and should only be serviced by an authorized HYUNDAI dealer.

Malfunctions caused by improper alterations, adjustments or modifications to the theft-alarm system are not covered by your vehicle manufacturer warranty.

DOOR LOCKS

Operating door locks from outside the vehicle

Using the folding key (if equipped)

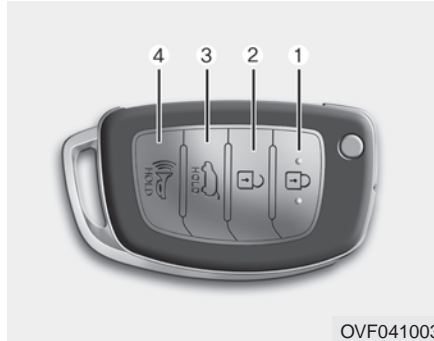

- Doors can be locked and unlocked by pressing the lock button(1) and unlock button(2) on the folding key.

Once the doors are unlocked, they may be opened by pulling the door handle. When closing the door, push the door by hand. Make sure that doors are closed securely.

For more detailed information, refer to "Folding key" in this section.

Using the smart key (if equipped)

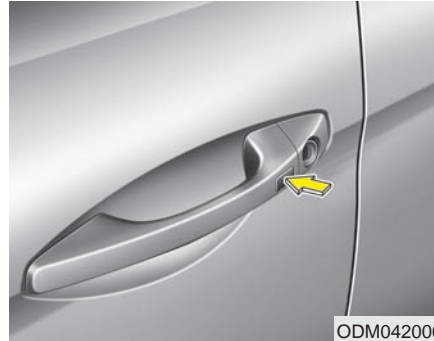

- Doors can be locked and unlocked pressing the button of the outside door handle with the smart key in your possession.

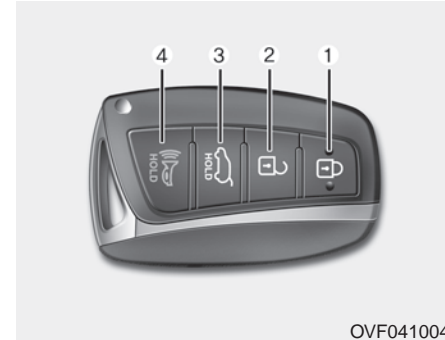

- Doors can be locked and unlocked by pressing the lock button(1) and unlock button(2) on the smart key.

Once the doors are unlocked, they may be opened by pulling the door handle. When closing the door, push the door by hand. Make sure that doors are closed securely.

For more detailed information, refer to "Smart key" in this section.

Using the mechanical key in an emergency situation

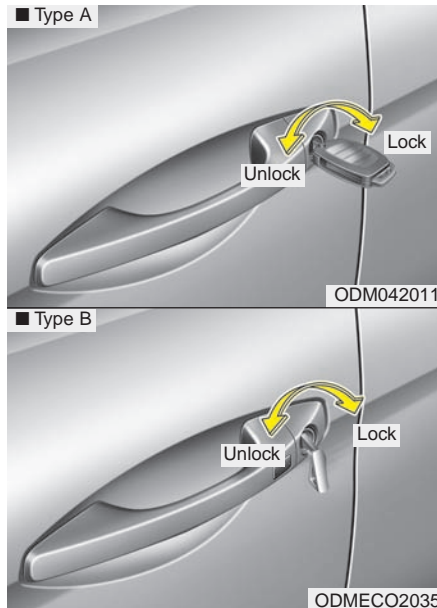

If the smart key or folding key does not operate normally, you can lock or unlock the doors as follows:

1. Unfold the folding key or remove the mechanical key from the smart key.
2. Insert the key into the hole of the outside door handle. Turn the key toward the front of the vehicle to unlock and toward the rear of the vehicle to lock.

* NOTICE

- In cold and wet climates, door locks and door mechanisms may not work properly due to freezing conditions.
- If the door is locked/unlocked multiple times in rapid succession with either the vehicle key or door lock switch, the system may stop operating temporarily in order to protect the circuit and prevent damage to system components.

* NOTICE

You can activate or deactivate the Tow Turn Unlock function. Refer to "User Settings" in this section.

⚠ WARNING

- If you don't close the door securely, the door may open again.
- Be careful that someone's body and hands are not trapped when closing the door.

Operating door locks from inside the vehicle

With the door lock button

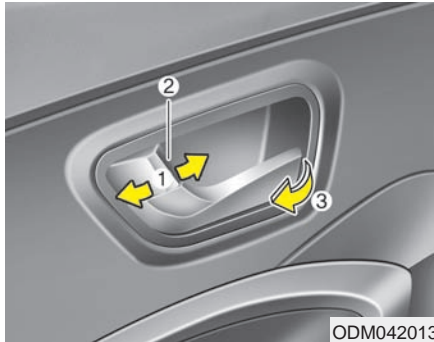

- To unlock a door, push the door lock button(1) to the “Unlock” position. The red mark (2) on the button will be visible.
- To lock a door, push the door lock button(1) to the “Lock” position. If the door is locked properly, the red mark (2) on the button will not be visible.
- To open a door, pull the door handle (3) outward.

- If the inner door handle on either front door is pulled when the door lock button is in the locked position, the door will unlock and open.
- The front door cannot be locked if the ignition key is in the ignition switch and the door is open.
- The door cannot be locked if the smart key is in the vehicle and any door is open.

If a power door lock ever fails to function while you are in the vehicle, try one or more of the following:

- Operate the door unlock feature repeatedly (both electronic and manual) while simultaneously pulling on the door handle.
- Operate the other door locks and handles, front and rear.
- Lower a front window and use the key to unlock the door from outside.

Central door lock switch

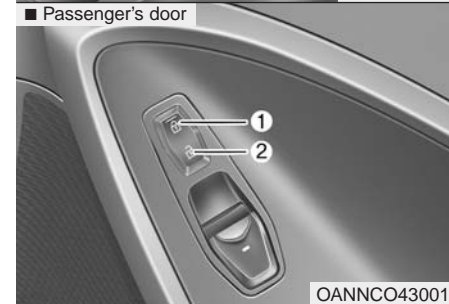
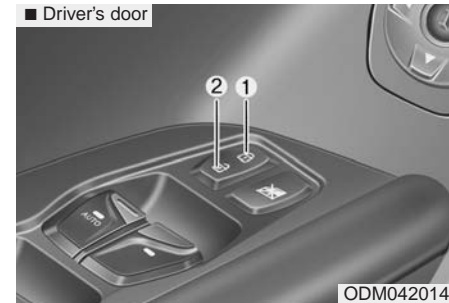

Operate by depressing the central door lock switch.

- When pushing down the lock switch (1), all vehicle doors will lock.

- When pushing down the lock release switch (2), all vehicle doors will unlock.
- If the key is in the ignition switch and front door is open, the doors will not lock even though the central door lock switch (1) is pressed.
- If the smart key is in the vehicle and any door is open, the doors will not lock even though the central door lock switch (1) is pressed.

WARNING - Doors

- **The doors should always be fully closed and locked while the vehicle is in motion to prevent accidental opening of the door. Locked doors will also discourage potential intruders when the vehicle stops or slows.**
- **Be careful when opening doors and watch for vehicles, motorcycles, bicycles or pedestrians approaching the vehicle in the path of the door. Opening a door when something is approaching can cause damage or injury.**

WARNING - Unlocked vehicles

Leaving your vehicle unlocked can invite theft or possible harm to you or others from someone hiding in your vehicle while you are gone. Always remove the ignition key, engage the parking brake, close all windows and lock all doors when leaving your vehicle unattended.

WARNING - Unattended children

An enclosed vehicle can become extremely hot, causing death or severe injury to unattended children or animals who cannot escape the vehicle. Furthermore, children might operate features of the vehicle that could injure them, or they could encounter other harm, possibly from someone gaining entry to the vehicle. Never leave children or animals unattended in your vehicle.

Impact sensing door unlock system

All doors will be automatically unlocked if an impact or collision is detected by the impact sensors while the ignition switch is ON.

However, the doors may not be unlocked if mechanical problems occur with the door lock system or battery.

* NOTICE

You can select some auto door lock/unlock features in “User Settings” as follows;

- Speed sensing auto door lock
- Auto door unlock when the ignition key is removed from the ignition switch or engine is turned off.
- Auto door lock/unlock by shifting the shift lever out of P(Park) or into P(Park).

For more information, refer to “User Settings” in this section.

Child-protector rear door lock

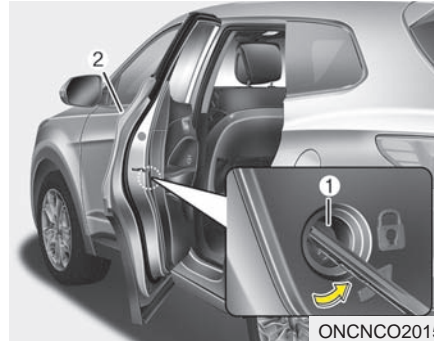

The child safety lock is provided to help prevent children from accidentally opening the rear doors from inside the vehicle. The rear door safety locks should be used whenever children are in the vehicle.

1. Open the rear door.
2. Insert a key (or screwdriver) into the hole (1) and turn it to the lock () position. When the child safety lock is in the lock position, the rear door will not open even when the inner door handle is pulled.

3. Close the rear door.

To open the rear door, pull the outside door handle (2).

Even though the doors are unlocked, the rear door will not open by pulling the inner door handle until the rear door child safety lock is unlocked.

WARNING - Rear door locks

If children accidentally open the rear doors while the vehicle is in motion, they could fall out of the vehicle, resulting in severe injury or death. To prevent children from opening the rear doors from the inside, the rear door safety locks should be used whenever children are in the vehicle.

LIFTGATE (TAILGATE)

Non-Powered liftgate (tailgate)

Opening the liftgate (tailgate)

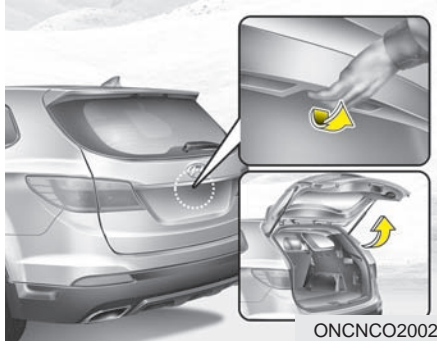

- The liftgate (tailgate) is locked or unlocked when all doors are locked or unlocked with the key, transmitter, smart key or central door lock switch.
- If unlocked, the liftgate (tailgate) can be opened by pressing the handle switch and pulling the handle up.
- Only the liftgate (tailgate) is unlocked if the liftgate (tailgate) unlock button on the transmitter or smart key is pressed for about 1 second, or the liftgate (tailgate) handle button is pressed when the smart key is detected.

* NOTICE

In cold and wet climates, door lock and door mechanisms may not work properly due to freezing conditions.

⚠ WARNING

The liftgate (tailgate) swings upward. Make sure no objects or people are near the rear of the vehicle when opening the liftgate (tailgate).

⚠ CAUTION

Make certain that you close the liftgate (tailgate) before driving your vehicle. Possible damage may occur to the liftgate (tailgate) lift cylinders and attached hardware if the liftgate (tailgate) is not closed prior to driving.

Closing the liftgate (tailgate)



To close the liftgate (tailgate), lower and push down the liftgate (tailgate) firmly. Make sure that the liftgate (tailgate) is securely latched.

⚠ WARNING - Exhaust fumes

If you drive with the liftgate (tailgate) opened, you will draw dangerous exhaust fumes into your vehicle which can cause serious injury or death to vehicle occupants.

If you must drive with the liftgate (tailgate) opened, keep the air vents and all windows open so that additional outside air comes into the vehicle.

⚠ WARNING - Rear cargo area

Occupants should never ride in the rear cargo area where no restraints are available. To avoid injury in the event of an accident or sudden stops, occupants should always be properly restrained.

Power liftgate (Power tailgate) (if equipped)



- (1) Power liftgate (Power tailgate) handle switch
- (2) Power liftgate (Power tailgate) close button

*** NOTICE**

When the engine is not running, the power liftgate (power tailgate) can be operated regardless of gear position.

However, if ignition switch is ON position, the power liftgate (power tailgate) can operate when the automatic shift lever is in P (Park).

⚠ WARNING

Never leave children or animals unattended in your vehicle. Children or animals might operate the power liftgate (power tailgate) that could result in injury to themselves or others, or damage the vehicle.

⚠ WARNING

Make sure there are no people or objects around the liftgate (tailgate) before operating the power liftgate (power tailgate). Wait until the liftgate (tailgate) is opened fully and stopped before loading or unloading cargo or passengers from the vehicle.

⚠ CAUTION

Do not close or open the power liftgate (power tailgate) manually. This may cause damage to the power liftgate (power tailgate). If it is necessary to close or open the power liftgate (power tailgate) manually when the battery is discharged or disconnected, do not apply excessive force.

Opening the liftgate (tailgate)



The power liftgate (power tailgate) will open automatically by doing one of the following:

- Press the liftgate (tailgate) unlock button on the transmitter or smart key.
- Press the liftgate (tailgate) handle switch carrying the smart key with you.

For emergency stop while operating, press the power liftgate (power tailgate) open button shortly.

Closing the liftgate (tailgate)



1. Press the power liftgate (power tailgate) close button (approximately 1 second).
2. The liftgate (tailgate) will close and lock automatically.

For emergency stop while operating, press the power liftgate (power tailgate) close button shortly.

⚠ WARNING

The chime will sound and the hazard warning flasher will blink 10 times if you drive with the liftgate (tailgate) closed but not locked. Stop your vehicle immediately at a safe place and check if your liftgate (tailgate) is securely locked.

Power liftgate (Power tailgate) non-opening conditions

The power liftgate (power tailgate) will not open or close automatically, when the vehicle is moving more than 2 mph (3 km/h).

⚠ WARNING

The chime will sound continuously if you drive over 2 mph (3 km/h) with the liftgate (tailgate) opened. Stop your vehicle immediately at a safe place and check if your liftgate (tailgate) is opened.

⚠ CAUTION

Operating the power liftgate (power tailgate) more than 5 times continuously could cause damages to the operating motor. In this case, the system enters into a thermal protection mode. In thermal protection mode, the power liftgate (power tailgate) can not operate and the chime will sound for 3 times by any switch inputs. Leave your power liftgate (power tailgate) system for rest about 1 minute and then operate.

*** NOTICE**

- The power liftgate (power tailgate) can be operated when the engine is not running. However the power liftgate (power tailgate) operation consumes large amounts of vehicle electric power. To prevent the battery from being discharged, do not operate it excessively e.g.: more than approximately 10 times repeatedly.
- To prevent the battery from being discharged, do not leave the power liftgate (power tailgate) in the open position for a long time.
- Do not modify or repair any part of the power liftgate (power tailgate) by yourself. This must be done by an authorized HYUNDAI dealer.
- When jacking up the vehicle to change a tire or repair the vehicle, do not operate the power liftgate (power tailgate). This could cause the power liftgate (power tailgate) to operate improperly.
- In cold and wet climates, the power liftgate (power tailgate) may not work properly due to freezing conditions.

Automatic reversal



During power opening and closing if the power liftgate (power tailgate) is blocked by an object or part of the body, the power liftgate (power tailgate) will detect the resistance.

- If the resistance is detected while opening the liftgate (tailgate), it will stop and move in the opposite direction.
- If the resistance is detected while closing the liftgate (tailgate), it will stop and move in the opposite direction.

However, if the resistance is weak such as from an object that is thin or soft, or the liftgate (tailgate) is near the latched position, the automatic stop and reversal may not detect the resistance.

If the automatic reversal feature operates continuously more than twice during opening or closing operation, the power liftgate (power tailgate) may stop at that position. At this time, close the liftgate (tailgate) manually and operate the liftgate (tailgate) automatically again.

⚠ WARNING

Never intentionally place any object or part of your body in the path of the power liftgate (power tailgate) to make sure the automatic reversal operates.

⚠ CAUTION

Do not put heavy stuffs on the power liftgate (power tailgate) before you operate the power liftgate (power tailgate). Additional weight on liftgate (tailgate) could cause damages to the system.

How to reset the power liftgate (power tailgate)

If the battery has been discharged or disconnected, or if the related fuse has been replaced or disconnected, for the power liftgate (power tailgate) to operate normally, reset the power liftgate (power tailgate) as follow:

1. Put the shift lever in P (Park).
2. While pressing the liftgate (tailgate) close button, press the liftgate (tailgate) handle switch for more than 3 seconds. (the chime will sound)
3. Close the liftgate (tailgate) manually.

If the power liftgate (power tailgate) does not work properly after the above procedure, have the system checked by an authorized HYUNDAI dealer.

* NOTICE

If the power liftgate (power tailgate) does not operate normally, first check the following condition before using the power liftgate (power tailgate).

Check if the shift lever is in:

- P (Park) for automatic transaxle vehicles

Power liftgate (Power tailgate) opening height user setting

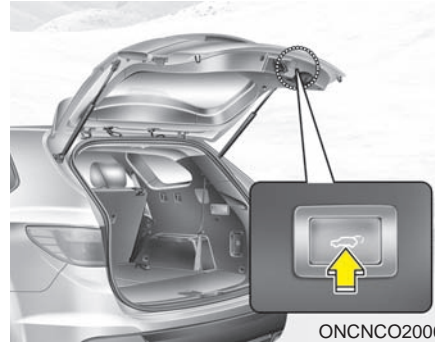

The driver may set the height of a fully opened liftgate (tailgate) by following the below instruction.

1. Position the liftgate (tailgate) manually to the height you prefer.
2. Press the liftgate (tailgate) close button for more than 3 seconds.
3. Close the liftgate (tailgate) manually after hearing the buzzer sound.

The liftgate (tailgate) will open to the height the driver has set up.

▲ WARNING - Exhaust fumes

If you drive with the liftgate (tailgate) open, you will draw dangerous exhaust fumes into your vehicle which can cause serious injury or death to vehicle occupants. If you must drive with the liftgate (tailgate) open, keep the air vents and all windows open so that additional outside air comes into the vehicle.

▲ WARNING - Rear cargo area

Occupants should never ride in the rear cargo area where no restraints are available. To avoid injury in the event of an accident or sudden stops, occupants should always be properly restrained.

Smart Liftgate (Smart Tailgate) (if equipped)



On the vehicle equipped with a smart key, the liftgate (tailgate) can be opened with no-touch activation using the Smart Liftgate (Smart Tailgate) system.

How to use the Smart Liftgate (Smart Tailgate)

The liftgate (tailgate) can be opened with no-touch activation satisfying all the conditions below.

- After 15 seconds when all doors are closed and locked
- Positioned in the detecting area for more than 3 seconds.

*** NOTICE**

- **The Smart Liftgate (Smart Tailgate) does not operate when:**
 - The smart key is detected within 15 seconds after the doors are closed and locked, and is continuously detected.
 - The smart key is detected within 15 seconds after the doors are closed and locked, and 60 inches (1.5 m) from the front door handles. (for vehicles equipped with Welcome Light)
 - A door is not locked or closed.
 - The smart key is in the vehicle.

1. Setting

To activate the Smart Liftgate (Smart Tailgate), go to User Settings Mode and select Smart Liftgate (Smart Tailgate) on the LCD display.

* For more details, refer to "LCD Display" in this chapter.

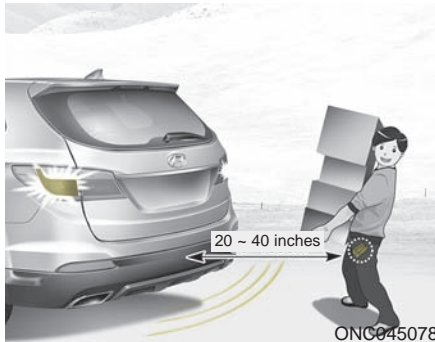

2. Detect and Alert

If you are positioned in the detecting area (20 ~ 40 inches (50 ~ 100 cm) behind the vehicle) carrying a smart key, the hazard warning lights will blink and chime will sound for about 3 seconds to alert you the smart key has been detected and the liftgate (tailgate) will open.

* NOTICE

Do not approach the detecting area if you do not want the liftgate (tailgate) to open. If you have unintentionally entered the detecting area and the hazard warning lights and chime starts to operate, leave the detecting area with the smart key. The liftgate (tailgate) will stay closed.



3. Automatic opening

The hazard warning lights will blink and chime will sound 2 times and then the liftgate (tailgate) will slowly open.

⚠ WARNING

- Make certain that you close the liftgate (tailgate) before driving your vehicle.
- Make sure there are no people or objects around the liftgate (tailgate) before opening or closing the liftgate (tailgate).
- Make sure objects in the rear cargo area do not come out when opening the liftgate (tailgate) on the slope way. It may cause serious injury.
- Make sure to deactivate the Smart Liftgate (Smart Tailgate) function when washing your vehicle.
Otherwise, the liftgate (tailgate) may open inadvertently.
- The key should be kept out of reach of children. Children may inadvertently open the Smart Liftgate (Smart Tailgate) while playing around the rear area of the vehicle.

How to deactivate the Smart Liftgate (Smart Tailgate) function using the smart key

■ Smart key

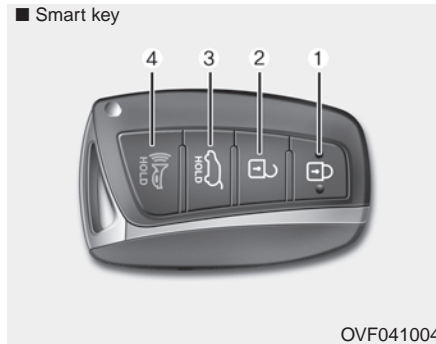

1. Door lock
2. Door unlock
3. Liftgate (Tailgate) open
4. Panic

If you press any button of the smart key during the Detect and Alert stage, the Smart Liftgate (Smart Tailgate) function will be deactivated. Make sure to be aware of how to deactivate the Smart Liftgate (Smart Tailgate) function for emergency situations.

* NOTICE

- If you press the door unlock button (2), the Smart Liftgate (Smart Tailgate) function will be deactivated temporarily. But, if you do not open any door for 30 seconds, the Smart Liftgate (Smart Tailgate) function will be activated again.
- If you press the liftgate (tailgate) open button (3) for more than 1 second, the liftgate (tailgate) opens.
- If you press the door lock button (1) or liftgate (tailgate) open button (3) when the Smart Liftgate (Smart Tailgate) function is not in the Detect and Alert stage, the Smart Liftgate (Smart Tailgate) function will not be deactivated.
- In case you have deactivated the Smart Liftgate (Smart Tailgate) function by pressing the smart key button and opened a door, the Smart Liftgate (Smart Tailgate) function can be activated again by closing and locking all doors.

Detecting area



- The Smart Liftgate (Smart Tailgate) operates with a welcome alert if the smart key is detected within 20~40 inches (50~100 cm) from the liftgate (tailgate).
- The alert stops at once if the smart key is positioned outside the detecting area during the Detect and Alert stage.

*** NOTICE**

- The Smart Liftgate (Smart Tailgate) function will not work if any of the following occurs:
 - The smart key is close to a radio transmitter such as a radio station or an airport which can interfere with normal operation of the transmitter.
 - The smart key is near a mobile two way radio system or a cellular phone.
 - Another vehicle's smart key is being operated close to your vehicle.
- The detecting range may decrease or increase when :
 - One side of the tire is raised to replace a tire or to inspect the vehicle.
 - The vehicle is slantingly parked on a slope or unpaved road, etc.

Emergency liftgate (tailgate) safety release

Your vehicle is equipped with the emergency liftgate (tailgate) safety release lever located on the bottom of the liftgate (tailgate). When someone is inadvertently locked in the luggage compartment, the liftgate (tailgate) can be opened by doing as follows:

1. Remove the cover.
2. Push the release lever to the right.
3. Push up the liftgate (tailgate).

⚠ WARNING

- For emergencies, be fully aware of the location of the emergency liftgate (tailgate) safety release lever in this vehicle and how to open the liftgate (tailgate) if you are accidentally locked in the luggage compartment.
- No one should be allowed to occupy the luggage compartment of the vehicle at any time. The luggage compartment is a very dangerous location in the event of a crash.
- Use the release lever for emergencies only. Use extreme caution, especially while the vehicle is in motion.

WINDOWS

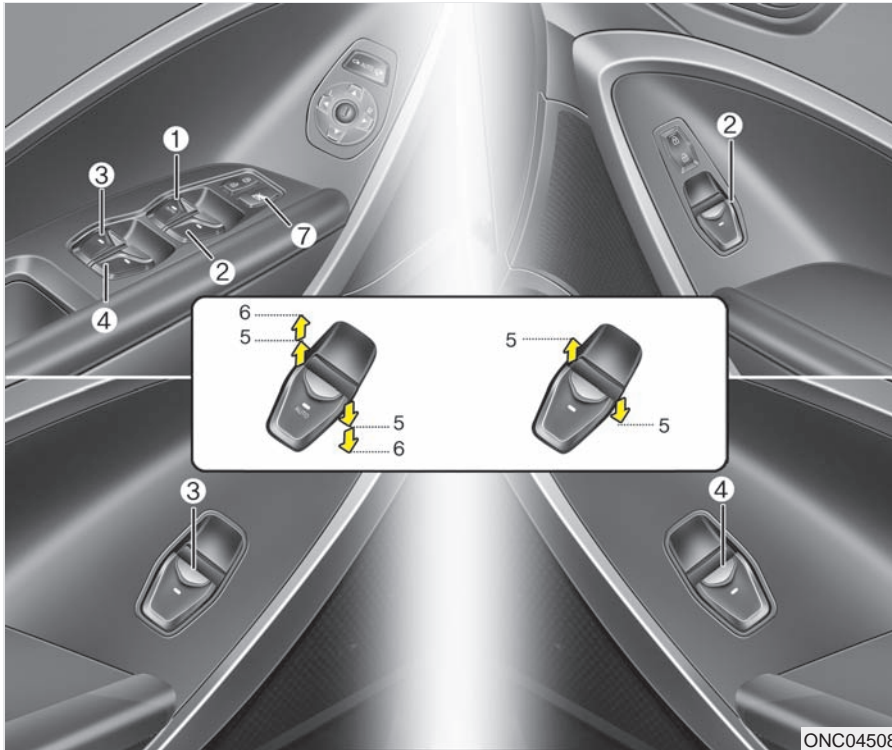

- (1) Driver's door power window switch
- (2) Front passenger's door power window switch
- (3) Rear door (left) power window switch
- (4) Rear door (right) power window switch
- (5) Window opening and closing
- (6) Automatic power window up/down
- (7) Power window lock switch

* NOTICE

In cold and wet climates, power windows may not work properly due to freezing conditions.

ONC045081

Power windows

The ignition switch must be in the ON position for power windows to operate. Each door has a power window switch that controls that door's window. The driver has a power window lock switch which can block the operation of passenger windows. The driver's door has a master power window switch that controls all the windows in the vehicle. The power windows can be operated for approximately 30 seconds after the ignition key is removed or turned to the ACC or LOCK position. However, if the front doors open, the power windows cannot be operated within the 30 second period.

* NOTICE

While driving with the rear windows down or with the sunroof (if equipped) in an open (or partially open) position, your vehicle may demonstrate a wind buffeting or pulsation noise. This noise is a normal occurrence and can be reduced or eliminated by taking the following actions. If the noise occurs with one or both of the rear windows down, partially lower both front windows approximately one inch. If you experience the noise with the sunroof open, slightly reduce the size of the sunroof opening.

Window opening and closing

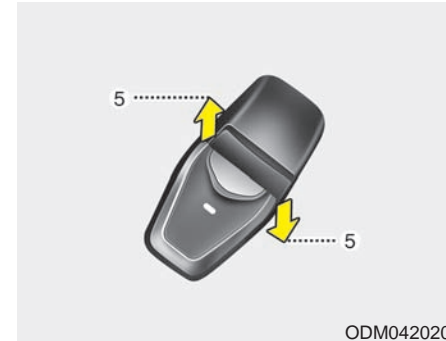

ODM042020

To open or close a window, press down or pull up the front portion of the corresponding switch to the first detent position (5).

Auto up/down window (front seat) (if equipped)

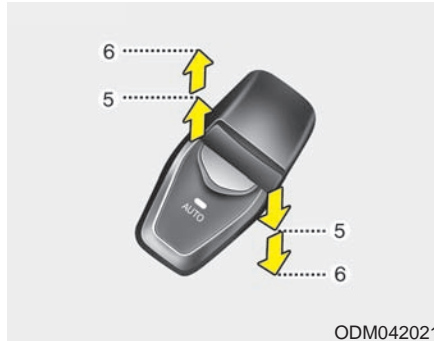

Pressing down or pulling up the power window switch momentarily to the second detent position (6) completely lowers or lifts the window even when the switch is released. To stop the window at the desired position while the window is in operation, momentarily pull or push the switch in the direction opposite of the window's movement.

If the power window is not operated correctly, the automatic power window system must be reset as follows:

1. Turn the ignition switch to the ON position.
2. Close windows and continue pulling up on the power window switch for at least 1 second after the window is completely closed.

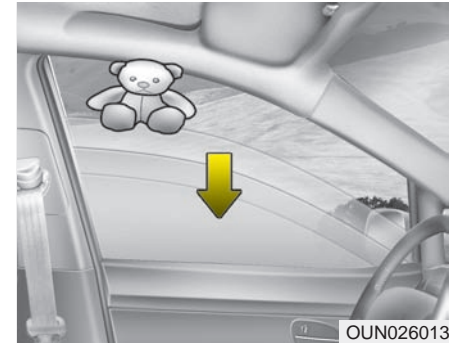

Automatic reversal

If the upward movement of the window is blocked by an object or part of the body, the window will detect the resistance and will stop upward movement. The window will then lower approximately 11.8 in. (30 cm) to allow the object to be cleared.

If the window detects the resistance while the power window switch is pulled up continuously, the window will stop upward movement then lower approximately 1 in. (2.5 cm). If the power window switch is pulled up continuously again within 5 seconds after the window is lowered by the automatic window reversal feature, the automatic window reversal will not operate.

* NOTICE

The automatic reverse feature for the driver's window is only active when the "auto up" feature is used by fully pulling up the switch. The automatic reverse feature will not operate if the window is raised using the halfway position on the power window switch.

WARNING

Always check for obstructions before raising any window to avoid injuries or vehicle damage. If an object less than 0.16 in. (4 mm) in diameter is caught between the window glass and the upper window channel, the automatic reverse window may not detect the resistance and will not stop and reverse direction.

Power window lock button



ODM042022

The driver can disable the power window switches on the rear passengers' doors by pressing the power window lock switch to the lock position (pressed).

When the power window lock switch is pressed:

- The driver's master control can operate all the power windows.
- The front passenger's control can operate the front passenger's power window.
- The rear passenger's control cannot operate the rear passenger's power window.

CAUTION

- *To prevent possible damage to the power window system, do not open or close two windows or more at the same time. This will also ensure the longevity of the fuse.*
- *Never try to operate the main switch on the driver's door and the individual door switch in opposing directions at the same time. If this is done, the window will stop and cannot be opened or closed.*

WARNING - Windows

- **NEVER** leave the ignition key (or smart key) in the vehicle.
- **NEVER** leave any child unattended in the vehicle. Even very young children may inadvertently cause the vehicle to move, entangle themselves in the windows, or otherwise injure themselves or others.
- Always double check to make sure all arms, hands, head and other obstructions are safely out of the way before closing a window.
- Do not allow children to play with the power windows. Keep the driver's door power window lock switch in the LOCK position (depressed). Serious injury can result from unintentional window operation by the child.
- Do not extend any head or arms outside through the window opening while driving.

HOOD

Opening the hood

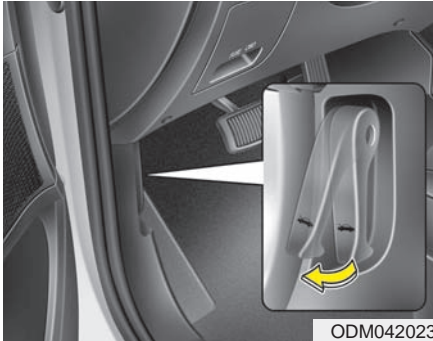

1. Pull the release lever to unlatch the hood. The hood should pop open slightly.

⚠ WARNING

Open the hood after turning off the engine on a flat surface, shifting the shift lever to the P(Park) position, and setting the parking brake.

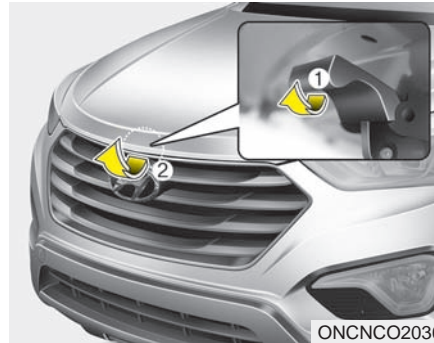

2. Go to the front of the vehicle, raise the hood slightly, pull the secondary latch (1) inside of the hood up and lift the hood (2).
3. Raise the hood. It will raise completely by itself after it has been raised about halfway.

⚠ WARNING

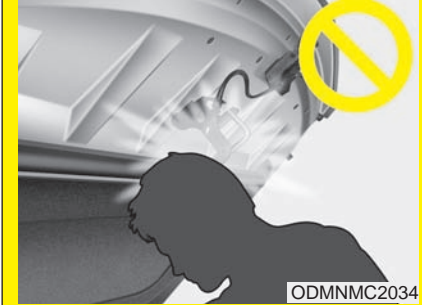

When you check the engine compartment, please make sure your head is not injured by the hood safety hook which is located inside of the hood.

Closing the hood

1. Before closing the hood, check the following:
 - All filler caps in engine compartment must be correctly installed.
 - Gloves, rags or any other combustible material must be removed from the engine compartment.
2. Lower the hood halfway and push down to securely lock in place.

WARNING

- **Before closing the hood, ensure that all obstructions are removed from the hood opening. Closing the hood with an obstruction present in the hood opening may result in property damage or severe personal injury.**
- **Do not leave gloves, rags or any other combustible material in the engine compartment. Doing so may cause a heat-induced fire.**
- **Always double check to be sure that the hood is firmly latched before driving away. If it is not latched, the hood could open while the vehicle is being driven, causing a total loss of visibility, which might result in an accident.**
- **Do not move the vehicle with the hood in the raised position, as vision is obstructed and the hood could fall or be damaged.**

FUEL FILLER LID

Opening the fuel filler lid

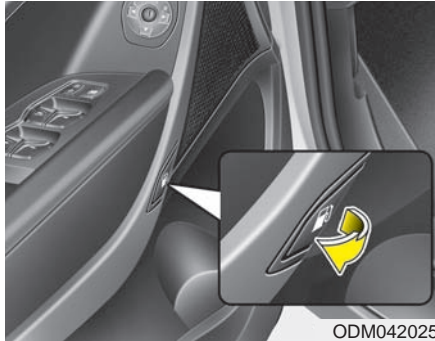

The fuel filler lid must be opened from inside the vehicle by pulling the fuel filler lid opener lever located on the driver's door.

* NOTICE

If the fuel filler lid will not open because ice has formed around it, tap lightly or push on the lid to break the ice and release the lid. Do not pry on the lid. If necessary, spray around the lid with an approved de-icer fluid (do not use radiator anti-freeze) or move the vehicle to a warm place and allow the ice to melt.

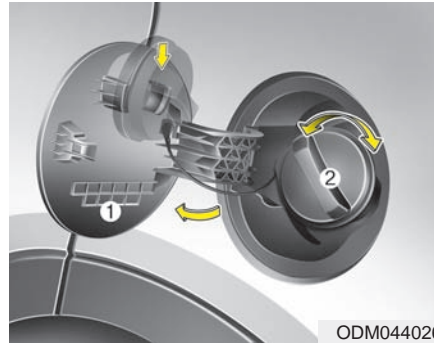

Closing the fuel filler lid

1. To install the cap, turn it clockwise until it clicks one time. This indicates that the cap is securely tightened.
2. Close the fuel filler lid and push it in lightly making sure that it is securely closed.

1. Stop the engine.
2. Pull the fuel filler lid opener lever, then the fuel filler lid will pop up.
3. Pull the fuel filler lid (1) out to fully open.
4. To remove the cap, turn the fuel tank cap (2) counterclockwise.
5. Refuel as needed.

⚠ WARNING - Refueling

- If pressurized fuel sprays out, it can cover your clothes or skin and thus subject you to the risk of fire and burns. Always remove the fuel cap carefully and slowly. If the cap is venting fuel or if you hear a hissing sound, wait until the condition stops before completely removing the cap.
- Do not "top off" after the nozzle automatically shuts off when refueling.
- Tighten the cap until it clicks one time, otherwise the Malfunction Indicator Light  will illuminate.
- Always check that the fuel cap is installed securely to prevent fuel spillage in the event of an accident.

⚠ WARNING - Refueling dangers

Automotive fuels are flammable materials. When refueling, please note the following guidelines carefully. Failure to follow these guidelines may result in severe personal injury, severe burns or death by fire or explosion.

- Read and follow all warnings posted at the gas station facility.
- Before refueling, note the location of the Emergency Gasoline Shut-Off, if available, at the gas station facility.
- Before touching the fuel nozzle, you should eliminate potentially dangerous static electricity discharge by touching another metal part of the vehicle, a safe distance away from the fuel filler neck, nozzle, or other gas source.

(Continued)

(Continued)

- Do not get back into a vehicle once you have begun refueling since you can generate static electricity by touching, rubbing or sliding against any item or fabric (polyester, satin, nylon, etc.) capable of producing static electricity. Static electricity discharge can ignite fuel vapors resulting in rapid burning. If you must re-enter the vehicle, you should once again eliminate potentially dangerous static electricity discharge by touching a metal part of the vehicle, away from the fuel filler neck, nozzle or other gasoline source.

(Continued)

(Continued)

- When using an approved portable fuel container, be sure to place the container on the ground prior to refueling. Static electricity discharge from the container can ignite fuel vapors causing a fire. Once refueling has begun, contact with the vehicle should be maintained until the filling is complete.

Use only approved portable plastic fuel containers designed to carry and store gasoline.

- Do not use cellular phones while refueling. Electric current and/or electronic interference from cellular phones can potentially ignite fuel vapors causing a fire.

(Continued)

(Continued)

- When refueling, always shut the engine off. Sparks produced by electrical components related to the engine can ignite fuel vapors causing a fire. Once refueling is complete, check to make sure the filler cap and filler door are securely closed, before starting the engine.
- DO NOT use matches or a lighter and DO NOT SMOKE or leave a lit cigarette in your vehicle while at a gas station especially during refueling. Automotive fuel is highly flammable and can, when ignited, result in fire.
- If a fire breaks out during refueling, leave the vicinity of the vehicle, and immediately contact the manager of the gas station and then contact the local fire department or 911. Follow any safety instructions they provide.

 **CAUTION**

- *Make sure to refuel your vehicle according to the "Fuel requirements" suggested in section 1.*
- *If the fuel filler cap requires replacement, use only a genuine HYUNDAI cap or the equivalent specified for your vehicle. An incorrect fuel filler cap can result in a serious malfunction of the fuel system or emission control system.*
- *Do not spill fuel on the exterior surfaces of the vehicle. Any type of fuel spilled on painted surfaces may damage the paint.*
- *After refueling, make sure the fuel cap is installed securely to prevent fuel spillage in the event of an accident.*

Emergency fuel filler door release

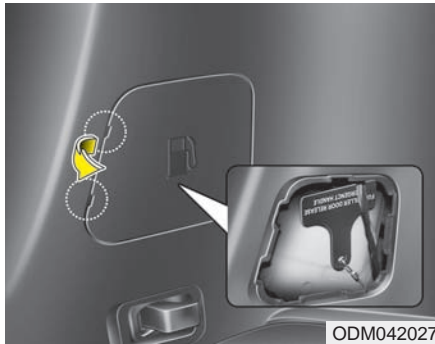

If the fuel filler door does not open using the remote fuel filler door release, you can open it manually. Unsnap and remove the panel in the cargo area. Pull the handle outward slightly.

CAUTION

Do not pull the handle excessively, otherwise the luggage area trim or release handle may be damaged.

PANORAMIC SUNROOF (IF EQUIPPED)

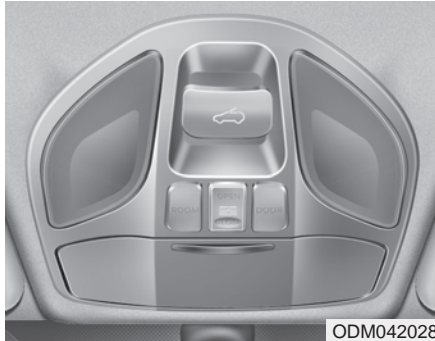

If your vehicle is equipped with a sunroof, you can slide or tilt your sunroof with the sunroof control lever located on the overhead console.

Type A

The sunroof can only be opened, closed, or tilted when the ignition switch is in the ON position.

Type B

The sunroof can be operated for approximately 30 seconds after the ignition key is removed or turned to the ACC or LOCK position. However, if the front doors are opened, the sunroof cannot be opened even within the 30 seconds period.

- In cold and wet climates, the sunroof may not work properly due to freezing conditions.
- After the vehicle is washed or in a rainstorm, be sure to wipe off any water that is on the sunroof before operating it.

 **CAUTION - Sunroof control lever**

Do not continue to move the sunroof control lever after the sunroof is fully opened, closed, or tilted. Damage to the motor or system components could occur.

 **CAUTION**

Make sure the sunroof is fully closed when leaving your vehicle. If the sunroof is opened, rain or snow may leak through the sunroof and wet the interior as well as cause theft.

Sunroof open warning (if equipped)



Type A

If the driver removes the ignition key (smart key: turns off the engine) and opens the driver-side door when the sunroof is not fully closed.

Type B

If the driver removes the ignition key (smart key: turns off the engine) when the sunroof is not fully closed.

The warning chime will sound for a few seconds and a message "Sunroof Open" will appear on the LCD display. Close the sunroof securely when leaving your vehicle.

⚠ WARNING

- Never adjust the sunroof or sunshade while driving. This could result in loss of control and an accident that may cause death, serious injury, or property damage.
- If you would like to carry items on the roof using a cross bar, do not operate the sunroof.
- When carrying cargo on the roof, do not load heavy items above the sunroof or glass roof.
- Do not allow children to operate the sunroof.

⚠ CAUTION

Do not extend any luggage outside the sunroof while driving.

Sunshade

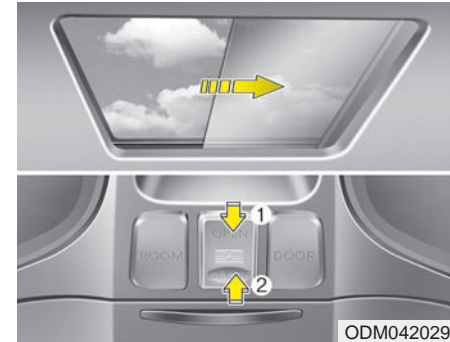

To open the sunshade

Press the sunshade open button (1).

To close the sunshade when the sunroof glass is closed

Type A

- Press the sunshade close button (2).
 - * When you press the sunshade close button (2) with the sunroof glass opened, the sunshade will be closed halfway.
- Push the sunroof control lever forward or pull it down.

Type B

- Press the sunshade close button (2).
 - * When you press the sunshade close button (2) with the sunroof glass opened, the sunshade will be closed halfway, then sunroof glass will be closed and then sunshade will be fully closed finally.

To stop the sliding at any point, press the sunshade control switch momentarily.

*** NOTICE**

Wrinkles formed on the sunshade as material characteristic are normal.

⚠ CAUTION

- **Do not pull or push the sunshade by hand. It could cause sunshade failure.**
- **Close the sunroof when driving through dusty roads. Dust may cause a malfunction of the vehicle system.**

Sliding the sunroof

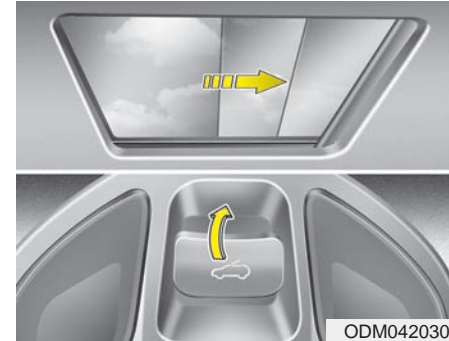

ODM042030

When the sunshade is closed

If you pull the sunroof control lever backward, the sunshade and sunroof glass will slide all the way open. To stop the sunroof movement at any point, pull or push the sunroof control lever momentarily.

When the sunshade is opened

If you pull the sunroof control lever backward, the sunroof glass will slide all the way open. To stop the sunroof movement at any point, pull or push the sunroof control lever momentarily.

*** NOTICE**

Only the front glass of the panorama sunroof opens and closes.

Tilting the sunroof

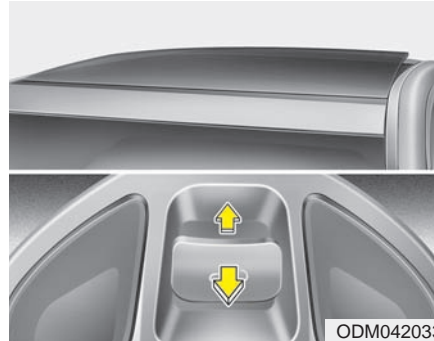

When the sunshade is closed

If you push the sunroof control lever upward, the sunshade will slide halfway open then the sunroof glass will tilt.

To stop the sunroof movement at any point, pull or push the sunroof control lever momentarily.

When the sunshade is opened

If you push the sunroof control lever upward, the sunroof glass will tilt.

To stop the sunroof movement at any point, pull or push the sunroof control lever momentarily.

Closing the sunroof

To close (or tilt down) the sunroof

- Pull the sunroof glass control lever downward (or forward).

Type A

* When you pull the sunroof glass control lever downward (or forward) with the sunshade opened, the sunshade will be closed halfway and then glass will be closed (or tilt down) and then sunshade will be fully closed finally.

Type B

* When you pull the sunroof glass control lever downward (or forward) with the sunshade opened, the glass will be closed (or tilt down).

To stop the sunroof movement at any point, pull or push the sunroof control lever momentarily.

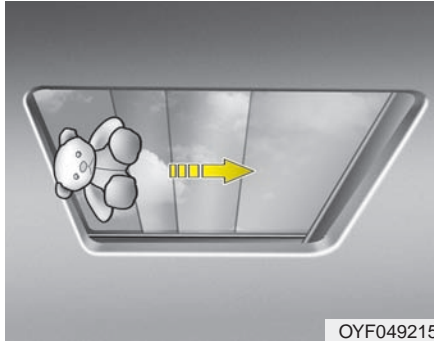
Automatic reversal

If an object or part of the body is detected while the sunroof glass or sunshade is closing automatically, it will reverse the direction, and then stop.

The auto reverse function does not work if a tiny obstacle is between the sliding glass or sunshade and the sunroof sash. You should always check that all passengers and objects are away from the sunroof before closing it.

Do not extend the face, neck, arms or body outside the sunroof while driving.

⚠ WARNING - Sunroof

- Be careful that someone's head, hands and body are not trapped by a closing sunroof.
- Do not extend the face, neck, arms or body outside through an opened sunroof while driving.
- Make sure your hands and face are safely out of the way before closing a sunroof.
- A panoramic sunroof is made of glass, therefore it may break in an accident. If you do not have your seat belt on, you may contact the broken glass and get injured or killed. For all passengers safety, have the seat belts on. (ex. seat belt, CRS, etc.)

⚠ CAUTION

- Periodically remove any dirt that may accumulate on the guide rail.
- If you drive with the sunroof opened right after a car wash or rain, water may get inside the vehicle.

⚠ CAUTION - Sunroof motor damage

If you try to open the sunroof when the temperature is below freezing or when the sunroof is covered with snow or ice, the glass or the motor could be damaged.

Resetting the sunroof

Sunroof needs to be reset if (in the followings)

- Battery is discharged or disconnected or the related fuse has been replaced or disconnected.
- The one-touch sliding function of the sunroof does not normally operate.

1. Turn the ignition switch to the ON position.
2. Close the sunshade and sunroof completely if opened.
3. Release the sunroof control lever.
4. Push the sunroof control lever forward in the direction of close (about 10 seconds) until the sunroof moves a little. Then, release the lever.

5. Push the sunroof control lever forward in the direction of close, until the sunroof operates as follows again:

The sunshade and sunroof glass slide open → The sunroof glass slide close → The sunshade close

Then, release the lever.

When this is complete, the sunroof system has been reset.

* NOTICE

If you do not reset the sunroof, it may not work properly.

STEERING WHEEL

Electric power steering (EPS)

The power steering uses a motor to assist you in steering the vehicle. If the engine is off or if the power steering system becomes inoperative, the vehicle may still be steered, but it will require increased steering effort.

The motor driven power steering is controlled by a power steering control unit which senses the steering wheel torque and vehicle speed to command the motor.

The steering becomes heavier as the vehicle's speed increases and becomes lighter as the vehicle's speed decreases for optimum steering control.

Should you notice any change in the effort required to steer during normal vehicle operation, have the power steering checked by an authorized HYUNDAI dealer.

CAUTION

- ***If the Electric Power Steering System does not operate normally, the warning light will illuminate on the instrument cluster. The steering wheel may become difficult to control or operate abnormally. Take your vehicle to an authorized HYUNDAI dealer and have the vehicle checked as soon as possible.***
- ***When you operate the steering wheel in low temperature, abnormal noise could occur. If temperature rises, the noise will disappear. This is a normal condition.***

* NOTICE

The following symptoms may occur during normal vehicle operation:

- The EPS warning light does not illuminate.
- The steering gets heavy immediately after turning the ignition switch on. This happens as the system performs the EPS system diagnostics. When the diagnostics is completed, the steering wheel will return to its normal condition.
- A click noise may be heard from the EPS relay after the ignition switch is turned to the ON or LOCK (OFF) position.
- A motor noise may be heard when the vehicle is at a stop or at a low driving speed.
- If the Electric Power Steering System does not operate normally, the warning light will illuminate on the instrument cluster. The steering wheel may become difficult to control or operate abnormally. Take your vehicle to an authorized HYUNDAI dealer and have the vehicle checked as soon as possible.

(Continued)

(Continued)

- Some noises may be heard when operating the steering in low temperatures. When the temperature rises, the noise will disappear. This is a normal condition.
- The steering effort may become heavy when the charging system warning light comes on.

Tilt & telescopic steering

A tilt steering wheel allows you to adjust the steering wheel before you drive. You can also raise it to give your legs more room when you exit and enter the vehicle (if equipped).

The steering wheel should be positioned so that it is comfortable for you to drive, while permitting you to see the instrument panel warning lights and gauges.

⚠ WARNING - Steering

- **Never adjust the angle and height of steering wheel while driving. You may lose your steering control and cause severe personal injury or accidents.**
- **After adjusting, push the steering wheel both up and down to be certain it is locked in position.**

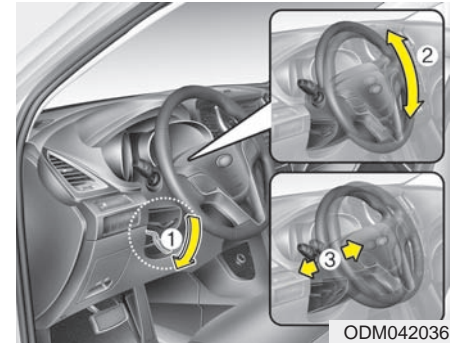

To change the steering wheel angle, pull down the lock release lever (1), adjust the steering wheel to the desired angle (2) and height (if equipped) (3), then pull up the lock-release lever to lock the steering wheel in place. Be sure to adjust the steering wheel to the desired position before driving.

Heated steering wheel (if equipped)

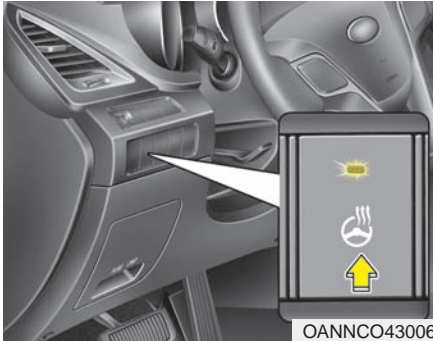

With the ignition switch in the ON position, pressing the heated steering wheel button warms the steering wheel. The indicator on the button will illuminate and notify you on the LCD display.

To turn the heated steering wheel off, press the button once again. The indicator on the button will turn off and notify you on the LCD display.

* NOTICE

- The heated steering wheel will turn off automatically approximately 30 minutes after the heated steering wheel is turned on.
- If you turn on the ignition again after turning off your engine in half an hour (after operating heater button), the heating system will be maintained in its 'on' condition.

⚠ CAUTION

- **Do not install any grip to operate the steering wheel. This causes damage to the heated steering wheel system.**
- **When cleaning the heated steering wheel, do not use an organic solvent such as paint thinner, benzene, alcohol and gasoline. Doing so may damage the surface of the steering wheel.**
- **If the surface of the steering wheel is damaged by a sharp object, damage to the heated steering wheel components could occur.**

Horn



To sound the horn, press the area indicated by the horn symbol on your steering wheel (see illustration). The horn will operate only when this area is pressed.

Check the horn regularly to be sure it operates properly.

⚠ CAUTION

- *Do not strike the horn severely to operate it, or hit it with your fist. Do not press on the horn with a sharp-pointed object.*
- *When cleaning the steering wheel, do not use an organic solvent such as thinner, benzene, alcohol or gasoline. Doing so may damage the steering wheel.*

Driver selectable steering mode (if equipped)



ODM042039

The driver selectable steering mode controls steering effort as driver's preference or road condition.

You can select the desired steering mode by pressing the driver selectable steering mode button.

The driver selectable steering mode stays in the last mode selected when turning the engine on.

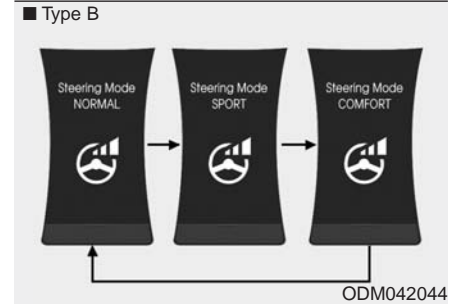
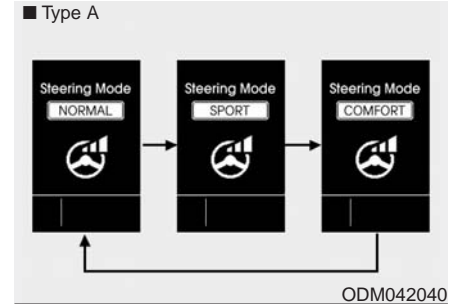

When the steering mode button is pressed, the selected steering mode will appear on the LCD display.

If the steering mode button is pressed within 4 seconds, the steering mode will change as above pictures.

If the steering wheel mode button is not pressed for about 4 seconds, the LCD display will change to the previous screen.

Normal mode



The normal mode offers medium steering effort.

Comfort mode



The steering effort becomes lighter in comfort mode.

Sport mode

■ Type A



ODM042043

■ Type B



ODM042047

The steering effort becomes heavier.

⚠ CAUTION

- *For your safety, if you press the steering mode button to change the mode while turning the steering wheel, the LCD display will change as you selected, but the steering effort will not change. After that, if you leave the steering wheel centered, the steering effort will change to the selected mode.*
- *Be careful when changing the steering mode while driving.*
- *When the electronic power steering is not working properly, the driver selectable steering mode will not work.*

MIRRORS

Inside rearview mirror

Adjust the rearview mirror so that the center view through the rear window is seen. Make this adjustment before you start driving.

⚠ WARNING - Rear visibility
Do not place objects in the rear seat or cargo area which would interfere with your vision through the rear window.

⚠ WARNING
Do not modify the inside mirror and do not install a wide mirror. It could result in injury, during an accident or deployment of the air bag.

Day/night rearview mirror

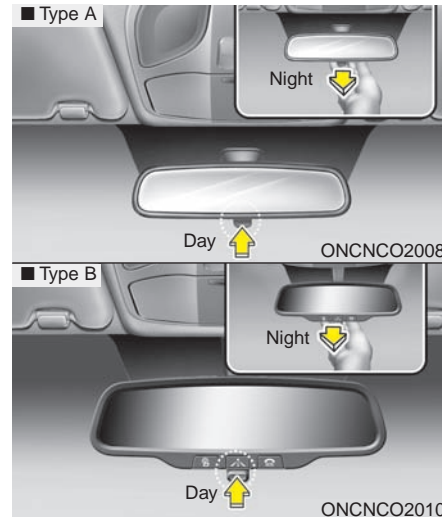

Make this adjustment before you start driving and while the day/night lever is in the day position.

Pull the day/night lever toward you to reduce glare from the headlights of the vehicles behind you during night driving.

Remember that you lose some rearview clarity in the night position.

Electric chromic mirror (ECM) with HomeLink® system, compass and Blue Link® (if equipped)

Your vehicle may be equipped with a Gentex Automatic-Dimming Mirror with a Z-Nav™ Electronic Compass Display and an Integrated HomeLink® Wireless Control System. During nighttime driving, this feature will automatically detect and reduce rearview mirror glare while the compass indicates the direction the vehicle is pointed. The HomeLink® Universal Transceiver allows you to activate your garage door(s), electric gate, home lighting, etc.



- (1) Telematics button
- (2) Telematics button
- (3) Telematics button
- (4) Compass control button & Dimming ON/OFF button
- (5) Status indicator LED
- (6) Channel 1 button
- (7) Channel 2 button
- (8) Channel 3 button
- (9) Compass display
- (10) Rear light sensor

Automatic-Dimming Night Vision Safety™ (NVS®) Mirror

The NVS® Mirror in your vehicle is the most advanced way to reduce annoying glare in the rearview mirror during any driving situation. For more information regarding NVS® mirrors and other applications, please refer to the Gentex website:

www.gentex.com

*** NOTICE**

The NVS® Mirror automatically reduces glare during driving conditions based upon light levels monitored in front of the vehicle and from the rear of the vehicle. These light sensors are visible through openings in the front and rear of the mirror case. Any object that obstructs either light sensor will degrade the automatic dimming control feature.

Automatic-dimming function

Your mirror will automatically dim upon detecting glare from the vehicles traveling behind you. The auto-dimming function can be controlled by the Dimming ON/OFF Button:

1. Pressing and hold the ☺ button for 3 seconds turns the autodimming function OFF which is indicated by the green Status Indicator LED turning off.
2. Pressing and hold the ☺ button for 3 seconds again turns the auto-dimming function ON which is indicated by the green Status Indicator LED turning on.



The mirror defaults to the ON position each time the vehicle is started.

Z-Nav™ Compass Display

The NVS™ Mirror in your vehicle is also equipped with a Z-Nav™ Compass that shows the vehicle Compass heading in the Display Window using the 8 basic cardinal headings (N, NE, E, SE, etc.).

Compass function

The Compass can be turned ON and OFF and will remember the last state when the ignition is cycled. To turn the display feature ON/OFF:



1. Press and release the  button within 1 second to turn the display feature OFF.
2. Press and release the  button again within 1 second to turn the display back ON.

Additional options can be set with press and hold sequences of the  button and are detailed below.

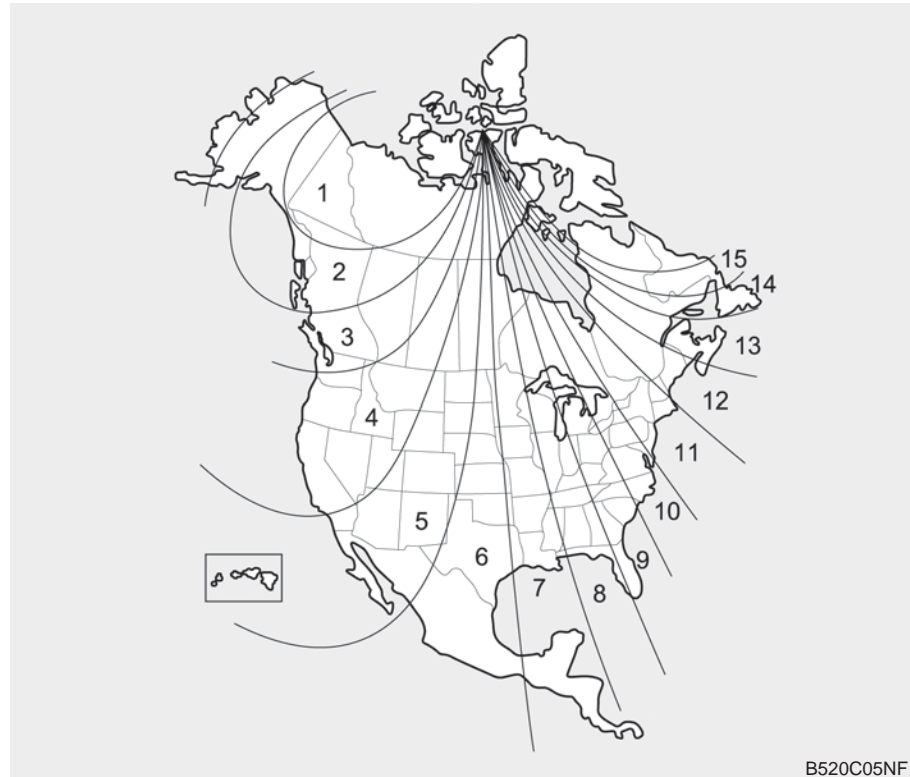
There is a difference between magnetic north and true north. The compass in the mirror can compensate for this difference when it knows the Magnetic Zone in which it is operating. This is set either by the dealer or by the user. The operating Zone Numbers for North America are shown in the figure on the following section.



To adjust the Zone setting:

1. Determine the desired Zone Number based upon your current location on the Zone Map.
2. Press and hold the  button for 6 seconds, the current Zone Number will appear on the display.
3. Pressing and holding the  button again will cause the numbers to increment (Note: they will repeat ...13, 14, 15, 1, 2, ...). Releasing the button when the desired Zone Number appears on the display will set the new Zone.
4. Within about 5 seconds the compass will start displaying a compass heading again.

There are some conditions that can cause changes to the vehicle magnets, such as installing a ski rack or a CB antenna. Body repair work on the vehicle can also cause changes to the vehicle's magnetic field. In these situations, the compass will need to be re-calibrated to quickly correct for these changes. To re-calibrate the compass:

1. Press and hold the  button for more than 9 seconds. When the compass memory is cleared a "C" will appear in the display.
2. To calibrate the compass, drive the vehicle in 2 complete circles at less than 5 mph (8 km/h).

Integrated HomeLink® Wireless Control System

The HomeLink® Wireless Control System provides a convenient way to replace up to three hand-held radio-frequency (RF) transmitters with a single built-in device. This innovative feature will learn the radio frequency codes of most current transmitters to operate devices such as gate operators, garage door openers, entry door locks, security systems, even home lighting. Both standard and rolling code-equipped transmitters can be programmed by following the outlined procedures. Additional HomeLink® information can be found at: www.homelink.com or by calling 1-800-355-3515.

⚠ WARNING

Before programming HomeLink® to a garage door opener or gate operator, make sure that people and objects are out of the way of the device to prevent potential harm or damage. Do not use HomeLink® with any garage door opener that lacks the safety stop and reverse features required by U.S. federal safety standards (this includes any garage door opener model manufactured before April 1, 1982). A garage door that cannot detect an object - signaling the door to stop and reverse - does not meet current U.S. federal safety standards. Using a garage door opener without these features increases the risk of serious injury or death.

Retain the original transmitter of the RF device you are programming for use in other vehicles as well as for future HomeLink® programming. It is also suggested that upon the sale of the vehicle, the programmed HomeLink® buttons be erased for security purposes.

Programming HomeLink®*** NOTICE**

- When programming a garage door opener, it is advised to park the vehicle outside of the garage.
- It is recommended that a new battery be placed in the hand-held transmitter of the device being programmed to HomeLink® for quicker training and accurate transmission of the radio-frequency signal.
- Some vehicles may require the ignition switch to be turned to the second (or "accessories") position for programming and/or operation of HomeLink.
- In the event that there are still programming difficulties or questions after following the programming steps listed below, contact HomeLink® at: www.homelink.com or 1-800-355-3515.

Programming

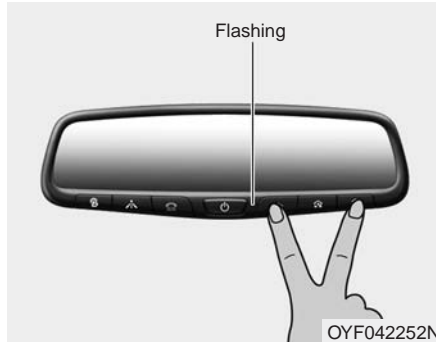

To train most devices, follow these instructions:

1. For first-time programming, press and hold the two outside buttons (🏠, 📶), HomeLink® Channel 1 and Channel 3, until the indicator light begins to flash (after 10 seconds). Release both buttons. Do not hold the buttons for longer than 20 seconds.

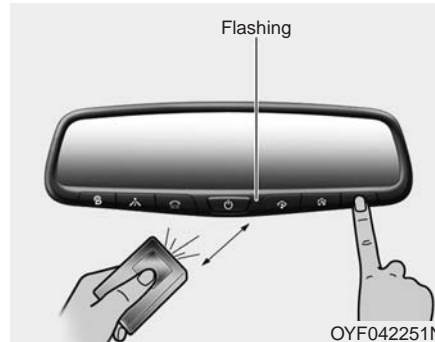

2. Position the end of your hand-held transmitter 1-3 inches (2-8 cm) away from the HomeLink® button you wish to program while keeping the indicator light in view.
3. Simultaneously press and hold both the HomeLink® and hand-held transmitter buttons until the HomeLink® indicator light changes from a slow to a rapid blinking light. Now you may release both the HomeLink® and hand-held transmitter buttons.

* NOTICE

Some devices may require you to replace this Programming step 3 with procedures noted in the "Gate Operator/Canadian Programming" section. If the HomeLink® indicator light does not change to a rapidly blinking light after performing these steps, contact HomeLink® at www.homelink.com.

4. Firmly press, hold for 5 seconds and release the programmed HomeLink® button up to two separate times to activate the door. If the door does not activate, press and hold the just-trained HomeLink® button and observe the indicator light.
 - If the indicator light stays on constantly, programming is complete and your device should activate when the HomeLink® button is pressed and released.
 - If the indicator light blinks rapidly for 2 seconds and then turns to a constant light, continue with "Programming" steps 5-7 to complete the programming of a rolling code equipped device (most commonly a garage door opener).
5. At the garage door opener receiver (motor-head unit) in the garage, locate the "learn" or "smart" button. This can usually be found where the hanging antenna wire is attached to the motor-head unit.
6. Firmly press and release the "learn" or "smart" button. (The name and color of the button vary by manufacturer). There are 30 seconds to initiate step 7.
7. Return to the vehicle and firmly press, hold for 2 seconds and release the programmed HomeLink® button. Repeat the "press/hold/release" sequence a second time, and, depending on the brand of the garage door opener (or other rolling code equipped device), repeat this sequence a third time to complete the programming process.

HomeLink® should now activate your rolling code equipped device.

Gate operator & Canadian programming

During programming, your handheld transmitter may automatically stop transmitting. Continue to press the Integrated HomeLink® Wireless Control System button (note steps 2 through 3 in the Programming portion of this document) while you press and re-press ("cycle") your handheld transmitter every two seconds until the frequency signal has been learned. The indicator light will flash slowly and then rapidly after several seconds upon successful training.

Operating HomeLink®

To operate, simply press and release the programmed HomeLink® button. Activation will now occur for the trained device (i.e. garage door opener, gate operator, security system, entry door lock, home/office lighting, etc.). For convenience, the hand-held transmitter of the device may also be used at any time.

Reprogramming a single HomeLink® button

To program a device to HomeLink® using a HomeLink® button previously trained, follow these steps:

1. Press and hold the desired HomeLink® button. DO NOT release the button.
2. The indicator light will begin to flash after 20 seconds. Without releasing the HomeLink® button, proceed with "Programming" step 2.

For questions or comments, contact HomeLink® at www.homelink.com or 1-800-355-3515.

Erasing HomeLink® buttons

Individual buttons cannot be erased. However, to erase all three programmed buttons:

1. Press and hold the two outer HomeLink® buttons until the indicator light begins to flash after 10 seconds.
2. Release both buttons. Do not hold for longer than 20 seconds.

The Integrated HomeLink® Wireless Control System is now in the training (learn) mode and can be programmed at any time following the appropriate steps in the Programming sections above.

FCC ID: NZLTLMHL4

IC: 4112A-TLMHL4

This device complies with Part 15 of the FCC Rules.

Operation is subject to the following two conditions:

1. This device may not cause harmful interference, and
2. This device must accept any interference received, including interference that may cause undesired operation.



CAUTION

The transceiver has been tested and complies with FCC and Industry Canada rules. Changes or modifications not expressly approved by the party responsible for compliance could void the user's authority to operate the device.

NVS® is a registered trademark and Z-Nav™ is a trademark of the Gentex Corporation, Zeeland, Michigan. HomeLink® is a registered trademark owned by Johnson Controls, Incorporated, Milwaukee, Wisconsin.

Blue Link® center

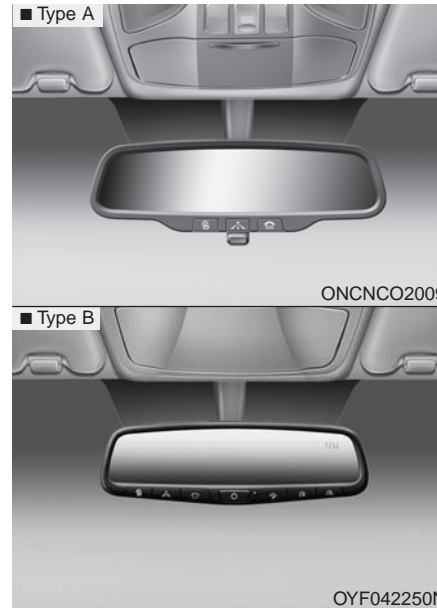

For the details, refer to the Blue Link® Owner's Guide, navigation manual or audio manual. The audio manual is in this section.

Outside rearview mirror

Be sure to adjust mirror angles before driving.

Your vehicle is equipped with both left-hand and right-hand outside rearview mirrors. The mirrors can be adjusted remotely with the remote switch. The mirror heads can be folded back to prevent damage during an automatic car wash or when passing in a narrow street.



CAUTION - Outside rearview mirrors

- *The right outside rearview mirror is convex. Objects seen in the mirror are closer than they appear.*
- *Use your interior rearview mirror or direct observation to determine the actual distance of following vehicles when changing lanes.*

⚠ CAUTION

Do not scrape ice off the mirror face; this may damage the surface of the glass. If ice should restrict movement of the mirror, do not force the mirror for adjustment. To remove ice, use a deicer spray, or a sponge or soft cloth with warm water.

⚠ CAUTION

If the mirror is jammed with ice, do not adjust the mirror by force. Use an approved spray de-icer (not radiator antifreeze) to release the frozen mechanism or move the vehicle to a warm place and allow the ice to melt.

⚠ WARNING

Do not adjust or fold the outside rearview mirrors while the vehicle is moving. This could result in loss of control, and an accident which could cause death, serious injury or property damage.

Remote control



The electric remote control mirror switch allows you to adjust the position of the left and right outside rearview mirrors.

To adjust the position of the mirrors:

1. Place the ignition switch in the ON position.
2. Move the lever(1) to R (right) or L (left) to select the right side mirror or the left side mirror.
3. Press a corresponding point on the mirror adjustment control to position the selected mirror up, down, left or right.
4. After the adjustment, position the lever in the center to prevent inadvertent movement.

⚠ CAUTION

- *The mirrors stop moving when they reach the maximum adjusting angles, but the motor continues to operate while the switch is pressed. Do not press the switch longer than necessary, the motor may be damaged.*
- *Do not attempt to adjust the outside rearview mirror by hand. Doing so may damage the mirror.*

**Reverse parking aid function
(if equipped)**

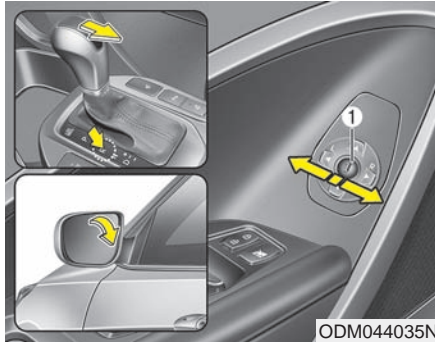

When you shift the shift lever to the R (Reverse) position, the outside rearview mirror(s) will move downward to aid reverse parking. According to the position of the outside rearview mirror control switch (1), the outside rearview mirror(s) will operate as follows:

Left or Right : When the outside rearview mirror control switch is in the L (Left) or R (Right) position, both outside rearview mirrors will move downward.

Neutral : When the outside rearview mirror control switch is in the neutral (center) position, the outside rearview mirrors will not operate.

*** NOTICE**

The outside rearview mirrors will automatically revert to their original positions under the following conditions:

- **When the ignition switch or engine start/stop button is set to the ACC or OFF position.**
- **When the shift lever is moved to any position except the R (Reverse) position.**

Folding the outside rearview mirror



To fold outside rearview mirror, grasp the housing of mirror and then fold it toward the rear of the vehicle.

Blind zone mirror (BZM) (if equipped)

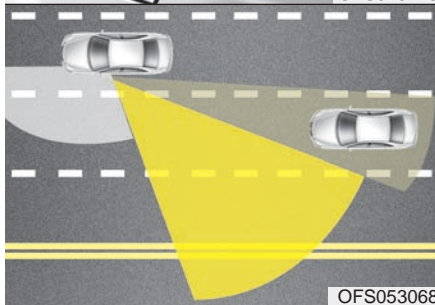

The blind zone mirror (BZM) is supplemental mirror to reduce a driver's blind zone that will show the rear side territory of your vehicle. The blind zone mirror is equipped with the driver's outside rearview mirror.

⚠ WARNING

- Always check the road condition while driving for unexpected situations even though the vehicle is equipped with a blind zone mirror.
- The blind zone mirror is a device made for convenience. Do not solely rely on the mirror but always pay attention to drive safely.

⚠ CAUTION

Do not clean the glass of any mirror with harsh abrasives, fuel or other petroleum-based on cleaning products.

INSTRUMENT CLUSTER

■ Type A



1. Tachometer
2. Speedometer
3. Engine coolant temperature gauge
4. Fuel gauge
5. LCD display
6. Warning and indicator lights (if equipped)
7. Turn signal indicator lights

■ Type B



- * The actual cluster in the vehicle may differ from the illustration.
For more details, refer to the "Gauges" in this chapter.

ODMNM2054/ODMNM2055

Instrument Cluster Control

Adjusting Instrument Cluster Illumination

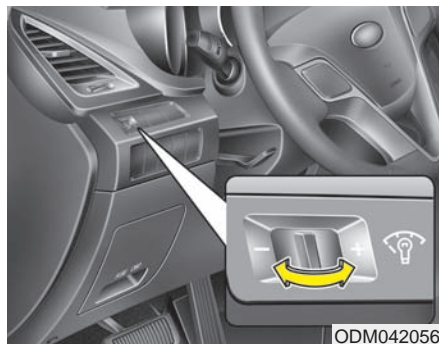

The brightness of the instrument panel illumination is changed by moving the illumination control knob right or left when the ignition switch or Engine Start/Stop button is ON, or the tale lights are turned on.

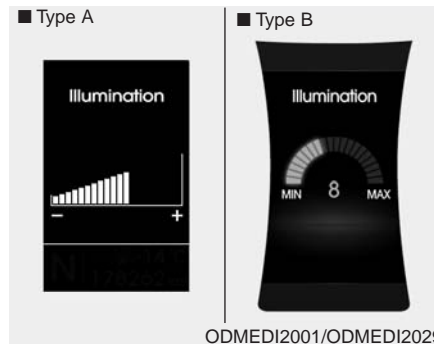

- The brightness has 20 levels : 1 (MIN) ~ 20 (MAX)
- If you hold the illumination control knob on the right end (+) or left end (-), the brightness will be changed continuously.
- If the brightness reaches to the maximum or minimum level, an alarm will sound.

LCD Display Control



The LCD display modes can be changed by using the control buttons on the steering wheel.

- (1) : MODE button for changing modes
- (2) : MOVE button for changing items
- (3) : SELECT/RESET button for setting or resetting the selected item

* For the LCD modes, refer to “LCD Display” in this chapter.

Gauges

Speedometer

■ Type A



ODMNM2057

■ Type B



ODMNM2058

The speedometer indicates the speed of the vehicle and is calibrated in miles per hour (mph) and/or kilometers per hour (km/h).

Tachometer

■ Type A

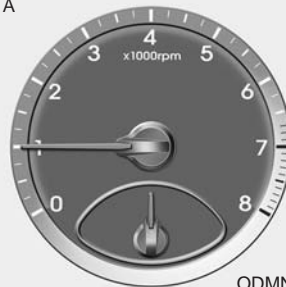

ODMNM2059

■ Type B

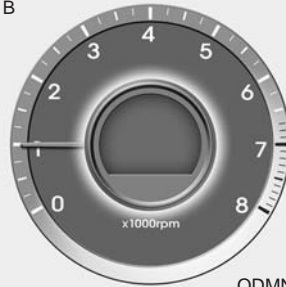

ODMNM2221

The tachometer indicates the approximate number of engine revolutions per minute (rpm).

Use the tachometer to select the correct shift points and to prevent lugging and/or over-revving the engine.

CAUTION

Do not operate the engine within the tachometer's RED ZONE. This may cause severe engine damage.

Engine Coolant Temperature Gauge

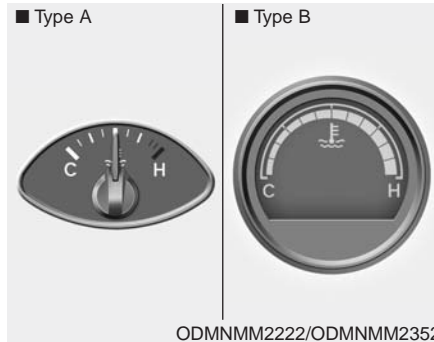

This gauge indicates the temperature of the engine coolant when the ignition switch or Engine Start/Stop button is ON.

⚠ CAUTION

If the gauge pointer moves beyond the normal range area toward the “H” position, it indicates overheating that may damage the engine.

Do not continue driving with an overheated engine. If your vehicle overheats, refer to “If the Engine Overheats” in chapter 6.

⚠ WARNING

Never remove the radiator cap when the engine is hot. The engine coolant is under pressure and could severely burn. Wait until the engine is cool before adding coolant to the reservoir.

Fuel Gauge

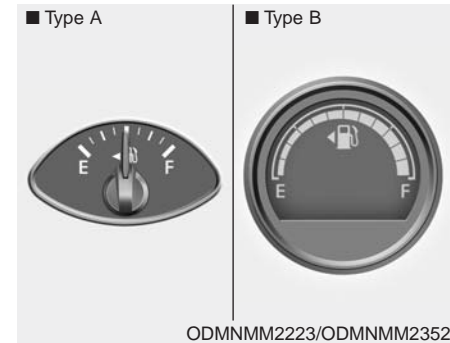

This gauge indicates the approximate amount of fuel remaining in the fuel tank.

*** NOTICE**

- The fuel tank capacity is given in chapter 8.
- The fuel gauge is supplemented by a low fuel warning light, which will illuminate when the fuel tank is nearly empty.
- On inclines or curves, the fuel gauge pointer may fluctuate or the low fuel warning light may come on earlier than usual due to the movement of fuel in the tank.

⚠ WARNING - Fuel Gauge
 Running out of fuel can expose vehicle occupants to danger. You must stop and obtain additional fuel as soon as possible after the warning light comes on or when the gauge indicator comes close to the "E (Empty)" level.

⚠ CAUTION
 Avoid driving with a extremely low fuel level. Running out of fuel could cause the engine to misfire damaging the catalytic converter.

Odometer

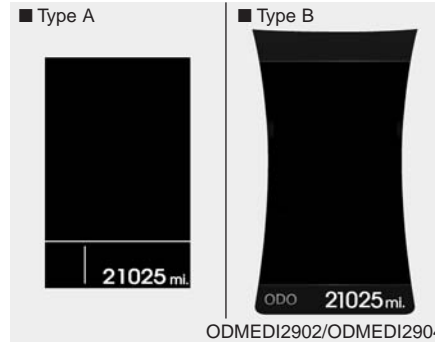

The odometer Indicates the total distance that the vehicle has been driven and should be used to determine when periodic maintenance should be performed.

- Odometer range : 0 ~ 999999 miles or kilometers.

Outside Temperature Gauge

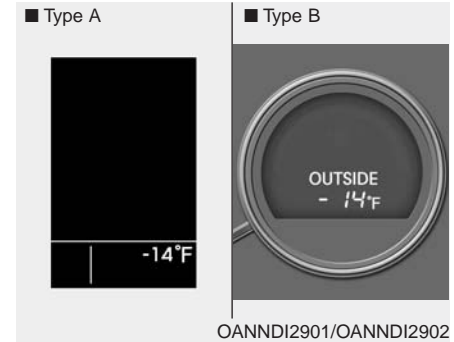

This gauge indicates the current outside air temperatures by 1°F (1°C).

- Temperature range : -40°F ~ 140°F (-40°C ~ 60°C)

The outside temperature on the display may not change immediately like a general thermometer to prevent the driver from being inattentive.

The temperature unit (from °F to °C or from °C to °F) can be changed by using the "User Settings" mode of the LCD display.

* For more details, refer to "LCD Display" in this chapter.

Transaxle Shift Indicator

Automatic Transaxle Shift Indicator













This indicator displays which automatic transaxle shift lever is selected.

- Park : P
- Reverse : R
- Neutral : N
- Drive : D
- Sports Mode : 1, 2, 3, 4, 5, 6

LCD DISPLAY

LCD Modes

Modes	Symbol		Explanation
	Type A	Type B	
Trip Computer			This mode displays driving information like the tripmeter, fuel economy, and so on. For more details, refer to "Trip Computer" in this chapter.
Service	 or 	 or 	This mode informs of the tire pressure information (if equipped), service interval (mileage or days) and warning messages related to TPMS, washer fluid.
User Settings			On this mode, you can change settings of the doors, lamps, and so on.
A/V (if equipped)	-		This mode displays the state of the A/V system.
Turn By Turn (if equipped)	-		This mode displays the state of the navigation.

* For controlling the LCD modes, refer to "LCD Display Control" in this chapter.

* For "Trip Computer" mode, refer to "Trip Computer" in this chapter.

Service Mode

Service Interval

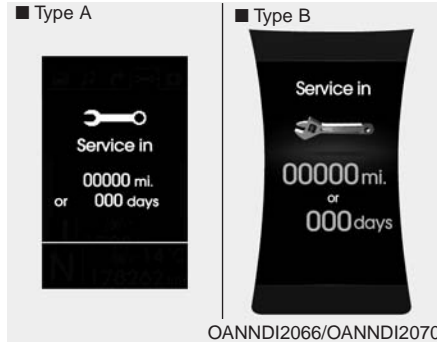

Service in

It calculates and displays when you need a scheduled maintenance service (mileage or days).

If the remaining mileage or time reaches 900 mi. (1,500 km) or 30 days, "Service in" message is displayed for several seconds each time you set the ignition switch or Engine Start/Stop Button to the ON position.

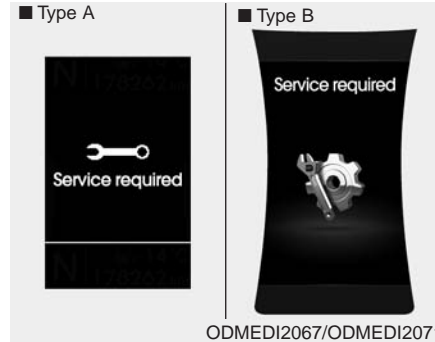

Service required

If you do not have your vehicle serviced according to the already inputted service interval, "Service required" message is displayed for several seconds each time you set the ignition switch or Engine Start/Stop Button to the ON position (The mileage and time changes to "---").

To reset the service interval to the mileage and days you inputted before:

- Press the SELECT/RESET button  for more than 1 second.

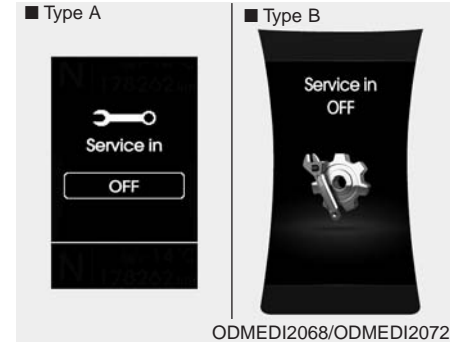

Service in OFF

If the service interval is not set, "Service in OFF" message is displayed on the LCD display.

* NOTICE

If any of the following conditions occurs, the mileage and days may be incorrect.

- The battery cable is disconnected.
- The fuse switch is turned off.
- The battery is discharged.

User Settings Mode

Description

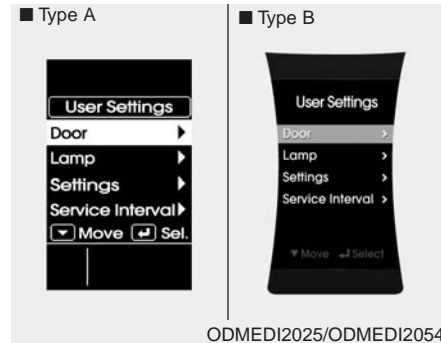

On this mode, you can change setting of the doors, lamps, and so on.

Door

Auto Door Lock (if equipped)

- Off:
The auto door lock operation will be deactivated.
- Speed:
All doors will be automatically locked when the vehicle speed exceeds 15km/h (9.3mph).
- Shift Lever:
All doors will be automatically locked if the automatic transaxle shift lever is shifted from the P (Park) position to the R (Reverse), N (Neutral), or D (Drive) position.

Auto Door Unlock (if equipped)

- Off:
The auto door unlock operation will be canceled.
- Key Out or Power Off:
All doors will be automatically unlocked when the ignition key is removed from ignition switch or Engine Start/Stop Button is set to the OFF position.
- Shift Lever:
All doors will be automatically unlocked if the automatic transaxle shift lever is shifted to the P (Park) position.

Two Press Unlock (if equipped)

- Off (not checked) :

The two press unlock function will be deactivated. Therefore, all doors will unlock if the door is unlocked.

- On (checked) :

The driver's door will unlock if the door is unlocked. When the door is unlocked again within 4 seconds, all doors will unlock.

Power Liftgate (Power Tailgate) (if equipped)

If this item is checked, the power liftgate (power tailgate) system function will be activated.

Smart Liftgate (Smart Tailgate) (if equipped)

If this item is checked, the Smart Liftgate (Smart Tailgate) system function will be activated.

For more details, refer to "Liftgate (Tailgate)" in this chapter.

Horn Feedback (if equipped)

- Off (not checked) :

The Horn feedback operation will be deactivated.

- On (checked) :

After locking the door by pressing the lock button on the transmitter, if you press the lock button again within 4 seconds, the warning sound will operate once to indicate that all doors are locked.

Lamp

Head Lamp Delay (if equipped)

If this item is checked, the headlamp delay and headlamp welcome function will be activated.

Welcome Light (if equipped)

If this item is checked, the welcome light function of the puddle lamp will be activated.

Auto Triple Turn (One-touch triple turn signal) (if equipped)

If this item is checked, the lane change signals will blink 3 times when the turn signal lever is moved slightly.

One Touch Turn Signal (if equipped)

- Off:

The one touch turn signal function will be deactivated.

- 3, 5, 7 Flashing :

The lane change signals will blink 3, 5, or 7 times when the turn signal lever is moved slightly.

For more details, refer to "Light" in this chapter.

Settings

Temperature Unit

Convert the temperature unit from °C to °F or from °F to °C.

Welcome Sound

If this item is checked, the welcome sound function will be activated.

Shift Indicator (if equipped)

If this item is checked, the shift indicator function will be activated.

For more details, refer to “Instrument Cluster” in this chapter.

Seat Easy Access (if equipped)

If this item is checked, the driver's seat will automatically move forward or rearward for the driver to enter or exit the vehicle comfortably.

Tire Pressure Unit (if equipped)

Choose the tire pressure unit. (psi, kPa, Bar)

AVG Fuel Eco Reset

- Auto Reset: The average fuel economy will reset automatically when refueling.
- Manual Reset: The average fuel economy will not reset automatically whenever refueling.

For more details, refer to “Trip Computer” in this chapter.

Service Interval

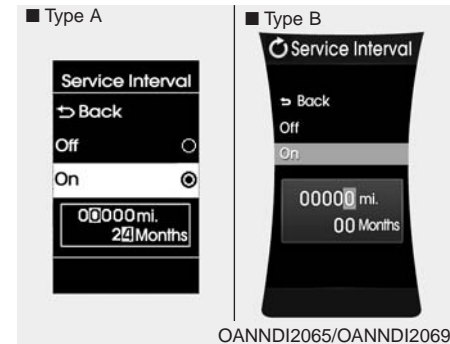

On this mode, you can activate the service interval function with mileage (mi. or km) and period (months).

A/V Mode (if equipped)

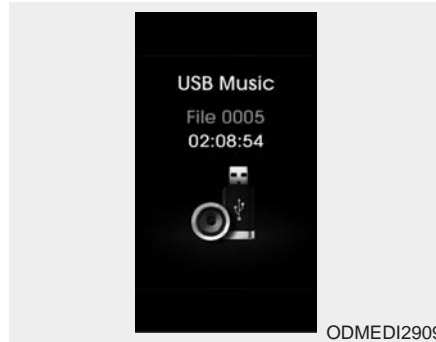

This mode displays the state of the A/V system.

Turn By Turn Mode (if equipped)



This mode displays the state of the navigation.

Warning Messages

*Shift to "P" position
(for smart key system)*

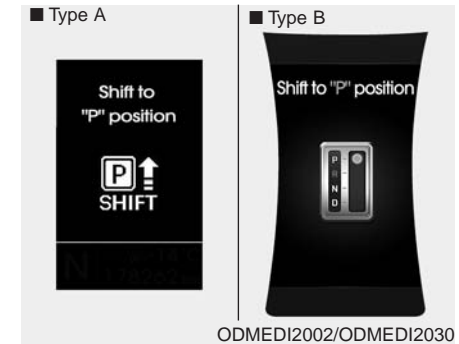

- This warning message illuminates if you try to turn off the engine without the shift lever in P (Park) position.
- At this time, the Engine Start/Stop Button turns to the ACC position (If you press the Engine Start/Stop Button once more, it will turn to the ON position).

**Low Key Battery
(for smart key system)**

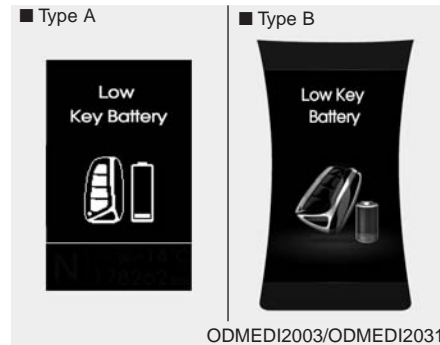

- This warning message illuminates if the battery of the smart key is discharged when the Engine Start/Stop Button changes to the OFF position.

**Press start button while turn steering
(for smart key system)**

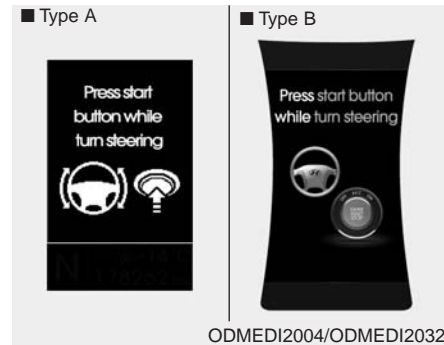

- This warning message illuminates if the steering wheel does not unlock normally when the Engine Start/Stop Button is pressed.
- It means that you should press the Engine Start/Stop Button while turning the steering wheel right and left.

**Steering wheel unlocked
(for smart key system)**

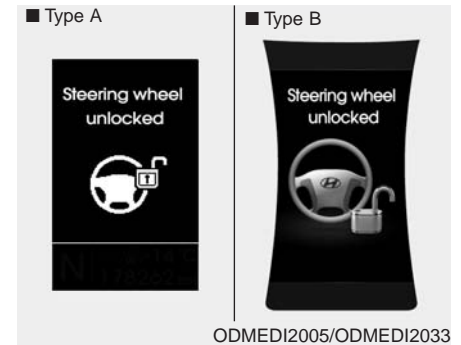

- This warning message illuminates if the steering wheel does not lock when the Engine Start/Stop Button changes to the OFF position.

Check steering wheel lock system (for smart key system)

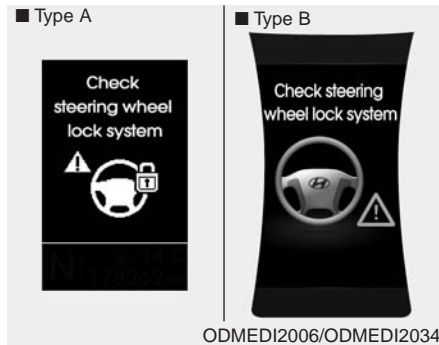

- This warning message illuminates if the steering wheel does not lock normally when the Engine Start/Stop Button changes to the ACC position.

Press brake pedal to start engine (for smart key system)

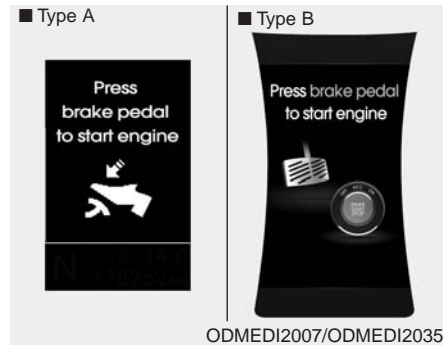

- This warning message illuminates if the Engine Start/Stop Button changes to the ACC position twice by pressing the button repeatedly without depressing the brake pedal.
- It means that you should depress the brake pedal to start the engine.

Key not in vehicle (for smart key system)

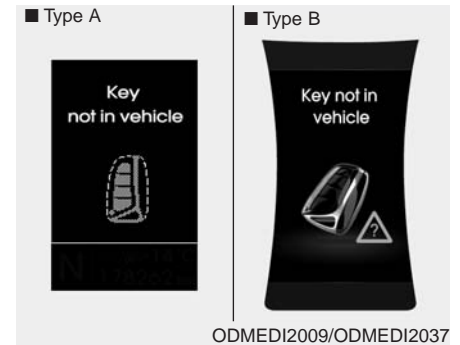

- This warning message illuminates if the smart key is not in the vehicle when you press the Engine Start/Stop Button.
- It means that you should always have the smart key with you.

**Key not detected
(for smart key system)**

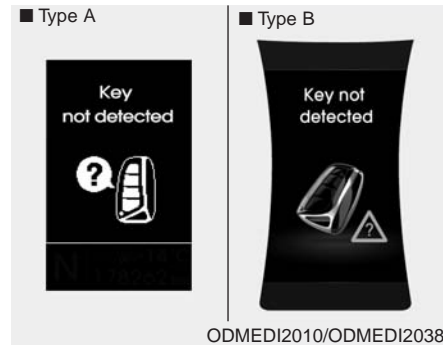

- This warning message illuminates if the smart key is not detected when you press the Engine Start/Stop Button.

**Press start button again
(for smart key system)**

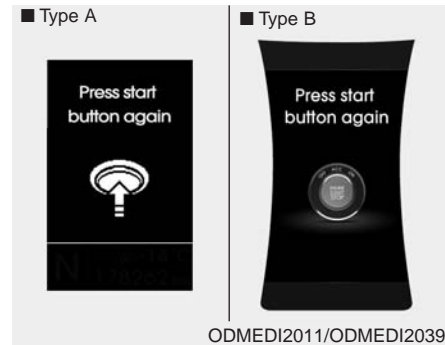

- This warning message illuminates if you can not operate the Engine Start/Stop Button when there is a problem with the Engine Start/Stop Button system.
- It means that you could start the engine by pressing the Engine Start/ Stop Button once more.
- If the warning illuminates each time you press the Engine Start/Stop Button, have your vehicle inspected by an authorized HYUNDAI dealer.

**Press start button with smart key
(for smart key system)**

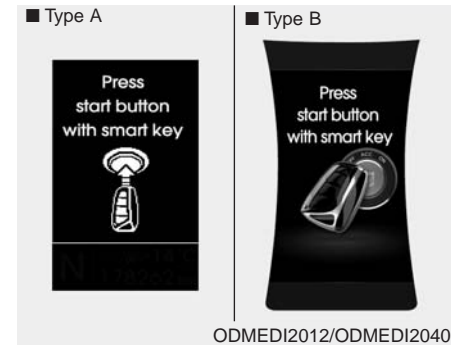

- This warning message illuminates if you press the Engine Start/Stop Button while the warning message “Key not detected” is illuminating.
- At this time, the immobilizer indicator light blinks.

Check fuse "BRAKE SWITCH" (for smart key system)

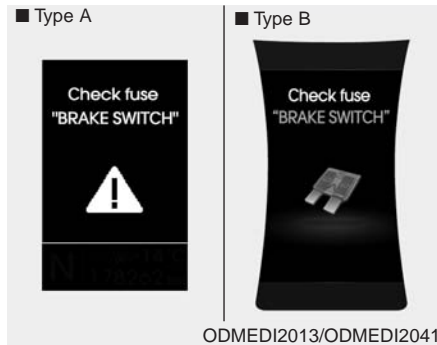

- This warning message illuminates if the brake switch fuse is disconnected.
- It means that you should replace the fuse with a new one. If that is not possible, you can start the engine by pressing the Engine Start/Stop Button for 10 seconds in the ACC position.

Shift to "P" or "N" to start engine (for smart key system)

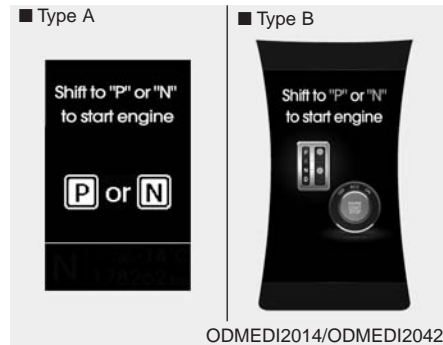

- This warning message illuminates if you try to start the engine with the shift lever not in the P (Park) or N (Neutral) position.

* NOTICE

You can start the engine with the shift lever in the N (Neutral) position. But, for your safety, we recommend that you start the engine with the shift lever in the P (Park) position.

Door Open

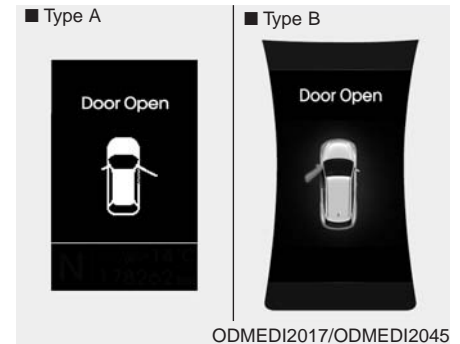

- It means that any door is open.

Liftgate (Tailgate) Open

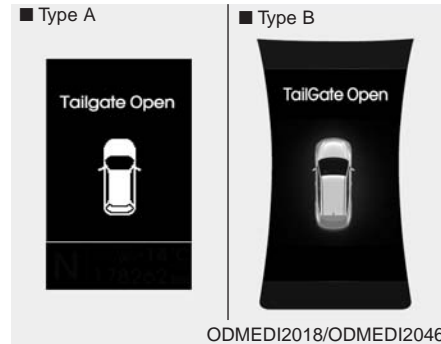

- It means that the liftgate (tailgate) is open.

Sunroof Open (if equipped)

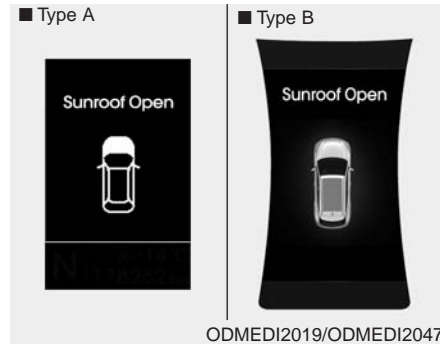

- The warning message illuminates if you turn off the engine (and then open the driver's door, if equipped) when the sunroof is open.

Align steering wheel

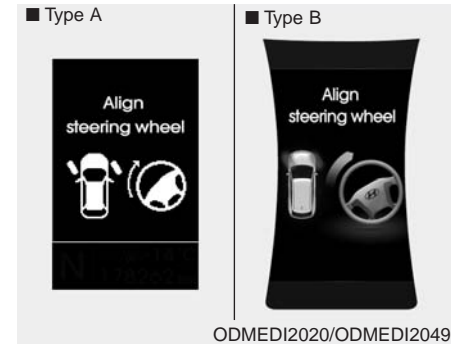

- This warning message illuminates if you start the engine when the steering wheel is turned to more than 90 degrees to the left or right.
- It means that you should turn the steering wheel and make the angle of the steering wheel be less than 30 degrees.

Low Washer Fluid (if equipped)

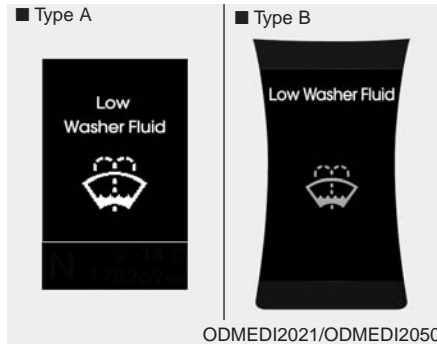

- This warning message illuminates on the service reminder mode if the washer fluid level in the reservoir is nearly empty.
- It means that you should refill the washer fluid.

Low Tire Pressure (if equipped)

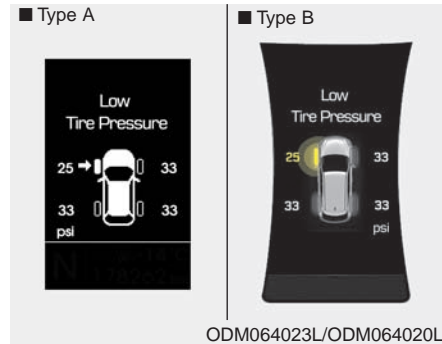

- This warning message illuminates if the tire pressure is low with the ignition switch or the Engine/Start Button in ON position.

For more information, refer to "Tire Pressure Monitoring System (TPMS)" in chapter 6.

Turn on "FUSE SWITCH" (if equipped)

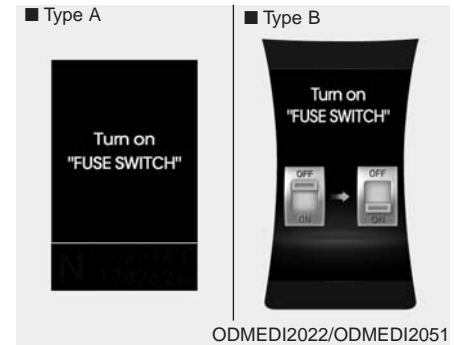

- This warning message illuminates if the fuse switch on the fuse box is OFF.
- It means that you should turn the fuse switch on.

For more details, refer to "Fuses" in chapter 7.

TRIP COMPUTER

Overview

Description

The trip computer is a microcomputer-controlled driver information system that displays information related to driving.

* NOTICE

Some driving information stored in the trip computer (for example Average Vehicle Speed) resets if the battery is disconnected.

Trip Modes

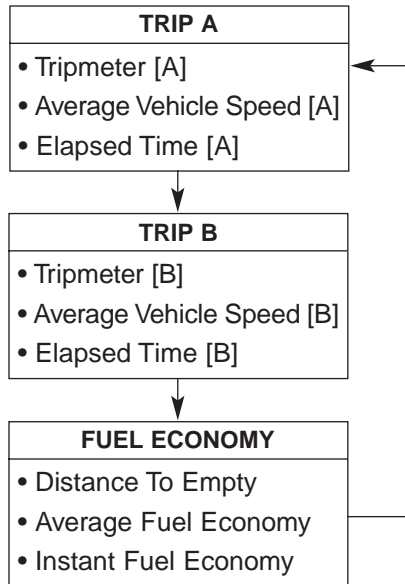

To change the trip mode, press the MOVE button ▼.

Trip A/B

■ Type A

- Trip A

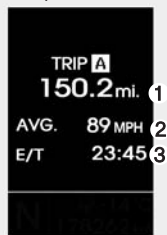

- Trip B

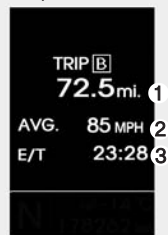

OANNDI2062/OANNDI2063

■ Type B

- Trip A



- Trip B



OANNDI2058/OANNDI2060

Tripmeter (1)

- The tripmeter is the total driving distance since the last tripmeter reset.
 - Distance range: 0.0 ~ 9999.9 mi. or km
- To reset the tripmeter, press the SELECT/RESET button ↵ on the steering wheel for more than 1 second when the tripmeter is displayed.

Average Vehicle Speed (2)

- The average vehicle speed is calculated by the total driving distance and driving time since the last average vehicle speed reset.
 - Speed range: 0 ~ 999 MPH or km/h
- To reset the average vehicle speed, press the SELECT/RESET button ↵ on the steering wheel for more than 1 second when the average vehicle speed is displayed.

* NOTICE

- The average vehicle speed is not displayed if the driving distance is less than 0.03 miles (50 meters) or the driving time is less than 10 seconds since the ignition switch or Engine Start/Stop button is turned to ON.
- Even if the vehicle is not in motion, the average vehicle speed keeps going while the engine is running.

Elapsed Time (3)

- The elapsed time is the total driving time since the last elapsed time reset.
 - Time range (hh:mm): 00:00 ~ 99:59
- To reset the elapsed time, press the SELECT/RESET button ↵ on the steering wheel for more than 1 second when the elapsed time is displayed.

* NOTICE

- Even if the vehicle is not in motion, the elapsed time keeps going while the engine is running.

Fuel Economy

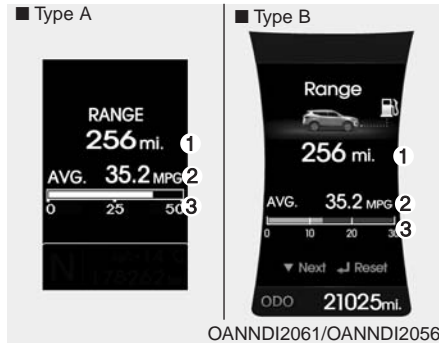

Distance To Empty (1)

- The distance to empty is the estimated distance the vehicle can be driven with the remaining fuel.
 - Distance range : 30 ~ 9999 mi or 50 ~ 9999 km.
- If the estimated distance is below 30 mi. (50 km), the trip computer will display “---” as distance to empty.

* NOTICE

- If the vehicle is not on level ground or the battery power has been interrupted, the distance to empty function may not operate correctly.
- The distance to empty may differ from the actual driving distance as it is an estimate of the available driving distance.
- The trip computer may not register additional fuel if less than 6 liters (1.6 gallons) of fuel are added to the vehicle.
- The fuel economy and distance to empty may vary significantly based on driving conditions, driving habits, and condition of the vehicle.

Average Fuel Economy (2)

- The average fuel economy is calculated by the total driving distance and fuel consumption since the last average fuel economy reset.
 - Fuel economy range: 0.0 ~ 99.9 MPG or L/100km
- The average fuel economy can be reset both manually and automatically.

Manual reset

To clear the average fuel economy manually, press the SELECT/RESET button  on the steering wheel for more than 1 second when the average fuel economy is displayed.

Automatic reset

To make the average fuel economy be reset automatically whenever refueling, select the “Auto Reset” mode in User Setting menu of the LCD display (Refer to “LCD Display”).

Under “Auto Reset” mode, the average fuel economy will be cleared to zero (---) when the vehicle speed exceeds 1 km/h after refueling more than 1.6 gallons (6 liters).

* NOTICE

The average fuel economy is not displayed for more accurate calculation if the vehicle does not drive more than 10 seconds or 0.03 miles (50 meters) since the ignition switch or Engine Start/Stop button is turned to ON.

Instant Fuel Economy (3)

- This mode displays the instant fuel economy during the last few seconds when the vehicle speed is more than 6.2 MPH (10 km/h).
 - Fuel economy range: 0 ~ 50 MPG or 0 ~ 30 L/100km

One time driving information mode (if equipped)

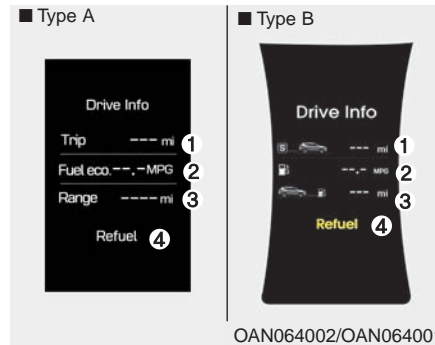

This display shows trip distance (1), average fuel economy (2) and the vehicle can be driven with the remaining fuel (3).

This information is displayed for a few seconds when you turn off the engine and then goes off automatically. The information provided is calculated according to each trip.

If the estimated distance is below 1 mi. (1km), the distance to empty (3) will display as "---" and a refuel message will appear (4).

* NOTICE

If "Window Open" or "Sunroof Open" warning message are displayed in the cluster, this display may not be displayed in the cluster.

WARNING AND INDICATOR LIGHTS

Warning lights

* NOTICE - Warning lights

Make sure that all warning lights are OFF after starting the engine. If any light is still ON, this indicates a situation that needs attention.

Air bag Warning Light



This warning light illuminates:

- Once you set the ignition switch or Engine Start/Stop Button to the ON position.
 - It illuminates for approximately 6 seconds and then goes off.
- When there is a malfunction with the SRS.

In this case, have your vehicle inspected by an authorized HYUNDAI dealer.

Seat Belt Warning Light



This warning light informs the driver that the seat belt is not fastened. For more details, refer to the “Seat Belts” in chapter 3.

Parking Brake & Brake Fluid Warning Light



This warning light illuminates:

- Once you set the ignition switch or Engine Start/Stop Button to the ON position.
 - It illuminates for approximately 3 seconds
 - It remains on if the parking brake is applied.
- When the parking brake is applied.
- When the brake fluid level in the reservoir is low.
 - If the warning light illuminates with the parking brake released, it indicates the brake fluid level in reservoir is low.

If the brake fluid level in the reservoir is low:

1. Drive carefully to the nearest safe location and stop your vehicle.
2. With the engine stopped, check the brake fluid level immediately and add fluid as required (For more details, refer to “Brake Fluid” in chapter 7).

Then check all brake components for fluid leaks. If any leak on the brake system is still found, the warning light remains on, or the brakes do not operate properly, do not drive the vehicle.

In this case, have your vehicle towed to an authorized HYUNDAI dealer and inspected.

Dual-diagonal braking system

Your vehicle is equipped with dual-diagonal braking systems. This means you still have braking on two wheels even if one of the dual systems should fail.

With only one of the dual systems working, more than normal pedal travel and greater pedal pressure are required to stop the vehicle.

Also, the vehicle will not stop in as short a distance with only a portion of the brake system working.

If the brakes fail while you are driving, shift to a lower gear for additional engine braking and stop the vehicle as soon as it is safe to do so.

⚠ WARNING - Parking Brake & Brake Fluid Warning Light

Driving the vehicle with a warning light ON is dangerous. If the Parking Brake & Brake Fluid Warning Light illuminates with the parking brake released, it indicates that the brake fluid level is low.

In this case, have your vehicle inspected by an authorized HYUNDAI dealer.

Anti-lock Brake System (ABS) Warning Light



This warning light illuminates:

- Once you set the ignition switch or Engine Start/Stop Button to the ON position.
 - It illuminates for approximately 3 seconds and then goes off.
- When there is a malfunction with the ABS (The normal braking system will still be operational without the assistance of the anti-lock brake system).

In this case, have your vehicle inspected by an authorized HYUNDAI dealer.

Electronic Brake force Distribution (EBD) System Warning Light



These two warning lights illuminate at the same time while driving:

- When the ABS and regular brake system may not work normally. In this case, have your vehicle inspected by an authorized HYUNDAI dealer.

⚠ WARNING - Electronic Brake force Distribution (EBD) System Warning Light

When both ABS and Parking Brake & Brake Fluid Warning Lights are on, the brake system will not work normally and you may experience an unexpected and dangerous situation during sudden braking.

In this case, avoid high speed driving and abrupt braking.

Have your vehicle inspected by an authorized HYUNDAI dealer as soon as possible.

*** NOTICE - Electronic Brake force Distribution (EBD) System Warning Light**

When the ABS Warning Light is on or both ABS and Parking Brake & Brake Fluid Warning Lights are on, the speedometer, odometer, or trip-meter may not work. Also, the EPS Warning Light may illuminate and the steering effort may increase or decrease.

In this case, have your vehicle inspected by an authorized HYUNDAI dealer as soon as possible.

Electronic Power Steering (EPS) Warning Light (if equipped)



This warning light illuminates:

- Once you set the ignition switch or Engine Start/Stop Button to the ON position.
 - It remains on until the engine is started.
- When there is a malfunction with the EPS.

In this case, have your vehicle inspected by an authorized HYUNDAI dealer.

Malfunction Indicator Lamp (MIL)



This warning light illuminates:

- Once you set the ignition switch or Engine Start/Stop Button to the ON position.
 - It remains on until the engine is started.
- When there is a malfunction with the emission control system.

In this case, have your vehicle inspected by an authorized HYUNDAI dealer.



CAUTION - Gasoline Engine

If the Malfunction Indicator Lamp (MIL) illuminates, potential catalytic converter damage is possible which could result in loss of engine power.

In this case, have your vehicle inspected by an authorized HYUNDAI dealer as soon as possible.



CAUTION - Malfunction Indicator Lamp (MIL)

Driving with the Malfunction Indicator Lamp (MIL) on may cause damage to the emission control systems which could effect drivability and/or fuel economy.

Charging System Warning Light



This warning light illuminates:

- Once you set the ignition switch or Engine Start/Stop Button to the ON position.
 - It remains on until the engine is started.
- When there is a malfunction with either the alternator or electrical charging system.

If there is a malfunction with either the alternator or electrical charging system:

1. Drive carefully to the nearest safe location and stop your vehicle.
2. Turn the engine off and check the alternator drive belt for looseness or breakage.

If the belt is adjusted properly, there may be a problem in the electrical charging system.

In this case, have your vehicle inspected by an authorized HYUNDAI dealer as soon as possible.

Engine Coolant Temperature Warning Light (if equipped)



This warning light illuminates:

- When the engine coolant temperature is above 120°C (248°F). This means that the engine is overheated and may be damaged.

If your vehicle is overheated, refer to “Overheating” in chapter 6.

**⚠ CAUTION - Engine
Overheating**

Do not continue driving with the engine overheated. Otherwise engine may be damaged.

Engine Oil Pressure Warning Light



This warning light illuminates:

- Once you set the ignition switch or Engine Start/Stop Button to the ON position.
 - It remains on until the engine is started.
- When the engine oil pressure is low.

If the engine oil pressure is low:

1. Drive carefully to the nearest safe location and stop your vehicle.
2. Turn the engine off and check the engine oil level (For more details, refer to “Engine Oil” in section 7). If the level is low, add oil as required.
If the warning light remains on after adding oil or if oil is not available, have your vehicle inspected by an authorized HYUNDAI dealer as soon as possible.

CAUTION - Engine Oil Pressure Warning Light

- *If the engine does not stop immediately after the Engine Oil Pressure Warning Light is illuminated, severe damage could result.*
- *If the warning light stays on while the engine is running, it indicates that there may be serious engine damage or malfunction. In this case,*
 1. *Stop the vehicle as soon as it is safe to do so.*
 2. *Turn off the engine and check the oil level. If the oil level is low, fill the engine oil to the proper level.*
 3. *Start the engine again. If the warning light stays on after the engine is started, turn the engine off immediately. In this case, have your vehicle inspected by an authorized HYUNDAI dealer.*

Low Fuel Level Warning Light



This warning light illuminates:

When the fuel tank is nearly empty.

If the fuel tank is nearly empty:

Add fuel as soon as possible.

CAUTION - Low Fuel Level

Driving with the Low Fuel Level warning light on or with the fuel level below “0 or E” can cause the engine to misfire and damage the catalytic converter (if equipped).

Low Tire Pressure Warning Light



This warning light illuminates:

- Once you set the ignition switch or Engine Start/Stop Button to the ON position.
 - It illuminates for approximately 3 seconds and then goes off.
- When one or more of your tires are significantly underinflated.

For more details, refer to “Tire Pressure Monitoring System (TPMS)” in chapter 6.

This warning light remains on after blinking for approximately 60 seconds or repeats blinking and off at the intervals of approximately 3 seconds:

- When there is a malfunction with the TPMS.

In this case, have your vehicle inspected by an authorized HYUNDAI dealer as soon as possible.

For more details, refer to “Tire Pressure Monitoring System (TPMS)” in chapter 6.

⚠ WARNING - Low tire pressure

- **Significantly low tire pressure makes the vehicle unstable and can contribute to loss of vehicle control and increased braking distances.**
- **Continued driving or low pressure tires will cause the tires to overheat and fail.**

⚠ WARNING - Safe Stopping

- **The TPMS cannot alert you to severe and sudden tire damage caused by external factors.**
- **If you notice any vehicle instability, immediately take your foot off the accelerator pedal, apply the brakes gradually with light force, and slowly move to a safe position off the road.**

Door Ajar Warning Light



This warning light illuminates:
When a door is not closed securely.

Liftgate (Tailgate) Open Warning Light



This warning light illuminates:
When the liftgate (tailgate) is not closed securely.

All Wheel Drive (AWD) Warning Light (if equipped)

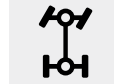

This warning light illuminates:

- Once you set the ignition switch or Engine Start/Stop Button to the ON position.
 - It illuminates for approximately 3 seconds and then goes off.
- When there is a malfunction with the AWD system.

In this case, have your vehicle inspected by an authorized HYUNDAI dealer.

Indicator Lights

Electronic Stability Control (ESC) Indicator Light



This indicator light illuminates:

- Once you set the ignition switch or Engine Start/Stop Button to the ON position.
 - It illuminates for approximately 3 seconds and then goes off.
- When there is a malfunction with the ESC system.

In this case, have your vehicle inspected by an authorized HYUNDAI dealer.

This indicator light blinks:

While the ESC is operating.

For more details, refer to “Electronic Stability Control (ESC)” in chapter 5.

Electronic Stability Control (ESC) OFF Indicator Light



This indicator light illuminates:

- Once you set the ignition switch or Engine Start/Stop Button to the ON position.
 - It illuminates for approximately 3 seconds and then goes off.
- When you deactivate the ESC system by pressing the ESC OFF button.

For more details, refer to “Electronic Stability Control (ESC)” in chapter 5.

ECO Indicator Light

ECO

This indicator light illuminates:

When you activate the active ECO system by pressing the ACTIVE ECO button.

For more details, refer to “Active ECO System” in chapter 5.

Immobilizer Indicator Light (Without Smart Key) (if equipped)



This indicator light illuminates:

- When the vehicle detects the immobilizer in your key properly while the ignition switch is ON.
 - At this time, you can start the engine.
 - The indicator light goes off after starting the engine.

This indicator light blinks:

- When there is a malfunction with the immobilizer system.

In this case, have your vehicle inspected by an authorized HYUNDAI dealer.

Immobilizer Indicator Light (With Smart Key) (if equipped)



This indicator light illuminates for up to 30 seconds:

- When the vehicle detects the smart key in the vehicle properly while the Engine Start/Stop Button is ACC or ON.
 - At this time, you can start the engine.
 - The indicator light goes off after starting the engine.

This indicator light blinks for a few seconds:

- When the smart key is not in the vehicle.
 - At this time, you can not start the engine.

This indicator light illuminates for 2 seconds and goes off:

- When the vehicle can not detect the smart key which is in the vehicle while the Engine Start/Stop Button is ON.

In this case, have your vehicle inspected by an authorized HYUNDAI dealer.

This indicator light blinks:

- When the battery of the smart key is weak.
 - At this time, you can not start the engine. However, you can start the engine if you press the Engine Start/Stop Button with the smart key. (For more details, refer to “Starting the Engine” in section 5).
- When there is a malfunction with the immobilizer system.

In this case, have your vehicle inspected by an authorized HYUNDAI dealer.

Turn Signal Indicator Light

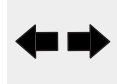

This indicator light blinks:

- When you turn the turn signal light on.

If any of the following occurs, there may be a malfunction with the turn signal system. In this case, have your vehicle inspected by an authorized HYUNDAI dealer.

- The indicator light does not blink but illuminates.
- The indicator light blinks more rapidly.
- The indicator light does not illuminate at all.

High Beam Indicator Light



This indicator light illuminates:

- When the headlights are on and in the high beam position
- When the turn signal lever is pulled into the Flash-to-Pass position.

Light ON Indicator Light



This indicator light illuminates:

- When the tail lights or headlights are on.

Front Fog Indicator Light (if equipped)



This indicator light illuminates:

- When the front fog lights are on.

All Wheel Drive (AWD) LOCK Indicator Light (if equipped)



This indicator light illuminates:

- Once you set the ignition switch or Engine Start/Stop Button to the ON position.
 - It illuminates for approximately 3 seconds and then goes off.
- When you select AWD Lock mode by pressing the AWD LOCK button.
 - The AWD LOCK mode is to increase the drive power when driving on wet pavement, snow covered roads and/or off-road.

⚠ CAUTION - AWD Lock Mode

Do not use AWD LOCK mode on dry paved roads or highway, it can cause noise, vibration or damage of AWD related parts.

Cruise Indicator Light (if equipped)

CRUISE

This indicator light illuminates:

- When the cruise control system is enabled.

For more details, refer to “Cruise Control System” in section 5.

Cruise SET Indicator Light (if equipped)

SET

This indicator light illuminates:

- When the cruise control speed is set.

For more details, refer to “Cruise Control System” in section 5.

Downhill Brake Control (DBC) Indicator Light



This warning light illuminates:

- Once you set the ignition switch or Engine Start/Stop Button to the ON position.
 - It illuminates for approximately 3 seconds and then goes off.
- When you activate the DBC system by pressing the DBC button.

This warning light blinks:

- When the DBC is operating.

This warning light illuminates yellow:

- When there is a malfunction with the DBC system.

In this case, have your vehicle inspected by an authorized HYUNDAI dealer.

For more details, refer to “Downhill Brake Control (DBC) System” in chapter 5.

REAR PARKING ASSIST SYSTEM (IF EQUIPPED)

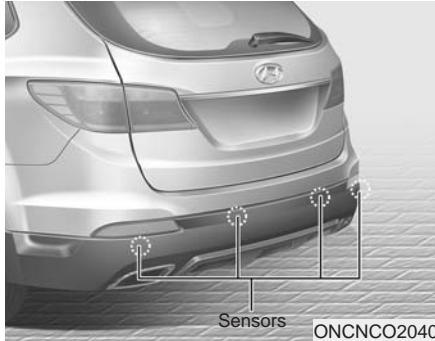

The rear parking assist system assists the driver during backward movement of the vehicle by chiming if any object is sensed within a distance of 47 in. (120 cm) behind the vehicle. This system is a supplemental system and it is not intended to nor does it replace the need for extreme care and attention by the driver. The sensing range and objects detectable by the back sensors are limited. Whenever backing-up, pay as much attention to what is behind you as you would in a vehicle without a rear parking assist system.

⚠ WARNING

The rear parking assist system is a supplementary function only. The operation of the rear parking assist system can be affected by several factors (including environmental conditions). It is the responsibility of the driver to always check the area behind the vehicle before and while backing up.

Operation of the rear parking assist system

Operating condition

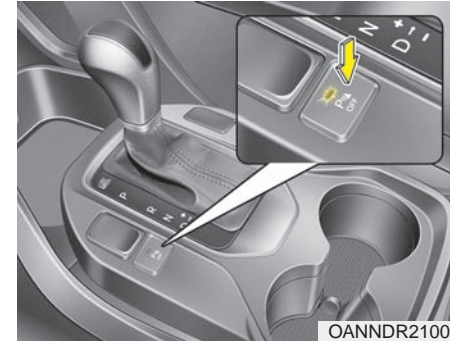

- This system will activate when the indicator on the rear parking assist OFF button is not illuminated.

If you desire to deactivate the rear parking assist system, press the rear parking assist OFF button again. (The indicator on the button will illuminate.) To turn the system on, press the button again. (The indicator on the button will go off.)

- This system will activate when backing up with the ignition switch ON.
If the vehicle is moving at a speed over 10 km/h (6 mph), the system will be deactivated.
- The sensing distance while the rear parking assist system is in operation is approximately 47 in. (120 cm).
- When more than two objects are sensed at the same time, the closest object will be recognized first.

Types of warning sound

- When an object is 47 in. to 24 in. (120 cm to 61 cm) from the rear bumper: Buzzer beeps intermittently.
- When an object is 23 in. to 12 in. (60 cm to 31 cm) from the rear bumper: Buzzer beeps more frequently.
- When an object is within 11.8 in. (30 cm) of the rear bumper: Buzzer sounds continuously.

Non-operational conditions of rear parking assist system

The rear parking assist system may not operate properly when:

1. Moisture is frozen to the sensor. (It will operate normally when the moisture has been cleared.)
2. The sensor is covered with foreign matter, such as snow or water, or the sensor cover is blocked. (It will operate normally when the material is removed or the sensor is no longer blocked.)
3. Driving on uneven road surfaces (unpaved roads, gravel, bumps, gradient).
4. Objects generating excessive noise (vehicle horns, loud motorcycle engines, or truck air brakes) are within range of the sensor.
5. Heavy rain or water spray exists.
6. Wireless transmitters or mobile phones are within range of the sensor.
7. Trailer towing.

The detecting range may decrease when:

1. The sensor is covered with foreign matter such as snow or water. (The sensing range will return to normal when removed.)
2. Outside air temperature is extremely hot or cold.

The following objects may not be recognized by the sensor:

1. Sharp or slim objects such as ropes, chains or small poles.
2. Objects which tend to absorb the sensor frequency such as clothes, spongy material or snow.
3. Undetectable objects smaller than 40 in. (1 m) and narrower than 6 in. (14 cm) in diameter.

Rear parking assist system precautions

- The rear parking assist system may not sound sequentially depending on the speed and shapes of the objects detected.
- The rear parking assist system may malfunction if the vehicle bumper height or sensor installation has been modified or damaged. Any non-factory installed equipment or accessories may also interfere with the sensor performance.
- The sensor may not recognize objects less than 15 in. (40 cm) from the sensor, or it may sense an incorrect distance. Use caution.
- When the sensor is frozen or covered with snow, dirt, or water, the sensor may be inoperative until the items are removed and the sensors are cleaned using a soft cloth.
- Do not push, scratch or strike the sensor. Sensor damage could occur.

*** NOTICE**

This system can only sense objects within the range and location of the sensors; it can not detect objects in other areas where sensors are not installed. Also, small or slim objects, such as poles or objects located between sensors may not be detected by the sensors.

Always visually check behind the vehicle when backing up.

Be sure to inform any drivers of the vehicle that may be unfamiliar with the system regarding the systems capabilities and limitations.

⚠ WARNING

Pay close attention when the vehicle is driven close to objects on the road, particularly pedestrians, and especially children. Be aware that some objects may not be detected by the sensors, due to the object's distance, size or material, all of which can limit the effectiveness of the sensor. Always perform a visual inspection to make sure the vehicle is clear of all obstructions before moving the vehicle in any direction.

Self-diagnosis (if equipped)

When you shift the gear to the R (Reverse) position and if one or more of the below occurs you may have a malfunction in the rear parking assist system.

- You don't hear an audible warning sound or if the buzzer sounds intermittently.

If this occurs, have your vehicle checked by an authorized HYUNDAI dealer as soon as possible.

⚠ WARNING

Your new vehicle warranty does not cover any accidents or damage to the vehicle or injuries to its occupants due to a rear parking assist system malfunction. Always drive safely and cautiously.

REAR VIEW CAMERA (IF EQUIPPED)

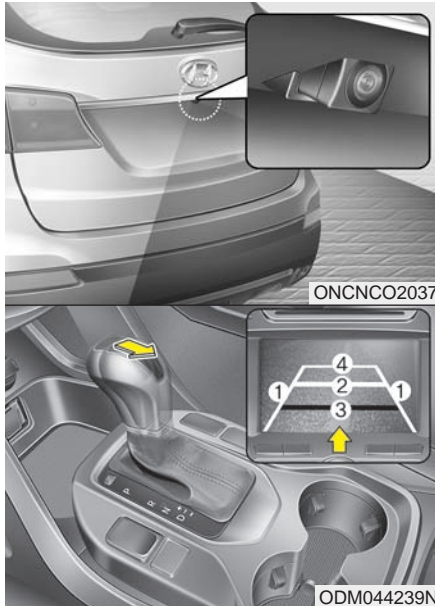

The rearview camera will activate when the back-up light is ON with the ignition switch ON and the shift lever in the R position.

This system is a supplemental system that shows behind the vehicle through the monitor while backing-up.

⚠ WARNING

- This system is a supplementary function only. It is the responsibility of the driver to always check the inside/outside rearview mirror and the area behind the vehicle before and while backing up.
- Always keep the camera lens clean. If the lens is covered with foreign matter, the camera may not operate normally.

*** NOTICE**

The rearview camera may not operate normally, in extremely high or low temperatures (operating temperature : -13°F~149°F (-20°C~65°C)).

HAZARD WARNING FLASHER

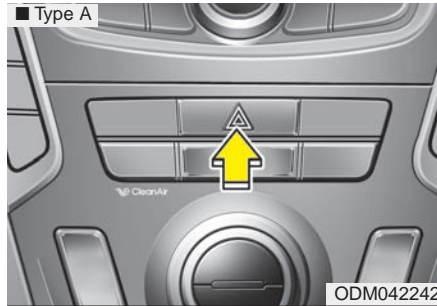

This causes all turn signal lights to blink. The hazard warning lights will operate even though the key is not in the ignition switch.

To turn the hazard warning lights off, push the switch a second time.

The hazard warning flasher should be used whenever you find it necessary to stop the car in a hazardous location. When you must make such an emergency stop, always pull off the road as far as possible.

The hazard warning lights are turned on by pushing in the hazard switch.

LIGHTING

Battery saver function

- The purpose of this feature is to prevent the battery from being discharged. The system automatically turns off the parking lights when the driver removes the ignition key (smart key : turns off the engine) and opens the driver-side door.
- With this feature, the parking lights will be turned off automatically if the driver parks on the side of the road at night.
If necessary, to keep the lights on when the ignition key is removed (smart key : turns off the engine), perform the following:
 - 1) Open the driver-side door.
 - 2) Turn the parking lights OFF and ON again using the light switch on the steering column.

Headlamp delay (if equipped)

If you turn the ignition switch to the ACC or OFF position with the headlights ON, the headlights remain on for about 5 minutes. However, if the driver's door is opened and closed, the headlights are turned off after 15 seconds.

The headlights can be turned off by pressing the lock button on the transmitter (or smart key) twice or turning the light switch to the OFF or Auto position.

However, if you turn the light switch to the Auto position when it is dark outside, the headlights will not be turned off.

You can activate or deactivate this feature. Refer to "User Settings" in this section.



CAUTION

If the driver gets out of the vehicle through other doors (other than the driver's door), the battery saver function does not operate and the headlamp delay does not turn off automatically. This will cause the battery to be discharged. In this case, make sure to turn off the lamp before getting out of the vehicle.

Daytime running light (if equipped)

Daytime Running Lights (DRL) can make it easier for others to see the front of your vehicle during the day. DRL can be helpful in many different driving conditions, and it is especially helpful after dawn and before sunset.

The DRL system will turn OFF when:

- The headlights are ON.
- Engine stops.
- The parking brake is applied.

Lighting control

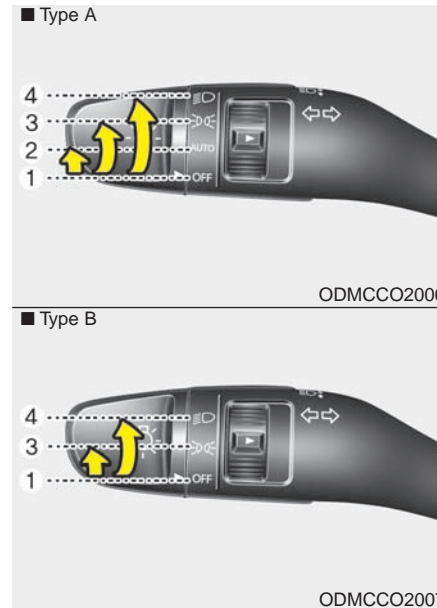

- (1) OFF position
- (2) Auto light position (if equipped)
- (3) Parking light position
- (4) Headlight position

The light switch has a Headlight and a Parking light position.

To operate the lights, turn the knob at the end of the control lever to one of the following positions:

Parking light position (㉔)

■ Type A



ONCNC02016

■ Type B

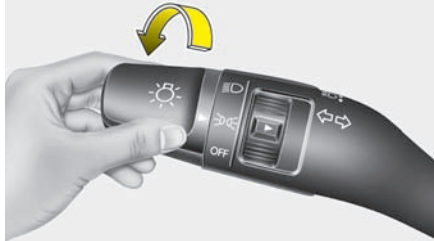

ONCNC02017

When the light switch is in the parking light position, the tail, position, license plate lights and the tail light indicator will turn on.

Headlight position (㉕)

■ Type A



ONCNC02018

■ Type B



ONCNC02019

When the light switch is in the headlight position, the head, tail, license and instrument panel lights will turn on.

*** NOTICE**

The ignition switch must be in the ON position to turn on the headlights.

Auto light position (if equipped)

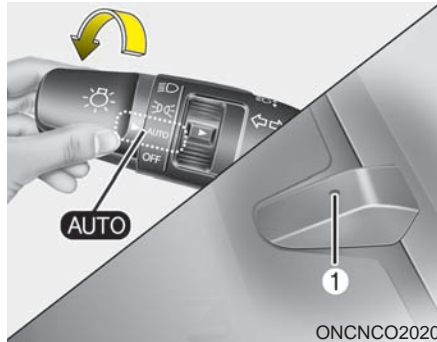

When the light switch is in the AUTO light position, the taillights and headlights will be turned ON or OFF automatically depending on the amount of light outside the vehicle.

CAUTION

- **Never place anything over sensor (1) located on the instrument panel. This will ensure better auto-light system control.**
- **Don't clean the sensor using a window cleaner. The cleaner may leave a light film which could interfere with sensor operation.**
- **If your vehicle has window tint or other types of metallic coating on the front windshield, the Auto light system may not work properly.**

High beam operation

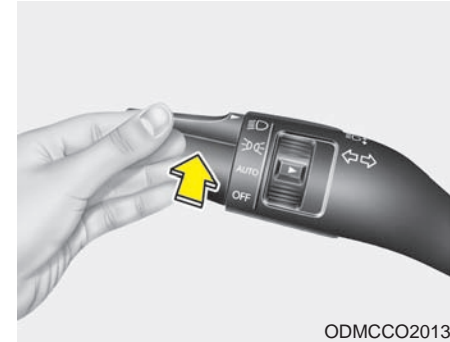

To turn on the high beam headlights, push the lever away from you. Pull it back for low beams.

The high beam indicator will light when the headlight high beams are switched on.

To prevent the battery from being discharged, do not leave the lights on for a prolonged time while the engine is not running.

⚠ WARNING

Do not use the high beams when there are other vehicles. Using high beam could obstruct the other driver's vision.

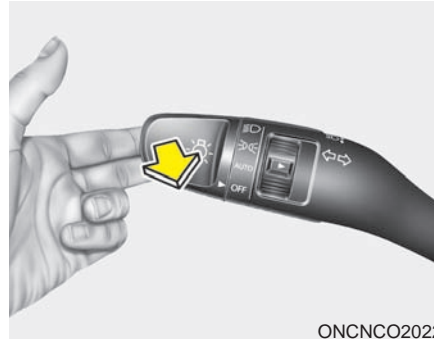

ONCNC02022

To flash the headlights, pull the lever towards you. It will return to the normal (low beam) position when released. The headlight switch does not need to be on to use this flashing feature.

Turn signals and lane change signals

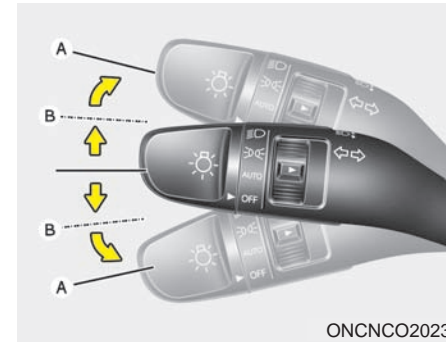

ONCNC02023

The ignition switch must be on for the turn signals to function. To turn on the turn signals, move the lever up or down (A). Green arrow indicators on the instrument panel indicate which turn signal is operating. They will self-cancel after a turn is completed. If the indicator continues to flash after a turn, manually return the lever to the OFF position.

To signal a lane change, move the turn signal lever slightly and hold it in position (B). The lever will return to the OFF position when released.

If an indicator stays on and does not flash or if it flashes abnormally, one of the turn signal bulbs may be burned out and will require replacement.

One-touch triple turn signal (One Touch Turn Signal)

To activate the one-touch lane change function, move the turn signal lever slightly and then release it. The lane change signals will blink 3 (5 or 7, if equipped) times.

You can activate/deactivate the One Touch Turn Signal function or choose the number of blinking (3, 5, or 7) from the User Settings Mode on the LCD display (if equipped).

*** NOTICE**

If an indicator flash is abnormally quick or slow, a bulb may be burned out or have a poor electrical connection in the circuit.

Front fog light



Fog lights are used to provide illumination close to the road surface when visibility is poor due to fog, rain or snow, etc. The fog lights will turn on when the fog light switch (1) is turned to the on position after the headlight is turned on.

To turn off the fog lights, turn the fog light switch (1) to the OFF position.



CAUTION

When in operation, the fog lights consume large amounts of vehicle electrical power. Only use the fog lights when visibility is poor or unnecessary battery and generator drain could occur.

WIPERS AND WASHERS

Windshield wiper/washer

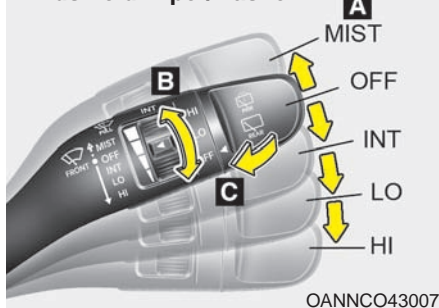

Rear window wiper/washer



A : Wiper speed control

- MIST – Single wipe
- OFF – Off
- INT – Intermittent wipe
- LO – Low wiper speed
- HI – High wiper speed

B : Intermittent wipe time adjustment

C : Wash with brief wipes (front)*

D : Rear wiper/washer control*

- HI – High wiper speed
- LO – Low wiper speed
- OFF – Off

E : Wash with brief wipes (rear)

* : if equipped

Windshield wipers

Operates as follows when the ignition switch is turned ON.

MIST : For a single wiping cycle, move the lever to this (MIST) position and release it. The wipers will operate continuously if the lever is held in this position.

OFF : Wiper is not in operation

INT : Wiper operates intermittently at the same wiping intervals. Use this mode in a light rain or mist. To vary the speed setting, turn the speed control knob.

LO : Normal wiper speed

HI : Fast wiper speed

* NOTICE

If there is heavy accumulation of snow or ice on the windshield, defrost the windshield for about 10 minutes, or until the snow and/or ice is removed before using the windshield wipers to ensure proper operation.

* NOTICE

- When you operate the wipers, if your vehicle has a problem in any part of the wiper operation system, the wiper may operate in the LO mode regardless of the wiper switch position. In this case, have your vehicle checked by an authorized HYUNDAI dealer as soon as possible.
- When the ignition key is removed, the wiper blade sometimes may move slightly for reducing the deterioration of the windshield wipers.

Windshield washers

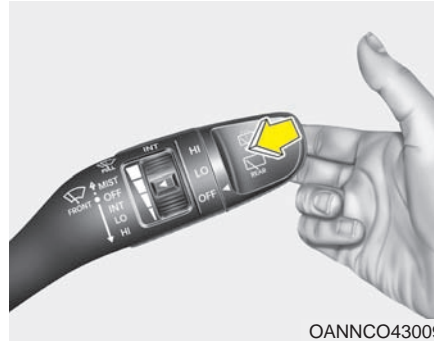

In the OFF position, pull the lever gently toward you to spray washer fluid on the windshield and to run the wipers 1-3 cycles.

Use this function when the windshield is dirty.

The spray and wiper operation will continue until you release the lever.

If the washer does not work, check the washer fluid level. If the fluid level is not sufficient, you will need to add appropriate non-abrasive windshield washer fluid to the washer reservoir.

The reservoir filler neck is located in the front of the engine compartment on the passenger side.

⚠ CAUTION

To prevent possible damage to the washer pump, do not operate the washer when the fluid reservoir is empty.

⚠ WARNING

Do not use the washer in freezing temperatures without first warming the windshield with the defrosters; the washer solution could freeze on the windshield and obscure your vision.

⚠ CAUTION

- To prevent possible damage to the wipers or windshield, do not operate the wipers when the windshield is dry.
- To prevent damage to the wiper blades, do not use gasoline, kerosene, paint thinner, or other solvents on or near them.
- To prevent damage to the wiper arms and other components, do not attempt to move the wipers manually.

Rear window wiper and washer switch

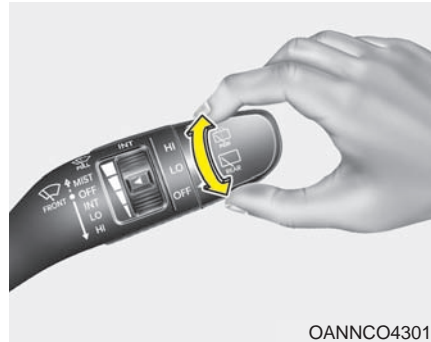

The rear window wiper and washer switch is located at the end of the wiper and washer switch lever. Turn the switch to the desired position to operate the rear wiper and washer.

- HI : High wiper speed
- LO : Low wiper speed
- OFF : Off

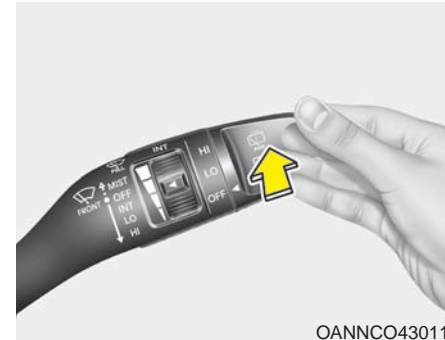

Push the lever away from you to spray rear washer fluid and to run the rear wipers 1~3 cycles. The spray and wiper operation will continue until you release the lever.

INTERIOR LIGHT

CAUTION

Do not use the interior lights for extended periods when the engine is not running.

It may cause battery discharge.

WARNING

Do not use the interior lights when driving in the dark. Accidents could happen because the view may be obscured by interior lights.

Automatic turn off function (if equipped)

The interior lights automatically turn off approximately 20 minutes after the ignition switch is turned off.

If your vehicle is equipped with the theft alarm system, the interior lights automatically turn off approximately 5 seconds after the system is in the armed stage.

Map lamp

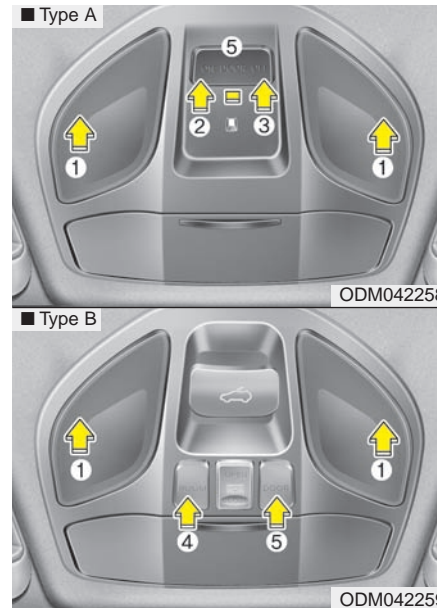

Press the lens (1) to turn the map lamp on or off

- ON (2): The map lamp and room lamp stays on at all times.

- OFF (3): The lamps are off even if a door is opened.
- ROOM (4): The map lamp and room lamp stays on at all times.
- DOOR (5):
 - The map lamp and room lamp comes on for approximately 30 seconds when doors are unlocked with a transmitter or smart key as long as the doors are not opened.
 - When the ignition switch is in the ACC or LOCK/OFF position, if any door is opened, the map lamp and room lamp will stay on for approximately 20 minutes. If the door is closed, the lamps will go out in 30 seconds.
 - The map lamp and room lamp will go out immediately if the ignition switch is changed to the ON position with all doors closed.
 - When the ignition switch is in the ON position, if any door is opened, the map lamp and room lamp will stay on continuously. If the door is closed, the lamps will go out immediately.

*** NOTICE**

When the lamp is turned on by pressing the lens (1), the lamp does not turn off even if the switch is in the OFF position (3).

Room lamp

■ Type A

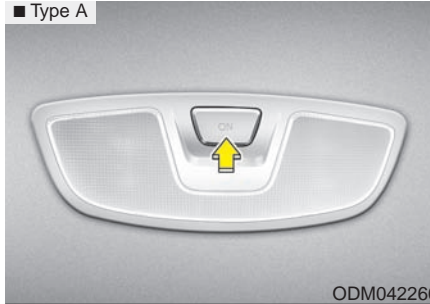

■ Type B



Press the button to turn the light on or off.

**CAUTION**

Do not leave the lamp switches on for an extended period of time when the vehicle is not running because the battery may drain.

Luggage room lamp

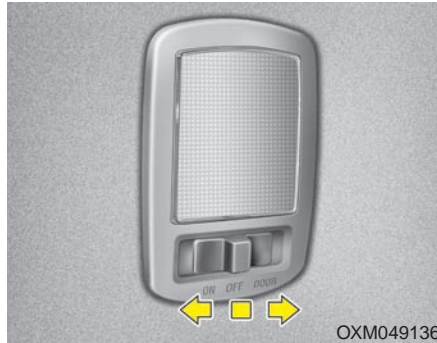

- ON : The luggage room lamp stays on at all times.
- DOOR : The luggage room lamp comes on when the liftgate (tailgate) is opened.
- OFF : The luggage room lamp is off.

Vanity mirror lamp

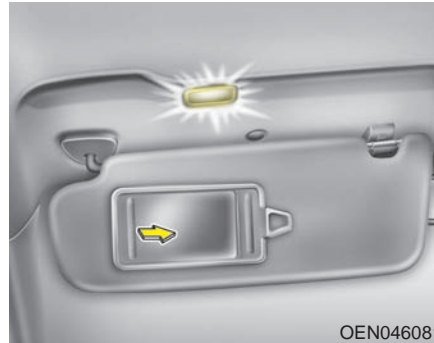

Opening the lid of the vanity mirror will automatically turn on the mirror light.

 **CAUTION**

To prevent unnecessary charging system drain, close the vanity mirror cover after using the mirror.

Glove box lamp

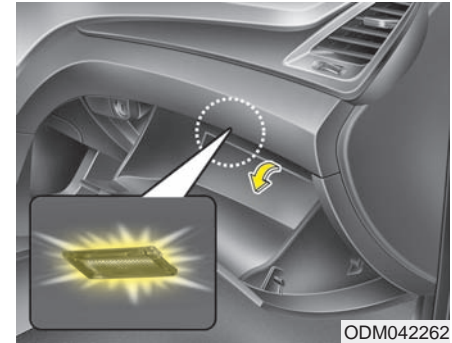

The glove box lamp comes on when the light switch is in the parking light position or headlight position and the glove box is opened.

WELCOME SYSTEM

Headlamp welcome

When the headlight(light switch in the headlight or AUTO position) is on and all doors (and liftgate (tailgate)) are locked and closed, the headlight, position light and tail light will come on for 15 seconds if any of the below is performed.

- Without smart key system
 - When the door unlock button is pressed on the transmitter.
- With the smart key system
 - When the door unlock button is pressed on the smart key.

At this time, if you press the door lock button (on the transmitter or smart key), the lights will turn off immediately.

Interior light

When the interior light switch is in the DOOR position and all doors (and liftgate (tailgate)) are locked and closed, the room lamp will come on for 30 seconds if any of the below is performed.

- Without smart key system
 - When the door unlock button is pressed on the transmitter.
- With the smart key system
 - When the door unlock button is pressed on the smart key.
 - When the button of the outside door handle is pressed.

At this time, if you press the door lock button, the lamps will turn off immediately.

Pocket lamp

When all doors are locked and closed, the pocket lamp will come on for 15 seconds if any of the below is performed.

- Without smart key system
 - When the door unlock button is pressed on the transmitter.
- With the smart key system
 - When the door unlock button is pressed on the smart key.
 - When the button of the outside door handle is pressed.
 - When the vehicle is approached with the smart key in possession.

At this time, if you press the door lock button, the lamps will turn off immediately.

DEFROSTER

CAUTION

To prevent damage to the conductors bonded to the inside surface of the rear window, never use sharp instruments or window cleaners containing abrasives to clean the window.

* NOTICE

If you want to defrost and defog the front windshield, refer to “Windshield defrosting and defogging” in this section.

Rear window defroster

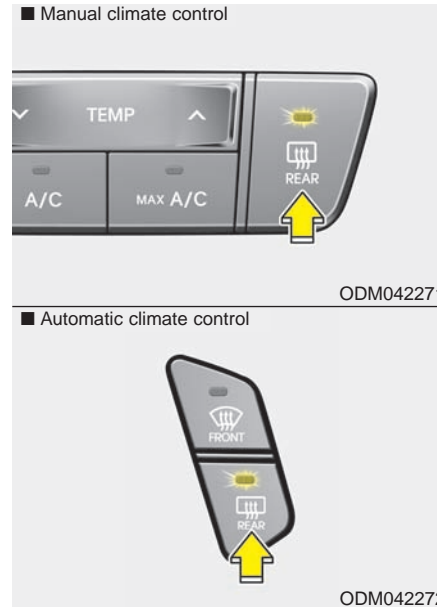

The defroster heats the window to remove frost, fog and thin ice from the rear window, while the engine is running.

To activate the rear window defroster, press the rear window defroster button located in the center facia switch panel.

The indicator on the rear window defroster button illuminates when the defroster is ON.

If there is heavy accumulation of snow on the rear window, brush it off before operating the rear defroster.

The rear window defroster automatically turns off after approximately 20 minutes or when the ignition switch is turned off. To turn off the defroster, press the rear window defroster button again.

Outside rearview mirror defroster (if equipped)

If your vehicle is equipped with the outside rearview mirror defrosters, they will operate at the same time you turn on the rear window defroster.

Front wiper deicer (if equipped)

If your vehicle is equipped with the front wiper deicer, it will be operating at the same time you operate the front windshield defroster.

MANUAL CLIMATE CONTROL SYSTEM (IF EQUIPPED)

■ Front climate control (Type A)



■ Front climate control (Type B)





■ 3rd row air climate control (for Type A)



1. Front windshield defrost button
 2. Temperature control button
 3. Air conditioning button
 4. MAX A/C (Max airconditioning) button
 5. Rear window defroster button
 6. Air intake control button
 7. Mode selection button
 8. Fan speed control knob
 9. 3rd row climate control ON/OFF button
 10. 3rd row fan speed control knob
 11. 3rd row blower ON/OFF button
 12. 3rd row mode selection button
 13. 3rd row temperature control knob
- * if equipped

ONCNCL2001/ODM042273/ONCNCL2002

Heating and air conditioning

1. Start the engine.
2. Set the mode to the desired position.
For improving the effectiveness of heating and cooling;
- Heating: 
- Cooling: 
3. Set the temperature control to the desired position.
4. Set the air intake control to the outside (fresh) air position. (if equipped)
5. Set the fan speed control to the desired speed.
6. If air conditioning is desired, turn the air conditioning system (if equipped) on.

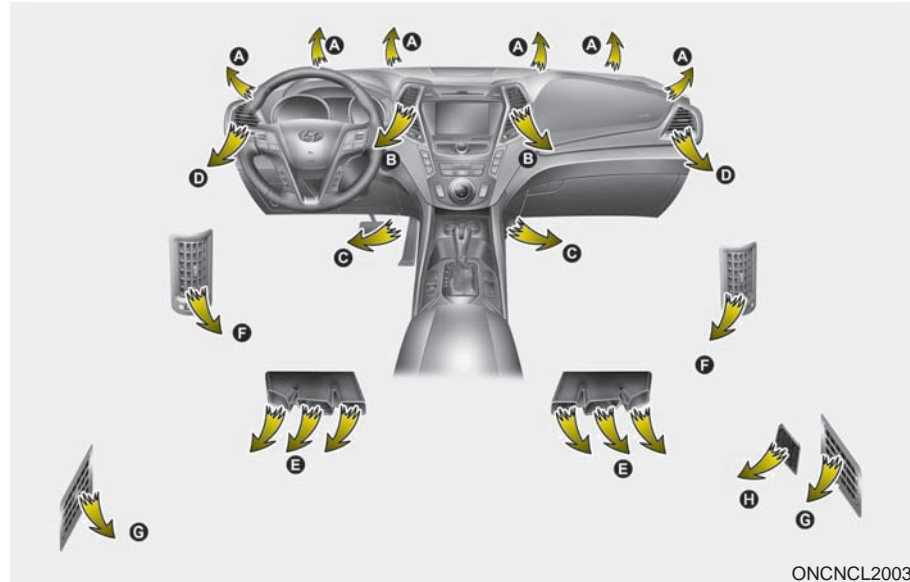

* 2nd and 3rd row outlet vents (E, F, G, H) (G, H : if equipped)

- The air flow of the 2nd and 3rd row outlet vents is controlled by the front climate control system and delivered through the inside air duct of the floor (E, F, H).
- The air flow of the 2nd and 3rd row outlet vents (E, F, H) may be weaker than the instrument panel vents for the long air duct.
- Close the air vents (F) in cold weather. The air flow of the 2nd and 3rd row outlet vents may not be as warm during heating operation. (Use the 2nd and 3rd row outlet vents (F, G) during cooling operation.)

Mode selection

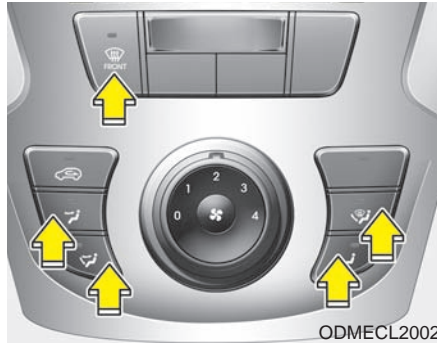

ODMECL2002

The mode selection button controls the direction of the air flow through the ventilation system.



Face-Level (B, D, F)

Air flow is directed toward the upper body and face. Additionally, each outlet can be controlled to direct the air discharged from the outlet.



Bi-Level (B, D, E, C, F)

Air flow is directed towards the face and the floor.



Floor-Level (C, A, D, E)

Most of the air flow is directed to the floor, with a small amount of the air being directed to the windshield, side window defrosters, and side vents.



Floor/Defrost-Level (A, C, D, E)

Most of the air flow is directed to the floor and the windshield with a small amount directed to the side window defrosters, and side vents.



Defrost-Level (A, D)

Most of the air flow is directed to the windshield with a small amount of air directed to the side vents.

MAX A/C-Level (B, D)

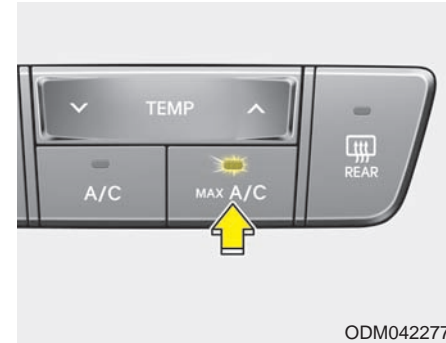

ODM042277

To operate the MAX A/C, turn the fan speed control knob to the right to maximum fan speed, then press the MAX A/C button. Air flow is directed toward the upper body and face.

In this mode, the air conditioning, the recirculated air position and max cool temperature will be selected automatically.

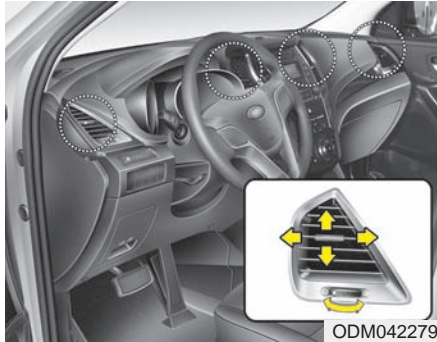

Instrument panel vents

The outlet vents can be opened or closed separately using the thumb-wheel.

Also, you can adjust the direction of air delivered from these vents using the vent control lever as shown.

Temperature control

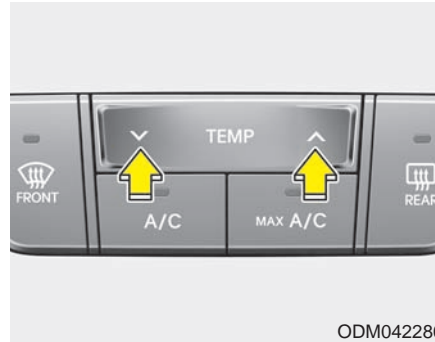

The temperature control switch allows you to control the temperature of the airflow in the vehicle.

To change the temperature:

- Press the \wedge (red) switch to increase temperature.
- Press the \vee (blue) switch to decrease temperature.

The temperature status will be displayed at the above switch panel as an indicator.

Air intake control

■ Type A



ONCNCL2004

■ Type B



ODM042281

This is used to select outside (fresh) air position or recirculated air position.

To change the air intake control position, push the control button.

Recirculated air position

■ Type A, B



The indicator light on the button illuminates when the recirculated air position is selected.

With the recirculated air position selected, air from the passenger compartment will be recirculated and heated or cooled according to the function selected.

Outside (fresh) air position

■ Type A



With the outside (fresh) air position selected, air enters the vehicle from outside and is heated or cooled according to the function selected.

■ Type B

*** NOTICE**

Prolonged operation of the heater in the recirculated air position (without air conditioning selected) may cause fogging of the windshield and side windows and the air within the passenger compartment may become stale.

In addition, prolonged operation of the air conditioning with the recirculated air position selected will result in excessively dry air in the passenger compartment.

⚠ WARNING

- Continued use of the climate control system operation in the recirculated air position without A/C selected may allow humidity to increase inside the vehicle which may fog the glass and obscure visibility.
- Do not sleep in a vehicle with the air conditioning or heating system on. This may cause serious harm or death due to a drop in the oxygen level and/or body temperature.
- Continued use of the climate control system operation in the recirculated air position may cause drowsiness or sleepiness and loss of vehicle control. Set the air intake control to the outside (fresh) air position as much as possible while driving.

Fan speed control



ODM042282

The ignition switch must be in the ON position for fan operation.

The fan speed control knob allows you to control the fan speed of the air flowing from the ventilation system. To change the fan speed, turn the knob to the right for higher speed or left for lower speed.

Setting the fan speed control knob to the "0" position turns off the fan.

To turn off the blowers



ODM042283

To turn off the blowers, turn the fan speed control knob to the "0" position.

Air conditioning

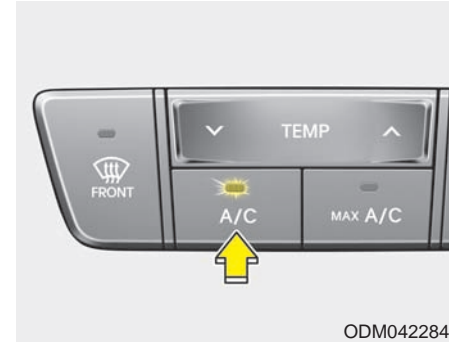

ODM042284

Press the A/C button to turn the air conditioning system on (indicator light will illuminate). Press the button again to turn the air conditioning system off.

3rd row climate control (if equipped)

■ Front



ONCNCL2005

■ 3rd row



ONCNCL2002

1. To turn the 3rd row climate control on or off, press the 3rd row climate control ON/OFF button (1 or 5).



2. Set the fan speed control knob (2) to the desired position.
3. Set the temperature control knob (3) to the desired position.
4. Select the desired direction of the air flow by pressing the mode selecting button (4).

System operation

Ventilation

1. Set the mode to the  position.
2. Set the air intake control to the outside (fresh) air position.
3. Set the temperature control to the desired position.
4. Set the fan speed control to the desired speed.

Heating

1. Set the mode to the  position.
2. Set the air intake control to the outside (fresh) air position.
3. Set the temperature control to the desired position.
4. Set the fan speed control to the desired speed.
5. If dehumidified heating is desired, turn the air conditioning system (if equipped) on.
 - If the windshield fogs up, set the mode to the  or  position.

Operation Tips

- To prevent dust or unpleasant fumes from entering the vehicle through the ventilation system, temporarily set the air intake control to the recirculated air position. Be sure to return the control to the fresh air position when the irritation has passed to keep fresh air in the vehicle. This will help keep the driver alert and comfortable.
- Air for the heating/cooling system is drawn in through the grilles just ahead of the windshield. Care should be taken that these are not blocked by leaves, snow, ice or other obstructions.
- To prevent interior fog on the windshield, set the air intake control to the fresh air position and fan speed to the desired position, turn on the air conditioning system, and adjust the temperature control to desired temperature.

Air conditioning

HYUNDAI Air Conditioning Systems are filled with environmentally friendly R-134a refrigerant.

1. Start the engine. Push the air conditioning button.
 2. Set the mode to the  position.
 3. Set the air intake control to the recirculated air position. However, prolonged operation of the recirculated air position will excessively dry the air. In this case, change the air position.
 4. Adjust the fan speed control and temperature control to maintain maximum comfort.
- When maximum cooling is desired, set the temperature control to the extreme left position then set the fan speed control to the highest speed.

* NOTICE

- While using the air conditioning system, monitor the engine temperature gauge closely while driving up hills or in heavy traffic when outside temperatures are high. Air conditioning system operation may cause engine overheating. Continue to use the blower fan but turn the air conditioning system off if the engine temperature gauge indicates engine overheating.
- Opening the windows in humid weather while operating the air conditioning system may create water droplets inside the vehicle. Since excessive water droplets may cause damage to electrical equipment, air conditioning should only be used with the windows closed.

Air conditioning system operation tips

- If the vehicle has been parked in direct sunlight during hot weather, open the windows for a short time to let the hot air inside the vehicle escape.
- To help reduce moisture inside of the windows on rainy or humid days, decrease the humidity inside the vehicle by operating the air conditioning system.
- During air conditioning system operation, you may occasionally notice a slight change in engine speed as the air conditioning compressor cycles. This is a normal system operation characteristic.
- During the winter months, use the air conditioning system every month for a few minutes to ensure maximum system performance.
- When using the air conditioning system, you may notice clear water dripping (or even puddling) on the ground under the passenger side of the vehicle. This condensation is a normal system operation characteristic.
- Operating the air conditioning system in the recirculated air position provides maximum cooling, however, continual operation in this mode may cause the air inside the vehicle to become stale.
- During cooling operation, you may occasionally notice a misty air flow because of rapid cooling and humid air intake. This is a normal system operation characteristic.
- If you operate air conditioner excessively, the difference between the temperature of the outside air and that of the windshield could cause the outer surface of the windshield to fog up, causing loss of visibility. In this case, set the mode selection knob or button to the  position and fan speed control to the lower speed.

Climate control air filter

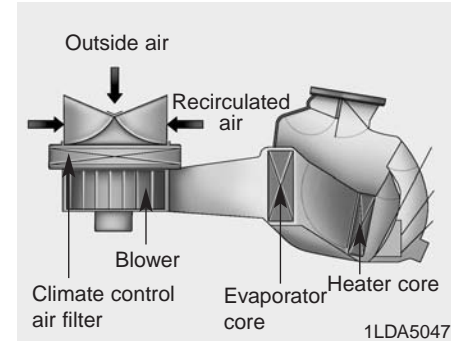

The climate control air filter installed behind the glove box filters the dust or other pollutants that come into the vehicle from the outside through the heating and air conditioning system. If dust or other pollutants accumulate in the filter over a period of time, the air flow from the air vents may decrease, resulting in moisture accumulation on the inside of the windshield even when the outside (fresh) air position is selected. If this happens, have the climate control air filter replaced by an authorized HYUNDAI dealer.

* NOTICE

- Replace the filter according to the Maintenance Schedule.
If the vehicle is being driven in severe conditions such as dusty, rough roads, more frequent climate control air filter inspections and changes are required.
- When the air flow rate suddenly decreases, the system should be checked at an authorized HYUNDAI dealer.

Checking the amount of air conditioner refrigerant and compressor lubricant

When the amount of refrigerant is low, the performance of the air conditioning is reduced. Overfilling also has a negative influence on the air conditioning system.

Therefore, if abnormal operation is found, have the system inspected by an authorized HYUNDAI dealer.

WARNING



Because the refrigerant is at very high pressure, the air conditioning system should only be serviced by trained and certified technicians. It is important that the correct type and amount of oil and refrigerant is used, otherwise damage to the vehicle and personal injury may occur.

Air Conditioning refrigerant label

■ Example

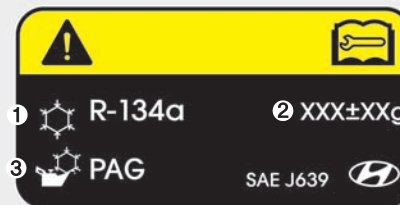

OHG045533N

The actual Air Conditioning refrigerant label in the vehicle may differ from the illustration.

Each symbols and specification on air conditioning refrigerant label means as below ;

1. Classification of refrigerant
2. Amount of refrigerant
3. Classification of Compressor lubricant

Refer to chapter 8 for more detail location of air conditioning refrigerant label.

AUTOMATIC CLIMATE CONTROL SYSTEM (IF EQUIPPED)

■ Front climate control (Type A)



■ Front climate control (Type B)



1. Front windshield defrost button
2. Rear window defrost button
3. Display
4. Air conditioning button*
5. Mode selection button
6. Dual temperature control selection button
7. Driver's temperature control button
8. Front fan speed control knob
9. AUTO (automatic control) button
10. Front blower OFF button
11. Air intake control button* or recirculated air position button*
12. 3rd row climate control ON/OFF button (controlled from the front)
13. Passenger's temperature control button
14. 3rd row fan speed control knob
15. 3rd row blower ON/OFF button
16. 3rd row mode selection button
17. 3rd row temperature control knob
18. Climate control information screen selection button

■ 3rd row climate control (for Type A and B)



* if equipped

ONCNCL2006/ONCNCL2009/ONCNCL2002

■ Front climate control (Type C)



1. Front windshield defroster button
2. Rear window defrost button
3. A/C display
4. Air conditioning button*
5. Mode selection button
6. Dual temperature control selection button
7. Driver's temperature control button
8. Front fan speed control knob
9. AUTO (automatic control) button
10. Blower OFF button
11. Air intake control button* or recirculated air position button*
12. Passenger's temperature control button
13. Climate information screen selection button

* if equipped

■ Front climate control (Type D)



ODMECL2010/OANNMM2002

Automatic heating and air conditioning



1. Press the AUTO button.
The modes, fan speeds, air intake and air-conditioning will be controlled automatically according to the temperature setting.

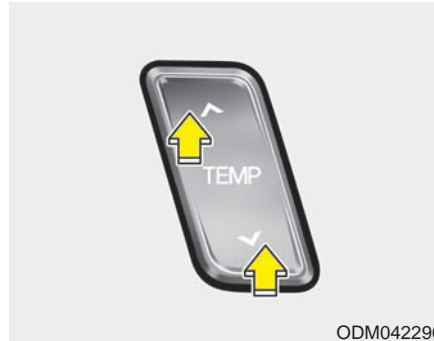

2. Set the driver's temperature control button to set the desired temperature.

* NOTICE

- To turn the automatic operation off, select any button or knob of the following:
 - Mode selection button
 - Front windshield defrost button (Press the button one more time to deselect the front windshield defroster function. The 'AUTO' sign will illuminate on the information display once again.)
 - Fan speed control knob
 The selected function will be controlled manually while other functions operate automatically.
- For your convenience and to improve the effectiveness of the climate control, use the AUTO button and set the temperature to 73°F (23°C).

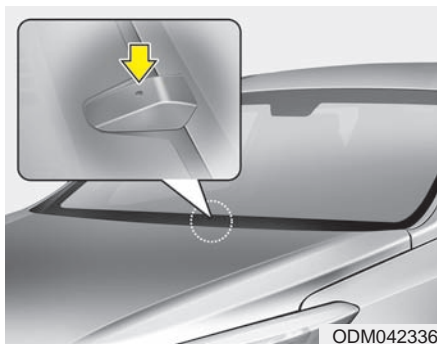

*** NOTICE**

Never place anything over the sensor located on the instrument panel to ensure better control of the heating and cooling system.

Manual heating and air conditioning

The heating and cooling system can be controlled manually by pressing buttons or turning knob(s) other than the AUTO button. In this case, the system works sequentially according to the order of buttons or knob(s) selected.

1. Start the engine.
2. Set the mode to the desired position.

For improving the effectiveness of heating and cooling;

- Heating:
- Cooling:

3. Set the temperature control to the desired position.
4. Set the air intake control to the outside (fresh) air position.
5. Set the fan speed control to the desired speed.
6. If air conditioning is desired, turn the air conditioning system on.

Press the AUTO button in order to convert to full automatic control of the system.

Mode selection

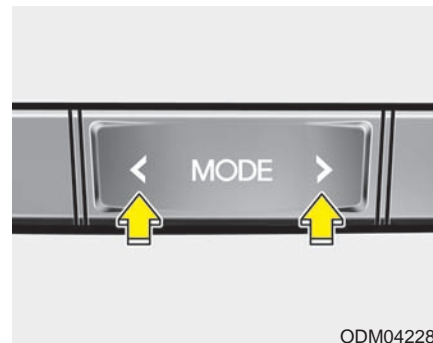

The mode selection button controls the direction of the air flow through the ventilation system.

The air flow outlet port is converted as follows:



Refer to the illustration in the "Manual climate control system".



Face-Level

Air flow is directed toward the upper body and face. Additionally, each outlet can be controlled to direct the air discharged from the outlet.



Bi-Level

Air flow is directed towards the face and the floor.



Floor-Level

Most of the air flow is directed to the floor, with a small amount of the air being directed to the windshield and side window defrosters.



Floor & Defrost

Most of the air flow is directed to the floor and the windshield with a small amount directed to the side window defrosters.

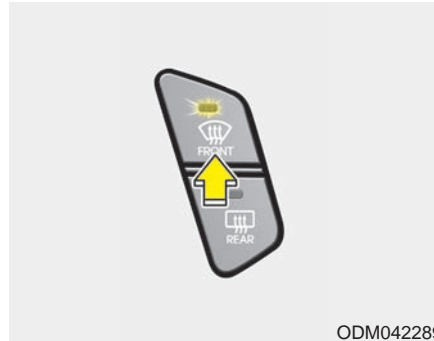

ODM042289

Defrost-Level

Most of the air flow is directed to the windshield with a small amount of air directed to the side window defrosters.

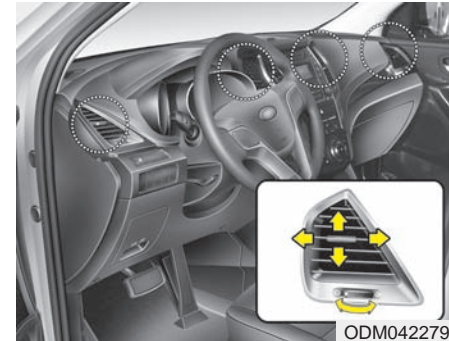

ODM042279

Instrument panel vents

The outlet vents can be opened or closed separately using the thumb-wheel.

Also, you can adjust the direction of air delivered from these vents using the vent control lever as shown.

Temperature control

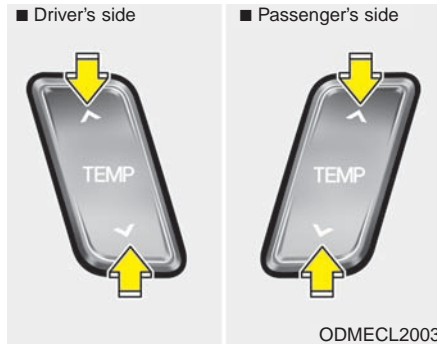

The temperature will increase by pushing the up button. Each push of the button will cause the temperature to increase by 1°F/0.5°C.

The temperature will decrease by pushing the down button. Each push of the button will cause the temperature to decrease by 1°F/0.5°C. When set to the lowest temperature setting, the air conditioning will operate continuously.

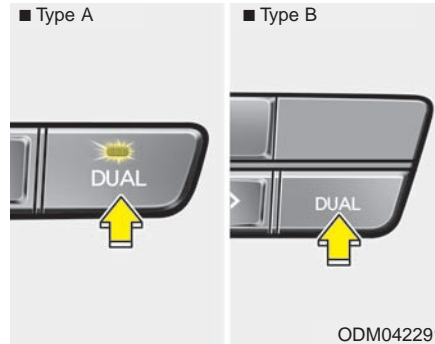

Adjusting the driver and passenger side temperature individually

1. Press the DUAL button to operate the driver and passenger side temperature individually. Pressing the right temperature control button will automatically switch to the DUAL mode as well.
2. Press the left temperature control button to adjust the driver side temperature. Press the right temperature control button to adjust the passenger side temperature.

When the driver side temperature is set to the highest or lowest temperature setting, the DUAL mode is deactivated for maximum heating or cooling.

Adjusting the driver and passenger side temperature equally

1. Press the DUAL button again to deactivate DUAL mode. The passenger side temperature will be set to the same temperature as the driver side temperature.
2. Press the left temperature control button. The driver and passenger side temperature will be adjusted equally.

Temperature conversion

If the battery has been discharged or disconnected, the temperature mode display will reset to Fahrenheit.

This is a normal condition. You can switch the temperature mode between Fahrenheit to Celsius as follows;

While pressing the OFF button, depress the AUTO button for 3 seconds or more. The display will change from Fahrenheit to Celsius, or from Celsius to Fahrenheit.

Air intake control

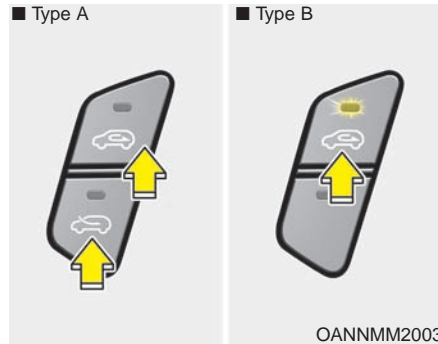

This is used to select the outside (fresh) air position or recirculated air position.

To change the air intake control position, push the control button.

Recirculated air position

■ Type A, B The indicator light on the button illuminates when the recirculated air position is selected.



With the recirculated air position selected, air from the passenger compartment will be drawn through the heating system and heated or cooled according to the function selected.

Outside (fresh) air position

■ Type A With the outside (fresh) air position selected, air enters the vehicle from outside and is heated or cooled according to the function selected.

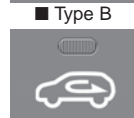

* NOTICE

Prolonged operation of the heater in the recirculated air position (without air conditioning selected) may cause fogging of the windshield and side windows and the air within the passenger compartment may become stale.

(Continued)

(Continued)

In addition, prolonged use of the air conditioning with the recirculated air position selected will result in excessively dry air in the passenger compartment.

⚠ WARNING

- Continued use of the climate control system operation in the recirculated air position may allow humidity to increase inside the vehicle which may fog the glass and obscure visibility.
- Do not sleep in a vehicle with the air conditioning or heating system on. This may cause serious harm or death due to a drop in the oxygen level and/or body temperature.
- Continued use of the climate control system operation in the recirculated air position may cause drowsiness or sleepiness and loss of vehicle control. Set the air intake control to the outside (fresh) air position as much as possible while driving.

Fan speed control

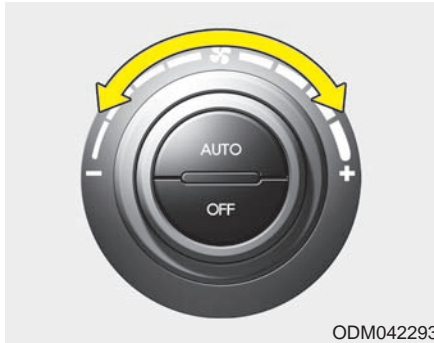

The fan speed can be set to the desired speed by turning the fan speed control knob.

The higher the fan speed is, the more air is delivered.

To turn off the fan speed, press the OFF button.

Air conditioning

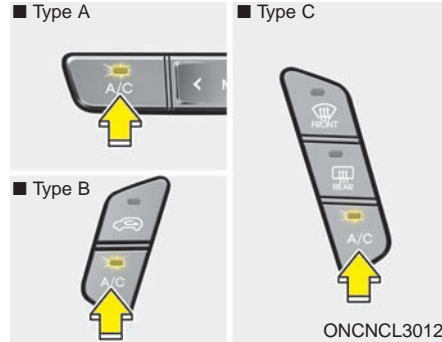

Push the A/C button to turn the air conditioning system on (indicator light will illuminate).

Push the button again to turn the air conditioning system off.

OFF mode



Push the OFF button to turn off the air climate control system. However, you can still operate the mode and air intake buttons as long as the ignition switch is in the ON position.

Climate information screen selection (if equipped)

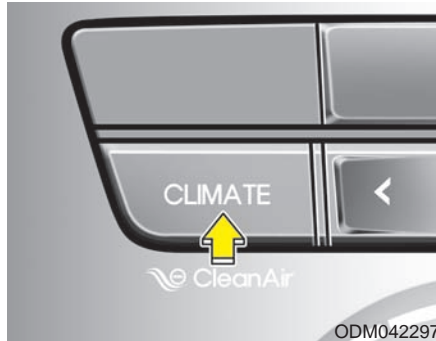

Press the climate information screen selection button to display climate information on the screen.

3rd row climate control (if equipped)

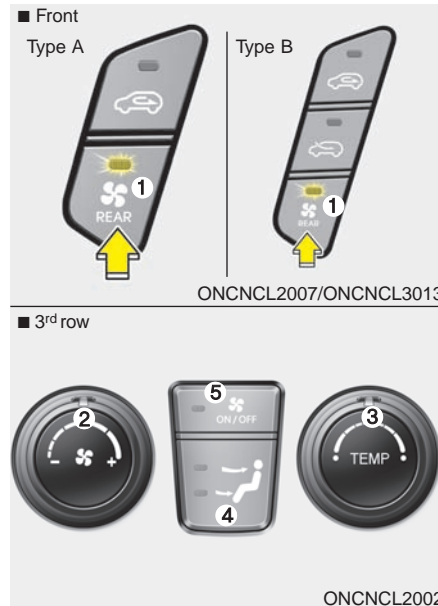



1. To turn the 3rd row climate control on or off, press the 3rd row climate control ON/OFF button (1 or 5).

2. Set the fan speed control knob (2) to the desired position.
3. Set the temperature control knob (3) to the desired position.
4. Select the desired direction of the air flow by pressing the mode selecting button (4).

WINDSHIELD DEFROSTING AND DEFOGGING

⚠ WARNING - Windshield heating

Do not use the  or  position during cooling operation in extremely humid weather. The difference between the temperature of the outside air and that of the windshield could cause the outer surface of the windshield to fog up, causing loss of visibility. In this case, set the mode selection knob or button to the  position and fan speed control knob or button to a lower speed.



- For maximum defrosting, set the temperature control to the extreme right/hot position and the fan speed control to the highest speed.
- If warm air to the floor is desired while defrosting or defogging, set the mode to the floor-defrost position.
- Before driving, clear all snow and ice from the windshield, rear window, outside rear view mirrors, and all side windows.
- Clear all snow and ice from the hood and air inlet in the cowl grill to improve heater and defroster efficiency and to reduce the probability of fogging up the inside of the windshield.

*** NOTICE**

Be sure to keep the interior surface of the windshield clean by wiping it with a clean cloth and glass cleaner. This will help reduce the tendency of the glass fogging and also improve visibility.

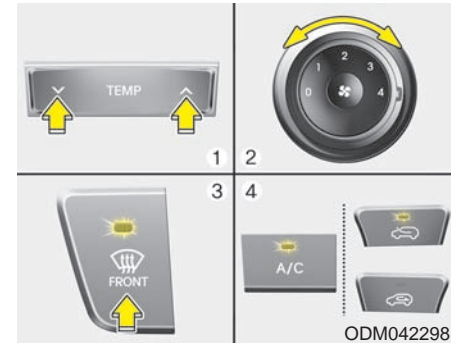
Manual climate control system *To defog inside windshield*



1. Select desired temperature.
2. Select any fan speed except "0" position.
3. Select the  or  position.
4. The outside (fresh) air will be selected automatically.

If the outside (fresh) air position is not selected automatically, press the corresponding button manually.

To defrost outside windshield

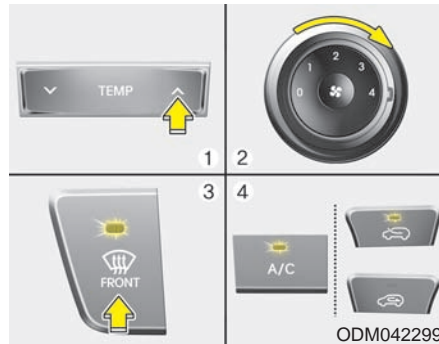

1. Set the temperature to the extreme hot position.
2. Set the fan speed to the highest (extreme right) position.
3. Select the position.
4. The outside (fresh) air will be selected automatically.

ODM042299

Automatic climate control system

To defog inside windshield

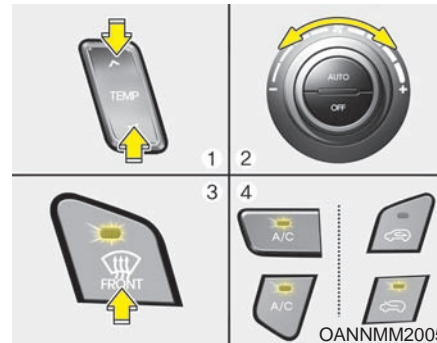

1. Select desired temperature.
2. Select desired fan speed.
3. Press the defrost button ().
4. The outside (fresh) air position will be selected automatically.

If the outside (fresh) air position is not selected automatically, adjust the corresponding button manually.

If the position is selected, lower fan speed is adjusted to a higher fan speed.

OANNMM2005

To defrost outside windshield

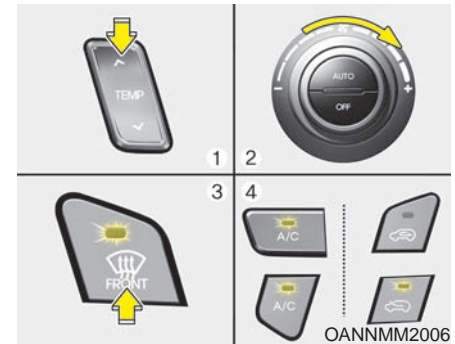

1. Set the temperature to the extreme hot (HI) position.
2. Set the fan speed to the highest (extreme right) position.
3. Press the defrost button ().
4. The outside (fresh) air position will be selected automatically.

If the position is selected, lower fan speed is adjusted to a higher fan speed.

OANNMM2006

Auto defogging system (if equipped)

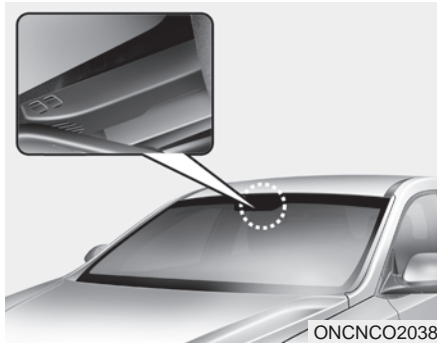

Auto defogging reduces the probability of fogging up the inside of the windshield by automatically sensing the moisture of inside the windshield.

The auto defogging system operates when the heater or air conditioning is on.



This indicator illuminates when the auto defogging system senses the moisture of inside the windshield and operates.

If more moisture is in the vehicle, the automated steps operate as follows: If auto defogging does not defog the window at step 1, outside air position, step 2, blowing air toward the windshield occurs.

Step 1 : Outside air position

Step 2 : Blowing air toward the windshield

Step 3 : Increasing air flow toward the windshield

Step 4 : Operating the air conditioning

Step 5 : Maximizing the air conditioning

The auto defogging system is automatically activated when the conditions are met. However, if you would like to cancel the auto defogging system, press the front defroster button 4 times within 2 seconds while pressing the AUTO button. The indicator of the front defroster button will blink 3 times to notify you that the system is cancelled. To use the auto defogging system again, follow the procedures mentioned above.

If the battery has been disconnected or discharged, it resets to the auto defogging status.

*** NOTICE**

When the air conditioning is turned on and the outside air position is selected by the auto defogging system, if you try to turn off the air conditioning and select the recirculated air position, the indicator will blink 3 times and the air conditioning will not be turned off and recirculated air position will not be selected.



CAUTION

Do not remove the sensor cover located on the upper end of the driver side windshield glass. Damage to system parts could occur and may not be covered by your vehicle warranty.

STORAGE COMPARTMENTS

⚠ CAUTION

- To avoid possible theft, do not leave valuables in the storage compartments.
- Always keep the storage compartment covers closed while driving. Do not attempt to place so many items in the storage compartment that the storage compartment cover cannot close securely.

⚠ WARNING - Flammable materials

Do not store cigarette lighters, propane cylinders, or other flammable/explosive materials in the vehicle. These items may catch fire and/or explode if the vehicle is exposed to hot temperatures for extended periods.

Center console storage

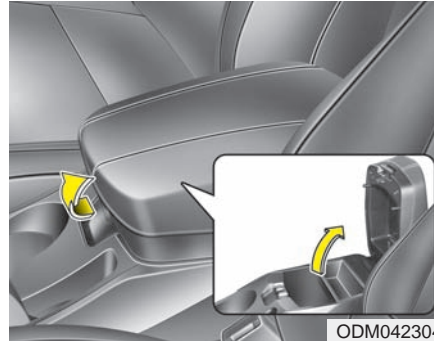

To open the center console storage, pull up the lever.

Glove box

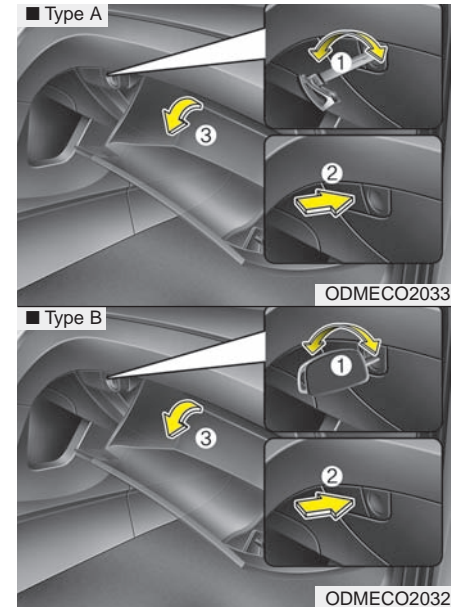

The glove box can be locked and unlocked with the mechanical key (1). To open the glove box, push the button (2) and the glove box will automatically open (3). Close the glove box after use.

⚠ WARNING

To reduce the risk of injury in an accident or sudden stop, always keep the glove box door closed while driving.

Multi box (if equipped)

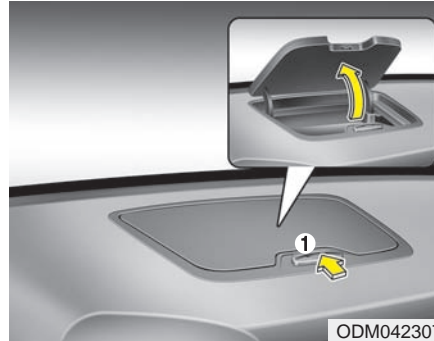

To open the cover, push the lever (1) and the multi box will open automatically.

It can be used for storing small items.

⚠ CAUTION

Do not drive with the multi box open.

Sunglass holder

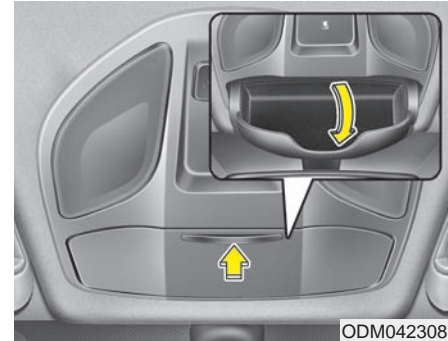

To open the sunglasses holder, press the cover and the holder will slowly open. Place your sunglasses in the compartment door with the lenses facing out. Push to close.

⚠ WARNING

- Do not keep objects except sunglasses inside the sunglass holder. Such objects can be thrown from the holder in the event of a sudden stop or an accident, possibly injuring the passengers in the vehicle.
- Do not open the sunglass holder while the vehicle is moving. The rear view mirror of the vehicle can be blocked by an open sunglass holder.
- Do not put the glasses forcibly into a sunglass holder to prevent breakage or deformation of glasses. It may cause personal injury if you try to open it forcibly when the glasses are jammed in holder.

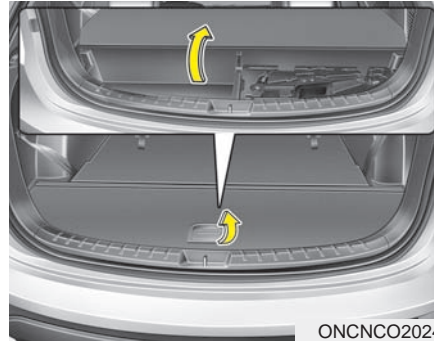
Luggage tray

You can place a first aid kit, a reflector triangle, tools, etc. in the luggage tray for easy access.

Grasp the handle on the top of the cover and lift it.

INTERIOR FEATURES

Cigarette lighter (if equipped)

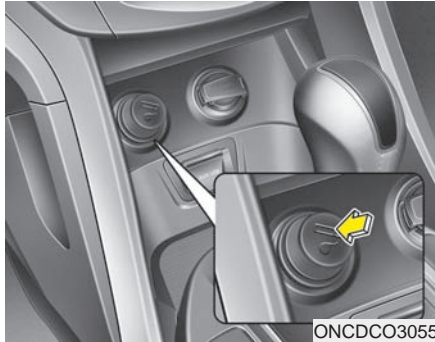

For the cigarette lighter to work, the ignition switch must be in the ACC position or the ON position.

To use the cigarette lighter:

1. Open the cover by pressing the switch.
2. Push the lighter all the way into the socket.

When the element has heated, the lighter will pop out to the "ready" position.

If it is necessary to replace the cigarette lighter, use only a genuine HYUNDAI replacement or its approved equivalent.

⚠ WARNING

- Holding the lighter in after it is heated will cause it to over-heat.
- If the lighter does not pop out within 30 seconds, remove it to prevent overheating.

⚠ CAUTION

The use of plug-in accessories (shavers, hand-held vacuums, and coffee pots, for example) may damage the socket or cause electrical failure.

Cup holder

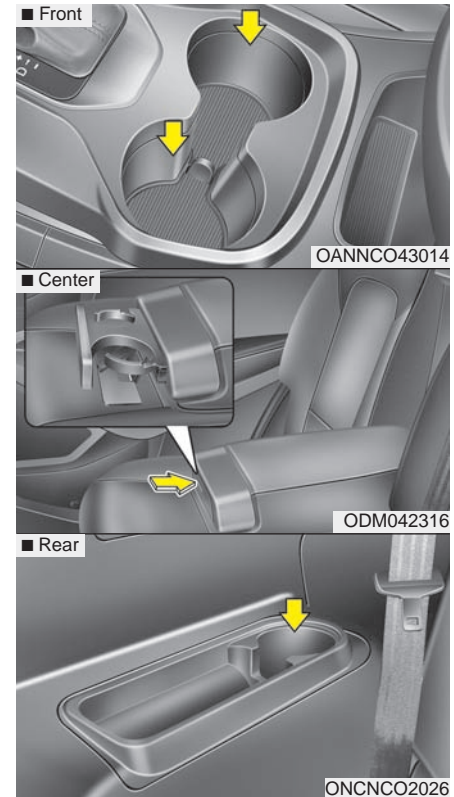

Cups or small beverage cans may be placed in the cup holders.

To use the center cup holder, pull down the armrest and press the open button.

⚠ WARNING - Hot liquids

- Do not place uncovered cups of hot liquid in the cup holder while the vehicle is in motion. If the hot liquid spills, you may burn yourself. Such a burn to the driver could lead to loss of control of the vehicle.
- To reduce the risk of personal injury in the event of sudden stop or collision, do not place uncovered or unsecured bottles, glasses, cans, etc., in the cup holder while the vehicle is in motion.

⚠ WARNING

Keep cans or bottles out of direct sun light and do not put them in a vehicle that is hot up. It may explode.

⚠ CAUTION

When cleaning spilled liquids, do not dry the cup holder at high temperatures. This may damage the chrome trim of the cup holder.

⚠ CAUTION

Do not place uncovered cups in the cup holder while the vehicle is in motion. If the liquid spills, electric systems may malfunction.

Sunvisor

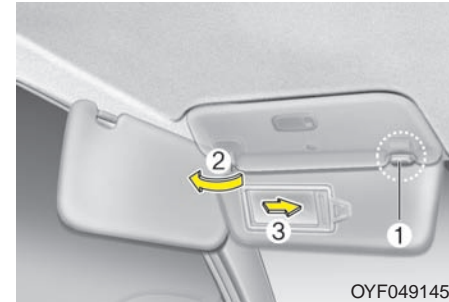

OYF049145



HTG2174

Use the sunvisor to shield direct light through the front or side windows.

To use a sunvisor, pull it downward.

To use a sunvisor for a side window, pull it downward, unsnap it from the bracket (1) and swing it to the side (2).

To use the vanity mirror, pull down the visor and slide the mirror cover (3).

Adjust the sunvisor extension (if equipped) forward or backward (4).

CAUTION

- *Always have the switch in the off position when the vanity mirror lamp is not in use. If the sunvisor is closed without the lamp off, it may discharge the battery or damage the sunvisor.*
- *Always use the sunvisor extension, after swinging the sunvisor to the side.*

Power outlet

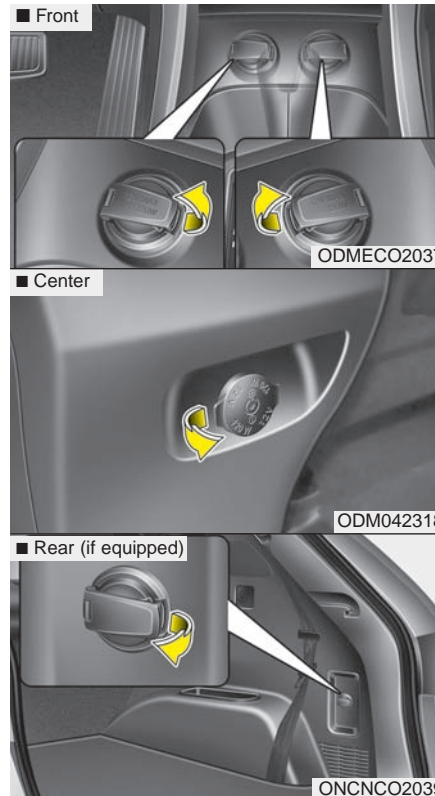

The power outlet is designed to provide power for mobile telephones or other devices designed to operate with vehicle electrical systems. The devices should draw less than 10 amps with the engine running.

CAUTION

- *Use the power outlet only when the engine is running and remove the accessory plug after use. Using the accessory plug for prolonged periods of time with the engine off could cause the battery to discharge.*
- *Only use 10V electric accessories which are less than 10A in electric capacity. If not, it could lead to an overheated power outlet or electric wiring in the vehicle and electric systems may malfunction.*

(Continued)

(Continued)

- *Adjust the air-conditioner or heater to the lowest operating level when using the power outlet.*
- *Close the cover when not in use.*
- *Some electronic devices can cause electronic interference when plugged into a vehicle's power outlet. These devices may cause excessive audio static and malfunctions in other electronic systems or devices used in your vehicle.*
- *Make sure that the electric devices are plugged in securely. If not, it could cause a malfunction of electric systems.*
- *If you use an electric device with a battery, electric current may flow from the electric device into the vehicle and may cause a malfunction of electric systems. Only use electric devices which could prevent inverse current.*

⚠ WARNING

Do not put fingers or foreign elements (pin, etc.) into a power outlet and do not touch with a wet hand. You may get an electric shock.

AC inverter (if equipped)

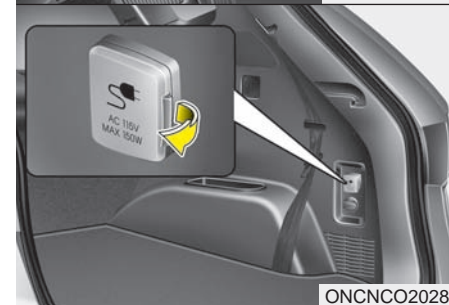
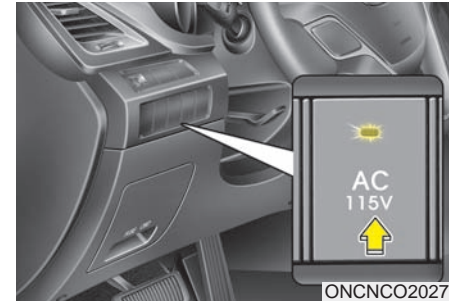

The AC inverter supplies 115V/150W electric power to operate electric accessories or equipments.

If you wish to use the AC inverter, press the AC inverter button while the engine is running. The light on the AC inverter button will illuminate.

If you press the AC inverter button again, the AC inverter will be deactivated and the light on the AC inverter button will turn off.

* NOTICE

When turning on the AC inverter, the indicator on the AC inverter button is delayed while the system conducts a self-check.

WARNING

To reduce a risk of serious or fatal injuries:

- Do not use a heated electric device such as a coffeepot, toaster, heater, iron, etc.
- Do not insert foreign objects into the outlet and do not touch the outlet as you may get shocked.
- Do not let children touch the AC inverter.

CAUTION

- *To prevent the battery from being discharged, do not use the AC inverter while the engine is not running.*
- *When not using the AC inverter, make sure to turn off the AC inverter (the indicator on the button does not illuminate) and close the AC inverter cover.*
- *After using an electronic accessory or equipment, pull the plug out. Leaving the accessory or equipment plugged in for a long time may cause battery discharge.*
- *Do not use an electronic accessory or equipment with the power consumption greater than 150W(115V).*

(Continued)

(Continued)

- *Some electronic accessories or equipments can cause electronic interference. It may cause excessive audio noise and malfunctions in other electronic systems or devices in the vehicle.*
- *Do not use broken electronic accessories or equipments, which may damage the AC inverter and electrical systems of the vehicle.*
- *Do not use two or more electronic accessories or equipments at the same time. It may cause damage to the electrical systems of the vehicle.*
- *When the input voltage is under 11V, the outlet LED will blink and the AC inverter will turn off automatically. If the input voltage goes up to normal, the AC inverter will turn on again.*
- *Do not use extensions or power strips.*

Clothes hanger (if equipped)

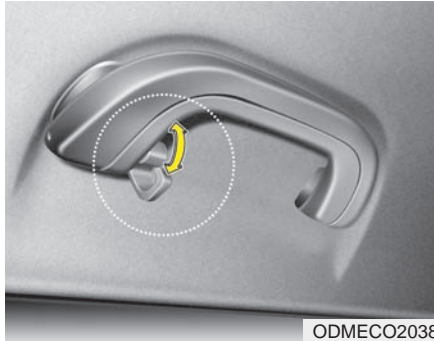

To use the hanger, pull down the upper portion of hanger.

⚠ CAUTION

Do not hang heavy clothes, because it may damage the hook.

Floor mat anchor(s)

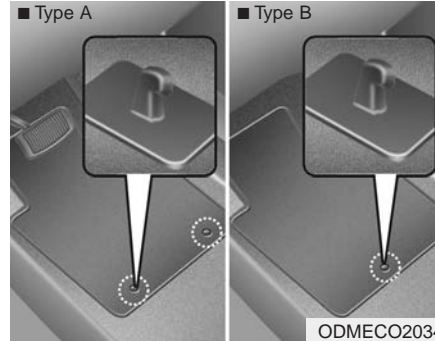

When using a floor mat on the front floor carpet, make sure it attaches to the floor mat anchor(s) in your vehicle. This keeps the floor mat from sliding forward.

⚠ WARNING

The floor mat must be properly anchored so that it will not interfere with the operation of the accelerator pedal. Any interference with the accelerator pedal could cause the accelerator pedal not to return to the idle position. A pedal that cannot return to the idle position could lead to an accident which may result in severe personal injury or death.

⚠ WARNING

The following must be observed when installing ANY floor mat to the vehicle, so that it will not interfere with the pedal.

- Ensure that the floor mats are securely attached to the vehicle's floor mat anchor(s) before driving the vehicle.
- Do not use ANY floor mat that cannot be firmly attached to the vehicle's floor mat anchors.
- Do not stack floor mats on top of one another (e.g. all-weather rubber mat on top of a carpeted floor mat). Only a single floor mat should be installed in each position.

IMPORTANT – Your vehicle was manufactured with driver's side floor mat anchors that are designed to securely hold the floor mat in place. To avoid any interference with pedal operation, HYUNDAI recommends that only the HYUNDAI floor mat designed for use in your vehicle be installed.

Aux, USB and iPod® port

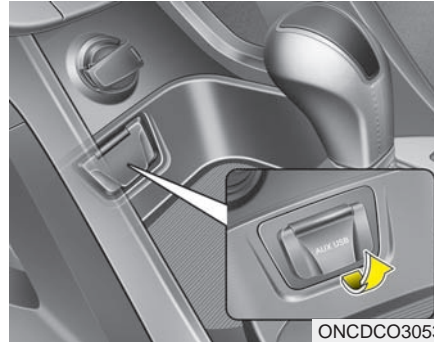

If your vehicle has an aux and/or USB(universal serial bus) port or iPod® port, you can use an aux port to connect audio devices and a USB port to plug in a USB and also in an iPod®.

*** NOTICE**

When using a portable audio device connected to the power outlet, noise may occur during playback. If this happens, use the power source of the portable audio device.

* iPod® is a trademark of Apple Inc.

Luggage net (holder) (if equipped)

■ Type A



■ Type B

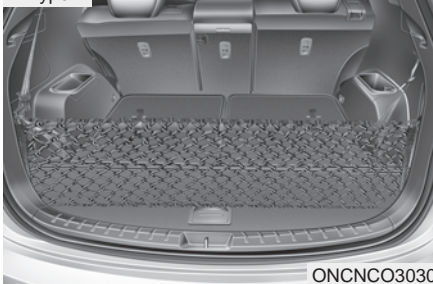

To keep items from shifting in the cargo area, you can use the four holders located in the cargo area to attach the luggage net.

If necessary, contact your authorized HYUNDAI dealer to obtain a luggage net.

* NOTICE

Vehicles equipped with a luggage rail system may use the shackles to hook the luggage net.

⚠ CAUTION

To prevent damage to the goods or the vehicle, care should be taken when carrying fragile or bulky objects in the luggage compartment.

⚠ WARNING

To avoid eye injury, DO NOT overstretch the luggage net. ALWAYS keep your face and body out of the luggage net's recoil path. DO NOT use the luggage net when the strap has visible signs of wear or damage.

Cargo security screen (if equipped)



Use the cargo security screen to hide items stored in the cargo area.

To use the cargo security screen

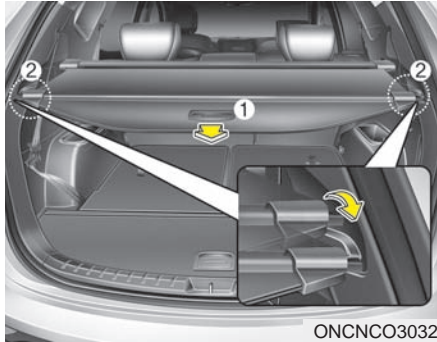

1. Pull the cargo security screen towards the rear of the vehicle by the handle (1).
2. Insert the guide pin into the guide (2).

* NOTICE

Pull out the cargo security screen with the handle in the center to prevent the guide pin from falling out of the guide.

When the cargo security screen is not in use:

1. Pull the cargo security screen backward and up to release it from the guides.
2. The cargo security screen will automatically slide back in.

* NOTICE

The cargo security screen may not automatically slide back in if the cargo security screen is not fully pulled out. Fully pull it out and then carefully slide back in.

To remove the cargo security screen (if equipped)

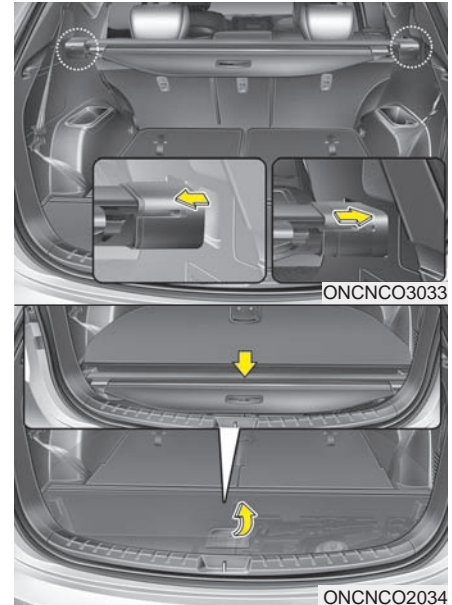

1. Push in the guide pin.
2. While pushing the lever, pull out the cargo security screen.
3. Open the luggage tray and keep the cargo security screen in the tray.

To remove the cargo security screen from the luggage tray

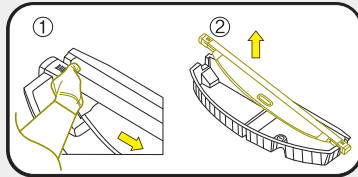

ONCNCO2035

1. Push in the guide pin.
2. While pushing the guide pin, pull out the cargo security screen.

⚠ WARNING

- Do not place objects on the cargo security screen. Such objects may be thrown about inside the vehicle and possibly injure vehicle occupants during an accident or when braking.
- Never allow anyone to ride in the luggage compartment. It is designed for luggage only.

⚠ CAUTION

Since the cargo security screen may be damaged or deformed, do not put luggage on it when it is used.

Side curtain (if equipped)

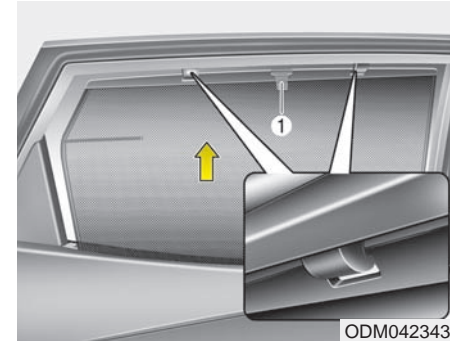

ODM042343

To use the side curtain:

1. Lift the curtain by the hook (1).
2. Hang the curtain on both sides of the hook.

EXTERIOR FEATURES

Roof rack (if equipped)

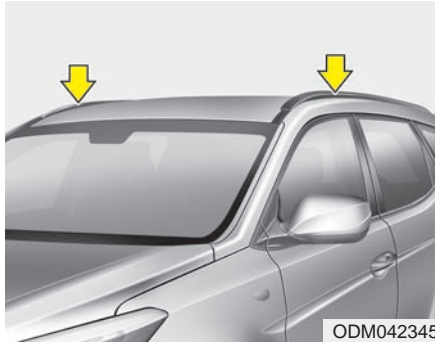

If the vehicle has a roof rack, you can load cargo on top of your vehicle.

* NOTICE

If the vehicle is equipped with a sunroof, be sure not to position cargo onto the roof rack in such a way that it could interfere with sunroof operation.

CAUTION

- *When carrying cargo on the roof rack, take the necessary precautions to make sure the cargo does not damage the roof of the vehicle.*
- *When carrying large objects on the roof rack, make sure they do not exceed the overall roof length or width.*

WARNING

- The following specification is the maximum weight that can be loaded onto the roof rack. Distribute the load as evenly as possible onto the roof rack and secure the load firmly.

ROOF RACK	100 kg (220 lbs.) EVENLY DISTRIBUTED
-----------	---

Loading cargo or luggage in excess of the specified weight limit on the roof rack may damage your vehicle.

(Continued)

(Continued)

- The vehicle center of gravity will be higher when items are loaded onto the roof rack. Avoid sudden starts, braking, sharp turns, abrupt maneuvers or high speeds that may result in loss of vehicle control or rollover resulting in an accident.
- Always drive slowly and turn corners carefully when carrying items on the roof rack. Severe wind updrafts, caused by passing vehicles or natural causes, can cause sudden upward pressure on items loaded on the roof rack. This is especially true when carrying large, flat items such as wood panels or mattresses. This could cause the items to fall off the roof rack and cause damage to your vehicle or others around you.
- To prevent damage or loss of cargo while driving, check frequently before or while driving to make sure the items on the roof rack are securely fastened.

AUDIO SYSTEM

* NOTICE

- If you install an aftermarket HID headlamp, your vehicle's audio and electronic device may malfunction.
- Prevent chemicals such as perfume, cosmetic oil, sun cream, hand cleaner, and air freshener from contacting the interior parts because they may cause damage or discoloration.

Antenna

Roof antenna

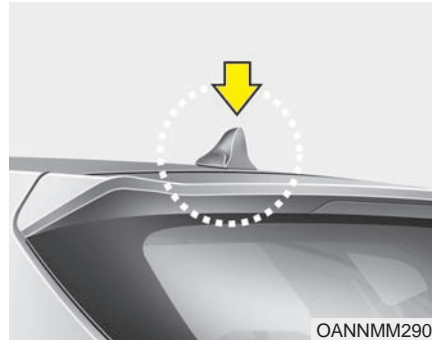

Your vehicle uses a roof antenna to receive both AM and FM broadcast signals.

Steering wheel audio control

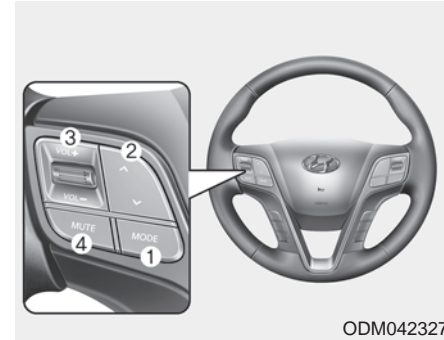

The steering wheel incorporates audio control buttons on the left hand side of the steering wheel.

CAUTION

Do not operate audio remote control buttons simultaneously.

MODE (1)

Press the button to change audio source.

PRESET/SEEK (^ / v) (2)

The SEEK/PRESET button has different functions based on the system mode.

For the following functions the button should be pressed for 0.8 second or more.

RADIO mode

It will function as the AUTO SEEK select button.

CD/USB/iPod® mode

It will function as the FF/REW button.

If the SEEK/PRESET button is pressed for less than 0.8 second, it will work as follows in each mode.

RADIO mode

It will function as the PRESET STATION buttons.

CD/USB/iPod® mode

It will function as TRACK UP/DOWN button.

VOLUME (VOL+/-) (3)

- Push the lever upward (+) to increase the volume.
- Push the lever downward (-) to decrease the volume.

MUTE (4)

- Press the button to mute the sound.
- Press the button to turn off the microphone during a telephone call.

Detailed information for audio control buttons are described in the following pages in this section.

How vehicle audio works

FM reception

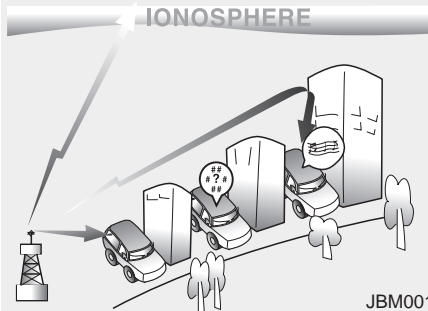

AM and FM radio signals are broadcast from transmitter towers located around your city. They are intercepted by the radio antenna on your vehicle. This signal is then processed by the radio and sent to your vehicle speakers.

When a strong radio signal has reached your vehicle, the precise engineering of your audio system ensures the best possible quality reproduction. However, in some cases the signal coming to your vehicle may not be strong and clear.

This can be due to factors, such as the distance from the radio station, closeness of other strong radio stations or the presence of buildings, bridges or other large obstructions in the area.

AM reception

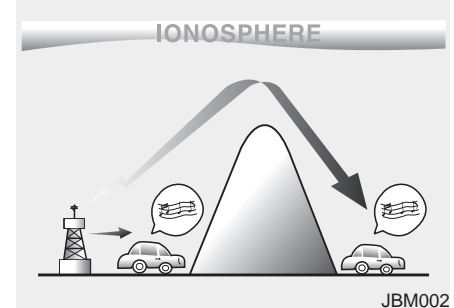

AM broadcasts can be received at greater distances than FM broadcasts. This is because AM radio waves are transmitted at low frequencies. These long distance, low frequency radio waves can follow the curvature of the earth rather than travelling straight. In addition, they curve around obstructions resulting in better signal coverage.

Features of your vehicle

FM radio station

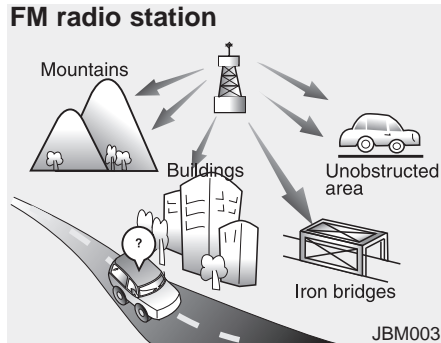

FM broadcasts are transmitted at high frequencies and do not bend to follow the earth's surface. Because of this, FM broadcasts generally begin to fade within short distances from the station. Also, FM signals are easily affected by buildings, mountains, and obstructions. This can lead to undesirable or unpleasant listening conditions which might lead you to believe a problem exists with your radio. The following conditions are normal and do not indicate radio trouble:

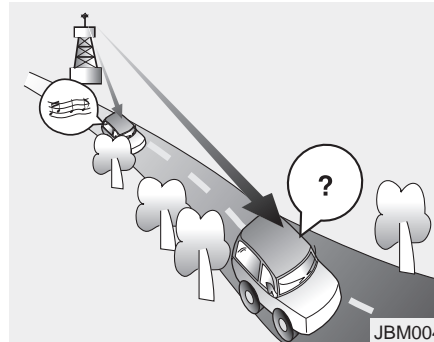

- **Fading** - As your vehicle moves away from the radio station, the signal will weaken and sound will begin to fade. When this occurs, we suggest that you select another stronger station.
- **Flutter/Static** - Weak FM signals or large obstructions between the transmitter and your radio can disturb the signal causing static or fluttering noises to occur. Reducing the treble level may lessen this effect until the disturbance clears.

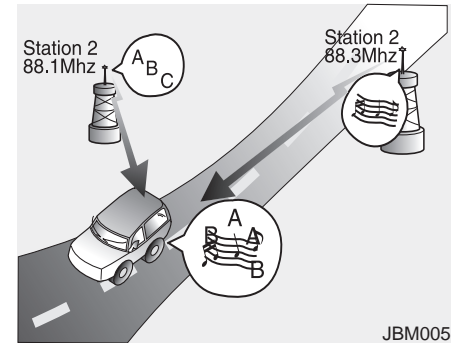

- **Station Swapping** - As an FM signal weakens, another more powerful signal near the same frequency may begin to play. This is because your radio is designed to lock onto the clearest signal. If this occurs, select another station with a stronger signal.
- **Multi-Path Cancellation** - Radio signals being received from several directions can cause distortion or fluttering. This can be caused by a direct and reflected signal from the same station, or by signals from two stations with close frequencies. If this occurs, select another station until the condition has passed.

Using a cellular phone or a two-way radio

When a cellular phone is used inside the vehicle, noise may be produced from the audio system. This does not mean that something is wrong with the audio equipment. In such a case, try to operate mobile devices as far from the audio equipment as possible.

⚠ CAUTION

When using a communication system such as a cellular phone or a radio set inside the vehicle, a separate external antenna must be fitted. When a cellular phone or a radio set is used with an internal antenna alone, it may interfere with the vehicle's electrical system and adversely affect safe operation of the vehicle.

⚠ WARNING

Do not use a cellular phone while driving. Stop at a safe location to use a cellular phone.

Caring for CDs

- If the temperature inside the car is too high, open the car windows to ventilate before using the system.
- It is illegal to copy and use MP3/WMA files without permission. Use CDs that are created only by lawful means.
- Do not apply volatile agents, such as benzene and thinner, normal cleaners and magnetic sprays made for analogue disc onto CDs.
- To prevent the disc surface from getting damaged, hold CDs by the edges or the center hole only.
- Clean the disc surface with a piece of soft cloth before playback (wipe it from the center to the outside edge).
- Do not damage the disc surface or attach pieces of sticky tape or paper.
- Make certain only CDs are inserted into the CD player (Do not insert more than one CD at a time).
- Keep CDs in their cases after use to protect them from scratches or dirt.

- Depending on the type of CD-R/CD-RW CDs, certain CDs may not operate normally according to the manufacturing companies. In such circumstances, continued use may cause malfunctions to your audio system.

*** NOTICE**

- Playing an Incompatible Copy Protected Audio CD

Some copy protected CDs, which do not comply with international audio CD standards (Red Book), may not play on your car audio. Please note that inability to properly play a copy protected CD may indicate that the CD is defective, not the CD player.

* NOTICE

Order of playing files (folders) :

1. Song playing order : ① to ⑭ sequentially.

2. Folder playing order :

* If no song file is contained in the folder, that folder is not displayed.

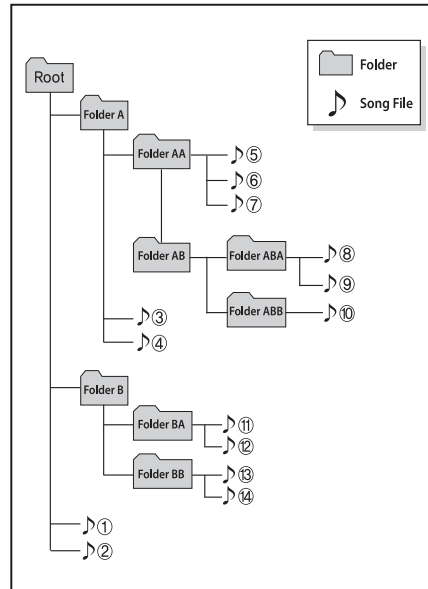
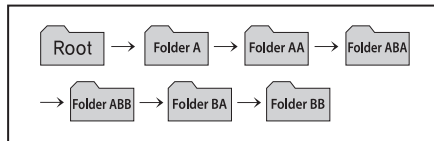

⚠ WARNING

- Do not stare at the screen while driving. Staring at the screen for prolonged periods of time could lead to traffic accidents.
- Do not disassemble, assemble, or modify the audio system. Such acts could result in accidents, fire, or electric shock.
- Using the phone while driving may lead to a lack of attention of traffic conditions and increase the likelihood of accidents. Use the phone feature after parking the vehicle.
- Heed caution not to spill water or introduce foreign objects into the device. Such acts could lead to smoke, fire, or product malfunction.

(Continued)

(Continued)

- Please refrain from use if the screen is blank or no sound can be heard as these signs may indicate product malfunction. Continued use in such conditions could lead to accidents (fires, electric shock) or product malfunctions.
- Do not touch the antenna during thunder or lightning as such acts may lead to lightning induced electric shock.
- Do not stop or park in parking-restricted areas to operate the product. Such acts could lead to traffic accidents.
- Use the system with the vehicle ignition turned on. Prolonged use with the ignition turned off could result in battery discharge.

 **CAUTION**

- *Operating the device while driving could lead to accidents due to a lack of attention to external surroundings. First park the vehicle before operating the device.*
- *Adjust the volume to levels that allow the driver to hear sounds from outside of the vehicle. Driving in a state where external sounds cannot be heard may lead to accidents.*
- *Pay attention to the volume setting when turning the device on. A sudden output of extreme volume upon turning the device on could lead to hearing impairment. (Adjust the volume to a suitable levels before turning off the device.)*

(Continued)

(Continued)

- *Turn on the car ignition before using this device. Do not operate the audio system for long periods of time with the ignition turned off as such operations may lead to battery discharge.*
- *Do not subject the device to severe shock or impact. Direct pressure onto the front side of the monitor may cause damage to the LCD or touch screen.*
- *When cleaning the device, make sure to turn off the device and use a dry and smooth cloth. Never use tough materials, chemical cloths, or solvents (alcohol, benzene, thinners, etc.) as such materials may damage the device panel or cause color/quality deterioration.*

(Continued)

(Continued)

- *Do not place beverages close to the audio system. Spilling beverages may lead to system malfunction.*
- *In case of product malfunction, please contact your place of purchase or After Service center.*
- *Placing the audio system within an electromagnetic environment may result in noise interference.*
- *Prevent caustic solutions such as perfume and cosmetic oil from contacting the dashboard because they may cause damage or discoloration.*

*** NOTICE - USING THE USB DEVICE**

- To use an external USB device, make sure the device is not connected when starting up the vehicle. Connect the device after starting up.
- If you start the engine when the USB device is connected, it may damage the USB device. (USB flashdrives are very sensitive to electric shock.)
- If the engine is started up or turned off while the external USB device is connected, the external USB device may not work.
- The System may not play unauthenticated MP3 or WMA files.
 - 1) It can only play MP3 files with the compression rate between 8Kbps~320Kbps.
 - 2) It can only play WMA music files with the compression rate between 8Kbps~320Kbps.
- Take precautions for static electricity when connecting or disconnecting the external USB device.

(Continued)

(Continued)

- An encrypted MP3 PLAYER is not recognizable.
- Depending on the condition of the external USB device, the connected external USB device can be unrecognizable.
- When the formatted byte/sector setting of External USB device is not either 512BYTE or 2048BYTE, then the device will not be recognized.
- Use only a USB device formatted to FAT 12/16/32.
- USB devices without USB I/F authentication may not be recognizable.
- Make sure the USB connection terminal does not come in contact with the human body or other objects.
- If you repeatedly connect or disconnect the USB device in a short period of time, it may break the device.
- You may hear a strange noise when connecting or disconnecting a USB device.

(Continued)

(Continued)

- If you disconnect the external USB device during playback in USB mode, the external USB device can be damaged or may malfunction. Therefore, disconnect the external USB device when the audio is turned off or in another mode. (e.g, Radio, CD)
- Depending on the type and capacity of the external USB device or the type of the files stored in the device, there is a difference in the time taken for recognition of the device.
- Do not use the USB device for purposes other than playing music files.
- Playing videos through the USB is not supported.
- Use of USB accessories such as rechargers or heaters using USB I/F may lower performance or cause trouble.

(Continued)

(Continued)

- If you use devices such as a USB hub purchased separately, the vehicle's audio system may not recognize the USB device. In that case, connect the USB device directly to the multimedia terminal of the vehicle.
- If the USB device is divided by logical drives, only the music files on the highest-priority drive are recognized by car audio.
- Devices such as MP3 Player/ Cellular phone/Digital camera can be unrecognizable by standard USB I/F can be unrecognizable.
- Charging through the USB may not be supported in some mobile devices.
- USB HDD or USB types liable to connection failures due to vehicle vibrations are not supported. (i-stick type)
- Some non-standard USB devices (METAL COVER TYPE USB) can be unrecognizable.

(Continued)

(Continued)

- Some USB flash memory readers (such as CF, SD, micro SD, etc.) or external-HDD type devices can be unrecognizable.
- Music files protected by DRM (DIGITAL RIGHTS MANAGEMENT) are not recognizable.
- The data in the USB memory may be lost while using this audio. Always back up important data on a personal storage device.
- Please avoid using USB memory products which can be used as key chains or cellular phone accessories as they could cause damage to the USB jack. Please make certain only to use plug type connector products.



*** NOTICE - USING THE iPod® DEVICE**

- Some iPod® models may not support communication protocol and files may not properly play.

Supported iPod® models:

- iPhone® 3GS/4
 - iPod® touch 1st~4th generation
 - iPod® nano 1st~6th generation
 - iPod® classic
- The order of search or playback of songs in the iPod® can be different from the order searched in the audio system.
 - If the iPod® is disabled due to its own malfunction, reset the iPod®. (Reset: Refer to iPod® manual)
 - An iPod® may not operate normally on low battery.

(Continued)

(Continued)

- Some iPod® devices, such as the iPhone®, can be connected through the *Bluetooth*® Wireless Technology interface. The device must have audio *Bluetooth*® Wireless Technology capability (such as for stereo headphone *Bluetooth*® Wireless Technology). The device can play, but it will not be controlled by the audio system.
- To use iPod® features within the audio, use the cable provided upon purchasing an iPod® device.
- Skipping or improper operation may occur depending on the characteristics of your iPod®/iPhone® device.
- If your iPhone® is connected to both the *Bluetooth*® Wireless Technology and USB, the sound may not be properly played. In your iPhone®, select the Dock connector or *Bluetooth*® Wireless Technology to change the sound output (source).

(Continued)

(Continued)

- When connecting iPod® with the iPod® Power Cable, insert the connector to the multimedia socket completely. If not inserted completely, communications between iPod® and audio may be interrupted.
- When adjusting the sound effects of the iPod® and the audio system, the sound effects of both devices will overlap and might reduce or distort the quality of the sound.
- Deactivate (turn off) the equalizer function of an iPod® when adjusting the audio system's volume, and turn off the equalizer of the audio system when using the equalizer of an iPod®.
- When not using iPod® with car audio, detach the iPod® cable from iPod®. Otherwise, iPod® may remain in accessory mode, and may not work properly.

* NOTICE - *Bluetooth*[®] Wireless Technology

- The *Bluetooth*[®] word mark and logos are registered trademarks owned by Bluetooth SIG, Inc. and any use of such marks is under license.
A *Bluetooth*[®] enabled call phone is required to use *Bluetooth*[®] wireless technology.
- *Bluetooth*[®] Wireless Technology phone compatibility can be checked by visiting www.hyundaiusa.com and under the CARING FOR YOUR CAR - BLUETOOTH COMPATIBILITY menu.

* NOTICE - BEFORE USING THE *Bluetooth*[®] HANDSFREE

What is Bluetooth[®] ?

- *Bluetooth*[®] refers to a short-distance wireless networking technology which uses a 2.4GHz ~ 2.48GHz frequency to connect various devices within a certain distance.
- Supported within PCs, external devices, *Bluetooth*[®] phones, PDAs, various electronic devices, and automotive environments, *Bluetooth*[®] allows data to be transmitted at high speeds without having to use a connector cable.
- *Bluetooth*[®] Handsfree refers to a device which allows the user to conveniently make phone calls with *Bluetooth*[®] mobile phones through the audio system.
- *Bluetooth*[®] Handsfree may not be supported in some mobile phones. To learn more about mobile device compatibility, visit www.hyundaiusa.com.

* NOTICE - PRECAUTIONS FOR SAFE DRIVING

- *Bluetooth*[®] Handsfree is a feature that enables drivers to practice safe driving. Connecting the head unit with a *Bluetooth*[®] phone allows the user to conveniently make and receive calls and use contacts. Before using *Bluetooth*[®], carefully read the contents of this user's manual.
- Excessive use or operations while driving may lead to negligent driving practices and result in accidents. Refrain from excessive operations while driving.
- Viewing the screen for prolonged periods of time is dangerous and may lead to accidents. When driving, view the screen only for short periods of time.

*** NOTICE -WHEN CONNECTING A *Bluetooth*® PHONE**

- Before connecting the head unit with the mobile phone, check to see that the mobile phone supports *Bluetooth*® features.
- Even if the phone supports *Bluetooth*®, the phone will not be found during device searches if the phone has been set to hidden state or the *Bluetooth*® power is turned off. Disable the hidden state or turn on the *Bluetooth*® power prior to searching/connecting with the Head unit.
- After a *Bluetooth* phone has been successfully paired, the phone will automatically connect when the ignition is turned on.
- If you do not want automatic connection with your *Bluetooth*® device, turn off the *Bluetooth*® feature within your mobile phone.
- The Handsfree call volume and quality may differ depending on the mobile phone.

(Continued)

(Continued)

- Park the vehicle when connecting the head unit with the mobile phone.
- *Bluetooth*® connection may become intermittently disconnected in some mobile phones. Follow these steps to try again.
 1. Within the mobile phone, turn the *Bluetooth*® function off/on and try again.
 2. Turn the mobile phone power Off/On and try again.
 3. Completely remove the mobile phone battery, reboot, and then again.
 4. Reboot the Audio System and try again.
 5. Delete all paired devices, pair and try again.
- Handsfree call quality and volume may differ depending on the model of your mobile phone.

* NOTICE - USING THE Voice Recognition

- When using the voice recognition feature, only commands listed within the user's manual are supported.
- Be aware that during the operation of the voice recognition system, pressing any key other than the  key terminate voice recognition mode.
- For superior voice recognition performance, position the microphone used for voice recognition above the head of the driver's seat and maintain a proper position when saying commands.
- Within the following situations, voice recognition may not function properly due to background noises which may be picked up by the overhead microphone.
 - When the windows and sunroof are open
 - When the heating and air conditioning fan blower speed is high
 - When entering and passing through tunnels

(Continued)

(Continued)

- When driving on rugged and uneven roads
- During severe rain (heavy rains, windstorms)
- Phone related voice commands can be used only when a *Bluetooth*® Wireless Technology device is connected.
- When making calls by stating a name, the corresponding contact must be downloaded and stored within the audio system.
- After downloading the *Bluetooth*® Wireless Technology phone book, it takes some times to convert the phone book data into voice information. During this time, voice recognition may not properly operate.
- Pronounce the voice commands naturally and clearly as if in a normal conversation.

Features of your vehicle

The Bluetooth and Voice Recognition Manual is provided in two versions due to software version differences. Before reading the manual, check the following.

Press the  key in FM Radio screen.

1. If you can find "FM <87.5~107.9>" on the screen,

▶ (Go to 4-210 page)

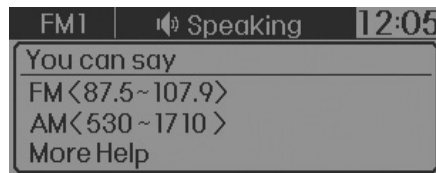

▶ (Go to 4-277 page)

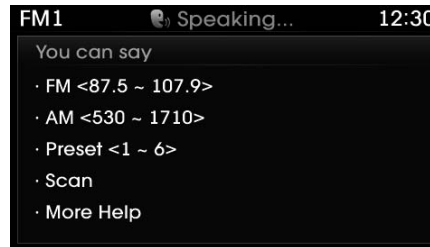

2. If you can find "FM <89.1>" on the screen,

▶ (Go to 4-342 page)

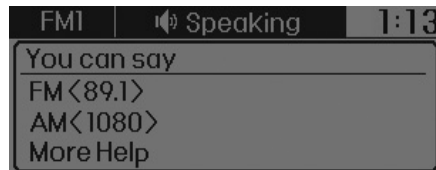

▶ (Go to 4-411 page)

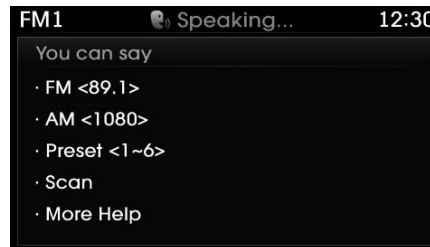

■ CD Player : AM1B2DMKN, AM1B3DMAN



SYSTEM CONTROLLERS AND FUNCTIONS

* Display and settings may differ depending on the selected audio.



Audio Head Unit

1. **EJECT** (EJECT)

- Ejects the disc.

2. **RADIO**

- Changes to FM/AM/XM mode.

- Each time the key is pressed, the mode is changed in order of FM1 → FM2 → AM → XM1 → XM2 → XM3.

* In Setup>Display, the radio pop up screen will be displayed when [Mode Pop up] is turned **On**.

When the pop up screen is displayed, use the **TUNE** knob or keys **1** ~ **6** to select the desired mode.

3. **MEDIA**

- Changes to CD, USB(iPod®), AUX, My Music, BT Audio mode.

- Each time the key is pressed, the mode is changed in order of CD, USB(iPod®), AUX, My Music, BT Audio.

* In Setup>Display, the media pop up screen will be displayed when [Mode Pop up] is turned **On**.

When the pop up screen is displayed, use the **TUNE** knob or keys **1** ~ **5** to select the desired mode.

4. **PHONE**

- Operates Phone Screen

* When a phone is not connected, the connection screen is displayed.

5. **PWR/VOL knob**

- **Power** : Turns power On/Off by pressing the knob
- **Volume** : Sets volume by turning the knob left/right

6. **SEEK TRACK**

- **Radio Mode** : Automatically searches for broadcast frequencies.

- **CD, USB, iPod®, My Music modes**
 - Shortly press the key (under 0.8 seconds): Moves to next or previous song (file)
 - Press and hold the key (over 0.8 seconds): Rewinds or fast-forwards the current song.

- **BT Audio mode** : Moves to next or previous song(file)

* The Play/Pause feature may operate differently depending on the mobile phone.



7. **CAT FOLDER**

- Radio Mode
 - XM RADIO™ : Category Search
- MP3, CD, USB mode : Folder Search

8. **1** ~ **6** (Preset)

- Radio Mode: Saves frequencies (channels) or receives saved frequencies (channels)
- CD, USB, iPod®, My Music mode
 - **1** : Repeat
 - **2** : Random

- In the Radio, Media, Setup, and Menu pop up screen, the number menu is selected.

9. **DISP**

- Each time the button is shortly pressed (under 0.8 seconds), it sets the screen Off → Screen On → Screen Off
 - * Audio operation is maintained and only the screen will be turned Off. In the screen Off state, press any key to turn the screen On again.

10. **SCAN**

- Radio Mode
 - Shortly press the key (under 0.8 seconds): Previews each broadcast for 5 seconds each.
 - Press and hold the key (over 0.8 seconds): Previews the broadcasts saved in Preset **1** ~ **6** for 5 seconds each.
 - * Press the **SCAN** key again to continue listening to the current frequency.
 - * XM Radio™ does not support the Preset scan feature.

- CD, USB, My Music mode
 - Shortly press the key (under 0.8 seconds): Previews each song (file) for 10 seconds each.

- * Press the **SCAN** key again to continue listening to the current song (file).

11. **SETUP CLOCK**

- Shortly press the key (under 0.8 seconds) : Moves to the Display, Sound, Clock, Phone, System setting modes.
- Press and hold the key (over 0.8 seconds) : Move to the Time setting screen.

12. **MENU**

- Displays menus for the current mode.

13. **TUNE** knob

- Radio mode : Changes frequency by turning the knob left/right.
- CD, USB, iPod®, My Music mode: Searches songs (files) by turning the knob left/right.

Features of your vehicle

- ✳ When the desired song is displayed, press the knob to play the song.
- Moves focus in all selection menus and selects menus.



14. DISC-IN LED

- LED that indicates whether a disc is inserted

SETUP

Display Settings

Press the **SETUP** key ▶ Select [Display] through **TUNE** knob or **1** key ▶ Select menu through **TUNE** knob

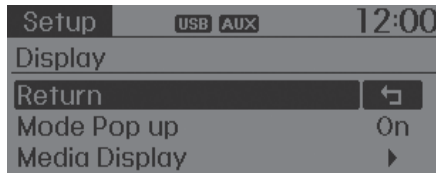

Mode Pop up

[Mode Pop up] ▶ Changes **On**/**Off** selection mode

- During On state, press the **RADIO** or **MEDIA** key to display the mode change pop up screen.

Media Display

When playing an MP3 file, select the desired display info from 'Folder/File' or 'Album/Artist/Song'.



Sound Settings

Press the **SETUP** key ▶ Select [Sound] through **TUNE** knob or **2** key ▶ Select menu through **TUNE** knob

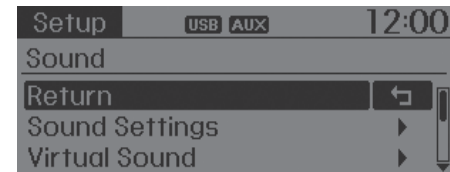

Sound Settings

This menu allows you to set the 'Bass, Middle, Treble' and the Sound Fader and Balance.

Select [Sound Settings] ▶ Select menu through **TUNE knob** ▶ Turn **TUNE knob** left/right to set

- Bass, Middle, Treble : Selects the sound tone.
- Fader, Balance : Moves the sound fader and balance.
- Default : Restores default settings.

* Back : While adjusting values, repressing the **TUNE knob** will restore the parent menu.

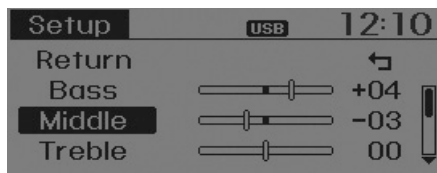

Virtual Sound

The PowerBass, PowerTreble, and Surround can be set.

Select [Virtual Sound] ▶ Set menu through **TUNE knob** ▶ Set **(On)/ (Off)** through **TUNE knob**

- PowerBass : This is a sound system feature that provides live bass.
- PowerTreble : This is a sound system feature that provides live tremble.
- Surround : This is a sound system feature that provides surround sound.

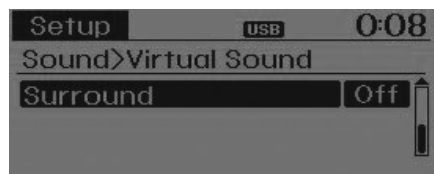
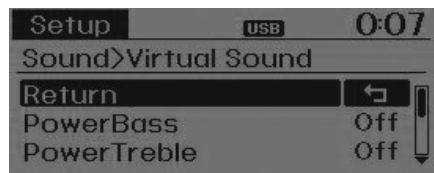

* May differ depending on the selected audio.

Speed Dependent Volume Control

This feature is used to automatically control the volume level according to the speed of the vehicle.

Select [Speed Dependent Vol.] ▶ Set [On/Off] **TUNE knob**

Voice Recognition Volume

Adjusts voice recognition volume.

Select [Voice Recognition Vol.] ▶ Set volume of **TUNE knob**

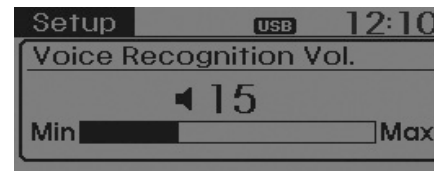

Blue Link® Voice Volume

(for Blue Link® equipped model)

Sets the Blue Link® voice recognition volume.

- * While using Blue Link® voice recognition, turning the tune knob will display the volume control popup screen.
- * May differ depending on the selected audio.

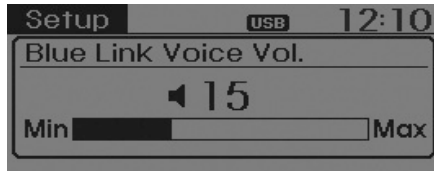

Clock Settings

Press the **SETUP** CLOCK key ▶ Select [Clock] through **TUNE** knob or **3** key ▶ Select menu through **TUNE** knob

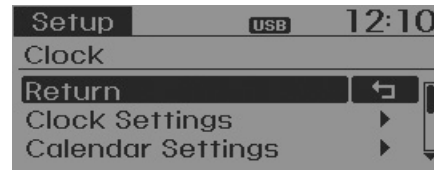

Clock Settings

This menu is used to set the time.

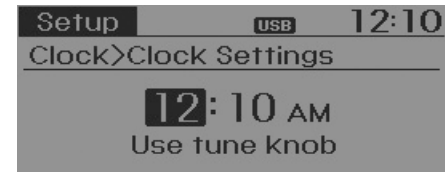

Select [Clock Settings] ▶ Set through **TUNE** knob ▶ Press **TUNE** knob



- * Adjust the number currently in focus to set the [hour] and press the tune knob to set the [minute] and [AM/PM].

Calendar Settings

This menu is used to set the date (MM/DD/YYYY).

Select [Calendar Settings]▶Set through  TUNE knob▶Press  TUNE knob



* Adjust the number currently in focus to make the settings and press the tune knob to move to the next setting. (Set in order of Year/Month/Day)



Time Format

This function is used to set the 12/24 hour time format of the audio system.

Select [Time Format]▶Set 12Hr / 24Hr through 

Clock Display when Power is OFF

Select [Clock Disp.(Pwr Off)]▶Set  /  through 

-  : Displays time/date on screen
-  : Turn off.

SYSTEM SETTINGS

Press the **SETUP** key ▶ Select [System] through tune knob or **5** key ▶ Select menu through **TUNE** knob

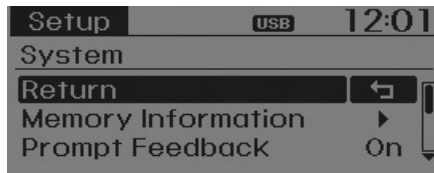

Memory Information

Displays currently used memory and total system memory.

Select [Memory Information] ▶ OK

The currently used memory is displayed on the left side while the total system memory is displayed on the right side.



Prompt Feedback

This feature is used to change voice command feedback between Normal and Expert modes.

Select [Prompt Feedback] ▶ Set through **TUNE** knob

- On : This mode is for beginner users and provides detailed instructions during voice command operation.

- Off : This mode is for expert users and omits some information during voice command operation. (When using Expert mode, guidance instructions can be heard through the [Help] or [Menu] commands.)

Language

This menu is used to set the display and voice recognition language.

Select [Language] ▶

Set through **TUNE** knob

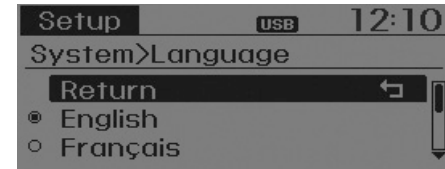

- * The system will reboot after the language is changed.
- * Language support by region
 - English, Francais, Espanol

RADIO : FM, AM OR XM





SEEK

Press the  key

- Shortly pressing the key (under 0.8 seconds): Changes the frequency.
- Pressing and holding the key (over 0.8 seconds): Automatically searches for the next frequency.



Preset SEEK

Press the  ~  key

- Shortly pressing the key (under 0.8 seconds): Plays the frequency saved in the corresponding key.
- Pressing and holding the key (over 0.8 seconds): Pressing and holding the desired key from  ~  will save the currently playing broadcast to the selected key and sound a BEEP.

SCAN

Press the  key

- Shortly pressing the key (under 0.8 seconds): The broadcast frequency increases and previews each broadcast for 5 seconds each. After scanning all frequencies, returns and plays the current broadcast frequency.
- Pressing and holding the key (over 0.8 seconds): Previews the broadcasts saved in Preset  ~  for 5 seconds each.

Selecting through manual search

Turn the  TUNE knob left/right to adjust the frequency.

- FM : Changes by 200KHz
- AM : Changes by 10MHZ

MENU

Within **MENU** key are the A.Store (Auto Store) and Info functions.



① A.Store

Press the **MENU** key ▶ Set [A.Store] through **TUNE** knob or **1** key.

Saves broadcasts with superior reception to **1** ~ **6** keys. If no frequencies are received, then the most recently received frequency will be broadcast.

XM RADIO

Using XM satellite™ Radio

Your vehicle is equipped with a 3 month complimentary period of XM Satellite™ Radio. XM provides access to over 130 channels of music, information, and entertainment programming.



SEEK

Press the **SEEK TRACK** key

- Shortly pressing the key: select previous or next channel.
- Pressing and holding the key (over 0.8 seconds): continuously move to previous or next channel.

*If the "Category" icon is displayed, channels are changed within the current category.

SCAN

Press the **SCAN** key

- Shortly pressing the key: Previews each broadcast for 10 seconds each
- *Press the **SCAN** key again to continue listening to the current frequency
- *If the "Category" icon is displayed, channels are changed within the current category.

Category

Press the **CAT FOLDER** key ▶ Set through the **TUNE** knob

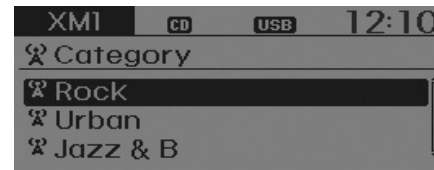



- The display will indicate the category menus, highlight the category that the current channel belongs to.
- In the Category List Mode, press the **CAT FOLDER** key to navigate category list.
- Press the tune knob to select the lowest channel in the highlighted category.
- * If channel is selected by selecting category, then the "CATEGORY" icon is displayed at the top of the screen.

Preset



Press the **1** ~ **6** key

- Shortly pressing the key: Plays the frequency saved in the corresponding key.
- Pressing and holding the key (over 0.8 seconds): Pressing and holding the desired key from **1** ~ **6** will save the current broadcast to the selected key and sound a BEEP.

Tune

- Rotate  TUNE knob : Changes the channel number or scrolls category list.
- Press  TUNE knob : Selects the menu.

Menu

Select category menu through the  TUNE knob ▶ Press the **MENU** key
▶ Select [**Info**] through the  TUNE knob or **1** key

Info (Information)

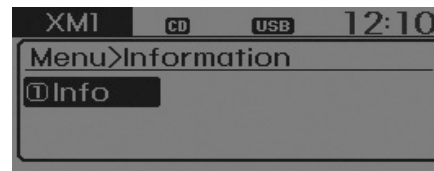

Displays the Artist/Song info of the current song.

BASIC METHOD OF USE :

Audio CD / MP3 CD / USB / iPod® / My Music

Press the **MEDIA** key to change the mod mode in order of CD → USB(iPod®) → AUX → My Music → BT Audio.

The folder/file name is displayed on the screen.



<Audio CD>

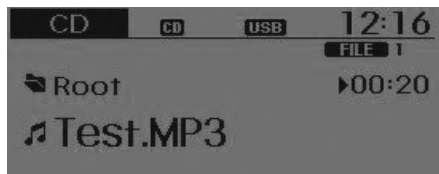

<CD MP3>

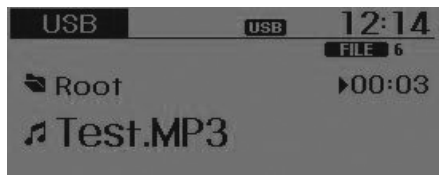

<USB>



<My Music>

- * The CD is automatically played when a CD is inserted.
- * The USB music is automatically played when a USB is connected.

Repeat

While song (file) is playing ▶ **1 RPT** (RPT) key

Audio CD, MP3 CD, USB, iPod®, My Music mode: RPT on screen

- To repeat one song (Press the key): Repeats the current song.

MP3 CD, USB mode: FLD.RPT on screen

- To repeat folder (pressing twice): repeats all files within the current folder.

* Press the **1 RPT** key again to turn off repeat.

Random

While song (file) is playing ▶ **2 RDM** (RDM) key

Audio CD, My Music mode: RDM on screen

- Random (Press the key): Plays all songs in random order.

MP3 CD, USB mode: FLD.RDM on screen

- Folder Random (Press the key) : Plays all files within the current folder in random order.

iPod® mode: ALB RDM on screen

- Album Random (Press the key) : Plays all files within albums of the current category in random order.

MP3 CD, USB, iPod® mode: ALL RDM on screen

- All Random (pressing twice): Plays all files in random order.
- * Press the **2RDM** key again to turn off repeat.

Changing Song/File

While song (file) is playing▶ **SEEK TRACK** key

- Shortly pressing the key : Plays the current song from the beginning.
- * If the **SEEK TRACK** key is pressed again within 3 second, the previous song is played.
- Pressing and holding the key (over 0.8 seconds): Rewinds the song.

While song (file) is playing▶ **SEEK TRACK** key

- Shortly pressing the key : Plays the next song.
- Pressing and holding the key (over 0.8 seconds): Fast forwards the song.

Scan

While song (file) is playing▶ **SCAN** key

- Shortly pressing the key : Scans all songs from the next song for 10 seconds each.
- * Press the **SCAN** key again to turn off.
- * The SCAN function is not supported in iPod® mode.

Folder Search : MP3 CD, USB Mode

While file is playing▶ **CAT FOLDER** (Folder Up) key

- Searches the next folder.

While file is playing▶ **CAT FOLDER** (Folder Down) key

- Searches the parent folder.

* If a folder is selected by pressing the **TUNE** knob, the first file within the selected folder will be played.

* In iPod® mode, moves to the Parent Folder.

Searching Songs (File)

- Turning **TUNE** knob : Searches for songs (files)
- Pressing **TUNE** knob : Plays selected song (file).

MENU : Audio CD

Press the CD MP3 mode **MENU** key to set the Repeat, Random, Information features.



Repeat

Press the **MENU** key ▶ Set [**1 RPT**] through the **TUNE** knob or **1 RPT** key to repeat the current song.

* Press RPT again to turn off.

Random

Press the **MENU** key ▶ Set [**2 RDM**] through the **TUNE** knob or **2 RDM** key to randomly play songs within the current folder.

* Press RDM again to turn off.

Information

Press the **MENU** key ▶ Set [**3 Info**] through the **TUNE** knob or **3** key to display information of the current song.

* Press the **MENU** key to turn off info display.

MENU : MP3 CD / USB

Press the CD MP3 mode **MENU** key to set the Repeat, Folder Random, Folder Repeat, All Random, Information, and Copy features.



Repeat

Press the **MENU** key ▶ Set [**1 RPT**] through the **TUNE** knob or **1 RPT** key to repeat the current song.

* Press RPT again to turn off.

Folder Random

Press the **MENU** key ▶ Set [**2**]F.RDM] through the **TUNE** knob or **2 RDM** key to randomly play songs within the current folder.

* Press F.RDM again to turn off.

Folder Repeat

Press the **MENU** key ▶ Set [**3**]F.RPT] through the **TUNE** knob or **3** key to repeat songs within the current folder.

* Press F.RPT again to turn off.

All Random

Press the **MENU** key ▶ Set [**4**]A.RDM] through the **TUNE** knob or **4** key to randomly play all songs within the CD.

* Press A.RDM again to turn off.

Information

Press the **MENU** key ▶ Set [**5**]Info] through the **TUNE** knob or **5** key to display information of the current song.

* Press the **MENU** key to turn off info display.

Copy

Press the **MENU** key ▶ Set [**6**]Copy] through the **TUNE** knob or **6** key.

- This is used to copy the current song into My Music. You can play the copied Music in My Music mode.

- * If another key is pressed while copying is in progress, a pop up asking you whether to cancel copying is displayed.

- * If another media is connected or inserted (USB, CD, iPod®, AUX) while copying is in progress, copying is canceled.

- * Music will not be played while copying is in progress.

MENU : iPod®

In iPod® mode, press the **MENU** key to set the Repeat, Album Random, All Random, Information and Search features.



Repeat

Press the **MENU** key ▶ Set [**1**RPT] through the **TUNE** knob or **1 RPT** key to repeat the current song.

* Press RPT again to turn repeat off.

Album Random

Press the **MENU** key ▶ Set [**2**Alb.RDM] through the **TUNE** knob or **2 RDM** key.

Plays albums within the currently playing category in random order.

* Press Alb.RDM again to turn off.

All Random

Press the **MENU** key ▶ Set [**3**A.RDM] through the **TUNE** knob or **3** key.

Plays all songs within the currently playing category in random order.

* Press A.RDM again to turn off.

Information

Press the **MENU** key ▶ Set [**4**Info] through the **TUNE** knob or **4** key.

Displays information of the current song.

* Press the **MENU** key to turn off info display.

Search

Press the **MENU** key ▶ Set [**5**Search] through the **TUNE** knob or **5** key.

Displays iPod® category list.

* Searching iPod® category is **MENU** key pressed, move to parent category.

MENU : My Music Mode

In My Music mode, press the **MENU** key to set the Repeat, Random, Information, Delete, Delete All, and Delete Selection features.



Repeat

Press the **MENU** key ▶ Set [**1**RPT] through the **TUNE** knob or **1** RPT key.

Repeats the currently playing song.

* Press RPT again to turn repeat off.

Random

Press the **MENU** key ▶ Set [**2**RDM] through the **TUNE** knob or **2** RDM key.

Plays all songs in random order.

* Press RDM again to turn random off.

Information

Press the **MENU** key ▶ Set [**3**Info] through the **TUNE** knob or **3** key.

Displays information of the current song.

* Press the **MENU** key to turn off info display.

Delete

Press the **MENU** key ▶ Set [**4**Delete] through the **TUNE** knob or **4** key.

- Deletes currently playing file

In the play screen, pressing delete will delete the currently playing song.

- Deletes file from list

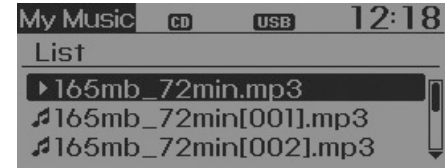

- ① Select the file you wish to delete by using the **TUNE** knob.
- ② Press the **MENU** key and select the delete menu to delete the selected file.

Delete All

Press the **MENU** key ▶ Set [**5**Del.All] through the **TUNE** knob or **5** key. Deletes all songs of My Music.

Delete Selection

Press the **MENU** key ▶ Set [**6**Del.Sel] through the **TUNE** knob or **6** key.

Songs within My Music are selected and deleted.

- ① Select the songs you wish to delete from the list.

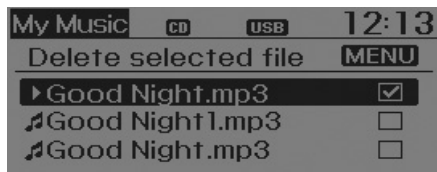

- ② After selecting, press the **key** and select the delete menu.



* NOTICE - USING THE My Music Feature

- Even if memory is available, a maximum of 6,000 songs can be stored.
- The same song can be copied up to 1,000 times.
- Memory info can be checked in the System menu of Setup.

AUX

AUX is used to play external MEDIA currently connected with the AUX terminal.

AUX mode will automatically start when an external device is connected with the AUX terminal.

If an external device is connected, you can also press the **MEDIA** key to change to AUX mode.

- * AUX mode cannot be started unless there is an external device connected to the AUX terminal.



* NOTICE - USING THE AUX

Fully insert the AUX cable into the AUX terminal for use.

Bluetooth® Wireless Technology AUDIO

What is Bluetooth® Wireless Technology?

Bluetooth® Wireless Technology allows devices to be connected in a short distance, including hands-free devices, stereo headsets, wireless remote controllers, etc. For more information, visit the *Bluetooth®* Wireless Technology website at www.Bluetooth.com

Before using Bluetooth® Wireless Technology audio features

- *Bluetooth®* Wireless Technology audio may not be supported depending on the compatibility of your *Bluetooth®* Wireless Technology mobile phone.
- In order to use *Bluetooth®* Wireless Technology audio, you must first pair and connect the *Bluetooth®* Wireless Technology mobile phone.
- *Bluetooth®* Wireless Technology audio can be used only when the [Audio Streaming] of Phone is turned (On).

* Setting *Bluetooth®* Wireless Technology Audio Streaming : Press the **SETUP** key ▶ Select [Phone] through the tune knob or **4** key ▶ Select [Audio Streaming] through the **TUNE** knob ▶ Set (On)/(Off)

Starting Bluetooth® Wireless Technology Audio

- Press the **MEDIA** key to change the mode in order of CD → USB → AUX → My Music → BT Audio.
- If BT Audio is selected, *Bluetooth®* Wireless Technology audio will start playing.
- * Audio may not automatically start playing in some mobile phones.

Using the Bluetooth® Wireless Technology audio features

- Play / Stop

Press the **TUNE** knob to play and pause the current song.



- * The play / pause functions may not be supported in some mobile phones.

PHONE



Before using the *Bluetooth*® Wireless Technology phone features



- In order to use *Bluetooth*® Wireless Technology phone, you must first pair and connect the *Bluetooth*® Wireless Technology mobile phone.
- If the mobile phone is not paired or connected, it is not possible to enter Phone mode. Once a phone is paired or connected, the guidance screen will be displayed.
- If Priority is set upon vehicle ignition (IGN/ACC ON), the *Bluetooth*® Wireless Technology phone will be automatically connected. Even if you are outside, the first *Bluetooth*® Wireless Technology phone will be automatically connected once you are in the vicinity of the vehicle. If you do not want automatic *Bluetooth*® Wireless Technology phone connection, set the *Bluetooth*® Wireless Technology power to OFF.

PHONE

Making a call using the Steering-wheel mount controls



- 1)  button : Activates voice recognition.
- 2)  button : Places and transfers calls.
- 3)  button : Ends calls or cancels functions.

- Check call history and making call
 - ① Shortly press (under 0.8 seconds) the  key on the steering remote controller .
 - ② The call history list will be displayed on the screen.
 - ③ Press the  key again to connect a call to the selected number.
- Redialing the most recently called number
 - ① Press and hold (over 0.8 seconds) the  key on the steering remote controller.
 - ② The most recently called number is redialed.
- * If call history does not exist, a screen asking whether to download call history is displayed. (The download feature may not be supported in some mobile phones)

Pairing a *Bluetooth*[®] Wireless Technology Device

What is Bluetooth[®] Wireless Technology Pairing?

Pairing refers to the process of synchronizing your *Bluetooth*[®] Wireless Technology phone or device with the car audio system for connection. Pairing is necessary to connect and use the *Bluetooth*[®] Wireless Technology feature.

⚠ WARNING

Driving while distracted can result in a loss of vehicle control that may lead to an accident, severe personal injury, and death. The driver's primary responsibility is in the safe and legal operation of a vehicle, and use of any handheld devices, other equipment, or vehicle systems which take the driver's eyes, attention and focus away from the safe operation of a vehicle or which are not permissible by law should never be used during operation of the vehicle.

Pairing **PHONE** Key / Key on the Steering Remote Controller

When No Devices have been Paired

1. Press the **PHONE** key or the  key on the steering remote controller. The following screen is displayed.



2. Select [OK] button to enter the Pair Phone screen.

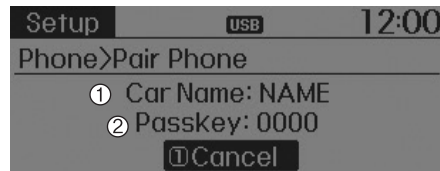

- 1) Car Name : Name of device as shown when searching from your *Bluetooth*[®] Wireless Technology device
- 2) Passkey : Passkey used to pair the device
3. From your *Bluetooth*[®] Wireless Technology device (i.e. Mobile Phone), search and select your car audio system.

[Non SSP supported device]
(SSP: Secure Simple Pairing)

4. After a few moments, a screen is displayed where the passkey is entered.

Hear, enter the passkey "0000" to pair your *Bluetooth*[®] Wireless Technology device with the car audio system.

[SSP supported device]

4. After a few moments, a screen is displayed 6 digits passkey.

Hear, check the passkey on your *Bluetooth*[®] Wireless Technology device and confirm.

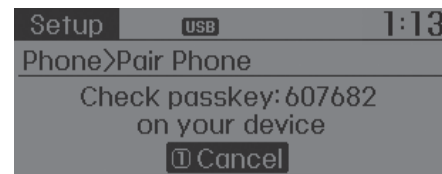

5. Once pairing is complete, the following screen is displayed.

*** NOTICE**

If *Bluetooth*® Wireless Technology devices are paired but none are currently connected, pressing the **PHONE** key or the  key on the steering wheel displays the following screen. Select [Pair] button to pair a new device or select [Connect] to connect a previously paired device.

Pairing through [PHONE] Setup

Press the **SETUP** key ▶ Select [Phone] ▶ Select [Pair Phone] ▶ Select  TUNE knob



The following steps are the same as those described in the section "When No Devices have been Paired" on the previous page.

*** NOTICE**

- *Bluetooth*® Wireless Technology features supported within the vehicle are as follows. Some features may not be supported depending on your *Bluetooth*® Wireless Technology device.
 - Outgoing/Incoming Handsfree calls
 - Operations during a call (Switch to Private, Switch to call waiting, MIC on/off)
 - Downloading Call History
 - Downloading Mobile Contacts
 - *Bluetooth*® Wireless Technology device auto connection
 - Bluetooth Audio Streaming
- Up to five *Bluetooth*® Wireless Technology devices can be paired to the Car Handsfree system.
- Only one *Bluetooth*® Wireless Technology device can be connected at a time.
- Other devices cannot be paired while a *Bluetooth*® Wireless Technology device is connected.
- Only *Bluetooth*® Wireless Technology Handsfree and Bluetooth audio related features are supported.

(Continued)

(Continued)

- Bluetooth related operations are possible only with devices that support Handsfree or audio features, such as a *Bluetooth*® Wireless Technology mobile phone or a Bluetooth audio device.
- If a connected *Bluetooth*® Wireless Technology device becomes disconnected due to being out of communication range, turning the device OFF, or a *Bluetooth*® Wireless Technology communication error, corresponding *Bluetooth*® Wireless Technology devices are automatically searched and reconnected.
- If the system becomes unstable due to communication errors between the car Handsfree and the *Bluetooth*® Wireless Technology device, reset the device by turning off and back on again. Upon resetting *Bluetooth*® Wireless Technology device, the system will be restored.

(Continued)

(Continued)

- After pairing is complete, a contacts download request is sent once to the mobile phone. Some mobile phones may require confirmation upon receiving a download request, ensure your mobile phone accepts the connection. Refer to your phones user's manual for additional information regarding phone pairing and connections.

Connecting a Device

Press the **SETUP** key ▶ Select [Phone] ▶ Select [Paired Phone List]

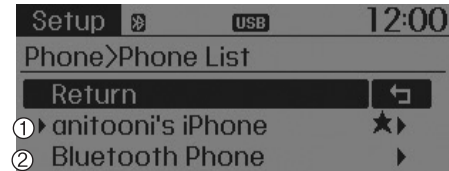

- 1) Connected Phone : Device that is currently connected
- 2) Paired Phone : Device that is paired but not connected

From the paired phone list, select the device you want to connect and select [Connect].



Changing Priority

What is Priority?

It is possible to pair up to five *Bluetooth*® Wireless Technology devices with the car audio system. The "Change Priority" feature is used to set the connection priority of paired phones.

Press the **SETUP** key ▶ Select [Phone] ▶ Select [Paired Phone List]

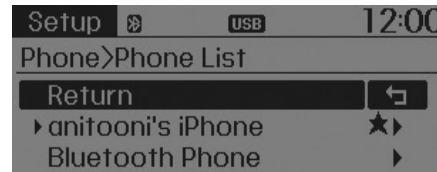

From the paired phone list, select the phone you want to switch to the highest priority, then select [Change Priority] button from the Menu. The selected device will be changed to the highest priority.

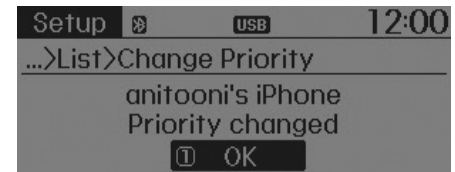
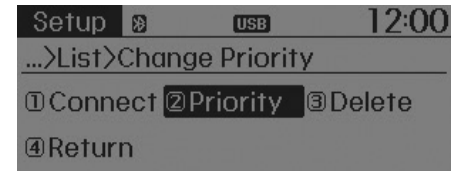

* NOTICE

Priority icon will be displayed when the selected phone is set as a priority phone.



Disconnecting a Device

Press the **SETUP** key ▶ Select [Phone] ▶ Select [Paired Phone List]

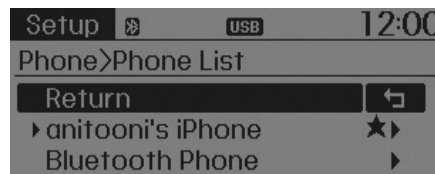

From the paired phone list, select the currently connected device and select [Disconnect] button.

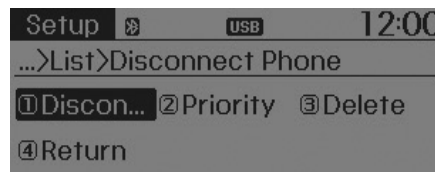

Deleting a Device

Press the **SETUP** key ▶ Select [Phone] ▶ Select [Paired Phone List]

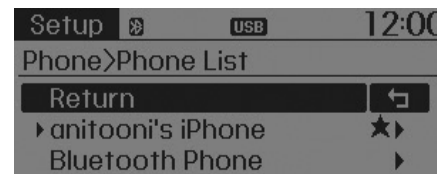

From the paired phone list, select the device you want to delete and select [Delete] button.

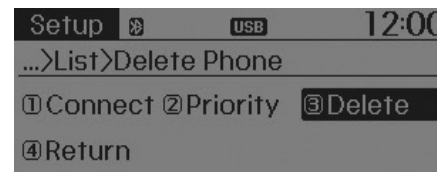

*** NOTICE**

- When deleting the currently connected device, the device will automatically be disconnected to proceed with the deleting process.
- If a paired *Bluetooth*[®] Wireless Technology device is deleted, the device's call history and contacts data will also be deleted.
- To re-use a deleted device, you must pair the device again.

USING *Bluetooth*® Wireless Technology

Phone Menu Screen

Phone Menus

With a *Bluetooth*® Wireless Technology device connected, press the **PHONE** key to display the Phone menu screen.



- 1) Favorite : Up to 20 frequently used contacts saved for easy access
- 2) Call History : Displays call history list screen
- 3) Contacts : Displays the Contacts list
- 4) Setup : Displays Phone related settings.

* NOTICE

- If you select the [Call History] button but there is no call history data, a prompt is displayed which asks to download call history data.
- If you select the [Contacts] button but there is no contacts data stored, a prompt is displayed which asks to download contacts data.
- This feature may not be supported in some mobile phones. For more information on download support, refer to your mobile phone user's manual.

Answering Calls

Answering a Call

Answering a call with a *Bluetooth*® Wireless Technology device connected will display the following screen.

To accept the call, press  key on the steering wheel while the call is incoming.

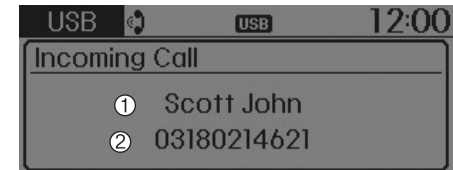

- 1) Caller : Displays the other party's name when the incoming caller is saved within your contacts
- 2) Incoming Number : Displays the incoming number

*** NOTICE**

- When an incoming call pop-up is displayed, most Audio and SETUP mode features are disabled. Only the call volume will operate.
- The telephone number may not be properly displayed in some mobile phones.
- When a call is answered with the mobile phone, the call mode will automatically revert to Private mode.

Favorites

Press the **PHONE** key ▶ Select [Favorites]



- 1) Saved favorite contact : Connects call upon selection
- 2) To add favorite : Downloaded contacts be saved as favorite.

*** NOTICE**

- To save Favorite, contacts should be downloaded.
- Contact saved in Favorites will not be automatically updated if the contact has been updated in the phone. To update Favorites, delete the Favorite and create a new Favorite.

Call History

Press the **PHONE** key ▶ Select [Call History]

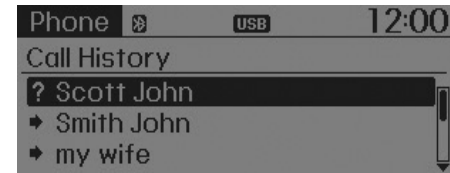

A list of incoming, outgoing and missed calls is displayed.

- Call history may not be saved in the call history list in some mobile phones.
- Calls received with hidden caller ID will not be saved in the call history list.
- Calling through the call history is not possible when there is no call history stored or a *Bluetooth*® Wireless Technology phone is not connected.
- Up to 50 received, dialed and missed calls are stored in Call History.
- Time of received/dialed calls and call time information are not saved.

Contacts

Press the **PHONE** key ▶ Select [Contacts]



The list of saved phone book entries is displayed.

* NOTICE

Find a contact in an alphabetical order, press the **MENU** key.



* NOTICE

- Up to 1,000 contacts saved in your *Bluetooth*® Wireless Technology phone can be downloaded into the car contacts. Contacts that have been downloaded to the car cannot be edited or deleted on the phone.
- Mobile phone contacts are managed separately for each paired *Bluetooth*® Wireless Technology device (max 5 devices x 1,000 contacts each). Previously downloaded data is maintained even if the *Bluetooth*® Wireless Technology device has been disconnected. (However, the contacts and call history saved to the phone will be deleted if a paired phone is deleted.)
- It is possible to download contacts during Bluetooth streaming audio.
- When downloading contacts, the icon will be displayed within the status bar.

(Continued)

(Continued)

- It is not possible to begin downloading a contact list when the contact download feature has been turned off within the *Bluetooth*® Wireless Technology device. In addition, some devices may require device authorization upon attempting to download contacts. If downloading does not normally occur, check the *Bluetooth*® Wireless Technology device settings or the screen state.
- The contacts download feature may not be supported in some mobile phones. For more information of supported *Bluetooth*® devices and function support, refer to your phone's user manual.

Bluetooth® Wireless Technology Setting

Pairing a New Device

Press the **SETUP** key ▶ Select [Phone] ▶ Select [Pair Phone]



Bluetooth® Wireless Technology devices can be paired with the audio system.

For more information, refer to the “Pairing through Phone Setup” section within *Bluetooth® Wireless Technology*.

Viewing Paired Phone List

Press the **SETUP** key ▶ Select [Phone] ▶ Select [Paired Phone List]

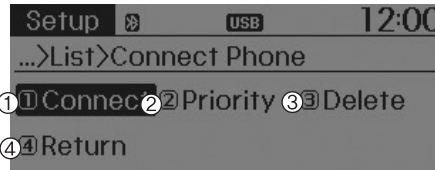
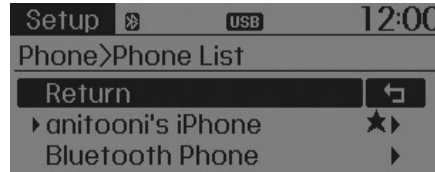

This feature is used to view mobile phones that have been paired with the audio system. Upon selecting a paired phone, the setup menu is displayed.

For more information, refer to the “Setting *Bluetooth® Wireless Technology Connection*” section within *Bluetooth® Wireless Technology*.

- 1) Connect/Disconnect Phone : Connect/ disconnects currently selected phone
- 2) Change Priority : Sets currently selected phone to highest connection priority
- 3) Delete : Deletes the currently selected phone
- 4) Return : Moves to the previous screen

* NOTICE BEFORE DOWNLOADING CONTACTS

- Only contacts within connected phones can be downloaded. Also check to see that your mobile phone supports the download feature.
- To learn more about whether your mobile phone supports contacts downloads, refer to your mobile phone user's manual.
- The contacts for only the connected phone can be downloaded.

Downloading Contacts

Press the **SETUP** key ▶ Select [Phone] ▶ Select [Contacts Download]



As the contacts are downloaded from the mobile phone, a download progress bar is displayed.

* NOTICE

- Upon downloading phone contacts, the previous corresponding data is deleted.
- This feature may not be supported in some mobile phones.
- Voice Recognition may not operate while contacts are being downloaded.

Outgoing Volume

Press the **SETUP** key ▶ Select [Phone] ▶ Select [Outgoing Volume]

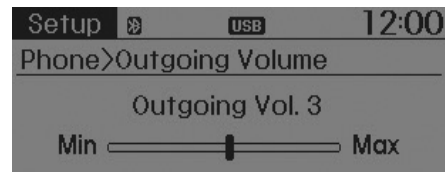

Use **TUNE** knob to adjust the outgoing volume level.

* NOTICE

While on a call, the volume can be changed by using the **SEEK TRACK** key.

Turning Bluetooth System Off

Press the **SETUP** key ▶ Select [Phone] ▶ Select [Bluetooth System Off]

Once *Bluetooth*® Wireless Technology is turned off, *Bluetooth*® Wireless Technology related features will not be supported within the audio system.

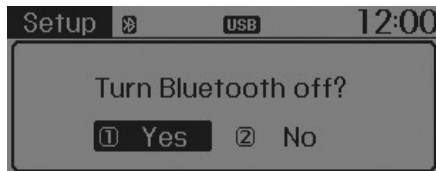
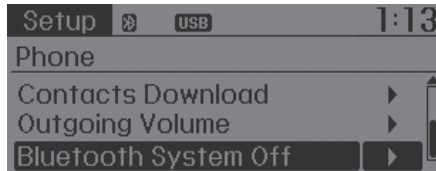

* NOTICE

To turn *Bluetooth*® Wireless Technology back on, go to **SETUP** ▶ [Phone] and select “Yes”.

VOICE RECOGNITION

Using Voice Recognition

Starting Voice Recognition

Shortly press the  key on the steering wheel. Say a command.

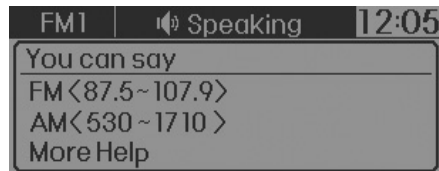

If prompt feedback is in [ON], then the system will say "Please say a command after the beep (BEEP)"

- If prompt feedback is in [OFF] mode, then the system will only say "(BEEP)"
- To change Prompt Feedback [On]/[Off], go to **SETUP** ▶ [System] ▶ [Prompt Feedback]

* NOTICE

For proper recognition, say the command after the voice instruction and beep tone.

Contact List Best Practices

- 1) Do not store single-name entries (e.g., "Bob", "Mom", "Kim", etc.). Instead, always use full names (including first and last names) for all contacts (e.g., use "Jacob Stevenson" instead of "Dad").
- 2) Do not use abbreviations (i.e., use "Lieutenant" instead of "Lt." or "Sergeant" instead of "Sgt.").
- 3) Do not use acronyms (i.e., use "County Finance Department" instead of "CFD").

4) Do not use special characters (e.g., "@", "hyphen -", "asterisk *", "ampersand &").

5) If a name is not recognized from the contact list, change it to a more descriptive name (e.g., use "Grandpa Joseph" instead of "Pa Joe").

Skipping Prompt Messages

While prompt message is being stated ▶ Shortly press the  key on the steering remote controller

The prompt message is immediately ended and the beep tone will sound. After the "beep", say the voice command.

Re-starting Voice Recognition

While system waits for a command ▶ Shortly press the  key on the steering remote controller

The command wait state is immediately ended and the beep will sound. After the "beep", say the voice command.

ENDING VOICE RECOGNITION

While Voice Recognition is operating
▶ Press and hold the  key on the steering remote controller

* NOTICE

- While using voice command, pressing any steering wheel control or a different key will end voice command.
- When the system is waiting for a voice command, say “cancel” or “end” to end voice command.
- When the system is waiting for a voice command, press and hold the  key on the steering wheel to end voice command.

Voice Recognition and Phone Contact Tips:

The Hyundai Voice Recognition System may have difficulty understanding some accents or uncommon names.

When using Voice Recognition to place a call, speak in a moderate tone, with clear pronunciation. To maximize the use of Voice Recognition, consider these guidelines when storing contacts:

- Do not store single-name entries (e.g., “Bob”, “Mom”, etc.). Instead, always use full names (including first and last names) for these contacts
- Do not use special characters (e.g., '@', '-', '*', '&', etc.)
- Do not use abbreviations (i.e., use “Lieutenant” instead of “Lt.”) or acronyms (i.e., use “County Finance Department” instead of “C. F. D.”); Be sure to say the name exactly as it is entered in the contacts list

Illustration on using voice commands

• Starting voice command.

Shortly pressing the  key (under 0.8 seconds):

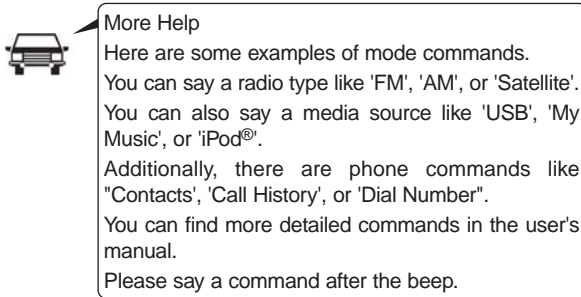
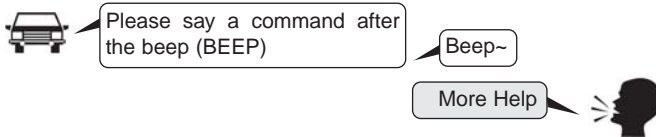

• Skipping Voice Recognition

Shortly pressing the  key (under 0.8 seconds):

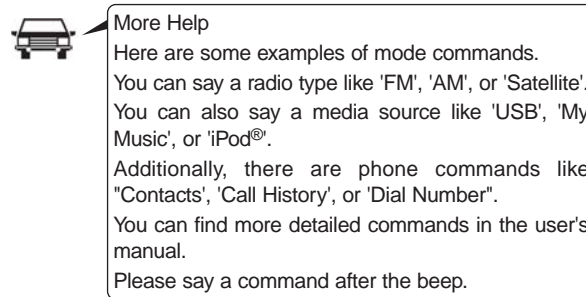
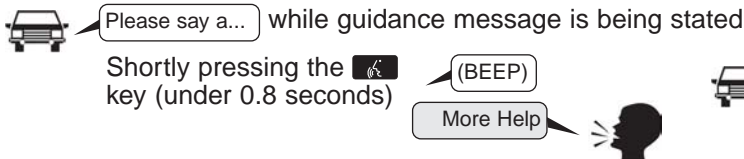

• End voice command.

Shortly pressing the  key (under 0.8 seconds):

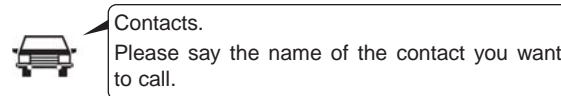
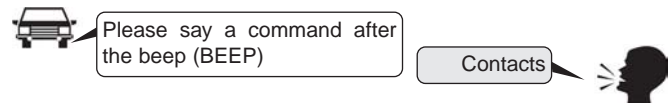

Voice Command List

- **Common Commands:** These commands can be used in most operations. (However a few commands may not be available during certain operations)

Command	Function
More Help	Provides guidance on commands that can be used anywhere in the system.
Help	Provides guidance on commands that can be used within the current mode.
Call<Name>	Calls <Name> saved in Contacts Ex) Call "John Smith"
Call <Name> on Mobile	Calls <Name> to the number that is saved as "Mobile" in Contacts Ex) Call "John Smith" on Mobile
Call <Name> in Office	Calls <Name> to the number that is saved as "Office" in Contacts Ex) Call "John Smith" in Office
Call <Name> at Home	Calls <Name> to the number that is saved as "Home" in Contacts Ex) Call "John Smith" at Home
Call <Name> on Other	Calls <Name> to the number that is saved as "Other" in Contacts Ex) Call "John Smith" on Other
Phone	Provides guidance on Phone related commands. After saying this command, say "Favorites", "Call History", "Contacts" or "Dial Number" execute corresponding functions.
Favorites	Display the Favorite screen.
Call History	Displays the Call History screen.

Command	Function
Contacts (Call by Name)	Displays the Contacts screen. After saying this command, say the name of a contact saved in the Contacts to automatically connect the call.
Dial Number	Display the Dial number screen. After saying this command, you can say the number that you want to call.
Redial	Connects the most recently called number.
Tutorial	Provide guidance on how to use voice recognition and Bluetooth® connections.
Radio	<ul style="list-style-type: none"> • When listening to the radio, displays the next radio screen. (FM1→FM2→AM→XM1→XM2→XM3→FM1) • When listening to a different mode, displays the most recently played radio screen. • When currently listening to the FM radio, maintains the current state. • When listening to a different mode, displays the most recently played FM screen.
FM1(FM One)	Displays the FM1 screen.
FM2(FM Two)	Displays the FM2 screen.
AM	Displays the AM screen.

Features of your vehicle

Command	Function
FM Preset 1~6	Plays the most recently played broadcast saved in FM Preset 1~6.
AM Preset 1~6	Plays the broadcast saved in AM Preset 1~6.
FM 87.5~107.9	Plays the FM broadcast of the corresponding frequency.
AM 530~1710	Plays the AM broadcast of the corresponding frequency.
XM (Satellite)	<ul style="list-style-type: none">• When currently listening to the XM, maintains the current state.• When listening to a different mode, displays the most recently played XM screen.
XM (Satellite) 1~3	Displays the selected XM screen.
XM Channel 0~255	Plays the selected XM channel.
Media	Moves to the most recently played media screen.
CD	Plays the music saved in the CD.
USB	Plays USB music.
iPod®	Plays iPod® music.

Command	Function
My Music	Plays the music saved in My Music.
AUX (Auxiliary)	Plays the connected external device.
Bluetooth® Audio	Plays the music saved in connected Bluetooth® device.
Please repeat	Repeats the most recent comment.
Mute	Mutes the sound.
Cancel (Exit)	Ends voice command.

- FM/AM radio commands: Commands available during FM, AM radio operation

Command	Function
Preset 1~6	Plays the broadcast station saved in Preset 1~6.
Scan	Scans receivable frequencies from the current broadcast and plays for 10 seconds each.
Preset Scan	Moves to the next preset from the current present and plays for 10 seconds each.
Information	Displays the information of the current broadcast. (This feature can be used when receiving RBDS broadcasts.)

- Satellite radio commands: Commands that can be used while listening to Satellite Radio.

Command	Function
Channel 0~255	Play the selected Satellite Radio channel.
Scan	Scans receivable channels from the current broadcast and plays for 10 seconds each.
Preset 1~6	Plays the broadcast saved in Preset 1~6.
Information	Displays the information of the current broadcast.

Features of your vehicle

- Audio CD commands: Commands available during Audio CD operation

Command	Function
Random	Randomly plays the tracks within the CD.
Random Off	Cancels random play to play tracks in sequential order.
Repeat	Repeats the current track.
Repeat Off	Cancels repeat play to play tracks in sequential order.
Track 1-30	Plays the desired track number.

- MP3 CD / USB commands: Commands available during USB and MP3 CD operation

Command	Function
Random	Randomly plays the files within the current folder.
Random Off	Cancels random play to play files in sequential order.
Repeat	Repeats the current file.
Repeat Off	Cancels repeat play to play files in sequential order.
Information	Displays the information screen of the current file.
Next Folder	Play the first file in the next folder
Previous Folder	Play the first file in the previous folder

- iPod® Commands: Commands available during iPod® operation

Command	Function
Random	Randomly plays the songs within the current category.
Random Off	Cancels random play to play songs in sequential order.
Repeat	Repeats the current song.
Repeat Off	Cancels repeat play to play songs in sequential order.

- My Music Commands: Commands available during My Music operation

Command	Function
Random	Randomly plays all saved files.
Random Off	Cancels random play to play files in sequential order.
Repeat	Repeats the current file.
Repeat Off	Cancels repeat play to play files in sequential order.
Delete	Deletes the current file. You will bypass an additional confirmation process.

Features of your vehicle

- *Bluetooth*[®] Wireless Technology Audio Commands: Commands available during *Bluetooth*[®] Wireless Technology audio streaming from mobile phone operation Command Operation



Command	Function
Play	Plays the currently paused song.
Pause	Pauses the current song.

Blue Link®

Hyundai aims to offer differentiated customer values through a 'Connected Car Life,' which provides consumers with fast and reliable IT technology. As consumers' lifestyles become more and more mobile in thanks to remarkable advances in smart phones, tablet PCs and overall wireless telecommunication, new lifestyle patterns demand seamless connection between one's office, home, outdoors and automobiles.

Blue Link® is Hyundai's innovative telematics solution that combines safety, service, and infotainment into a complete package. It works to both help simplify Hyundai owners' lives and reduce distracted driving. The Blue Link® "  " button offers access to a voice-response menu of services.



The Blue Link®  button offers access to enhanced navigation services. The "  " button offers immediate contact to SOS Emergency Assistance. A detailed list of commands is available in the Blue Link User's Manual.

Using Rear View Mirror Buttons

Pressing the Blue Link® buttons located on the rear view mirror will allow you to make service required inquiries, POI info searches, and emergency rescues by connecting to the Blue Link® Center.

Such features can be used only after subscribing to the Blue Link® service.

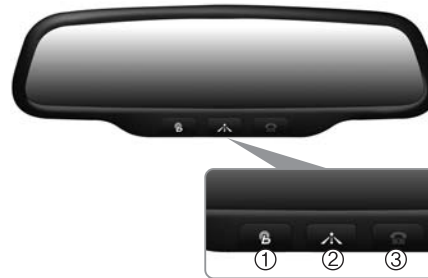

① (Blue Link® Center)

Makes requests for Blue Link® service related inquiries and consultations.

A call is connected to the Blue Link® service center employee.

Pressing the key again will end the call.

This feature does not operate when you are on a Bluetooth® phone call.

② (Blue Link® for POI)

- Blue Link® for Voice command

Starts Blue Link® voice command.

Voice receiving voice guidance, shortly press the button to convert to voice command mode. Press and hold the button to end voice command.

- TBT VR Commands

1. Navigate to

"Navigate to" voice command is used to request the download of route data for a new destination, saved destinations, daily routes and previous destinations.

2. Save Destination

“Save Destination” VR command is used to assign a voice tag to the last downloaded destination and store it in a destination directory.

* NOTICE

The Turn by Turn(TBT) feature supports the store of ten(10) destinations in the TBT destinations directory.

3. Route Preview

“Route Preview” VR command allows the user to preview the route instructions (upcoming maneuver instructions) at any time during the route guidance.

4. Destinations List

“Destinations List” VR command allows the user to preview and delete the stored destinations with their associated voice tags in the Turn by Turn destinations directory.

5. Voice Guidance

“Voice Guidance” VR command allows the user to mute/unmute the Turn by Turn(TBT) direction announcements.

6. Suspend Route

“Suspend Route” VR command allows the user to suspend and pause Turn by Turn(TBT) route guidance while in the guidance mode.

7. Resume Route

“Resume Route” VR command allows the user to resume Turn by Turn(TBT) route guidance.



③ (Blue Link® for SOS)

In the case of an emergency, requests for help to the Blue Link® center.

Call is connected to the Blue Link® emergency rescue center. Pressing the key again will end the call.

If you are already on a Bluetooth® phone call, the call will end to connect you to the Blue Link® Emergency Rescue Center.

CAUTION

- **You cannot talk simultaneously on the Bluetooth® phone call and a Blue Link® services phone all.**
- **While on a Bluetooth® call, pressing the  key or  key will display a message indicating that you are currently on a call.**
- **A message will be displayed if you receive a Bluetooth® call while already on a Blue Link® call. To answer the incoming call, press the  button on the steering wheel controls. You will not hear a ring to alert you that there is an incoming call.**

Eco Coach



- What is Eco Coach?

Every 2.5 minutes, Eco Coach compares your fuel economy against the government tested average (EPA) or other similar Hyundai models (community), based on your preference. Each month, or after every tank fill up, Eco Coach rates your extended average and gives you a reward star if you best the average.

See your My Hyundai web page for more information.

- What does the bar graph and horizontal line mean?

The horizontal line is adjusted once per month or at each tank full, based on your preference; it represents the EPA combined average or community average fuel economy target.

- What is My Eco MPG?

Your actual fuel economy average over 2.5 minutes.

This value is also shown in bar graph as your “now” rating.

- What are Eco Rewards?

If you beat the average (the EPA or community), you will receive an Eco Reward point.

See your my Hyundai web page for more information.

[Eco Driving] will not operate if the vehicle ignition is not turned on. Please operate with the ignition turned on.

Turn by Turn

The Turn by Turn feature can be used through Blue Link®.

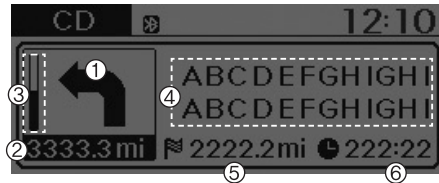

1. Direction Indicator Image
2. Remaining distance until next point
3. The Count bar is divided into a total of 9 levels.

9 Level	0.5mi	8 Level	0.4mi
7 Level	0.3mi	6 Level	0.2mi
5 Level	0.1mi	4 Level	400ft
3 Level	300ft	2 Level	200ft
1 Level	100ft		

4. Next Street name
5. Distance to destination
6. Expected Time Arrival

* For information on specific Blue Link® operations, please refer to the Blue Link® User's Manual that was provided with your vehicle.

■ CD Player : AM9B2DMKN, AM943DMAN



*  Radio® logo will be shown if the HD Radio™ feature is supported.

SYSTEM CONTROLLERS AND FUNCTIONS

Audio Head Unit

(for HD RADIO™ equipped model)



1.  (EJECT)

- Ejects the disc.

2. 

- Convert to Radio mode.
- Each time the key is pressed, the mode is changed in order of FM1, FM2, AM, XM1, XM2, XM3.



3. 

- Convert to Media Mode
- Each time the key is pressed, the mode is changed in order of CD, USB(iPod®), AUX, My Music, BT Audio.

4.  (for *Bluetooth*® Wireless Technology equipped model)

- Converts to Phone mode
- ✳ When a phone is not connected, the connection screen is displayed.

5. PWR/VOL knob

-  Power : Press to turn power on/off.
-  Volume : Turn left/right to control volume.

6. 

- When pressed shortly (under 0.8 seconds)
 - Radio mode : plays previous/next frequency.
 - Media (CD/USB/iPod®/My Music) modes : changes the track, Song(file)
- When pressed and held (Over 0.8 seconds)
 - Radio mode : continuously changes the frequency. Upon release, plays the current frequency.
 - Media (CD/USB/iPod®/My Music) modes : rewinds or fast forwards the track or file
 - During a Handsfree call, controls the call volume.

7. 

- HD RADIO™ : Channel Change
- XM RADIO™ : Category Search
- CD/USB/MP3 mode : Search Folder



8. **DISP**

- Turns the monitor display on/off.

9. **CLOCK**

Displays the time/date/day.

10. **SCAN**

- Radio Mode : previews all receivable broadcasts for 5 seconds each
- Media (CD/USB/My Music) modes : previews each song (file) for 10 seconds each.

11. **SETUP**

Converts to Setup mode.

12. **TUNE knob**

- Radio mode : turn to change broadcast frequencies.
- Media (CD/USB/iPod®/My Music) modes : turn to search tracks/channels/files.

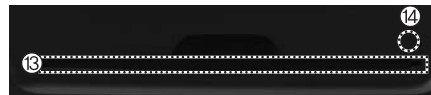

13. **DISC-IN LED**

- LED that indicates whether a disc is inserted.

14. **RESET**

- Forced system termination and system restart.

Audio Head Unit



15. **CAT FOLDER**

- XM RADIO™ : Category Search
- CD, USB/MP3 mode : Search Folder

Steering remote controller



1. VOLUME

- Used to control volume.

2. MUTE

- Mutes audio volume.

3. SEEK

- When pressed shortly (under 0.8 seconds)
 - Radio mode : searches broadcast frequencies saved to presets.
 - Media (CD/USB/iPod®/My Music/ BT Audio) modes : changes the track, file or chapter.
- When pressed and held (over 0.8 seconds)
 - Radio mode, automatically searches broadcast frequencies and channels
 - Media (CD/USB/iPod®/My Music) modes, rewinds or fast forwards the track or song(file)
 - BT Audio mode may not be supported in some mobile phones.

4. MODE

- Each time this key is pressed, the mode is changed in order of FM1→FM2→AM→XM1→XM2→XM3→CD→USB or iPod®→AUX→My Music→BT Audio
- If the media is not connected or a disc is not inserted, corresponding modes will be disabled.

5.

- When pressed shortly
 - Starts voice recognition
 - When selecting during a voice prompt, stops the prompt and converts to voice command waiting state
- When pressed and held (over 0.8 seconds)
 - Ends voice recognition

6. 

- When pressed shortly
 - When pressed in the phone screen, displays call history screen
 - When pressed in the dial screen, makes a call
 - When pressed in the incoming call screen, answers the call
 - When pressed during call waiting, switches to waiting call (Call Waiting)
- When pressed and held (over 0.8 seconds)
 - When pressed in the *Bluetooth*[®] Wireless Technology Handsfree wait mode, redials the last call
 - When pressed during a *Bluetooth*[®] Wireless Technology Handsfree call, switches call back to mobile phone (Private)
 - When pressed while calling on the mobile phone, switches call back to *Bluetooth*[®] Wireless Technology Handsfree (Operates only when *Bluetooth*[®] Wireless Technology Handsfree is connected)

7. 

- Ends phone call

HD Radio™ Technology

(for HD RADIO™ equipped model)

HD Radio Technology manufactured under license from iBiquity Digital Corporation. U.S. and Foreign Patents. HD Radio™ and the HD, HD Radio, and “Arc” logos are proprietary trademarks of iBiquity Digital Corp.



PSD

Program Service Data: Contributes to the superior user experience of HD Radio Technology. Presents song name, artist, station IDs, HD2/HD3 Channel Guide, and other relevant data streams.

HD2/HD3

Adjacent to traditional main stations are extra local FM channels. These HD2/HD3 Channels provide new, original music as well as deep cuts into traditional genre.

Digital Sound

Digital, CD-quality sound. HD Radio Technology enables local radio stations to broadcast a clean digital signal. AM sounds like today's FM and FM sounds like a CD.

HD Radio™ signal delay

To overcome the delay that digital systems inherently produce, HD Radio™ technology first uses the audio signal of the analog broadcasting when you tune to an AM station or to the main channel of a FM station. After that, the system will blend from analog to digital signal.

Normally, this blending is very smooth. If you experience a skip in program content of several seconds, the radio station has not implemented HD Radio™ broadcasting correctly. This is not a problem with your audio system.

Due to the fact that sub channels are only broadcasting digital, blending from analog to digital signal is not possible if you tune to a sub channel. In this case playback of the sub channel starts after several seconds, this is a normal function.

RADIO MODE

Basic Mode Screen

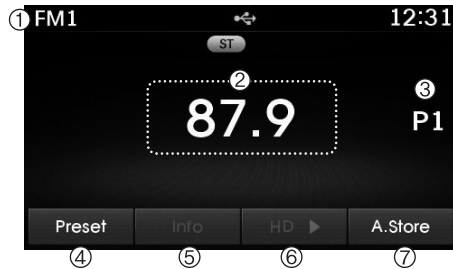

1. Mode Display
Displays currently operating mode.
2. Frequency
Displays the current frequency.
3. Preset
Displays current preset number [1] ~ [6].
4. Preset Display
Displays preset buttons.
5. Info
Displays broadcast information.
6. HD ▶
Changes HD Radio channels.
7. A.store
Automatically saves frequencies with superior reception to Preset buttons.

HD RADIO MODE

(for HD RADIO™ equipped model)

Basic Mode Screen



1. Mode Display

Displays currently operating mode.

2. HD Channel

Displays information for the currently playing HD Radio broadcast.

3. Song Information

Displays the album, artist, and title information.

4. Frequency

Displays the current frequency.

5. HD Radio Broadcast Station

Displays the HD Radio broadcast station name.

6. Preset

Displays currently playing preset number [1] ~ [6].

7. Preset Display

Displays saved presets.

8. Info

Displays broadcast information.

9. HD ▶

Changes HD Radio channels.

10. A.Store

Automatically saves frequencies with superior reception to Preset buttons.

Switching to Radio Mode

Pressing the **RADIO** key will change the operating mode in order of FM1 → FM2 → AM → XM1 → XM2 → XM3

If [Mode Pop up] is turned on within **SETUP** ▶ [Display], then pressing the **RADIO** key will display the Radio Pop-up Mode screen.

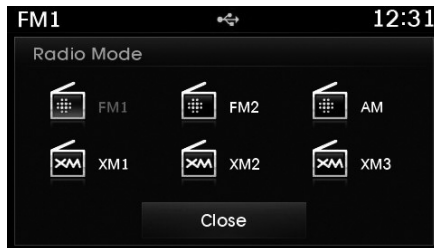

Turn the **TUNE** knob to move the focus. Press the knob to select.

Searching Radio Frequencies

Using Seek

Press the **SEEK TRACK** key to play the previous/next frequency.

Using TUNE

Turn the **TUNE** knob to select the desired frequency.

- FM : Increases/decreased by 200kHz
- AM : Increases/decreased by 10kHz

Using Radio Mode

Selecting Presets/Saving Presets

Press the **Preset** button to display the broadcast information for the frequency saved to each button.

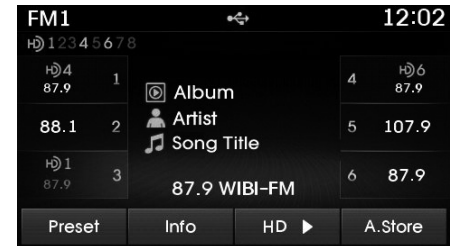

Press the **1** ~ **6** buttons to play the desired preset.

* NOTICE

While listening to a frequency you want to save as a preset, press and hold one of the **1** ~ **6** preset buttons (over 0.8 seconds) to save the current frequency to the selected preset.

Auto Store

Press the **A.Store** button to automatically save receivable frequencies to Preset buttons.

* NOTICE

While Auto Store is operating, pressing the [Cancel] button again will cancel Auto Store and restore the previous frequency.

Scan

Press the **SCAN** key to preview frequencies with superior reception for 5 seconds each.

Press and hold the **SCAN** key (over 0.8 seconds) to preview presets for 5 seconds each.

Once scan is complete, the previous frequency will be restored.

While Scan is operating, pressing the **SCAN** key will cancel the scan operation.

Listening to HD Radio Stations

HD Radio Technology is a digital radio technology used by AM and FM radio station to transmit audio and data via a digital signal in conjunction with their analog signals.

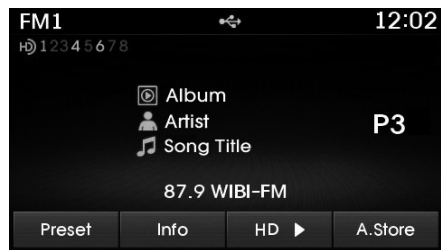

While listening to the radio, the HD Radio icon will become displayed if receiving an HD Radio broadcast.

Changing HD Radio stations

Press the **HD ▶** button to change HD Radio station.

Viewing Station Information

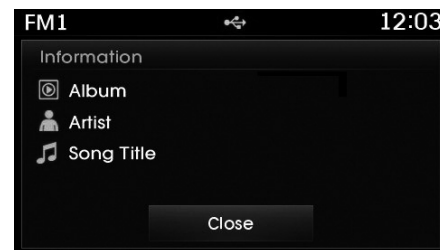

Press the **Info** button to view station information.

XM RADIO™ MODE

Features of your vehicle

Satellite radio reception

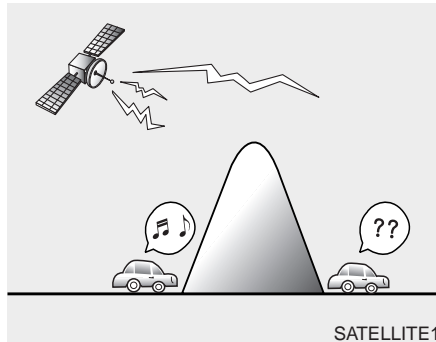

You may experience difficulties in receiving XM satellite™ radio signals in the following situations.

- If you are driving in a tunnel or a covered parking area.
- If you are driving beneath the top level of a multi-level freeway.
- If you are driving under a bridge.
- If you are driving next to a tall vehicle (such as a truck or a bus) that blocks the signal.

- If you are driving in a valley where the surrounding hills or peaks block the signal from the satellite.
- If you are driving on a mountain road where the signal is blocked by mountains.

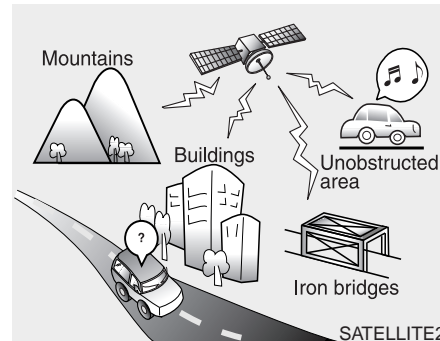

- If you are driving in an area with tall trees that block the signal (30 ft. /10m or more), for example on a road that goes through a dense forest.
- The signal can become weak in some areas that are not covered by the XM repeater network.

* NOTICE

There may also be additional unforeseen circumstances leading to reception problems with the XM satellite™ radio signal.

Advisory Messages, such as ‘CH Unavailable’ may occur when starting XM Radio™.

XM RADIO™ MODE

Basic Mode Screen



1. Mode Display

Displays currently operating mode.

2. Channel Information

Displays the category, channel number, channel name, artist and title information.

3. Preset

Displays currently playing preset number [1] ~ [6].

4. Preset Display

Displays saved presets.

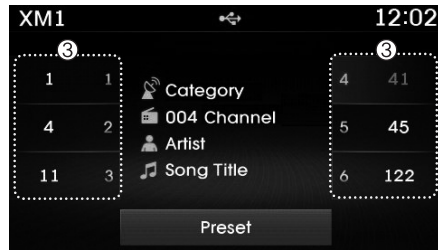

Using SEEK

Press the **SEEK TRACK** key to play the previous/next channel.

* If the “Category” icon is displayed, channels are changed within the current category.

Using Tune

Turn the **TUNE** knob to select the desired channel.

SCAN

Press the **SCAN** key to scan all channels with superior reception for 10 seconds each.

Once scan is complete, the previously played channel will be restored.

During Scan, pressing the **SCAN** key again will cancel the scan operation and restore the previously played channel.

If the “Category” icon is displayed, channels are changed within the current category.

Searching Categories

Select the category by using the **HD/CAT FOLDER** (**CAT FOLDER**) key and press the **TUNE** knob to select.

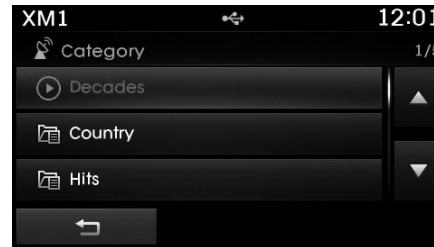

Channels for the selected category are played.

Selecting Presets/Saving Presets

Press the **Preset** button to display the broadcast information for the channel saved to each button.

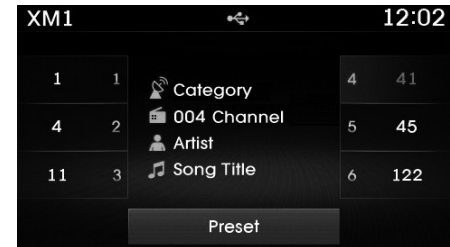

Press the **1** ~ **6** buttons to play the desired preset.

* NOTICE

While listening to a channel you want to save as a preset, press and hold one of the **1** ~ **6** preset buttons (over 0.8 seconds) to save the current channel to the selected preset.

*** NOTICE - USING CDs**

- This device has been manufactured to be compatible with software bearing the following logo marks.
- Do not clean discs with chemical solutions, such as record sprays, antistatic sprays, antistatic liquids, benzene, or thinners.
- After using a disc, put the disc back in its original case to prevent disc scratches.
- Hold discs by their edges or within the center hole to prevent damages to disc surfaces.
- Do not introduce foreign substances into the disc insert/eject slot. Introducing foreign substances could damage the device interior.
- Do not insert two discs simultaneously.
- When using CD-R/CD-RW discs, differences in disc reading and playing times may occur depending on the disc manufacturer, production method and the recording method as used by the user.

(Continued)

(Continued)

- Clean fingerprints and dust off the disc surface (coated side) with a soft cloth.
- The use of CD-R/CD-RW discs attached with labels may result in disc slot jams or difficulties in disc removal. Such discs may also result in noise while playing.
- Some CD-R/CD-RW discs may not properly operate depending on the disc manufacturer, production method and the record method as used by the user. If problems persist, trying using a different CD as continued use may result in malfunctions.
- The performance of this product may differ depending on the CD-RW Drive Software.
- Copy-protected CDs such as S-type CDs may not function in the device. DATA discs cannot be played. (However, such discs may still operate but will do so abnormally.)

(Continued)

(Continued)

- Do not use abnormally shaped discs (8cm, heart-shaped, octagon-shaped) as such discs could lead to malfunctions.
- If the disc is straddled on the disc slot without removal for 10 seconds, the disc will automatically be re-inserted into the disc player.
- Only genuine audio CDs are supported. Other discs may result in recognition failure. (e.g. copy CD-R, CDs with labels)

MEDIA MODE

Pressing the **MEDIA** key will change the operating mode in order of CD→USB(iPod®)→AUX→My Music → BT Audio.

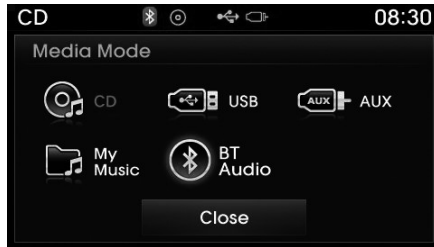

If [Mode Pop up] is turned on within **SETUP** ▶ [Display], then pressing the **MEDIA** key will display the Media Pop-up Mode screen.

Turn the **TUNE** knob to move the focus. Press the knob to select.

* NOTICE

The media mode pop up screen can be displayed only when there are two or more media modes turned on.

Title Icon

When a *Bluetooth*® Wireless Technology, iPod®, USB, or AUX device is connected or a CD is inserted, the corresponding mode icon will be displayed.



Icon	Title
	<i>Bluetooth</i> ® Wireless Technology
	CD
	iPod®
	USB
	AUX

AUDIO CD MODE

Basic Mode Screen



1. Mode

Displays currently operating mode.

2. Operation State

From Repeat/Random(Shuffle)/ Scan, displays the currently operating function.

3. Track Info

Displays information about the current track.

4. Play/Pause

Changes the play/pause state.

5. Play Time

Displays the current play time.

6. Info

Shows detailed information about the current track.

7. Random(Shuffle)

Turns the Random(Shuffle) feature on/off.

8. Repeat

Turns the Repeat feature on/off.

9. List

Moves to the list screen.

Using Audio CD Mode

Playing/Pausing CD Tracks

Once an audio CD is inserted, the mode will automatically start and begin playing.



While playing, press the **||** button to pause and press **▶** button to play.

* NOTICE

- Only genuine audio CDs are supported. Other discs may result in recognition failure (e.g. copy CD-R, CDs with labels)
- The artist and title information are displayed on the screen if track information is included within the audio CD.

Changing Tracks

Press the **SEEK TRACK** key to move to the previous or next track.

* NOTICE

- Pressing the **SEEK TRACK** key after the track has been playing for 2 seconds will start the current track from the beginning.
- Pressing the **SEEK TRACK** key before the track has been playing for 1 seconds will start the previous track.

Selecting from the List

Turn the **TUNE** knob left/right to search for the desired track.

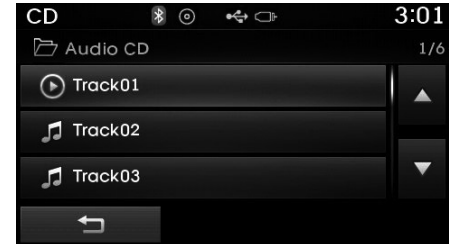

Once you find the desired track, press the **TUNE** knob to start playing.

Rewinding / Fast-forwarding Tracks

While playing, press and hold the **SEEK TRACK** key (over 0.8 seconds) to rewind or fast-forward the current track.

Scan

Press the **SCAN** key to play the first 10 seconds of each file.

Audio CD Mode Menu

Within this mode, you will have access to the Info, Random(Shuffle), Repeat and List features.

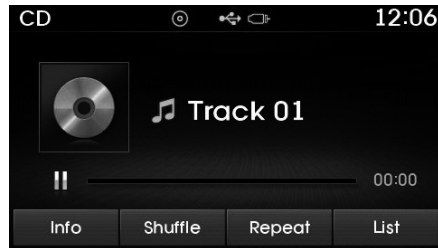

Info

Press the **Info** button to display details about the current disc.

Random(Shuffle)

Press the **Shuffle** button to play tracks in random(Shuffle) order.

Press the **Shuffle** button again to turn the Random(Shuffle) feature off.

- Random(Shuffle): Plays all tracks in random(Shuffle) order.

Repeat

Press the **Repeat** button to repeat the current track. Press the button again to turn the repeat feature off.

- Repeat : Repeats the current track.

List

Press the **List** button to display the track list screen.

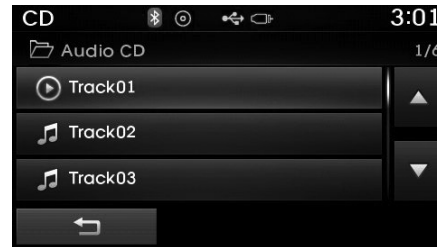

Turn the **TUNE** knob left/right to search for tracks. Once the desired track is displayed, press the knob to select and play.

MP3 CD MODE

Basic Mode Screen

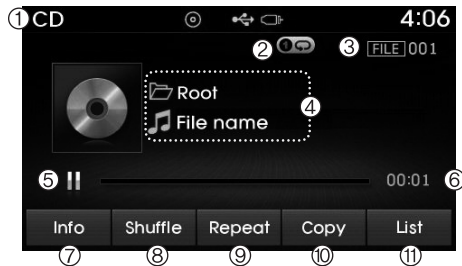

1. Mode

Displays currently operating mode.

2. Operation State

From Repeat/Random(Shuffle)/Scan, displays the currently operating function.

3. File Index

Displays the current file number.

4. File Info

Displays information about the current file.

5. Play/Pause

Changes the play/pause state.

6. Play Time

Displays the current play time.

7. Info

Shows detailed information about the current file.

8. Random(Shuffle)

Turns the Random(Shuffle) feature on/off.

9. Repeat

Turns the Repeat feature on/off.

10. Copy

Copies the current file into My Music

11. List

Moves to the list screen.

Using MP3 CD Mode

Playing/Pausing MP3 Files

Once an MP3 disc is inserted the mode will automatically start and be playing.



While playing, press the **||** button to pause and press **▶** button to play.

* NOTICE

If there are numerous files and folders within the disc, reading time could take more than 10 seconds and the list may not be displayed or song searches may not operate. Once loading is complete, try again.

Changing Files

Press the **SEEK TRACK** key to move to the previous or next file.

* NOTICE

- Pressing the **SEEK TRACK** key after the file has been playing for 2 seconds will start the current file from the beginning.
- Pressing the **SEEK TRACK** key before the file has been playing for 1 second will start the previous file.

Selecting from the List

Turn the **TUNE** knob left/right to search for the desired file.



Once you find the desired file, press the **TUNE** knob to start playing.

Rewinding / Fast-forwarding Files

While playing, press and hold the **SEEK TRACK** key (over 0.8 seconds) to rewind or fast-forward the current file.

Scan

Press the **SCAN** key to play the first 10 seconds of each file.

Searching Folders

Press the **HD/CAT FOLDER** (**CAT FOLDER**) key to select and search folders.

Once the desired folder is displayed, press the **TUNE** knob to select.

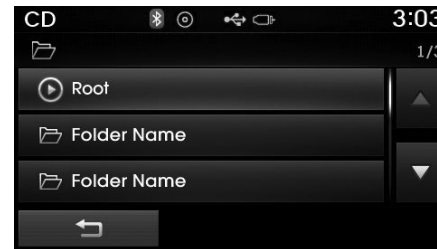

The first file within the selected folder will begin playing.

MP3 CD Mode Menu

Within this mode, you will have access to the Info, Random(Shuffle), Repeat, Copy and List features.



Info

Press the **Info** button to display details about the current file.

* NOTICE

- When the 'Folder File' option is set as the default display within **Display setup**, the album/artist/file information are displayed as detailed file information.
- When the 'Album Artist Song' option is set as the default display, the folder name/file name are displayed as detailed file information.
- The title, artist and album info are displayed only when such information are recorded within the MP3 file ID3 tag.

Random(Shuffle)

Press the **Shuffle** button to play files in random(Shuffle) order.

Each time the button is pressed, the feature changes in order of Random (Shuffle) Folder → Random (Shuffle) All → Off.

- Random(Shuffle) Folder : Plays all files within the current folder in Random (Shuffle) order.
- Random(Shuffle) All : Plays all files in Random(Shuffle) order.

Repeat

Press the **Repeat** button to repeat the current file or folder.

Each time the button is pressed, the feature changes in order of Repeat → Repeat Folder → Off.

- Repeat: Repeats the current file.
- Repeat Folder: Repeats all files within the current Folder.

Copying Files

Press the **Copy** button to copy the current file into My Music.

* NOTICE

Selecting another feature during copying will display a pop-up asking whether you wish to cancel copying. To cancel, select 'Yes'.

Features of your vehicle

List

Press the **List** button to display the file list screen.

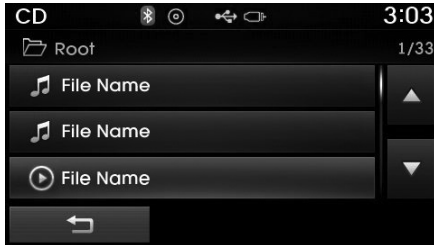

Turn the **TUNE** knob left/right to search for files. Once the desired file is displayed, press the knob to select and play.

*** NOTICE - USING THE USB DEVICE**

- Connect the USB device after turning on the engine. The USB device may become damaged if it is already connected when the ignition is turned on. The USB device may not operate properly if the car ignition is turned on or off with the USB device connected.
- Heed caution to static electricity when connecting/disconnecting USB devices.
- Encoded MP3 Players will not be recognized when connected as an external device.
- When connecting an external USB device, the device may not properly recognize the USB is in some states.
- Only products formatted with byte/sectors under 64Kbyte will be recognized.
- This device recognizes USB devices formatted in FAT 12/16/32 file formats. This device does not recognize files in NTFS file format.

(Continued)

(Continued)

- Some USB devices may not be supported due to compatibility issues.
- Avoid contact between the USB connector with bodily parts or foreign objects.
- Repeated connecting/disconnecting of USB devices within short periods of time may result in product malfunction.
- A strange noise may occur when disconnecting the USB.
- Make sure to connect/disconnect external USB devices with the audio power turned off.
- The amount of time required to recognize the USB device may differ depending on the type, size or file formats stored in the USB. Such differences in time are not indications of malfunctions.
- The device only supports USB devices used to play music files.
- USB images and videos are not supported.

(Continued)

(Continued)

- Do not use the USB I/F to charge batteries or USB accessories that generate heat. Such acts may lead to worsened performance or damage to the device.
- The device may not recognize the USB device if separately purchased USB hubs and extension cables are being used. Connect the USB directly with the multimedia terminal of the vehicle.
- When using mass storage USB devices with separate logical drives, only files saved to the root drive can be played.
- Files may not properly operate if application programs are installed to the USBs.
- The device may not operate normally if MP3 Players, cellular phones, digital cameras, or other electronic devices (USB devices not recognized as portable disk drives) are connected with the device.

(Continued)

- Charging through the USB may not work for some mobile devices.
- The device may not support normal operation when using a USB memory type besides (Metal Cover Type) USB Memory.
- The device may not support normal operation when using formats such as HDD Type, CF, or SD Memory.
- The device will not support files locked by DRM (Digital Rights Management.)
- USB memory sticks used by connecting an Adaptor (SD Type or CF Type) may not be properly recognized.
- The device may not operate properly when using USB HDDs or USBs subject to connection failures caused by vehicle vibrations. (e.g. i-stick type)

(Continued)

(Continued)

- Avoid use of USB memory products that can also be used as key chains or mobile phone accessories. Use of such products may cause damage to the USB jack.
- Connecting an MP3 device or phone through various channels, such as AUX/BT or Audio/USB mode may result in pop noises or abnormal operation.



USB MODE

Basic Mode Screen

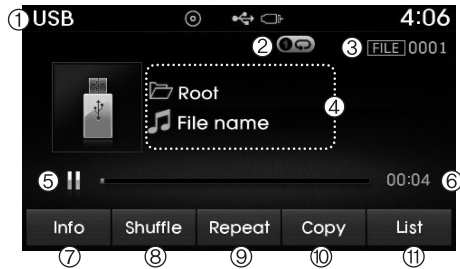

1. Mode

Displays currently operating mode.

2. Operation State

From Repeat/Random(Shuffle)/Scan, displays the currently operating function.

3. File Index

Displays the current file number.

4. File Info

Displays information about the current file.

5. Play/Pause

Changes the play/pause state.

6. Play Time

Displays the current play time.

7. Info

Displays detailed information for the current file.

8. Random(Shuffle)

Turns the Random(Shuffle) feature on/off.

9. Repeat

Turns the Repeat feature on/off.

10. Copy

Copies the current file into My Music.

11. List

Moves to the list screen.

Using USB Mode

Playing/Pausing USB Files

Once a USB is connected, the mode will automatically start and begin playing a USB file.



While playing, press the **||** button to pause and press **▶** button to play.

* NOTICE

- Loading may require additional time if there are many files and folders within the USB and result in faulty list display or file searching. Normal operations will resume once loading is complete.
- The device may not support normal operation when using a USB memory type besides (Metal Cover Type) USB Memory.

Changing Files

Press the **SEEK TRACK** keys to move to the previous or next file.

* NOTICE

- Pressing the **SEEK TRACK** key after the file has been playing for 2 seconds will start the current file from the beginning.
- Pressing the **SEEK TRACK** key before the file has been playing for 1 seconds will start the previous file.

Selecting from the List

Turn the **TUNE** knob left/right to search for the desired file.

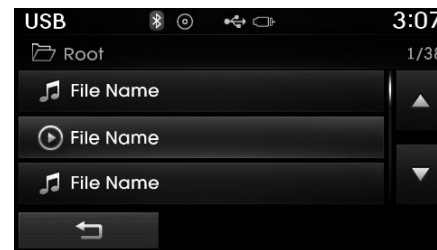

Once you find the desired file, press the **TUNE** knob to start playing.

Rewinding / Fast-forwarding Files

While playing, press and hold the **SEEK TRACK** key (over 0.8 seconds) to rewind or fast-forward the current file.

Scan

Press the **SCAN** key to play the first 10 seconds of each file.

Searching Folders

Press the  () key to select and search folders.

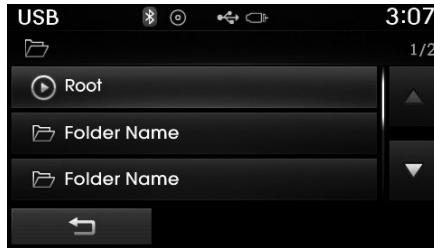

Once the desired folder is displayed, press the  TUNE knob to select.

The first file within the selected folder will begin playing.

USB Mode Menu

Within this mode, you will have access to the Info, Random(Shuffle), Repeat, Copy and List features.



Info

Press the  button to display details about the current file.

* NOTICE

- When the 'Folder File' option is set as the default display within Display setup, the album/artist/file information are displayed as detailed file information.
- When the 'Album Artist Song' option is set as the default display, the folder name/file name are displayed as detailed file information.
- The title, artist and album info are displayed only when such information are recorded within the MP3 file ID3 tag.

Random(Shuffle)

Press the  button to play files in random(Shuffle) order.

Each time the button is pressed, the feature changes in order of Random(Shuffle) Folder → Random(Shuffle) All → Off.

- Random(Shuffle) Folder : Plays the files in the current folder in random(Shuffle) order.
- Random(Shuffle) All : Plays all files in random(Shuffle) order.

Repeat

Press the **Repeat** button to repeat the current file or folder.

Each time the button is pressed, the feature changes in order of Repeat → Repeat Folder → Off.

- Repeat (Icon) : Repeats the current file.
- Repeat Folder (Icon) : Repeats all files within the current folder.

Copying Files

Press the **Copy** button to copy the current file into My Music.

*** NOTICE**

Selecting another feature during copying will display a pop-up asking whether you wish to cancel copying. To cancel, select 'Yes'.

List

Press the **List** button to display the file list screen.

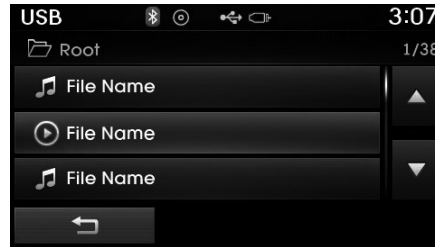

Turn the **ⓄTUNE** knob left/right to search for files. Once the desired file is displayed, press the knob to select and play.

*** NOTICE - USING THE iPod® DEVICE**

- iPod® is a registered trademark of Apple Inc.
- In order to use the iPod® while operating the keys, you must use a dedicated iPod® cable. (the cable that is supplied when purchasing iPod®/iPhone® products)
- If the iPod® is connected to the vehicle while it is playing, a high pitch sound could occur for approximately 1-2 seconds immediately after connecting. If possible, connect the iPod® to the vehicle with the iPod® stopped/paused.
- During ACC ON state, connecting the iPod® through the iPod® cable will charge the iPod® through the car audio system.
- When connecting with the iPod® cable, make sure to fully insert the jack to prevent communication interference.

(Continued)

(Continued)

- When the EQ features of an external device, such as the iPod®, and the audio system are both active, EQ effects could overlap and cause sound deterioration and distortion. Whenever possible, turn off the EQ feature within the external device upon use by connecting with the audio system.
- Noise may occur when an iPod® or AUX device is connected. When such devices are not being used, disconnect the device for storage.
- When the iPod® or AUX device power is connected to the power jack, playing the external device may result in noise. In such cases, disconnect the power connection before use.
- Skipping or improper operation may occur depending on the characteristics of your iPod®/iPhone® device.

(Continued)

(Continued)

- If your iPhone® is connected to both the *Bluetooth®* Wireless Technology and USB, the sound may not be properly played. In your iPhone®, select the Dock connector or *Bluetooth®* Wireless Technology to change the sound output (source).
- iPod® mode cannot be operated when the iPod® cannot be recognized due to versions that do not support communication protocols.
- For fifth generation iPod® Nano devices, the iPod® may not be recognized when the battery level is low. Please charge the iPod® for use.
- Search/play orders shown within the iPod® device may differ with the orders shown within the audio system.
- If the iPod® malfunctions due to an iPod® device defect, reset the iPod® and try again. (To learn more, refer to your iPod® manual)

(Continued)

(Continued)

- Some iPod®s may not sync with the System depending on its version. If the Media is removed before the Media is recognized, then the system may not properly restore the previously operated mode. (iPad® charging is not supported.)

iPod® MODE

Basic Mode Screen



1. Mode

Displays currently operating mode.

2. Operation State

From Repeat/Random(Shuffle), displays the currently operating function.

3. Song Index

Displays the current song/total number of songs.

4. Song Info

Displays information about the current song.

5. Play/Pause

Changes the play/pause state.

6. Play Time

Displays the current play time.

7. Random(Shuffle)

Turns the Random(Shuffle) feature on/off.

8. Repeat

Turns the Repeat feature on/off.

9. List



Moves to the list screen.

Using iPod® Mode

Playing/Pausing iPod® Songs

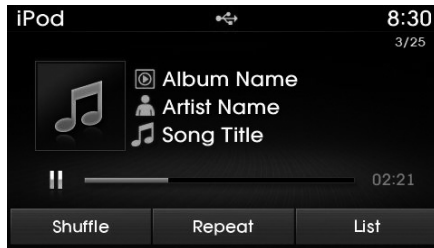
Once an iPod® is connected, the mode will automatically start and begin playing an iPod® song.



While playing, press the  button to pause and press  button to play.



* NOTICE

iPod®s with unsupported communication protocols may not properly operate in the audio system.

Changing Songs

Press the  key to move to the previous or next song.

* NOTICE

- Pressing the  key after the song has been playing for 2 seconds will start the current song from the beginning.
- Pressing the  key before the song has been playing for 1 second will start the previous song.
- Slight time differences may exist depending your iPod® product.

Rewinding / Fast-forwarding Songs

While playing, press and hold the  key (over 0.8 seconds) to rewind or fast-forward the current song.

Searching Categories

Turn the  TUNE knob left/right to search for the desired category.

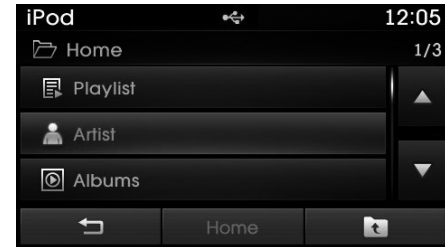

Once you find the desired category, press the  TUNE knob to select and play.



* NOTICE

There are eight categories that can be searched, including Playlists, Artists, Albums, Genres, Songs, Composers, Audiobooks and Podcasts.

Category Menu

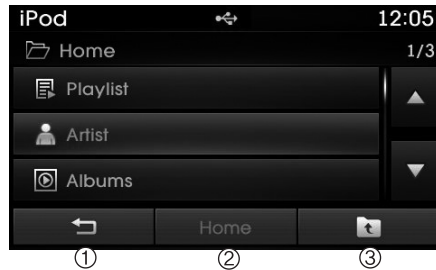
Within the iPod® Category menu, you will have access to the , Home, and  features.



1.  : Displays the play screen
2. Home : Moves to the iPod® root category screen
3.  : Moves to the previous category

* NOTICE

- If the search mode is accessed while playing a song, the most recently searched category is displayed.
- Search steps upon initial connection may differ depending on the type of iPod® device.

iPod® Mode Menu

Within this mode, you will have access to the Random(Shuffle), Repeat and List features.



Random(Shuffle)

Press the **Shuffle** button to play songs in random(Shuffle) order.

Each time the button is pressed, the feature changes in order of Random(Shuffle) Album→Random(Shuffle) All→Off.

- Random(Shuffle) Album : Shuffle Album plays album in Random(Shuffle) order.
- Random(Shuffle) All : Plays all songs in Random(Shuffle) order.

Repeat

Press the **Repeat** button to repeat the current song. Press the button again to turn the repeat feature off.

- Repeat : Repeats the current song

List

Press the **List** button to display the Category Menu.

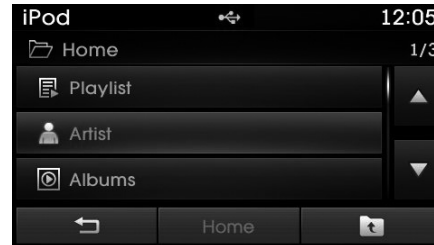

Turn the **TUNE** knob left/right to search for the desired category.

Once you find the desired category, press the **TUNE** knob to select and play.

AUX MODE

Using AUX Mode

Press the **MEDIA** key ▶ Select [AUX]

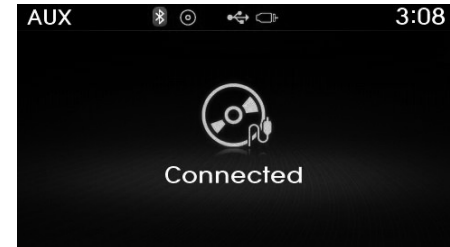

An external device can be connected to play music.

Connecting an External Device

External audio players (Camcorders, car VCR, etc.) can be played through a dedicated cable.

* NOTICE

- If an external device connector is connected with the AUX terminal, then AUX mode will automatically operate. Once the connector is disconnected, the previous mode will be restored.
- AUX mode can be used only when an external audio player (camcorder, car VCR, etc.) has been connected.
- The AUX volume can be controlled separately from other audio modes.
- Connecting a connector jack to the AUX terminal without an external device will convert the system to AUX mode, but only output noise. When an external device is not being used, also remove the connector jack.
- When the external device power is connected to the power jack, playing the external device may output noise. In such cases, disconnect the power connection before use.
- Fully insert the AUX cable to the AUX jack upon use.

MY MUSIC MODE

Basic Mode Screen



1. Mode

Displays currently operating mode.

2. Operation State

From Repeat/Random(Shuffle)/Scan, displays the currently operating function.

3. File Index

Displays the current file/total number of files.

4. File Info

Displays information about the current file.

5. Play/Pause

Changes the play/pause state.

6. Play Time

Displays the current play time.

7. Info

Displays detailed information for the current file.

8. Random(Shuffle)

Turns the Random(Shuffle) feature on/off.

9. Repeat

Turns the Repeat feature on/off.

10. Delete

Deletes the current file.

11. List

Moves to the list screen.

Using My Music Mode

Playing/Pausing My Music Files

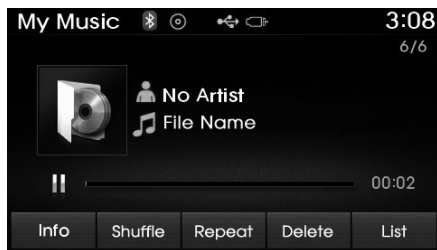

While playing, press the **||** button to pause and press **▶** button to play.

* NOTICE

If there are no files saved within My Music, the [My Music] button will be disabled.

Changing Files

Press the **SEEK TRACK** key to move to the previous or next file.

* NOTICE

- Pressing the **SEEK TRACK** key after the file has been playing for 2 seconds will start the current file from the beginning.
- Pressing the **SEEK TRACK** key before the file has been playing for 1 seconds will start the previous file.

Selecting from the List

Turn the **TUNE** knob left/right to search for the desired file.

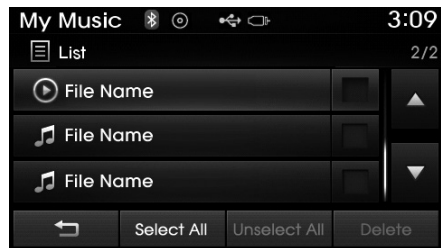

Once you find the desired file, press the **TUNE** knob to start playing.

Rewinding / Fast-forwarding Files

While playing, press and hold the **SEEK TRACK** key (over 0.8 seconds) to rewind or fast-forward the current file.

Scan

Press the **SCAN** key to play the first 10 seconds of each file.

My Music Mode Menu

Within this mode, you will have access to the Info, Random(Shuffle), Repeat, Delete and List features.

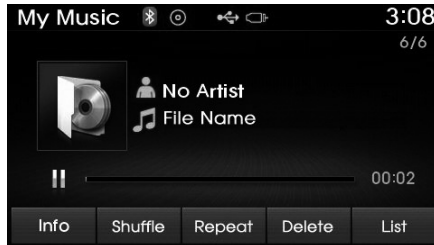

Info

Press the **Info** button to display details about the current file.

* NOTICE

The title, artist and album info are displayed only when such information is recorded within the MP3 file ID3 tag.

Random

Press the **Shuffle** button to play files in random order. Press the button again to turn the Random feature off.

Repeat

Press the **Repeat** button to repeat the current song. Press the button again to turn the repeat feature off.

Deleting Files

Press the **Delete** button to delete the current file.

List

Press the **List** button to display the file list screen.

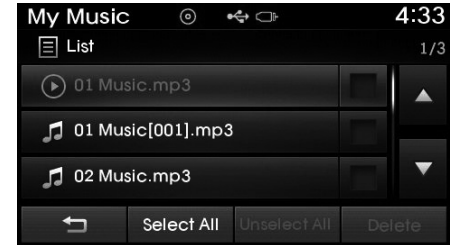

Turn the **TUNE** knob left/right to search for files. Once the desired file is displayed, press the knob to select and play.

List Menu

From the List screen, it is possible to delete files you previously saved into My Music.

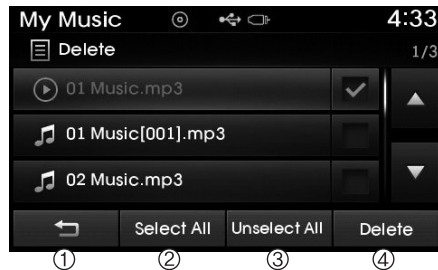

Press the **Select All** button or individually select the files you want to delete. Once files are selected, the **Unselect All** button and **Delete** buttons will be enabled.

- 1) **←** : Moves to the previous screen
- 2) **Select All**: Selects all files
- 3) **Unselect All**: Deselects all selected files
- 4) **Delete**: Deletes selected files

After selecting the files you want to delete, press the **Delete** button to delete the selected files.

* NOTICE

- If there is memory available, up to 6,000 files can be saved.
- Identical files cannot be copied more than 1,000 times.
- To check memory information, go to **SETUP** ▶ [System] ▶ [Memory Information]

*** NOTICE - USING THE
Bluetooth® Wireless
Technology Audio Mode**

- *Bluetooth*® Wireless Technology Audio Mode can be used only when a *Bluetooth*® Wireless Technology phone has been connected.
- *Bluetooth*® Wireless Technology Audio Mode will not be available when connecting mobile phones that do not support this feature.
- While *Bluetooth*® Wireless Technology Audio is playing, if the *Bluetooth*® Wireless Technology phone is connected, then the music will also stop.
- Moving the Track up/down while playing *Bluetooth*® Wireless Technology audio mode may result in pop noises in some mobile phones.
- *Bluetooth*® Wireless Technology streaming audio may not be supported in some mobile phones.

(Continued)

(Continued)

- When returning to *Bluetooth*® Wireless Technology Audio mode after ending a call, the mode may not automatically restart in some mobile phones.
- Receiving an incoming call or making an outgoing call while playing *Bluetooth*® Wireless Technology Audio may result in audio interference.



Bluetooth® Wireless Technology AUDIO MODE

Using Bluetooth® Wireless Technology Audio Mode

Playing/Pausing Bluetooth® Wireless Technology Audio

Once a *Bluetooth®* Wireless Technology device is connected, the mode will automatically start.



While playing, press the  button to pause and press  button to play.

*** NOTICE**

The play/pause feature may operate differently depending on the mobile phone.

Changing Files

Press the  key to move to the previous or next file.

Setting Connection

If a *Bluetooth®* Wireless Technology device has not been connected, press the  key ►[Phone] button to display the *Bluetooth®* Wireless Technology connection screen.

It is possible to use the pair phone, connect/disconnect and delete features from your *Bluetooth®* Wireless Technology phone.

*** NOTICE**

- If the *Bluetooth*[®] Wireless Technology audio is not operating properly, check whether the feature is turned off at **SETUP** ▶ [Phone] ▶ [Streaming Audio]. If the feature is off, turn back on and try again.
- If music is not yet playing from your mobile device after converting to *Bluetooth*[®] Wireless Technology Audio mode, pressing the play button once may start playing the mode. Check to see that music is playing from the *Bluetooth*[®] Wireless Technology device after converting to *Bluetooth*[®] Wireless Technology Audio Mode.

Pairing a *Bluetooth*[®] Wireless Technology Device

What is Bluetooth[®] *Wireless Technology Pairing?*

Pairing refers to the process of synchronizing your *Bluetooth*[®] Wireless Technology phone or device with the car audio system for connection. Pairing is necessary to connect and use the *Bluetooth*[®] Wireless Technology feature.

Pairing Using the **PHONE** Button or the Steering Wheel Control **Button**

When No Devices have been Paired

1. Press the **PHONE** key or the  key on the steering remote controller. The following screen is displayed.
2. Press the **OK** button to enter the Pair Phone screen.

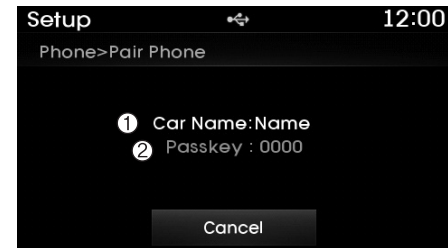
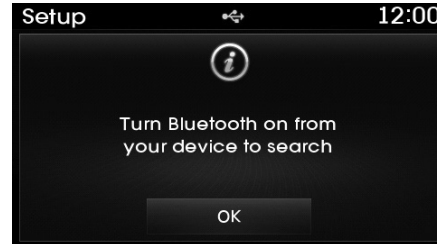

- 1) Car Name : Name of device as shown when searching from your *Bluetooth*[®] Wireless Technology device
- 2) Passkey : Passkey used to pair the device
3. From your *Bluetooth*[®] Wireless Technology device (i.e. Mobile Phone), search and select your car audio system.

[Non SSP supported device]
(SSP: Secure Simple Pairing)

4. After a few moments, a screen is displayed where the passkey is entered.

Hear, enter the passkey "0000" to pair your *Bluetooth*® Wireless Technology device with the car audio system.

[SSP supported device]

4. After a few moments, a screen is displayed 6 digits passkey.

Hear, check the passkey on your *Bluetooth*® Wireless Technology device and confirm.

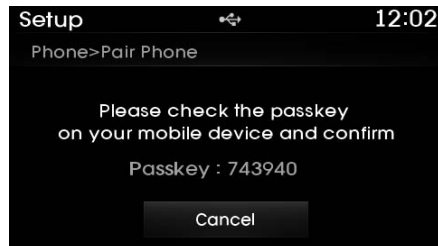

5. Once pairing is complete, the following screen is displayed.

* NOTICE



If *Bluetooth*® Wireless Technology devices are paired but none are currently connected, pressing the **PHONE** key or the **↶** key on the steering wheel displays the following screen. Press the [Pair] button to pair a new device or press the [Connect] to connect a previously paired device.

Pairing through [PHONE] Setup

Press the **SETUP** key ▶ Select [Phone] ▶ Select [Pair Phone] ▶ Select **TUNE** knob

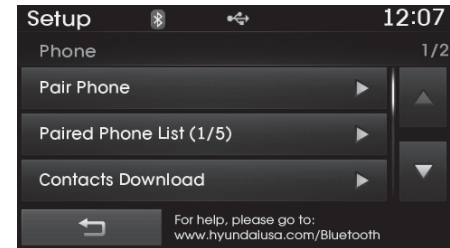

The following steps are the same as those described in the section "When No Devices have been Paired" on the previous page.

* NOTICE

- **Bluetooth® Wireless Technology** features supported within the vehicle are as follows. Some features may not be supported depending on your **Bluetooth® Wireless Technology** device.
 - Outgoing/Incoming Handsfree calls
 - Operations during a call (Switch to Private, Switch to call waiting, MIC on/off)
 - Downloading Call History
 - Downloading Mobile Contacts
 - **Bluetooth® Wireless Technology** device auto connection
 - Bluetooth Audio Streaming
- Up to five **Bluetooth® Wireless Technology** devices can be paired to the Car Handsfree system.
- Only one **Bluetooth® Wireless Technology** device can be connected at a time.
- Other devices cannot be paired while a **Bluetooth® Wireless Technology** device is connected.
- Only **Bluetooth® Wireless Technology Handsfree** and Bluetooth audio related features are supported.
- Bluetooth related operations are possible only with devices that support Handsfree or audio features, such as a **Bluetooth® Wireless Technology** mobile phone or a Bluetooth audio device.
- If a connected **Bluetooth® Wireless Technology** device becomes disconnected due to being out of communication range, turning the device OFF, or a **Bluetooth® Wireless Technology** communication error, corresponding **Bluetooth® Wireless Technology** devices are automatically searched and reconnected.
- If the system becomes unstable due to communication errors between the car Handsfree and the **Bluetooth® Wireless Technology** device, reset the device by turning off and back on again. Upon resetting **Bluetooth® Wireless Technology** device, the system will be restored.
- After pairing is complete, a contacts download request is sent once to the mobile phone. Some mobile phones may require confirmation upon receiving a download request, ensure your mobile phone accepts the connection. Refer to your phones user's manual for additional information regarding phone pairing and connections.

Connecting a Device

Press the **SETUP** key ▶ Select [Phone] ▶ Select [Paired Phone List]



- 1) Connected Phone : Device that is currently connected
- 2) Paired Phone : Device that is paired but not connected

From the paired phone list, select the device you want to connect and press the **Connect** button.



Changing Priority

What is Priority?

It is possible to pair up to five *Bluetooth*® Wireless Technology devices with the car audio system. The "Change Priority" feature is used to set the connection priority of paired phones.

Press the **SETUP** key ▶ Select [Phone] ▶ Select [Paired Phone List]



From the paired phone list, select the phone you want to switch to the highest priority, then press the **Change priority** button from the Menu. The selected device will be changed to the highest priority.

* NOTICE

Priority icon will be displayed when the selected phone is set as a priority phone.



Disconnecting a Device

Press the **SETUP** key ▶ Select [Phone] ▶ Select [Paired Phone List]



From the paired phone list, select the currently connected device and press the **Disconnect** button.

Deleting a Device

Press the **SETUP** key ▶ Select [Phone] ▶ Select [Paired Phone List]



From the paired phone list, select the device you want to delete and press the **Delete** button.

* NOTICE

- When deleting the currently connected device, the device will automatically be disconnected to proceed with the deleting process.
- If a paired *Bluetooth*® Wireless Technology device is deleted, the device's call history and contacts data will also be deleted.
- To re-use a deleted device, you must pair the device again.

USING *Bluetooth*® Wireless Technology

Phone Menu Screen

Phone Menus

With a *Bluetooth*® Wireless Technology device connected, press the **PHONE** key to display the Phone menu screen.



- 1) Favorite : Up to 20 frequently used contacts saved for easy access
- 2) Dial Number : Displays the dial screen where numbers can be dialed to make calls
- 3) Call History : Device the call history list screen

- 4) Contacts : Displays the Contacts list screen
- 5) Setup : Displays Phone related settings.

* NOTICE

- If you press the [Call History] button but there is no call history data, a prompt is displayed which asks to download call history data.
- If you press the [Contacts] button but there is no contacts data stored, a prompt is displayed which asks to download contacts data.
- This feature may not be supported in some mobile phones. For more information on download support, refer to your mobile phone user's manual.

Favorites

Press the **PHONE** key ▶ Select [Favorites]



- 1) Saved favorite contact : Connects call upon selection
- 2) To add favorite : Downloaded contacts be saved as favorite.
- 3) Delete All : Delete all stored favorite contacts

* NOTICE

- To save Favorite, contacts should be downloaded.
- Contact saved in Favorites will not be automatically updated if the contact has been updated in the phone. To update Favorites, delete the Favorite and create a new Favorite.

Calling by Dialing a Number

Press the **PHONE** key ▶ Select [Dial Number]

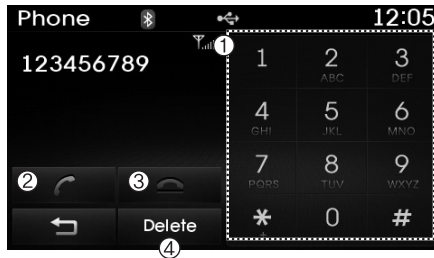

- 1) Dial Pad : Used to enter phone number
- 2) Call : If a number has been entered, calls the number. If no number has been entered, switches to call history screen
- 3) End : Deletes the entered phone number
- 4) Delete : Deletes entered numbers one digit at a time

Answering Calls

Answering a Call

Answering a call with a *Bluetooth®* Wireless Technology device connected will display the following screen.

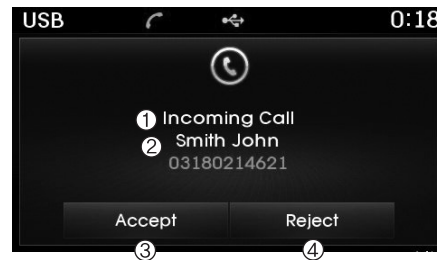

- 1) Caller : Displays the other party's name when the incoming caller is saved within your contacts
- 2) Incoming Number : Displays the incoming number
- 3) Accept : Accept the incoming call
- 4) Reject : Reject the incoming call

* NOTICE

- When an incoming call pop-up is displayed, most Audio and SETUP mode features are disabled. Only the call volume will operate.
- The telephone number may not be properly displayed in some mobile phones.
- When a call is answered with the mobile phone, the call mode will automatically revert to Private mode.

During a Handsfree Call



- 1) Caller : Displays the other party's name if the incoming caller is saved within your contacts
- 2) Incoming Number : Displays the incoming number
- 3) Call time : Displays the call time
- 4) End : Ends call
- 5) Private : Converts to Private mode
- 6) Out Vol. : Sets call volume as heard by the other party
- 7) Mute : Turns Mic Mute On/Off

* NOTICE

If the mic is muted, the other party will not be able to hear your voice.

Call History

Press the **PHONE** key ▶ Select [Call History]



A list of incoming, outgoing and missed calls is displayed.

Press the **Download** button to download the call history.

- 1) Call History :
 - Displays recent calls (call history)
 - Connects call upon selection
- 2) Download : Download Recent Call History

- Call history may not be saved in the call history list in some mobile phones.
- Calls received with hidden caller ID will not be saved in the call history list.
- Calling through the call history is not possible when there is no call history stored or a *Bluetooth®* Wireless Technology phone is not connected.
- Up to 50 received, dialed and missed calls are stored in Call History.
- Time of received/dialed calls and call time information are not saved.

Contacts

Press the **PHONE** key ▶ Select [Contacts]

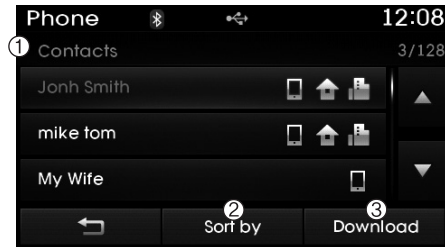

The list of saved phone book entries is displayed. Press the **Download** button to download the call history.

- 1) Contacts List :
 - Displays downloaded contacts entries
 - Connects call upon selection
- 2) Sort by : Find a contact in an alphabetical order.
- 3) Download : Download contacts entries

* NOTICE

- Up to 1,000 contacts saved in your *Bluetooth*® Wireless Technology phone can be downloaded into the car contacts. Contacts that have been downloaded to the car cannot be edited or deleted on the phone.
- Mobile phone contacts are managed separately for each paired *Bluetooth*® Wireless Technology device (max 5 devices x 1,000 contacts each). Previously downloaded data is maintained even if the *Bluetooth*® Wireless Technology device has been disconnected. (However, the contacts and call history saved to the phone will be deleted if a paired phone is deleted.)
- It is possible to download contacts during Bluetooth streaming audio.
- When downloading contacts, the icon will be displayed within the status bar.
- It is not possible to begin downloading a contact list when the contact download feature has been turned off within the *Bluetooth*® Wireless Technology device. In addition, some devices may require device authorization upon attempting to download contacts. If downloading does not normally occur, check the *Bluetooth*® Wireless Technology device settings or the screen state.
- The contacts download feature may not be supported in some mobile phones. For more information of supported *Bluetooth*® devices and function support, refer to your phone's user manual.

Bluetooth® Wireless Technology Setting

Pairing a New Device

Press the **SETUP** key ▶ Select [Phone] ▶ Select [Pair Phone]

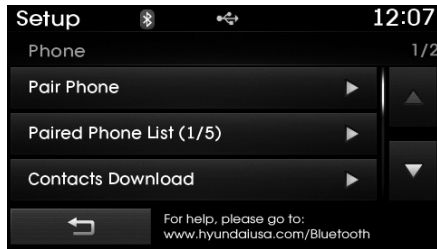

Bluetooth® Wireless Technology devices can be paired with the audio system.

For more information, refer to the "Pairing through Phone Setup" section within Bluetooth® Wireless Technology.

Viewing Paired Phone List

Press the **SETUP** key ▶ Select [Phone] ▶ Select [Paired Phone List]



This feature is used to view mobile phones that have been paired with the audio system. Upon selecting a paired phone, the setup menu is displayed.

For more information, refer to the "Setting Bluetooth® Wireless Technology Connection" section within Bluetooth® Wireless Technology.

- 1)  : Moves to the previous screen
- 2) Connect/Disconnect Phone : Connect/ disconnects currently selected phone

- 3) Delete : Deletes the currently selected phone
- 4) Change Priority : Sets currently selected phone to highest connection priority

*** NOTICE BEFORE DOWNLOADING CONTACTS**

- Only contacts within connected phones can be downloaded. Also check to see that your mobile phone supports the download feature.
- To learn more about whether your mobile phone supports contacts downloads, refer to your mobile phone user's manual.
- The contacts for only the connected phone can be downloaded.

Downloading Contacts

Press the **SETUP** key ▶ Select [Phone] ▶ Select [Contacts Download]

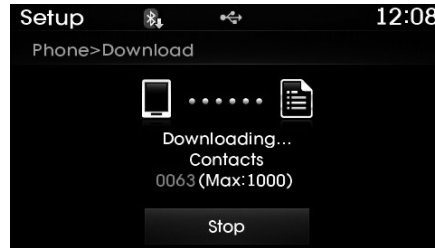

As the contacts are downloaded from the mobile phone, a download progress bar is displayed.

*** NOTICE**

- Upon downloading phone contacts, the previous corresponding data is deleted.
- This feature may not be supported in some mobile phones.
- Voice Recognition may not operate while contacts are being downloaded.

Outgoing Volume

Press the **SETUP** key ▶ Select [Phone] ▶ Select [Outgoing Volume]

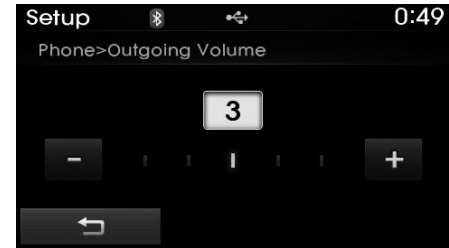

Use the **-**, **+** buttons to adjust the outgoing volume level.

*** NOTICE**

While on a call, the volume can be changed by using the **SEEK TRACK** key.

Turning Bluetooth System Off

Press the **SETUP** key ▶ Select [Phone] ▶ Select [Bluetooth System Off]

Once *Bluetooth*® Wireless Technology is turned off, *Bluetooth*® Wireless Technology related features will not be supported within the audio system.

* NOTICE

To turn *Bluetooth*® Wireless Technology back on, go to **SETUP** ▶ [Phone] and press “Yes”.

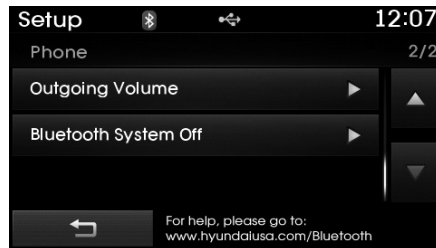

VOICE RECOGNITION

Using Voice Recognition

Starting Voice Recognition

Shortly press the  key on the steering wheel remote controller. Say a command.

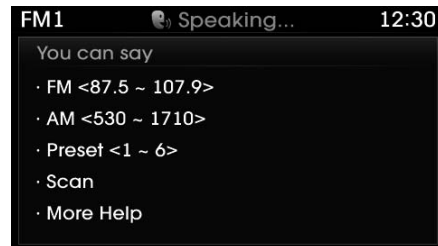

If prompt feedback is in [ON], then the system will say “Please say a command after the beep (BEEP)”

- If prompt feedback is in [OFF] mode, then the system will only say “(BEEP)”
- To change Prompt Feedback [On]/[Off], go to **SETUP** ▶ [System] ▶ [Prompt Feedback]

* NOTICE

For proper recognition, say the command after the voice instruction and beep tone.

Contact List Best Practices

- 1) Do not store single-name entries (e.g., “Bob”, “Mom”, “Kim”, etc.). Instead, always use full names (including first and last names) for all contacts (e.g., use “Jacob Stevenson” instead of “Dad”).
- 2) Do not use abbreviations (i.e., use “Lieutenant” instead of “Lt.” or “Sergeant” instead of “Sgt.”).
- 3) Do not use acronyms (i.e., use “County Finance Department” instead of “CFD”).

- 4) Do not use special characters (e.g., “@”, “hyphen -”, “asterisk *”, “ampersand &”).
- 5) If a name is not recognized from the contact list, change it to a more descriptive name (e.g., use “Grandpa Joseph” instead of “Pa Joe”).

Skipping Prompt Messages

While prompt message is being stated ▶ Shortly press the  key on the steering wheel remote controller.

The prompt message is immediately ended and the beep tone will sound. After the “beep”, say the voice command.

Re-starting Voice Recognition

While system waits for a command ▶ Shortly press the  key on the steering wheel remote controller.

The command wait state is immediately ended and the beep tone will sound. After the “beep”, say the voice command.

* Illustration on using voice commands

• Starting voice command.

Shortly pressing the  key (under 0.8 seconds):

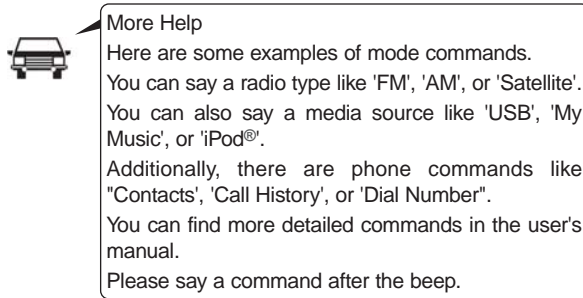
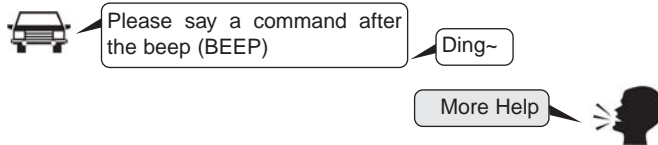

• Skipping Voice Recognition

Shortly pressing the  key (under 0.8 seconds):

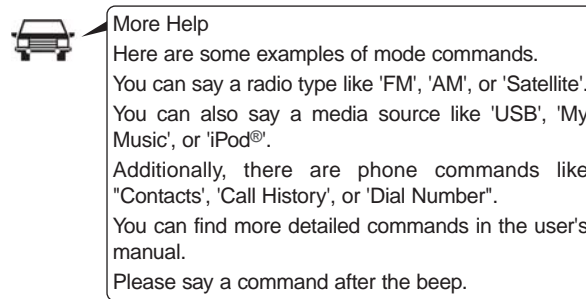

• End voice command.

Shortly pressing the  key (under 0.8 seconds):

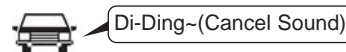
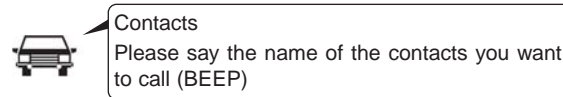
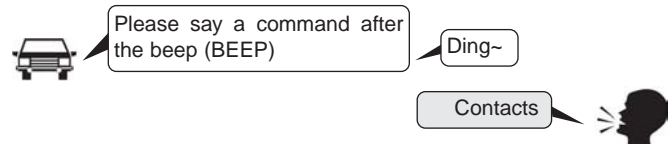

Voice Command List

- **Common Commands:** These commands can be used in most operations. (However a few commands may not be available during certain operations)

Command	Function
More Help	Provides guidance on commands that can be used anywhere in the system.
Help	Provides guidance on commands that can be used within the current mode.
Call<Name>	Calls <Name> saved in Contacts Ex) Call "John Smith"
Call <Name> on Mobile	Calls <Name> to the number that is saved as "Mobile" in Contacts Ex) Call "John Smith" on Mobile
Call <Name> in Office	Calls <Name> to the number that is saved as "Office" in Contacts Ex) Call "John Smith" in Office
Call <Name> at Home	Calls <Name> to the number that is saved as "Home" in Contacts Ex) Call "John Smith" at Home
Call <Name> on Other	Calls <Name> to the number that is saved as "Other" in Contacts Ex) Call "John Smith" on Other
Phone	Provides guidance on Phone related commands. After saying this command, say "Favorites", "Dial Number", "Call History" or "Contacts" execute corresponding functions.
Favorites	Display the Favorite screen.
Call History	Displays the Call History screen.

Command	Function
Contacts (Call by Name)	Displays the Contacts screen. After saying this command, say the name of a contact saved in the Contacts to automatically connect the call.
Dial Number	Display the Dial number screen. After saying this command, you can say the number that you want to call.
Redial	Connects the most recently called number.
Tutorial	Provide guidance on how to use voice recognition and Bluetooth® connections.
Radio	<ul style="list-style-type: none"> • When listening to the radio, displays the next radio screen. (FM1→FM2→AM→XM1→XM2→XM3→FM1) • When listening to a different mode, displays the most recently played radio screen. • When currently listening to the FM radio, maintains the current state. • When listening to a different mode, displays the most recently played FM screen.
FM1(FM One)	Displays the FM1 screen.
FM2(FM Two)	Displays the FM2 screen.
AM	Displays the AM screen.

Features of your vehicle

Command	Function
FM Preset 1~6	Plays the most recently played broadcast saved in FM Preset 1~6.
AM Preset 1~6	Plays the broadcast saved in AM Preset 1~6.
FM 87.5~107.9	Plays the FM broadcast of the corresponding frequency.
AM 530~1710	Plays the AM broadcast of the corresponding frequency.
XM (Satellite)	<ul style="list-style-type: none">• When currently listening to the XM, maintains the current state.• When listening to a different mode, displays the most recently played XM screen.
XM (Satellite) 1~3	Displays the selected XM screen.
XM Channel 0~255	Plays the selected XM channel.
Media	Moves to the most recently played media screen.
CD	Plays the music saved in the CD.
USB	Plays USB music.
iPod®	Plays iPod® music.

Command	Function
My Music	Plays the music saved in My Music.
AUX (Auxiliary)	Plays the connected external device.
Bluetooth® Audio	Plays the music saved in connected Bluetooth® device.
Please repeat	Repeats the most recent comment.
Mute	Mutes the sound
Cancel (Exit)	Ends voice command.

- FM/AM radio commands: available during FM, AM radio operation

Command	Function
Preset 1~6	Plays the broadcast saved in Preset 1~6.
Scan	Scans receivable frequencies from the current broadcast and plays for 10 seconds each.
Preset Scan	Moves to the next preset from the current present and plays for 10 seconds each.
Information	Displays the information of the current broadcast.(This feature can be used when receiving RBDS broadcasts.)

- Satellite radio commands: Commands that can be used while listening to Satellite Radio.

Command	Function
Channel 0~255	Play the selected Satellite Radio channel.
Scan	Scans receivable channels from the current broadcast and plays for 10 seconds each.
Preset 1~6	Plays the broadcast saved in Preset 1~6.
Information	Displays the information of the current broadcast.

Features of your vehicle

- Audio CD commands: Commands available during Audio CD operation

Command	Function
Play	Plays the currently paused track.
Pause	Pauses the current track.
Shuffle	Randomly plays the tracks within the CD.
Shuffle Off	Cancels random play to play tracks in sequential order.
Repeat	Repeats the current track.
Repeat Off	Cancels repeat play to play tracks in sequential order.
Track 1-30	Plays the desired track number.

- MP3 CD / USB commands: Commands available during USB and MP3 CD operation

Command	Function
Play	Plays the currently paused file.
Pause	Pauses the current file.
Shuffle	Randomly plays the files within the current folder.
Shuffle Off	Cancels random play to play files in sequential order.
Repeat	Repeats the current file.
Repeat Off	Cancels repeat play to play files in sequential order.
Next Folder	Play the first file in the next folder
Previous Folder	Play the first file in the previous folder

- iPod® Commands: Commands available during iPod® operation

Command	Function
Play	Plays the currently paused song.
Pause	Pauses the current song.
Shuffle	Randomly plays the songs within the current category.
Shuffle Off	Cancels random play to play songs in sequential order.
Repeat	Repeats the current song.
Repeat Off	Cancels repeat play to play songs in sequential order.

- My Music Commands: Commands available during My Music operation

Command	Function
Play	Plays the currently paused file.
Pause	Pauses the current file.
Shuffle	Randomly plays all saved files.
Shuffle Off	Cancels random play to play files in sequential order.
Repeat	Repeats the current file.
Repeat Off	Cancels repeat play to play files in sequential order.
Delete	Deletes the current file. You will bypass an additional confirmation process.

SETUP

Starting Mode

Press the **SETUP** key to display the Setup screen.

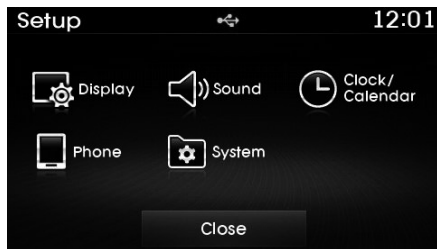

You can select and control options related to [Display], [Sound], [Clock/Calendar], [Phone] and [System].

Display Settings

Adjusting the Brightness

Press the **SETUP** key to Select [Display] to Select [Brightness]

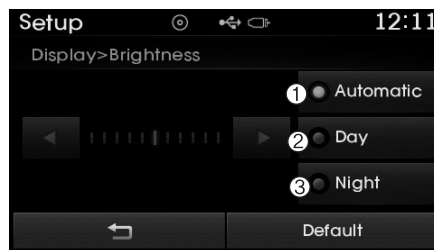

Use the **◀**, **▶** buttons to adjust the screen brightness or set the Brightness on Automatic, Daylight, or Night mode.

Press the **Default** button to reset.

- 1) Automatic : Adjusts the brightness automatically
- 2) Daylight : Always maintains the brightness on high
- 3) Night: Always maintains the brightness on low

Mode Pop-up

Press the **SETUP** key to Select [Display] to Select [Mode Pop up]

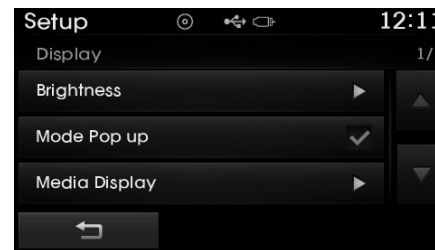

This feature is used to display the Mode Pop-up screen when entering radio and media modes.

When this feature is turned on, pressing the **RADIO** or **MEDIA** key will display the Mode Pop-up screen.

* NOTICE

The media Mode Pop-up screen can be displayed only when two or more media modes have been connected.

MP3 Information Display

Press the **SETUP** key ▶ Select [Display] ▶ Select [Media Display]



This feature is used to change the information displayed within USB and MP3 CD modes.

- 1) Folder File : Displays file name and folder name
- 2) Album Artist Song : Displays album name/artist name/song

Sound Settings

Sound Settings

Press the **SETUP** key ▶ Select [Sound] ▶ Select [Sound Setting]



Use the ◀, ▶, ▲, ▼ buttons to adjust the Fader/Balance settings.

Use the ◀, ▶ buttons to adjust the Bass/Middle/Treble settings.

Press the **Default** button to reset.

Virtual Sound

Press the **SETUP** key ▶ Select [Sound] ▶ Select [Virtual Sound]

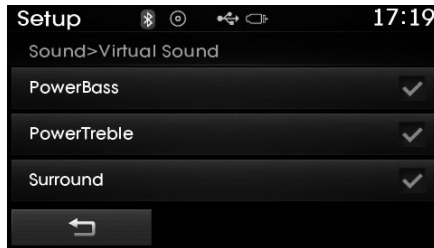

This feature is used to set the Power Bass, Power Treble and Surround sound options.

SDVC (Speed Dependent Volume Control)

Press the **SETUP** key ▶ Select [Sound] ▶ Select [Speed Dependent Vol.]

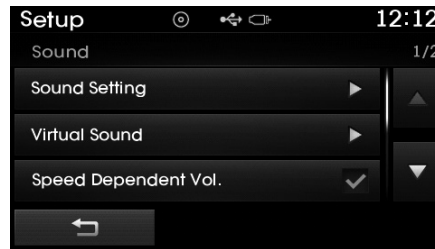

The volume level is controlled automatically according to the vehicle speed. SDVC can be set by selecting from On/Off.

Voice Recognition Volume

Press the **SETUP** key ▶ Select [Sound] ▶ Select [Voice Recognition Vol.]



Turn the **TUNE** knob to adjust the Voice Recognition volume.

Touch Screen Beep

Press the **SETUP** key ▶ Select [Sound] ▶ Select [Touch Screen Beep]

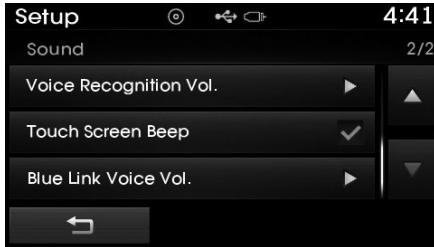

This feature is used to turn the touch screen beep on/off.

Blue Link Voice Volume

Press the **SETUP** key ▶ Select [Sound] ▶ Select [Blue Link Voice Vol.]



Turn the **TUNE** knob to adjust the Blue Link Voice Volume.

* Blue Link® may differ depending on the selected audio.

Clock/Calendar Setting

Clock Setting

Press the **SETUP** key ▶ Select [Clock/Calendar] ▶ Select [Clock Settings]

Use the **▲**, **▼** buttons to set the Hour, Minutes setting and select AM/PM.

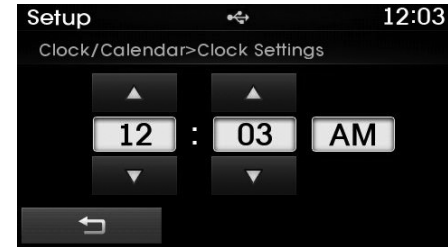

* NOTICE

Press and hold the **CLOCK** key (over 0.8 seconds) to set the Clock/Calendar screen.

Calendar Setting

Press the **SETUP** key ▶ Select [Clock/Calendar] ▶ Select [Calendar Settings]

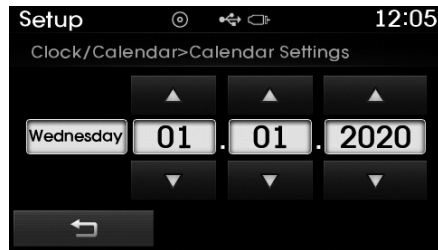

Use the **▲**, **▼** buttons to set the Month, Day and Year setting.

Time Format

Press the **SETUP** key ▶ Select [Clock/Calendar] ▶ Select [Time Format]

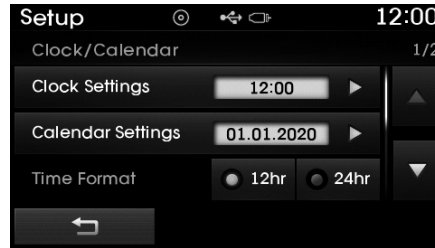

This feature is used to change the clock format between 12hr or 24hr.

Clock Display

Press the **SETUP** key ▶ Select [Clock/Calendar] ▶ Select [Clock Display (Power off)]

This feature is used to display a clock on the screen when the audio system is turned off.

System Setting

HD Radio™ On/Off

Press the **SETUP** key ▶ Select [System] ▶ Select [FM], [AM]

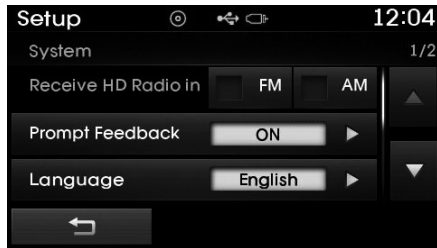

This feature is used to set whether to receive FM/AM HD Radio™ broadcasts.

Prompt Feedback

Press the **SETUP** key ▶ Select [System] ▶ Select [Prompt Feedback]

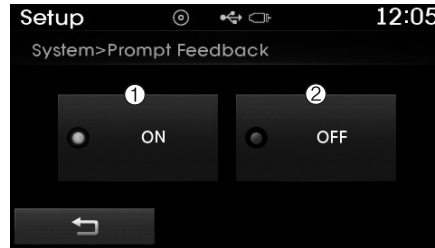

This feature is used to select the desired prompt feedback option from ON and OFF.

- 1) ON : When using voice recognition, provides detailed guidance prompts
- 2) OFF : When using voice recognition, omits some guidance prompts

Language

Press the **SETUP** key ▶ Select [System] ▶ Select [Language]

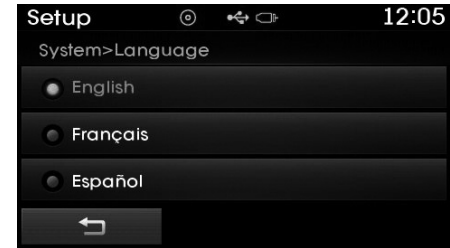

This feature is used to change the system and voice recognition language.

If the language is changed, the system will restart and apply the selected language.

Memory Information

Press the **SETUP** key ▶ Select [System] ▶ Select [Memory Information]

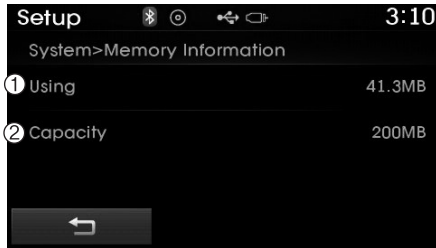

This feature displays information related to system memory.

- 1) Using : Displays capacity currently in use
- 2) Capacity : Displays total capacity

REAR VIEW CAMERA (if equipped)

- The system has been equipped with a rear view camera for user safety by allowing a wider rear range of vision.
- The rear view camera will automatically operate when the ignition key is turned ON and the transmission shift lever is positioned into reverse (R).
- The rear view camera will automatically stop operating when set to a the transmission shift lever is positioned to another gear.

CAUTION



The rear view camera has been equipped with an optical lens to provide a wider range of vision and may appear different from the actual distance. For safety, directly check the rear and left/right sides.

Blue Link®

Hyundai aims to offer differentiated customer values through a 'Connected Car Life,' which provides consumers with fast and reliable IT technology. As consumers' lifestyles become more and more mobile in thanks to remarkable advances in smart phones, tablet PCs and overall wireless telecommunication, new lifestyle patterns demand seamless connection between one's office, home, outdoors and automobiles.

Blue Link® is Hyundai's innovative telematics solution that combines safety, service, and infotainment into a complete package. It works to both help simplify Hyundai owners' lives and reduce distracted driving. The Blue Link® "  " button offers access to a voice-response menu of services.



The Blue Link®  button offers access to enhanced navigation services. The "  " button offers immediate contact to SOS Emergency Assistance. A detailed list of commands is available in the Blue Link User's Manual.

Using Rear View Mirror Buttons

Pressing the Blue Link® buttons located on the rear view mirror will allow you to make service required inquiries, POI info searches, and emergency rescues by connecting to the Blue Link® Center.

Such features can be used only after subscribing to the Blue Link® service.

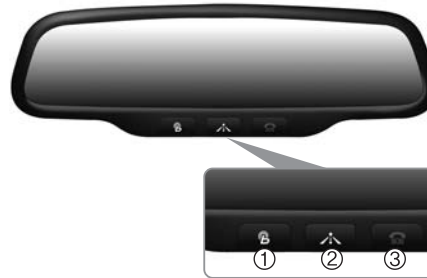

① (Blue Link® Center)

Makes requests for Blue Link® service related inquiries and consultations.

A call is connected to the Blue Link® service center employee.

Pressing the key again will end the call.

This feature does not operate when you are on a Bluetooth® phone call.

② (Blue Link® for POI)

- Blue Link® for Voice command

Starts Blue Link® voice command.

Voice receiving voice guidance, shortly press the button to convert to voice command mode. Press and hold the button to end voice command.

- TBT VR Commands

1. Navigate to

"Navigate to" voice command is used to request the download of route data for a new destination, saved destinations, daily routes and previous destinations.

2. Save Destination

“Save Destination” VR command is used to assign a voice tag to the last downloaded destination and store it in a destination directory.

* NOTICE

The Turn by Turn(TBT) feature supports the store of ten(10) destinations in the TBT destinations directory.

3. Route Preview

“Route Preview” VR command allows the user to preview the route instructions (upcoming maneuver instructions) at any time during the route guidance.

4. Destinations List

“Destinations List” VR command allows the user to preview and delete the stored destinations with their associated voice tags in the Turn by Turn destinations directory.

5. Voice Guidance

“Voice Guidance” VR command allows the user to mute/unmute the Turn by Turn(TBT) direction announcements.

6. Suspend Route

“Suspend Route” VR command allows the user to suspend and pause Turn by Turn(TBT) route guidance while in the guidance mode.

7. Resume Route

“Resume Route” VR command allows the user to resume Turn by Turn(TBT) route guidance.



③ (Blue Link® for SOS)

In the case of an emergency, requests for help to the Blue Link® center.

Call is connected to the Blue Link® emergency rescue center. Pressing the key again will end the call.

If you are already on a Bluetooth® phone call, the call will end to connect you to the Blue Link® Emergency Rescue Center.

CAUTION

- **You cannot talk simultaneously on the Bluetooth® phone call and a Blue Link® services phone all.**
- **While on a Bluetooth® call, pressing the  key or  key will display a message indicating that you are currently on a call.**
- **A message will be displayed if you receive a Bluetooth® call while already on a Blue Link® call. To answer the incoming call, press the  button on the steering wheel controls. You will not hear a ring to alert you that there is an incoming call.**

Eco Coach

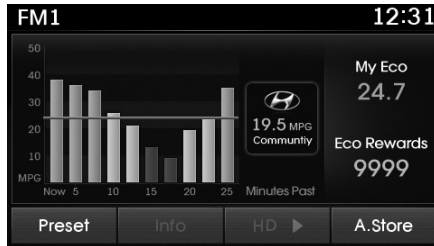

- What is Eco Coach?

Every 2.5 minutes, Eco Coach compares your fuel economy against the government tested average (EPA) or other similar Hyundai models (community), based on your preference. Each month, or after every tank fill up, Eco Coach rates your extended average and gives you a reward star if you best the average.

See your My Hyundai web page for more information.

- What does the bar graph and horizontal line mean?

The horizontal line is adjusted once per month or at each tank full, based on your preference; it represents the EPA combined average or community average fuel economy target.

- What is My Eco MPG?

Your actual fuel economy average over 2.5 minutes.

This value is also shown in bar graph as your “now” rating.

- What are Eco Rewards?

If you beat the average (the EPA or community), you will receive an Eco Reward point.

See your my Hyundai web page for more information.

[Eco Driving] will not operate if the vehicle ignition is not turned on. Please operate with the ignition turned on.

Turn by Turn

The Turn by Turn feature can be used through Blue Link®.

* For information on specific Blue Link® operations, please refer to the Blue Link® User's Manual that was provided with your vehicle.

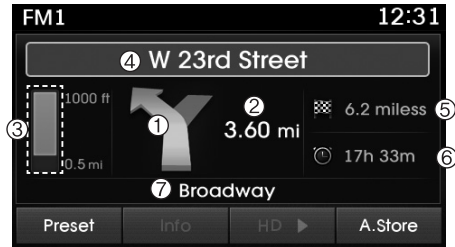

1. Direction Indicator Image
2. Remaining distance until next point
3. The Count bar is divided into a total of 9 levels.

9 Level	0.5mi	8 Level	0.4mi
7 Level	0.3mi	6 Level	0.2mi
5 Level	0.1mi	4 Level	400ft
3 Level	300ft	2 Level	200ft
1 Level	100ft		

4. Next Street name
5. Distance to destination
6. Expected Time Arrival
7. Current Street name

How vehicle audio works

FM reception

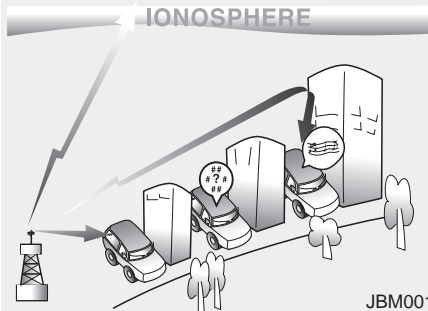

AM and FM radio signals are broadcast from transmitter towers located around your city. They are intercepted by the radio antenna on your vehicle. This signal is then processed by the radio and sent to your vehicle speakers.

When a strong radio signal has reached your vehicle, the precise engineering of your audio system ensures the best possible quality reproduction. However, in some cases the signal coming to your vehicle may not be strong and clear.

This can be due to factors, such as the distance from the radio station, closeness of other strong radio stations or the presence of buildings, bridges or other large obstructions in the area.

AM reception

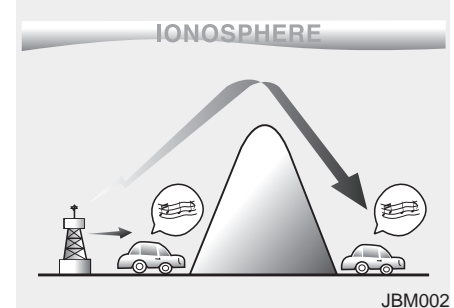

AM broadcasts can be received at greater distances than FM broadcasts. This is because AM radio waves are transmitted at low frequencies. These long distance, low frequency radio waves can follow the curvature of the earth rather than travelling straight. In addition, they curve around obstructions resulting in better signal coverage.

Features of your vehicle

FM radio station

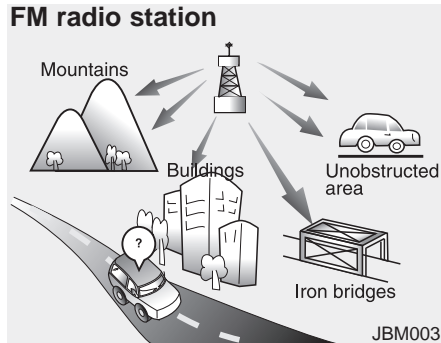

FM broadcasts are transmitted at high frequencies and do not bend to follow the earth's surface. Because of this, FM broadcasts generally begin to fade within short distances from the station. Also, FM signals are easily affected by buildings, mountains, and obstructions. This can lead to undesirable or unpleasant listening conditions which might lead you to believe a problem exists with your radio. The following conditions are normal and do not indicate radio trouble:

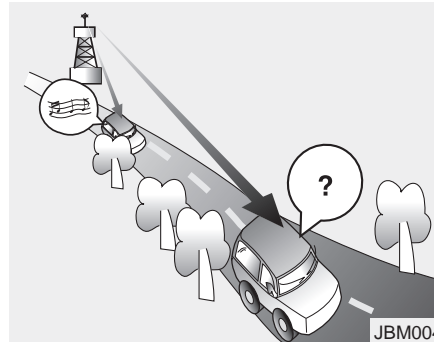

- **Fading** - As your vehicle moves away from the radio station, the signal will weaken and sound will begin to fade. When this occurs, we suggest that you select another stronger station.
- **Flutter/Static** - Weak FM signals or large obstructions between the transmitter and your radio can disturb the signal causing static or fluttering noises to occur. Reducing the treble level may lessen this effect until the disturbance clears.

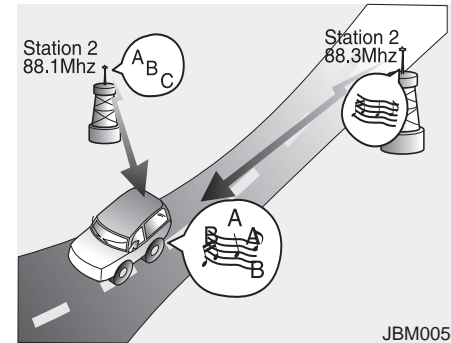

- **Station Swapping** - As an FM signal weakens, another more powerful signal near the same frequency may begin to play. This is because your radio is designed to lock onto the clearest signal. If this occurs, select another station with a stronger signal.
- **Multi-Path Cancellation** - Radio signals being received from several directions can cause distortion or fluttering. This can be caused by a direct and reflected signal from the same station, or by signals from two stations with close frequencies. If this occurs, select another station until the condition has passed.

Using a cellular phone or a two-way radio

When a cellular phone is used inside the vehicle, noise may be produced from the audio system. This does not mean that something is wrong with the audio equipment. In such a case, try to operate mobile devices as far from the audio equipment as possible.

 CAUTION

When using a communication system such as a cellular phone or a radio set inside the vehicle, a separate external antenna must be fitted. When a cellular phone or a radio set is used with an internal antenna alone, it may interfere with the vehicle's electrical system and adversely affect safe operation of the vehicle.

 WARNING

Do not use a cellular phone while driving. Stop at a safe location to use a cellular phone.

Caring for CDs

- If the temperature inside the car is too high, open the car windows to ventilate before using the system.
- It is illegal to copy and use MP3/WMA files without permission. Use CDs that are created only by lawful means.
- Do not apply volatile agents, such as benzene and thinner, normal cleaners and magnetic sprays made for analogue disc onto CDs.
- To prevent the disc surface from getting damaged, hold CDs by the edges or the center hole only.
- Clean the disc surface with a piece of soft cloth before playback (wipe it from the center to the outside edge).
- Do not damage the disc surface or attach pieces of sticky tape or paper.
- Make certain only CDs are inserted into the CD player (Do not insert more than one CD at a time).
- Keep CDs in their cases after use to protect them from scratches or dirt.

- Depending on the type of CD-R/CD-RW CDs, certain CDs may not operate normally according to the manufacturing companies. In such circumstances, continued use may cause malfunctions to your audio system.

*** NOTICE - Playing an Incompatible Copy Protected Audio CD**

Some copy protected CDs, which do not comply with international audio CD standards (Red Book), may not play on your car audio. Please note that inability to properly play a copy protected CD may indicate that the CD is defective, not the CD player.

* NOTICE

Order of playing files (folders) :

1. Song playing order : ① to ⑭ sequentially.

2. Folder playing order :

* If no song file is contained in the folder, that folder is not displayed.

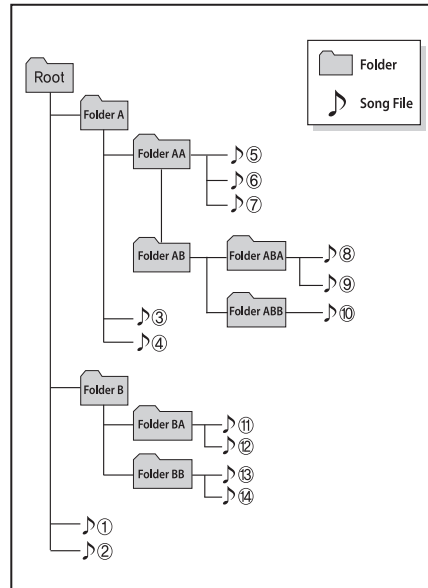
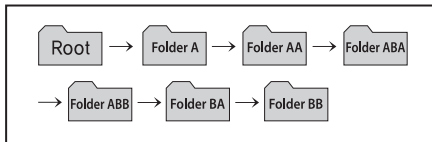

⚠ WARNING

- Do not stare at the screen while driving. Staring at the screen for prolonged periods of time could lead to traffic accidents.
- Do not disassemble, assemble, or modify the audio system. Such acts could result in accidents, fire, or electric shock.
- Using the phone while driving may lead to a lack of attention of traffic conditions and increase the likelihood of accidents. Use the phone feature after parking the vehicle.
- Heed caution not to spill water or introduce foreign objects into the device. Such acts could lead to smoke, fire, or product malfunction.

(Continued)

(Continued)

- Please refrain from use if the screen is blank or no sound can be heard as these signs may indicate product malfunction. Continued use in such conditions could lead to accidents (fires, electric shock) or product malfunctions.
- Do not touch the antenna during thunder or lightning as such acts may lead to lightning induced electric shock.
- Do not stop or park in parking-restricted areas to operate the product. Such acts could lead to traffic accidents.
- Use the system with the vehicle ignition turned on. Prolonged use with the ignition turned off could result in battery discharge.

 **CAUTION**

- *Operating the device while driving could lead to accidents due to a lack of attention to external surroundings. First park the vehicle before operating the device.*
- *Adjust the volume to levels that allow the driver to hear sounds from outside of the vehicle. Driving in a state where external sounds cannot be heard may lead to accidents.*
- *Pay attention to the volume setting when turning the device on. A sudden output of extreme volume upon turning the device on could lead to hearing impairment. (Adjust the volume to a suitable levels before turning off the device.)*

(Continued)

(Continued)

- *Turn on the car ignition before using this device. Do not operate the audio system for long periods of time with the ignition turned off as such operations may lead to battery discharge.*
- *Do not subject the device to severe shock or impact. Direct pressure onto the front side of the monitor may cause damage to the LCD or touch screen.*
- *When cleaning the device, make sure to turn off the device and use a dry and smooth cloth. Never use tough materials, chemical cloths, or solvents (alcohol, benzene, thinners, etc.) as such materials may damage the device panel or cause color/quality deterioration.*

(Continued)

(Continued)

- *Do not place beverages close to the audio system. Spilling beverages may lead to system malfunction.*
- *In case of product malfunction, please contact your place of purchase or After Service center.*
- *Placing the audio system within an electromagnetic environment may result in noise interference.*
- *Prevent caustic solutions such as perfume and cosmetic oil from contacting the dashboard because they may cause damage or discoloration.*

*** NOTICE - USING THE USB DEVICE**

- To use an external USB device, make sure the device is not connected when starting up the vehicle. Connect the device after starting up.
- If you start the engine when the USB device is connected, it may damage the USB device. (USB flashdrives are very sensitive to electric shock.)
- If the engine is started up or turned off while the external USB device is connected, the external USB device may not work.
- The System may not play unauthenticated MP3 or WMA files.
 - 1) It can only play MP3 files with the compression rate between 8Kbps~320Kbps.
 - 2) It can only play WMA music files with the compression rate between 8Kbps~320Kbps.
- Take precautions for static electricity when connecting or disconnecting the external USB device.

(Continued)

(Continued)

- An encrypted MP3 PLAYER is not recognizable.
- Depending on the condition of the external USB device, the connected external USB device can be unrecognizable.
- When the formatted byte/sector setting of External USB device is not either 512BYTE or 2048BYTE, then the device will not be recognized.
- Use only a USB device formatted to FAT 12/16/32.
- USB devices without USB I/F authentication may not be recognizable.
- Make sure the USB connection terminal does not come in contact with the human body or other objects.
- If you repeatedly connect or disconnect the USB device in a short period of time, it may break the device.
- You may hear a strange noise when connecting or disconnecting a USB device.

(Continued)

(Continued)

- If you disconnect the external USB device during playback in USB mode, the external USB device can be damaged or may malfunction. Therefore, disconnect the external USB device when the audio is turned off or in another mode. (e.g, Radio, CD)
- Depending on the type and capacity of the external USB device or the type of the files stored in the device, there is a difference in the time taken for recognition of the device.
- Do not use the USB device for purposes other than playing music files.
- Playing videos through the USB is not supported.
- Use of USB accessories such as rechargers or heaters using USB I/F may lower performance or cause trouble.

(Continued)

(Continued)

- If you use devices such as a USB hub purchased separately, the vehicle's audio system may not recognize the USB device. In that case, connect the USB device directly to the multimedia terminal of the vehicle.
- If the USB device is divided by logical drives, only the music files on the highest-priority drive are recognized by car audio.
- Devices such as MP3 Player/ Cellular phone/Digital camera can be unrecognizable by standard USB I/F can be unrecognizable.
- Charging through the USB may not be supported in some mobile devices.
- USB HDD or USB types liable to connection failures due to vehicle vibrations are not supported. (i-stick type)
- Some non-standard USB devices (METAL COVER TYPE USB) can be unrecognizable.

(Continued)

(Continued)

- Some USB flash memory readers (such as CF, SD, micro SD, etc.) or external-HDD type devices can be unrecognizable.
- Music files protected by DRM (DIGITAL RIGHTS MANAGEMENT) are not recognizable.
- The data in the USB memory may be lost while using this audio. Always back up important data on a personal storage device.
- Please avoid using USB memory products which can be used as key chains or cellular phone accessories as they could cause damage to the USB jack. Please make certain only to use plug type connector products.



*** NOTICE - USING THE iPod® DEVICE**

- iPhone® is a registered trademark of Apple inc.
- Some iPod® models may not support communication protocol and files may not play properly.

Supported iPod® models:

- iPhone® 3GS/4
- iPod® touch 1st~4th generation
- iPod® nano 1st~6th generation
- iPod® classic
- The order of search or playback of songs in the iPod® can be different from the order searched in the audio system.
- If the iPod® is disabled due to its own malfunction, reset the iPod®. (Reset: Refer to iPod® manual)
- An iPod® may not operate normally on low battery.

(Continued)

(Continued)

- Some iPod® devices, such as the iPhone®, can be connected through the *Bluetooth*® Wireless Technology interface. The device must have audio *Bluetooth*® Wireless Technology capability (such as for stereo headphone *Bluetooth*® Wireless Technology).
The device can play, but it will not be controlled by the audio system.
- To use iPod® features within the audio, use the cable provided upon purchasing an iPod® device.
- Skipping or improper operation may occur depending on the characteristics of your iPod®/iPhone® device.
- If your iPhone® is connected to both the *Bluetooth*® Wireless Technology and USB, the sound may not be properly played. In your iPhone®, select the Dock connector or *Bluetooth*® Wireless Technology to change the sound output (source).

(Continued)

(Continued)

- When connecting iPod® with the iPod® Power Cable, insert the connector to the multimedia socket completely. If not inserted completely, communications between iPod® and audio may be interrupted.
- When adjusting the sound effects of the iPod® and the audio system, the sound effects of both devices will overlap and might reduce or distort the quality of the sound.
- Deactivate (turn off) the equalizer function of an iPod® when adjusting the audio system's volume, and turn off the equalizer of the audio system when using the equalizer of an iPod®.
- When not using iPod® with car audio, detach the iPod® cable from iPod®. Otherwise, iPod® may remain in accessory mode, and may not work properly.

*** NOTICE - *Bluetooth*® Wireless Technology**

- The *Bluetooth*® word mark and logos are registered trademarks owned by Bluetooth SIG, Inc. and any use of such marks is under license.
A *Bluetooth*® enabled call phone is required to use *Bluetooth*® wireless technology.
- *Bluetooth*® Wireless Technology phone compatibility can be checked by visiting www.hyundaiusa.com and under the CARING FOR YOUR CAR - BLUETOOTH COMPATIBILITY menu.

*** NOTICE - BEFORE USING THE *Bluetooth*® HANDSFREE**

***What is Bluetooth*® ?**

- *Bluetooth*® refers to a short-distance wireless networking technology which uses a 2.4GHz ~ 2.48GHz frequency to connect various devices within a certain distance.
- Supported within PCs, external devices, *Bluetooth*® phones, PDAs, various electronic devices, and automotive environments, *Bluetooth*® allows data to be transmitted at high speeds without having to use a connector cable.
- *Bluetooth*® Handsfree refers to a device which allows the user to conveniently make phone calls with *Bluetooth*® mobile phones through the audio system.
- *Bluetooth*® Handsfree may not be supported in some mobile phones. To learn more about mobile device compatibility, visit www.hyundaiusa.com.

*** NOTICE - Precautions for Safe Driving**

- *Bluetooth*® Handsfree is a feature that enables drivers to practice safe driving. Connecting the head unit with a *Bluetooth*® phone allows the user to conveniently make and receive calls and use contacts. Before using *Bluetooth*®, carefully read the contents of this user's manual.
- Excessive use or operations while driving may lead to negligent driving practices and result in accidents. Refrain from excessive operations while driving.
- Viewing the screen for prolonged periods of time is dangerous and may lead to accidents. When driving, view the screen only for short periods of time.

*** NOTICE - WHEN CONNECTING A *Bluetooth*® PHONE**

- Before connecting the head unit with the mobile phone, check to see that the mobile phone supports Bluetooth® features.
- Even if the phone supports Bluetooth®, the phone will not be found during device searches if the phone has been set to hidden state or the Bluetooth® power is turned off. Disable the hidden state or turn on the Bluetooth® power prior to searching/connecting with the Head unit.
- After a Bluetooth phone has been successfully paired, the phone will automatically connect when the ignition is turned on.
- If you do not want automatic connection with your Bluetooth® device, turn off the Bluetooth® feature within your mobile phone.
- The Handsfree call volume and quality may differ depending on the mobile phone.

(Continued)

(Continued)

- Park the vehicle when connecting the head unit with the mobile phone.
- Bluetooth® connection may become intermittently disconnected in some mobile phones. Follow these steps to try again.
 1. Within the mobile phone, turn the Bluetooth® function off/on and try again.
 2. Turn the mobile phone power Off/On and try again.
 3. Completely remove the mobile phone battery, reboot, and then again.
 4. Reboot the Audio System and try again.
 5. Delete all paired devices, pair and try again.

*** NOTICE - USING THE Voice Recognition**

- When using the voice recognition feature, only commands listed within the user's manual are supported.
- Be aware that during the operation of the voice recognition system, pressing any key other than the  key terminate voice recognition mode.
- For superior voice recognition performance, position the microphone used for voice recognition above the head of the driver's seat and maintain a proper position when saying commands.
- Within the following situations, voice recognition may not function properly due to background noises which may be picked up by the overhead microphone.
 - When the windows and sunroof are open
 - When the heating and air conditioning fan blower speed is high
 - When entering and passing through tunnels

(Continued)

(Continued)

- When driving on rugged and uneven roads
- During severe rain (heavy rains, windstorms)
- Phone related voice commands can be used only when a *Bluetooth*® Wireless Technology device is connected.
- When making calls by stating a name, the corresponding contact must be downloaded and stored within the audio system.
- After downloading the *Bluetooth*® Wireless Technology phone book, it takes some times to convert the phone book data into voice information. During this time, voice recognition may not properly operate.
- Pronounce the voice commands naturally and clearly as if in a normal conversation.

■ CD Player : AM1B2DMKN, AM1B3DMAN



SYSTEM CONTROLLERS AND FUNCTIONS

* Display and settings may differ depending on the selected audio.



Audio Head Unit

1. **EJECT** (EJECT)
 - Ejects the disc.
2. **RADIO**
 - Changes to FM/AM/SiriusXM mode.
3. **MEDIA**
 - Changes to CD, USB(iPod®), AUX, My Music, BT Audio mode.
 - Each time the key is pressed, the mode is changed in order of CD, USB(iPod®), AUX, My Music, BT Audio.
 - * In Setup>Display, the media pop up screen will be displayed when [Mode Pop up] is turned **On**. When the pop up screen is displayed, use the **TUNE** knob or keys **1** ~ **5** to select the desired mode.
4. **PHONE**
 - Operates Phone Screen
 - * When a phone is not connected, the connection screen is displayed.
5. **PWR/VOL knob**
 - **Power** : Turns power On/Off by pressing the knob
 - **Volume** : Sets volume by turning the knob left/right
6. **SEEK TRACK**
 - **Radio Mode** : Automatically searches for broadcast frequencies.
 - **CD, USB, iPod®, My Music modes**
 - Shortly press the key (under 0.8 seconds): Moves to next or previous song (file)
 - Press and hold the key (over 0.8 seconds): Rewinds or fast-forwards the current song.
 - **BT Audio mode** : Moves to next or previous song(file)
 - * The Play/Pause feature may operate differently depending on the mobile phone.



7. **CAT FOLDER**

- Radio Mode
 - SiriusXM RADIO : Category Search
- MP3 CD, USB mode : Folder Search

8. **1** ~ **6** (Preset)

- Radio Mode: Saves frequencies (channels) or receives saved frequencies (channels)
- CD, USB, iPod®, My Music mode
 - **1** : Repeat
 - **2** : Random
- In the Radio, Media, Setup, and Menu pop up screen, the number menu is selected.

9. **DISP**

- Each time the button is shortly pressed (under 0.8 seconds), it sets the screen Off → Screen On → Screen Off

* Audio operation is maintained and only the screen will be turned Off. In the screen Off state, press any key to turn the screen On again.

10. **SCAN**

- Radio Mode
 - Shortly press the key (under 0.8 seconds): Previews each broadcast for 5 seconds each.
 - Press and hold the key (over 0.8 seconds): Previews the broadcasts saved in Preset **1** ~ **6** for 5 seconds each.
- * Press the **SCAN** key again to continue listening to the current frequency.
- * SiriusXM RADIO does not support the Preset scan feature.
- CD, USB, My Music mode
 - Shortly press the key (under 0.8 seconds): Previews each song (file) for 10 seconds each.

* Press the **SCAN** key again to continue listening to the current song (file).

11. **SETUP CLOCK**

- Shortly press the key (under 0.8 seconds) : Moves to the Display, Sound, Clock, Phone, System setting modes.
- Press and hold the key (over 0.8 seconds) : Move to the Time setting screen.

12. **MENU**

- Displays menus for the current mode.

13. **TUNE** knob

- Radio mode : Changes frequency by turning the knob left/right.
- CD, USB, iPod®, My Music mode: Searches songs (files) by turning the knob left/right.

- ✱ When the desired song is displayed, press the knob to play the song.
- Moves focus in all selection menus and selects menus.



14. DISC-IN LED

- LED that indicates whether a disc is inserted

SETUP

Display Settings

Press the **SETUP**
CLOCK key ▶ Select [Display]
through TUNE knob or **1** key ▶
Select menu through TUNE knob



Mode Pop up

[Mode Pop up] ▶ Changes On / Off
selection mode

- During On state, press the **RADIO** or **MEDIA** key to display the mode change pop up screen.

Media Display

When playing an MP3 file, select the desired display info from 'Folder/File' or 'Album/Artist/Song'.

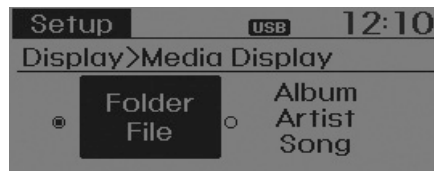

Sound Settings

Press the **SETUP**
CLOCK key ▶ Select [Sound]
through TUNE knob or **2** key ▶
Select menu through TUNE knob



Tone

This menu allows you to set the Bass Middle, Treble.

Select [Tone] ▶ Select menu through **TUNE knob** ▶ Turn **TUNE knob** left/right to set

- Bass, Middle, Treble : Selects the sound tone.
- Default : Restores default settings.
- * Return : While adjusting values, re-pressing the **TUNE knob** will restore the parent menu.



Position

This menu allows you to set the 'Bass, Middle, Treble' and the Sound Fader and Balance.

Select [Position] ▶ Select menu through **TUNE knob** ▶ Turn **TUNE knob** left/right to set

- Fader, Balance : Selects the sound fader and balance.
- Default : Restores default settings.
- * Return : While adjusting values, re-pressing the **TUNE knob** will restore the parent menu.

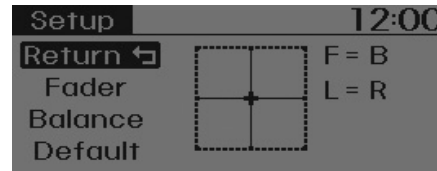

Virtual Sound

The PoewrBass, PowerTreble, and Sound Surround can be set.

Select [Virtual Sound] ▶ Set menu through **TUNE knob** ▶ Set **(On)/ (Off)** through **TUNE knob**

- PowerBass : This is a sound system feature that provides live bass.
- PowerTreble : This is a sound system feature that provides live tremble.
- Surround : This is a sound system feature that provides surround sound.

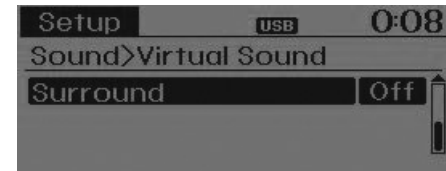
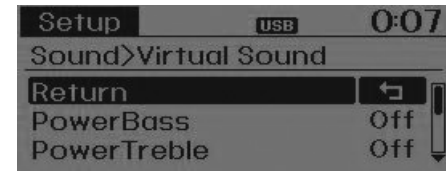

* May differ depending on the selected audio.

Speed Dependent Volume Control

This feature is used to automatically control the volume level according to the speed of the vehicle.

Select [Speed Dependent Vol.] ▶ Set [On/Off] ● TUNE knob

Voice Recognition Volume

Adjusts voice recognition volume.

Select [Voice Recognition Vol.] ▶ Set volume of ● TUNE knob

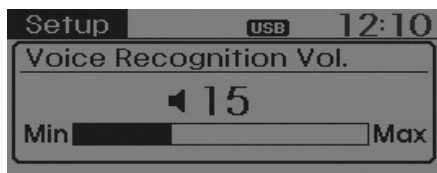

Blue Link® Voice Volume

(for Blue Link® equipped model)

Sets the Blue Link® voice recognition volume.

* While using Blue Link® voice recognition, turning the tune knob will display the volume control popup screen.

* May differ depending on the selected audio.

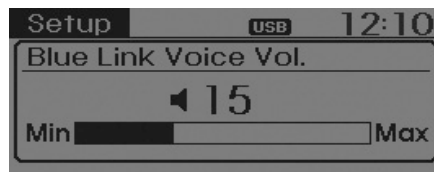

Clock Settings

Press the **SETUP** key ▶ Select [Clock] through ● TUNE knob or **3** key ▶ Select menu through ● TUNE knob

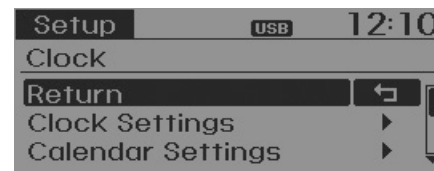

Clock Settings

This menu is used to set the time.

Select [Clock Settings]▶Set through
 TUNE knob▶Press TUNE knob

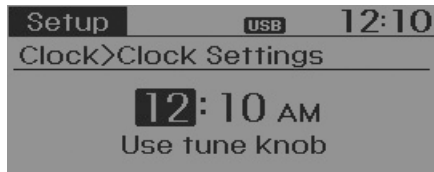

※ Adjust the number currently in focus to set the [hour] and press the tune knob to set the [minute] and [AM/PM].

Calendar Settings

This menu is used to set the date (DD/MM/YYYY).

Select [Calendar Settings]▶Set through TUNE knob▶Press TUNE knob

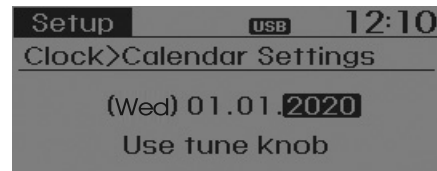

※ Adjust the number currently in focus to make the settings and press the tune knob to move to the next setting. (Set in order of Day/Month/Year)

Time Format

This function is used to set the 12/24 hour time format of the audio system.

Select [Time Format]▶Set 12Hr / 24Hr through TUNE knob

Clock Display when Power is OFF

Select [Clock Disp.(Pwr Off)]▶Set On / Off through TUNE knob

- On : Displays time/date on screen
- Off : Turn off.

SYSTEM SETTINGS

Press the **SETUP** CLOCK key ▶ Select [System] through tune knob or **5** key ▶ Select menu through **TUNE** knob

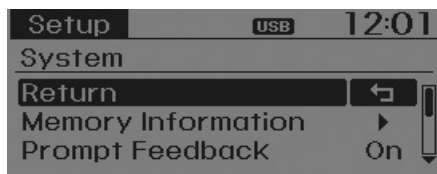

Memory Information

Displays currently used memory and total system memory.

Select [Memory Information] ▶ OK

The currently used memory is displayed on the left side while the total system memory is displayed on the right side.

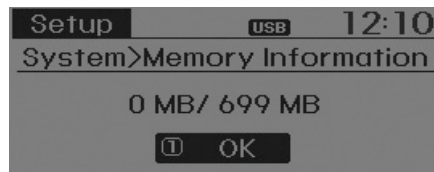

Prompt Feedback

This feature is used to change voice command feedback between Normal and Expert modes.

Select [Prompt Feedback] ▶ Set through **TUNE** knob

- On : This mode is for beginner users and provides detailed instructions during voice command operation.

- Off : This mode is for expert users and omits some information during voice command operation. (When using Expert mode, guidance instructions can be heard through the [Help] or [Menu] commands.

Language

This menu is used to set the display and voice recognition language.

Select [Language] ▶

Set through **TUNE** knob

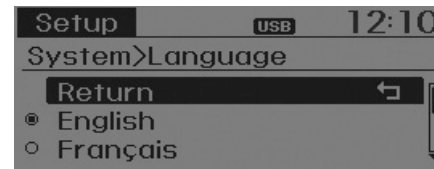

- * The system will reboot after the language is changed.
- * Language support by region
 - English, Francais, Espanol

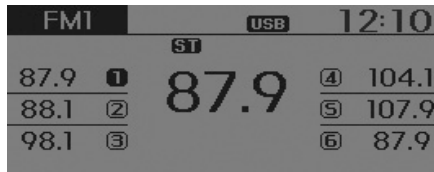
RADIO : FM, AM OR SiriusXM**SEEK**

Press the key

- Shortly pressing the key (under 0.8 seconds): Changes the frequency.
- Pressing and holding the key (over 0.8 seconds): Automatically searches for the next frequency.

Preset SEEK

Press the ~ key

- Shortly pressing the key (under 0.8 seconds): Plays the frequency saved in the corresponding key.
- Pressing and holding the key (over 0.8 seconds): Pressing and holding the desired key from ~ will save the currently playing broadcast to the selected key and sound a BEEP.

SCAN

Press the key

- Shortly pressing the key (under 0.8 seconds): The broadcast frequency increases and previews each broadcast for 5 seconds each. After scanning all frequencies, returns and plays the current broadcast frequency.
- Pressing and holding the key (over 0.8 seconds): Previews the broadcasts saved in Preset ~ for 5 seconds each.

Selecting through manual search

Turn the TUNE knob left/right to adjust the frequency.

MENU

Within key are the A.Store (Auto Store) and Info functions.

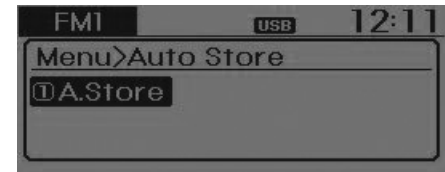
 **A.Store**

Press the key ▶ Set [A.Store] through TUNE knob or key.

Saves broadcasts with superior reception to ~ keys. If no frequencies are received, then the most recently received frequency will be broadcast.

SiriusXM® Satellite Radio information

Satellite Radio channels:

Enjoy SiriusXM Satellite Radio with a 3-month trial subscription to the Sirius Select package. You'll get over 140 channels, including commercial-free music, plus all your favorite sports, exclusive talk, entertainment, and a selection of premium programming. For more information and a complete list of SiriusXM channels, visit siriusxm.com in the United States, siriusxm.ca in Canada, or call SiriusXM at 1-888-539-7474.

Satellite Radio reception factors:

To receive the satellite signal, your vehicle has been equipped with a satellite radio antenna located on the roof of your vehicle. The vehicle roof provides the best location for an unobstructed, open view of the sky, a requirement of a satellite radio system. Like AM/FM, there are several factors that can affect satellite radio reception performance:

- Antenna obstructions: For optimal reception performance, keep the antenna clear of snow and ice build-up and keep luggage and other material as far away from the antenna as possible.
- Terrain: Hills, mountains, tall buildings, bridges, tunnels, freeway overpasses, parking garages, dense tree foliage and thunderstorms can interfere with your reception.

SiriusXM Satellite Radio service:

SiriusXM is a subscription-based satellite radio service that broadcasts music, sports, news and entertainment programming to radio receivers, which are available for installation in motor vehicles or factory installed, as well as for the home, portable and wireless devices, and through an Internet connection on personal computer.

Vehicles that are equipped with a factory installed SiriusXM Satellite Radio system include:

- Hardware and an introductory trial subscription term, which begins on the date of sale or lease of the vehicle.
- For a small upgrade fee, access to SiriusXM music channels, and other select channels over the Internet using any computer connected to the Internet (U.S. customers only).

For information on extended subscription terms, contact SiriusXM at 1-888-539-7474.

*** NOTICE**

SiriusXM services require a subscription sold separately, or as a package, by Sirius XM Radio Inc. If you decide to continue service after your trial, the subscription plan you choose will automatically renew thereafter and you will be charged according to your chosen payment method at then-current rates. Fees and taxes apply. To cancel you must call SiriusXM at 1-866-635-2349. See SiriusXM Customer Agreement for complete terms at www.siriusxm.com. SiriusXM U.S. satellite and data services are available only in the 48 contiguous USA, DC and PR (with coverage limitations). SiriusXM satellite service is also available in Canada; see www.siriusxm.ca. All fees and programming subject to change. Sirius, XM and all related marks and logos are trademarks of Sirius XM Radio Inc.

SiriusXM RADIO

Using SiriusXM Satellite Radio

Your vehicle is equipped with a 3-month trial subscription to SiriusXM so you have access to over 140 channels of music, information, and entertainment programming.

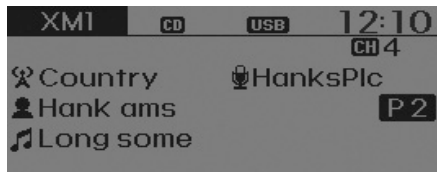

Activation

In order to extend or reactivate your Sirius Select subscription, you will need to contact SiriusXM Customer Care at 1-800-643-2112. Have your 12-digit RID (Radio Identification Number) / ESN (Electronic Serial Number) ready. To retrieve the RID / ESN, turn on the radio, press the key, and tune to channel zero.

Please note that the vehicle will need to be turned on, in Sirius mode, and have an unobstructed view of the sky in order for the radio to receive the activation signal.

SEEK

Press the  key

- Shortly pressing the key: select previous or next channel.
- Pressing and holding the key (over 0.8 seconds): continuously move to previous or next channel.

* If the “Category” icon is displayed, channels are changed within the current category.

SCAN

Press the  key

- Shortly pressing the key: Previews each broadcast for 10 seconds each
- * Press the  key again to continue listening to the current frequency
- * If the “Category” icon is displayed, channels are changed within the current category.

Category

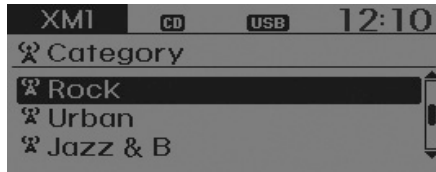

Press the  key ▶ Set through the 



- The display will indicate the category menus, highlight the category that the current channel belongs to.
- In the Category List Mode, press the  key to navigate category list.
- Press the tune knob to select the lowest channel in the highlighted category.
- * If channel is selected by selecting category, then the “CATEGORY” icon is displayed at the top of the screen.

Preset

Press the  ~  key

- Shortly pressing the key: Plays the frequency saved in the corresponding key.
- Pressing and holding the key (over 0.8 seconds): Pressing and holding the desired key from  ~  will save the current broadcast to the selected key and sound a BEEP.

* Troubleshooting



1. Antenna Error

If this message is displayed, the antenna or antenna cable is broken or unplugged. Please consult with your Hyundai dealership.





2. No Signal

If this message is displayed, it means that the antenna is covered and that the SiriusXM Satellite Radio signal is not available. Ensure the antenna is uncovered and has a clear view of the sky.

Tune

- Rotate  : Changes the channel number or scrolls category list.
- Press  : Selects the menu.

Menu

Select category menu through the  ▶ Press the  key
▶ Select [] Info through the  or  key

Info (Information)

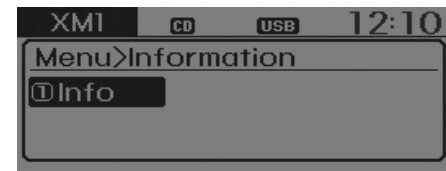

Displays the Artist/Song info of the current song.

BASIC METHOD OF USE : Audio CD / MP3 CD / USB / iPod® / My Music

Press the **MEDIA** key to change the mode in order of CD → USB(iPod®) → AUX → My Music → BT Audio.

The folder/file name is displayed on the screen.



<Audio CD>



<MP3 CD>



<USB>



<My Music>

- * The CD is automatically played when a CD is inserted.
- * The USB music is automatically played when a USB is connected.

Repeat

While song (file) is playing ▶ **1 RPT** (RPT) key

Audio CD, MP3 CD, USB, iPod®, My Music mode: RPT on screen

- To repeat one song (Press the key): Repeats the current song.

MP3 CD, USB mode: FLD.RPT on screen

- To repeat folder (pressing twice): repeats all files within the current folder.

* Press the **1 RPT** key again to turn off repeat.

Random

While song (file) is playing ▶ **2 RDM** (RDM) key

Audio CD, My Music mode: RDM on screen

- Random (Press the key): Plays all songs in random order.

MP3 CD, USB mode: FLD.RDM on screen

- Folder Random (Press the key) : Plays all files within the current folder in random order.

iPod® mode: ALB RDM on screen

- Album Random (Press the key) : Plays all files within albums of the current category in random order.

MP3 CD, USB, iPod® mode: ALL RDM on screen

- All Random (pressing twice): Plays all files in random order.
- * Press the **2RDM** key again to turn off repeat.

Changing Song/File

While song (file) is playing▶

SEEK TRACK key

- Shortly pressing the key : Plays the current song from the beginning.
- * If the **SEEK TRACK** key is pressed again within 3 second, the previous song is played.
- Pressing and holding the key (over 0.8 seconds): Rewinds the song.

While song (file) is playing▶

SEEK TRACK key

- Shortly pressing the key : Plays the next song.
- Pressing and holding the key (over 0.8 seconds): Fast forwards the song.

Scan

While song (file) is playing▶ **SCAN** key

- Shortly pressing the key : Scans all songs from the next song for 10 seconds each.
- * Press the **SCAN** key again to turn off.
- * The SCAN function is not supported in iPod® mode.

Folder Search : MP3 CD, USB Mode

While file is playing▶ **CAT FOLDER** (Folder Up) key

- Searches the next folder.

While file is playing▶ **CAT FOLDER** (Folder Down) key

- Searches the parent folder.

* If a folder is selected by pressing the **TUNE** knob, the first file within the selected folder will be played.

* In iPod® mode, moves to the Parent Folder.

Searching Songs (File)

- Turning **TUNE** knob : Searches for songs (files)
- Pressing **TUNE** knob : Plays selected song (file).

MENU : Audio CD

Press the Audio CD mode **MENU** key to set the Repeat, Random, Information features.



Repeat

Press the **MENU** key ▶ Set [**1 RPT**] through the **TUNE** knob or **1 RPT** key to repeat the current song.

* Press RPT again to turn off.

Random

Press the **MENU** key ▶ Set [**2 RDM**] through the **TUNE** knob or **2 RDM** key to randomly play songs within the current CD.

* Press RDM again to turn off.

Information

Press the **MENU** key ▶ Set [**3 Info**] through the **TUNE** knob or **3** key to display information of the current song.

* Press the **MENU** key to turn off info display.

MENU : MP3 CD / USB

Press the MP3 CD/USB mode **MENU** key to set the Repeat, Folder Random, Folder Repeat, All Random, Information, and Copy features.



Repeat

Press the **MENU** key ▶ Set [**1 RPT**] through the **TUNE** knob or **1 RPT** key to repeat the current song.

* Press RPT again to turn off.

Folder Random

Press the **MENU** key ▶ Set [**2**]F.RDM] through the **TUNE** knob or **2 RDM** key to randomly play songs within the current folder.

* Press F.RDM again to turn off.

Folder Repeat

Press the **MENU** key ▶ Set [**3**]F.RPT] through the **TUNE** knob or **3** key to repeat songs within the current folder.

* Press F.RPT again to turn off.

All Random

Press the **MENU** key ▶ Set [**4**]A.RDM] through the **TUNE** knob or **4** key to randomly play all songs within the CD.

* Press A.RDM again to turn off.

Information

Press the **MENU** key ▶ Set [**5**]Info] through the **TUNE** knob or **5** key to display information of the current song.

* Press the **MENU** key to turn off info display.

Copy

Press the **MENU** key ▶ Set [**6**]Copy] through the **TUNE** knob or **6** key.

- This is used to copy the current song into My Music. You can play the copied Music in My Music mode.
- * If another key is pressed while copying is in progress, a pop up asking you whether to cancel copying is displayed.
- * If another media is connected or inserted (USB, CD, iPod®, AUX) while copying is in progress, copying is canceled.
- * Music will not be played while copying is in progress.

MENU : iPod®

In iPod® mode, press the **MENU** key to set the Repeat, Album Random, All Random, Information and Search features.



Repeat

Press the **MENU** key ▶ Set [**1**RPT] through the **TUNE** knob or **1 RPT** key to repeat the current song.

* Press RPT again to turn repeat off.

Album Random

Press the **MENU** key ▶ Set [**2**Alb.RDM] through the **TUNE** knob or **2 RDM** key.

Plays albums within the currently playing category in random order.

* Press Alb.RDM again to turn off.

All Random

Press the **MENU** key ▶ Set [**3**A.RDM] through the **TUNE** knob or **3** key.

Plays all songs within the currently playing category in random order.

* Press A.RDM again to turn off.

Information

Press the **MENU** key ▶ Set [**4**Info] through the **TUNE** knob or **4** key.

Displays information of the current song.

* Press the **MENU** key to turn off info display.

Search

Press the **MENU** key ▶ Set [**5**Search] through the **TUNE** knob or **5** key.

Displays iPod® category list.

* Searching iPod® category is **MENU** key pressed, move to parent category.

MENU : My Music Mode

In My Music mode, press the **MENU** key to set the Repeat, Random, Information, Delete, Delete All, and Delete Selection features.



Repeat

Press the **MENU** key ▶ Set [**1**RPT] through the **TUNE** knob or **1 RPT** key.

Repeats the currently playing song.

* Press RPT again to turn repeat off.

Random

Press the **MENU** key ▶ Set [**2**RDM] through the **TUNE** knob or **2 RDM** key.

Plays all songs in random order.

* Press RDM again to turn random off.

Information

Press the **MENU** key ▶ Set [**3**Info] through the **TUNE** knob or **3** key.

Displays information of the current song.

* Press the **MENU** key to turn off info display.

Delete

Press the **MENU** key ▶ Set [**4**Delete] through the **TUNE** knob or **4** key.

• Deletes currently playing file

In the play screen, pressing delete will delete the currently playing song.

• Deletes file from list

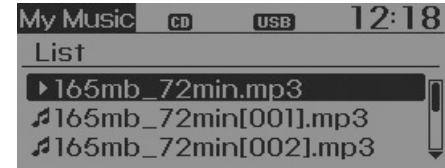

① Select the file you wish to delete by using the **TUNE** knob.

② Press the **MENU** key and select the delete menu to delete the selected file.

Delete All

Press the **MENU** key ▶ Set [**5**Del.All] through the **TUNE** knob or **5** key. Deletes all songs of My Music.

Delete Selection

Press the **MENU** key ▶ Set [**6**Del.Sel] through the **TUNE** knob or **6** key.

Songs within My Music are selected and deleted.

- ① Select the songs you wish to delete from the list.

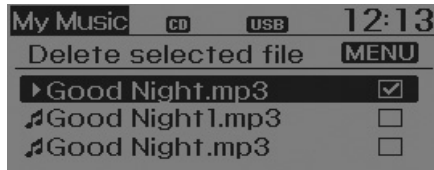

- ② After selecting, press the **key** and select the delete menu.



* NOTICE - USING THE My Music Feature

- Even if memory is available, a maximum of 6,000 songs can be stored.
- The same song can be copied up to 1,000 times.
- Memory info can be checked in the System menu of Setup.

AUX

AUX is used to play external MEDIA currently connected with the AUX terminal.

AUX mode will automatically start when an external device is connected with the AUX terminal.

If an external device is connected, you can also press the **MEDIA** key to change to AUX mode.

- * AUX mode cannot be started unless there is an external device connected to the AUX terminal.



* NOTICE - USING THE AUX

Fully insert the AUX cable into the AUX terminal for use.

Bluetooth® Wireless Technology AUDIO

What is Bluetooth® Wireless Technology?

Bluetooth® Wireless Technology allows devices to be connected in a short distance, including hands-free devices, stereo headsets, wireless remote controllers, etc. For more information, visit the *Bluetooth®* Wireless Technology website at www.Bluetooth.com

Before using Bluetooth® Wireless Technology audio features

- Bluetooth® Wireless Technology audio may not be supported depending on the compatibility of your Bluetooth® Wireless Technology mobile phone.
- In order to use Bluetooth® Wireless Technology audio, you must first pair and connect the Bluetooth® Wireless Technology mobile phone.
- Bluetooth® Wireless Technology audio can be used only when the [Audio Streaming] of Phone is turned (On).

Starting Bluetooth® Wireless Technology Audio

- Press the **MEDIA** key to change the mode in order of CD → USB → AUX → My Music → BT Audio.
- If BT Audio is selected, Bluetooth® Wireless Technology audio will start playing.
- * Audio may not automatically start playing in some mobile phones.

Using the Bluetooth® Wireless Technology audio features

- Play / Stop
Press the **TUNE** knob to play and pause the current song.



- * The title / artist info may not be supported in some mobile phone. When it is not supported, no title/no artist will be displayed.
- Previous / Next song
Press **SEEK TRACK** or **SEEK TRACK** to play previous or next song.
- * The previous song / next song / play / pause functions may not be supported in some mobile phones.

PHONE



Before using the *Bluetooth*® Wireless Technology phone features



- In order to use *Bluetooth*® Wireless Technology phone, you must first pair and connect the *Bluetooth*® Wireless Technology mobile phone.
- If the mobile phone is not paired or connected, it is not possible to enter Phone mode. Once a phone is paired or connected, the guidance screen will be displayed.
- If Priority is set upon vehicle ignition (IGN/ACC ON), the *Bluetooth*® Wireless Technology phone will be automatically connected. Even if you are outside, the first *Bluetooth*® Wireless Technology phone will be automatically connected once you are in the vicinity of the vehicle. If you do not want automatic *Bluetooth*® Wireless Technology phone connection, set the *Bluetooth*® Wireless Technology power to OFF.

PHONE

Making a call using the Steering-wheel mount controls



- 1)  key: Activates voice recognition.
- 2)  key: Places and transfers calls.
- 3)  key: Ends calls or cancels functions.

- Check call history and making call
 - Shortly press (under 0.8 seconds) the  key on the steering remote controller .
 - The call history list will be displayed on the screen.
 - Press the  key again to connect a call to the selected number.
- Redialing the most recently called number
 - Press and hold (over 0.8 seconds) the  key on the steering remote controller.
 - The most recently called number is redialed.
- * If call history does not exist, a screen asking whether to download call history is displayed. (The download feature may not be supported in some mobile phones)

Pairing a *Bluetooth*[®] Wireless Technology Device

What is Bluetooth[®] Wireless Technology Pairing?

Pairing refers to the process of synchronizing your *Bluetooth*[®] Wireless Technology phone or device with the car audio system for connection. Pairing is necessary to connect and use the *Bluetooth*[®] Wireless Technology feature.

⚠ WARNING

Driving while distracted can result in a loss of vehicle control that may lead to an accident, severe personal injury, and death. The driver's primary responsibility is in the safe and legal operation of a vehicle, and use of any handheld devices, other equipment, or vehicle systems which take the driver's eyes, attention and focus away from the safe operation of a vehicle or which are not permissible by law should never be used during operation of the vehicle.

Pairing **PHONE** key / key on the Steering Remote Controller

When No Devices have been Paired

1. Press the **PHONE** key or the  key on the steering remote controller. The following screen is displayed.

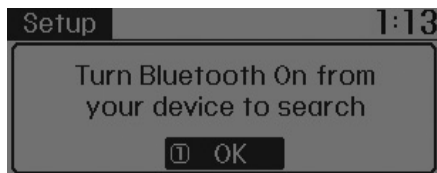

2. Select [OK] button to enter the Pair Phone screen.

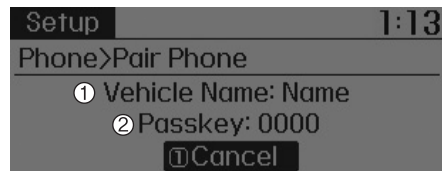

- 1) Vehicle Name : Name of device as shown when searching from your *Bluetooth*[®] Wireless Technology device
- 2) Passkey : Passkey used to pair the device
3. From your *Bluetooth*[®] Wireless Technology device (i.e. Mobile Phone), search and select your car audio system.

[Non SSP supported device]
(SSP: Secure Simple Pairing)

4. After a few moments, a screen is displayed where the passkey is entered.

Hear, enter the passkey "0000" to pair your *Bluetooth*[®] Wireless Technology device with the car audio system.

[SSP supported device]

4. After a few moments, a screen is displayed 6 digits passkey.

Hear, check the passkey on your *Bluetooth*[®] Wireless Technology device and confirm.

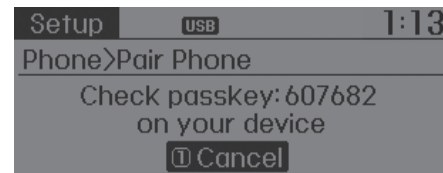

5. Once pairing is complete, the following screen is displayed.

*** NOTICE**

If *Bluetooth*® Wireless Technology devices are paired but none are currently connected, pressing the **PHONE** key or the  key on the steering wheel displays the following screen. Select [Pair] button to pair a new device or select [Connect] to connect a previously paired device.

Pairing through [PHONE] Setup

Press the **SETUP** CLOCK key ▶ Select [Phone] ▶ Select [Pair Phone] ▶ Select  TUNE knob



The following steps are the same as those described in the section "When No Devices have been Paired" on the previous page.

*** NOTICE**

- *Bluetooth*® Wireless Technology features supported within the vehicle are as follows. Some features may not be supported depending on your *Bluetooth*® Wireless Technology device.
 - Outgoing/Incoming Handsfree calls
 - Operations during a call (Switch to Private, Switch to call waiting, MIC on/off)
 - Downloading Call History
 - Downloading Mobile Contacts
 - *Bluetooth*® Wireless Technology device auto connection
 - Bluetooth Audio Streaming
- Up to five *Bluetooth*® Wireless Technology devices can be paired to the Car Handsfree system.
- Only one *Bluetooth*® Wireless Technology device can be connected at a time.
- Other devices cannot be paired while a *Bluetooth*® Wireless Technology device is connected.
- Only *Bluetooth*® Wireless Technology Handsfree and Bluetooth audio related features are supported.

(Continued)

(Continued)

- Bluetooth related operations are possible only with devices that support Handsfree or audio features, such as a *Bluetooth*® Wireless Technology mobile phone or a Bluetooth audio device.
- If a connected *Bluetooth*® Wireless Technology device becomes disconnected due to being out of communication range, turning the device OFF, or a *Bluetooth*® Wireless Technology communication error, corresponding *Bluetooth*® Wireless Technology devices are automatically searched and reconnected.
- If the system becomes unstable due to communication errors between the car Handsfree and the *Bluetooth*® Wireless Technology device, reset the device by turning off and back on again. Upon resetting *Bluetooth*® Wireless Technology device, the system will be restored.

(Continued)

(Continued)

- After pairing is complete, a contacts download request is sent once to the mobile phone. Some mobile phones may require confirmation upon receiving a download request, ensure your mobile phone accepts the connection. Refer to your phones user's manual for additional information regarding phone pairing and connections.

Connecting a Device

Press the **SETUP** CLOCK key ▶ Select [Phone] ▶ Select [Paired Phone List]

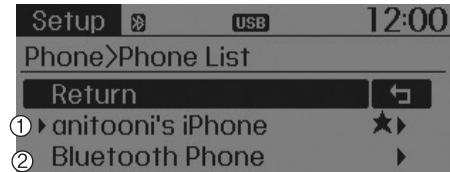

- 1) Connected Phone : Device that is currently connected
- 2) Paired Phone : Device that is paired but not connected

From the paired phone list, select the device you want to connect and select [Connect].

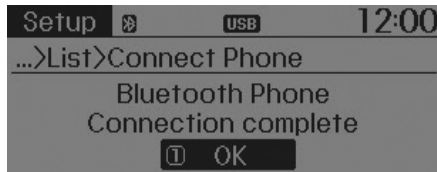

Changing Priority

What is Priority?

It is possible to pair up to five *Bluetooth*® Wireless Technology devices with the car audio system. The "Change Priority" feature is used to set the connection priority of paired phones.

Press the **SETUP** CLOCK key ▶ Select [Phone] ▶ Select [Paired Phone List]

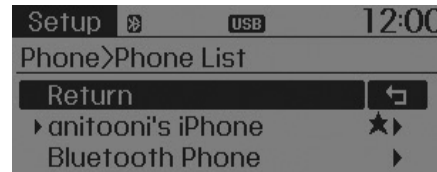

From the paired phone list, select the phone you want to switch to the highest priority, then select [Change Priority] button from the Menu. The selected device will be changed to the highest priority.

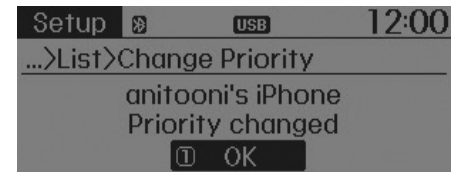
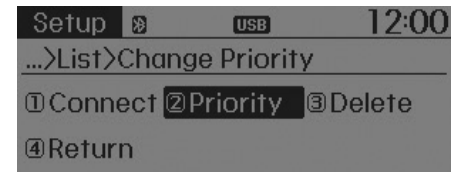

* NOTICE

Priority icon will be displayed when the selected phone is set as a priority phone.

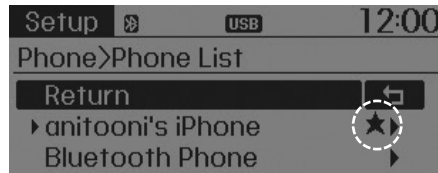

Disconnecting a Device

Press the **SETUP** CLOCK key ▶ Select [Phone] ▶ Select [Paired Phone List]

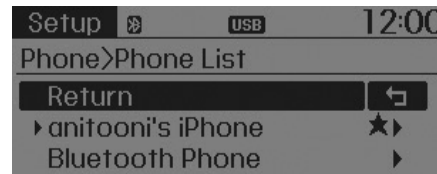

From the paired phone list, select the currently connected device and select [Disconnect] button.

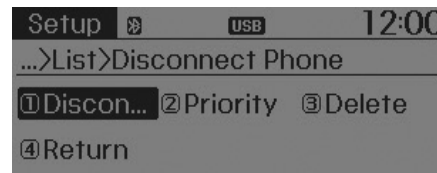

Deleting a Device

Press the **SETUP** CLOCK key ▶ Select [Phone] ▶ Select [Paired Phone List]

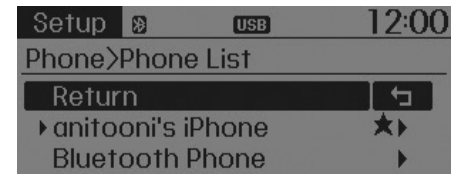

From the paired phone list, select the device you want to delete and select [Delete] button.

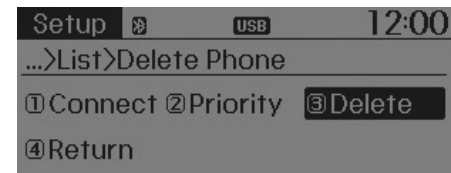

*** NOTICE**

- When deleting the currently connected device, the device will automatically be disconnected to proceed with the deleting process.
- If a paired *Bluetooth*[®] Wireless Technology device is deleted, the device's call history and contacts data will also be deleted.
- To re-use a deleted device, you must pair the device again.

USING *Bluetooth*[®] Wireless Technology

Phone Menu Screen

Phone Menus

With a *Bluetooth*[®] Wireless Technology device connected, press the **PHONE** key to display the Phone menu screen.



- 1) Favorite : Up to 20 frequently used contacts saved for easy access
- 2) Call History : Displays call history list screen
- 3) Contacts : Displays the Contacts list
- 4) Setup : Displays Phone related settings.

* NOTICE

- If you select the [Call History] button but there is no call history data, a prompt is displayed which asks to download call history data.
- If you select the [Contacts] button but there is no contacts data stored, a prompt is displayed which asks to download contacts data.
- This feature may not be supported in some mobile phones. For more information on download support, refer to your mobile phone user's manual.

Answering Calls

Answering a Call

Answering a call with a *Bluetooth*[®] Wireless Technology device connected will display the following screen.

To accept the call, press  key on the steering wheel while the call is incoming.

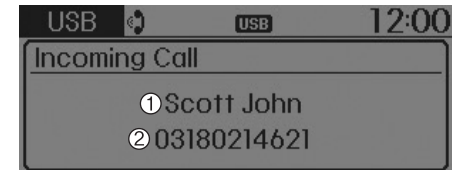

- 1) Caller : Displays the other party's name when the incoming caller is saved within your contacts
- 2) Incoming Number : Displays the incoming number

*** NOTICE**

- When an incoming call pop-up is displayed, most Audio and SETUP mode features are disabled. Only the call volume will operate.
- The telephone number may not be properly displayed in some mobile phones.

Favorites

Press the **PHONE** key ▶ Select [Favorites]



- 1) Saved favorite contact : Connects call upon selection
- 2) To add favorite : Downloaded contacts be saved as favorite.

*** NOTICE**

- To save Favorite, contacts should be downloaded.
- Contact saved in Favorites will not be automatically updated if the contact has been updated in the phone. To update Favorites, delete the Favorite and create a new Favorite.

Call History

Press the **PHONE** key ▶ Select [Call History]

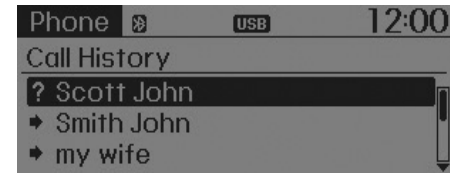

A list of incoming, outgoing and missed calls is displayed.

- Call history may not be saved in the call history list in some mobile phones.
- Calls received with hidden caller ID will not be saved in the call history list.
- Calling through the call history is not possible when there is no call history stored or a *Bluetooth*® Wireless Technology phone is not connected.
- Up to 50 received, dialed and missed calls are stored in Call History.
- Time of received/dialed calls and call time information are not saved.

Contacts

Press the **PHONE** key ▶ Select [Contacts]

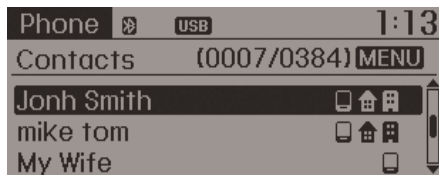

The list of saved phone book entries is displayed.

* NOTICE

Find a contact in an alphabetical order, press the **MENU** key.



* NOTICE

- Up to 1,000 contacts saved in your *Bluetooth*® Wireless Technology phone can be downloaded into the car contacts. Contacts that have been downloaded to the car cannot be edited or deleted on the phone.
- Mobile phone contacts are managed separately for each paired *Bluetooth*® Wireless Technology device (max 5 devices x 1,000 contacts each). Previously downloaded data is maintained even if the *Bluetooth*® Wireless Technology device has been disconnected. (However, the contacts and call history saved to the phone will be deleted if a paired phone is deleted.)
- It is possible to download contacts during Bluetooth streaming audio.
- When downloading contacts, the icon will be displayed within the status bar.

(Continued)

(Continued)

- It is not possible to begin downloading a contact list when the contact download feature has been turned off within the *Bluetooth*® Wireless Technology device. In addition, some devices may require device authorization upon attempting to download contacts. If downloading does not normally occur, check the *Bluetooth*® Wireless Technology device settings or the screen state.
- The contacts download feature may not be supported in some mobile phones. For more information of supported *Bluetooth*® devices and function support, refer to your phone's user manual.

Bluetooth® Wireless Technology Setting

Pairing a New Device

Press the **SETUP** CLOCK key ▶ Select [Phone] ▶ Select [Pair Phone]



Bluetooth® Wireless Technology devices can be paired with the audio system.

For more information, refer to the “Pairing through Phone Setup” section within *Bluetooth® Wireless Technology*.

Viewing Paired Phone List

Press the **SETUP** CLOCK key ▶ Select [Phone] ▶ Select [Paired Phone List]

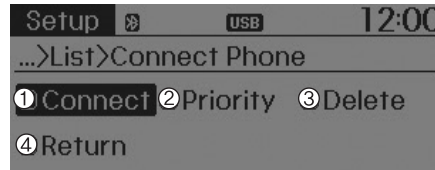
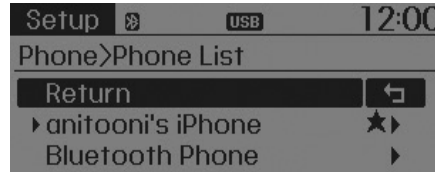

This feature is used to view mobile phones that have been paired with the audio system. Upon selecting a paired phone, the setup menu is displayed.

For more information, refer to the “Setting *Bluetooth® Wireless Technology Connection*” section within *Bluetooth® Wireless Technology*.

- 1) Connect/Disconnect Phone : Connect/ disconnects currently selected phone
- 2) Change Priority : Sets currently selected phone to highest connection priority
- 3) Delete : Deletes the currently selected phone
- 4) Return : Moves to the previous screen

* NOTICE BEFORE DOWNLOADING CONTACTS

- Only contacts within connected phones can be downloaded. Also check to see that your mobile phone supports the download feature.
- To learn more about whether your mobile phone supports contacts downloads, refer to your mobile phone user's manual.
- The contacts for only the connected phone can be downloaded.

Downloading Contacts

Press the **SETUP** CLOCK key ▶ Select [Phone] ▶ Select [Contacts Download]



As the contacts are downloaded from the mobile phone, a download progress bar is displayed.

* NOTICE

- Upon downloading phone contacts, the previous corresponding data is deleted.
- This feature may not be supported in some mobile phones.
- Voice Recognition may not operate while contacts are being downloaded.

Outgoing Volume

Press the **SETUP** CLOCK key ▶ Select [Phone] ▶ Select [Outgoing Volume]

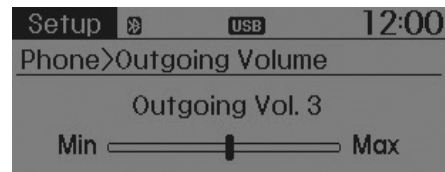

Use **TUNE** knob to adjust the outgoing volume level.

* NOTICE

While on a call, the volume can be changed by using the **SEEK** TRACK key.

Turning Bluetooth System Off

Press the **SETUP**
CLOCK key ▶ Select [Phone] ▶ Select [Bluetooth System Off]

Once *Bluetooth*® Wireless Technology is turned off, *Bluetooth*® Wireless Technology related features will not be supported within the audio system.

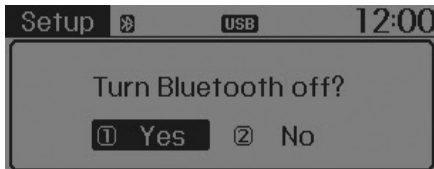
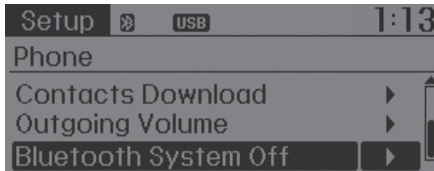

* NOTICE

To turn *Bluetooth*® Wireless Technology back on, go to **SETUP**
CLOCK ▶ [Phone] and select "Yes".

VOICE RECOGNITION

Using Voice Recognition

Starting Voice Recognition

Shortly press the  key on the steering wheel. Say a command.

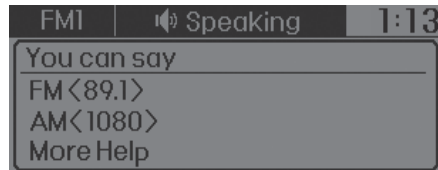

If prompt feedback is in [ON], then the system will say "Please say a command after the beep (BEEP)"

- If prompt feedback is in [OFF] mode, then the system will only say "(BEEP)"
- To change Prompt Feedback [On]/[Off], go to  [System] ▶ [Prompt Feedback]

* NOTICE

For proper recognition, say the command after the voice instruction and beep tone.

Contact List Best Practices

- 1) Do not store single-name entries (e.g., "Bob", "Mom", "Kim", etc.). Instead, always use full names (including first and last names) for all contacts (e.g., use "Jacob Stevenson" instead of "Dad").
- 2) Do not use abbreviations (i.e., use "Lieutenant" instead of "Lt." or "Sergeant" instead of "Sgt.").
- 3) Do not use acronyms (i.e., use "County Finance Department" instead of "CFD").
- 4) Do not use special characters (e.g., "@", "hyphen -", "asterisk *", "ampersand &").
- 5) If a name is not recognized from the contact list, change it to a more descriptive name (e.g., use "Grandpa Joseph" instead of "Pa Joe").

Skipping Prompt Messages

While prompt message is being stated ▶ Shortly press the  key on the steering remote controller

The prompt message is immediately ended and the beep tone will sound. After the "beep", say the voice command.

Re-starting Voice Recognition

While system waits for a command ▶ Shortly press the  key on the steering remote controller

The command wait state is immediately ended and the beep will sound. After the "beep", say the voice command.

ENDING VOICE RECOGNITION

While Voice Recognition is operating

▶ Press and hold the  key on the steering remote controller

*** NOTICE**

- While using voice command, pressing any steering wheel control or a different key will end voice command.
- When the system is waiting for a voice command, say "cancel" or "end" to end voice command.
- When the system is waiting for a voice command, press and hold the  key on the steering wheel to end voice command.

Voice Recognition and Phone Contact Tips:

The Hyundai Voice Recognition System may have difficulty understanding some accents or uncommon names.

When using Voice Recognition to place a call, speak in a moderate tone, with clear pronunciation To maximize the use of Voice Recognition, consider these guidelines when storing contacts:

- Do not store single-name entries (e.g., "Bob", "Mom", etc.). Instead, always use full names (including first and last names) for these contacts
- Do not use special characters (e.g., '@', '-', '*', '&', etc.)
- Do not use abbreviations (i.e., use "Lieutenant" instead of "Lt.") or acronyms (i.e., use "County Finance Department" instead of "C. F. D."); Be sure to say the name exactly as it is entered in the contacts list

Illustration on using voice commands

• Starting voice command.

Shortly pressing the  key (under 0.8 seconds):

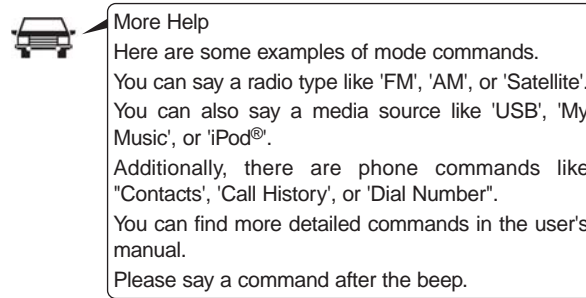
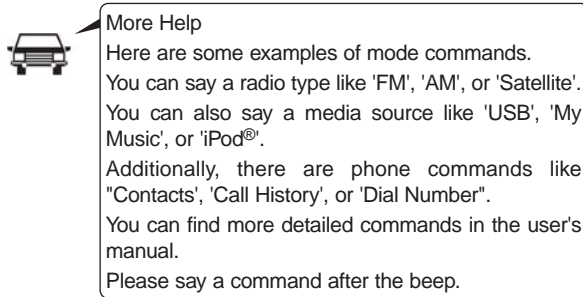
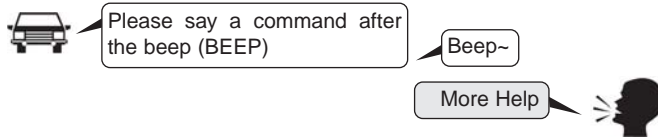

• Skipping Voice Recognition

Shortly pressing the  key (under 0.8 seconds):

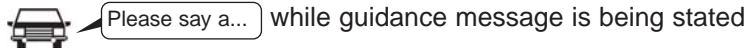

Shortly pressing the  key (under 0.8 seconds):



• Ending voice command.

Shortly pressing the  key (under 0.8 seconds):

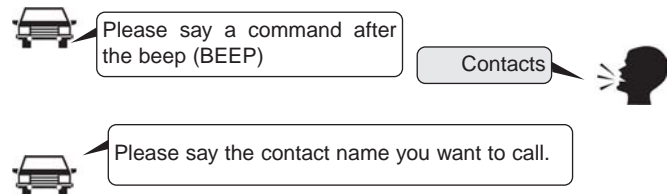

Voice Command List

- **Common Commands:** These commands can be used in most operations. (However a few commands may not be available during certain operations)

Command	Function
More Help	Provides guidance on commands that can be used anywhere in the system.
Help	Provides guidance on commands that can be used within the current mode.
Call<Name>	Calls <Name> saved in Contacts Ex) Call "John Smith"
Call <Name> on Mobile	Calls <Name> to the number that is saved as "Mobile" in Contacts Ex) Call "John Smith" on Mobile
Call <Name> in Office	Calls <Name> to the number that is saved as "Office" in Contacts Ex) Call "John Smith" in Office
Call <Name> at Home	Calls <Name> to the number that is saved as "Home" in Contacts Ex) Call "John Smith" at Home
Call <Name> on Other	Calls <Name> to the number that is saved as "Other" in Contacts Ex) Call "John Smith" on Other
Phone	Provides guidance on Phone related commands. After saying this command, say "Favorites", "Call History", "Contacts" or "Dial Number" execute corresponding functions.
Favorites	Displays the Favorite screen.
Call History	Displays the Call History screen.

Command	Function
Contacts (Call by Name)	Displays the Contacts screen. After saying this command, say the name of a contact saved in the Contacts to automatically connect the call.
Dial Number	Displays the Dial number screen. After saying this command, you can say the number that you want to call.
Redial	Connects the last dialed call number.
Tutorial	Provides guidance on how to use voice recognition and Bluetooth® connections.
Radio	<ul style="list-style-type: none"> • When listening to the radio, displays the next radio screen. (FM1→FM2→AM→XM1→XM2→XM3→FM1) • When listening to a different mode, displays the most recently played radio screen. • When currently listening to the FM radio, maintains the current state. • When listening to a different mode, displays the most recently played FM screen.
FM1(FM One)	Displays the FM1 screen.
FM2(FM Two)	Displays the FM2 screen.
AM	Displays the AM screen.

Features of your vehicle

Command	Function
FM Preset 1~6	Plays the most recently played broadcast saved in FM Preset 1~6.
AM Preset 1~6	Plays the broadcast saved in AM Preset 1~6.
FM 87.5~107.9	Plays the FM broadcast of the corresponding frequency.
AM 530~1710	Plays the AM broadcast of the corresponding frequency.
XM (Satellite)	<ul style="list-style-type: none"> • When currently listening to the SiriusXM® maintains the current state. • When listening to a different mode, displays the most recently played SiriusXM® screen.
XM (Satellite) 1~3	Displays the selected SiriusXM® screen.
XM Channel 0~223	Plays the selected SiriusXM® channel.
Media	Moves to the most recently played media screen.
CD	Plays the music saved in the CD.
USB	Plays USB music.
iPod®	Plays iPod® music.

Command	Function
My Music	Plays the music saved in My Music.
AUX (Auxiliary)	Plays the connected external device.
Bluetooth® Audio	Plays the music saved in connected Bluetooth® device.
Mute	Mutes the sound.
Cancel (Exit)	Ends voice command.

- FM/AM radio commands: Commands available during FM, AM radio operation

Command	Function
Preset 1~6	Plays the broadcast station saved in Preset 1~6.
Scan	Scans receivable frequencies from the current broadcast and plays for 10 seconds each.
Preset Scan	Moves to the next preset from the current present and plays for 10 seconds each.
Information	Displays the information of the current broadcast. (This feature can be used when receiving RBDS broadcasts.)

- Satellite radio commands: Commands that can be used while listening to Satellite Radio.

Command	Function
Channel 0~255	Play the selected Satellite Radio channel.
Scan	Scans receivable channels from the current broadcast and plays for 10 seconds each.
Preset 1~6	Plays the broadcast saved in Preset 1~6.
Information	Displays the information of the current broadcast.

Features of your vehicle

- Audio CD commands: Commands available during Audio CD operation

Command	Function
Random	Randomly plays the tracks within the CD.
Random Off	Cancels random play to play tracks in sequential order.
Repeat	Repeats the current track.
Repeat Off	Cancels repeat play to play tracks in sequential order.
Track 1-30	Plays the desired track number.

- MP3 CD / USB commands: Commands available during USB and MP3 CD operation

Command	Function
Random	Randomly plays the files within the current folder.
Random Off	Cancels random play to play files in sequential order.
Repeat	Repeats the current file.
Repeat Off	Cancels repeat play to play files in sequential order.
Information	Displays the information screen of the current file.
Next Folder	Play the first file in the next folder
Previous Folder	Play the first file in the previous folder

- iPod® Commands: Commands available during iPod® operation

Command	Function
Random	Randomly plays the songs within the current category.
Random Off	Cancels random play to play songs in sequential order.
Repeat	Repeats the current song.
Repeat Off	Cancels repeat play to play songs in sequential order.

- My Music Commands: Commands available during My Music operation

Command	Function
Random	Randomly plays all saved files.
Random Off	Cancels random play to play files in sequential order.
Repeat	Repeats the current file.
Repeat Off	Cancels repeat play to play files in sequential order.
Delete	Deletes the current file. You will bypass an additional confirmation process.

Features of your vehicle

- *Bluetooth*[®] Wireless Technology Audio Commands: Commands available during *Bluetooth*[®] Wireless Technology audio streaming from mobile phone operation Command Operation



Command	Function
Play	Plays the currently paused song.
Pause	Pauses the current song.

Blue Link®

Hyundai aims to offer differentiated customer values through a 'Connected Car Life,' which provides consumers with fast and reliable IT technology. As consumers' lifestyles become more and more mobile in thanks to remarkable advances in smart phones, tablet PCs and overall wireless telecommunication, new lifestyle patterns demand seamless connection between one's office, home, outdoors and automobiles.

Blue Link® is Hyundai's innovative telematics solution that combines safety, service, and infotainment into a complete package. It works to both help simplify Hyundai owners' lives and reduce distracted driving. The Blue Link® "  " button offers access to a voice-response menu of services.



The Blue Link®  button offers access to enhanced navigation services. The "  " button offers immediate contact to SOS Emergency Assistance. A detailed list of commands is available in the Blue Link User's Manual.

Using Rear View Mirror Buttons

Pressing the Blue Link® buttons located on the rear view mirror will allow you to make service required inquiries, POI info searches, and emergency rescues by connecting to the Blue Link® Center.

Such features can be used only after subscribing to the Blue Link® service.

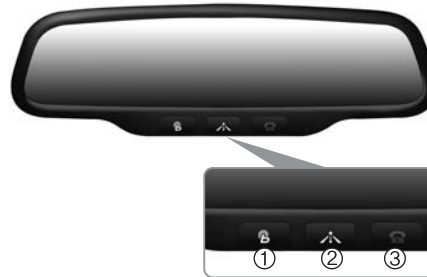

① (Blue Link® Center)

Makes requests for Blue Link® service related inquiries and consultations.

A call is connected to the Blue Link® service center employee.

Pressing the key again will end the call.

This feature does not operate when you are on a Bluetooth® phone call.

② (Blue Link® for POI)

- Blue Link® for Voice command

Starts Blue Link® voice command.

Voice receiving voice guidance, shortly press the button to convert to voice command mode. Press and hold the button to end voice command.

- TBT VR Commands

1. Navigate to

"Navigate to" voice command is used to request the download of route data for a new destination, saved destinations, daily routes and previous destinations.

2. Save Destination

“Save Destination” VR command is used to assign a voice tag to the last downloaded destination and store it in a destination directory.

* NOTICE

The Turn by Turn(TBT) feature supports the store of ten(10) destinations in the TBT destinations directory.

3. Route Preview

“Route Preview” VR command allows the user to preview the route instructions (upcoming maneuver instructions) at any time during the route guidance.

4. Destinations List

“Destinations List” VR command allows the user to preview and delete the stored destinations with their associated voice tags in the Turn by Turn destinations directory.

5. Voice Guidance

“Voice Guidance” VR command allows the user to mute/unmute the Turn by Turn(TBT) direction announcements.

6. Suspend Route

“Suspend Route” VR command allows the user to suspend and pause Turn by Turn(TBT) route guidance while in the guidance mode.

7. Resume Route

“Resume Route” VR command allows the user to resume Turn by Turn(TBT) route guidance.



③ (Blue Link® for SOS)

In the case of an emergency, requests for help to the Blue Link® center.

Call is connected to the Blue Link® emergency rescue center. Pressing the key again will end the call.

If you are already on a Bluetooth® phone call, the call will end to connect you to the Blue Link® Emergency Rescue Center.

CAUTION

- **You cannot talk simultaneously on the Bluetooth® phone call and a Blue Link® services phone all.**
- **While on a Bluetooth® call, pressing the  key or  key will display a message indicating that you are currently on a call.**
- **A message will be displayed if you receive a Bluetooth® call while already on a Blue Link® call. To answer the incoming call, press the  button on the steering wheel controls. You will not hear a ring to alert you that there is an incoming call.**

Turn by Turn

The Turn by Turn feature can be used through Blue Link®.

* For information on specific Blue Link® operations, please refer to the Blue Link® User's Manual that was provided with your vehicle.

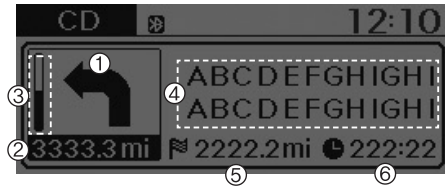

1. Direction Indicator Image
2. Remaining distance until next point
3. The Count bar is divided into a total of 9 levels.

9 Level	0.5mi	8 Level	0.4mi
7 Level	0.3mi	6 Level	0.2mi
5 Level	0.1mi	4 Level	400ft
3 Level	300ft	2 Level	200ft
1 Level	100ft		

4. Next Street name
5. Distance to destination
6. Expected Time Arrival

iPod® is a registered trademark of Apple Inc. iPod® mobile digital device sold separately. The Bluetooth® word mark and logos are registered trademarks owned by Bluetooth SIG, Inc. and any use of such marks by Hyundai is under license. SiriusXM services require a subscription sold separately, or as a package, by Sirius XM Radio Inc. If you decide to continue service after your trial, the subscription plan you choose will automatically renew thereafter and you will be charged according to your chosen payment method at then-current rates. Fees and taxes apply. To cancel you must call SiriusXM at 1-866-635-2349. See SiriusXM Customer Agreement for complete terms at www.siriusxm.com. SiriusXM U.S. satellite and data services are available only in the 48 contiguous USA, DC and PR (with coverage limitations). SiriusXM satellite service is also available in Canada; see www.siriusxm.ca. All fees and programming subject to change. Sirius, XM and all related marks and logos are trademarks of Sirius XM Radio Inc. Android™ is a trademark of Google, Inc. BlackBerry is a registered trademark of Research In Motion Limited (RIM). All other marks, channel names and logos are the property of their respective owners. All rights reserved.

■ CD Player : AM9B2DMKN, AM943DMAN



* HD Radio® logo will be shown if the HD Radio™ feature is supported.

SYSTEM CONTROLLERS AND FUNCTIONS

Audio Head Unit

(for HD RADIO™ equipped model)



1.  (EJECT)

- Ejects the disc.

2. 

- Convert to Radio mode.
- Each time the key is pressed, the mode is changed in order of FM1, FM2, AM, XM1, XM2, XM3.



3. 

- Convert to Media Mode
- Each time the key is pressed, the mode is changed in order of CD, USB(iPod®), AUX, My Music, BT Audio.

4.  (for *Bluetooth*® Wireless Technology equipped model)

- Converts to Phone mode
- * When a phone is not connected, the connection screen is displayed.

5. PWR/VOL knob

-  Power : Press to turn power on/off.
-  Volume : Turn left/right to control volume.

6. 

- When pressed shortly (under 0.8 seconds)
 - Radio mode : plays previous/next frequency.
 - Media (CD/USB/iPod®/My Music) modes : changes the track, Song(file)
- When pressed and held (Over 0.8 seconds)
 - Radio mode : continuously changes the frequency. Upon release, plays the current frequency.
 - Media (CD/USB/iPod®/My Music) modes : rewinds or fast forwards the track or file
 - During a Handsfree call, controls the call volume.

7. 

- HD RADIO™ : Channel Change
- SiriusXM RADIO : Category Search
- MP3 CD/USB mode : Search Folder



- 8. **DISP**
 - Turns the monitor display on/off.
- 9. **CLOCK**
 - Displays the time/date/day.
- 10. **SCAN**
 - Radio Mode : previews all receivable broadcasts for 5 seconds each
 - Media (CD/USB/My Music) modes : previews each song (file) for 10 seconds each.

- 11. **SETUP**
 - Converts to Setup mode.

- 12. **TUNE knob**
 - Radio mode : turn to change broadcast frequencies.
 - Media (CD/USB/iPod®/My Music) modes : turn to search tracks/channels/files.

13. DISC-IN LED



- LED that indicates whether a disc is inserted.

- 14. **RESET**
 - Forced system termination and system restart.



Audio Head Unit

- 15. **CAT FOLDER**
 - SiriusXM RADIO : Category Search
 - MP3 CD/USB mode : Search Folder

Steering remote controller



1. VOLUME

- Used to control volume.

2. MUTE

- Mutes audio volume.

3. SEEK

- When pressed shortly (under 0.8 seconds)
 - Radio mode : searches broadcast frequencies saved to pre-sets.
 - Media (CD/USB/iPod®/My Music /BT Audio) modes : changes the track, file or chapter.
- When pressed and held (over 0.8 seconds)
 - Radio mode, automatically searches broadcast frequencies and channels
 - Media (CD/USB/iPod®/My Music) modes, rewinds or fast forwards the track or song(file)
 - BT Audio mode may not be supported in some mobile phones.

4. MODE

- Each time this key is pressed, the mode is changed in order of FM1→FM2→AM→XM1→XM2→XM3→CD→USB or iPod®→AUX→My Music→BT Audio
- If the media is not connected or a disc is not inserted, corresponding modes will be disabled.

5.

- When pressed shortly
 - Starts voice recognition
 - When selecting during a voice prompt, stops the prompt and converts to voice command waiting state
- When pressed and held (over 0.8 seconds)
 - Ends voice recognition

6. 

- When pressed shortly
 - When pressed in the phone screen, displays call history screen
 - When pressed in the dial screen, makes a call
 - When pressed in the incoming call screen, answers the call
 - When pressed during call waiting, switches to waiting call (Call Waiting)
- When pressed and held (over 0.8 seconds)
 - When pressed in the *Bluetooth*[®] Wireless Technology Handsfree wait mode, redials the last call
 - When pressed during a *Bluetooth*[®] Wireless Technology Handsfree call, switches call back to mobile phone (Private)
 - When pressed while calling on the mobile phone, switches call back to *Bluetooth*[®] Wireless Technology Handsfree (Operates only when *Bluetooth*[®] Wireless Technology Handsfree is connected)

7. 

- Ends phone call

HD Radio™ Technology

(for HD RADIO™ equipped model)

HD Radio Technology manufactured under license from iBiquity Digital Corporation. U.S. and Foreign Patents. HD Radio™ and the HD, HD Radio, and “Arc” logos are proprietary trademarks of iBiquity Digital Corp.



PSD

Program Service Data: Contributes to the superior user experience of HD Radio Technology. Presents song name, artist, station IDs, HD2/HD3 Channel Guide, and other relevant data streams.

HD2/HD3

Adjacent to traditional main stations are extra local FM channels. These HD2/HD3 Channels provide new, original music as well as deep cuts into traditional genre.

Digital Sound

Digital, CD-quality sound. HD Radio Technology enables local radio stations to broadcast a clean digital signal. AM sounds like today's FM and FM sounds like a CD.

HD Radio™ signal delay

To overcome the delay that digital systems inherently produce, HD Radio™ technology first uses the audio signal of the analog broadcasting when you tune to an AM station or to the main channel of a FM station. After that, the system will blend from analog to digital signal.

Normally, this blending is very smooth. If you experience a skip in program content of several seconds, the radio station has not implemented HD Radio™ broadcasting correctly. This is not a problem with your audio system.

Due to the fact that sub channels are only broadcasting digital, blending from analog to digital signal is not possible if you tune to a sub channel. In this case playback of the sub channel starts after several seconds, this is a normal function.

RADIO MODE

Basic Mode Screen

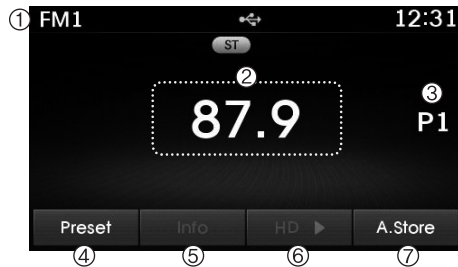

1. Mode Display
Displays currently operating mode.
2. Frequency
Displays the current frequency.
3. Preset
Displays current preset number [1] ~ [6].
4. Preset Display
Displays preset buttons.
5. Info
Displays broadcast information.
6. HD ▶
Changes HD Radio channels.
7. A.store
Automatically saves frequencies with superior reception to Preset buttons.

HD RADIO MODE

(for HD RADIO™ equipped model)

Basic Mode Screen



1. Mode Display

Displays currently operating mode.

2. HD Channel

Displays information for the currently playing HD Radio broadcast.

3. Song Information

Displays the album, artist, and title information.

4. Frequency

Displays the current frequency.

5. HD Radio Broadcast Station

Displays the HD Radio broadcast station name.

6. Preset

Displays currently playing preset number [1] ~ [6].

7. Preset Display

Displays saved presets.

8. Info

Displays broadcast information.

9. HD ▶

Changes HD Radio channels.

10. A.Store

Automatically saves frequencies with superior reception to Preset buttons.

Switching to Radio Mode

Pressing the **RADIO** key will change the operating mode in order of FM1 → FM2 → AM → XM1 → XM2 → XM3

If [Mode Pop up] is turned on within **SETUP** ▶ [Display], then pressing the **RADIO** key will display the Radio Pop-up Mode screen.

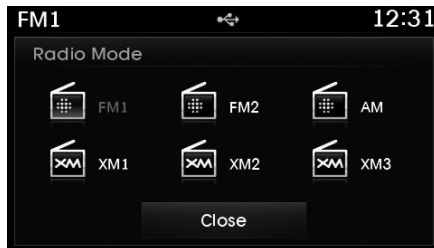

Turn the **TUNE** knob to move the focus. Press the knob to select.

Searching Radio Frequencies

Using Seek

Press the **SEEK TRACK** key to play the previous/next frequency.

Using TUNE

Turn the **TUNE** knob to select the desired frequency.

- FM : Increases/decreased by 200kHz
- AM : Increases/decreased by 10kHz

Using Radio Mode

Selecting Presets/Saving Presets

Press the **Preset** button to display the broadcast information for the frequency saved to each button.

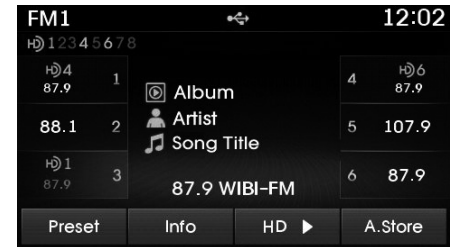

Press the **1** ~ **6** buttons to play the desired preset.

* NOTICE

While listening to a frequency you want to save as a preset, press and hold one of the **1** ~ **6** preset buttons (over 0.8 seconds) to save the current frequency to the selected preset.

Auto Store

Press the **A.Store** button to automatically save receivable frequencies to Preset buttons.

* NOTICE

While Auto Store is operating, pressing the [Cancel] button again will cancel Auto Store and restore the previous frequency.

Scan

Press the **SCAN** key to preview frequencies with superior reception for 5 seconds each.

Press and hold the **SCAN** key (over 0.8 seconds) to preview presets for 5 seconds each.

Once scan is complete, the previous frequency will be restored.

While Scan is operating, pressing the **SCAN** key will cancel the scan operation.

Listening to HD Radio Stations

HD Radio Technology is a digital radio technology used by AM and FM radio station to transmit audio and data via a digital signal in conjunction with their analog signals.

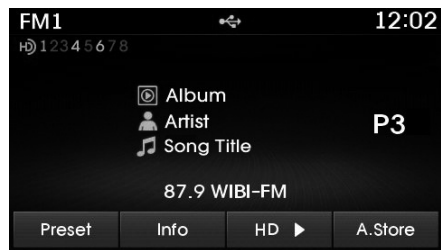

While listening to the radio, the HD Radio icon will become displayed if receiving an HD Radio broadcast.

Changing HD Radio stations

Press the **HD ▶** button to change HD Radio station.

Viewing Station Information

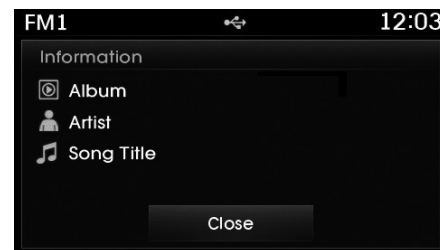

Press the **Info** button to view station information.

XM RADIO™ MODE

Features of your vehicle

Satellite radio reception

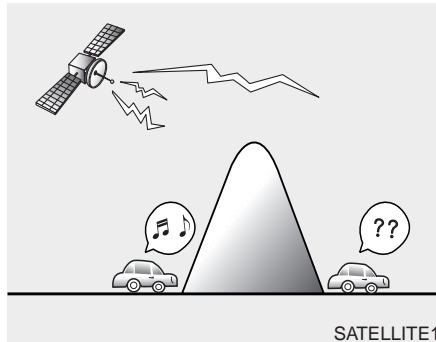

You may experience difficulties in receiving XM satellite™ radio signals in the following situations.

- If you are driving in a tunnel or a covered parking area.
- If you are driving beneath the top level of a multi-level freeway.
- If you are driving under a bridge.
- If you are driving next to a tall vehicle (such as a truck or a bus) that blocks the signal.

- If you are driving in a valley where the surrounding hills or peaks block the signal from the satellite.
- If you are driving on a mountain road where the signal is blocked by mountains.

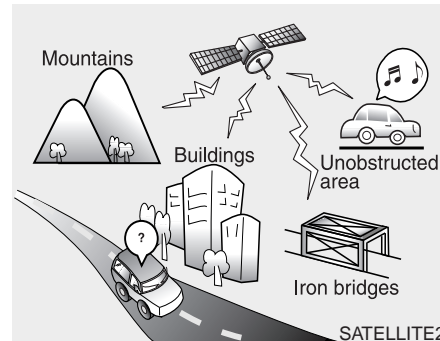

- If you are driving in an area with tall trees that block the signal (30 ft. /10m or more), for example on a road that goes through a dense forest.
- The signal can become weak in some areas that are not covered by the XM repeater network.

* NOTICE

There may also be additional unforeseen circumstances leading to reception problems with the XM satellite™ radio signal.

Advisory Messages, such as 'CH Unavailable' may occur when starting XM Radio™.

SiriusXM® Satellite Radio information

Satellite Radio channels:

Enjoy SiriusXM Satellite Radio with a 3-month trial subscription to the Sirius Select package. You'll get over 140 channels, including commercial-free music, plus all your favorite sports, exclusive talk, entertainment, and a selection of premium programming. For more information and a complete list of SiriusXM channels, visit siriusxm.com in the United States, siriusxm.ca in Canada, or call SiriusXM at 1-888-539-7474.

Satellite Radio reception factors:

To receive the satellite signal, your vehicle has been equipped with a satellite radio antenna located on the roof of your vehicle. The vehicle roof provides the best location for an unobstructed, open view of the sky, a requirement of a satellite radio system. Like AM/FM, there are several factors that can affect satellite radio reception performance:

- Antenna obstructions: For optimal reception performance, keep the antenna clear of snow and ice build-up and keep luggage and other material as far away from the antenna as possible.
- Terrain: Hills, mountains, tall buildings, bridges, tunnels, freeway overpasses, parking garages, dense tree foliage and thunderstorms can interfere with your reception.

SiriusXM Satellite Radio service:

SiriusXM is a subscription-based satellite radio service that broadcasts music, sports, news and entertainment programming to radio receivers, which are available for installation in motor vehicles or factory installed, as well as for the home, portable and wireless devices, and through an Internet connection on personal computer.

Vehicles that are equipped with a factory installed SiriusXM Satellite Radio system include:

- Hardware and an introductory trial subscription term, which begins on the date of sale or lease of the vehicle.
- For a small upgrade fee, access to SiriusXM music channels, and other select channels over the Internet using any computer connected to the Internet (U.S. customers only).

For information on extended subscription terms, contact SiriusXM at 1-888-539-7474.

*** NOTICE**

SiriusXM services require a subscription sold separately, or as a package, by Sirius XM Radio Inc. If you decide to continue service after your trial, the subscription plan you choose will automatically renew thereafter and you will be charged according to your chosen payment method at then-current rates. Fees and taxes apply. To cancel you must call SiriusXM at 1-866-635-2349. See SiriusXM Customer Agreement for complete terms at www.siriusxm.com. SiriusXM U.S. satellite and data services are available only in the 48 contiguous USA, DC and PR (with coverage limitations). SiriusXM satellite service is also available in Canada; see www.siriusxm.ca. All fees and programming subject to change. Sirius, XM and all related marks and logos are trademarks of Sirius XM Radio Inc.

SiriusXM RADIO MODE

Basic Mode Screen

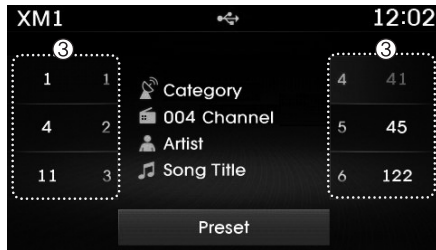

1. Mode Display

Displays currently operating mode.

2. Channel Information

Displays the category, channel number, channel name, artist and title information.

3. Preset

Displays currently playing preset number [1] ~ [6].

4. Preset Display

Displays saved presets.

Using SiriusXM Satellite Radio

Your vehicle is equipped with a 3-month trial subscription to SiriusXM so you have access to over 140 channels of music, information, and entertainment programming.

Activation

In order to extend or reactivate your Sirius Select subscription, you will need to contact SiriusXM Customer Care at 1-800-643-2112. Have your 12-digit RID (Radio Identification Number) / ESN (Electronic Serial Number) ready. To retrieve the RID / ESN, turn on the radio, press the key, and tune to channel zero.

Please note that the vehicle will need to be turned on, in Sirius mode, and have an unobstructed view of the sky in order for the radio to receive the activation signal.

Using SEEK

Press the **SEEK TRACK** key to play the previous/next channel.

* If the “Category” icon is displayed, channels are changed within the current category.

Using Tune

Turn the **TUNE** knob to select the desired channel.

SCAN

Press the **SCAN** key to scan all channels with superior reception for 10 seconds each.

Once scan is complete, the previously played channel will be restored.

During Scan, pressing the **SCAN** key again will cancel the scan operation and restore the previously played channel.

If the “Category” icon is displayed, channels are changed within the current category.

Searching Categories

Select the category by using the **HD/CAT FOLDER** (**CAT FOLDER**) key and press the **TUNE** knob to select.

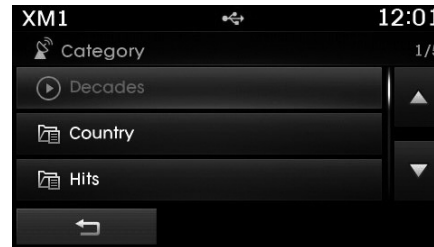

Channels for the selected category are played.

* Troubleshooting

1. Antenna Error

If this message is displayed, the antenna or antenna cable is broken or unplugged. Please consult with your Hyundai dealership.

2. No Signal

If this message is displayed, it means that the antenna is covered and that the SiriusXM Satellite Radio signal is not available. Ensure the antenna is uncovered and has a clear view of the sky.

Selecting Presets/Saving Presets

Press the **Presets** button to display the broadcast information for the channel saved to each button.

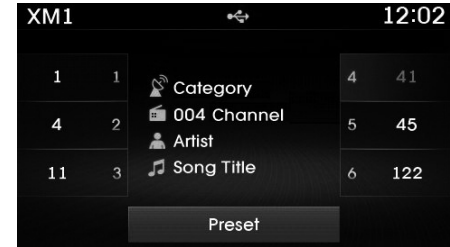

Press the **1** ~ **6** buttons to play the desired preset.

* NOTICE

While listening to a channel you want to save as a preset, press and hold one of the **1** ~ **6** preset buttons (over 0.8 seconds) to save the current channel to the selected preset.

*** NOTICE - USING CDs**

- This device has been manufactured to be compatible with software bearing the following logo marks.
- Do not clean discs with chemical solutions, such as record sprays, antistatic sprays, antistatic liquids, benzene, or thinners.
- After using a disc, put the disc back in its original case to prevent disc scratches.
- Hold discs by their edges or within the center hole to prevent damages to disc surfaces.
- Do not introduce foreign substances into the disc insert/eject slot. Introducing foreign substances could damage the device interior.
- Do not insert two discs simultaneously.
- When using CD-R/CD-RW discs, differences in disc reading and playing times may occur depending on the disc manufacturer, production method and the recording method as used by the user.

(Continued)

(Continued)

- Clean fingerprints and dust off the disc surface (coated side) with a soft cloth.
- The use of CD-R/CD-RW discs attached with labels may result in disc slot jams or difficulties in disc removal. Such discs may also result in noise while playing.
- Some CD-R/CD-RW discs may not properly operate depending on the disc manufacturer, production method and the record method as used by the user. If problems persist, trying using a different CD as continued use may result in malfunctions.
- The performance of this product may differ depending on the CD-RW Drive Software.
- Copy-protected CDs such as S-type CDs may not function in the device. DATA discs cannot be played. (However, such discs may still operate but will do so abnormally.)

(Continued)

(Continued)

- Do not use abnormally shaped discs (8cm, heart-shaped, octagon-shaped) as such discs could lead to malfunctions.
- If the disc is straddled on the disc slot without removal for 10 seconds, the disc will automatically be re-inserted into the disc player.
- Only genuine audio CDs are supported. Other discs may result in recognition failure. (e.g. copy CD-R, CDs with labels)

MEDIA MODE

Pressing the **MEDIA** key will change the operating mode in order of CD→USB(iPod®)→AUX→My Music → BT Audio.



If [Mode Pop up] is turned on within **SETUP** ▶ [Display], then pressing the **MEDIA** key will display the Media Pop-up Mode screen.

Turn the **TUNE** knob to move the focus. Press the knob to select.

* NOTICE

The media mode pop up screen can be displayed only when there are two or more media modes turned on.

Title Icon

When a *Bluetooth*® Wireless Technology, iPod®, USB, or AUX device is connected or a CD is inserted, the corresponding mode icon will be displayed.



Icon	Title
	<i>Bluetooth</i> ® Wireless Technology
	CD
	iPod®
	USB
	AUX

AUDIO CD MODE

Basic Mode Screen



1. Mode

Displays currently operating mode.

2. Operation State

From Repeat/Random(Shuffle)/ Scan, displays the currently operating function.

3. Track Info

Displays information about the current track.

4. Play/Pause

Changes the play/pause state.

5. Play Time

Displays the current play time.

6. Info

Shows detailed information about the current track.

7. Random(Shuffle)

Turns the Random(Shuffle) feature on/off.

8. Repeat

Turns the Repeat feature on/off.

9. List

Moves to the list screen.

Using Audio CD Mode

Playing/Pausing CD Tracks

Once an audio CD is inserted, the mode will automatically start and begin playing.



While playing, press the **||** button to pause and press **▶** button to play.

* NOTICE

- Only genuine audio CDs are supported. Other discs may result in recognition failure (e.g. copy CD-R, CDs with labels)
- The artist and title information are displayed on the screen if track information is included within the audio CD.

Changing Tracks

Press the **SEEK TRACK** key to move to the previous or next track.

* NOTICE

- Pressing the **SEEK TRACK** key after the track has been playing for 2 seconds will start the current track from the beginning.
- Pressing the **SEEK TRACK** key before the track has been playing for 1 seconds will start the previous track.

Selecting from the List

Turn the **TUNE** knob left/right to search for the desired track.

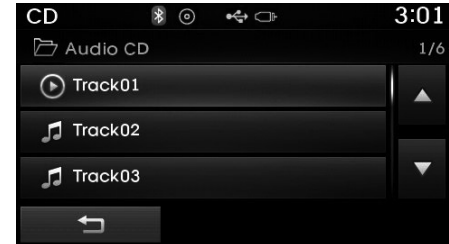

Once you find the desired track, press the **TUNE** knob to start playing.

Rewinding / Fast-forwarding Tracks

While playing, press and hold the **SEEK TRACK** key (over 0.8 seconds) to rewind or fast-forward the current track.

Scan

Press the **SCAN** key to play the first 10 seconds of each file.

Audio CD Mode Menu

Within this mode, you will have access to the Info, Random(Shuffle), Repeat and List features.

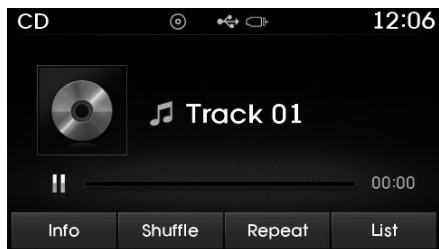

Info

Press the **Info** button to display details about the current disc.

Random(Shuffle)

Press the **Shuffle** button to play tracks in random(Shuffle) order.

Press the **Shuffle** button again to turn the Random(Shuffle) feature off.

- Random(Shuffle): Plays all tracks in random(Shuffle) order.

Repeat

Press the **Repeat** button to repeat the current track. Press the button again to turn the repeat feature off.

- Repeat : Repeats the current track.

List

Press the **List** button to display the track list screen.

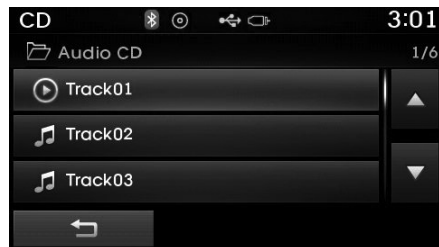

Turn the **⊙TUNE** knob left/right to search for tracks. Once the desired track is displayed, press the knob to select and play.

MP3 CD MODE

Basic Mode Screen

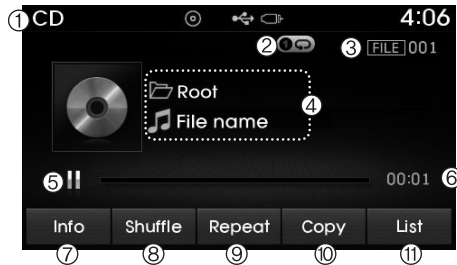

1. Mode

Displays currently operating mode.

2. Operation State

From Repeat/Random(Shuffle)/Scan, displays the currently operating function.

3. File Index

Displays the current file number.

4. File Info

Displays information about the current file.

5. Play/Pause

Changes the play/pause state.

6. Play Time

Displays the current play time.

7. Info

Shows detailed information about the current file.

8. Random(Shuffle)

Turns the Random(Shuffle) feature on/off.

9. Repeat

Turns the Repeat feature on/off.

10. Copy

Copies the current file into My Music

11. List

Moves to the list screen.

Using MP3 CD Mode

Playing/Pausing MP3 Files

Once an MP3 disc is inserted the mode will automatically start and begin playing.



While playing, press the **||** button to pause and press **▶** button to play.

* NOTICE

If there are numerous files and folders within the disc, reading time could take more than 10 seconds and the list may not be displayed or song searches may not operate. Once loading is complete, try again.

Changing Files

Press the **SEEK TRACK** key to move to the previous or next file.

* NOTICE

- Pressing the **SEEK TRACK** key after the file has been playing for 2 seconds will start the current file from the beginning.
- Pressing the **SEEK TRACK** key before the file has been playing for 1 second will start the previous file.

Selecting from the List

Turn the **TUNE** knob left/right to search for the desired file.

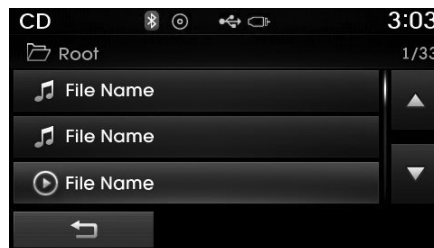

Once you find the desired file, press the **TUNE** knob to start playing.

Rewinding / Fast-forwarding Files

While playing, press and hold the **SEEK TRACK** key (over 0.8 seconds) to rewind or fast-forward the current file.

Scan

Press the **SCAN** key to play the first 10 seconds of each file.

Searching Folders

Press the **HD/CAT FOLDER** (**CAT FOLDER**) key to select and search folders.

Once the desired folder is displayed, press the **TUNE** knob to select.

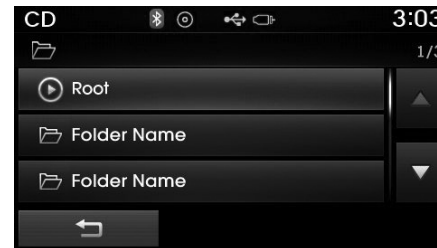

The first file within the selected folder will begin playing.

MP3 CD Mode Menu

Within this mode, you will have access to the Info, Random(Shuffle), Repeat, Copy and List features.



Info

Press the **Info** button to display details about the current file.

* NOTICE

- When the 'Folder File' option is set as the default display within Display setup, the album/artist/file information are displayed as detailed file information.
- When the 'Album Artist Song' option is set as the default display, the folder name/file name are displayed as detailed file information.
- The title, artist and album info are displayed only when such information are recorded within the MP3 file ID3 tag.

Random(Shuffle)

Press the **Shuffle** button to play files in random(Shuffle) order.

Each time the button is pressed, the feature changes in order of Random (Shuffle) Folder → Random (Shuffle) All → Off.

- Random (Shuffle) Folder : Plays all files within the current folder in Random (Shuffle) order.
- Random (Shuffle) All : Plays all files in Random (Shuffle) order.

Features of your vehicle

Repeat

Press the **Repeat** button to repeat the current file or folder.

Each time the button is pressed, the feature changes in order of Repeat → Repeat Folder → Off.

- Repeat: Repeats the current file.
- Repeat Folder: Repeats all files within the current Folder.

Copying Files

Press the **Copy** button to copy the current file into My Music.

*** NOTICE**

Selecting another feature during copying will display a pop-up asking whether you wish to cancel copying. To cancel, select 'Yes'.

List

Press the **List** button to display the file list screen.



Turn the **TUNE** knob left/right to search for files. Once the desired file is displayed, press the knob to select and play.

*** NOTICE - USING THE USB DEVICE**

- Connect the USB device after turning on the engine. The USB device may become damaged if it is already connected when the ignition is turned on. The USB device may not operate properly if the car ignition is turned on or off with the USB device connected.
- Heed caution to static electricity when connecting/disconnecting USB devices.
- Encoded MP3 Players will not be recognized when connected as an external device.
- When connecting an external USB device, the device may not properly recognize the USB is in some states.
- Only products formatted with byte/sectors under 64Kbyte will be recognized.
- This device recognizes USB devices formatted in FAT 12/16/32 file formats. This device does not recognize files in NTFS file format.

(Continued)

(Continued)

- Some USB devices may not be supported due to compatibility issues.
- Avoid contact between the USB connector with bodily parts or foreign objects.
- Repeated connecting/disconnecting of USB devices within short periods of time may result in product malfunction.
- A strange noise may occur when disconnecting the USB.
- Make sure to connect/disconnect external USB devices with the audio power turned off.
- The amount of time required to recognize the USB device may differ depending on the type, size or file formats stored in the USB. Such differences in time are not indications of malfunctions.
- The device only supports USB devices used to play music files.
- USB images and videos are not supported.

(Continued)

(Continued)

- Do not use the USB I/F to charge batteries or USB accessories that generate heat. Such acts may lead to worsened performance or damage to the device.
- The device may not recognize the USB device if separately purchased USB hubs and extension cables are being used. Connect the USB directly with the multimedia terminal of the vehicle.
- When using mass storage USB devices with separate logical drives, only files saved to the root drive can be played.
- Files may not properly operate if application programs are installed to the USBs.
- The device may not operate normally if MP3 Players, cellular phones, digital cameras, or other electronic devices (USB devices not recognized as portable disk drives) are connected with the device.

(Continued)

(Continued)

- Charging through the USB may not work for some mobile devices.
- The device may not support normal operation when using a USB memory type besides (Metal Cover Type) USB Memory.
- The device may not support normal operation when using formats such as HDD Type, CF, or SD Memory.
- The device will not support files locked by DRM (Digital Rights Management.)
- USB memory sticks used by connecting an Adaptor (SD Type or CF Type) may not be properly recognized.
- The device may not operate properly when using USB HDDs or USBs subject to connection failures caused by vehicle vibrations. (e.g. i-stick type)

(Continued)

(Continued)

- Avoid use of USB memory products that can also be used as key chains or mobile phone accessories. Use of such products may cause damage to the USB jack.
- Connecting an MP3 device or phone through various channels, such as AUX/BT or Audio/USB mode may result in pop noises or abnormal operation.



USB MODE

Basic Mode Screen

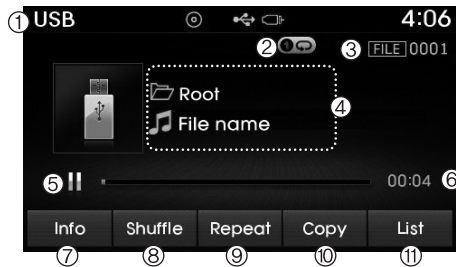

1. Mode

Displays currently operating mode.

2. Operation State

From Repeat/Random(Shuffle)/Scan, displays the currently operating function.

3. File Index

Displays the current file number.

4. File Info

Displays information about the current file.

5. Play/Pause

Changes the play/pause state.

6. Play Time

Displays the current play time.

7. Info

Displays detailed information for the current file.

8. Random(Shuffle)

Turns the Random(Shuffle) feature on/off.

9. Repeat

Turns the Repeat feature on/off.

10. Copy

Copies the current file into My Music.

11. List

Moves to the list screen.

Using USB Mode

Playing/Pausing USB Files

Once a USB is connected, the mode will automatically start and begin playing a USB file.



While playing, press the **||** button to pause and press **▶** button to play.

* NOTICE

- Loading may require additional time if there are many files and folders within the USB and result in faulty list display or file searching. Normal operations will resume once loading is complete.
- The device may not support normal operation when using a USB memory type besides (Metal Cover Type) USB Memory.

Changing Files

Press the **SEEK TRACK** keys to move to the previous or next file.

* NOTICE

- Pressing the **SEEK TRACK** key after the file has been playing for 2 seconds will start the current file from the beginning.
- Pressing the **SEEK TRACK** key before the file has been playing for 1 seconds will start the previous file.

Selecting from the List

Turn the **TUNE** knob left/right to search for the desired file.

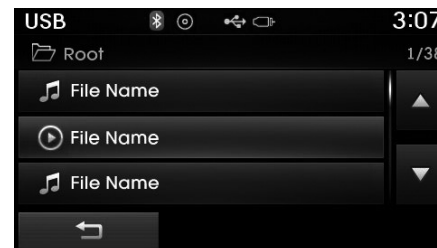

Once you find the desired file, press the **TUNE** knob to start playing.

Rewinding / Fast-forwarding Files

While playing, press and hold the **SEEK TRACK** key (over 0.8 seconds) to rewind or fast-forward the current file.

Scan

Press the **SCAN** key to play the first 10 seconds of each file.

Searching Folders

Press the **HD/CAT FOLDER** (▼) (**CAT FOLDER** ▲) key to select and search folders.

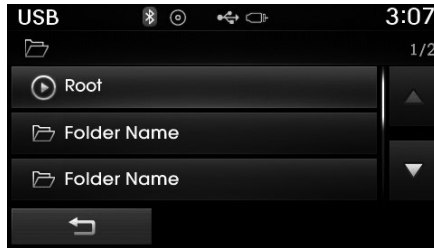

Once the desired folder is displayed, press the **TUNE** knob to select. The first file within the selected folder will begin playing.

USB Mode Menu

Within this mode, you will have access to the Info, Random(Shuffle), Repeat, Copy and List features.



Info

Press the **Info** button to display details about the current file.

* NOTICE

- When the 'Folder File' option is set as the default display within Display setup, the album/artist/file information are displayed as detailed file information.
- When the 'Album Artist Song' option is set as the default display, the folder name/file name are displayed as detailed file information.
- The title, artist and album info are displayed only when such information are recorded within the MP3 file ID3 tag.

Random(Shuffle)

Press the **Shuffle** button to play files in random(Shuffle) order.

Each time the button is pressed, the feature changes in order of Random(Shuffle) Folder → Random(Shuffle) All → Off.

- Random(Shuffle) Folder : Plays the files in the current folder in random(Shuffle) order.
- Random(Shuffle) All : Plays all files in random(Shuffle) order.

Repeat

Press the **Repeat** button to repeat the current file or folder.

Each time the button is pressed, the feature changes in order of Repeat → Repeat Folder → Off.

- Repeat (Icon) : Repeats the current file.
- Repeat Folder (Icon) : Repeats all files within the current folder.

Copying Files

Press the **Copy** button to copy the current file into My Music.

*** NOTICE**

Selecting another feature during copying will display a pop-up asking whether you wish to cancel copying. To cancel, select 'Yes'.

List

Press the **List** button to display the file list screen.

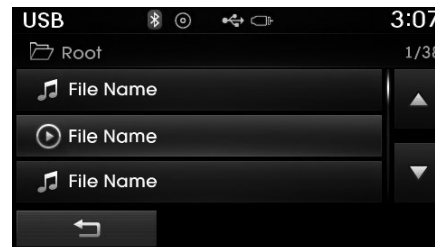

Turn the **TUNE** knob left/right to search for files. Once the desired file is displayed, press the knob to select and play.

*** NOTICE - USING THE iPod®
DEVICE**

- iPod® is a registered trademark of Apple Inc.
- In order to use the iPod® while operating the keys, you must use a dedicated iPod® cable. (the cable that is supplied when purchasing iPod®/iPhone® products)
- If the iPod® is connected to the vehicle while it is playing, a high pitch sound could occur for approximately 1-2 seconds immediately after connecting. If possible, connect the iPod® to the vehicle with the iPod® stopped/paused.
- During ACC ON state, connecting the iPod® through the iPod® cable will charge the iPod® through the car audio system.
- When connecting with the iPod® cable, make sure to fully insert the jack to prevent communication interference.

(Continued)

(Continued)

- When the EQ features of an external device, such as the iPod®, and the audio system are both active, EQ effects could overlap and cause sound deterioration and distortion. Whenever possible, turn off the EQ feature within the external device upon use by connecting with the audio system.
- Noise may occur when an iPod® or AUX device is connected. When such devices are not being used, disconnect the device for storage.
- When the iPod® or AUX device power is connected to the power jack, playing the external device may result in noise. In such cases, disconnect the power connection before use.
- Skipping or improper operation may occur depending on the characteristics of your iPod®/iPhone® device.

(Continued)

(Continued)

- If your iPhone® is connected to both the *Bluetooth*® Wireless Technology and USB, the sound may not be properly played. In your iPhone®, select the Dock connector or *Bluetooth*® Wireless Technology to change the sound output (source).
- iPod® mode cannot be operated when the iPod® cannot be recognized due to versions that do not support communication protocols.
- For fifth generation iPod® Nano devices, the iPod® may not be recognized when the battery level is low. Please charge the iPod® for use.
- Search/play orders shown within the iPod® device may differ with the orders shown within the audio system.
- If the iPod® malfunctions due to an iPod® device defect, reset the iPod® and try again. (To learn more, refer to your iPod® manual)

(Continued)

(Continued)

- Some iPod®s may not sync with the System depending on its version. If the Media is removed before the Media is recognized, then the system may not properly restore the previously operated mode. (iPad® charging is not supported.)

iPod® MODE

Basic Mode Screen



1. Mode

Displays currently operating mode.

2. Operation State

From Repeat/Random(Shuffle), displays the currently operating function.

3. Song Index

Displays the current song/total number of songs.

4. Song Info

Displays information about the current song.

5. Play/Pause

Changes the play/pause state.

6. Play Time

Displays the current play time.

7. Random(Shuffle)

Turns the Random(Shuffle) feature on/off.

8. Repeat

Turns the Repeat feature on/off.

9. List



Moves to the list screen.

Using iPod® Mode

Playing/Pausing iPod® Songs

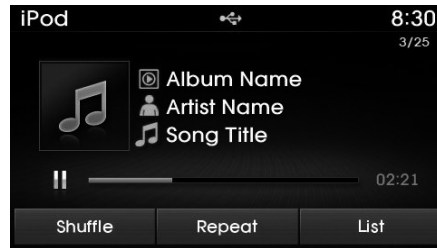
Once an iPod® is connected, the mode will automatically start and begin playing an iPod® song.



While playing, press the  button to pause and press  button to play.



* NOTICE

iPod®s with unsupported communication protocols may not properly operate in the audio system.

Changing Songs

Press the  key to move to the previous or next song.

* NOTICE

- Pressing the  key after the song has been playing for 2 seconds will start the current song from the beginning.
- Pressing the  key before the song has been playing for 1 second will start the previous song.
- Slight time differences may exist depending your iPod® product.

Rewinding / Fast-forwarding Songs

While playing, press and hold the  key (over 0.8 seconds) to rewind or fast-forward the current song.

Searching Categories

Turn the  TUNE knob left/right to search for the desired category.

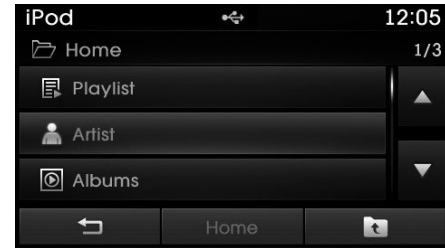

Once you find the desired category, press the  TUNE knob to select and play.



* NOTICE

There are eight categories that can be searched, including Playlists, Artists, Albums, Genres, Songs, Composers, Audiobooks and Podcasts.

Category Menu

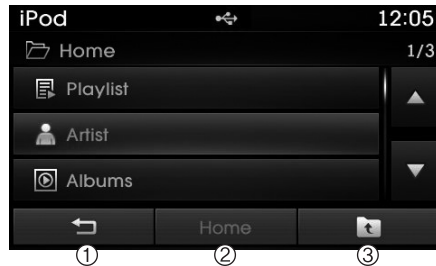
Within the iPod® Category menu, you will have access to the , Home, and  features.



1.  : Displays the play screen
2. Home : Moves to the iPod® root category screen
3.  : Moves to the previous category

* NOTICE

- If the search mode is accessed while playing a song, the most recently searched category is displayed.
- Search steps upon initial connection may differ depending on the type of iPod® device.

iPod® Mode Menu

Within this mode, you will have access to the Random (Shuffle), Repeat and List features.

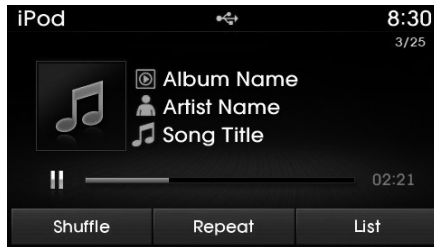

Random(Shuffle)

Press the **Shuffle** button to play songs in random (Shuffle) order.

Each time the button is pressed, the feature changes in order of Random (Shuffle) Album → Random (Shuffle) All → Off.

- Random (Shuffle) Album : Shuffle Album plays album in Random(Shuffle) order.
- Random (Shuffle) All : Plays all songs in Random(Shuffle) order.

Repeat

Press the **Repeat** button to repeat the current song. Press the button again to turn the repeat feature off.

- Repeat : Repeats the current song

List

Press the **List** button to display the Category Menu.

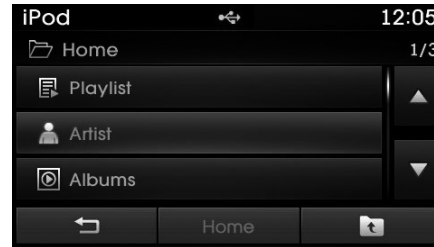

Turn the **TUNE** knob left/right to search for the desired category.

Once you find the desired category, press the **TUNE** knob to select and play.

AUX MODE

Using AUX Mode

Press the **MEDIA** key ▶ Select [AUX]

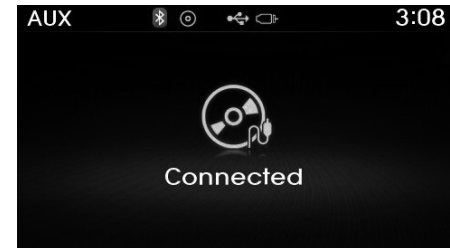

An external device can be connected to play music.

Connecting an External Device

External audio players (Camcorders, car VCR, etc.) can be played through a dedicated cable.

* NOTICE

- If an external device connector is connected with the AUX terminal, then AUX mode will automatically operate. Once the connector is disconnected, the previous mode will be restored.
- AUX mode can be used only when an external audio player (camcorder, car VCR, etc.) has been connected.
- The AUX volume can be controlled separately from other audio modes.
- Connecting a connector jack to the AUX terminal without an external device will convert the system to AUX mode, but only output noise. When an external device is not being used, also remove the connector jack.
- When the external device power is connected to the power jack, playing the external device may output noise. In such cases, disconnect the power connection before use.
- Fully insert the AUX cable to the AUX jack upon use.

MY MUSIC MODE

Basic Mode Screen



1. Mode

Displays currently operating mode.

2. Operation State

From Repeat/Random(Shuffle)/Scan, displays the currently operating function.

3. File Index

Displays the current file/total number of files.

4. File Info

Displays information about the current file.

5. Play/Pause

Changes the play/pause state.

6. Play Time

Displays the current play time.

7. Info

Displays detailed information for the current file.

8. Random(Shuffle)

Turns the Random(Shuffle) feature on/off.

9. Repeat

Turns the Repeat feature on/off.

10. Delete

Deletes the current file.

11. List

Moves to the list screen.

Using My Music Mode

Playing/Pausing My Music Files

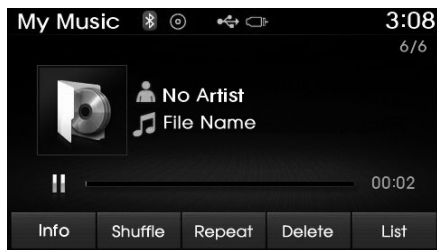

While playing, press the **||** button to pause and press **▶** button to play.

* NOTICE

If there are no files saved within My Music, the [My Music] button will be disabled.

Changing Files

Press the **SEEK TRACK** key to move to the previous or next file.

* NOTICE

- Pressing the **SEEK TRACK** key after the file has been playing for 2 seconds will start the current file from the beginning.
- Pressing the **SEEK TRACK** key before the file has been playing for 1 second will start the previous file.

Selecting from the List

Turn the **TUNE** knob left/right to search for the desired file.

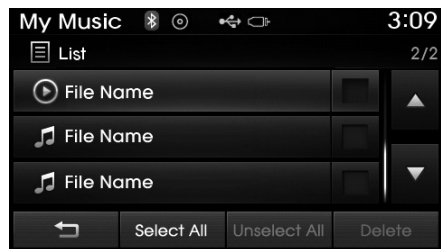

Once you find the desired file, press the **TUNE** knob to start playing.

Rewinding / Fast-forwarding Files

While playing, press and hold the **SEEK TRACK** key (over 0.8 seconds) to rewind or fast-forward the current file.

Scan

Press the **SCAN** key to play the first 10 seconds of each file.

My Music Mode Menu

Within this mode, you will have access to the Info, Random(Shuffle), Repeat, Delete and List features.

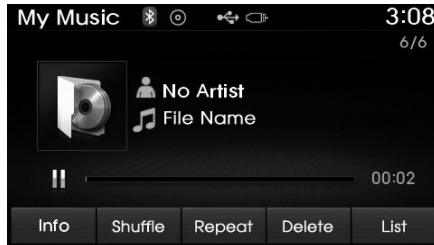

Info

Press the **Info** button to display details about the current file.

* NOTICE

The title, artist and album info are displayed only when such information is recorded within the MP3 file ID3 tag.

Random

Press the **Shuffle** button to play files in random order. Press the button again to turn the Random feature off.

Repeat

Press the **Repeat** button to repeat the current song. Press the button again to turn the repeat feature off.

Deleting Files

Press the **Delete** button to delete the current file.

List

Press the **List** button to display the file list screen.

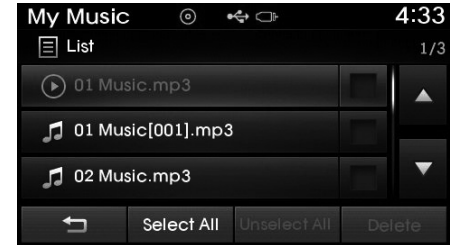

Turn the **TUNE** knob left/right to search for files. Once the desired file is displayed, press the knob to select and play.

List Menu

From the List screen, it is possible to delete files you previously saved into My Music.

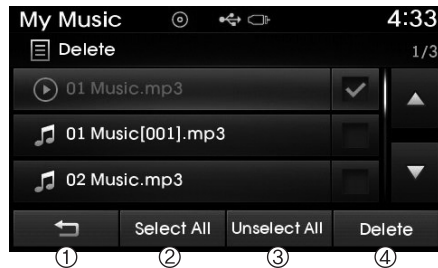

Press the **Select All** button or individually select the files you want to delete. Once files are selected, the **Unselect All** button and **Delete** buttons will be enabled.

- 1) **←** : Moves to the previous screen
- 2) **Select All**: Selects all files
- 3) **Unselect All**: Deselects all selected files
- 4) **Delete**: Deletes selected files

After selecting the files you want to delete, press the **Delete** button to delete the selected files.

* NOTICE

- If there is memory available, up to 6,000 files can be saved.
- Identical files cannot be copied more than 1,000 times.
- To check memory information, go to **SETUP** ▶ [System] ▶ [Memory Information]

*** NOTICE - USING THE
Bluetooth[®] Wireless
Technology Audio Mode**

- *Bluetooth*[®] Wireless Technology Audio Mode can be used only when a *Bluetooth*[®] Wireless Technology phone has been connected.
- *Bluetooth*[®] Wireless Technology Audio Mode will not be available when connecting mobile phones that do not support this feature.
- While *Bluetooth*[®] Wireless Technology Audio is playing, if the *Bluetooth*[®] Wireless Technology phone is connected, then the music will also stop.
- Moving the Track up/down while playing *Bluetooth*[®] Wireless Technology audio mode may result in pop noises in some mobile phones.
- *Bluetooth*[®] Wireless Technology streaming audio may not be supported in some mobile phones.

(Continued)

(Continued)

- When returning to *Bluetooth*[®] Wireless Technology Audio mode after ending a call, the mode may not automatically restart in some mobile phones.
- Receiving an incoming call or making an outgoing call while playing *Bluetooth*[®] Wireless Technology Audio may result in audio interference.



Bluetooth® Wireless Technology AUDIO MODE

Using Bluetooth® Wireless Technology Audio Mode

Playing/Pausing Bluetooth® Wireless Technology Audio

Once a *Bluetooth®* Wireless Technology device is connected, the mode will automatically start.



While playing, press the  button to pause and press  button to play.

*** NOTICE**

The play/pause feature may operate differently depending on the mobile phone.

Changing Files

Press the  key to move to the previous or next file.

Setting Connection

If a *Bluetooth®* Wireless Technology device has not been connected, press the  key ►[Phone] button to display the *Bluetooth®* Wireless Technology connection screen.

It is possible to use the pair phone, connect/disconnect and delete features from your *Bluetooth®* Wireless Technology phone.

*** NOTICE**

If music is not yet playing from your mobile device after converting to *Bluetooth*[®] Wireless Technology Audio mode, pressing the play button once may start playing the mode. Check to see that music is playing from the *Bluetooth*[®] Wireless Technology device after converting to *Bluetooth*[®] Wireless Technology Audio Mode.

Pairing a *Bluetooth*[®] Wireless Technology Device

What is Bluetooth[®] *Wireless Technology Pairing?*

Pairing refers to the process of synchronizing your *Bluetooth*[®] Wireless Technology phone or device with the car audio system for connection. Pairing is necessary to connect and use the *Bluetooth*[®] Wireless Technology feature.

Pairing Using the **PHONE** key or the Steering Wheel Control key

When No Devices have been Paired

1. Press the **PHONE** key or the  key on the steering remote controller. The following screen is displayed.
2. Press the **OK** button to enter the Pair Phone screen.

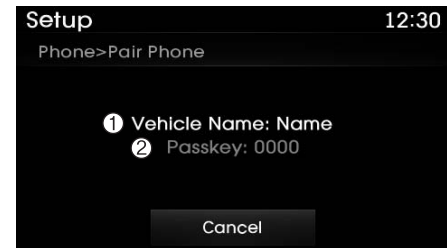
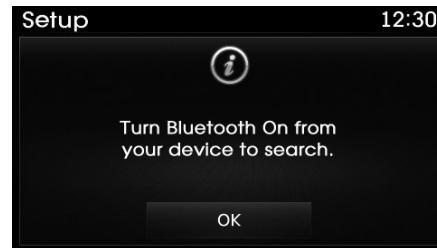

- 1) Vehicle Name : Name of device as shown when searching from your *Bluetooth*[®] Wireless Technology device
- 2) Passkey : Passkey used to pair the device
3. From your *Bluetooth*[®] Wireless Technology device (i.e. Mobile Phone), search and select your car audio system.

[Non SSP supported device]
(SSP: Secure Simple Pairing)

4. After a few moments, a screen is displayed where the passkey is entered.

Hear, enter the passkey "0000" to pair your *Bluetooth*® Wireless Technology device with the car audio system.

[SSP supported device]

4. After a few moments, a screen is displayed 6 digits passkey.

Hear, check the passkey on your *Bluetooth*® Wireless Technology device and confirm.

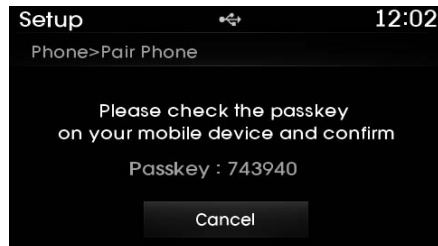

5. Once pairing is complete, the following screen is displayed.

* NOTICE



If *Bluetooth*® Wireless Technology devices are paired but none are currently connected, pressing the **PHONE** key or the  key on the steering wheel displays the following screen. Press the [Pair] button to pair a new device or press the [Connect] to connect a previously paired device.

Pairing through [PHONE] Setup

Press the **SETUP** key ▶ Select [Phone] ▶ Select [Pair Phone] ▶ Select  TUNE knob

(For USA)

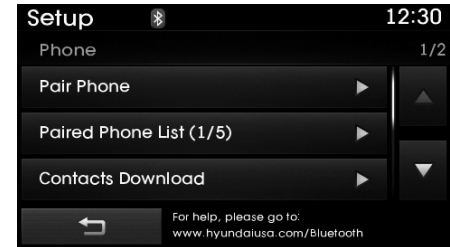

(Except USA)

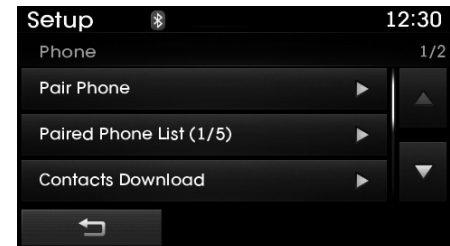

The following steps are the same as those described in the section "When No Devices have been Paired" on the previous page.

*** NOTICE**

- **Bluetooth®** Wireless Technology features supported within the vehicle are as follows. Some features may not be supported depending on your **Bluetooth®** Wireless Technology device.
 - Outgoing/Incoming Handsfree calls
 - Operations during a call (Switch to Private, Switch to call waiting, MIC on/off)
 - Downloading Call History
 - Downloading Mobile Contacts
 - **Bluetooth®** Wireless Technology device auto connection
 - Bluetooth Audio Streaming
- Up to five **Bluetooth®** Wireless Technology devices can be paired to the Car Handsfree system.
- Only one **Bluetooth®** Wireless Technology device can be connected at a time.
- Other devices cannot be paired while a **Bluetooth®** Wireless Technology device is connected.

(Continued)

(Continued)

- Only **Bluetooth®** Wireless Technology Handsfree and Bluetooth audio related features are supported.
- Bluetooth related operations are possible only with devices that support Handsfree or audio features, such as a **Bluetooth®** Wireless Technology mobile phone or a Bluetooth audio device.
- If a connected **Bluetooth®** Wireless Technology device becomes disconnected due to being out of communication range, turning the device OFF, or a **Bluetooth®** Wireless Technology communication error, corresponding **Bluetooth®** Wireless Technology devices are automatically searched and reconnected.
- If the system becomes unstable due to communication errors between the car Handsfree and the **Bluetooth®** Wireless Technology device, reset the device by turning off and back on again. Upon resetting **Bluetooth®** Wireless Technology device, the system will be restored.

(Continued)

(Continued)

- After pairing is complete, a contacts download request is sent once to the mobile phone. Some mobile phones may require confirmation upon receiving a download request, ensure your mobile phone accepts the connection. Refer to your phone's user's manual for additional information regarding phone pairing and connections.

Connecting a Device

Press the **SETUP** key ▶ Select [Phone] ▶ Select [Paired Phone List]



- 1) Connected Phone : Device that is currently connected
- 2) Paired Phone : Device that is paired but not connected

From the paired phone list, select the device you want to connect and press the **Connect** button.



Changing Priority

What is Priority?

It is possible to pair up to five *Bluetooth*® Wireless Technology devices with the car audio system. The "Change Priority" feature is used to set the connection priority of paired phones.

Press the **SETUP** key ▶ Select [Phone] ▶ Select [Paired Phone List]



From the paired phone list, select the phone you want to switch to the highest priority, then press the **Change priority** button from the Menu. The selected device will be changed to the highest priority.

* NOTICE

Priority icon will be displayed when the selected phone is set as a priority phone.



Disconnecting a Device

Press the **SETUP** key ▶ Select [Phone] ▶ Select [Paired Phone List]



From the paired phone list, select the currently connected device and press the **Disconnect** button.

Deleting a Device

Press the **SETUP** key ▶ Select [Phone] ▶ Select [Paired Phone List]



From the paired phone list, select the device you want to delete and press the **Delete** button.

* NOTICE

- When deleting the currently connected device, the device will automatically be disconnected to proceed with the deleting process.
- If a paired *Bluetooth*® Wireless Technology device is deleted, the device's call history and contacts data will also be deleted.
- To re-use a deleted device, you must pair the device again.

USING Bluetooth® Wireless Technology

Phone Menu Screen

Phone Menus

With a Bluetooth® Wireless Technology device connected, press the **PHONE** key to display the Phone menu screen.

(For USA)

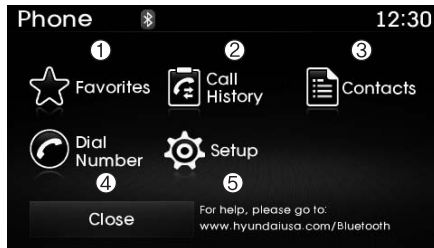

(Except USA)

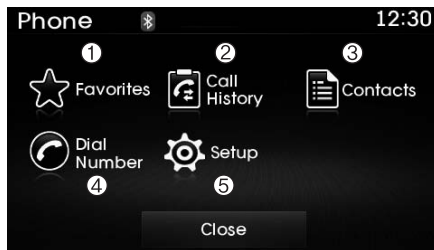

- 1) Favorite : Up to 20 frequently used contacts saved for easy access
- 2) Call History : Device the call history list screen
- 3) Contacts : Displays the Contacts list screen
- 4) Dial Number : Displays the dial screen where numbers can be dialed to make calls
- 5) Setup : Displays Phone related settings.

* NOTICE

- If you press the [Call History] button but there is no call history data, a prompt is displayed which asks to download call history data.
- If you press the [Contacts] button but there is no contacts data stored, a prompt is displayed which asks to download contacts data.
- This feature may not be supported in some mobile phones. For more information on download support, refer to your mobile phone user's manual.

Favorites

Press the **PHONE** key ▶ Select [Favorites]



- 1) Saved favorite contact : Connects call upon selection
- 2) To add favorite : Downloaded contacts be saved as favorite.
- 3) Delete All : Delete all stored favorite contacts

* NOTICE

- To save Favorite, contacts should be downloaded.
- Contact saved in Favorites will not be automatically updated if the contact has been updated in the phone. To update Favorites, delete the Favorite and create a new Favorite.

Call History

Press the **PHONE** key ▶ Select [Call History]



A list of incoming, outgoing and missed calls is displayed.

Press the **Download** button to download the call history.

- 1) Call History :
 - Displays recent calls (call history)
 - Connects call upon selection
- 2) Download : Download Recent Call History

- Call history may not be saved in the call history list in some mobile phones.
- Calls received with hidden caller ID will not be saved in the call history list.
- Calling through the call history is not possible when there is no call history stored or a *Bluetooth*® Wireless Technology phone is not connected.
- Up to 50 received, dialed and missed calls are stored in Call History.
- Time of received/dialed calls and call time information are not saved.

Contacts

Press the **PHONE** key ▶ Select [Contacts]

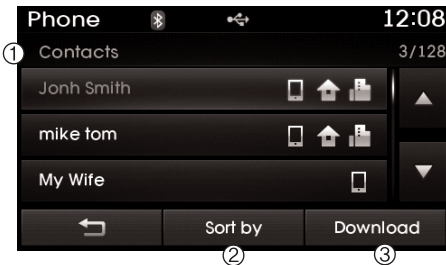

The list of saved phone book entries is displayed. Press the **Download** button to download the call history.

1) Contacts List :

- Displays downloaded contacts entries
- Connects call upon selection

2) Sort by : Find a contact in an alphabetical order.

3) Download : Download contacts entries

* NOTICE

- Up to 1,000 contacts saved in your *Bluetooth*® Wireless Technology phone can be downloaded into the car contacts. Contacts that have been downloaded to the car cannot be edited or deleted on the phone.
- Mobile phone contacts are managed separately for each paired *Bluetooth*® Wireless Technology device (max 5 devices x 1,000 contacts each). Previously downloaded data is maintained even if the *Bluetooth*® Wireless Technology device has been disconnected. (However, the contacts and call history saved to the phone will be deleted if a paired phone is deleted.)

(Continued)

(Continued)

- It is possible to download contacts during *Bluetooth* streaming audio.
- When downloading contacts, the icon will be displayed within the status bar.
- It is not possible to begin downloading a contact list when the contact download feature has been turned off within the *Bluetooth*® Wireless Technology device. In addition, some devices may require device authorization upon attempting to download contacts. If downloading does not normally occur, check the *Bluetooth*® Wireless Technology device settings or the screen state.
- The contacts download feature may not be supported in some mobile phones. For more information of supported *Bluetooth*® devices and function support, refer to your phone's user manual.

Calling by Dialing a Number

Press the **PHONE** key ▶ Select [Dial Number]

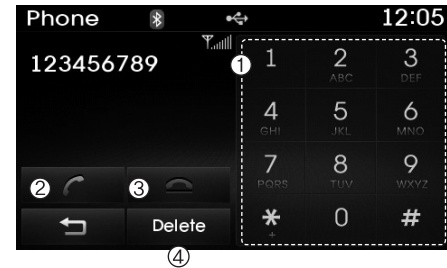

- 1) Dial Pad : Used to enter phone number
- 2) Call : If a number has been entered, calls the number. If no number has been entered, switches to call history screen
- 3) End : Deletes the entered phone number
- 4) Delete : Deletes entered numbers one digit at a time

Answering Calls

Answering a Call

Answering a call with a *Bluetooth®* Wireless Technology device connected will display the following screen.



- 1) Caller : Displays the other party's name when the incoming caller is saved within your contacts
- 2) Incoming Number : Displays the incoming number
- 3) Accept : Accepts the incoming call
- 4) Reject : Rejects the incoming call

* NOTICE

- When an incoming call pop-up is displayed, most Audio and SETUP mode features are disabled. Only the call volume will operate.
- The telephone number may not be properly displayed in some mobile phones.

During a Handsfree Call

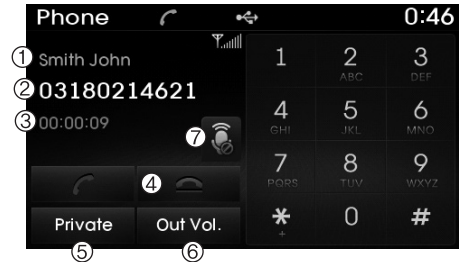

- 1) Caller : Displays the other party's name if the incoming caller is saved within your contacts
- 2) Incoming Number : Displays the incoming number
- 3) Call time : Displays the call time
- 4) End : Ends call
- 5) Private : Converts to Private mode
- 6) Out Vol. : Sets call volume as heard by the other party
- 7) Mute : Turns Mic Mute On/Off

* NOTICE

If the mic is muted, the other party will not be able to hear your voice.

Bluetooth® Wireless Technology Setting

Pairing a New Device

Press the **SETUP** key ▶ Select [Phone] ▶ Select [Pair Phone] (For USA)

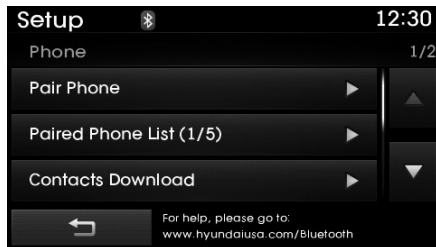

(Except USA)

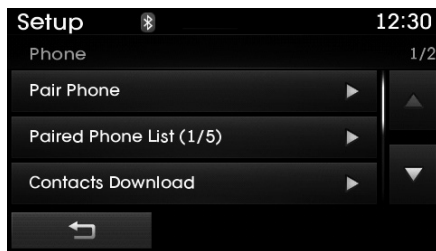

Bluetooth® Wireless Technology devices can be paired with the audio system.

For more information, refer to the "Pairing through Phone Setup" section within Bluetooth® Wireless Technology.

Viewing Paired Phone List

Press the **SETUP** key ▶ Select [Phone] ▶ Select [Paired Phone List]



This feature is used to view mobile phones that have been paired with the audio system. Upon selecting a paired phone, the setup menu is displayed.

For more information, refer to the "Setting Bluetooth® Wireless Technology Connection" section within Bluetooth® Wireless Technology.

- 1)  : Moves to the previous screen
- 2) Connect/Disconnect Phone : Connect/ disconnects currently selected phone
- 3) Delete : Deletes the currently selected phone
- 4) Change Priority : Sets currently selected phone to highest connection priority

*** NOTICE BEFORE DOWNLOADING CONTACTS**

- Only contacts within connected phones can be downloaded. Also check to see that your mobile phone supports the download feature.
- To learn more about whether your mobile phone supports contacts downloads, refer to your mobile phone user's manual.
- The contacts for only the connected phone can be downloaded.

Downloading Contacts

Press the **SETUP** key ▶ Select [Phone] ▶ Select [Contacts Download]

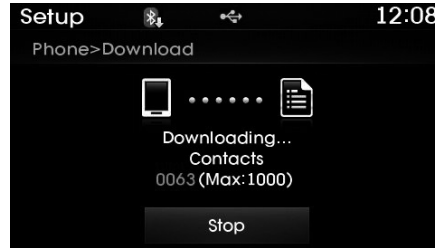

As the contacts are downloaded from the mobile phone, a download progress bar is displayed.

*** NOTICE**

- Upon downloading phone contacts, the previous corresponding data is deleted.
- This feature may not be supported in some mobile phones.
- Voice Recognition may not operate while contacts are being downloaded.

Outgoing Volume

Press the **SETUP** key ▶ Select [Phone] ▶ Select [Outgoing Volume]

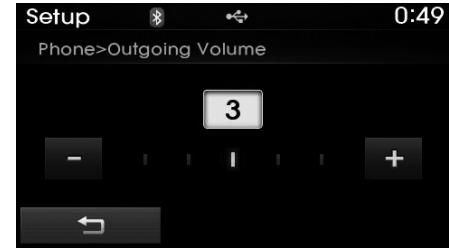

Use the **-**, **+** buttons to adjust the outgoing volume level.

*** NOTICE**

While on a call, the volume can be changed by using the **SEEK TRACK** key.

Turning Bluetooth System Off

Press the **SETUP** key ▶ Select [Phone] ▶ Select [Bluetooth System Off]

Once *Bluetooth*[®] Wireless Technology is turned off, *Bluetooth*[®] Wireless Technology related features will not be supported within the audio system.

(For USA)

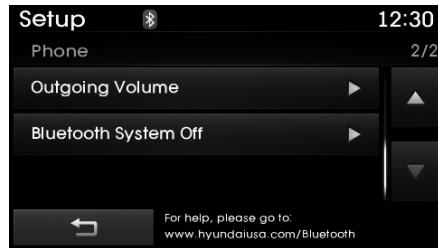

(Except USA)

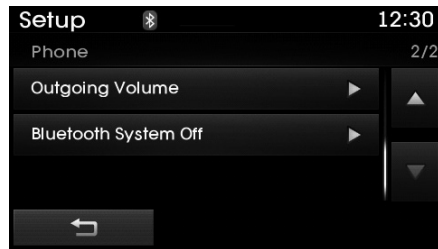

* NOTICE

To turn *Bluetooth*[®] Wireless Technology back on, go to **SETUP** ▶ [Phone] and press “Yes”.

VOICE RECOGNITION

Using Voice Recognition

Starting Voice Recognition

Shortly press the  key on the steering wheel remote controller. Say a command.

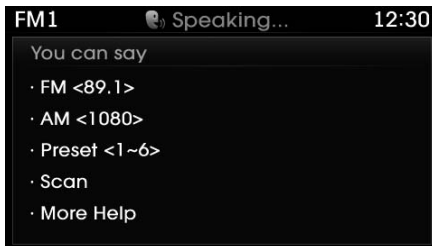

If prompt feedback is in [ON], then the system will say "Please say a command after the beep (BEEP)"

- If prompt feedback is in [OFF] mode, then the system will only say "(BEEP)"
- To change Prompt Feedback [On]/[Off], go to **SETUP** ▶ [System] ▶ [Prompt Feedback]

* NOTICE

For proper recognition, say the command after the voice instruction and beep tone.

Contact List Best Practices

- 1) Do not store single-name entries (e.g., "Bob", "Mom", "Kim", etc.). Instead, always use full names (including first and last names) for all contacts (e.g., use "Jacob Stevenson" instead of "Dad").
- 2) Do not use abbreviations (i.e., use "Lieutenant" instead of "Lt." or "Sergeant" instead of "Sgt.").
- 3) Do not use acronyms (i.e., use "County Finance Department" instead of "CFD").
- 4) Do not use special characters (e.g., "@", "hyphen -", "asterisk **", "ampersand &").
- 5) If a name is not recognized from the contact list, change it to a more descriptive name (e.g., use "Grandpa Joseph" instead of "Pa Joe").

Skipping Prompt Messages

While prompt message is being stated ▶ Shortly press the  key on the steering remote controller.

The prompt message is immediately ended and the beep tone will sound. After the "beep", say the voice command.

Re-starting Voice Recognition

While system waits for a command ▶ Shortly press the  key on the steering remote controller.

The command wait state is immediately ended and the beep tone will sound. After the "beep", say the voice command.

* Illustration on using voice commands

• **Starting voice command.**

Shortly pressing the  key (under 0.8 seconds):

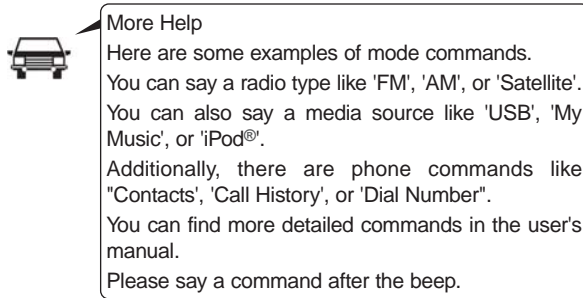
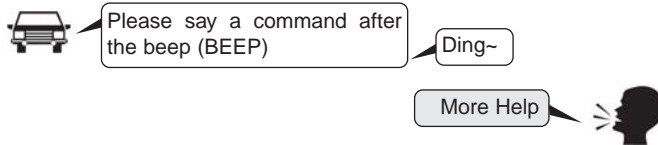

• **Skipping Voice Recognition**

Shortly pressing the  key (under 0.8 seconds):



Shortly pressing the  key (under 0.8 seconds):

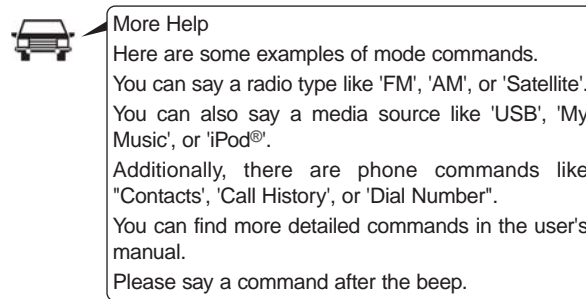

• **Ending voice command.**

Shortly pressing the  key (under 0.8 seconds):

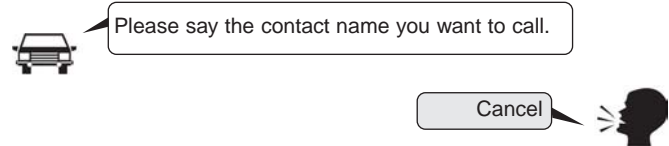
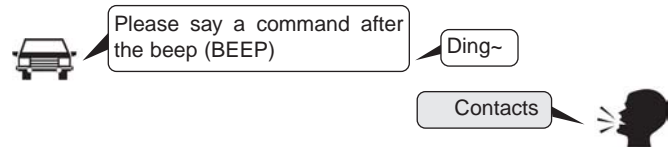

Voice Command List

- **Common Commands:** These commands can be used in most operations. (However a few commands may not be available during certain operations)

Command	Function
More Help	Provides guidance on commands that can be used anywhere in the system.
Help	Provides guidance on commands that can be used within the current mode.
Call<Name>	Calls <Name> saved in Contacts Ex) Call "John Smith"
Call <Name> on Mobile	Calls <Name> to the number that is saved as "Mobile" in Contacts Ex) Call "John Smith" on Mobile
Call <Name> in Office	Calls <Name> to the number that is saved as "Office" in Contacts Ex) Call "John Smith" in Office
Call <Name> at Home	Calls <Name> to the number that is saved as "Home" in Contacts Ex) Call "John Smith" at Home
Call <Name> on Other	Calls <Name> to the number that is saved as "Other" in Contacts Ex) Call "John Smith" on Other
Phone	Provides guidance on Phone related commands. After saying this command, say "Favorites", "Dial Number", "Call History" or "Contacts" execute corresponding functions.
Favorites	Displays the Favorite screen.
Call History	Displays the Call History screen.

Command	Function
Contacts (Call by Name)	Displays the Contacts screen. After saying this command, say the name of a contact saved in the Contacts to automatically connect the call.
Dial Number	Displays the Dial number screen. After saying this command, you can say the number that you want to call.
Redial	Connects the last dialed call number.
Tutorial	Provides guidance on how to use voice recognition and Bluetooth® connections.
Radio	<ul style="list-style-type: none"> • When listening to the radio, displays the next radio screen. (FM1→FM2→AM→XM1→XM2→XM3→FM1) • When listening to a different mode, displays the most recently played radio screen. • When currently listening to the FM radio, maintains the current state. • When listening to a different mode, displays the most recently played FM screen.
FM1(FM One)	Displays the FM1 screen.
FM2(FM Two)	Displays the FM2 screen.
AM	Displays the AM screen.

Features of your vehicle

Command	Function
FM Preset 1~6	Plays the most recently played broadcast saved in FM Preset 1~6.
AM Preset 1~6	Plays the broadcast saved in AM Preset 1~6.
FM 87.5~107.9	Plays the FM broadcast of the corresponding frequency.
AM 530~1710	Plays the AM broadcast of the corresponding frequency.
XM (Satellite)	<ul style="list-style-type: none"> • When currently listening to the SiriusXM®, maintains the current state. • When listening to a different mode, displays the most recently played SiriusXM® screen.
XM (Satellite) 1~3	Displays the selected SiriusXM® screen.
XM Channel 0~223	Plays the selected SiriusXM® channel.
Media	Moves to the most recently played media screen.
CD	Plays the music saved in the CD.
USB	Plays USB music.
iPod®	Plays iPod® music.

Command	Function
My Music	Plays the music saved in My Music.
AUX (Auxiliary)	Plays the connected external device.
Bluetooth® Audio	Plays the music saved in connected Bluetooth® device.
Mute	Mutes the sound
Cancel (Exit)	Ends voice command.

- FM/AM radio commands: available during FM, AM radio operation

Command	Function
Preset 1~6	Plays the broadcast saved in Preset 1~6.
Scan	Scans receivable frequencies from the current broadcast and plays for 10 seconds each.
Preset Scan	Moves to the next preset from the current present and plays for 10 seconds each.
Information	Displays the information of the current broadcast.(This feature can be used when receiving RBDS broadcasts.)

- Satellite radio commands: Commands that can be used while listening to Satellite Radio.

Command	Function
Channel 0~255	Play the selected Satellite Radio channel.
Scan	Scans receivable channels from the current broadcast and plays for 10 seconds each.
Preset 1~6	Plays the broadcast saved in Preset 1~6.
Information	Displays the information of the current broadcast.

Features of your vehicle

- Audio CD commands: Commands available during Audio CD operation

Command	Function
Play	Plays the currently paused track.
Pause	Pauses the current track.
Shuffle	Randomly plays the tracks within the CD.
Shuffle Off	Cancels random play to play tracks in sequential order.
Repeat	Repeats the current track.
Repeat Off	Cancels repeat play to play tracks in sequential order.
Track 1-30	Plays the desired track number.

- MP3 CD / USB commands: Commands available during USB and MP3 CD operation

Command	Function
Play	Plays the currently paused file.
Pause	Pauses the current file.
Shuffle	Randomly plays the files within the current folder.
Shuffle Off	Cancels random play to play files in sequential order.
Repeat	Repeats the current file.
Repeat Off	Cancels repeat play to play files in sequential order.
Next Folder	Play the first file in the next folder
Previous Folder	Play the first file in the previous folder

- iPod® Commands: Commands available during iPod® operation

Command	Function
Play	Plays the currently paused song.
Pause	Pauses the current song.
Shuffle	Randomly plays the songs within the current category.
Shuffle Off	Cancel random play to play songs in sequential order.
Repeat	Repeats the current song.
Repeat Off	Cancel repeat play to play songs in sequential order.

- My Music Commands: Commands available during My Music operation

Command	Function
Play	Plays the currently paused file.
Pause	Pauses the current file.
Shuffle	Randomly plays all saved files.
Shuffle Off	Cancel random play to play files in sequential order.
Repeat	Repeats the current file.
Repeat Off	Cancel repeat play to play files in sequential order.
Delete	Deletes the current file. You will bypass an additional confirmation process.

SETUP

Starting Mode

Press the **SETUP** key to display the Setup screen.

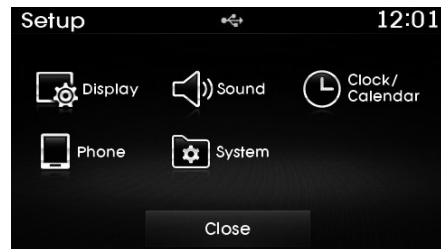

You can select and control options related to [Display], [Sound], [Clock/Calendar], [Phone] and [System].

Display Settings

Adjusting the Brightness

Press the **SETUP** key to Select [Display] to Select [Brightness]

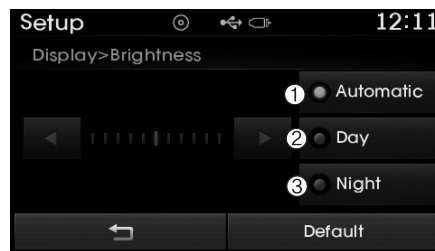

Use the **◀**, **▶** buttons to adjust the screen brightness or set the Brightness on Automatic, Daylight, or Night mode.

Press the **Default** button to reset.

- 1) Automatic : Adjusts the brightness automatically
- 2) Daylight : Always maintains the brightness on high
- 3) Night: Always maintains the brightness on low

Mode Pop-up

Press the **SETUP** key to Select [Display] to Select [Mode Pop up]

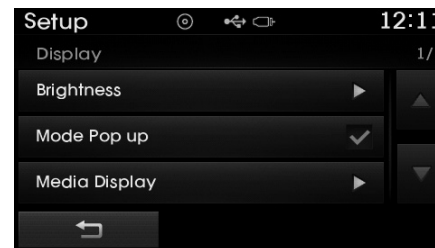

This feature is used to display the Mode Pop-up screen when entering radio and media modes.

When this feature is turned on, pressing the **RADIO** or **MEDIA** key will display the Mode Pop-up screen.

* NOTICE

The media Mode Pop-up screen can be displayed only when two or more media modes have been connected.

MP3 Information Display

Press the **SETUP** key ▶ Select [Display] ▶ Select [Media Display]



This feature is used to change the information displayed within USB and MP3 CD modes.

- 1) Folder File : Displays file name and folder name
- 2) Album Artist Song : Displays album name/artist name/song

Sound Settings

Sound Settings

Press the **SETUP** key ▶ Select [Sound] ▶ Select [Sound Setting]



Use the **◀**, **▶**, **▲**, **▼** buttons to adjust the Fader/Balance settings.

Use the **◀**, **▶** buttons to adjust the Bass/Middle/Treble settings.

Press the **Default** button to reset.

Virtual Sound

Press the **SETUP** key ▶ Select [Sound] ▶ Select [Virtual Sound]

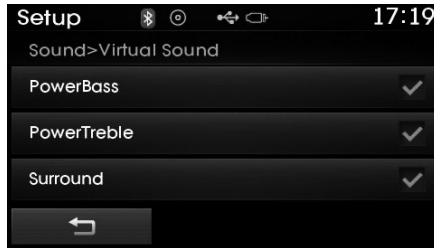

This feature is used to set the Power Bass, Power Treble and Surround sound options.

SDVC (Speed Dependent Volume Control)

Press the **SETUP** key ▶ Select [Sound] ▶ Select [Speed Dependent Vol.]

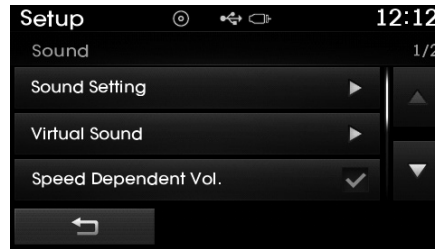

The volume level is controlled automatically according to the vehicle speed. SDVC can be set by selecting from On/Off.

Voice Recognition Volume

Press the **SETUP** key ▶ Select [Sound] ▶ Select [Voice Recognition Vol.]



Turn the **TUNE** knob to adjust the Voice Recognition volume.

Touch Screen Beep

Press the **SETUP** key ▶ Select [Sound] ▶ Select [Touch Screen Beep]

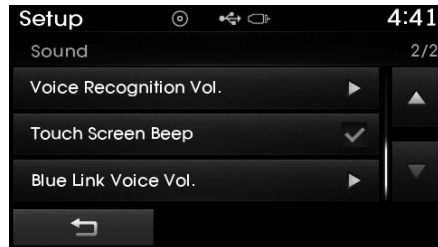

This feature is used to turn the touch screen beep on/off.

Blue Link Voice Volume

Press the **SETUP** key ▶ Select [Sound] ▶ Select [Blue Link Voice Vol.]



Turn the **TUNE** knob to adjust the Blue Link Voice Volume.

* Blue Link® may differ depending on the selected audio.

Clock/Calendar Setting

Clock Setting

Press the **SETUP** key ▶ Select [Clock/Calendar] ▶ Select [Clock Settings]

Use the **▲**, **▼** buttons to set the Hour, Minutes setting and select AM/PM.



* NOTICE

Press and hold the **CLOCK** key (over 0.8 seconds) to set the Clock/Calendar screen.

Calendar Setting

Press the **SETUP** key ▶ Select [Clock/Calendar] ▶ Select [Calendar Settings]

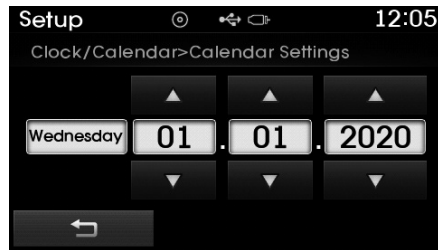

Use the **▲**, **▼** buttons to set the Month, Day and Year setting.

Time Format

Press the **SETUP** key ▶ Select [Clock/Calendar] ▶ Select [Time Format]

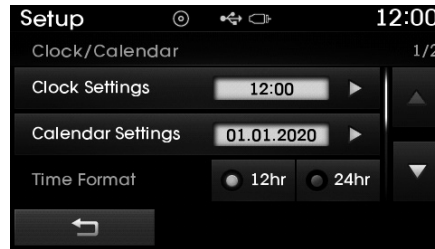

This feature is used to change the clock format between 12hr or 24hr.

Clock Display

Press the **SETUP** key ▶ Select [Clock/Calendar] ▶ Select [Clock Display (Power off)]

This feature is used to display a clock on the screen when the audio system is turned off.

System Setting

HD Radio™ On/Off

Press the **SETUP** key ▶ Select [System] ▶ Select [FM], [AM]

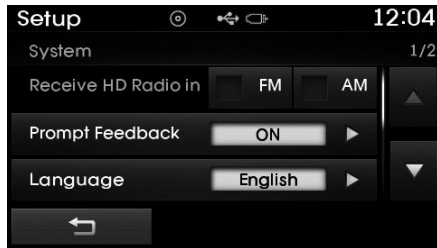

This feature is used to set whether to receive FM/AM HD Radio™ broadcasts.

Prompt Feedback

Press the **SETUP** key ▶ Select [System] ▶ Select [Prompt Feedback]

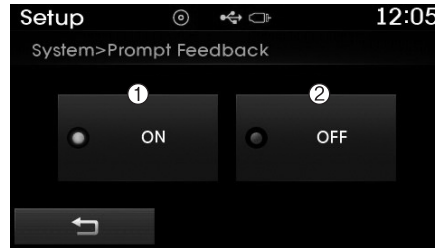

This feature is used to select the desired prompt feedback option from ON and OFF.

- 1) ON : When using voice recognition, provides detailed guidance prompts
- 2) OFF : When using voice recognition, omits some guidance prompts

Language

Press the **SETUP** key ▶ Select [System] ▶ Select [Language]

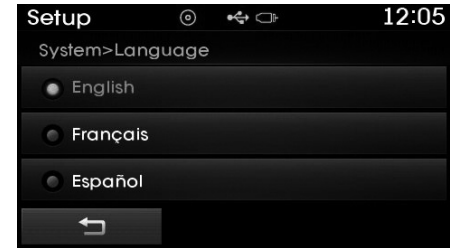

This feature is used to change the system and voice recognition language.

If the language is changed, the system will restart and apply the selected language.

Memory Information

Press the **SETUP** key ▶ Select [System] ▶ Select [Memory Information]

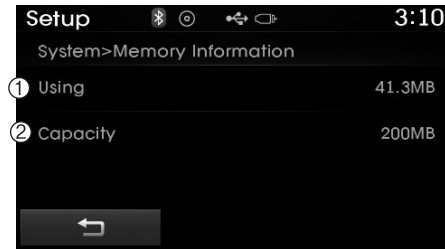

This feature displays information related to system memory.

- 1) Using : Displays capacity currently in use
- 2) Capacity : Displays total capacity

REAR VIEW CAMERA (if equipped)

- The system has been equipped with a rear view camera for user safety by allowing a wider rear range of vision.
- The rear view camera will automatically operate when the ignition key is turned ON and the transmission shift lever is positioned into reverse (R).
- The rear view camera will automatically stop operating when set to a the transmission shift lever is positioned to another gear.

CAUTION



The rear view camera has been equipped with an optical lens to provide a wider range of vision and may appear different from the actual distance. For safety, directly check the rear and left/right sides.

Blue Link®

Hyundai aims to offer differentiated customer values through a 'Connected Car Life,' which provides consumers with fast and reliable IT technology. As consumers' lifestyles become more and more mobile in thanks to remarkable advances in smart phones, tablet PCs and overall wireless telecommunication, new lifestyle patterns demand seamless connection between one's office, home, outdoors and automobiles.

Blue Link® is Hyundai's innovative telematics solution that combines safety, service, and infotainment into a complete package. It works to both help simplify Hyundai owners' lives and reduce distracted driving. The Blue Link® "  " button offers access to a voice-response menu of services.



The Blue Link®  button offers access to enhanced navigation services. The "  " button offers immediate contact to SOS Emergency Assistance. A detailed list of commands is available in the Blue Link User's Manual.

Using Rear View Mirror Buttons

Pressing the Blue Link® buttons located on the rear view mirror will allow you to make service required inquiries, POI info searches, and emergency rescues by connecting to the Blue Link® Center.

Such features can be used only after subscribing to the Blue Link® service.

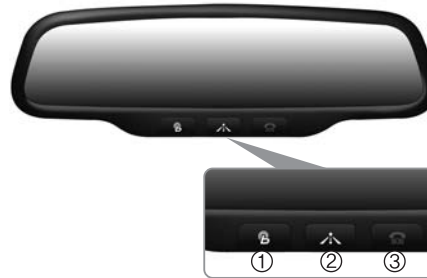

① (Blue Link® Center)

Makes requests for Blue Link® service related inquiries and consultations.

A call is connected to the Blue Link® service center employee.

Pressing the key again will end the call.

This feature does not operate when you are on a Bluetooth® phone call.

② (Blue Link® for POI)

- Blue Link® for Voice command

Starts Blue Link® voice command.

Voice receiving voice guidance, shortly press the button to convert to voice command mode. Press and hold the button to end voice command.

- TBT VR Commands

1. Navigate to

"Navigate to" voice command is used to request the download of route data for a new destination, saved destinations, daily routes and previous destinations.

2. Save Destination

“Save Destination” VR command is used to assign a voice tag to the last downloaded destination and store it in a destination directory.

* NOTICE

The Turn by Turn(TBT) feature supports the store of ten(10) destinations in the TBT destinations directory.

3. Route Preview

“Route Preview” VR command allows the user to preview the route instructions (upcoming maneuver instructions) at any time during the route guidance.

4. Destinations List

“Destinations List” VR command allows the user to preview and delete the stored destinations with their associated voice tags in the Turn by Turn destinations directory.

5. Voice Guidance

“Voice Guidance” VR command allows the user to mute/unmute the Turn by Turn(TBT) direction announcements.

6. Suspend Route

“Suspend Route” VR command allows the user to suspend and pause Turn by Turn(TBT) route guidance while in the guidance mode.

7. Resume Route

“Resume Route” VR command allows the user to resume Turn by Turn(TBT) route guidance.

③ (Blue Link® for SOS)



In the case of an emergency, requests for help to the Blue Link® center.

Call is connected to the Blue Link® emergency rescue center. Pressing the key again will end the call.

If you are already on a Bluetooth® phone call, the call will end to connect you to the Blue Link® Emergency Rescue Center.



CAUTION

- **You cannot talk simultaneously on the Bluetooth® phone call and a Blue Link® services phone all.**
- **While on a Bluetooth® call, pressing the  key or  key will display a message indicating that you are currently on a call.**
- **A message will be displayed if you receive a Bluetooth® call while already on a Blue Link® call. To answer the incoming call, press the  button on the steering wheel controls. You will not hear a ring to alert you that there is an incoming call.**

Turn by Turn

The Turn by Turn feature can be used through Blue Link®.

* For information on specific Blue Link® operations, please refer to the Blue Link® User's Manual that was provided with your vehicle.

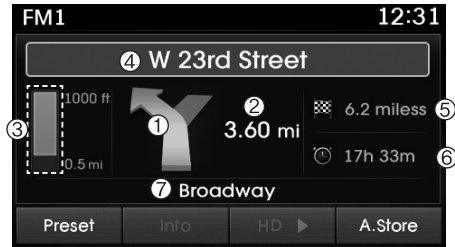

1. Direction Indicator Image
2. Remaining distance until next point
3. The Count bar is divided into a total of 9 levels.

9 Level	0.5mi	8 Level	0.4mi
7 Level	0.3mi	6 Level	0.2mi
5 Level	0.1mi	4 Level	400ft
3 Level	300ft	2 Level	200ft
1 Level	100ft		

4. Next Street name
5. Distance to destination
6. Expected Time Arrival
7. Current Street name

iPod® is a registered trademark of Apple Inc. iPod® mobile digital device sold separately. The Bluetooth® word mark and logos are registered trademarks owned by Bluetooth SIG, Inc. and any use of such marks by Hyundai is under license. SiriusXM services require a subscription sold separately, or as a package, by Sirius XM Radio Inc. If you decide to continue service after your trial, the subscription plan you choose will automatically renew thereafter and you will be charged according to your chosen payment method at then-current rates. Fees and taxes apply. To cancel you must call SiriusXM at 1-866-635-2349. See SiriusXM Customer Agreement for complete terms at www.siriusxm.com. SiriusXM U.S. satellite and data services are available only in the 48 contiguous USA, DC and PR (with coverage limitations). SiriusXM satellite service is also available in Canada; see www.siriusxm.ca. All fees and programming subject to change. Sirius, XM and all related marks and logos are trademarks of Sirius XM Radio Inc. Android™ is a trademark of Google, Inc. BlackBerry is a registered trademark of Research In Motion Limited (RIM). All other marks, channel names and logos are the property of their respective owners. All rights reserved.

Driving your vehicle

Before driving	5-3	Special driving conditions	5-59
Key	5-6	• Hazardous driving conditions	5-59
Engine start/stop button	5-9	• Rocking the vehicle	5-60
Automatic transaxle	5-14	• Smooth cornering	5-61
• Automatic transaxle operation	5-14	• Driving at night	5-61
All wheel drive (AWD)	5-21	• Driving in the rain	5-62
Brake system	5-28	• Driving in flooded areas	5-63
• Power brakes	5-28	• Driving off-road	5-63
• Parking brake	5-30	• Highway driving	5-63
• Anti-lock brake system (ABS)	5-32	Winter driving	5-65
• Electronic stability control (ESC)	5-35	Trailer towing	5-70
• Vehicle stability management (VSM)	5-39	Vehicle load limit	5-79
• Downhill brake control (DBC)	5-40	Vehicle weight	5-84
• Hill-start assist control (HAC)	5-42	• Base curb weight	5-84
Cruise control system	5-45	• Vehicle curb weight	5-84
Blind spot detection system (BSD)	5-50	• Cargo weight	5-84
Active ECO system	5-56	• GAW (Gross axle weight)	5-84
Economical operation	5-57	• GAWR (Gross axle weight rating)	5-84
		• GVW (Gross vehicle weight)	5-84
		• GVWR (Gross vehicle weight rating)	5-84

⚠ WARNING - ENGINE EXHAUST CAN BE DANGEROUS!

Engine exhaust fumes can be extremely dangerous. If, at any time, you smell exhaust fumes inside the vehicle, open the windows immediately.

- **Do not inhale exhaust fumes.**

Exhaust fumes contain carbon monoxide, a colorless, odorless gas that can cause unconsciousness and death by asphyxiation.

- **Be sure the exhaust system does not leak.**

The exhaust system should be checked whenever the vehicle is raised to change the oil or for any other purpose. If you hear a change in the sound of the exhaust or if you drive over something that strikes the underneath side of the vehicle, have the exhaust system checked as soon as possible by an authorized HYUNDAI dealer.

- **Do not run the engine in an enclosed area.**

Letting the engine idle in your garage, even with the garage door open, is a hazardous practice. Never run the engine in your garage any longer than it takes to start the engine and back the vehicle out.

- **Avoid idling the engine for prolonged periods with people inside the vehicle.**

If it is necessary to idle the engine for a prolonged period with people inside the vehicle, be sure to do so only in an open area with the air intake set at "Fresh" and fan operating at one of the higher speeds so fresh air is drawn into the interior.

If you must drive with the liftgate (tailgate) open because you are carrying objects that make this necessary:

1. Close all windows.
2. Open side vents.
3. Set the air intake control at "Fresh", the air flow control at "Floor" or "Face" and the fan at one of the higher speeds.

To assure proper operation of the ventilation system, be sure the ventilation air intakes located just in front of the windshield are kept clear of snow, ice, leaves or other obstructions.

⚠ CALIFORNIA PROPOSITION 65 WARNING

Engine exhaust and a wide variety of automobile components and parts, including components found in the interior furnishings in a vehicle, contain or emit chemicals known to the State of California to cause cancer and birth defects and reproductive harm. In addition, certain fluids contained in vehicles and certain products of component wear contain or emit chemicals known to the State of California to cause cancer and birth defects or other reproductive harm.

BEFORE DRIVING**Before entering vehicle**

- Be sure that all windows, outside mirror(s), and outside lights are clean.
- Check the condition of the tires.
- Check under the vehicle for any sign of leaks.
- Be sure there are no obstacles behind you if you intend to back up.

Necessary inspections

Fluid levels, such as engine oil, engine coolant, brake fluid, and washer fluid should be checked on a regular basis, with the exact interval depending on the fluid. Further details are provided in Section 7, "Maintenance".

⚠ WARNING

Driving while distracted can result in a loss of vehicle control, that may lead to an accident, severe personal injury, and death. The driver's primary responsibility is in the safe and legal operation of a vehicle, and use of any handheld devices, other equipment, or vehicle systems which take the driver's eyes, attention and focus away from the safe operation of a vehicle or which are not permissible by law should never be used during operation of the vehicle.

Before starting

- Close and lock all doors.
- Position the seat so that all controls are easily reached.
- Adjust the inside and outside rearview mirrors.
- Be sure that all lights work.
- Check all gauges.
- Check the operation of warning lights when the ignition switch is turned to the ON position.
- Release the parking brake and make sure the brake warning light goes out.

For safe operation, be sure you are familiar with your vehicle and its equipment.

WARNING

All passengers must be properly belted whenever the vehicle is moving. Refer to “Seat belts” in section 3 for more information on their proper use.

WARNING

Always check the surrounding areas near your vehicle for people, especially children, before putting a vehicle into D (Drive) or R (Reverse).

WARNING - Driving under the influence of alcohol or drugs

Drinking and driving is dangerous. Drunk driving is the number one contributor to the highway death toll each year. Even a small amount of alcohol will affect your reflexes, perceptions and judgement. Driving while under the influence of drugs is as dangerous or more dangerous than driving drunk.

You are much more likely to have a serious accident if you drink or take drugs and drive.

If you are drinking or taking drugs, do not drive. Do not ride with a driver who has been drinking or taking drugs. Choose a designated driver or call a cab.

⚠ WARNING

- When you intend to park or stop the vehicle with the engine on, be careful not to depress the accelerator pedal for a long period of time. It may overheat the engine or exhaust system and cause fire.
- When you make a sudden stop or turn the steering wheel rapidly, loose objects may drop on the floor and it could interfere with the operation of the foot pedals, possibly causing an accident. Keep all things in the vehicle safely stored.
- If you do not focus on driving, it may cause an accident. Be careful when operating what may disturb driving such as audio or heater. It is the responsibility of the driver to always drive safely.

KEY POSITIONS

Illuminated ignition switch (if equipped)



Whenever a front door is opened, the ignition switch will be illuminated for your convenience, provided the ignition switch is not in the ON position. The light will go off immediately when the ignition switch is turned on or go off after about 30 seconds when the door is closed.

Ignition switch position *LOCK*



The steering wheel locks to protect against theft. The ignition key can be removed only in the LOCK position. When turning the ignition switch to the LOCK position, push the key inward at the ACC position and turn the key toward the LOCK position.

ACC (Accessory)

The steering wheel is unlocked and electrical accessories are operative.

* NOTICE

If difficulty is experienced turning the ignition switch to the ACC position, turn the key while turning the steering wheel right and left to release the tension.

ON

The warning lights can be checked before the engine is started. This is the normal running position after the engine is started.

Do not leave the ignition switch ON if the engine is not running to prevent battery discharge.

START

Turn the ignition switch to the START position to start the engine. The engine will crank until you release the key; then it returns to the ON position. The brake warning light can be checked in this position.

⚠ WARNING - Ignition key

- **Never turn the ignition switch to LOCK or ACC while the vehicle is moving. This would result in loss of directional control and braking function, which could cause an accident.**
- **The anti-theft steering column lock is not a substitute for the parking brake. Before leaving the driver's seat, always make sure the shift lever is engaged in P (Park), set the parking brake fully and shut the engine off. Unexpected and sudden vehicle movement may occur if these precautions are not taken.**

(Continued)

(Continued)

- **Never reach for the ignition switch, or any other controls through the steering wheel while the vehicle is in motion. The presence of your hand or arm in this area could cause a loss of vehicle control, an accident and serious bodily injury or death.**
- **Do not place any movable objects around the driver's seat as they may move while driving, interfere with the driver and lead to an accident.**

Starting the engine

WARNING

Always wear appropriate shoes when operating your vehicle. Unsuitable shoes (high heels, ski boots, etc.) may interfere with your ability to use the brake or the accelerator pedal.

1. Make sure the parking brake is applied.
2. Place the transaxle shift lever in P (Park). Depress the brake pedal fully.
You can also start the engine when the shift lever is in the N (Neutral) position.
3. Turn the ignition switch to START and hold it there until the engine starts (a maximum of 10 seconds), then release the key.

*It should be started **without depressing the accelerator pedal.***

4. Do not wait for the engine to warm up while the vehicle remains stationary.

Start driving at moderate engine speeds. (Steep accelerating and decelerating should be avoided.)

CAUTION

If the engine stalls while you are in motion, do not attempt to move the shift lever to the P (Park) position. If traffic and road conditions permit, you may put the shift lever in the N (Neutral) position while the vehicle is still moving and turn the ignition switch to the START position in an attempt to restart the engine.

CAUTION

Do not engage the starter for more than 10 seconds. If the engine stalls or fails to start, wait 5 to 10 seconds before re-engaging the starter. Improper use of the starter may damage it.

ENGINE START/STOP BUTTON (IF EQUIPPED)

Illuminated engine start/stop button



ODM052006

Whenever the front door is opened, the engine start/stop button will illuminate for your convenience. The light will go off after about 30 seconds when the door is closed. It will also go off immediately when the theft-alarm system is armed.

Engine start/stop button position

OFF

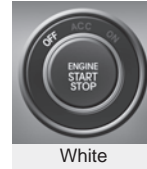

White

To turn off the engine (START/RUN position) or vehicle power (ON position), press the engine start/stop button with the shift lever in the P (Park) position. When you press the engine start/stop button without the shift lever in the P (Park) position, the engine start/stop button will not change to the OFF position but to the ACC position.

* NOTICE

You are able to turn off the engine (START/RUN) or vehicle power (ON), only when the vehicle is not in motion.

⚠ CAUTION

In an emergency situation while the vehicle is in motion, you are able to turn the engine off and to the ACC position by pressing the engine start/stop button for more than 2 seconds or 3 times successively within 3 seconds. If the vehicle is still moving, you can restart the engine without depressing the brake pedal by pressing the engine start/stop button with the shift lever in the N (Neutral) position.

ACC(Accessory)



Orange

With automatic transaxle

Press the engine start/stop button while it is in the OFF position without depressing the brake pedal.

The electrical accessories are operational.

If the engine start/stop button is in the ACC position for more than 1 hour, the button is turned off automatically to prevent battery discharge.

ON



Blue

With automatic transaxle

Press the engine start/stop button while it is in the ACC position without depressing the brake pedal.

The warning lights can be checked before the engine is started. Do not leave the engine start/stop button in the ON position for a long time. The battery may discharge, because the engine is not running.

START/RUN



Not illuminated

With automatic transaxle

To start the engine, depress the brake pedal and press the engine start/stop button with the shift lever in the P (Park) or the N (Neutral) position. For your safety, start the engine with the shift lever in the P (Park) position.

*** NOTICE**

If you press the engine start/stop button without depressing the brake pedal, the engine will not start and the engine start/stop button changes as follow:

OFF → ACC → ON → OFF or ACC

*** NOTICE**

If you leave the engine start/stop button in the ACC or ON position for a long time, the battery will discharge.

⚠ WARNING

- Never press the engine start/stop button while the vehicle is in motion. This would result in loss of directional control and braking function, which could cause an accident.
- Before leaving the driver's seat, always make sure the shift lever is engaged in P (Park), set the parking brake fully and shut the engine off. Unexpected and sudden vehicle movement may occur if these precautions are not taken.

(Continued)

(Continued)

- Never reach for the engine start/ stop button or any other controls through the steering wheel while the vehicle is in motion. The presence of your hand or arm in the area could cause loss of vehicle control, an accident and serious bodily injury or death.
- Do not place any movable objects around the driver's seat as they may move while driving, interfere with the driver and lead to an accident.

Starting the engine

WARNING

Always wear appropriate shoes when operating your vehicle. Unsuitable shoes (high heels, ski boots, etc.) may interfere with your ability to use the brake, accelerator pedal.

1. Carry the smart key or leave it inside the vehicle.
2. Make sure the parking brake is firmly applied.
3. Place the transaxle shift lever in P (Park). Depress the brake pedal fully.

You can also start the engine when the shift lever is in the N (Neutral) position.

4. Press the engine start/stop button. It should be started without depressing the accelerator pedal.

5. Do not wait for the engine to warm up while the vehicle remains stationary.

Start driving at moderate engine speeds. (Steep accelerating and decelerating should be avoided.)

- Even if the smart key is in the vehicle, if it is far away from you, the engine may not start.
- When the engine start/stop button is in the ACC position or above, if any door is opened, the system checks for the smart key. If the smart key is not in the vehicle, the “

WARNING

The engine will start, only when the smart key is in the vehicle.

Never allow children or any person who is unfamiliar with the vehicle to press the engine start/stop button or related parts.

⚠ CAUTION

If the engine stalls while the vehicle is in motion, do not attempt to move the shift lever to the P (Park) position. If the traffic and road conditions permit, you may put the shift lever in the N (Neutral) position while the vehicle is still moving and press the engine start/stop button in an attempt to restart the engine.



ODM052007

*** NOTICE**

- If the battery is weak or the smart key does not work correctly, you can start the engine by pressing the engine start/stop button with the smart key.

The side with the lock button should contact the engine start/stop button directly.

When you press the engine start/stop button directly with the smart key, the smart key should contact the button at a right angle.

(Continued)

(Continued)

- When the stop lamp fuse is blown, you cannot start the engine normally.

Replace the fuse with a new one. If it is not possible, you can start the engine by pressing the engine start/stop button for 10 seconds while it is in the ACC position. The engine can start without depressing the brake pedal. But for your safety always depress the brake pedal before starting the engine.

⚠ CAUTION

Do not press the engine start/stop button for more than 10 seconds except when the stop lamp fuse is blown.

AUTOMATIC TRANSAXLE

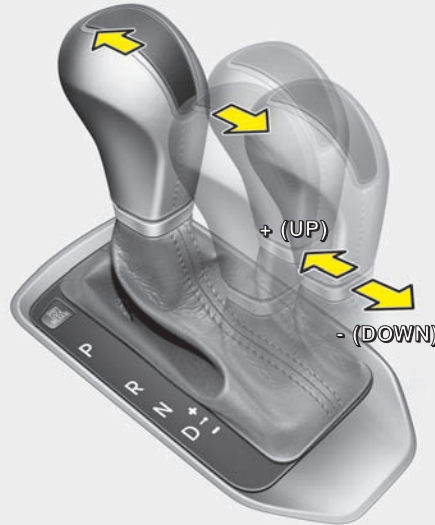
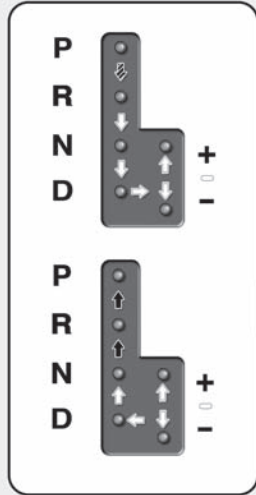



Automatic transaxle operation

The highly efficient automatic transaxle has 6 forward speeds and one reverse speed. The individual speeds are selected automatically, depending on the position of the shift lever.

The individual speeds are selected automatically in Drive, depending on the position of the accelerator pedal.

* NOTICE

The first few shifts on a new vehicle may be somewhat abrupt. This is a normal condition, and the shifting sequence will adjust after shifts are cycled a few times by the PCM (Powertrain Control Module).

-  Depress the brake pedal and the knob button when shifting.
-  Press the knob button when shifting.
-  The shift lever can be shifted freely.

ODM052011

For smooth operation, depress the brake pedal when shifting from N (Neutral) to a forward or reverse gear.

⚠ WARNING - Automatic transaxle

- Always check the surrounding areas near your vehicle for people, especially children, before shifting a vehicle into D (Drive) or R (Reverse).
- Before leaving the driver's seat, always make sure the shift lever is in the P (Park) position; then set the parking brake fully and shut the engine off. Unexpected and sudden vehicle movement can occur if these precautions are not followed in the order identified.

⚠ CAUTION

- *To avoid damage to your transaxle, do not accelerate the engine in R (Reverse) or any forward gear position with the brakes on.*
- *When stopped on an incline, do not hold the vehicle stationary with engine power. Use the service brake or the parking brake.*
- *Do not shift from N (Neutral) or P (Park) into D (Drive), or R (Reverse) when the engine is above idle speed.*

Transaxle ranges

The indicator lights in the instrument cluster displays the shift lever position when the ignition switch is in the ON position.

P (Park)

Always come to a complete stop before shifting into P (Park). This position locks the transaxle and prevents the front wheels from rotating.

⚠ WARNING

- Shifting into P (Park) while the vehicle is in motion will cause the drive wheels to lock which will cause you to lose control of the vehicle.
- Do not use the P (Park) position in place of the parking brake. Move the shift lever to the P (Park) position and set the parking brake fully.
- Never leave a child unattended in a vehicle.

⚠ CAUTION

The transaxle may be damaged if you shift into P (Park) while the vehicle is in motion.

R (Reverse)

Use this position to drive the vehicle backward.

⚠ CAUTION

Always come to a complete stop before shifting into or out of R (Reverse); you may damage the transaxle if you shift into R (Reverse) while the vehicle is in motion, except as explained in “Rocking the vehicle”, in this manual.

N (Neutral)

The wheels and transaxle are not engaged. The vehicle will roll freely even on the slightest incline unless the parking brake or service brakes are applied.

D (Drive)

This is the normal forward driving position. The transaxle will automatically shift through a 6-gear sequence, providing the best fuel economy and power.

For extra power when passing another vehicle or climbing grades, depress the accelerator fully, at which time the transaxle will automatically downshift to the next lower gear.

*** NOTICE**

Always come to a complete stop before shifting into D (Drive).

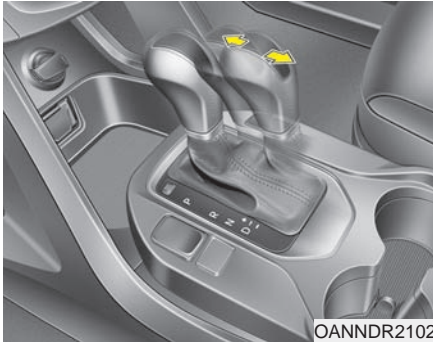

Sports mode

Whether the vehicle is stationary or in motion, sports mode is selected by pushing the shift lever from the D (Drive) position into the manual gate. To return to D (Drive) range operation, push the shift lever back into the main gate.

In sports mode, moving the shift lever backwards and forwards will allow you to make gearshifts rapidly. In contrast to a manual transaxle, the sports mode allows gearshifts with the accelerator pedal depressed.

Up (+) : Push the lever forward once to shift up one gear.

Down (-) : Pull the lever backwards once to shift down one gear.

* NOTICE

- In sports mode, the driver must execute upshifts in accordance with road conditions, taking care to keep the engine speed below the red zone.
- In sports mode, only the 6 forward gears can be selected. To reverse or park the vehicle, move the shift lever to the R (Reverse) or P (Park) position as required.
- In sports mode, downshifts are made automatically when the vehicle slows down. When the vehicle stops, 1st gear is automatically selected.

(Continued)

(Continued)

- In sports mode, when the engine rpm approaches the red zone, the transaxle will upshift automatically.
- To maintain the required levels of vehicle performance and safety, the system may not execute certain gearshifts when the shift lever is operated.
- When accelerating from a stop on a slippery road, push the shift lever forward into the +(up) position. This causes the transaxle to shift into 2nd gear which is better for smooth accelerating on a slippery road.

Shift lock system

For your safety, the automatic transaxle has a shift lock system which prevents shifting the transaxle from P (Park) or N (Neutral) into R (Reverse) unless the brake pedal is depressed.

To shift the transaxle from P (Park) or N (Neutral) into R (Reverse):

1. Depress and hold the brake pedal.
2. Start the engine or turn the ignition switch to the ON position to R.
3. Move the shift lever to R.

⚠ WARNING

Always fully depress the brake pedal before and while shifting out of the P (Park) position into another position to avoid inadvertent motion of the vehicle which could injure persons in or around the vehicle.

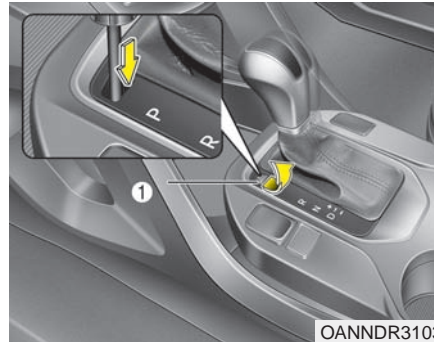

Shift-lock override

If the shift lever cannot be moved from the P (Park) or N (Neutral) position into R (Reverse) position with the brake pedal depressed, continue depressing the brake, then do the following:

1. Carefully remove the cap covering the shift-lock override access hole.
2. Insert a screwdriver into the access hole and press down on the screwdriver.
3. Move the shift lever.
4. Have your vehicle inspected by an authorized HYUNDAI dealer as soon as possible.

Ignition key interlock system (if equipped)

The ignition key cannot be removed unless the shift lever is in the P (Park) position. If the ignition switch is in any other position, the key cannot be removed.

Good driving practices

- Never move the shift lever from P (Park) or N (Neutral) to any other position with the accelerator pedal depressed.
- Never move the shift lever into "P" when the vehicle is in motion.
- Be sure the vehicle is completely stopped before you attempt to shift into R (Reverse) or D (Drive).
- Never take the vehicle out of gear and coast down a hill. This may be extremely hazardous. Always leave the vehicle in gear when moving.
- Do not "ride" the brakes. This can cause them to overheat and malfunction. Instead, when you are driving down a long hill, slow down, move the shift lever to sports mode and shift to a lower gear.
- When using sports mode, slow down before shifting to a lower gear.
- Always use the parking brake and shift into P (Park) when parking the vehicle. Do not depend on placing the transaxle in P (Park) to keep the vehicle from moving.
- Exercise extreme caution when driving on a slippery surface. Be especially careful when braking, accelerating or shifting gears. On a slippery surface, an abrupt change in vehicle speed can cause the drive wheels to lose traction and the vehicle to go out of control.
- Optimum vehicle performance and economy is obtained by smoothly depressing and releasing the accelerator pedal.

WARNING

- **Always buckle-up! In a collision, an unbelted occupant is significantly more likely to be seriously injured or killed than a properly belted occupant.**
- **Avoid high speeds when cornering or turning.**
- **Do not make quick steering wheel movements, such as sharp lane changes or fast, sharp turns.**
- **The risk of rollover is greatly increased if you lose control of your vehicle at highway speeds.**
- **Loss of control often occurs if two or more wheels drop off the roadway and the driver oversteers to reenter the roadway.**
- **In the event your vehicle leaves the roadway, do not steer sharply. Instead, slow down before pulling back into the travel lanes.**
- **Never exceed posted speed limits.**

⚠ WARNING

If your vehicle becomes stuck in snow, mud, sand, etc., then you may attempt to rock the vehicle free by moving it forward and backward. Do not attempt this procedure if people or objects are anywhere near the vehicle. During the rocking operation the vehicle may suddenly move forward or backward as it becomes unstuck, causing injury or damage to nearby people or objects.

Moving up a steep grade from a standing start

To move up a steep grade from a standing start, depress the brake pedal, move the shift lever to D (Drive) and release the parking brake. Depress the accelerator gradually while releasing the service brakes.

ALL WHEEL DRIVE (AWD) (IF EQUIPPED)

Engine power can be delivered to the front and rear wheels for maximum traction. AWD is useful when extra traction is required, such as, when driving on slippery, muddy, wet, or snow-covered roads. Occasional off-road use such as established unpaved roads and trails are OK. It is always important when traveling off-highway that the driver carefully reduces the speed to a level that does not exceed the safe operating speed for those conditions. In general, off-road conditions provide less traction and braking effectiveness than normal road conditions. The driver must be especially alert to avoid driving on slopes which tilt the vehicle to either side.

These factors must be carefully considered when driving off-road. Keeping the vehicle in contact with the driving surface and under control in these conditions is always the driver's responsibility for the safety of him/herself and passengers.

WARNING - Off road driving

This vehicle is designed primarily for on road use although it can operate effectively off road. It was not designed to drive in challenging off-road conditions. Driving in conditions that exceed the vehicle's intended design or the driver's experience level may result in severe injury or death.

Tight corner brake effect





CAUTION - AWD

When turning sharply on a paved road at low speed while in all wheel drive, steering control will be difficult.

Tight corner brake effect is a unique characteristic of all-wheel drive vehicles caused by the difference in tire rotation at the four wheels.

Sharp turns at low speeds should be carried out with caution.

ALL Wheel Drive (AWD) transfer mode selection

Transfer mode	Selection button	Indicator light	Description
<p>AWD AUTO (AWD LOCK is deactivated)</p>		 LOCK (Indicator light is not illuminated)	<ul style="list-style-type: none"> When driving in AWD AUTO mode, the vehicle operates similar to conventional 2WD vehicles under normal operating conditions. However, if the system determines that there is a need for the AWD mode, the engine's driving power is distributed to all four wheels automatically without driver intervention. When driving on normal roads and pavement, the vehicle moves similar to conventional 2WD vehicles.
<p>AWD LOCK</p>		 LOCK (Indicator light is illuminated)	<ul style="list-style-type: none"> This mode is used for climbing or descending sharp grades, off-road driving, driving on sandy and muddy roads, etc., to maximize traction. This mode automatically begins to deactivate at speeds above 30 km/h (19 mph) and is shifted to AWD AUTO mode at speed above 40 km/h (25 mph). If the vehicle decelerates to speeds below 30 km/h (19 mph), however, the transfer mode is shifted into AWD LOCK mode again.

* NOTICE

- When driving on normal roads, deactivate the AWD LOCK mode by pushing the AWD LOCK button (the indicator light goes off). Driving on normal roads with AWD LOCK mode (especially, when cornering) may cause mechanical noise or vibration. The noise and vibration will disappear when the AWD LOCK mode is deactivated. Some parts of the power train may be damaged by prolonged driving with the noise and vibration.
- When the AWD LOCK mode is deactivated, a shock may be felt as the drive power is delivered entirely to the front wheels. This shock is not a mechanical failure.

For safe all wheel drive operation

⚠ WARNING - All wheel driving

When conditions demand the use of four-wheel drive, all functions of your vehicle are exposed to extreme stress. Slow down and be ready for changes in the composition and traction of the surface under your tires. If you have any doubt about the safety of the conditions you are facing, stop and consider the best way to proceed. Do not exceed the ability of yourself or your vehicle to operate safely.

- Do not try to drive in deep standing water or mud since such conditions can stall your engine and clog your exhaust pipes. Do not drive down steep hills since it requires extreme skill to maintain control of the vehicle.

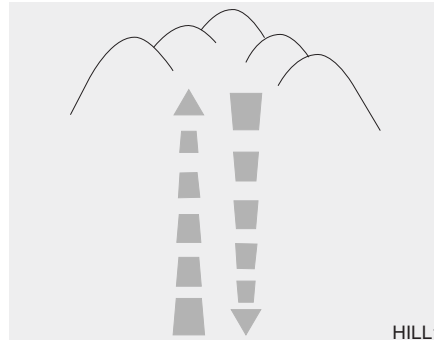

HILL1

- When you are driving up or down hills drive as straight as possible. Use extreme caution in going up or down steep hills, since you may flip your vehicle over depending on the grade, terrain and water/mud conditions.



HILL2

⚠ WARNING - Hills

Driving across the contour of steep hills can be extremely dangerous. This danger can come from slight changes in the wheel angle which can destabilize the vehicle or, even if the vehicle is maintaining stability under power, it can lose that stability if the vehicle stops its forward motion. Your vehicle may roll over without warning and without time for you to correct a mistake that could cause serious injury or death.

- You must consciously take the effort to learn how to corner in an AWD vehicle. Do not rely on your experience in conventional 2WD vehicles in choosing safe cornering speed in AWD mode. You must drive more slowly in AWD.
- Drive carefully off-road because your vehicle may be damaged by rocks or roots of trees. Become familiar with the off-road conditions where you are going to be before you begin driving.



ODMEDR2146

⚠ WARNING - AWD

Reduce speed when you turn corners. The center of gravity of AWD vehicles is higher than that of conventional 2WD vehicles, making them more likely to roll over when you turn corners too fast.

⚠ WARNING - Steering wheel

Do not grab the inside of the steering wheel when you are driving off-road. You may hurt your arm by a sudden steering maneuver or from steering wheel rebound due to impact with objects on the ground. You could lose control of the steering wheel.

- Always hold the steering wheel firmly when you are driving off-road.
- Make sure all passengers are wearing seat belts.

⚠ WARNING - Wind danger
If you are driving in heavy wind, the vehicle's higher center of gravity decreases your steering control capacity and requires you to drive more slowly.

- If you need to drive through water, stop your vehicle, set your transfer to the AWD LOCK mode and drive at less than 5 mph (8 km/h).

⚠ WARNING - Driving through water

Drive slowly. If you are driving too fast in water, the water can get into the engine compartment and wet the ignition system, causing your vehicle to suddenly stop. If this happens and your vehicle is in a tilted position, your vehicle may roll over.

*** NOTICE**

- Do not drive through water if the level is higher than the bottom of the vehicle.
- Check your brake condition once you are out of mud or water. Press the brake pedal several times as you move slowly until you feel normal braking forces return.
- Shorten your scheduled maintenance interval if you drive in off-road conditions such as sand, mud or water (see “Maintenance under severe usage conditions” in section 7). Always wash your vehicle thoroughly after off road use, especially cleaning the bottom of the vehicle.
- Since the driving torque is always applied to the 4 wheels the performance of the AWD vehicle is greatly affected by the condition of the tires. Be sure to equip the vehicle with four tires of the same size and type.
- A full time all wheel drive vehicle cannot be towed by an ordinary tow truck. Make sure that the vehicle is placed on a flat bed truck for towing.

⚠ WARNING - AWD driving

- Avoid high cornering speed.
- Do not make quick steering wheel movements, such as sharp lane changes or fast, sharp turns.
- The risk of rollover is greatly increased if you lose control of your vehicle at high speed.
- In a collision, an unbelted person is significantly more likely to die compared to a person wearing a seat belt.
- Loss of control often occurs if two or more wheels drop off the roadway and the driver over steers to re-enter the roadway. In the event your vehicle leaves the roadway, do not steer sharply. Instead, slow down before pulling back into the travel lanes.

⚠ CAUTION - Mud or snow

If one of the front or rear wheels begins to spin in mud, snow, etc. the vehicle can sometimes be driven out by depressing the accelerator pedal further; however avoid running the engine continuously at high rpm because doing so could damage the AWD system.

Reducing the risk of a rollover

This multi-purpose passenger vehicle is defined as a Sports Utility Vehicle (SUV). SUV's have higher ground clearance and a narrower track to make them capable of performing in a wide variety of off-road applications. Specific design characteristics give them a higher center of gravity than ordinary vehicles. An advantage of the higher ground clearance is a better view of the road, which allows you to anticipate problems. They are not designed for cornering at the same speeds as conventional passenger vehicles, any more than low-slung sports cars are designed to perform satisfactorily in off-road conditions. Due to this risk, driver and passengers are strongly recommended to buckle their seat belts. In a rollover crash, an unbelted person is more likely to die than a person wearing a seat belt. There are steps that a driver can make to reduce the risk of a rollover. If at all possible, avoid sharp turns or abrupt maneuvers, do not load your roof rack with heavy cargo, and never modify your vehicle in any way.

WARNING - Rollover

As with other Sport Utility Vehicle (SUVs), failure to operate this vehicle correctly may result in loss of control, an accident or vehicle rollover.

- **Utility vehicles have a significantly higher rollover rate than other types of vehicles.**
- **Specific design characteristics (higher ground clearance, narrower track, etc.) give this vehicle a higher center of gravity than ordinary vehicles.**
- **SUVs not designed for cornering at the same speeds as conventional vehicles.**
- **Avoid sharp turns or abrupt maneuvers.**
- **In a rollover crash, an unbelted person is significantly more likely to die than a person wearing a seat belt. Make sure everyone in the vehicle is properly buckled up.**

WARNING

Your vehicle is equipped with tires designed to provide safe ride and handling capability. Do not use a size and type of tire and wheel that is different from the one that is originally installed on your vehicle. It can affect the safety and performance of your vehicle, which could lead to steering failure or rollover and serious injury. When replacing the tires, be sure to equip all four tires with the tire and wheel of the same size, type, tread, brand and load-carrying capacity. If you nevertheless decide to equip your vehicle with any tire/wheel combination not recommended by HYUNDAI for off road driving, you should not use these tires for highway driving.

⚠ WARNING - Jacked vehicle

While a full-time AWD vehicle is raised on a jack, never start the engine or cause the tires to rotate.

There is a danger that rotating tires touching the ground could cause the vehicle to fall off the jack and to jump forward or rearward.

- Full-time AWD vehicles must be tested on a special four wheel chassis dynamometer.

*** NOTICE**

Never engage the parking brake while performing these tests.

- A full-time AWD vehicle should not be tested on a 2WD roll tester. If a 2WD roll tester must be used, perform the following:

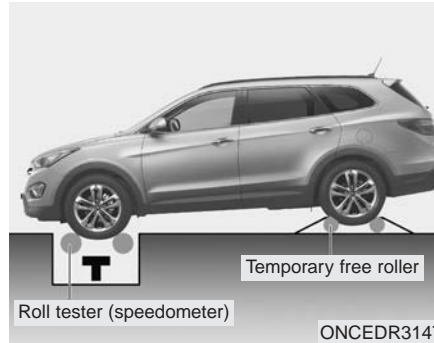

1. Check the tire pressures recommended for your vehicle.
2. Place the front wheels on the roll tester for a speedometer test as shown in the illustration.
3. Release the parking brake.
4. Place the rear wheels on the temporary free roller as shown in the illustration.

⚠ WARNING - Dynamometer testing

Keep away from the front of the vehicle while the vehicle is in gear on the dynamometer. This is very dangerous as the vehicle can jump forward and cause serious injury or death.

BRAKE SYSTEM

Power brakes

Your vehicle has power-assisted brakes that adjust automatically through normal usage.

In the event that the power-assisted brakes lose power because of a stalled engine or some other reason, you can still stop your vehicle by applying greater force to the brake pedal than you normally would. The stopping distance, however, will be longer.

When the engine is not running, the reserve brake power is partially depleted each time the brake pedal is applied. Do not pump the brake pedal when the power assist has been interrupted.

Pump the brake pedal only when necessary to maintain steering control on slippery surfaces.

⚠ WARNING - Brakes

- **Do not drive with your foot resting on the brake pedal. This will create abnormal high brake temperatures, excessive brake lining and pad wear, and increased stopping distances.**
- **When descending a long or steep hill, shift to a lower gear and avoid continuous application of the brakes. Continuous brake application will cause the brakes to overheat and could result in a temporary loss of braking performance.**

(Continued)

(Continued)

- **Wet brakes may impair the vehicle's ability to safely slow down; the vehicle may also pull to one side when the brakes are applied. Applying the brakes lightly will indicate whether they have been affected in this way. Always test your brakes in this fashion after driving through deep water. To dry the brakes, apply them lightly while maintaining a safe forward speed until brake performance returns to normal.**
- **Always, confirm the position of the brake and accelerator pedal before driving. If you don't check the position of the accelerator and brake pedal before driving, you may depress the accelerator instead of the brake pedal. It may cause a serious accident.**

In the event of brake failure

If service brakes fail to operate while the vehicle is in motion, you can make an emergency stop with the parking brake. The stopping distance, however, will be much greater than normal.

⚠ WARNING - Parking brake

Applying the parking brake while the vehicle is moving at normal speeds can cause a sudden loss of control of the vehicle. If you must use the parking brake to stop the vehicle, use great caution in applying the brake.

Disc brakes wear indicator

When your brake pads are worn and new pads are required, you will hear a high-pitched warning sound from your front brakes or rear brakes (if equipped). You may hear this sound come and go or it may occur whenever you depress the brake pedal.

Please remember that some driving conditions or climates may cause a brake squeal when you first apply (or lightly apply) the brakes. This is normal and does not indicate a problem with your brakes.

⚠ CAUTION

- *To avoid costly brake repairs, do not continue to drive with worn brake pads.*
- *Always replace the front or rear brake pads as pairs.*

⚠ WARNING - Brake wear

This brake wear warning sound means your vehicle needs service. If you ignore this audible warning, you will eventually lose braking performance, which could lead to a serious accident.

Parking brake

Applying the parking brake

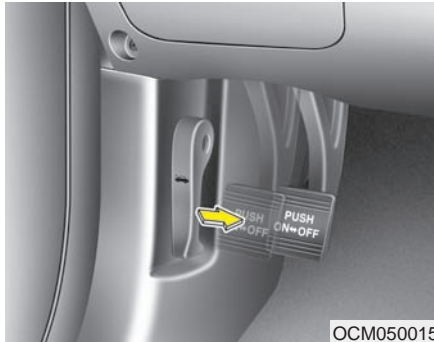

Foot type

To engage the parking brake, first apply the foot brake and then depress the parking brake pedal down as far as possible.

CAUTION

- *Driving with the parking brake applied will cause excessive brake pad and brake rotor wear.*
- *Do not operate the parking brake while the vehicle is moving except in an emergency situation. It could damage the vehicle system and endanger driving safety.*

Releasing the parking brake

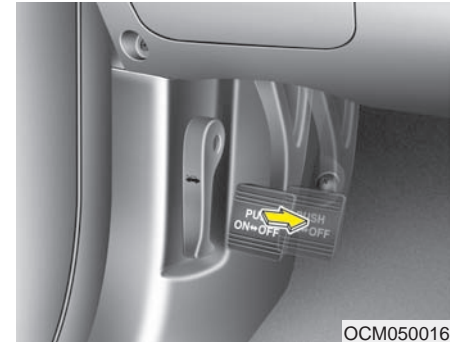

Foot type

To release the parking brake, depress the parking brake pedal a second time while applying the foot brake. The pedal will automatically extend to the fully released position.

If the parking brake does not release or does not release all the way, have the system checked by an authorized HYUNDAI dealer.

⚠ WARNING

- To prevent unintentional movement when stopped and leaving the vehicle, do not use the gearshift lever in place of the parking brake. Set the parking brake AND make sure the gearshift lever is securely positioned in P (Park) for automatic transaxle equipped vehicles.
- Never allow anyone who is unfamiliar with the vehicle to touch the parking brake. If the parking brake is released unintentionally, serious injury may occur.

(Continued)

(Continued)

- All vehicles should always have the parking brake fully engaged when parking to avoid inadvertent movement of the vehicle which can injure occupants or pedestrians.



Check the brake warning light by turning the ignition switch ON (do not start the engine). This light will be illuminated when the parking brake is applied with the ignition switch in the START or ON position.

Before driving, be sure the parking brake is fully released and the brake warning light is off.

If the brake warning light remains on after the parking brake is released while engine is running, there may be a malfunction in the brake system. Immediate attention is necessary.

If at all possible, cease driving the vehicle immediately. If that is not possible, use extreme caution while operating the vehicle and only continue to drive the vehicle until you can reach a safe location or repair shop.

Anti-lock brake system (ABS)

⚠ WARNING

ABS (or ESC) will not prevent accidents due to improper or dangerous driving maneuvers. Even though vehicle control is improved during emergency braking, always maintain a safe distance between you and objects ahead. Vehicle speeds should always be reduced during extreme road conditions.

The braking distance for vehicles equipped with an anti-lock braking system or (Electronic Stability Control System) may be longer than for those without it in the following road conditions.

During these conditions the vehicle should be driven at reduced speeds:

(Continued)

(Continued)

- **Rough, gravel or snow-covered roads.**
- **With tire chains installed.**
- **On roads where the road surface is pitted or has different surface height.**

The safety features of an ABS (or ESC) equipped vehicle should not be tested by high speed driving or cornering. This could endanger the safety of yourself or others.

The ABS continuously senses the speed of the wheels. If the wheels are going to lock, the ABS system repeatedly modulates the hydraulic brake pressure to the wheels.

When you apply your brakes under conditions which may lock the wheels, you may hear a “tik-tik” sound from the brakes, or feel a corresponding sensation in the brake pedal. This is normal and it means your ABS is active.

In order to obtain the maximum benefit from your ABS in an emergency situation, do not attempt to modulate your brake pressure and do not try to pump your brakes. Press your brake pedal as hard as possible or as hard as the situation warrants and allow the ABS to control the force being delivered to the brakes.

* NOTICE

A click sound may be heard in the engine compartment when the vehicle begins to move after the engine is started. These conditions are normal and indicate that the anti-lock brake system is functioning properly.

- Even with the anti-lock brake system, your vehicle still requires sufficient stopping distance. Always maintain a safe distance from the vehicle in front of you.
- Always slow down when cornering. The anti-lock brake system cannot prevent accidents resulting from excessive speeds.
- On loose or uneven road surfaces, operation of the anti-lock brake system may result in a longer stopping distance than for vehicles equipped with a conventional brake system.

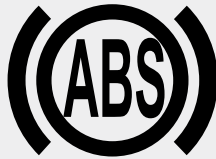

W-78

⚠ CAUTION

- *If the ABS warning light is on and stays on, you may have a problem with the ABS. In this case, however, your regular brakes will work normally.*

(Continued)

(Continued)

- *The ABS warning light will stay on for approximately 3 seconds after the ignition switch is ON. During that time, the ABS will go through self-diagnosis and the light will go off if everything is normal. If the light stays on, you may have a problem with your ABS. Contact an authorized HYUNDAI dealer as soon as possible.*

⚠ CAUTION

- *When the brakes are operated continuously on a road having poor traction, the ABS will be active and the ABS warning light may illuminate. Pull your vehicle over to a safe place and stop the engine.*
- *Restart the engine. If the ABS warning light is off, then your ABS system is normal. Otherwise, you may have a problem with the ABS. Contact an authorized HYUNDAI dealer as soon as possible.*

*** NOTICE**

When you jump start your vehicle because of a drained battery, the engine may not run as smoothly and the ABS warning light may turn on at the same time. This happens because of the low battery voltage. It does not mean your ABS is malfunctioning.

- Do not pump your brakes!
- Have the battery recharged before driving the vehicle.

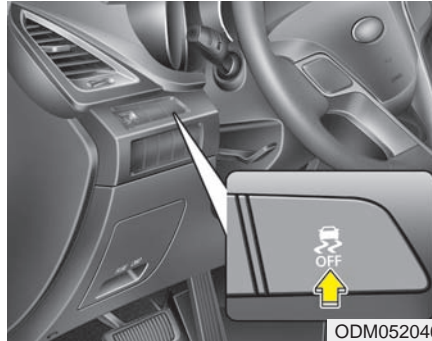
Electronic Stability Control (ESC)

The Electronic Stability Control (ESC) system helps to stabilize the vehicle during cornering maneuvers. ESC checks where you are steering and where the vehicle is actually going. ESC applies braking pressure to any one of the vehicle's brakes and intervenes in the engine management system to assist the driver with keeping the vehicle on the intended path. It is not a substitute for safe driving practices. Always adjust your speed and driving to the road conditions.

⚠ WARNING

Never drive too fast for the road conditions or too quickly when cornering. The ESC system will not prevent accidents. Excessive speed in turns, abrupt maneuvers, and hydroplaning on wet surfaces can result in severe accidents.

ESC operation

ESC ON condition

When the ignition switch is in the ON position, the ESC and the ESC OFF indicator lights illuminate for approximately three seconds and goes off, then the ESC is turned on.

If this light stays on, your vehicle may have a malfunction with the ESC system. Have your vehicle checked by an authorized HYUNDAI dealer as soon as possible.

When operating



When the ESC is in operation, the ESC indicator light blinks:

- When you apply your brakes under conditions which may lock the wheels, you may hear sounds from the brakes, or feel a corresponding sensation in the brake pedal. This is normal and it means your ESC is active.
- When the ESC activates, the engine may not respond to the accelerator as it does under routine conditions.
- If the Cruise Control was in use when the ESC activates, the cruise control automatically disengages. The Cruise Control can be reengaged when the road conditions allow. See "Cruise Control System" later in this chapter.

- When moving out of the mud or driving on a slippery road, the engine rpm (revolutions per minute) may not increase even if you press the accelerator pedal deeply. This is to maintain the stability and traction of the vehicle and does not indicate a problem.

ESC OFF condition

To cancel ESC operation :

• State 1

Press the ESC OFF button shortly (ESC OFF indicator light illuminates). At this state, the engine control function does not operate. In other words, the traction control function does not operate but only the brake control function operates.

• State 2

Press the ESC OFF button for more than 3 seconds. ESC OFF indicator light illuminates and ESC OFF warning chime will sound. At this state, the engine control function and brake control function does not operate. In other words, the vehicle stability control function does not operate any more.

If the ignition switch is placed to the LOCK/OFF position when ESC is off, ESC remains off. Upon restarting the engine, the ESC will automatically turn on again.

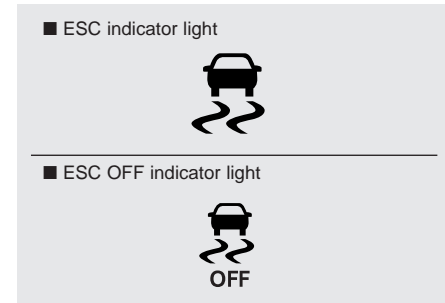
Indicator lights

When the ignition switch is placed to the ON position, the ESC indicator light illuminates, then goes off if the ESC system is operating normally.

The ESC indicator light blinks whenever the ESC is operating.

If ESC indicator light stays on, your vehicle may have a malfunction with the ESC system. When this warning light illuminates have your vehicle checked by an authorized HYUNDAI dealer as soon as possible.

The ESC OFF indicator light comes on when the ESC is turned off with the button.

 **WARNING**

When the ESC is blinking, this indicates the ESC is active:

Drive slowly and **NEVER** attempt to accelerate. **NEVER** press the ESC OFF button while the ESC indicator light is blinking or you may lose control of the vehicle resulting in an accident.

 **CAUTION**

Driving with varying tire or wheel sizes may cause the ESC system to malfunction. When replacing tires, make sure they are the same size as your original tires for this vehicle.

ESC OFF usage

When driving

The ESC OFF mode should only be used briefly to help free the vehicle if stuck in snow or mud by temporarily stopping operation of the ESC to maintain wheel torque.

To turn ESC off while driving, press the ESC OFF button while driving on a flat road surface.

 **CAUTION**

To prevent damage to the transaxle:

- *Do not allow wheel(s) of one axle to spin excessively while the ESC, ABS, and brake warning lights are displayed. The repairs would not be covered by the vehicle warranty. Reduce engine power and do not spin the wheel(s) excessively while these lights are displayed.*
- *When operating the vehicle on a dynamometer, ensure the ESC is turned off (ESC OFF light illuminated).*

*** NOTICE**

Turning the ESC OFF does not affect ABS or standard brake system operation.

Vehicle stability management (VSM) (if equipped)

This system provides further enhancements to vehicle stability and steering responses when a vehicle is driving on a slippery road or a vehicle detected changes in coefficient of friction between right wheels and left wheels when braking.

VSM operation

When the VSM is in operation, ESC indicator light () blinks.

When the vehicle stability management is operating properly, you can feel a slight pulsation in the vehicle and/or abnormal steering responses (EPS). This is only the effect of brake and EPS control and indicates nothing unusual.

The VSM does not operate when:

- Driving on a banked road such as gradient or incline
- Driving rearward
- ESC OFF indicator light () remains on the instrument cluster
- EPS indicator light remains on the instrument cluster

VSM operation off

If you press the ESC OFF button to turn off the ESC, the VSM will also cancel and the ESC OFF indicator light () illuminates.

To turn on the VSM, press the button again. The ESC OFF indicator light goes out.

Malfunction indicator

The VSM system will automatically be deactivated if a malfunction has been detected somewhere in the Electric Power Steering system or the VSM system. If a malfunction is detected, the ESC indicator light will illuminate and remain on. If the ESC indicator light () or EPS warning light remains on, take your vehicle to an authorized HYUNDAI dealer and have the system checked.

* NOTICE

- The VSM is designed to function above approximately 9 mph (15 km/h) on curves.
- The VSM is designed to function above approximately 18 mph (30 km/h) when a vehicle is braking on a split-mu road. The split-mu road is made of surfaces which have different friction forces.

WARNING

- **The Vehicle Stability Management system is not a substitute for safe driving practices but a supplementary function only. It is the responsibility of the driver to always check the speed and the distance to the vehicle ahead. Always hold the steering wheel firmly while driving.**
- **Your vehicle is designed to operate according to the driver's input through steering, acceleration, and braking, even with the VSM operational. Always follow all the normal precautions for driving at safe speeds for the conditions – including driving in inclement weather and on a slippery road.**
- **Driving with varying tire or wheel sizes may cause the VSM system to malfunction. When replacing tires, make sure they are the same size as your original tires.**

Downhill brake control (DBC)

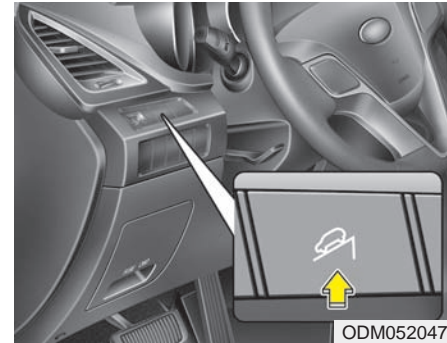

The Downhill Brake Control (DBC) assists the driver when descending a steep hill without the driver depressing the brake pedal. It slows the vehicle to approximately 6.3 mph (10 km/h) and lets the driver concentrate on steering the vehicle.

DBC defaults to the OFF position whenever the ignition is turned on.

The DBC can be turned on or off by pushing the button.

Mode	Indicator light	Description
Standby	Green light illuminated	Press the DBC button when the vehicle speed is under 25 mph (40 km/h). The DBC system will turn ON and enter the standby mode. The system maintains the standby mode when vehicle speed is under approximately 38 mph (60km/h).
Activated	Green light blink	In the standby mode, DBC will activate automatically under the following conditions: <ul style="list-style-type: none"> • The incline is over a certain degree. • The brake pedal or accelerator pedal is not depressed.
OFF	Green light OFF	The DBC will turn OFF under the following conditions: <ul style="list-style-type: none"> • The DBC button is pressed again. • The vehicle speed is over approximately 38 mph (60 km/h).
Temporarily deactivated	Green light illuminated	In the activated mode, the DBC will temporarily deactivate under the following conditions: <ul style="list-style-type: none"> • The hill is not steep enough. • The brake pedal or accelerator pedal is depressed. When the above conditions are gone, the DBC will automatically activate again.

WARNING

If the DBC yellow indicator light illuminates, the system has overheated or there is an operational problem. The DBC will not activate. If the DBC yellow indicator light illuminates even though the DBC system has cooled, have the system checked by an authorized HYUNDAI dealer.

*** NOTICE**

- The DBC does not turn ON in the P (Park) position.
- The DBC may not activate if the ESC (or ABS) is activated.
- Noise or vibration may occur from the brakes when the DBC is activated.
- The rear stop light comes on when the DBC is activated.
- Always turn OFF the DBC on normal roads. The DBC might activate from the standby mode during abrupt cornering or driving over speed bumps.

⚠ WARNING

- Unnecessary or unwanted DBC activation may result in an accident.
- On a very steep hill even though the brake pedal or accelerator pedal is depressed the DBC may not deactivate.

Hill-start assist control (HAC)

A vehicle has the tendency to roll back on a steep hill when the driver begins to accelerate after a stop. The Hill-start Assist Control (HAC) prevents the vehicle from rolling back by operating the brakes automatically for about 1.5 seconds. The brakes are released when the accelerator pedal is depressed or after about 1.5 seconds.

⚠ WARNING

The HAC is activated only for about 1.5 seconds, so always depress the accelerator pedal to begin accelerating after a stop.

*** NOTICE**

- The HAC does not operate when the transaxle shift lever is in the P (Park) or N (Neutral) position.
- The HAC activates even though the ESC is off but it does not activate when the ESC has malfunctioned.

Good braking practices**⚠ WARNING**

- **Whenever you leave or park your vehicle, always set the parking brake as far as possible and fully engage the vehicle's transaxle into the P (Park) position. If the parking brake is not fully engaged, the vehicle may move inadvertently and injure yourself and others.**
 - **All vehicles should always have the parking brake fully engaged when parking to avoid inadvertent movement of the vehicle which can injure occupants or pedestrians.**
- After being parked, check to be sure the parking brake is not engaged and that the parking brake indicator light is out before driving away.

- Driving through water may get the brakes wet. They can also get wet when the vehicle is washed. Wet brakes can be dangerous! Your vehicle will not stop as quickly if the brakes are wet. Wet brakes may cause the vehicle to pull to one side.
To dry the brakes, apply the brakes lightly until the braking action returns to normal, taking care to keep the vehicle under control at all times. If the braking action does not return to normal, stop as soon as it is safe to do so and call an authorized HYUNDAI dealer for assistance.
- Don't coast down hills with the vehicle out of gear. This is extremely hazardous. Keep the vehicle in gear at all times, use the brakes to slow down, then shift to a lower gear so that engine braking will help you maintain a safe speed.
- Don't "ride" the brake pedal. Resting your foot on the brake pedal while driving can be dangerous because it can result in the brakes overheating and losing their effectiveness. It also increases the wear of the brake components.

- If a tire goes flat while you are driving, apply the brakes gently and keep the vehicle pointed straight ahead while you slow down. When you are moving slowly enough for it to be safe to do so, pull off the road and stop in a safe place.
- If your vehicle is equipped with an automatic transaxle, don't let your vehicle creep forward. To avoid creeping forward, keep your foot firmly on the brake pedal when the vehicle is stopped.
- Use caution when parking on a hill. Firmly engage the parking brake and place the shift lever in P (automatic transaxle). If your vehicle is facing downhill, turn the front wheels into the curb to help keep the vehicle from rolling. If your vehicle is facing uphill, turn the front wheels away from the curb to help keep the vehicle from rolling. If there is no curb or if it is required by other conditions to keep the vehicle from rolling, block the wheels.
- Under some conditions your parking brake can freeze in the engaged position. This is most likely to happen when there is an accumulation of snow or ice around or near the rear brakes or if the brakes are wet. If there is a risk that the parking brake may freeze, apply it only temporarily while you put the gear selector lever in P (automatic transaxle) and block the rear wheels so the vehicle cannot roll. Then release the parking brake.
- Do not hold the vehicle on an incline with the accelerator pedal. This can cause the transaxle to overheat. Always use the brake pedal or parking brake.

CRUISE CONTROL SYSTEM

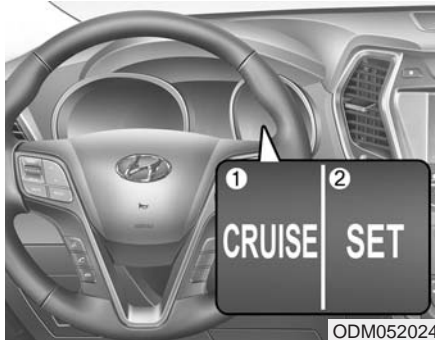

1. Cruise indicator
2. Cruise set indicator

The cruise control system allows you to program the vehicle to maintain a constant speed without depressing the accelerator pedal.

This system is designed to function above approximately 25 mph (40 km/h).

⚠ WARNING

- If the cruise control is left on, (CRUISE indicator light in the instrument cluster is illuminated), the cruise control can be switched on accidentally. Keep the cruise control system off (CRUISE indicator light OFF) when the cruise control is not in use, to avoid inadvertently setting a speed.
- Use the cruise control system only when driving on open highways in good weather.
- Do not use the cruise control when it may not be safe to keep the vehicle at a constant speed, for instance, driving in heavy or varying traffic, or on slippery (rainy, icy or snow-covered) or winding roads or over 6% up-hill or down-hill roads.

(Continued)

(Continued)

- Pay particular attention to the driving conditions whenever using the cruise control system.
- Be careful when driving downhill using the cruise control system, which may increase the vehicle speed.

*** NOTICE**

- During normal cruise control operation, when the SET switch is activated or reactivated after applying the brakes, the cruise control will energize after approximately 3 seconds. This delay is normal.
- To activate cruise control, depress the brake pedal at least once after turning the ignition switch to the ON position or starting the engine. This is to check if the brake switch which is important part to cancel cruise control is in normal condition.

Cruise control switch



- CRUISE : Turns cruise control system on or off.
- CANCEL: Cancels cruise control operation.
- RES+: Resumes or increases cruise control speed.
- SET-: Sets or decreases cruise control speed.

To set cruise control speed:



1. Press the CRUISE button on the steering wheel to turn the system on. The CRUISE indicator light in the instrument cluster will illuminate.
2. Accelerate to the desired speed, which must be more than 25 mph (40 km/h).



ODM052027

3. Move the lever down (to SET-), and release it at the desired speed. The SET indicator light in the instrument cluster will illuminate. Release the accelerator pedal at the same time. The desired speed will automatically be maintained.

On a steep grade, the vehicle may slow down or speed up slightly while going uphill or downhill.

To increase cruise control set speed:

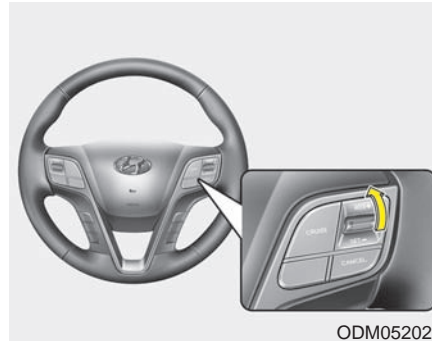

ODM052026

Follow either of these procedures:

- Move the lever up (to RES+) and hold it. Your vehicle will accelerate. Release the lever at the speed you want.
- Move the lever up (to RES+) and release it immediately.

The cruising speed will increase by 1 mph (or 2km/h) each time you move the lever up (to RES+) in this manner.

To decrease the cruising speed:



ODM052027

Follow either of these procedures:

- Move the lever down (to SET-) and hold it. Your vehicle will gradually slow down. Release the lever at the speed you want to maintain.
- Move the lever down (to SET-) and release it immediately.

The cruising speed will decrease by 1 mph (1.6 km/h) each time you move the lever down (to SET-) in this manner.

To temporarily accelerate with the cruise control on:

If you want to speed up temporarily when the cruise control is on, depress the accelerator pedal. Increased speed will not interfere with cruise control operation or change the set speed.

To return to the set speed, take your foot off the accelerator pedal.

To cancel cruise control, do one of the following:



- Depress the brake pedal.
- Shift into N (Neutral) with an automatic transaxle.
- Press the CANCEL switch located on the steering wheel.
- Decrease the vehicle speed lower than the memory speed by 9 mph (15 km/h).
- Decrease the vehicle speed to less than approximately 25 mph (40 km/h).

Each of these actions will cancel cruise control operation (the SET indicator light in the instrument cluster will go off), but it will not turn the system off. If you wish to resume cruise control operation, move up the lever (to RES+) located on your steering wheel. You will return to your previously preset speed.

To resume cruising speed at more than approximately 25 mph (40 km/h):

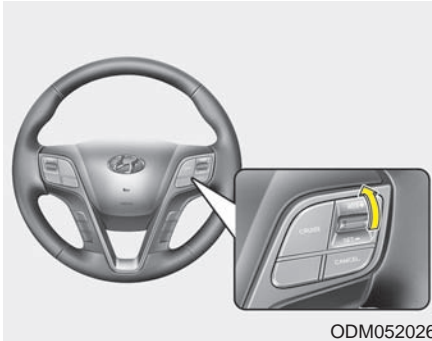

If any method other than the CRUISE button was used to cancel cruising speed and the system is still activated, the most recent set speed will automatically resume when you move the lever up (to RES+).

It will not resume, however, if the vehicle speed has dropped below approximately 25 mph (40 km/h).

*** NOTICE**

Always check the road conditions when you move the lever up (to RES+) to resume the speed.

To turn cruise control off, do one of the following:



- Press the CRUISE button (the CRUISE indicator light in the instrument cluster will go off).
- Turn the ignition off.

Both of these actions cancel cruise control operation. If you want to resume cruise control operation, repeat the steps provided in "To set cruise control speed" on the previous page.

BLIND SPOT DETECTION SYSTEM (BSD) (IF EQUIPPED)

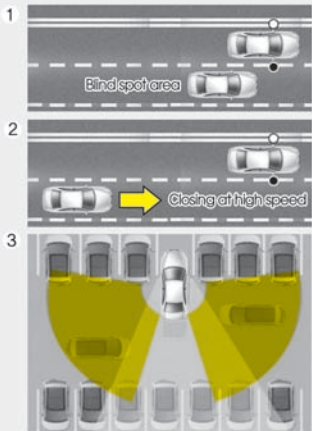
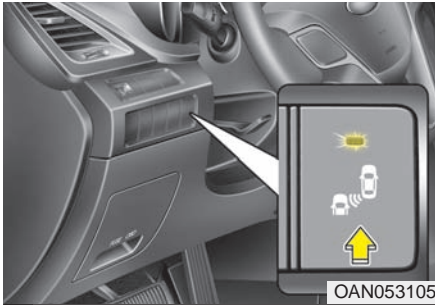

The BSD (Blind spot detection) system uses a radar sensor to alert the driver while driving.

It senses the rear side territory of the vehicle and provides information to the driver.

① BSD (Blind spot detection)

When a vehicle approaches you and is detected in your blind spot area, the system will warn you. The warning range depends on your vehicle speed. However, if your vehicle is about 6 mph (10 km/h) faster than the other vehicle, the system will not warn you.

② LCA (Lane change assist)

When a vehicle approaches you at high speed, the system will warn you.

③ RCTA (Rear cross traffic alert)

When your vehicle moves rearward and the sensor detects an approaching vehicle on either the left or right side, the system will warn you.

⚠ WARNING

- While driving, keep your eyes on the road and be aware of your surroundings even though the BSD (Blind spot detection) system is operating.
- The BSD (Blind spot detection) system is a convenient feature designed to assist the driver. However, do not rely solely on the system to alert you when vehicles are approaching. Always pay proper attention to your surroundings and use caution when changing lanes.

Operating conditions

The indicator on the switch will illuminate when the BSD (Blind spot detection) system switch is pressed with the ignition switch ON.

If the vehicle speed exceeds 18.6 mph (30 km/h) the system will activate.

If you press the switch again, the switch indicator and system will be turned off.

If the ignition switch is turned OFF and ON the system returns to the previous state.

When the system is not used, turn the system off by turning off the switch.

When the system is turned on, the warning light will illuminate for 3 seconds on the outside rearview mirror.

Warning type

The system will activate when:

1. The system is on
2. Vehicle speed is above 18.6 mph (30 km/h)
3. Other vehicles are detected in the boundaries of the radar system.

1st stage

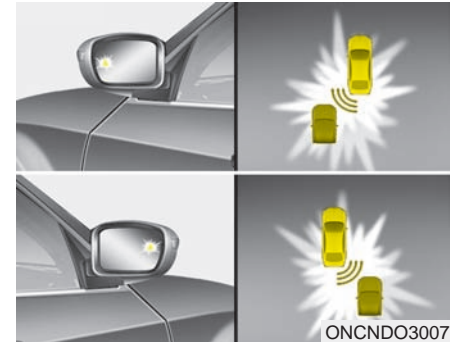

If a vehicle is detected within the boundary of the system, a yellow warning light will illuminate in the outside rearview mirror glass.

Once the detected vehicle moves out of the boundary of the system, the warning will turn off.

2nd stage

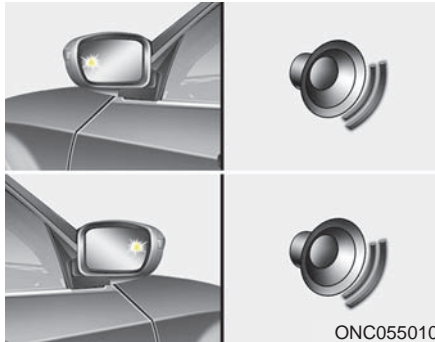

The second stage alarm will activate when:

1. The first stage alert is on
2. The turn signal is on to change a lane.

When the second stage alert is activated, a warning light will blink on the outside rearview mirror housing and a warning alarm will sound.

If you move the turn signal switch back to its original position, the second stage alert will be deactivated.

BSD Detecting Sensor



The sensors are located on the inside of the rear bumper.

Always keep the rear bumper clean for the system to work properly.

Warning message



The message will appear to notify the driver if there are foreign substances on the rear bumper. The light on the switch and the system will turn off automatically.

Remove the foreign substance on the rear bumper.

After the foreign substances are removed, if you drive for approximately 10 minutes, the system will work normally.

If the system does not work normally even though the foreign substances are removed, consult an authorized HYUNDAI dealer and have the system check.



If there is a problem with BSD, a warning message will appear to notify the driver. If this occurs, have a vehicle checked by an authorized HYUNDAI dealer.

Rear cross traffic alert

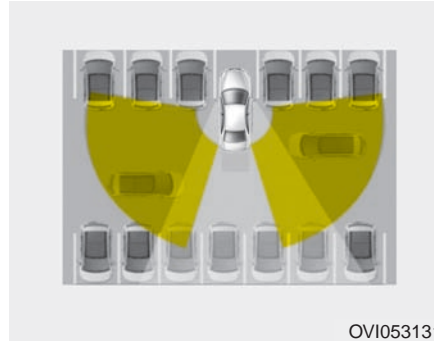

When your vehicle moves backwards from a parking position, the sensor detects approaching vehicles to the left or right side direction and gives information to the driver.

Operating conditions - RCTA

- When the ignition is ON, if you press the BSD switch, the switch indicator illuminates and the system turns on.
- The system operates when the vehicle speed is below 6.2 mph (10 km/h) when the gear shift lever is in reverse (R).
- The RCTA (Rear Cross Traffic Alert) detecting range is 0.5 - 20m (1.6 - 65.6 ft) based on the side direction. If an approaching vehicle is within the sensing range and is traveling at a speed of 2.5 - 22 mph (4 - 36 km/h), the system will detect the vehicle. However, the system sensing range may vary based on the surrounding conditions. Always use good judgment and pay attention to your surroundings while driving even while using the BSD system.

Warning type

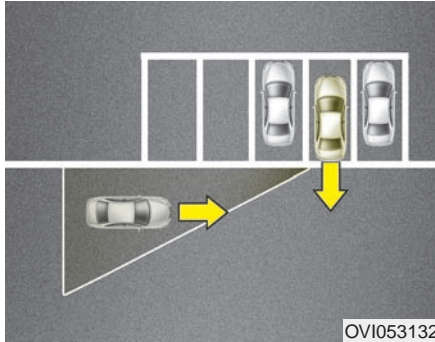

- If the vehicle detected by sensors approaches your vehicle, the warning chime will sound and the warning light will blink on the outside rearview mirror.
- If the detected vehicle is out of the sensing range from behind your vehicle, moves in the opposite direction away from your vehicle or moves slowly, the warning is cancelled.
- The system may not operate properly due to other factors or circumstances. Always pay attention to your surroundings.

※ If the left or right side bumper of your vehicle is blocked by a barrier or another vehicle, the system sensing ability may be limited.

⚠ WARNING

- The warning light on the outside rearview mirror housing will illuminate whenever a vehicle is detected at the rear side by the system.

To avoid accidents, do not focus only on the warning light and neglect to see the surroundings of the vehicle.

- Drive safely even though the vehicle is equipped with a BSD (Blind spot detection) system. Do not solely rely on the system but check for yourself before changing lanes.

The system may not alert the driver in some conditions so always check the surroundings while driving.

⚠ CAUTION

- *The system may not work properly if the bumper has been replaced or if repair work has been done near the sensor.*
- *The detection area differs according to the roads width. If the road is narrow the system may detect other vehicles in the next lane.*
- *Conversely, if the road is very wide the system may not detect other vehicles.*
- *The system may turn off due to strong electromagnetic waves.*

Non-operating conditions

Driver's Attention

The driver must be extra cautious in the following situations in which the system may not assist the driver and may not function properly.

- Curved roads, tollgates, etc.
- The area around the sensor is covered by rain, snow, mud, etc
- The rear bumper near the sensor is covered or hidden with foreign matter such as a sticker, bumper guard, bicycle stand etc.
- The rear bumper is damaged or the sensor is out of place.
- The height of the vehicle is changed or altered such as when the cargo area is loaded with heavy objects, or has abnormal tire pressure etc.
- Due to bad weather such as heavy rain or snow.
- A fixed object is near such as a guardrail, tunnel etc.
- A large amount of metal substances are near the vehicles such as a construction area.

- A big vehicle is near such as a bus or truck.
- A motorcycle or bicycle is near.
- A flatbed trailer is near.
- If the vehicle has been started at the same time as the vehicle next to it and the vehicle has started to move.
- When the other vehicle passes by very fast.
- When changing lanes.
- When going down or up a steep road where the height of the lane is different.
- When the other vehicle drives at the rear very nearby or drives very close.
- When the temperature of the rear bumper is high.
- When a trailer or carrier is installed.
- When driving through a narrow road with many trees or bushes.

Outside rearview mirror may not alert the driver when:

- The outside rearview mirror housing is very muddy or dirty.
- The driver or passenger window is very muddy or dirty.
- The driver or passenger window is tinted with a very dark tint.

This device complies with Part 15 of the FCC rules.

Operation is subject to the following two conditions:

1. This device may not cause harmful interference, and
2. This device must accept any interference received, including interference that may cause undesired operation.

ACTIVE ECO SYSTEM

Active ECO operation

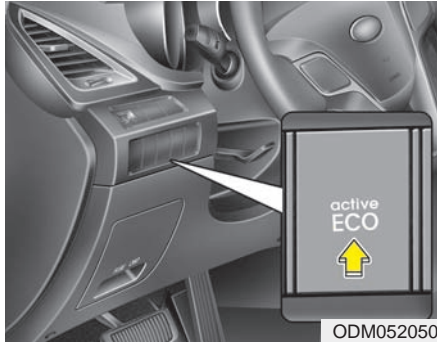

Active ECO helps improve fuel efficiency by controlling certain engine and transaxle system operating parameters. Fuel efficiency depends on the driver's driving habit and road condition.

- When the Active ECO button is pressed the ECO indicator (green) will illuminate to show that the Active ECO is operating.
- When the Active ECO is activated, it will remain on until the Active ECO button is pressed again. Active ECO does not turn off when the engine is restarted. To turn off Active ECO, press the Active ECO button again.
- If Active ECO is turned off, the system will return to normal mode.

When Active ECO is activated :

- The engine noise may get louder.
- The vehicle speed may slightly be reduced.
- The air conditioner performance may be affected.

Limitation of Active ECO operation:

If the following conditions occur while Active ECO is operating, the system operation is limited even though there is no change in the ECO indicator.

- When the coolant temperature is low: The system will be limited until engine performance becomes normal.
- When driving up a hill: The system will be limited to gain power when driving uphill because the engine torque is restricted.
- When using sports mode: The system will be limited according to the shift location.
- When the accelerator pedal is deeply depressed for a few seconds: The system will be limited, judging that the driver wants to speed up.

ECONOMICAL OPERATION

Your vehicle's fuel economy depends mainly on your style of driving, where you drive and when you drive.

Each of these factors affects how many miles (kilometers) you can get from a gallon (liter) of fuel. To operate your vehicle as economically as possible, use the following driving suggestions to help save money in both fuel and repairs:

- Drive smoothly. Accelerate at a moderate rate. Don't make "jack-rabbit" starts or full-throttle shifts and maintain a steady cruising speed. Don't race between stoplights. Try to adjust your speed to the traffic so you don't have to change speeds unnecessarily. Avoid heavy traffic whenever possible. Always maintain a safe distance from other vehicles so you can avoid unnecessary braking. This also reduces brake wear.
- Drive at a moderate speed. The faster you drive, the more fuel your vehicle uses. Driving at a moderate speed, especially on the highway, is one of the most effective ways to reduce fuel consumption.
- Don't "ride" the brake pedal. This can increase fuel consumption and also increase wear on these components. In addition, driving with your foot resting on the brake pedal may cause the brakes to overheat, which reduces their effectiveness and may lead to more serious consequences.
- Take care of your tires. Keep them inflated to the recommended pressure. Incorrect inflation, either too much or too little, results in unnecessary tire wear. Check the tire pressures at least once a month.
- Be sure that the wheels are aligned correctly. Improper alignment can result from hitting curbs or driving too fast over irregular surfaces. Poor alignment causes faster tire wear and may also result in other problems as well as greater fuel consumption.
- Keep your vehicle in good condition. For better fuel economy and reduced maintenance costs, maintain your vehicle in accordance with the maintenance schedule in Section 7. If you drive your vehicle in severe conditions, more frequent maintenance is required (see Section 7 for details).
- Keep your vehicle clean. For maximum service, your vehicle should be kept clean and free of corrosive materials. It is especially important that mud, dirt, ice, etc. not be allowed to accumulate on the underside of the vehicle. This extra weight can result in increased fuel consumption and also contribute to corrosion.
- Travel lightly. Don't carry unnecessary weight in your vehicle. Weight reduces fuel economy.
- Don't let the engine idle longer than necessary. If you are waiting (and not in traffic), turn off your engine and restart only when you're ready to go.

- Remember, your vehicle does not require extended warm-up. After the engine has started, allow the engine to run for 10 to 20 seconds prior to placing the vehicle in gear. In very cold weather, however, give your engine a slightly longer warm-up period.
- Don't "lug" or "over-rev" the engine. Lugging is driving too slowly in too high a gear resulting engine bucking. If this happens, shift to a lower gear. Over-revving is racing the engine beyond its safe limit. This can be avoided by shifting at the recommended speeds.
- Use your air conditioning sparingly. The air conditioning system is operated by engine power so your fuel economy is reduced when you use it.
- Open windows at high speeds can reduce fuel economy.
- Fuel economy is less in crosswinds and headwinds. To help offset some of this loss, slow down when driving in these conditions.

Keeping a vehicle in good operating condition is important both for economy and safety. Therefore, have an authorized HYUNDAI dealer perform scheduled inspections and maintenance.

 **WARNING - Engine off during motion**

Never turn the engine off to coast down hills or anytime the vehicle is in motion. The power steering and power brakes will not function properly without the engine running. Instead, keep the engine on and downshift to an appropriate gear for engine braking effect. In addition, turning off the ignition while driving could engage the steering wheel lock resulting in loss of vehicle steering which could cause serious injury or death.

SPECIAL DRIVING CONDITIONS

Hazardous driving conditions

When hazardous driving conditions are encountered such as water, snow, ice, mud, sand, or similar hazards, follow these suggestions:

- Drive cautiously and allow extra distance for braking.
- Avoid sudden braking or steering.
- When braking with non-ABS brakes pump the brake pedal with a light up-and-down motion until the vehicle is stopped.

WARNING - ABS

Do not pump the brake pedal on a vehicle equipped with ABS.

- If stalled in snow, mud, or sand, use second gear. Accelerate slowly to avoid spinning the drive wheels.
- Use sand, rock salt, tire chains, or other non-slip material under the drive wheels to provide traction when stalled in ice, snow, or mud.

 **WARNING - Downshifting**
Downshifting with an automatic transaxle, while driving on slippery surfaces can cause an accident. The sudden change in tire speed could cause the tires to skid. Be careful when downshifting on slippery surfaces.

Reducing the risk of a rollover

This multi-purpose passenger vehicle is defined as a Sports Utility Vehicle (SUV). SUV's have higher ground clearance and a narrower track to make them capable of performing in a wide variety of off-road applications. Specific design characteristics give them a higher center of gravity than ordinary vehicles. An advantage of the higher ground clearance is a better view of the road, which allows you to anticipate problems. They are not designed for cornering at the same speeds as conventional passenger vehicles, any more than low-slung sports vehicles are designed to perform satisfactorily in off-road conditions. Due to this risk, driver and passengers are strongly recommended to buckle their seat belts. In a rollover crash, an unbelted person is more likely to die than a person wearing a seat belt. There are steps that a driver can make to reduce the risk of a rollover.

If at all possible, avoid sharp turns or abrupt maneuvers, do not load your roof rack with heavy cargo, and never modify your vehicle in any way.

⚠ WARNING - Rollover

As with other Sports Utility Vehicle (SUV), failure to operate this vehicle correctly may result in loss of control, an accident or vehicle rollover.

- Utility vehicles have a significantly higher rollover rate than other types of vehicles.
- Specific design characteristics (higher ground clearance, narrower track, etc.) give this vehicle a higher center of gravity than ordinary vehicles.
- A SUV is not designed for cornering at the same speeds as conventional vehicles.
- Avoid sharp turns or abrupt maneuvers.
- In a rollover crash, an unbelted person is significantly more likely to die than a person wearing a seat belt. Make sure everyone in the vehicle is properly buckled up.

⚠ WARNING

Your vehicle is equipped with tires designed to provide safe ride and handling capability. Do not use a size and type of tire and wheel that is different from the one that is originally installed on your vehicle. It can affect the safety and performance of your vehicle, which could lead to steering failure or rollover and serious injury. When replacing the tires, be sure to equip all four tires with the tire and wheel of the same size, type, tread, brand and load-carrying capacity. If you nevertheless decide to equip your vehicle with any tire/wheel combination not recommended by HYUNDAI for off road driving, you should not use these tires for highway driving.

Rocking the vehicle

If it is necessary to rock the vehicle to free it from snow, sand, or mud, first turn the steering wheel right and left to clear the area around your front wheels. Then, shift back and forth between R (Reverse) and any forward gear in vehicles equipped with an automatic transaxle. Do not race the engine, and spin the wheels as little as possible. If you are still stuck after a few tries, have the vehicle pulled out by a tow vehicle to avoid engine overheating and possible damage to the transaxle.

⚠ CAUTION

Prolonged rocking may cause engine over-heating, transaxle damage or failure, and tire damage.

⚠ WARNING - Spinning tires

Do not spin the wheels, especially at speeds more than 35 mph (56 km/h). Spinning the wheels at high speeds when the vehicle is stationary could cause a tire to overheat which could result in tire damage that may injure bystanders.

*** NOTICE**

The ESC system should be turned OFF prior to rocking the vehicle.

⚠ WARNING

If your vehicle becomes stuck in snow, mud, sand, etc., then you may attempt to rock the vehicle free by moving it forward and backward. Do not attempt this procedure if people or objects are anywhere near the vehicle. During the rocking operation the vehicle may suddenly move forward or backward as it becomes unstuck, causing injury or damage to nearby people or objects.

Smooth cornering



Avoid braking or gear changing in corners, especially when roads are wet. Ideally, corners should always be taken under gentle acceleration. If you follow these suggestions, tire wear will be held to a minimum.

Driving at night



Because night driving presents more hazards than driving in the daylight, here are some important tips to remember:

- Slow down and keep more distance between you and other vehicles, as it may be more difficult to see at night, especially in areas where there may not be any street lights.
- Adjust your mirrors to reduce the glare from other driver's headlights.

- Keep your headlights clean and properly aimed on vehicles not equipped with the automatic headlight aiming feature. Dirty or improperly aimed headlights will make it much more difficult to see at night.
- Avoid staring directly at the headlights of oncoming vehicles. You could be temporarily blinded, and it will take several seconds for your eyes to readjust to the darkness.

Driving in the rain



Rain and wet roads can make driving dangerous, especially if you're not prepared for the slick pavement. Here are a few things to consider when driving in the rain:

- A heavy rainfall will make it harder to see and will increase the distance needed to stop your vehicle, so slow down.
- Keep your windshield wiping equipment in good shape. Replace your windshield wiper blades when they show signs of streaking or missing areas on the windshield.

- If your tires are not in good condition, making a quick stop on wet pavement can cause a skid and possibly lead to an accident. Be sure your tires are in good shape.
- Turn on your headlights to make it easier for others to see you.
- Driving too fast through large puddles can affect your brakes. If you must go through puddles, try to drive through them slowly.
- If you believe you may have gotten your brakes wet, apply them lightly while driving until normal braking operation returns.

Driving in flooded areas

Avoid driving through flooded areas unless you are sure the water is no higher than the bottom of the wheel hub. Drive through any water slowly. Allow adequate stopping distance because brake performance may be affected.

After driving through water, dry the brakes by gently applying them several times while the vehicle is moving slowly.

Driving off-road

Drive carefully off-road because your vehicle may be damaged by rocks or roots of trees. Become familiar with the off-road conditions where you are going to drive before you begin driving.

Highway driving

Tires:

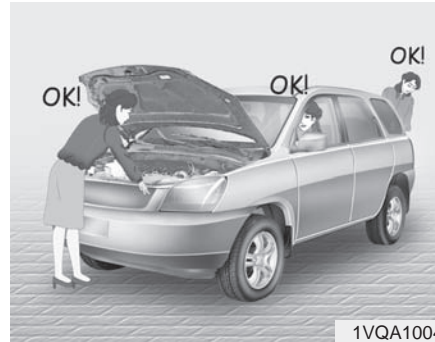

Adjust the tire inflation pressures to specification. Low tire inflation pressures will result in overheating and possible failure of the tires.

Avoid using worn or damaged tires which may result in reduced traction or tire failure.

* NOTICE

Never exceed the maximum tire inflation pressure shown on the tires.

⚠ WARNING

- **Underinflated or overinflated tires can cause poor handling, loss of vehicle control, and sudden tire failure leading to accidents, injuries, and even death. Always check the tires for proper inflation before driving. For proper tire pressures, refer to section 8, "Tires and wheels".**
- **Driving on tires with no or insufficient tread is dangerous. Worn-out tires can result in loss of vehicle control, collisions, injury, and even death. Worn-out tires should be replaced as soon as possible and should never be used for driving. Always check the tire tread before driving your vehicle. For further information and tread limits, refer to section 7, "Tires and wheels".**

Fuel, engine coolant and engine oil:

High speed travel consumes more fuel than urban motoring. Do not forget to check both engine coolant and engine oil.

Drive belt:

A loose or damaged drive belt may result in overheating of the engine.

WINTER DRIVING



1VQA3005

Severe weather conditions in the winter result in greater wear and other problems. To minimize the problems of winter driving, you should follow these suggestions:

Snowy or Icy conditions

To drive your vehicle in deep snow, it may be necessary to use snow tires or to install tire chains on your tires. If snow tires are needed, it is necessary to select tires equivalent in size and type of the original equipment tires. Failure to do so may adversely affect the safety and handling of your vehicle. Furthermore, speeding, rapid acceleration, sudden brake applications, and sharp turns are potentially very hazardous practices.

During deceleration, use engine braking to the fullest extent. Sudden brake applications on snowy or icy roads may cause skids to occur. You need to keep sufficient distance between the vehicle in operation in front and your vehicle. Also, apply the brake gently. It should be noted that installing tire chains on the tire will provide a greater driving force, but will not prevent side skids.

* NOTICE

Tire chains are not legal in all states. Check the state laws before fitting tire chains.

Snow tires

If you mount snow tires on your vehicle, make sure they are radial tires of the same size and load range as the original tires. Mount snow tires on all four wheels to balance your vehicle's handling in all weather conditions. Keep in mind that the traction provided by snow tires on dry roads may not be as high as your vehicle's original equipment tires. You should drive cautiously even when the roads are clear. Check with the tire dealer for maximum speed recommendations.

⚠ WARNING - Snow tire size
Snow tires should be equivalent in size and type to the vehicle's standard tires. Otherwise, the safety and handling of your vehicle may be adversely affected.

Do not install studded tires without first checking local, state and municipal regulations for possible restrictions against their use.

Tire chains



Since the sidewalls of radial tires are thinner, they can be damaged by mounting some types of snow chains on them. Therefore, the use of snow tires is recommended instead of snow chains. Do not mount tire chains on vehicles equipped with aluminum wheels; snow chains may cause damage to the wheels. If snow chains must be used, use wire-type chains with a thickness of less than 0.59 in (15 mm). Damage to your vehicle caused by improper snow chain use is not covered by your vehicle manufacturer's warranty.

When using tire chains, attach them to the drive wheels as follows.

2WD : Front wheels

AWD : All four wheels

If a full set of chains is not available for an AWD vehicle, chains may be installed on the front wheels only.

CAUTION

- ***Make sure the snow chains are the correct size and type for your tires. Incorrect snow chains can cause damage to the vehicle body and suspension and may not be covered by your vehicle manufacturer warranty. Also, the snow chain connecting hooks may be damaged from contacting vehicle components causing the snow chains to come loose from the tire. Make sure the snow chains are SAE class "S" certified.***
- ***Always check chain installation for proper mounting after driving approximately 0.3 to 0.6 miles (0.5 to 1 km) to ensure safe mounting. Retighten or remount the chains if they are loose.***

Chain installation

When installing chains, follow the manufacturer's instructions and mount them as tightly as you can. Drive slowly with chains installed. If you hear the chains contacting the body or chassis, stop and tighten them. If they still make contact, slow down until it stops. Remove the chains as soon as you begin driving on cleared roads.

WARNING - Mounting chains

When mounting snow chains, park the vehicle on level ground away from traffic. Turn on the vehicle Hazard Warning flashers and place a triangular emergency warning device behind the vehicle if available. Always place the vehicle in P (Park), apply the parking brake and turn off the engine before installing snow chains.

WARNING - Tire chains

- **The use of chains may adversely affect vehicle handling.**
- **Do not exceed 20 mph (30 km/h) or the chain manufacturer's recommended speed limit, whichever is lower.**
- **Drive carefully and avoid bumps, holes, sharp turns, and other road hazards, which may cause the vehicle to bounce.**
- **Avoid sharp turns or locked-wheel braking.**

CAUTION

- *Chains that are the wrong size or improperly installed can damage your vehicle's brake lines, suspension, body and wheels.*
- *Stop driving and retighten the chains any time you hear them hitting the vehicle.*

Use high quality ethylene glycol coolant

Your vehicle is delivered with high quality ethylene glycol coolant in the cooling system. It is the only type of coolant that should be used because it helps prevent corrosion in the cooling system, lubricates the water pump and prevents freezing. Be sure to replace or replenish your coolant in accordance with the maintenance schedule in section 7. Before winter, have your coolant tested to assure that its freezing point is sufficient for the temperatures anticipated during the winter.

Check battery and cables

Winter puts additional burdens on the battery system. Visually inspect the battery and cables as described in section 7. The level of charge in your battery can be checked by an authorized HYUNDAI dealer or a service station.

Change to "winter weight" oil if necessary

In some climates it is recommended that a lower viscosity "winter weight" oil be used during cold weather. See section 8 for recommendations. If you aren't sure what weight oil you should use, consult an authorized HYUNDAI dealer.

Check spark plugs and ignition system

Inspect your spark plugs as described in section 7 and replace them if necessary. Also check all ignition wiring and components to be sure they are not cracked, worn or damaged in any way.

To keep locks from freezing

To keep the locks from freezing, squirt an approved de-icer fluid or glycerine into the key opening. If a lock is covered with ice, squirt it with an approved de-icing fluid to remove the ice. If the lock is frozen internally, you may be able to thaw it out by using a heated key. Handle the heated key with care to avoid injury.

Use approved window washer anti-freeze in system

To keep the water in the window washer system from freezing, add an approved window washer anti-freeze solution in accordance with instructions on the container. Window washer anti-freeze is available from an authorized HYUNDAI dealer and most auto parts outlets. Do not use engine coolant or other types of anti-freeze as these may damage the paint finish.

Don't let your parking brake freeze

Under some conditions your parking brake can freeze in the engaged position. This is most likely to happen when there is an accumulation of snow or ice around or near the rear brakes or if the brakes are wet. If there is a risk the parking brake may freeze, apply it only temporarily while you put the shift lever in P (automatic transaxle) and block the rear wheels so the vehicle cannot roll. Then release the parking brake.

Don't let ice and snow accumulate underneath

Under some conditions, snow and ice can build up under the fenders and interfere with the steering. When driving in severe winter conditions where this may happen, you should periodically check underneath the vehicle to be sure the movement of the front wheels and the steering components is not obstructed.

Carry emergency equipment

Depending on the severity of the weather, you should carry appropriate emergency equipment. Some of the items you may want to carry include tire chains, tow straps or chains, flashlight, emergency flares, sand, a shovel, jumper cables, a window scraper, gloves, ground cloth, coveralls or a blanket, etc.

Don't place foreign objects or materials in the engine compartment

Placement of foreign objects or materials which prevent cooling of the engine, in the engine compartment, may cause a failure or combustion. The manufacturer is not responsible for the damage caused by such placement.

TRAILER TOWING

If you are considering towing with your vehicle, you should first check with your state's Department of Motor Vehicles to determine their legal requirements.

Since laws vary the requirements for towing trailers, cars, or other types of vehicles or apparatus may differ. Ask an authorized HYUNDAI dealer for further details before towing.

WARNING - Towing a trailer

If you don't use the correct equipment and/or drive improperly, you can lose control when you pull a trailer. For example, if the trailer is too heavy, the brakes may not work well - or even at all. You and your passengers could be seriously or fatally injured. Pull a trailer only if you have followed all the steps in this section.

WARNING - Weight limits

Before towing, make sure the total trailer weight, GCW (gross combination weight), GVW (gross vehicle weight), GAW (gross axle weight) and trailer tongue load are all within the limits.

CAUTION

Pulling a trailer improperly can damage your vehicle and result in costly repairs not covered by your warranty. To pull a trailer correctly, follow the advice in this section.

Your vehicle can tow a trailer. To identify what the vehicle trailering capacity is for your vehicle, you should read the information in "Weight of the trailer" that appears later in this section.

Remember that trailering is different than just driving your vehicle by itself. Trailering means changes in handling, durability, and fuel economy. Successful, safe trailering requires correct equipment, and it has to be used properly.

This section contains many time-tested, important trailering tips and safety rules. Many of these are important for your safety and that of your passengers. Please read this section carefully before you pull a trailer.

Load-pulling components such as the engine, transaxle, wheel assemblies, and tires are forced to work harder against the load of the added weight. The engine is required to operate at relatively higher speeds and under greater loads. This additional burden generates extra heat. The trailer also considerably adds wind resistance, increasing the pulling requirements.

Hitches

It's important to have the correct hitch equipment. Crosswinds, large trucks going by, and rough roads are a few reasons why you'll need the right hitch. Here are some rules to follow:

- If you have to make any holes in the body of your vehicle when you install a trailer hitch, be sure to seal the holes later when you remove the hitch.
If not sealed, deadly carbon monoxide (CO) from your exhaust can get into your vehicle, as well as dirt and water.
- The bumpers on your vehicle are not intended for hitches. Do not attach rental hitches or other bumper-type hitches to them. Use only a frame-mounted hitch that does not attach to the bumper.
- A HYUNDAI trailer hitch accessory is available at an authorized HYUNDAI dealer.

Safety chains

You should always attach chains between your vehicle and your trailer. Cross the safety chains under the tongue of the trailer so that the tongue will not drop to the road if it becomes separated from the hitch.

Instructions about safety chains may be provided by the hitch manufacturer or by the trailer manufacturer. Follow the manufacturer's recommendation for attaching safety chains. Always leave just enough slack so you can turn with your trailer. And, never allow safety chains to drag on the ground.

Trailer brakes

If your trailer is equipped with a braking system, make sure it conforms to federal and/or local regulations and that it is properly installed and operating correctly.

If your trailer weight exceeds the maximum allowed weight without trailer brakes, then the trailer will also require its own brakes as well. Be sure to read and follow the instructions for the trailer brakes so you'll be able to install, adjust and maintain them properly.

- Don't tap into or modify your vehicle's brake system.

⚠ WARNING - Trailer brakes
Do not use a trailer with its own brakes unless you are absolutely certain that you have properly set up the brake system. This is not a task for amateurs. Use an experienced, competent trailer shop for this work.

Driving with a trailer

Towing a trailer requires a certain amount of experience. Before setting out for the open road, you must get to know your trailer. Acquaint yourself with the feel of handling and braking with the added weight of the trailer. And always keep in mind that the vehicle you are driving is now a good deal longer and not nearly so responsive as your vehicle is by itself.

Before you start, check the trailer hitch and platform, safety chains, electrical connector(s), lights, tires and mirror adjustment. If the trailer has electric brakes, start your vehicle and trailer moving and then apply the trailer brake controller by hand to be sure the brakes are working. This lets you check your electrical connection at the same time.

During your trip, check occasionally to be sure that the load is secure, and that the lights and any trailer brakes are still working.

Following distance

Stay at least twice as far behind the vehicle ahead as you would when driving your vehicle without a trailer. This can help you avoid situations that require heavy braking and sudden turns.

Passing

You'll need more passing distance up ahead when you're towing a trailer. And, because of the increased vehicle length, you'll need to go much farther beyond the passed vehicle before you can return to your lane. Due to the added load to the engine when going uphill the vehicle may also take longer to pass than it would on flat ground.

Backing up

Hold the bottom of the steering wheel with one hand. Then, to move the trailer to the left, just move your hand to the left. To move the trailer to the right, move your hand to the right. Always back up slowly and, if possible, have someone guide you.

Making turns

When you're turning with a trailer, make wider turns than normal. Do this so your trailer won't strike soft shoulders, curbs, road signs, trees, or other objects near the edge of the road. Avoid jerky or sudden maneuvers. Signal well in advance before turning or lane changes.

Turn signals when towing a trailer

When you tow a trailer, your vehicle has to have a different turn signal flasher and extra wiring. The green arrows on your instrument panel will flash whenever you signal a turn or lane change. Properly connected, the trailer lights will also flash to alert other drivers you're about to turn, change lanes, or stop.

When towing a trailer, the green arrows on your instrument panel will flash for turns even if the bulbs on the trailer are burned out. Thus, you may think drivers behind you are seeing your signals when, in fact, they are not. It's important to check occasionally to be sure the trailer bulbs are still working. You must also check the lights every time you disconnect and then reconnect the wires.

Do not connect a trailer lighting system directly to your vehicle's lighting system. Use only an approved trailer wiring harness.

An authorized HYUNDAI dealer can assist you in installing the wiring harness.

⚠ WARNING

Failure to use an approved trailer wiring harness could result in damage to the vehicle electrical system and/or personal injury.

Driving on grades

Reduce speed and shift to a lower gear before you start down a long or steep downgrade. If you don't shift down, you might have to use your brakes so much that they would get hot and no longer operate efficiently.

On a long uphill grade, shift down and reduce your speed to around 45 mph (70 km/h) to reduce the possibility of engine and transaxle overheating.

Operating your vehicle in D (Drive) when towing a trailer will minimize heat build up and extend the life of your transaxle.

 **CAUTION**

- ***When towing a trailer on steep grades (in excess of 6%) pay close attention to the engine coolant temperature gauge to ensure the engine does not overheat.***

If the needle of the coolant temperature gauge moves across the dial towards “H” (HOT), pull over and stop as soon as it is safe to do so, and allow the engine to idle until it cools down. You may proceed once the engine has cooled sufficiently.

- ***Use caution when driving on an uphill grade to reduce the possibility of engine and transaxle overheating.***

Parking on hills

Generally, if you have a trailer attached to your vehicle, you should not park your vehicle on a hill. People can be seriously or fatally injured, and both your vehicle and the trailer can be damaged if they unexpectedly roll down hill.

 **WARNING - Parking on a hill**

Parking your vehicle on a hill with a trailer attached could cause serious injury or death, should the trailer break loose or the brake stops working.

However, if you ever have to park your trailer on a hill, here's how to do it:

1. Pull the vehicle into the parking space. Turn the steering wheel in the direction of the curb (right if headed down hill, left if headed up hill).
2. If the vehicle has an automatic transaxle, place the car in P (Park).
3. Set the parking brake and shut off the vehicle.
4. Place chocks under the trailer wheels on the down hill side of the wheels.
5. Start the vehicle, hold the brakes, shift to neutral, release the parking brake and slowly release the brakes until the trailer chocks absorb the load.
6. Reapply the brakes, reapply the parking brake and shift the vehicle to P (Park) for automatic transaxle.
7. Shut off the vehicle and release the vehicle brakes but leave the parking brake set.

⚠ WARNING - Parking brake

It can be dangerous to get out of your vehicle if the parking brake is not firmly set.

If you have left the engine running, the vehicle can move suddenly. You or others could be seriously or fatally injured.

When you are ready to leave after parking on a hill

1. With the automatic transaxle in P (Park), apply your brakes and hold the brake pedal down while you:
 - Start your engine;
 - Shift into gear; and
 - Release the parking brake.
2. Slowly remove your foot from the brake pedal.
3. Drive slowly until the trailer is clear of the chocks.
4. Stop and have someone pick up and store the chocks.

Maintenance when trailer towing

Your vehicle will need service more often when you regularly pull a trailer. Important items to pay particular attention to include engine oil, automatic transaxle fluid, axle lubricant and cooling system fluid. Brake condition is another important item to frequently check. Each item is covered in this manual, and the Index will help you find them quickly. If you're trailering, it's a good idea to review these sections before you start your trip.

Don't forget to also maintain your trailer and hitch. Follow the maintenance schedule that accompanied your trailer and check it periodically. Preferably, conduct the check at the start of each day's driving. Most importantly, all hitch nuts and bolts should be tight.

⚠ CAUTION

- *Due to higher load during trailer usage, overheating might occur in hot days or during uphill driving. If the coolant gauge indicates overheating, switch off the A/C and stop the vehicle in a safe area to cool down the engine.*
- *When towing check transaxle fluid more frequently.*

If you do decide to pull a trailer

Here are some important points if you decide to pull a trailer:

- Consider using a sway control. You can ask a hitch dealer about sway control.
- Do not do any towing with your car during its first 1,200 miles (2,000 km) in order to allow the engine to properly break in. Failure to heed this caution may result in serious engine or transaxle damage.
- When towing a trailer, be sure to consult an authorized HYUNDAI dealer for further information on additional requirements such as a towing kit, etc.
- Always drive your vehicle at a moderate speed (less than 60 mph (100 km/h)).
- On a long uphill grade, do not exceed 45 mph (70 km/h) or the posted towing speed limit, whichever is lower.
- The chart contains important considerations that have to do with weight:

Item		Engine	
		Gasoline Engine	
		3.3 GDI	
Maximum trailer weight lbs. (kg)	Without brake System		1653 lbs (750 kg)
	With brake System	Without trailer package	2000 lbs (907 kg)
		With trailer package	5000 lbs (2267 kg)
Maximum permissible static vertical load on the coupling device lbs. (kg)			500 lbs (226 kg)

Weight of the trailer

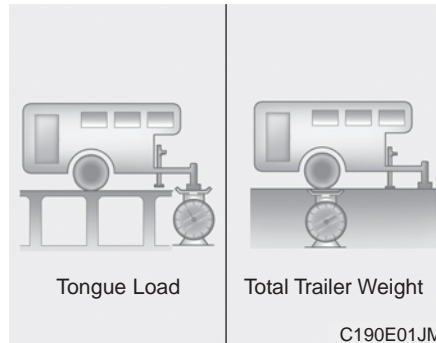

What is the maximum safe weight of a trailer? It should never weigh more than the maximum trailer weight with trailer brakes. But even that can be too heavy.

It depends on how you plan to use your trailer. For example, speed, altitude, road grades, outside temperature and how often your vehicle is used to pull a trailer are all important. The ideal trailer weight can also depend on any special equipment that you have on your vehicle.

Weight of the trailer tongue

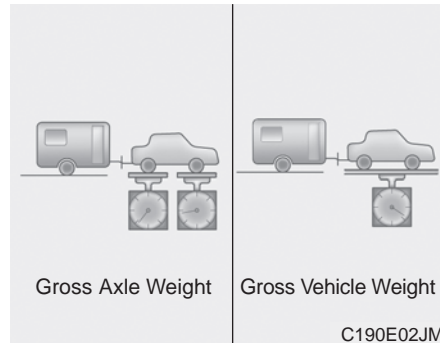

The tongue load of any trailer is an important weight to measure because it affects the total gross vehicle weight (GVW) of your vehicle. This weight includes the curb weight of the vehicle, any cargo you may carry in it, and the people who will be riding in the vehicle. And if you will tow a trailer, you must add the tongue load to the GVW because your vehicle will also be carrying that weight.

The trailer tongue should weigh a maximum of 10% of the total loaded trailer weight, within the limits of the maximum permissible trailer tongue load. After you've loaded your trailer, weigh the trailer and then the tongue, separately, to see if the weights are proper. If they aren't, you may be able to correct them simply by moving some items around in the trailer.

⚠ WARNING - Trailer

- Never load a trailer with more weight in the rear than in the front. The front should be loaded with approximately 60% of the total trailer load; the rear should be loaded with approximately 40% of the total trailer load.
- Never exceed the maximum weight limits of the trailer or trailer towing equipment. Improper loading can result in damage to your vehicle and/or personal injury. Check weights and loading at a commercial scale or highway patrol office equipped with scales.
- An improperly loaded trailer can cause loss of vehicle control.

VEHICLE LOAD LIMIT

Tire and loading information label

TIRE AND LOADING INFORMATION RENSEIGNEMENTS SUR LES PNEUS ET LE CHARGEMENT			
SEATING CAPACITY NOMBRE DE PLACES		TOTAL 6	FRONT AVANT 2 REAR ARRIÈRE 4
The combined weight of occupants and cargo should never exceed 504 kg or 1111 lbs. Le poids total des occupants et du chargement ne doit jamais dépasser 504 kg ou 1111 lb.			
TIRE PNEU	SIZE DIMENSIONS	COLD TIRE PRESSURE PRESSION DES PNEUS À FROID	SEE OWNER'S MANUAL FOR ADDITIONAL INFORMATION VOIR LE MANUEL DE L'USAGER POUR PLUS DE RENSEIGNEMENTS
FRONT AVANT	235/60R18	230kPa, 33psi	
REAR ARRIÈRE	235/60R18	230kPa, 33psi	
SPARE DE SECOURS	T165/90R17	420kPa, 60psi	

ONCNMC3200

TIRE AND LOADING INFORMATION RENSEIGNEMENTS SUR LES PNEUS ET LE CHARGEMENT			
SEATING CAPACITY NOMBRE DE PLACES		TOTAL 6	FRONT AVANT 2 REAR ARRIÈRE 4
The combined weight of occupants and cargo should never exceed 504 kg or 1111 lbs. Le poids total des occupants et du chargement ne doit jamais dépasser 504 kg ou 1111 lb.			
TIRE PNEU	SIZE DIMENSIONS	COLD TIRE PRESSURE PRESSION DES PNEUS À FROID	SEE OWNER'S MANUAL FOR ADDITIONAL INFORMATION VOIR LE MANUEL DE L'USAGER POUR PLUS DE RENSEIGNEMENTS
FRONT AVANT	P235/55R19	230kPa, 33psi	
REAR ARRIÈRE	P235/55R19	230kPa, 33psi	
SPARE DE SECOURS	T165/90R17	420kPa, 60psi	

ONCNMC3202

TIRE AND LOADING INFORMATION RENSEIGNEMENTS SUR LES PNEUS ET LE CHARGEMENT			
SEATING CAPACITY NOMBRE DE PLACES		TOTAL 7	FRONT AVANT 2 REAR ARRIÈRE 5
The combined weight of occupants and cargo should never exceed 568 kg or 1250 lbs. Le poids total des occupants et du chargement ne doit jamais dépasser 568 kg ou 1250 lb.			
TIRE PNEU	SIZE DIMENSIONS	COLD TIRE PRESSURE PRESSION DES PNEUS À FROID	SEE OWNER'S MANUAL FOR ADDITIONAL INFORMATION VOIR LE MANUEL DE L'USAGER POUR PLUS DE RENSEIGNEMENTS
FRONT AVANT	235/60R18	230kPa, 33psi	
REAR ARRIÈRE	235/60R18	230kPa, 33psi	
SPARE DE SECOURS	T165/90R17	420kPa, 60psi	

ONCNMC3201

TIRE AND LOADING INFORMATION RENSEIGNEMENTS SUR LES PNEUS ET LE CHARGEMENT			
SEATING CAPACITY NOMBRE DE PLACES		TOTAL 7	FRONT AVANT 2 REAR ARRIÈRE 5
The combined weight of occupants and cargo should never exceed 568 kg or 1250 lbs. Le poids total des occupants et du chargement ne doit jamais dépasser 568 kg ou 1250 lb.			
TIRE PNEU	SIZE DIMENSIONS	COLD TIRE PRESSURE PRESSION DES PNEUS À FROID	SEE OWNER'S MANUAL FOR ADDITIONAL INFORMATION VOIR LE MANUEL DE L'USAGER POUR PLUS DE RENSEIGNEMENTS
FRONT AVANT	P235/55R19	230kPa, 33psi	
REAR ARRIÈRE	P235/55R19	230kPa, 33psi	
SPARE DE SECOURS	T165/90R17	420kPa, 60psi	

ONCNMC3203

The label located on the driver's door sill gives the original tire size, cold tire pressures recommended for your vehicle, the number of people that can be in your vehicle and vehicle capacity weight.

Vehicle capacity weight:

- 6 persons : 1111 lbs. (504 kg)
- 7 persons : 1296 lbs. (588 kg)

Vehicle capacity weight is the maximum combined weight of occupants and cargo. If your vehicle is equipped with a trailer, the combined weight includes the tongue load.

Seating capacity:

- Total : 6 or 7 persons
- (Front seat : 2 persons,
Rear seat : 4 or 5 persons)

Seating capacity is the maximum number of occupants including a driver, your vehicle may carry. However, the seating capacity may be reduced based upon the weight of all of the occupants, and the weight of the cargo being carried or towed.

Do not overload the vehicle as there is a limit to the total weight, or load limit including occupants and cargo, the vehicle can carry.

Towing capacity:

Without trailer brakes:

1653 lbs (750 kg)

With trailer brakes:

2000 lbs (907 kg)

Towing capacity is the maximum trailer weight including its cargo weight, your vehicle can tow.

Cargo capacity:

The cargo capacity of your vehicle will increase or decrease depending on the weight and the number of occupants and the tongue load, if your vehicle is equipped with a trailer.

Steps For Determining Correct Load Limit

1. Locate the statement "The combined weight of occupants and cargo should never exceed XXX kg or XXX lbs." on your vehicle's placard.
2. Determine the combined weight of the driver and passengers that will be riding in your vehicle.
3. Subtract the combined weight of the driver and passengers from XXX kg or XXX lbs.
4. The resulting figure equals the available amount of cargo and luggage load capacity. For example, if the "XXX" amount equals 1400 lbs. and there will be five 150 lbs. passengers in your vehicle, the amount of available cargo and luggage load capacity is 650 lb (1400-750 (5 x 150) = 650 lbs.)
5. Determine the combined weight of luggage and cargo being loaded on the vehicle. That weight may not safely exceed the available cargo and luggage load capacity calculated in Step 4.
6. If your vehicle will be towing a trailer, load from your trailer will be transferred to your vehicle. Consult this manual to determine how this reduces the available cargo and luggage load capacity of your vehicle.

Example 1



C190F01JM

Item	Description	Total
A	Vehicle Capacity Weight	1400 lbs (635 kg)
B	Subtract Occupant Weight 150 lbs (68 kg) × 2	300 lbs (136 kg)
C	Available Cargo and Luggage weight	1100 lbs (499 kg)

Example 2



C190F02JM

Item	Description	Total
A	Vehicle Capacity Weight	1400 lbs (635 kg)
B	Subtract Occupant Weight 150 lbs (68 kg) × 5	750 lbs (340 kg)
C	Available Cargo and Luggage weight	650 lbs (295 kg)

Example 3

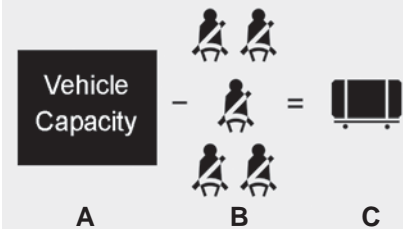

C190F03JM

Item	Description	Total
A	Vehicle Capacity Weight	1400 lbs (635 kg)
B	Subtract Occupant Weight 172 lbs (78 kg) × 3	516 lbs (234 kg)
C	Available Cargo and Luggage weight	884 lbs (400 kg)

Refer to your vehicle's tire and loading information label for specific information about your vehicle's capacity weight and seating positions. The combined weight of the driver, passengers and cargo should never exceed your vehicle's capacity weight.

Certification label

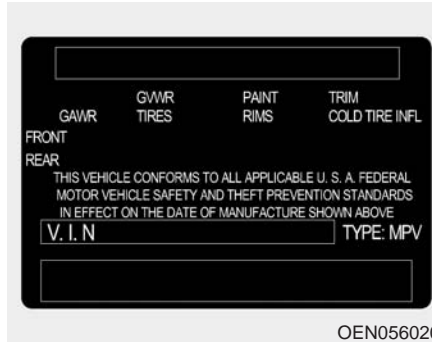

The certification label is located on the driver's door sill at the center pillar.

This label shows the maximum allowable weight of the fully loaded vehicle. This is called the GVWR (Gross Vehicle Weight Rating). The GVWR includes the weight of the vehicle, all occupants, fuel and cargo.

This label also tells you the maximum weight that can be supported by the front and rear axles, called Gross Axle Weight Rating (GAWR).

To find out the actual loads on your front and rear axles, you need to go to a weigh station and weigh your vehicle. Your dealer can help you with this. Be sure to spread out your load equally on both sides of the centerline.

⚠ WARNING - Over loading

- **Never exceed the GVWR for your vehicle, the GAWR for either the front or rear axle and vehicle capacity weight. Exceeding these ratings can cause an accident or vehicle damage. You can calculate the weight of your load by weighing the items (or people) before putting them in the vehicle. Be careful not to overload your vehicle.**

(Continued)

(Continued)

- **Do not load your vehicle any heavier than the GVWR, either the maximum front or rear GAWR and vehicle capacity weight. If you do, parts, including tires on your vehicle can break, and it can change the way your vehicle handles and braking ability. This could cause you to lose control and crash. Also, overloading can shorten the life of your vehicle.**

The label will help you decide how much cargo and installed equipment your vehicle can carry.

If you carry items inside your vehicle - like suitcases, tools, packages, or anything else - they are moving as fast as the vehicle. If you have to stop or turn quickly, or if there is a crash, the items will keep going and can cause an injury if they strike the driver or a passenger.

⚠ WARNING

- Overloading your vehicle can cause heat buildup in your vehicle's tires and possible tire failure that could lead to a crash.
- Overloading your vehicle can cause increased stopping distances that could lead to a crash.
- A crash resulting from poor handling vehicle damage, tire failure, or increased stopping distances could result in serious injury or death.

⚠ CAUTION

Overloading your vehicle may cause damage. Repairs would not be covered by your warranty. Do not overload your vehicle.

⚠ WARNING - Loose cargo

Items you carry inside your vehicle can strike and injure occupants in a sudden stop or turn, or in a crash.

- Put items in the cargo area of your vehicle. Try to spread the weight evenly.
- Never stack items, like suitcases, inside the vehicle above the tops of the seats.
- Do not leave an unsecured child restraint in your vehicle.
- When you carry something inside the vehicle, secure it.
- Do not drive with a seat folded down unless necessary.

VEHICLE WEIGHT

This section will guide you in the proper loading of your vehicle and/or trailer, to keep your loaded vehicle weight within its design rating capability, with or without a trailer. Properly loading your vehicle will provide maximum return of the vehicle design performance. Before loading your vehicle, familiarize yourself with the following terms for determining your vehicle's weight ratings, with or without a trailer, from the vehicle's specifications and the compliance label:

Base curb weight

This is the weight of the vehicle including a full tank of fuel and all standard equipment. It does not include passengers, cargo, or optional equipment.

Vehicle curb weight

This is the weight of your new vehicle when you picked it up from your dealer plus any aftermarket equipment.

Cargo weight

This figure includes all weight added to the Base Curb Weight, including cargo and optional equipment.

GAW (Gross axle weight)

This is the total weight placed on each axle (front and rear) - including vehicle curb weight and all payload.

GAWR (Gross axle weight rating)

This is the maximum allowable weight that can be carried by a single axle (front or rear). These numbers are shown on the compliance label.

The total load on each axle must never exceed its GAWR.

GVW (Gross vehicle weight)

This is the Base Curb Weight plus actual Cargo Weight plus passengers.

GVWR (Gross vehicle weight rating)

This is the maximum allowable weight of the fully loaded vehicle (including all options, equipment, passengers and cargo). The GVWR is shown on the certification label.

What to do in an emergency

Road warning	6-2	If you have a flat tire	6-20
• Hazard warning flasher	6-2	• Jack and tools	6-20
In case of an emergency while driving.	6-3	• Removing and storing the spare tire	6-21
• If the engine stalls at a crossroad or crossing	6-3	• Changing tires	6-23
• If you have a flat tire while driving	6-3	• Use of temporary compact spare tire	6-27
• If engine stalls while driving	6-3	• Jack label	6-29
If the engine does not start	6-4	Towing	6-30
• If engine doesn't turn over or turns over slowly	6-4	• Towing service	6-30
• If engine turns over normally but does not start	6-4	• Removable towing hook	6-31
Emergency starting	6-5	• Emergency towing	6-32
• Jump starting	6-5		
• Push-starting	6-7		
If the engine overheats.	6-8		
Tire Pressure Monitoring System (TPMS)			
- Type A	6-9		
• Low tire pressure indicator	6-10		
• TPMS malfunction indicator	6-11		
• Changing a tire with TPMS	6-12		
Tire Pressure Monitoring System (TPMS)			
- Type B	6-14		
• Check tire pressure	6-14		
• Tire pressure monitoring system	6-15		
• TPMS malfunction indicator	6-17		
• Changing a tire with TPMS	6-18		

ROAD WARNING

Hazard warning flasher

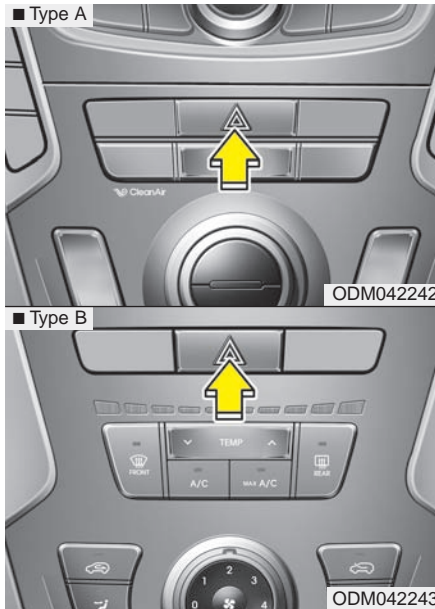

The hazard warning flasher serves as a warning to other drivers to exercise extreme caution when approaching, overtaking, or passing your vehicle.

It should be used whenever emergency repairs are being made or when the vehicle is stopped near the edge of a roadway.

Depress the flasher switch with the ignition switch in any position. The flasher switch is located in the center console switch panel. All turn signal lights will flash simultaneously.

When you must make such an emergency stop, always pull off the road as far as possible.

- The hazard warning flasher operates whether your vehicle is running or not.
- The turn signals do not work when the hazard flasher is on.
- Care must be taken when using the hazard warning flasher while the vehicle is being towed.
- To turn the hazard warning lights off, push the switch again.

IN CASE OF AN EMERGENCY WHILE DRIVING

If the engine stalls at a cross-road or crossing

If the engine stalls at a crossroad or crossing, set the shift lever in the N (Neutral) position and then push the vehicle to a safe place.

If you have a flat tire while driving

If a tire goes flat while you are driving:

1. Take your foot off the accelerator pedal and let the car slow down while driving straight ahead. Do not apply the brakes immediately or attempt to pull off the road as this may cause a loss of control. When the car has slowed to such a speed that it is safe to do so, brake carefully and pull off the road. Drive off the road as far as possible and park on firm, level ground. If you are on a divided highway, do not park in the median area between the two traffic lanes.
2. When the vehicle is stopped, turn on your emergency hazard flashers, set the parking brake and put the transaxle in P.
3. Have all passengers get out of the car. Be sure they all get out on the side of the car that is away from traffic.
4. When repairing a flat tire, follow the instruction provided later in this section.

If engine stalls while driving

1. Reduce your speed gradually, keeping a straight line. Move cautiously off the road to a safe place.
2. Turn on your emergency flashers.
3. Try to start the engine again. If your vehicle will not start, contact an authorized HYUNDAI dealer or seek other qualified assistance.

* NOTICE

If there was a check engine light and loss of power or stall, it is best if safe to do so to wait at least 10 seconds to restart a vehicle after it stalls. This may reset the car so it will no longer run at low power (limp home) condition.

IF THE ENGINE WILL NOT START

If engine doesn't turn over or turns over slowly

1. If your vehicle has an automatic transaxle, be sure the shift lever is in N (Neutral) or P (Park) and the emergency brake is set.
2. Check the battery connections to be sure they are clean and tight.
3. Turn on the interior light. If the light dims or goes out when you operate the starter, the battery is discharged.
4. Do not push or pull the vehicle to start it. See instructions for "Jump starting".

If engine turns over normally but does not start

1. Check fuel level.
2. With the ignition switch in the LOCK position, check all connectors at ignition coils and spark plugs. Reconnect any that may be disconnected or loose.
3. If the engine still does not start, call an authorized HYUNDAI dealer or seek other qualified assistance.

WARNING

If the engine will not start, do not push or pull the vehicle to start it. This could result in a collision or cause other damage. In addition, push or pull starting may cause the catalytic converter to be overloaded and create a fire hazard.

EMERGENCY STARTING

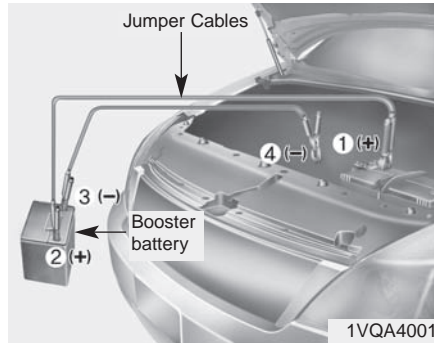

Connect cables in numerical order and disconnect in reverse order.

Jump starting

Jump starting can be dangerous if done incorrectly. Therefore, to avoid harm to yourself or damage to your vehicle or battery, follow the jump starting procedures. If in doubt, we strongly recommend that you have a technician or towing service jump start your vehicle.

⚠ CAUTION

Use only a 12-volt jumper system. You can damage a 12-volt starting motor, ignition system, and other electrical parts beyond repair by use of a 24-volt power supply (either two 12-volt batteries in series or a 24-volt motor generator set).

⚠ WARNING - Battery

- **Keep all flames or sparks away from the battery. The battery produces hydrogen gas which may explode if exposed to flame or sparks.**

If these instructions are not followed exactly, serious personal injury and damage to the vehicle may occur! If you are not sure how to follow this procedure, seek qualified assistance. Automobile batteries contain sulfuric acid. This is poisonous and highly corrosive. When jump starting, wear protective glasses and be careful not to get acid on yourself, your clothing or on the car.

- **Do not attempt to jump start the vehicle if the discharged battery is frozen or if the electrolyte level is low; the battery may rupture or explode.**

Jump starting procedure

* NOTICE

If the battery is discharged, the engine can be started using a battery of another vehicle and two jumper cables. Only use jumper cables with fully insulated clamp handles.

To prevent personal injury or damage to both vehicles, adhere strictly to the following procedure.

1. Make sure the booster battery is 12-volt and that its negative terminal is grounded.
2. If the booster battery is in another vehicle, do not allow the vehicles to touch.
3. Turn off all unnecessary electrical loads.

4. Connect the jumper cables in the exact sequence shown in the illustration. First connect one end of a jumper cable to the positive terminal of the discharged battery (1), then connect the other end to the positive terminal on the booster battery (2). Proceed to connect one end of the other jumper cable to the negative terminal of the booster battery (3), then the other end to a solid, stationary, metallic point (for example, the engine lifting bracket) away from the battery (4). Do not connect it to or near any part that moves when the engine is cranked.

Make sure that there is no contact between the bodywork of the two vehicles; otherwise, there is the danger of short circuits.

Do not allow the jumper cables to contact anything except the correct battery terminals or the correct ground. Do not lean over the battery when making connections.



CAUTION - Battery cables

Do not connect the jumper cable from the negative terminal of the booster battery to the negative terminal of the discharged battery. This can cause the discharged battery to overheat and crack, releasing battery acid.

5. Start the engine of the vehicle with the booster battery and let it run at 2,000 rpm, then start the engine of the vehicle with the discharged battery. If the first starting attempt is not successful, wait a few minutes before making another attempt in order to allow the discharged battery to recharge.

To charge the discharged battery enough, it is recommended to let the engine at idle or to drive the vehicle for a certain period of time.

If the cause of your battery discharging is not apparent, you should have your vehicle checked by an authorized HYUNDAI dealer.

Push-starting

Vehicles equipped with automatic transaxle cannot be push-started.

Follow the directions in this section for jump-starting.

⚠ WARNING

Never tow a vehicle to start it because the sudden surge forward when the engine starts could cause a collision with the tow vehicle.

IF THE ENGINE OVERHEATS

If your temperature gauge indicates overheating, you experience a loss of power, or hear loud pinging or knocking, the engine is probably too hot. If this happens, you should:

1. Pull off the road and stop as soon as it is safe to do so.
2. Place the shift lever in P and set the parking brake. If the air conditioning is on, turn it off.
3. If engine coolant is running out under the car or steam is coming out from the hood, stop the engine. Do not open the hood until the coolant has stopped running or the steaming has stopped. If there is no visible loss of engine coolant and no steam, leave the engine running and check to be sure the engine cooling fan is operating. If the fan is not running, turn the engine off.

4. Check to see if the water pump drive belt is missing. If it is not missing, check to see that it is tight. If the drive belt seems to be satisfactory, check for coolant leaking from the radiator, hoses or under the car. (If the air conditioning had been in use, it is normal for cold water to be draining from it when you stop.)

WARNING

While the engine is running, keep hair, hands and clothing away from moving parts such as the fan and drive belts to prevent injury.

5. If the water pump drive belt is broken or engine coolant is leaking out, stop the engine immediately and call the nearest authorized HYUNDAI dealer for assistance.

WARNING

Do not remove the radiator cap when the engine is hot. This may result in coolant being blown out of the opening and cause serious burns.

6. If you cannot find the cause of the overheating, wait until the engine temperature has returned to normal. Then, if coolant has been lost, carefully add coolant to the reservoir to bring the fluid level in the reservoir up to the halfway mark.
7. Proceed with caution, keeping alert for further signs of overheating. If overheating happens again, call an authorized HYUNDAI dealer for assistance.

CAUTION

Serious loss of coolant indicates there is a leak in the cooling system and this should be checked as soon as possible by an authorized HYUNDAI dealer.

TIRE PRESSURE MONITORING SYSTEM (TPMS) - TYPE A



ODM062002

■ Type A

2

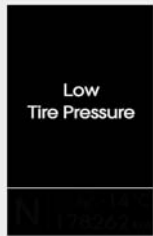

■ Type B

2



OANND2003/OANND2004

- (1) Low Tire Pressure Telltale / TPMS malfunction indicator
- (2) Low tire pressure indicator (Shown on the LCD display)

Each tire, including the spare (if provided), should be checked monthly when cold and inflated to the inflation pressure recommended by the vehicle manufacturer on the vehicle placard or tire inflation pressure label. (If your vehicle has tires of a different size than the size indicated on the vehicle placard or tire inflation pressure label, you should determine the proper tire inflation pressure for those tires.)

As an added safety feature, your vehicle has been equipped with a tire pressure monitoring system (TPMS) that illuminates a low tire pressure telltale when one or more of your tires is significantly under-inflated.

Accordingly, when the low tire pressure telltale illuminates, you should stop and check your tires as soon as possible, and inflate them to the proper pressure. Driving on a significantly under-inflated tire causes the tire to overheat and can lead to tire failure. Under-inflation also reduces fuel efficiency and tire tread life, and may affect the vehicle's handling and stopping ability.

Please note that the TPMS is not a substitute for proper tire maintenance, and it is the driver's responsibility to maintain correct tire pressure, even if under-inflation has not reached the level to trigger illumination of the TPMS low tire pressure telltale.

Your vehicle has also been equipped with a TPMS malfunction indicator to indicate when the system is not operating properly. The TPMS malfunction indicator is combined with the low tire pressure telltale. When the system detects a malfunction, the telltale will flash for approximately one minute and then remain continuously illuminated. This sequence will continue upon subsequent vehicle start-ups as long as the malfunction exists. When the malfunction indicator is illuminated, the system may not be able to detect or signal low tire pressure as intended. TPMS malfunctions may occur for a variety of reasons, including the installation of replacement or alternate tires or wheels on the vehicle that prevent the TPMS from functioning properly.

Always check the TPMS malfunction telltale after replacing one or more tires or wheels on your vehicle to ensure that the replacement or alternate tires and wheels allow the TPMS to continue to function properly.

* NOTICE

If the TPMS indicator does not illuminate for 3 seconds when the ignition switch is turned to the ON position or engine is running, or if it comes on after blinking for approximately one minute, take your car to your nearest authorized HYUNDAI dealer and have the system checked.

Low tire pressure indicator

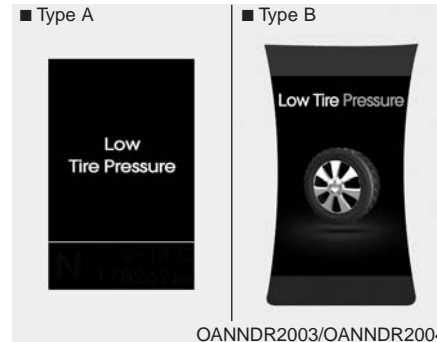

When the tire pressure monitoring system warning indicator is illuminated, one or more of your tires is significantly under-inflated.

If the indicator illuminates, immediately reduce your speed, avoid hard cornering and anticipate increased stopping distances. You should check your tires as soon as possible.

Inflate the tires to the proper pressure as indicated on the vehicle's placard or tire inflation pressure label located on the driver's side center pillar outer panel. If you cannot reach a service station or if the tire cannot hold the newly added air, replace the low pressure tire with the spare tire.

The Low Tire Pressure Telltale will remain on and the TPMS Malfunction Indicator may blink for one minute and then remain illuminated (when the vehicle is driven approximately 20 minutes at speed above 15.5 mph (25 km/h)) until you have the low pressure tire repaired and replaced on the vehicle.

CAUTION

In winter or cold weather, the low tire pressure indicator may be illuminated if the tire pressure was adjusted to the recommended tire inflation pressure in warm weather.

(Continued)

(Continued)

It does not mean your TPMS is malfunctioning because the decreased temperature leads to a lowering of tire pressure. When you drive your vehicle from a warm area to a cold area or from a cold area to a warm area, or the outside temperature is higher or lower, you should check the tire inflation pressure and adjust the tires to the recommended cold tire inflation pressure.

⚠ WARNING - Low pressure damage

Significantly low tire pressure makes the vehicle unstable and can contribute to loss of vehicle control and increased braking distances.

Continued driving on low pressure tires can cause the tires to overheat and fail.



TPMS (Tire Pressure Monitoring System) malfunction indicator

The TPMS malfunction indicator will illuminate after it blinks for approximately one minute when there is a problem with the Tire Pressure Monitoring System. If the system is able to correctly detect an under inflation warning at the same time as system failure then it will illuminate the TPMS malfunction indicator.

Have the system checked by an authorized HYUNDAI dealer as soon as possible to determine the cause of the problem.

⚠ CAUTION

- *The TPMS malfunction indicator may be illuminated if the vehicle is moving around electric power supply cables or radios transmitter such as at police stations, government public offices, broadcasting stations, military installations, airports, or transmitting towers, etc. This can interfere with normal operation of the Tire Pressure Monitoring System (TPMS).*
- *The TPMS malfunction indicator may illuminate if snow chains or some separately purchased devices such as notebook computers, mobile charger, remote starter, navigation etc. are used in the vehicle. This can interfere with normal operation of the Tire Pressure Monitoring System (TPMS).*

Changing a tire with TPMS

If you have a flat tire, the Low Tire Pressure indicator will come on. Have the flat tire repaired by an authorized HYUNDAI dealer as soon as possible or replace the flat tire with the spare tire.

CAUTION

Never use a puncture-repairing agent not approved by HYUNDAI to repair and/or inflate a low pressure tire. Tire sealant not approved by HYUNDAI may damage the tire pressure sensor.

The spare tire (if equipped) does not come with a tire pressure monitoring sensor. When the low pressure tire or the flat tire is replaced with the spare tire, the Low Tire Pressure Telltale will remain on. Also, the TPMS Malfunction Indicator will illuminate after blinking for one minute if the vehicle is driven at speed above 15.5 mph (25 km/h) for approximately 20 minutes.

Once the original tire equipped with a tire pressure monitoring sensor is reinflated to the recommended pressure and reinstalled on the vehicle, the Low Tire Pressure Telltale and TPMS Malfunction Indicator will go off within a few minutes.

If the indicators do not extinguish after a few minutes, please visit an authorized HYUNDAI dealer.

Each wheel is equipped with a tire pressure sensor mounted inside the tire behind the valve stem (except for the spare tire). You must use TPMS specific wheels. It is recommended that you always have your tires serviced by an authorized HYUNDAI dealer as soon as possible.

You may not be able to identify a tire with low pressure by simply looking at it. Always use a good quality tire pressure gauge to measure. Please note that a tire that is hot (from being driven) will have a higher pressure measurement than a tire that is cold.

A cold tire means the vehicle has been sitting for 3 hours and driven for less than 1 mile (1.6 km) in that 3 hour period.

Allow the tire to cool before measuring the inflation pressure. Always be sure the tire is cold before inflating to the recommended pressure.

⚠ WARNING - TPMS

- **The TPMS cannot alert you to severe and sudden tire damage caused by external factors such as nails or road debris.**
- **If you feel any vehicle instability, immediately take your foot off the accelerator, apply the brakes gradually with light force, and slowly move to a safe position off the road.**

⚠ WARNING - Protecting TPMS

Tampering with, modifying, or disabling the Tire Pressure Monitoring System (TPMS) components may interfere with the system's ability to warn the driver of low tire pressure conditions and/or TPMS malfunctions. Tampering with, modifying, or disabling the Tire Pressure Monitoring System (TPMS) components may void the warranty for that portion of the vehicle.

This device complies with Part 15 of the FCC rules.

Operation is subject to the following two conditions:

1. This device may not cause harmful interference, and
2. This device must accept any interference received, including interference that may cause undesired operation.

⚠ CAUTION

Changes or modifications not expressly approved by the party responsible for compliance could void the user's authority to operate the equipment.

TIRE PRESSURE MONITORING SYSTEM (TPMS) - TYPE B



ODM062002

■ Type A

■ Type B

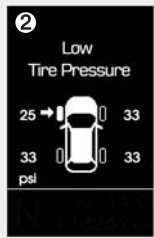

ODM064023L/ODM064020L

Check tire pressure

■ Type A

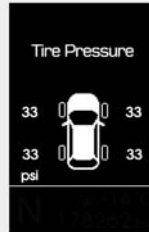

■ Type B



ODM064024L/ODM064021L

- (1) Low Tire Pressure Telltale/ TPMS Malfunction Indicator
- (2) Low tire pressure position telltale and tire pressure telltale (Shown on the LCD display)

- You can change the tire pressure unit in the user settings mode on the cluster.
 - psi, kpa, bar (Refer to “User settings mode” in chapter 4).

- You can check the tire pressure in the information mode on the cluster.
 - Refer to “User settings mode” in chapter 4.
- Tire pressure is displayed 1~2 minutes later after driving.
- If tire pressure is not displayed when the vehicle is stopped, “Drive to display” message displays. After driving, check the tire pressure.

Tire pressure monitoring system

WARNING

Over-inflation or under-inflation can reduce tire life, adversely affect vehicle handling, and lead to sudden tire failure that may cause loss of vehicle control resulting in an accident.

Each tire, including the spare (if provided), should be checked monthly when cold and inflated to the inflation pressure recommended by the vehicle manufacturer on the vehicle placard or tire inflation pressure label. (If your vehicle has tires of a different size than the size indicated on the vehicle placard or tire inflation pressure label, you should determine the proper tire inflation pressure for those tires.)

As an added safety feature, your vehicle has been equipped with a tire pressure monitoring system (TPMS) that illuminates a low tire pressure telltale when one or more of your tires is significantly under-inflated. Accordingly, when the low tire pressure telltale illuminates, you should stop and check your tires as soon as possible, and inflate them to the proper pressure. Driving on a significantly under-inflated tire causes the tire to overheat and can lead to tire failure. Under-inflation also reduces fuel efficiency and tire tread life, and may affect the vehicle's handling and stopping ability.

Please note that the TPMS is not a substitute for proper tire maintenance, and it is the driver's responsibility to maintain correct tire pressure, even if under-inflation has not reached the level to trigger illumination of the TPMS low tire pressure telltale.

Your vehicle has also been equipped with a TPMS malfunction indicator to indicate when the system is not operating properly. The TPMS malfunction indicator is combined with the low tire pressure telltale. When the system detects a malfunction, the telltale will flash for approximately one minute and then remain continuously illuminated. This sequence will continue upon subsequent vehicle start-ups as long as the malfunction exists. When the malfunction indicator is illuminated, the system may not be able to detect or signal low tire pressure as intended.

TPMS malfunctions may occur for a variety of reasons, including the installation of replacement or alternate tires or wheels on the vehicle that prevent the TPMS from functioning properly. Always check the TPMS malfunction telltale after replacing one or more tires or wheels on your vehicle to ensure that the replacement or alternate tires and wheels allow the TPMS to continue to function properly.

* NOTICE

If any of the below happens, we recommend that the system be checked by an authorized HYUNDAI dealer.

1. The low tire pressure telltale/TPMS malfunction indicator does not illuminate for 3 seconds when Engine Start/Stop button is turned to the ON or engine is running.
2. The TPMS malfunction indicator remains illuminated after blinking for approximately 1 minute.
3. The Low tire pressure position telltale remains illuminated.



Low tire pressure telltale

Low tire pressure position telltale and tire pressure telltale

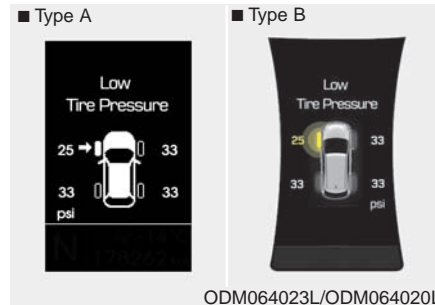

When the tire pressure monitoring system warning indicators are illuminated and warning message displayed on the cluster LCD display, one or more of your tires is significantly under-inflated. The low tire pressure position telltale light will indicate which tire is significantly under-inflated by illuminating the corresponding position light.

If either telltale illuminates, immediately reduce your speed, avoid hard cornering and anticipate increased stopping distances. You should stop and check your tires as soon as possible. Inflate the tires to the proper pressure as indicated on the vehicle's placard or tire inflation pressure label located on the driver's side center pillar outer panel. If you cannot reach a service station or if the tire cannot hold the newly added air, replace the low pressure tire with a spare tire.

If you drive the vehicle for about 10 minutes at speeds above 15.5 mph (25 km/h) after replacing the low pressure tire with the spare tire, the below will happen:

- The TPMS malfunction indicator may blink for approximately 1 minute and then remain continuously illuminated because the TPMS sensor is not mounted on the spare wheel.

*** NOTICE**

The spare tire is not equipped with a tire pressure sensor.

 **CAUTION**

In winter or cold weather, the low tire pressure telltale may illuminate if the tire pressure was adjusted to the recommended tire inflation pressure in warm weather. It does not mean your TPMS is malfunctioning because the decreased temperature leads to a lowering of tire pressure.

When you drive your vehicle from a warm area to a cold area or from a cold area to a warm area, or the outside temperature is higher or lower, you should check the tire inflation pressure and adjust the tires to the recommended tire inflation pressure.

 **WARNING - Low pressure damage**

Significantly low tire pressure makes the vehicle unstable and can contribute to loss of vehicle control and increased braking distances.

Continued driving on low pressure tires can cause the tires to overheat and fail.



TPMS (Tire Pressure Monitoring System) malfunction indicator

The TPMS malfunction indicator will illuminate after it blinks for approximately one minute when there is a problem with the Tire Pressure Monitoring System.

We recommend that the system be checked by an authorized HYUNDAI dealer.

*** NOTICE**

If there is a malfunction with the TPMS, the low tire pressure position telltale will not be displayed even though the vehicle has an under-inflated tire.

 **CAUTION**

- ***The TPMS malfunction indicator may blink for approximately 1 minute and then remain continuously illuminated if the vehicle is moving around electric power supply cables or radios transmitter such as at police stations, government and public offices, broadcasting stations, military installations, airports, or transmitting towers, etc. This can interfere with normal operation of the Tire Pressure Monitoring System (TPMS).***
- ***The TPMS malfunction indicator may blink for approximately 1 minute and then remain continuously illuminated if snow chains are used or some separate electronic devices such as notebook computer, mobile charger, remote starter or navigation etc., are used in the vehicle.***
This can interfere with normal operation of the Tire Pressure Monitoring System (TPMS).

Changing a tire with TPMS

If you have a flat tire, the low Tire Pressure and Position telltales will come on. We recommend that the system be checked by an authorized HYUNDAI dealer.

 **CAUTION**

NEVER use a puncture-repairing agent to repair and/or inflate a low pressure tire. The tire sealant can damage the tire pressure sensor. If used, you will have to replace the tire pressure sensor.

Each wheel is equipped with a tire pressure sensor mounted inside the tire behind the valve stem. You must use TPMS specific wheels. It is recommended that you have your tires serviced by an authorized HYUNDAI dealer.

If you drive the vehicle for about 10 minutes at speeds above 15.5 mph (25 km/h) after replacing the low pressure tire with the spare tire, the below will happen:

- The TPMS malfunction indicator may blink for approximately 1 minute and then remain continuously illuminated because the TPMS sensor is not mounted on the spare wheel.

You may not be able identify a low tire by simply looking at it. Always use a good quality tire pressure gauge to measure the tire's inflation pressure. Please note that a tire that is hot (from being driven) will have a higher pressure measurement than a tire that is cold (from sitting stationary for at least 3 hours and driven less than 1 mile (1.6 km) during that 3 hour period).

Allow the tire to cool before measuring the inflation pressure. Always be sure the tire is cold before inflating to the recommended pressure.

A cold tire means the vehicle has been sitting for 3 hours and driven for less than 1 mile (1.6 km) in that 3 hour period.

⚠ WARNING - TPMS

- The TPMS cannot alert you to severe and sudden tire damage caused by external factors such as nails or road debris.
- If you feel any vehicle instability, immediately take your foot off the accelerator, apply the brakes gradually and with light force, and slowly move to a safe position off the road.

⚠ WARNING - Protecting TPMS

Tampering with, modifying, or disabling the Tire Pressure Monitoring System (TPMS) components may interfere with the system's ability to warn the driver of low tire pressure conditions and/or TPMS malfunctions. Tampering with, modifying, or disabling the Tire Pressure Monitoring System (TPMS) components may void the warranty for that portion of the vehicle.

This device complies with Part 15 of the FCC rules.

Operation is subject to the following two conditions:

1. This device may not cause harmful interference, and
2. This device must accept any interference received, including interference that may cause undesired operation.

⚠ CAUTION

Changes or modifications not expressly approved by the party responsible for compliance could void the user's authority to operate the equipment.

IF YOU HAVE A FLAT TIRE

Jack and tools

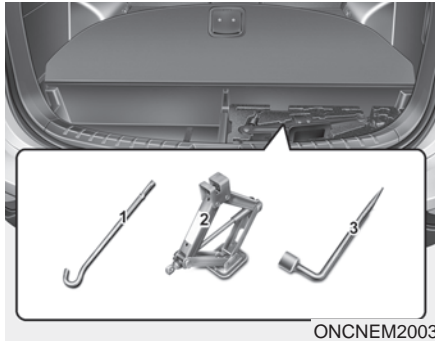

The jack, jack handle, and wheel lug nut wrench are stored in the luggage compartment. Pull up the luggage box cover to find these equipment.

- (1) Jack handle
- (2) Jack
- (3) Wheel lug nut wrench

Jacking instructions

The jack is provided for emergency tire changing only.

To prevent the jack from “rattling” while the vehicle is in motion, store it properly.

Follow jacking instructions to reduce the possibility of personal injury.

⚠ WARNING - Changing tires

- **Never attempt vehicle repairs in the traffic lanes of a public road or highway.**
- **Always move the vehicle completely off the road and onto the shoulder before trying to change a tire. The jack should be used on level firm ground. If you cannot find a firm, level place off the road, call a towing service company for assistance.**
- **Be sure to use the correct front and rear jacking positions on the vehicle; never use the bumpers or any other part of the vehicle for jack support.**
- **The vehicle can roll off the jack causing serious injury or death. No person should place any portion of their body under a vehicle that is supported only by a jack; use vehicle support stands.**

(Continued)

(Continued)

- Do not start or run the engine while the vehicle is on the jack.
- Do not allow anyone to remain in the vehicle while it is on the jack.
- Make sure any children present are in a secure place away from the road and from the vehicle to be raised with the jack.

Removing and storing the spare tire

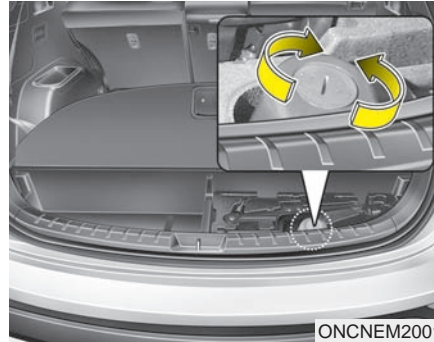

Your spare tire is stored underneath your vehicle, directly below the cargo area.

To remove the spare tire:

1. Open the liftgate (tailgate).
2. Remove cover with coin or flat-head screwdriver.

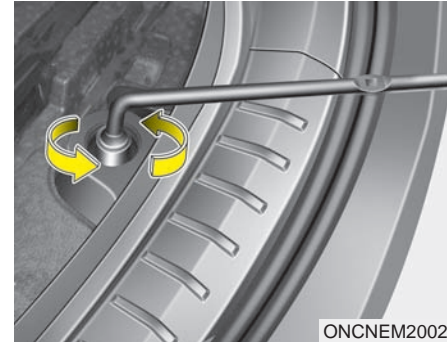

3. Connect the wheel lug nut wrench.
4. Loosen the bolt enough to lower the spare tire.

Turn the wrench counterclockwise until the spare tire reaches the ground.

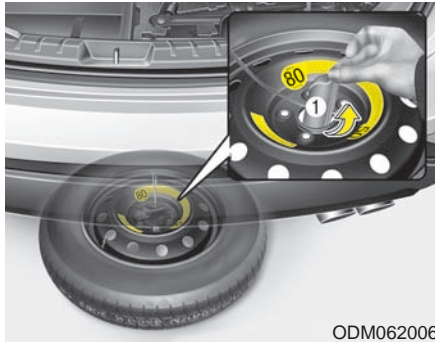

5. After the spare tire reaches the ground, continue to turn the wrench counterclockwise, and draw the spare tire outside. Never rotate the wrench excessively, otherwise the spare tire carrier may be damaged.
6. Remove the retainer (1) from the center of the spare tire

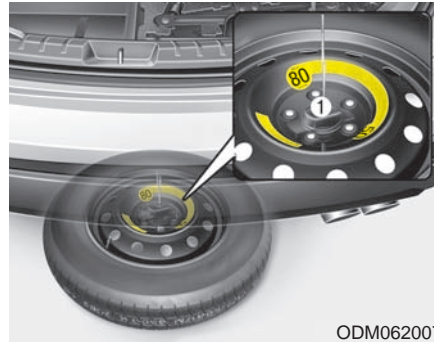

To store the spare tire:

1. Lay the tire on the ground with the valve stem facing up.
2. Place the wheel under the vehicle and install the retainer (1) through the wheel center.
3. Turn the wrench clockwise until it clicks.

⚠ WARNING - Storing the spare tire

Ensure the spare tire retainer is properly aligned with the center of the spare tire to prevent the spare tire from “rattling”.

Otherwise, it may cause the spare tire to fall off the carrier and lead to an accident.

Changing tires

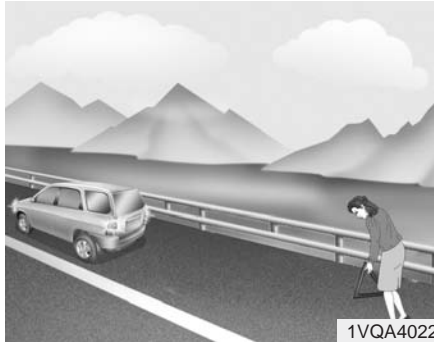

1. Park on a level surface and apply the parking brake firmly.
2. Shift the shift lever into P (Park).
3. Activate the hazard warning flasher.



4. Remove the wheel lug nut wrench, jack, jack handle, and spare tire from the vehicle.
5. Block both the front and rear of the wheel that is diagonally opposite the jack position.

⚠ WARNING - Changing a tire

- To prevent vehicle movement while changing a tire, always set the parking brake fully, and always block the wheel diagonally opposite the wheel being changed.
- We recommend that the wheels of the vehicle be blocked, and that no person remain in a vehicle that is being jacked.



6. Loosen the wheel lug nuts counterclockwise one turn each, but do not remove any nut until the tire has been raised off the ground.

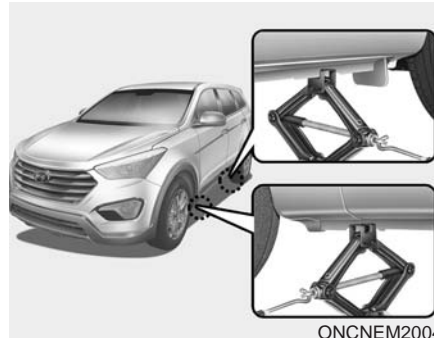

7. Place the jack at the front or rear jacking position closest to the tire you are changing. Place the jack at the designated locations under the frame.

⚠ WARNING - Jack location
To reduce the possibility of injury, be sure to use only the jack provided with the vehicle and in the correct jack position; never use any other part of the vehicle for jack support.

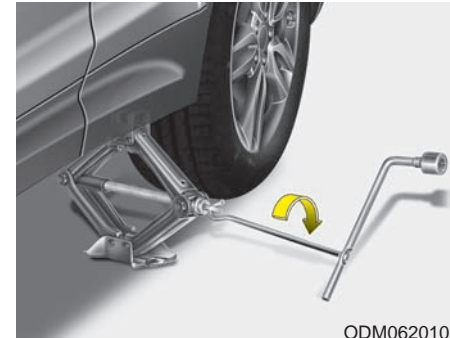

8. Insert the jack handle into the jack and turn it clockwise, raising the vehicle until the tire just clears the ground. This measurement is approximately 1.2 in (30 mm). Before removing the wheel lug nuts, make sure the vehicle is stable and that there is no chance for movement or slippage.

9. Loosen the wheel nuts and remove them with your fingers. Slide the wheel off the studs and lay it flat so it cannot roll away. To put the wheel on the hub, pick up the spare tire, line up the holes with the studs and slide the wheel onto them. If this is difficult, tip the wheel slightly and get the top hole in the wheel lined up with the top stud. Then jiggle the wheel back and forth until the wheel can be slid over the other studs.

⚠ WARNING

Wheels may have sharp edges. Handle them carefully to avoid possible severe injury. Before putting the wheel into place, be sure that there is nothing on the hub or wheel (such as mud, tar, gravel, etc.) that prevents the wheel from fitting solidly against the hub.

If there is, remove it. If there is insufficient contact on the mounting surface between the wheel and hub, the wheel nuts could come loose and cause the loss of a wheel. Loss of a wheel may result in loss of control of the vehicle. This may cause serious injury or death.

10. To reinstall the wheel, hold it on the studs, put the wheel nuts on the studs and tighten them finger tight. The nuts should be installed with their tapered small diameter ends directed inward. Jiggle the tire to be sure it is completely seated, then tighten the nuts as much as possible with your fingers again.
11. Lower the car to the ground by turning the wheel nut wrench counterclockwise.



Then position the wrench as shown in the drawing and tighten the wheel nuts. Be sure the socket is seated completely over the nut. Do not stand on the wrench handle or use an extension pipe over the wrench handle. Go around the wheel tightening every other nut until they are all tight. Then double-check each nut for tightness. After changing wheels, have an authorized HYUNDAI dealer tighten the wheel nuts to their proper torque as soon as possible.

Wheel nut tightening torque:

Steel wheel & aluminum alloy wheel:
65~79 lb-ft (9~11 kg·m)

If you have a tire gauge, remove the valve cap and check the air pressure. If the pressure is lower than recommended, drive slowly to the nearest service station and inflate to the correct pressure. If it is too high, adjust it until it is correct. Always reinstall the valve cap after checking or adjusting tire pressure. If the cap is not replaced, air may leak from the tire. If you lose a valve cap, buy another and install it as soon as possible.

After you have changed wheels, always secure the flat tire in its place and return the jack and tools to their proper storage locations.

CAUTION

Your vehicle has metric threads on the wheel studs and nuts. Make certain during wheel removal that the same nuts that were removed are reinstalled - or, if replaced, that nuts with metric threads and the same chamfer configuration are used. Installation of a non-metric thread nut on a metric stud or vice-versa will not secure the wheel to the hub properly and will damage the stud so that it must be replaced.

Note that most lug nuts do not have metric threads. Be sure to use extreme care in checking for thread style before installing aftermarket lug nuts or wheels. If in doubt, consult an authorized HYUNDAI dealer.

⚠ WARNING - Wheel studs

If the studs are damaged, they may lose their ability to retain the wheel. This could lead to the loss of the wheel and a collision resulting in serious injuries.

To prevent the jack, jack handle, wheel lug nut wrench and spare tire from rattling while the vehicle is in motion, store them properly.

⚠ WARNING - Inadequate spare tire pressure

Check the inflation pressures as soon as possible after installing the spare tire. Adjust it to the specified pressure, if necessary. Refer to “Tires and wheels” section 8.

Important - use of temporary compact spare tire

If your vehicle is equipped with a compact spare tire, it will take up less space than a regular-size tire. This tire is smaller than a conventional tire and is designed for temporary use only.

⚠ CAUTION

- *You should drive carefully when the temporary compact spare is in use. The compact spare should be replaced by the proper conventional tire and rim at the first opportunity.*
- *Do not drive a vehicle with more than one compact spare tire in use at the same time.*

⚠ WARNING

The temporary compact spare tire is for emergency use only. Do not operate your vehicle on this compact spare at speeds over 50 mph (80 km/h). The original tire should be repaired or replaced as soon as is possible to avoid failure of the spare possibly leading to personal injury or death.

The compact spare should be inflated to 60 psi (420 kPa).

*** NOTICE**

Check the inflation pressure after installing the spare tire. Adjust it to the specified pressure, as necessary.

When using a temporary compact spare tire, observe the following precautions:

- Under no circumstances should you exceed 50 mph (80 km/h); higher speeds could damage the tire.
- Ensure that you drive slowly enough for the road conditions to avoid all hazards. Any road hazard, such as a pothole or debris, could seriously damage the compact spare.
- Any continuous road use of this tire could result in tire failure, loss of vehicle control, and possible personal injury.
- Do not exceed the vehicle's maximum load rating or the load-carrying capacity shown on the sidewall of the compact spare tire.
- Avoid driving over obstacles. The compact spare tire diameter is smaller than the diameter of a conventional tire and reduces the ground clearance approximately 1 inch (25 mm), which could result in damage to the vehicle.
- Do not take the vehicle through an automatic car wash while the compact spare tire is installed.
- Do not use tire chains on the compact spare tire. Because of the smaller size, a tire chain will not fit properly. This could damage the vehicle and result in loss of the chain.
- Do not use the compact spare tire on any other vehicle because this tire has been designed especially for your vehicle.
- The compact spare tire's tread life is shorter than a regular tire. Inspect your compact spare tire regularly and replace worn compact spare tires with the same size and design, mounted on the same wheel.
- The compact spare tire should not be used on any other wheels, nor should standard tires, snow tires, wheel covers or trim rings be used with the compact spare wheel. If such use is attempted, damage to these items or other car components may occur.
- Do not use more than one compact spare tire at a time.
- Do not tow a trailer while the compact spare tire is installed.

Jack label

- Example
- Type A

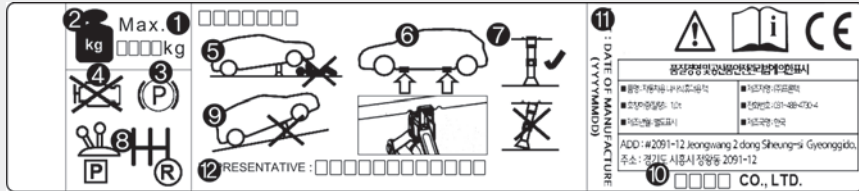

OTQ044219

- Type B



OHYK064002

* The actual Jack label in the vehicle may differ from the illustration.
For more detailed specifications, refer to the label attached to the jack.

1. Model Name
2. Maximum allowable load
3. When using the jack, set your parking brake.
4. When using the jack, stop the engine.
5. Do not get under a vehicle that is supported by a jack.
6. The designated locations under the frame
7. When supporting the vehicle, the base plate of jack must be vertical under the lifting point.
8. Shift into Reverse gear on vehicles with manual transaxle or move the shift lever to the P position on vehicles with automatic transaxle.
9. The jack should be used on firm level ground.
10. Jack manufacturer
11. Production date
12. Representative company and address

TOWING

Towing service

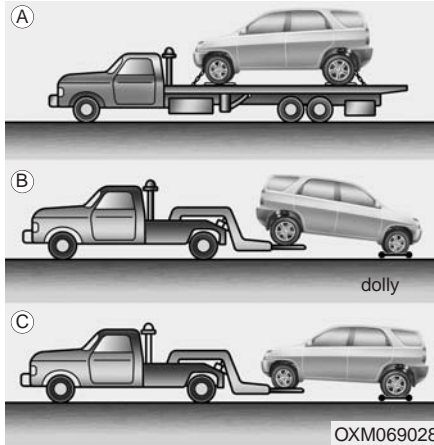

If emergency towing is necessary, we recommend having it done by an authorized HYUNDAI dealer or a commercial tow-truck service. Proper lifting and towing procedures are necessary to prevent damage to the vehicle. The use of wheel dollies or flatbed is recommended.

For trailer towing guidelines information, refer to "Trailer towing" in chapter 5.

On AWD vehicles, your vehicle must be towed with a wheel lift and dollies or flatbed equipment with all the wheels off the ground.

CAUTION

The AWD vehicle should never be towed with the wheels on the ground. This can cause serious damage to the transaxle or the AWD system.

On 2WD vehicles, it is acceptable to tow the vehicle with the rear wheels on the ground (without dollies) and the front wheels off the ground.

If any of the loaded wheels or suspension components are damaged or the vehicle is being towed with the front wheels on the ground, use a towing dolly under the front wheels.

When being towed by a commercial tow truck and wheel dollies are not used, the front of the vehicle should always be lifted, not the rear.

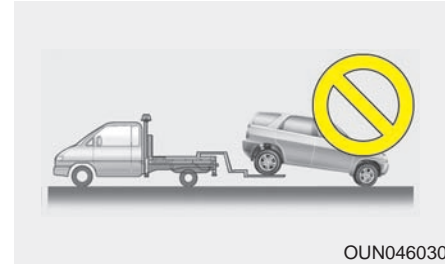

OUN046030



OCM054034

CAUTION

- *Do not tow with sling-type equipment. Use wheel lift or flatbed equipment.*
- *Do not tow the vehicle backwards with the front wheels on the ground as this may cause damage to the vehicle.*

When towing your vehicle in an emergency without wheel dollies :

1. Set the ignition switch in the ACC position.
2. Place the shift lever in N (Neutral).
3. Release the parking brake.

CAUTION

Failure to place the transaxle shift lever in N (Neutral) may cause internal damage to the transaxle.

Removable towing hook (if equipped)

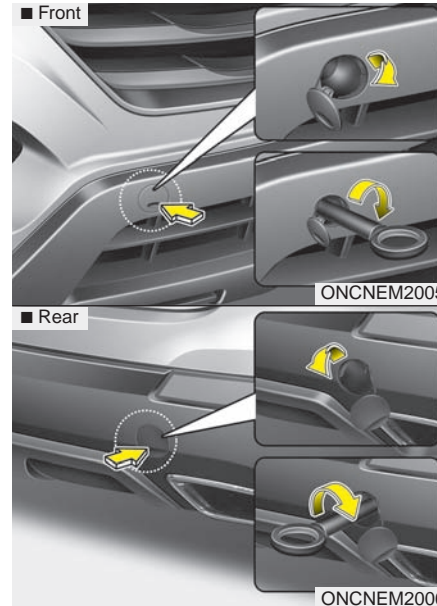

3. Install the towing hook by turning it clockwise into the hole until it is fully secured.
4. Remove the towing hook and install the cover after use.

1. Open the liftgate (tailgate), and remove the towing hook from the tool case.
2. Remove the hole cover pressing the lower part of the cover on the bumper.

Emergency towing (if equipped)

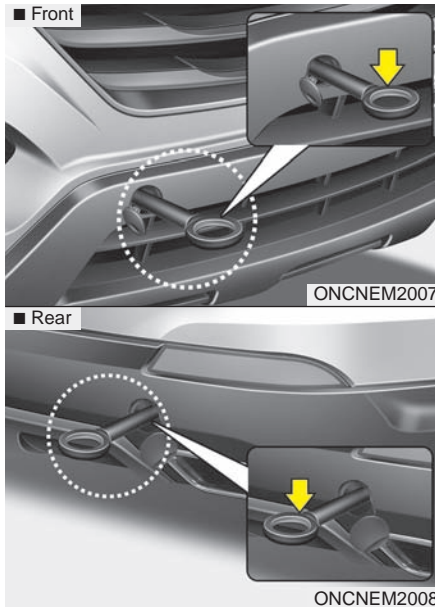

If towing is necessary, we recommend you to have it done by an authorized HYUNDAI dealer or a commercial tow truck service.

If towing service is not available in an emergency, your vehicle may be temporarily towed using a cable or chain secured to the emergency towing hook attached to the front (or under the rear) of the vehicle.

Use extreme caution when towing the vehicle. A driver must be in the vehicle to steer it and operate the brakes. Towing in this manner may be done only on hard-surfaced roads for a short distance and at low speeds. Also, the wheels, axles, power train, steering and brakes must all be in good condition.

- Do not use the tow hooks to pull a vehicle out of mud, sand or other conditions from which the vehicle cannot be driven out under its own power.
- Avoid towing a vehicle heavier than the vehicle doing the towing.
- The drivers of both vehicles should communicate with each other frequently.

⚠ CAUTION

- **Attach a towing strap to the tow hook.**
 - **Using a portion of the vehicle other than the tow hooks for towing may damage the body of your vehicle.**
 - **Use only a cable or chain specifically intended for use in towing vehicles. Securely fasten the cable or chain to the towing hook provided.**
- Before emergency towing, check that the hook is not broken or damaged.
 - Fasten the towing cable or chain securely to the hook.
 - Do not jerk the hook. Apply steady and even force.
 - To avoid damaging the hook, do not pull from the side or at a vertical angle. Always pull straight ahead.

⚠ WARNING

Use extreme caution when towing the vehicle.

- Avoid sudden starts or erratic driving maneuvers which would place excessive stress on the emergency towing hook and towing cable or chain. The hook and towing cable or chain may break and cause serious injury or damage.
- If the disabled vehicle cannot be moved, do not forcibly continue the towing. Contact an authorized HYUNDAI dealer or a commercial tow truck service for assistance.
- Tow the vehicle as straight ahead as possible.
- Keep away from the vehicle during towing.

Emergency towing precautions

- Turn the ignition switch to ACC so the steering wheel isn't locked.
- Place the transaxle shift lever in N (Neutral).
- Release the parking brake.
- Press the brake pedal with more force than normal since you will have reduced brake performance.
- More steering effort will be required because the power steering system will be disabled.
- If you are driving down a long hill, the brakes may overheat and brake performance will be reduced. Stop often and let the brakes cool off.

⚠ CAUTION - Automatic transaxle

- *If the car is being towed with all four wheels on the ground, it can be towed only from the front. Be sure that the transaxle is in neutral. Be sure the steering is unlocked by placing the ignition switch in the ACC position. A driver must be in the towed vehicle to operate the steering and brakes.*
- *To avoid serious damage to the automatic transaxle, limit the vehicle speed to 10 mph (15 km/h) and drive less than 1 mile (1.5 km) when towing.*
- *Before towing, check under your vehicle for leaking automatic transaxle fluid. If the automatic transaxle fluid is leaking, a flatbed equipment or towing dolly must be used.*

Maintenance

Engine compartment	7-3	Wiper blades	7-42
Maintenance services	7-4	• Blade inspection	7-42
• Owner's responsibility	7-4	• Blade replacement	7-42
• Owner maintenance precautions	7-5	Battery	7-45
Owner maintenance	7-6	• For best battery service	7-45
• Owner maintenance schedule	7-6	• Battery recharging	7-46
Scheduled maintenance service	7-8	• Reset items	7-47
Explanation of scheduled maintenance items	7-26	Tires and wheels	7-48
Engine oil	7-30	• Tire care	7-48
• Checking the engine oil level	7-30	• Recommended cold tire inflation pressures	7-48
• Changing the engine oil and filter	7-31	• Checking tire inflation pressure	7-49
Engine coolant	7-32	• Tire rotation	7-50
• Checking the coolant level	7-32	• Wheel alignment and tire balance	7-51
• Changing the coolant	7-34	• Tire replacement	7-52
Brake fluid	7-35	• Wheel replacement	7-53
• Checking the brake fluid level	7-35	• Tire traction	7-53
Washer fluid	7-37	• Tire maintenance	7-54
• Checking the washer fluid level	7-37	• Tire sidewall labeling	7-54
Parking brake	7-37	Fuses	7-62
• Checking the parking brake	7-37	• Fuse/relay panel description	7-66
Air cleaner	7-38	Light bulbs	7-74
• Filter replacement	7-38	• Front light replacement	7-75
Climate control air filter	7-40	• Side repeater light bulb replacement	7-78
• Filter inspection	7-40	• Rear combination light bulb replacement	7-79
• Filter replacement	7-40	• High mounted stop light bulb replacement	7-81

- License plate light bulb replacement..... 7-82
- Interior light bulb replacement 7-83

Appearance care..... 7-84

- Exterior care 7-84
- Interior care..... 7-89

Emission control system 7-91

California perchlorate notice 7-95

ENGINE COMPARTMENT

■ Gasoline Engine (LAMBDA 3.3) - GDI



1. Engine coolant reservoir
2. Engine oil filler cap
3. Brake fluid reservoir
4. Air cleaner
5. Fuse box
6. Negative battery terminal
7. Positive battery terminal
8. Radiator cap
9. Engine oil dipstick
10. Windshield washer fluid reservoir

※ The actual engine room in the vehicle may differ from the illustration.

MAINTENANCE SERVICES

You should exercise the utmost care to prevent damage to your vehicle and injury to yourself whenever performing any maintenance or inspection procedures.

Should you have any doubts concerning the inspection or servicing of your vehicle, we strongly recommend that you have an authorized HYUNDAI dealer perform this work.

An authorized HYUNDAI dealer has factory-trained technicians and genuine HYUNDAI parts to service your vehicle properly. For expert advice and quality service, see an authorized HYUNDAI dealer.

Inadequate, incomplete or insufficient servicing may result in operational problems with your vehicle that could lead to vehicle damage, an accident, or personal injury.

Owner's responsibility

* NOTICE

Maintenance Service and Record Retention are the owner's responsibility.

You should retain documents that show proper maintenance has been performed on your vehicle in accordance with the scheduled maintenance service charts shown on the following pages. You need this information to establish your compliance with the servicing and maintenance requirements of your vehicle warranties.

Detailed warranty information is provided in your Owner's Handbook & Warranty Information booklet.

Repairs and adjustments required as a result of improper maintenance or a lack of required maintenance are not covered.

We recommend you have your vehicle maintained and repaired by an authorized HYUNDAI dealer. An authorized HYUNDAI dealer meets HYUNDAI's high service quality standards and receives technical support from HYUNDAI in order to provide you with a high level of service satisfaction.

Owner maintenance precautions

Improper or incomplete service may result in problems. This section gives instructions only for the maintenance items that are easy to perform.

As explained earlier in this section, several procedures can be done only by an authorized HYUNDAI dealer with special tools.

* NOTICE

Improper owner maintenance during the warranty period may affect warranty coverage. For details, read the separate Owner's Handbook & Warranty Information booklet provided with the vehicle. If you're unsure about any servicing or maintenance procedure, have it done by an authorized HYUNDAI dealer.

⚠ WARNING - Maintenance work

- **Performing maintenance work on a vehicle can be dangerous. You can be seriously injured while performing some maintenance procedures. If you lack sufficient knowledge and experience or the proper tools and equipment to do the work, have it done by an authorized HYUNDAI dealer.**
- **Working under the hood with the engine running is dangerous. It becomes even more dangerous when you wear jewelry or loose clothing. These can become entangled in moving parts and result in injury. Therefore, if you must run the engine while working under the hood, make certain that you remove all jewelry (especially rings, bracelets, watches, and necklaces) and all neckties, scarves, and similar loose clothing before getting near the engine or cooling fans.**

OWNER MAINTENANCE

The following lists are vehicle checks and inspections that should be performed by the owner or an authorized HYUNDAI dealer at the frequencies indicated to help ensure safe, dependable operation of your vehicle.

Any adverse conditions should be brought to the attention of your dealer as soon as possible.

These Owner Maintenance Checks are generally not covered by warranties and you may be charged for labor, parts and lubricants used.

Owner maintenance schedule

When you stop for fuel:

- Check the engine oil level.
- Check coolant level in coolant reservoir.
- Check the windshield washer fluid level.
- Look for low or under-inflated tires.

⚠ WARNING

Be careful when checking your engine coolant level when the engine is hot. Scalding hot coolant and steam may blow out under pressure. This could cause burns or other serious injury.

While operating your vehicle:

- Note any changes in the sound of the exhaust or any smell of exhaust fumes in the vehicle.
- Check for vibrations in the steering wheel. Notice any increased steering effort or looseness in the steering wheel, or change in its straight-ahead position.
- Notice if your vehicle constantly turns slightly or “pulls” to one side when traveling on smooth, level road.
- When stopping, listen and check for unusual sounds, pulling to one side, increased brake pedal travel or “hard-to-push” brake pedal.
- If any slipping or changes in the operation of your transaxle occurs, check the transaxle fluid level.
- Check automatic transaxle P (Park) function.
- Check parking brake.

- Check for fluid leaks under your vehicle (water dripping from the air conditioning system during or after use is normal).

At least monthly:

- Check coolant level in the engine coolant reservoir.
- Check the operation of all exterior lights, including the stoplights, turn signals and hazard warning flashers.
- Check the inflation pressures of all tires including the spare.

***At least twice a year
(i.e., every Spring and Fall) :***

- Check radiator, heater and air conditioning hoses for leaks or damage.
- Check windshield washer spray and wiper operation. Clean wiper blades with clean cloth dampened with washer fluid.
- Check headlight alignment.
- Check muffler, exhaust pipes, shields and clamps.
- Check the lap/shoulder belts for wear and function.
- Check for worn tires and loose wheel lug nuts.

At least once a year :

- Clean body and door drain holes.
- Lubricate door hinges and checks, and hood hinges.
- Lubricate door and hood locks and latches.
- Lubricate door rubber weatherstrips.
- Check the air conditioning system.
- Inspect and lubricate automatic transaxle linkage and controls.
- Clean battery and terminals.
- Check the brake fluid level.

SCHEDULED MAINTENANCE SERVICE

Follow Normal Maintenance Schedule if the vehicle is usually operated where none of the following conditions apply. If any of the following conditions apply, follow Maintenance Under Severe Usage Conditions.

- Repeated short distance driving.
- Driving in dusty conditions or sandy areas.
- Extensive use of brakes.
- Driving in areas where salt or other corrosive materials are being used.
- Driving on rough or muddy roads.
- Driving in mountainous areas.
- Extended periods of idling or low speed operation.
- Driving for a prolonged period in cold temperatures and/or extremely humid climates.
- More than 50% driving in heavy city traffic during hot weather above 90°F (32°C).

If your vehicle is operated under the above conditions, you should inspect, replace or refill more frequently than the following Normal Maintenance Schedule. After 120 months or 150,000 miles (240,000 km) continue to follow the prescribed maintenance intervals.

NORMAL MAINTENANCE SCHEDULE

The following maintenance services must be performed to ensure good emission control and performance.

Keep receipts for all vehicle emission services to protect your warranty. Where both mileage and time are shown, the frequency of service is determined by whichever occurs first.

- *1 : If TOP TIER Detergent Gasoline is not available, one bottle of additive is recommended. Additives are available from your authorized HYUNDAI dealer along with information on how to use them. Do not mix other additives.
- *2 : Fuel filter & Fuel tank air filter are considered to be maintenance free but periodic inspection is recommended for this maintenance schedule depends on fuel quality. If there are some important safety matters like fuel flow restriction, surging, loss of power, hard starting problem etc, replace the fuel filter immediately regardless of maintenance schedule and consult an authorized HYUNDAI dealer for details.
- *3 : Transfer case oil and rear axle oil should be changed anytime they have been submerged in water.
- *4 : Inspect for excessive tappet noise and/or engine vibration and adjust if necessary.
- *5 : The drive belt should be replaced when cracks occur or tension is reduced excessively.

NORMAL MAINTENANCE SCHEDULE (CONT.)

7,500 miles (12,000 km) or 6 months

- Rotate tire
- Inspect battery condition
- Inspect air cleaner filter
- Inspect vacuum hose
- Replace engine oil and filter
(7,500 miles (12,000 km) or 12 months)
- Add fuel additive *¹
(7,500 miles (12,000 km) or 12 months)

* Inspect : Inspect and if necessary, adjust, correct, clean or replace.

15,000 miles (24,000 km) or 12 months

- Rotate tire
- Inspect battery condition
- Inspect air cleaner filter
- Inspect vacuum hose
- Inspect air conditioning refrigerant
- Inspect brake hoses and lines
- Inspect drive shafts and boots
- Inspect exhaust pipe and muffler
- Inspect front brake disc/pads, calipers
- Inspect propeller shaft (AWD)
- Inspect rear brake disc/pads
- Inspect steering gear box, linkage & boots/lower arm ball joint, upper arm ball joint
- Inspect suspension mounting bolts
- Replace climate control air filter
(for evaporator and blower unit)
- Replace engine oil and filter
(15,000 miles (24,000 km) or 24 months)
- Add fuel additive *¹
(15,000 miles (24,000 km) or 24 months)

* Inspect : Inspect and if necessary, adjust, correct, clean or replace.

NORMAL MAINTENANCE SCHEDULE (CONT.)**22,500 miles (36,000 km) or 18 months**

- Rotate tire
- Inspect battery condition
- Inspect air cleaner filter
- Inspect vacuum hose
- Replace engine oil and filter
(22,500 miles (36,000 km) or 36 months)
- Add fuel additive *¹
(22,500 miles (36,000 km) or 36 months)

* Inspect : Inspect and if necessary, adjust, correct, clean or replace.

30,000 miles (48,000 km) or 24 months

- Rotate tire
- Inspect battery condition
- Inspect vacuum hose
- Inspect air conditioning refrigerant
- Inspect brake hoses and lines
- Inspect drive shafts and boots
- Inspect exhaust pipe and muffler
- Inspect front brake disc/pads, calipers
- Inspect propeller shaft (AWD)
- Inspect rear brake disc/pads
- Inspect steering gear box, linkage & boots/lower arm ball joint, upper arm ball joint
- Inspect suspension mounting bolts
- Inspect brake fluid
- Inspect fuel filter *²
- Inspect fuel lines, fuel hoses and connections
- Inspect fuel tank air filter (if equipped) *²
- Inspect parking brake
- Inspect vapor hose and fuel filler cap, fuel tank
- Replace climate control air filter
(for evaporator and blower unit)

(Continued)

NORMAL MAINTENANCE SCHEDULE (CONT.)

(Continued)

- Replace air cleaner filter
- Replace engine oil and filter
(30,000 miles (48,000 km) or 48 months)
- Add fuel additive *¹
(30,000 miles (48,000 km) or 48 months)

* Inspect : Inspect and if necessary, adjust, correct, clean or replace.

37,500 miles (60,000 km) or 30 months

- Rotate tire
- Inspect battery condition
- Inspect air cleaner filter
- Inspect vacuum hose
- Inspect rear axle oil (AWD) *³
- Inspect transfer case oil (AWD) *³
- Replace engine oil and filter
(37,500 miles (60,000 km) or 60 months)
- Add fuel additive *¹
(37,500 miles (60,000 km) or 60 months)

* Inspect : Inspect and if necessary, adjust, correct, clean or replace.

NORMAL MAINTENANCE SCHEDULE (CONT.)**45,000 miles (72,000 km) or 36 months**

- Rotate tire
- Inspect battery condition
- Inspect air cleaner filter
- Inspect vacuum hose
- Inspect air conditioning refrigerant
- Inspect brake hoses and lines
- Inspect drive shafts and boots
- Inspect exhaust pipe and muffler
- Inspect front brake disc/pads, calipers
- Inspect propeller shaft (AWD)
- Inspect rear brake disc/pads
- Inspect steering gear box, linkage & boots/lower arm ball joint, upper arm ball joint
- Inspect suspension mounting bolts
- Replace climate control air filter (for evaporator and blower unit)
- Replace engine oil and filter (45,000 miles (72,000 km) or 72 months)
- Add fuel additive *1 (45,000 miles (72,000 km) or 72 months)

* Inspect : Inspect and if necessary, adjust, correct, clean or replace.

52,500 miles (84,000 km) or 42 months

- Rotate tire
- Inspect battery condition
- Inspect air cleaner filter
- Inspect vacuum hose
- Replace engine oil and filter (52,500 miles (84,000 km) or 84 months)
- Add fuel additive *1 (52,500 miles (84,000 km) or 84 months)

* Inspect : Inspect and if necessary, adjust, correct, clean or replace.

NORMAL MAINTENANCE SCHEDULE (CONT.)

60,000 miles (96,000 km) or 48 months

- Rotate tire
- Inspect battery condition
- Inspect vacuum hose
- Inspect air conditioning refrigerant
- Inspect brake hoses and lines
- Inspect drive shafts and boots
- Inspect exhaust pipe and muffler
- Inspect front brake disc/pads, calipers
- Inspect propeller shaft (AWD)
- Inspect rear brake disc/pads
- Inspect steering gear box, linkage & boots/lower arm ball joint, upper arm ball joint
- Inspect suspension mounting bolts
- Inspect brake fluid
- Inspect fuel filter *2
- Inspect fuel lines, fuel hoses and connections
- Inspect fuel tank air filter (if equipped) *2
- Inspect parking brake
- Inspect vapor hose and fuel filler cap, fuel tank
- Inspect valve clearance *4
(60,000 miles (96,000 km) or 72 months)

(Continued)

(Continued)

- Inspect drive belts
(First, 60,000 miles (96,000 km) or 72 months
after that, every 15,000 miles (24,000 km) or 24 months) *5
- Replace climate control air filter
(for evaporator and blower unit)
- Replace air cleaner filter
- Replace engine oil and filter
(60,000 miles (96,000 km) or 96 months)
- Add fuel additive *1
(60,000 miles (96,000 km) or 96 months)

* Inspect : Inspect and if necessary, adjust, correct, clean or replace.

NORMAL MAINTENANCE SCHEDULE (CONT.)**67,500 miles (108,000 km) or 54 months**

- Rotate tire
- Inspect battery condition
- Inspect air cleaner filter
- Inspect vacuum hose
- Replace engine oil and filter
(67,500 miles (108,000 km) or 108 months)
- Add fuel additive *¹
(67,500 miles (108,000 km) or 108 months)

75,000 miles (120,000 km) or 60 months

- Rotate tire
- Inspect battery condition
- Inspect air cleaner filter
- Inspect vacuum hose
- Inspect air conditioning refrigerant
- Inspect brake hoses and lines
- Inspect drive shafts and boots
- Inspect exhaust pipe and muffler
- Inspect front brake disc/pads, calipers
- Inspect propeller shaft (AWD)
- Inspect rear brake disc/pads
- Inspect steering gear box, linkage & boots/lower arm ball joint, upper arm ball joint
- Inspect suspension mounting bolts
- Inspect rear axle oil (AWD) *³
- Inspect transfer case oil (AWD) *³
- Inspect drive belts
(First, 60,000 miles (96,000 km) or 72 months
after that, every 15,000 miles (24,000 km) or 24 months)*⁵
- Replace climate control air filter
(for evaporator and blower unit)

(Continued)

* Inspect : Inspect and if necessary, adjust, correct, clean or replace.

NORMAL MAINTENANCE SCHEDULE (CONT.)

(Continued)

- Replace engine oil and filter
(75,000 miles (120,000 km) or 120 months)
- Replace coolant
(First, 120,000 miles (192,000 km) or 60 months
after every 30,000 miles (48,000 km) or 24 months)
- Add fuel additive *1
(75,000 miles (120,000 km) or 120 months)

82,500 miles (132,000 km) or 66 months

- Rotate tire
- Inspect battery condition
- Inspect air cleaner filter
- Inspect vacuum hose
- Replace engine oil and filter
(82,500 miles (132,000 km) or 132 months)
- Add fuel additive *1
(82,500 miles (132,000 km) or 132 months)

* Inspect : Inspect and if necessary, adjust, correct, clean or replace.

NORMAL MAINTENANCE SCHEDULE (CONT.)**90,000 miles (144,000 km) or 72 months**

- Rotate tire
- Inspect battery condition
- Inspect vacuum hose
- Inspect air conditioning refrigerant
- Inspect brake hoses and lines
- Inspect drive shafts and boots
- Inspect exhaust pipe and muffler
- Inspect front brake disc/pads, calipers
- Inspect propeller shaft (AWD)
- Inspect rear brake disc/pads
- Inspect steering gear box, linkage & boots/lower arm ball joint, upper arm ball joint
- Inspect suspension mounting bolts
- Inspect brake fluid
- Inspect fuel filter *2
- Inspect fuel lines, fuel hoses and connections
- Inspect fuel tank air filter (if equipped) *2
- Inspect parking brake
- Inspect vapor hose and fuel filler cap, fuel tank
- Inspect drive belts
(First, 60,000 miles (96,000 km) or 72 months
after that, every 15,000 miles (24,000 km) or 24 months) *5

(Continued)

(Continued)

- Replace climate control air filter
(for evaporator and blower unit)
- Replace air cleaner filter
- Replace engine oil and filter
(90,000 miles (144,000 km) or 144 months)
- Add fuel additive *1
(90,000 miles (144,000 km) or 144 months)

* Inspect : Inspect and if necessary, adjust, correct, clean or replace.

NORMAL MAINTENANCE SCHEDULE (CONT.)

97,500 miles (156,000 km) or 78 months

- Rotate tire
- Inspect battery condition
- Inspect air cleaner filter
- Inspect vacuum hose
- Replace engine oil and filter
(97,500 miles (156,000 km) or 156 months)
- Replace spark plugs
(Every 100,000 miles (160,000 km) or 10 years)
- Add fuel additive *¹
(97,500 miles (156,000 km) or 156 months)

* Inspect : Inspect and if necessary, adjust, correct, clean or replace.

105,000 miles (168,000 km) or 84 months

- Rotate tire
- Inspect battery condition
- Inspect air cleaner filter
- Inspect vacuum hose
- Inspect air conditioning refrigerant
- Inspect brake hoses and lines
- Inspect drive shafts and boots
- Inspect exhaust pipe and muffler
- Inspect front brake disc/pads, calipers
- Inspect propeller shaft (AWD)
- Inspect rear brake disc/pads
- Inspect steering gear box, linkage & boots/lower arm ball joint, upper arm ball joint
- Inspect suspension mounting bolts
- Inspect drive belts
(First, 60,000 miles (96,000 km) or 72 months
after that, every 15,000 miles (24,000 km) or 24 months) *⁵
- Replace climate control air filter
(for evaporator and blower unit)
- Replace engine oil and filter
(105,000 miles (168,000 km) or 168 months)

(Continued)

NORMAL MAINTENANCE SCHEDULE (CONT.)

(Continued)

- Replace coolant
(First, 120,000 miles (192,000 km) or 60 months
after every 30,000 miles (48,000 km) or 24 months)
- Add fuel additive *¹
(105,000 miles (168,000 km) or 168 months)

* Inspect : Inspect and if necessary, adjust, correct, clean or replace.

112,500 miles (180,000 km) or 90 months

- Rotate tire
- Inspect battery condition
- Inspect air cleaner filter
- Inspect vacuum hose
- Inspect rear axle oil (AWD) *³
- Inspect transfer case oil (AWD) *³
- Replace engine oil and filter
(112,500 miles (180,000 km) or 180 months)
- Add fuel additive *¹
(112,500 miles (180,000 km) or 180 months)

* Inspect : Inspect and if necessary, adjust, correct, clean or replace.

NORMAL MAINTENANCE SCHEDULE (CONT.)

120,000 miles (192,000 km) or 96 months

- Rotate tire
- Inspect battery condition
- Inspect vacuum hose
- Inspect air conditioning refrigerant
- Inspect brake hoses and lines
- Inspect drive shafts and boots
- Inspect exhaust pipe and muffler
- Inspect front brake disc/pads, calipers
- Inspect propeller shaft (AWD)
- Inspect rear brake disc/pads
- Inspect steering gear box, linkage & boots/lower arm ball joint, upper arm ball joint
- Inspect suspension mounting bolts
- Inspect brake fluid
- Inspect fuel filter *2
- Inspect fuel lines, fuel hoses and connections
- Inspect fuel tank air filter (if equipped) *2
- Inspect parking brake
- Inspect vapor hose and fuel filler cap, fuel tank
- Inspect valve clearance *4
(120,000 miles (192,000 km) or 144 months)

(Continued)

(Continued)

- Inspect drive belts
(First, 60,000 miles (96,000 km) or 72 months
after that, every 15,000 miles (24,000 km) or 24 months) *5
- Replace climate control air filter
(for evaporator and blower unit)
- Replace air cleaner filter
- Replace engine oil and filter
(120,000 miles (192,000 km) or 192 months)
- Replace coolant
(First, 120,000 miles (192,000 km) or 60 months
after that, every 30,000 miles (48,000 km) or 24 months)
- Add fuel additive *1
(120,000 miles (192,000 km) or 192 months)

* Inspect : Inspect and if necessary, adjust, correct, clean or replace.

NORMAL MAINTENANCE SCHEDULE (CONT.)**127,500 miles (204,000 km) or 102 months**

- Rotate tire
- Inspect battery condition
- Inspect air cleaner filter
- Inspect vacuum hose
- Replace engine oil and filter
(127,500 miles (204,000 km) or 204 months)
- Add fuel additive *1
(127,500 miles (204,000 km) or 204 months)

* Inspect : Inspect and if necessary, adjust, correct, clean or replace.

135,000 miles (216,000 km) or 108 months

- Rotate tire
- Inspect battery condition
- Inspect air cleaner filter
- Inspect vacuum hose
- Inspect air conditioning refrigerant
- Inspect brake hoses and lines
- Inspect drive shafts and boots
- Inspect exhaust pipe and muffler
- Inspect front brake disc/pads, calipers
- Inspect propeller shaft (AWD)
- Inspect rear brake disc/pads
- Inspect steering gear box, linkage & boots/lower arm ball joint, upper arm ball joint
- Inspect suspension mounting bolts
- Inspect drive belts
(First, 60,000 miles (96,000 km) or 72 months
after that, every 15,000 miles (24,000 km) or 24 months) *5
- Replace climate control air filter
(for evaporator and blower unit)
- Replace engine oil and filter
(135,000 miles (216,000 km) or 216 months)

(Continued)

NORMAL MAINTENANCE SCHEDULE (CONT.)

(Continued)

- Replace coolant
(First, 120,000 miles (192,000 km) or 60 months
after that, every 30,000 miles (48,000 km) or 24 months)
- Add fuel additive *¹
(135,000 miles (216,000 km) or 216 months)

* Inspect : Inspect and if necessary, adjust, correct, clean or replace.

142,500 miles (228,000 km) or 114 months

- Rotate tire
- Inspect battery condition
- Inspect air cleaner filter
- Inspect vacuum hose
- Replace engine oil and filter
(142,500 miles (228,000 km) or 228 months)
- Add fuel additive *¹
(142,500 miles (228,000 km) or 228 months)

* Inspect : Inspect and if necessary, adjust, correct, clean or replace.

NORMAL MAINTENANCE SCHEDULE (CONT.)**150,000 miles (240,000 km) or 120 months**

- Rotate tire
- Inspect battery condition
- Inspect vacuum hose
- Inspect air conditioning refrigerant
- Inspect brake hoses and lines
- Inspect drive shafts and boots
- Inspect exhaust pipe and muffler
- Inspect front brake disc/pads, calipers
- Inspect propeller shaft (AWD)
- Inspect rear brake disc/pads
- Inspect steering gear box, linkage & boots/lower arm ball joint, upper arm ball joint
- Inspect suspension mounting bolts
- Inspect brake fluid
- Inspect fuel filter *2
- Inspect fuel lines, fuel hoses and connections
- Inspect fuel tank air filter (if equipped) *2
- Inspect parking brake
- Inspect vapor hose and fuel filler cap, fuel tank
- Inspect rear axle oil (AWD) *3
- Inspect transfer case oil (AWD) *3

(Continued)

(Continued)

- Inspect drive belts
(First, 60,000 miles (96,000 km) or 72 months after that, every 15,000 miles (24,000 km) or 24 months) *5
- Replace climate control air filter
(for evaporator and blower unit)
- Replace air cleaner filter
- Replace engine oil and filter
(150,000 miles (240,000 km) or 240 months)
- Replace coolant
(First, 120,000 miles (192,000 km) or 60 months after every 30,000 miles (48,000 km) or 24 months)
- Add fuel additive *1
(150,000 miles (240,000 km) or 240 months)

* Inspect : Inspect and if necessary, adjust, correct, clean or replace.

No check, No service required

- Automatic transaxle fluid

MAINTENANCE UNDER SEVERE USAGE CONDITIONS

The following items must be serviced more frequently on cars normally used under severe driving conditions. Refer to the chart below for the appropriate maintenance intervals.

R : Replace I : Inspect and, after inspection, clean, adjust, repair or replace if necessary

MAINTENANCE ITEM	MAINTENANCE OPERATION	MAINTENANCE INTERVALS	DRIVING CONDITION
ENGINE OIL AND FILTER	R	EVERY 3,750 MILES (6,000 KM) OR 6 MONTHS	A, B, C, D, E, F, G, H, I, K
AIR CLEANER FILTER	R	MORE FREQUENTLY	C, E
SPARK PLUGS	R	MORE FREQUENTLY	B, H
AUTOMATIC TRANSAXLE FLUID	R	EVERY 60,000 MILES (96,000 KM)	A, B, F, G, H, I, J, K
FRONT BRAKE DISC/PADS, CALIPERS	I	MORE FREQUENTLY	C, D, G, H
REAR BRAKE DISC /PADS	I	MORE FREQUENTLY	C, D, G, H
PARKING BRAKE	I	MORE FREQUENTLY	C, D, G, H
STEERING GEAR BOX, LINKAGE & BOOTS/LOWER ARM BALL JOINT, UPPER ARM BALL JOINT	I	MORE FREQUENTLY	C, D, E, F, G, H, I

MAINTENANCE ITEM	MAINTENANCE OPERATION	MAINTENANCE INTERVALS	DRIVING CONDITION
DRIVE SHAFTS AND BOOTS	I	EVERY 7,500 MILES (12,000 KM) OR 6 MONTHS	C, D, E, F, G, H, I, J
TRANSFER CASE OIL (AWD)	R	EVERY 75,000 MILES (120,000 KM)	C, D, E, G, H, I, J
REAR AXLE OIL (AWD)	R	EVERY 75,000 MILES (120,000 KM)	C, D, E, G, H, I, J
CLIMATE CONTROL AIR FILTER (FOR EVAPORATOR AND BLOWER UNIT)	R	MORE FREQUENTLY	C, E
PROPELLER SHAFT	I	EVERY 7,500 MILES (12,000 KM) OR 6 MONTHS	C, E

SEVERE DRIVING CONDITIONS

- A - Repeatedly driving short distance of less than 5 miles (8 km) in normal temperature or less than 10 miles (16 km) in freezing temperature
- B - Extensive engine idling or low speed driving for long distances
- C - Driving on rough, dusty, muddy, unpaved, graveled or salt-spread roads
- D - Driving in areas using salt or other corrosive materials or in very cold weather
- E - Driving in sandy areas

- F - Driving in heavy traffic area over 90°F (32°C)
- G - Driving on uphill, downhill, or mountain road
- H - Towing a Trailer, or using a camper, or roof rack
- I - Driving as a patrol car, taxi, other commercial use or vehicle towing
- J - Driving over 106 mph (170 km/h)
- K - Frequently driving in stop-and-go conditions

EXPLANATION OF SCHEDULED MAINTENANCE ITEMS

Engine oil and filter

The engine oil and filter should be changed at the intervals specified in the maintenance schedule. If the car is being driven in severe conditions, more frequent oil and filter changes are required.

Drive belts

Inspect all drive belts for evidence of cuts, cracks, excessive wear or oil saturation and replace if necessary. Drive belts should be checked periodically for proper tension and adjusted as necessary.

Fuel filter

A clogged filter can limit the speed at which the vehicle may be driven, damage the emission system and cause multiple issues such as hard starting. If an excessive amount of foreign matter accumulates in the fuel tank, the filter may require replacement more frequently.

After installing a new filter, run the engine for several minutes, and check for leaks at the connections. Fuel filters should be installed by an authorized HYUNDAI dealer.

Fuel lines, fuel hoses and connections

Check the fuel lines, fuel hoses and connections for leakage and damage. Have an authorized HYUNDAI dealer replace any damaged or leaking parts immediately.

Vapor hose and fuel filler cap

The vapor hose and fuel filler cap should be inspected at those intervals specified in the maintenance schedule. Make sure that a new vapor hose or fuel filler cap is correctly replaced.

Vacuum crankcase ventilation hoses (if equipped)

Inspect the surface of hoses for evidence of heat and/or mechanical damage. Hard and brittle rubber, cracking, tears, cuts, abrasions, and excessive swelling indicate deterioration. Particular attention should be paid to examine those hose surfaces nearest to high heat sources, such as the exhaust manifold.

Inspect the hose routing to assure that the hoses do not come in contact with any heat source, sharp edges or moving component which might cause heat damage or mechanical wear. Inspect all hose connections, such as clamps and couplings, to make sure they are secure, and that no leaks are present. Hoses should be replaced immediately if there is any evidence of deterioration or damage.

Air cleaner filter

A Genuine HYUNDAI air cleaner filter is recommended when the filter is replaced.

Spark plugs

Make sure to install new spark plugs of the correct heat range.

Valve clearance

Inspect excessive valve noise and/or engine vibration and adjust if necessary. An authorized HYUNDAI dealer should perform the operation.

Cooling system

Check the cooling system parts, such as radiator, coolant reservoir, hoses and connections for leakage and damage. Replace any damaged parts.

Coolant

The coolant should be changed at the intervals specified in the maintenance schedule.

Automatic transaxle fluid (if equipped)

Automatic transaxle fluid should not be checked under normal usage conditions.

But in severe conditions, the fluid should be changed at an authorized HYUNDAI dealer in accordance to the scheduled maintenance at the beginning of this chapter.

*** NOTICE**

Automatic transaxle fluid color is basically red.

As the vehicle is driven, the automatic transaxle fluid will begin to look darker.

It is normal condition and you should not judge the need to replace the fluid based upon the changed color.

CAUTION

The use of a non-specified fluid could result in transaxle malfunction and failure.

Use only specified automatic transaxle fluid. (Refer to "Recommended lubricants and capacities" in section 8.)

Brake hoses and lines

Visually check for proper installation, chafing, cracks, deterioration and any leakage. Replace any deteriorated or damaged parts immediately.

Brake fluid

Check brake fluid level in the brake fluid reservoir. The level should be between "MIN" and "MAX" marks on the side of the reservoir. Use only hydraulic brake fluid conforming to DOT 3 or DOT 4 specification.

Parking brake

Inspect the parking brake system including the parking brake lever (or pedal) and cables.

Brake pads, calipers and rotors

Check the pads for excessive wear, discs for run out and wear, and calipers for fluid leakage.

Suspension mounting bolts

Check the suspension connections for looseness or damage. Retighten to the specified torque.

Steering gear box, linkage & boots/lower arm ball joint

With the vehicle stopped and engine off, check for excessive free-play in the steering wheel.

Check the linkage for bends or damage. Check the dust boots and ball joints for deterioration, cracks, or damage. Replace any damaged parts.

Drive shafts and boots

Check the drive shafts, boots and clamps for cracks, deterioration, or damage. Replace any damaged parts and, if necessary, repack the grease.

Air conditioning refrigerant/compressor (if equipped)

Check the air conditioning lines and connections for leakage and damage.

ENGINE OIL

Checking the engine oil level

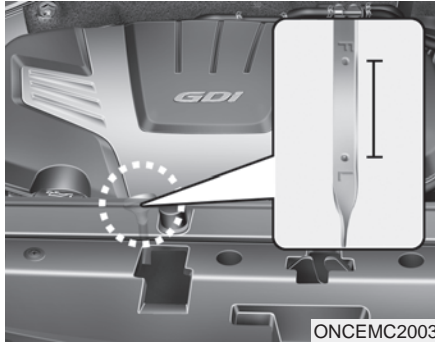

1. Be sure the vehicle is on level ground.
2. Start the engine and allow it to reach normal operating temperature.
3. Turn the engine off and wait for a few minutes (about 5 minutes) for the oil to return to the oil pan.
4. Pull the dipstick out, wipe it clean, and re-insert it fully.

⚠ WARNING - Radiator hose

Be very careful not to touch the radiator hose when checking or adding the engine oil as it may be hot enough to burn you.

5. Pull the dipstick out again and check the level. The level should be between F and L.

⚠ CAUTION

- **Do not overfill with engine oil. Engine damage may result.**
- **Do not spill engine oil, when adding or changing engine oil. If you spill engine oil on the engine room, wipe it off immediately.**

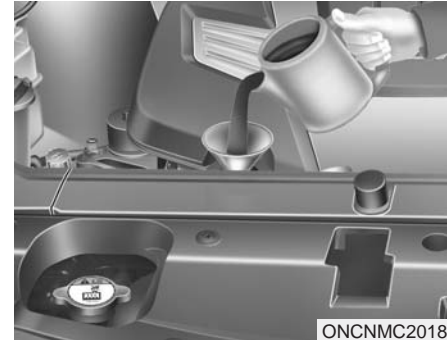

If it is near or at L, add enough oil to bring the level to F. **Do not overfill.**

Use a funnel to help prevent oil from being spilled on engine components.

Use only the specified engine oil. (Refer to "Recommended lubricants and capacities" in section 8.)

Changing the engine oil and filter



Have engine oil and filter changed by an authorized HYUNDAI dealer according to the Maintenance Schedule at the beginning of this section.

⚠ CALIFORNIA PROPOSITION 65 WARNING

Engine oil contains chemicals known to the State of California to cause cancer, birth defects, and reproductive harm.

Used engine oil may cause irritation or cancer of the skin if left in contact with the skin for prolonged periods of time. Used engine oil contains chemicals that have caused cancer in laboratory animals. Always protect your skin by washing your hands thoroughly with soap and warm water as soon as possible after handling used oil.

ENGINE COOLANT

The high-pressure cooling system has a reservoir filled with year-round antifreeze coolant. The reservoir is filled at the factory.

Check the antifreeze protection and coolant concentration level at least once a year, at the beginning of the winter season, and before traveling to a colder climate.

Checking the coolant level

WARNING



Removing radiator cap

- Never attempt to remove the radiator cap while the engine is operating or hot. Doing so might lead to cooling system and engine damage and could result in serious personal injury from escaping hot coolant or steam.

(Continued)

(Continued)

- Turn the engine off and wait until it cools down. Use extreme care when removing the radiator cap. Wrap a thick towel around it, and turn it counterclockwise slowly to the first stop. Step back while the pressure is released from the cooling system.

When you are sure all the pressure has been released, press down on the cap, using a thick towel, and continue turning counterclockwise to remove it.

- Even if the engine is not operating, do not remove the radiator cap or the drain plug while the engine and radiator are hot. Hot coolant and steam may still blow out under pressure, causing serious injury.

WARNING



The electric motor (cooling fan) is controlled by engine coolant temperature, refrigerant pressure and vehicle speed. It may sometimes operate even when the engine is not running. Use extreme caution when working near the blades of the cooling fan so that you are not injured by a rotating fan blades. As the engine coolant temperature decreases, the electric motor will automatically shut off. This is a normal condition.

If your vehicle is equipped with GDI, the electric motor (cooling fan) may operate until you disconnect the negative battery cable.

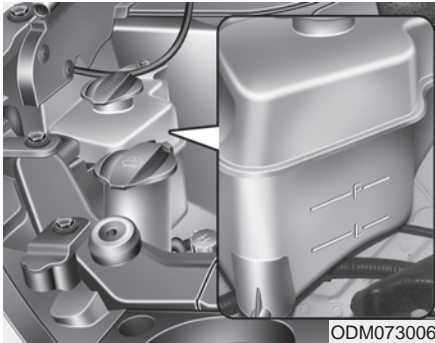

Check the condition and connections of all cooling system hoses and heater hoses. Replace any swollen or deteriorated hoses.

The coolant level should be filled between F (MAX) and L (MIN) marks on the side of the coolant reservoir when the engine is cool.

If the coolant level is low, add enough distilled (deionized) water. Bring the level to F (MAX), but do not overfill.

If frequent coolant refill is required, see an authorized HYUNDAI dealer for a cooling system inspection.

Recommended engine coolant

- When adding coolant, use only deionized water for your vehicle and never mix hard water in the coolant filled at the factory. An improper coolant mixture can result in serious malfunction or engine damage.
- The engine in your vehicle has aluminum engine parts and must be protected by an ethylene-glycol-based coolant to prevent corrosion and freezing.
- DO NOT USE alcohol or methanol coolant or mix them with the specified coolant.
- Do not use a solution that contains more than 60% antifreeze or less than 35% antifreeze, which would reduce the effectiveness of the solution.

For mixture percentage, refer to the following table.

Ambient Temperature	Mixture Percentage (volume)	
	Antifreeze	Water
5°F (-15°C)	35	65
-13°F (-25°C)	40	60
-31°F (-35°C)	50	50
-49°F (-45°C)	60	40

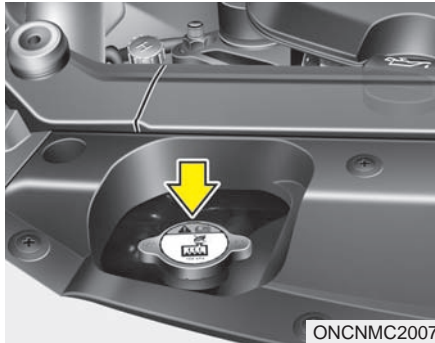

Changing the coolant

Have coolant changed by an authorized HYUNDAI dealer according to the Maintenance Schedule at the beginning of this section.

CAUTION

Put a thick cloth or fabric around the radiator cap before refilling the coolant in order to prevent the coolant from overflowing into engine parts such as generator.

WARNING



Radiator cap

Do not remove the radiator cap when the engine and radiator are hot. Scalding hot coolant and steam may blow out under pressure causing serious injury.

WARNING - Coolant

- Do not use radiator coolant or antifreeze in the washer fluid reservoir.
- Radiator coolant can severely obscure visibility when sprayed on the windshield and may cause loss of vehicle control or damage to paint and body trim.

BRAKE FLUID

Checking the brake fluid level

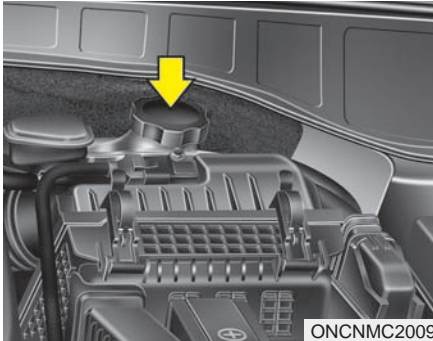

Check the fluid level in the reservoir periodically. The fluid level should be between MAX and MIN marks on the side of the reservoir.

Before removing the reservoir cap and adding brake fluid, clean the area around the reservoir cap thoroughly to prevent brake fluid contamination.

If the level is low, add fluid to the MAX level. The level will fall with accumulated mileage. This is a normal condition associated with the wear of the brake linings. If the fluid level is excessively low, have the brake system checked by an authorized HYUNDAI dealer.

Use only the specified brake fluid. (Refer to "Recommended lubricants and capacities" in section 8.)

Never mix different types of fluid.

⚠ WARNING - Loss of brake fluid

In the event the brake system requires frequent additions of fluid, the vehicle should be inspected by an authorized HYUNDAI dealer.

⚠ WARNING - Brake fluid

When changing and adding brake fluid, handle it carefully.

Do not let it come in contact with your eyes. If brake fluid should come in contact with your eyes, immediately flush them with a large quantity of fresh tap water. Have your eyes examined by a doctor as soon as possible.

⚠ CAUTION

Do not allow brake fluid to contact the vehicle's body paint, as paint damage will result. Brake fluid, which has been exposed to open air for an extended time should never be used as its quality cannot be guaranteed. It should be disposed of properly. Do not put in the wrong type of fluid. A few drops of mineral-based oil, such as engine oil, in your brake system can damage brake system parts.

WASHER FLUID

Checking the washer fluid level

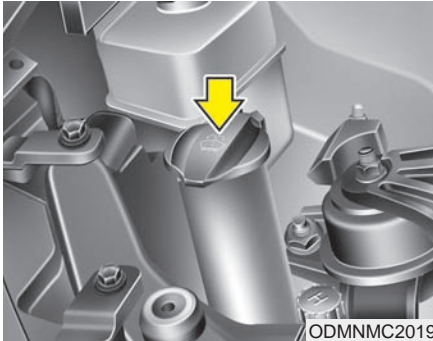

The reservoir is translucent so that you can check the level with a quick visual inspection.

Check the fluid level in the washer fluid reservoir and add fluid if necessary. Plain water may be used if washer fluid is not available. However, use washer solvent with antifreeze characteristics in cold climates to prevent freezing.

⚠ WARNING - Coolant

- Do not use radiator coolant or antifreeze in the washer fluid reservoir.
- Radiator coolant can severely obscure visibility when sprayed on the windshield and may cause loss of vehicle control or damage to paint and body trim.
- Windshield Washer fluid agents contain some amounts of alcohol and can be flammable under certain circumstances. Do not allow sparks or flame to contact the washer fluid or the washer fluid reservoir. Damage to the vehicle or occupants could occur.
- Windshield washer fluid is poisonous to humans and animals. Do not drink and avoid contacting windshield washer fluid. Serious injury or death could occur.

PARKING BRAKE

Checking the parking brake

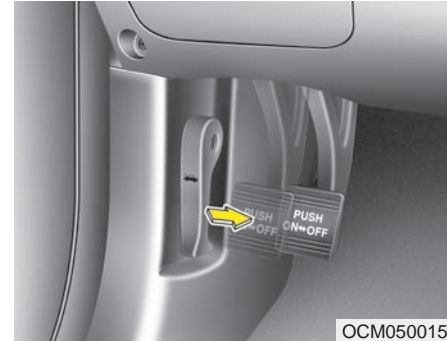

Check whether the stroke is within the recommended specification when the parking brake pedal is fully engaged. When engaged, the parking brake alone should hold the vehicle securely. If the stroke is more or less than specified, have the parking brake adjusted by an authorized HYUNDAI dealer.

Stroke : 8-9 notches

AIR CLEANER

Filter replacement

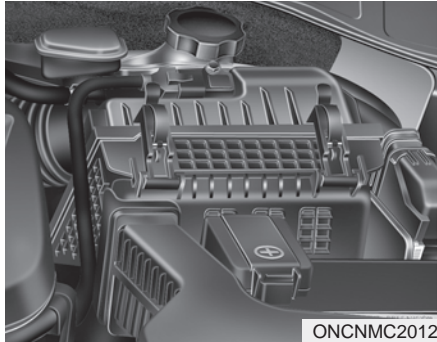

It must be replaced when necessary, and should not be washed.

You can clean the filter when inspecting the air cleaner element.

Clean the filter by using compressed air.

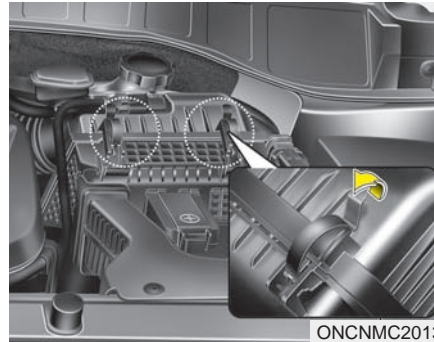

1. Loosen the air cleaner cover attaching clips and open the cover.

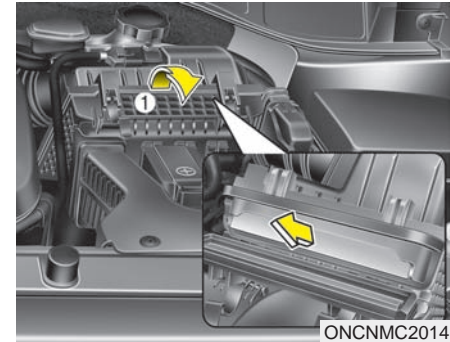

2. Wipe the inside of the air cleaner.
3. Lift the air cleaner cover and pull the air cleaner filter cover.
4. Pull the air cleaner to replace.
5. Lock the cover (1) with the cover attaching clips.
6. Verify that the air cleaner cover is properly attached at all four corners and sealing against air cleaner.

Replace the filter according to the Maintenance Schedule.

If the vehicle is operated in extremely dusty or sandy areas, replace the element more often than the usual recommended intervals. (Refer to "Maintenance under severe usage conditions" in this section.)

 **CAUTION**

- ***Do not drive with the air cleaner removed; this will result in excessive engine wear.***
- ***When removing the air cleaner filter, be careful that dust or dirt does not enter the air intake, or damage may result.***
- ***Use a HYUNDAI genuine part. Use of nongenuine part could damage the air flow sensor.***

CLIMATE CONTROL AIR FILTER (IF EQUIPPED)

Filter inspection

If the vehicle is operated in the severely air-polluted cities or on dusty rough roads for a long period, it should be inspected more frequently and replaced earlier. When you, the owner, replace the climate control air filter, replace it performing the following procedure, and be careful to avoid damaging other components.

Replace the filter according to the maintenance Schedule.

Filter replacement

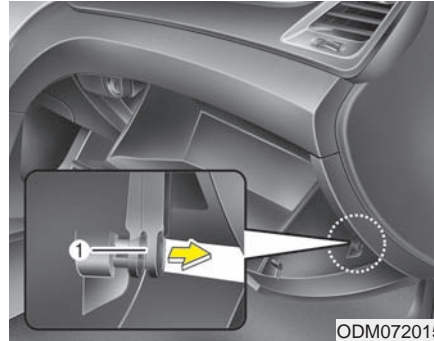

1. Open the glove box and remove the support strap (1).

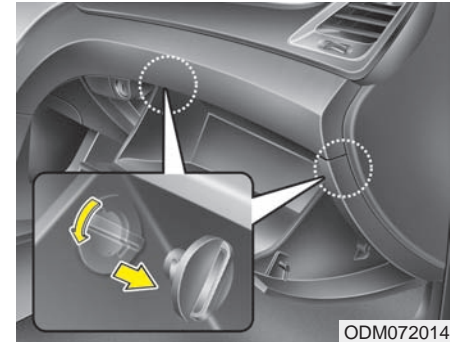

2. With the glove box open, remove the stoppers on both sides.

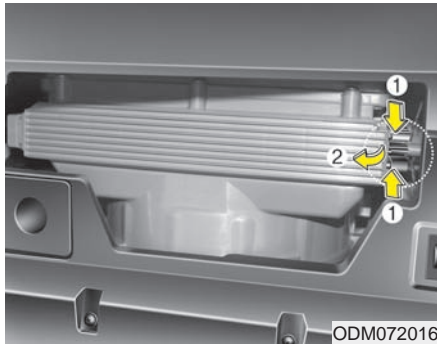

3. Remove the climate control air filter case by pulling out both sides of the cover.

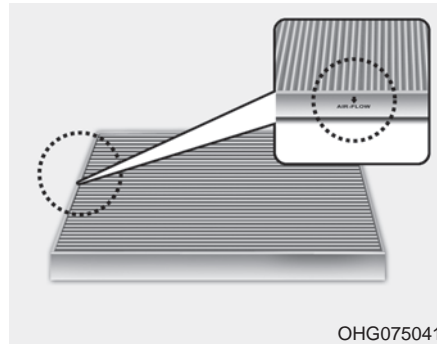

4. Replace the climate control air filter.
5. Reassemble in the reverse order of disassembly.

* NOTICE

Install a new climate control air filter in the correct direction with the arrow symbol (↓) facing downwards.

Otherwise, the climate control effects may decrease, possibly with a noise.

WIPER BLADES

Blade inspection

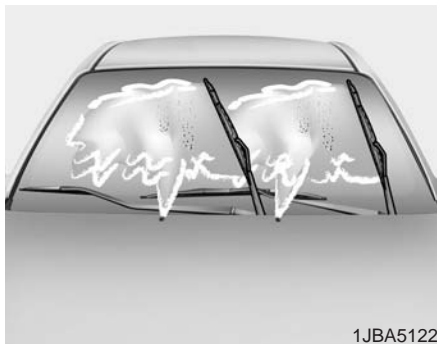

1JBA5122

* NOTICE

Commercial hot waxes applied by automatic car washes have been known to make the windshield difficult to clean.

Contamination of either the windshield or the wiper blades with foreign matter can reduce the effectiveness of the windshield wipers. Common sources of contamination are insects, tree sap, and hot wax treatments used by some commercial car washes. If the blades are not wiping properly, clean both the window and the blades with a good cleaner or mild detergent, and rinse thoroughly with clean water.

⚠ CAUTION

To prevent damage to the wiper blades, do not use gasoline, kerosene, paint thinner, or other solvents on or near them.

Blade replacement

When the wipers no longer clean adequately, the blades may be worn or cracked, and require replacement.

⚠ CAUTION

To prevent damage to the wiper arms or other components, do not attempt to move the wipers manually.

⚠ CAUTION

The use of a non-specified wiper blade could result in wiper malfunction and failure.

Front windshield wiper blade

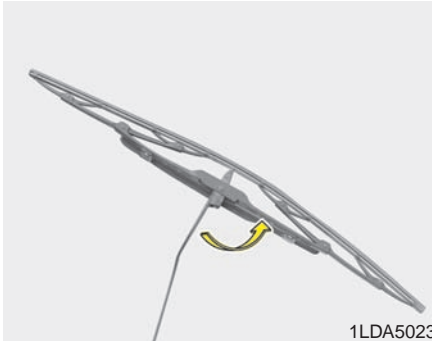

1. Raise the wiper arm and turn the wiper blade assembly to expose the plastic locking clip.

CAUTION

Do not allow the wiper arm to fall against the windshield, since it may chip or crack the windshield.

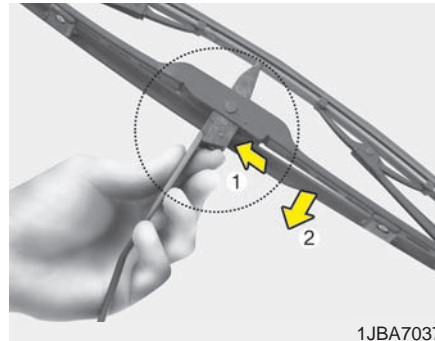

2. Compress the clip and slide the blade assembly downward.

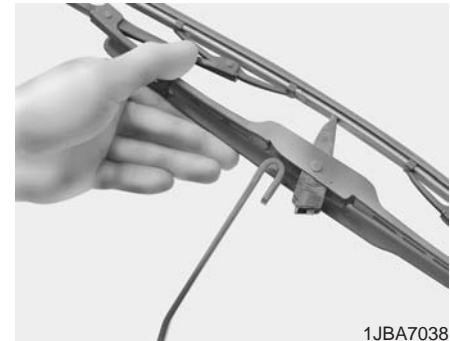

3. Lift it off the arm.
4. Install the blade assembly in the reverse order of removal.

Rear window wiper blade

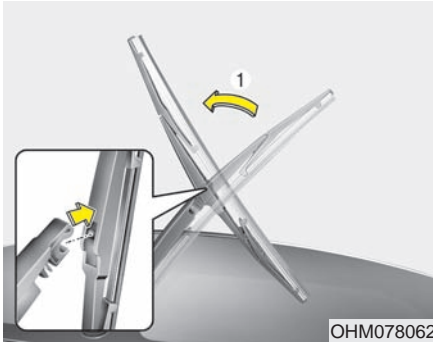

1. Raise the wiper arm and pull out the wiper blade assembly.

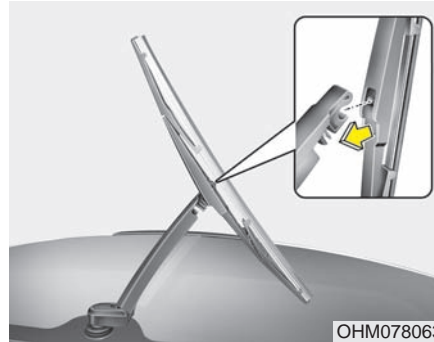

2. Install the new blade assembly by inserting the center part into the slot in the wiper arm until it clicks into place.
3. Make sure the blade assembly is installed firmly by trying to pull it slightly.

To prevent damage to the wiper arms or other components, have an authorized HYUNDAI dealer replace the wiper blade.

BATTERY

For best battery service

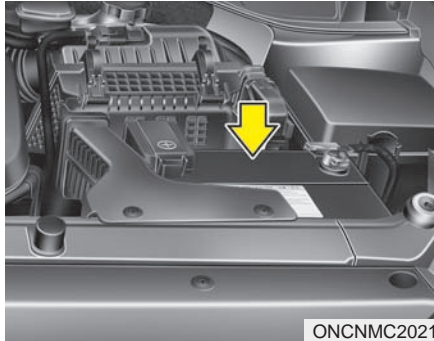

- Keep the battery securely mounted.
- Keep the battery top clean and dry.
- Keep the terminals and connections clean, tight, and coated with petroleum jelly or terminal grease.
- Rinse any spilled electrolyte from the battery immediately with a solution of water and baking soda.
- If the vehicle is not going to be used for an extended time, disconnect the battery cables.

⚠ WARNING - Battery dangers



Always read the following instructions carefully when handling a battery.



Keep lighted cigarettes and all other flames or sparks away from the battery.



Hydrogen, a highly combustible gas, is always present in battery cells and may explode if ignited.



Keep batteries out of the reach of children because batteries contain highly corrosive **SULFURIC ACID**. Do not allow battery acid to contact your skin, eyes, clothing or paint finish.

(Continued)

(Continued)



If any electrolyte gets into your eyes, flush your eyes with clean water for at least 15 minutes and get immediate medical attention.

If electrolyte gets on your skin, thoroughly wash the contacted area. If you feel a pain or a burning sensation, get medical attention immediately.



Wear eye protection when charging or working near a battery. Always provide ventilation when working in an enclosed space.



An inappropriately disposed battery can be harmful to the environment and human health. Dispose the battery according to your local law(s) or regulation.

(Continued)

(Continued)

- When lifting a plastic-cased battery, excessive pressure on the case may cause battery acid to leak, resulting in personal injury. Lift with a battery carrier or with your hands on opposite corners.
- Never attempt to recharge the battery when the battery cables are connected.
- The electrical ignition system works with high voltage. Never touch these components with the engine running or the ignition switched on.

Failure to follow the above warnings can result in serious bodily injury or death.

 **CALIFORNIA PROPOSITION 65 WARNING**

Battery posts, terminals, and related accessories contain lead and lead compounds, chemicals known to the State of California to cause cancer, birth defects, and reproductive harm. Batteries also contain other chemicals known to the State of California to cause cancer. Wash hands after handling.

 **CAUTION**

- *Always charge the battery fully to prevent battery case damage in low temperature area.*
- *If you connect unauthorized electronic devices to the battery, the battery may discharge. Never use unauthorized devices.*

Battery recharging

Your vehicle has a maintenance-free, calcium-based battery.

- If the battery becomes discharged in a short time (because, for example, the headlights or interior lights were left on while the vehicle was not in use), recharge it by slow charging (trickle) for 10 hours.
- If the battery gradually discharges because of high electric load while the vehicle is being used, recharge it at 20-30A for two hours.

⚠ WARNING - Recharging battery

When recharging the battery, observe the following precautions:

- The battery must be removed from the vehicle and placed in an area with good ventilation.
- Do not allow cigarettes, sparks, or flame near the battery.
- Watch the battery during charging, and stop or reduce the charging rate if the battery cells begin gassing (boiling) violently or if the temperature of the electrolyte of any cell exceeds 120°F (49°C).
- Wear eye protection when checking the battery during charging.

(Continued)

(Continued)

- **Disconnect the battery charger in the following order.**
 1. Turn off the battery charger main switch.
 2. Unhook the negative clamp from the negative battery terminal.
 3. Unhook the positive clamp from the positive battery terminal.
- Before performing maintenance or recharging the battery, turn off all accessories and stop the engine.
- The negative battery cable must be removed first and installed last when the battery is disconnected.

Reset items

Items should be reset after the battery has been discharged or the battery has been disconnected.

- Auto up/down window (See section 4)
- Sunroof (See section 4)
- Trip computer (See section 4)
- Climate control system (See section 4)
- Clock (See section 4)
- Audio (See section 4)

TIRES AND WHEELS

Tire care

For proper maintenance, safety, and maximum fuel economy, you must always maintain recommended tire inflation pressures and stay within the load limits and weight distribution recommended for your vehicle.

Recommended cold tire inflation pressures

All tire pressures (including the spare) should be checked when the tires are cold. "Cold Tires" means the vehicle has not been driven for at least three hours or driven less than 1 mile (1.6 km).

Recommended pressures must be maintained for the best ride, top vehicle handling, and minimum tire wear.

For recommended inflation pressure refer to "Tire and wheels" in section 8.



ODMNM2017

All specifications (sizes and pressures) can be found on a label attached to the vehicle.

⚠ WARNING - Tire underinflation

Severe underinflation (10 psi (70 kPa) or more) can lead to severe heat build-up, causing blowouts, tread separation and other tire failures that can result in the loss of vehicle control leading to severe injury or death. This risk is much higher on hot days and when driving for long periods at high speeds.

⚠ CAUTION

- ***Underinflation also results in excessive wear, poor handling and reduced fuel economy. Wheel deformation also is possible. Keep your tire pressures at the proper levels. If a tire frequently needs refilling, have it checked by an authorized HYUNDAI dealer.***
- ***Overinflation produces a harsh ride, excessive wear at the center of the tire tread, and a greater possibility of damage from road hazards.***

⚠ CAUTION

- *Warm tires normally exceed recommended cold tire pressures by 4 to 6 psi (28 to 41 kPa). Do not release air from warm tires to adjust the pressure or the tires will be under-inflated.*
- *Be sure to reinstall the tire inflation valve caps. Without the valve cap, dirt or moisture could get into the valve core and cause air leakage. If a valve cap is missing, install a new one as soon as possible.*

⚠ WARNING - Tire inflation

Overinflation or underinflation can reduce tire life, adversely affect vehicle handling, and lead to sudden tire failure. This could result in loss of vehicle control and potential injury.

⚠ CAUTION - Tire pressure

Always observe the following:

- *Check tire pressure when the tires are cold. (After vehicle has been parked for at least three hours or hasn't been driven more than 1 mile (1.6 km) since startup.)*
- *Check the pressure of your spare tire each time you check the pressure of other tires.*
- *Never overload your vehicle. Be careful not to overload a vehicle luggage rack if your vehicle is equipped with one.*
- *Worn, old tires can cause accidents. If your tread is badly worn, or if your tires have been damaged, replace them.*

Checking tire inflation pressure

Check your tires once a month or more.

Also, check the tire pressure of the spare tire.

How to check

Use a good quality gage to check tire pressure. You can not tell if your tires are properly inflated simply by looking at them. Radial tires may look properly inflated even when they're underinflated.

Check the tire's inflation pressure when the tires are cold. - "Cold" means your vehicle has been sitting for at least three hours or driven no more than 1 mile (1.6 km).

Remove the valve cap from the tire valve stem. Press the tire gauge firmly onto the valve to get a pressure measurement. If the cold tire inflation pressure matches the recommended pressure on the tire and loading information label, no further adjustment is necessary. If the pressure is low, add air until you reach the recommended amount.

If you overfill the tire, release air by pushing on the metal stem in the center of the tire valve. Recheck the tire pressure with the tire gauge. Be sure to put the valve caps back on the valve stems. They help prevent leaks by keeping out dirt and moisture.

WARNING

- **Inspect your tires frequently for proper inflation as well as wear and damage. Always use a tire pressure gauge.**
- **Tires with too much or too little pressure wear unevenly causing poor handling, loss of vehicle control, and sudden tire failure leading to accidents, injuries, and even death. The recommended cold tire pressure for your vehicle can be found in this manual and on the tire label located on the driver's side center pillar.**
- **Worn tires can cause accidents. Replace tires that are worn, show uneven wear, or are damaged.**
- **Remember to check the pressure of your spare tire. HYUNDAI recommends that you check the spare every time you check the pressure of the other tires on your vehicle.**

Tire rotation

To equalize tread wear, it is recommended that the tires be rotated every 7,500 miles (12,000 km) or sooner if irregular wear develops.

During rotation, check the tires for correct balance.

When rotating tires, check for uneven wear and damage. Abnormal wear is usually caused by incorrect tire pressure, improper wheel alignment, out-of-balance wheels, severe braking or severe cornering. Look for bumps or bulges in the tread or side of tire. Replace the tire if you find either of these conditions. Replace the tire if fabric or cord is visible. After rotation, be sure to bring the front and rear tire pressures to specification and check lug nut tightness.

Refer to "Tire and wheels" in section 8.

Without a spare tire

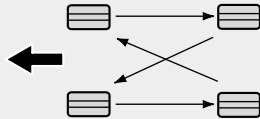

S2BLA790A

Disc brake pads should be inspected for wear whenever tires are rotated.

* NOTICE

Rotate radial tires that have an asymmetric tread pattern only from front to rear and not from right to left.

⚠ WARNING

- Do not use the compact spare tire for tire rotation.
- Do not mix bias ply and radial ply tires under any circumstances. This may cause unusual handling characteristics that could result in death, severe injury, or property damage.

Wheel alignment and tire balance

The wheels on your vehicle were aligned and balanced carefully at the factory to give you the longest tire life and best overall performance.

In most cases, you will not need to have your wheels aligned again. However, if you notice unusual tire wear or your vehicle pulling one way or the other, the alignment may need to be reset.

If you notice your vehicle vibrating when driving on a smooth road, your wheels may need to be rebalanced.

⚠ CAUTION

Improper wheel weights can damage your vehicle's aluminum wheels. Use only approved wheel weights.

Tire replacement



If the tire is worn evenly, a tread wear indicator will appear as a solid band across the tread. This shows there is less than 1/16 in. (1.6 mm) of tread left on the tire. Replace the tire when this happens.

Do not wait for the band to appear across the entire tread before replacing the tire.

⚠ WARNING - Replacing tires

- Driving on worn-out tires is very hazardous and will reduce braking effectiveness, steering accuracy, and traction.
- Your vehicle is equipped with tires designed to provide for safe ride and handling capability. Do not use a size and type of tire and wheel that is different from the one that is originally installed on your vehicle. It can affect the safety and performance of your vehicle, which could lead to handling failure or rollover and serious injury. When replacing the tires, be sure to equip all four tires with the tire and wheel of the same size, type, tread, brand and load-carrying capacity.

(Continued)

(Continued)

- The use of any other tire size or type may seriously affect ride, handling, ground clearance, stopping distance, body to tire clearance, snow tire clearance, and speedometer reliability.
- It is best to replace all four tires at the same time. If that is not possible, or necessary, then replace the two front or two rear tires as a pair. Replacing just one tire can seriously affect your vehicle's handling.
- The ABS works by comparing the speed of the wheels. Tire size can affect wheel speed. When replacing tires, all 4 tires must use the same size originally supplied with the vehicle. Using tires of a different size can cause the ABS (Anti-lock Brake System) and ESC (Electronic Stability Control), to work irregularly.

Compact spare tire replacement (if equipped)

A compact spare tire has a shorter tread life than a regular size tire. Replace it when you can see the tread wear indicator bars on the tire. The replacement compact spare tire should be the same size and design tire as the one provided with your new vehicle and should be mounted on the same compact spare tire wheel. The compact spare tire is not designed to be mounted on a regular size wheel, and the compact spare tire wheel is not designed for mounting a regular size tire.

Wheel replacement

When replacing the metal wheels for any reason, make sure the new wheels are equivalent to the original factory units in diameter, rim width and offset.

⚠ WARNING

A wheel that is not the correct size may adversely affect wheel and bearing life, braking and stopping abilities, handling characteristics, ground clearance, body-to-tire clearance, snow chain clearance, speedometer and odometer calibration, headlight aim and bumper height.

Tire traction

Tire traction can be reduced if you drive on worn tires, tires that are improperly inflated or on slippery road surfaces. Tires should be replaced when tread wear indicators appear. To reduce the possibility of losing control, slow down whenever there is rain, snow or ice on the road.

Tire maintenance

In addition to proper inflation, correct wheel alignment helps to decrease tire wear. If you find a tire is worn unevenly, have your dealer check the wheel alignment.

When you have new tires installed, make sure they are balanced. This will increase vehicle ride comfort and tire life. Additionally, a tire should always be rebalanced if it is removed from the wheel.

Tire sidewall labeling

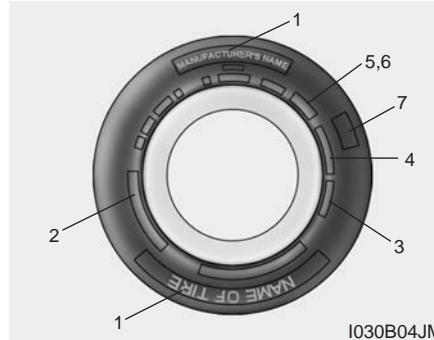

This information identifies and describes the fundamental characteristics of the tire and also provides the tire identification number (TIN) for safety standard certification. The TIN can be used to identify the tire in case of a recall.

1. *Manufacturer or brand name*

Manufacturer or Brand name is shown.

2. *Tire size designation*

A tire's sidewall is marked with a tire size designation. You will need this information when selecting replacement tires for your car. The following explains what the letters and numbers in the tire size designation mean.

Example tire size designation:

(These numbers are provided as an example only; your tire size designator could vary depending on your vehicle.)

(P)235/65R17 102H

(P) - Applicable vehicle type (tires marked with the prefix "P" are intended for use on passenger vehicles or light trucks; however, not all tires have this marking).

235 - Tire width in millimeters.

65 - Aspect ratio. The tire's section height as a percentage of its width.

R - Tire construction code (Radial).

17 - Rim diameter in inches.

102 - Load Index, a numerical code associated with the maximum load the tire can carry.

H - Speed Rating Symbol. See the speed rating chart in this section for additional information.

Wheel size designation

Wheels are also marked with important information that you need if you ever have to replace one. The following explains what the letters and numbers in the wheel size designation mean.

Example wheel size designation:

7.0JX17

7.0 - Rim width in inches.

J - Rim contour designation.

17 - Rim diameter in inches.

Tire speed ratings

The chart below lists many of the different speed ratings currently being used for passenger car tires. The speed rating is part of the tire size designation on the sidewall of the tire. This symbol corresponds to that tire's designed maximum safe operating speed.

Speed Rating Symbol	Maximum Speed
S	112 mph (180 km/h)
T	118 mph (190 km/h)
H	130 mph (210 km/h)
V	149 mph (240 km/h)
Z	Above 149 mph (240 km/h)

3. Checking tire life (TIN : Tire Identification Number)

Any tires that are over 6 years old, based on the manufacturing date (including the spare tire) should be replaced by new ones. You can find the manufacturing date on the tire sidewall (possibly on the inside of the wheel), displaying the DOT Code. The DOT Code is a series of numbers on a tire consisting of numbers and English letters. The manufacturing date is designated by the last four digits (characters) of the DOT code.

DOT : XXXX XXXX OOOO

The front part of the DOT means a plant code number, tire size and tread pattern and the last four numbers indicate week and year manufactured.

For example:

DOT XXXX XXXX 1615 represents that the tire was produced in the 16th week of 2015.

⚠ WARNING - Tire age

Tires degrade over time, even when they are not being used. Regardless of the remaining tread, it is recommended that tires generally be replaced after six (6) years of normal service. Heat caused by hot climates or frequent high loading conditions can accelerate the aging process. Failure to follow this Warning can result in sudden tire failure, which could lead to a loss of control and an accident involving serious injury or death.

4. Tire ply composition and material

The number of layers or plies of rubber-coated fabric in the tire. Tire manufacturers also must indicate the materials in the tire, which include steel, nylon, polyester, and others. The letter "R" means radial ply construction; the letter "D" means diagonal or bias ply construction; and the letter "B" means belted-bias ply construction.

5. Maximum permissible inflation pressure

This number is the greatest amount of air pressure that should be put in the tire. Do not exceed the maximum permissible inflation pressure. Refer to the Tire and Loading Information label for recommended inflation pressure.

6. Maximum load rating

This number indicates the maximum load in kilograms and pounds that can be carried by the tire. When replacing the tires on the vehicle, always use a tire that has the same load rating as the factory installed tire.

7. Uniform tire quality grading

Quality grades can be found where applicable on the tire sidewall between tread shoulder and maximum section width.

For example:

TREADWEAR 200
TRACTION AA
TEMPERATURE A

Tread wear

The tread wear grade is a comparative rating based on the wear rate of the tire when tested under controlled conditions on a specified government test course. For example, a tire graded 150 would wear one-and-a-half times (1½) as well on the government course as a tire graded 100.

The relative performance of tires depends upon the actual conditions of their use, however, and may depart significantly from the norm because of variations in driving habits, service practices and differences in road characteristics and climate.

These grades are molded on the side-walls of passenger vehicle tires. The tires available as standard or optional equipment on your vehicle may vary with respect to grade.

Traction - AA, A, B & C

The traction grades, from highest to lowest, are AA, A, B and C. Those grades represent the tires ability to stop on wet pavement as measured under controlled conditions on specified government test surfaces of asphalt and concrete. A tire marked C may have poor traction performance.

WARNING

The traction grade assigned to this tire is based on straight-ahead braking traction tests, and does not include acceleration, cornering, hydroplaning, or peak traction characteristics.

Temperature -A, B & C

The temperature grades are A (the highest), B and C representing the tire's resistance to the generation of heat and its ability to dissipate heat when tested under controlled conditions on a specified indoor laboratory test wheel.

Sustained high temperature can cause the material of the tire to degenerate and reduce tire life, and excessive temperature can lead to sudden tire failure. The Grade C corresponds to a level of performance which all passenger car tires must meet under the Federal Motor Vehicle Safety Standard NO. 109. Grades B and A represent higher levels of performance on the laboratory test wheel than the minimum required by the law.

WARNING - Tire temperature

The temperature grade for this tire is established for a tire that is properly inflated and not overloaded. Excessive speed, underinflation, or excessive loading, either separately or in combination, can cause heat build-up and possible sudden tire failure. This can cause loss of vehicle control and serious injury or death.

Tire terminology and definitions

Air Pressure: The amount of air inside the tire pressing outward on the tire. Air pressure is expressed in pounds per square inch (psi) or kilopascal (kPa).

Accessory Weight: This means the combined weight of optional accessories. Some examples of optional accessories are, automatic transaxle power seats, and air conditioning.

Aspect Ratio: The relationship of a tire's height to its width.

Belt: A rubber coated layer of cords that is located between the plies and the tread. Cords may be made from steel or other reinforcing materials.

Bead: The tire bead contains steel wires wrapped by steel cords that hold the tire onto the rim.

Bias Ply Tire: A pneumatic tire in which the plies are laid at alternate angles less than 90 degrees to the centerline of the tread.

Cold Tire Pressure: The amount of air pressure in a tire, measured in pounds per square inch (psi) or kilopascals (kPa) before a tire has built up heat from driving.

Curb Weight: This means the weight of a motor vehicle with standard and optional equipment including the maximum capacity of fuel, oil and coolant, but without passengers and cargo.

DOT Markings: A code molded into the sidewall of a tire signifying that the tire is in compliance with the U.S. Department of Transportation motor vehicle safety standards. The DOT code includes the Tire Identification Number (TIN), an alphanumeric designator which can also identify the tire manufacturer, production plant, brand and date of production.

GVWR: Gross Vehicle Weight Rating

GAWR FRT: Gross Axle Weight Rating for the Front Axle.

GAWR RR: Gross Axle Weight Rating for the Rear axle.

Intended Outboard Sidewall: The side of an asymmetrical tire, that must always face outward when mounted on a vehicle.

Kilopascal (kPa): The metric unit for air pressure.

Light truck(LT) tire: A tire designated by its manufacturer as primarily intended for use on lightweight trucks or multipurpose passenger vehicles.

Load ratings: The maximum load that a tire is rated to carry for a given inflation pressure.

Load Index: An assigned number ranging from 1 to 279 that corresponds to the load carrying capacity of a tire.

Maximum Inflation Pressure: The maximum air pressure to which a cold tire may be inflated. The maximum air pressure is molded onto the sidewall.

Maximum Load Rating: The load rating for a tire at the maximum permissible inflation pressure for that tire.

Maximum Loaded Vehicle Weight: The sum of curb weight; accessory weight; vehicle capacity weight; and production options weight.

Normal Occupant Weight: The number of occupants a vehicle is designed to seat multiplied by 150 pounds (68 kg).

Occupant Distribution: Designated seating positions.

Outward Facing Sidewall: The side of a asymmetrical tire that has a particular side that faces outward when mounted on a vehicle. The outward facing sidewall bears white lettering or bears manufacturer, brand, and/or model name molding that is higher or deeper than the same moldings on the inner facing sidewall.

Passenger (P-Metric) Tire: A tire used on passenger cars and some light duty trucks and multipurpose vehicles.

Ply: A layer of rubber-coated parallel cords

Pneumatic tire: A mechanical device made of rubber, chemicals, fabric and steel or other materials, that, when mounted on an automotive wheel, provides the traction and contains the gas or fluid that sustains the load.

Production options weight: The combined weight of installed regular production options weighing over 5 lb. (2.3 kg) in excess of the standard items which they replace, not previously considered in curb weight or accessory weight, including heavy duty brakes, ride levelers, roof rack, heavy duty battery, and special trim.

Recommended Inflation Pressure: Vehicle manufacturer's recommended tire inflation pressure and shown on the tire placard.

Radial Ply Tire: A pneumatic tire in which the ply cords that extend to the beads are laid at 90 degrees to the centerline of the tread.

Rim: A metal support for a tire and upon which the tire beads are seated.

Sidewall: The portion of a tire between the tread and the bead.

Speed Rating: An alphanumeric code assigned to a tire indicating the maximum speed at which a tire can operate.

Traction: The friction between the tire and the road surface. The amount of grip provided.

Tread: The portion of a tire that comes into contact with the road.

Treadwear Indicators: Narrow bands, sometimes called "wear bars", that show across the tread of a tire when only 2/32 inch of tread remains.

UTQGS: Uniform Tire Quality Grading Standards, a tire information system that provides consumers with ratings for a tire's traction, temperature and treadwear. Ratings are determined by tire manufacturers using government testing procedures. The ratings are molded into the sidewall of the tire.

Vehicle Capacity Weight: The number of designated seating positions multiplied by 150 lbs. (68 kg) plus the rated cargo and luggage load.

Vehicle Maximum Load on the Tire: Load on an individual tire due to curb and accessory weight plus maximum occupant and cargo weight.

Vehicle Normal Load on the Tire: Load on an individual tire that is determined by distributing to each axle its share of the curb weight, accessory weight, and normal occupant weight and dividing by 2.

Vehicle Placard: A label permanently attached to a vehicle showing the original equipment tire size and recommended inflation pressure.

All season tires

HYUNDAI specifies all season tires on some models to provide good performance for use all year round, including snowy and icy road conditions. All season tires are identified by ALL SEASON and/or M+S (Mud and Snow) on the tire sidewall. Snow tires have better snow traction than all season tires and may be more appropriate in some areas.

Summer tires

HYUNDAI specifies summer tires on some models to provide superior performance on dry roads. Summer tire performance is substantially reduced in snow and ice. Summer tires do not have the tire traction rating M+S (Mud and Snow) on the tire side wall. If you plan to operate your vehicle in snowy or icy conditions, HYUNDAI recommends the use of snow tires or all season tires on all four wheels.

Snow tires

If you equip your car with snow tires, they should be the same size and have the same load capacity as the original tires. Snow tires should be installed on all four wheels; otherwise, poor handling may result.

Snow tires should carry 4 psi (28 kPa) more air pressure than the pressure recommended for the standard tires on the tire label on the driver's side of the center pillar, or up to the maximum pressure shown on the tire sidewall, whichever is less.

Do not drive faster than 75 mph (120 km/h) when your car is equipped with snow tires.

Tire chains

Tire chains, if necessary, should be installed on the drive wheels as follows.

2WD : Front wheels

AWD : All four wheels

If a full set of chains is not available for a AWD vehicle, chains may be installed on the front wheels only.

Be sure that the chains are installed in accordance with the manufacturer's instructions.

To minimize tire and chain wear, do not continue to use tire chains when they are no longer needed.

WARNING - Snow or ice

- When driving on roads covered with snow or ice, drive at less than 20 mph (30 km/h).
- Use the SAE "S" class or wire chains.
- If you hear noise caused by chains contacting the body, retighten the chain to avoid contact with the vehicle body.
- To prevent body damage, retighten the chains after driving 0.3~0.6 miles (0.5~1.0 km).
- Do not use tire chains on vehicles equipped with aluminum wheels. In unavoidable circumstance, use a wire type chain.
- Use wire chains less than 0.59 inches (15mm) to prevent damage to the chain's connection.

Radial-ply tires

Radial-ply tires provide improved tread life, road hazard resistance and smoother high speed ride. The radial-ply tires used on this vehicle are of belted construction, and are selected to complement the ride and handling characteristics of your vehicle. Radial-ply tires have the same load carrying capacity, as bias-ply or bias belted tires of the same size, and use the same recommended inflation pressure. Mixing of radial-ply tires with bias-ply or bias belted tires is not recommended. Any combinations of radial-ply and bias-ply or bias belted tires when used on the same vehicle will seriously deteriorate vehicle handling. The best rule to follow is: Identical radial-ply tires should always be used as a set of four. Longer wearing tires can be more susceptible to irregular tread wear. It is very important to follow the tire rotation interval shown in this section to achieve the tread life potential of these tires. Cuts and punctures in radial-ply tires are repairable only in the tread area, because of sidewall flexing. Consult your tire dealer for radial-ply tire repairs.

Low aspect ratio tire (if equipped)

Low aspect ratio tires, whose aspect ratio is lower than 50, are provided for sporty looks.

Because the low aspect ratio tires are optimized for handling and braking, it may be more uncomfortable to ride in and there is more noise compare with normal tires.

CAUTION

Because the sidewall of the low aspect ratio tire is shorter than the normal, the wheel and tire of the low aspect ratio tire is easier to be damaged. So, follow the instructions below.

- ***When driving on a rough road or off road, drive cautiously because tires and wheels may be damaged. And after driving, inspect tires and wheels.***
- ***When passing over a pothole, speed bump, manhole, or curb stone, drive slowly so that the tires and wheels are not damaged.***

(Continued)

(Continued)

- ***If the tire is impacted, inspect the tire condition or contact an authorized HYUNDAI dealer.***
- ***To prevent damage to the tire, inspect the tire condition and pressure every 1,800miles (3,000km).***

CAUTION

- ***It is not easy to recognize the tire damage with your own eyes. But if there is the slightest hint of tire damage, even though you cannot see the tire damage with your own eyes, have the tire checked or replaced because the tire damage may cause air leakage from the tire.***
- ***If the tire is damaged by driving on a rough road, off road, pothole, manhole, or curb stone, it will not be covered by the warranty.***
- ***You can find out the tire information on the tire sidewall.***

FUSES

■ Blade type



Normal



Blown

■ Cartridge type



Normal



Blown

■ Multi fuse



Normal

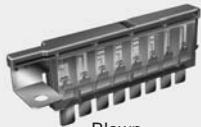

Blown

■ BFT



Normal



Blown

OLM079051N

A vehicle's electrical system is protected from electrical overload damage by fuses.

This vehicle has 2 fuse panels, one located in the driver's side panel bolster, the other in the engine compartment near the battery.

If any of your vehicle's lights, accessories, or controls do not work, check the appropriate circuit fuse. If a fuse has blown, the element inside the fuse will be melted.

If the electrical system does not work, first check the driver's side fuse panel.

Always replace a blown fuse with one of the same rating.

Before replacing an open fuse, disconnect the negative battery cable.

If the replacement fuse blows, this indicates an electrical problem. Avoid using the system involved and immediately consult an authorized HYUNDAI dealer.

Three kinds of fuses are used: blade type for lower amperage rating, cartridge type, and multi fuse for higher amperage ratings.

⚠ WARNING - Fuse replacement

- **Never replace a fuse with anything but another fuse of the same rating.**
- **A higher capacity fuse could cause damage and possibly a fire.**
- **Never install a wire or aluminum foil instead of the proper fuse - even as a temporary repair. It may cause extensive wiring damage and a possible fire.**

⚠ CAUTION

Do not use a screwdriver or any other metal object to remove fuses because it may cause a short circuit and damage the system.

*** NOTICE**

The actual fuse/relay panel label may differ from equipped items.

CAUTION

- **When replacing an open fuse or relay with a new one, make sure the new fuse or relay fits tightly into the clips. The incomplete fastening fuse or relay may cause the vehicle wiring and electric systems damage and a possible fire.**
- **Do not remove fuses, relays and terminals fastened with bolts or nuts. The fuses, relays and terminals may be fastened incompletely, and it may cause a possible fire. If fuses, relays and terminals fastened with bolts or nuts are open, consult with an authorized HYUNDAI dealer.**
- **Do not input any other objects except fuses or relays into fuse/relay terminals such as a driver or wiring. It may cause contact failure and system malfunction.**

Inner panel fuse replacement

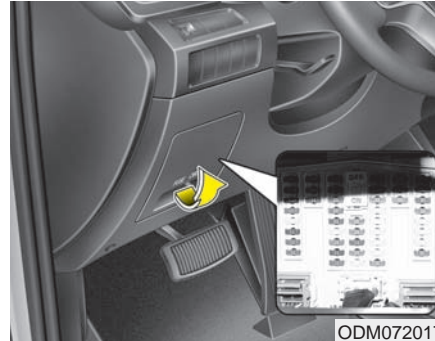

1. Turn the ignition switch and all other switches off.
2. Open the fuse panel cover.

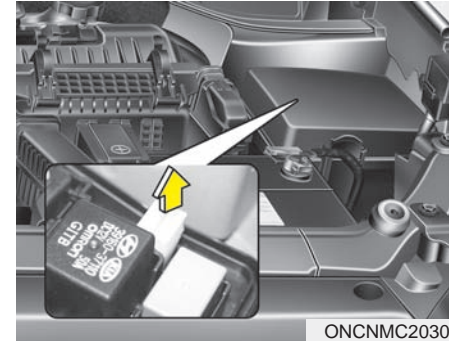

3. Pull the suspected fuse straight out. Use the removal tool provided in the engine compartment fuse panel.
4. Check the removed fuse; replace it if it is blown.
5. Push in a new fuse of the same rating, and make sure it fits tightly in the clips.

If it fits loosely, consult an authorized HYUNDAI dealer.

If you do not have a spare, use a fuse of the same rating from a circuit you may not need for operating the vehicle, such as the cigar lighter fuse.

If the headlights or other electrical components do not work and the fuses are OK, check the fuse block in the engine compartment. If a fuse is blown, it must be replaced.

Fuse switch

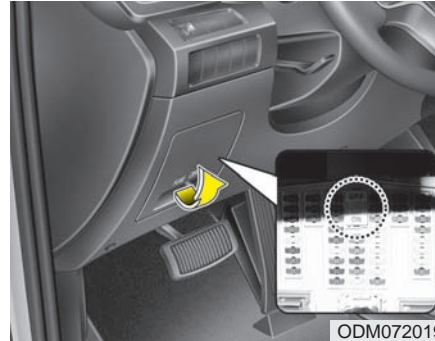

Always, put the mode switch at the ON position.

If you move the switch to the OFF position, some items such as audio and digital clock must be reset and transmitter (or smart key) may not work properly.

CAUTION

Always place the fuse switch in the ON position while driving the vehicle.

Engine compartment panel fuse replacement

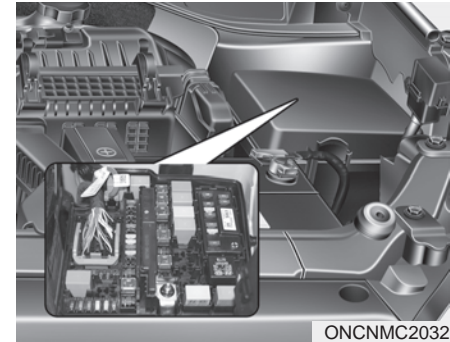

1. Turn the ignition switch and all other switches off.
2. Remove the fuse box cover by pressing the tab and pulling up.

3. Check the removed fuse; replace it if it is blown. To remove or insert the fuse, use the fuse puller in the engine compartment fuse panel.
4. Push in a new fuse of the same rating, and make sure it fits tightly in the clips. If it fits loosely, consult an authorized HYUNDAI dealer.

CAUTION

After checking the fuse box in the engine compartment, securely install the fuse box cover. If not, electrical failures may occur from water leaking in.

Multi fuse

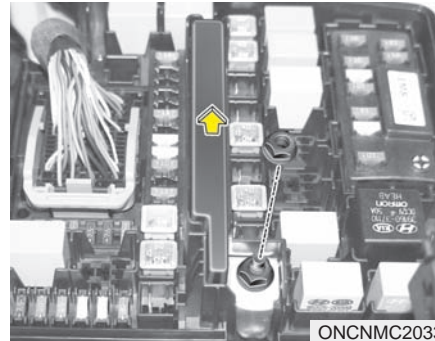

If the multi fuse is blown, it must be removed as follows:

1. Disconnect the negative battery cable.
2. Remove the bolts shown in the picture above.
3. Replace the fuse with a new one of the same rating.
4. Reinstall in the reverse order of removal.

* NOTICE

If the multi fuse is blown, consult an Authorized HYUNDAI Dealer.

Main fuse

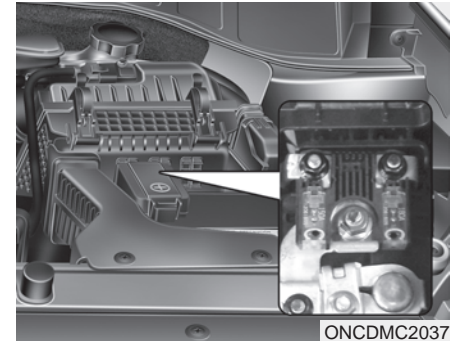

If the main fuse is blown, it must be removed as follows:

1. Disconnect the negative battery cable.
2. Remove the nuts shown in the picture above.
3. Replace the fuse with a new one of the same rating.
4. Reinstall in the reverse order of removal.

Fuse/Relay panel description



Inside the fuse/relay box covers, you can find the fuse/relay label describing fuse/relay name and capacity.

* NOTICE

Not all fuse panel descriptions in this manual may be applicable to your vehicle. It is accurate at the time of printing. When you inspect the fuse box on your vehicle, refer to the fuse box label.

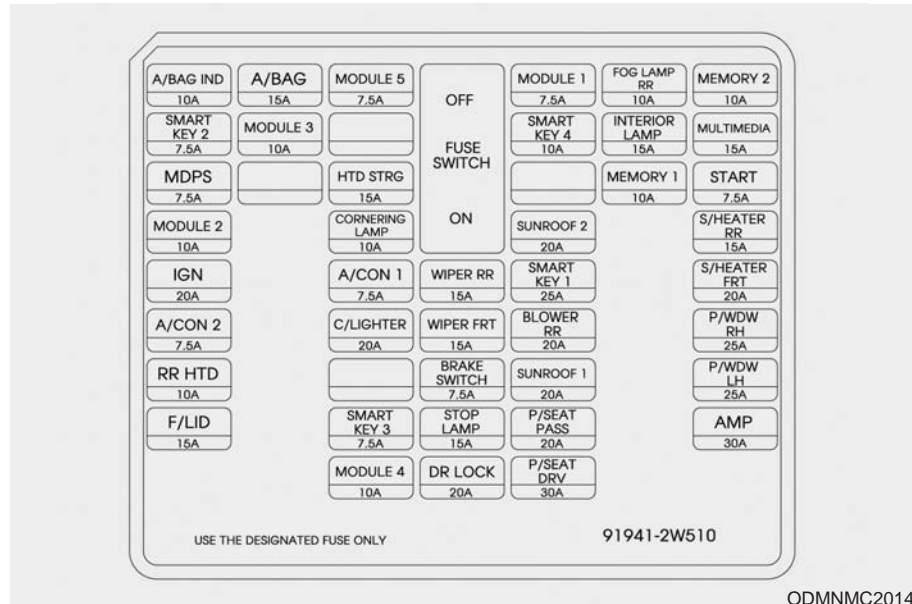

ODMNM2014

Description	Fuse rating	Protected Component
A/BAG IND	10A	Instrument Cluster
A/BAG	15A	ACU, A/C Control Module, Passenger Occupant Detection Sensor
MODULE 5	7.5A	Sunroof_MTR, RAIN_SNSR,RR_BLOWER,PGS, AC_INVERTER_UNIT,Smart Key Control Module, BCM, Rear Seat Warmer LH/RH,Driver/Passenger Seat Warmer Module,
MODULE 1	7.5A	Sport Mode Switch, Key Solenoid, Console Switch LH/RH,Rear Power Window Switch LH/RH
FOG LAMP RR	10A	RR_FOG_LH/RH
MEMORY 2	10A	BCM, Tire Pressure Monitoring Module, Electro Chromic Mirror, Driver/Passenger Door Module, Auto Light & Photo Sensor, Data Link Connector, A/C Control Module, Instrument Cluster, FRT_DRV_SEAT
SMART KEY 2	7.5A	Smart Key Control Module, Immobilizer Module
MODULE 3	10A	BCM, Instrument Cluster, Tire Pressure Monitoring Module, A/C Control Module, Driver/Passenger Door Module, ATM Shift Lever Indicator, Rear Seat Warmer LH/RH, AWD ECU, Driver/Passenger Seat Warmer Module, MTS Module, Rear(SMART) Parking Assist Sensor LH/RH, A/V & Navigation Head Unit, Rear Parking Assist Sensor (Center)LH/RH, AMP, SAS_ESP,EPB_EXT, Electro Chromic Mirror, BSD
SMART KEY 4	10A	Start/Stop Button Switch, Immobilizer Module
INTERIOR LAMP	15A	Cargo Lamp, Vanity Lamp LH/RH, Overhead Console Lamp, Center Room Lamp, Personal Lamp LH/RH
MULTI MEDIA	15A	Audio, A/V & Navigation Head Unit, MTS Module,D_CLOCK
MDPS	7.5A	MDPS Unit
HTD STRG	15A	Steering Wheel Switch
MEMORY 1	10A	RF Receiver, Ignition Key III. & Door Warning Switch

Maintenance

Description	Fuse rating	Protected Component
START	7.5A	W/O IMMO. & Smart Key : ICM Relay Box (Burglar Alarm Relay) With IMMO. or Smart Key : INHIBIT_SW(POSITION_SW)
MODULE 2	10A	Crash Pad Switch, Multipurpose Check Connector, Head Lamp Leveling Device Actuator LH/RH, Auto Head Lamp Leveling Device Module, Stop Lamp Switch,AFLS_UNIT, F_WATER_SNSR, GLOW_RLY_UNIT_METAL, FPAS_SNSR, DSL_BOX
SUNROOF 2	20A	Sunroof_MTR
S/HEATER RR	15A	Rear Seat Warmer LH/RH
IGN	20A	E/R Fuse & Relay Box (Fuse - ABS 3, SENSOR 5, TCU)
A/CON 1	7.5A	E/R Fuse & Relay Box (Blower Relay), A/C Control Module, Cluster Ionizer, DSL_BOX(PTC_RLY)
WIPER RR	15A	Rear Wiper Relay, Rear Wiper Motor, Multifunction Switch,BCM
SMART KEY 1	25A	Smart Key Control Module
S/HEATER FRT	20A	Driver/Passenger Seat Warmer Module
A/CON 2	7.5A	A/C Control Module
C/LIGHTER	20A	Front Power Outlet & Cigarette Lighter, Luggage Power Outlet
WIPER FRT	15A	Multifunction Switch, E/R Fuse & Relay Box (Wiper HI Relay, IG2 Relay)
BLOWER RR	20A	ICM Relay Box (RR BLOWER Relay)
P/WDW RH	25A	Passenger Door Module, Rear Power Window Switch RH
RR HTD	10A	A/C Control Module
BRAKE SWITCH	7.5A	Smart Key Control Module, Stop Lamp Switch

Description	Fuse rating	Protected Component
SUNROOF 1	20A	SUNROOF_MTR
P/WDW LH	25A	Driver Safety Power Window Module, Driver Door Module, Rear Power Window Switch LH
FUEL LID	15A	Fuel Fillar Door Switch (DOOR_EXT)
SMART KEY 3	7.5A	Smart Key Control Module
STOP LAMP	15A	Stop Signal Electronic Module
P/SEAT PASS	20A	Passenger Seat Manual Switch, Passenger Lumbar Support Switch
AMP	30A	AMP
MODULE 4	10A	Audio, A/V & Navigation Head Unit, BCM, Overhead Console Lamp, AMP, MTS Module, Power Outside Mirror Switch, E/R Fuse & Relay Box (Power Outlet Relay),PGS,D_CLOCK
DR LOCK	20A	Door Lock/Unlock Relay, Tail Gate Relay, ICM Relay Box (Dead Lock Relay)
P/SEAT DRV	30A	Driver IMS Module, Driver Seat Manual Switch, Driver Lumbar Support Switch

Relay NO.	Relay Name	Relay Type
E30	POWER OUTLET RELAY	ISO MICRO
E31	START RELAY	ISO MICRO
E32	FRONT DEICER RELAY	ISO MICRO
E33	BLOWER RELAY	ISO MICRO
E34	WIPER LO RELAY	ISO MICRO
E36	ACC RELAY	ISO MICRO
E37	IG1 RELAY	ISO MICRO
E38	IG2 RELAY	ISO MICRO
E39	COOLING FAN RELAY	ISO MINI
E40	WIPER HI RELAY	ISO MICRO
E41	REAR DEFOGGER RELAY	ISO MICRO
E42	HORN RELAY	ISO MICRO

	Description	Fuse rating	Protected Component
MULTI FUSE	MDPS	80A	MDPS Unit
	B+2	60A	Smart Junction Box (IPS 1 (4CH), IPS 2 (1CH), IPS 5 (1CH), Fuse - SUNROOF 1, P/SEAT PASS, P/SEAT DRV), RR A/CON
	BLOWER	40A	Blower Relay
	RR HTD	40A	Rear Defogger Relay
	ABS1	40A	ESC Module, Multipurpose Check Connector
	ABS2	40A	ESC Module
	C/FAN	60A	Cooling Fan Relay
	B+3	60A	Smart Junction Box (Fuse - MODULE 1, SMART KEY 4, SUNROOF 2, SMART KEY 1, Leak Current Autocut Device)
FUSE	B+4	50A	Smart Junction Box (IPS 3 (4CH), IPS 6 (2CH), Fuse - F/LID, STOP LAMP, DR LOCK, BRAKE SWITCH), FUEL LID
	EMS	40A	EMS Box
	IG1	40A	W/O Smart Key : Ignition Switch, With Smart Key - ACC Relay, IG1 Relay
	IG2	40A	Start Relay, IG2 Relay, W/O Smart Key : Ignition Switch
	TRAILER	30A	Trailer Power Outlet
	B+1	50A	Smart Junction Box (Fuse - S/HEATER RR, S/HEATER FRT, P/WDW RH, P/WDW LH)
	HORN	15A	Horn Relay
	DEICER	15A	Front Deicer Relay
	POWER OUTLET	25A	Power Outlet Relay
AC INVERTER	30A	AC Inverter Module	

	Description	Fuse rating	Protected Component
FUSE	P/TAIL GATE	30A	Power Tail Gate Module
	IDB	15A	IDB Module
	4WD	20A	4WD ECM
	AMS	10A	Battery Sensor
	AMS (WIPER)	10A	BCM, PCM
	WIPER FRT	25A	Wiper LO Relay, Front Wiper Motor
	B/UP LAMP	10A	A/T - Rear Combination Lamp (IN) LH/RH, Electro Chromic Mirror, Audio, A/V & Navigation Head Unit
	ABS3	7.5A	ESC Module
	SENSOR5	7.5A	PCM
	TCU	15A	A/T : Transaxle Range Switch
	F/PUMP	15A	Fuel Pump Relay
	ECU 1	15A	PCM
	ECU 2	10A	IDB Module
	SENSOR 3	10A	Fuel Pump Relay
	IGN COIL	20A	Condenser, Ignition Coil #1/#2/#3/#4
	SENSOR 2	10A	Purge Control Solenoid Valve, Variable Intake Solenoid Valve(G4KJ), Oil Control Valve #1/#2
	SENSOR 1	15A	Oxygen sensor(#1/#2/#3/#4), PCM, Oxygen Sensor(Down), E/R Fuse & Relay Box (Cooling Fan Relay)
	B/A HORN	10A	Burgl Aralarm Horn Relay

LIGHT BULBS

WARNING - Working on the lights

Prior to working on the light, firmly apply the parking brake, ensure that the ignition switch is turned to the "LOCK" position and turn off the lights to avoid sudden movement of the vehicle and burning your fingers or receiving an electric shock.

Use only the bulbs of the specified wattage.

CAUTION

Be sure to replace the burned-out bulb with one of the same wattage rating. Otherwise, it may cause damage to the fuse or electric wiring system.

CAUTION

If you don't have necessary tools, the correct bulbs and the expertise, consult an authorized HYUNDAI dealer. In many cases, it is difficult to replace vehicle light bulbs because other parts of the vehicle must be removed before you can get to the bulb. This is especially true if you have to remove the headlight assembly to get to the bulb(s). Removing/installing the headlight assembly can result in damage to the vehicle.

*** NOTICE**

After heavy, driving rain or washing, headlamp and taillamp lenses could appear frosty. This condition is caused by the temperature difference between the lamp inside and outside. This is similar to the condensation on your windows inside your vehicle during the rain and doesn't indicate a problem with your vehicle. If the water leaks into the lamp bulb circuitry, have the vehicle checked by an authorized HYUNDAI dealer.

Headlamp, Front position lamp, Front turn signal lamp, Front fog lamp bulb replacement



- (1) Headlamp (High)
- (2) Headlamp (Low)
- (3) Front position lamp (LED)
- (4) Front turn signal lamp
- (5) Front side marker
- (6) Front fog lamp (if equipped)

Headlamp bulb

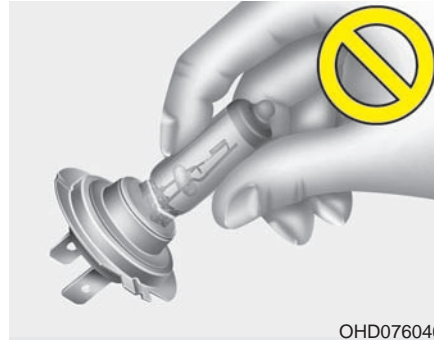

⚠ WARNING - Halogen bulbs

- Halogen bulbs contain pressurized gas that will produce flying pieces of glass if broken.

(Continued)

(Continued)

- Always handle them carefully, and avoid scratches and abrasions. If the bulbs are lit, avoid contact with liquids. Never touch the glass with bare hands. Residual oil may cause the bulb to overheat and burst when lit. A bulb should be operated only when installed in a headlamp.
- If a bulb becomes damaged or cracked, replace it immediately and carefully dispose of it.
- Wear eye protection when changing a bulb. Allow the bulb to cool down before handling it.

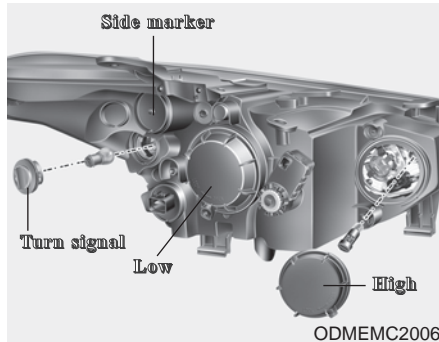

1. Open the hood.
2. Remove the headlamp bulb cover by turning it counterclockwise.
3. Disconnect the headlamp bulb socket-connector.
4. Remove the socket from the assembly by turning the socket counterclockwise until the tabs on the socket align with the slots on the assembly.
5. Remove the bulb by pulling it out.
6. Inset a new bulb by inserting it into the socket.
7. Install the socket in the assembly by aligning the tabs on the socket with the slots in the assembly. Push the socket into the assembly and turn the socket clockwise.
8. Install the headlamp bulb cover by turning it clockwise.

* NOTICE

Always have the headlight aiming adjusted after an accident or the headlight assembly is reinstalled at an authorized HYUNDAI dealer.

Side marker lamp/Turn signal lamp

1. Remove the socket from the assembly by turning the socket counterclockwise until the tabs on the socket align with the slots on the assembly.
2. Remove the bulb from the socket by pressing it in and rotating it counterclockwise until the tabs on the bulb align with the slots in the socket. Pull the bulb out of the socket
3. Insert a new bulb by inserting it into the socket and rotating it until it locks into place.
4. Install the socket in the assembly by aligning the tabs on the socket with the slots in the assembly. Push the socket into the assembly and turn the socket clockwise.

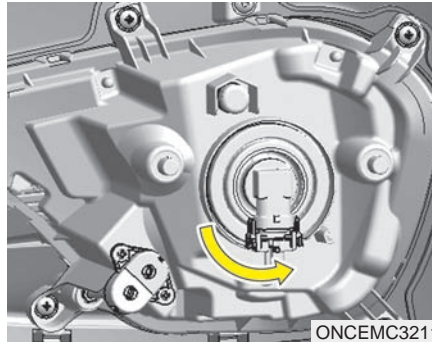
**Front fog lamp bulbs
(if equipped)**

1. Remove the front bumper under cover.
2. Reach your hand into the back of the front bumper.
3. Disconnect the power connector from the socket.
4. Remove the bulb-socket from the housing by turning the socket counter clockwise until the tabs on the socket align with the slots on the housing.

5. Install the new bulb-socket into the housing by aligning the tabs on the socket with the slots in the housing. Push the socket into the housing and turn the socket clockwise.
6. Connect the power connector to the socket.
7. Reinstall the front bumper under cover.

Headlamp (HID type), position (LED), turn signal, and front fog lamp bulb replacement

If the lamp bulb does not operate, have the vehicle checked by an authorized HYUNDAI dealer.

⚠ WARNING - HID Headlamp low beam (if equipped)

Do not attempt to replace or inspect the low beam (XENON bulb) due to electric shock danger. If the low beam (XENON bulb) is not working, have your vehicle checked by an authorized HYUNDAI Dealer.

*** NOTICE**

A skilled technician should check or repair the LED light. Otherwise, it may damage related parts.

*** NOTICE**

HID lamps have superior performance vs. halogen bulbs. HID lamps are estimated by the manufacturer to last twice as long or longer than halogen bulbs depending on their frequency of use. They will probably require replacement at some point in the life of the vehicle. Cycling the headlamps on and off more than typical use will shorten HID lamps life. HID lamps do not fail in the same manner as halogen incandescent lamps. If a headlamp goes out after a period of operation but will immediately relight when the headlamp switch is cycled it is likely the HID lamp needs to be replaced. HID lighting components are more complex than conventional halogen bulbs thus have higher replacement cost.

Side repeater lamp replacement



If the lamp bulb does not operate, have the vehicle checked by an authorized HYUNDAI dealer.

*** NOTICE**

A skilled technician should check or repair the side repeater lamp. Otherwise, it may damage related parts (ex. outside mirror).

Rear combination lamp bulb replacement

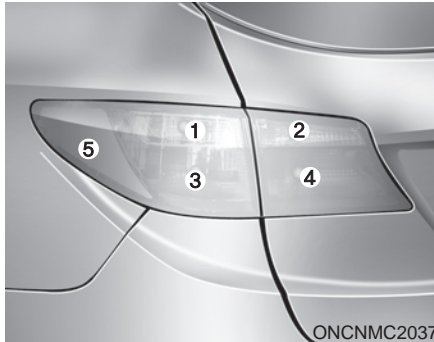

- (1) Rear turn signal lamp
- (2) Back-up lamp
- (3) Rear stop and tail lamp
- (4) Rear tail lamp/Rear stop and tail lamp*

(5) Rear side marker

* : if equipped

Outside lamp

1. Open the liftgate (tailgate).
2. Remove the service cover using a flat-blade screwdriver.
3. Loosen the lamp assembly retaining please verify.
4. Remove the rear combination lamp assembly from the body of the vehicle.

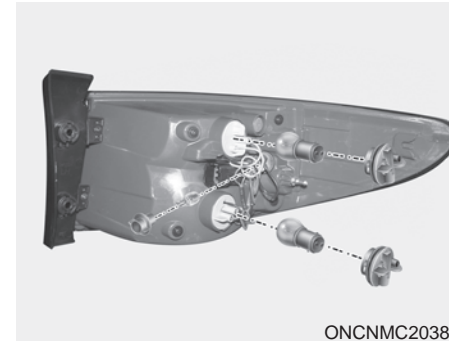

5. Remove the socket from the assembly by turning the socket counterclockwise until the tabs on the socket align with the slots on the assembly.
6. Remove the bulb from the socket by pressing it in and rotating it counterclockwise until the tabs on the bulb align with the slots in the socket. Pull the bulb out of the socket. (Side marker : Remove the bulb from the socket by pulling it out)

7. Insert a new bulb by inserting it into the socket and rotating it until it locks into place.
8. Install the socket in the assembly by aligning the tabs on the socket with the slots in the assembly. Push the socket into the assembly and turn the socket clockwise.
9. Reinstall the lamp assembly to the body of the vehicle.

Inside lamp

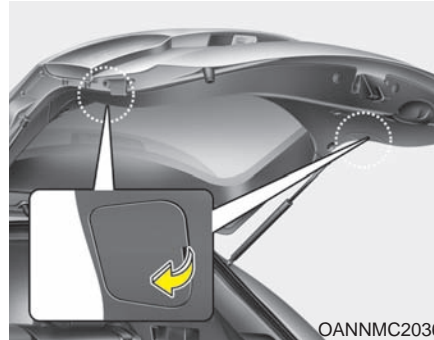

1. Open the liftgate (tailgate).
2. Remove the service cover using a flat-blade screwdriver.



3. Remove the socket from the assembly by turning the socket counterclockwise until the tabs on the socket align with the slots on the assembly.
4. Remove the bulb from the socket by pressing it in and rotating it counterclockwise until the tabs on the bulb align with the slots in the socket. Pull the bulb out of the socket. (Back-up lamp : Remove the bulb from the socket by pulling it out)

5. Insert a new bulb by inserting it into the socket and rotating it until it locks into place.
6. Install the socket in the assembly by aligning the tabs on the socket with the slots in the assembly. Push the socket into the assembly and turn the socket clockwise.
7. Install the service cover by putting it into the service hole.

High mounted stop lamp replacement

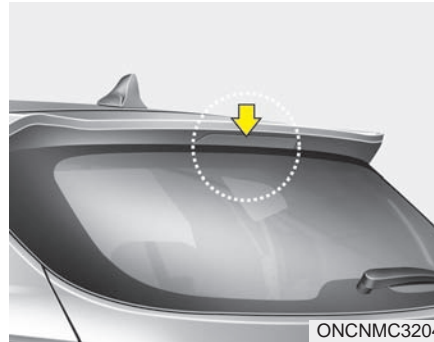

1. Open the liftgate (tailgate).
2. Gently remove the center cover of the rear liftgate (tailgate) trim.
3. Disconnect the electrical connector.

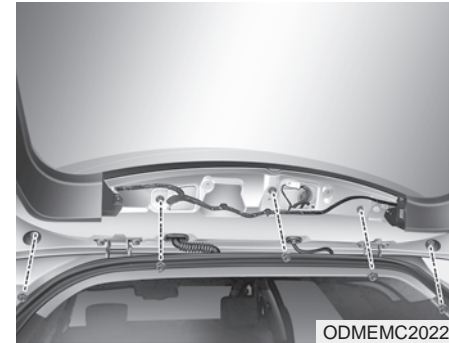

4. Loosen the retaining nuts and remove the spoiler.

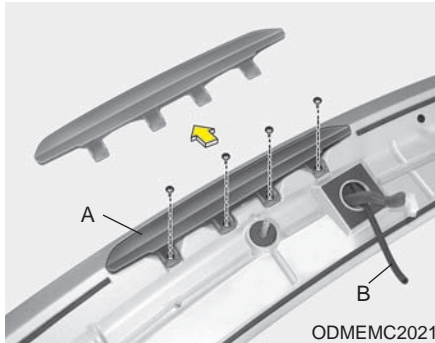

5. Remove the high mounted stop lamp assembly (A) after loosening the nuts and washer nozzle (B).
6. Reinstall a new lamp assembly in the reverse order of removal.

License plate lamp bulb replacement

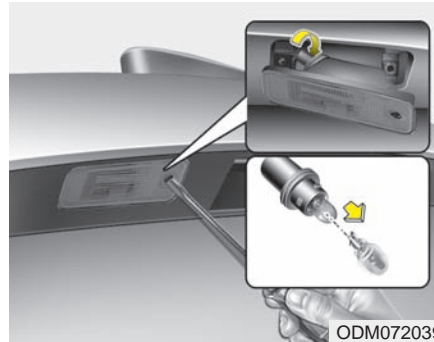

1. Loosen the lens retaining screws with a screwdriver.
2. Remove the lens.
3. Remove the bulb.
4. Install a new bulb.
5. Reinstall the lens securely with the lens retaining screws.

Door courtesy lamp bulb replacement

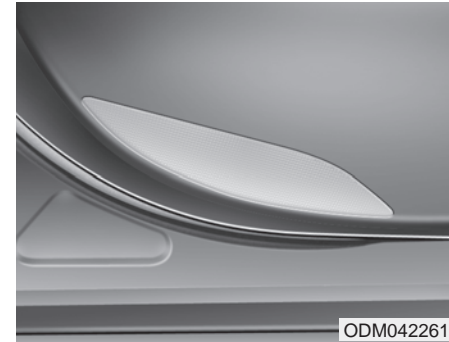

If the lamp does not operate, have the vehicle checked by an authorized HYUNDAI dealer.

* NOTICE

A skilled technician should check or repair the door courtesy lamp. Otherwise, it may damage related parts (ex. door trim).

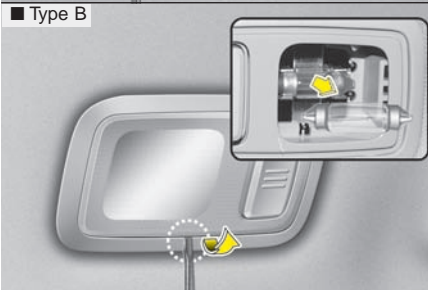
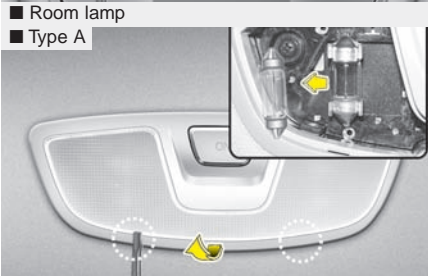
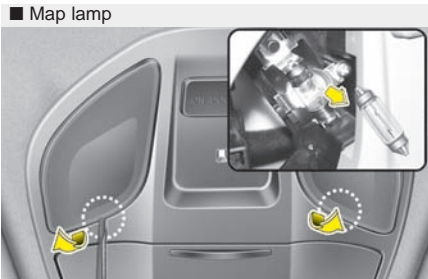

ODM072040/ODM072042/ODM072052

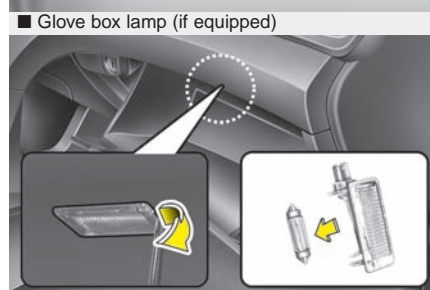
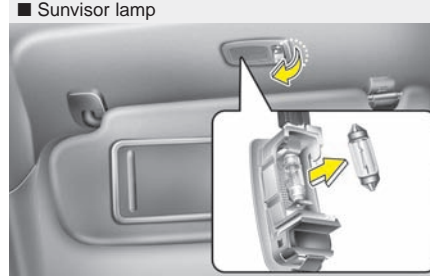
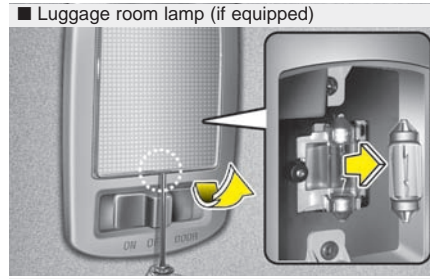

OXM079044/ODM072041/ODM072043

Interior lamp bulb replacement

⚠ WARNING

Prior to working on the Interior Lamps, ensure that the “OFF” button is depressed to avoid burning your fingers or receiving an electric shock.

1. Using a flat-blade screwdriver, gently pry the lens from the interior lamp housing.
2. Remove the bulb by pulling it straight out.
3. Install a new bulb in the socket.
4. Align the lens tabs with the interior lamp housing and snap the lens into place.

⚠ CAUTION

Use care not to dirty or damage lens, lens tab, and plastic housings.

APPEARANCE CARE

Exterior care

Exterior general caution

It is very important to follow the label directions when using any chemical cleaner or polish. Read all warning and caution statements that appear on the label.

High-pressure washing

- When using high-pressure washers, make sure to maintain sufficient distance from the vehicle. Insufficient clearance or excessive pressure can lead to component damage or water penetration.
- Do not spray the camera, sensors or its surrounding area directly with a high pressure washer. Shock applied from high pressure water may cause the device to not operate normally.
- Do not bring the nozzle tip close to boots (rubber or plastic covers) or connectors as they may be damaged if they come into contact with high pressure water.

Finish maintenance

Washing

To help protect your vehicle's finish from rust and deterioration, wash it thoroughly and frequently at least once a month with lukewarm or cold water.

If you use your vehicle for off-road driving, you should wash it after each off-road trip. Pay special attention to the removal of any accumulation of salt, dirt, mud, and other foreign materials. Make sure the drain holes in the lower edges of the doors and rocker panels are kept clear and clean.

Insects, tar, tree sap, bird droppings, industrial pollution and similar deposits can damage your vehicle's finish if not removed immediately.

Even prompt washing with plain water may not completely remove all these deposits.

A mild soap, safe for use on painted surfaces, may be used.

After washing, rinse the vehicle thoroughly with lukewarm or cold water. Do not allow soap to dry on the finish.

CAUTION

- ***Do not use strong soap, chemical detergents or hot water, and do not wash the vehicle in direct sunlight or when the body of the vehicle is warm.***
- ***Be careful when washing the side windows of your vehicle. Especially, with high-pressure water, water may leak through the windows and wet the interior.***
- ***To prevent damage to the plastic parts and lamps, do not clean with chemical solvents or strong detergents.***

WARNING - Wet brakes

After washing the vehicle, test the brakes while driving slowly to see if they have been affected by water. If braking performance is impaired, dry the brakes by applying them lightly while maintaining a slow forward speed.

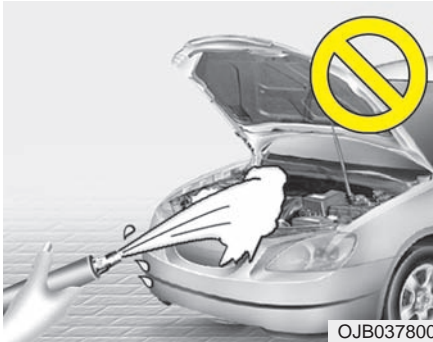

⚠ CAUTION

- *Water washing in the engine compartment including high pressure water washing may cause the failure of electrical circuits located in the engine compartment.*
- *Never allow water or other liquids to come in contact with electrical/electronic components inside the vehicle as this may damage them.*

Waxing

Wax the vehicle when water will no longer bead on the paint.

Always wash and dry the vehicle before waxing. Use a good quality liquid or paste wax, and follow the manufacturer's instructions. Wax all metal trim to protect it and to maintain its luster.

Removing oil, tar, and similar materials with a spot remover will usually strip the wax from the finish. Be sure to re-wax these areas even if the rest of the vehicle does not yet need waxing.

⚠ CAUTION

- *Wiping dust or dirt off the body with a dry cloth will scratch the finish.*
- *Do not use steel wool, abrasive cleaners, or strong detergents containing highly alkaline or caustic agents on chrome-plated or anodized aluminum parts. This may result in damage to the protective coating and cause discoloration or paint deterioration.*

Finish damage repair

Deep scratches or stone chips in the painted surface must be repaired promptly. Exposed metal will quickly rust and may develop into a major repair expense.

*** NOTICE**

If your vehicle is damaged and requires any metal repair or replacement, be sure the body shop applies anti-corrosion materials to the parts repaired or replaced.

Bright-metal maintenance

- To remove road tar and insects, use a tar remover, not a scraper or other sharp object.
- To protect the surfaces of bright-metal parts from corrosion, apply a coating of wax or chrome preservative and rub to a high luster.
- During winter weather or in coastal areas, cover the bright metal parts with a heavier coating of wax or preservative. If necessary, coat the parts with non-corrosive petroleum jelly or other protective compound.

Underbody maintenance

Corrosive materials used for ice and snow removal and dust control may collect on the underbody. If these materials are not removed, accelerated rusting can occur on underbody parts such as the fuel lines, frame, floor pan and exhaust system, even though they have been treated with rust protection.

Thoroughly flush the vehicle underbody and wheel openings with lukewarm or cold water once a month, after off-road driving and at the end of each winter. Pay special attention to these areas because it is difficult to see all the mud and dirt. It will do more harm than good to wet down the road grime without removing it. The lower edges of doors, rocker panels, and frame members have drain holes that should not be allowed to clog with dirt; trapped water in these areas can cause rusting.

⚠ WARNING

After washing the vehicle, test the brakes while driving slowly to see if they have been affected by water. If braking performance is impaired, dry the brakes by applying them lightly while maintaining a slow forward speed.

Aluminum wheel maintenance

The aluminum wheels are coated with a clear protective finish.

- Do not use any abrasive cleaner, polishing compound, solvent, or wire brushes on aluminum wheels. They may scratch or damage the finish.
- Clean the wheel when it has cooled.
- Use only a mild soap or neutral detergent, and rinse thoroughly with water. Also, be sure to clean the wheels after driving on salted roads. This helps prevent corrosion.
- Avoid washing the wheels with high-speed car wash brushes.
- Do not use any alkaline or acid detergent. It may damage and corrode the aluminum wheels coated with a clear protective finish.

Corrosion protection**Protecting your vehicle from corrosion**

By using the most advanced design and construction practices to combat corrosion, we produce cars of the highest quality. However, this is only part of the job. To achieve the long-term corrosion resistance your vehicle can deliver, the owner's cooperation and assistance is also required.

Common causes of corrosion

The most common causes of corrosion on your vehicle are:

- Road salt, dirt and moisture that is allowed to accumulate underneath the car.
- Removal of paint or protective coatings by stones, gravel, abrasion or minor scrapes and dents which leave unprotected metal exposed to corrosion.

High-corrosion areas

If you live in an area where your car is regularly exposed to corrosive materials, corrosion protection is particularly important. Some of the common causes of accelerated corrosion are road salts, dust control chemicals, ocean air and industrial pollution.

Moisture breeds corrosion

Moisture creates an atmosphere that both promotes and facilitates corrosion. For example, corrosion is accelerated by high humidity, particularly when temperatures are just above freezing. In such conditions, the corrosive material is kept in contact with the car surfaces by moisture that is slow to evaporate.

Mud is particularly corrosive because it is slow to dry and holds moisture in contact with the vehicle. Although the mud appears to be dry, it can still retain the moisture and promote corrosion.

High temperatures can also accelerate corrosion of parts that are poorly ventilated against moisture dispersal. It is particularly important to keep your car clean and free of mud or accumulations of other materials. This applies not only to the visible surfaces but particularly to the underside of the car.

To help prevent corrosion

You can help prevent corrosion or drastically limit by observing the following:

Keep your car clean

The best way to prevent corrosion is to keep your car clean and free of corrosive materials. Attention to the underside of the car is particularly important.

- If you live in a high-corrosion area where road salts are used, near the ocean, areas with industrial pollution, or acid rain, etc., you should take extra care to prevent corrosion. In winter, spray or rinse the underside of your car at least once a month and be sure to clean the underside thoroughly when winter is over.
- When cleaning underneath the car, give particular attention to the components under the fenders and other areas that are hidden from view. Do a thorough job; just dampening the accumulated mud rather than washing it away will accelerate corrosion rather than prevent it. Water under high pressure and steam are particularly effective in removing accumulated mud and corrosive materials.

- When cleaning lower door panels, rocker panels and frame members, be sure that drain holes are kept open so that moisture can escape. If these areas are not kept clear, moisture could become trapped and accelerate corrosion.

Keep your garage dry

Don't park your car in a damp or poorly ventilated garage. This creates a favorable environment for corrosion. This is particularly true if you wash your car in the garage or drive it into the garage when it is still wet or covered with snow, ice or mud. Even a heated garage can contribute to corrosion unless it is well ventilated so moisture can be dispersed.

Keep paint and trim in good condition

Scratches or chips in the finish should be covered with "touch-up" paint as soon as possible to reduce the possibility of corrosion. If bare metal is showing, the attention of a qualified body and paint shop is recommended.

Bird droppings : Bird droppings are highly corrosive and may damage painted surfaces in just a few hours. Always remove bird droppings as soon as possible.

Don't neglect the interior

Moisture can collect under the floor mats and carpeting to cause corrosion. Check under the mats periodically to be sure the carpeting is dry. Use particular care if you carry fertilizers, cleaning materials or chemicals in the car.

These should be carried only in proper containers and any spills or leaks should be cleaned up, flushed with clean water and thoroughly dried.

Interior care

Interior general precautions

Prevent caustic solutions such as perfume and cosmetic oil from contacting the dashboard because they may cause damage or discoloration. If they do contact the dashboard, clean immediately. See the instructions that follow for the proper way to clean vinyl.

CAUTION

Never allow water or other liquids to come in contact with electrical/electronic components inside the vehicle as this may damage them.

CAUTION

When cleaning leather products (steering wheel, seats etc.), use neutral detergents or low alcohol content solutions. If you use high alcohol content solutions or acid/alkaline detergents, the color of the leather may fade or the surface may get stripped off.

Cleaning the upholstery and interior trim

Vinyl

Remove dust and loose dirt from vinyl with a whisk broom or vacuum cleaner. Clean vinyl surfaces with a vinyl cleaner.

Fabric

Remove dust and loose dirt from fabric with a whisk broom or vacuum cleaner. Clean with a mild soap solution recommended for upholstery or carpets. Remove fresh spots immediately with a fabric spot cleaner. If fresh spots do not receive immediate attention, the fabric can be stained and its color can be affected. Also, its fire-resistant properties can be reduced if the material is not properly maintained.

CAUTION

Using anything but recommended cleaners and procedures may affect the fabric's appearance and fire-resistant properties.

Cleaning the lap/shoulder belt webbing

Clean the belt webbing with any mild soap solution recommended for cleaning upholstery or carpet. Follow the instructions provided with the soap. Do not bleach or re-dye the webbing because this may weaken it.

Cleaning the interior window glass

If the interior glass surfaces of the vehicle become fogged (that is, covered with an oily, greasy or waxy film), they should be cleaned with glass cleaner. Follow the directions on the glass cleaner container.

CAUTION

Do not scrape or scratch the inside of the rear window. This may result in damage to the rear window defroster grid.

EMISSION CONTROL SYSTEM

The emission control system of your vehicle is covered by a written limited warranty. Please see the warranty information contained in the Owner's Handbook & Warranty Information booklet in your vehicle.

Your vehicle is equipped with an emission control system to meet all emission regulations.

There are three emission control systems which are as follows.

- (1) Crankcase emission control system
- (2) Evaporative emission control system
- (3) Exhaust emission control system

In order to assure the proper function of the emission control systems, it is recommended that you have your car inspected and maintained by an authorized HYUNDAI dealer in accordance with the maintenance schedule in this manual.

Caution for the Inspection and Maintenance Test (With Electronic Stability Control (ESC) system)

- To prevent the vehicle from misfiring during dynamometer testing, turn the Electronic Stability Control (ESC) system off by pressing the ESC switch.
- After dynamometer testing is completed, turn the ESC system back on by pressing the ESC switch again.

1. Crankcase emission control system

The positive crankcase ventilation system is employed to prevent air pollution caused by blow-by gases being emitted from the crankcase. This system supplies fresh filtered air to the crankcase through the air intake hose. Inside the crankcase, the fresh air mixes with blow-by gases, which then pass through the PCV valve into the induction system.

2. Evaporative emission control (including ORVR: Onboard Refueling Vapor Recovery) system

The Evaporative Emission Control System is designed to prevent fuel vapors from escaping into the atmosphere.

(The ORVR system is designed to allow the vapors from the fuel tank to be loaded into a canister while refueling at the gas station, preventing the escape of fuel vapors into the atmosphere.)

Canister

Fuel vapors generated inside the fuel tank are absorbed and stored in the onboard canister. When the engine is running, the fuel vapors absorbed in the canister are drawn into the surge tank through the purge control solenoid valve.

Purge Control Solenoid Valve (PCSV)

The purge control solenoid valve is controlled by the Engine Control Module (ECM); when the engine coolant temperature is low during idling, the PCSV closes so that evaporated fuel is not taken into the engine. After the engine warms-up during ordinary driving, the PCSV opens to introduce evaporated fuel to the engine.

3. Exhaust emission control system

The Exhaust Emission Control System is a highly effective system which controls exhaust emissions while maintaining good vehicle performance.

Vehicle modifications

This vehicle should not be modified. Modification of your vehicle could affect its performance, safety or durability and may even violate governmental safety and emissions regulations.

In addition, damage or performance problems resulting from any modification may not be covered under warranty.

- If you use unauthorized electronic devices, it may cause the vehicle to operate abnormally, wire damage, battery discharge and fire. For your safety, do not use unauthorized electronic devices.

Engine exhaust gas precautions (carbon monoxide)

- Carbon monoxide can be present with other exhaust fumes. Therefore, if you smell exhaust fumes of any kind inside your vehicle, have it inspected and repaired immediately. If you ever suspect exhaust fumes are coming into your vehicle, drive it only with all the windows fully open. Have your vehicle checked and repaired immediately.

⚠ WARNING - Exhaust
Engine exhaust gases contain carbon monoxide (CO). Though colorless and odorless, it is dangerous and could be lethal if inhaled. Follow the instructions on this page to avoid CO poisoning.

⚠ CALIFORNIA PROPOSITION 65 WARNING

Engine exhaust and a wide variety of automobile components and parts, including components found in the interior furnishings in a vehicle, contain or emit chemicals known to the State of California to cause cancer and birth defects and reproductive harm. In addition, certain fluids contained in vehicles and certain products of component wear contain or emit chemicals known to the State of California to cause cancer and birth defects or other reproductive harm.

- Do not operate the engine in confined or closed areas (such as garages) any more than what is necessary to move the vehicle in or out of the area.
- When the vehicle is stopped in an open area for more than a short time with the engine running, adjust the ventilation system (as needed) to draw outside air into the vehicle.
- Never sit in a parked or stopped vehicle for any extended time with the engine running.
- When the engine stalls or fails to start, excessive attempts to restart the engine may cause damage to the emission control system.

Operating precautions for catalytic converters (if equipped)**⚠ WARNING - Fire**

- A hot exhaust system can ignite flammable items under your vehicle. Do not park, idle, or drive the vehicle over or near flammable objects, such as grass, vegetation, paper, leaves, etc.
- The exhaust system and catalytic system are very hot while the engine is running or immediately after the engine is turned off. Keep away from the exhaust system and catalytic, you may get burned.

Also, do not remove the heat sink around the exhaust system, do not seal the bottom of the vehicle or do not coat the vehicle for corrosion control. It may present a fire risk under certain conditions.

Your vehicle is equipped with a catalytic converter emission control device.

Therefore, the following precautions must be observed:

- Use only UNLEADED FUEL for gasoline engine.
- Do not operate the vehicle when there are signs of engine malfunction, such as misfire or a noticeable loss of performance.
- Do not misuse or abuse the engine. Examples of misuse are coasting with the ignition off and descending steep grades in gear with the ignition off.
- Do not operate the engine at high idle speed for extended periods (5 minutes or more).
- Do not modify or tamper with any part of the engine or emission control system. All inspections and adjustments must be made by an authorized HYUNDAI dealer.
- Avoid driving with a very low fuel level. If you run out of gasoline, it could cause the engine to misfire and result in excessive loading of the catalytic converter.

Failure to observe these precautions could result in damage to the catalytic converter and to your vehicle. Additionally, such actions could void your warranties.

CALIFORNIA PERCHLORATE NOTICE

Perchlorate Material-special handling may apply, See www.dtsc.ca.gov/hazardouswaste/perchlorate.

Notice to California Vehicle Dismantlers:

Perchlorate containing materials, such as air bag inflators, seatbelt pretensioners and keyless remote entry batteries, must be disposed of according to Title 22 California Code of Regulations Section 67384.10 (a).

Specifications, Consumer information and Reporting safety defects

Dimensions	8-2
Engine	8-2
Bulb wattage	8-3
Tires and wheels	8-4
Air conditioning system	8-5
Gross vehicle weight	8-5
Luggage volume	8-5
Recommended lubricants and capacities	8-6
• Recommended SAE viscosity number	8-7
Vehicle identification number (VIN)	8-8
Vehicle certification label	8-8
Tire specification and pressure label	8-9
Engine number	8-9
Refrigerant label	8-9
Consumer information	8-10
Reporting safety defects	8-11

DIMENSIONS

Item	in (mm)	
Overall length	193.11 (4,905)	
Overall width	74.21 (1,885)	
Overall height	66.54 (1,690), 66.93 (1,700) *1	
Front tread	235/60R18	64.09 (1,628)
	P235/55R19	64.09 (1,628)
Rear tread	235/60R18	64.53 (1,639)
	P235/55R19	64.53 (1,639)
Wheelbase	110.24 (2,800)	

*1 with roof rack

ENGINE

Item	Lambda 3.3
Displacement cu. in (cc)	203.9 (3,342)
Bore x Stroke in. (mm)	3.6x3.3 (92x83.8)
Firing order	1-2-3-4-5-6
No. of cylinders	6



BULB WATTAGE

	Lamp Bulb	Wattage	Bulb type
Front	Headlamp (Low)	55 or 35 (HID)*	H11B or D3S
	Headlamp (High)	55	H7SL
	Front turn signal lamp	28	PY28W
	Front position lamp	LED	LED
	Front fog lamp*	35	H8
	Front turn signal lamp (Outside mirror)*	LED*	LED
	Front marker lamp	5	W5W
Rear	Rear Stop/Tail lamp (Outside)	28 or 8, LED*	P28 or W8W, LED
	Tail lamp (Inside)	8, LED*	W8W, LED
	Rear turn signal lamp	27	PY27W
	Back-up lamp	16	W16W
	Rear marker lamp	5 or LED*	W5W or LED
	High mounted stop lamp*	LED*	LED
	License plate lamp	5	W5W
Interior	Map lamp	10	FESTOON
	Room lamp	8	FESTOON
	Vanity mirror lamp	5	FESTOON
	Glove box lamp	5	FESTOON
	Luggage lamp	5	FESTOON

* If equipped

* HID : High Intensity Discharge

TIRES AND WHEELS

Item	Tire size	Wheel size	Inflation pressure [psi (kPa)]				Wheel lug nut torque lb•ft, N•m (kg•m)
			Normal load ( + \emptyset)		Maximum load ( + )		
			Front	Rear	Front	Rear	
Full size tire	235/60R18	7.5Jx18	33	33	33	33	65~79, 88~107 (9~11)
	P235/55R19	7.5Jx19	(230)	(230)	(230)	(230)	
Compact spare tire (if equipped)	T165/90R17	4.0Tx17	60 (420)	60 (420)	60 (420)	60 (420)	

 **CAUTION**

*When replacing tires, use the same size originally supplied with the vehicle.
Using tires of a different size can damage the related parts or make it work irregularly.*

AIR CONDITIONING SYSTEM

Item		Weight of volume	Classification
Refrigerant	FRONT A/CON	600 ± 25g	R-134a
	FRONT + REAR A/CON	800 ± 25g	
Compressor lubricant	FRONT A/CON	120 ± 10g	PAG (FD46XG)
	FRONT + REAR A/CON	210 ± 10g	

Contact an authorized HYUNDAI dealer for more details.

GROSS VEHICLE WEIGHT

Item	Lambda 3.3	
	2WD	AWD
Automatic transaxle	2500 kg (5510 lbs)	2550 kg (5620 lbs)

LUGGAGE VOLUME

Item		6 Seater	7 Seater
SAE	1 Seat	2265 l (79 cu f)	
	2 Seat	1159 l (40.9 cu f)	
	3 Seat	383 l (13.5 cu f)	

RECOMMENDED LUBRICANTS AND CAPACITIES

To help achieve proper engine and powertrain performance and durability, use only lubricants of the proper quality. The correct lubricants also help promote engine efficiency that results in improved fuel economy.

These lubricants and fluids are recommended for use in your vehicle.

Lubricant			Volume	Classification
Engine oil ^{*1} ^{*2} (drain and refill) Recommends 	Gasoline Engine	Lambda 3.3	6.02 US qt. (5.7 l)	API Service SM ^{*3} , ILSAC GF-4 (or above), ACEA A5 (or above)
Automatic transaxle fluid	Gasoline Engine	Lambda 3.3	8.24 US qt. (7.8 l)	MICHANG ATF SP-IV, SK ATF SP-IV, NOCA ATF SP-IV, HYUNDAI genuine ATF SP-IV or other brands meeting the above specification approved by HYUNDAI Motor Company
Coolant	Gasoline Engine	Lambda 3.3	9.6 US qt. (9.1 l)	Mixture of antifreeze and distilled water (Ethylene glycol base coolant for aluminum radiator)
Brake fluid			0.74 ~ 0.85 US qt. (0.7 ~ 0.8 l)	FMVSS116 DOT-3 or DOT-4
Rear differential oil (AWD)			0.56 US qt. (0.53 l)	HYPOID GEAR OIL API GL-5, SAE 75W/90 (SHELL SPIRAX X or equivalent)
Transfer case oil (AWD)		Lambda 3.3	0.72 US qt. (0.68 l)	HYPOID GEAR OIL API GL-5, SAE 75W/90 (SHELL SPIRAX X or equivalent)
Fuel			18.95 US gal. (71 l)	Refer to "Fuel requirements" in section 1

^{*1} Refer to the recommended SAE viscosity numbers on the next page.

^{*2} Engine oils labeled Energy Conserving Oil are now available. Along with other additional benefits, they contribute to fuel economy by reducing the amount of fuel necessary to overcome engine friction. Often, these improvements are difficult to measure in everyday driving, but in a year's time, they can offer significant cost and energy savings.

^{*3} If the API service SM engine oil is not available in your country, you are able to use API service SL.

Recommended SAE viscosity number

⚠ CAUTION

Always be sure to clean the area around any filler plug, drain plug, or dipstick before checking or draining any lubricant. This is especially important in dusty or sandy areas and when the vehicle is used on unpaved roads. Cleaning the plug and dipstick areas will prevent dirt and grit from entering the engine and other mechanisms that could be damaged.

Engine oil viscosity (thickness) has an effect on fuel economy and cold weather operating (engine start and engine oil flowability). Lower viscosity engine oils can provide better fuel economy and cold weather performance, however, higher viscosity engine oils are required for satisfactory lubrication in hot weather. Using oils of any viscosity other than those recommended could result in engine damage.

When choosing an oil, consider the range of temperature your vehicle will be operated in before the next oil change. Proceed to select the recommended oil viscosity from the chart.

Temperature Range for SAE Viscosity Numbers										
Temperature	°C	-30	-20	-10	0	10	20	30	40	50
	(°F)	-10	0	20	40	60	80	100	120	
Gasoline Engine Oil *1		10W-30								
		5W-30, 5W-40								

1. For better fuel economy, it is recommended to use the engine oil of a viscosity grade SAE 5W-30 (API SM/ILSAC GF-4). However, if the engine oil is not available in your country, select the proper engine oil using the engine oil viscosity chart.



VEHICLE IDENTIFICATION NUMBER (VIN)

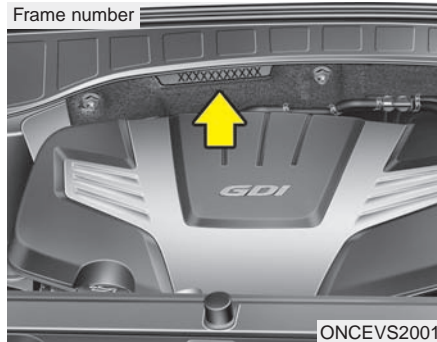

The vehicle identification number (VIN) is the number used in registering your vehicle and in all legal matters pertaining to its ownership, etc. The number is punched on the engine compartment bulkhead.

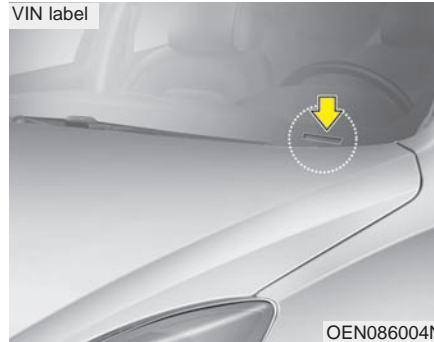

The VIN is also on a plate attached to the top of the dashboard. The number on the plate can easily be seen through the windshield from outside.

VEHICLE CERTIFICATION LABEL



The vehicle certification label attached on the driver's side center pillar gives the vehicle identification number (VIN).

TIRE SPECIFICATION AND PRESSURE LABEL

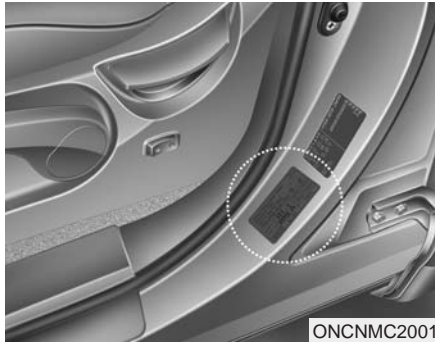

The tires supplied on your new vehicle are chosen to provide the best performance for normal driving.

The tire label located on the driver's side center pillar gives the tire pressures recommended for your vehicle.

ENGINE NUMBER

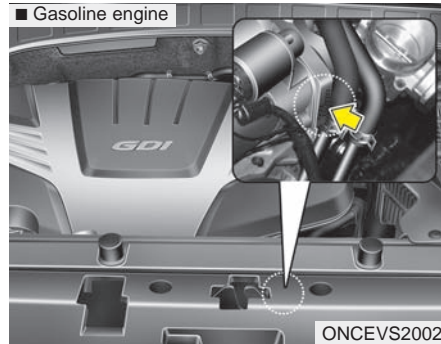

The engine number is stamped on the engine block as shown in the drawing.

REFRIGERANT LABEL

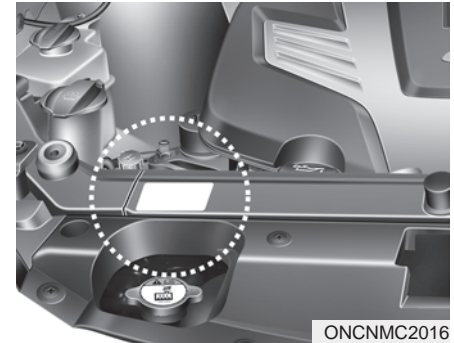

The refrigerant label is located at the front of the engine room.

The label contains the following information:

- Type of refrigerant
- Amount of refrigerant

CONSUMER INFORMATION

This consumer information has been prepared in accordance with regulations issued by the National Highway Traffic Safety Administration of the U.S. Department of Transportation. Your Hyundai dealer will help answer any questions you may have as you read this information.

Hyundai motor vehicles are designed and manufactured to meet or exceed all applicable safety standards.

For your safety, however, we strongly urge you to read and follow all directions in this Owner's Manual, particularly the information under the headings "**NOTICE**", "**CAUTION**" and "**WARNING**".

If, after reading this manual, you have any questions regarding the operation of your vehicle, please contact your nearest Hyundai Motor America Regional Office as listed in the following:

Eastern Region: Connecticut, Delaware, Maine, Massachusetts, New Hampshire, New Jersey, New York, Pennsylvania, Rhode Island, Vermont.

Eastern Region
1122 Cranbury South River Road
Jamesburg, NJ 08831
(800) 633-5151

Southern Region: Florida, Georgia, North Carolina, South Carolina, Virginia, and West Virginia.

Southern Region
3025 Chastain Meadows Parkway
suite 100 Marietta, GA 30066
(800) 633-5151

South Central Region: Alabama, Arkansas, Louisiana, Mississippi, New Mexico, Oklahoma, Tennessee, Texas.

South Central Region
1421 South Beltline Road,
Suite 400 Coppell, TX 75019
(800) 633-5151

Central Region: Illinois, Indiana, Iowa, Kentucky, Michigan, Minnesota, Nebraska, North Dakota, South Dakota, Ohio, Wisconsin, Kansas, Missouri.

Central Region
1705 Sequoia Drive
Aurora, Illinois 60506
(800) 633-5151

Western Region: Alaska, Hawaii, Arizona, California, Colorado, Idaho, Montana, Nevada, Oregon, Utah, Washington, Wyoming.

Western Region
10550 Talbert Avenue
P.O.Box 20850
Fountain Valley,
California 92728-0850
(800) 633-5151

REPORTING SAFETY DEFECTS

If you believe that your vehicle has a defect which could cause a crash or could cause injury or death, you should immediately inform the National Highway Traffic Safety Administration (NHTSA) in addition to notifying HYUNDAI MOTOR AMERICA. If NHTSA receives similar complaints, it may open an investigation, and if it finds that a safety defect exists in a group of vehicles, it may order a recall and remedy campaign. However, NHTSA cannot become involved in individual problems between you, your dealer, or HYUNDAI MOTOR AMERICA.

To contact NHTSA, you may call the Vehicle Safety Hotline toll-free at 1-888-327-4236 (TTY: 1-800-424-9153); go to <http://www.safercar.gov>; or write to: Administrator, NHTSA, 1200 New Jersey Avenue, SE., West Building Washington, DC 20590 You can also obtain other information about motor vehicle safety from <http://www.safercar.gov>.

Index

A

A/V Mode	4-82
AC inverter	4-153
Active ECO.....	5-56
Air bag collision sensors	3-70
Air bag inflation conditions.....	3-71
Air bag non-inflation conditions	3-73
Air bag warning label	3-77
Air bag warning light	3-52
Air bags.....	3-49
Air bag collision sensors.....	3-70
Air bag inflation conditions	3-71
Air bag non-inflation conditions	3-73
Air bag warning label.....	3-77
Air bag warning light.....	3-52
Curtain air bag.....	3-68
Driver's front air bag	3-62
Occupant classification system	3-56
Operation.....	3-50
Passenger's front air bag.....	3-60
Side impact air bag.....	3-65
SRS components and functions	3-52
Air cleaner	7-38
Air conditioning system	8-5
All wheel drive (4WD).....	5-21
Antenna.....	4-161
Anti-lock brake system (ABS)	5-32

Appearance care	7-84
Exterior care	7-84
Interior care	7-89
Armrest (Rear seat).....	3-17
Audio remote control.....	4-161
Audio system	4-161
Antenna	4-161
Audio remote control	4-161
Auto light position	4-114
Automatic climate control system	4-135
3rd row climate control.....	4-143
Automatic heating and air conditioning.....	4-137
Manual heating and air conditioning	4-137
Automatic transaxle.....	5-14
Shift-lock override	5-18
Sports mode.....	5-17
Automatic turn off function.....	4-120
Aux, USB and iPod®	4-156

B

Battery.....	7-45
Battery saver function.....	4-111
Before driving.....	5-3
Blind spot detection system (BSD)	5-50
Blue Link® center	4-67
Bottle holder, see Cup holders	4-150
Brake system.....	5-28

Anti-lock brake system (ABS).....	5-32
Downhill brake control (DBC)	5-40
Electronic stability control (ESC).....	5-35
Hill-start assist control (HAC).....	5-42
Parking brake	5-30
Power brakes	5-28
Vehicle stability management (VSM).....	5-39
Brakes fluid.....	7-35
Bulb replacement.....	7-74
Bulb wattage.....	8-3
Button start/stop, see engine start/stop button.....	5-9

C

California perchlorate notice	7-95
Camera (Rear view).....	4-109
Capacities (Lubricants).....	8-6
Care	
Exterior care	7-84
Interior care	7-89
Tire care.....	7-48
Care of seat belts	3-39
Cargo security screen	4-157
Center console storage.....	4-147
Central door lock switch.....	4-23
Certification label	8-8
Chains, See Tire chains	5-66
Checking tire inflation pressure	7-49

Child restraint system	3-40
Lower anchor system	3-47
Tether anchor system.....	3-45
Child-protector rear door lock	4-25
Cigarette lighter	4-150
Climate control air filter.....	4-133
Clothes hanger	4-155
Combined instrument, see Instrument cluster	4-71
Compact spare tire	6-27
Consumer information	8-10
Coolant.....	7-32
Cooling fluid, see engine coolant.....	7-32
Crankcase emission control system.....	7-91
Cruise control switch.....	5-46
Cruise control system	5-45
Cruise control switch	5-46
Cup holder	4-150
Curtain air bag	3-68

D

Dashboard illumination, see Instrument cluster	
illumination.....	4-71
Dashboard, see Instrument cluster.....	4-71
Day/night rearview mirror	4-59
Daytime running light.....	4-112
Defogging (Windshield)	4-144
Defroster (Rear window).....	4-124

Index

Defrosting (Windshield)4-144
Dimensions8-2
Display illumination, see Instrument cluster
illumination.....4-71
Displays, see Instrument cluster.....4-71
Door locks.....4-21
 Central door lock switch4-23
 Child-protector rear door lock4-25
Downhill brake control (DBC).....5-40
Drinks holders, see Cup holders.....4-150
Driver position memory system3-8
Driver selectable steering mode4-56
Driver's front air bag3-62
Driving at night.....5-61
Driving in flooded areas5-63
Driving in the rain5-62
Driving off-road.....5-63

E

Economical operation5-57
Electric chromic mirror (ECM).....4-59
Electric chromic mirror (ECM) with compass.....4-59
Electric power steering (EPS)4-53
Electronic stability control (ESC)5-35
Emergency fuel filler door release4-46
Emergency starting6-5
 Jump starting6-5

Emergency tailgate safety release4-34
Emergency while driving6-3
Emission control system.....7-91
 Crankcase emission control system7-91
 Evaporative emission control System.....7-91
 Exhaust emission control system7-92
Engine8-2
Engine compartment.....2-7
Engine compartment panel fuse.....7-64, 7-70
Engine coolant7-32
Engine coolant temperature gauge4-74
Engine number.....8-9
Engine oil.....7-30
Engine overheats.....6-8
Engine start/stop button5-9
Engine will not start6-4
Evaporative emission control System7-91
Exhaust emission control system7-92
Explanation of scheduled maintenance items7-26
Exterior care7-84
Exterior overview (Front).....2-2
Exterior overview (Rear).....2-3

F

Flat tire (with spare tire).....6-20
 Changing tires6-23
 Compact spare tire6-27

Jack and tools6-20
 Jack label6-29
 Removing and storing the spare tire6-21
 Floor mat anchor(s)4-155
 Fluid
 Brakes fluid7-35
 Washer fluid7-37
 Folding Key4-4
 Folding the rear seat3-21
 Front fog light4-116
 Front seat adjustment - Manual3-5
 Front seat adjustment - power3-6
 Fuel Economy4-91
 Fuel filler lid4-43
 Emergency fuel filler door release4-46
 Fuel Gauge4-74
 Fuel requirements1-3
 Fuse switch7-64
 Fuse/relay panel description7-66
 Fuses7-62
 Engine compartment panel fuse7-64, 7-70
 Fuse switch7-64
 Fuse/relay panel description7-66
 Instrument panel fuse7-63
 Main fuse7-65
 Multi fuse7-65

G

Gauges4-73
 Glove box4-147
 Glove box lamp4-122
 Good braking practices5-43
 Good driving practices5-19
 Gross vehicle weight8-5

H

Hazard warning flasher4-110
 Hazardous driving conditions5-59
 Headlamp delay4-111
 Headlamp welcome4-123
 Headlight bulb replacement7-74
 Headlight position4-113
 Headrest(3rd row)3-18
 Headrest(front)3-10
 Headrest(rear)3-17
 Heated steering wheel4-55
 Height adjustment (Front)3-30
 High beam operation4-114
 Highway driving5-63
 Hill-start assist control (HAC)5-42
 Hood4-41
 Horn4-55
 How to use this manual1-2

I

Immobilizer system4-8, 4-14

Indicator lights4-101

Inside rearview mirror4-59

Instrument cluster4-71

 Gauges4-73

 Instrument cluster illumination4-72

 LCD Display Control4-72

 Transaxle Shift Indicator4-76

Instrument panel fuse7-63

Instrument panel overview2-6

Interior care7-89

Interior features4-150

 AC inverter4-153

 Aux, USB and iPod®4-156

 Cargo security screen4-157

 Cigarette lighter4-150

 Clothes hanger4-155

 Cup holder4-150

 Floor mat anchor(s)4-155

 Luggage net (holder)4-157

 Power outlet4-152

 Side curtain4-159

 Sunvisor4-151

Interior light4-120

 Automatic turn off function4-120

 Glove box lamp4-122

 Luggage room lamp4-122

Map lamp4-120

Room lamp4-121

Vanity mirror lamp4-122

Interior light welcome4-123

Interior overview2-4

J

Jack and tools6-20

Jump starting6-5

K

Key positions5-6

Keys

 Folding key4-4

 Immobilizer system4-8, 4-14

 Smart key4-10

L

Label

 Air bag warning label3-77

 Jack label6-29

 Refrigerant label4-134, 8-9

 Tire sidewall labeling7-54

 Tire specification and pressure label8-9

 Vehicle certification label8-8

Index

Outside rearview mirror	4-67
Programming HomeLink®	4-63
Moonroof, see Panoramic sunroof	4-47
Multi box	4-148
Multi fuse.....	7-65

O

Occupant classification system.....	3-56
Odometer	4-75
Oil (Engine).....	7-30
Outside rearview mirror	4-67
Outside temperature gauge.....	4-75
Overheats	6-8
Owner maintenance	7-6

P

Panoramic sunroof.....	4-47
Parking brake	5-30, 7-37
Parking light position.....	4-113
Passenger's front air bag.....	3-60
Pocket lamp	4-123
Power brakes.....	5-28
Power outlet.....	4-152
Power steering	4-53
Power tailgate	4-27
Power window lock button.....	4-40

Pre-tensioner seat belt.....	3-33
Programming HomeLink®	4-63

R

Rear parking assist system	4-105
Rear seat adjustment.....	3-15
Rearview camera	4-109
Rear window wiper and washer	4-119
Recommended cold tire inflation pressures	7-48
Recommended lubricants and capacities.....	8-6
Recommended SAE viscosity number.....	8-7
Reducing the risk of a rollover.....	5-59
Refrigerant label	8-9
Replacement light bulb.....	7-74
Reporting safety defects	8-11
Road warning.....	6-2
Rocking the vehicle	5-54
Room lamp	4-121
Rotation (Tire)	7-50

S

Scheduled maintenance service.....	7-8
Seat belt precautions.....	3-36
Seat belt warning	3-28

Seat belts.....	3-27	Snow tires	5-65
Care of seat belts.....	3-39	Spare tire	
Height adjustment (Front).....	3-30	Changing tires	6-23
Pre-tensioner seat belt	3-33	Removing and storing the spare tire	6-21
Seat belt precautions	3-36	Special driving conditions	5-59
Seat belt warning.....	3-28	Driving at night	5-61
Seat warmer (Rear seat)	3-19	Driving in flooded areas.....	5-63
Seat warmer(front).....	3-13	Driving in the rain.....	5-62
Seatback pocket.....	3-15	Driving off-road	5-63
Seats.....	3-2	Hazardous driving conditions	5-59
Armrest (Rear seat)	3-19	Highway driving.....	5-63
Driver position memory system.....	3-8	Reducing the risk of a rollover	5-59
Folding the rear seat.....	3-21	Rocking the vehicle.....	5-60
Front seat adjustment - Manual	3-5	Smooth cornering.....	5-61
Front seat adjustment - power.....	3-6	Speedometer	4-73
Headrest(3rd row)	3-18	Sports mode	5-17
Headrest(front)	3-10	SRS components and functions.....	3-50
Headrest(rear).....	3-17	Starting difficulties, see engine will not start.....	6-4
Rear seat adjustment	3-15	Steering wheel	4-53
Seat warmer (Rear seat).....	3-19	Driver selectable steering mode.....	4-56
Seat warmer(front).....	3-13	Electric power steering (EPS).....	4-53
Seatback pocket.....	3-15	Heated steering wheel	4-55
Service Mode.....	4-78	Horn.....	4-55
Shift-lock override.....	5-18	Power steering.....	4-53
Side curtain.....	4-159	Tilt & telescopic steering	4-54
Side impact air bag.....	3-67		
Smart key.....	4-10		
Smooth cornering	5-61		

Index

Storage compartment	4-147
Center console storage	4-147
Glove box	4-147
Luggage tray	4-149
Multi box	4-148
Sunglass holder	4-148
Sunglass holder	4-148
Sunroof, see Panoramic sunroof	4-47
Sunvisor	4-151

T

Tachometer	4-73
Tether anchor system	3-43
Theft-alarm system	4-17
Tilt & telescopic steering	4-54
Tire chains	5-66
Tire maintenance	7-54
Tire pressure monitoring system (TPMS)	6-9, 6-14
Tire replacement	7-52
Tire rotation	7-50
Tire sidewall labeling	7-54
Tire specification and pressure label	8-9
Tire traction	7-53
Tires and wheels	8-4
Checking tire inflation pressure	7-49
Recommended cold tire inflation pressures	7-48
Tire care	7-48

Tire maintenance	7-54
Tire replacement	7-52
Tire rotation	7-50
Tire sidewall labeling	7-54
Tire traction	7-53
Wheel alignment and tire balance	7-51
Wheel replacement	7-53
Towing	6-30
Towing hook	6-31
Towing hook	6-31
Trailer towing	5-70
Transaxle Shift Indicator	4-76
Trip A/B	4-90
Trip computer	4-89
Fuel Economy	4-91
Trip A/B	4-90
Trip Modes	4-89
Trip Modes	4-89
Turn By Turn Mode	4-82
Turn signals	4-115

U

User Settings Mode	4-79
--------------------------	------

V

Vanity mirror lamp4-122
 Vehicle break-in process1-5
 Vehicle certification label8-8
 Vehicle data collection and event data recorders1-6
 Vehicle handling instructions1-5
 Vehicle identification number (VIN).....8-8
 Vehicle load limit.....5-79
 Vehicle stability management (VSM)5-39
 Vehicle weight5-84

W

Warning lights.....4-93
 Warning messages4-82
 Washer fluid.....7-37
 Welcome system4-123
 Headlamp welcome4-123
 Interior light welcome4-123
 Pocket lamp4-123
 Wheel alignment and tire balance7-51
 Wheel replacement7-53
 Windows4-36
 Power window lock button4-40
 Windshield defrosting and defogging4-144
 Windshield washers (Front).....4-118
 Windshield wipers (Front)4-117

Winter driving.....5-65
 Snow tires.....5-65
 Tire chains5-66
 Wiper blades7-42
 Wipers and washers4-117
 Rear window wiper and washer4-119
 Windshield washers (Front)4-118
 Windshield wipers (Front).....4-117