

## WALK THE CUSTOMER THROUGH EACH OF THE FOLLOWING KEY DELIVERY FEATURES

☐ DEMONSTRATE HOW TO SET THE CLOCK - page 29

☐ AUTOMATIC CLIMATE CONTROL - page 18 – 19

☐ HOW TO DEFROST

- 1 Press the front defrost button.
- 2 Set to warmest temperature setting.
- 3 Set to highest fan speed.

☐ BLUE LINK – page 21-23 (if applicable)

- Assist with creating MyHyundai.com account
- Assist with Blue Link enrollment
- Show Blue Link Users Manual
- Encourage customers to press the Blue link button  after enrollment to initiate Welcome Call

☐ TIRE PRESSURE MONITORING SYSTEM (TPMS)- page 35

Low tire pressure indicator /  
TPMS malfunction indicator



NOTE: Tire pressure may vary in colder temperatures causing the low tire pressure indicator  to illuminate. Inflate tires according to the Tire Pressure Label located on the driver's side door pillar.

☐ WINDSHIELD WIPER / WASHER - page 09

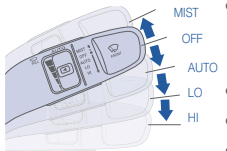

- To activate wipers move the switch down to one of the three positions (AUTO, LO, HI)
- To adjust "AUTO" speed move switch
- To spray washer fluid pull lever toward you
- Push lever up for a single wiper pass

☐ PARKING ASSIST SYSTEM (PAS) - page 33

If the PAS is OFF, it will automatically turn ON when in Reverse. PAS will turn OFF after the shift lever is shifted out of Reverse.

## MAINTENANCE

Scheduled Maintenance	Normal Usage		Severe Usage*	
Engine Oil And Filter*	Replace	7,500 or 12 mos.	Replace	3,750 or 6 mos.
Fuel Additives	Add	Every 7,500 or 12 mos.		
Tire Rotation	Perform	7,500	Perform	7,500
Air Cleaner Filter	Inspect Replace	7,500 30,000	Inspect Replace	More Frequently Same As Normal
Fuel Tank Air Filter	Inspect	30,000	Inspect Replace	Same As Normal More Frequently
Vacuum Hose	Inspect	7,500	Inspect	Same As Normal
Fuel Lines, Fuel Hoses And Connections	Inspect	30,000	Inspect	Same As Normal
Vapor Hose & Fuel Filler Cap, Fuel tank	Inspect	30,000	Inspect	Same As Normal
Climate Control Air Filter (For Evaporator And Blower Unit)	Replace	15,000	Replace	More Frequently
Air Conditioning Refrigerant	Inspect	15,000	Inspect	Same As Normal
Brake Hoses & Lines	Inspect	15,000	Inspect	Same As Normal
Drive Shafts & Boots	Inspect	15,000	Inspect	7,500 or 6 mos.
Exhaust Pipe & Muffler	Inspect	15,000	Inspect	Same As Normal
Front Brake Disc/Pads, Calipers	Inspect	15,000	Inspect	More Frequently
Rear Brake Disc/Pads	Inspect	15,000	Inspect	More Frequently
Steering Gear Box, Linkage & Boots/ Lower Arm Ball Joint, Upper Arm Ball Joint	Inspect	15,000	Inspect	More Frequently
Suspension Mounting Bolts	Inspect	15,000	Inspect	Same As Normal
Propeller Shaft	Inspect	15,000	Inspect	7,500 or 6 mos.
Brake Fluid	Inspect	30,000	Inspect	Same As Normal
Parking Brake	Inspect	30,000	Inspect	More Frequently
Front(AWD)/Rear Differential Oil	Inspect	37,500	Replace	75,000
Fuel Filter	Inspect	30,000	Inspect	Same As Normal
Valve Clearance (3.8L)	Inspect	60,000	Inspect	Same As Normal
Drive Belt	1st Inspect 60,000 or 72 mos. Add. Inspect 15,000 or 24 mos.		Inspect	Same As Normal
Spark Plugs (Iridium Coated)	Replace	105,000	Replace	More Frequently
Coolant	1st Replace 120,000 or 120 mos. Add. Replace 30,000 or 24 mos.		Replace	Same As Normal
Automatic Transmission Fluid	No, Check, No service required		Replace	60,000

\*Check the engine oil regularly between recommended oil change. Hyundai recommends Quaker State oil.

\*See Owner's Manual for details.

Looking For more detailed information? This Quick Reference Guide does not replace your vehicle's Owner's Manual. If you require additional information or are unsure of a specific issue, We recommend that you always refer to the vehicle's Owner's Manual or contact your authorized Hyundai dealer. The information contained in this Quick Reference Guide is correct at the time of printing; however, specifications and equipment can change without notice. No warranty or guarantee is being extended in this Quick Reference Guide, and Hyundai reserves the right to change product specifications and equipment at any time without incurring obligations. Some vehicles are shown with optional equipment.

NP150-G2015-A  
(Rev 07/09/15)  
Printing 07/12/15



**HYUNDAI GENESIS**  
Quick Reference Guide

[www.hyundai.com](http://www.hyundai.com)



**HYUNDAI**  
NEW THINKING.  
NEW POSSIBILITIES.

Roadside Assistance: **1-800-243-7766**  
 Consumer Affairs: **1-800-633-5151**  
 XM® Radio: **1-800-967-2346**  
 Blue Link: **1-855-2BLUELINK**  
**(1-855-225-8354)**

# Table of contents

Automatic transmission	36
Automatic Emergency Braking (AEB)	35
Auto Hold	34
AUX, USB and iPod port	27
Blind Spot Detection system (BSD)	38
Blue Link Telematics system	21-23
Bluetooth operational tips	24
Bluetooth phone pairing	20
Central control panel	28
Child - protector rear door lock	12
Climate control	18-19
Climate control system seat	31
Clock adjustment	29
Cruise control/advanced smart Cruise control	40
Drive mode integrated control system	39
Driver position memory system	05
Driver's main controls	07
Electronic Stability Control (ESC)	37
Electric Parking Brake (EPB)	34
Engine start / stop button	05
Front seat	03
Fuel filler lid	07
Headlights and fog lights	08
Headrest adjustment	04
Head up display	17
Heated steering wheel	32
Homelink wireless control system	13
Instrument cluster	14-15
Interior lights	10
Lane Keeping Assist System (LKAS)	37
LCD display control	16
LCD display modes	16
Navigation	26
Paddle shifter	36
Panoramic Sunroof	10
Parking assist system (PAS)	33
Parking Guide system	33
Rearview camera	32
Rear window curtain	30
Seat belt adjustment	04
Seat warmer	31
Smart key	02
Steering wheel adjustment	06
Steering wheel audio control	24
Tire Pressure Monitoring System (TPMS)	35
Trunk	11
Voice recognition tips	25
Wipers and washer	09

\*Some vehicles may not be equipped with all the listed features.

## FREQUENTLY ASKED QUESTIONS

• Pair phone to your vehicle. Refer to page 20.

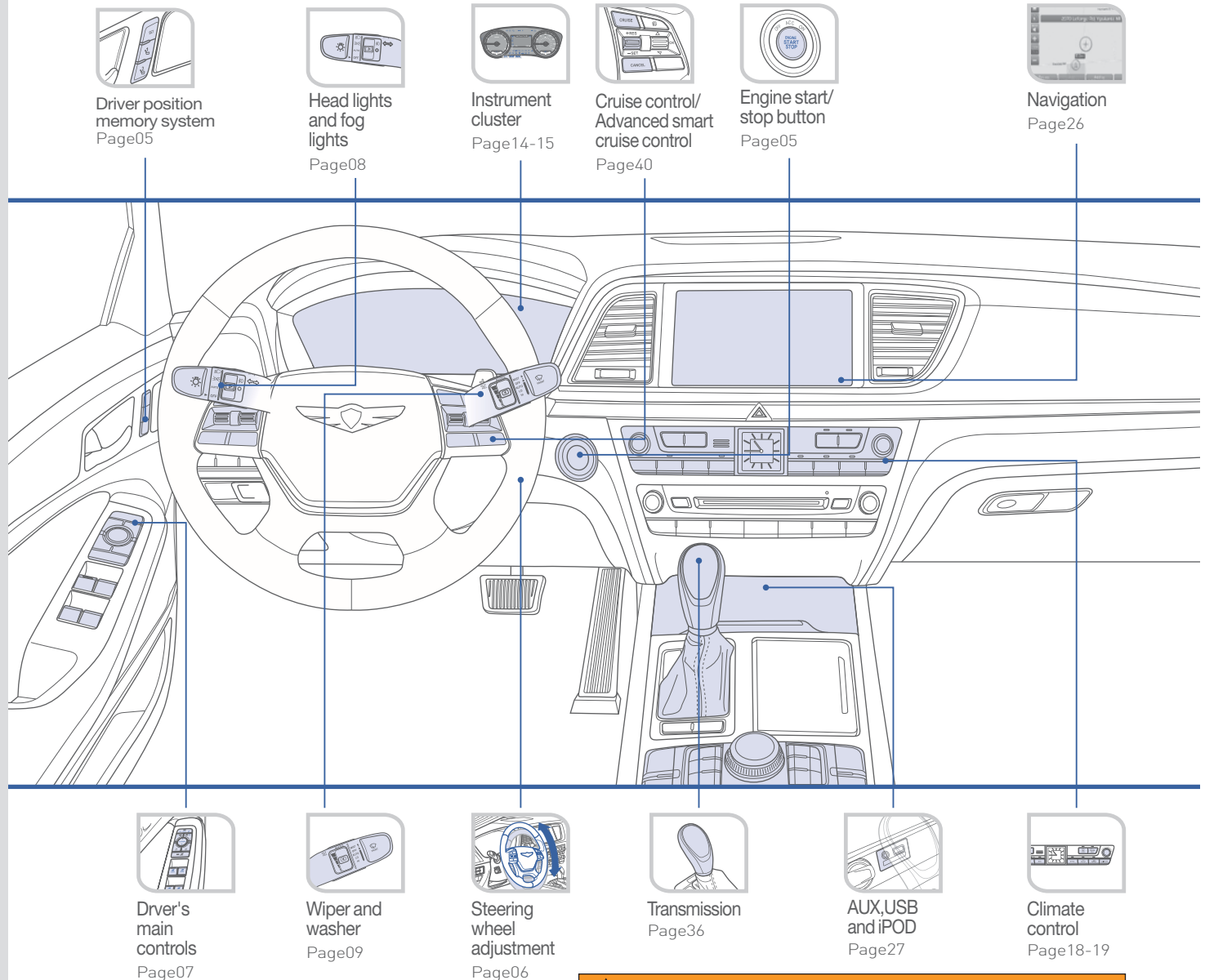

Use this Quick Reference Guide to learn about the features that will enhance your enjoyment of your Hyundai. More detailed information about these features are available in your Owner's Manual.

### WARNING!

To reduce the risk of serious injury to yourself and others, read and understand the important SAFETY INFORMATION in your Owner's Manual.

## GETTING STARTED

### SMART KEY

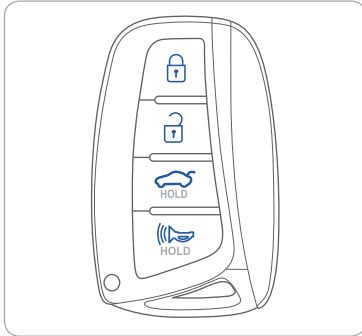

- Lock
- Unlock
- Trunk unlock
- Panic



**NOTE:** User selectable option see Owner's Manual for more detail.

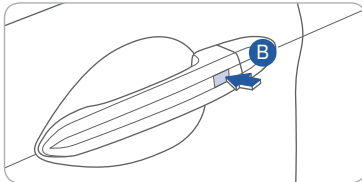

**Driver's door Lock / Unlock**  
Smart key must be within 28~40 in. from the outside door handle.  
**Press:** Once – Unlock driver door  
Twice – Unlock all doors  
Third – Lock all doors

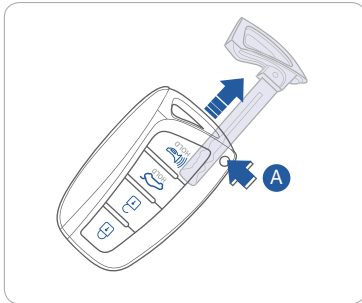

**Remove mechanical key.**  
Press and hold the release button **A** to remove the mechanical key

**NOTE:** The key hole is located under the key hole cover **B**.

### FRONT SEAT

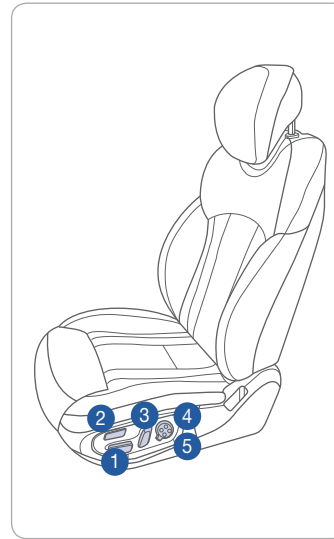

**Forward and backward** ①

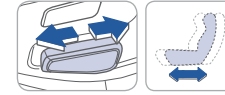

**Seat cushion length (for driver's seat)** ②



**Seatback angle** ③



**Seat cushion height** ④

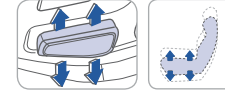

**Lumbar support** ④

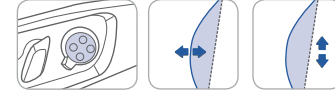

**Seat bolster adjustment (for driver's seat)** ⑤





## GETTING STARTED

### HEADREST ADJUSTMENT

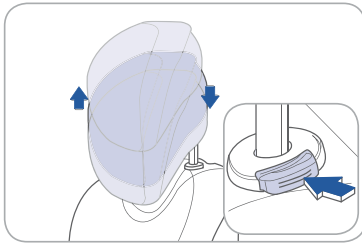

**To Raise Headrest:**  
Pull headrest up.

**To Lower Headrest:**  
Press lock button while pressing down on headrest.

**To Adjust Headrest Forward:**  
Pull forward to 1 of 3 positions

**To Adjust Backward:**  
Pull it fully forward to the farthest position and release it.

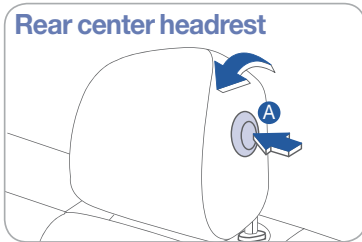

#### Rear center headrest

**To Raise Center Headrest:**  
Rotate headrest forward.  
Lift headrest up.

**To Lower Center Headrest:**  
Press lock button while pressing down on headrest.  
Press button **A** to rotate headrest down.

### SEAT BELT ADJUSTMENT (Front seat)

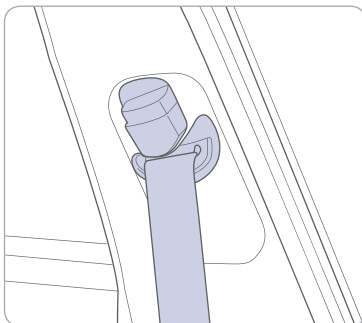

Pull up to raise.

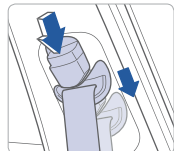

Press button and push down to lower.



### ENGINE START/STOP BUTTON

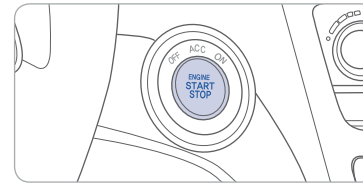

With the ignition OFF and foot OFF of brake pedal, press the engine start/stop button.

- Once for ACC(Accessory) mode.
- Twice for ON mode.
- Three times for OFF.

To start the engine in any mode(including OFF), press the engine start/stop button while pressing the brake pedal.

To shut the engine OFF, place shift lever in P(Park) and press the engine start/stop button again.

#### Emergency situations

##### Shut off engine while driving

Press and hold engine start/stop button for more than 2 seconds or press 3 times consecutively within 3 seconds.

##### Restart engine while driving

Press engine start/stop button with shift lever in N(Neutral).

### DRIVER POSITION MEMORY SYSTEM

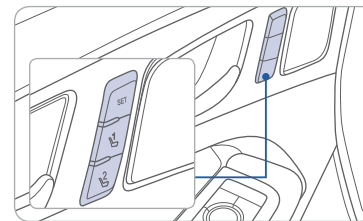

#### Storing

1. Adjust the driver's seat, outside rearview mirrors, steering wheel, instrument panel illumination and head up display.
2. Press the SET button. The system will beep once.
3. Press one of the memory buttons (1 or 2) within 5 seconds. The system will beep twice.

**NOTE:** Transmission must be in P(Park).

#### Resetting

1. Set the ignition to the ON position, gear in the P (Park) position, and open driver's door.
2. Set the driver's seat and seatback to the foremost position.
3. Simultaneously press the SET button and push the control lever to forward for 2 seconds.

#### Recalling

Press the desired memory button (1 or 2). The system will beep once.

## STEERING WHEEL ADJUSTMENTS

### Power tilt and telescopic

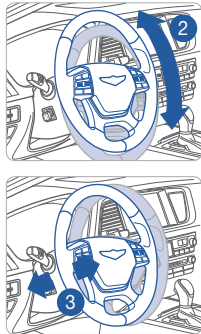
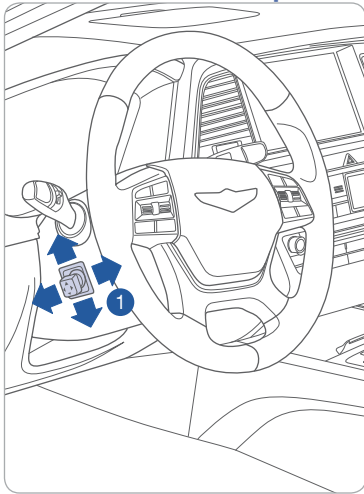

NOTE: Do not adjust while driving.

Set the angle **2** and distance **3** with the switch **1**.

### Manual tilt and telescopic

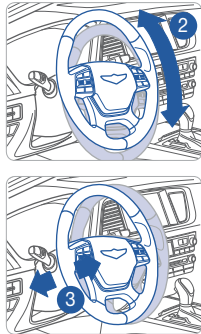
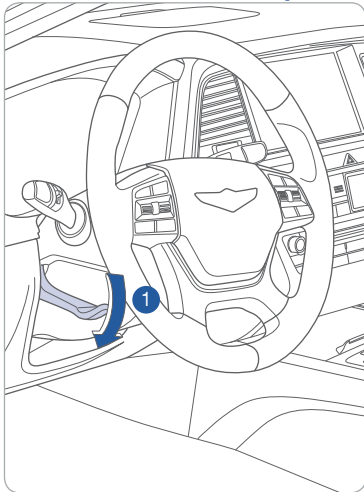

NOTE: Do not adjust while driving.

1. Pull down the lever **1**.
2. Set the angle **2** and distance **3**.
3. Pull up the lever.

## FUEL FILLER LID

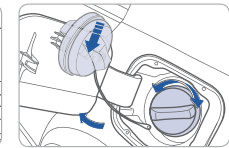
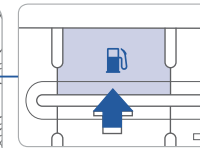
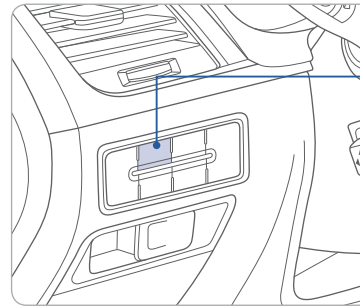

NOTE: Tighten fuel cap until one click is heard.

Failure to do this may result in the Check Engine Light illuminating.

## DRIVER'S MAIN CONTROLS

### Driver's door

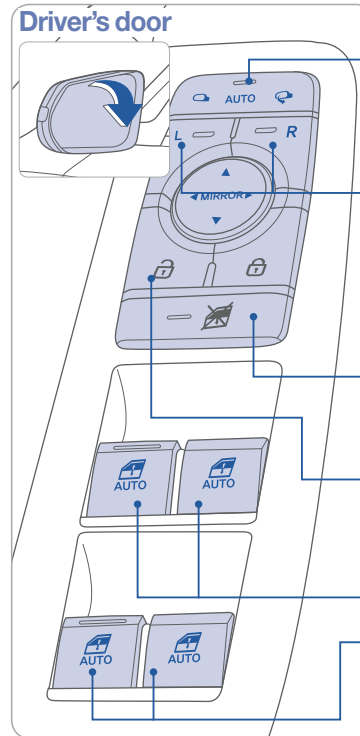

### Outside Rearview Mirror

- Press to fold/unfold mirrors. Press the lock or unlock button on the smart key, and the mirrors will be folded or unfolded when AUTO is set.

- Press the L or R button. Adjust the mirror by using the directional switch. If L or R button is still selected, both mirrors will tilt downward when reversing. Deselect L or R will disable the auto tilt down.

### Power window lock button

Disables the power window switches on the rear passenger doors.

### Door Lock

Locks/unlocks all doors.

### Window Switches

- Front doors power window switches.
- Rear doors power window switches.

## HEADLIGHTS AND FOG LIGHTS

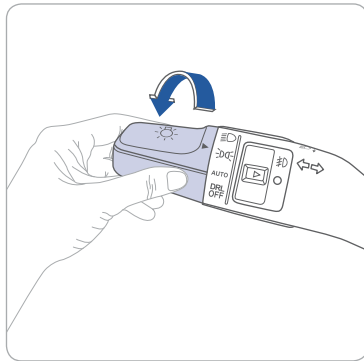

- ▶ | Headlight position
- ▶ | Parking light position
- ▶ | **AUTO** Auto light position
- ▶ | **DRL OFF** DRL OFF position

### Headlight delay

Headlights may stay on for 15 seconds after exiting and locking vehicle. Press remote lock button twice to turn headlights off.

See Owner's Manual for more detail.

### Turn signals and lane change signals

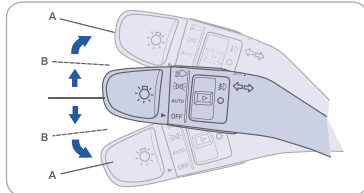

### High beam

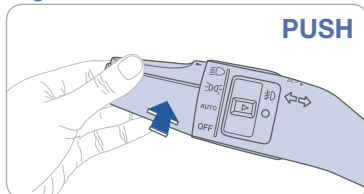

### Flashing high beam

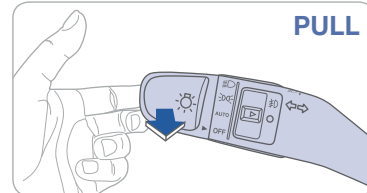

### Fog light

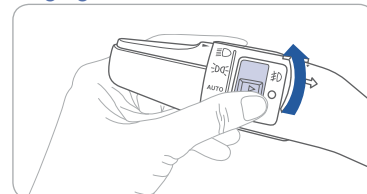

### Smart High Beam Function

1. Select auto position on stalk.
2. Push lever forward to engage Auto High beam.
3. Push lever forward again to disengage.

See Owner's Manual for more details.

## WIPERS AND WASHER

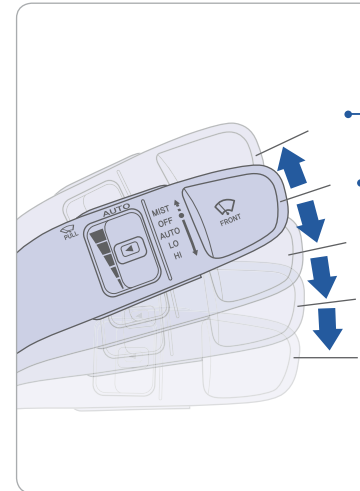

- **MIST** - Single wipe
- **OFF**
- **AUTO** - Auto control wipe
- **LO** - Low wiper speed
- **HI** - High wiper speed

### Auto control wipe interval adjustment

Adjust the control knob.

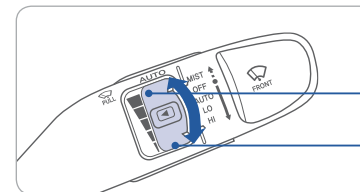

Fast wiper speed

Slow wiper speed

### Windshield washer

Pull the lever gently toward you to spray washer fluid on the windshield and to run the wipers 1-3 cycles.

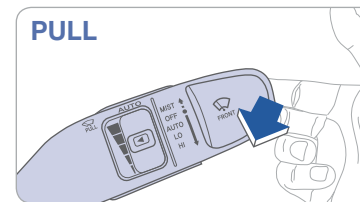

### Headlamp washer

Fluid will spray on headlamp assemblies when headlamps are turned ON. Will activate only once for every ignition key cycle or only once every 15 minutes.



## FEATURES AND CONTROLS

### PANORAMIC SUNROOF

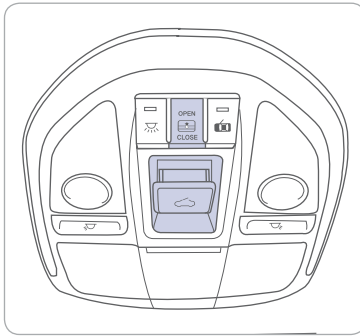

#### Sunshade



#### Sliding the sunroof

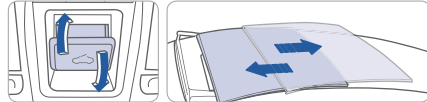

#### Tilting the sunroof

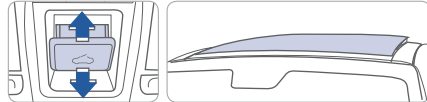

### INTERIOR LIGHTS

#### Type A

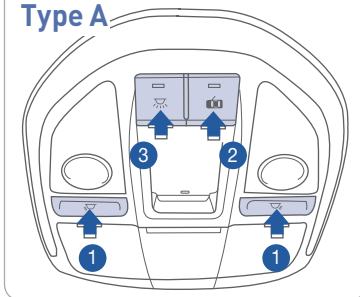

#### Front Map Lamp (☞ ☞) ①

Push the switch to turn the map lamp on or off.

#### Front Door Lamp (☞) ②

Lights will turn on when any door is open.

#### Front Room Lamp (☞) ③

Push the switch to turn the room lamp on or off.

#### Type B

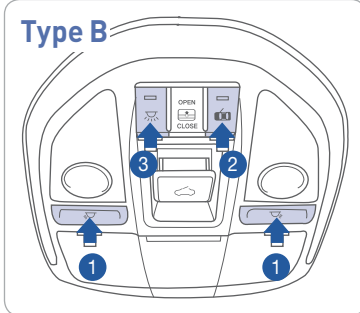

### TRUNK

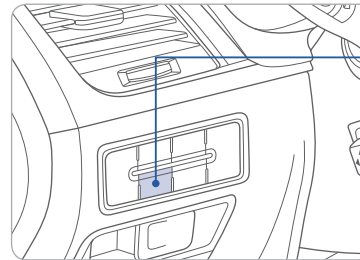

#### Trunk main control button

Press the button to open the trunk.

#### Power trunk:

To close, press and hold until trunk is closed securely.

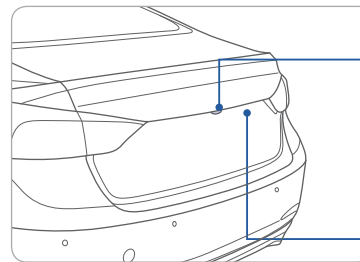

#### Trunk open button

Press to open. Smart key needs to be within range.

Use the mechanical key.

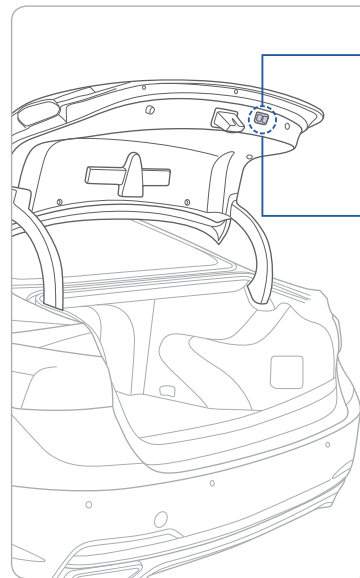

#### Power trunk close button

Pressing the button closes the power trunk automatically.

#### Power Trunk lock button

Pressing the button with the smart key closes and locks all doors and power trunk automatically.

#### Trunk open button on the smart key

Pressing the button for more than 1 second opens the power trunk automatically.



## FEATURES AND CONTROLS



### Smart Trunk

Trunk will open automatically when detecting smart key within range near the trunk for more than 3 seconds.

#### To enable Smart Trunk function:

Vehicle must be in P (Park) to adjust settings in the User Setting mode.

1. Select "Door/Trunk" in the User Settings in the instrument cluster.
2. Check "Smart Trunk".



**NOTE:** Function is active after 15 seconds when all doors are closed and locked. The vehicle will also provide an audible and visual alarm while activating. For more details, refer to Owner's Manual. Factory setting defaults Smart Trunk in OFF position.

## CHILD-PROTECTOR REAR DOOR LOCK

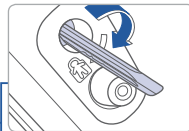
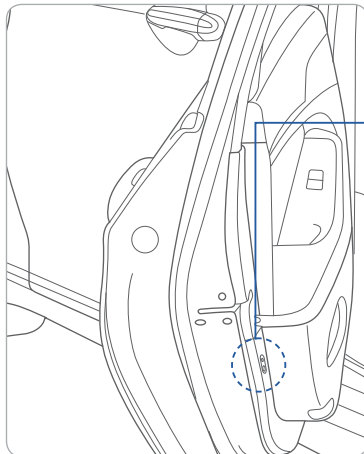

#### Lock

Insert a screwdriver into the hole and turn it to the lock position.

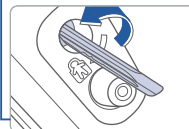

#### Unlock

Insert a screwdriver into the hole and turn it counterclockwise to unlock position.

## HOMELINK WIRELESS CONTROL SYSTEM

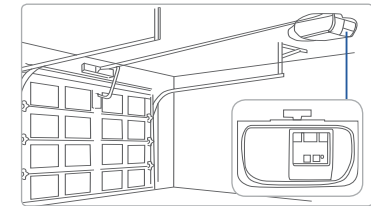
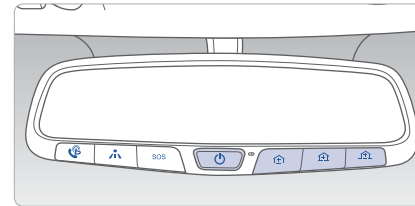

### Standard Programming

To program most devices, follow these instructions:

1. For first-time programming, press and hold the two outside buttons, HomeLink® Channel 1 and Channel 3 Buttons, until the indicator light begins to flash (after 10 seconds). Release both buttons. Do not hold the buttons for longer than 20 seconds.
2. Position the end of your hand-held transmitter 1-3 inches (2-8 cm) away from the HomeLink® buttons while keeping the indicator light in view.
3. Simultaneously press and hold both the HomeLink® and hand-held transmitter button. DO NOT release the buttons until step 4 has been completed.
4. While continuing to hold the buttons the red indicator Status LED will flash slowly and then rapidly after HomeLink® successfully trains to the frequency signal from the hand-held transmitter. Release both buttons.

For detail instructions, refer to your Owner's Manual or visit [www.homelink.com](http://www.homelink.com).



**INSTRUMENT CLUSTER**

**Type A with 4.3" LCD Display**

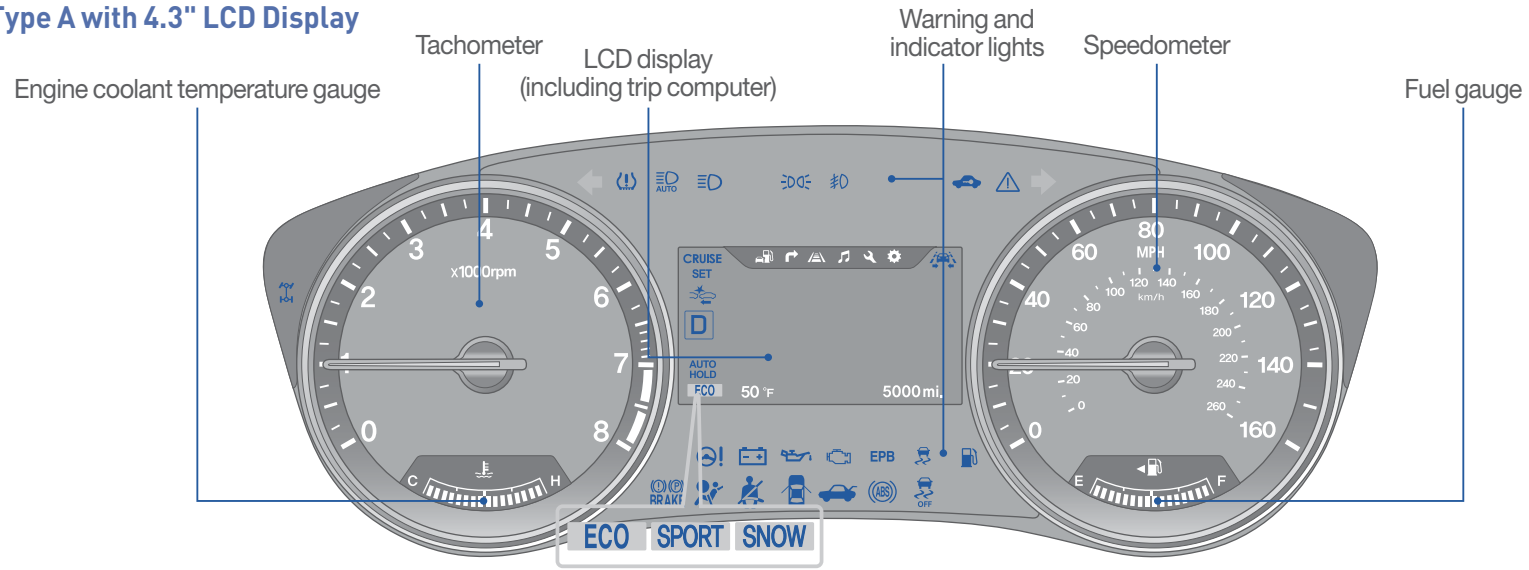

**Type B with 7" LCD Display**

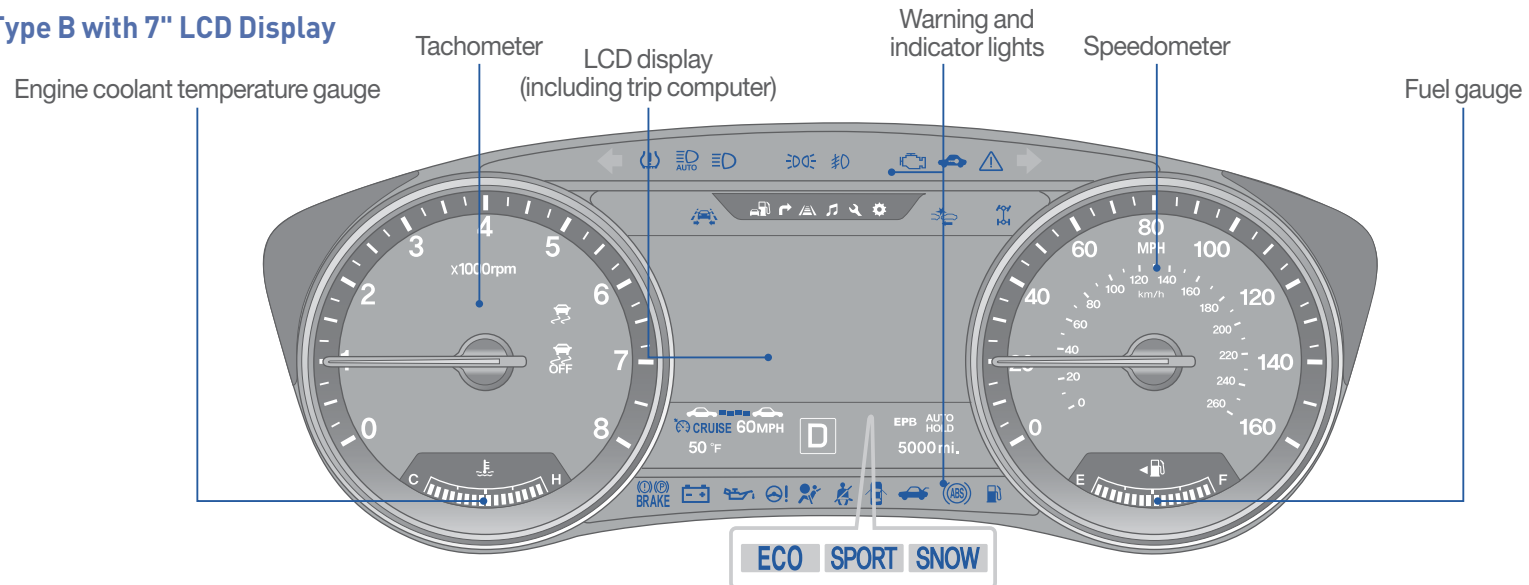



## INSTRUMENT CLUSTER

### LCD DISPLAY MODES

Modes	Symbol	Explanation
Trip Computer		This mode displays driving information like the tripmeter, fuel economy, and so on.
Turn By Turn (TBT) (if equipped)		This mode displays the navigation turn by turn guidance.
ASCC/LKAS (if equipped)		This mode displays the state of the Advanced Smart Cruise Control (ASCC) and Lane Keeping Assist System (LKAS).
AV		This mode displays the state of the AV system.
Information		Displays service interval and warning messages.
User Settings		Changes settings.

### LCD DISPLAY CONTROL

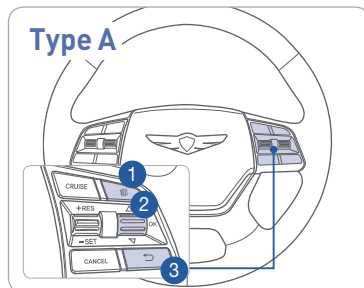

- ① : MODE button for changing modes
- ② : MOVE switch for changing items
- OK : SELECT/RESET button for setting or resetting the selected item
- ③ : BACK button for moving to upper level menu (if equipped)

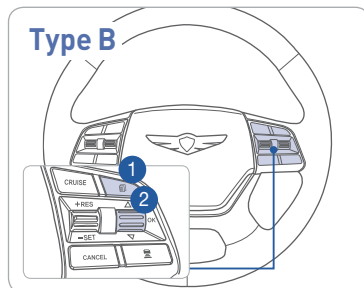

### WARNINGS AND INDICATORS

Air bag warning light	Seat belt warning	Parking brake & Brake fluid warning light
Anti-lock Brake System (ABS) warning light	Electronic Brake Force Distribution (EBD) system warning light	
Electric Power Steering (EPS) warning light	Malfunction Indicator Lamp (MIL)	Charging system warning light
Engine coolant temperature warning light	Engine oil pressure warning light	Low fuel level warning light
Low tire pressure warning light	Door open warning light	Trunk open warning light
AWD warning light	Electric Parking Brake (EPB) warning light	Automatic Emergency Braking (AEB) warning light
Master warning light	Electronic Stability Control (ESC) indicator	Electronic Stability Control (ESC) OFF indicator
Immobilizer indicator	Turn signal indicator	Low beam indicator
High beam indicator	Light ON indicator	Smart high beam indicator
Front fog light indicator	Cruise indicator	Cruise SET indicator
AUTO HOLD indicator	SPORT mode indicator	SNOW mode indicator
ECO indicator	Lane Keeping Assistant System (LKAS) indicator	

### HEAD UP DISPLAY

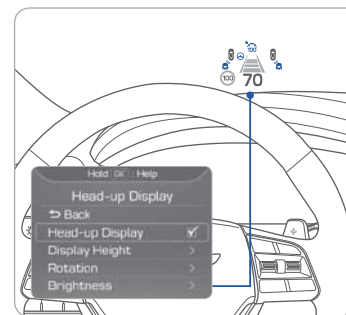

The head up display is a transparent display which projects a shadow of selected information of the instrument cluster and navigation on the windshield glass.

To activate the head up display, select "Head-up Display" on the "User Settings Mode" in the LCD display. Adjust "Head-up Display" height until in view.

NOTE: See Owner's Manual for more details on selecting content to display on the Head Up Display.



## CLIMATE CONTROL



### Front

#### Type A

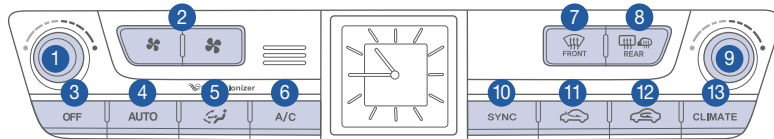

#### Type B

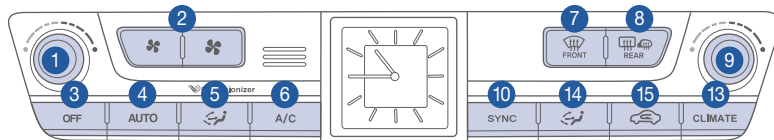

- 1 Driver's temperature control knob
- 2 Fan speed control button
- 3 OFF button
- 4 AUTO (automatic control) button
- 5 Mode selection button (Driver)
- 6 Air conditioning button
- 7 Front windshield defrost button
- 8 Rear window defrost button
- 9 Passenger's temperature control knob

### DEFOGGING/DEFROSTING

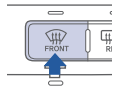

1. Press the defrost button.



2. Select warmest temperature.

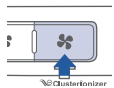

3. Set the fan speed to the highest speed.

### SYSTEM OFF

Pressing the OFF button will place the system in the OFF mode.

- Front blower will turn off.
- Outside (fresh) air position will be selected.
- Vented air will be at last set temperature.

### MODE SELECTION



Changing the direction of the air flow as follow.



### Rear

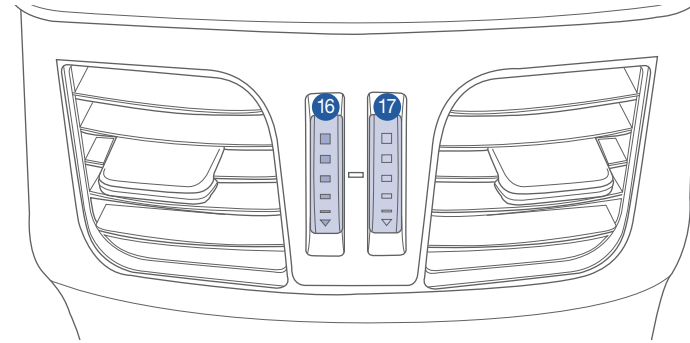

- 10 SYNC button (sync driver and passenger front air temperature)
- 11 Air intake control button (Outside air)
- 12 Air intake control button (Recirculated air)
- 13 Climate information screen selection button
- 14 Mode selection button (Passenger)
- 15 Air intake control button
- 16 Rear temperature control thumbwheel
- 17 Rear vent ON/OFF thumbwheel

### AIR INTAKE CONTROL



Recirculated air position



Outside (fresh) air position (type A)



Outside (fresh) air position (type B)

### AUTOMATIC HEATING / AIR CONDITIONING

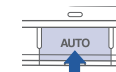

Controlling the modes, fan speeds, air intake and air-conditioning automatically.

### SMART VENT

When cabin humidity and carbon dioxide levels increase while Climate Control is off, fresh air will be circulated into the cabin.

Please refer to the Owner's Manual for more information.



## MULTIMEDIA

### BLUETOOTH PHONE PAIRING

Pairing tutorials, phone compatibility and Operational tips can be found through the Smart QR code using the QR reader application on your Smartphone.



#### Pairing a new device

**NOTE:** Vehicle must be parked to complete pairing process.

1. Press the PHONE button in the head unit (or DIS navigation system) or button in the steering wheel remote control.

#### Standard AVN

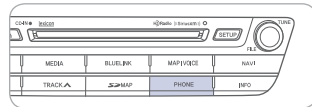

#### DIS navigation system

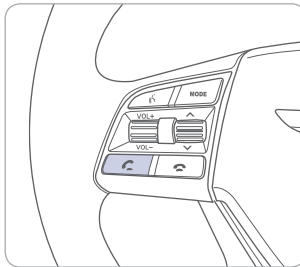
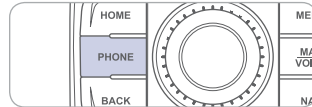

2. Press <YES> to search for Bluetooth phones.
3. Pair your car after your mobile phone detects the Bluetooth device.
4. Enter the passkey or accept the authorization popup. (The default passkey is 0000.)
5. Connect Bluetooth.

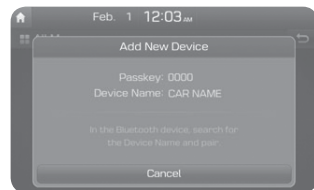

### BLUE LINK TELEMATICS SYSTEM

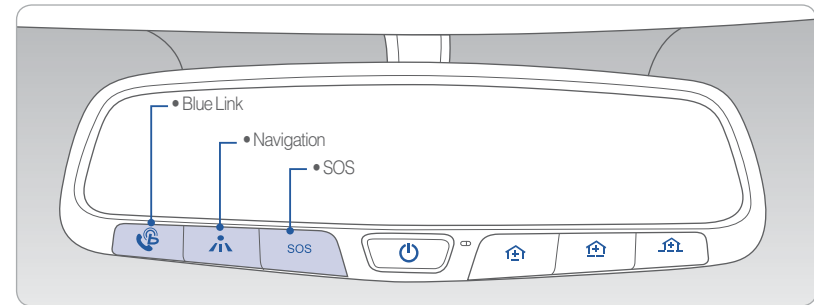

Press the button for access to the voice-response menu of services.

You can say:

- "Service Link" to schedule a service appointment.
- "Roadside Assistance" for roadside services.
- "Blue Link Account Services" for help with your Blue Link subscription.

- Press the button for Destination Search Powered by Google®.
- Press the **SOS** button for SOS Emergency Assistance.
- Refer to your Blue Link User's Manual for detailed information on system operation.
- For immediate assistance with subscription services, please call 1-855-2BLUELINK (1-855-225-8354).

Google® is a registered trademark of Google Inc.



## MULTIMEDIA



### Remote Features

#### Genesis Intelligent Assistance App



You can download the Blue Link mobile app to your compatible smart phone from the following sites:

- iPhone® — Apple® App Store
- Android® — Google Play

This feature enables you to remotely start your vehicle and set an engine timer (1-10 minutes) from virtually anywhere. You can also set the climate control temperature and turn on the rear-window defroster, ensuring a warm or cool car is ready to go when you are.

- To use this feature, you must have a Blue Link Personal Identification Number (PIN). To create or change your PIN, log on to [www.MyHyundai.com](http://www.MyHyundai.com). See page 5 of this guide for more information.

#### Remember...

- Remote Start with Climate Control will automatically shut off after 10 minutes or after selected engine timer runs out.
- While this feature is active, the parking lights will blink until vehicle is turned off or when vehicle is in operation.
- To continue operation of the vehicle, the proximity key must be inside the vehicle with the driver prior to pressing the brake and being able to move the gearshift from the "P" (park) position.

Please note: Remote Services are subject to adequate cellular coverage and signal strength, and only available in the 50 United States.

#### Remote Start Preconditions:

- Ignition is OFF
- Alarm is armed (i.e., vehicle locked by key fob Remote Door Lock)
- Gearshift level is in the "P" (park) position
- Brake pedal is not depressed
- Engine hood is securely closed
- All the doors are closed and locked
- The tailgate or trunk lid is closed
- The security/panic system is not activated
- The proximity key is not inside the vehicle
- The battery power is not low
- Vehicle is located in an open area
- It has been less than 4 days since last vehicle ignition off
- Vehicle located in area with good cell reception

#### Remote Start with Climate will terminate...

- After 10 minutes or after selected engine timer runs out
- Brake is pressed without proximity key inside vehicle
- Alarm is triggered without proximity key inside vehicle
- Door/trunk is opened from inside the vehicle

Notice: Laws in some communities may restrict the use of the features that remotely start the engine. For example, some laws may require a person using the remote start feature to have the vehicle in view when doing so or limit the length of time a vehicle engine may idle. Please check local and state regulations for any requirements and restrictions on remote starting of vehicles and engine idling time.

#### ⚠ WARNING!

Do not remote start vehicle in an enclosed environment (i.e., closed garage). Prolonged operation of a motor vehicle in an enclosed environment can cause a harmful build-up of carbon monoxide. Carbon monoxide is harmful to your health. Exposure to high levels of carbon monoxide can cause headaches, dizziness or in extreme cases unconsciousness and/or death. Do not leave children or animals unattended in a vehicle while using the remote start function.

#### ⚠ CAUTION!

If the vehicle's windshield wipers are left on when the vehicle was last driven, then the wipers will turn on if the remote start function is activated. To avoid damage to the wiper blades (i.e., due to heavy ice or snow accumulated on the windshield), please always turn the vehicle's windshield wipers off when parking the vehicle.



## MULTIMEDIA

### STEERING WHEEL AUDIO CONTROL

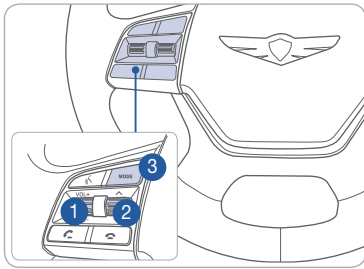

- 1 **VOLUME/MUTE**  
Scroll up or down to adjust the volume. Press to mute or unmute the sound.
- 2 **SEEK/PRESET**  
Change station.
- 3 **MODE**  
Change the audio source.

### BLUETOOTH OPERATIONAL TIPS

In the following situations you or the other party may have difficulty hearing each other:

1. When Bluetooth volume is set too high. High volume may result in distortion and echo.
2. When driving on a rough road, high speeds and/or with the window open.
3. When the air conditioning vents are facing the microphone and/or when the air conditioning fan is at the max speed.

### Steering wheel bluetooth control

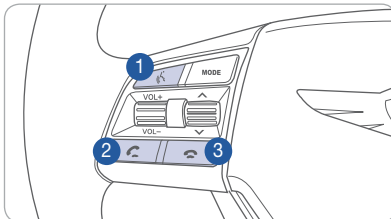

- 1 **TALK**  
Activates voice recognition.
- 2 **CALL**  
Places and transfers calls.
- 3 **END**  
Ends calls or cancels functions.

#### To Answer a Call:

- Press button on the steering wheel.

#### To Reject a Call:

- Press button on the steering wheel.

#### To Adjust Ring Volume:

- Use the VOLUME buttons on the steering wheel.

#### To Transfer a Call to the Phone

##### (Secret Call):

- Press and hold button on the steering wheel until the audio system transfers a call to the phone.

#### To Finish a Call:

- Press button on the steering wheel.



### Making a call using voice recognition:

The menu tree identifies available voice recognition Bluetooth® functions.

#### Calling by Name:

1. Press .
2. Say the following command after the Voice Recognition beep:
  - “Call <John Smith>”: Connects the call to John Smith.
  - “Call <John Smith> on <on Mobile/in Office/at Home>”: Connects the call to John Smith’s Mobile, Home, or Office phone number.

#### Dialing by Number:

1. Press .
2. Say “Dial Number” after the Voice Recognition beep.
3. Say desired phone number. For complete list of commands, refer to your Owner’s Manual.

### VOICE RECOGNITION TIPS

Your vehicle is equipped with Voice Recognition technology which allows drivers to operate their phones without having to take their eyes off the road to minimize distractions.

Voice recognition performance may be affected if speaking before Voice Recognition beep is heard, driving with windows and sun roof open; when the heating-cooling system is on; when passing in a tunnel or when driving on rugged and uneven roads.

Quick reference on using voice commands

To start voice command. Press the key, the following commands are available:

Command	Function
Call	Displays downloaded Contacts.
Call <Name>	Calls <Name> saved in Contacts.
Dial Number	Displays a screen where you can say a phone number to dial.
Dial <Phone #>	You can directly say the number to call. ex) Dial 111 555 1234
Redial	Directly calls at the number that you last dialed.
Call History	Displays your Call History.



## MULTIMEDIA



### NAVIGATION

#### Map position

##### Standard AVN



- 1 Move to the Home Screen
- 2 Change the map view mode
- 3 Navigation Voice Guidance On/Off
- 4 Zoom in the map
- 5 Map scale display
- 6 Zoom out the map



- 7 [MENU] button
- 8 Touch to scroll the map
- 9 Quick and easy selection of a destination from the map screen
- 10 Set a waypoint to the current route
- 11 Save frequently used address to address book
- 12 Find a POI(Point Of Interest) around the current position
- 13 Vehicle position

#### North UP/Heading up.

- Displays the current map mode to reflect the position in reference to the screen. The map mode can be switched between North Up and Heading Up.
- Each time the button is pressed, the screen will switch in the order shown below.
  - Heading Up ➡ North Up ➡ Heading Up ➡
  - Map Scale: Increases or decreases the map size.
  - Map Scale indicator: shows the scale of the map.
  - Map Voice Key: Activate/deactivate the voice guidance.

##### DIS Navigation system



- 1 Clock display
- 2 Move to the Home Screen
- 3 Change the map view mode
- 4 Navigation voice guidance on/off
- 5 Zoom in the map
- 6 Map scale display
- 7 Zoom out the map

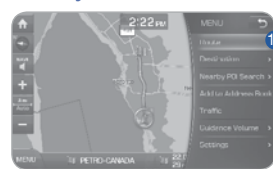

- 8 [MENU] button
- 9 Route guidance
- 10 Vehicle position
- 11 Current position and Destination
- 12 Remaining distance display/ Remaining time
- 13 Cancel Route
- 14 [Route] button

### AUX, USB AND iPod PORT

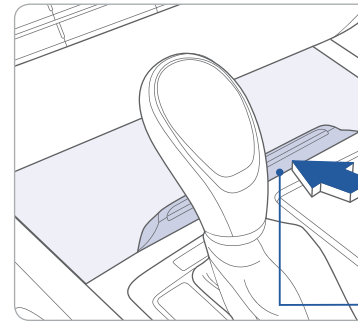

Use the input jack to connect an external audio device and listen to it through the audio system in your vehicle.

NOTE: To operate your iPod® through the vehicle's audio system, connect your Apple supplied USB cable to the USB port  
iPod® is a trademark of Apple Inc.



## FEATURES AND CONTROLS

### CENTRAL CONTROL PANEL

The central control panel is located in the vehicle center console. It comprises the controller and the main function buttons.

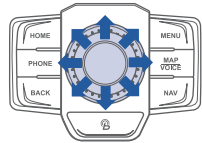
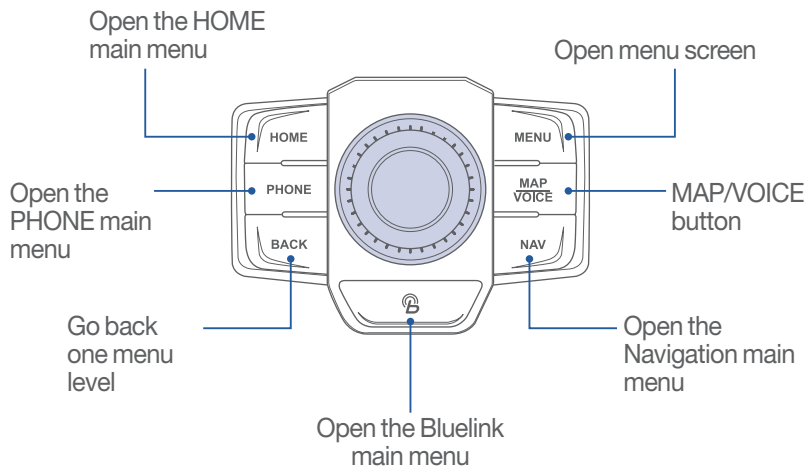

#### Scrolling through Controller

Move the focus or scroll through the navigation map.

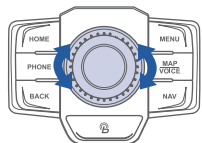

#### Turning the controller

Move the focus, or zoom in/out the navigation map.

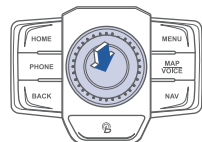

#### Pressing the controller

Start/Select the focused feature.



### CLOCK ADJUSTMENT

#### With DIS Touch System

1. Press "HOME" button.

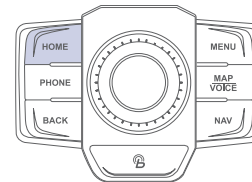

2. Press "Settings" icon on the screen, then press "Clock".

3. To set your preferred Time Setting:

- Check "GPS Time" to adjust the time automatically.
- Press "Time Setting" to adjust the clock manually. GPS Time must not be selected.
- If "Daylight Savings Time" is selected, the clock will be adjusted forward by one hour.

#### With Touch Screen System

1. Press the "SETUP" button.

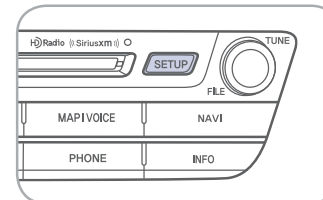

2. Press "Clock" icon on the screen.

3. To set your preferred Time Setting:

- Check "GPS Time" to adjust the time automatically.
- Press "Date/Time Setting" to adjust the clock manually. GPS Time must not be selected.
- If "Daylight Savings Time" is selected, the clock will be adjusted forward by one hour.

NOTE: Once the digital clock is adjusted, the analog clock will be updated accordingly.







## FEATURES AND CONTROLS



### REAR WINDOW CURTAIN

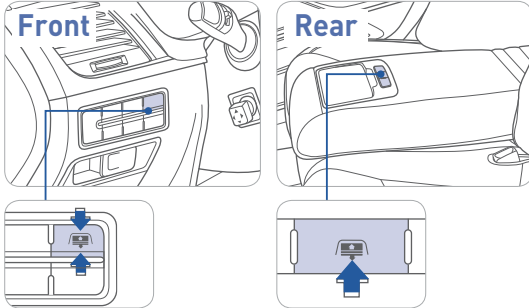
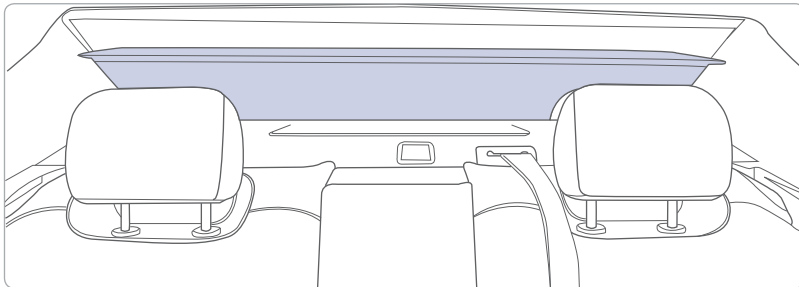

Press the button to lower.  
Press the button again to raise.

**NOTE:** If curtain is in up position, curtain will move downward automatically when shifting into Reverse. Curtain will raise automatically when shifter is in Drive and vehicle speed is above 10 mph.

### SEAT WARMER (front seats)

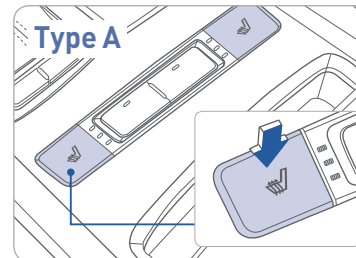

Each time you push the button, the setting is changed as follows:

**OFF → HIGH → MIDDLE → LOW**

If you want to turn it off immediately, press and hold the button.

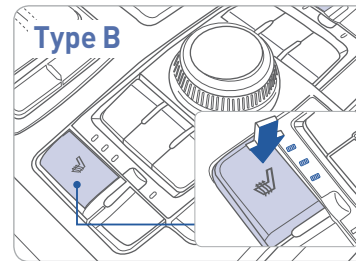

### CLIMATE CONTROL SYSTEM SEAT (front seats)

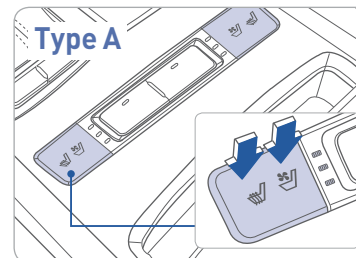

 - Heat  
 - Cool

Each time you push the button, the setting is changed as follows:

**OFF → HIGH → MIDDLE → LOW**

If you want to turn it off immediately, press and hold the button.

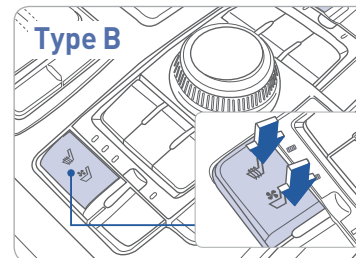



## FEATURES AND CONTROLS

### HEATED STEERING WHEEL

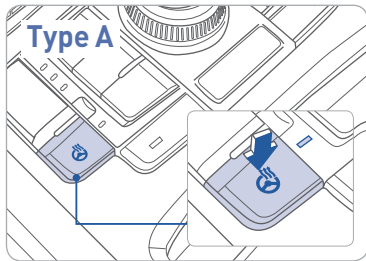

Pressing the heated steering wheel button warms the steering wheel. The indicator on the button is illuminated.

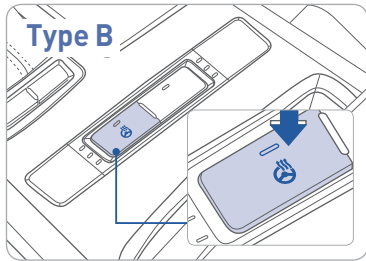

### REARVIEW CAMERA

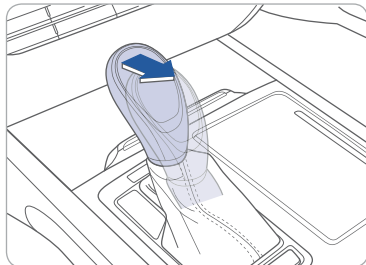

When transmission is shifted into R (Reverse), rearview camera displays the area behind the vehicle.

To switch view, press "Top View" button on screen.



## DRIVING

### PARKING GUIDE SYSTEM

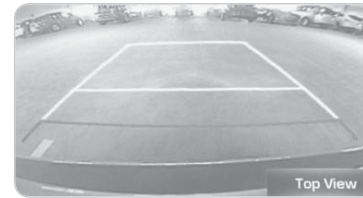

The parking guide system will activate when the back-up light is ON and the shift lever in the R (Reverse) position.

### PARKING ASSIST SYSTEM (PAS)

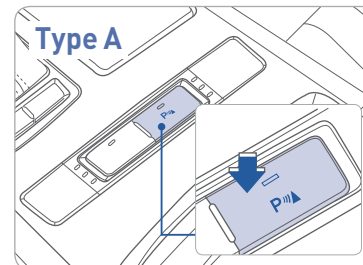

The parking assist system assists the driver during movement of the vehicle by chiming if any object is sensed within the distance of 39.5 inches in front and 47.2 inches in behind the vehicle.

#### PAS ON/OFF

To turn the PAS off, press the ON/OFF button. To turn the PAS on, press it again.

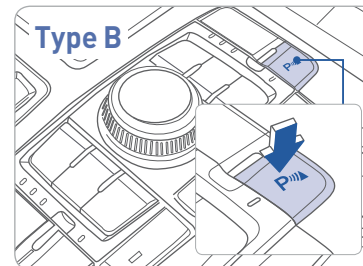

If you move the shift lever to R with the engine start/stop button in ON and the parking assist system in OFF, the parking assist system will turn ON automatically. The system will automatically turn off when vehicle is driven forward at a speed above 6 mph.

## ELECTRIC PARKING BRAKE (EPB)

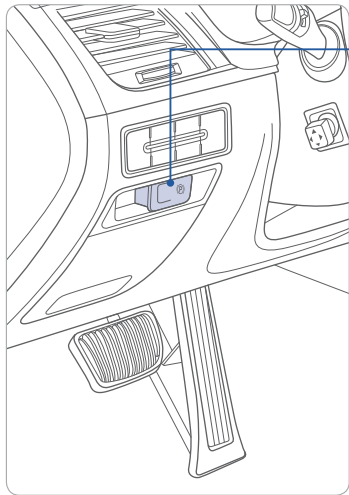

### Applying

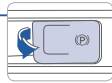

Stop the vehicle then pull the EPB switch.

### Releasing



Move shift lever from P to R, N or D while depressing the brake pedal.

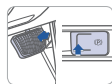

or  
Press the EPB switch while depressing the brake pedal.

**NOTE:** If necessary, emergency braking is possible by pulling and holding the EPB switch.

## AUTO HOLD

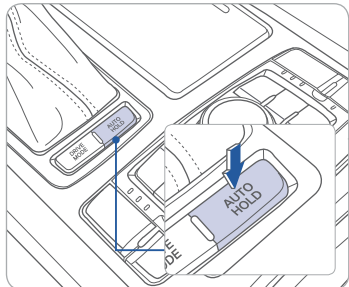

The Auto Hold feature assists in steep hill areas. It holds the brake until the accelerator pedal is pressed.



1. Press the AUTO HOLD switch.



2. Stop the vehicle by pressing the brake pedal. The brakes will remain engaged even if the brake pedal is released.



3. The brakes will release when the accelerator pedal is pressed with transmission in D, R or manual mode.

To cancel the AUTO HOLD operation, press the AUTO HOLD switch again.

## AUTOMATIC EMERGENCY BRAKING (AEB)



The Automatic Emergency Braking (AEB) helps avoid accidents by identifying critical situations early and warning the driver.

Also, the system helps reduce the severity of crashes which cannot be avoided by lowering the speed of collision and, in some cases, by preparing the vehicle and restraint systems for impact.

**NOTE:** System can be Enabled/ Disabled in the User Settings page of the instrument cluster under Driving Assist.

## TIRE PRESSURE MONITORING SYSTEM (TPMS)

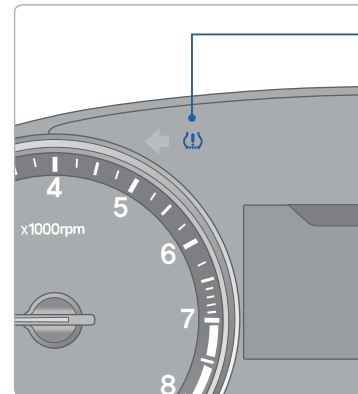

Low Tire Pressure Indicator / TPMS Malfunction Indicator



**NOTE:** Vehicle must be driven for accurate tire pressure reading.

Low Tire Pressure Position Telltale and Tire Pressure Telltale (Shown on the LCD display)

### LOW TIRE PRESSURE INDICATOR

Illuminates if one or more of your tires is significantly under-inflated.

### TPMS MALFUNCTION INDICATOR

Blinks for approximately one minute, then remains illuminated when there is a malfunction with the TPMS. Inspect all tires and adjust tire pressure to specification. If the lamp remains illuminated, have the system checked by an authorized Hyundai dealer as soon as possible.

**NOTE:** Units can be changed in the User Settings page of the instrument cluster under Other Features.

## AUTOMATIC TRANSMISSION

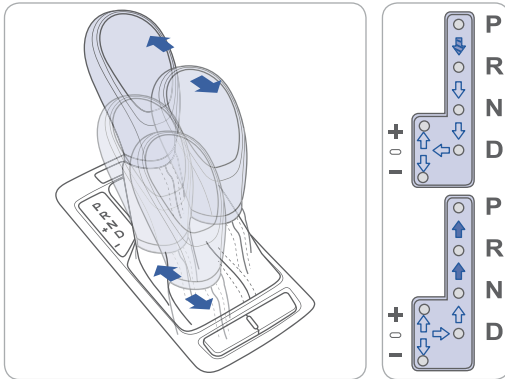

- (➡): Press the shift button, then move shift lever.
- (⏏➡): Depress the brake pedal, then move shift lever.
- (➡): Move shift lever.

### Sport mode

Move the shift lever from D (Drive) into the manual gate to select.  
Move the shift lever forward (+) to up shift or rearward (-) to downshift.

## PADDLE SHIFTER

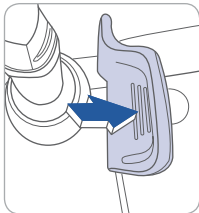

Press (-) to downshift

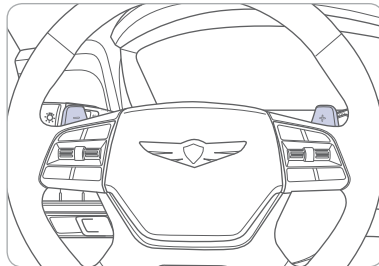

The Paddle shifter is available when the shift lever is in the D position or the sport mode.

Pull the [+] or [-] paddle shifter once to shift up or down one gear.

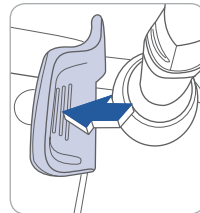

Press (+) to upshift

## ELECTRONIC STABILITY CONTROL (ESC)

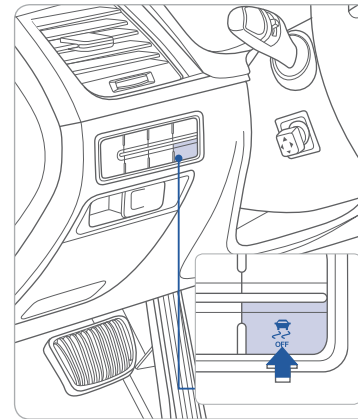

The ESC system is an electronic system designed to help the driver maintain vehicle control under adverse conditions.

ESC automatically selects the ON position when the engine is started.

**To turn off Traction Control**  
press the ESC OFF button once.

**To turn off Traction and Stability Control**  
Press and hold the ESC OFF button for more than 3 seconds.

## LANE KEEPING ASSIST SYSTEM (LKAS)

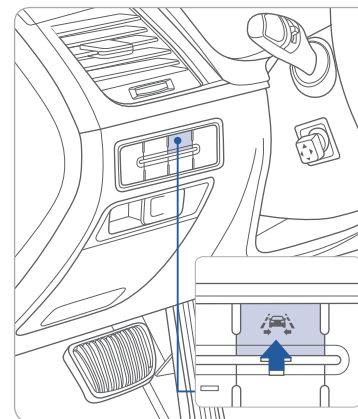

The Lane Keeping Assist System detects lane markers on the road, and assists the driver's steering to help keep the vehicle between lanes.

- To turn LKAS on, press the LKAS switch
- To turn LKAS off, press the switch again.

**NOTE:** LKAS Settings can be adjusted in the User Settings page of the instrument cluster under Driving Assist.

**NOTE:** LKAS operates only when the vehicle speed is above 38 mph and when the LKAS indicator is green displayed in the instrument cluster. Refer to the Owner's Manual for more detailed information and how to setup LKAS in the User Setting Mode.

## BLIND SPOT DETECTION SYSTEM (BSD)

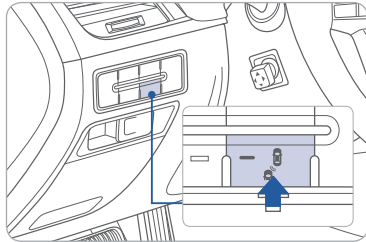
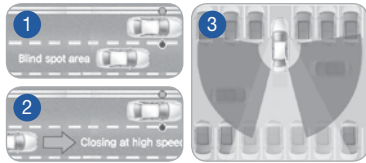

The BSD (Blind spot detection) system uses a radar sensor to alert the driver while driving. It senses the rear side territory of the vehicle and provides information to the driver.

- 1 Blind spot detection
- 2 Lane change assist
- 3 Rear cross traffic alert

- To turn the BSD on, press the BSD button. (indicator illuminated)
- To turn the BSD off, press the BSD button again.

The BSD system will activate, if vehicle speed exceeds 19mph.

The rear cross traffic alert will activate, if vehicle is in reverse at speeds below 6 mph.

## DRIVE MODE INTEGRATED CONTROL SYSTEM

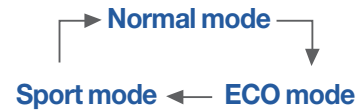
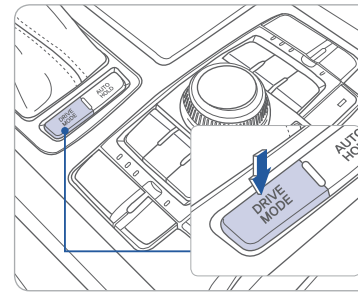

You can select the drive mode according to your preference or the road condition. The drive mode defaults to the Normal mode whenever the engine start/stop button is turned to the ON position.

Each time you press the button, the drive mode is changed as follows :

### Snow mode

Snow mode helps you to drive more effectively on the slippery road such as snowy or muddy road.

Press and hold the button to select the Snow mode. Press the button again to return to previous mode.

### Normal mode

Normal mode is not displayed on the instrument cluster.

### ECO mode

Active ECO helps improve fuel efficiency by controlling certain engine and transmission system operating parameters.

### Sport mode

Sport mode focuses on dynamic driving by automatically controlling the steering wheel, engine and transmission system.



DRIVING



MEMO

Series of horizontal lines for taking notes.

CRUISE CONTROL/ADVANCED SMART CRUISE CONTROL

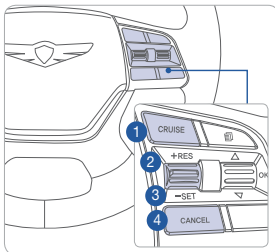

The cruise control system allows you to program the vehicle to maintain a constant speed without holding the accelerator pedal.

- 1 To On/Off the cruise control.
2 To Resume or Increase the cruise control speed.
3 To Set or Decrease the cruise control speed.
4 To Cancel the cruise control.

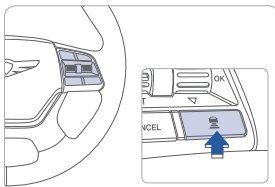

Setting vehicle distance (Advanced smart cruise control only)

This system assist you in setting the distance from the vehicle ahead and will maintain the selected distance without you depressing the accelerator or the brake pedal.



The vehicle to vehicle distance will automatically activate when you set the cruise speed.

Each time the vehicle distance set button is pressed, the vehicle to vehicle distance changes as follows:

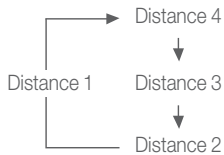

If your vehicle is equipped with Advanced smart cruise control and you wish to eliminate the vehicle distance function, you can change cruise control setting to a standard setting.

Press the Cruise Control button on the steering wheel to turn on Cruise Control. Then press and hold the vehicle distance button for more than 2 seconds to toggle between Smart Cruise Control (SCC) and Cruise Control (CC) mode.

Please refer to your Owner's Manual for more information.

GENESIS CUSTOMER DELIVERY CHECKLIST

Table with 2 columns: HYUNDAI OWNER, SALES CONSULTANT, VIN and DEALERSHIP NAME, DATE, PREVIOUS VEHICLE.

BEFORE DELIVERY

- CONFIRM "GOOD BATTERY" USING GR8 AND STAPLE TEST TICKET HERE
SET TIRE PRESURE LF RF RR LR
VERIFY VEHICLE IS CLEAN, IN GOOD CONDITION, FREE OF CHIPS AND SCRATCHES · CLEAN WINDSHIELD AND BACK WINDOW
ENSURE FLOORMATS ARE SNAPPED INTO PLACE

Sales Consultant Date Sales Manager Date

Customer Date

Email @