



HYUNDAI

OWNER'S MANUAL

Operation
Maintenance
Specifications

All information in this Owner's Manual is up to date at the time of publication. However, HYUNDAI reserves the rights to change the contents at any time in order to carry out our policy of continual product improvements.

This manual applies to all models, including descriptions of options and standard equipment. Thus, you may find that some contents in this manual do not apply to your specific vehicle.

**CAUTION: MODIFICATIONS
TO YOUR HYUNDAI VEHI-
CLE**

Your vehicle should not be modified in any form. Such modifications may adversely affect the driving performance, safety or durability of your vehicle and may, in addition, violate conditions of your limited warranty coverage. Certain modifications may also violate regulations established by the U.S. Department of Transportation and other federal/state agencies.

**TWO-WAY RADIO OR
CELLULAR TELEPHONE
INSTALLATION**

Your vehicle is equipped with electronic components, including an electronic fuel injection. However, any improperly installed/adjusted two-way radio or cellular telephone may adversely affect those electronic components. Thus, we recommend you to carefully follow the radio manufacturer's instructions or to consult EQUUS dealer for precautionary measures or special instructions, before installing one of these devices.

SAFETY AND VEHICLE DAMAGE WARNING

This manual includes information titled as DANGER, WARNING, CAUTION and NOTICE.

These titles indicate the following situations:

 DANGER
DANGER indicates a hazardous situation, which, if not avoided, results in death or serious injury.

 WARNING
WARNING indicates a hazardous situation, which, if not avoided, may result in death or serious injury.

 CAUTION
CAUTION indicates a hazardous situation, which, if not avoided, may result in minor or moderate injury.

NOTICE
NOTICE indicates a situation, which, if not avoided, may result in vehicle damage.

FOREWORD

Thank you for purchasing EQUUS. We are pleased to welcome you to the growing number of discerning EQUUS drivers. We are very proud of our advanced engineering and high-quality EQUUS construction.

This Owner's Manual will introduce you to the features and operation of your new EQUUS. Please carefully read this Owner's Manual for your information, so you could receive great satisfaction from your new car.

We also recommend you to have services and maintenance of your car from an authorized EQUUS dealer. Our EQUUS dealers are prepared to provide high-quality maintenance services and any other assistance, which your vehicle may require.

HYUNDAI MOTOR AMERICA

Note : When selling your used vehicle in the used-auto market, please pass this Owner's Guide to the next owner for his or her use, because the next owner will also need the information in this manual. Thank you.

CAUTION

Poor-quality fuels and lubricants, which fail to meet HYUNDAI specification, may severely damage an engine and transmission. You must always use the high-quality fuels and lubricants that meet the specifications, listed in the Vehicle Specifications and Consumer Information chapter on page 8-4 and 8-8.

Copyright 2015 HYUNDAI Motor America. All rights reserved. No part of this publication may be reproduced, stored in any retrieval system or transmitted in any form or by any means without the prior written permission of HYUNDAI Motor America.

GUIDE TO HYUNDAI GENUINE PARTS



1. What are HYUNDAI Genuine Parts?

HYUNDAI Genuine Parts are the same parts used by HYUNDAI Motor Company to manufacture vehicles. They are designed and tested to optimize driving safety, performance and reliability for our customers.

2. Why should you use genuine parts?

HYUNDAI Genuine Parts are engineered and manufactured to meet rigid manufacturing requirements. Any imitated, counterfeit or used-auto parts are not covered by the HYUNDAI New Vehicle Limited Warranty or any other HYUNDAI warranties.

In addition, any damage or failure of HYUNDAI Genuine Parts caused by other imitated, counterfeit or used-auto parts is not covered by any HYUNDAI warranty.

3. How can you distinguish HYUNDAI Genuine Parts from other imitated, counterfeit or used-auto parts?

Look for the HYUNDAI Genuine Parts logo on the package (See the below illustration).

The package label of HYUNDAI Genuine Parts for U.S. export is written only in English.

You can purchase HYUNDAI Genuine Parts only through an authorized EQUUS dealership.

HOW TO USE THIS MANUAL

We want you to get the greatest driving pleasure from your vehicle. This Owner's Manual will assist you in many ways. We strongly recommend you to read the entire manual. In order to minimize the chance of death or injury, you must read the DANGER, WARNING, CAUTION, and NOTICE sections of this manual.

Illustrations are supplementary explanation of the text in order to best explain how to enjoy your vehicle. By reading your manual, you will learn your vehicle features, important safety information, and driving tips under various road conditions.

The general layout of the manual contents is provided in the Table of Contents. A good place to start is the index, as it has an alphabetical listing of all information.

Sections: This manual has 8 chapters plus an index. Each section begins with a brief list of contents, so you can pinpoint the information location that you wish to read at a glance.

SAFETY MESSAGES

Your safety, and the safety of others, is very important. This Owner's Manual provides you with many safety precautions and operating procedures. This information alerts you to potential hazards that may hurt you or others, as well as damage to your vehicle.

Safety messages found on vehicle labels and in this manual describe these hazards and what to do to avoid or reduce the risks.

Warnings and instructions contained in this manual are for your safety. Failure to follow safety warnings and instructions can lead to serious injury or death.

Throughout this manual DANGER, WARNING, CAUTION, NOTICE and the SAFETY ALERT SYMBOL will be used.



This is the safety alert symbol. It is used to alert you to potential physical injury hazards. Obey all safety messages that follow this symbol to avoid possible injury or death. The safety alert symbol precedes the signal words DANGER, WARNING and CAUTION.

 **DANGER**

DANGER indicates a hazardous situation, which, if not avoided, results in death or serious injury.

 **WARNING**

WARNING indicates a hazardous situation, which, if not avoided, may result in death or serious injury.

 **CAUTION**

CAUTION indicates a hazardous situation, which, if not avoided, may result in minor or moderate injury.

NOTICE

NOTICE indicates a situation, which, if not avoided, may result in vehicle damage.

Symbols used in illustrations

Safety symbol

 The symbol means to "Avoid" or "Do not do anything".

Arrows

 Indicates the location.

 Indicates the action (pressing, turning, etc.) or outcome of an operation.

FUEL REQUIREMENTS

Your vehicle is designed to maximize its driving performance as well as to minimize exhaust emissions and spark plug fouling, when being refueled with UNLEADED FUEL.

Your vehicle is designed to use only the unleaded fuel having a Pump Octane number ((R+M)/2) of 87 (Research Octane Number 91) or higher.

To further improve your vehicle performance, premium unleaded fuel having a Pump Octane number ((R+M)/2) of 91 (Research Octane Number 96) or higher is recommended. (Do not use methanol blended fuels.)

CAUTION

Never add any fuel-system cleaning additives to the fuel tank, unless specified. (Consult an authorized EQUUS dealer for further details.)

WARNING

- Do not "top off" after the nozzle automatically shuts off when refueling.
- Tightly close the cap, until it clicks one time. Otherwise, the Malfunction Indicator Light " " will illuminate.
- Always confirm that the fuel cap is securely closed in order to prevent fuel spillage in the event of an accident.

Gasoline containing alcohol and methanol

Gasohol, a mixture of gasoline and ethanol (also known as grain alcohol), is on sale along with or instead of leaded or unleaded gasoline.

Do not use gasohol, of which the ethanol percentage is 10% or more. Also, do not use gasoline or gasohol containing any methanol. Either of these fuels may cause drivability problems, including hard starting, rough running before the engine warm-up, illumination of the Malfunction Indicator Light and damage to the fuel system, engine control system and emission control system.

Stop using gasohol of any kind, if a drivability problem occurs.

The manufacturer's warranty does not cover vehicle damage or a drivability problem, which is caused by one of the followings:

1. Gasohol, of which the ethanol percentage is 10% or more
2. Gasoline or gasohol, containing methanol
3. Leaded fuel or leaded gasohol

"E85" fuel is an alternative fuel comprised of 85% of ethanol and 15% of gasoline, and is exclusively manufactured for Flexible Fuel Vehicles. "E85" cannot be refueled in your vehicle. Refueling with "E85" will result in poor engine performance and damage to your vehicle's engine and fuel system. HYUNDAI recommends you not to use the fuel, of which the ethanol percentage is 10% or more.

⚠ CAUTION

Your New Vehicle Limited Warranty does not cover damage to the fuel system or any performance problems caused by the use of "E85" fuel.

⚠ CAUTION

Never use gasoline, containing methanol. Stop using any gasohol product, which impairs your drivability.

Other fuels

Using fuels such as;

- Silicone (Si) contained fuel,
- Ferrocene (Fe) contained fuel, and
- Other metallic additives contained fuels,

may cause vehicle and engine damage or cause plugging, misfiring, poor acceleration, engine stalling, catalyst melting, abnormal corrosion, life cycle reduction, etc.

Also, the Malfunction Indicator Lamp (MIL) may illuminate.

NOTICE

Damage to the fuel system or performance problem caused by the use of these fuels may not be covered by your New Vehicle Limited Warranty.

Gasoline containing MMT

Some gasoline contains harmful manganese-based fuel additives such as MMT (Methylcyclopentadienyl Manganese Tricarbonyl). HYUNDAI does not recommend to use gasoline containing MMT. This type of fuel may reduce vehicle performance and affect your emission control system.

The malfunction indicator lamp on the cluster may illuminate.

Do not use methanol

Fuels containing methanol (wood alcohol) should not be used. This type of fuel may reduce vehicle performance and damage the fuel system components, engine control system and emission control system.

⚠ CAUTION

Your New Vehicle Limited Warranty may not cover damage to the fuel system and any performance problems that are caused by the use of fuels containing methanol.

Fuel Additives

HYUNDAI recommends you to use high-quality gasoline, treated with detergent additives such as TOP TIER Detergent Gasoline. This prevents deposit formation in the engine. These types of gasoline will help to clean the engine and to enhance performance of the Emission Control System. For more information on TOP TIER Detergent Gasoline, please go to the website (www.toptiergas.com).

For drivers, who do not regularly use TOP TIER Detergent Gasoline and have problems, such as hard starting or rough engine running, gasoline additives can be separately added.

When TOP TIER Detergent Gasoline is unavailable, one bottle of additives is recommended at every 7,500 miles or in every 12 months.

Additives are available from your authorized EQUUS dealer along with information on how to use them. Do not mix it with other additives.

Operation in foreign countries

When you plan to drive your vehicle in another country, make sure to:

- Check all regulations, regarding registrations and insurances.
- Find out whether the acceptable fuel is available.

VEHICLE BREAK-IN PROCESS

No special break-in period is needed. By following a few simple steps for the first 600 miles (1,000 km), you may enhance the performance, fuel economy and life of your vehicle.

- Do not race the engine.
- While driving, keep your engine speed between 2,000 rpm (revolutions per minute) and 4,000 rpm.
- Do not maintain the same speed for a long period of time, either fast or slow. The engine speed needs to be varied for the proper break-in.
- Avoid hard stops, except in an emergency, to allow the brakes to set properly.
- Do not tow a trailer for the first 1,200 miles (2,000 km).

CALIFORNIA PROPOSITION 65 WARNING

Items contained in motor vehicles or emitted from them are known to the State of California to cause cancer and birth defects or reproductive harm.

These include:

- Gasoline and its vapors
- Engine exhaust
- Used engine oil
- Interior passenger compartment components and materials
- Component parts which are subject to heat and wear

In addition, battery posts, terminals and related accessories contain lead, lead compounds and other chemicals known to the State of California to cause cancer and reproductive harm.

VEHICLE DATA COLLECTION AND EVENT DATA RECORDERS

This vehicle is equipped with an event data recorder (EDR). The main purpose of an EDR is to record, in certain crash or near crash-like situations, such as an air bag deployment or hitting a road obstacle, data that will assist in understanding how a vehicle's systems performed. The EDR is designed to record data related to vehicle dynamics and safety systems for a short period of time, typically 30 seconds or less. The EDR in this vehicle is designed to record such data as:

- How various systems in your vehicle were operating;
- Whether or not the driver and passenger safety belts were buckled/fastened;
- How far (if at all) the driver was depressing the accelerator and/or brake pedal; and,
- How fast the vehicle was traveling.

These data can help provide a better understanding of the circumstances in which crashes and injuries occur. **NOTE:** EDR data are recorded by your vehicle only if a non-trivial crash situation occurs; no data are recorded by the EDR under normal driving conditions and no personal data (e.g., name, gender, age, and crash location) are recorded. However, other parties, such as law enforcement, could combine the EDR data with the type of personally identifying data routinely acquired during a crash investigation.

To read data recorded by an EDR, special equipment is required, and access to the vehicle or the EDR is needed. In addition to the vehicle manufacturer, other parties, such as law enforcement, that have the special equipment, can read the information if they have access to the vehicle or the EDR.

TABLE OF CONTENTS

Your vehicle at a glance

Safety system of your vehicle

Convenient features of your vehicle

Multimedia system

Driving your vehicle

What to do in an emergency

Maintenance

Specifications, Consumer information
and Reporting safety defects

Index

1 Your vehicle at a glance

Exterior overview (front) ...	1-2
Exterior overview (rear).....	1-3
Interior overview.....	1-4
Instrument panel overview..	1-5
Engine compartment	1-6

2 Safety system of your vehicle

Seats	2-2
Front seat adjustment.....	2-4
Rear seat adjustment.....	2-11
Seat belts	2-21
Seat belt restraint system....	2-21
Pre-tensioner seat belt.....	2-25
Pre-safe seat belt (PSB).....	2-28
Automatic Seat Belt	
Retracting.....	2-29
Seat belt precautions	2-29
Care of seat belts	2-32
Child restraint system	2-33
Rear-Facing child restraint..	2-35
Forward-Facing child	
restraints	2-35

Air bag – Advanced supplemental restraint system	2-42
How the air bag system operates.....	2-43
SRS components and functions	2-45
Occupant classification system.....	2-48
Main components of occupant classification system.....	2-49
Driver's and front passenger's air bag	2-54
Side air bag.....	2-58
Curtain air bag	2-60
Why is an air bag not inflated in a collision?	2-61
SRS Care	2-65
Additional safety precautions	2-66
Air bag warning label	2-68

3 Convenient features of your vehicle

Smart key	3-6
Locking.....	3-7
Unlocking.....	3-7
Trunk Unlocking.....	3-8
Panic Button	3-8
Start-Up.....	3-8
Mechanical Key.....	3-9
Loss of a Smart Key.....	3-10
Smart key precautions.....	3-10
Record your key number	3-10
Immobilizer system	3-10
Restrictions in Handling	
Keys	3-11
Battery Replacement.....	3-12
Theft-Alarm system	3-13
Door locks	3-14
Operating Door Locks From	
Outside the Vehicle.....	3-14
Power Door Latch.....	3-15
Operating Door Locks From	
Inside the Vehicle	3-15
Auto Door Lock/Unlock	
Features.....	3-17
Child-Protector Rear Door	
Locks	3-17
Trunk	3-18
Non-Powered Trunk.....	3-18
Power Trunk	3-19
To Reset the Power Trunk...3-22	
Trunk Lid Control Button.....	3-22
Emergency Trunk Safety	
Release.....	3-23
Smart Trunk.....	3-24
Windows	3-28
Power Windows.....	3-29
Hood	3-33
Opening the Hood	3-33
Closing the Hood	3-33
Fuel filler lid	3-34
Opening the Fuel Filler Lid ..3-34	
Closing the Fuel Filler Lid ...3-34	
Sunroof	3-37
Sliding the Sunroof	3-37
Tilting the Sunroof	3-38
Resetting the Sunroof	3-39
Sunshade	3-39
Driver position memory	
system	3-40
Storing the Position	
Memory	3-40
Recalling the Position	
Memory	3-41
Easy Access Function.....	3-41
Steering wheel	3-42
Electronic Hydraulic Power	
Steering (EHPS).....	3-42
Tilt Steering/	
Telescope Steering.....	3-42
Heated Steering Wheel.....	3-43
Horn.....	3-43
Mirrors	3-44
Interior rearview mirrors.....	3-44
Electric chromic mirror (ECM)	
with HomeLink® system and	
compass.....	3-44, 3-51
Outside rearview mirror	3-58
Reverse Parking Aid	
Function.....	3-61
Instrument cluster	3-62
Instrument Cluster Control...3-64	
LCD Display Control.....	3-64
Gauges	3-65

LCD display	3-69	Headlight leveling device ...	3-113
LCD Modes.....	3-69	AFLS (Adaptive Front	
Trip Computer Mode.....	3-70	Lighting System).....	3-114
ASCC/LDWS Mode	3-70	Wipers and washer	3-115
A/V Mode.....	3-70	Windshield wipers	3-115
Turn By Turn (TBT) Mode....	3-70	Windshield washer	3-117
Information Mode	3-71	Interior light	3-118
User Settings Mode.....	3-72	Front.....	3-118
Warning Messages.....	3-78	Rear	3-119
Trip computer	3-86	Trunk room lamp	3-119
Overview.....	3-86	Door courtesy lamp.....	3-119
Trip A/B	3-86	Glove box lamp	3-120
Fuel Economy.....	3-87	Vanity mirror lamp	3-120
Warning and indicator		Welcome system	3-121
lights	3-89	Puddle lamp	3-121
Warning lights	3-89	Headlamp.....	3-121
Indicator Lights	3-96	Interior light	3-121
Head Up Display (HUD) ...3-100		Defroster	3-122
Description.....	3-100	Rear window defroster	3-122
Head Up Display ON/OFF ..3-101		Front wiper deicer	3-122
Head Up Display		Automatic climate control	
Information	3-101	system	3-123
Head Up Display Setting3-101		Automatic heating and air	
Parking assist system3-102		conditioning	3-124
Operation of the parking		Manual air heating and	
assist system.....	3-103	cooling	3-126
Inoperable conditions of the		System operation.....	3-135
Parking Assist System	3-105	Climate control air filter3-136	
Self-diagnosis.....	3-106	Checking the amount of air	
Rearview camera	3-107	conditioner refrigerant and	
Multi-view camera		compressor lubricant	3-137
system	3-108	Windshield defrosting and	
Lighting	3-109	defogging	3-138
Battery saver function	3-109	Defogging logic.....	3-139
Headlamp escort function..3-109		Storage compartments3-141	
Lighting control	3-110	Center console storage	3-141
High beam operation.....	3-111	Glove box	3-141
Turn signals and lane		Sunglass holder	3-142
change signals	3-112	Rear console storage.....	3-142
Front fog light.....	3-113	Cool and warm box.....	3-143
Daytime running light	3-113		

Interior features.....	3-145
Ashtray	3-145
Cup holder.....	3-146
Sunvisor	3-147
Rear vanity mirror	3-147
Power outlet.....	3-148
Clock.....	3-149
Clothes hanger.....	3-150
Bag hanger	3-150
Floor mat anchor(s).....	3-150
Luggage net (holder)	3-151
Rear curtain.....	3-152
AUX, USB and iPod® port ..	3-153

4 Multimedia system

Multimedia system.....	4-2
Antenna.....	4-2
Steering wheel audio control	4-3

5 Driving your vehicle

Before driving	5-5
Before entering vehicle	5-5
Necessary inspections	5-5
Before starting	5-5
Engine start/stop button	5-7
Illuminated Engine Start/Stop Button.....	5-7
Engine Start/Stop Button position.....	5-7
Starting the engine.....	5-9
Automatic transmission.....	5-11
Automatic transmission operation	5-12
Good driving practices.....	5-15
Brake system.....	5-17
Power brakes	5-17
Electric parking brake (EPB).....	5-19
Emergency braking.....	5-22
AUTO HOLD	5-23
Anti-lock brake system (ABS).....	5-26
Electronic stability control (ESC)	5-28
Hill-start assist control (HAC)	5-32
Good braking practices.....	5-32
Drive mode integrated control system.....	5-34
DRIVE mode / SNOW mode ..	5-34
Electronic controlled suspension (ECS)	5-36
To control the vehicle height	5-36
ECS (Electronic Controlled Suspension) malfunction warning message.....	5-37

Advanced smart cruise control system	5-38
Smart cruise control speed ..	5-39
Smart cruise control vehicle-to-vehicle distance	5-43
Vehicle-to-vehicle distance sensor.....	5-45
To convert to the cruise control mode	5-46
Limitations of the system	5-47
Lane departure warning system (LDWS)	5-51
LDWS operation.....	5-52
Advanced vehicle safety management (AVSM)	5-55
Blind spot detection system (BSD)	5-58
Operating conditions	5-59
Warning types.....	5-59
Detecting sensor	5-60
Warning message.....	5-61
RCTA (Rear cross traffic alert)	5-62
Non-operating condition.....	5-63
Economical operation	5-65
Special driving conditions ..	5-67
Hazardous driving conditions.....	5-67
Rocking the vehicle	5-68
Smooth cornering	5-69
Driving at night.....	5-69
Driving in the rain	5-70
Driving in flooded areas.....	5-70
Off-road driving.....	5-70
Highway driving.....	5-71

Winter driving	5-72
Snowy or icy conditions.....	5-72
Use high quality ethylene glycol coolant.....	5-74
Check battery and cables	5-74
Change to "winter weight" oil if necessary	5-74
Check spark plugs and ignition system.....	5-74
To prevent the locks from frozen.....	5-75
Use authorized window washer anti-freezer solution in system	5-75
Do not let your parking brake freeze.....	5-75
Do not let ice and snow accumulate underneath.....	5-75
Carry emergency equipment.....	5-75
Do not place objects or materials in the engine compartment	5-75
Vehicle load limit	5-76
Tire and loading information label	5-76
Certification label.....	5-80
Vehicle weight	5-82
Base curb weight	5-82
Vehicle curb weight	5-82
Load weight	5-82
GAW (Gross axle weight)	5-82
GAWR (Gross axle weight rating).....	5-82
GVW (Gross vehicle weight).....	5-82
GVWR (Gross vehicle weight rating).....	5-82
Trailer towing	5-82

6 What to do in an emergency

Road warning.....	6-2
Hazard warning flasher	6-2
In case of an emergency while driving	6-2
If the engine stalls at a crossroad or a railroad crossing.....	6-2
If you have a flat tire while driving.....	6-2
If engine stalls while driving..	6-3
If the engine will not start..	6-3
When the engine does not revolve, or slowly revolves.....	6-3
When the engine normally revolves, but does not start..	6-3
Emergency starting	6-4
Jump starting	6-4
Push-starting	6-5
If the engine overheats	6-6
Tire pressure monitoring system (TPMS).....	6-7
Low tire pressure telltale	6-8
Low tire pressure position telltale.....	6-8
TPMS (Tire Pressure Monitoring System) malfunction indicator	6-9
Changing a tire with TPMS..	6-10
If you have a flat tire.....	6-12
Jack and tools	6-12
Removing and storing the spare tire	6-13
Changing tires	6-13
Jack label.....	6-19
Towing	6-20
Towing service	6-20
Removable towing hook	6-22
Emergency towing	6-22

7 Maintenance

Engine compartment	7-4
Maintenance services	7-5
Owner's responsibility.....	7-5
Owner's maintenance precautions	7-6
Owner's maintenance	7-7
Owner's maintenance schedule.....	7-7
Scheduled maintenance service	7-8
Normal maintenance schedule.....	7-9
Maintenance under severe usage conditions.....	7-22
Explanation of scheduled maintenance items.....	7-23
Engine oil	7-25
Checking the engine oil level.....	7-25
Changing the engine oil and filter	7-26
Engine coolant	7-27
Checking the coolant level..	7-27
Changing the coolant.....	7-29
Brake fluid	7-30
Checking the brake fluid level.....	7-30
Power steering fluid.....	7-31
Checking the power steering fluid level.....	7-31
Checking the power steering hose	7-31
Washer fluid	7-32
Checking the washer fluid level.....	7-32
Air cleaner	7-33
Filter replacement.....	7-33

Climate control air filter ...	7-35
Filter inspection	7-35
Filter replacement	7-35
Wiper blades	7-36
Blade inspection	7-36
Blade replacement	7-36
Battery	7-39
For best battery service.....	7-39
Battery recharging by	
battery charger	7-41
Battery recharging by	
vehicle	7-41
Reset items	7-42
Tires and wheels	7-42
Tire care	7-42
Recommended cold tire	
inflation pressures	7-42
Checking tire inflation	
pressure	7-44
Tire rotation	7-45
Wheel alignment and tire	
balance.....	7-45
Tire replacement	7-46
Wheel replacement	7-47
Tire traction.....	7-47
Tire maintenance.....	7-48
Tire sidewall labeling.....	7-48
Low aspect ratio tire.....	7-51
Tire terminology and	
definitions	7-52
All season tires	7-54
Summer tires	7-54
Snow tires	7-54
Tire chains	7-55
Radial-ply tires	7-55
Fuses.....	7-56
Inner panel fuse	
replacement.....	7-57
Engine compartment fuse	
replacement.....	7-59
Fuse/relay panel	
description	7-60
Light bulbs	7-69
Headlight, position light, turn	
signal light, side marker light	
and front fog light bulb	
replacement	7-70
Side repeater light bulb	
replacement	7-74
Rear combination light bulb	
replacement	7-75
High mounted stop light.....	7-75
License plate lamp	
replacement	7-79
Interior light bulb	
replacement	7-82
Appearance care.....	7-83
Exterior care	7-83
Interior care.....	7-88
Emission control system...7-89	
Crankcase emission control	
system.....	7-89
Evaporative emission control	
system.....	7-89
Exhaust emission control	
system.....	7-90
California perchlorate	
notice	7-92

8 Specifications, Consumer information and Reporting safety defects

Dimensions.....	8-2
Bulb wattage.....	8-2
Tires and wheels.....	8-3
Recommended lubricants and capacities.....	8-4
Recommended SAE viscosity number	8-5
Vehicle identification number (VIN).....	8-6
Vehicle certification label...8-6	
Tire specification and pressure label.....	8-6
Engine number	8-7
Refrigerant label.....	8-7
Consumer information.....	8-8
Reporting safety defects....	8-9



Your vehicle at a glance

Exterior overview (front)1-2

: Towing hook, Hood, Front windshield wiper blades, Sunroof, Outside rearview mirror, Door locks, Tires and wheels, Headlamps, Front fog light

Exterior overview (rear)1-3

: Glass antenna and Defroster, High mounted stop light, Trunk, Rear combination light, Rearview camera, Parking assist system, Towing hook, Fuel filler lid, Door locks, Window

Interior overview1-4

: Inside door handle, Driver's seat control, Driver position memory system button, Power window switch, Outside rearview mirror control, Fuel-filler lid opener, Trunk lid release switch or power trunk main control switch, Seats, Steering wheel, etc...

Instrument panel overview1-5

: Instrument cluster, Lighting control lever, Wiper and washer control lever, Engine Start/Stop Button, Climate control system, Vehicle height control button, etc...

Engine compartment1-6

: Engine coolant reservoir, Air cleaner, Engine oil filler cap, Windshield washer fluid reservoir, Fuse box, Jump start connector, etc...

EXTERIOR OVERVIEW

■ Front view



1. Towing hook	6-22	6. Door locks	3-14
2. Hood.....	3-33	7. Tires and wheels.....	7-42, 8-3
3. Front windshield wiper blades	3-115, 7-36	8. Headlamps.....	3-111, 7-70
4. Sunroof.....	3-37	9. Front fog light.....	3-113, 7-70
5. Outside rearview mirror	3-58		

■ Rear view

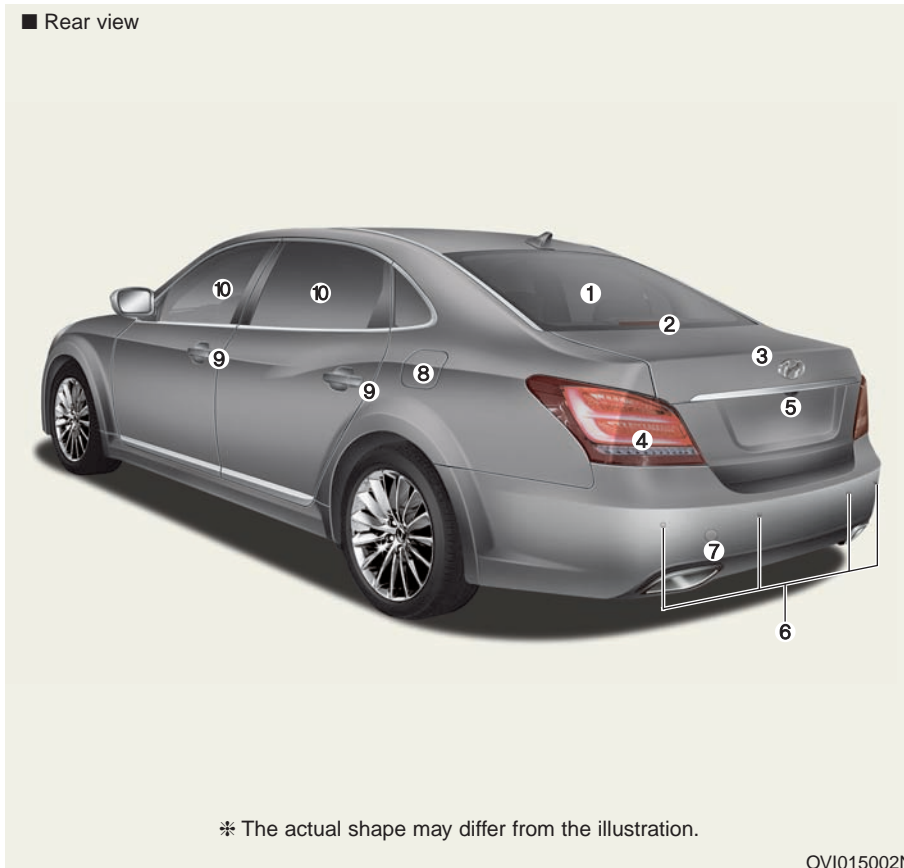

- | | |
|---|--|
| 1. Glass antenna and Defroster . . . 4-2, 3-122 | 6. Parking assist system 3-102 |
| 2. High mounted stop light 7-75 | 7. Towing hook 6-22 |
| 3. Trunk 3-18 | 8. Fuel filler lid. 3-34 |
| 4. Rear combination light 7-75 | 9. Door locks 3-14 |
| 5. Rearview camera 3-107 | 10. Window 3-28 |

INTERIOR OVERVIEW

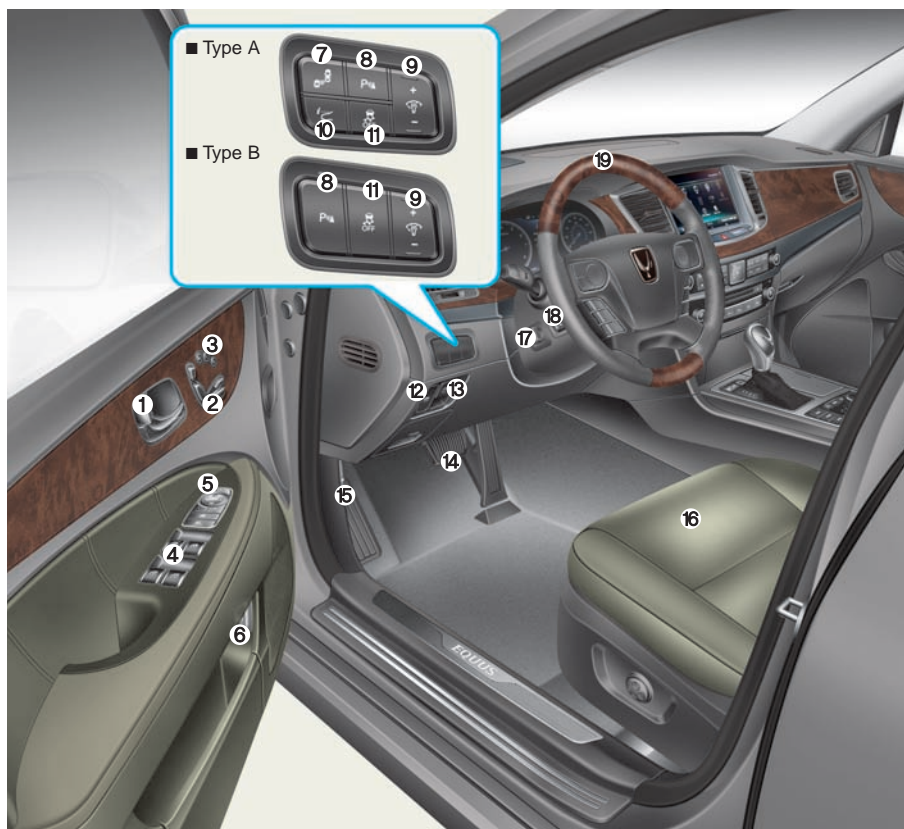

* The actual shape may differ from the illustration.

OVI015003N

1. Inside door handle.....	3-15	11. ESC (Electronic stability control) off button.....	5-28
2. Driver's seat control.....	2-5	12. Trunk lid release switch or power trunk main control switch ..	3-18/3-19
3. Driver position memory system button ..	3-40	13. EPB (Electric parking brake) switch.....	5-19
4. Power window switch	3-28	14. Brake pedal	5-17
5. Outside rearview mirror control.....	3-58	15. Hood release lever	3-33
6. Fuel-filler lid opener.....	3-34	16. Seats.....	2-2
7. BSD (Blind spot detection) on/off button ..	5-58	17. Tilt/Telescope steering control lever.....	3-42
8. Parking assist system on/off button	3-102	18. Heated steering wheel on/off button.....	3-43
9. Instrument panel illumination control button	3-64	19. Steering wheel.....	3-42
10. HUD (Head up display) on/off button....	3-100		

INSTRUMENT PANEL OVERVIEW



* The actual shape may differ from the illustration.

OVI015004N

1. Instrument cluster	3-62	10. Climate control system seat.....	2-9
2. Lighting control lever.....	3-110	11. Multi-view camera system	
3. Wiper and washer control lever.....	3-115	on/off button	3-108
4. Horn	3-43	12. Vehicle height control button	5-36
5. Driver's front air bag.....	2-54	13. Rear curtain folding button.....	3-152
6. Engine Start/Stop Button	5-7	14. Center console storage box	3-141
7. Hazard warning flasher	6-2	15. Passenger's front air bag	2-54
8. Climate control system.....	3-123	16. Glove box	3-141
9. Shift lever	5-11		

ENGINE COMPARTMENT

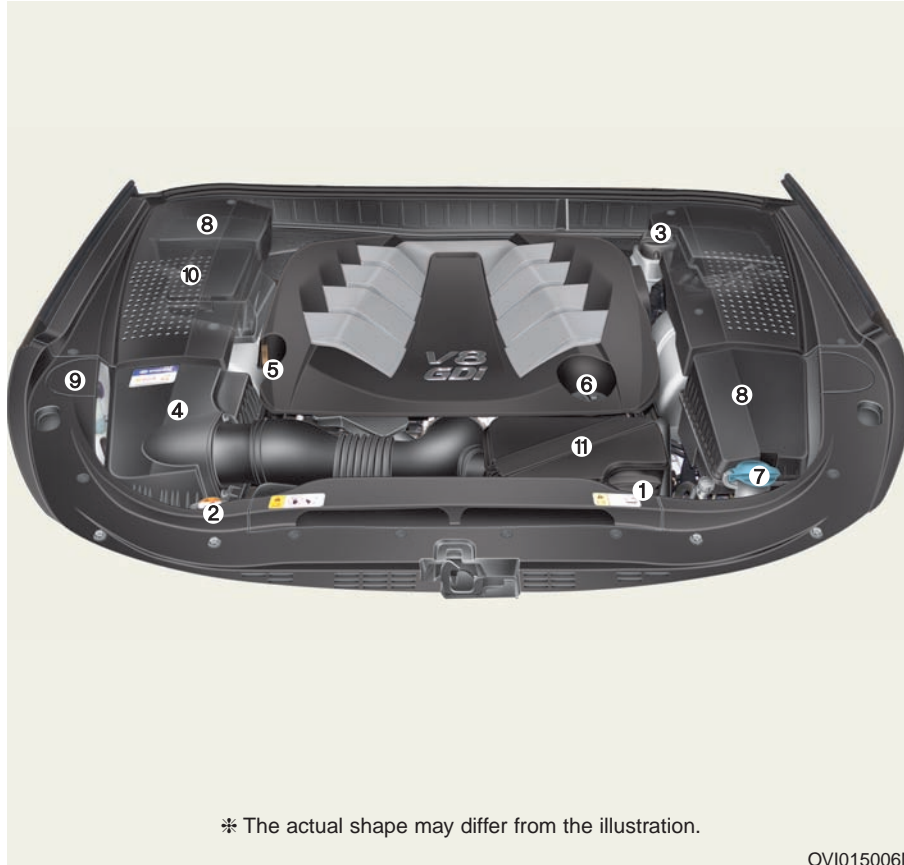

1. Engine coolant reservoir	7-27	7. Windshield washer fluid reservoir	7-32
2. Radiator cap	7-29	8. Fuse box	7-56
3. Brake fluid reservoir	7-30	9. Power steering fluid reservoir	7-31
4. Air cleaner	7-33	10. Jump start connector	6-4
5. Engine oil dipstick	7-25	11. Chamber air cleaner	7-34
6. Engine oil filler cap	7-25		



Safety system of your vehicle

Seats	2-2
Front seat adjustment.....	2-4
Rear seat adjustment.....	2-11
Seat belts	2-21
Seat belt restraint system	2-21
Pre-tensioner seat belt.....	2-25
Pre-safe seat belt (PSB).....	2-28
Automatic Seat Belt Retracting	2-29
Seat belt precautions	2-29
Care of seat belts	2-32
Child restraint system	2-33
Rear-Facing child restraint.....	2-35
Forward-Facing child restraints.....	2-35
Air bag – Advanced supplemental restraint system	2-42
How the air bag system operates	2-43
SRS components and functions	2-45
Occupant classification system	2-48
Main components of occupant classification system.....	2-49
Driver's and front passenger's air bag	2-54
Side air bag	2-58
Curtain air bag	2-60
Why is an air bag not inflated in a collision?.....	2-61
SRS Care.....	2-65
Additional safety precautions.....	2-66
Air bag warning label	2-68

SEATS

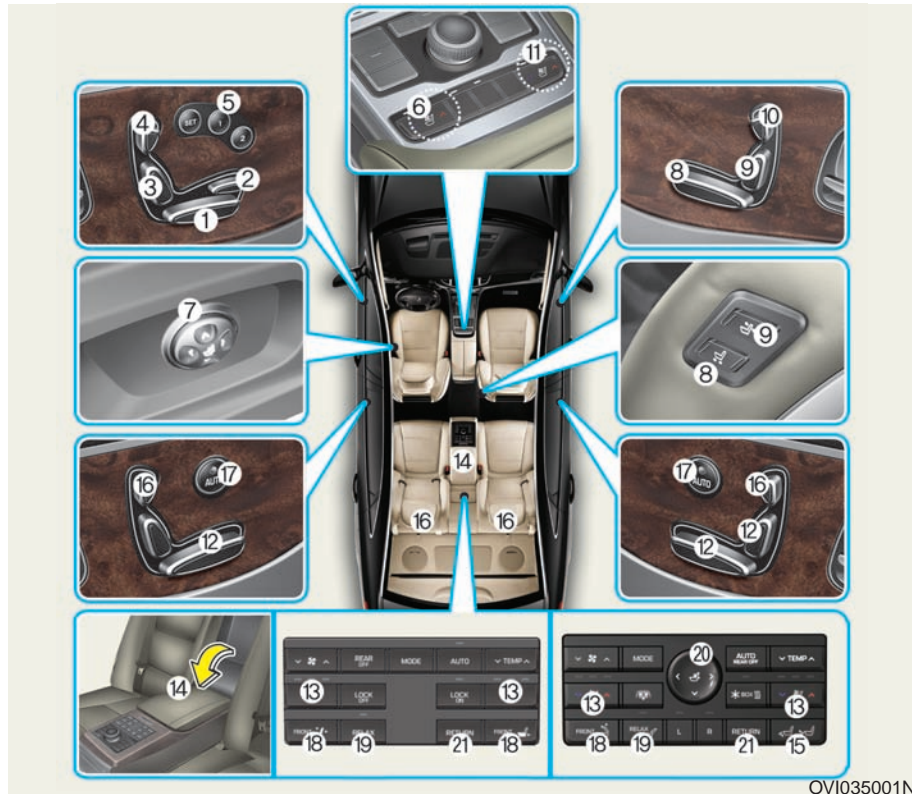

OVI035001N

Driver's seat

- (1) Seat sliding forward or backward**/
Seat height and cushion tilting adjustment
- (2) Seat cushion length adjustment
- (3) Seatback angle adjustment
- (4) Head restraint height adjustment
- (5) Driver position memory system
- (6) Climate control system seat*
- (7) Lumbar support adjustment

Front passenger's seat

- (8) Seat sliding forward or backward/
Seat height and cushion tilting adjustment*
- (9) Seatback angle adjustment
- (10) Head restraint height adjustment
- (11) Climate control system seat*

Rear seat

- (12) Seat sliding forward or backward
adjustment with seatback angle
adjustment
- (13) Climate control system seat*
- (14) Armrest
- (15) Leg support angle adjustment
- (16) Head restraint height adjustment
- (17) Easy access
- (18) Front passenger side walk-in seat
- (19) Rear relaxation seat system
- (20) Lumbar support adjustment
- (21) Return switch

*: if equipped

**.: The height of the driver's head restraint is automatically and simultaneously adjusted with the driver's seat sliding.

⚠ WARNING**- Loose objects**

Any objects in the driver's foot area may interfere with pedal operation, possibly causing an accident. Do not place anything under the driver's seat.

⚠ WARNING**- Driver's responsibility for passengers**

Riding in a seatback-reclined seat may lead to serious or fatal injury in an accident. When a seatback is reclined in an accident, the occupant may slide below the lap portion of the seat belt and be applied with great force on the unprotected abdomen. Serious or fatal internal injuries may result. The driver must advise passengers to keep the seatback in an upright position whenever the vehicle is in motion.

⚠ WARNING

Do not place a seat cushion, because it reduces friction between a seat and a passenger. The passenger may slide below the lap portion of the seat belt in an accident or a sudden stop. Serious or fatal internal injuries may result because the seat belt does not normally operate.

⚠ WARNING**- Driver's seat**

- Never attempt to adjust the seat position while the vehicle is in motion. This may result in loss of control and an accident, causing death, serious injury, or property damage.
- Do not allow anything to disturb the seatback position. Any items stored behind a seatback or any other items, which disturb the proper latching of a seatback, may result in serious or fatal injury in a sudden stop or collision.
- Always drive and ride with your seatback upright and the lap portion of the seat belt snug and low across the hips. This is the best position to protect you in case of an accident.
- In order to avoid unnecessary and perhaps severe air bag injuries, always sit as far back as possible from the steering wheel while comfortably maintaining the control of the vehicle. We recommend that your chest be at least 10 inches (250mm) away from the steering wheel.

⚠ WARNING

- Do not adjust the seat while fastening a seat belt. Moving the seat cushion forward may apply strong pressure on the abdomen.
- While adjusting the seat position, use extreme caution not to caught hands or other objects inside the seat components.
- Do not leave a cigarette lighter on the floor mat or seat. The operation of seat adjustment may leak gas out of the lighter and cause a fire.
- Use extreme caution when picking small objects trapped under the seats or between the seat and the center console. Your hands might be cut or injured by the sharp edges of the seat mechanism.

Front seat adjustment

The front seat position can be adjusted by pressing the control switches on the doors. Before driving, adjust the seat position, as desired, so as to easily control the steering wheel, pedals and instrument-panel buttons.

⚠ CAUTION

The power seat is operable, even when the ignition is OFF. Therefore, children should never be left unattended in the vehicle.

⚠ CAUTION

Do not adjust the seat position, while fastening a seat belt. Moving the seat cushion forward may apply strong pressure on the abdomen.

NOTICE

- The power seat is operated by electric motors. Pause the motor operation after each seat-position adjustment. Excessive motor operation may damage the electric equipment.
- The operation of a power seat consumes a large amount of electric power. To prevent unnecessary battery drain, when the engine is turned OFF, do not adjust the power seat longer than necessary.
- Do not press two power seat control switches or more at the same time. Doing so may fail the electric motor or components.

Forward and rearward

Push the control buttons forward or backwards to adjust the seat to the desired position. Release the button, once the seat is adjusted as desired. The adjustment of the seat position simultaneously changes the head restraint to the proper position.

Seatback Reclining

Push the upper part of the control switch either forwards or backwards to recline the seatback, as desired. Release the switch, once the seatback is adjusted as desired.

Seat cushion height and tilt

Pull up the front portion of the control switch to raise the front part of the seat cushion, or pull it down to lower the front part. Pull up the rear portion of the control switch up to raise the rear part of the seat cushion, or pull it down to lower the rear part. Release the switch, once the seat is adjusted as desired.



Push the control switch either forwards or backwards to move the seat cushion to the desired length. Release the switch, once the cushion length is adjusted as desired.

Lumbar support (for driver's seat)



The lumbar support can be adjusted by pressing the lumbar support switch on the side of the driver's seat. Press the front portion of the switch (1) to increase support, or press the rear portion (2) to decrease support.

Move the lumbar-support component up or down by pressing either (3) or (4).

Head Restraint



The driver's and front passenger's seats are equipped with head restraints for their safety and comfort.

The head restraints not only provide comfort for the driver and front passenger, but also protect their heads and necks in the event of a collision.

⚠ WARNING

- For maximum effects in case of an accident, the median height of a head restraint should be adjusted to the gravity center of the occupant's head.

Generally, the center of gravity of most people's head is located at the top of their eyes. Also, adjust the head restraint as close to your head as possible. For this reason, the use of a cushion, which holds the body away from the seatback, is not recommended.

- Do not drive the vehicle with a head restraint removed, because severe injury may occur to an occupant in the event of an accident. A properly-adjusted head restraint may provide protection against neck injury.
- Do not adjust the driver's head restraint, while the vehicle is in motion.

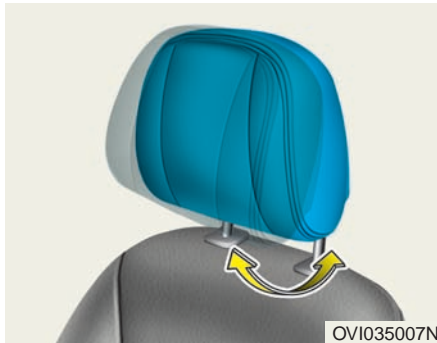

OVI035007N

Adjusting a head restraint forward and backwards

A head restraint may be adjusted in a direction of arrows by pulling the lower part of the head restraint either forwards or backwards. Adjust a head restraint, so it properly supports the head and neck.

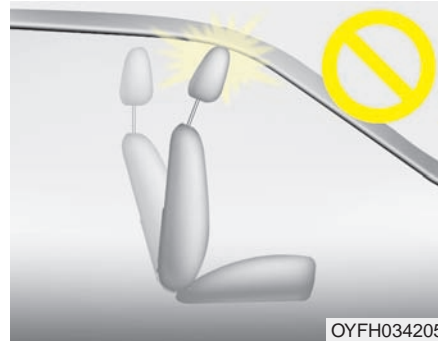

OYFH034205

NOTICE

If you recline the seatback towards the front with the head restraint and seat cushion raised, the head restraint may come in contact with the sunvisor or other parts of the vehicle.

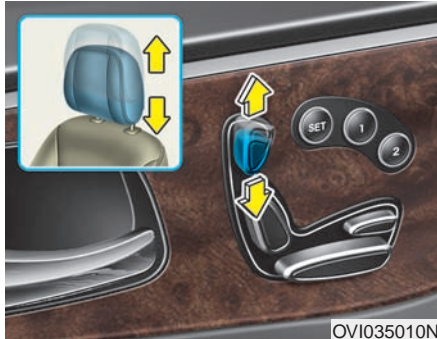

OVI035010N

Adjusting the head restraint up and down

Pull up the control switch to raise the head restraint, or pull it down to lower the head restraint. Release the switch, once the head restraint is adjusted as desired.

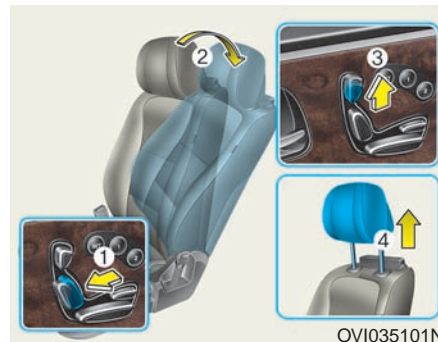

OVI035101N

Removal

To remove the head restraint:

1. Recline the seatback (2) by pressing the recliner control switch (1).
2. Raise the head restraint to the highest by pressing up the switch (3). Then, take off the head restraint (4).

⚠ CAUTION

Never allow anyone to take a seat, of which a head restraint is removed.

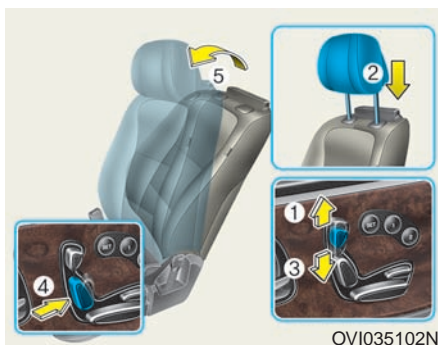

Reinstall

To reinstall a head restraint:

1. Raise a head restraint to the highest by pressing up the switch (1).
2. Put the poles of the head restraint (2) into the holes. Then, pull down the switch (3) until the head restraint lowers to the lowest.
3. To securely install the head restraint, raise and lower the head restraint 2 or 3 times by pressing the switch.
4. Recline the seatback (5) by pressing the recliner control switch (4).
5. Adjust the head restraint to the appropriate height.

NOTICE

Do not attempt to reinstall a head restraint from the incorrect height, other than from the highest. Do not force it. It causes damage to the head restraint.

⚠ WARNING

- When a head restraint is not securely installed, a head restraint may not normally and actively operate. When reinstalling a head restraint, securely latch it, as instructed in the procedures.
- Always confirm that a head restraint is fully latched in the right position, after reinstalling it.
- Do not operate the vehicle, when a head restraint is removed, as severe injury to an occupant may occur in the event of an accident. A head restraint may provide protection against neck injuries when properly adjusted.



Electronic active head restraint

The electronic active head restraint is designed to automatically adjust its position forwards and upwards, when a rear impact is detected. This helps to prevent the driver's and front passenger's heads from moving backwards and thus helps minimize neck injuries.

NOTICE

The electronic active head restraint is a safety device to reduce injury in a rear impact. Do not intentionally hit or pull the head restraint.

Climate control system seat (if equipped)



This system cools or warms the front seats by blowing air through small vent holes both on the seat cushions and on seatbacks.

While the engine is running, press the rear portion of the button to cool or warm the driver's or the front passenger's seats.

When the operation of the climate system seat is unnecessary, press OFF the button.

- Each time you press the button, the air flow changes as follows:

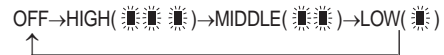

- When pressing the button for 1.5 seconds or over with the climate control system ON, the climate control system seat will be turned OFF.
- The default setting of the climate control system seat resets is OFF, when the Engine Start/Stop Button is turned ON.
- With the climate control system seat ON, the system automatically operates or stops in accordance with a seat temperature.

NOTICE

- The climate control system seat is a supplementary cooling and warming system. Operate the climate control system seat after turning ON the climate control system. Operate the climate control seat for a prolonged period of time without turning ON the climate control system may reduce performance of the climate control system seat.
- When cleaning the seats, do not use an organic solvent such as thinner, benzene, alcohol and gasoline. Such solvent may damage the seat surface.
- Do not spill liquid such as water or beverages over the front seat cushions and seatbacks. Otherwise, the air vent holes may be blocked and prevent the system from working properly.
- Do not leave materials, such as plastic bags or newspapers, under the seats. The air vent hole may not properly operate, because the air intake is blocked.
- When the air vent hole does not operate, restart the vehicle. If a problem persists, we recommend that the system be inspected by an authorized EQUUS dealer.

Seatback pocket



The seatback pockets are located on the back of the driver's and the front passenger's seats.

⚠ CAUTION

- **Seatback pocket**
Do not put a heavy or sharp object inside the seatback pockets. In an accident, it may fall out from the pocket and injure an occupant.

⚠ WARNING

- For proper operation of the occupant classification system:
- Do not put any items cumulatively weighing over 2.2 lbs. (1kg) inside the seatback pockets.
 - Do not hang anything onto the front passenger's seatback.

Rear seat adjustment

The rear seat position can be adjusted by pressing the control switches on doors.

WARNING

The power seat is operable even after turning OFF the Engine Start/Stop button. Therefore, children should never be left unattended in the vehicle.

NOTICE

- The power seat is operated by electric motors. Pause the motor operation after each seat-position adjustment. Excessive motor operation may damage the electric equipment.
- The operation of a power seat consumes a large amount of electric power. To prevent unnecessary battery drain, when the engine is turned OFF, do not adjust the power seat longer than necessary.
- Do not press two power seat control switches or more at the same time. Doing so may fail the electric motor or components.

CAUTION

While adjusting the seat position, use extreme caution not to caught hands or other objects inside the seat components.

Do not adjust the seat while fastening a seat belt. Moving the seat cushion forward may apply strong pressure on the abdomen.

NOTICE

Do not operate the rear power seat, when a child restraint is installed.

Safety system of your vehicle

Forward, backward and seat-back angle

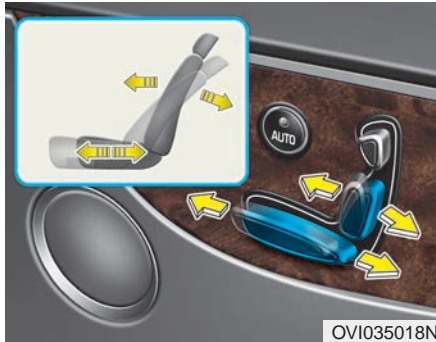

Push the control switch forward or backwards to adjust the seat positions to the desired position. Release the switch, once the seat position is adjusted as desired.

Easy access switch



Your vehicle is equipped with the easy access system to enhance convenience of rear seat occupants. When opening the rear door, the rear seats will automatically slide backwards to provide easier access. This system operates only when the control switch is ON.

Additional switches for adjusting the front passenger's seat (if equipped)

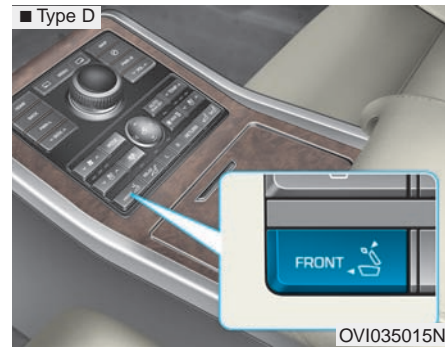
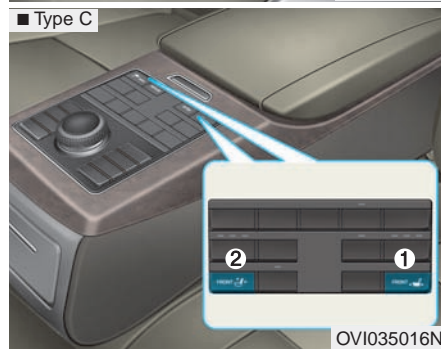
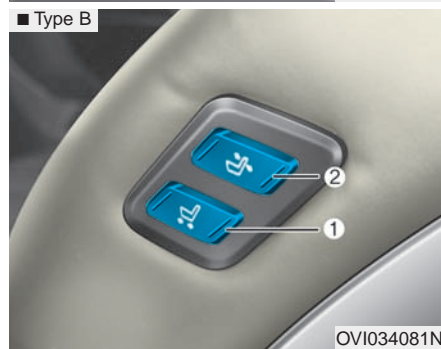
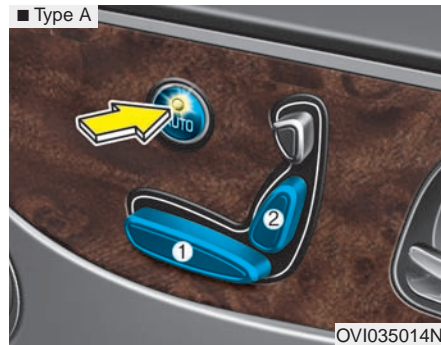

Type A

By pressing the FRONT switch, the front passenger's seat moves forward and backwards (1), and the seatback reclines.

Type B, C

Additional switches are equipped to move the front passenger's seat forward and backwards (1) and recline the seatback (2).

Type D

By pressing the switch, the front passenger's seat moves forward and backwards and the seatback reclines.

**Lumbar support (for rear seats)
(if equipped)**

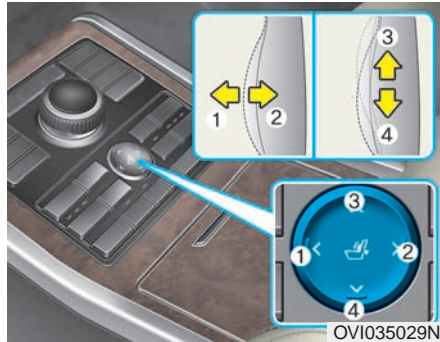

• For right side :
Press the R switch.
The lumbar support can be adjusted by controlling the lumbar support switch. Press the front portion of the switch (1) to increase support or the rear portion of the switch (2) to decrease support.
To raise or lower the support position, press either (3) or (4).

• For left side :
Press the L switch.
The lumbar support can be adjusted by controlling the lumbar support switch. Press the front portion of the switch (1) to increase support or the rear portion of the switch (2) to decrease support.
To raise or lower the support position, press either (3) or (4).

**Rear switches operating limitation
(if equipped)**

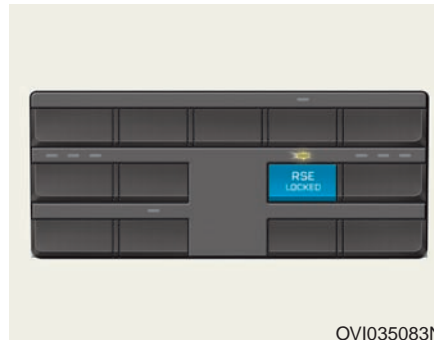

When the switch to adjust the rear seats is locked, the RSE LOCKED indicator illuminates.

* RSE : Rear Seat Entertainment

* The RSE LOCKED is controlled by AVN. Refer to the AVN manual.

VIP Convenience function (3 seat configuration)

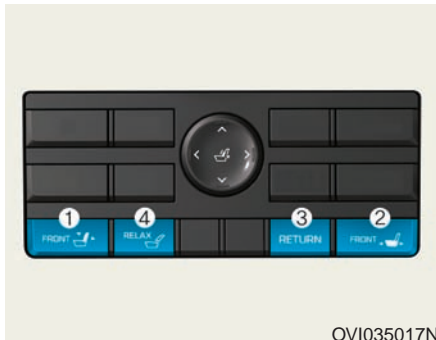

OVI035017N

Occupants may use the switches to control the rear seats.



OVI035062N

Front passenger's walk-in seat

Press the switch (1):

The seatback will be adjusted.

Press the switch (2):

The seat will move forward or backwards.

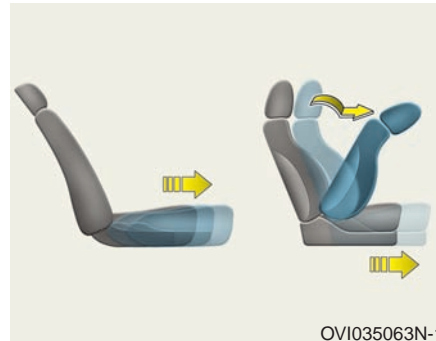

OVI035063N-1

Rear relaxation seat system

Press the switch (3):

The front passenger's seat and the right rear seat will reset to its original position. Upon being reset, there will be a beeping sound.

Press the switch (4):

The front passenger's seat will move forward with the seatback folding. Also, the right rear seatback will recline. Upon being reset, there will be a beeping sound.

**VIP Convenience function
(2 seat configuration)**



Occupants may use the switches to control the right rear seat or front passenger's seat.

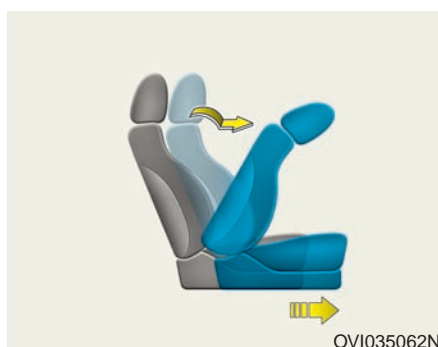

Front passenger's walk-in seat

Press the switch (1):

The front passenger's seat will move forward with the seatback folding.

When you want the front passenger's seat, press the switch (3).

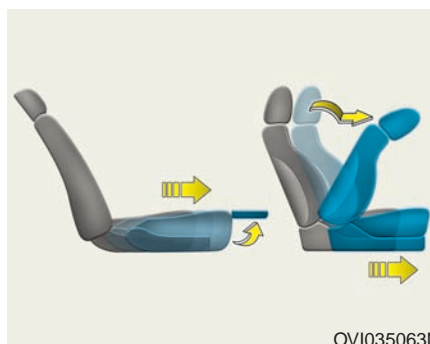

Rear relaxation seat system

Press the switch (2):

The front passenger's seat will move forward, the seatback will fold down. Then, the right rear seat cushion will move forward, and the leg support will rise up. Re-pressing the switch, while adjusting the seats, will stop the system. Upon being reset, there will be a beeping sound.

Return function

When the switch (3) is pressed, the rear seat will move to the rearmost position, and the leg support will lower down. The front passenger seat will automatically moves to its default position. Upon being completed, there will be a beeping sound.

Leg support

- Press the switch (4):
The leg support will lower down.
- Press the switch (5):
The leg support will rise up.

Head restraint



OVI035106N

A rear seat is equipped with a head restraint for an occupant's safety and comfort.

The head restraint not only provides comfort, but also helps to protect the head and neck in the event of a collision.

⚠ WARNING

- For maximum effects in case of an accident, the median height of a head restraint should be adjusted to the gravity center of an occupant's head.

Generally, the center of gravity of most people's head is located at the top of their eyes. Also, adjust the head restraint as close to your head as possible. For this reason, the use of a cushion, which holds the body away from the seatback, is not recommended.

- Do not drive the vehicle with a head restraint removed, because severe injury may occur to an occupant in the event of an accident. A properly-adjusted head restraint may provide protection against neck injury.

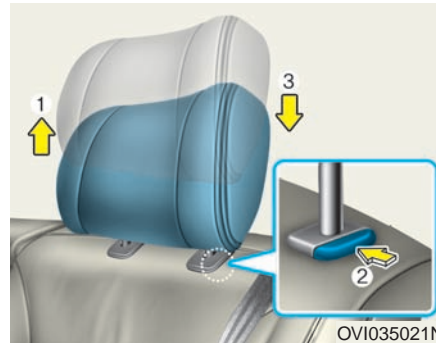

OVI035021N

Adjusting the head restraint up and down

To rise up a head restraint, pull up the head restraint to the desired height (1). To lower down the head restraint, press and hold the release button (2) next to the head restraint support. Then, lower down the head restraint to the desired height (3).

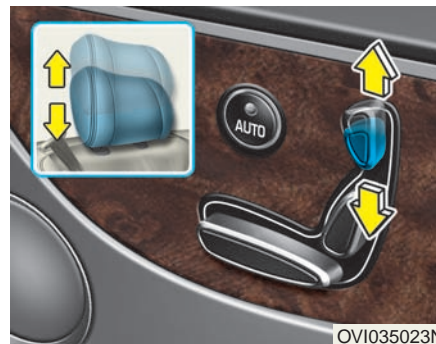

OVI035023N

Adjusting the head restraint up and down (electric) (if equipped)

Pull up the control switch to raise or lower a head restraint. Release the switch, once the head restraint is adjusted, as desired.



OVI035094N

Forward and backward adjustment

A head restraint can be adjusted forward or backwards to the desired dent, by pulling forward or pushing backwards the lower part of the head restraint in directions of the arrows. Adjust the head restraint, so it properly supports the head and neck.



OVI035024N

Wing-out

For an occupant's comfort, the head restraint of rear seats (excluding the rear center seat) can curve inwards.

Armrest (if equipped)



OVI035025N

To use the armrest, pull forward the knob (1) on the seatback.



OVI035026N

Cup holder (if equipped)

To use the cup holder, press the cup holder storage (1).



Storage compartment (if equipped)
To use the storage compartment, press the button (2). Close the cover after usage.

Rear tower console storage (if equipped)

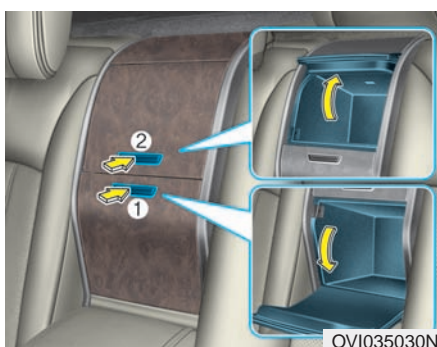

These spaces are to store small items.
To open the upper console storage, press the button (2). To open the lower console storage, press the button (1). Close the covers after usage.

⚠ WARNING

- To reduce injury risk in an accident or a sudden stop, always close the storage covers while driving.
- Close the storage covers, while the vehicle is in motion. Failure to follow this instruction may cause death or serious injury.

Climate control system seat (if equipped)

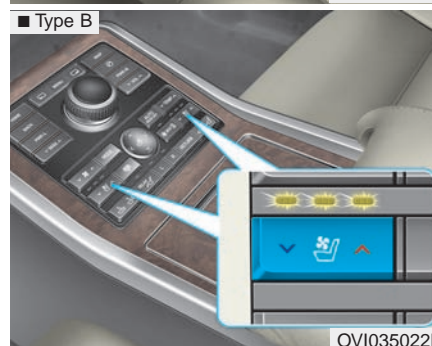
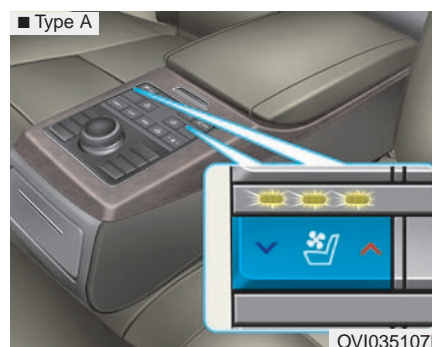







This cools or warms the rear seats by blowing air through small air vents on the seats and seatbacks.

Safety system of your vehicle

While the engine is running, push the rear portion of the button either to warm or to cool the rear seats.

When the climate control system seat is not needed, press OFF the button.

- Each time you press the button, the air flow changes as follows:

OFF → HIGH (  ) → MIDDLE ( ) → LOW ()

- When pressing the button for 1.5 seconds or over with the climate control system seat ON, the seat cooler will turn OFF.
- The default setting of the climate control system seat is OFF, when the Engine Start/Stop Button is turned ON.
- With the climate control system seat ON, the system automatically operates or stops in accordance with a seat temperature.

NOTICE

- The climate control system seat is a supplementary cooling and warming system. Operate the climate control system seat after turning ON the climate control system. Operate the climate control seat for a prolonged period of time without turning ON the climate control system may reduce performance of the climate control system seat.
- When cleaning the seats, do not use an organic solvent such as thinner, benzene, alcohol and gasoline. Such solvent may damage the seat surface.

(Continued)

(Continued)

- Do not spill liquid such as water or beverages over the front seat cushions or seatbacks. Otherwise, the air vent holes may be blocked and prevent the system from working properly.
- Do not leave materials, such as plastic bags or newspapers, under the seats. The air vent hole may not properly operate, because the air intake is blocked.
- When the air vent hole does not operate, restart the vehicle. If a problem persists, we recommend that the system be inspected by an authorized EQUUS dealer.

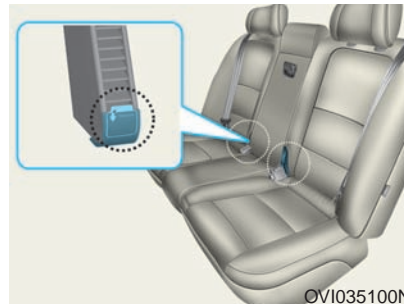

- Before using the climate control system seat, remove the attached sticker to the rear air vent hole.

If not, the cooling and warming performance may decrease.

SEAT BELTS

Seat belt restraint system

WARNING

- To achieve the maximum protection of the restraint system, the seat belts must always be fastened whenever the vehicle is in motion.
- A seat belt is most effective, when a seatback is in the upright position.
- Children age 12 and under must always be properly restrained in the rear seat. Never allow children to ride in the front passenger's seat. When a child over the age of 12 needs to seat in the front, he/she must be properly belted and the seat should be set in the rearmost position.
- Never fasten the shoulder belt under your arm or behind your back. An improperly positioned shoulder belt may cause serious injury in a crash. The shoulder belt should be positioned midway over your shoulder across your collarbone.
- Always wear both the shoulder portion and lap portion of the lap/shoulder belt.
- Avoid wearing a twisted seat belt. A twisted belt cannot properly activate. It may even cut through in a collision. Make sure that a belt webbing is straight and untwisted.
- Be careful not to damage a belt webbing or other components. When the belt webbing or other components is damaged, replace it.

WARNING

A seat belt is designed to be fastened across the bony structure of the body. The lap portion of the belt should be fastened low across the front pelvis. Fastening the lap portion of the belt across the abdomen must be avoided.

A seat belt should be tightly fastened, in accordance with an occupant's comfort, to provide the protection, for which a seat belt is designed.

Loose fastening of a seat belt greatly reduces an occupants' protection.

Particular care should be taken to avoid any webbing contamination with polishes, oils, chemicals or battery acid. Immediately clean the webbing, using mild soap and water. A belt should be replaced, when its webbing is frayed, contaminated or damaged. It is essential to replace the entire assembly after a severe impact, even if damage to the assembly is not obvious. A belt, of which straps are twisted, should not be fastened. Each seat belt assembly must be used only by one occupant. It is dangerous to fasten a belt over a child being carried on an occupant's laps.

⚠ WARNING

- Any modifications or additions should not be done by a driver. Such modifications or additions may make the seat belt assembly slack, and the seat belt assembly may not firmly and tightly tighten.
- When fastening a seat belt, be careful not to latch your seat belt in a buckle of other seats. It is very dangerous, and you may not be properly protected by the seat belt.
- Do not unfasten the seat belt, or do not repeatedly fasten and unfasten the seat belt, while driving. This may result in loss of control, and an accident, causing death, serious injury, or property damage.
- When fastening a seat belt, make sure that it is not fastened over any hard or fragile object.
- Before latching a seatbelt, make sure that there is nothing inside a buckle, not to block the mechanism. Otherwise, a seat belt may not be securely fastened.

**Seat belt warning
(for driver's seat)**

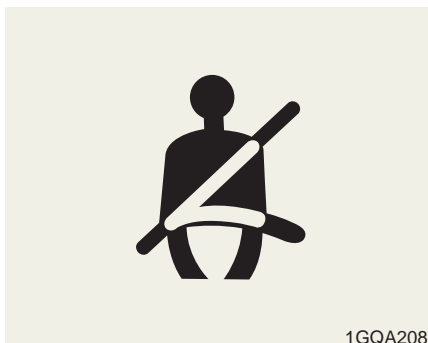

1GQA2083

The warning light and the chime will activate, as in the following table, when the ignition switch is ON.

Conditions		Warning Pattern	
Seat Belt	Vehicle Speed	Light-Blink	Chime-Sound
Unbuckled		6 seconds	
Buckled		6 seconds	None
Buckled → Unbuckled	Below 3 mph (5 km/h)	6 seconds	None
	3 mph~ 6 mph	6 seconds	
	Above 6 mph (10 km/h)	6 sec. on / 24 sec. off (11 times)	
Unbuckled	Above 6 mph (10 km/h)	6 seconds * ¹	
	↓ Below 3 mph (5 km/h)	↓ Stop * ²	

*¹ The flashing will repeat 11 times at an interval of 24 seconds. Upon buckling the driver's seat belt, the flashing will stop in 6 seconds, and chime will immediately stop.

*² The flashing will stop in 6 seconds, and the chime will immediately stop.

Seat belt warning (for front passenger's seat)



To remind the front passenger, the front passenger's seat belt warning light will flash, whenever you turn ON the ignition switch regardless of belt fastening. When the passenger's seat belt is unfastened, when the vehicle drives over 6 mph (10 km/h), and when occupant presence is detected, the passenger's seat belt warning light will flash until being fastened.

⚠ WARNING

Riding in an improper position adversely affects the front passenger's seat belt warning system. It is important for the driver to properly instruct the passengers, as in this manual.

3-point system with emergency locking retractor

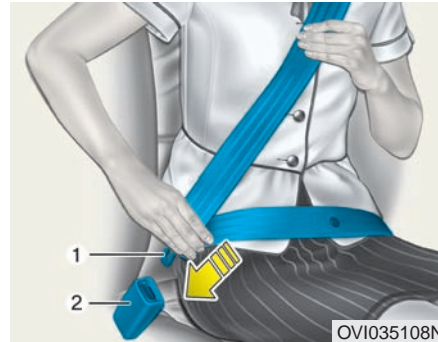

To fasten your seat belt:

Pull the belt webbing out of the retractor and insert the metal tab (1) into the buckle (2). It will "click" when the tab locks into the buckle. The seat belt automatically adjusts to the proper length only after the lap portion of the belt is manually adjusted so that it fits snugly around your body. If you lean forward slowly and comfortably, the belt will extend and move with you. If there is a sudden stop or impact, the belt will be locked. It will be also locked if you try to lean forward too quickly.

i Information

When a seat belt is not smoothly stretched from the retractor, pull it hard and release. After this, the seat belt can be smoothly stretched.

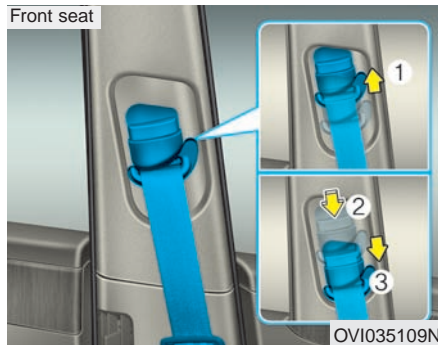

Height adjustment

The anchor height for the shoulder portion of the belt can be adjusted to one of the 4 positions for your greatest comfort and safety.

The anchor height should be adjusted, so the shoulder portion is fastened over your chest and midway over the shoulder nearest the door, not over your neck.

To adjust the anchor height, rise up or lower down the adjuster.

To rise up the adjuster, pull it up (1). To lower it down, push it down (3) while pressing the height adjuster button (2).

Release the button to lock the anchor height. Attempt to slide up or down the adjuster to confirm its locking.

⚠ WARNING

- **Make sure that the shoulder belt anchor is securely locked at an appropriate height. Never fasten the shoulder portion of the belt over your neck or face. Improper fastening may cause serious injury in an accident.**

(Continued)

(Continued)

- **Failure to replace a seat belt assembly after an accident may put you in danger, because the damaged seat belt will not provide protection in the event of another collision, leading to personal injury or death. Immediately replace your seat belts after an accident.**

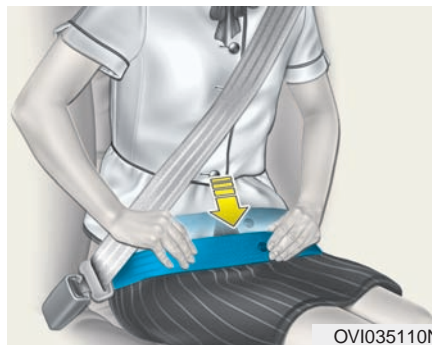

⚠ WARNING

The lap portion of a seat belt should be fastened as low as possible and snugly across your hips, not on your waist. When the lap belt is fastened too high on your waist, it may increase injury risk in the event of a collision. Both arms should not be under or over the belt. Rather, one should be over and the other under, as shown in the illustration.

The seat belt should not be fastened under the driver's left arm, or the front passenger's right arm.

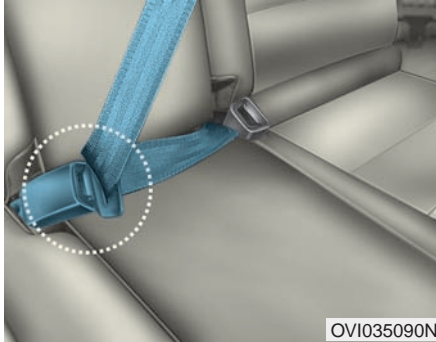

OVI035090N

When fastening the seat belt of the rear center seat, an occupant should and ALWAYS use the buckle with the CENTER mark.

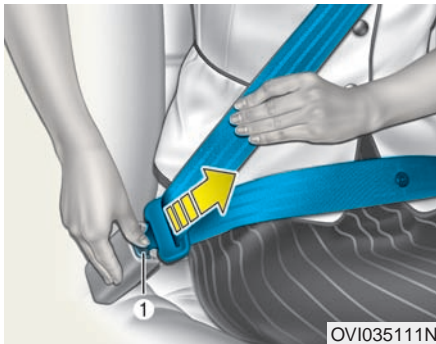

OVI035111N

To release the seat belt:

Press the release button (1) on a buckle. When released, the belt will automatically retract. When it is not released, make sure that the belt is not twisted, and then try again.

Pre-tensioner seat belt

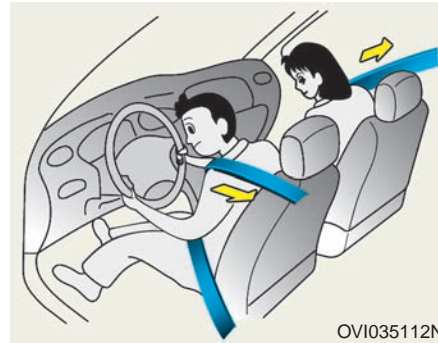

OVI035112N

Your vehicle is equipped with driver's and front passenger's pre-tensioner seat belts. The purpose of the pre-tensioner seat belt is to make sure that a seat belt tightly fits over an occupant's body in case of a frontal collision. The pre-tensioner seat belts will activate in a crash over a certain scale.

⚠ WARNING

For your safety, make sure that the belt webbing is not slack or twisted. Always properly sit in your seat.

When the vehicle suddenly stops, or when an occupant abruptly lean forward, the seat belt retractor locks into position. In a certain frontal collision, the pre-tensioner will activate and fasten the seat belt more tightly against an occupant's body.

When the pre-tensioner senses an excessive tension on a seat belt, the Load Limiter of the pretensioner will release some of the pressure.

⚠ WARNING

Do not leave any objects near a buckle. Placing objects near the buckle may adversely affect the buckle pre-tensioner and increase the injury risk in the event of a collision.

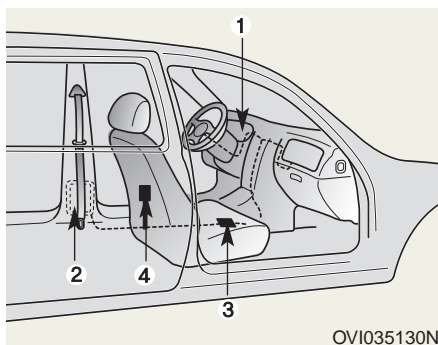

The seat belt pre-tensioner system mainly consists of the following components.

Their locations are shown in the above illustration:

- 1.SRS air bag warning light
- 2.Retractor pre-tensioner assembly
- 3.SRS control module
- 4.Anchor pre-tensioner assembly

⚠ WARNING

To obtain maximum benefits from a pre-tensioner seat belt:

1. The seat belt must be correctly fastened and adjusted to the proper position.

(Continued)

(Continued)

Please read and follow all of the important information and precautions about your vehicle's occupant safety features – including seat belts and air bags – that are provided in this manual.

2. Make sure that you and your passengers always properly fasten seat belts.

i Information

- Both the driver's and front passenger's pre-tensioner seat belts may activate in a certain frontal/side collision or rollovers.

The pre-tensioner will not activate, when the seat belt is not fastened at the time of the collision.

- When the pre-tensioner seat belt activates, there will be a loud noise with fine dust, which may appear to be smoke and be visible in the passenger compartment.

These are normal, not indicating any hazard.

- Although it is non-toxic, the fine dust may cause skin irritation and should not be inhaled for a prolonged period of time. Thoroughly Wash all exposed skin areas after an accident, in which a pre-tensioner seat belt activates.

i Information

The sensor, which triggers the SRS air bag activation, is connected with the pretensioner seat belt. The SRS air bag warning light  on the instrument panel will illuminate for approximately 6 seconds, when the ignition switch is turned ON. This will be automatically turned OFF.

NOTICE

Even when there is not malfunction of the SRS air bag, but the malfunction of the pre-tensioner seat belt, the warning light will illuminate. When the SRS air bag warning light does not illuminate after turning ON the ignition switch, when it remains illuminated approximately for more than 6 seconds, or when it remains illustrated while driving, immediately have an authorized EQUUS dealer inspect the pre-tensioner seat belt and SRS air bag system.

⚠ WARNING

- Pre-tensioners are designed to operate only one time. After activation, pre-tensioner seat belts must be replaced. All seat belts of any type should always be replaced after a collision.
- The pre-tensioner seat belt assembly mechanism gets hot while being activated. Do not touch the pre-tensioner seat belt assembly for several minutes after its activation.
- Do not attempt to inspect or replace the pre-tensioner seat belt by yourself. This must be done by an authorized EQUUS dealer.
- Do not hit hard the pre-tensioner seat belt assemblies.
- Never attempt to maintain or repair the pre-tensioner seat belt system in any manner.
- Improper handling of pretensioner seat belt assemblies, and failure to heed the warnings not to hit, modify, inspect, replace, maintain or repair the pre-tensioner seat belt assemblies may lead to improper operation, malfunction and serious injury.
- Always fasten a seat belt, while the vehicle is in motion.
- When the pre-tensioner seat belt needs to be discarded, contact an authorized EQUUS dealer.

Pre-safe seat belt (PSB) (if equipped)



The purpose of the pre-safe seat belt is to tighten the seat belt in an emergency braking or upon sensing a loss of control.

NOTICE

The pre-safe seat belt activates, only when a seat belt is fastened.

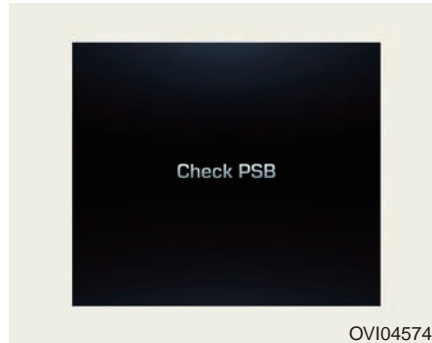

The pre-safe seat belt warning light will illuminate, when a malfunction of a pre-safe seat belt is detected.

Have the system checked, when;

- The warning light illuminates while driving.

In order to maximize occupants' safety, the pre-safe seat belt system operates, as below:

- The seat belt is tightened when;
 - An emergency braking situation occurs,
 - The control of the vehicle is lost, and
 - A passenger leans toward one side.
- The seat belt vibrates when;
 - The Lane Departure Warning System (if equipped) detects the vehicle swerves out of its lane.

NOTICE

Do not be surprised when the seat belt vibrates. It is a warning for your safety, not a malfunction.

Automatic Seat Belt Retracting

In order to prevent a seat belt from being slack due to weak fabric durability, your seat belt assembly is equipped with the automatic retracting function. A motor automatically retracts the seat belt after approximately 3 seconds. However, this does not operate, when the seat belt is unfastened with little slack.

Seat belt precautions

WARNING

All occupants of the vehicle must and always fasten their seat belts. Seat belts and child restraints reduce the risk of serious or fatal injury in the event of a collision or a sudden stop. Without fastening a seat belt, occupants may fall too close to a deploying air bag, strike the interior structure or be thrown out of the vehicle. Proper fastening greatly reduces these hazards.

Even with advanced air bag technologies, unbelted occupants may be severely injured due to air bag inflation. Always follow the precautions about seat belts, air bags and occupant safety contained in this manual.

Infant or small child

All 50 states have child restraint laws which require children to travel in approved child restraint devices, including booster seats. The ages, at which seat belts may be used instead of child restraints, differ among states, so you should check the specific requirements in your state before driving. Infant and child restraints must be properly placed and installed in a rear seat.

For further information, refer to the Child Restraint Systems chapter.

WARNING

Every person in your vehicle needs to be properly and always restrained, including infants and children. Never hold a child in your arms or on your laps when riding in a vehicle. The violent impact in a crash may force you miss the child from your arms and the child may strike against the vehicle interior.

Always use a child restraint appropriate for your child's height and weight.

i Information

Small children are best protected from injury in an accident when being properly restrained in the rear seat by a child restraint system, which meets the requirements of the Federal Motor Vehicle Safety Standards.

Before purchasing any child restraint, make sure that it has a label certifying that it meets Federal Motor Vehicle Safety Standard 213. The restraint must be appropriate for your child's height and weight.

Check the label on the child restraint for this information. Refer to Child Restraint Systems in this chapter.

Big child

Children, who are under age 13 but too big for a booster seat, must always ride in the rear seat and use the available lap/shoulder belts. A seat belt should be fastened over the upper thighs and be snug across the shoulder and chest to safely restrain the child. Often check belt fastening. A child's squirming may move the belt out of position. Children are best protected in the event of an accident when they are restrained by a proper restraint system and in the rear seat.

When a big child over age 13 is seated in the front seat, the child must be securely restrained by the available lap/shoulder belt and the seat should be placed in the rearmost position. If the shoulder portion of the seat belt slightly crosses over the child's neck or face, have the child slightly moves leftwards. When the shoulder portion still touches the child's face or neck, he or she needs to be returned to an appropriate booster seat.

⚠ WARNING

- **Shoulder belts on small children**
- **Never allow a shoulder portions to be fastened over a child's neck or face while the vehicle is in motion.**
- **When a seat belt is improperly fastened and adjusted over a child, there is a risk of death or serious injury.**

Restraint of pregnant women

Pregnant women should fasten a lap/shoulder belt whenever possible as specifically recommended by their doctors. The lap portion of the belt should be worn **AS SNUGLY AND LOW AS POSSIBLE** on the hips, not across the abdomen.

⚠ WARNING**- Pregnant women**

Pregnant women must not place a lap portion of a seat belt over their abdomen where they have an unborn child. A safety belt above the abdomen may seriously injure or even cause death of an unborn child in an impact.

Injured person

A seat belt should be used to transport an injured person. Before doing this, you should consult a physician for recommendation.

One person per belt

A single seat belt should never be fastened over two people (including children). This may increase the severity of injury in case of an accident.

Do not lie down

To reduce the chance of injury in the event of an accident and to achieve maximum effects of the restraint system, all passengers should seat in an upright position in front and rear seats when the vehicle is in motion. Proper protection cannot be provided, when an occupant lies on rear seats, or when a seat is reclined.

⚠ DANGER

Riding with a reclined seatback increases your chance of serious or fatal injuries in the event of a collision or sudden stop. The protection of your restraint system (seat belts and air bags) increasingly reduces, when your seat is reclined. A seat belt must be snug against your hips and chest to properly operate. The more a seatback is reclined, the greater the chance that an occupant's hips will slide under the lap portion of a seat belt, causing serious internal injury or hard pressure on the occupant's neck from the shoulder portion of a seat belt. Drivers and passengers should always sit well back in their seats, be properly belted, and put their seatbacks upright.

Care of seat belts

Seat belt systems should never be disassembled or modified. In addition, care should be taken not to damage seat belts or belt assemblies by seat hinges, doors or other abuse.

Periodic inspection

All seat belts should be checked on a regular basis for any wear-out or damage. Any damaged parts should be replaced as soon as possible.

Keep belts clean and dry

Seat belts should be kept clean and dry. When belts become dirty, clean them with mild soap and warm water. Bleach, dye, strong detergents or abrasives should not be used, because they may damage and weaken the fabric.

When to replace seat belts

An entire seat belt assembly should be replaced after an accident. This should be done, even when no damage is visible. Consult an authorized EQUUS dealer for additional questions about the seat belt operation.

CHILD RESTRAINT SYSTEM

Children under age 13 must always ride in rear seats and be properly restrained to minimize the risk of injury in an accident, a sudden stop or a sudden maneuver. According to the accident statistics, children are safer when being properly restrained in rear seats than in the front passenger's seat. Even with advanced air bag systems, children may be seriously injured or killed. A child, who is too big for a child restraint, must fasten a seat belt provided.

All 50 states have child restraint laws, which require children to travel in approved child restraint devices. The laws to govern and restrict children's age, height, and weight, at which a seat belt is allowed to use instead of a child restraint, differ among states. So, you should check any specific requirements in your state, before travelling. A child restraint must be properly placed and installed in a rear seat. You must use a commercially available child restraint, which meets the requirements of the Federal Motor Vehicle Safety Standards (FMVSS).

A child restraint is generally designed to be secured in a seat by a lap belt, lap/shoulder belts, or a LATCH system.

A child may be injured or killed in a crash, when a child restraint is not properly secured.

WARNING

- **A child restraint must be placed in a rear seat. Never install a child or infant seat in the front passenger's seat. When an accident occurs and the passenger-side air bag inflates, it may severely injure or kill an infant or a child. Thus, always install a child restraint in a rear seat.**
- **When a child restraint is not in use, fasten it with a seat belt or store it in the trunk, so it does not fall forward in a sudden stop or an accident.**
- **Children may be seriously injured or killed by an inflating air bag. All children, even who are too big for child restraints, must ride in a rear seat.**

CAUTION

A seat belt or a child restraint easily gets hot, when it is exposed to the sunlight in a closed vehicle even in the mild weather. Check the temperature of a seat cover and buckles before seating a child.

⚠ WARNING

To reduce the chance of serious or fatal injuries:

- Children of all ages are safer when being restrained in a rear seat. A child, seating in front, may be forcefully struck with an inflating air bag. This may result in serious or fatal injury.
- Always follow the instructions of the child restraint manufacturer's for installation and usage.
- Always make sure that the child seat is properly secured, and that your child is securely restrained in the child seat.
- Never hold a child in your arms or on your laps when riding in a vehicle. The violent impact in a crash may force you miss the child from your arms and the child may strike against the vehicle interior.
- Never fasten a single seat belt over you and a child. In a crash, the belt may apply sharp pressure on the child, causing serious internal injury.
- Never leave a child unattended in a vehicle – not even for a short time. The vehicle is easily heated up, resulting in serious injury of a child inside. Even very young children may inadvertently move the vehicle, entangle themselves in a window frame, or lock themselves or others inside the vehicle.

(Continued)

(Continued)

- Never allow two children, or any two persons, to fasten the same seat belt.
- Children often squirm and shift their position. Never let a child ride with the shoulder belt under their arm or behind their back. Always properly seat and secure a child in a rear seat.
- Never allow a child to stand up, or kneel on a seat or a floor mat, while the vehicle is in motion. During a collision or a sudden stop, the child may be violently strike against the vehicle interior, resulting in serious injury.
- Never use an infant carrier or a child safety seat, which "hooks" over a seatback. It may not provide adequate security in an accident.
- Do not operate a rear power seat, when a child seat is installed. The power seat may be broken.
- After an accident, have an authorized EQUUS dealer check the child restraint, seat belt, and tether/lower anchors.
- When the space to place a child restraint is insufficient due to the driver's seat, install it in the right rear seat.

Rear-Facing child restraint

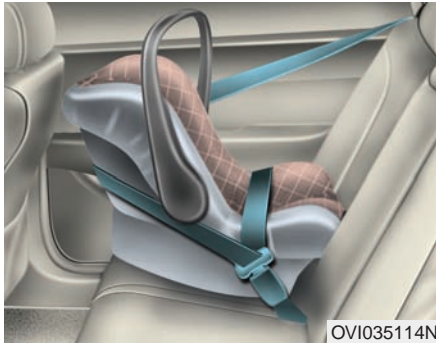

⚠ WARNING

NEVER install a child or infant restraint in the front passenger's seat. Placing a rear-facing child restraint in front may result in **SERIOUS INJURY** or **DEATH**, when an inflating air bag strikes the child restraint.

A rear-facing child restraint utilizes the friction between the seating surface and a child's back. The harness system holds the child in place, and keeps the child in position in an accident, and reduces the stress to the fragile neck and spinal cord.

All children under age one must always ride in a rear-facing child restraint. There are several types of rear-facing child restraints: infant-only seats can be used only for rear-facing. Convertible and 3-in-1 child restraints typically have higher height and weight limits for the rear-facing position, allowing you to keep your child rear-facing for a longer period of time.

Keep a child restrained in a rear-facing restraint as long as a child is under the height/weight limits of a child restraint. It is the best way to keep them safe. Once your child outgrows the rear-facing child restraint limit, your child is ready for a forward-facing child restraint with a harness.

Forward-Facing child restraints



A forward-facing child restraint utilizes the friction between a child's body and a harness. Keep a child harnessed in a forward-facing child restraint as long as the child is under the height/weight limit of a child restraint.

Once your child outgrows the forward-facing child restraint limit, your child is ready for a booster seat.

⚠ WARNING

- Child seat installation
- A child may be seriously injured or killed in a collision, when the child restraint is not properly anchored to the vehicle, or when the child is not properly secured in the child restraint. Before installing a child restraint, read the instructions supplied by the child restraint manufacturer.
- When a seat belt does not operate as described in this chapter, immediately have the belt system checked by your authorized EQUUS dealer.
- Failure to follow the instructions regarding child restraint, which are provided in this Owner's Manual and from a child restraint manufacturer, may increase the chance and severity of injury in an accident.
- If the vehicle head restraint prevents proper installation of a child seat (as described in the child seat system manual), the head restraint of the respective seating position shall be readjusted or entirely removed.

Setting the automatic locking mode of a passenger seat belt

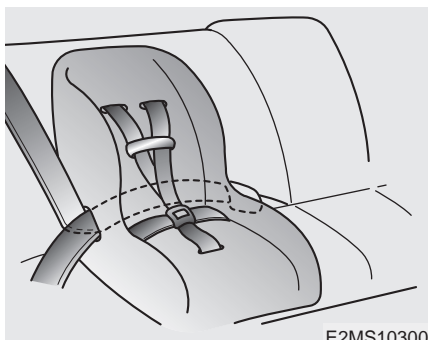

E2MS103005

The automatic locking mode restricts a child's movement, which compromises the effects of a seat belt and a child restraint. To secure a child restraint, follow the below procedures.

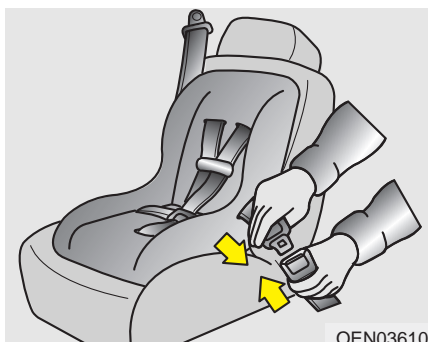

OEN036101

To install a child restraint system in rear seats, follow the below instructions:

1. Place the child restraint in a seat and route the lap/shoulder belt around or through the restraint, following the restraint manufacturer's instructions. Make sure the seat belt webbing is untwisted.

2. Fasten the lap/shoulder belt latch into the buckle, until you hear a "clicking" sound.

Make sure that the release button is easily accessible in case of an emergency.

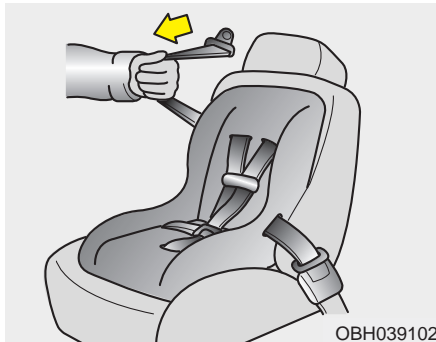

3. Pull the entire shoulder portion of the seat belt from the retractor. When the shoulder portion of the seat belt is fully extended, the belt system will shift into the "Automatic Locking" (child restraint) mode.



4. Slowly allow the shoulder portion of the seat belt to retract, until you hear a "clicking" or "ratcheting" sound. This indicates that the retractor is set in the "Automatic Locking" mode. When you do not hear any "clicking" sound, repeat the steps 3 and 4.

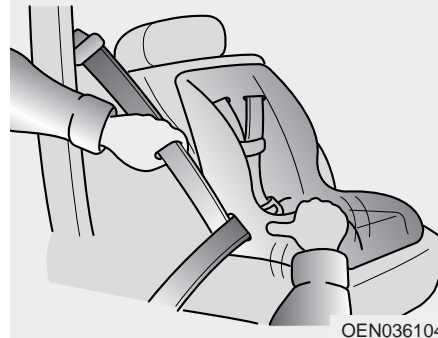

5. Tighten the belt as secure as possible by slightly tugging it on the child restraint, while retracting the shoulder portion of the belt back into the retractor.
6. Slightly push and pull the child restraint to confirm its firm installation. If not, release the seat belt, and repeat the steps 2 to 6.
7. Double check that the retractor is in the "Automatic Locking" mode by slightly pulling the seat belt out of the retractor. If unstretched, the seat belt is set in the "Automatic Locking" mode.

To remove the child restraint, press the release button on the buckle, pull off the lap/shoulder belt from the restraint, and then fully retract the belt.

⚠ WARNING

- Automatic locking mode

A lap/shoulder belt automatically resets to be in the "Emergency Locking" mode whenever the belt is fully retracted. Therefore, must follow the 7 steps on the previous page, when installing a child restraint.

When the retractor is not set in the "Automatic Locking" mode, the child restraint may move, when your vehicle sharply turns or stops. A child may be seriously injured or killed, when a child restraint is not properly anchored, such as failure to set the retractor in the "Automatic Locking" mode.

Once the seat belt is released after being fully retracted, the retractor will automatically switch from the "Automatic Locking" mode to the "Emergency Locking" mode for normal usage.

Securing a child restraint with "Tether Anchor" system

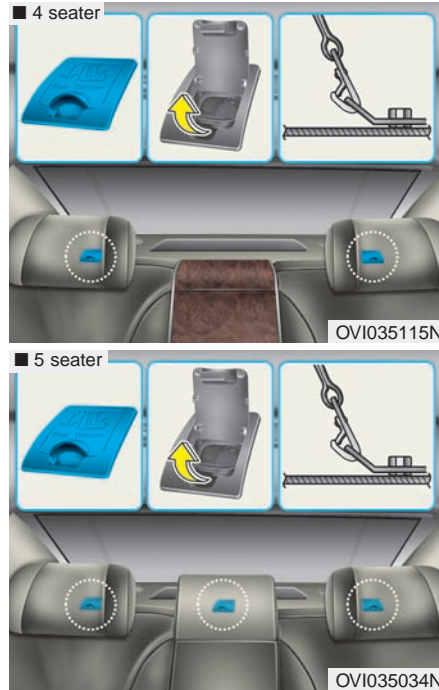

Hooks for a child restraint are located on the package tray.



1. Tie the child restraint seat tether strap over the seatback.
For a vehicle with an adjustable head restraint, tie the tether straps between the head restraint posts and under the head restraint. Otherwise, tie the tether strap over the top of a seatback.
2. Connect the appropriate child restraint hooks to the tether strap hooks, and securely tighten the child restraint seat.

⚠ WARNING

A child may be seriously injured or killed in a collision, when the child restraint is not properly anchored, and when the child is not properly restrained in the child restraint. Always follow the instruction of child seat manufacturer for installation and usage.

⚠ WARNING

- Tether strap

Never install more than one child restraint to a single tether anchor or to a single lower anchor. The increased load, caused by multiple child restraints, may break the tether or lower anchors, causing serious injury or death.

⚠ WARNING

- Child restraint check

Make sure that the child restraint is well secured by slightly pushing and pulling it in different directions. Improperly installed child restraints may slip, tip over, toss about, or break apart, causing death or serious injury.

⚠ WARNING

- Child restraint anchors

- Child restraint anchors are designed to withstand the load capacity, only when a child restraint is correctly installed. Under no circumstances, should child restraint anchors not be used for adult seat belts, and harnessing/storing other items and equipment.
- The tether strap may not properly work, when it is attached to the wrong tether anchor.

Securing a child restraint to the lower anchor



OVI035060N

Some manufacturers produce child restraints, which are labeled as LATCH or LATCH-compatible. LATCH stands for "Lower Anchors and Tethers for Children". These child restraints are equipped with two rigid or webbing-mounted attachments, which are to be connected to the two LATCH anchors in a specific seat of your vehicle. This type of child restraint does not use a seat belt to be attached in a rear seat.

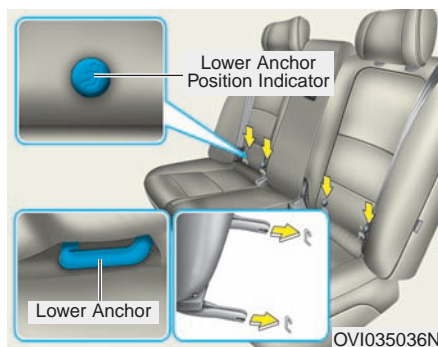

OVI035036N

A sign is marked on the left rear and right rear seatbacks to indicate the location of the lower anchors for child restraints.

⚠ WARNING

- When using the vehicle's "LATCH" system to install a child restraint in a rear seat, all seat belts taps of unoccupied seats should be securely buckled in metal latch plates, and the seat belt webbing must be fully retracted behind the child restraint to prevent the child from reaching or holding any un-retracted seat belts. Child's reaching to any un-buckled metal latch plates or tabs may result in strangulation, serious injury or death to the child.
- Do not place anything around the lower anchors. Also make sure that the seat belt is not caught inside the lower anchors.

LATCH anchors are equipped in your vehicle. The LATCH anchors are located in the left rear and right rear seats. Their locations are shown in the illustration. There is no LATCH anchor in the rear center seat.

The LATCH anchors are located between the seatback and the seat cushion. Follow instructions of the child restraint manufacturer to properly install a LATCH or LATCH-compatible child restraint.

Upon installing the LATCH child restraint, make sure that the seat is properly attached to the LATCH and tether anchors.

Also, test the child restraint before seating your child. Slightly shake the restraint from side to side. Also try to tug the restraint forward. Check whether the anchors securely hold the restraint in place.

NOTICE

Do not scratch or pinch a rear seat belt webbing with a child restraint latch or a LATCH anchor during the installation.

⚠ DANGER

When the child restraint is not properly anchored, the risk of a child's serious injury or death in a collision greatly increases.

⚠ WARNING

- LATCH lower anchors
LATCH lower anchors are to be used only in the left rear and right rear seats. Never attempt to install a child restraint in the rear center seat. You may damage the anchors, or the anchors may fail and break apart in a collision.

NOTICE

The recommended weight for the LATCH system is under 65 lbs (30 kg).

How to calculate the child restraint weight :

Child restraint weight =

65 lbs (30 kg) - Child weight

AIR BAG – ADVANCED SUPPLEMENTAL RESTRAINT SYSTEM

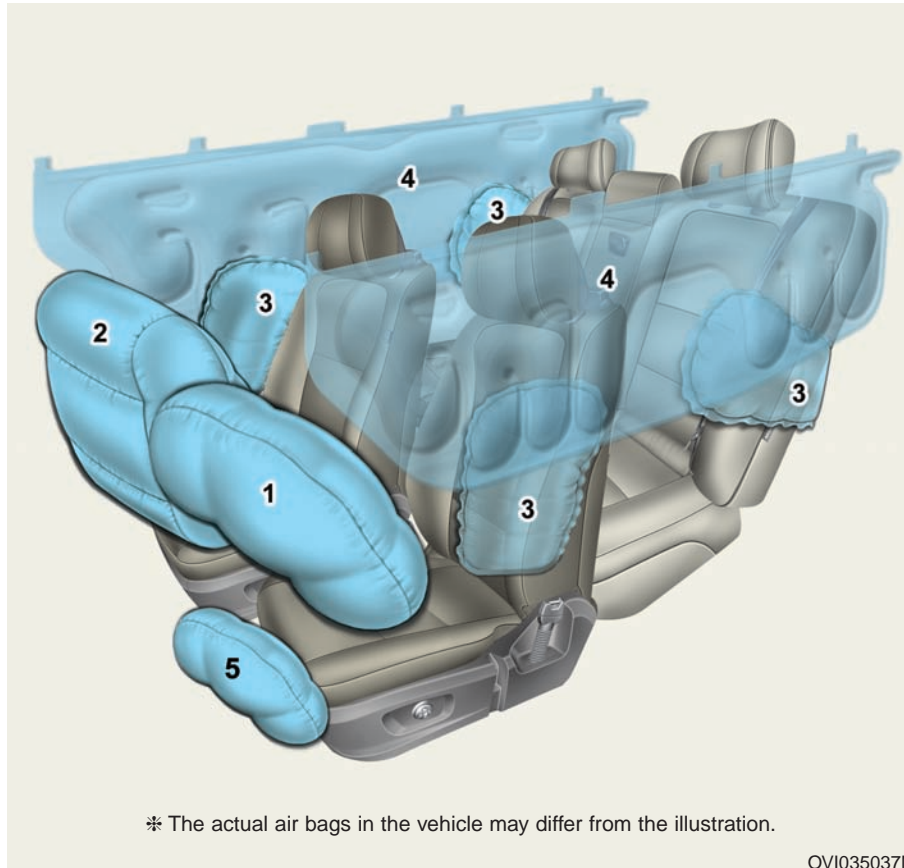

- | | |
|-------------------------------|---------------------------|
| (1) Driver's front air bag | (4) Curtain air bag |
| (2) Passenger's front air bag | (5) Driver's knee air bag |
| (3) Side air bag | |

⚠ WARNING

Even in vehicles with air bags, a driver and all passengers must always wear the seat belts provided in order to minimize the risk and severity of injury in the event of a collision or a rollover.

How the air bag system operates

- Air bags activate (able to inflate if necessary) only when the Engine Start/Stop Button is ON or in the START position.
- Air bags inflate in the event of a severe frontal or side collision in order to protect occupants from serious physical injury.
- There is no single speed, at which air bags inflate.

Generally, air bags are designed to inflate based upon a collision severity and collision direction. These two factors mainly determine whether the sensors produce an electronic deployment/inflation signal.

- Air bag deployment depends on a number of factors, including a driving speed, impact angles, vehicle density, vehicle stiffness or an object, which your vehicle collides with. Beyond those mentioned above, there are more determining factors.
- The front air bags completely inflates and then deflates in an instant. It is virtually impossible for you to see the air bags inflating during an accident.

It is much more likely that you simply see the deflated air bags hanging out of their storage compartments after the collision.

- To help provide protection in a severe collision, the air bags must inflate rapidly. The speed of air bag inflation is extremely fast, because a collision instantly requires to inflate the air bag between an occupant and the vehicle structures, before the occupant strikes with the vehicle interior.

This instant inflation reduces the risk of serious or life-threatening injury in a severe collision. So, this fast speed is a necessary part of air bag design.

However, air bag inflation may also cause injury, such as facial abrasions, bruises and broken bones, because the inflation speed also causes the air bags to expand with a great deal of force.

- **There are even some circumstances, under which the air bag may cause fatal injury, especially when an occupant is positioned excessively close to the air bag.**

WARNING

- **To avoid severe personal injury or death caused by deploying air bags in a collision, the driver should sit as far back from the steering wheel air bag as possible (at least 10 inches (250 mm) away). The front passenger should always sit in the rear-most position.**
- **Air bags instantly inflate in the event of a collision, and an occupant may be injured by the expanding force, when he or she sits in an inappropriate position.**
- **Air bag inflation may cause injury, normally including facial or bodily abrasions, injuries from broken glasses or burns by the air bag inflation gas.**

Noise and smoke

When the air bags inflate, they produce not only a loud noise, but also smoke and powder inside the vehicle. This is normal and is a result of the ignition of the air bag inflator. After the air bag inflates, you may feel substantial discomfort, while breathing due to the contact of your chest with both the seat belt and the air bag, as well as from inhaled smoke and powder. **Open your doors and windows as soon as possible after air bag deployment in order to reduce your discomfort and prevent prolonged exposure to the smoke and powder.**

Though the smoke and powder are non-toxic, they may cause skin irritation (i.e. eyes, nose and throat). In this case, immediately wash your skin with cold water and consult a doctor if the symptom persists.

⚠ WARNING

After the air bag inflation, air-bag related components, which are on the steering wheel, instrument panel, roof rails above doors and the front seat-backs, are very hot. To prevent injury, do not touch those components inside the air bag storage right after air bag inflation.

Do not install a child restraint in the front passenger's seat.



Never place a rear-facing child restraint in the front passenger's seat. When an air bag deploys, it would impact the rear-facing child restraint, causing serious or fatal injury. In addition, do not place front-facing child restraints in the front passenger's seat, either. When the front passenger air bag inflates, it may cause serious or fatal injury to the child.

⚠ WARNING

- **Extremely Hazard!** Do not place a rear-facing child restraint in a seat protected by an air bag!
- **Never install a child restraint in the front passenger's seat. When the front passenger air bag inflates, it may cause serious or fatal injury.**

(Continued)

(Continued)

- When a child is seated in rear seats (not in the rear center seat) equipped with side/curtain air bags, make sure to install the child restraint as far away from the door as possible, and securely lock the child restraint in position.

Inflation of side/curtain air bags may cause serious injury or death to an infant or child.

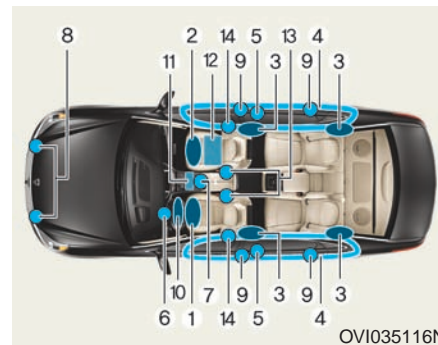
SRS components and functions

The SRS consists of the following components:

1. Driver's front air bag module
2. Passenger's front air bag module
3. Side air bag modules
4. Curtain air bag modules
5. Retractor pre-tensioner assemblies
6. Air bag warning light
7. SRS control module (SRSCM)
8. Front impact sensors
9. Side impact sensors
10. Driver's knee air bag module
11. "PASSENGER AIR BAG OFF" indicator (Front passenger's seat only)
12. Occupant classification system (Front passenger's seat only)
13. Driver's and front passenger's seat belt buckle sensors
14. Anchor pre-tensioner assembly

The SRSCM continually monitors all SRS components while the Engine Start/Stop Button is ON to determine if a crash impact is severe enough to require air bag deployment or pre-tensioner seat belt deployment.

Safety system of your vehicle



The SRS air bag warning light "⚠️" on the instrument panel will illuminate for approximately 6 seconds after the Engine Start/Stop Button is turned ON. Soon, the SRS air bag warning light "⚠️" turns OFF.

⚠️ WARNING

When any of the following conditions occurs, this indicates a SRS malfunction. Have an authorized EQUUS dealer inspect the air bag system as soon as possible.

- The light does not turn ON, right after turning ON the ignition.
- The light remains illuminated after approximately 6 seconds.
- The light remains illuminated, when the vehicle is in motion.
- The light flashes, when the ignition switch is ON.



The front air bag modules are located inside the center of the steering wheel, the front passenger's panel above the glove box, and the driver's side knee bolster. When the SRSCM detects sufficient impact from the front of a vehicle, it automatically deploys the front air bags.



During an air bag deployment, tear seams, which are directly molded under the pad cover, will break apart under pressure. Opening of the cover allows full inflation of air bags.

Driver's front air bag (3)



OVI035119N

Passenger's front air bag



OVI035120N

A fully inflated air bag, in combination with a properly fastened seat belt, slows the driver's or the passenger's forward motion, reducing the risk of head and chest injury.

After a complete inflation, an air bag immediately starts deflating, enabling the driver to maintain forward visibility and the ability to steer and operate other controls.

⚠ WARNING

- Do not install or place any accessories (drink holder, CD holder, sticker, etc.) on the front passenger's panel above the glove box, in which a passenger's air bag is equipped. Such objects may become dangerous projectiles and cause injury, when the passenger's air bag inflates.
- When installing a container of liquid air freshener inside the vehicle, do not locate it near the instrument cluster nor on the instrument panel. It may become a dangerous projectile and cause injury, when the passenger's air bag inflates.

⚠ CAUTION

- When an air bag deploys, there may be a loud noise with fine dust released inside the vehicle. These conditions are normal and not hazardous - the air bags are packed in fine powder. The dust released during air bag deployment may cause skin or eye irritation as well as aggravate asthma for some occupants. Thoroughly wash all exposed skin areas with warm water and mild soap after an accident in which the air bags deploy.
- The SRS operates, only when the ignition switch is ON. When the SRS air bag warning light "⚠" does not illuminate, and when it continuously remains ON for more than 6 seconds after turning ON the ignition switch or starting the engine, the SRS does not properly operate. In this case, have your vehicle immediately inspected by an authorized EQUUS dealer.
- Before you replace a fuse or disconnect a battery terminal, turn the Engine Start/Stop Button OFF. Never remove or replace the air bag related fuse(s) when the Engine Start/Stop Button is ON. Failure to follow this warning may cause the SRS air bag warning light "⚠" to illuminate.

Occupant classification system



Your vehicle is equipped with an occupant classification system in the front passenger's seat. The occupant classification system is designed to detect the presence of a properly-seated front passenger and determine whether to inflate the front passenger's air bag or not. The driver's front air bag is not affected or controlled by the occupant classification system.

Main components of occupant classification system

- A detection device located under the front passenger's seat cushion.
- Electronic system to determine whether to activate the front passenger's air bag (both front and side) or not.
- A warning light on the instrument panel, which displays the message of "PASSENGER AIR BAG OFF" to indicate that the front passenger's air bag system is deactivated.
- The air bag indicator on the instrument panel is interconnected with the occupant classification system.

The OCS is designed to detect the presence of a properly-seated front passenger and determine if the passenger's front air bag should be enabled (may inflate) or not.

The purpose is to help reduce the risk of injury or death from an inflating air bag to certain front passenger seat occupants, such as children, by requiring the air bag to be automatically turned OFF.

For example, if a child restraint of the type specified in the regulations is on the seat, the occupant classification sensor can detect it and cause the air bag to turn OFF.

Front passenger seat adult occupants who are properly seated and wearing the seat belt properly, should not cause the passenger air bag to be automatically turned OFF. For small adults it may be turned OFF, however, if the occupant does not sit in the seat properly (for example, by not sitting upright, by sitting on the edge of the seat, or by otherwise being out of position), this could cause the sensor to turn the air bag OFF.

Always make sure that you and all occupants are properly seated and fastened for the most effective protection from air bags and the seat belts.

- The OCS may not properly function, when an occupant takes an action, which may affect the classification system. These include:
 - (1) Failing to sit in an upright position.
 - (2) Leaning against the door or center console.
 - (3) Sitting towards the front or the sides.
 - (4) Putting their legs on the dashboard or other areas, reducing the occupant's weight on the front seat.
 - (5) Improperly fastening the seat belt.
 - (6) Reclining the seat back.

Conditions to operate the occupant classification system

Condition detected by the occupant classification system	Indicator/Warning light		Devices
	"PASSENGER AIR BAG OFF" indicator light	SRS warning light	Front passenger air bag
1. Adult *1	Off	Off	Activated
2. Child restraint system*2*3	On	Off	Deactivated
3. Unoccupied	On	Off	Deactivated
4. There is a malfunction in the system	Off	On	Activated

*1 : The system judges a person as an adult based on a body size. When a smaller adult sits in the front passenger seat, the system may recognize him/her as a child in accordance with a physique and posture.

*2 : Never install a child restraint in the front passenger's seat.

*3 : The PASSENGER AIR BAG "OFF" indicator may turn ON or OFF, when a child under age 13 (with or without child restraint) sits in the front passenger's seat. This is a normal condition.

⚠ WARNING

Riding in an improper position or slanting forward in the front passenger's seat adversely affects the occupant classification system (OCS).

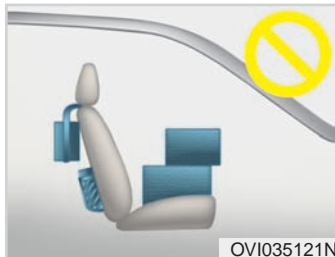

- Never pile a heavy load on the front passenger's seat or in the seatback pocket.



- Never place feet on the front passenger seatback.



- Never slant forward, sitting the hips on the edge of the seat.



- NEVER ride with the seatback reclined when the vehicle is moving.



- Never place feet or legs on the dashboard.



- NEVER lean on the door or center console or sit on one side of the front passenger seat.

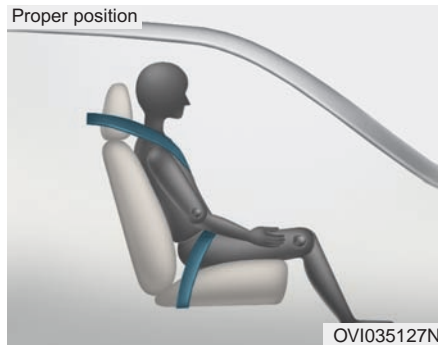

When the "PASSENGER AIR BAG OFF" indicator is turned ON with an adult's occupation in the front passenger's seat, press OFF the Engine Start/Stop Button and ask the occupant to sit properly (sitting in an upright position, and sitting on the center of the seat cushion with their seat belt fastened, legs comfortably extended and their feet on the floor).

Restart the engine and have the occupant maintain that position. This allows the system to detect a person and to enable the front passenger's air bag. In case that the "PASSENGER AIR BAG OFF" indicator remains illuminated, ask the occupant to move to a rear seat.

⚠ WARNING

Do not allow an adult passenger to ride in the front seat, when the "PASSENGER AIR BAG OFF" indicator remains illuminated. The air bag will not deploy in the event of a crash. In case that the "PASSENGER AIR BAG OFF" indicator remains illuminated, even after the adult occupant corrects his or her posture to properly sit and the vehicle is restarted, it is recommended that he or she move to a rear seat. The front passenger's air bag will not deploy.

The front passenger must stay properly seated to avoid serious injury from a deploying air bag.

i Information

The "PASSENGER AIR BAG OFF" indicator illuminates after turning ON the Engine Start/Stop button, or starting the engine. When the front passenger seat is occupied, the OCS classifies the front passenger in a few seconds.

⚠ WARNING

Do not put a heavy load on the front passenger's seat. Do not place any items under the front passenger's seat. Any of these may interfere with the sensor operation.

⚠ WARNING

- Even though your vehicle is equipped with the occupant classification system, never install a child restraint system in the front passenger's seat. A deploying air bag may forcefully strike a child, resulting in serious injury or death. Any child age 12 and under should ride in a rear seat. Children too big for a child restraint should use the available lap/shoulder belts. No matter what type of a crash occurs, children of all ages are safer, when restrained in a rear seat.
- When the "PASSENGER AIR BAG OFF" indicator illuminates with an adult's occupation in the front passenger's seat, he/she sits properly (sitting in an upright position, and sitting on the center of the seat cushion with their seat belt fastened, legs comfortably extended and their feet on the floor), have that person sit in a rear seat.
- Do not modify or replace the front passenger's seat. Do not place or attach any items, such as a blanket or seat heater, on the front passenger's seat. This may adversely affect the occupant classification system.
- When the weight load is changed in the front passenger's seat, the PASSENGER "AIR BAG OFF" indicator may flash ON and OFF for a few seconds, enabling and disabling the front passenger's air bag.

(Continued)

(Continued)

- Do not sit over a sharp object, such as a tool, in the front passenger's seat. This may adversely affect the occupant classification system.
- Do not use an accessory seat cover over the front passenger's seat.
- Accident statistics show that children are safer, when restrained in a rear than in the front. It is recommended that all child restraints be secured in a rear seat, including a rear-facing infant seat, a forward-facing child seat and a booster seat
- Air bags can be used only once – have an authorized EQUUS dealer replace the air bag immediately after a deployment.
- A tiny adult's incorrect seating (i.e. excessively reclining, leaning toward the door or the center console, or slanting forward) may cause a condition where the advanced front passenger's air bag system senses less weight than occupant's the actual weight (when properly sitting in an upright position, and sitting on the center of the seat cushion with their seat belt fastened, legs comfortably extended and their feet on the floor). This condition may result in misclassification of an occupant and illumination of the "PASSENGER AIR BAG OFF" indicator.

⚠ WARNING

When the occupant classification system does not properly operate, the SRS air bag warning light  will illuminate on the instrument panel. This is because the front passenger's air bag is connected with the occupant classification system. When there is a malfunction of the occupant classification system, the "PASSENGER AIR BAG OFF" indicator will not illuminate, and the passenger's front air bag may inflate in a frontal crash even without any occupant in the seat. When the SRS air bag warning light does not illuminate when turning ON the Engine Start/Stop button, when it remains illuminated approximately 6 seconds after the Engine Start/Stop button is turned ON, or when it remains illuminated while driving, have an authorized EQUUS dealer inspect the occupant classification system and the SRS air bag system as soon as possible.

Driver's and front passenger's air bag



Your vehicle is equipped with a Supplemental Restraint System (Air Bag) and the seat belts in both the driver's and front passenger's seats.

The presence of this system is indicated with the letters, "SRS AIR BAG," embossed on the air bag pad cover on the steering wheel, the knee bolster below the steering wheel column and the front panel above the glove box.

The SRS air bags are installed under the steering wheel, the knee bolster below the steering wheel column and the front panel above the glove box.

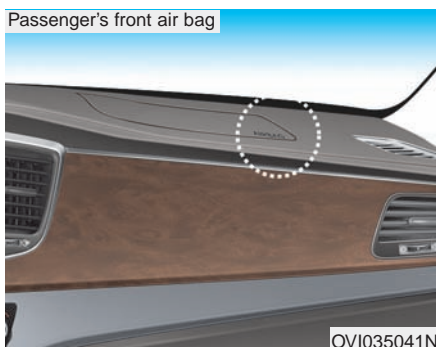

The purpose of the SRS is to provide greater protection to the driver and the front passenger than being protected only by the seat belt system in a frontal crash of a sufficient severity. The SRS uses sensors to gather information about occupants' seat position, seat belt fastening and impact severity.

⚠ WARNING

When the occupant classification system does not properly operate, the SRS air bag warning light  will illuminate on the instrument panel. This is because the SRS warning light is connected with the occupant classification system. When the SRS air bag warning light does not illuminate when turning ON the Engine Start/Stop button, when it remains illuminated approximately 6 seconds after the Engine Start/Stop Button is turned ON, or when it remains illuminated while driving, have an authorized EQUUS dealer inspect the advanced SRS air bag system as soon as possible.

The seat belt buckle sensors verify whether an occupant's seat belt is fastened or not. These sensors control the SRS deployment with the information, such as fastening of a seat belt and an impact severity.

The advanced SRS controls the air bag inflation in two levels. The first level is provided for a moderate impact. The second level is provided for a severe impact.

According to the impact severity and seat belt usage, the SRSCM (SRS Control Module) controls the air bag inflation. Failure to properly fasten a seat belt may increase the risk or severity of injury in an accident.

In addition, your vehicle is equipped with the occupant classification system in the front passenger's seat. The occupant classification system detects the front passenger's seat occupation and deactivates the front passenger's air bag under certain conditions. For further information, refer to "Occupant classification system" in this chapter.

⚠ WARNING

Do not place any objects under the front seats, as they may interfere with the occupant classification system.

⚠ WARNING

Before modifying your vehicle due to a disability, please contact the EQUUS Customer Connect Center at 1-877-378-8727.

i Information

- Must read the SRS information on the sun visor.
- The combination of the advanced air bags and pre-tensioner seat belts provides more enhanced protection in a frontal crash. Front air bags are not designed to inflate in a minor collision in which enough protection can be provided by the pre-tensioner seat belt.

⚠ WARNING

Always use seat belts and child restraints – every trip, every time, everyone! Air bags instantly inflate with considerable force. Seat belts help occupants keep the proper position for their maximum benefits of an air bag. Even with advanced air bags, improperly belted and unbelted occupants may be severely injured when an air bag inflates. Always follow the precautions about seat belts, air bags and occupants' safety in this manual.

(Continued)

(Continued)

To reduce the possibilities of serious or fatal injury and receive the maximum safety benefit from your restraint system:

- Never place a child in any child restraint or booster seat in the front seat.
- ABC – Always Buckle Children in a rear seat. It is the safest place for children of all ages.
- Front and side air bags may injure an occupant, who is improperly positioned in the front seats.
- Move your seat as far back as possible from the front air bags, while still maintaining control of the vehicle.
- You and occupants should never sit or lean unnecessarily close to the air bags. Improperly positioned driver and occupants may be severely injured by inflating air bags.
- Never lean against the door or the center console – always sit in an upright position.
- Do not allow an adult occupant to ride in the front seat, when the "PASSENGER AIR BAG OFF" indicator illuminates. An air bag will not deploy in the event of a moderate or severe frontal crash.

(Continued)

(Continued)

- No objects should be placed over or near the air bag modules on the steering wheel, instrument panel, and the front panel above the glove box, because such an object may cause harm in a crash severe enough to cause the air bags to deploy.
- Never place covers, blankets or seat warmers on the passenger's seat. These may interfere with the occupant classification system.
- Do not modify or disconnect the SRS wirings or other SRS components.
Doing so may result in injury, due to an accidental air bag deployment or the deactivated SRS.
- When the SRS air bag warning light remains illuminated while driving, have an authorized EQUUS dealer inspect the air bag system as soon as possible.
- Air bags can be used only once – have an authorized EQUUS dealer replace the air bag immediately after deployment.
- The SRS is designed to deploy front air bags only when an impact is sufficiently severe, and when the impact angle is smaller than 30° from the forward longitudinal axis. In addition, air bags will inflate only once. Seat belts must be fastened at all times.

(Continued)

(Continued)

- Front air bags are not designed to deploy in side/rear impacts or a rollover. In addition, front air bags will not deploy in a frontal crash, when an impact severity is below the deployment threshold.
- Even though your vehicle is equipped with the occupant classification system, do not install a child restraint system in the front passenger's seat. A child restraint system must never be installed in front. An infant or child may be severely injured or killed by an air bag deployment in case of an accident.
- Children age 12 and under must always be properly restrained in a rear seat. Never allow children to ride in the front passenger's seat. In case that a child over the age of 12 is seated in the front passenger's seat, the child must be properly fastened and the seat should be moved to the rearmost position.
- To maximize protection and to minimize the possibility of serious injury or death in all types of crashes, all occupants including the driver should always fasten a seat belt regardless of the air bag installment in their seats. Do not sit or lean unnecessarily close to an air bag while the vehicle is in motion.

(Continued)

(Continued)

- Improper sitting may result in serious or fatal injury in a crash. All occupants should put their seatback upright, sit on the center of the seat cushion with their seat belt fastened, legs comfortably extended and their feet on the floor, unless the vehicle is parked and the engine is turned OFF.
- The SRS air bag system instantly deploys to provide protection in a crash. When an occupant improperly sits without fastening a seat belt, the air bag may forcefully strike the occupant, causing serious or fatal injury.

Side air bag

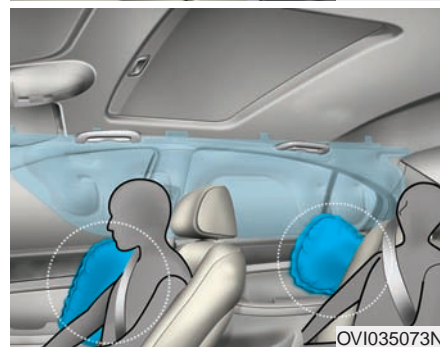
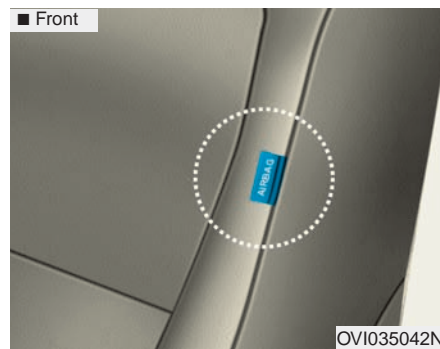

Your vehicle is equipped with the side air bags next to each seat. The purpose of these air bags is to provide additional protection to the driver and all occupants than being protected only by a seat belt.

The side air bags are designed to deploy only in a certain side-impact collision, depending on an impact severity, an angle, a speed and a direction. The side air bags are not designed to deploy in all side-impact crashes.

⚠ WARNING

Do not allow occupants to lean their heads or bodies toward doors, to put their arms on the doors, to stretch their arms out of the window, or to place objects between the doors and the occupant, when they occupy the seat equipped with side and/or curtain air bags.

⚠ WARNING

- The side air bag is supplemental to the seat belt system, not a substitute. Therefore, your seat belt must be fastened at all times while the vehicle is in motion. The air bags deploy only in a certain side impact, which is severe enough to cause significant injury.
- For the maximum protection from side air bags and to avoid injury by a deploying side air bag, all occupants should sit in an upright position with a seat belt properly fastened. The driver's hands should be placed on the steering wheel in the 9:00-o'clock and 3:00-o'clock position. The passenger' arms and hands should be placed on their laps.

(Continued)

(Continued)

- Do not use any accessory seat covers.
- Use of a seat cover may reduce the system effects or prevent the system operation.
- Do not install any accessories over or near the side air bags.
- Do not place any objects over the air bag or between the air bag and yourself.
- Do not place any objects (i.e. umbrella and bag) between a door and a seat. Such objects may become dangerous projectiles and may cause injury, when a side air bag inflates.
- To prevent inadvertent deployment of a side air bag, which may result in personal injury, avoid any impact on the air bag sensor, when the ignition switch is ON.
- When a seat or a seat cover is damaged, have the vehicle checked and repaired by an authorized EQUUS dealer because your vehicle is equipped with side air bags and an occupant classification system.

Curtain air bag

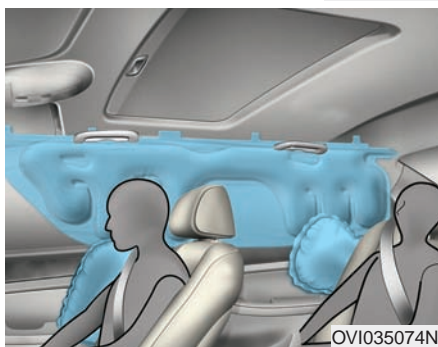

Curtain air bags are located along both sides of the roof rails above the front and rear doors.

They are designed to help protect the passengers' heads in the front and the rear seats (excluding the rear center seat) in a certain side impact collision.

The curtain air bags are designed to deploy only in a certain side-impact collision, depending on an impact severity, an angle, a speed and a direction. The curtain air bags are not designed to deploy in all side impact situations, a frontal/rear collision or most rollovers.

⚠ WARNING

- In order to get best protection from the side and curtain air bags, occupants of the front and rear seats (excluding the rear center seat) should sit in an upright position with the seat belts properly fastened. Importantly, children should sit in a proper child restraint in a rear seat.
 - When a child is seated in a rear seat, the child must be seated in a proper child restraint. Make sure to install a child restraint system as far away from a door as possible, and secure the child restraint system in a locked position.
 - Do not allow the occupants to lean their heads or bodies onto doors, to put their arms on the doors, to stretch their arms out of the window, or to place objects between the doors and passengers, when occupying in the seat equipped with side and/or curtain air bags.
 - Never attempt to modify or repair any components of the side curtain air bag system. This should be done only by an authorized EQUUS dealer.
- Failure to follow the above instructions may result in injury or death in an accident.**

Why is an air bag not inflated in a collision?

There are certain types of accidents in which the air bag would not provide additional protection.

These include a rear impact, second/third collisions after the inflation, as well as a low speed impact.

Air bag collision sensors

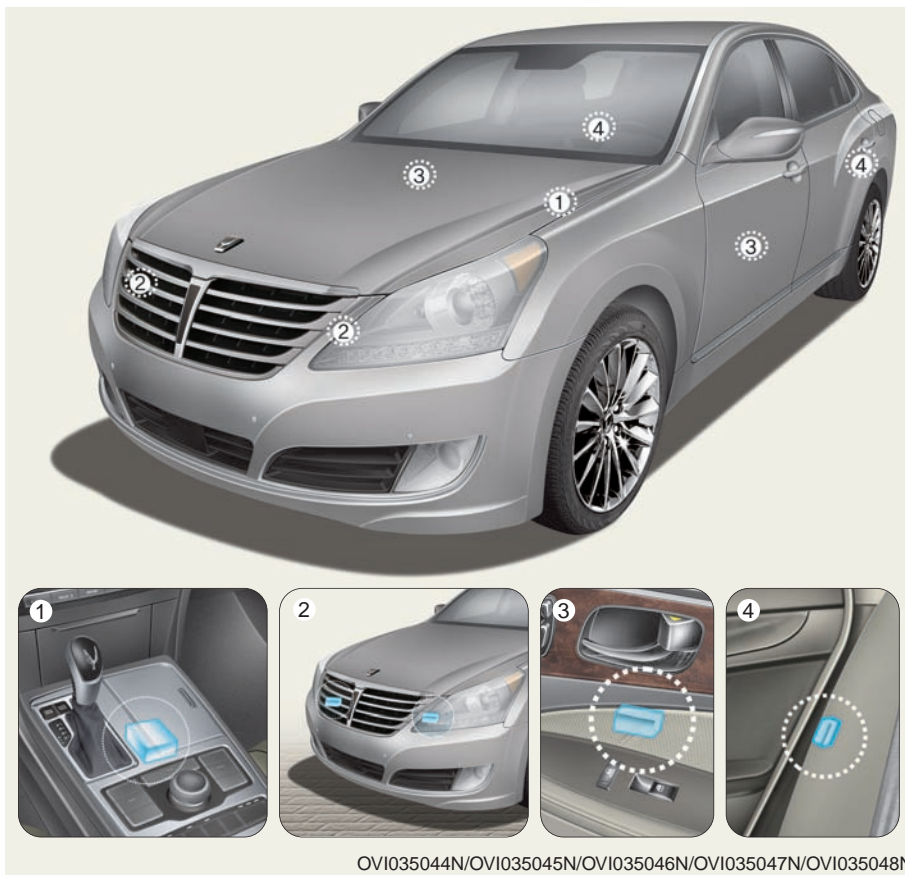

OVI035044N/OVI035045N/OVI035046N/OVI035047N/OVI035048N

- (1) SRS control module
- (2) Front impact sensor

- (3) Side impact sensor (front)
- (4) Side impact sensor (rear)

⚠ WARNING

- Do not hit or allow any objects to strike the areas where the air bags or the sensors are installed.

This may cause unexpected air bag deployment, resulting in serious personal injury or death.

- When the sensor position or angle moves out of its default position, the air bags may deploy, or they should not/may not deploy when they should, causing severe injury or death.

Therefore, do not attempt to modify or repair the air bag sensors. Have the vehicle checked and repaired by an authorized EQUUS dealer.

- Problems may arise, when the sensor moves out of its default position due to the deformation of the front bumper, the vehicle body and the B-and-C pillars, where side impact sensors are installed. Have the vehicle checked and repaired by an authorized EQUUS dealer.

- Your vehicle is designed to absorb impact and deploy the air bag(s) in a certain collision. Installing bumper guards or replacing a bumper with imitated or counterfeit parts may adversely affect your vehicle and the air bags.

Air bag inflation conditions



Front air bags

Front air bags are designed to inflate in a frontal collision depending on impact intensity, a speed or an impact angle.

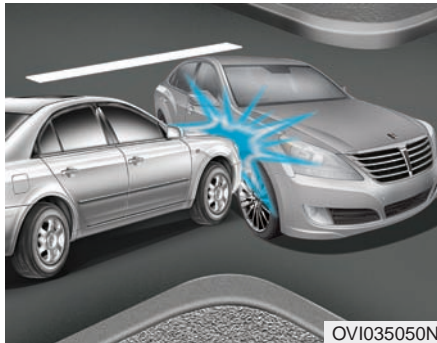

OVI035050N

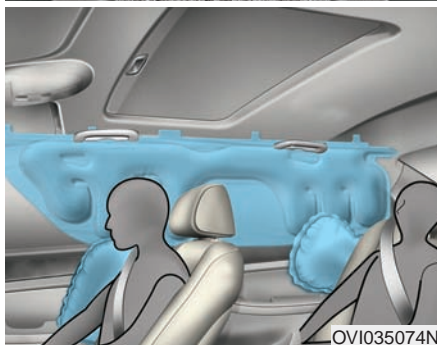

OVI035074N

Side and curtain air bags

Side and curtain air bags are designed to inflate, when a side impact is detected by the side impact sensors, depending on an impact intensity, a speed or angles.

Although the front air bags are designed to inflate only in a frontal collision, they also may inflate in other types of collisions, when the front impact sensors detect a sufficient impact. Side impact and curtain air bags are designed to inflate only in a side impact collision, but they may inflate in other collisions, when the side impact sensors detect a sufficient impact.

When the vehicle chassis is impacted by a bump or an object on a rough road, the air bags may deploy. Be careful to avoid inadvertent air bag deployment, while driving on a rough road or on a surface not designed for the vehicle traffic.

Air bag non-inflation conditions



OVI035051N

- In a collision at a low speed, air bags may not deploy. The air bags are designed not to deploy in such a case, as a seat belt can provide enough protection.



OVI035052N

- Front air bags are not designed to inflate in a rear collision, because occupants are forced to move backwards by the impact. In this case, inflated front air bags would not be able to provide any additional benefit.

Safety system of your vehicle



OVI035053N

- Front air bags may not inflate in a side impact collision, because occupants are forced to move towards an impact direction. In this case, inflated front air bags would not provide additional protection. However, side impact and curtain air bags may inflate depending on an impact intensity, a speed, angles and a direction.

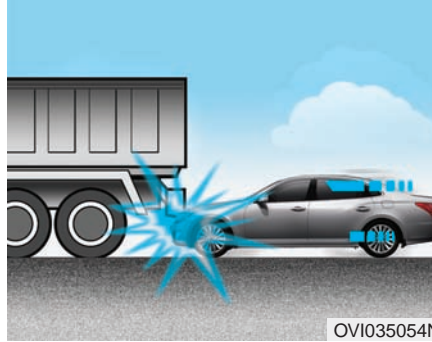

OVI035054N

- Just before an impact, drivers tend to heavily depress a brake pedal. Such heavy braking lowers the front portion of the vehicle, possibly causing it to “under-ride” below a vehicle with a higher ground clearance.

Air bags may not inflate in this "under-ride" situation, because the force, which is detected by sensors, may be significantly decelerated in such a “under-ride” collision.

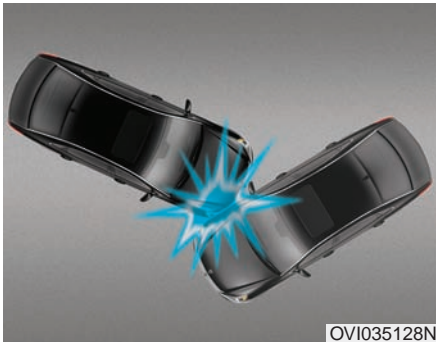

OVI035128N

- In an angled collision, occupants are forced to move toward an impact direction. In this case, the air bags would not be able to provide any additional benefit, and thus the sensors may not deploy any air bags.

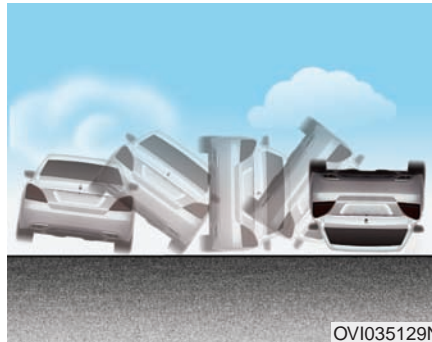

OVI035129N

- Front air bags may not inflate in a rollover, because air bag deployment would not provide protection to occupants.

However, side and curtain air bags may inflate, when the vehicle rolls over in a side-impact collision.

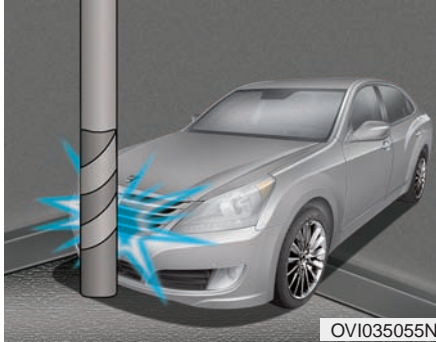

- Air bags may not inflate, when a vehicle collides with objects such as utility poles or trees, where the impact point is concentrated and the collision energy is absorbed by the vehicle.

SRS Care

The SRS is virtually maintenance free and there are no parts you can safely maintain by yourself. In case that the SRS air bag warning light "⚠" does not illuminate when turning ON the Engine Start/Stop button, or when continuously remains ON, have your vehicle immediately inspected by an authorized EQUUS dealer.

The SRS system, the steering wheel, the front panel, the front seats and the roof rails must be installed, repaired, maintained or removed only by an authorized EQUUS dealer. Improper SRS modification may result in serious personal injury.

⚠ WARNING

- **Modification to SRS components, such as a bandage addition to the pad covers, or other modifications to the body structure may adversely affect SRS performance and result in injury.**
- **Not only the modification of the area, where the SRS sensor are installed, but also the modification of other areas may affect the SRS performance and result in possible injury.**
- **When cleaning the air bag pad covers, use only a soft and dry cloth, or the one soaked with plain water. Solvents or cleaners may adversely affect the air bag covers and prevent its proper deployment.**

(Continued)

(Continued)

- **No objects should be placed over or near the air bag modules on the steering wheel, instrument panel, and the front panel above the glove box, because such an object may cause harm in a crash, which is severe enough to inflate the air bags.**
- **After the air bags inflate, those must be replaced by an authorized EQUUS dealer.**
- **Do not modify or disconnect SRS wiring and other components. Doing so may result in injury, due to inadvertent air bag inflation or the deactivated air bag system.**
- **When components of the air bag system are to be discarded, or when the vehicle must be scrapped, certain safety precautions must be observed. An authorized EQUUS dealer knows these precautions and can give you the necessary information. Failure to follow these precautions and procedures may increase the risk of personal injury.**
- **When your vehicle is flooded and the floor mats are soaked, you should not attempt to start the engine. Have the vehicle towed to an authorized EQUUS dealer.**

Additional safety precautions

- All occupants should sit in an upright position, fully back in their seats with their seat belts fastened and their feet rested on the floor.
- **Occupants should not take an inappropriate seating position, while the vehicle is moving.** An unfastened occupant may strike against the vehicle interior, against other occupants, or out of the vehicle, in a crash or emergency stop.
- **Each seat belt is designed to restrain only one occupant.** When more than one person fasten the same seat belt, they may be seriously injured or killed in a collision.
- **Do not put any accessories on seat belts.** Devices, which claims to improve occupants' comfort, may reduce the protection of a seat belt and increase the chance of serious injury in a crash.
- **Occupants should not place hard or sharp objects between themselves and the air bags.** Carrying hard or sharp objects on your laps or in your mouth may result in injuries, when an air bag inflates.
- **Keep occupants away from the air bags.** All occupants should sit upright, fully back in their seats with their seat belts fastened and their feet rested on the floor. When the occupants are too close to the air bag covers, they could be injured if the air bags inflate.
- **Do not attach or place objects on or near the air bag covers.** Any object attached to or placed on the front or side impact air bag covers could interfere with the proper operation of the air bags.

- **Do not modify the front seats.** Modification of the front seats could interfere with the operation of the SRS sensing components or side impact air bags.
- **Do not place items under the front seats.** Items under the front seats could interfere with the operation of the SRS sensing components or wiring harnesses.
- **Never hold an infant or child on your laps.** The infant or child may be seriously injured or killed in the event of a crash. All infants and children should be properly restrained in an appropriate child restraint or in a rear seat with a seat belt.

Adding equipment to or modifying your air bag-equipped vehicle

When you modify your vehicle frame, bumper system, front-end or side-sheet metal or ride height, this may adversely affect the operation of your vehicle's air bag system.

⚠ WARNING

- **Sitting improperly or out of position may cause occupants to slant too close towards a deploying air bag, strike the interior structure or be thrown from the vehicle, resulting in serious injury or death.**
- **Always put a seatback upright, and seat on the center of the seat cushion with your seat belt fastened, legs comfortably extended and your feet rested on the floor.**
- **Be careful not to impact doors, when the Engine Start/Stop Button is ON. The impact may cause the air bags to inflate.**

Safety system of your vehicle

Air bag warning label



Air bag warning labels, some required by the U.S. National Highway Traffic Safety Administration (NHTSA), are attached to alert the driver and passengers of potential risks of the air bag system.

Convenient features of your vehicle

Smart key	3-6
Locking.....	3-7
Unlocking.....	3-7
Trunk Unlocking.....	3-8
Panic Button	3-8
Start-Up.....	3-8
Mechanical Key.....	3-9
Loss of a Smart Key.....	3-10
Smart key precautions.....	3-10
Record your key number	3-10
Immobilizer system	3-10
Restrictions in Handling Keys	3-11
Battery Replacement.....	3-12
Theft-Alarm system	3-13
Door locks	3-14
Operating Door Locks From Outside the Vehicle ...	3-14
Power Door Latch.....	3-15
Operating Door Locks From Inside the Vehicle	3-15
Auto Door Lock/Unlock Features.....	3-17
Child-Protector Rear Door Locks.....	3-17
Trunk	3-18
Non-Powered Trunk.....	3-18
Power Trunk.....	3-19
To Reset the Power Trunk	3-22
Trunk Lid Control Button	3-22
Emergency Trunk Safety Release	3-23
Smart Trunk.....	3-24
Windows	3-28
Power Windows.....	3-29

Convenient features of your vehicle

Hood	3-33
Opening the Hood	3-33
Closing the Hood.....	3-33
Fuel filler lid	3-34
Opening the Fuel Filler Lid	3-34
Closing the Fuel Filler Lid	3-34
Sunroof	3-37
Sliding the Sunroof.....	3-37
Tilting the Sunroof	3-38
Resetting the Sunroof	3-39
Sunshade.....	3-39
Driver position memory system	3-40
Storing the Position Memory.....	3-40
Recalling the Position Memory	3-41
Easy Access Function	3-41
Steering wheel	3-42
Electronic Hydraulic Power Steering (EHPS).....	3-42
Tilt Steering/Telescope Steering.....	3-42
Heated Steering Wheel.....	3-43
Horn.....	3-43
Mirrors	3-44
Interior rearview mirrors.....	3-44
Electric chromic mirror (ECM) with HomeLink® system and compass.....	3-44, 3-51
Outside rearview mirror	3-58
Reverse Parking Aid Function.....	3-61

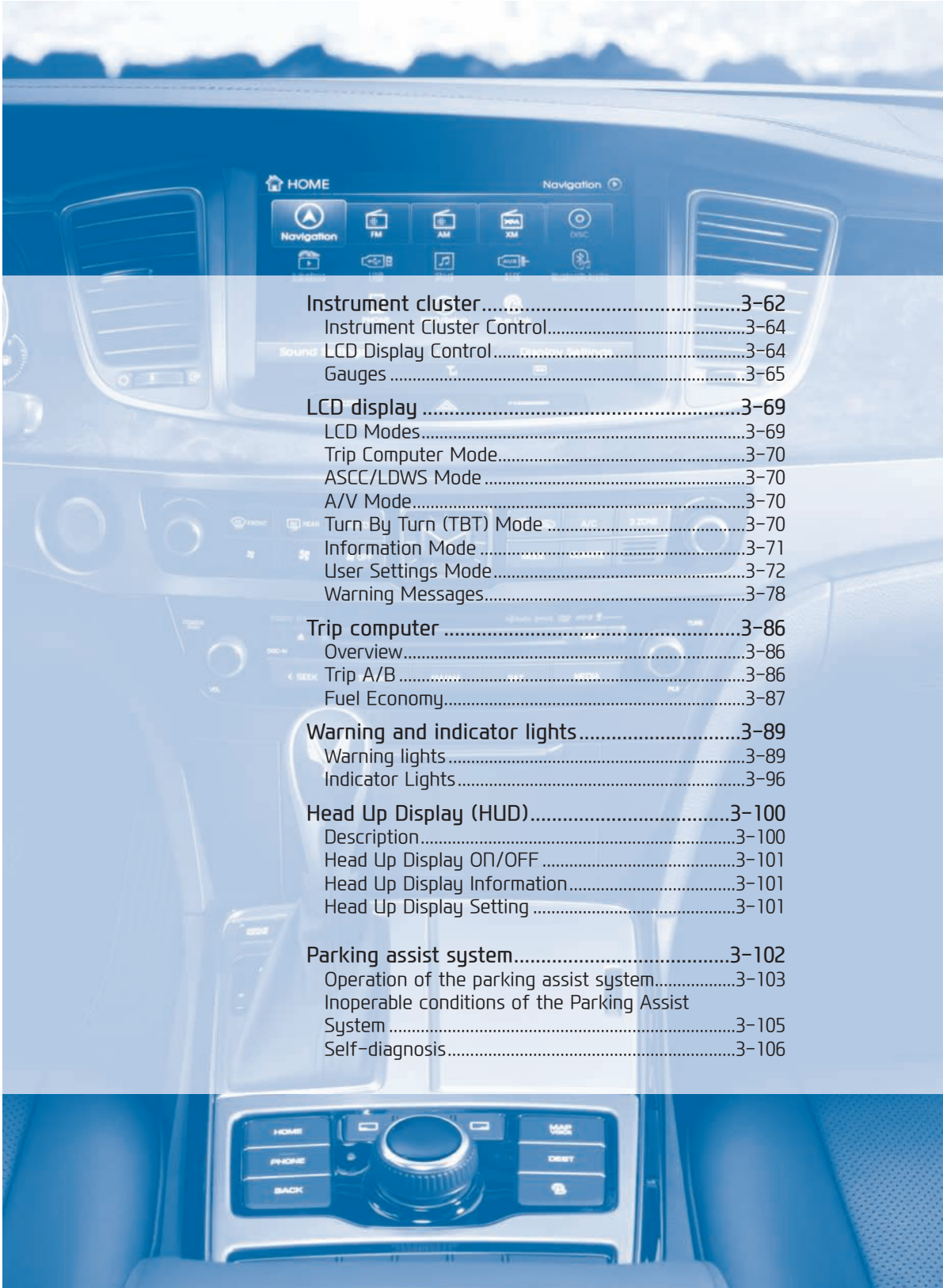

Instrument cluster	3-62
Instrument Cluster Control.....	3-64
LCD Display Control.....	3-64
Gauges	3-65
LCD display	3-69
LCD Modes.....	3-69
Trip Computer Mode.....	3-70
ASCC/LDWS Mode	3-70
A/V Mode.....	3-70
Turn By Turn (TBT) Mode	3-70
Information Mode	3-71
User Settings Mode.....	3-72
Warning Messages.....	3-78
Trip computer	3-86
Overview.....	3-86
Trip A/B	3-86
Fuel Economy.....	3-87
Warning and indicator lights	3-89
Warning lights.....	3-89
Indicator Lights.....	3-96
Head Up Display (HUD)	3-100
Description.....	3-100
Head Up Display ON/OFF	3-101
Head Up Display Information.....	3-101
Head Up Display Setting	3-101
Parking assist system	3-102
Operation of the parking assist system.....	3-103
Inoperable conditions of the Parking Assist System	3-105
Self-diagnosis.....	3-106

Convenient features of your vehicle

Rearview camera.....	3-107
Multi-view camera system.....	3-108
Lighting.....	3-109
Battery saver function.....	3-109
Headlamp escort function.....	3-109
Lighting control.....	3-110
High beam operation.....	3-111
Turn signals and lane change signals.....	3-112
Front fog light.....	3-113
Daytime running light.....	3-113
Headlight leveling device.....	3-113
AFLS (Adaptive Front Lighting System).....	3-114
Wipers and washer.....	3-115
Windshield wipers.....	3-115
Windshield washer.....	3-117
Interior light.....	3-118
Front.....	3-118
Rear.....	3-119
Trunk room lamp.....	3-119
Door courtesy lamp.....	3-119
Glove box lamp.....	3-120
Vanity mirror lamp.....	3-120
Welcome system.....	3-121
Puddle lamp.....	3-121
Headlamp.....	3-121
Interior light.....	3-121
Defroster.....	3-122
Rear window defroster.....	3-122
Front wiper deicer.....	3-122

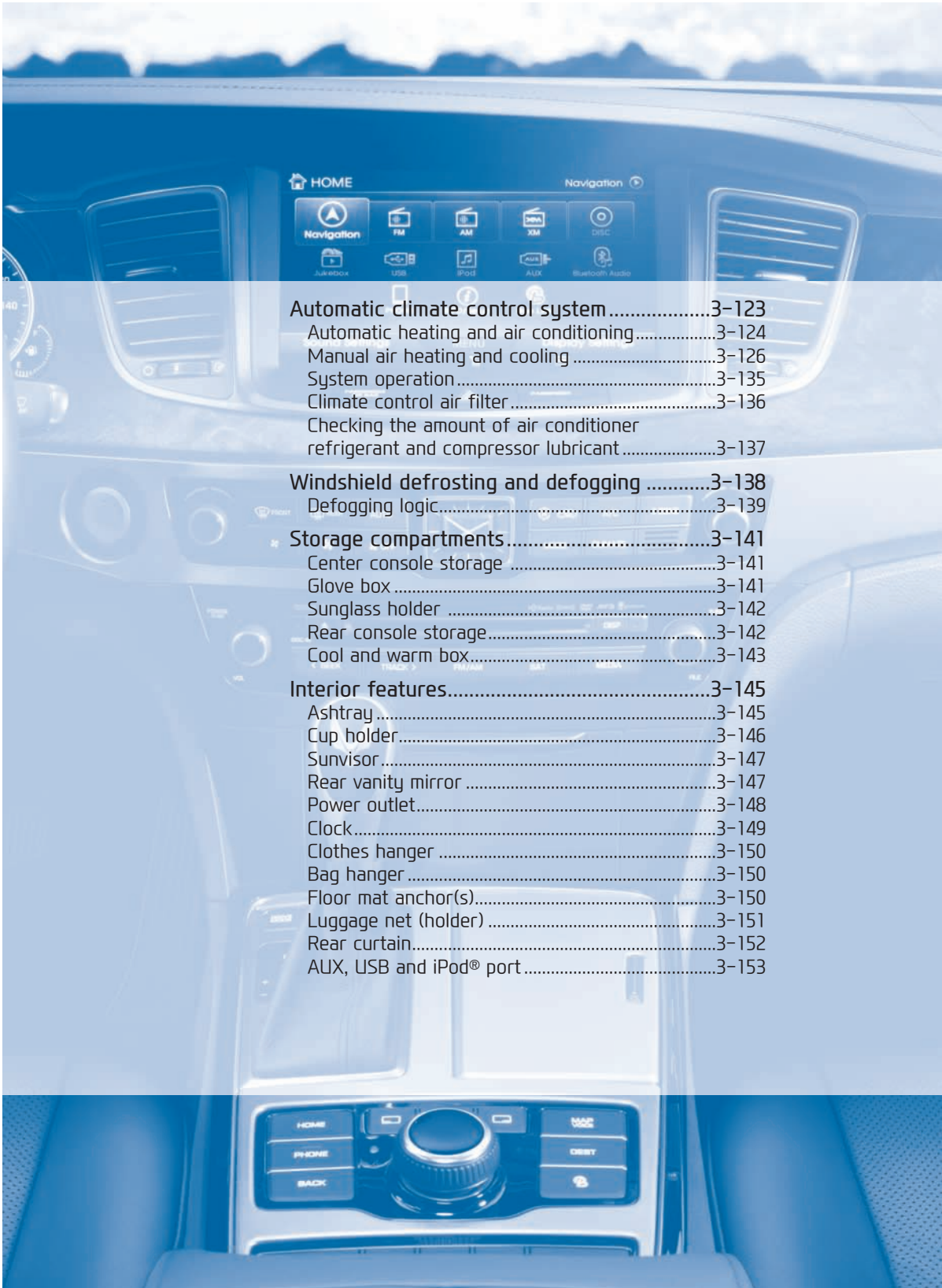

Automatic climate control system	3-123
Automatic heating and air conditioning.....	3-124
Manual air heating and cooling.....	3-126
System operation.....	3-135
Climate control air filter.....	3-136
Checking the amount of air conditioner refrigerant and compressor lubricant.....	3-137
Windshield defrosting and defogging	3-138
Defogging logic.....	3-139
Storage compartments	3-141
Center console storage.....	3-141
Glove box.....	3-141
Sunglass holder.....	3-142
Rear console storage.....	3-142
Cool and warm box.....	3-143
Interior features	3-145
Ashtray.....	3-145
Cup holder.....	3-146
Sunvisor.....	3-147
Rear vanity mirror.....	3-147
Power outlet.....	3-148
Clock.....	3-149
Clothes hanger.....	3-150
Bag hanger.....	3-150
Floor mat anchor(s).....	3-150
Luggage net (holder).....	3-151
Rear curtain.....	3-152
AUX, USB and iPod® port.....	3-153

SMART KEY

■ Conventional smart key



OVI045601N

■ Card type smart key



OVI045001N

Your EQUUS is equipped with a Smart Key to lock/unlock doors (and a trunk) and even start the engine.

1. Door Lock
2. Door Unlock
3. Trunk Unlock
4. Panic

WARNING

- Smart key

Leaving children unattended in a vehicle with the Smart Key is more dangerous, when the Engine Start/Stop button is in the ACC or ON position.

Children could imitate adults' behavior and press the Engine Start/Stop Button.

The Smart Key enables children to operate power windows or other controls, or even make the vehicle move, which may result in serious bodily injury or even death. Never leave the keys in your vehicle with unsupervised children, when the Engine is running.

Locking

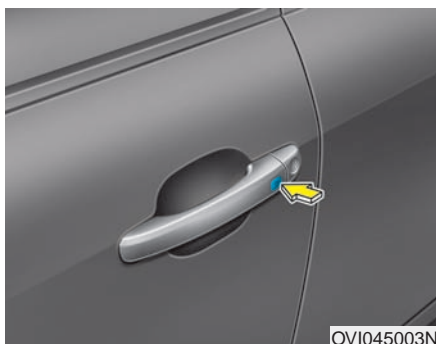

OVI045003N

To lock :

1. Close all doors, engine hood and trunk.
2. Either press the door handle button or press the Door Lock button on the Smart Key.
3. The hazard warning lights will flash with a chime sound. Also the outside rearview mirror will fold.
4. Make sure the doors are locked.

i Information

The door handle button will only operate when the Smart Key is within 28 in. (0.7 m) from the outside door handle.

Even though you press the outside door handle button, the doors will not lock and the chime will sound for three seconds, when any of the followings occurs:

- The Smart Key is in the vehicle.
- The Engine Start/Stop button is in the ACC position or ON.
- Any door except the trunk is open.

Unlocking



OVI045008N

To unlock:

1. Carry the Smart Key.
2. Either grab the driver's outside door handle or press the door unlock button on the Smart Key.
3. The driver's door will unlock. The hazard warning lights will flash two times. Also the outside rearview mirror will unfold.

i Information

- The door handle unlocking only operates when the Smart Key is within 28 in. (0.7 m) from the outside door handle. When it operates, other people can also open the doors.
- When you grab the front passenger's outside door handle, while carrying the Smart Key, all doors will unlock.
- When you press the door unlock button again within four seconds, all the doors will unlock.
- When a door is closed 30 seconds after unlocking, the doors will be automatically locked.

(Continued)

(Continued)

- You can control the door unlock mode in the User Settings menu on the LCD display, such as unlocking all the doors by pressing the unlock button one time.

Trunk Unlocking

To unlock:

1. Carry the Smart Key.
2. Press either the trunk handle button or the Trunk Unlock button on the Smart Key for one second or over.
3. The hazard warning lights will flash two times.

After opening and closing the trunk, the trunk will automatically lock.

Information

The power trunk (if equipped) can be operated even when the engine is not running. However, the power trunk consumes large amounts of vehicle electric power. To prevent the battery from being discharged, do not operate it consecutively (more than approximately 10 times).

Panic Button

Press the Panic button (4) for more than one second. The horn sounds and hazard warning lights flash for about 30 seconds.

To cancel the panic mode, press any button on the Smart Key.

Start-Up

You can start the engine without inserting the key. For detailed information, refer to the Engine Start/Stop Button in the chapter 5.

NOTICE

To prevent the Smart Key from being damaged:

- Keep the Smart Key away from water or any liquid and fire. If the inside of the Smart Key gets damp (due to drinks or moisture), or is heated, internal circuit may malfunction, excluding the vehicle from the warranty.
- Avoid dropping or throwing the Smart Key.
- Do not keep the Smart Key at an extreme temperature.

Mechanical Key

When the Smart Key does not normally operate, you can use the mechanical key to lock or unlock the doors.

Mechanical Key inside the Conventional-type Smart Key

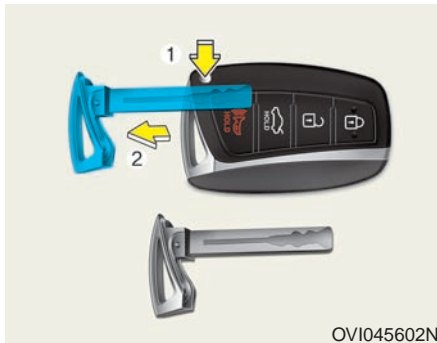

OVI045602N

Depress and hold the release button (1) and remove the mechanical key. (2) Insert the mechanical key into a key hole on a door.

To reinsert the mechanical key into the Smart Key case, put the key into the hole and push it until it clicks.

Mechanical Key inside the Card-type Smart Key

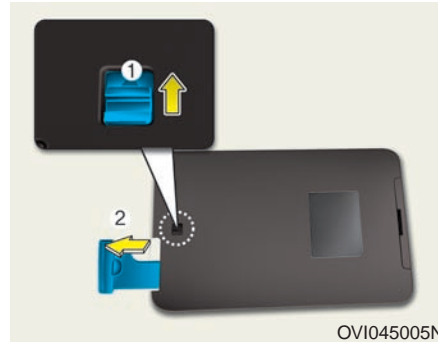

OVI045005N

Push and hold the release button (1) and remove the mechanical key. (2) Insert the mechanical key into a key hole on a door.

To reinsert the mechanical key into the Smart Key case, push and hold the release button (1) and put the key into the hole and push it until it clicks.

Convenient features of your vehicle

Loss of a Smart Key

Three Smart Keys can be registered at maximum to a single vehicle, including a Card-type Smart Key. When you happen to lose your Smart Key, you should immediately take the vehicle and the remaining keys to your authorized EQUUS dealer, or tow the vehicle, if necessary.

Smart key precautions

- The Smart Key will not operate, when any of the followings occurs:
 - The Smart Key is close to radio transmitters such as a radio station or an airport which may interfere with normal operation of the Smart Key.
 - The Smart Key is near to a mobile two-way radio system or a mobile phone.
 - Another vehicle's Smart Key is being operated close to your vehicle.
- When the Smart Key does not normally operate, use the mechanical key to lock/unlock a door and contact an authorized EQUUS dealer.
- When the Smart Key is in close proximity to a mobile phone, the signal may be blocked by the normal signals of your mobile phone. This is especially important when the phone is active, such as making/receiving calls, text messaging, or sending/receiving emails.

Avoid placing the Smart Key and your mobile phone in the same pants or the jacket pocket. Always try to maintain an adequate distance between the two devices.

Record your key number



The key code number is stamped or printed on the code tag attached to the key set. When you lose your keys, this number will enable an authorized EQUUS dealer to easily duplicate the keys. Remove the key code tag and store it in a safe place. Also, record the key code number and keep it in a safe and handy place, but not inside the vehicle.

Immobilizer system

The immobilizer system protects your vehicle from theft. When a key of the wrong code (or other devices) is used, the engine fuel system is disabled. After turning ON the Engine Start/Stop button, the Immobilizer System briefly operates, and then goes OFF. When the indicator flashes, the system does not recognize the Smart Key code.

Press the Engine Start/Stop button to turn OFF, and then re-press the Engine Start/Stop button to turn ON. The system may not recognize your Smart Key code, when another immobilizer key or other metal object (i.e. key chain) is near the Smart Key. The engine may not start, because the transponder signal is interrupted by a metal.

When the system does not repeatedly recognize the Smart Key code, contact your EQUUS dealer.

Do not attempt to modify this system or add other devices. Other electric problems may result, making your vehicle inoperable.

i Information

ALWAYS take the Smart Key with you, when leaving the vehicle.

This device complies with Part 15 of the FCC rules.

Operation is subject to the following two conditions:

1. This device may not cause harmful interference, and
2. This device must accept any interference received, including interference that may cause undesired operation.

i Information

Changes or modifications not expressly approved by the party responsible for compliance could void the user's authority to operate the device.

Restrictions in Handling Keys



When leaving keys with parking and valet-parking attendants, make sure that your trunk and glove box can be opened only with the mechanical key, by following the below procedures.

To lock:

1. Pull the mechanical key out of the Smart Key.
2. Unlock the glove box with the mechanical key, and then open it.
3. Set the Trunk Lid Control button to the OFF position (not pressed).
4. Close and lock the glove box with the mechanical key.
5. Leave the Smart Key with the attendant and keep the mechanical key with you.

The Smart Key can be used only for the engine starting and the door locking/unlocking.

i Information

Once the trunk lid control button sets OFF, the automatic opening function of Smart Trunk system (if equipped) will be also deactivated.

Convenient features of your vehicle

To release:

1. Open the glove box with the mechanical key.
2. Set the Trunk Lid Control button to the ON position (depressed).

In this position, the trunk lid will open with the Trunk Lid button of the Smart Key.

Battery Replacement

When the Smart Key does not properly operate, replace the battery with a new one.

Battery Replacement of the Conventional-type Smart Key



Battery Type: CR2032

To Replace the Battery:

1. Open the rear cover of the Smart Key.
2. Remove the old battery and insert a new one. Make sure the battery is in the correct position.
3. Close the rear cover of the Smart Key.

Battery Replacement of the Card-type Smart Key

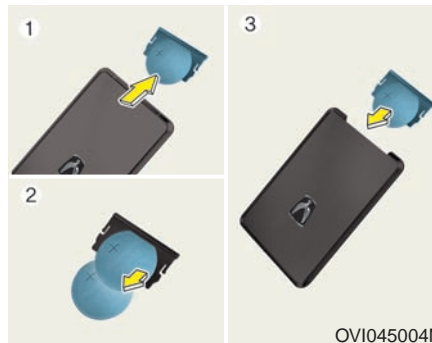

Battery Type: CR2412

To Replace the Battery:

1. Open the sliding battery cover.
2. Remove the old battery and insert a new one. Make sure the battery is in the correct position.
3. Close the sliding battery cover.

i Information

- When your Smart Key is suspected to be damaged, or when your Smart Key does not properly operate, contact an authorized EQUUS dealer.
-  An inappropriate disposal of the battery can be harmful to the environment and human health. Dispose of the battery in accordance with your local law(s) and regulation(s).

THEFT-ALARM SYSTEM

This system helps to protect your vehicle and valuables. The hazard warning lights will continuously flash with a warning alarm, when any of the followings occurs:

- A door is opened without using the Smart Key.
- The trunk is opened without using the Smart Key.
- The engine hood is opened.

The alarm continues for 30 seconds. This repeats once more, and then the system resets. To turn OFF the alarm, unlock the doors with the Smart Key.

The Theft Alarm System automatically sets ON 30 seconds, after locking the doors and the trunk. To activate the system, you must lock the doors and the trunk from outside with the Smart Key or by pressing the button on the door handles with the Smart Key. The hazard warning lights flash once with a chime sound to indicate onset of the system.

Once the Theft Alarm System sets ON, opening any door, the trunk, or the hood without using the Smart Key will activate the alarm. The Theft Alarm System will not set ON, when the hood, the trunk, or any door is not securely closed. When the system does not set ON, check the hood, the trunk, or the doors are securely closed.

Do not attempt to modify this system or add other devices to it.

i Information

- **Do not lock the doors until all passengers leave the vehicle. When any passenger remains in the vehicle, the alarm will activate.**
- **When you cannot cancel the Theft Alarm System with the Smart Key, open the doors by using the mechanical key and turn ON the Engine Start/Stop button.**

DOOR LOCKS

Operating Door Locks From Outside the Vehicle

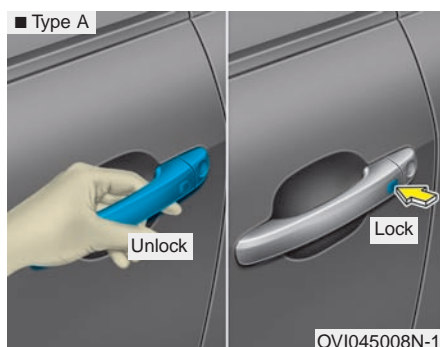

To lock the doors, press the button on the outside door handle while carrying the Smart Key with you or press the Door Lock button on the Smart Key.

Grab the driver's outside door handle while carrying the Smart Key or press the Door Unlock button on the Smart Key to open the driver's door. When you touch the door handle of the front outside doors, all doors will unlock. When you press the Door Unlock button on the Smart Key again within four seconds, then all the doors will unlock.

Once the doors are unlocked, they may be opened by pulling the door handle.

When closing the door, push the door with your hand. Make sure that doors are securely closed.

i Information

You can control the door unlock mode in the User Settings menu on the LCD display. You can unlock all doors by simply pressing the unlock button.

i Information

- In a cold and wet climate, door locks and door mechanisms may not properly operate due to freezing conditions.
- When the door is locked and unlocked multiple times in a rapid and consecutive manner with either the vehicle key or door lock switch, the system operation may temporarily stop in order to protect the circuit and prevent component damages.

⚠ WARNING

- If you don't close the door securely, the door may open again.
- Be careful that someone's body and hands are not trapped when closing the door.

Power Door Latch (if equipped)

OVI045007N

When a door is not completely closed, but is just slightly latched in the first detent position, the door will automatically close.

NOTICE

To reduce the risk of injury:

- Before closing a door, check there are no obstructions in the path of the door.
- Keep your fingers away from a door edge, otherwise they may become trapped inside when the power door latch operates.

Operating Door Locks From Inside the Vehicle

With the Door Lock Button :

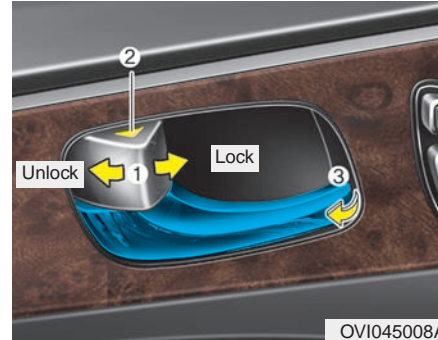

OVI045008A

- To unlock doors, push the door lock button (1) to the “Unlock” position. The red mark (2) on the door lock button will be visible.
- To lock doors, push the door lock button (1) to the “Lock” position. When the door is locked properly, the red mark (2) on the door lock button will be invisible.
- To open a door, pull the door handle (3) outwards.
- When the inner door handle of the driver’s (or front passenger’s) door is pulled when the door lock button is in the lock position, the button will be unlocked and doors open.
- Doors cannot be locked, when the Smart Key is in the vehicle, and when any door is open.

i Information

When a power door lock fails to operate while you are in the vehicle, try one or more of the following procedures to exit:

(Continued)

Convenient features of your vehicle

(Continued)

Repeatedly attempt to unlock a door (both electronic and manual) while simultaneously pulling out a door handle.

Operate the locks and handles of other front/rear doors.

Lower a front window and use the mechanical key from outside to unlock the door.

With the Central Door Lock Switch:



- When pressing the switch (1), all vehicle doors will lock.
- When pressing the switch (2), all vehicle doors will unlock.

- When the Smart Key is in the vehicle, or when any door is opened, the doors cannot be locked by pressing the lock button (1) of the central door lock switch.

⚠ WARNING

The doors should always be securely closed and locked while the vehicle is in motion. When the doors are unlocked, the doors are at increasing risk of opening up in a crash.

⚠ WARNING

Do not leave children or animals unattended in your vehicle. An enclosed vehicle may become extremely hot, causing death or serious injury to unattended children or animals who cannot escape the vehicle. Children may operate the vehicle, injuring themselves or encountering other harm from someone entering to the vehicle.

⚠ CAUTION

Opening a door when something is approaching may cause damage or injury. Carefully open the doors and watch for vehicles, motorcycles, bicycles or pedestrians approaching to the vehicle door.

⚠ WARNING

Always secure your vehicle.
Leaving your vehicle unlocked increases the potential risk to you or others from someone hiding in your vehicle.

To secure your vehicle, depress the brake pedal, move the shift lever to P (Park), set the parking brake, turn OFF the Engine Start/Stop button, close all windows, lock all doors, and take the Smart Key with you.

Auto Door Lock/Unlock Features

You can adjust the auto door lock/unlock modes in the User Setting. Refer to the User Setting Mode in the chapter 3.

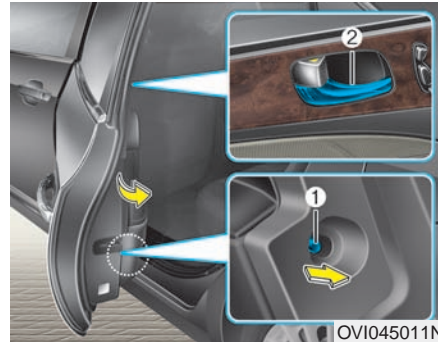
Child-Protector Rear Door Locks

The child safety lock is equipped to prevent a child seated in a rear from accidentally opening a rear door. The rear door safety lock should be used whenever a child seats in a vehicle.

The child safety lock (1) is located on the edge of each rear door. When the child safety lock is in the lock position (🔒), that rear door will not open by pulling the inner door handle (2).

To open a rear door from inside the vehicle, unlock (🔓) the child safety lock.

⚠ WARNING

When a child accidentally opens a rear door while driving, the child may fall out of the vehicle. The rear door safety locks should always be used whenever a child is in the vehicle.

TRUNK

Non-Powered Trunk



To open:

1. Locate the shift lever in P(Park).
2. Then do one of the followings:
 - Press the Smart Key Trunk Unlock button for one second or over.
 - Press the button on the trunk, while taking the Smart Key in your possession.
 - Use the mechanical key.
 - Use the trunk release button.
3. Lift up the trunk lid.

To close:

Close the trunk lid and press it down, until it latches.

⚠ WARNING

Always securely close the trunk lid while the vehicle is in motion. When it is still open or ajar, poisonous exhaust gases containing carbon monoxide (CO) may enter the vehicle, resulting serious illness or death.

⚠ WARNING

The trunk lid swings open upwards. Make sure there is no object or people near the trunk lid area, before opening it.

NOTICE

To prevent the trunk lift cylinders and other attached components from being damaged, always close the trunk before driving.

i Information

In a cold and wet temperature, the trunk lock and trunk mechanisms may not properly operate due to freezing conditions.

Power Trunk (if equipped)



(1) Power Trunk Main Control button



(2) Power Trunk Open button



(3) Power Trunk Close button



(4) Power Trunk Lock button

To open:

1. Locate the shift lever in P(Park).
2. Then do one of the following:
 - Press the Trunk Unlock button on the Smart Key for one second or over.
 - Press the Power Trunk Open button on the trunk, taking the Smart Key in your possession, with all doors locked.
 - Press the Power Trunk Main Control button.

To close:

Do one of the followings:

- Press the Power Trunk Main Control button until the Power Trunk is securely closed.
- Press the Power Trunk Close button on the trunk.
- Press the Lock button on the trunk, while carrying the Smart Key, with all doors closed. All doors will lock and the theft alarm system sets ON.

Pressing a button or switch, while opening or closing the trunk, may stop the operation. Press any button to re-operate the Power Trunk.

i Information

The Power Trunk Lock button will not operate in one of the following situations:

- Any door is open.
- The Engine Start/Stop Button is not OFF.
- The Smart Key is in the vehicle.

⚠ WARNING

Never leave children or animals unattended in your vehicle. Children or animals may operate the power trunk, injuring themselves, others, or vehicle damage.

⚠ WARNING

Always securely close the trunk lid while the vehicle is in motion. When it is still open or ajar, poisonous exhaust gases containing carbon monoxide (CO) may enter the vehicle, resulting serious illness or death.

⚠ WARNING

Make sure there are no people or objects around the trunk before opening or closing the Power Trunk. Wait until the trunk is fully open, before loading or unloading.

NOTICE

- Do not manually close or open the Power Trunk. This may damage the Power Trunk. If necessary, when the battery is drained or disconnected, do not apply excessive force.
- Do not leave the Power Trunk open for a long period of time. This may drain the battery.
- To prevent the trunk lift cylinders and other attached components from being damaged, always close the trunk before driving.

i Information

In a cold and wet temperature, trunk lock and trunk mechanisms may not properly operate due to freezing conditions.

Power Trunk Non-Opening or Closing Conditions:

- The Power Trunk will not operate, when driving faster than 1.8 mph (3 km/h).
- The Power Trunk is operable when the engine is not running. However, the Power Trunk operation consumes large amounts of vehicle electric power. To prevent the battery from being drained, do not operate it excessively (i.e. more than approximately 10 times in a consecutive manner.)
- Do not modify or repair any part of the Power Trunk by yourself. This must be done by an authorized EQUUS dealer.
- Before jacking up the vehicle to change a tire or repair the vehicle, open the Power Trunk. Do not operate the Power Trunk, when the vehicle is raised up. Otherwise, this may cause the Power Trunk to improperly operate.
- When there are substances, such as snow, on the Power Trunk, it may not automatically open. After removing the substances, try to open it again.

Automatic stop and Reverse

When the trunk lid is blocked by an object or someone's body, while opening or closing, the power trunk will detect the resistance, stop the operation, or swing open in a reverse direction to clear the object.

However, when the resistance is weak with a thin or soft object, or when the trunk is slightly latched, the Power Trunk may not detect the resistance, and not swing open to clear an object. In addition, when the Power Trunk is applied with strong force, the Power Trunk may stop its operation and swing open in the reverse direction.

When the Power Trunk stops its operation and swings open in a reverse direction more than twice in one opening or closing, the Power Trunk may stop at that position. When this occurs, manually close the trunk lid and re-operate the Power Trunk.

⚠ WARNING

To prevent serious injury and damage, take the following precautions when operating the power trunk:

- Keep all faces, hands, arms, body parts and other objects away in the path of the Power Trunk opening.
- Do not intentionally operate the automatic stop and reversal of the Power Trunk by placing any body parts or objects on it.
- Do not allow children to play with the Power Trunk.

To Reset the Power Trunk

When the battery is discharged or disconnected, or when the related fuse is replaced or disconnected, reset the Power Trunk as follows:

1. Set the shift lever in P(Park).
2. Manually close the trunk.

When the Power Trunk does not properly operate after following the above procedures, have the system checked by an authorized EQUUS dealer.

Trunk Lid Control Button

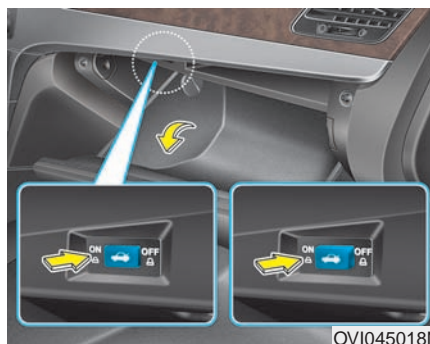

When the Trunk Lid Control button is ON (depressed), the power trunk can be controlled with the Power Trunk Main Control button, Power Trunk Open/Close buttons, and the Smart Key. When this trunk lid control button is OFF (not depressed), the Power Trunk operates with the mechanical key inside the Smart Key only.

***i* Information**

Once the trunk lid control button sets OFF, the automatic opening function of Smart Trunk system (if equipped) will be also deactivated.

Even though the trunk lid control button is OFF (not depressed), the trunk still swings open upwards after being manually open by more than 10 degrees from the fully closed position with mechanical force. In addition, when the trunk is manually closed to the secondary latch position, the trunk will be electrically closed to the fully latched position.

⚠ WARNING

- Always keep the Trunk Lid Control button OFF (not depressed), if not in use. A child's unintentional operation may result serious injury or death.
- Make sure heads, other body parts or other obstacles are safely out of the way before operating the Power Trunk.

NOTICE

Close the trunk, and keep the Trunk Lid Control button OFF (not depressed), before washing the vehicle in an automatic car wash.

Emergency Trunk Safety Release

Your vehicle is equipped with an Emergency Trunk Safety Release lever inside the trunk. When someone is inadvertently locked inside, he or she can open the trunk by pulling the lever in the arrow direction and pushing the trunk lid upwards.

⚠ WARNING

- You and your passengers must be aware of the location of the Emergency Trunk Safety Release lever in this vehicle and how to open the trunk in case you are accidentally locked inside.
- NEVER allow anyone to sit inside the trunk at any time. When the trunk is slightly or fully latched, and when the person is unable to get out, serious injury or death may occur due to lack of ventilation, exhaust fumes and rapid heat build-up, or exposure to a cold temperature. The trunk is also a highly dangerous location in the event of a crash, because it is not a protected space, but a vehicle's crush zone.
- Your vehicle should be kept locked and the Smart Key should be kept away from children. Parents should instruct children about the danger of playing in the trunk.
- Use the Emergency Trunk Safety Release lever for emergencies only.

Smart trunk (if equipped)

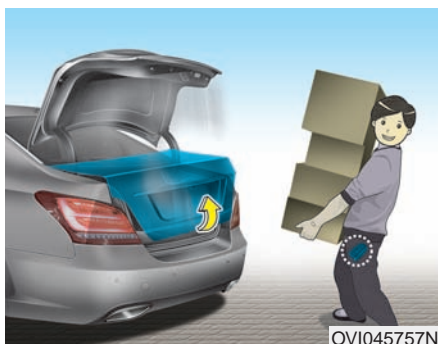

On a vehicle equipped with a smart key and power trunk, the trunk can be opened with no-touch activation using the Smart Trunk system.

How to use the Smart Trunk

The trunk can be opened with no-touch activation satisfying all the conditions below.

- After 15 seconds when all doors are closed and locked
- Positioned in the detecting area for more than 3 seconds.

i Information

- **The Smart Trunk does not operate when:**
 - The smart key is detected within 15 seconds after the doors are closed and locked, and is continuously detected.
 - The smart key is detected within 15 seconds after the doors are closed and locked, and within 60 inches (1.5 m) from the front door handles. (for vehicles equipped with Welcome Light)
 - A door is not locked or closed.
 - The smart key is in the vehicle.

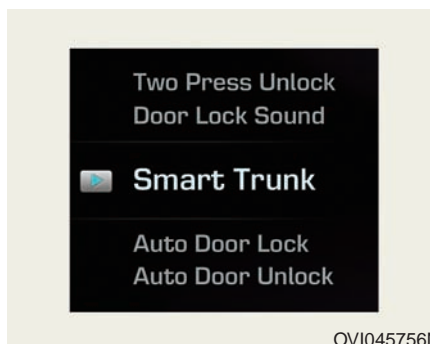

1. Setting

To activate the Smart Trunk, go to User Settings Mode and select Smart Trunk on the LCD display.

For more details, refer to "LCD Display" in this chapter.

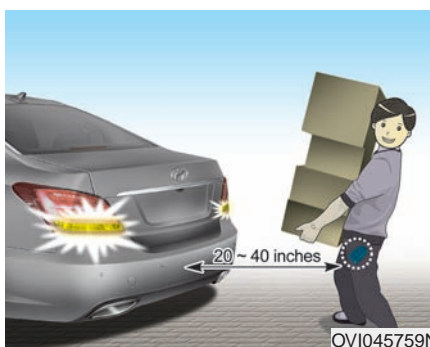

2. Detect and Alert

If you are positioned in the detecting area (20~40 inches (50 ~100 cm) behind the vehicle) carrying a smart key, the hazard warning lights will blink and chime will sound for about 3 seconds to alert you the smart key has been detected and the trunk will open.

i Information

Do not approach the detecting area if you do not want the trunk to open. If you have unintentionally entered the detecting area and the hazard warning lights and chime starts to operate, leave the detecting area with the smart key. The trunk will stay closed.

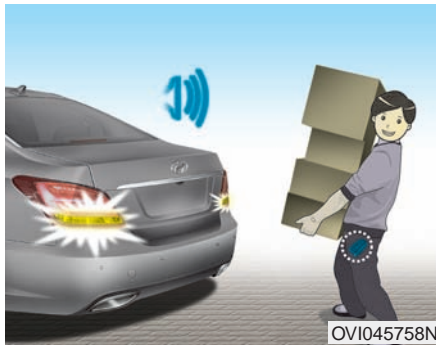

3. Automatic opening

The hazard warning lights will blink and chime will sound 2 times and then the trunk will slowly open.

i Information

Once the trunk lid control button sets OFF, the trunk will not open automatically but the welcome and detect alert will activate for about 3 seconds in detecting area.

⚠ WARNING

- Make sure you close the trunk before driving your vehicle.
- Make sure there are no people or objects around the trunk before opening or closing the trunk.
- Make sure objects in the trunk do not come out when opening the trunk on a slope. It may cause serious injury.
- Make sure to deactivate the Smart Trunk when washing your vehicle. Otherwise, the trunk may open inadvertently.
- The key should be kept out of reach of children. Children may inadvertently open the Smart Trunk while playing around the rear area of the vehicle.

How to deactivate the Smart Trunk function using the smart key



1. Door lock
2. Door unlock
3. Trunk open
4. Panic

If you press any button of the smart key during the Detect and Alert stage, the Smart Trunk function will be deactivated.

Make sure to be aware of how to deactivate the Smart Trunk function for emergency situations.

i Information

- If you press the door unlock button (2), the Smart Trunk function will be deactivated temporarily. But, if you do not open any door for 30 seconds, the smart trunk function will be activated again.
- If you press the trunk open button (3) for more than 1 second, the trunk opens.
- If you press the door lock button (1) or trunk open button (3) when the Smart Trunk function is not in the Detect and Alert stage, the smart trunk function will not be deactivated.
- In case you have deactivated the Smart Trunk function by pressing the smart key button and opened a door, the smart trunk function can be activated again by closing and locking all doors.

Detecting area

- The Smart Trunk operates with a welcome alert if the smart key is detected within 20~40 inches (50~100 cm) from the trunk.
- The alert stops at once if the smart key is positioned outside the detecting area during the Detect and Alert stage.

***i* Information**

- The Smart Trunk function will not work if any of the following occurs:
 - The smart key is close to a radio transmitter such as a radio station or an airport which can interfere with normal operation of the transmitter.
 - The smart key is near a mobile two way radio system or a cellular phone.
 - Another vehicle's smart key is being operated close to your vehicle.

(Continued)

(Continued)

- The detecting range may decrease or increase when :
 - One side of the tire is raised to replace a tire or to inspect the vehicle.
 - The vehicle is slantingly parked on a slope or unpaved road, etc.

WINDOWS

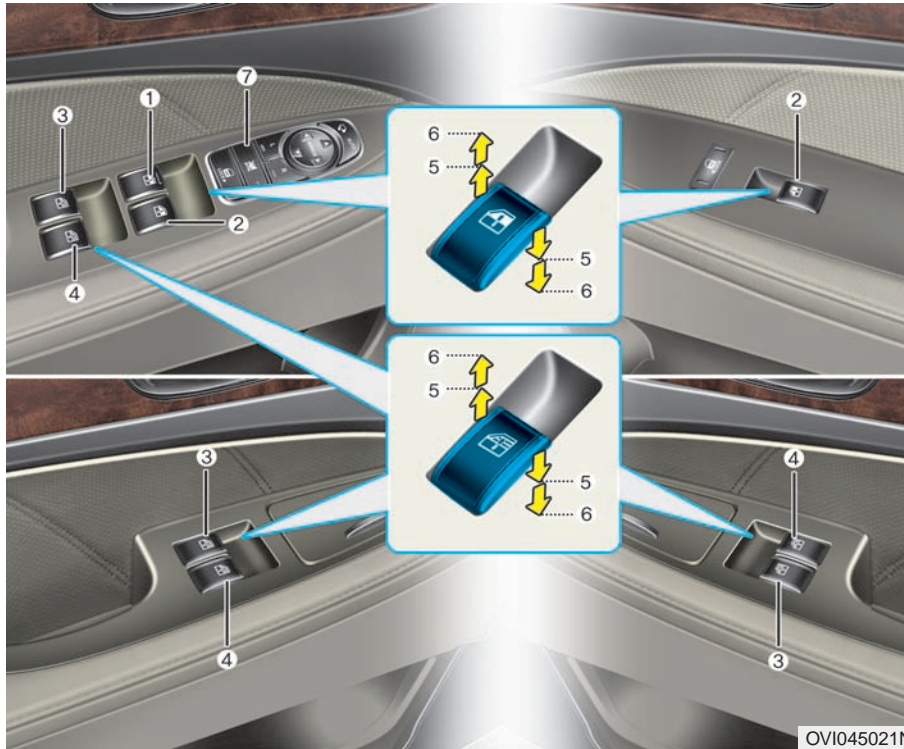

- (1) Driver's Door Power Window Switch
- (2) Front Passenger's Door Power Window Switch
- (3) Rear Door (left) Power Window Switch and Curtain Switch (if equipped)
- (4) Rear Door (right) Power Window Switch and Curtain Switch (if equipped)

- (5) Window Opening and Closing
- (6) Automatic Power Window Up/Down
- (7) Power Window Lock Switch

i Information

In a cold and wet temperature, power windows may not properly operate due to a possible ice formation.

Power Windows

The Engine Start/Stop Button must be ON, before raising or lowering the windows.

Each door has a Power Window switch to control that door's window. The driver has a Power Window Lock switch to block the operation of passenger windows. The power windows even operate for approximately 30 seconds after turning the Engine Start/Stop Button to the ACC or LOCK position. However, after opening a front door, the Power Windows do not operate.

⚠ WARNING

To avoid serious injury or death, do not extend your head, arms or body outside the windows while driving.

i Information

While driving with the rear windows down or with the sunroof (if equipped) open (or partially open), your vehicle may experience noise due to the wind resistance. This is normal, and the noise can be reduced or eliminated by taking the following actions. When the noise occurs with one or both of the rear windows down, lower both the front windows approximately by one inch. When you experience the noise with the sunroof open, slightly close the sunroof to reduce the opening size.

Window Opening and Closing

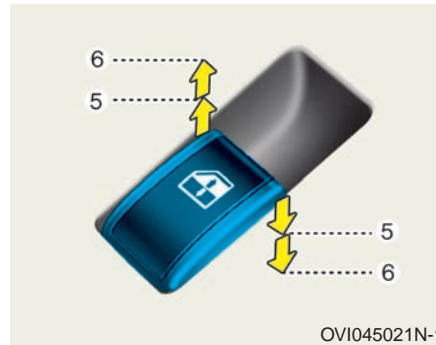

OVI045021N-1

To open:

Press the window switch to the first detent position (5). Release the switch to stop the operation, as desired.

To close:

Pull up the window switch to the first detent position (5). Release the switch to stop the operation, as desired.

Auto Up/Down Window

Momentary pressing or pulling up of the Power Window Switch to the second detent position (6) can completely raise or lower the window, even when the switch is released. To stop the window at the desired position while the window is in operation, slightly press or pull up the switch, and release.

To Reset the Power Windows

When the power windows do not normally operate, the automatic power window system must be reset as follows:

1. Press the Engine Start/Stop button twice to the ON position.
2. Continue pulling up the power window switch even after fully closing the windows for one second or more.

If the problem persists, have the system checked by an authorized EQUUS dealer.

Automatic Reverse

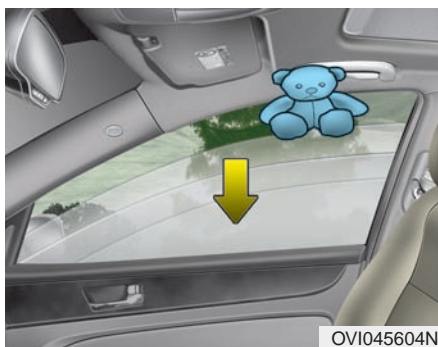

When a window sensor detects any obstacle while automatically closing the window, the window will stop the upward movement, and then be lowered by approximately 12 in (30 cm) to allow the object to be cleared.

When the window sensor detects the resistance while pulling up the power window switch, the window will stop the upward movement, and then be lowered by approximately 1 in (2.5 cm).

When the power window switch is pulled up again within five seconds after the window is lowered by the automatic reverse function, this function does not operate.

i Information

The automatic reverse function for the driver's window is only active when the "auto up" function is used by fully pulling up the switch. The automatic reverse function will not operate, when the window is half open by operating the Power Window switch.

⚠ WARNING

Make sure heads, other body parts or other objects are not extended from the windows, before closing, to avoid injury or vehicle damage.

Objects, which are less than 0.16 in. (4 mm) in diameter and caught between the window and the upper window frame, may not be detected by the automatic reverse sensor. Thus, the window operation will not automatically stop and be reversed.

Rear Door Window Curtains (if equipped)

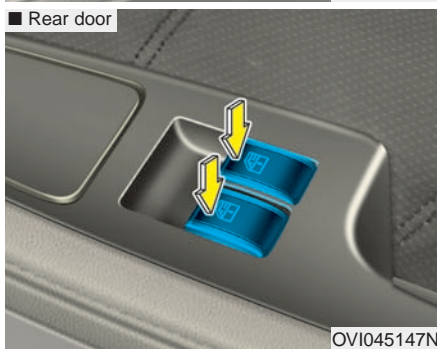

You can fold or unfold a rear door window curtain with Power Window switches on each rear door. The switch on the driver's door also operates the rear curtains.

To unfold:

1. Pull up the switch to close the window.
2. Pull up the switch again to unfold the window curtain.

To fold:

1. Press down the switch to fold the window curtain.
2. Press down the switch again to open the window.

i Information

When the upward or downward movement of a curtain is blocked by an object or part of the body, the curtain will detect the resistance, stop its movement, and move downwards or upwards.

NOTICE

Do not apply excessive force while operating a window curtain. This may damage a window curtain.

i Information

The rear door window curtain may not properly operate, when a temperature inside the vehicle is lower than 5°F (-15°C).

To Reset the Rear Door Window Curtains

When a window curtain does not properly operate, it must be reset as follows:

1. Press the Engine Start/Stop Button to the ON position.
2. Close the window curtain by pressing the power window switch to the first detent position and continuously pull it up for 10 seconds or over.

If the problem persists, have the system checked by an authorized EQUUS dealer.

Power Window Lock Button



The driver can disengage the Power Window switches of the rear doors by pressing the Power Window Lock Switch. The indicator will illuminate.

The Power Window Lock Switch indicator illuminates in one of the following situations:

- The driver's master control can operate all the power windows.
- The front passenger's control can operate the front passenger's Power Window
- The rear control cannot operate the Power Windows of rear doors.

WARNING

Do not allow children to play with the power windows. Keep the Power Window Lock Switch on the driver's door in the LOCK position (indicator illuminating).

Serious injury or death may result from a child's unintentional operation.

NOTICE

- To prevent possible damage to the Power Window system, do not simultaneously open or close two windows or more. This will lengthen the fuse durability.
- Never operate the main switch on the driver's door and a window switch of other doors in an opposing direction at the same time. In this case, the window will stop and cannot be opened or closed.

HOOD

Opening the Hood



OVI045020N

1. Pull up the vehicle and set the parking brake.
2. Pull the release lever under the lower left corner of the instrument cluster to open the hood. The hood will slightly pop up.

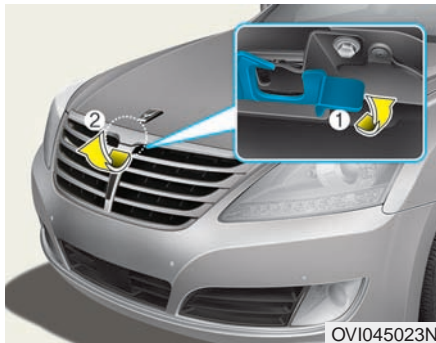

OVI045023N

3. Slightly raise the hood to the second detent position (1) under the hood center until it releases the hood and lifts the hood (2). After being raised halfway up, the hood will automatically swing open.

Closing the Hood

1. Before closing the hood, check the followings:
 - All filler caps in engine compartment must be securely closed.
 - Gloves, rags or any other combustible material must be removed from the engine compartment.
2. Lower the hood halfway and push down to securely lock in place. Then, double check that the hood is securely latched.

⚠ WARNING

- Before closing the hood, make sure that all obstacles are removed from the path of the hood opening.
- Always double check that the hood is firmly latched before driving. If not, the hood may swing open while driving, causing a total loss of visibility and an accident.
- Do not drive the vehicle, when the hood is slightly opened, as vision is obstructed, possibly resulting in an accident and damaging the hood.

FUEL FILLER LID

Opening the Fuel Filler Lid

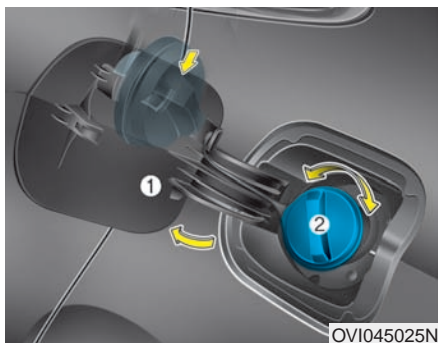
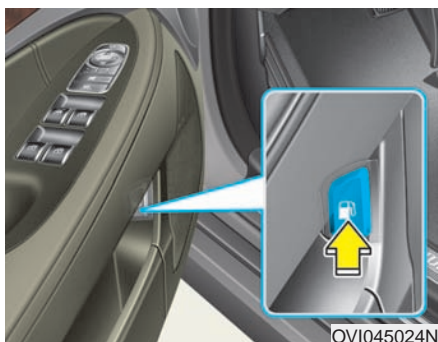

1. Turn OFF the engine.
2. Push the fuel filler lid open button on the driver's door. Then, the fuel filler lid will slowly swing open (1).
3. To open the fuel tank cap (2), turn it in a counterclockwise direction. You may hear a hissing noise, as the inside pressure equalizes.
4. Place the cap on the fuel filler door.

Closing the Fuel Filler Lid

1. To close the fuel tank cap, turn it in a clockwise direction, until it clicks.
2. Close the Fuel Filler Lid until it is securely latched.

When the Malfunction Indicator Light (MIL) illuminates, turn OFF the engine, check or retighten the fuel filler cap until it clicks. When the Malfunction Indicator Light (MIL) remains illuminated, have your vehicle checked by your EQUUS dealer.

⚠ WARNING

Gasoline is highly flammable and explosive. Failure to follow these guidelines may result in SERIOUS INJURY or DEATH:

- Read and follow all warnings posted at the gas station.
- Before refueling, check the location of the Emergency Gasoline Shut-Off, if available, at the gas station.
- Before touching the fuel nozzle, you should eliminate the static electricity potentially built up on your body by touching a metal part of the vehicle with your bare hand, keeping a safe distance away from the fuel filler neck, nozzle, or other gas source.
- Do not use cellular phones while refueling. Electric current and/or electronic interference from cellular phones may potentially ignite fuel vapors and cause a fire.

(Continued)

(Continued)

- Do not get back into a vehicle while refueling. You may build up static electricity by touching, rubbing or sliding against any item or fabric capable of producing static electricity. Static electricity discharge may ignite fuel vapors, causing a fire. When you must re-enter the vehicle, you should eliminate potentially dangerous static electricity once again by touching a metal part of the vehicle with your bare hand, keeping a safe distance away from the fuel filler neck, nozzle, or other gas source.
- When using an approved portable fuel container, make sure to place the container on the ground, before refueling. Static electricity discharged from the container may ignite fuel vapors, causing a fire. Once refueling has begun, contact between your bare hand and the vehicle should be maintained until the filling is complete.
- Use only approved portable plastic fuel containers designed to carry and store gasoline.
- When refueling, always set the shift lever in P (Park), set the parking brake, and turn OFF the Engine Start/Stop button. Sparks produced by electrical components related to the engine may ignite fuel vapors, causing a fire.

(Continued)**(Continued)**

- Do not use matches or a lighter and do not smoke or leave a lit cigarette in your vehicle while at a gas station, especially during refueling.
- Do not overfill or "top-off" your vehicle tank, which may cause gasoline spillage.
- When a fire breaks out during refueling, stay away from the vehicle, and immediately notify it to the gas station manager, and call the local fire department. Follow any safety instructions they provide.
- When pressurized fuel sprays out, it may cover your clothes or skin. This puts you at risk of fire and burns. Always carefully and slowly open the fuel cap. When the fuel vents out from the tank, or when you hear a hissing sound, wait until those stop before completely opening the cap.
- Always check that the fuel cap is securely closed to prevent fuel spillage in the event of an accident.

i Information

- Make sure to refuel your vehicle in accordance with the "Fuel requirements" in the "Foreword" chapter.
- Do not spill fuel on the exterior surface of the vehicle. Any type of fuel spillage on a painted surface may damage the paint.

NOTICE

When the fuel filler cap requires to be replaced, use only a genuine EQUUS cap or the equivalent specified for your vehicle. An unauthorized fuel filler cap may result in a serious malfunction of the fuel system or emission control system.

SUNROOF

Sliding the Sunroof

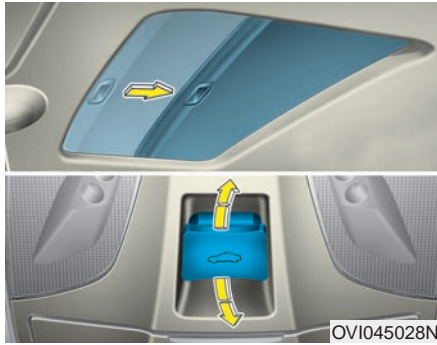

The Engine Start/Stop Button must be ON, before opening or closing the sunroof.

Momentary pressing of the sunroof control switch to the second detent position either forwards or backwards completely opens or closes the sunroof, even when the switch is released. To stop the sunroof at the desired position, while the sunroof is in motion, re-press the sunroof control lever either forwards or backwards. Then, release the switch.

The sunroof can open or close by pressing the sunroof control switch forwards and backwards to the first detent position. However, the sunroof opens or closes only by pressing the sunroof control switch.

Automatic Reverse

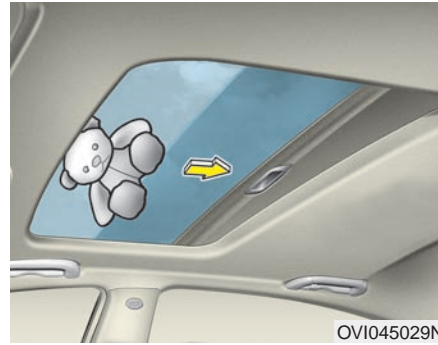

When the sunroof detects any obstacle while automatically closing, it will move in a reverse direction to allow the object to be cleared.

⚠ WARNING

Objects less than 0.16 in. (4 mm) in diameter caught between the sunroof glass and the sunroof sunshade may not be detected by the sensor, and the sunroof will not move in a reverse direction.

Tilting the Sunroof

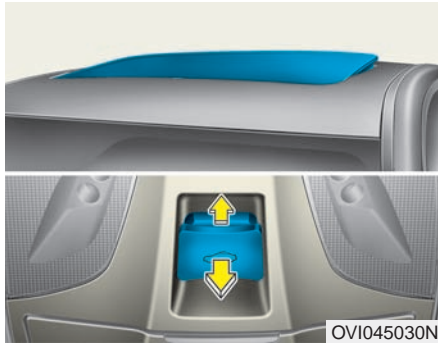

To tilt the sunroof open:

Push the sunroof control lever upwards to the second detent position. To stop the sunroof tilting at the desired point, adjust the control lever.

To close the sunroof:

Pull the sunroof lever downwards until the sunroof moves to the desired position.

⚠ WARNING

- Make sure heads, other body parts or other objects are not extended out of the sunroof to avoid injury or vehicle damage.
- Never operate the sunroof or sunshade while driving. This may cause loss of vehicle control, resulting in an accident.
- To avoid serious injury or death, do not extend your head, arms or body out of the sunroof while driving.

i Information

The sunroof cannot slide in the tilt position nor can it be tilted while in an open/slided position.

After washing the vehicle or after a rain, make sure to wipe off the water on the sunroof before operating it.

NOTICE

- Periodically remove dirt accumulation over the sunroof guide rails or between the sunroof and roof panel, which may cause a noise.
- Do not attempt to open the sunroof, when a temperature is below the freezing point, or when the sunroof is covered with snow or ice. Otherwise, the motor may be damaged. In a cold and wet temperature, the sunroof may not properly operate.
- To prevent damage to the sunroof and the motor, do not continuously press the sunroof control lever, after it is fully opened, closed or tilted.

Resetting the Sunroof

Sunroof needs to be reset if (in the followings)

- Battery is discharged or disconnected or the related fuse has been replaced or disconnected.
 - The one-touch sliding function of the sunroof does not normally operate.
1. The Engine Start/Stop Button must be ON.
 2. Completely close the sunroof. Then, release the control lever.
 3. Pull down the control lever and hold it, until the sunroof slightly moves up and down. Then, release the control lever.
 4. Pull down the control lever and hold it, until the sunroof operates as follows:
TILT DOWN → SLIDE OPEN → SLIDE CLOSE
Then, release the control lever.

If the problem persists, have the system checked by an EQUUS dealer.

Sunshade

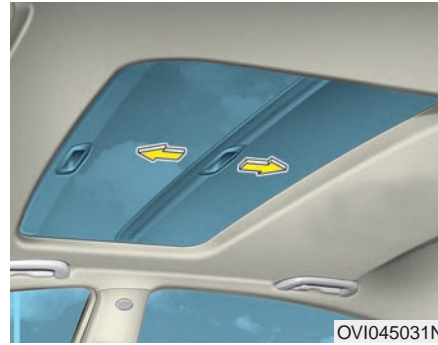

The sunshade will open automatically along with the sunroof when the glass panel moves. You can manually close the sunshade. Do not leave the sunshade closed while the sunroof is open.

DRIVER POSITION MEMORY SYSTEM

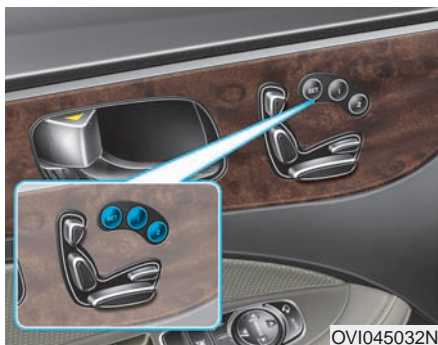

This system is to set and recall the position memory about the driver's seat, the outside rearview mirrors, the steering wheel and the HUD (Head-Up Display) height. When the battery is disconnected, the position memory will be erased and the driving position memory must be re-set in the system. When this system does not normally operate, have the driver position memory system checked by an authorized EQUUS dealer.

Storing the Position Memory

1. Make sure that the shift lever is in P (Park), and the Engine Start/Stop Button is ON.
2. Adjust the driver's seat, the outside rearview mirrors, the steering wheel and the HUD (Head-Up Display) height as desired.
3. Press the SET button on the control panel. There will be a beeping sound.
4. Press one of the memory buttons (1 or 2) for 5 seconds after pressing the SET button. There will be beeping sounds twice, when the position memory is successfully saved.

⚠ WARNING

Never attempt to operate the driver position memory system while driving. This may cause loss of vehicle control resulting in an accident.

Recalling the Position Memory

1. Check that the shift lever is in P (Park) and the Engine Start/Stop button is ON.
2. Press the memory button (1 or 2) to recall the desired position. There will be a beeping sound. Then, the driver's seat, outside rearview mirrors, steering wheel and HUD (Head-Up Display) height will be automatically adjusted, as set in the memory.

While the pre-set position is being recalled, pressing one of the control buttons for the driver's seat, the outside rearview mirror, or the steering wheel will stop the movement of that component in that position. Other components will be continuously adjusted, as set in the memory.

WARNING

Use caution when recalling the position memory while sitting in the vehicle. Immediately push the seat position control knob, when the seat moves too far in any direction.

Easy Access Function

When the engine is turned OFF, and when the driver exits from the vehicle, the steering wheel moves away from the driver, and the seat moves backwards. After entering the vehicle, the steering wheel will move toward the driver. After turning the Engine Start/Stop button to the ACC position, the seat will move forwards.

You can activate or deactivate the Easy Access Function in the User Setting Mode. Refer to "User Setting Mode" in this chapter.

STEERING WHEEL

Electronic Hydraulic Power Steering (EHPS)

This system uses an electromotor to assist your steering. When the engine is turned OFF, or when the EHPS becomes inoperative, you may still steer the vehicle, but it requires more effort in steering.

When you notice such a change while steering, have the EHPS checked by an authorized EQUUS dealer.

NOTICE

Do not turn the steering wheel to the extreme right or left for five seconds or over, while running the engine. This may cause damage to the EHPS motor pump.

i Information

When there is a malfunction with the EHPS motor pump, the efforts to steer may greatly increase.

i Information

When the vehicle is parked outside for an extended period of time at a cold temperature (below 14°F/-10°C), the power steering may require more efforts, after first starting the engine. This is due to the increased fluid viscosity at a cold temperature and does not indicate a malfunction.

When this happens, depress the accelerator to increase the engine RPM, until it reaches 1,500 rpm. Then, let the engine idle for two-to-three minutes to warm up the fluid.

Tilt Steering/Telescope Steering

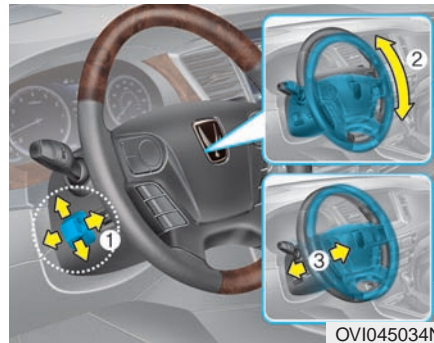

Adjust the steering wheel angle (2) and position (3) with the knob (1) on the steering column. Move the steering wheel, so it points toward your chest, not toward your face. Make sure you can monitor the warning lights and gauges on the instrument cluster. After adjusting, slightly push up and down the steering wheel to assure that it is locked in position. Always adjust the position of the steering wheel before driving.

⚠ WARNING

NEVER adjust the steering wheel while driving. This may cause loss of vehicle control, resulting in an accident.

Heated Steering Wheel



When the Engine Start/Stop Button is ON, press the heated steering wheel button to warm up the steering wheel. The indicator will illuminate. To turn the heated steering wheel OFF, press the button again. The indicator will be turned OFF. The heated steering wheel will turn OFF in approximately 30 minutes.

WARNING

When the steering wheel gets too hot, turn OFF the system. The heated steering wheel may cause burns even at a low temperature, especially if used for a long period of time.

NOTICE

Do not install any cover and grip on the steering wheel. This may cause damage to the heated steering wheel system.

Horn



To sound the horn, press the horn-symbol area on the steering wheel (see illustration). The horn will operate, only by pressing this horn-symbol area.

NOTICE

Do not strike the horn hard to operate it, or hit it with your fist. Do not press on the horn with a sharp object.

Convenient features of your vehicle

MIRRORS

Interior rearview mirrors

Before you start driving, adjust the rearview mirror to focus on the center of the rearview through the rear window.

⚠ WARNING

Make sure that your sight is not obstructed. Do not pile up objects on a rear seat, in a trunk, or behind a head restraint, which may interfere with your vision through the rear window.

⚠ WARNING

To prevent serious injury during an accident or deployment of the air bag, do not modify the rearview mirror and do not install a wide mirror.

⚠ WARNING

NEVER adjust the mirror while driving. This may cause loss of vehicle control resulting in an accident.

Electric chromic mirror (ECM) with HomeLink® system and compass (Type A)

Your vehicle is equipped with a Gentex Automatic-Dimming Mirror with a Z-Nav™ Electronic Compass Display and an Integrated HomeLink® Wireless Control System.

During the night-time driving, this feature automatically detects and reduces rearview mirror glare while the compass indicates the direction the vehicle heads for. The HomeLink® Universal Transceiver allows you to activate your garage door(s), electric gate, home lighting, etc.



OVI045605N

- (1) Telematics button
- (2) Telematics button
- (3) Telematics button
- (4) Compass control button & Dimming ON/OFF button
- (5) Status indicator LED
- (6) Channel 1 button
- (7) Channel 2 button
- (8) Channel 3 button
- (9) Compass display
- (10) Rear light sensor

Automatic-Dimming Night Vision Safety™ (NVS®) Mirror



The NVS® Mirror in your vehicle is the most advanced mirror to reduce annoying glare in the rearview mirror in any driving situation. For more information regarding NVS® mirrors and other applications, please visit the [Gentex website: www.gentex.com](http://www.gentex.com)

i Information

The NVS® Mirror automatically reduces glare while driving based upon light levels detected in front of the vehicle and from the rear of the vehicle. These light sensors are visible through openings in the front and rear of the mirror case. Any object that obstructs either light sensor will degrade the automatic dimming control function.

Automatic-dimming function

Your mirror automatically dims the glare upon detecting it from the vehicles traveling behind you. The automatic-dimming function can be controlled by the Dimming ON/OFF Button:

1. Pressing and holding the button for 3 seconds  turns OFF the automatic-dimming function, which is indicated by the turned-OFF green light of the Status Indicator LED.
2. Re-pressing and holding the  button for 3 seconds turns ON the automatic-dimming function which is indicated by the turned-ON green light of the Status Indicator LED.



The mirror defaults to the ON position whenever the vehicle is started.

Z-Nav™ Compass Display

The NVS™ Mirror in your vehicle is also equipped with a Z-Nav™ Compass that shows the vehicle Compass heading on the Display Window in the 8 cardinals headings (N, NE, E, SE, etc.).

Compass function

The Compass can be turned ON/OFF and remember the last heading information when the ignition is cycled. To turn ON/OFF the display function:

1. Press and release the  button within 1 second to turn OFF the display function.
2. Press and release the  button again within 1 second to turn ON the display back.

Additional options can be set by pressing and holding  buttons in sequences.

There is a difference between the magnetic north and the actual north. The compass in the mirror can offset this difference by knowing the Magnetic Zone in which it is operating. This is set either by the dealer or by the user. The operating Zone Numbers for North America are shown in the figure on the next page.

Convenient features of your vehicle

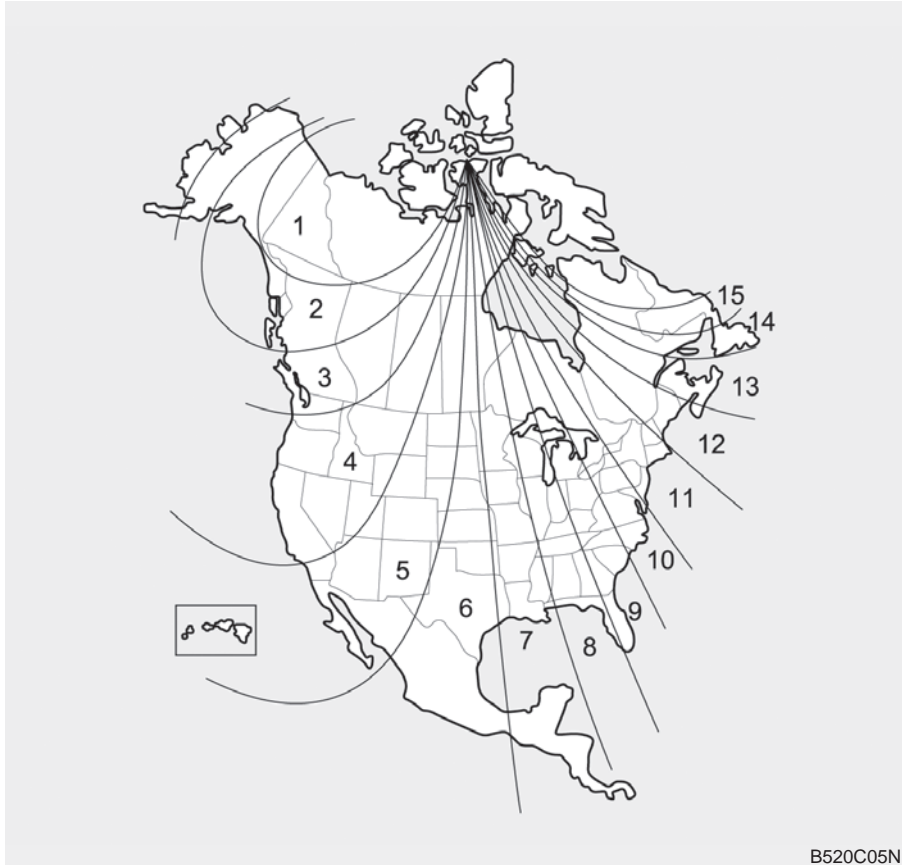

To adjust the Zone setting:

1. Determine the desired Zone Number based upon your current location on the Zone Map.
2. Press and hold the button for 6 seconds to display the current Zone Number.
3. Re-press and hold the button again to increase the Zone Number (Note: they will repeat ...13, 14, 15, 1, 2, ...). Release the button when the desired Zone Number appears on the display to set up the new Zone.
4. Within about 5 seconds the compass will start displaying a compass heading again.

There are some conditions that can cause changes to the vehicle magnets, such as installing a ski rack or a CB antenna. Body repair work on the vehicle can also cause changes to the vehicle's magnetic field. In these situations, the compass will need to be re-calibrated to quickly correct these changes. To re-calibrate the compass:

1. Press and hold the  button for more than 9 seconds. When the compass memory is deleted, a letter "C" will appear on the display.
2. To calibrate the compass, drive the vehicle in a circle twice at less than 5 mph (8 km/h).

Integrated HomeLink® Wireless Control System

The HomeLink® Wireless Control System provides a convenient way to replace up to three hand-held radiofrequency (RF) transmitters with a single built-in device. This innovative feature will learn the radio frequency codes of most current transmitters to operate devices such as gate operators, garage door openers, entry door locks, security systems, and even home lighting. Both standard and rolling code-equipped transmitters can be programmed by following the outlined procedures. Additional HomeLink® information can be found at: www.homelink.com or by calling 1-800-355-3515.

WARNING

Before programming HomeLink® to a garage door opener or gate operator, make sure that people and objects are out of the way from the device to prevent potential harm or damage. Do not use HomeLink® with any garage door opener that lacks the safety stop and reverse features required by U.S. federal safety standards (this includes any garage door opener model manufactured before April 1, 1982). A garage door that cannot detect an object - signaling the door to stop and reverse - does not meet current U.S. federal safety standards. Using a garage door opener without these features increases the risk of serious injury or death.

Retain the original transmitter of the RF device you programmed for use in other vehicles as well as for future HomeLink® programming. It is also suggested that upon the sale of the vehicle, the programmed HomeLink® buttons be erased for security purposes.

Programming HomeLink®

i Information

- When programming a garage door opener, it is advised to park the vehicle outside of the garage.
- It is recommended to replace the hand-held transmitter battery of the device being programmed to HomeLink® for quicker training and accurate transmission of the radio-frequency signal.
- Some vehicles may require the ignition switch to be turned to the second (or "accessories") position for programming and/or operation of HomeLink.
- In the event that there are still programming difficulties or questions after following the programming steps listed below, contact HomeLink® at: www.homelink.com or 1-800-355-3515.

Programming

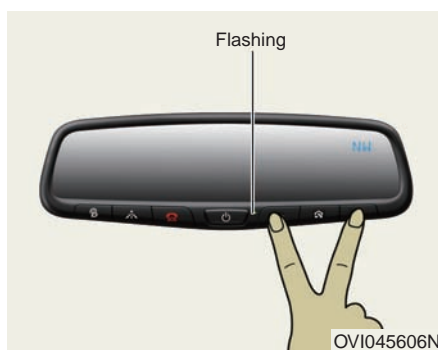

To train most devices, follow these instructions:

1. For first-time programming, press and hold the two outside buttons (🏠, 🏠), HomeLink® Channel 1 and Channel 3, until the indicator light begins to flash (after 10 seconds). Release both buttons. Do not hold the buttons for longer than 20 seconds.

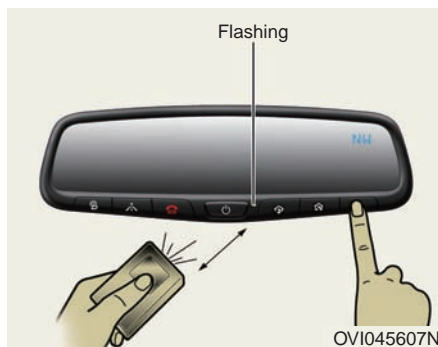

2. Point the end of your hand-held transmitter 1-3 inches (2-8 cm) away from the HomeLink® button you wish to program while keeping the indicator light in view.

3. Simultaneously press and hold both the HomeLink® and handheld transmitter buttons until the HomeLink® indicator changes from slow flashing to rapid flashing. Now you may release both the HomeLink® and hand-held transmitter buttons.
4. Firmly press, hold for 5 seconds and release the programmed HomeLink® button up to two separate times to activate the door. When the door does not activate, press and hold the just-programmed HomeLink® button and observe the indicator.
 - When the indicator remains illuminated, programming is complete. Your device will activate by pressing and releasing the HomeLink® button.
 - When the indicator flashes rapidly for 2 seconds and then turns to a constant light, continue with "Programming" steps 5-7 to complete the programming of a rolling code-equipped device (most commonly a garage door opener).
5. At the garage door opener receiver (motor-head unit) in the garage, find the "learn" or "smart" button. This can usually be found where the hanging antenna wire is attached to the motor-head unit.
6. Firmly press and release the "learn" or "smart" button. (The name and color of the button vary by manufacturer). Wait for 30 seconds before starting the step 7.
7. Return to the vehicle. Firmly press and hold the programmed HomeLink® button for 2 seconds. Then release it. Repeat this "press/hold/release" sequence for the second time. Depending on the brand of the garage door opener (or other rolling code equipped device), repeat this sequence for the third time to complete the programming process.

HomeLink® should now activate your rolling code equipped device.

i Information

Some devices may require you to replace this Programming step 3 with procedures noted in the "Gate Operator/Canadian Programming" chapter. When the HomeLink® indicator does not change to rapid flashing after performing these steps, contact HomeLink® at www.homelink.com.

Gate operator & Canadian programming

During programming, your handheld transmitter may automatically stop transmitting. Continue to press the Integrated HomeLink® Wireless Control System button (refer to the steps 2 to 3 in the Programming part) while you press and re-press ("cycle") your handheld transmitter every two seconds until the frequency signal is learned. The indicator light will flash slowly and then rapidly after a few seconds when successfully trained.

Operating HomeLink®

To operate, simply press and release the programmed HomeLink® button. Activation will now occur for the trained devices (i.e. garage door opener, gate operator, security system entry door lock, home/office lighting, etc.). For convenience, the hand-held transmitter of the device may also be used at any time.

Reprogramming a single HomeLink® button

To program a device to HomeLink® using a HomeLink® button previously trained, follow these steps:

1. Press and hold the desired HomeLink® button. DO NOT release the button.
2. The indicator light will begin to flash after 20 seconds. Without releasing the HomeLink® button, proceed to the "Programming" step 2.

For more questions or comments, contact HomeLink® at www.home-link.com or 1-800-355-3515.

Erasing HomeLink® buttons

An individual programming cannot be erased respectively. However, all three programming can be erased at the same time by following below steps;

1. Press and hold the two outer HomeLink® buttons until the indicator light begins to flash after 10 seconds.
2. Release both buttons. Do not hold for longer than 20 seconds.

The Integrated HomeLink® Wireless Control System is now in the training (learning) mode and can be programmed at any time by following the appropriate steps as in the "Programming".

FCC ID: NZLTMHL4

IC: 4112A-TLMHL4

This device complies with Part 15 of the FCC Rules.

Operation is subject to the following two conditions:

1. This device may not cause harmful interference, and
2. This device must accept any interference received, including interference that may cause undesired operation.

CAUTION

The transceiver has been tested and complies with FCC and Industry Canada rules. Changes or modifications not expressly approved by the party responsible for compliance could void the user's authority to operate the device.

NVS® is a registered trademark and Z-Nav™ is a trademark of the Gentex Corporation, Zeeland, Michigan. HomeLink® is a registered trademark owned by Johnson Controls, Incorporated, Milwaukee, Wisconsin.

Electric chromic mirror (ECM) with HomeLink® system and compass (Type B)

Your vehicle may be equipped with a Gentex Automatic-Dimming Mirror with a Z-Nav™ Electronic Compass Display and an Integrated HomeLink® Wireless Control System. During the night-time driving, this feature automatically detects and reduces rearview mirror glare while the compass indicates the direction the vehicle heads for. The HomeLink® Universal Transceiver allows you to activate your garage door(s), electric gate, home lighting, etc.

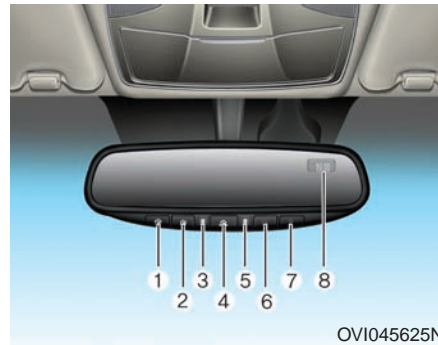

- (1) Channel 1 button
- (2) Channel 2 button
- (3) Status indicator LED
- (4) Channel 3 button
- (5) Rear light sensor
- (6) Dimming ON/OFF button
- (7) Compass control button
- (8) Compass display

Automatic-Dimming Night Vision Safety™ (NVS®) Mirror

The NVS® Mirror in your vehicle is the most advanced mirror to reduce annoying glare in the rearview mirror in any driving situation. For more information regarding NVS® mirrors and other applications, please visit the Gentex website:



www.gentex.com

NOTICE

The NVS® Mirror automatically dims glare in driving conditions based upon light levels detected in front of the vehicle and from the rear of the vehicle. These light sensors are visible through openings in the front and rear of the mirror case. Any object that obstructs either light sensor will degrade the automatic dimming control function.

Automatic-dimming function

Your mirror automatically dims the glare upon detecting it from the vehicles traveling behind you. The automatic-dimming function can be controlled by the Dimming ON/OFF Button:

1. Pressing and hold the  button for 3 seconds turns OFF the automatic-dimming function, which is indicated by the turned-OFF green light of the Status Indicator LED.
2. Pressing and hold the  button for 3 seconds again turns ON the automatic-dimming function which is indicated by the turned-ON green light of the Status Indicator LED.

Information



The mirror resets to be ON whenever the vehicle is started.

Z-Nav™ Compass Display

The NVS™ Mirror in your vehicle is also equipped with a Z-Nav™ Compass that shows the vehicle Compass heading on the Display Window in the 8 cardinals headings (N, NE, E, SE, etc.).

Compass function

The Compass can be turned ON/OFF and remember the last heading information when the ignition is cycled. To turn ON/OFF the display function:



1. Press and release the  button within 1 second to turn OFF the display function.
2. Press and release the  button again within 1 second to turn ON the display back.

Additional options can be set by pressing and holding buttons in sequences, as detailed below.

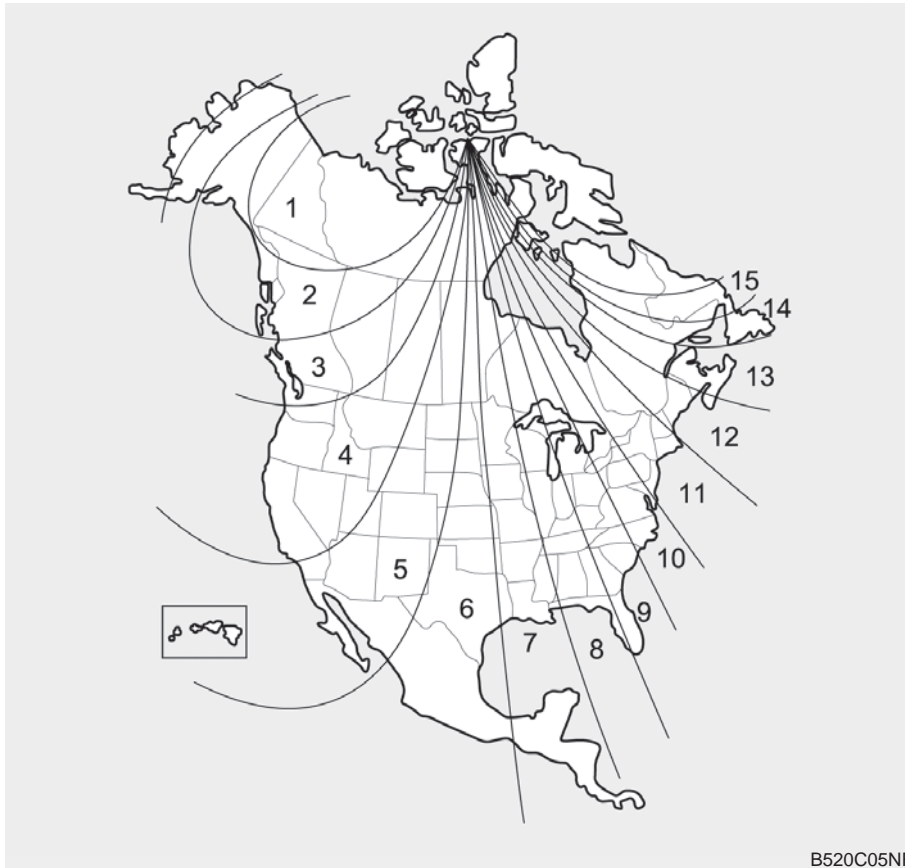
There is a difference between the magnetic north and the actual north. The compass in the mirror can offset this difference by knowing the Magnetic Zone in which it is operating. This is set either by the dealer or by the user. The operating Zone Numbers for North America are shown in the figure on the next page.



To adjust the Zone setting:

1. Determine the desired Zone Number based upon your current location on the Zone Map.
2. Press and hold the  button for 6 seconds to display the current Zone Number.
3. Re-press and hold the  button again to increase the Zone Number (Note: they will repeat ...13, 14, 15, 1, 2, ...). Release the button when the desired Zone Number appears on the display to set up the new Zone.
4. Within about 5 seconds the compass will start displaying a compass heading again.

Convenient features of your vehicle

There are some conditions that can cause changes to the vehicle magnets, such as installing a ski rack or a CB antenna. Body repair work on the vehicle can also cause changes to the vehicle's magnetic field. In these situations, the compass will need to be re-calibrated to quickly correct these changes. To re-calibrate the compass:

1. Press and hold the  button for more than 6 seconds. When the compass memory is deleted, a letter "C" will appear on the display.
2. To calibrate the compass, drive the vehicle in 2 complete circles at less than 5 mph (8 km/h).

Integrated HomeLink® Wireless Control System

The HomeLink® Wireless Control System provides a convenient way to replace up to three hand-held radiofrequency (RF) transmitters with a single built-in device. This innovative feature will learn the radio frequency codes of most current transmitters to operate devices such as gate operators, garage door openers, entry door locks, security systems, and even home lighting. Both standard and rolling code-equipped transmitters can be programmed by following the outlined procedures. Additional HomeLink® information can be found at: www.homelink.com or by calling 1-800-355-3515.

NOTICE

Before programming HomeLink® to a garage door opener or gate operator, make sure that people and objects are out of the way from the device to prevent potential harm or damage. Do not use HomeLink® with any garage door opener that lacks the safety stop and reverse features required by U.S. federal safety standards (this includes any garage door opener model manufactured before April 1, 1982). A garage door that cannot detect an object - signaling the door to stop and reverse - does not meet current U.S. federal safety standards. Using a garage door opener without these features increases the risk of serious injury or death.

Retain the original transmitter of the RF device you programmed for use in other vehicles as well as for future HomeLink® programming. It is also suggested that upon the sale of the vehicle, the programmed HomeLink® buttons be erased for security purposes.

Programming HomeLink®

i Information

- When programming a garage door opener, it is advised to park the vehicle outside of the garage.
- It is recommended to replace the hand-held transmitter battery of the device being programmed to HomeLink® for quicker training and accurate transmission of the radio-frequency signal.
- Some vehicles may require the ignition switch to be turned to the second (or "accessories") position for programming and/or operation of HomeLink®.
- In the event that there are still programming difficulties or questions after following the programming steps listed below, contact HomeLink® at: www.homelink.com or 1-800-355-3515.

Standard programming

To train most devices, follow these instructions:

1. For first-time programming, press and hold the two outside buttons, HomeLink® Channel 1 and Channel 3 Buttons, until the indicator light begins to flash (after 20 seconds). Release both buttons. Do not hold the buttons for longer than 30 seconds.
2. Point the end of your hand-held transmitter 1-3 inches (2-8 cm) away from the HomeLink® button you wish to program while keeping the indicator light in view.
3. Simultaneously press and hold both the HomeLink® and handheld transmitter buttons. DO NOT release the buttons until step 4 is completed.
4. When continuously pressing the buttons, the red Indicator Status LED will flash slowly and then rapidly after HomeLink® successfully trains to the frequency signal from the hand-held transmitter. Then, release both buttons.
5. Press and hold the just-trained HomeLink® button and observe the red Status Indicator LED. If the indicator light stays on constantly, programming is complete and your device will activate when the HomeLink® button is pressed and released.
6. To program the remaining two HomeLink® buttons, follow the steps 2 to 5.

Rolling code programming

Rolling code devices, which are "code-protected" and manufactured after 1996, may be determined by the followings:

- Reference in the device manual for verification.
- The handheld transmitter appears to program the HomeLink® Universal Transceiver but does not activate the device.
- Press and hold the trained HomeLink® button. The device has the rolling code function if the indicator light flashes rapidly and then turns constantly ON after 2 seconds.

To train rolling code devices, follow these instructions:

1. At the garage door opener receiver (motor-head unit) in the garage, locate the "learn" or "smart" button. This can usually be found where the hanging antenna wire is attached to the motor-head unit. Exact location and color of the button may vary by garage door opener brand. If there is difficulty locating the training button, reference the device owner's manual or please visit our Web site at www.homelink.com.
2. Firmly press and release the "learn" or "smart" button (which activates the "training light").

Information

Wait for 30 seconds before starting the step 3.

3. Return to the vehicle. Firmly press and hold the desired HomeLink® button for two seconds. Then, release it. Repeat the "press/hold/release" sequence a second time to complete the programming. (Some devices may require you to repeat this sequence a third time to complete the programming.)
4. Press and hold the just-trained HomeLink® button and observe the red Status Indicator LED. If the indicator light stays on constantly, programming is complete and your device should activate.
5. To program the remaining two HomeLink® buttons, follow either the steps 1 to 4, as above, for other Rolling Code devices or the steps 2 to 5 in Standard Programming for standard devices.

Gate operator & Canadian programming

During programming, your handheld transmitter may automatically stop transmitting. Continue to press the Integrated HomeLink® Wireless Control System button (refer to the steps 2 to 4 in the Standard Programming) while you press and re-press ("cycle") your handheld transmitter every two seconds until the frequency signal is learned. The indicator light will flash slowly and then rapidly after several seconds upon successful training.

Operating HomeLink®

To operate, simply press and release the programmed HomeLink® button. Activation will occur for the trained device (i.e. garage door opener, gate operator, security system, entry door lock, home/office lighting, etc.). For convenience, the hand-held transmitter of the device may also be used at any time.

Reprogramming a single HomeLink® button

To program a new device to a previously trained HomeLink® button, follow these steps:

1. Press and hold the desired HomeLink® button. Do NOT release until the step 4 is completed.
2. When the indicator light begins to flash slowly (after 20 seconds), point the handheld transmitter 1 to 3 inches away from the HomeLink® surface.
3. Press and hold the handheld transmitter button. The HomeLink® indicator light will flash, first slowly and then rapidly.
4. When the indicator light begins to flash rapidly, release both buttons.
5. Press and hold the just-trained HomeLink® button and observe the red Status Indicator LED. If the indicator light stays on constantly, programming is complete and your new device should activate.

Erasing HomeLink® buttons

An individual programming cannot be erased. However, to erase all three programmings;

1. Press and hold the two outer HomeLink® buttons until the indicator light begins to flash after 20 seconds; and
2. Release both buttons. Do not hold for longer than 30 seconds.

The Integrated HomeLink® Wireless Control System is now in the training (learning) mode and can be programmed at any time by following the appropriate steps as in the "Programming".

FCC ID: NZLZTVHL3

IC: 4112A-ZTVHL3

Convenient features of your vehicle

This device complies with Part 15 of the FCC Rules.

Operation is subject to the following two conditions:

1. This device may not cause harmful interference, and
2. This device must accept any interference received, including interference that may cause undesired operation.

⚠ CAUTION

The transceiver has been tested and complies with FCC and Industry Canada rules. Changes or modifications not expressly approved by the party responsible for compliance could void the user's authority to operate the device.

NVS® is a registered trademark and Z-Nav™ is a trademark of the Gentex Corporation, Zeeland, Michigan. HomeLink® is a registered trademark owned by Johnson Controls, Incorporated, Milwaukee, Wisconsin.

Outside rearview mirror



Your vehicle is equipped with both left-hand and right-hand outside rearview mirrors.

⚠ WARNING

- **The right outside rearview mirror is convex. Objects seen in the mirror are closer than they appear.**
- **Use your interior rearview mirror or turn your head and look to determine the actual distance of following vehicles when changing lanes.**

⚠ WARNING

Do not adjust or fold the outside rearview mirrors while driving. This may cause loss of vehicle control resulting in an accident.

NOTICE

Do not scrape ice off a mirror surface; this may damage the mirror surface. If ice should restrict movement of the mirror, do not force the mirror for adjustment. To remove ice, use a deicer spray, a sponge or soft cloth with warm water.

NOTICE

If the mirror is jammed with ice, do not adjust the mirror by force. Use an approved spray de-icer (not radiator antifreeze) to release the frozen mechanism or move the vehicle to a warm place in order to melt the ice.



Adjusting the rearview mirrors:

Press either the L (driver's side) or R (passenger's side) button (1) to select the rearview mirror you would like to adjust.

Use the mirror adjustment control (2) to move the selected mirror up, down, left or right.

After adjustment, press the L or R button (1) again to prevent inadvertent adjustment.

NOTICE

- The mirrors stop moving when they reach the maximum adjustment angles, but the motor continues to operate while the switch is depressed. Do not depress the switch longer than necessary; the motor may be damaged.
- Do not attempt to adjust the outside rearview mirror by hand or the motor may be damaged.

Folding the Outside Rearview Mirrors



To fold:

Press the button located on the driver's side door panel.

The Engine Start/Stop Button must be ON or within approximately 30 seconds after the Engine Start/Stop Button is pressed to the ACC position or the OFF position.

Also, the outside rearview mirrors can be folded when you lock the doors with the Smart Key.

To unfold:

Press the button located on the driver's side door panel.

The Engine Start/Stop Button must be in the ON position or within approximately 30 seconds after the Engine Start/Stop Button is pressed to the ACC position or the OFF position.

Also, the outside rearview mirrors can be unfolded when you approach the vehicle with the Smart Key in your possession or unlock the doors with the Smart Key.

When you fold the outside mirror after locking the doors, the automatic unfolding function by the Smart Key does not work.

NOTICE

Do not fold the automatic type of the outside rearview mirror by hand. This could cause failure of the motor.

Electric chromic mirror (ECM) (if equipped)

The electric chromic mirror automatically controls the glare from the headlamps of the vehicles behind during the night time or low light driving conditions. The sensor mounted in the mirror senses the light level around the vehicle, and automatically controls the headlamp glare from following vehicles.

When the engine is running, the glare is automatically controlled by the sensor mounted in the rearview mirror.

Whenever the shift lever is in R (Reverse), the mirror automatically sets to be in the brightest mode in order to improve the driver's rearview. When the ECM inside the rear view mirror operates, it will operate.

NOTICE

When cleaning the mirror, use a paper towel or clean cloth dampened with glass cleaner. Do not spray glass cleaner directly on the mirror as that may cause the liquid cleaner to enter the mirror housing.

Reverse Parking Aid Function



When you set the shift lever in R (Reverse), the outside rearview mirror(s) will slightly rotate downwards to aid the driver to drive backwards. The position of the outside rearview mirror switch (1) determines whether or not the mirrors will move:

Left/Right: When either the L or R switch is selected, both outside rearview mirrors will move.

Neutral: When neither of the switches is selected, the outside rearview mirrors will not move.

The outside rearview mirrors will automatically reset to their default positions, when one of the followings occurs:

- The Engine Start/Stop Button is pressed to either the OFF position or the ACC position.
- The shift lever is not in R(Reverse).
- The outside rearview mirror switch is not selected.

Convenient features of your vehicle

INSTRUMENT CLUSTER



- | | |
|-------------------------------------|--|
| 1. Tachometer | 4. Fuel Gauge |
| 2. Speedometer | 5. Odometer |
| 3. Engine Coolant Temperature Gauge | 6. LCD Display (Including trip computer) |

■ Type B



- | | |
|-------------------------------------|--|
| 1. Tachometer | 4. Fuel Gauge |
| 2. Speedometer | 5. Odometer |
| 3. Engine Coolant Temperature Gauge | 6. LCD Display (Including trip computer) |

- The instrument cluster theme is automatically changed in accordance with the drive mode (NORMAL, SPORT, SNOW).
- ※ For further information of the drive mode, refer to "Drive mode integrated control system" in the chapter 5.
- In the "User Settings Mode" of the LCD display, you can activate or deactivate the automatic change of the instrument cluster theme.
- ※ For further information, refer to "LCD Display" in this chapter.

Instrument Cluster Control

Adjusting Instrument Cluster Illumination

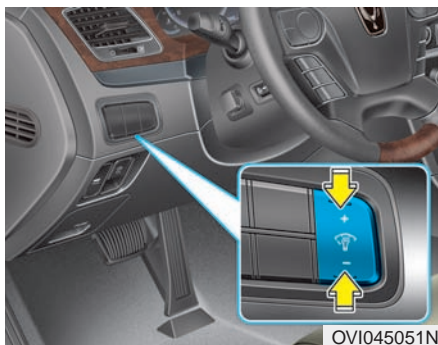

The brightness of the instrument panel illumination can be adjusted by pressing the illumination control buttons (“+” or “-”) when the Engine Start/Stop Button is ON or the tale lights are turned ON.

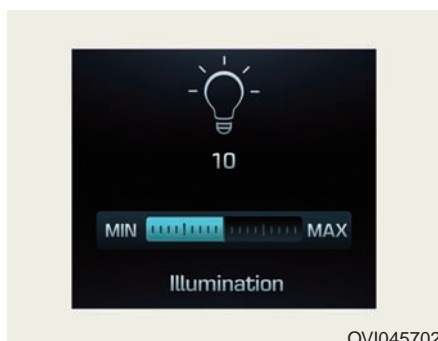

- The brightness has 20 levels: 1 (MIN) ~ 20 (MAX)
- If you press the illumination control button (“+” or “-”), the brightness level will be continuously adjusted.
- If the brightness reaches to the maximum or minimum level, an alarm will sound.

LCD Display Control

The LCD display modes can be changed with the control buttons on the steering wheel.

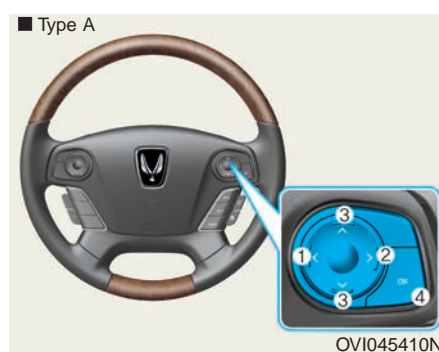

- (1) < button : Changing LCD modes (right to left), or returning to previous position
- (2) > button : Changing LCD modes (left to right)
- (3) ^ , v button : Changing items (upper or lower)
- (4) OK button : Selecting or resetting

* For the LCD modes, refer to "LCD Display" in this chapter.

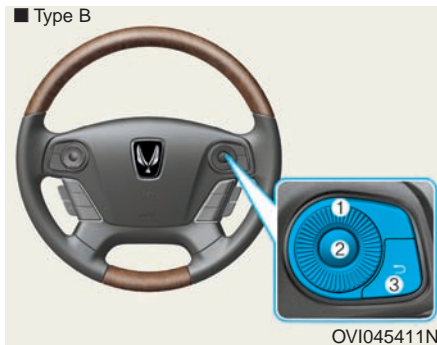

- (1) Haptic switch : Changing LCD modes or items
- (2) OK button : Selecting or resetting
- (3) RETURN button : Returning to previous position

You can adjust a tightening level of the haptic rotating switch in the "User Settings Mode" on the LCD Display

* For further information, refer to "LCD Display" to in this chapter.

Gauges

Speedometer

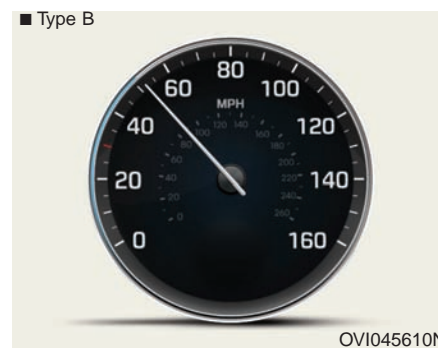
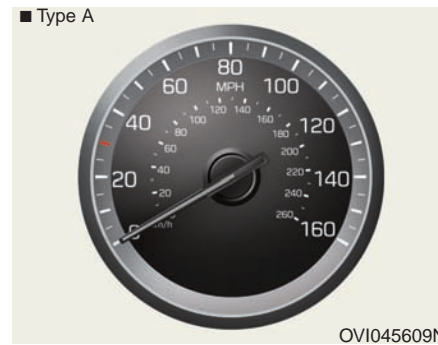

The speedometer indicates the speed of the vehicle, calibrated in miles per hour (mph) and/or kilometers per hour (km/h).

i Information

In the "User Settings Mode" of the LCD display, you can set the font size of the speedometer (Normal or Large) (Type B).

Convenient features of your vehicle

Tachometer

■ Type A



OVI045611N

■ Type B



OVI045612N

The tachometer indicates the approximate number of engine revolutions per minute (rpm).

Use the tachometer to find the correct shift points and to prevent lugging and/or over-revving the engine.

NOTICE

Do not operate the engine when the tachometer pointer is in the RED ZONE. This may cause severe engine damage.

Engine Coolant Temperature Gauge

■ Type A

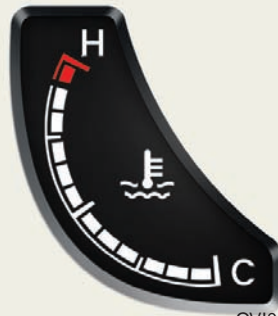

OVI045613N

■ Type B

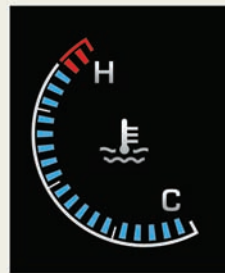

OVI045614N

This gauge indicates the temperature of the engine coolant when the engine is running.

NOTICE

If the gauge pointer moves out of the normal range area, toward the "H" position, it indicates overheating of the engine that may damage the engine.

Do not continue driving with an overheated engine. If your vehicle is overheated, refer to "If the Engine Overheats" in the chapter 6.

CAUTION

Never remove the radiator cap when the engine is hot. The engine coolant is under pressure and could severely burn. Wait until the engine cools down before adding coolant to the reservoir.

Fuel Gauge

■ Type A



OVI045615N

■ Type B

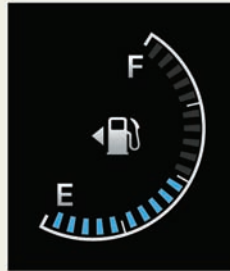

OVI045616N

This gauge indicates the approximate amount of fuel remaining in the fuel tank.

i Information

- The fuel tank capacity is indicated in chapter 8.
- The fuel gauge is supplemented by a low fuel warning light, which will illuminate when the fuel tank is nearly empty.
- On slopes or curves, the fuel gauge pointer may fluctuate or the low fuel warning light may come on earlier than usual due to the fuel fluctuation in the tank.

CAUTION

- Fuel Gauge

Running out of fuel can expose vehicle occupants to danger. You must stop the vehicle and obtain additional fuel as soon as possible, after the warning light comes on or when the gauge indicator comes close to the "E (Empty)" level.

NOTICE

Avoid driving with the extremely low amount of fuel. Running out of fuel could cause the engine to misfire, damaging the catalytic converter.

Convenient features of your vehicle

Odometer

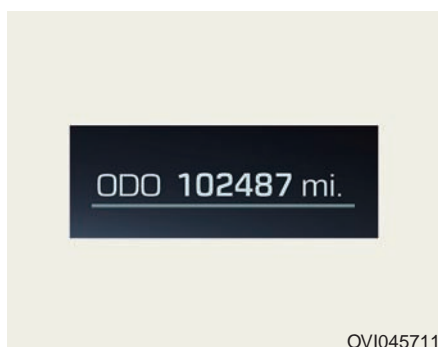

OVI045711

The odometer indicates the accumulated distance that the vehicle has driven and determines the periodic maintenance schedule that should be performed.

- Odometer range :
0 ~ 999999 miles or kilometers

Outside Temperature Gauge

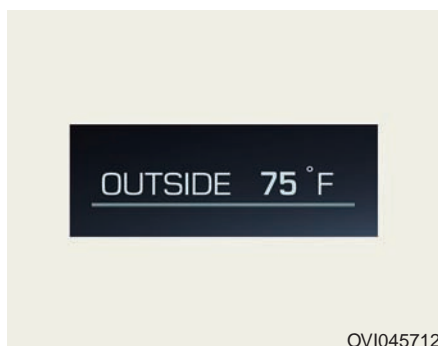

OVI045712

This gauge indicates the current outside air temperatures by 1°F (1°C).

- Temperature range :
-40°F ~ 140°F (-40°C ~ 60°C)

The outside temperature on the display may not change immediately like a general thermometer not to distract the driver.

The temperature unit (from °C to °F or from °F to °C) can be changed by pressing the AUTO/OFF buttons on the front climate control panel for 3 seconds simultaneously.

Automatic Transmission Shift Indicator

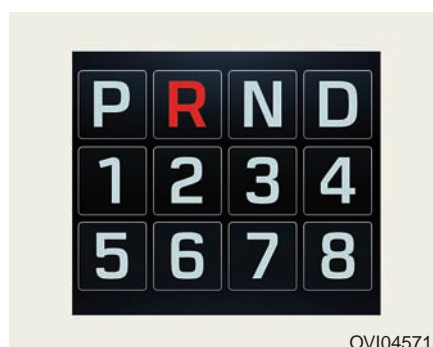







OVI045713

This indicator displays where the automatic transmission shift lever is located.

- Park : P
- Reverse : R
- Neutral : N
- Drive : D
- Sports Mode : 1, 2, 3, 4, 5, 6, 7, 8

LCD DISPLAY

LCD Modes

Modes	Symbol	Explanation
Trip Computer		This mode displays driving information like the trip-meter, fuel economy, etc. * For further information, refer to "Trip Computer" in this chapter.
ASCC/LDWS (if equipped)		This mode displays the state of the Advanced Smart Cruise Control (ASCC) and Lane Departure Warning System (LDWS). * For further information, refer to "Advanced Smart Cruise Control (ASCC)" and "Lane Departure Warning System (LDWS)" in the chapter 5.
A/V (if equipped)		This mode displays the state of the A/V system.
Turn By Turn (TBT) (if equipped)		This mode displays the state of the navigation.
Information	 or 	This mode displays service interval (mileage or days) and warning messages related to the advanced smart cruise control system, pre-safe seat belt, etc.
User Settings		In this mode, you can change settings of the doors, lamps, and so on.

* For controlling the LCD modes, refer to "LCD Display Control" in this chapter.

Convenient features of your vehicle

Trip Computer Mode

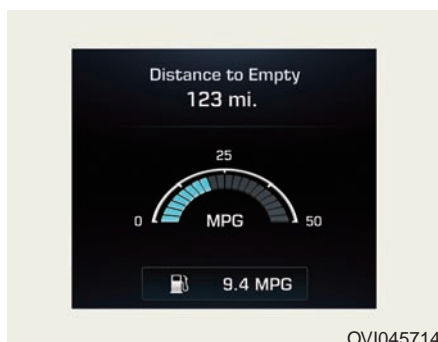

OVI045714

This mode displays driving information like the tripmeter, fuel economy, etc.

* For further information, refer to "Trip Computer" in this chapter.

ASCC/LDWS Mode (if equipped)



OVI045715/OVI045716

This mode displays the state of the Advanced Smart Cruise Control (ASCC) and Lane Departure Warning System (LDWS).

* For further information, refer to "Advanced Smart Cruise Control (ASCC)" and "Lane Departure Warning System (LDWS)" in the chapter 5.

A/V Mode

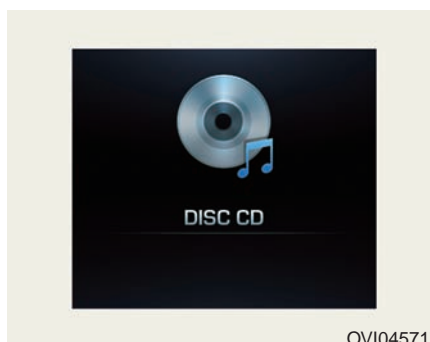

OVI045717

This mode displays the state of the A/V system.

Turn By Turn (TBT) Mode (if equipped)

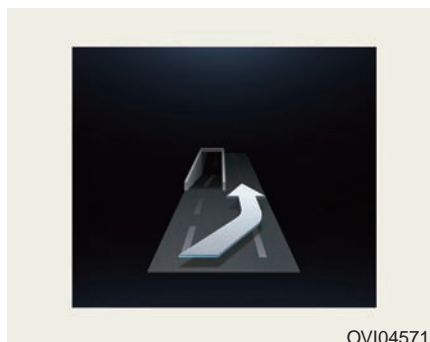

OVI045718

This mode displays the state of the navigation.

Information Mode

Service Interval

This mode displays the service interval (mileage and days).

- * For the setting of the service interval, refer to "User Settings Mode" of the LCD display.

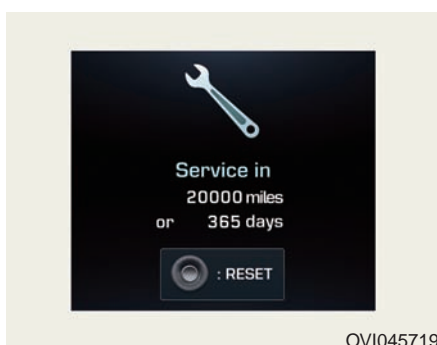

Service in

It calculates and displays when you need a scheduled maintenance service (mileage or days).

If the mileage or day after service passes 900 miles (1,500 km) or 30 days, "Service in" message is displayed for several seconds each time you turn ON the Engine Start/Stop Button.

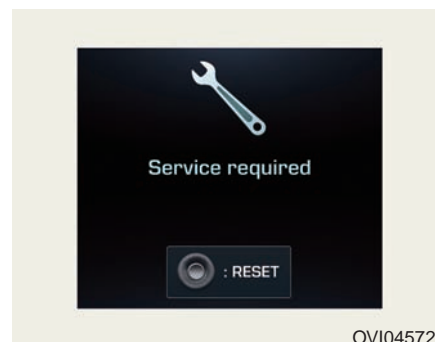

Service required

When you fail to have your vehicle serviced according to the already inputted service interval, "Service required" message is displayed for several seconds each time you turn ON the Engine Start/Stop Button.

To reset the service interval in miles or days that you initially set:

- Press the OK button for more than 1 second.

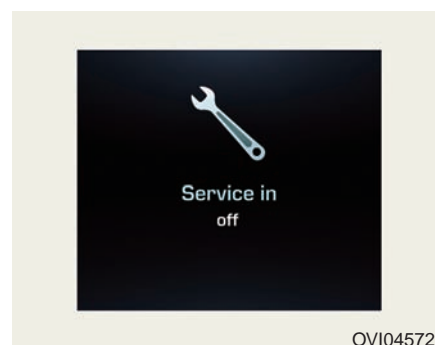

Service in OFF

When the service interval is not set, "Service in OFF" message is displayed on the LCD display.

Convenient features of your vehicle

i Information

If any of the following conditions occurs, the mileage and days may be incorrect.

- The battery cable is disconnected.
- The fuse switch is turned off.
- The battery is discharged.

Warning Message

If one of followings occurs, warning messages will be displayed in the information mode for about 10 seconds.

- Malfunction of the pre-safe seat belt, electronic control suspension, or advanced smart cruise control system
- Low washer fluid
- Check fuel cap

User Settings Mode

Head-Up Display (HUD) Settings (if equipped)

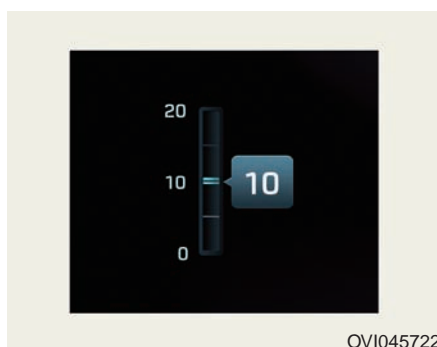

Display Height

Adjust the height of the HUD image on the windshield glass (Level 0 to 20).



Rotation

Rotate the angle of the HUD image on the windshield glass (Level -5 to +5).

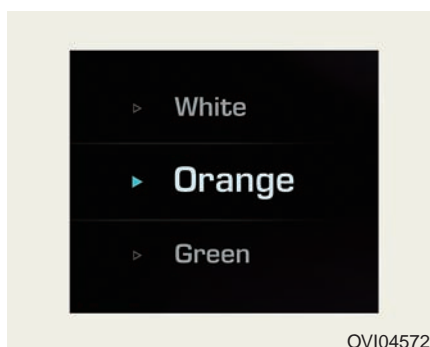

Font Color

Choose the font color of the HUD (White, Orange, Green).



OVI045725

Font Size

Choose the font size of the HUD (Large, Medium, Small).



OVI045726

Contents Setting (if equipped)

Activate or deactivate each HUD contents (TBT, SCC, LDWS, BSD).

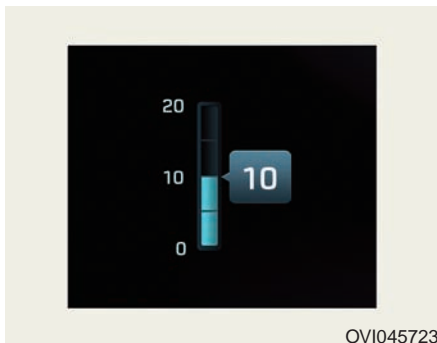

OVI045723

Illumination

Adjust the brightness of the HUD illumination (Level 0 to 20).

* TBT : Turn By Turn

SCC : (Advanced) Smart Cruise Control

LDWS : Lane Departure Warning System

BSD : Blind Spot Detection

***i* Information**

If you select the Turn By Turn (TBT) navigation information as HUD contents, the Turn By Turn (TBT) navigation information will not be displayed on the LCD.

Convenient features of your vehicle

Vehicle Settings

In this mode, you can change setting of the instrument cluster, doors, lamps, etc.

Cluster Settings

Items	Explanation
Welcome Sound	<ul style="list-style-type: none">• On: The welcome sound will be activated when the instrument cluster is turned on.• Off: The welcome sound will be deactivated.
AVSM (if equipped)	<ul style="list-style-type: none">• On: The AVSM system will be activated.• Off: The AVSM system will be deactivated.※ For further information, refer to “Advanced Vehicle Safety Management (AVSM) System” in the chapter 5.※ AVSM: Advanced Vehicle Safety Management
LDWS Haptic (if equipped)	<ul style="list-style-type: none">• On: The haptic function of the Lane Departure Warning System (LDWS) will be activated.• Off: The haptic function of the Lane Departure Warning System (LDWS) will be deactivated.※ For further information, refer to “Lane Departure Warning System (LDWS)” in the chapter 5.
Traffic Information (if equipped)	<ul style="list-style-type: none">• On: The LCD will show traffic information.• Off: The LCD will not show traffic information.
Speedometer Size (if equipped)	<ul style="list-style-type: none">• Choose the font size in the speedometer (Large or Normal).
Driving Mode Theme (if equipped)	<ul style="list-style-type: none">• On : The instrument cluster theme is automatically changed in accordance with the drive mode (NORMAL, SPORT, SNOW).• Off : The automatic change function of the instrument cluster theme will be deactivated.

Items	Explanation
ECO Driving	<ul style="list-style-type: none"> • On : The ECO driving mode will be activated. • Off : The ECO driving mode will be deactivated.
AVG Fuel Eco Reset	<ul style="list-style-type: none"> • Auto Reset: The memory of the average fuel economy will be automatically reset when refueling. • Manual Reset: The memory of the average fuel economy will not be automatically reset when refueling. <p>✳ For further information, refer to "Trip Computer" in this chapter.</p>

Door

Items	Explanation
Auto Door Lock	<ul style="list-style-type: none"> • Off: The auto door lock function will be deactivated. • Speed: All doors will be automatically locked when the vehicle speed exceeds 9.3mph (15km/h). • Shift Lever: All doors will be automatically locked, when the automatic transmission is shifted from P (Park) to R (Reverse), N (Neutral), or D (Drive).
Auto Door Unlock	<ul style="list-style-type: none"> • Off: The auto door unlock function will be deactivated. • Power Off: All doors will be automatically unlocked when turning OFF the Engine Start/Stop Button. • Shift Lever: All doors will be automatically unlocked, when the automatic transmission is shifted to P(Park). • Driver Door Unlock: All doors will be automatically unlocked, when the driver's door is unlocked.
Smart Trunk (if equipped)	<ul style="list-style-type: none"> • On : The Smart Trunk system will be activated. • Off : The Smart Trunk system will be deactivated. <p>✳ For more details, refer to "Smart Trunk" in this chapter.</p>

Convenient features of your vehicle

Lamp

Items	Explanation
Head Lamp Delay	<ul style="list-style-type: none">• On: The head lamp delay function is active.• Off: The headlamp delay function is deactivated. * For further information, refer to "Lighting" in this chapter.
Welcome Light	<ul style="list-style-type: none">• On: The welcome light function is active.• Off: The welcome light function is deactivated. * For further information, refer to "Welcome System" in this chapter.
One Touch Turn Lamp	<ul style="list-style-type: none">• Off: The one touch turn lamp function will be deactivated.• 3, 5, 7 Flashing : The lane change signals flash three, five or seven times, when the turn signal lever is slightly operated. * For further information, refer to "Lighting" in this chapter.

Driver Convenience

Items	Explanation
Seat Easy Access	<ul style="list-style-type: none"> • Off: The seat easy access function is deactivated. • Normal/Enhanced: <ul style="list-style-type: none"> - When you turn OFF the engine, the driver's seat automatically moves backwards by 2 inch (Normal) or 3 inch (Enhanced) for more comfortable entering or exiting. - When the Engine Start/Stop Button is turned to the ACC, ON, or START position from the OFF position, the driver's seat resets to its default position. ✳ For further information, refer to "Driver Position Memory System" in the chapter 3.
Steering Easy Access	<ul style="list-style-type: none"> • On: The steering wheel automatically moves forwards or backwards for the driver's comfortable entering or exiting. • Off: The steering easy access function is deactivated. ✳ For further information, refer to "Driver Position Memory System" in the chapter 3.

Haptic Steering System Switch (if equipped)

Adjust a tightening level of the haptic rotating switch on the steering wheel on the LCD display (Strong, Normal, Mild).

✳ For further information about the haptic switch, refer to "LCD Display Control" in this chapter.

Service Interval

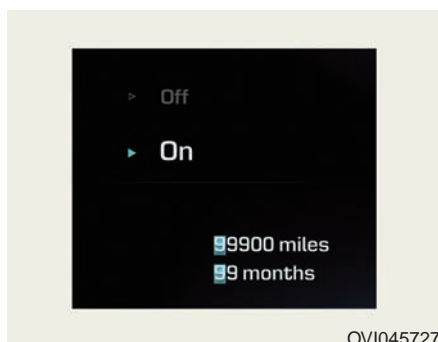

In this mode, you can activate the service interval function in mileage (mile or kilometer) and period (month).

- Off : The service interval function is deactivated.
- On : The service interval function is active (mileage or month).

Quick Guide (if equipped)

This mode provides quick guides for the Head-Up Display (HUD), the Blind Spot Detection (BSD) System, the Smart Cruise Control (SCC) System, the Lane Departure Warning System (LDWS), etc.

For further information about each system, refer to this Owner's Manual.

Warning Messages

Shift to "P" or "N" to start engine

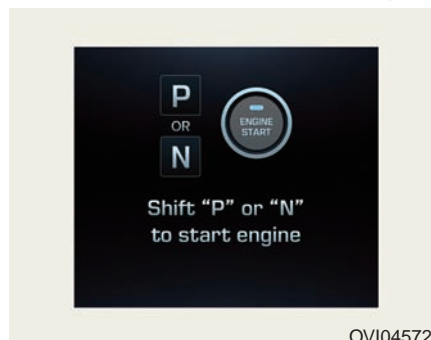

- This warning message illuminates, when you try to start the engine with the shift lever not in P (Park) or N (Neutral).

i Information

You can start the engine with the shift lever in N (Neutral). However, for your safety, we recommend that you start the engine with the shift lever in P (Park).

Shift to "P" position

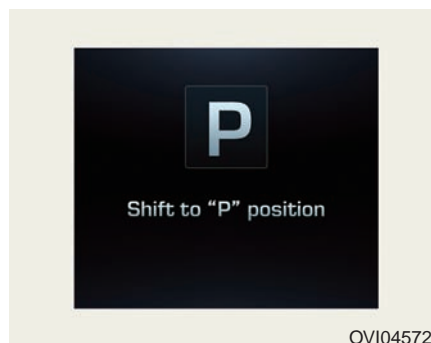

- This warning message illuminates, when you attempt to turn OFF the engine without setting the shift lever in P (Park).

- At this time, the Engine Start/Stop Button turns to the ACC position (When you re-press the Engine Start/Stop Button again, it will turn to the ON position).

Press start button again

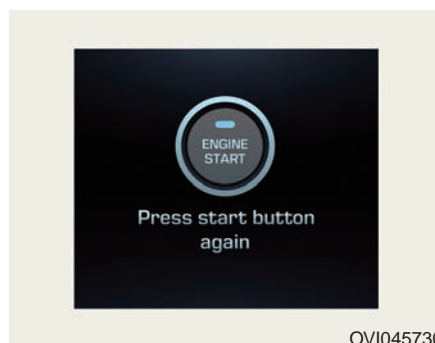

- This warning message illuminates, when you cannot operate the Engine Start/Stop button due to a malfunction with the Engine Start/Stop button.
- You can start the engine by re-pressing the Engine Start/Stop button again.
- When the warning light illuminates each time you press the Engine Start/Stop button, have your vehicle inspected by an authorized EQUUS dealer.

Press brake pedal to start engine

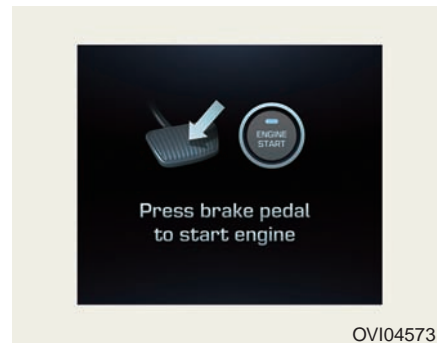

- This warning message illuminates, the Engine Start/Stop button changes to the ACC position twice by repeatedly pressing the button without pressing the brake pedal.
- You can start the engine by pressing the brake pedal.

Press start button with Smart Key

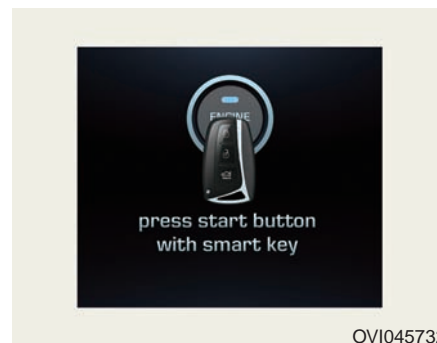

- This warning message illuminates, when you press the Engine Start/Stop button while the warning message, "Key not detected," is displayed.
- At this time, the immobilizer indicator flashes.

Low Key Battery

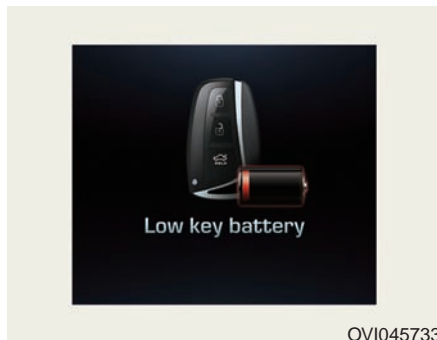

- This warning message illuminates, when the Smart-Key battery is discharged while turning the Engine Start/Stop button to the OFF position.

Key not in vehicle

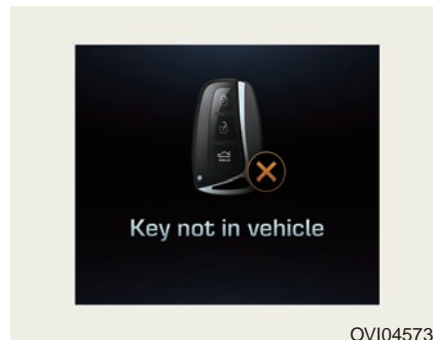

- This warning message illuminates, when the Smart Key is out of the vehicle while pressing the Engine Start/Stop button.
- You should always carry the Smart Key in your possession.

Key not detected

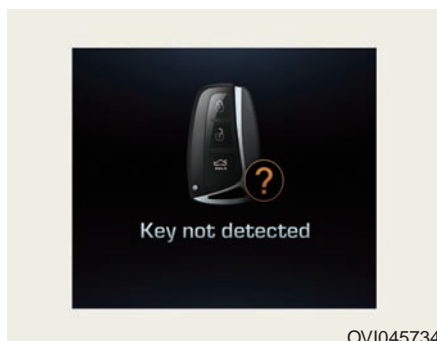

- This warning message illuminates, when the Smart Key is not detected while pressing the Engine Start/Stop button.

Press start button while turn steering

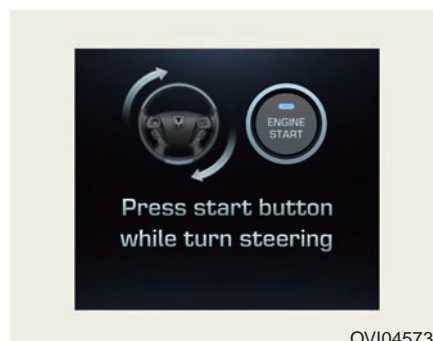

- This warning message illuminates, when the steering wheel is abnormally locked while pressing the Engine Start/Stop button.
- You should press the Engine Start/Stop button while turning the steering wheel from side to side.

Align steering wheel

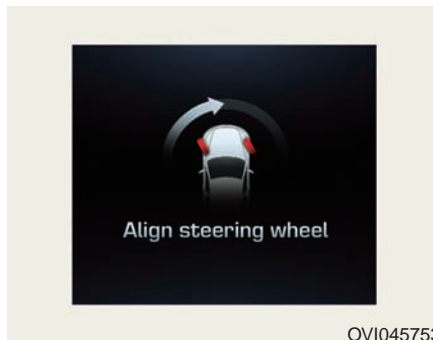

OVI045753

- This warning message illuminates, when the steering wheel is turned at an angle of 90 degrees or wider, either to left or to right, while starting the engine.
- You should align the steering wheel and narrow the steering wheel angle to be less than 30 degrees.

Door / Hood / Trunk Open

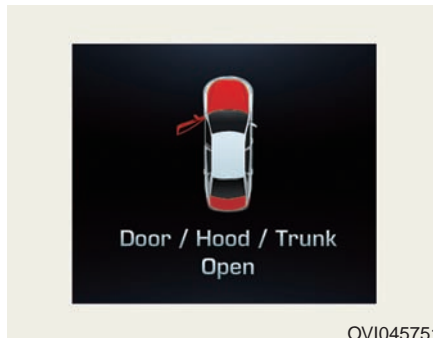

OVI045751

- It means that any door, hood, or trunk is open.

Sunroof Open

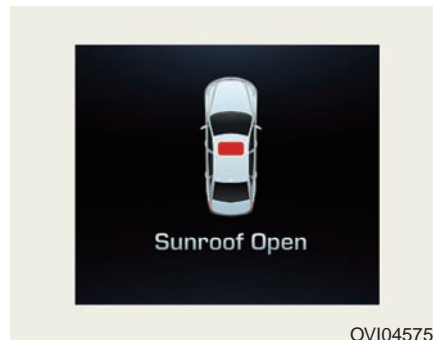

OVI045752

- This warning message illuminates, when the sunroof is open while turning OFF the engine.

Window Open

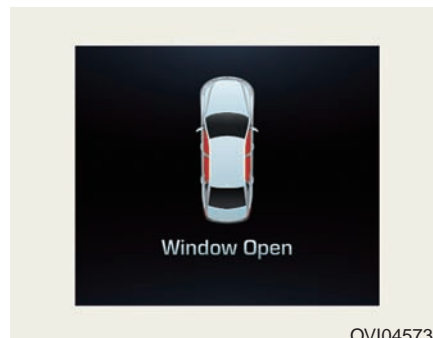

OVI045737

- This warning message illuminates, when any window is open while turning OFF the engine.

Convenient features of your vehicle

Check fuse "BRAKE SWITCH"

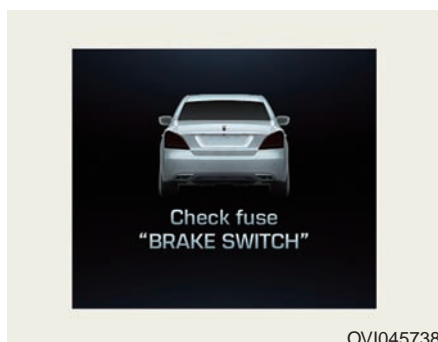

OVI045738

- This warning message illuminates if the brake switch fuse is disconnected.
- You need to replace the fuse with a new one. If not possible, you can start the engine by pressing the Engine Start/Stop button for 10 seconds in the ACC position.

Low Tire Pressure

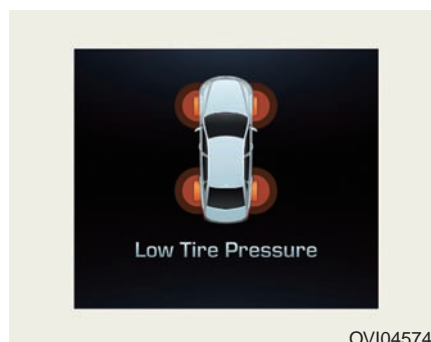

OVI045740

- This warning message illuminates, when the tire is under-inflated with the Engine Start/Stop button ON.

* For further information, refer to "Tire Pressure Monitoring System (TPMS)" in the chapter 6.

Turn on "FUSE SWITCH"

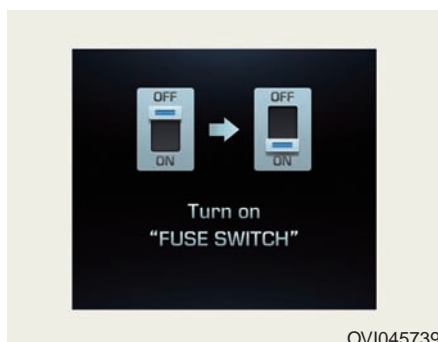

OVI045739

- This warning message illuminates if the fuse switch under the steering wheel is OFF.
- You should turn ON the fuse switch.

* For further information, refer to "Fuses" in the chapter 7.

Check Fuel Cap

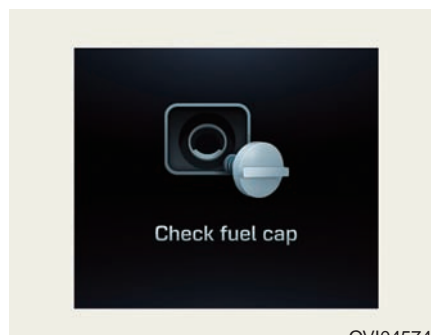

OVI045741

- This warning message illuminates, when the fuel filler cap is open or is not securely tightened. Securely close the fuel filler cap.

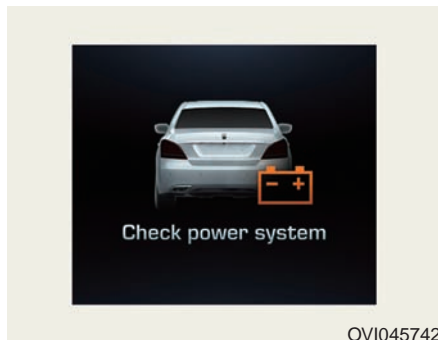
Check Power System

OVI045742

- This warning message illuminates, when the battery voltage is abnormally low, or the battery has poor performance. In this case, have your vehicle inspected by an authorized EQUUS dealer.

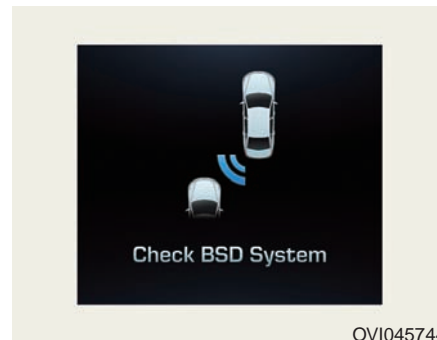
Check BSD System (if equipped)

OVI045744

- This warning message illuminates, when there is a malfunction with the Blind Spot Detection (BSD) system. The BSD indicator will turn OFF, when the BSD system is unintentionally deactivated. In this case, have your vehicle inspected by an authorized EQUUS dealer.

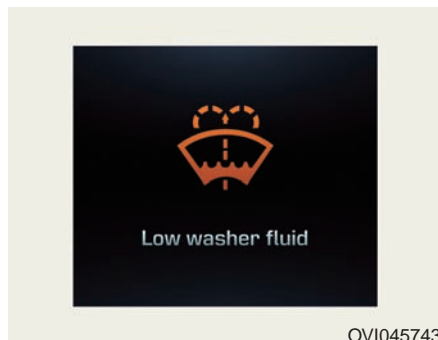
Low Washer Fluid

OVI045743

- This warning message illuminates in the service reminder mode, when the washer fluid level in the reservoir is nearly empty.
- You should refill the washer fluid.

* For further information, refer to "Blind Spot Detection (BSD) System" in the chapter 5.

Service Engine Immediately

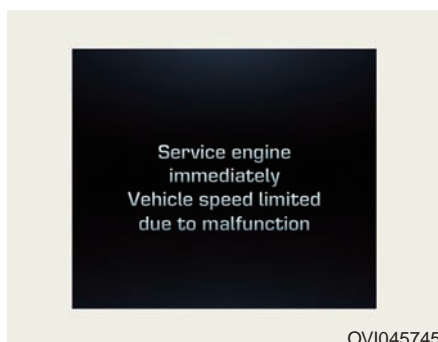

OVI045745

- This warning message illuminates, when there is a malfunction with the engine, and a driving speed is limited. In this case, have your vehicle inspected by an authorized EQUUS dealer.

Check ECS

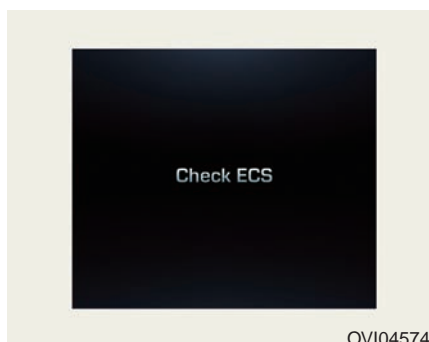

OVI045747

- This warning message illuminates, when there is a malfunction with the Electronic Controlled Suspension (ECS) system. In this case, have your vehicle inspected by an authorized EQUUS dealer.

Check PSB

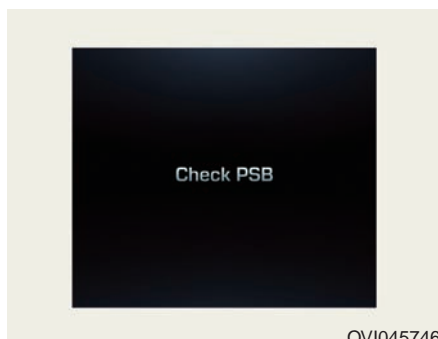

OVI045746

- This warning message illuminates, when there is a malfunction with the Presafe Seat Belt (PSB) system. In this case, have your vehicle inspected by an authorized EQUUS dealer.

* For further information, refer to "Electronic Controlled Suspension (ECS)" in the chapter 5.

Information - ECS Warning Message

When there is a malfunction with the Electronic Stability Control (ESC), the Electronic Controlled Suspension (ECS) warning message will illuminate, along with the illumination of the Electronic Stability Control (ESC) Indicator.

* For further information, refer to "Seat Belt" in the chapter 2.

NOTICE**- ECS Warning Message**

- When the Electronic Controlled Suspension (ECS) Warning Message illuminates due to the under-pressure inside the suspension, the vehicle height will be very low. In this case, do not drive the vehicle in order to protect it from a projection on a surface. In this case, have your vehicle inspected by an authorized EQUUS dealer.
- When towing the vehicle, you should follow the "Electronic Controlled Suspension (ECS)" instructions in the chapter 5.

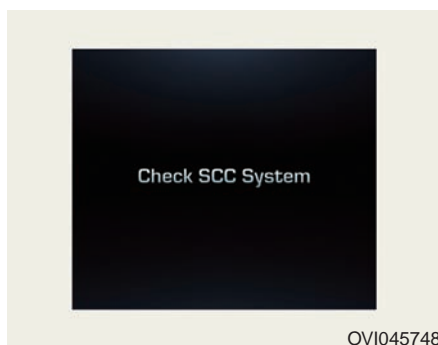
Check SCC System

- This warning message illuminates, when there is a malfunction with the advanced smart cruise control system. In this case, have your vehicle inspected by an authorized EQUUS dealer.
- ✳ For further information, refer to "Advanced Smart Cruise Control System" in the chapter 5.

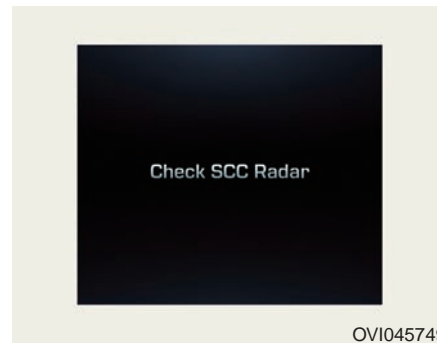
Check SCC Radar

- This warning message illuminates, when the radar of the advanced smart cruise control system or its cover is stained. Remove the stains with a soft cloth.

✳ For further information, refer to "Advanced Smart Cruise Control System" in the chapter 5.

TRIP COMPUTER

Overview

Description

The trip computer is a driving information system, controlled by a micro-computer. This displays driving-related information.

i Information

Some driving information, stored in the trip computer (i.e. average vehicle speed), is reset, when the battery is disconnected.

Trip Modes

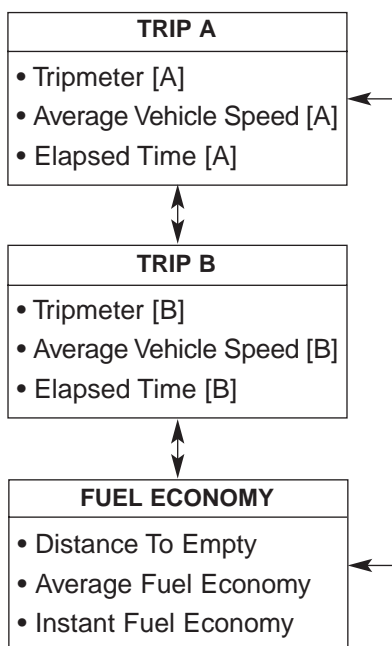

- Type A : To change the trip mode, press the > or < button.
- Type B : To change the trip mode, rotate the haptic switch.

* For further information, refer to "LCD Display control" in this chapter.

Trip A/B

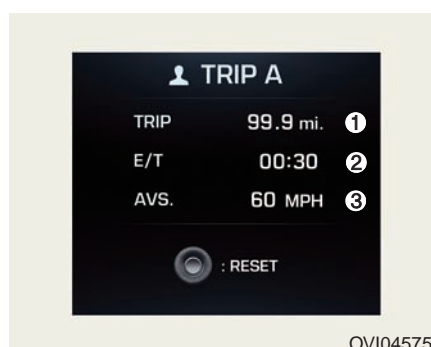

OVI045750

i Information

Even though you attempt to reset one of the tripmeter, elapsed time, and average vehicle speed information, it will reset all information together.

* For further information about the OK button, refer to "LCD Display Control" in this chapter.

Tripmeter (1)

- The tripmeter displays the accumulated driving distance information since its last default setting.
 - Distance range: 0.0 ~ 9999.9 mi. or km
- To reset the tripmeter, press the OK button on the steering wheel for 1 second or longer, when the tripmeter is displayed.

Elapsed Time (2)

- The elapsed time displays the accumulated driving hour information since its last default setting.
 - Time range (hh:mm): 00:00 ~ 99:59
- To reset the elapsed time, press the OK button on the steering wheel for 1 second or longer, when the elapsed time is displayed.

***i* Information**

Even though the vehicle is not in motion, the elapsed time keeps being recorded, while the engine is running.

Average Vehicle Speed (3)

- The average vehicle speed is calculated by dividing the accumulated driving distance by the accumulated driving hour since its last default setting.
 - Speed range: 0 ~ 999 MPH or km/h
- To reset the average vehicle speed, press the OK button on the steering wheel for 1 second or over, when the average vehicle speed is displayed.

***i* Information**

- The average vehicle speed is not displayed, when the vehicle drives shorter than 0.19 miles (300 meters) after turning ON the Engine Start/Stop button.
- Even though the vehicle is not in motion, the average vehicle speed keeps being recorded while the engine is running.

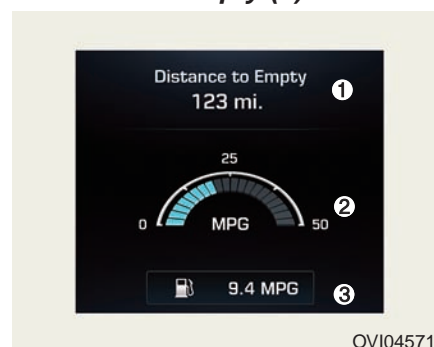
Fuel Economy**Distance To Empty (1)**

OVI045714

- The distance to empty is the estimated distance the vehicle can drive with the remaining fuel.
 - Distance range: 30 ~ 999 mi. or 50 ~ 999 km
- When the estimated distance to empty is shorter than 30 mi. (50 km), the trip computer displays “---”.

***i* Information**

- When the vehicle is not on level ground, or when the battery power is interrupted, the distance to empty may not be correctly calculated.
- The distance to empty may differ from the actual distance, as it is estimated with the calculable driving distance.
- The trip computer may not recognize additional fuel adding, when less than 1.6 gallons (6 liters) of fuel is added.
- The fuel economy and distance to empty may significantly vary according to driving conditions, driving habits, and vehicle conditions.

Convenient features of your vehicle

Instant Fuel Economy (2)

- This mode displays the instant fuel economy during the last few seconds when a driving speed exceeds 6.2 MPH (10 km/h).
 - Fuel economy range: 0 ~ 50 MPG or 0 ~ 20 L/100km

Average Fuel Economy (3)

- The average fuel economy is calculated by dividing the total driving distance by the fuel consumption since its last default setting.
 - Fuel economy range: 0.0 ~ 99.9 MPG or L/100km
- The average fuel economy can be reset both manually and automatically.

Manual reset

To manually reset the average fuel economy, press the OK button on the steering wheel for 1 second or over, when the average fuel economy is displayed.

- * For further information about the OK button, refer to "LCD Display Control" in this chapter.

Automatic reset

To automatically reset the average fuel economy after refueling, select the "Auto Reset" mode in User Setting menu on the LCD display (Refer to "LCD Display").

In "Auto Reset" mode, the average fuel economy will be reset to zero (---), when more than 1.6 gallons (6 liters) of fuel is added, and then a driving speed exceeds 1 km/h.

Information

The average fuel economy may display inaccurate calculation, when the vehicle drives shorter than 0.19 miles (300 meters) after turning ON the Engine Start/Stop button.

WARNING AND INDICATOR LIGHTS

Warning lights

Information

Make sure that all warning lights are turned OFF after starting the engine. When any light remains ON, this indicates the situation that your attention is required.

Supplemental Restraint System Warning Light



This warning light illuminates:

- Once you turn ON the ignition switch or Engine Start/Stop button.
 - It illuminates for approximately 6 seconds and then goes OFF.
- When there is a malfunction with the SRS.

In this case, have your vehicle inspected by an authorized EQUUS dealer.

Seat Belt Warning Light



This warning light informs the driver that the seat belt is not fastened.

- * For further information, refer to the "Seat Belts" in the chapter 2.

Parking Brake & Brake Fluid Warning Light



This warning light illuminates:

- Once you turn ON the ignition switch or Engine Start/Stop button.
 - It illuminates for approximately 3 seconds.
 - It remains ON, when the parking brake is set.
- When the parking brake is set.
- When the brake fluid level in the reservoir is low.
 - When the warning light illuminates with the parking brake released, it indicates the brake fluid level in reservoir is low.

When the brake fluid level in the reservoir is low:

1. Drive carefully to the nearest safe location and stop your vehicle.
2. Stop the engine, immediately check the brake fluid level and add fluid, as required (For further information, refer to "Brake Fluid" in the chapter 7). Then check all brake components for fluid leaks. When any leak in the brake system is still detected, when the warning light remains ON, or when the brakes do not properly operate, do not drive the vehicle.

In this case, have your vehicle inspected by an authorized EQUUS dealer.

Convenient features of your vehicle

Dual-diagonal braking system

Your vehicle is equipped with dual-diagonal braking systems. This means you still have braking on two wheels even if one of the dual systems fails.

With only one of the dual systems working, longer pedal travel and greater pedal pressure may be required to stop the vehicle.

Also, the vehicle will not stop in as short a distance only with one portion of the brake systems working.

If the brakes fail while you are driving, shift to a lower gear for additional engine braking and stop the vehicle as soon as it is safe to do so.

WARNING

- Parking Brake & Brake Fluid Warning Light

Driving the vehicle with a warning light ON is dangerous. If the Parking Brake & Brake Fluid Warning Light illuminates with the parking brake released, it indicates that the brake fluid level is low.

In this case, have your vehicle inspected by an authorized EQUUS dealer.

Anti-lock Brake System (ABS) Warning Light



This warning light illuminates in one of the following situations:

- You turn ON the ignition switch or Engine Start/Stop button.
 - It illuminates for approximately 3 seconds and then goes OFF.
- There is a malfunction with the ABS (The normal braking system is still operational without the assistance of the anti-lock brake system).

In this case, have your vehicle inspected by an authorized EQUUS dealer.

Electronic Brake force Distribution (EBD) System Warning Light



These two warning lights illuminate at the same time while driving in the following situation:

- The ABS and the regular brake system may not properly operate.
In this case, have your vehicle inspected by an authorized EQUUS dealer.

WARNING**- Electronic Brake force Distribution (EBD) System Warning Light**

When both ABS and the Parking Brake & Brake Fluid warning lights illuminate, the brake system does not properly operate. You may experience an unexpected and dangerous situation in a sudden braking.

In this case, avoid sharp driving and abrupt braking. Have your vehicle inspected by an authorized EQUUS dealer.

i Information**- Electronic Brake force Distribution (EBD) System Warning Light**

When the ABS warning light illuminates, or when both the ABS and the Parking Brake & Brake Fluid warning lights illuminate, the speedometer, the odometer, or the tripmeter may not properly operate. Also, the EPS warning light may illuminate, and the efforts to operate the steering wheel may require to increase or decrease.

In this case, have your vehicle inspected by an authorized EQUUS dealer.

Malfunction Indicator Lamp (MIL)

This warning light illuminates in one of the following situations:

- You turn ON either the ignition switch or the Engine Start/Stop button.
 - It remains ON until the engine is started.
- There is a malfunction with the emission control system.

In this case, have your vehicle inspected by an authorized EQUUS dealer.

NOTICE

- Malfunction Indicator Lamp (MIL)
Driving with the Malfunction Indicator Lamp (MIL) ON may damage the emission control systems which could affect drivability and/or fuel economy.

NOTICE**- Gasoline Engine**

When the Malfunction Indicator Lamp (MIL) illuminates, the catalytic converter is possibly damaged, resulting in loss of engine power.

In this case, have your vehicle inspected by an authorized EQUUS dealer.

Convenient features of your vehicle

Charging System Warning Light



When this warning light illuminates while the engine is running, the battery is not being charged. Immediately turn OFF all electrical accessories. Try not to use electrically operated controls, such as the power windows. Keep running the engine. Starting the engine will quickly discharge the battery.

When there is a malfunction with either the alternator or electrical charging system:

1. Drive carefully to the nearest safe location and stop your vehicle.
2. Turn OFF the engine and check whether the alternator drive belt is loose or broken.

Even though the belt is properly adjusted, there may be a problem in the electrical charging system.

In this case, have your vehicle inspected by an authorized EQUUS dealer.

Engine Coolant Temperature Warning Light



This warning light illuminates:

- When the engine coolant temperature is above 248°F (120°C). This means that the engine is overheated and may be damaged.

When your vehicle is overheated, refer to "Overheating" in the chapter 6.

NOTICE

- Engine Overheating

Do not continue driving with the overheated engine. Otherwise, the engine may be damaged.

Engine Oil Pressure Warning Light



This warning light illuminates:

- Once you turn ON the ignition switch or the Engine Start/Stop Button.
 - It remains ON until the engine is started.
- When the engine oil pressure is low.

When the engine oil pressure is low, follow the below procedures:

1. Carefully drive to the nearest safe location and stop your vehicle.
2. Turn OFF the engine and check the engine oil level (For further information, refer to the "Engine Oil" in the chapter 7). If the level is low, add the engine oil.

When the warning light remains ON after adding engine oil and restarting the engine, or when engine oil refilling is unavailable, turn OFF the engine. These indicate a mechanical problem, which needs to be repaired before continuously driving. In this case, have your vehicle inspected by an authorized EQUUS dealer.

NOTICE

- Engine Oil Pressure Warning light

To prevent severe engine damage, after the Engine Oil Pressure Warning Light illuminates and as soon as it is safe to do so, turn OFF the engine and check the engine oil level. When the oil level is low, add the engine oil to the proper level and start the engine again. When the light stays ON with the engine running, immediately turn OFF the engine.

In this case, have your vehicle inspected by an authorized EQUUS dealer.

Low Fuel Level Warning Light



This warning light illuminates:

When the fuel tank is nearly empty.

When the fuel tank is nearly empty:

Immediately refuel the vehicle.

NOTICE

- Low Fuel Level

Driving with the Low Fuel Level warning light ON or with the fuel level in the "E" range may cause the engine to misfire and damage the catalytic converter (if equipped).

Low Tire Pressure Warning Light



This warning light illuminates:

- Once you turn ON the ignition switch or the Engine Start/Stop button.
 - It illuminates for approximately 3 seconds and then goes OFF.
- When one or more of your tires are significantly underinflated (The location of the underinflated tires are displayed on the LCD display).

* For further information, refer to “Tire Pressure Monitoring System (TPMS)” in the chapter 6.

This warning light remains ON after flashing for approximately 60 seconds, or it repeatedly flashes an interval of approximately three seconds:

- There is a malfunction with the TPMS
In this case, have your vehicle inspected by an authorized EQUUS dealer.

* For further information, refer to “Tire Pressure Monitoring System (TPMS)” in the chapter 6.

WARNING

- Safe Stopping
- The TPMS cannot alert you to a severe and sudden tire damage caused by external factors.
- When any vehicle instability is noticed, immediately take your foot off the accelerator, gradually apply the brakes with light force, and slowly move to a safe place off a road.

Door Ajar Warning Light



This warning light illuminates:
When a door is not securely closed.

Trunk Open Warning Light



This warning light illuminates:
When the trunk lid is not securely closed.

Adaptive Front Lighting System (AFLS) Warning Light



This warning light blinks:

- Once you set the Engine Start/Stop Button to the ON position.
 - It illuminates for approximately 3 seconds and then goes off.
- When there is a malfunction with the AFLS.

When there is a malfunction with the AFLS:

1. Carefully drive to the nearest safe location and stop your vehicle.
2. Turn OFF the engine and restart the engine. If the problem persists, have your vehicle inspected by an authorized EQUUS dealer.

Electric Parking Brake (EPB) Warning Light



This warning light illuminates:

- Once you turn ON the ignition switch or the Engine Start/Stop button.
 - It illuminates for approximately 3 seconds and then goes off.
- When there is a malfunction with the EPB.

In this case, have your vehicle inspected by an authorized EQUUS dealer.

Information

- Electric Parking Brake (EPB) Warning Light

The Electric Parking Brake (EPB) warning light may illuminate, when the Electronic Stability control (ESC) indicator illuminates due to the ESC malfunction (This does not indicate malfunction of the EPB).

Master Warning Light



This indicator light illuminates:

- When there is a malfunction with the pre-safe seat belt, check the fuel cap, the washer level, the electronic control suspension, or the advanced smart cruise control. To identify the cause of the warning, look at the LCD display.

Indicator Lights

Electronic Stability Control (ESC) Indicator Light



This indicator light illuminates:

- Once you turn ON the ignition switch or the Engine Start/Stop button.
 - It illuminates for approximately 3 seconds and then goes OFF.
- When there is a malfunction with the ESC system.

In this case, have your vehicle inspected by an authorized EQUUS dealer.

This indicator flashes:

While the ESC is operating.

* For further information, refer to "Electronic Stability Control (ESC)" in the chapter 5.

Electronic Stability Control (ESC) OFF Indicator Light



This indicator light illuminates:

- Once you turn ON the ignition switch or the Engine Start/Stop button.
 - It illuminates for approximately 3 seconds and then goes OFF.
- When you deactivate the ESC system by pressing the ESC OFF button.

* For further information, refer to "Electronic Stability Control (ESC)" in the chapter 5.

Immobilizer Indicator Light



This indicator illuminates up to 30 seconds:

- When the vehicle detects the Smart Key in the vehicle while the Engine Start/Stop button is the ACC or ON position.
 - At this time, you can start the engine.
 - The indicator light goes off after starting the engine.

This indicator flashes for a few seconds:

- When the smart key is out of the vehicle.
 - At this time, you cannot start the engine.

This indicator illuminates for 2 seconds and goes OFF:

- When the Smart Key is not detected inside the vehicle while the Engine Start/Stop button is ON.

In this case, have your vehicle inspected by an authorized EQUUS dealer.

This indicator flashes:

- When the Smart Key battery is weak.
 - In this case, you cannot start the engine. However, by pressing the Engine Start/Stop button with the smart key, you may start the engine. (For further information, refer to "Starting the Engine" in the chapter 5).

- When there is a malfunction with the immobilizer system.

In this case, have your vehicle inspected by an authorized EQUUS dealer.

Turn Signal Indicator Light



This indicator flashes:

- When you turn the turn signal light ON.

When any of the followings occurs, there may a malfunction with the turn signal system. In this case, have your vehicle inspected by an authorized EQUUS dealer.

- The indicator light does not blink but illuminates.
- The indicator light blinks more rapidly.
- The indicator light does not illuminate at all.

Low Beam Indicator Light (if equipped)



This indicator light illuminates:

- When the headlamps are ON.

High Beam Indicator Light



This indicator light illuminates:

- When the headlamps are ON, or in the high beam position.
- When the turn signal lever is in the Flash-to-Pass position.

Light ON Indicator Light



This indicator light illuminates:

- When the headlamps or tail lights are ON.

Front Fog Indicator Light



This indicator light illuminates:

- When the front fog lights are ON.

Cruise Indicator Light



This indicator light illuminates:

- When the cruise control system is enabled.

* For further information, refer to "Cruise Control System" in the chapter 5.

Cruise SET Indicator Light



This indicator light illuminates:

- When the cruise control speed is set.

* For further information, refer to "Cruise Control System" in the chapter 5.

**AUTO HOLD Indicator Light
(if equipped)**



This indicator light illuminates:

- [White] When you activate the auto hold system by pressing the AUTO HOLD button.
- [Green] When you completely stop the vehicle by depressing the brake pedal with the auto hold system ON.
- [Yellow] When there is a malfunction with the auto hold system.
In this case, have your vehicle inspected by an authorized EQUUS dealer.

* For further information, refer to "Auto Hold" in the chapter 5.

**Lane Departure Warning System
(LDWS) Indicator Light
(if equipped)**



This indicator light illuminates:

- [Green] When you activate the Lane Departure Warning System by pressing the LDWS button.
- [White] When system operating conditions are not satisfied, or when the sensor does not detect the lane line.
- [Yellow] When there is a malfunction with the Lane Departure Warning System.

In this case, have your vehicle inspected by an authorized EQUUS dealer.

* For further information, refer to "Lane Departure Warning System (LDWS)" in the chapter 5.

Advanced Vehicle Safety Management (AVSM) OFF Indicator Light (if equipped)



This indicator light illuminates:

- Once you turn ON the Engine Start/Stop button
 - It illuminates for approximately 3 seconds and then goes OFF.
- When you deactivate the AVSM system on the LCD display.

* For further information, refer to "LCD Display" in this chapter.

When this indicator illuminates without selecting the AVSM OFF, there is a malfunction with the AVSM.

In this case, have your vehicle inspected by an authorized EQUUS dealer.

* For further information, refer to "Advanced Vehicle Safety Management (AVSM) System" in the chapter 5.

SPORT/SNOW Mode Indicator Light



This indicator light illuminates:

- When you select "SPORT/SNOW" mode as the drive mode.

* For further information, refer to "Drive mode integrated control system" in the chapter 5.

i Information

If you activate the Driving Mode Theme on the User Settings Mode of the LCD display (if equipped), the SPORT and SNOW indicators will not turn on the instrument cluster.

ECO Indicator Light (if equipped)



The ECO indicator light informs you to drive economically, and turns on green in accordance with the driving condition.

This indicator light illuminates:

- [Green] when you are driving economically.
- The driver's driving habit and road condition can affect fuel efficiency.
- The light will not display :
 - If the condition does not meet economical driving such as P (Park), N (Neutral), R (Reverse), or sports mode.
 - While the instant fuel Economy of the trip computer is display on the LCD display.
- In the "User Settings Mode" of the LCD, you can activate or deactivate the ECO driving mode.

* For further information, refer to "LCD Display" in this chapter.

⚠ WARNING

Do not monitor the ECO indicator while driving. This will distract you and may cause an accident, resulting in severe personal injury.

HEAD UP DISPLAY (HUD) (IF EQUIPPED)

Description



The head up display is a transparent display which projects a shadow of some instrument cluster information and navigation on the windshield glass.

- The head up display image on the windshield glass may be invisible when:
 - Sitting posture is bad.
 - Wearing polarized sunglasses.
 - There is an object on the cover of the head up display.
 - Driving on a wet road.
 - An inadequate lighting is turned ON inside the vehicle.
 - Any light comes from the outside.
 - Wearing glasses.
- If the head up display image is not shown well, adjust the height or illumination of the head up display in the LCD display.

※ For further information, refer to "LCD Display" in this chapter.

- When the head up display needs inspection or repair, have your vehicle inspected by an authorized EQUUS dealer.

⚠ WARNING

- Head Up Display
- Do not tint the front windshield glass or add other types of metallic coating. Otherwise, the head up display image may be invisible.
- Do not place any accessories on the crash pad or attach any objects on the windshield glass.
- Even though the Blind Spot Detection (BSD) system is a supplemental device for your safe driving, it may be dangerous to rely on only the BSD information on the head up display when changing the lane. Always pay attention to drive safely.

NOTICE

When replacing the front windshield glass of the vehicles equipped with the head up display, replace it with a windshield glass designed for the head up display operation. Otherwise, a single image may display in duplicate on the windshield glass.

Head Up Display ON/OFF

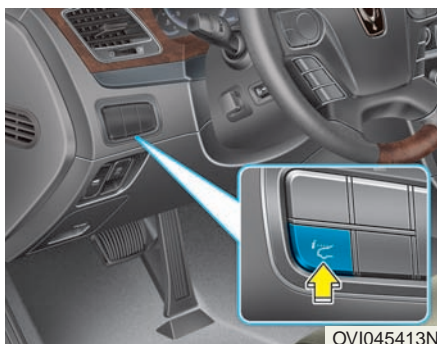

To activate the head up display, press the HUD button.

If you press the HUD button again, the head up display will be deactivated.

Head Up Display Information



1. Cruise Setting Speed
2. Lane Departure Warning System (LDWS) Information (if equipped)
3. Advanced Smart Cruise Control (ASCC) Information (if equipped)
4. Road Signs
5. Speedometer
6. Turn By Turn (TBT) Navigation Information (if equipped)
7. Blind Spot Detection (BSD) System Information (if equipped)
8. Warning Lights (Low fuel, BSD)

In the "User settings Mode" of the LCD display, you can activate or deactivate the Turn By Turn (TBT) navigation, the Smart Cruise Control (SCC), the Lane Departure Warning System (LDWS), and the Blind Spot Detection (BSD) system information.

i Information

When you select the Turn By Turn (TBT) navigation as the HUD content, the Turn By Turn (TBT) navigation will not be displayed on the LCD display.

Head Up Display Setting

On the LCD display, you can change the head up display settings as follows.

1. Display height
2. Rotation
3. Font color
4. Font size
5. Illumination
6. Contents setting

* For further information, refer to "LCD Display" in this chapter.

PARKING ASSIST SYSTEM

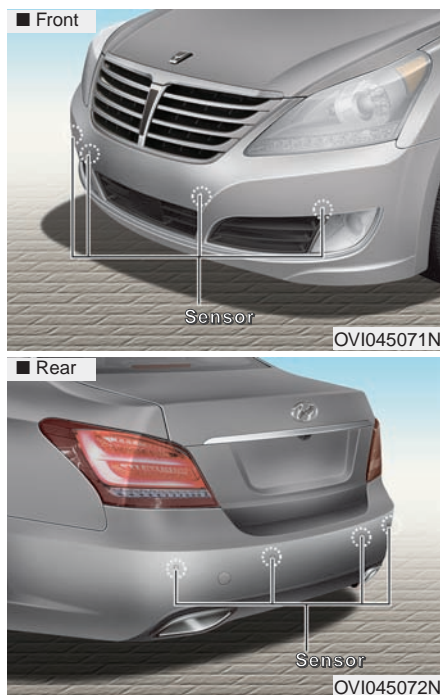

⚠ WARNING

The parking assist system should be considered only as a supplementary function. The driver must check the front and rear views. The operational function of the parking assist system can be affected by many factors and surrounding conditions, so the responsibility should always be held by the driver.

The parking assist system helps the driver in parking the vehicle by beeping the buzzer, when any object is sensed within 39 in (100 cm) from a vehicle in front or 47 in (120 cm) from a vehicle behind.

This system is a supplemental system, which is not designed to be and cannot be replaced with driver's extreme care and attention.

The sensing range and detectable objects by the sensor is limited. Whenever parking the vehicle, pay as much attention to what is in front of and behind your vehicle, as you would drive without a parking assist system.

Operation of the Parking Assist System

Operating conditions

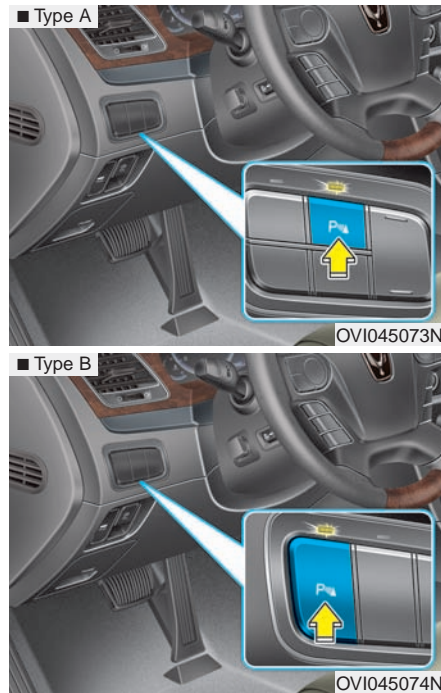

- When the Engine Start/Stop button is ON
- When the shift lever is in the D or R position
- When the vehicle speed is below 6 mph (10 km/h)







Press the parking assist system button to turn the parking assist system ON. The indicator in the button illuminates.

To turn OFF the system, press the button again. Then, the indicator goes OFF.

- The system will automatically operate every time the driving speed is below 6 mph (10 km/h) with the system switched ON.
- When you move the shift lever to the R position with the system switched OFF, the indicator will turn ON and the system will operate automatically regardless of button status. However, when the vehicle speed exceeds 12 mph (20 km/h) while driving forwards, the indicator will turn OFF. The system will not automatically operate again, even when the driving speed falls below 6 mph (10 km/h).
To turn ON the system, press the parking assist system button.
- When more than two objects are sensed at the same time, the closest one will be recognized first.

Convenient features of your vehicle

Types of warning sound and indicator

Distance from object		Warning indicator		Warning sound
		When driving forward	When driving rearward	
39 in. ~ 24 in. (100cm~60cm)	Front		-	Buzzer beeps intermittently
47 in. ~ 24 in. (120cm~60cm)	Rear	-		Buzzer beeps intermittently
24 in. ~ 12 in. (60cm~30cm)	Front			Buzzer beeps frequently
	Rear	-		Buzzer beeps frequently
12 in. (30cm)	Front			Buzzer sounds continuously
	Rear	-		Buzzer sounds continuously

Information

The indicator may differ from the illustration according to an object or a sensor status. When the indicator flashes, we recommend that the system be checked by an authorized EQUUS dealer.

Inoperable conditions of the Parking Assist System

The Parking Assist System may not properly operate, when:

1. Moisture is frozen over the sensor. (It will operate normally again when the frozen ice melts.)
2. The sensor is covered or blocked with foreign substances, such as snow or water. (It will normally operate again when the substance is removed, and the sensor is no longer blocked.)
3. The sensor is stained with foreign substances such as snow or water. (The sensing range will return to normal when foreign substances are removed.)

There is a possible malfunction with the Parking Assist System when:

1. The vehicle drives on uneven road surfaces such as unpaved roads, gravels, bumps, or slopes.
2. The sensor is interfered with objects, which generate excessive noise, such as horns, motorcycle engines, or truck air brakes.
3. Heavy rain or water is sprayed.
4. Wireless transmitters or mobile phones are near the sensor.
5. The sensor is covered with snow.

Detecting range may decrease when:

1. Outside air temperature is extremely hot or cold.
2. The sensor cannot detect an object, as it is smaller than 39 in (1 m) or narrower than 5.5 in (14 cm) in diameter.

The following objects may not be recognized by the sensor:

1. A sharp or slim object, such as ropes, chains or small poles.
2. An object, such as clothes, spongy material or snow, absorbs the sensor frequency.

***i* Information**

1. The warning may not sound sequentially depending on the speed and shapes of the objects detected.
2. The Parking Assist System may malfunction if the vehicle bumper height or sensor installation is modified. Any unauthorized installment of equipment or accessories may also limit the sensor performance.
3. Sensor may not recognize objects within 12 in (30 cm), or it may miscalculate the distance.
4. When the sensor is frozen or stained with snow or water, the sensor may be inoperative until the stains are removed using a soft cloth.
5. Do not push, scratch or strike the sensor with any hard objects that could damage the sensor surface. This may damage the sensor.

i Information

This system can only sense objects within the certain range and location. It cannot detect objects in other areas where sensors are not installed. Also, the sensor may not detect small and slim objects, or objects located in blind spots between sensors.

Always check the presence of any objects in front of or behind the vehicle with your eyes when parking. Make sure to inform these system capabilities and limitations to any drivers of this vehicle who may be unfamiliar with the system.

⚠ WARNING

Pay close attention when the vehicle is driven close to objects on the road, particularly pedestrians, and especially children. Be aware that some objects may not be detected by the sensors, due to the object distance, size or material, all of which can limit the effectiveness of the sensor. Always make sure that the vehicle stands clear of all objects with your eyes before moving the vehicle in any direction.

Self-diagnosis

If you do not hear an audible warning sound or if the buzzer sounds intermittently when shifting the gear to the R (Reverse) position, this may indicate a malfunction with the rear Parking Assist System. In this case, have your vehicle checked by an authorized EQUUS dealer as soon as possible.

⚠ WARNING

Your new vehicle warranty does not cover any accidents or damage to the vehicle or injuries to its occupants related to the Parking Assist System. Always drive safely and cautiously.

REARVIEW CAMERA (IF EQUIPPED)



i Information

The rearview camera may not operate normally, when you drive in the extremely high or low temperature. (Operating temperature: -4°F ~ 149°F (-20°C ~ 65°C))

The rearview camera activates when the back-up light and the ignition switch are ON and the shift lever in the R position.

This system is mere a supplemental system that shows the rearview behind the vehicle on the navigation display panel while backing up.

⚠ WARNING

- This system is for the supplementary function only. It is the driver's responsibility to always check the inside/outside rearview mirrors and the area behind the vehicle before and while backing up.
- Always keep the camera lens clean. If the lens is covered with foreign substance, the camera may not operate normally.

MULTI-VIEW CAMERA SYSTEM (IF EQUIPPED)



The Multi-view Camera System can assist in parking by allowing the driver to see around the vehicle. Press the button to turn ON the system. To turn OFF the system, press the button again.

Operating conditions

- When the Engine Start/Stop button is ON
- When the shift lever is in the D, N or R position
- When the vehicle speed is below 12.4 mph (20km/h)

CAUTION



- 1) Front camera
- 2) Left/Right camera
- 3) Rear camera

(Continued)

(Continued)

- Multi-view Camera System only serves to assist the driver in parking. ALWAYS look around your vehicle to make sure there are no objects or obstacles before moving the vehicle.
- Always keep the camera lens clean. The camera may not work normally if the lens is covered with foreign material.

i Information

- When vehicle speed is over 12.4 mph (20km/h), the multi-view camera system will turn off. The system will not automatically turn on again, even though vehicle speed gets below 12.4 mph (20 km/h). Push the button again, to turn on the system.
- When the vehicle is backing up, the multi-view camera system will turn ON regardless of vehicle speed or button status. However, if vehicle speed is over 6.2 mph (10 km/h) when driving forward, the system will turn off.
- A warning appears on the system in one of the following situations:
 - The trunk is opened
 - The driver's door is opened
 - The passenger's door is opened
 - The outside rearview mirror is folded
- When the multi-view camera system does not normally operate, have the system checked by an authorized EQUUS dealer.

You may find further information in a separate-volume supplement to this Owner's Manual.

LIGHTING

Battery saver function

- The purpose of this function is to prevent the battery from being discharged. The system automatically turns OFF the parking lights when the driver turns OFF the engine and opens the driver's door.
- With this function, the parking lights are turned OFF automatically if the driver parks the vehicle on the side of the road at night.
If necessary, in order to keep the lights ON when the engine is turned OFF, perform the followings:
 - 1) Open the driver-side door.
 - 2) Turn the parking lights ON and OFF again using the light switch on the steering column.

Headlamp escort function

When you press the Engine Start/Stop button to the ACC or OFF position with the headlamps ON, the headlamps (and/or tail lights) remain ON for approximately 5 minutes. However, when the driver's door is open and then closed, the headlamps are turned OFF after 15 seconds.

The headlamps can be turned OFF by pressing the lock button on the Smart Key twice or turning the light switch to the OFF or Auto position.

However, when you turn the light switch to the Auto position, and when it is dark outside, the headlamps will not be turned OFF.

NOTICE

If the driver exit the vehicle through other doors (except driver's door), the battery saver function does not operate and the headlamp escort function does not turn OFF automatically. Therefore, it discharges the battery. In this case, make sure to turn OFF the lamp before exiting the vehicle.

Lighting control

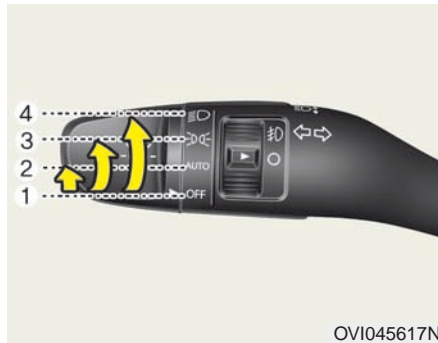

The light switch turns to be in the Headlamp or Parking light position.

To operate the lights, turn the knob on the control lever to one of the following positions:

- (1) OFF position
- (2) Auto light / AFLS position
- (3) Parking light position
- (4) Headlight position

Auto light/AFLS position

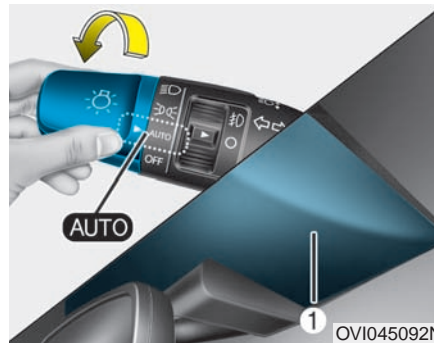

When the light switch is in the AUTO light position while the engine is running, the taillights and headlamps will be turned ON or OFF automatically depending on an outside brightness level.

When your vehicle is equipped with the Adaptive Front Lighting System (AFLS), and when the headlamp is ON, it will also operate.

NOTICE

- Never place anything over the sensor (1) located on the instrument panel. This will enhance the auto-light system control.
- Do not clean the sensor using window cleaner. The cleaner may leave on the light film, which may interfere with sensor operation.
- When your vehicle has window tint or other types of metallic coating on the front windshield, the Auto light system may not work properly.

Parking light position (㉔)



When the light switch is in the parking light position, the tail, license and instrument panel lights are ON and the tail light indicator is ON.

Headlamp position (㉕)



When the light switch is in the headlamp position, the head, tail, license and instrument panel lights are ON.

i Information

The Engine Start/Stop button must be pressed ON to turn ON the headlamps.

High beam operation

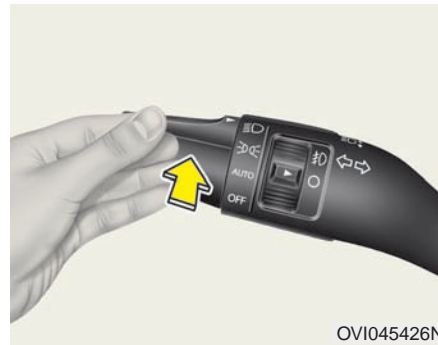

To turn ON the high beam headlamps, push the lever away from you. Pull it back for low beams. The high beam indicator illuminates, when the headlamp high beams are switched ON.

To prevent the battery from being discharged, do not leave the lights ON for a prolonged period of time while the engine is not running.

⚠ WARNING

Do not use high beam when there are other vehicles. Using high beam could obstruct the other driver's vision.



To flash the headlamps, pull the lever towards you. It will return to the default (low beam) position when released. The headlamp switch does not need to be ON to flash the headlamps.

Turn signals and lane change signals

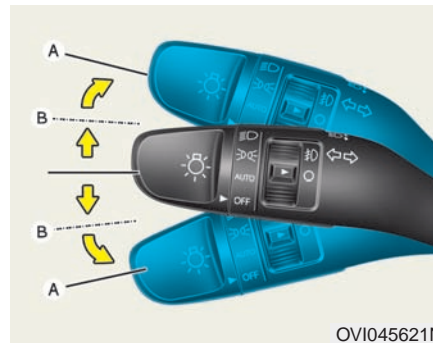

The ignition switch must be ON to turn ON the turn signals. To turn ON the turn signals, move the lever up or down (A). Green arrow indicators on the instrument panel indicate which turn signal is operating. They will be automatically OFF after a vehicle completes a turn. If the indicator continues to flash after a turn, manually return the lever to the OFF position.

To signal a lane change, move the turn signal lever slightly and hold it in position (B). The lever will return to the OFF position when released.

If an indicator stays on and does not flash or if it flashes abnormally, one of the turn signal bulbs may be burned out and require replacement.

One-touch triple turn signal

To activate a one-touch triple turn signal, move the turn signal lever slightly for less than 1.8 seconds and then release it. The lane change signals will flash three times.

You can activate or deactivate this function. Refer to the "User Settings" in this chapter.

i Information

If an indicator flash is abnormally quick or slow, a bulb may be burned out or have a poor electrical connection in the circuit.

Front fog light

OVI045251C

Fog lights improve visibility and help to avoid accidents which happen due to poor visibility with fog, rain, snow, etc. The fog lights will turn ON when fog light switch (1) is turned to ON with the headlamps ON.

To turn OFF the fog lights, turn the switch to OFF.

NOTICE

When in operation, the fog lights consume large amounts of vehicle electrical power. Use the fog lights only when visibility is poor. Unnecessary usage may drain the battery.

Daytime running light

Daytime Running Lights (DRL) can make it easier for others to see the front of your vehicle during the daytime. DRL can be helpful in many different driving conditions, especially after dawn or before sunset.

The DRL system will turn OFF when:

1. The headlamp switch is ON.
2. The parking brake is set.
3. Engine stops.

Headlight leveling device**Automatic type**

It automatically adjusts the headlamp beam levels according to the number of passengers and the loading weight in the luggage area.

It offers the proper headlight beam under various conditions.

WARNING

When it does not properly operate, or when the headlamp beam is isolated to the high or low position, have your vehicle inspected by an authorized EQUUS dealer.

Do not attempt to inspect or replace the wiring by yourself.

Convenient features of your vehicle

AFLS (Adaptive Front Lighting System) (if equipped)

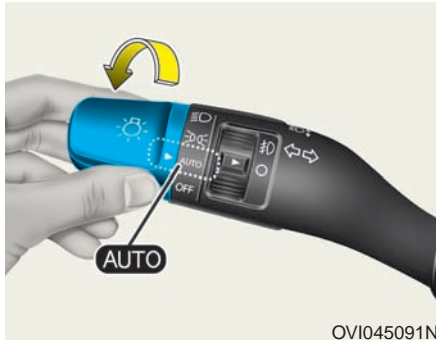

OVI045091N

The AFLS uses the steering angle and vehicle speed to widen your field of vision by swiveling and leveling the headlamp. Turn the knob to the AUTO position when the engine is running. The AFLS will operate when the headlamp is ON. To turn OFF the AFLS, turn the knob to the other position. After turning the AFLS OFF, headlamp swiveling no longer occurs, but leveling operates continuously.

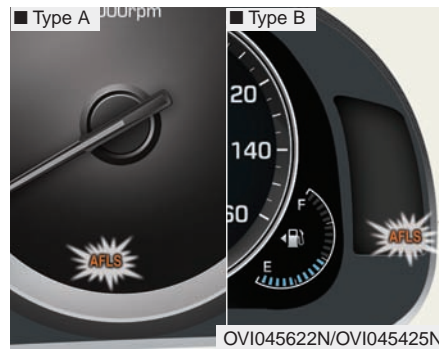

If the AFLS malfunction indicator illuminates, the AFLS does not work properly. Drive to the nearest safe location and restart the engine. If the indicator continuously remains ON, have your vehicle inspected by an authorized EQUUS dealer.

WIPERS AND WASHER

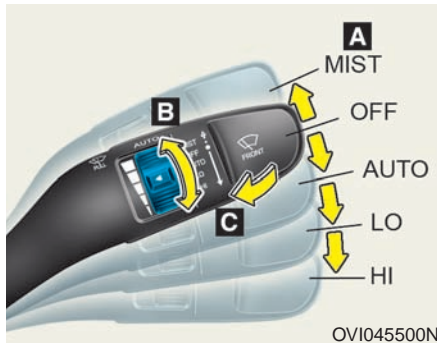

- A : Wiper speed control
- MIST – Single wipe
 - OFF – Off
 - AUTO – AUTO control wipe
 - LO – Low wiper speed
 - HI – High wiper speed
- B : Auto control wipe time adjustment
- C : Wash with brief wipes

Windshield wipers

Operate the windshield wipers as follows when the ignition switch is turned ON.

MIST : For a single wiping cycle, push the lever upward and release it with the lever in the OFF position. The wipers will operate continuously if the lever is pushed upward and held.

OFF : Wiper is not in operation.

AUTO : The rain sensor located on the upper end of the windshield glass senses the amount of rainfall and controls the wiping cycle at the proper interval. The more it rains, the faster the wiper operates. When the rain stops, the wiper stops. To vary the speed setting, turn the speed control knob (B).

LO : Normal wiper speed

HI : Fast wiper speed

i Information

If there is a thick pile of snow or ice on the windshield, defrost the windshield for about 10 minutes, or until the snow and/or ice is melted away before using the windshield wipers to properly operate.

i Information

- When you operate the wipers, if your vehicle has a problem in any part of the wiper operation system, the wiper may operate in the **LO** mode regardless of the wiper switch position. In this case, have your vehicle checked by an authorized **EQUUS** dealer as soon as possible.
- When the engine is turned OFF, the wiper blade sometimes may move slightly for reducing the deterioration of the windshield wipers.

Auto control

The rain sensor located on the upper end of the windshield glass senses the amount of rainfall and controls the wiping cycle at the proper interval. The more it rains, the faster the wiper operates. When the rain stops, the wiper stops. To vary the speed setting, turn the speed control knob (B). If the wiper switch is set in AUTO mode when the Engine Start/Stop Button is ON, the wiper will operate once to perform a self-check of the system. Set the wiper to OFF position when the wiper is not in use.

NOTICE

When the Engine Start/Stop Button is ON and the windshield wiper switch is placed in the AUTO mode, use caution in the following situations to avoid any injury to the hands or other parts of the body:

- Do not touch the upper end of the windshield glass facing the rain sensor.
- Do not wipe the upper end of the windshield glass with a damp or wet cloth.
- Do not put pressure on the windshield glass.

NOTICE

When washing the vehicle, set the wiper switch in the OFF position to stop the auto wiper operation.

The wiper may operate and be damaged if the switch is set in the AUTO mode while washing the vehicle.

Do not remove the sensor cover located on the upper end of the passenger side windshield glass. The system parts may be damaged and may not be covered by your vehicle warranty.

When starting the vehicle in winter, set the wiper switch in the OFF position. Otherwise, wipers may operate and ice may damage the windshield wiper blades. Always remove all snow and ice and defrost the windshield properly prior to operating the windshield wipers.

Windshield washer



OVI045099N

In the OFF position, pull the lever gently toward you to spray window washer fluid on the windshield and operate the wipers one to three times.

Use this function when the windshield is dirty.

The spray and wiper operation will continue until you release the lever.

If the washer does not work, check the washer fluid level. If the fluid level is not sufficient, you will need to add authorized non-abrasive windshield washer fluid to the washer reservoir.

The reservoir filler neck is located in the front of the engine compartment in the passenger side.

NOTICE

To prevent possible damage to the washer pump, do not operate the washer when the fluid reservoir is empty.

WARNING

Do not use the washer in freezing temperatures before warming the windshield with the defrosters; the washer fluid could be frozen on contact with the windshield and obscure your vision.

NOTICE

- To prevent possible damage to the wipers or windshield, do not operate the wipers when the windshield is dry.
- To prevent damage to the wiper blades, do not use gasoline, kerosene, paint thinner, or other solvents on or near them.
- To prevent damage to the wiper arms and other components, do not manually attempt to move the wipers.

INTERIOR LIGHT

NOTICE

Do not use the interior lights for an extended period of time when the engine is OFF.

It may discharge the battery.

⚠ WARNING

Do not use the interior lights when driving in the dark. Accidents could happen because the view may be obscured by interior lights.

Front

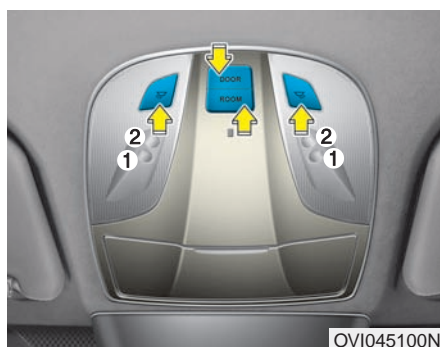

(1) Front map lamp

(2) Front room lamp

☞ ☞ :

Press the button to turn the map lamp ON. This light produces a spot beam for your convenience as a map lamp at night or as a personal lamp for the driver and the front passenger. To turn the lamp OFF, press the button again.

• DOOR :

The front and rear room lamps are turned ON for approximately 30 seconds after unlocking the doors with the smart key, but before opening a door. When the Engine Start/Stop Button is in the ACC or OFF position, and if any door is opened, the front or rear room lamp will be ON for approximately 20 minutes. If the door is closed, the lamps will be turned OFF in 30 seconds.

The front and rear room lamps will be turned OFF immediately if the Engine Start/Stop Button is turned ON with all doors closed.

When the Engine Start/Stop Button is ON, if any door is opened, the front or rear room lamp will be turned ON continuously. If the door is closed, the lamp will be turned OFF immediately.

• ROOM :

Press the button to turn the front and rear room lamps ON. To turn the lamps OFF, press the ROOM button again.

Rear

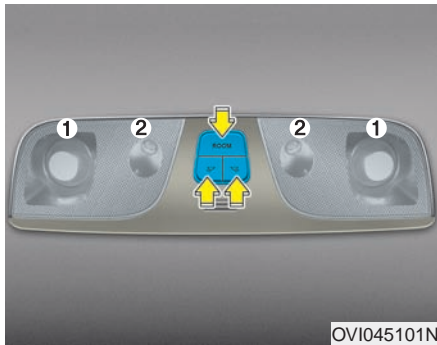

- (1) Rear map lamp
- (2) Rear room lamp

- :
Press the button to turn the rear lamp ON. To turn the lamp OFF, press the button again.
- ROOM :
Press the button to turn the rear room lamps ON. To turn the lamps OFF, press the ROOM button again.

NOTICE

Do not leave the lamp switches ON for an extended period of time when the vehicle is not running.

Trunk room lamp



The trunk room lamp is turned ON when the trunk is opened.

NOTICE

The trunk room lamp is ON until the trunk lid is opened. To prevent unnecessary charging system drain, close the trunk lid securely after using the trunk room.

Door courtesy lamp



The door courtesy lamp is turned ON when the door is opened to assist entering or exiting the vehicle. It also serves as a warning to passing vehicles that the vehicle door is opened.

Convenient features of your vehicle

Glove box lamp

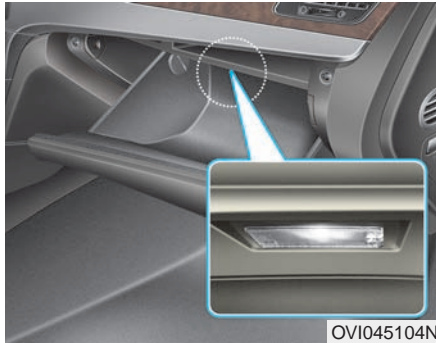

The glove box lamp is turned ON when the glove box is opened.

NOTICE

To prevent unnecessary charging system drain, close the glove box securely after using the glove box.

Vanity mirror lamp

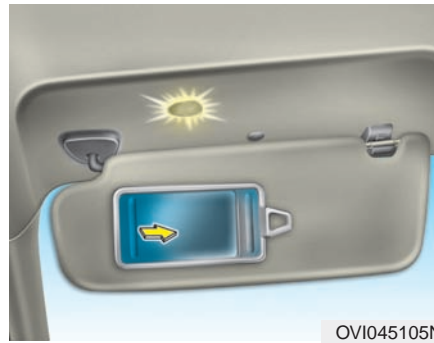

Opening the lid of the vanity mirror automatically turns the mirror light ON.

NOTICE

To prevent unnecessary charging system drain, close the vanity mirror cover after using the mirror.

WELCOME SYSTEM

Puddle lamp



OVI045402N

With all the doors (and trunk) closed and locked, the puddle lamp will be turned ON for approximately 15 seconds, when any of the followings is performed.

- The door unlock button on the Smart Key is pressed.
- You grab the door handle while taking the Smart Key in your possession.
- You approach to the vehicle, while taking the Smart Key in possession.

Also, when the outside rearview mirror folding switch is in the AUTO position, the outside rearview mirror will be automatically unfolded.

Headlamp

With the headlamp (light switch in the headlamp or AUTO position) ON, and with all doors (and trunk) closed and locked, the parking lights and headlamps will be turned ON for 15 seconds, when the following is performed.

- The door unlock button on the Smart Key is pressed.

At this time, when you press the door lock or unlock button, the position light and headlamps will immediately turn OFF.

Interior light

With the interior light switch in the DOOR position and all doors (and trunk) closed and locked, the room lamp will be turned ON for 30 seconds, if any of the followings is performed.

- The door unlock button on the smart key is pressed.
- You put your hand into the door handle while taking the smart key in your possession.

At this time, when you press the door lock or unlock button, the room lamp will be immediately turned OFF.

DEFROSTER

NOTICE

To prevent damage to the conductors located under the rear window surface, never use sharp instruments or window cleaners containing abrasives to clean the window.

i Information

If you want to defrost and defog the front windshield, refer to “Windshield defrosting and defogging” in this chapter.

Rear window defroster



The defroster heats the window to remove frost, fog and thin ice from the rear window, while the engine is running.

To activate the rear window defroster, press the rear window defroster button located on the center facia switch panel. The rear window defroster indicator illuminates when the defroster is ON.

If there is a heavy accumulation of snow on the rear window, brush it off before operating the rear defroster.

The rear window defroster automatically turns OFF after approximately 20 minutes or when the ignition switch is turned OFF. To turn OFF the defroster, press the rear window defroster button again.

Outside rearview mirror defroster

If your vehicle is equipped with the outside rearview mirror defrosters, they operate at the same time when the rear window defroster is turned ON.

Front wiper deicer

If your vehicle is equipped with the front wiper deicer, it operate at the same time when the rear window defroster is turned ON.

AUTOMATIC CLIMATE CONTROL SYSTEM

■ Front



■ Rear

• Type A



• Type B



OVI045107N/OVI045423N/OVI045424N/OVI045421N

- | | |
|--|---|
| 1. Driver's temperature control knob | 11. Mode selection button |
| 2. Front windshield defrost button | 12. Climate information screen selection button |
| 3. Rear window defrost button | 13. Fan speed control button |
| 4. AUTO (automatic control) button | 14. OFF button (Rear) |
| 5. Fan speed control button | 15. Mode selection button (Rear) |
| 6. OFF button | 16. AUTO (automatic control) button |
| 7. Air intake control button / AQS (Air quality system) button | 17. Rear side temperature control button |
| 8. Air conditioning button | 18. AUTO (automatic control) or off button |
| 9. 3 zone (Driver, passenger and rear side) control button | 19. LCD display |
| 10. Passenger's temperature control knob | |

Convenient features of your vehicle

Automatic heating and air conditioning

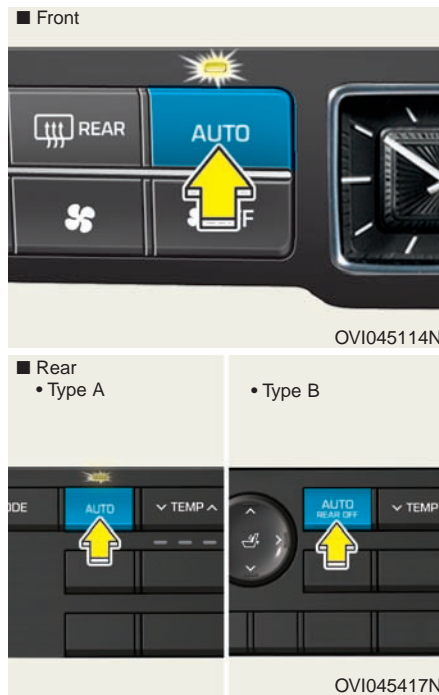

1. Press the AUTO button.
The modes, fan speeds, air intake and air-conditioning will be controlled automatically according to the temperature setting.



2. Turn the temperature control knob for front seats or press the temperature control button for rear seats to set the desired temperature.

i Information

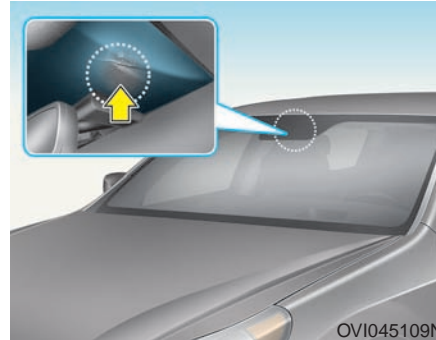

- To turn the automatic operation OFF, select any button among the followings and press:
 - Mode selection button
 - Front windshield defrost button (Press the button one more time to deselect the front windshield defroster function. The 'AUTO' sign will illuminate on the information display once again.)
 - Fan speed control buttonThe selected function will be controlled manually while other functions operate automatically.
- For your convenience and improved climate control effects, use the AUTO button and set the temperature at 73°F (23°C).

**i Information**

Never place anything near the sensor for better control of the heating and cooling system.

Manual air heating and cooling

The heating and cooling system can be controlled manually by pushing buttons except the AUTO button. In this case, the system works sequentially according to the order of button selection. When pressing any button except the AUTO button in automatic mode, the selected function will be changed not to be controlled automatically.

1. Start the engine.
2. Set the mode, as desired.
For improved heating and cooling effects:
 - Heating: 
 - Cooling: 
3. Set the temperature control, as desired.
4. Set the air intake control to the outside (fresh) air position.
5. Set the fan speed control, as desired.
6. If air conditioning operation is needed, turn the air conditioning system ON.

Press the AUTO button in order to convert to the full automatic mode of the climate control system.

3 Zone control button

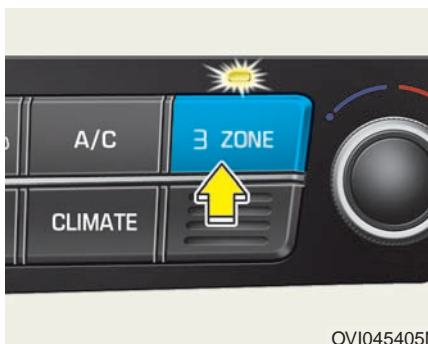

OVI045405N

1. Press the 3 zone control button to separately set the front passenger's temperature, rear side temperature, and rear side mode. The 3 zone control indicator will illuminate. Pressing the rear side temperature button, rear side mode button or turning the front passenger's temperature knob will activate the 3 zone control mode as well.
2. Press the 3 zone control button again to deactivate the 3 zone control mode. The front passenger's temperature, rear side temperature, and rear side mode will be set as the driver's side mode.

Information

You can activate or deactivate the rear climate control button on the rear armrest by pressing the RSE LOCKED button on the rear armrest or on AVN(Audio, Video, and Navigation).

You may find further information about AVN in a separate-volume supplement to this Owner's Manual.

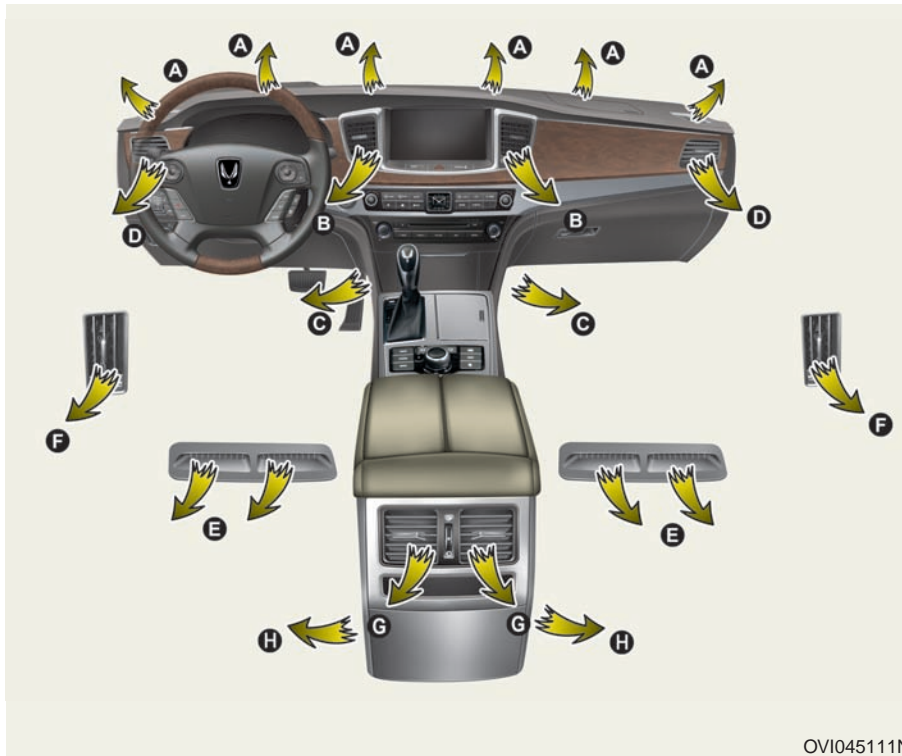
Mode selection*** Rear air outlet (F)**

- The air flow of the rear air outlets is controlled by the front climate control system, and the air is delivered through the air duct of the front doors. If the door is open or not securely closed, the air flow to the rear air outlet can be improperly delivered. Make sure the front doors are closed completely.
- The air flow from the rear air outlet may be weaker than the one from instrument panel air outlet due to the long air duct of the front doors.

Convenient features of your vehicle

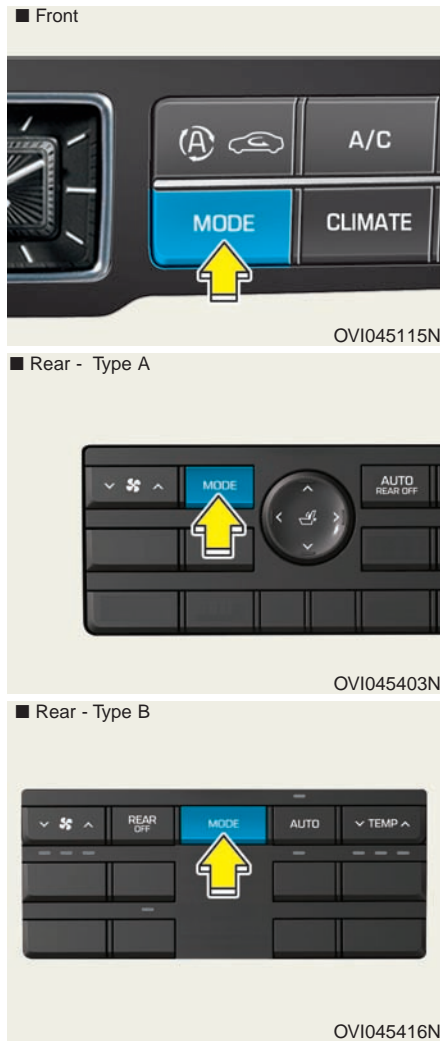

Front button

The mode selection button controls the air flow direction from the ventilation system.

The air flow outlet can be converted as follows:



 **Face-Level (B, D, F, G)**

Air flow is directed toward the upper body and face. Additionally, each air outlet port can be controlled and directed manually.

 **Bi-Level (B, C, D, E, F, G, H)**

Air flow is directed toward the face and the floor.

 **Floor & Defrost (A, C, E, D, G, H)**

Most of the air flow is directed to the floor and the windshield, while a small amount of the air flow is directed to the side window defrosters.

 **Floor-Level (A, C, E, D, G, H)**

Most of the air flow is directed to the floor, while a small amount of the air flow is directed to the windshield and side window defrosters.

Rear button

If you press the rear button, the 3 ZONE indicator will illuminate, and you can adjust the rear mode individually. If you press the 3 ZONE button, the 3 zone control indicator will be turned OFF, and the rear mode will be operated as the front mode.

The air flow outlet can be converted as follows:



Face-level (G)

Air flow is directed toward the upper body and face.



Bi-level (G, H)

Air flow is directed toward the face and floor.



Floor level (G, H)

Air flow is directed toward the floor.

i Information

When the front windshield defrost button is pressed, the rear air flow will be blocked.



OVI045112N

Defrost-Level (A)

Most of the air flow is directed to the windshield with a small amount of air directed to the side window defrosters.

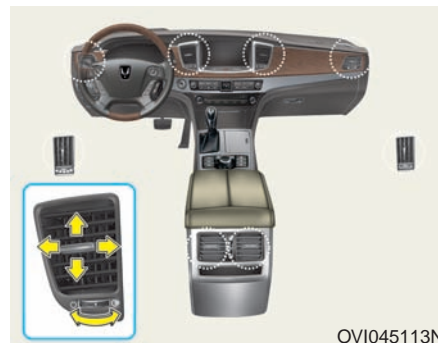

OVI045113N

Instrument panel outlet

The outlets can be opened or closed separately using the thumbwheel. To close the outlet, rotate it in a counter-clockwise direction. To open the outlet, rotate it in a clockwise direction. Also, you can adjust the air flow direction from these outlets using the vent control lever as shown.

Temperature control



The temperature will increase to the maximum (HI) by turning the knob to the right for front seats and pressing the up (^) button for rear seats.

The temperature will decrease (to Lo) when the knob is turned to the left for the front seat and the down (v) button is pressed for the rear seat. Each slight turning of the knob for the front seat and each pressing of the down button for the rear seat will increase or decrease the temperature by 1°F / 0.5°C. When set to the lowest temperature, the air conditioning will operate continuously.

If you turn the knob for front passenger's seat or if you press the down button, the 3 Zone indicator will illuminate. You can separately adjust the temperatures for the front passenger's seat and the rear seat. If you press the 3 Zone button, the 3 Zone indicator will be turned OFF, and the temperatures of the front passenger's seat and the rear seat will be adjusted like the one for the driver's seat.

Temperature conversion

If the battery is discharged or disconnected, the temperature mode display will reset to be in Fahrenheit.

This is a normal condition. The temperature mode can be changed between Celsius and Fahrenheit, as explained below.

While pressing the OFF button, press the AUTO button for 3 seconds or more. The temperature display will change from Celsius to Fahrenheit or from Fahrenheit to Celsius.

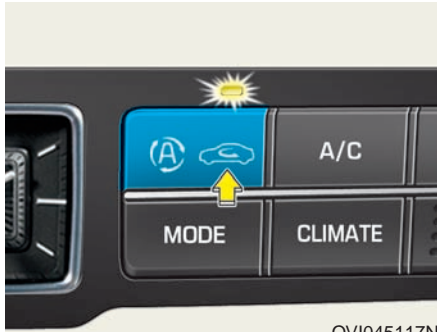
Air intake control

OVI045117N

This is to select either the (fresh) air intake mode or the air recirculation mode.

To change the air intake control mode, push the control button.

Air recirculation mode

With the air recirculation mode selected, air inside the vehicle will be taken out through the heating system, be cooled or heated according to the selected function, and be injected inside again.

(fresh) Air intake mode

With the (fresh) air intake mode selected, air outside the vehicle will enter inside the vehicle, and be heated or cooled according to the selected function.

i Information

A prolonged period of the heater operation in the air recirculation mode (without air conditioning selected) may cause fogging on the windshield and side windows, and make the air stale inside the vehicle.

In addition, a prolonged period of the air conditioning operation in the air recirculation mode may make air excessively dry inside the vehicle.

⚠ WARNING

- A prolonged period of the climate control system operation in the air recirculation mode may intake damp air, increase humidity inside the vehicle, cause fogging on windows and obscure driver's view.
- Do not sleep in a vehicle with the air conditioning or heating system ON. It may cause serious harm or death due to oxygen deficiency and hypothermia.
- A prolonged period of the climate control system operation in the air recirculation mode may cause drowsiness, sleepiness or loss of vehicle control. Set in the (fresh) air intake mode as much as possible while driving.

Air Quality System (AQS)



The air intake from outside can be automatically controlled. Press the button to activate the AQS.

When setting in the AQS mode, the system automatically senses outdoor air pollutants and minimizes the air pollutant entering into the vehicle. However, unpleasant or foul odors may be still noticeable inside the vehicle.

Exhaust gas cut-off mode :

The exhaust gas may enter the vehicle from the outside in the (fresh) air intake mode. However, with the exhaust gas cut-off mode selected, the air intake control automatically converts to the air recirculation mode to prevent the exhaust gas from entering the vehicle.

i Information

It should be noted that a prolonged period of the heater operation in the air recirculation mode may cause fogging on the windshield and side windows, and make the air stale inside the vehicle. In addition, a prolonged period of the air conditioning operation in the air recirculation mode may make air excessively dry inside the vehicle.

NOTICE

If the windows are fogged up in either the air recirculation mode or the AQS mode, change the air intake control to the (fresh) air intake mode or turn the AQS OFF.

Fan speed control

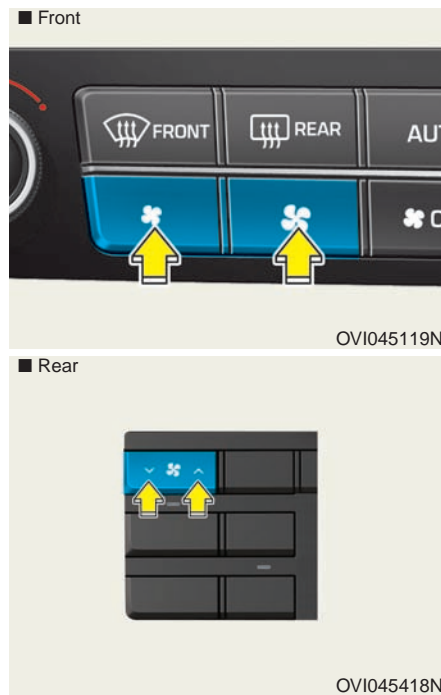

The fan speed can be set as desired by pressing the fan speed control button. The higher the fan speed is, the more air is delivered. Pressing the OFF button turns the fan OFF.

i Information

For better quality of the sound recognition system, the fan speed may automatically slow down for a couple of minutes when you activate voice recognition or hands-free systems.

A/C (Air conditioning)



Press the A/C button to turn the air conditioning system ON (The indicator light will illuminate). Press the button again to turn the A/C OFF.

Convenient features of your vehicle

OFF mode

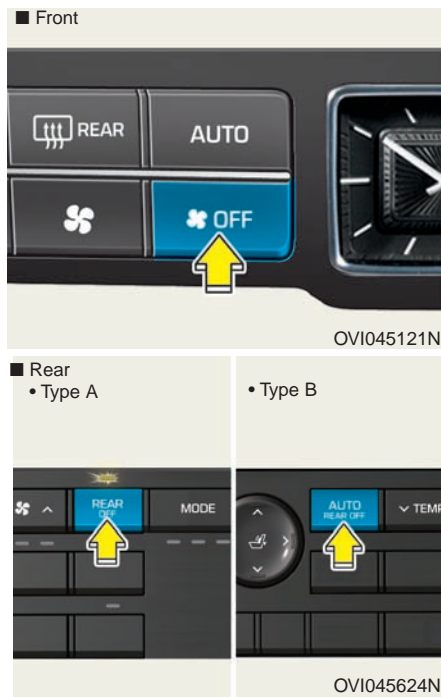

Press the OFF button in front to turn OFF the air climate control system. However, you can still select the mode and operate the air intake control as long as the ignition switch is ON. When the OFF button in the rear is pressed, the rear blower will be turned OFF.

Climate information screen selection button





To display the climate information on the screen, press the CLIMATE button.

System operation

Ventilation

1. Set in the  mode.
2. Set the air intake control in the (fresh) air intake mode.
3. Set the temperature, as desired.
4. Set the fan speed, as desired.

Heating

1. Set in the  mode.
 2. Set the air intake control in the (fresh) air intake mode.
 3. Set the temperature, as desired.
 4. Set the fan speed, as desired.
 5. In order to get dehumidified heating, turn ON the A/C.
- If the windshield is fogged up, set in the  mode or press the front defrost button .

Operation Tips

- To keep dust or unpleasant fumes from entering the vehicle through the ventilation system, temporarily set the air intake control in the air recirculation mode. Make sure to return to be in the (fresh) air intake mode when the irritating dust and gas fade away and the fresh air intake is possible. This will keep the driver alert and comfortable.
- Air needed for the heating/cooling system is taken inside through the grilles in front of the windshield. Care should be taken that these are not blocked by leaves, snow, ice or other substances.

- To prevent fogging on the inside of the windshield, set the air intake control in the (fresh) air intake mode, set the fan speed as desired, turn ON the A/C, and adjust the temperature as desired.

Air conditioning

1. Start the engine. Press the A/C button.
2. Set in the  mode.
3. Set the air intake control either in the (fresh) air intake mode or in the air recirculation mode.
4. Adjust the fan speed and temperature for your greatest comfort.

Information

- **When using the A/C system, closely monitor the engine temperature gauge while driving up hills or in heavy traffic when the outside temperature is high. A/C operation may overheat the engine. Continuously use the blower fan. However, turn the air conditioning system OFF if the engine temperature gauge indicates engine overheating.**
- **When opening the windows in humid weather, A/C operation may create dew condensation inside the vehicle. Since excessive dew condensation may cause damage to electrical equipment, A/C should be operated only with the windows closed.**

Air conditioning system operation tips

- When the vehicle is parked under the direct sunlight in hot weather, open the windows for a short time to expel the hot air inside from the vehicle.
- To reduce the dew condensation on the inside of the windows on rainy or humid days, lower the humidity inside the vehicle by operating the A/C system.
- During the A/C operation, you may occasionally notice a slight change in the engine speed, as the A/C compressor cycles. This is a normal condition.
- Test the A/C system every month only for a few minutes to maximize the system performance.
- After the inside temperature becomes sufficiently cool, change the air intake control from the air recirculation mode to the (fresh) air intake mode.
- When operating the A/C system, you may notice clear water dripping (or even puddling) from the passenger side of the vehicle. This does not indicate a system failure.
- The air recirculation mode of the A/C provides the maximum cooling. However, a prolonged period of the A/C operation in this mode may make the air stale inside the vehicle.
- While operating the A/C system, you may occasionally notice the dew condensation because of the rapid cooling process and humid air intake. This does not mean there is not a system failure.

Climate control air filter

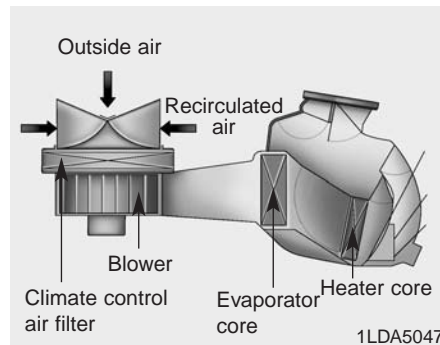

The climate control air filter is installed behind the glove box to filter out dust or other pollutants that come into the vehicle from the outside through the heating and air conditioning systems.

If dust or other pollutants accumulate in the filter over a period of time, the air intake volume may decrease, resulting in the dew condensation inside the windshield even when setting in the (fresh) air intake mode. In this case, have the climate control air filter replaced by an authorized EQUUS dealer.

i Information

- **Replace the filter every 15,000 miles (24,000 km) or once a year. If the car has been driven in severe conditions such as dusty or rough roads, more frequent air conditioner filter inspections and changes are required.**
- **When the air flow rate suddenly decreases, have the system checked by an authorized EQUUS dealer.**

Checking the amount of air conditioner refrigerant and compressor lubricant

When the amount of refrigerant is low, the A/C performance is reduced. Overfilling also has a negative impact on the A/C system.

Therefore, if abnormal operation is found, have the system inspected by an authorized EQUUS dealer.

Information

It is important that the correct type and the fixed amount of oil/refrigerant are observed. Otherwise, damage to the compressor and abnormal system operation may occur.



WARNING

The A/C system should be checked and repaired by an authorized EQUUS dealer. Improper maintenance may cause serious injury to the person performing the maintenance.

WINDSHIELD DEFROSTING AND DEFOGGING

⚠ WARNING

- Windshield heating

Do not set in the  or in the  position when operating the A/C in extremely humid weather. The difference between the outside and inside temperatures could cause the dew condensation on the outer surface of the windshield, causing loss of driver's view, serious injury or death. In this case, set the knob or the button in the  position and lower the fan speed.

- For the maximum defrosting effects, set the temperature to be extreme hot (extreme right) and set the fan speed in the highest.
- When you want warm air near the floor while defrosting or defogging, set the mode in the floor-defrost position.
- Before driving, clear all snow and ice from the windshield, rear window, outside rear view mirrors, and all side windows.
- Clear all snow and ice from the hood and air inlet in the cowl grill to improve heater and defroster efficiency and to prevent possible dew condensation on the inside of the windshield.

i Information

If the engine temperature is still cold after starting, brief warming up of the engine may be required to warm the air in the air outlet.

To defog inside windshield

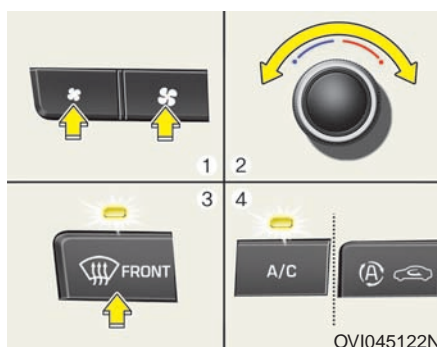

1. Select the desired fan speed.
2. Select the desired temperature.
3. Press the defrost button ().
4. The (fresh) air intake mode will be selected automatically.

If the (fresh) air intake mode is not selected automatically, adjust the corresponding buttons manually.

If the  position is selected, lower fan speed is adjusted according to the higher fan speed.

To defrost outside windshield

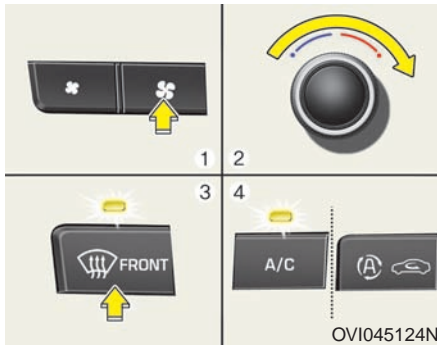

1. Set the fan speed in the highest (extreme right) position.
2. Set the temperature in the extreme hot (HI) position.
3. Press the defrost button (❄️).
4. The (fresh) air intake mode will be selected automatically.

When the ❄️ position is selected, the lower fan speed will be adjusted according to the higher fan speed.

Defogging logic

To reduce the possibility of the dew condensation on the inside of the windshield, the air intake is automatically controlled according to a driving condition such as setting in the ❄️ or ❄️ positions. To cancel or reset the defogging process, follow the below steps:

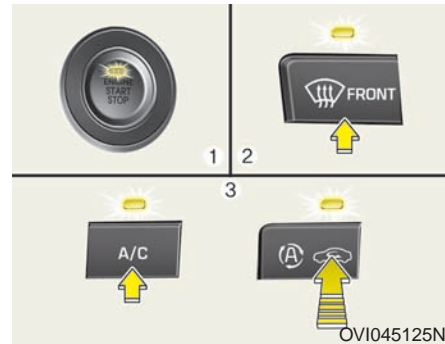

1. Turn the Engine Start/Stop button ON.
2. Press the defrost button (❄️).
3. While pressing the A/C button, press the air intake control button at least 5 times within 3 seconds.

The air intake control indicator flashes three times at an interval of 0.5 seconds. It indicates that the defogging process is canceled or reset to the original status.

When the battery is discharged or disconnected, the system resets to the defogging default setting.

Auto defogging system (if equipped)

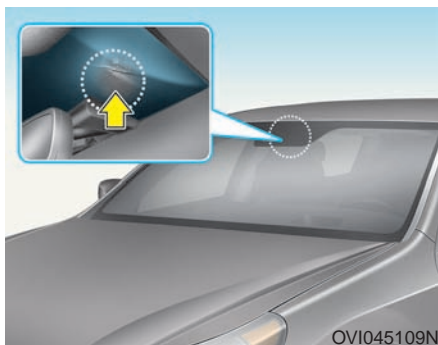

Auto defogging reduces the probability of the dew condensation on the inside of the windshield by automatically sensing the moisture.

The auto defogging system operates when the heater or the A/C is ON.



This indicator illuminates when the auto defogging system senses the moisture on the inside of the windshield and operates.

If it is humid inside the vehicle, the automated steps operate as follows:

If auto defogging system does not defog the window in the step 1 (fresh air intake mode), the steps 2 and 3 will be followed.

Step 1 : (fresh) air intake mode

Step 2 : Operating the A/C

Step 3 : Blowing air toward the windshield

Step 4 : Increasing air flow toward the windshield

The auto defogging system automatically activates in certain conditions. However, if you want to turn OFF the auto defogging system, press the front defroster button 4 times within 2 seconds while pressing the AUTO button. The front defroster indicator will flash 3 times to notify the system cancellation. To restart the auto defogging system, follow the procedures mentioned above.

If the battery is disconnected or discharged, it resets to the auto defogging status.

i Information

When the A/C is turned ON and the (fresh) air intake mode is selected by the auto defogging system, and when you try to turn OFF the A/C and select the air recirculation mode, the indicator will just flash 3 times, the A/C will not be turned OFF, and the air recirculation mode will not be selected.

NOTICE

Do not remove the sensor cover on the upper end of the driver's side windshield. Damage to system parts could occur and may not be covered by your vehicle warranty.

STORAGE COMPARTMENTS

These compartments are to store small items required by the driver or passengers.

NOTICE

- To avoid possible theft, do not leave valuables in the storage compartments.
- Always keep the storage compartment covers closed while driving. Do not attempt to place so many items in the storage compartment. Otherwise, the storage compartment cover cannot be securely closed.

WARNING

- Flammable materials
Do not place cigarette lighters, propane cylinders, or other flammable/explosive materials in the vehicle. These items may catch fire and/or explode if the vehicle is exposed to hot temperatures for an extended period of time.

Center console storage

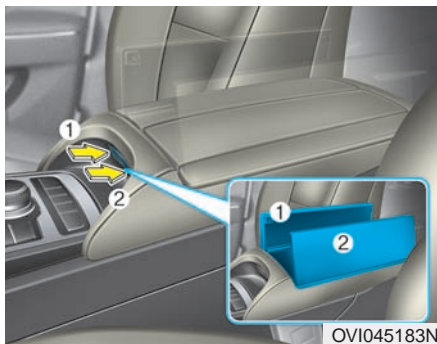

To open the center console storage, push the button (1) or (2).

Glove box

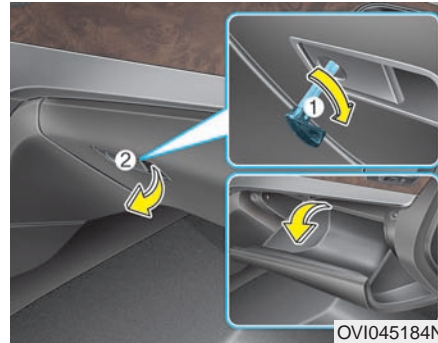

The glove box can be locked and unlocked with the mechanical key in the smart key (1).

To open the glove box, pull the lever (2) and the glove box will automatically open. Close the glove box after using it.

WARNING

To reduce the risk of injury in an accident or sudden stop, always keep the glove box door closed while driving.

NOTICE

Do not keep food in the glove box for a long period of time.

Sunglass holder



To open the sunglasses holder, press the cover and the holder will slowly open. Place your sunglasses inside the compartment holder with the lenses facing out. Push to close the sunglasses holder.

⚠ WARNING

- Do not keep objects except sunglasses inside the sunglasses holder. Such objects can be thrown from the holder in an accident or sudden stop, possibly injuring passengers inside the vehicle.
- Do not open the sunglasses holder while the vehicle is moving. The rear view mirror may be blocked by an open sunglasses holder.
- Do not force to put your sunglasses into the sunglasses holder to prevent breakage or deformation of glasses. It may cause personal injury if you force to open it, when the glasses are jammed inside the sunglasses holder.

Rear console storage

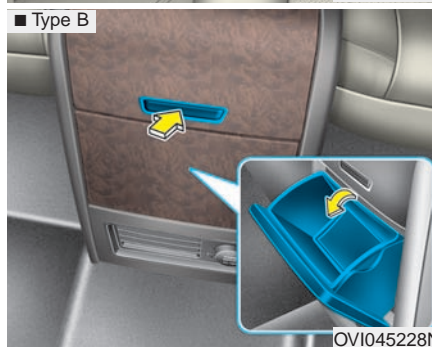
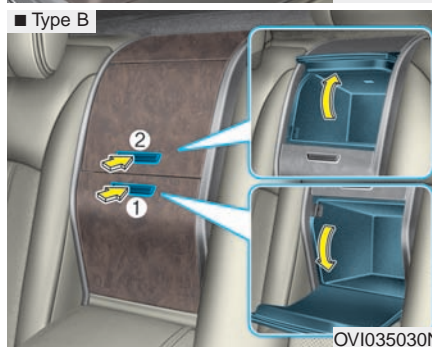
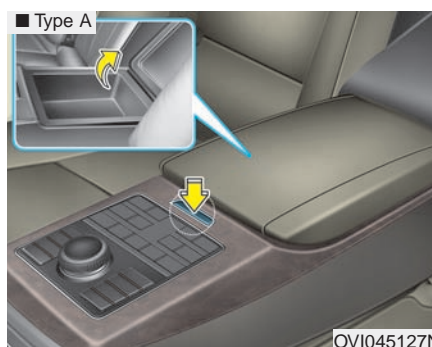

To open the console storage, push the open button. After using the console storage, make sure to close it.

Cool and warm box (if equipped)

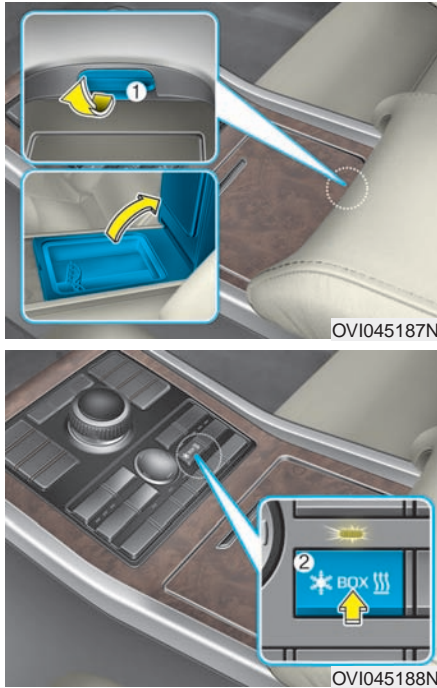

To open the box, pull up the lever (1). If you press the BOX button (2) once, the indicator will illuminate in blue and then it will keep your drinks cool. If you press the BOX button (2) again, the indicator color will be changed to amber and then it will keep your drinks warm.

To stop operating, press the BOX button (2) again. The indicator will be turned OFF. It takes about 5 minutes to swift from the warming mode to the cooling mode or vice versa. There are partitions in the box to fix drink bottles. You can remove the partitions for larger size bottles. Be careful not to damage the partitions.

⚠ WARNING

Have the system maintained and repaired by an authorized EQUUS dealer. Inappropriate repair may damage the system, resulting in a fire or injury.

NOTICE

- When operating in the cooling mode, and when the drink is hot, the system takes a long time to cool the drink. To use the cooling mode efficiently, cool down the hot drink at the room temperature before putting it in the box.
- When operating in the warming mode, and when the drink is cold, it takes a long time to warm the drink. To use the warming mode efficiently, warm up the cold drink at the room temperature before putting it in the box.
- If the cover is not securely closed, the efficiency will be lowered with frost formation. Always close the cover securely.
- If you force to close the cover when drink bottles are not correctly put inside, it may damage the cover.
- Because the temperature near the box bottom is very low, make sure that frost does not form inside the drink bottle.
- Securely put the cap on the bottle when you put the bottle in the box.
- Do not put sharp or any other object except drinks in the box. It may damage the box.

(Continued)

Convenient features of your vehicle

(Continued)

- If you leave food in the box for a long period of time, the food may go spoiled with bad smell.
- When you clean the inside of the box, use a soft cloth. Do not use strong soap or chemical detergents.

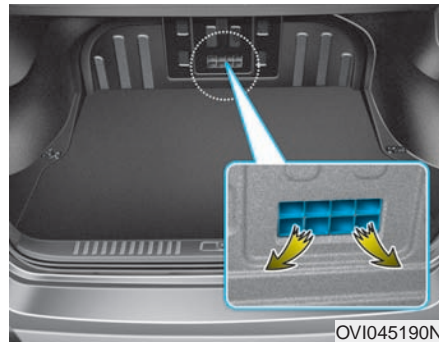
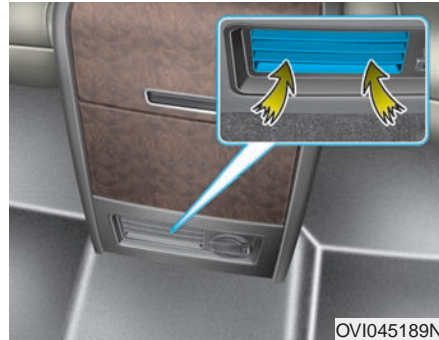

NOTICE

There are the air inlet on the rear seat center and the air outlet on the trunk. If the air inlet is blocked, the efficiency will be lowered. If the air inlet is blocked for a long period of time, the box may be damaged.

Do not let the air inlet and outlet be blocked.

INTERIOR FEATURES

Ashtray

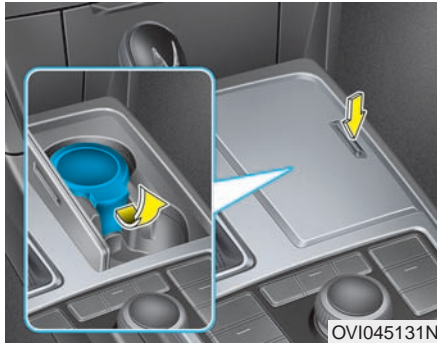

⚠ WARNING

- Ashtray use
- Do not use the vehicle's ashtrays as waste receptacles.
- Any lit cigarettes or matches in an ashtray with other inflammable materials may cause a fire.

Front

To open the ashtray, press the cover and it will slowly open. To clean the ashtray, lift up the plastic receptacle and pull it out.

Rear

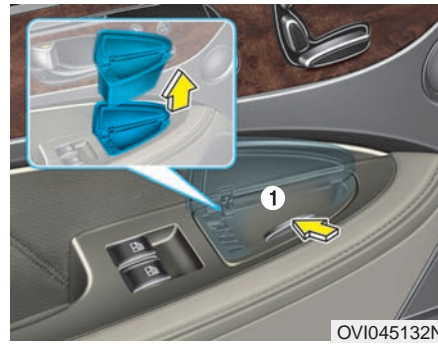

Use the rear ashtray after opening up the cover (1).

To clean the ashtray, lift up the plastic receptacle to pull it out.

Cup holder

⚠ WARNING

- Hot drinks

- Do not place hot drinks in the cup holder without covering the lid while the vehicle is in motion.

If the hot drink spills over, you may be burned. Such a burn to the driver may lead to loss of control of the vehicle.

- To reduce the risk of personal injury in the event of sudden stop or collision, do not place uncovered or insecurely covered bottles, glasses or cans in the cup holder while the vehicle is in motion.

⚠ WARNING

Keep cans or bottles out of direct sun lights and do not put them in a vehicle when the weather heats up. Otherwise, it may explode.

■ Front

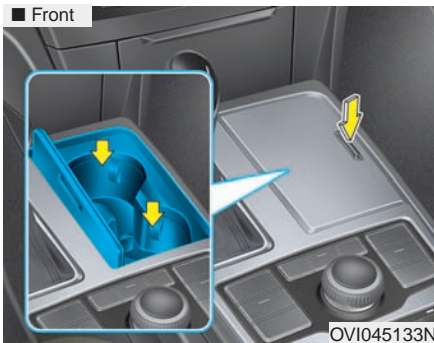

■ Rear (A) (if equipped)

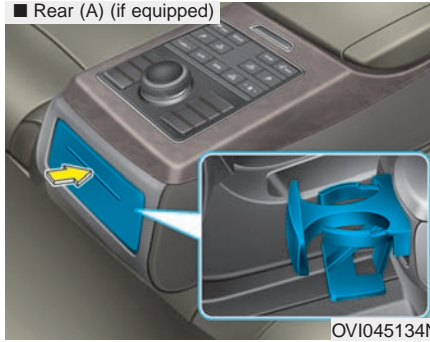

■ Rear (B) (if equipped)

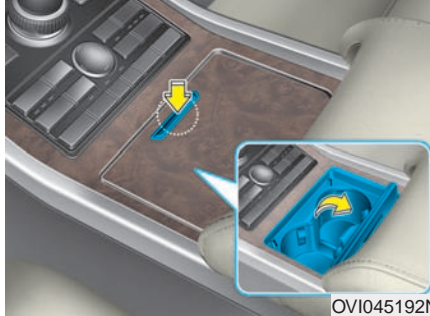

Cups or small beverage cans may be placed in the cup holders.

Front

To open the cover, press the cover and it will slowly open.

Rear (A)

To open the cover, press the button and it will slowly open.

Rear (B) (if equipped)

To open the cover, press the cover and it will slowly open.

Sunvisor



Use the sunvisor to block direct sunlight through the windshield or side windows.

To use the sunvisor for the windshield, pull it downward. To use the sunvisor for the side window, pull it downwards, unsnap it from the bracket (1) and swing it to the side (2).

To use the vanity mirror, pull down the sunvisor and slide open the mirror cover (3). Adjust the sunvisor extension forward or backward (4).

The ticket holder (5) is provided for holding a tollgate ticket.

NOTICE

- Vanity mirror lamp

Securely close the vanity mirror cover and return the sunvisor to its original position after using it. If the vanity mirror is not securely closed, the lamp will stay ON and may result in battery discharge or sunvisor damage.

CAUTION

For your safety, do not obstruct your view when using the sunvisor.

Rear vanity mirror (if equipped)

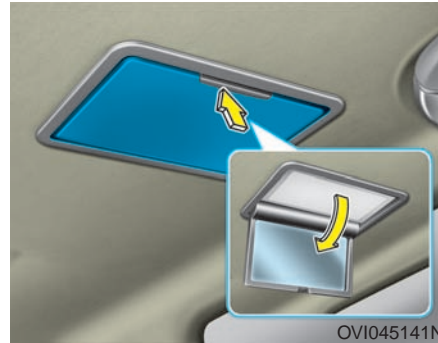

To use the rear vanity mirror, press the cover. Then, it will slowly open and the mirror lamp will turn ON.

NOTICE

Securely close the mirror cover. If the mirror cover is not closed, the lamp will stay ON and may result in battery discharge or mirror damage.

Convenient features of your vehicle

Power outlet

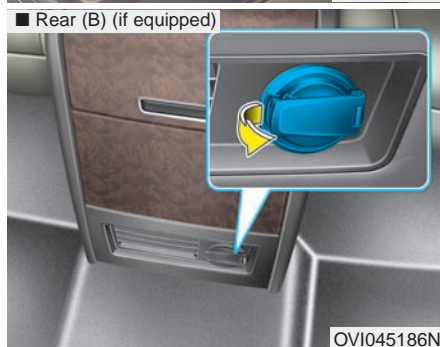
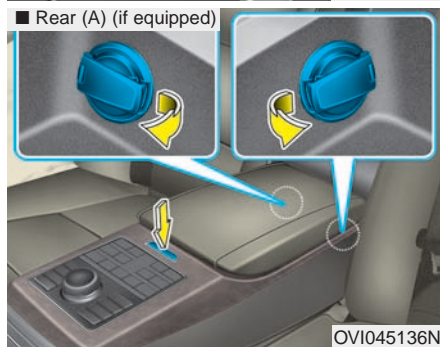
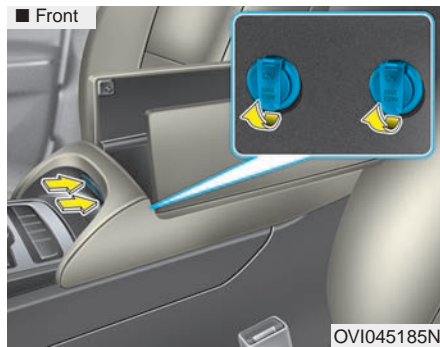

The power outlet is to provide power for mobile telephones or other devices, which operate with vehicle electric systems. The devices could draw less than 10 amps, when the engine is running.

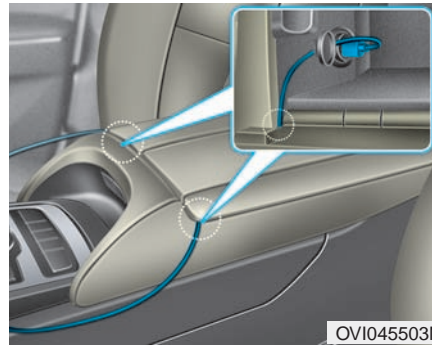

You should close the center console cover after using the front power outlets inside the center console and pulling out the wire from them.

(The USB charger and cable are not provided in your vehicle.)

NOTICE

- Use the power outlet only when the engine is running and remove the accessory plug after use. Using the accessory plug for a prolonged period of time with the engine OFF may discharge the battery.
- Only use 12V electric accessories which are less than 10A in electric capacity.
- Adjust the A/C or heater to the lowest operating level when using the power outlet.
- Close the cover when not in use.

(Continued)

(Continued)

- Some electronic devices can cause electronic interference when plugged into a vehicle's power outlet. These devices may cause excessive audio static and malfunctions in other electronic systems or devices used in your vehicle.

⚠ WARNING

Do not put a finger or a foreign element (pin, etc.) into a power outlet and do not touch it with a wet hand. You may get an electric shock.

Clock



You can set the clock by using the Navigation system.

Clock settings

GPS Time check

The clock is automatically updated in the GPS time.

GPS Time non-check

The clock can be manually adjusted.

1. Select the "System Settings" on the "INFO/Setup" screen.
2. Select the "Clock Settings."
3. Select the "Time Settings" by rotating the controller on the center console panel.

For further information, please refer to the Digital Navigation System Manual that was supplied with your vehicle.

⚠ WARNING

Do not adjust the clock while driving. You may lose your steering control and cause an accident that results in severe personal injury or death.

Convenient features of your vehicle

Clothes hanger

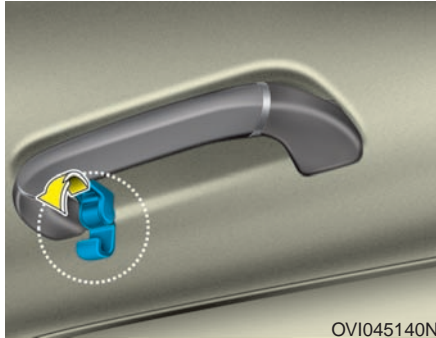

OVI045140N

To use the hanger, pull down the upper portion of hanger.

NOTICE

Do not hang heavy clothes, since those may damage the hook.

Bag hanger (if equipped)



OVI045212N

Pull the strap (1) to hang a bag on the hook (2).

When you do not use the hook, fold the hook.

Floor mat anchor(s) (if equipped)

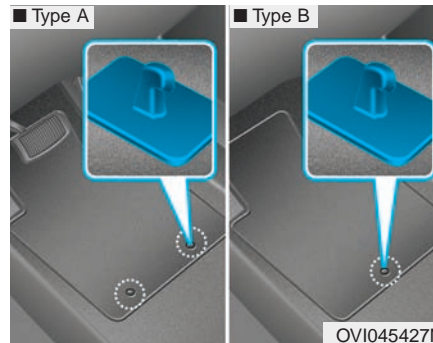

OVI045427N

When laying a floor mat under the driver's seat, make sure it attaches to the floor mat anchor(s) of your vehicle. This keeps the floor mat from sliding forward.

⚠ WARNING

The followings must be observed when installing ANY floor mat to the vehicle.

- Ensure that the floor mats are securely attached to the vehicle's floor mat anchor(s) before driving the vehicle.
- Do not use ANY floor mat that cannot be firmly attached to the vehicle's floor mat anchors.
- Do not stack floor mats on top of one another (i.e. all-weather rubber mat on top of a carpeted floor mat). Only a single floor mat should be installed under each seat.

(Continued)

(Continued)

IMPORTANT - Your vehicle is manufactured with driver's side floor mat anchors that are designed to securely hold the floor mat in place. To avoid any interference with pedal operation, it is highly recommended that only the authorized EQUUS floor mat be installed.

Luggage net (holder)



To keep items from tossing about in the cargo area, you can use the luggage net by hooking it on holders in the cargo.

NOTICE

To prevent damage to the goods or the vehicle, care should be taken when carrying fragile or bulky objects in the luggage compartment.

CAUTION

Avoid eye injury. **DO NOT** overstretch the luggage net. **ALWAYS** keep your face and body away from any rebound or spring of the luggage net. **DO NOT** use the luggage net when the strap is visibly worn out or damaged.

Convenient features of your vehicle

Rear curtain

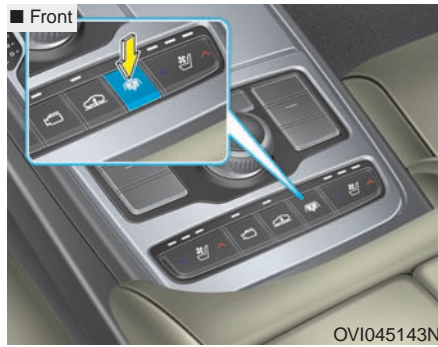

To raise the rear curtain, press the button. To lower the rear curtain, press the button again.

The rear curtain will be automatically lowered when you change the shift gear to the R (Reverse) and be automatically raised when you change the shift lever from R (Reverse) to P (Park).

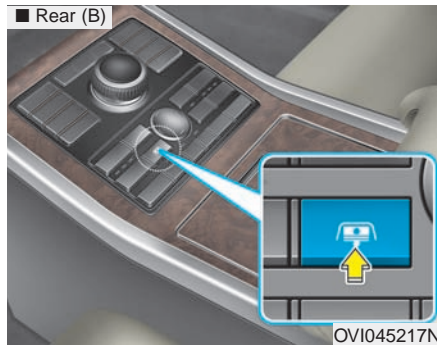
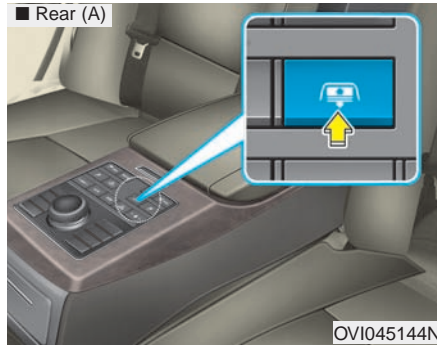

After the rear curtain is lowered by changing the shift lever to R (Reverse), if you drive faster than 12mph (20km/h) with the shift lever in D (Drive), the rear curtain will be automatically raised.

NOTICE

Do not manually lower or raise the rear curtain. It may cause motor failure.

AUX, USB and iPod® port



OVI045409N

If your vehicle has an AUX and/or USB(universal serial bus) port or iPod® port, you can use an AUX port to connect audio devices, a USB port to plug in a USB, and an iPod® port to plug in an iPod®.

i Information

When a portable audio device is connected to the power outlet, noise may occur during playback. If this happens, use the power source of the portable audio device.

* iPod® is a trademark of Apple Inc.

Multimedia system

Multimedia system	4-2
Antenna	4-2
Steering wheel audio control	4-3



MULTIMEDIA SYSTEM

i Information

- If you install an unauthorized HID head lamp, your vehicle's audio and electronic device may malfunction.
- Prevent chemicals such as perfume, cosmetic oil, sun cream, hand cleaner, and air freshener from contacting the interior parts because they may cause damage or discoloration.

Antenna

Glass antenna



When the radio power switch is turned ON while the Engine Start/Stop button is in either the "ON" or "ACC" position, both the AM and FM broadcast signals will be received through the antenna on the rear window glass.

NOTICE

- Do not clean the inside of the rear window glass with cleaner or a scraper to remove foreign substances. This may damage the antenna elements.
- Avoid adding metallic coatings such as nickel, cadmium, etc. These may disturb the AM/FM broadcast signals.

Steering wheel audio control

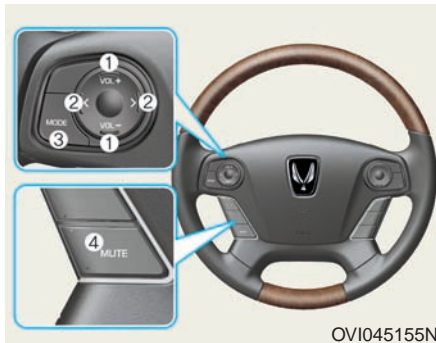

Audio control buttons may be provided on the steering wheel.

NOTICE

Do not simultaneously operate several audio remote control buttons.

VOLUME (VOL + / -) (1)

- Press the VOL + button to increase the volume.
- Press the VOL - button to decrease the volume.

SEEK/PRESET (< / >) (2)

When one of the < / > buttons is pressed for 0.8 seconds or longer, it will function as follows in each mode.

RADIO mode

Those will function as the AUTO SEEK buttons. It will SEEK (or tune in) a radio station until you release the button.

MEDIA mode

Those will function as the FF/REW button.

When one of the < / > buttons is pressed shorter than 0.8 seconds, it will function as follows in each mode.

RADIO mode

Those will function as the PRESET STATION buttons.

MEDIA mode

Those will function as the TRACK UP/DOWN buttons.

MODE (3)

Press the MODE button to select among the Radio, disc, or AUX modes.

MUTE (4)

- Press the MUTE button to cancel the sound.
- Press the MUTE button again to activate the sound.

i Information

Detailed information is described in a separate-volume supplement to this Owner's Manual.



Driving your vehicle

Before driving	5-5
Before entering vehicle.....	5-5
Necessary inspections	5-5
Before starting	5-5
Engine start/stop button	5-7
Illuminated Engine Start/Stop Button	5-7
Engine Start/Stop Button position	5-7
Starting the engine	5-9
Automatic transmission	5-11
Automatic transmission operation	5-12
Good driving practices.....	5-15
Brake system	5-17
Power brakes	5-17
Electric parking brake (EPB).....	5-19
Emergency braking.....	5-22
AUTO HOLD	5-23
Anti-lock brake system (ABS)	5-26
Electronic stability control (ESC)	5-28
Hill-start assist control (HAC).....	5-32
Good braking practices.....	5-32
Drive mode integrated control system	5-34
DRIVE mode / SNOW mode.....	5-34
Electronic controlled suspension (ECS)	5-36
To control the vehicle height.....	5-36
ECS (Electronic Controlled Suspension) malfunction warning message.....	5-37

Driving your vehicle

Advanced smart cruise control system	5-38
Smart cruise control speed	5-39
Smart cruise control vehicle-to-vehicle distance ..	5-43
Vehicle-to-vehicle distance sensor	5-45
To convert to the cruise control mode	5-46
Limitations of the system	5-47
Lane departure warning system (LDWS)	5-51
LDWS operation.....	5-52
Advanced vehicle safety management (AVSM)	5-55
Blind spot detection system (BSD)	5-58
Operating conditions.....	5-59
Warning types.....	5-59
Detecting sensor	5-60
Warning message.....	5-61
RCTA (Rear cross traffic alert).....	5-62
Non-operating condition.....	5-63
Economical operation	5-65
Special driving conditions	5-67
Hazardous driving conditions.....	5-67
Rocking the vehicle	5-68
Smooth cornering	5-69
Driving at night.....	5-69
Driving in the rain	5-70
Driving in flooded areas.....	5-70
Off-road driving.....	5-70
Highway driving.....	5-71

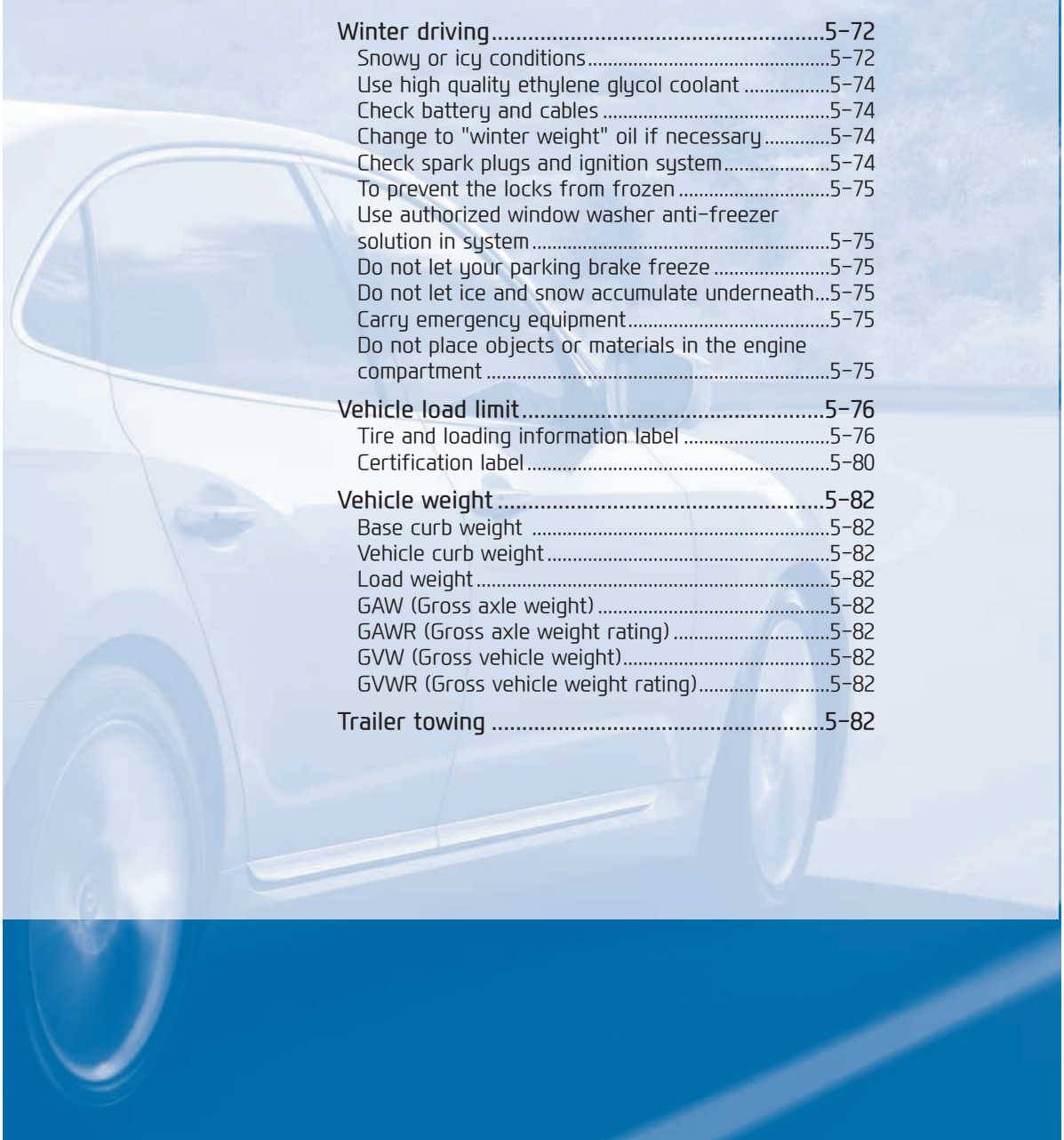

Winter driving	5-72
Snowy or icy conditions	5-72
Use high quality ethylene glycol coolant	5-74
Check battery and cables	5-74
Change to "winter weight" oil if necessary	5-74
Check spark plugs and ignition system	5-74
To prevent the locks from frozen	5-75
Use authorized window washer anti-freezer solution in system	5-75
Do not let your parking brake freeze	5-75
Do not let ice and snow accumulate underneath...	5-75
Carry emergency equipment.....	5-75
Do not place objects or materials in the engine compartment	5-75
Vehicle load limit	5-76
Tire and loading information label	5-76
Certification label	5-80
Vehicle weight	5-82
Base curb weight	5-82
Vehicle curb weight	5-82
Load weight	5-82
GAW (Gross axle weight)	5-82
GAWR (Gross axle weight rating)	5-82
GVW (Gross vehicle weight)	5-82
GVWR (Gross vehicle weight rating).....	5-82
Trailer towing	5-82

⚠ WARNING

- ENGINE EXHAUST CAN BE DANGEROUS!

Engine exhaust fumes may be extremely dangerous. When, at any time, you smell exhaust fumes inside the vehicle, immediately open the windows.

• Do not inhale exhaust fumes.

Exhaust fumes contain carbon monoxide, the colorless, odorless gas that may cause unconsciousness and death by asphyxiation.

• Be sure the exhaust system does not leak.

The exhaust system should be checked whenever the vehicle is raised to change the oil or for any other purpose. If you notice a change in the sound of the exhaust system or if you drive over something that strikes the vehicle underneath, have the exhaust system checked as soon as possible by an authorized EQUUS dealer.

• Do not run the engine in an enclosed area.

Letting the engine idle in a garage, even with the garage door open, is hazardous. Never run the engine in your garage any longer than it takes to start the engine and move out the vehicle.

• Avoid idling the engine for a prolonged period of time with people inside the vehicle.

If it is necessary to idle the engine for a prolonged period of time with people inside the vehicle, idle the engine in an open area with the air control in the (fresh) air intake mode and the fan operating at a high speed. Thus, fresh air can be taken into the interior.

When you need to drive with the trunk lid open because of the object you carry, make sure the followings:

1. Close all windows.
2. Open side vents.
3. Set the air intake control in (fresh) air intake mode, the air flow directed toward "Floor" or "Face," and the fan at a high speed.

To assure proper ventilation, clear snow, ice, leaves or other substances from the air inlet just in front of the windshield.

⚠ California PROPOSITION 65 WARNING

Engine exhaust and a wide variety of automobile components and parts, including components found in the interior furnishings in a vehicle, contain or emit chemicals known to the State of California to cause cancer and birth defects and reproductive harm. In addition, certain fluids contained in vehicles and certain products of component wear contain or emit chemicals known to the State of California to cause cancer and birth defects or other reproductive harm.

BEFORE DRIVING

Before entering vehicle

- Be sure that all windows, outside mirror(s), and outside lights are clean.
- Check the condition of the tires.
- Check underneath the vehicle for any leakage sign.
- Make sure there are no obstacles behind, when you intend to drive backwards.

Necessary inspections

Fluid levels, such as engine oil, engine coolant, brake fluid, and washer fluid should be checked on a regular basis, at exact intervals. Further details are provided in the chapter 7, "Maintenance".

WARNING

Careless driving may result in a loss of vehicle control, possibly leading to an accident, severe personal injury, and death. The driver's primary responsibility is to drive in the safe and legal manner. The use of any hand-held devices, other equipment, or vehicle systems, which take the driver's eyes, attention and focus away from the safe operation of a vehicle or which are not permissible by law, should never be used in driving.

Before starting

- Close and lock all doors.
- Check the seat position, so all controls are easily accessible.
- Adjust the inside and outside rearview mirrors.
- Make sure that all lights operate.
- Check all gauges.
- Check the operation of warning lights when the Engine Start/Stop button is turned ON.
- Release the parking brake and make sure the brake warning light goes OFF.

For safe operation, make sure you are familiar with your vehicle equipment and operation.

WARNING

All passengers must be properly belted whenever the vehicle is moving. Refer to "Seat belts" in chapter 2 for more information on the proper usage.

WARNING

Always take a look around your vehicle for any passers-by, especially children, before changing the shift lever to D (Drive) or R (Reverse).

⚠ WARNING

- Driving under the influence of alcohol or drugs

DUI (driving under the influence) is dangerous. DUI is the number one contributor to the highway death toll each year. Even a small amount of alcohol will affect your reflexes, perceptions and judgment. Driving under the influence of drugs is as dangerous as or more dangerous than driving under the influence of alcohol.

You are much more likely to have a serious accident if you drive under the influence of alcohol or drug. After you drink alcohol or take drugs, do not drive. Do not ride in a passenger's seat when a driver drinks or takes drugs.

Have a designated driver in your group or call a cab.

⚠ WARNING

- When you park or pull over the vehicle with the engine ON, be careful not to depress the accelerator pedal for a long period of time. It may overheat the engine or exhaust system and cause fire.
- When you make a sudden stop or rapidly turn the steering wheel, any loose objects may toss about inside the vehicle and interfere with the pedal operation, possibly causing an accident. Keep all things in the vehicle safely stored.
- If you are not concentrated while driving, it may cause an accident. Be careful when operating controls such as the audio or heater. It is always the driver's responsibility to be attentive to the driving safety.

ENGINE START/STOP BUTTON

Illuminated Engine Start/Stop Button



Whenever the front door is opened, the Engine Start/Stop button will illuminate for your convenience. The light will go OFF 30 seconds after the door is closed.

Engine Start/Stop Button position

OFF

To turn OFF the engine, re-press the turned-ON Engine Start/Stop button, when the gear shift in P(Park). When you turn OFF the Engine Start/Stop button with the gear shift not in P(Park), the Engine Start/Stop button will not be turned OFF, but turns to the ACC position.

i Information

When you turn OFF the engine, the vehicle should be stopped.

⚠ WARNING

- Emergency situation

In an emergency situation while the vehicle is in motion, you can turn the engine in the OFF or ACC position, by pressing the Engine Start/Stop button 2 seconds or longer or by pressing it 3 times successively within 3 seconds. If the vehicle is still moving, you can restart the engine without depressing the brake pedal by pressing the Engine Start/Stop button with the shift gear in the N (Neutral) position.

ACC(Accessory)

Press the Engine Start/Stop button when the button is OFF without depressing the brake pedal.

The electrical accessories are operative.

If you leave the Engine Start/Stop button in the ACC position for more than 1 hour, the battery power will be automatically turned OFF to prevent the battery discharge.

ON

Press the Engine Start/Stop button when the button is in the ACC position without depressing the brake pedal.

Check the warning lights before starting the engine. Do not leave the button turned ON for a long time if the engine is not running to prevent battery discharge.

START

To start the engine, depress the brake pedal and press the Engine Start/Stop Button with the shift gear in P(Park) or N(Neutral).

For your safety, start the engine with the shift gear in P(Park).

***i* Information**

- If you press the Engine Start/Stop button without depressing the brake pedal, the engine does not start. When the Engine Start/Stop button is pressed, it changes as follows:
OFF → ACC → ON → OFF
- If you leave the Engine Start/Stop Button in the ACC or the ON position for a long time, the battery will be discharged.

WARNING

- Never press the Engine Start/Stop button while the vehicle is in motion except in an emergency situation. This would turn the engine OFF, resulting in loss of power assist for the steering wheel and brake. This may lead to loss of directional control and braking function, which could cause an accident.

(Continued)

(Continued)

- Before leaving the driver's seat, always make sure the shift gear is engaged in P (Park), fully set the parking brake and turn the engine OFF. Unexpected and sudden vehicle movement may occur if these precautions are not taken.
- Never touch the Engine Start/Stop button, or any other controls on the steering wheel while the vehicle is in motion. Reaching out for those controls with your hand or arm may cause a loss of vehicle control, an accident, serious bodily injury or death.
- Do not place any loose objects around the driver's seat, as they may toss about while driving, interfering with the driver's pedal operation and leading to an accident.

STARTING THE ENGINE

WARNING

Always wear proper shoes when driving your vehicle. Improper types of shoes (i.e. high heels, slippers, ski boots, etc.) may interfere with your ability to control the brake and accelerator pedal.

1. Carry the Smart Key inside the vehicle.
2. Check the parking brake is firmly applied.
3. Place the shift lever in P(Park).
4. Depress the brake pedal.
5. Press the Engine Start/Stop button.

It should be started without depressing the accelerator.

6. Do not wait for the engine to warm up while idling the engine.

Start driving at a moderate speed. (Sudden accelerating and decelerating should be avoided.)

NOTICE

If the engine stops while driving, do not attempt to move the shift lever to P (Park). When traffic and road conditions permit, and while the vehicle is still moving, you may move the shift lever to N(Neutral), and press the Engine Start/Stop button to restart the engine.

- Even though the Smart Key is inside the vehicle, but when the key is far away from the driver, the engine may not start.
- When the Engine Start/Stop button is in the ACC or ON position, and when any door is open, the system checks for the presence of the Smart Key. If the Smart Key is not inside the vehicle, the "Key not in vehicle" indicator will illuminate. When all doors are closed, the chime will also sound for approximately 5 seconds. The indicator will be turned OFF while the vehicle is moving. Keep the Smart Key inside the vehicle when the Engine Start/Stop button is in the ACC or ON position.

WARNING

Only when the Smart Key is inside the vehicle, pressing the Engine Start/Stop button will start the engine. Never allow children or any persons, who are unfamiliar with the vehicle, to touch the Engine Start/Stop button or other related parts.

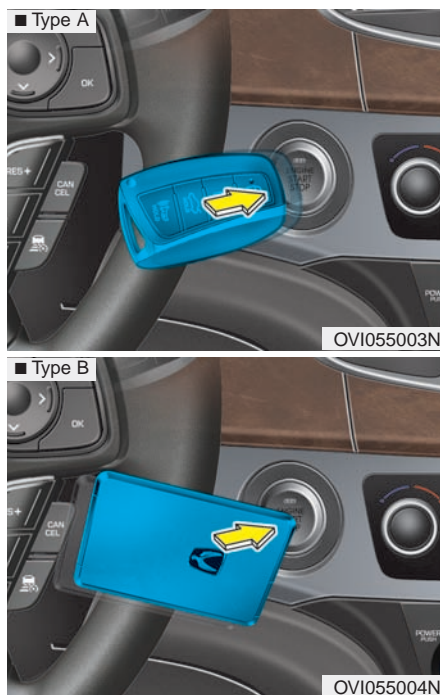

(Continued)

- When the stop light fuse is blown out, you cannot normally start the engine. Replace the blown-out fuse with a new one. If you are not able to replace the fuse, you can start the engine by pressing the Smart Key onto the Engine Start/Stop button for 10 seconds. The engine can start without depressing the brake pedal. However, for your safety, always depress the brake pedal before starting the engine.

NOTICE

Do not press the Engine Start/Stop Button for more than 5 seconds except when the stop light fuse is disconnected.

i Information



- When the battery is weak, or when the Smart Key does not properly operate, you can start the engine by pressing the Smart Key onto the Engine Start/Stop button.

The Smart Key edge near the lock button should be directly contacted onto the Engine Start/Stop button. When you press the Smart Key onto the Engine Start/Stop button, the Smart Key should be contacted onto the button at a right angle.

(Continued)

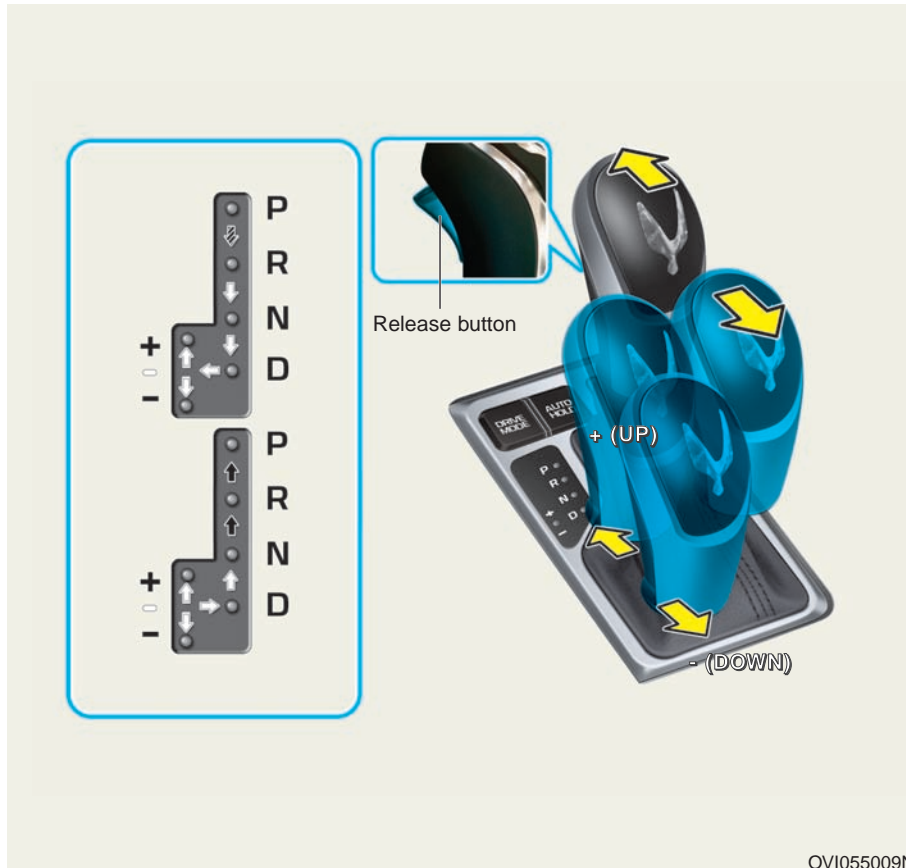
AUTOMATIC TRANSMISSION



-  Depress the brake pedal and press the release button when moving the shift lever.
(If the shift lock system is not equipped, it is not necessary to depress the brake pedal. However, it is recommended to depress the brake pedal to avoid inadvertent movement of the vehicle.)
-  Press the release button when moving the shift lever.
-  The shift lever can freely operate.

Automatic transmission operation

The automatic transmission has 8 forward speed levels and 1 reverse speed level. Vehicle speed is automatically selected, depending on the shift lever position.

i Information

A new vehicle may experience somewhat abrupt movement during the first few shifts.

Always depress the brake pedal when moving the shift lever from N (Neutral) to a forward or reverse gear.

⚠ WARNING

- Automatic transmission

- Always take a look around your vehicle for any passers-by, especially children, before moving the shift lever to D (Drive) or R (Reverse).
- Before leaving the driver's seat, always make sure the shift lever is in P (Park). Then, fully set the parking brake and turn the engine OFF. Unexpected and sudden vehicle movement may occur when these precautions are not taken.

NOTICE

- To avoid damage to your transmission, do not depress the accelerator, when the shift lever is in R (Reverse) or any forward gear positions, and when the brake is set.

(Continued)

(Continued)

- When a vehicle stops on a slope, do not stop the vehicle with the engine power.

Set the service brake or the parking brake.

- Do not shift from N(Neutral)/P(Park) to D(Drive)/R(Reverse), when the engine runs faster than the idle speed.

Transmission ranges

The shift lever position is displayed on the instrument cluster, when the Engine Start/Stop button is ON.

P (Park)

Always completely stop the vehicle before moving the shift lever to P (Park). This locks the transmission and prevents the drive wheels from rotating.

⚠ WARNING

- Moving the shift lever to P (Park), while driving, locks the drive wheels, possibly resulting in your loss of vehicle control.
- Do not set the shift lever in P (Park) instead of setting the parking brake. Always make sure the shift lever is latched in P(Park) position, and the parking brake is fully set.
- Never leave a child unattended in a vehicle.

R (Reverse)

Set the shift lever in this position to drive backwards.

NOTICE

Always completely stop the vehicle before changing the shift lever to or out of R (Reverse). You may damage the transmission when changing the shift lever to R while driving, except as explained in "Rocking the Vehicle" in this chapter.

N (Neutral)

The wheels and transmission are not engaged. The vehicle rolls freely even on the slightest slope, unless the parking brake or service brake is applied.

D (Drive)

This is for the forward driving position. The transmission will automatically shift in a 8-gear sequence, providing the best fuel economy and power.

For extra power to pass ahead another vehicle or to climb a slope, fully depress the accelerator. Then, the transmission will automatically downshift to the next lower gear (or gears, as appropriate).

i Information

Always come to a complete stop before changing the shift lever to D (Drive).

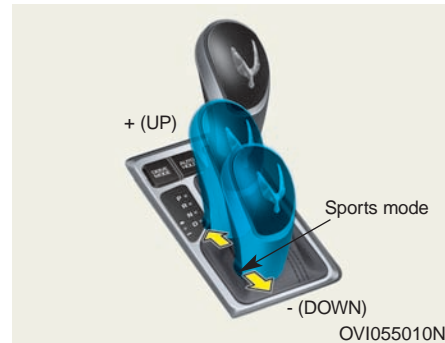
**Sports Mode**

Whether the vehicle is idle or in motion, sports mode is selected by moving the shift lever from D(Drive) to the manual gate. To return to D(Drive), push the shift lever back into the main gate.

In sports mode, moving the shift lever backwards and forwards will allow rapid gear shifting.

Up (+) : Push the shift lever forwards once to shift up one gear.

Down (-) : Pull the shift lever backwards once to shift down one gear.

i Information

- **In sports mode, the driver must execute upshifts in accordance with road conditions, taking care to keep the engine speed below the red zone.**
- **In sports mode, only the 8 forward gears can be selected. To reverse or park the vehicle, move the shift lever to the R (Reverse) or P (Park) position as required.**

(Continued)

(Continued)

- In sports mode, the transmission will automatically downshift, when it slows down. When the vehicle stops, the transmission automatically selects the 1st gear.
- In sports mode, the transmission will automatically upshift, when the engine rpm approaches toward the red zone.
- Even though the driver moves the shift lever to a +(up) or -(down) position, the transmission may not make the manually-requested gear change, if the requested gear is out of the allowable engine RPM range.
- When driving on a slippery road, set the shift lever in the 2nd gear, which is better for smooth acceleration on a slippery road.

Shift lock system

For your safety, the automatic transmission has a shift lock system to prevent the transmission shifting from P(Park) to R (Reverse), unless the brake pedal is depressed.

To shift the transmission from P(Park) into R(Reverse):

1. Depress the brake pedal.
2. Start the engine or turn the Engine Start/Stop button ON.
3. Move the shift lever.

When the brake pedal is repeatedly depressed and released with the shift lever in P(Park), you may experience chattering noises near the shift lever. This is a normal condition.

WARNING

Always fully depress the brake pedal before and while moving the shift lever out of P (Park) to another position to avoid inadvertent movement of the vehicle. This may injure persons in or around the car.



Shift-lock override

When the shift lever cannot be moved from P(Park)/N(Neutral) to R (Reverse), while depressing the brake pedal, keep depressing the brake, and do the followings:

1. Carefully remove the cover (1) of the shift-lock access hole.
2. Insert a screwdriver into the access hole and press it.
3. Move the shift lever.
4. Immediately have your vehicle inspected by an authorized EQUUS dealer.

Good driving practices

- Never move the shift lever from P(Park)/N(Neutral) to any other position, while depressing the accelerator.
- Never move the gearshift to P (Park), when the vehicle is in motion.
- Make sure to completely stop the vehicle before moving the shift lever to R(Reverse)/D(Drive).
- Never disengage the gear, while driving down on a slope. This may be extremely hazardous. Always engage the gear while driving.
- Do not "ride" the brakes. This may cause overheating and malfunction. Instead, when you drive down a long slope, slow the vehicle down, set in Sports Mode, and shift to a lower gear. Those will help the engine brake slow the vehicle down.
- Slow down before shifting to a lower gear in sports mode. Otherwise, the lower gear may not be engaged.
- Always set the parking brake. Do not depend on the shift gear in P (Park) to prevent the vehicle from moving.
- Exercise extreme caution when driving on a slippery surface. Be careful especially when braking, accelerating or shifting gears. On a slippery surface, an abrupt change in vehicle speed may cause the drive wheels to lose traction and the vehicle to go out of control.
- Optimum vehicle performance and fuel economy are obtained by smoothly depressing and releasing the accelerator.

⚠ WARNING

- Always buckle up! In a collision, an unbelted occupant is more likely to be seriously injured or killed than a properly belted occupant.
- Avoid high speeds when cornering or turning.
- Do not make quick wheel steering, such as sharp lane changes or fast, sharp turns.
- The risk of rollover is greatly increased when you lose control of your vehicle at a high speed.
- Loss of control often occurs, when two or more wheels are swerved out of the roadway and are overly steered to reenter the roadway.
- In the event your vehicle is swerved out of the roadway, do not make a sharp steering. Instead, slow down the vehicle before reentering into the lanes.
- Never exceed posted speed limits.

⚠ WARNING

When your vehicle is stuck in snow, mud, sand and others, you may rock the vehicle by moving it forward and backwards. Do not attempt this procedure when there are people or objects near the vehicle. During the rocking operation, the vehicle may suddenly move forwards or backwards as it becomes unstuck, causing injury or damage to nearby people or objects.

Moving up a steep grade from a standing start

To drive up on a steep slope, depress the brake pedal, move the shift gear to D (Drive), and release the parking brake. Gradually depress the accelerator while releasing the service brakes.

When accelerating on a steep slope, the vehicle may have a tendency to slide backwards. Shifting to the 2nd gear (Second Gear) will help prevent the vehicle from sliding backwards.

BRAKE SYSTEM

Power brakes

Your vehicle is equipped with the power-assisted brakes that automatically adjust themselves in a normal driving condition.

In the event that the power-assisted brakes lose power because of a stalled engine or some other reasons, you can still stop your vehicle by depressing the brake pedal harder than you do in normal driving. A braking distance, however, will be longer.

When the engine is OFF, the reserve brake power becomes partially depleted each time the brake pedal is depressed. Do not repeatedly depress the brake pedal when the power brake is automatically set.

Pump the brake pedal only when necessary to maintain the steering control on slippery surfaces.

WARNING

- Brakes

- Do not put your foot on the brake pedal while driving. This may abnormally increase the brake temperatures, wear down the brake lining/pad, and increase the braking distances.
- When driving down on a long or steep slope, shift to a lower gear and avoid depressing the brakes in a continuous manner. Depressing brakes in a continuous manner may overheat the brakes, resulting in a temporary loss of braking performance.

(Continued)

(Continued)

- Wet brakes may impair the vehicle's ability to safely slow down. The vehicle may also be swerved to one side when the wet brakes are depressed. Lightly depress the brakes to verify whether the brakes are wet and show the above symptom. Always test your brakes in this fashion after driving through deep water.

To dry the wet brakes, lightly depress the brakes, while maintaining a safe driving speed until the brake performance returns to normal.

- Always confirm the positions of the brake and accelerator, before driving. If you do not so, you may be confused and depress the accelerator instead of the brake pedal. It may cause a serious accident.

In the event of brake failure

When service brakes fail to operate while driving, you can make an emergency stop by setting the parking brake. The braking distance, however, will become longer than normal.

⚠ WARNING

- Parking brake

Setting the parking brake while driving at a normal speed may cause a sudden loss of vehicle control. If you must set the parking brake to stop, set it with great caution.

Disc brakes wear indicator

Your vehicle is equipped with disc brakes. When your brake pads are worn down and new pads are required, you will hear a high-pitched warning sound from the front or rear brakes. You may hear this beeping sound or it may sound when the brake pedal is depressed.

Please remember that some driving conditions or climates may cause a brake squeal when you first apply (or lightly apply) the brakes. This is normal and does not indicate a problem with your brakes.

NOTICE

- **To prevent costly brake repairs, do not drive continuously with the worn-down brake pads.**
- **Always replace brake pads in a set of a complete front and rear axle.**

⚠ WARNING

- Brake wear

This brake wear warning sound indicates that your vehicle should be repaired. If you ignore this audible warning sound, you will eventually lose braking performance, which may lead to a serious accident.

Electric parking brake (EPB)

Applying the parking brake



To set the parking brake, depress the brake pedal first and then pull the EPB switch. Make sure that the brake warning light illuminates.

WARNING

Do not set the parking brake while the vehicle is moving except in an emergency situation. It may damage the brake system and lead to an accident.

Releasing the parking brake

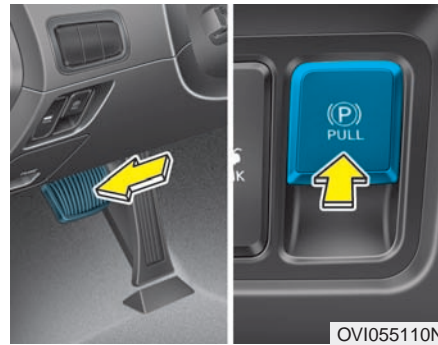

To release the EPB, press the EPB switch as follows:

- Turn the Engine Start/Stop Button ON.
- Depress the brake pedal.

Make sure the brake warning light goes OFF.

To automatically release EPB:

- Shift lever in P (Park)
 - With the engine running, depress the brake pedal and move the shift lever from P (Park) to R (Rear)/N (Neutral)/D (Drive).
- Shift lever in N (Neutral)
 - With the engine running, depress the brake pedal and move the shift lever from N(Neutral) to R (Rear)/D (Drive).
- Depress the accelerator pedal, satisfying the following conditions.
 1. Run the engine
 2. Fasten the driver's seat belt
 3. Close the driver's door, engine hood and trunk
 4. Shift the gear to R (Rear)/D (Drive)

Make sure the brake warning light goes OFF.

i Information

- You can set the EPB, even though the Engine Start/Stop button is OFF. However, for your safety, you cannot release it.
- For your safety, depress the brake pedal and manually release the parking brake by pressing the EPB switch, when driving down on a slope and driving back up.

NOTICE

- When the parking brake warning light is still ON, even when the EPB is released, have the system be checked by an authorized EQUUS dealer.
- Do not drive your vehicle with the EPB set. It may excessively wear down the brake pad and brake rotor.

EPB may automatically apply, when:

- It is requested by other systems.
- The engine is turned OFF and the EPB is set ON.

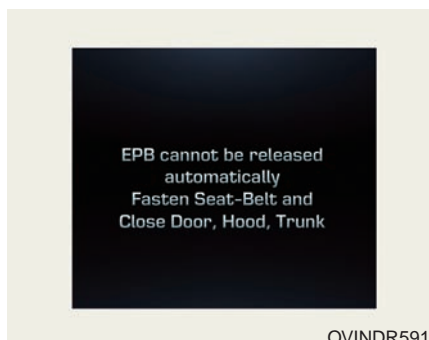

- If the accelerator is depressed, but still the EPB is not automatically released, a warning message will be displayed with a warning sound.
- When the driver's seat belt is unfastened, the engine hood is open with the shift lever in D(Drive), or the trunk is open with the shift lever in R(Reverse), a warning message will be displayed with a warning sound.
- When there is a problem with the vehicle, a warning message will be displayed with a warning sound.

If any of the above situations occurs, depress the brake pedal and release EPB by pressing the EPB switch.

⚠ WARNING

- To prevent unintentional vehicle movement when parking or after leaving the vehicle, do not substitute setting of the parking brake with setting of the shift lever. Set the parking brake and secure to position the shift lever in P(Park).
- Never allow anyone, who is unfamiliar with the vehicle, to touch the EPB switch. If the EPB is unintentionally released, serious injury may occur.
- All vehicles must always set the parking brake, while parking, in order to avoid inadvertent vehicle movement, which may injure occupants or passers-by.

NOTICE

- A clicking sound may be heard while setting or releasing the EPB. This is a normal condition, and indicates that the EPB properly functions.
- When leaving your key with a parking lot attendant or valet assistant, inform him/her of the EPB operation.
- The EPB may malfunction if you drive with the EPB set.
- Gradually depress the accelerator, when you want to automatically release EPB by depressing it.

EPB malfunction indicator

This warning light illuminates when the Engine Start/Stop button is turned ON and OFF in approximately 3 seconds, even though the system normally operates.

If the EPB malfunction indicator remains ON, flash, or does not illuminate, when turning ON the Engine Start/Stop button, this indicates the malfunction of the EPB.

If this occurs, immediately have your vehicle checked by an authorized EQUUS dealer.

The EPB malfunction indicator may illuminate, when the ESC malfunction indicator illuminates. In this case, it does not indicate the EPB malfunction.

NOTICE

- The EPB warning light may illuminate, when the EPB switch is abnormally operated. Turn the engine OFF and, after a few minutes, turn it ON again. The EPB warning light will go OFF and the EPB switch will be normally operable. However, when the EPB warning light still remains ON, have the system be checked by an authorized EQUUS dealer.
- The EPB is not set ON, when the parking brake warning light does not illuminate or flash, even though the EPB switch was pulled up.
- When the parking brake warning light flashes with the EPB warning light ON, press the EPB switch, and then pull it up. Repeat this one more time. When the EPB warning does not go OFF, have the system checked by an authorized EQUUS dealer.

Emergency braking

When there is a problem with the brake while driving, emergency braking is possible by pulling and holding the EPB switch.

However, braking distance will be longer than it is in normal driving.

⚠ WARNING

Do not operate the parking brake while the vehicle is moving except in an emergency situation. It may damage the brake system and lead to an accident.

i Information

In emergency braking with the EPB switch, the parking brake warning light will illuminate to indicate the system operation.

NOTICE

If there is noise or burning smell after emergency braking, immediately have your vehicle checked by an authorized EQUUS dealer.

When the EPB (electric parking brake) is not released

When the EPB is normally released, we recommend that you contact an authorized EQUUS dealer, tow your vehicle, and have the system checked.

NOTICE

If you continuously notice a noise or burning smell after using the EPB for emergency braking, we recommend that you have the system checked by an authorized EQUUS dealer.

AUTO HOLD

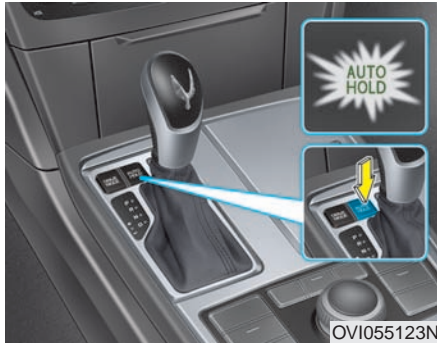

The AUTO HOLD makes the brakes keep being applied after the complete stop of the vehicle with the shift lever in D, R, or N. The brakes are released when the throttle is applied.

Set up

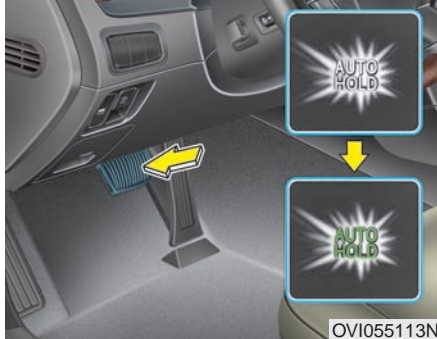

1. Press the AUTO HOLD switch. The AUTO HOLD indicator will illuminate in white and the system will be in the standby status.
2. When you completely stop the vehicle by depressing the brake pedal, the AUTO HOLD maintains the brake pressure in order to firmly stop the vehicle. The indicator color changes from white to green.

3. The vehicle will remain to be standstill even when you release the brake pedal.

4. When setting the EPB, the Auto Hold will be released.

Leaving

When you depress the accelerator pedal with the shift lever in R(Reverse)/D(Drive) or in sports mode, the AUTO HOLD will be automatically released automatically. Then, the vehicle will start to move. The indicator color changes from green to white.

⚠ WARNING

When driving off from the AUTO HOLD by depressing the accelerator, always take a look around your vehicle. Slowly press the accelerator for a smooth starting.

Cancel

If you want to manually release or cancel the AUTO HOLD, release the Auto Hold switch while depressing the brake pedal. The Auto Hold indicator will go OFF. For your safety, manually release the Auto Hold, when the distance from the vehicle ahead is too close or during downhill driving.

i Information

- The Auto Hold does not operate, when:
 - The driver's seat belt is unfastened and driver's door is opened
 - The engine hood is opened
 - The trunk is opened
 - The shift lever is in P (Park)
 - The EPB is set
- For your safety, the Auto Hold automatically switches to EPB, when:
 - The driver's seat belt is unfastened and driver's door is opened
 - The engine hood is opened with the shift lever in D (Drive)
 - The trunk is opened with the shift lever in R (Reverse)
 - The vehicle stops for more than 10 minutes
 - The vehicle stands on a steep slope
 - The vehicle moves several times

In these cases, the brake warning light illuminates, the AUTO HOLD indicator color changes from green to white, and a message will be displayed with warning sound to inform you that EPB is automatically set.

(Continued)

(Continued)

Before driving off again, depress brake pedal, take a look around your vehicle, and manually release the parking brake and the EPB switch.

- When the AUTO HOLD indicator illuminates in yellow, the Auto Hold does not properly work. Take your vehicle to an authorized EQUUS dealer and have the system checked.

⚠ WARNING

- Depress the accelerator slowly when you start the vehicle.
- For your safety, cancel the AUTO HOLD operation, when:
 - Drive a downhill
 - Slowly drive, park or drive backwards
 - Wash the vehicle in an automatic car wash

NOTICE

When there is a malfunction with the driver's door, hood or trunk open detection system, the AUTO HOLD may not properly operate. Take your vehicle to an authorized EQUUS dealer and have the system checked.

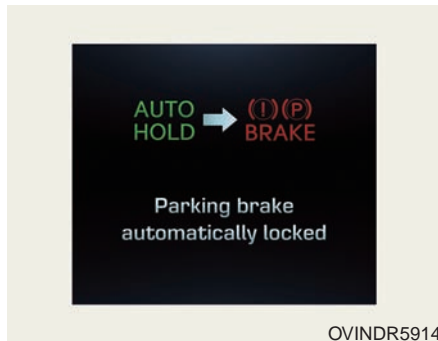

When the EPB is set ON after releasing the Auto Hold, a message will illuminate on the LCD display. Also, warning alarm sounds once.

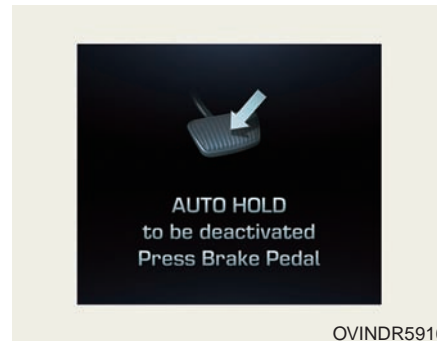

When you do not depress the brake pedal while pressing the AUTO HOLD switch to release it, a message will be displayed on the LCD display. Also, warning alarm sounds once.

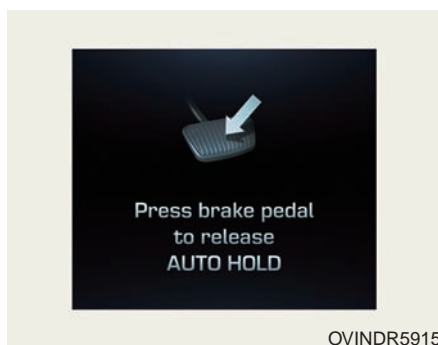

When it is impossible to set ON the EPB after releasing the Auto Hold, a message will illuminate on the LCD display. Also, warning alarm sounds once. At this moment, depress the brake pedal.

NOTICE

When this message is displayed, the Auto Hold and EPB may not be operable. For your safety, depress the brake pedal.

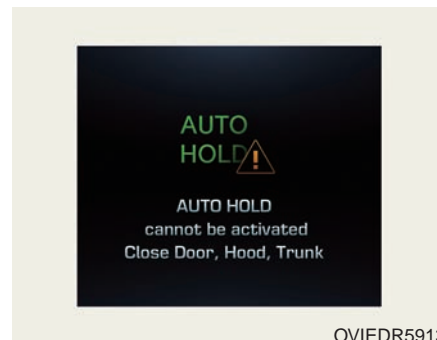

When you press the AUTO HOLD switch with the driver door/engine hood/trunk opened or with the seatbelt unfastened, a message will be displayed on the LCD display. Also, warning alarm sounds once. At this moment, press the AUTO HOLD switch with the driver door/engine hood/trunk closed and with the seatbelt fastened.

Anti-lock brake system (ABS)

WARNING

ABS (or ESC, Electronic Stability Control system) cannot prevent accidents caused by improper or dangerous driving maneuvers. Even though you have more control over the vehicle with emergency braking, always maintain a safe distance between you and objects ahead. Vehicle speeds should always be reduced in extreme rough road conditions. The braking distance of an ABS(or ESC)-equipped vehicle may be longer than the one of a ABS-unequipped vehicle in the following road conditions. In these conditions the vehicle should be driven at a reduced speed:

- A road surface is rough, or it is covered with gravel or snow
- Tire chains are installed
- The road surface is pitted or uneven.

The safety performance of an ABS(or ESC)-equipped vehicle should not be tested by driving at a high speed or cornering. This may put you and others in danger.

The ABS continuously monitors the wheel speed. When the wheels are about to be locked, the ABS system repeatedly modulates the hydraulic brake pressure to the wheels.

When you depress brake pedals in conditions, which may lock the wheels, you may hear a snapping sound or feel like that from the brakes. This is normal and indicates your ABS is active.

In order to obtain the maximum benefit from your ABS in an emergency situation, do not attempt to modulate your brake pressure or to pump your brakes. Press your brake pedal as hard, as possible, or as the situation allows, in order for the ABS to control the power delivery to the brakes.

Information

A clicking sound may be heard in the engine compartment, when the engine is started, and the vehicle begins to move. These conditions are normal and indicate that the anti-lock brake system properly operates.

- Even with the anti-lock brake system, your vehicle still requires a safe braking distance. Always maintain a safe distance from the vehicle in front of you.
- Always slow down the speed when cornering. The anti-lock brake system cannot prevent accidents resulted from an excessively high speed.
- On loose or uneven road surfaces, operation of the anti-lock brake system may result in a longer braking distance than the one of a vehicle equipped with a conventional brake system.

**NOTICE**

- When the ABS warning light illuminates and remains ON, your vehicle may have a problem with the ABS. In this case, however, your brake system is normally operable.
- The ABS warning light will stay ON for approximately 3 seconds after the ignition switch is ON. Then, the ABS will perform self-diagnosis, and if everything is normal, the light will go OFF. If the light stays ON, your vehicle may have a problem with the ABS. Immediately contact an authorized EQUUS dealer.

NOTICE

- When continuously depressing brakes, while driving on a road of poor traction, such as an icy road, the ABS will be continuously active, and the ABS warning light will illuminate. Pull over the vehicle in a safe place and stop the engine.
- When restart the engine, and then the ABS warning light goes OFF, your ABS system is normal. Otherwise, your vehicle may have a problem with the ABS. Immediately contact an authorized EQUUS dealer.

i Information

When you jump start your vehicle because of a drained battery, the engine may not run as smoothly, and the ABS warning light may be turned ON. This happens because of the low battery voltage. It does not indicate the ABS malfunction.

- Do not pump your brakes!
- Recharge the battery before driving the vehicle.



WKH-002

Check the brake warning light by turning the ignition switch ON (do not start the engine). This light illuminates when the parking brake is depressed with the ignition switch in the START or ON position.

Before driving, make sure that the parking brake is fully released and the brake warning light goes OFF.

When the brake warning light remains ON even after releasing the parking brake while engine is running, there may be a malfunction in the brake system. Immediate attention is necessary.

If at all possible, immediately stop driving. If not, use extreme caution and continuously drive the vehicle until you can reach a safe location.

Electronic stability control (ESC)

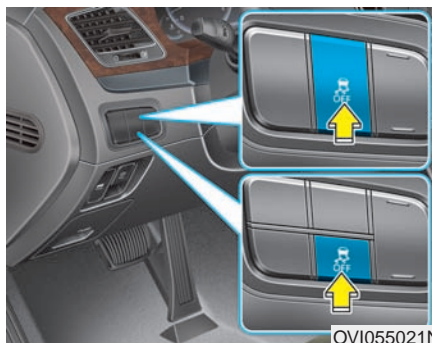

The ESC system is to stabilize the vehicle in cornering maneuvers. The ESC monitors your steering and driving. The ESC applies a brake of an individual wheel and engage in the engine management system in order to stabilize the vehicle.

⚠ WARNING

Never drive too fast or quickly when cornering. The ESC cannot prevent accidents under this condition. Excessively high speed in turning, abrupt driving maneuvers, and hydroplaning on a wet surface may result in serious accidents. Only safe and attentive driving can prevent accidents, avoiding traction loss of a vehicle. Even with the ESC equipment of your vehicle, always follow all the driving precautions, including driving at a safe speed.

The ESC system is an electronic system to help the driver maintain vehicle control in adverse conditions. It is not a substitute for safe driving practices. Various factors, including speed, road conditions and driver's steering maneuver, affect the ESC performance in preventing a loss of control. It is still driver's responsibility to drive and corner at a proper speed and to keep a safe distance. When depressing the brake under conditions, which may lock the wheels, you may hear a snapping sound and feel like that from the brake pedal. This is normal and indicates your ESC actively operates.

i Information

A clicking sound may be heard from the engine compartment, when the engine is started and the vehicle begins to move. This is normal, indicating that the ESC actively operates.

ESC operation

ESC ON condition

When the Engine Start/Stop button is turned ON, the ESC and the ESC OFF indicator lights illuminate for approximately 3 seconds and goes off, then the ESC is turned on.

When operating



When the ESC operates, the ESC indicator will flash.

- When the ESC properly operates, you can feel a slight pulsation from the vehicle. This is because of the brake control, and does not indicate a problem.
- When driving out of the mud or driving on a slippery road, the engine rpm may not be increased even with the accelerator deeply depressed. This is to maintain the stability and traction and does not indicate a problem.

ESC operation OFF

ESC OFF status



This vehicle has 2 types of ESC OFF status.

When the engine stops, and ESC is OFF, ESC remains OFF.

Upon restarting the engine, the ESC will be automatically turned ON again.

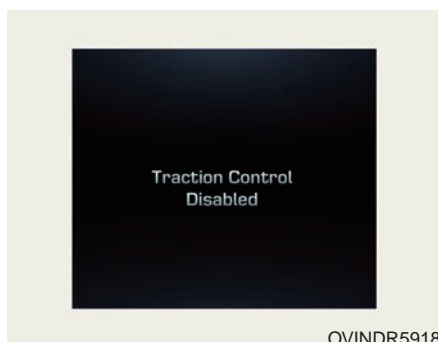

OVINDR5918

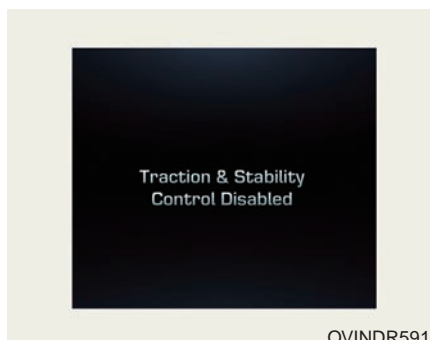

• ESC OFF state 1

To cancel the ESC, press the ESC OFF button shortly (ESC OFF ). At this state, the engine control function does not operate. It signifies the traction control function does not operate, either. Only the brake control function operates.



OVINDR5917

• ESC OFF state 2

To cancel ESC operation, press the ESC OFF button (ESC OFF ) for more than 3 seconds. ESC OFF indicator (ESC OFF ) illuminates with an ESC OFF warning alarm. At this state, the engine control function and brake control function do not operate. It signifies the vehicle stability control function does not operate any more.

Indicator light

- ESC indicator light (blinks)



- ESC OFF indicator light (comes on)



When the Engine Start/Stop button is turned ON, the ESC indicator illuminates. Then, it goes OFF, when the ESC system normally operates. The ESC indicator flashes, when the ESC operates or fails to operate. The ESC OFF indicator illuminates when the ESC is turned OFF by pressing the button.

NOTICE

Driving with tires or wheels in various sizes may cause the ESC system to malfunction. When replacing tires, make sure they are the same size as others. Never drive the vehicle, which is installed with the tires of different diameters.

⚠ WARNING

The ESC system is only a driving aid. Take precautions for safe driving, such as slowing down on curved, snowy, or icy roads. Drive slowly and do not attempt to accelerate when the ESC indicator light flashes, or when a road surface is slippery.

ESC OFF usage**When driving**

- ESC should be turned ON for daily driving whenever possible.
- To turn ESC OFF while driving, press the ESC OFF button while driving on a flat road.

⚠ WARNING

Never press the ESC OFF button while the ESC operates (ESC indicator flashes).
When the ESC is turned OFF while the ESC operates, the vehicle may go out of control.

NOTICE

Even if you turn OFF the ESC by pressing the button, the ESC function may be operated. It is normal condition for safety driving.

i Information

- When driving the vehicle on a dynamometer, make sure that the ESC is turned OFF (ESC OFF indicator illuminates with an alarm) by pressing the button for 3 seconds. When the ESC is left ON, it may prevent the vehicle from increasing the driving speed, resulting in false diagnosis.
- Turning the ESC OFF does not affect the operation of ABS or brake systems.

⚠ WARNING

Never press the ESC OFF button while ESC operates. If the ESC is turned OFF while the ESC operates, the vehicle may go out of control.

To turn ESC OFF while driving, press the ESC OFF button on a flat road.

Hill-start assist control (HAC)

A vehicle has the tendency to slide backwards on a steep slope, when the driver begins to accelerate after a stop. The HAC prevents the vehicle from sliding backwards by automatically operating the brake systems for about 2 seconds. The brake systems are automatically released, when the accelerator pedal is depressed or after about 2 seconds.

WARNING

The HAC is activated only for about 2 seconds, so always depress the accelerator pedal to begin driving upwards after a stop.

Information

- The HAC does not operate when the shift lever is in P(Park) or N(Neutral).
- The HAC activates, even when the ESC is OFF. However, it does not activate, when the ESC malfunctions.

Good braking practices

WARNING

- Whenever parking or leaving the vehicle, always securely set the parking brake and locate the vehicle's shift lever in P(Park). A vehicle, of which the shift lever is not in P(Park) with the parking brake set ON, is at risk of inadvertently moving and injuring you or others.
- All vehicles should always set the parking brake, when parking, to avoid inadvertent movement, which may injure occupants or pedestrians.

- Make sure the parking brake is released and that the parking brake indicator goes OFF before driving.
- Driving through water may get the brakes wet. The brakes may also get wet after washing the vehicle. Wet brakes can be dangerous! Your vehicle may not quickly stop, when the brakes are wet. Wet brakes may cause the vehicle to slide to one side.

To dry the brake, lightly depress the brake pedal until the braking operation returns to normal, taking care to keep the vehicle under control at all times. When the braking operation does not return to normal, immediately and safely stop the vehicle and call an authorized EQUUS dealer for assistance.

- Do not slide down (or coast down) the vehicle on a slope out of gear. This is extremely hazardous. Keep the vehicle in gear at all times, depress the brake pedal to slow down, and then shift to a lower gear so that engine braking will help you maintain a safe speed.
- Do not "ride" the brake pedal. Resting your foot on the brake pedal, while driving, is dangerous because it may result brake overheating or lose braking effects. It also wears out the brake components.
- If a tire goes flat while driving, gently depress the brake pedal. Keep the driving direction straight ahead while slowing down the speed. When the speed is lowered enough to be safe, pull off and stop the vehicle in a safe place.
- When your vehicle is equipped with an automatic transmission, do not let your car creep forward. To avoid creeping forward, firmly depress the brake pedal when stopping the vehicle.
- Be careful when parking on a slope. Firmly set the parking brake and place the shift lever in P(Park). When parking the vehicle on a downward slope, steer the front wheels sideways (into the curbs) to prevent the vehicle from rolling. When parking the vehicle on an upwards, turn the front wheels sideways (away from the curb) to prevent the vehicle from rolling.
If there is no curb, or if it is required by other conditions, block the wheels with obstacles to keep the vehicle from rolling.
- Under some conditions, your parking brake may freeze in the engaged position. This is most likely to happen, when there is an accumulation of snow or ice around or near the rear brakes, or when the brake is wet. When there is a risk that the parking brake may freeze, temporarily depress the brake pedal while locating the shift lever(automatic transmission) in P(Park) and block the rear wheels. Thus, the vehicle may not roll. Then, release the parking brake.
- Do not hold the vehicle on a slope by depressing the accelerator. This may overheat the transmission. Always use the brake pedal or parking brake.

DRIVE MODE INTEGRATED CONTROL SYSTEM

DRIVE mode / SNOW mode



The drive mode can be selected according to the driver's preference or road condition.

The system initializes to be in the NORMAL mode, when the Engine Start/Stop button is turned ON.

It is displayed on the AVN monitor which mode the vehicle is in as below.

- SPORT
- SNOW (if equipped)

The mode changes whenever the DRIVE MODE button is pressed.

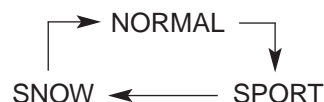

* If you turn OFF the User Settings Mode, the ECO indicator does not illuminate.

* According to the User Settings Mode, the background changes. You can turn OFF the background in User Settings Mode.

ECO mode

ECO

The ECO indicator is a guidance system for your fuel-efficient driving, when the NORMAL mode is selected.

- The ECO indicator color changes from white to green, when you drive with the best fuel efficiency.
- Maximize your fuel economy by adjusting your driving habit to be less aggressive and illuminating the green ECO indicator most of the driving time.

SPORT mode

The SPORT mode focuses on the driving dynamics by automatically adjusting the steering wheel, suspension (where the ECS is equipped), engine and transmission system.

SPORT

- When the SPORT mode is selected by pressing the DRIVE MODE button, the SPORT indicator will illuminate.
- Even after the SPORT mode is activated, restarting of the engine resets the DRIVE mode to be in the NORMAL mode. Thus, when necessary, re-select the SPORT mode.
- When the SPORT mode is activated:
 - The RPM(revolutions per minutes) level is maintained over a certain length of time, even when the accelerator is released.
 - Up-shifting timing is delayed, when accelerating.

***i* Information**

In the Sport mode, the fuel efficiency may decrease.

***i* Information**

When a Driving Mode theme is selected in the User Settings Mode of the LCD display (if equipped), the SPORT and SNOW indicators will not illuminate on the instrument cluster.

SNOW mode (if equipped)

Snow mode helps the driver to more effectively drive a vehicle on slippery roads, such as snowy or muddy roads.

SNOW

- When the SNOW mode is selected by pressing the DRIVE MODE button, the SNOW indicator will illuminate.

ELECTRONIC CONTROLLED SUSPENSION (ECS) (IF EQUIPPED)



The ECS automatically controls the vehicle suspension to maximize passengers' comfort with the air spring and the controllable shock absorber.

You can also manually control the vehicle height in the NORMAL or HIGH mode.

To control the vehicle height

Press the vehicle height control button to select the HIGH mode that makes the vehicle higher than the NORMAL mode. The vehicle height indicator will illuminate. It is useful on a rough road.

i Information

When the driving speed is over 42 mph (70 km/h), you cannot select the HIGH mode. When the driving speed exceeds 42 mph (70 km/h) in the HIGH mode, the mode automatically changes to the NORMAL mode.

Repress the vehicle height control button to select the NORMAL mode that makes the vehicle height lower than the HIGH mode. The vehicle height indicator will go OFF.

i Information

- Only when the vehicle stops with the shift lever in P(Park) or N(Neutral), the height control button is available.
 - When the driving speed exceeds 99 mph (160km) in NORMAL mode, the mode automatically changes to the LOW mode. LOW mode cannot be selected manually.
 - When the driving speed is under 50 mph (80 km/h) in the LOW mode, the mode automatically changes to the NORMAL mode.
 - When the Engine Start/Stop button is turned OFF in the HIGH mode, the HIGH mode selection will be maintained.
- It is to prevent damage the bottom of a vehicle when parking on a rough road.
- Make sure there are no objects under the vehicle before changing vehicle height.
 - A click sound may be heard while operating the ECS. This is normal and indicates that ECS properly functions.
 - Depending on the outside temperature the vehicle height may be different.
 - Do not press the Engine Start/Stop button while operating the ECS. This could cause damage to the ECS.

ECS (Electronic Controlled Suspension) malfunction warning message

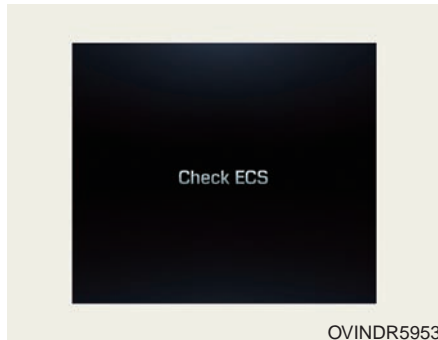

When the ECS malfunction warning message is displayed while driving, the ECS does not properly function. Have the system checked by an authorized EQUUS dealer.

i Information

- When the battery is discharged, or when either the SPORT button or the vehicle height control button is pressed repeatedly in a short time, the ECS malfunction indicator may illuminate to protect the system.
- When the height is adjusted repeatedly, the height control may temporarily stop due to the compressor overheat. This is to prevent damage to related parts.

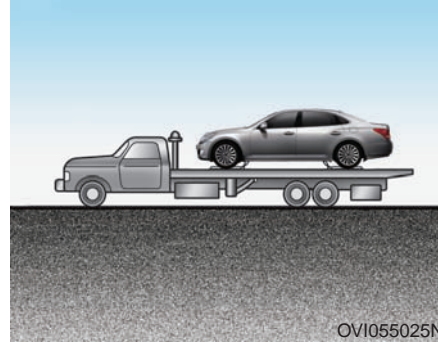

NOTICE

When the ECS malfunction message is displayed with no air inside the suspension, the vehicle height may be very low. Thus, do not drive the vehicle to protect it from the projections on the surface of the ground.

Take your vehicle to an authorized EQUUS dealer by towing it and have the system checked. You should tow the vehicle as shown in the picture.

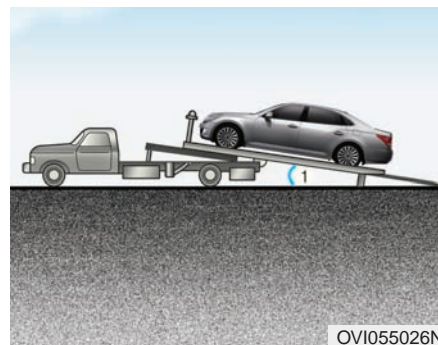

When you load the vehicle onto the tow truck, the loading angle(1) should be smaller than 6°.

ADVANCED SMART CRUISE CONTROL SYSTEM (IF EQUIPPED)

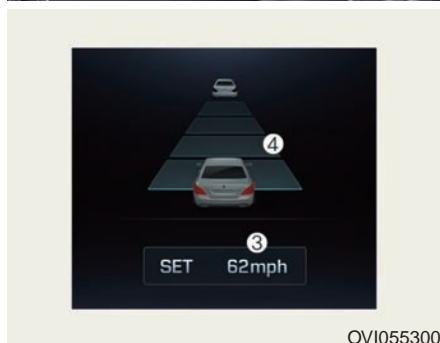

- (1) CRUISE indicator
- (2) SET indicator
- (3) Set speed
- (4) Vehicle-to-vehicle distance

The Smart Cruise Control system sets your vehicle to maintain a set speed unless it is not limited by traffic. When the system detects a vehicle in front, the vehicle will automatically slow down the speed to maintain a set distance without depressing the accelerator or the brake pedal.

⚠ WARNING

- When the Smart Cruise Control remains ON (CRUISE indicator on the instrument cluster illuminates), the Smart Cruise Control may be unintentionally activated. Keep the smart cruise control system OFF (CRUISE indicator OFF), when the smart cruise control is not in use, to avoid inadvertently setting the system.
- Use the smart cruise control system only when traveling on open highways in good weather.
- Do not use the Smart Cruise Control, when it may be unsafe to keep the vehicle at a constant speed, for instance, driving in heavy or fluctuating traffic, driving on slippery (rainy, icy or snow-covered) or sharply curving roads, or driving on a slope of 6 degrees or above.
- Pay particular attention to the driving conditions whenever using the smart cruise control system.
- Be careful when driving downhill using the smart cruise control system.
- The smart cruise control system is not a substitute for your safe driving practices, but a mere system for your convenience. It is the driver's responsibility to always check the speed and distance to the vehicle in front.

i Information

During the normal operation of the Smart Cruise Control, with the SET switch activated or reactivated after applying brakes, the Smart Cruise Control will energize after approximately 3 seconds. This delay is normal.

Smart Cruise Control speed

To set the cruising speed:



1. Press the CRUISE (ON•OFF) button on the steering wheel to turn the system ON. The CRUISE indicator on the instrument cluster will illuminate.
2. Accelerate to a desired speed.
 - 20 mph (30 km/h) ~ 113 mph (180 km/h) : when there is no vehicle in front
 - 0 mph (0 km/h) ~ 113 mph (180 km/h) : when there is a vehicle in front



3. Press the SET- switch, and release it at the desired speed. The SET indicator, the set speed and the vehicle-to-vehicle distance on the LCD display will illuminate. Release the accelerator. The set speed will automatically be maintained.

When there is a vehicle in front, the speed may decrease to maintain a safe distance.

On a steep slope, the vehicle may slow down or speed up slightly, while driving uphill or downhill.

To increase the cruising speed:



Follow one of the below procedures:

- Press the RES+ switch and hold it. The cruising speed will increase by 5 mph (10 km/h). Release the switch at the desired speed.
- Press the RES+ switch and release it immediately. The cruising speed will increase by 1.0 mph (1.6 km/h) each time the RES+ switch is pressed.
- The maximum speed of the Smart Cruise is 111 mph (180 km/h). However, you must observe all local speed limit laws.

To decrease the cruising speed:



Follow one of the below procedures:

- Press the SET- switch and hold it. Your cruising speed will decrease by 5 mph (10 km/h). Release the switch at the desired speed.
- Press the SET- switch and release it immediately. The cruising speed will decrease by 1.0 mph (1.6 km/h) each time the SET- switch is pressed.
- You can set the cruising speed above 19 mph (30 km/h).

To temporarily accelerate with the Smart Cruise Control ON:

When the driver wants to temporarily speed up with the Smart Cruise Control ON, depress the accelerator. The speed increase will not interfere with the Smart Cruise Control operation or change the set speed.

To return to the set speed, release the accelerator. When the SET- switch is re-pressed at an increased speed, the cruising speed will be re-set.

i Information

Be careful when accelerating temporarily, because the speed is not automatically regulated to keep a safe distance at this time, even when there is a vehicle in front.

The Smart Cruise Control will be canceled in following situations:



The Smart Cruise Control will be manually canceled in below situations:

- While driving
 - The brake pedal is depressed.
 - Pull the lever (to CANCEL) located on the steering wheel.
- While stopping with operating system
 - Depress the brake pedal and pull the lever (to CANCEL).

The advanced Smart Cruise Control turns OFF temporarily when the indicator on the LCD display turns OFF. The CRUISE indicator continuously illuminates.

The Smart Cruise Control will be automatically canceled in below situations:

- The driver's door is opened.
- The shift lever is moved to N (Neutral), R (Reverse) or P (Park).
- The EPB (electric parking brake) is set.
- The vehicle speed is over 120 mph (190 km/h).

- The vehicle stops on a steep slope.
- The ESC, ABS or TCS operates.
- The ESC is turned OFF.
- The sensor is covered or blocked with dust or foreign substances.
- When the vehicle is stopped for over 5 minutes.
- The vehicle stops and goes repeatedly for a long period of time.
- The driver starts driving by depressing the accelerator or pressing the RES+ button when a vehicle far away in front stops.
- The accelerator pedal is continuously depressed for more than 1 minute.

Each of depressing actions will cancel the Smart Cruise Control operation. (The SET indicator, the set speed and the vehicle-to-vehicle distance on the LCD display will go OFF.)

When the Smart Cruise Control is automatically canceled, it will not be resume even by pressing the RES+ or SET- button. Also, the EPB (electric parking brake) will be set upon stopping the vehicle.

NOTICE

When the Smart Cruise Control is cancelled by other than the above reasons, we recommend you to have the system checked by an authorized EQUUS dealer.

To resume the cruising speed:



When any actions other than pressing the CRUISE switch are taken to cancel the cruising speed, and when the system is still ON, the most recently set speed will be automatically resumed by pressing the RES+ switch.

It will not be resumed, however, when the vehicle speed is lower than approximately 6 mph (10 km/h) with a sensor detection of a vehicle in front, or when the vehicle speed is lower than approximately 19 mph (30 km/h) without a vehicle in front.

i Information

Always check the road conditions before pressing the RES+ switch to resume the cruising speed.

To turn OFF the Smart Cruise Control, do one of the followings:



- While driving
 - Push the CRUISE button
- While stopping, with the system ON
 - Depress the brake pedal and push the CRUISE button

Both of these actions cancel the Smart Cruise Control operation. When you want to resume the Smart Cruise Control operation, refer to "To set cruise control speed" on the previous page.

Smart Cruise Control vehicle-to-vehicle distance

To set a vehicle-to-vehicle distance:



This function sets your vehicle to maintain a safe distance from a vehicle in front without depressing the accelerator or brake pedal.

The vehicle-to-vehicle distance will automatically activate, when the Smart Cruise Control system is ON.

Select the appropriate distance according to road conditions and vehicle speed.

Each time the button is pressed, the vehicle to vehicle distance changes as follows:

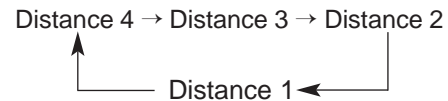

For example, if you drive at 56 mph (90 km/h), the vehicle-to-vehicle distance maintains as follows:

Distance 4 - approximately 170 feet

Distance 3 - approximately 131 feet

Distance 2 - approximately 106 feet

Distance 1 - approximately 82 feet

i Information

The 'Distance 4' is the default vehicle-to-vehicle distance, when the system is first turned ON, after starting the engine.

When there is no vehicle in front:



OVI055313/OVI055301



OVI055302/OVI055303

- The vehicle will maintain the set speed.
- Your vehicle speed will slow down or go up to maintain the selected distance.
- When a vehicle in front speeds up, your vehicle will drive at a steady cruising speed after accelerating to the set speed.

NOTICE

- The warning alarm sounds and the malfunction indicator flashes, when the vehicle is unable to maintain the selected distance from the vehicle in front.

(Continued)

(Continued)

- When the warning alarm sounds, actively adjust the vehicle speed, as well as the distance from the vehicle in front by depressing the accelerator or brake pedal.
- Even when there is no warning alarm, always pay attention to the driving conditions to prevent dangerous situations from occurring.



OVI055304

CAUTION

When a vehicle in front (vehicle speed: less than 20 mph (30 km/h)) change a lane to the next, a warning message will appear with a warning alarm. Adjust your vehicle speed for any sudden appearance of a vehicle or an object in front by depressing the brake pedal according to the road and driving conditions.

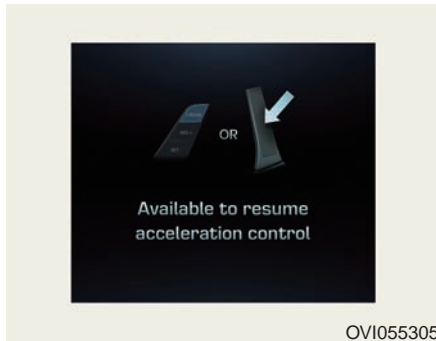
In traffic situation

OVI055305

In traffic, your vehicle will stop, when a vehicle in front stops. Also, when a vehicle in front starts moving, your vehicle will start as well. However, when your vehicle stops for more than 3 seconds, you must depress the accelerator or press the RES+ switch to start driving.

Vehicle-to-vehicle Distance Sensor

OVI055058N

The sensor measures a distance from a vehicle in front.

When this sensor is covered with dirt or other foreign substances, the vehicle-to-vehicle distance measurement may not be correct.

Always keep the sensor clean.

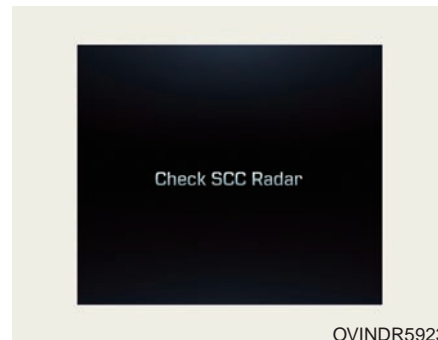
SCC (Smart cruise control) malfunction indicator

OVINDR5923



The warning message is displayed, when the vehicle-to-vehicle distance control system abnormally operates.

Have the system checked by an authorized EQUUS dealer.

⚠ CAUTION

- Do not install accessories around the sensor and do not replace the bumper by yourself. It may interfere with the sensor performance.
- Always keep the sensor and bumper clean.
- To prevent sensor cover from being damaged, use a soft cloth to clean your vehicle.
- Do not strike the sensor or the sensor area with a strong impact. When the sensor moves slightly off position, the Smart Cruise Control system will not correctly operate. If this occurs, immediately have your vehicle checked by an authorized EQUUS dealer.
- Use only an authorized HYUNDAI sensor cover for your vehicle.

To convert to the Cruise Control mode:

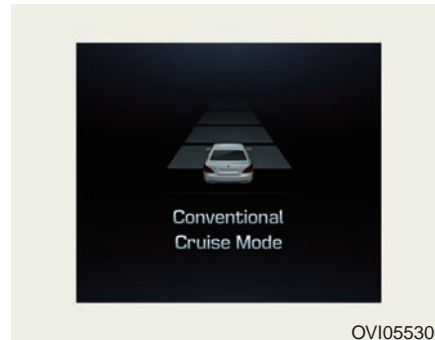

The driver may choose to only use the Cruise Control mode (speed control function) by following the directions below:

1. Turn the smart cruise control system ON (the cruise indicator will illuminate, but the system will not be active).
2. Press the vehicle-to-vehicle distance switch for more than 2 seconds.
3. Choose between "Smart Cruise Control(SCC) mode" and "Cruise Control(CC) mode".

⚠ WARNING

When using the Cruise Control mode, you must check the distance from other vehicles for yourself, as the system will not automatically brake to slow down.

Limitations of the system

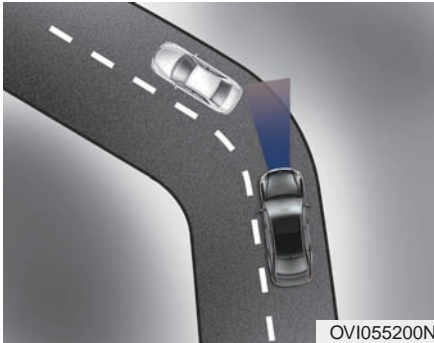

OVI055200N

The Smart Cruise Control system may have limits to its ability to measure a distance from a vehicle in front due to road and traffic conditions.

On curves

- On curves, the Smart Cruise Control system may not detect a moving vehicle in front in your lane. Then, your vehicle may accelerate to the set speed. Also, the vehicle speed will abruptly slow down, when suddenly recognizing a vehicle in front.
- Select an appropriate set speed on curves and depress the brake or the accelerator, if necessary.



OVI055201N

- Your vehicle speed may slow down due to an adjacent vehicle in the next lane. Depress the accelerator and select an appropriate set speed. Make sure that the road conditions are safe to operate the Smart Cruise Control.

On a slope

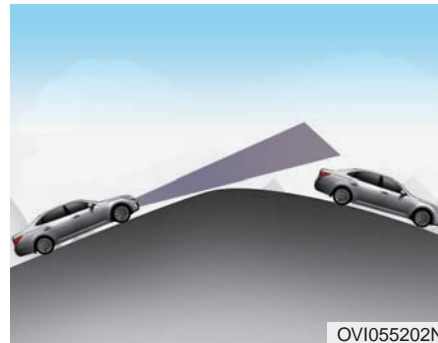

OVI055202N

- When driving uphill or downhill, the Smart Cruise Control system may not detect a moving vehicle in your lane, and cause your vehicle to accelerate to the set speed. Also, the vehicle speed will slow down, when the system suddenly detects a vehicle in front.
- Select an appropriate set speed for a slope and depress the brake or the accelerator, if necessary.

Lane changing

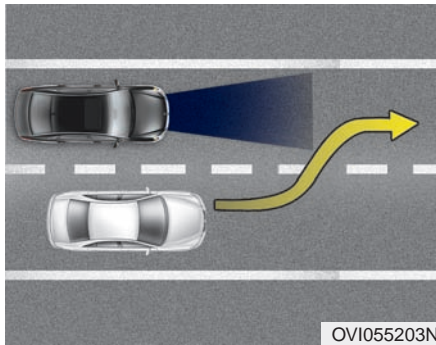

- A vehicle, which moves into your lane from the next, may not be recognized by the sensor until it moves within the sensor's detection range.
- The sensor may not immediately detect a vehicle in front, when a vehicle suddenly cuts in. Always pay attention to the traffic, road and driving conditions.
- When a vehicle, which moves into your lane, drives slower than yours, your speed may decrease to maintain a safe distance from a vehicle in front.
- When a vehicle, which moves into your lane, drives faster than yours, and when that vehicle drives slower than the set speed, your speed may accelerate.

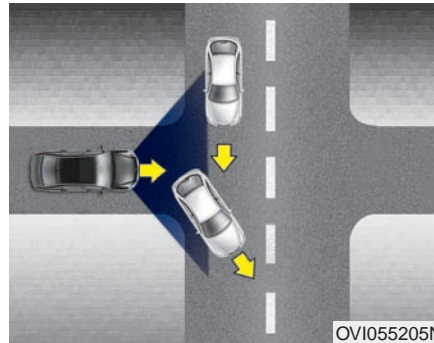

- Your vehicle may accelerate, when a vehicle in front disappears.
- When you are warned that a vehicle in front is undetectable, drive with caution.

Vehicle recognition

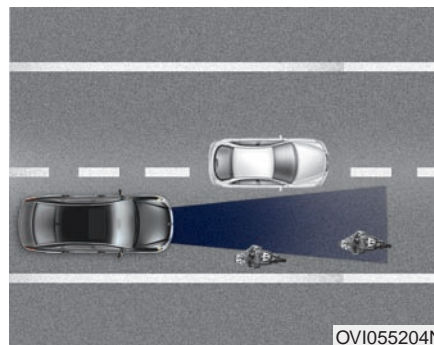

Some vehicles in front in your lane may not be recognized by the sensor in the following conditions:

- Small and narrow vehicles, such as motorcycles or bicycles
- Vehicles going astray to one side of a lane
- Slowly moving or suddenly decelerating vehicles
- Stopped vehicles
- Vehicles with a small and narrow rear profile, such as an unloaded trailer

A vehicle may be unrecognized by the sensor, when;

- The vehicle points upwards due to overloading in the trunk,
- The steering wheel is operated,
- The vehicle drives astray to one side of a lane, and
- The vehicle drives in a narrow lane or on a curve.

If necessary, depress the brake pedal or the accelerator.

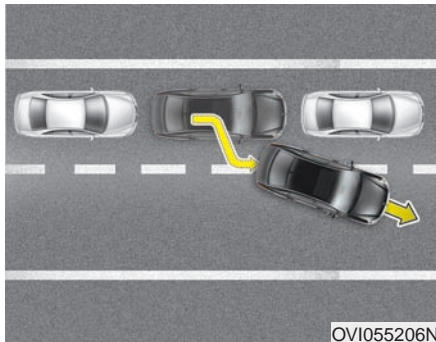

OVI055206N

- When vehicles are parked in a line, and when a vehicle in front drives out of the line, the system may not recognize other parked vehicles in the line. Thus, be careful, when you start to drive.

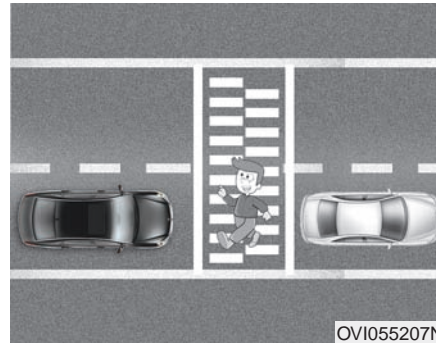

OVI055207N

- Always look out for abrupt appearance of any passers-by, while your vehicle system automatically controls and maintains a safe distance from a vehicle in front.

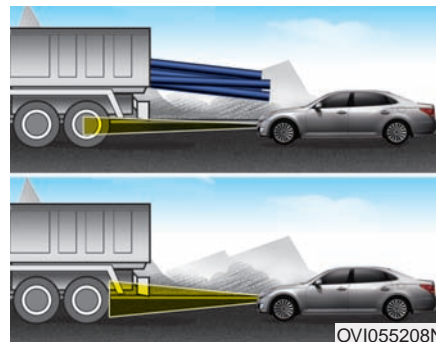

OVI055208N

- Always be cautious for vehicles with higher height or vehicles carrying loads that sticks out from the back of the vehicle.

⚠ WARNING

- The vehicle cannot be stopped by using the Smart Cruise Control system.

If necessary, you must depress the brake.

- Maintain a safe distance from a vehicle in front depending on the road conditions and the vehicle speed. When the vehicle-to-vehicle distance is too close while driving at a high speed, it may cause a serious collision.
- The Smart Cruise Control system cannot recognize stopped vehicles, pedestrians or oncoming vehicles.

Always cautiously look around the front to prevent unexpected and sudden situations from occurring.

- When a vehicle in front frequently change lanes, it may delay the system reaction time or may react to recognize a vehicle in the next lane. Always cautiously look around the front to prevent unexpected and sudden situations from occurring.
- The Smart Cruise Control system is not a substitute for your safe driving practices but only a system for your convenience. It is the driver's responsibility to always check the speed and the vehicle-to-vehicle distance.
- Always be aware of the set speed and vehicle-to-vehicle distance.

(Continued)

(Continued)

- Always maintain a sufficient braking distance. If necessary, decelerate your vehicle by depressing the brake.
- Always pay close attention to the driving conditions and the vehicle speed, since the Smart Cruise Control system may not recognize complex driving situations.
- For your safe operation, carefully read the manual in advance and follow the instructions.

NOTICE

The Smart Cruise Control system may be temporarily inoperable due to any strong electromagnetic waves.

LANE DEPARTURE WARNING SYSTEM (LDWS) (IF EQUIPPED)

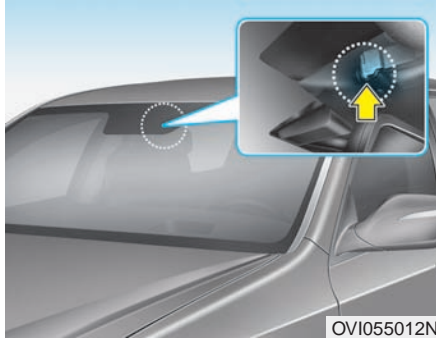

OVI055012N



OVI055013N

This system detects lane lines with the sensor located on the front windshield, and warns the driver of driving out of lane lines (lane departure).

WARNING

- The LDWS does not automatically control the driving direction. It is the driver's responsibility to always check the road conditions.
- Do not abruptly turn the steering wheel, upon getting the LDWS warnings.

(Continued)

(Continued)

- When the sensor cannot detect lane lines, or when the vehicle speed does not exceed 43 mph (70 km/h), the LDWS warnings will not be given, even while driving out of lane lines.
- When the front windshield is tinted or coated, the LDWS may not properly operate.
- Keep the LDWS sensor off water or any liquid to prevent damage.
- Do not disassemble the LDWS, nor damage the sensor with a strong impact.
- Do not put reflective objects on the dash board.
- Always check the road conditions, as you may not hear the warning alarm due to audio or other external noises.

LDWS operation



To turn ON the LDWS, pull the switch with the Engine Start/Stop button ON. The indicator illuminates on the cluster. To turn OFF the LDWS, pull the switch again.

LDWS indicator illuminate in 3 colors as follows:

- [Green]
When the system operating conditions are satisfied.
- [White]
 - The system operating conditions are not satisfied (The driving speed is below 43 mph (70 km/h)).
 - The sensor does not detect lane lines.
- [Yellow]
There is a malfunction with the LDWS. In this case, have your vehicle inspected by an authorized EQUUS dealer.

• When the sensor detects the lane line



OVI055307

• When the sensor doesn't detect the lane line



OVI055308

When the LDWS operates, when your vehicle drives out of the lane lines, and when your driving speed exceeds 43 mph (70 km/h), the warnings will be given as follows:

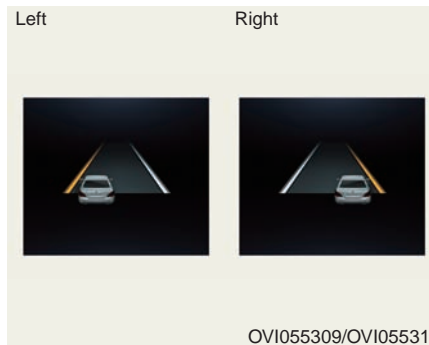

OVI055309/OVI055310

1. Visual warning

When driving out of the lane lines, a lane line, which you drive out of, will flash in yellow on the LCD display.

2. Auditory warning

When driving out of the lane lines, the warning alarm will sound.



OVI055063N

3. Tactual warning (if equipped with pre-safe seat belt)

When driving out of the lane lines for approximately 3 seconds, the pre-safe seat belt provides haptic warning.

You can activate or deactivate this tactual warning function. For this, refer to the "User Settings Mode" in chapter 3.

The LDWS does not operate in following conditions:

- The turn signal is turned ON before changing the lanes.
(When the hazard warning flasher is pressed ON, the LDWS exceptionally operates.)
- The vehicle drives on lane lines.

***i* Information**

Before changing the lanes, turn the turn signal ON.

DRIVER'S ATTENTION

The driver must be cautious in the below situations, because the system may not assist the driver nor work properly.

- The lane is not visible due to snow, rain, stain, puddles or others.
- The exterior brightness suddenly changes, such as driving through a tunnel.
- The headlamp is turned OFF or weak in the night time or in a tunnel.
- It is difficult to distinguish the lane mark colors from the road.
- The vehicle drives on a steep slope or a curve.
- Lights, such as sunlight, street-light or lights from other vehicles, reflect from the water on the road.
- The lens or windshield is stained with foreign substances.
- The sensor cannot detect the lane lines because of fog, heavy rain or heavy snow.
- The surrounding temperature of the inside rear view mirror is extremely high due to direct sunlight.
- The lane is very wide or narrow.
- The lane mark is damaged or indistinct.
- The shadow of median strips cast on the lane marks.
- There are similar marks to lane marks.
- There is a boundary structure.
- The distance from a vehicle in front is very short. So, its driving hides the lane marks in front.

(Continued)

(Continued)

- The vehicle is violently shaken.
- The number of lane marks increases or decreases, or the lane marks cross each other in a complicated manner.
- Something is placed on the dashboard.
- The vehicle drives against sunlight.
- The vehicle drives in a construction area.
- There are more than two lane marks.
- The lane marks are hard to be distinguished due to dust or grease in a tunnel.
- The lane marks are hard to be distinguished after raining at night.
- The lane marks are hard to be distinguished due to dust.

ADVANCED VEHICLE SAFETY MANAGEMENT (AVSM) (IF EQUIPPED)

The AVSM measures a distance from a vehicle in front with the sensor, warns you of a possible collision with a vehicle in front, and protects you in certain hazardous situations by giving a warning message, a warning alarm and seatbelt vibration (if equipped).

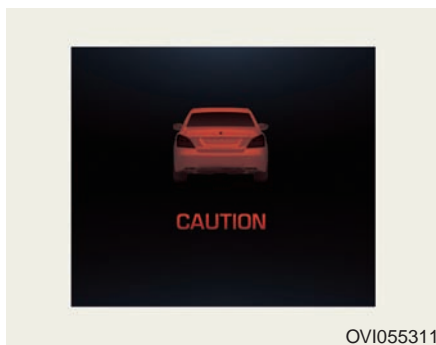

OVI055311

- When the AVSM detects that an object in front is too close from your vehicle, or when the driver needs to depress brake pedal or to turn the steering wheel, the warning light illuminates.

Immediately reduce your speed.

- When the AVSM senses a danger, the warning alarm will also sound with the seatbelt vibration.

Immediately reduce your speed.

NOTICE

Always check the road conditions to prevent any danger, even when the warning light does not illuminate, the warning alarm does not sound, or the seatbelt does not vibrate.

Brake operation

- When the AVSM senses an object in front is too close, the brake system enters into a standard mode to promptly react against the driver's possible depressing of the brake pedal.
- When the driver releases the accelerator after the warning, the AVSM automatically and gently decelerates the vehicle.
- When the driver depresses the brake pedal to reduce vehicle speed, the brake assistant system is activated to raise braking efficiency.
- When an object in front is away at a safe distance, and when the driver depresses the accelerator or releases the brake pedal, the braking will stop.

WARNING

The AVSM does not completely stop the vehicle and does not totally avoid a collision. Always cautiously look around the front to prevent unexpected and sudden situations from occurring.

Seat belt operating

The seat belt tightens when the vehicle senses a collision.

⚠ WARNING

The AVSM is activated depending on the vehicle-to-vehicle distance, relative velocity and driver's brake pedal/accelerator operation. Do not recklessly drive on purpose to activate the AVSM.

NOTICE

- When the AVSM is activated or deactivated, make sure that the vehicle is stopped.
- When the engine runs, the AVSM is automatically turned ON. If unnecessary, select the AVSM OFF in the User Settings mode.
- Even when the AVSM ON is selected in the User Settings mode, but when the ESC is turned OFF by pressing the ESC OFF button, the AVSM is automatically deactivated. Then, it is impossible to manually control the AVSM.

Malfunction indicator

- The AVSM OFF indicator illuminates, when the Engine Start/Stop button is pressed ON. However, it goes OFF in approximately 3 seconds. When the indicator does not illuminate, or continuously remains ON even after 3 seconds, with the Engine Start/Stop button ON, or when the indicator remains ON while driving, the AVSM does not properly operate. Take your vehicle to an authorized EQUUS dealer and have the system checked.
- The AVSM OFF indicator may illuminate, when the ESC indicator or SCC indicator illuminates. It does not indicate a malfunction of the AVSM.

⚠ WARNING

The AVSM is not a substitute for your safe driving practices, but only a supplementary system. It is the driver's responsibility to always check the speed and the vehicle-to-vehicle distance.

⚠ WARNING

- Even if there is a malfunction in AVSM braking, the brake is normally operable by depressing the brake pedal. The AVSM braking does not operate in certain hazardous situations.
- The AVSM is designed to be active, while driving above approximately 9.3 mph (15 km/h) and below approximately 111.8 mph (180 km/h).
- The AVSM does not react to:
 - A person or animal
 - An oncoming vehicle in lanes of the opposite direction or a vehicle in an intersection
 - A stopped object
- The AVSM cannot detect an object in below conditions:
 - The sensors are stained or covered with dirt.
 - There is heavy rain or heavy snow.
 - There is interference from electromagnetic waves.
 - There are strong radar reflections.
 - The vehicle drives in a curve.
 - The vehicle drives uphill or downhill.
 - The vehicle drives in a construction area.
 - An object in front is very narrow, such as a motorcycle or bicycle.
 - A vehicle suddenly cuts in front.

(Continued)

(Continued)

- The AVSM braking operation is inoperable, when the driver does not release the accelerator nor depress the brake pedal.

BLIND SPOT DETECTION SYSTEM (BSD) (IF EQUIPPED)

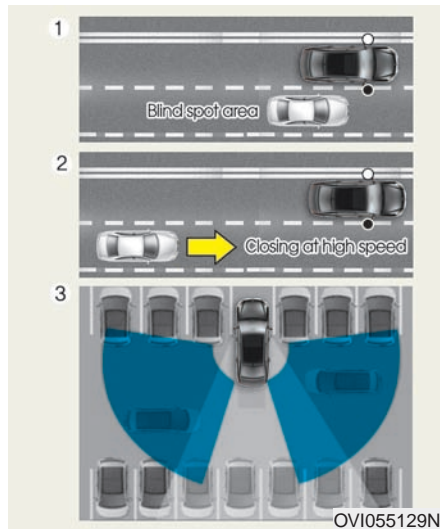
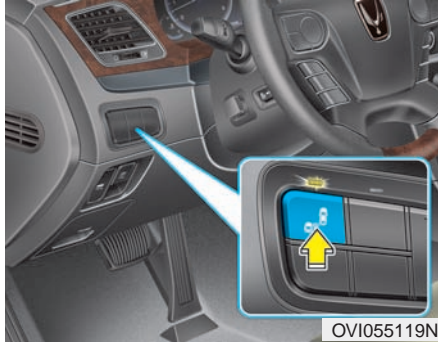

The BSD (Blind spot detection) system uses a radar sensor to alert the driver while driving.

It monitors the rear area of the vehicle and provides information to the driver.

(1) BSD (Blind spot detection)

The warning range varies in accordance with a driving speed. When your vehicle drives 6 mph (10 km/h) faster than the other vehicles, the system will not warn you.

(2) LCA (Lane change assist)

When a vehicle approaches you at a high speed, the system will warn you.

(3) RCTA (Rear cross traffic alert)

When your vehicle drives backwards, and when the sensor detects the approaching vehicle in the left and right side, the system will warn you.

⚠ WARNING

- Always check the road condition while driving for unexpected situations even with the BSD system ON.
- The BSD system is designed for your convenience. Do not solely rely on the system. Always concentrate on driving for your safety.

Operating conditions

The BSD indicator will illuminate when the BSD system switch is pressed ON after turning the Engine Start/Stop button ON.

When the vehicle speed exceeds 9.3 mph (15 km/h), the system will activate.

When you press the BSD switch again, the indicator and the BSD system will be turned OFF.

When the ignition switch is pressed ON after engine turn-OFF, the BSD system returns to the previous state.

When the BSD system is not used, turn the BSD system OFF by pressing the switch.

When the BSD system is turned ON, the warning light will illuminate for 3 seconds on the outside rearview mirror.

Warning types

The system will activate as below.

- 1.The system is ON.
- 2.The vehicle speed is above 9.3 mph (15 km/h).
- 3.Other vehicles are detected behind your vehicle.

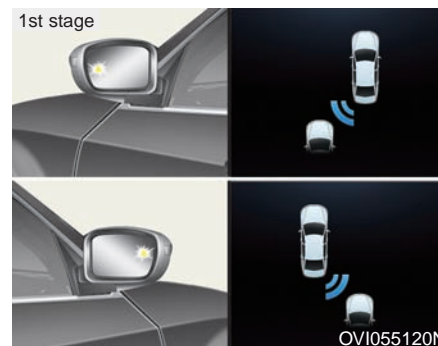

When a vehicle is detected within the system sensing range, a warning light will illuminate on the outside rearview mirror and the head-up display.

When a detected vehicle is out of the warning range, the warning alarm will be turned OFF according to driving conditions.



The second-stage alarm will activate when:

1. The first-stage alarm is ON.
2. The turn signal is pressed ON, before changing the lanes.

When the second-stage alert is active, a warning light will flash on the outside rearview mirror and the head up display, and an alarm will sound.

When the turn signal switch is pressed to the original position, the second-stage alert will be deactivated.

Detecting sensor



The sensors are located inside of the rear bumper.

Always keep the rear bumper clean for the proper operation of the system.

Warning message

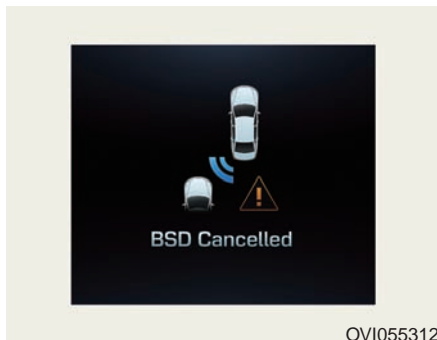

When the detecting sensor performance is bad, or when the sensors are overheated by foreign substances on the rear bumper, the warning message will be displayed to alert the driver. However, the message may be displayed even in an open place without any vehicles to be detected due to bad weather. Remove the foreign substance on the rear bumper.

After the foreign substance is removed, if you drive for approximately 10 minutes, the system will work normally.

If the system does not work normally even though the foreign substance is removed, take your vehicle to an authorized EQUUS dealer and have the system checked.

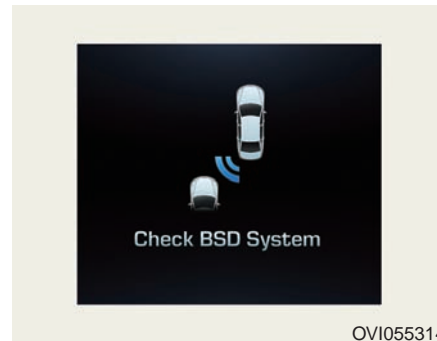

When there is a problem with the BSD system, the message will be displayed to alert the driver. In this case, have a vehicle checked by an authorized EQUUS dealer.

RCTA (Rear cross traffic alert)

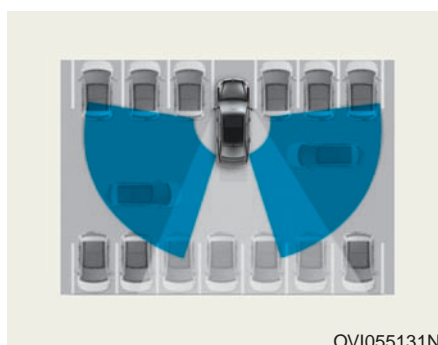

When your vehicle drives backwards after parking, the sensor detects any approaching vehicles from the left and right sides and gives information to the driver.

Operating conditions

- When you press the BSD switch with the ignition ON, the BSD indicator illuminates and the system turns ON.
- The system operates, when the driving speed is below 6.2 mph (10 km/h) with the shift lever in R(Rear).
- The RCTA sensing range is from 0.5m to 20m in accordance with the directions. When the approaching vehicle speed is from 2.5 mph (4 km/h) to 22 mph (36 km/h) within the sensing range, it will be detected. However, the system sensing range is varied in different conditions. Always take a look around the vehicle.

Warning type

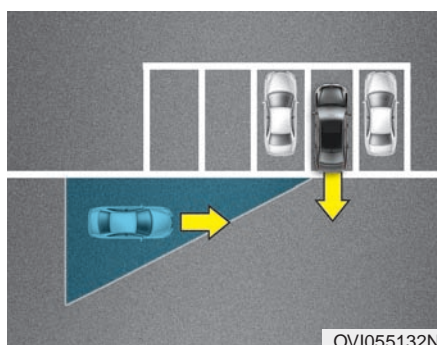

- When the sensor detects any approaching vehicles behind, the warning light will flash on the outside rearview mirror with a warning alarm.
 - When an approaching vehicle behind is out of the sensing range, when it drives away in the opposite direction or when it drives slowly, the warnings will be turned OFF.
 - The system may not normally operate due to certain factors. Always take a look around your vehicle.
- * When the left- or right-side bumper of your vehicle is blinded by barriers or vehicles, the system sensing performance may be deteriorated.

⚠ WARNING

- The warning light on the outside rearview mirror and the head-up display will illuminate whenever an approaching vehicle behind is detected by the system.

To avoid an accident, do not pay too much attention to the warnings, and do not neglect to take a look around.

- Drive safely even though the vehicle is equipped with the BSD system. Do not rely solely on the system. Check the road conditions before changing the lanes.

The system may not alert the driver in some conditions. Thus, take a look around.

NOTICE

- The system may not properly operate, when the bumper is replaced, or when a repair work is done near the sensor.
- The sensing range differs according to the roads width. When the road is narrow, the system may detect other vehicles in the next lane.
- On the contrary, when the road is wide, the system may not detect other vehicles.
- The system may be turn OFF due to the strong electromagnetic waves.

Non-operating condition***Driver's Attention***

The driver must be cautious in the below situations, because the system may not properly operate to assist the driver.

- The vehicle drives on a curved road or through a tollgate.
- The sensor is polluted with rain, snow, mud, etc.
- The rear bumper, in which the sensor is located, is covered or blocked with a foreign matter such as a sticker, a bumper guard, a bicycle stand, etc.
- The rear bumper is damaged, or the sensor is out of the original default position.
- The vehicle height gets lower or higher due to heavy loading in a trunk, abnormal tire pressure, etc.
- The vehicle drives in a bad weather such as heavy rain or snow.
- There is a fixed object near the vehicle, such as a guardrail.
- A huge amount of metal substances are near the vehicle, such as in a construction site.
- A big vehicle is near such as a bus or truck.
- A motorcycle or bicycle is near.
- A flat trailer like vehicle is near.
- When the other vehicle passes by very fast.
- When changing lanes.
- When going down or up a steep road where the height of the lane is different.

Driving your vehicle

- When the other vehicle drives at the rear very nearby or drives very close.
- When a trailer or carrier is installed.
- When the temperature of rear bumper is high.
- When the sensors are covered by the vehicle, wall and pillar of parking lot.
- When your vehicle moves back, if the detected vehicle also moves back.
- If there is small things like shopping cart and baby carriage.
- If there is low height vehicle like sport vehicle.
- When the vehicle is close to your vehicle.
- When driving through a narrow road with many trees or bushes.

The warning light on the outside rearview mirror may not alert the driver, when:

- The outside rearview mirrors are severely polluted
- The windows are severely polluted
- The windows are severely tinted.

This device complies with Part 15 of the FCC rules.

Operation is subject to the following two conditions:

1. This device may not cause harmful interference, and
2. This device must accept any interference received, including interference that may cause undesired operation.

ECONOMICAL OPERATION

Your vehicle's fuel economy depends mainly on your driving style such as where you drive and when you drive.

Each of these factors affects your fuel economy (how many miles/kilometers you can drive with a gallon/liter of fuel). To drive your vehicle as economically as possible, follow the below driving suggestions. These will help you save in both the fuel and repair expenses:

- Drive smoothly. Accelerate at a moderate rate. Do not make "jackrabbit" starts or full-throttle shifts. Maintain a steady cruising speed. Do not race between stoplights. Try to adjust your speed in accordance with other traffic to avoid unnecessary speed changes. Avoid heavy traffic whenever possible. Always maintain a safe distance from a vehicle in front to avoid unnecessary braking. This also reduces brake wear-out.
- Drive at a moderate speed. The faster you drive, the more fuel your vehicle uses. Driving at a moderate speed, in the highest gear appropriate for the driving conditions especially on the highway, is one of the most effective ways to reduce fuel consumption.
- Do not "ride" the brake pedal. This can increase fuel consumption and also wear out the brake components. In addition, resting your foot on the brake pedal, while driving, may overheat the brake, reducing braking effects and possibly leading a serious consequence.
- Check your tire conditions. Keep them inflated to the recommended pressure level. Under or over inflation will unnecessarily tire wear-out. Check the tire pressures at least once a month.
- Make sure that the wheels are correctly aligned. Hitting a curb or driving too fast on uneven surfaces may distort the wheel alignment. Poor alignment causes faster tire wear-out and may also result in other problems as well as greater fuel consumption.
- Keep your vehicle in good condition. For the better fuel economy and the cheaper maintenance expenses, maintain your vehicle in accordance with the maintenance schedule in the chapter 7. When you drive your vehicle in harsh conditions, more frequent maintenance is required (refer to the chapter 7 for further information).
- Keep your vehicle clean. Your vehicle should be kept clean and away from any corrosive substances. It is especially important that mud, dirt, ice and others are not daubed under the vehicle. This extra weight may increase the fuel consumption and also cause corrosion.
- Avoid a heavy loading. Do not carry unnecessary weight in your vehicle. It will improve your fuel economy.
- Do not let the engine idle longer than necessary. When you wait (not in traffic), turn OFF the engine. Then restart the engine, when you are ready to go.
- Remember that your vehicle does not require the engine warm-up for a long time. After turning On the engine, run the engine for 10 to 20 seconds, before shifting the gear. In cold weather, however, your engine needs a slightly longer warm-up period.

Driving your vehicle

- Do not "lug" or "over-rev" the engine. Lugging is to drive too slowly in a high gear, resulting in the engine bucking. In this case, shift to a lower gear. Over-revving is racing the engine beyond its safe limit. This can be avoided by decelerating to a recommended speed.
- Use your air conditioning at intervals. The air conditioning system operates by engine power. Thus, your fuel economy will decline, when turning it ON.
- Opening the windows, while driving at a high speed, may reduce the fuel economy.
- The fuel economy will decline in the crosswind and headwind. To offset some of this loss, slow down the driving speed.

Keeping a vehicle in good operating condition is important both for the fuel economy and safety. Therefore, have your vehicle inspected and maintained by an authorized EQUUS dealer on a regular basis.

WARNING

- Turning the engine OFF while driving

Never turn the engine OFF to coast down hills or anytime the vehicle is in motion. The power steering and power brakes will not properly operate, when the engine is turned OFF. Keep the engine ON and downshift to an appropriate gear for engine braking effect. Moreover, turning OFF the ignition, while driving, may lock the steering wheel, blocking the steering wheel movement and causing a serious injury or death.

SPECIAL DRIVING CONDITIONS

Hazardous driving conditions



When hazardous driving elements are encountered such as water, snow, ice, mud and sand, take these suggestions:

- Drive cautiously and keep a longer braking distance.
- Avoid abrupt braking or steering.

⚠ WARNING

- ABS

Do not pump the brake pedal, when your vehicle is equipped with the ABS.

⚠ WARNING

- Downshifting

Downshifting with an automatic transmission, while driving on slippery surfaces, may cause an accident. A sudden speed change in driving may cause the tires to skid. Be careful when downshifting on a slippery surface.

Rocking the vehicle

When it is necessary to rock the vehicle to escape from snow, sand, or mud, first move the steering wheel from side to side to clear the front-wheel area. Then, move the shift lever back and forth between R(Reverse) and any forward gears. Do not race the engine, and avoid unnecessary wheel spins. When your vehicle is still stuck in after trying the above, have the vehicle pulled out by a tow truck to avoid engine overheating and transmission damages.

NOTICE

A long-time rocking may overheat the engine and damage the transmission/tires.

⚠ WARNING

- Spinning tires

Do not spin the wheels, especially faster than 35 mph (56 km/h). Spinning the wheels at a high speed, while parking, may overheat a tire and injure passers-by.

i Information

The ESC system must be turned OFF before rocking the vehicle.

⚠ WARNING

When your vehicle is stuck in snow, mud, sand, etc., you may rock the vehicle to escape by moving forwards and backwards. Do not attempt this, when people or objects are anywhere near the vehicle. Rocking the vehicle may cause it to suddenly move forwards or backwards, as it becomes unstuck, injuring nearby people or damaging objects.

Smooth cornering



Avoid braking or shifting a gear on a corner, especially when a road surface is wet. It is ideal to drive a corner by gently accelerating. When you take this suggestion, the tire wear-out will be minimized.

Driving at night



Since night-time driving is more hazardous than day-time driving, here are some important tips to remember:

- Slow down a driving speed and keep a longer safe distance from a vehicle in front, as it may be harder to see at night, especially in areas without any street lights.
- Adjust your mirror angle to reduce glares from the headlamps of other vehicles.
- Keep your headlamps clean and properly aimed at. Any foreign substances on a headlamp and an improperly adjusted headlamp angle make it much harder to see at night. Turning the headlamp ON, while operating windshield wipers, is mandatory in some states.
- Avoid directly staring at the headlamps of approaching vehicles. This may temporarily blind your vision, and take several seconds for your eyes to readjust in the darkness.

Driving in the rain



Rain and wet roads make driving dangerous, especially when you are not prepared for the pavement slick from rain. Here are a few things to consider before driving in the rain:

- A heavy rainfall will make it harder to see and will increase a braking distance. Thus, slow down a driving speed.
- Keep your windshield wipers in good shape. Replace your wiper blades, when those fail to wipe out some parts on the windshield.
- When your tires are in bad shape, quick braking on a wet surface may cause a skid and possibly lead to an accident. Make sure your tires are in good shape.
- Turn the headlamps ON to make it easier for others to see you.
- Driving at a high speed through large puddles may affect your brake systems. While driving through puddles, slow down your driving speed.
- When your brakes are (or are suspected to be) wet, lightly apply them while driving, until the braking operation returns to normal.

Driving in flooded areas

Avoid driving through a flooded area, unless you are sure the water level is lower than the wheel hub bottom. Slowly drive, when driving through any water. Keep an adequate stopping distance, because your braking systems may become wet.

After driving through water, dry the brakes by gently applying them several times, while slowly driving.

Off-road driving

Carefully drive off the road, because your vehicle may become damaged by rocks or roots of trees. Check the off-road conditions, in advance, where you will drive.

Highway driving

Tires



Adjust the tire inflation, as specified. Under-inflation may overheat or damage the tires.

Do not install worn-out or damaged tires, which may reduce traction or fail the braking operation.

i Information

Never over-inflate your tires above the maximum inflation pressure, as specified on your tires.

⚠ WARNING

- Underinflated or overinflated tires may cause poor handling, loss of vehicle control, and sudden braking failure, leading to an accident, an injury, and even a death. Always check tire pressure to maintain the proper inflation, before driving. For further tire pressure information, refer to “Tires and wheels” in the chapter 8.
- Driving with tires with insufficient or extremely worn-out tread is dangerous. Those tires may result in loss of vehicle control, a collision, an injury, and even a death. Worn-out tires must be replaced immediately and not used for driving. Always check the tire tread before driving. For further information and tread limits, refer to “Tires and wheels” in the chapter 7.

Fuel, engine coolant and engine oil

Driving at a high speed consumes more fuel than driving in an urban area. Do not forget to check both the engine coolant and engine oil.

Drive belt

A loose or damaged drive belt may overheat the engine.

WINTER DRIVING



The severe weather conditions of winter quickly wear out tires and cause other problems. To minimize winter driving problems, you should take the following suggestions:

Snowy or icy conditions

To drive your vehicle in the deep snow, it may be necessary to use snow tires or tire chains. When installing snow tires, it is necessary to select tires in the equivalent size and type to the original ones. Failure to do so may adversely affect your safety and handling. Furthermore, speeding, rapid accelerating, sudden braking and sharp turning are potentially hazardous.

When decelerating, set the engine brake to the fullest extent. Sudden braking on a snowy or icy road may cause a skid. You need to keep a sufficient distance from a vehicle in front. Also, gently depress the brake. It should be noted that installing tire chains provides a greater driving force, but do not prevent a sideways skid.

i Information

Using tire chains are illegal in some states. Check state laws, before installing tire chains.

Snow tires

When installing snow tires, make sure they are radial tires of the same size and load range as the original ones. Install snow tires on all four wheels to balance your vehicle's handling in all weather conditions. Keep in mind that the traction provided by snow tires on a dry road may not be the same as the original tires. You should cautiously drive, even when a road surface is dry. Check the recommended speed maximum with your tire dealer.

⚠ WARNING

- Snow tire size

Snow tires should be equivalent in size and type to the vehicle's original ones. Otherwise, the safety and handling of your vehicle may be adversely affected.

Do not install studded tires before checking the local, state and municipal regulations. There may be a possible restriction against using those.

Tire chains



Since the sides of radial tires are thinner, they may be damaged by installing some types of snow chains. Therefore, snow tires are more recommended than snow chains. Do not install tire chains on tires over the aluminum wheels. Snow chains may cause damage to those wheels. When snow chains must be used, use the AutoSock (fabric snow chain). Damage to your vehicle caused from improper snow chains is not covered by your vehicle manufacturer's warranty.

Install the AutoSock only on the rear tires.

NOTICE

- Use authorized HYUNDAI (MOBIS) parts, after reading the instruction.
- Make sure to use the AutoSock of the correct size and type. Incorrect snow chains may damage your vehicle body and suspension. Those damages may not be covered by your vehicle manufacturer's warranty.
- Always check the AutoSock installation condition after driving approximately 0.3 to 0.6 miles (0.5 to 1 km). Tighten or reinstall the AutoSock, when they are loose.

Chain installation

When installing the AutoSock, follow the manufacturer's instructions and tighten them to the fullest. Slowly drive, when the AutoSock is installed. While hearing a snapping sound between the AutoSock and the vehicle body (or chassis), stop the vehicle and tighten the AutoSock. When still hearing the snapping sound after tightening, slow down the vehicle until it stops. Immediately remove the AutoSock before driving on a cleared road.

⚠ WARNING

- Chain installation

When installing the AutoSock, park the vehicle on level ground away from other vehicles. Press ON the Hazard Warning flasher and place a warning triangle behind your vehicle, if available. Place the shift lever in P(Park), set the parking brake and turn OFF the engine, before installing the AutoSock.

⚠ WARNING

- Tire chains

- The use of the AutoSock may adversely affect vehicle handling.
- Do not drive faster than the lower of the two - 20 mph (30 km/h) and the AutoSock manufacturer's recommended speed limit.
- Drive carefully and avoid bumps, holes, sharp turns, and other road hazards, which may bounce the vehicle.
- Avoid turning sharply or locking the wheel brake.

NOTICE

- An AutoSock, which is in the wrong size or is improperly installed, may damage brake lines, suspension, body and wheels of your vehicle.
- Stop driving and retighten the AutoSock, whenever there are snapping sounds between the vehicle and the AutoSock.

Use high quality ethylene glycol coolant

The cooling system of your vehicle is filled with the high-quality ethylene glycol coolant when being delivered. It is the only type of coolant that your vehicle is filled with, because it prevents corrosion of the cooling system, lubricates the water pump and prevents freezing. Refill the cooling system in accordance with your maintenance schedule in the chapter 7. Before winter, check your coolant to assure that the freezing point is sufficiently lower than the expected winter temperature.

Check battery and cables

The winter temperature increases the battery consumption. Inspect the battery and cables, as described in the chapter 7. The battery charging level can be checked by an authorized EQUUS dealer or in a service station.

Change to "winter weight" oil, if necessary

In some regions during the cold winter, it is recommended to use the "winter weight" oil with lower viscosity. For further information about this, refer to the chapter 8. When you cannot be sure about a type of winter weight oil, consult an authorized EQUUS dealer.

Check spark plugs and ignition system

Inspect your spark plugs and, if necessary, replace them. Also check all ignition wirings and components for any cracks, wear-out, and damage.

To prevent the locks from frozen

To prevent the locks from being frozen, spray authorized de-icing fluid or glycerin into key openings. When a lock opening is already covered with ice, spray authorized de-icing fluid on the ice to remove it. When an internal part of a lock freezes, try to thaw it with a heated key. Carefully use the heated key to avoid an injury.

Use authorized window-washer anti-freezer solution in system

To prevent the window washer from being frozen, add authorized window-washer anti-freeze solution, as instructed on the window-washer container. Window-washer anti-freeze solution is available from an authorized EQUUS dealer, and so are the most auto parts outlets. Do not use engine coolant or other types of anti-freezer solution, because these may damage the vehicle paint.

Do not let your parking brake freeze

Under some conditions, your parking brake may freeze in the engaged position. This is most likely to happen, when there is an accumulation of snow or ice around/near the rear brakes, or when the brakes are wet. When there is the risk that your parking brake may freeze, temporarily apply it after locating the shift lever in P(Park). Also, block the rear wheels in advance, so the vehicle may not roll. Then, release the parking brake.

Do not let ice and snow accumulate underneath

Under some conditions, snow and ice may build up under the fenders and interfere with the steering. When driving in such conditions during the severe winter, you should check underneath the vehicle on a regular basis to assure that moving the front wheels and the steering components is unobstructed.

Carry emergency equipment

In accordance with weather conditions, you should carry appropriate emergency equipment, while driving. Some of the items you may want to carry include tire chains, tow straps, chains, flashlight, emergency flares, sand, a shovel, jumper cables, a window scraper, gloves, ground cloth, coveralls and a blanket.

Do not place objects or materials in the engine compartment

Putting objects or materials in the engine compartment may cause an engine failure or combustion, because those may block the engine cooling. The manufacturer is not responsible for the damage caused by such placement.

VEHICLE LOAD LIMIT

Tire and loading information label

5 seater

TIRE AND LOADING INFORMATION RENSEIGNEMENTS SUR LES PNEUS ET LE CHARGEMENT			
SEATING CAPACITY NOMBRE DE PLACES		TOTAL 5	FRONT 2 AVANT 2
			REAR 3 ARRIÈRE 3
The combined weight of occupants and cargo should never exceed 410 kg or 904 lbs. Le poids total des occupants et du chargement ne doit jamais dépasser 410 kg ou 904 lb.			
TIRE PNEU	SIZE DIMENSIONS	COLD TIRE PRESSURE PRESSION DES PNEUS À FROID	SEE OWNER'S MANUAL FOR ADDITIONAL INFORMATION VOIR LE MANUEL DE L'USAGER POUR PLUS DE RENSEIGNEMENTS
FRONT AVANT	P245/45R19	205kPa, 30psi	
REAR ARRIÈRE	P275/40R19	205kPa, 30psi	
SPARE DE SECOURS	T155/70R19	420kPa, 60psi	

OVI052200N

4 seater

TIRE AND LOADING INFORMATION RENSEIGNEMENTS SUR LES PNEUS ET LE CHARGEMENT			
SEATING CAPACITY NOMBRE DE PLACES		TOTAL 4	FRONT 2 AVANT 2
			REAR 2 ARRIÈRE 2
The combined weight of occupants and cargo should never exceed 342 kg or 754 lbs. Le poids total des occupants et du chargement ne doit jamais dépasser 342 kg ou 754 lb.			
TIRE PNEU	SIZE DIMENSIONS	COLD TIRE PRESSURE PRESSION DES PNEUS À FROID	SEE OWNER'S MANUAL FOR ADDITIONAL INFORMATION VOIR LE MANUEL DE L'USAGER POUR PLUS DE RENSEIGNEMENTS
FRONT AVANT	P245/45R19	205kPa, 30psi	
REAR ARRIÈRE	P275/40R19	205kPa, 30psi	
SPARE DE SECOURS	T155/70R19	420kPa, 60psi	

OVI052201N

The label on the driver's door sill gives the original tire size, the recommended cold tire pressure, the seating capacity (the number of occupants), and load weight capacity.

Vehicle capacity weight:

5 seater
904 lbs. (410 kg)

4 seater
754 lbs. (342 kg)

The maximum weight capacity includes occupant weights and load weights.

Seating capacity:

5 seater
Total : 5 persons
(Front seat : 2 persons,
Rear seat : 3 persons)

4 seater
Total : 4 persons
(Front seat : 2 persons,
Rear seat : 2 persons)

Seating capacity is the maximum number of occupants including a driver, your vehicle may carry. However, the seating capacity may be reduced based upon the weight of all of the occupants, and the weight of the cargo being carried.

Do not overload the vehicle as there is a limit to the total weight, or load limit including occupants and cargo, the vehicle can carry.

Towing capacity:

We do not recommend using this vehicle for trailer towing.

Cargo capacity:

The cargo capacity of your vehicle will increase or decrease depending on the weight and the number of occupants.

Steps For Determining Correct Load Limit -

1. Locate the statement "The combined weight of occupants and cargo should never exceed XXX kg or XXX lbs." on your vehicle's placard.
2. Determine the combined weight of the driver and passengers that will be riding in your vehicle.
3. Subtract the combined weight of the driver and passengers from XXX kg or XXX lbs.
4. The resulting figure equals the available amount of cargo and luggage load capacity. For example, if the "XXX" amount equals 1400 lbs. and there will be five 150 lb passengers in your vehicle, the amount of available cargo and luggage load capacity is 650 lbs.
(1400 - 750(5x150) = 650 lbs.)
5. Determine the combined weight of luggage and cargo being loaded on the vehicle. That weight may not safely exceed the available cargo and luggage load capacity calculated in Step 4.
6. If your vehicle will be towing a trailer, load from your trailer will be transferred to your vehicle. Consult this manual to determine how this reduces the available cargo and luggage load capacity of your vehicle.

***i* Information**

We do not recommend using this vehicle to tow a trailer.

5 seater

Example 1

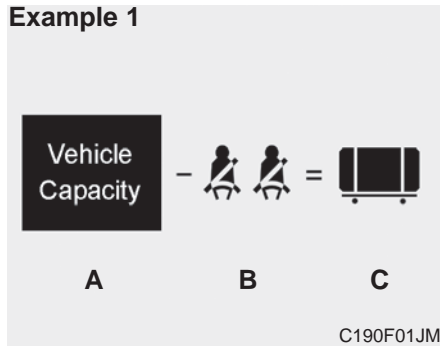

Item	Description	Total
A	Vehicle Capacity Weight	904 lbs (410 kg)
B	Subtract Occupant Weight 150 lbs (68 kg) × 2	300 lbs (136 kg)
C	Available Cargo and Luggage weight	604 lbs (274 kg)

Example 2

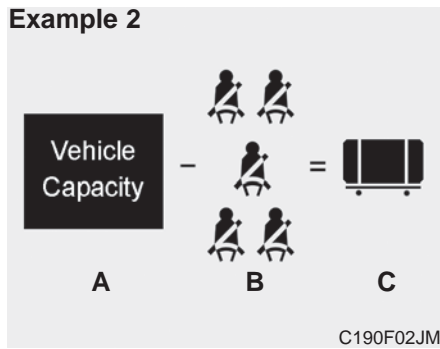

Item	Description	Total
A	Vehicle Capacity Weight	904 lbs (410 kg)
B	Subtract Occupant Weight 150 lbs (68 kg) × 5	750 lbs (340 kg)
C	Available Cargo and Luggage weight	154 lbs (70 kg)

Example 3

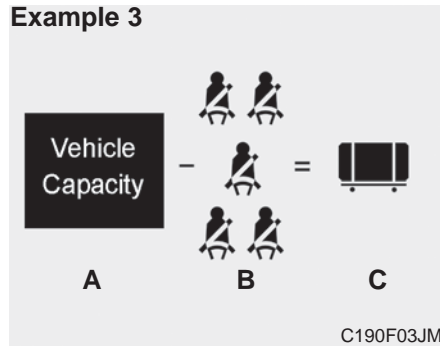

Item	Description	Total
A	Vehicle Capacity Weight	904 lbs (410 kg)
B	Subtract Occupant Weight 172 lbs (78 kg) × 5	860 lbs (390 kg)
C	Available Cargo and Luggage weight	44 lbs (20 kg)

Refer to the label of the tire/loading information for more specific information about the weight capacity and seating positions. The total weight of the driver, occupants and load should never exceed your vehicle's weight capacity.

4 seater

Example 1

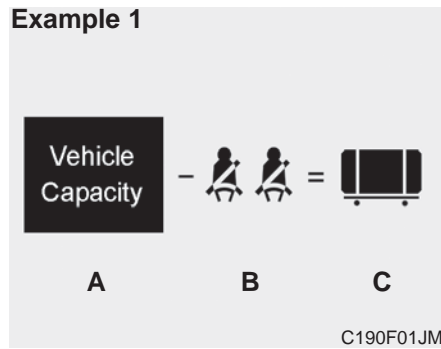

Item	Description	Total
A	Vehicle Capacity Weight	754 lbs (342 kg)
B	Subtract Occupant Weight 150 lbs (68 kg) × 2	300 lbs (136 kg)
C	Available Cargo and Luggage weight	454 lbs (206 kg)

Example 3

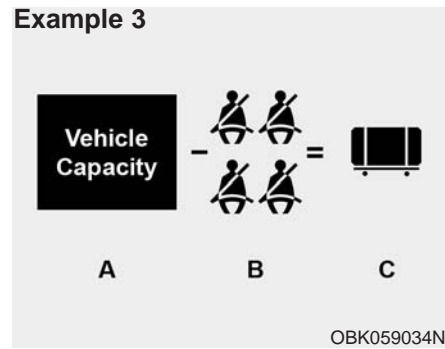

Item	Description	Total
A	Vehicle Capacity Weight	754 lbs (342 kg)
B	Subtract Occupant Weight 172 lbs (78 kg) × 4	688 lbs (312 kg)
C	Available Cargo and Luggage weight	66 lbs (30 kg)

Example 2

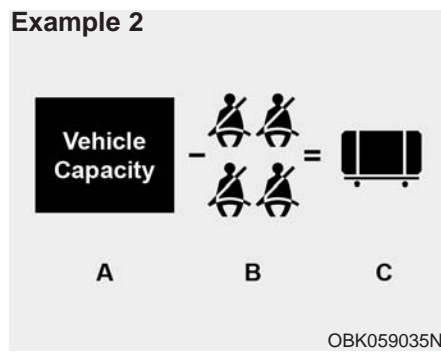

Item	Description	Total
A	Vehicle Capacity Weight	754 lbs (342 kg)
B	Subtract Occupant Weight 150 lbs (68 kg) × 4	600 lbs (272 kg)
C	Available Cargo and Luggage weight	154 lbs (70 kg)

Refer to the label of the tire/loading information for more specific information about the weight capacity and seating positions. The total weight of the driver, occupants and load should never exceed your vehicle's weight capacity.

Certification label



The certification label is located on right side of the driver's door sill.

This label shows the maximum weight capacity, or called GVWR (Gross Vehicle Weight Rating). The GVWR includes the weight of the vehicle, all occupants, fuel, and load.

This label also tells you the maximum weight that can be supported by the front and rear axles, called Gross Axle Weight Rating (GAWR).

To find out the actual load weight of the front and rear axles, you need to weigh your vehicle. Your dealer can help you with this. Equally and evenly spread out the loads across the centerline.

⚠ WARNING

- Over loading
- Never exceed the GVWR or the GAWR of your vehicle. Overloading above those limits may cause an accident or a vehicle damage. You can calculate the load weight capacity by weighing the items (or people), before putting them in the vehicle. Be careful not to overload your vehicle.
- Do not overload your vehicle above the GVWR, the front/rear GAWRs or the vehicle weight capacity. When overloading, including tires, parts may break. Even, it may adversely affects the vehicle handling and braking performance. You may lose control and crash. Also, overloading may shorten the life span of your vehicle.

The label will help you decide how much loads and installed equipment your vehicle can carry.

When your vehicle carries items inside, such as suitcases, tools and packages, those loads move as fast as your vehicle. When stopping or sharply turning, or if there is a crash, those loads may throw forwards under the influence of inertia, and cause an injury by hitting with the driver or an occupant.

⚠ WARNING

- Overloading your vehicle may overheat the tires and cause tire failure, possibly leading to a crash.
- Overloading your vehicle may increase a stopping distance, possibly leading to a crash.
- A crash, which is resulted from poor handling, vehicle damage, tire failure, or a longer stopping distance, may result in a serious injury or death.

NOTICE

- Overloading may damage your vehicle. Repairs are not covered by your warranty. Do not overload your vehicle.
- Heavier suspension components for higher durability may not change the weight capacity. Ask your dealer to help you load your vehicle the right way.

⚠ WARNING**- Unsecured loads**

Items you carry inside your vehicle may hit and injure an occupant in a sudden stop or turn, or in a crash.

- Put items in the trunk. Try to evenly spread the weight.
- Never stack up items, like suitcases, inside the vehicle, especially above the seat-backs.
- Do not leave an unsecured child restraint in your vehicle.
- When you carry something inside the vehicle, secure it.

VEHICLE WEIGHT

This is to guide you to load in a proper manner, and to keep the load weight under the maximum weight capacity. Proper loading will provide maximum vehicle performance. Before loading your vehicle, read the following terms and explanation for determining your vehicle's loading weight, based on the vehicle's specifications and the certification label:

Base curb weight

This is the weight of the vehicle, only including a full tank of fuel and all standard equipment. This weight excludes optional equipment, loads, or occupants.

Vehicle curb weight

This is the weight of your new vehicle, upon being delivered from a dealer, including any optional equipment.

Load weight

This is the weight of all the additional items, including the loads and optional equipment.

GAW (Gross axle weight)

This is the total weight on each axle (front and rear), including the vehicle curb weight and the load weight.

GAWR (Gross axle weight rating)

This is the maximum weight capacity of a single axle (front or rear). This GAWR is shown on the certification label. The total load weight on each axle must never exceed its GAWR.

GVW (Gross vehicle weight)

This is the accumulated weight of the base curb weight, the actual load weight, and the occupants' weight.

GVWR (Gross vehicle weight rating)

This is the maximum weight capacity of a vehicle, including all options, equipment, occupants and loads. The GVWR is shown on the certification label on the driver's door sill.

TRAILER TOWING

We do not recommend using this vehicle to tow a trailer.



What to do in an emergency

Road warning	6-2
Hazard warning flasher	6-2
In case of an emergency while driving	6-2
If the engine stalls at a crossroad or a railroad crossing.....	6-2
If you have a flat tire while driving.....	6-2
If engine stalls while driving.....	6-3
If the engine will not start	6-3
When the engine does not revolve, or slowly revolves.....	6-3
When the engine normally revolves, but does not start.....	6-3
Emergency starting	6-4
Jump starting.....	6-4
Push-starting	6-5
If the engine overheats	6-6
Tire pressure monitoring system (TPMS)	6-7
Low tire pressure telltale	6-8
Low tire pressure position telltale	6-8
TPMS (Tire Pressure Monitoring System) malfunction indicator	6-9
Changing a tire with TPMS.....	6-10
If you have a flat tire	6-12
Jack and tools	6-12
Removing and storing the spare tire	6-13
Changing tires	6-13
Jack label.....	6-19
Towing	6-20
Towing service	6-20
Removable towing hook	6-22
Emergency towing	6-22

ROAD WARNING

Hazard warning flasher



The hazard warning flasher serves as a warning to other drivers to be extremely cautious when approaching, passing by or passing ahead.

It should be used when your vehicle is under emergency repair, or when your vehicle stops on the edge of a roadway.

Press the flasher switch regardless of the ignition switch position. The flasher switch is on the switch panel of the center consol. All turn signal lights will simultaneously flash.

- The hazard warning flasher operates, whether your vehicle is running or not.
- The turn signals cannot be turned ON when the hazard flasher is ON.
- Care must be taken to turn ON the hazard warning flasher, when towing your vehicle.

IN CASE OF AN EMERGENCY WHILE DRIVING

If the engine stalls at a crossroad or a railroad crossing

If the engine stalls at a crossroad or a railroad crossing, set the shift lever in N(Neutral) and then push the vehicle to a safe place.

If you have a flat tire while driving

If a tire goes flat while driving:

1. Take your foot off the accelerator and slow down the speed while driving straight ahead. Do not abruptly apply the brakes in an attempt to pull over the vehicle, as this may cause a loss of control. When the driving speed gets sufficiently lowered to stop the vehicle, carefully apply the brake and pull off the road. Drive away from the road as far as possible and safely park the vehicle in a safe and flat place. When you are on a divided highway, do not park the vehicle in the median area between the two directions.
2. When the vehicle is stopped, turn ON the emergency hazard flasher, set the parking brake, and set the shift lever in P(Park).
3. Have all occupants get out of the vehicle. Make sure they stay out of the roadway.
4. When changing a flat tire, follow the instruction provided in the following part of this chapter.

If engine stalls while driving

1. Gradually reduce your driving speed while driving straight ahead. Cautiously drive off the road to a safe place.
2. Press the emergency hazard flasher.
3. Try to re-start the engine again. When your vehicle does not re-start, contact an authorized EQUUS dealer for the qualified assistance.

IF THE ENGINE WILL NOT START

When the engine does not revolve, or slowly revolves

1. Make sure that the shift lever is in N(Neutral) or P (Park), and the emergency brake is set.
2. Check that the battery connections are clean and tight.
3. Turn ON the interior light. When the light dims or goes out upon operating the starter, the battery is discharged.
4. Check that the starter connections are securely tightened.
5. Do not push or pull the vehicle to start it. Follow instructions provided in "Jump starting".

CAUTION

When the engine does not start, do not push or pull the car to start it. This may result in a collision or cause other damage.

When the engine normally revolves, but does not start

1. Check the fuel level.
2. With the Engine Start/Stop Button in the OFF position, check all connectors of the ignition coils and the spark plugs. Reconnect any disconnected or loose parts.
3. If the engine still does not start, contact an authorized EQUUS dealer for the qualified assistance

EMERGENCY STARTING

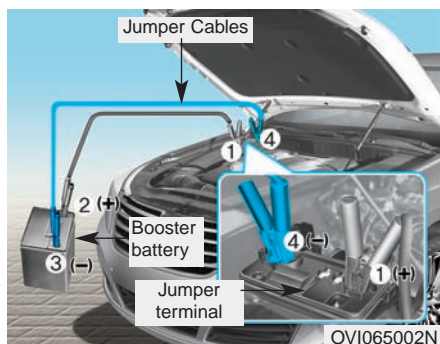

Connect cables in the numerical order, and then disconnect them in the reverse order.

i Information

Your vehicle has a battery in the trunk compartment. However, when you jump start your vehicle, use the jumper terminal in the engine compartment.

Jump starting

Jump starting can be dangerous, when incorrectly done. Therefore, to avoid any harm to yourself or damages to the vehicle or battery, follow the jump starting instructions. When you do not fully understand the instructions, we strongly recommend to contact a competent technician or to tow your vehicle for jump starting.

NOTICE

Use only a 12-volt jumper system. The 12-volt starting motor, ignition system, and other electrical parts may be damaged when using a 24-volt power supply. (There are two types of jumper systems; a 12-volt motor generator set or a 24-volt motor generator set.)

WARNING

- Battery

Never attempt to check the battery electrolyte level, as this may disrupt or explode the battery, causing a serious injury.

WARNING

- Battery

- Keep the battery away from any flames or sparks. The battery produces hydrogen gas, which may explode upon being exposed to flame or sparks. When you neglect this warning, a serious personal injury and vehicle damage may occur! When you do not fully understand these instructions, find the qualified assistance. Your battery contains sulfuric acids, which is poisonous and highly corrosive. When jump starting, wear protective glasses and be careful not to expose those acids to yourself, your clothing or even the vehicle itself.
- Do not attempt to jump start the vehicle, when the discharged battery is frozen or when the electrolyte level is low. This may disrupt or explode the battery.

Jump starting procedure

i Information

Your vehicle has a battery in the trunk compartment. However, when you jump start your vehicle, use the jumper terminal in the engine compartment.

1. Make sure the booster battery is 12-volt and that its negative terminal is grounded.
2. When the booster battery is in another vehicle, separate the two vehicles apart.
3. Turn OFF all unnecessary electrical systems.
4. Connect the jumper cables in the exact sequence as shown in the illustration of the previous page. First connect one of the jumper cable ends to the positive terminal of the jumper terminal (1), and then connect the other end to the positive terminal on the booster battery (2). Proceed to connect one of the other jumper cable ends to the negative terminal of the booster battery (3), then the other end to the negative terminal of the jumper terminal (4). Clear the jump cables away from any movable parts or other battery terminals, when jump starting.

Keep the jumper cables away from any others except the correct battery terminal connections and the correct grounding connections. Do not apply unnecessary forces on the battery when making connections.

NOTICE

- Battery cables

When jump starting the discharged battery in the trunk compartment, do not connect the jumper cable between the negative terminal of the booster battery and the negative terminal of the discharged battery. This may cause the discharged battery to overheat, crack, or release the acids.

Connect the jumper cable between the negative terminal of the booster battery and a solid, stationary or metallic point often discharges the battery.

5. First, start the engine of the vehicle with the booster battery, over 2,000 rpm. Then, start your engine with the discharged battery.
6. Turn your engine ON for at least 20 minutes either in the idling mode or the driving mode. Otherwise, your discharged battery is not recharged enough to re-start the vehicle.

When the cause of your battery discharging is not apparent, have your vehicle checked by an authorized EQUUS dealer.

Push-starting

A vehicle equipped with automatic transmission cannot be push-started. Follow the instructions in "Jump starting" of this chapter.

IF THE ENGINE OVERHEATS

When the temperature gauge indicates engine overheating, you may experience a loss of power, loud pinging, or knocking. The engine is probably too hot. If this happens, you should:

1. Pull off the road and stop the vehicle as soon as it is safe to do so.
2. Place the shift lever in P(Park), and set the parking brake. When the A/C is turned ON, turn it OFF.
3. When the engine coolant gushes out, or when steam comes out from the hood, stop the engine. Do not open the hood until the coolant outrushing or steaming stops. Even when there is no more coolant outrushing, leave the engine running and operate the engine cooling fan. When the fan does not operate, turn the engine OFF.
4. Check whether the water pump drive belt is missing. When it is not, check its tightening. When it seems to be loose, check for any coolant leaking from the radiator or hoses underneath the vehicle. (When the A/C is turned ON, cold-water draining is normal upon stopping the vehicle.)

⚠ WARNING

While the engine is running, keep hair, hands, and clothing away from moving parts, such as the fan and drive belts, in order to prevent an injury.

5. When the water pump drive belt is broken, or when engine coolant leaks out, immediately stop the engine and contact the nearest authorized EQUUS dealer for assistance.

⚠ WARNING



Do not remove the radiator cap, when the engine is hot. This may blow out the engine coolant out of the opening and cause a serious burn.

6. When you cannot find a cause, wait until the engine temperature cools down. When there is serious loss of engine coolant, carefully add coolant into the reservoir to bring the fluid level above the halfway mark.
7. Be cautious and keep alert for further signs of overheating. When finding further overheating signs, contact an authorized EQUUS dealer for assistance.

⚠ CAUTION

Serious loss of coolant indicates a leakage in the cooling system. This should be immediately checked by an authorized EQUUS dealer.

TIRE PRESSURE MONITORING SYSTEM (TPMS)



OVI065031N

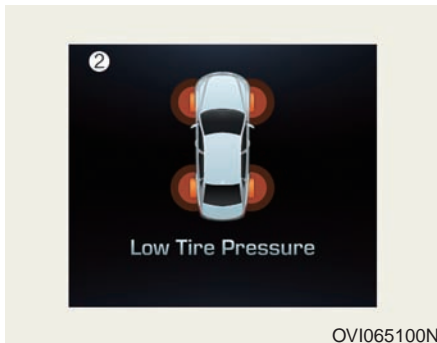

OVI065100N

- (1) Low Tire Pressure Telltale/
TPMS Malfunction Indicator
- (2) Low Tire Pressure Position Telltale

Each tire, including the spare (if provided), should be checked monthly when cold and inflated to the inflation pressure recommended by the vehicle manufacturer on the vehicle placard or tire inflation pressure label. (If your vehicle has tires of a different size than the size indicated on the vehicle placard or tire inflation pressure label, you should determine the proper tire inflation pressure for those tires.)

As an added safety feature, your vehicle has been equipped with a tire pressure monitoring system (TPMS) that illuminates a low tire pressure telltale when one or more of your tires is significantly under-inflated.

Accordingly, when the low tire pressure telltale illuminates, you should stop and check your tires as soon as possible, and inflate them to the proper pressure. Driving on a significantly under-inflated tire causes the tire to overheat and can lead to tire failure. Under-inflation also reduces fuel efficiency and tire tread life, and may affect the vehicle's handling and stopping ability.

Please note that the TPMS is not a substitute for proper tire maintenance, and it is the driver's responsibility to maintain correct tire pressure, even if under-inflation has not reached the level to trigger illumination of the TPMS low tire pressure telltale.

Your vehicle has also been equipped with a TPMS malfunction indicator to indicate when the system is not operating properly. The TPMS malfunction indicator is combined with the low tire pressure telltale. When the system detects a malfunction, the telltale will flash for approximately one minute and then remain continuously illuminated. This sequence will continue upon subsequent vehicle start-ups as long as the malfunction exists. When the malfunction indicator is illuminated, the system may not be able to detect or signal low tire pressure as intended. TPMS malfunctions may occur for a variety of reasons, including the installation of replacement or alternate tires or wheels on the vehicle that prevent the TPMS from functioning properly.

What to do in an emergency

Always check the TPMS malfunction telltale after replacing one or more tires or wheels on your vehicle to ensure that the replacement or alternate tires and wheels allow the TPMS to continue to function properly.

i Information

If any of the followings happens, we recommend that the system be checked by an authorized EQUUS dealer.

1. The low tire pressure telltale/TPMS malfunction indicator does not illuminate for 3 seconds when the ignition switch is turned ON or engine is running.
2. The TPMS malfunction indicator remains ON after flashing for approximately 1 minute.
3. The Low tire pressure position telltale remains ON.



Low tire pressure telltale

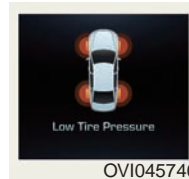

Low tire pressure position telltale

When the TPMS malfunction indicator illuminates with a warning message on the LCD display, one or more of your tires are significantly under-inflated. The low tire pressure position telltale pinpoints which tire is significantly under-inflated with the illumination of the corresponding position light.

When the low tire pressure telltale illuminates, immediately decrease your driving speed, avoid hard cornering and prepare for a longer stopping distance. You should immediately stop the vehicle and check your tires. Inflate the tires to the proper pressure as indicated on the vehicle's placard or tire inflation pressure label, which is on the right lower part of the driver's door sill.

When you cannot reach to a service station, or when the tire cannot keep the inflated air inside, replace the under-inflated tire with the spare tire.

Until you repair or replace the under-inflated tire, the low tire pressure telltale remains ON, and the TPMS malfunction indicator also remains ON after 1-minute flashing (when the vehicle is driven for approximately 20 minutes at a speed above 15.5 mph (25 km/h)).

i Information

A tire pressure sensor is not equipped with the spare tire.

CAUTION

The low tire pressure telltale may illuminate in cold weather, when the tire pressure was adjusted in warm weather. It does not indicate the TPMS malfunction, because the lower temperature proportionally lowers the tire pressure.

When your vehicle drive through the severe temperature difference, from warm to cold and vice versa, or the outside temperature is greatly higher or lower, you should check and readjust the tire pressure to the recommended level.

WARNING

- Low pressure damage
Significantly under-inflated tires makes your driving unstable, possibly increasing a braking distance and causing a loss of vehicle control.
Long-time driving on under-inflated tires may overheat or fail the tires.

**TPMS (Tire Pressure Monitoring System) malfunction indicator**

The TPMS malfunction indicator illuminates after approximately 1-minute flashing, when the TPMS detects the malfunction.

Immediately have the system checked by an authorized EQUUS dealer to find the cause of the malfunction.

i Information

If there is the TPMS malfunction, the low tire pressure position telltale will not illuminate even with an under-inflated tire.

NOTICE

- The TPMS malfunction indicator may remain ON after approximately 1-minute flashing, when the vehicle drives near electric power supply cables or a radio transmitter, such as a police station, government/public office, broadcasting station, military installation, airport, or transmitting tower. Those may interfere the normal TPMS operation.
- The TPMS malfunction indicator may remain ON after approximately 1-minute flashing, when the snow chains or some of your personal electronic devices, such as a laptop computer, mobile charger, remote starting device or navigation, are used inside the vehicle. Those may interrupt the normal TPMS operation.

Changing a tire with TPMS

When you have a flat tire, both of the low tire pressure telltale and the low tire position telltale will illuminate. Immediately have the flat tire repaired or replaced by an authorized EQUUS dealer.

CAUTION

Never use an unauthorized puncture-repairing agent to repair and/or inflate an under-inflated tire. Unauthorized tire sealant may damage the tire pressure sensor.

The spare tire is not equipped with a tire pressure monitoring sensor. Thus, when replacing with the spare tire, the low tire pressure telltale will remain ON.

Also, the TPMS Malfunction Indicator will illuminate after 1-minute flashing, when the vehicle drives at a speed above 15.5 mph (25 km/h) for approximately 20 minutes.

When the tire equipped with a tire pressure monitoring sensor is re-inflated to the recommended level, the low tire pressure telltale and TPMS malfunction indicator will go OFF for a few minutes.

When the indicator illumination does not go OFF after a few minutes, please visit an authorized EQUUS dealer.

Each wheel is equipped with a tire pressure sensor, inside the tire and behind the valve stem (except for the spare tire). You must use the TPMS-specific wheels. It is recommended that you always have your tires serviced by an authorized EQUUS dealer.

You cannot diagnose under-inflation of a tire only with eyes. Always use a tire pressure gauge of good quality to measure the pressure level. Please note that a heated tire (from being driven) has higher pressure measurement criteria than a cold tire.

A cold tire means the vehicle was driven for less than 1 mile (1.6 km), or was mostly idle for the last 3 hours.

Cool down the tire before measuring the inflation pressure. Always make sure that the tire is cold before inflating the tire to the recommended pressure level.

WARNING

- TPMS

- **The TPMS cannot alert the driver to a sudden but severe tire damage caused by external factors, such as nails or road debris.**
- **When you sense any driving instability, immediately take your foot off the accelerator, lightly apply the brakes, and slowly drive to a safe place off the road.**

⚠ WARNING**- Protecting TPMS**

Arbitral handling, modification and disabling of the TPMS may undermine the TPMS performance to warn the driver of the low tire pressures or the TPMS malfunction. Arbitral handling, modification and disabling of the TPMS components may invalidate your warranty of that part.

This device complies with Part 15 of the FCC rules.

Operation is subject to the following two conditions:

1. This device may not cause harmful interference, and
2. This device must accept any interference received, including interference that may cause undesired operation.

NOTICE

Changes or modifications not expressly approved by the party responsible for compliance could void the user's authority to operate the equipment.

IF YOU HAVE A FLAT TIRE

Jack and tools

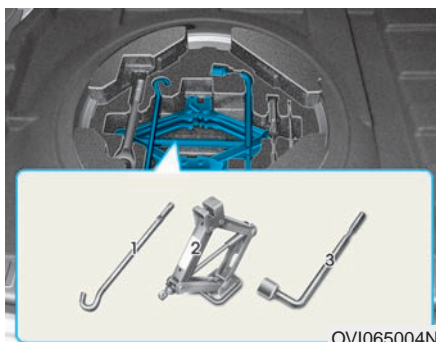

The jack, jack handle, and wheel lug nut wrench are stored in the luggage compartment. Pull up the luggage box cover to find those equipment.

- (1) Jack handle
- (2) Jack
- (3) Wheel lug nut wrench

Jacking instructions

The jack is provided for emergent tire changing only.

To prevent the jack from “rattling” inside while driving, store it properly.

Follow jacking instructions to prevent a possible personal injury.

⚠ WARNING

- Changing tires
- Never attempt to change tires in the traffic lanes of a road or highway.
- Always drive the vehicle completely off the road or onto the shoulder before changing a tire. The jack should be used on a level and firm ground. When you cannot find this level and firm place off the road, call a towing service company for assistance.
- Always check the jack direction - in the correct front and rear positions. Never use the bumper or any other parts of the vehicle for additional jacking-up support.
- The vehicle may roll off the jack, causing a serious injury or death. Never place any part of a person's body underneath a vehicle, while jacking up the vehicle; use vehicle support stands.
- Do not start or run the engine, while jacking up the vehicle.
- Do not allow anyone to remain inside, while jacking up the vehicle.
- Keep all children in a safe place away from the road and from the vehicle to be jacked up.

Removing and storing the spare tire



OVI065005N

Unscrew the hold-down wing bolt in a counterclockwise direction to remove the tire.

Screw it in the clockwise direction to store the spare tire.

To prevent the spare tire and tools from “rattling” inside while driving, properly store them.

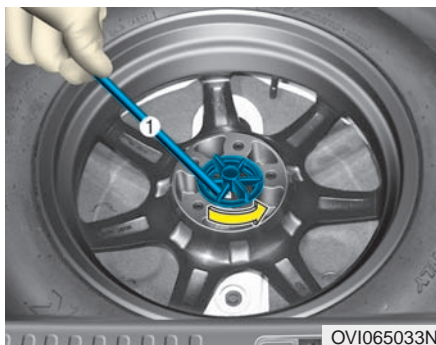

OVI065033N

When it is too tight to loosen the hold-down wing bolt by hand, you can easily loosen it, using the Jack handle.

1. Put the Jack handle (1) in the hold-down wing bolt.
2. Unscrew the hold-down wing bolt in a counterclockwise direction with the Jack handle, utilizing the principles of the lever and fulcrum.

NOTICE

When you remove or store the spare tire, do not touch or hit the battery with the spare tire. Touching or hitting of the battery may cause failure of electrical circuits.

Changing tires



OVI065001N

1. Park the vehicle on a level surface, and firmly set the parking brake.
2. Set the shift lever in P(Park).
3. Press ON the hazard warning flasher.



OVI065007N

4. Take out the wheel lug nut wrench, jack, jack handle, and spare tire from the vehicle.

What to do in an emergency

5. Block both the front and rear parts of the wheel by putting a prop in the diagonal position.

⚠ WARNING

- Changing a tire

- To prevent vehicle movement while changing a tire, always fully set the parking brake, and block the wheel by putting a prop in the diagonal direction.
- We recommend that the wheels be blocked, and that no person remain, while jacking up a vehicle.



6. Loosen the wheel lug nuts in a counterclockwise direction, in the numerical order, as shown in the illustration. Do not remove any nut until the tire has been raised off the ground.

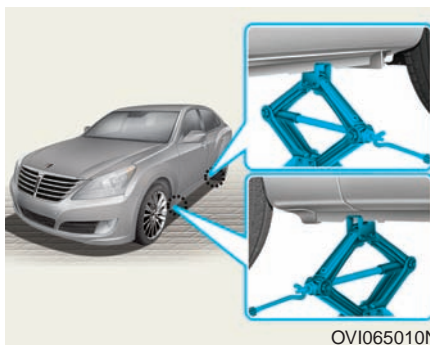

7. Place the jack in the front or rear jacking positions, closest to a tire, which is to be replaced. Place the jack under the intended place. Those intended places should be the plates welded to the frame with two tabs, a raised dot to index with the jack.

⚠ WARNING

- Jack location

To reduce a possible injury, only use the jack provided in the vehicle and in the correct jack position. Never use any other parts of the vehicle for additional jacking-up support.

NOTICE

Carefully place the jack, not to damage the plastic guard. When you place the jack under the plastic guard and jack up the vehicle, the plastic guard may be damaged.

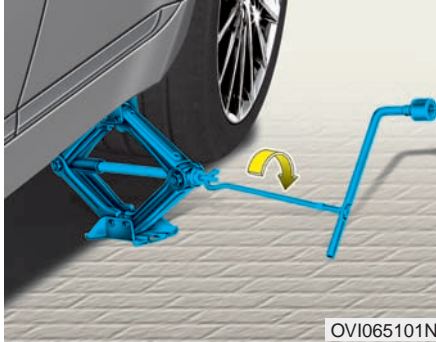

8. Insert the jack handle into the jack, turn it in a clockwise direction, and raise the vehicle until the tire just lifts above the ground. This would be approximately 30 mm (1.2 in).

Before removing the wheel lug nuts, make sure that the vehicle is stationary without a possibility of any movement or skid.

9. Loosen the wheel nuts and then remove them with your fingers. Slide the wheel off the studs and lay it on a flat ground to prevent rolling away. To install the wheel on the hub, pick up the spare tire, fit the studs into the holes, and screw them. When it is difficult, slightly tip the wheel, fitting the top wheel hole with its top stud. Then, shake the wheel back and forth until the wheel slide off other studs.

⚠ WARNING

Wheels may have sharp edges. Carefully handle them to avoid a possible severe injury. Before installing wheels into place, dust off any substances from the hub or wheel (i.e. mud, tar, gravel, etc., which may stick solid against the hub).

When a wheel is unsecurely or loosely installed on the hub, the wheel nuts may become loose, causing loss of a wheel. Loss of a wheel may result in loss of vehicle control, causing a serious injury or death.

10. To reinstall a wheel, fit its hole onto the studs, screw the wheel nuts, and tighten them. The nuts should be screwed with a small-diameter end in an inward direction. Lightly jiggle the tire to check its secure installment. If necessary, tighten the nuts with your fingers again.

11. Lower the vehicle onto the ground by rotating the wheel nut wrench in a counterclockwise direction.

What to do in an emergency



Put the wrench as shown in the above illustration, and tighten the wheel nuts. Make sure the sockets are completely tightened over the nuts. Do not step on the wrench handle, neither use an extension pipe over the wrench handle. Go around the wheel nuts to securely tight. Then, double-check the tightness of each nut. After changing wheels by yourself, immediately have an authorized EQUUS dealer tighten the wheel nuts with a proper torque.

Wheel nut tightening torque:

Steel wheel & aluminum alloy wheel:
65~79 lb·ft (9~11 kg·m)

When you have a tire gauge, remove the valve cap and check the air pressure. When it is under-inflated than recommended, slowly drive to the nearest service station and inflate the tire to the correct pressure. When it is over-inflated, deflate the tire to the proper pressure. Always close the valve cap after checking or adjusting a tire pressure. When the cap is not closed, air may leak out from the tire. When you lose a valve cap, immediately buy a new one and close the valve.

After changing a wheel, always put the flat tire in place and place the jack and other tools in the proper storage locations.

CAUTION

When your vehicle uses metric threads for the wheel studs and nuts, the same nuts should be used after removal - or, if replaced, the nuts of the same metric threads and the chamfer configuration are used. Tightening a non-metric thread nut on a metric stud or vice versa may lead to a loose wheel securement to the hub, damaging the stud and requiring another stud/nut replacement.

Note that most lug nuts do not have metric threads. Pay extreme attention to the thread type when installing the lug nuts or wheels, which are not yet authorized. When in doubt, consult an authorized EQUUS dealer.

WARNING

- Wheel studs

When a stud is damaged, it may lose its ability to retain a wheel. This may lead to loss of the wheel and a collision, resulting in a serious injury.

To prevent the jack, jack handle, wheel lug nut wrench and spare tire from rattling inside a vehicle while driving, store them in a proper place.

⚠ WARNING

- Inadequate spare tire pressure
Immediately check the inflation pressures of a spare tire after installment. If necessary, adjust it to the recommended pressure. Refer to "Tires and wheels" in the chapter 8.

Important - use of compact spare tire

Your vehicle is equipped with a compact spare tire. This compact spare tire takes up less space than an original one. This tire is smaller than an original one, and is designed for temporary use only.

NOTICE

- **You should carefully drive when a compact spare tire is in use. The compact spare tire should immediately be replaced with a proper regular tire.**
- **Driving on more than one compact spare tire is not recommended.**

⚠ WARNING

A compact spare tire is for emergency use only. Do not drive your vehicle on this compact spare at a speed over 50 mph (80 km/h). Replacement with a proper regular tire should immediately be done to avoid failure of the spare tire, possibly leading to a personal injury or death.

A compact spare tire should be inflated to 60 psi (420 kPa).

i Information

Check the inflation pressure after installing a spare tire. Adjust its pressure to the recommended level, if necessary.

When using a compact spare tire, take the following precautions:

- Under no circumstances should a driving speed exceed 50 mph (80 km/h). A higher speed may damage the tire.
- You should drive slowly enough to avoid all hazards in accordance of road conditions. Any road hazard, such as a pothole or debris, may seriously damage a compact spare.
- Any continuous driving on a spare tire may result in tire failure, loss of vehicle control, and a possible personal injury.
- Do not exceed the vehicle's maximum weight capacity or the load capacity, which is detailed on a side of a compact spare tire.

What to do in an emergency

- Avoid driving over obstacles. A compact spare tire diameter is smaller than one of an original tire, and the ground clearance is shorter by approximately 1 inch (25 mm). This may damage your vehicle.
- Do not drive through an automatic car wash while the compact spare tire is installed.
- Do not use tire chains on a compact spare tire. Because of the size difference, a tire chain will not tightly fit. This may result in loss of the chain and damage the vehicle.
- Do not use your compact spare tire on any other vehicles. This compact spare tire is designed exclusively for your vehicle.
- The tread life of a compact spare tire is shorter than other regular tires. Inspect your compact spare tire on a regular basis, and, if worn out, replace it with the one of the same size and the same design.
- A compact spare tire should not be used on any other wheels, nor should a compact spare wheel be used for standard tires, snow tires, snow tire wheel covers or snow tire trim rings. This attempt may damage the above items or other components.
- Do not use more than one compact spare tire at the same time.
- Do not tow a trailer while the compact spare tire is installed.

NOTICE

When a tire or a wheel is repaired or reinstalled, the wheel nut torque must be correctly set to prevent any wheel vibrations. The correct wheel nut torque is 65 ~ 79 lb-ft (9 ~ 11 kg.m).

Jack label

■ Example

• Type A

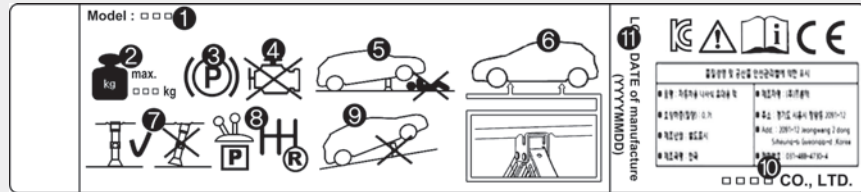

OHYK065010

• Type B

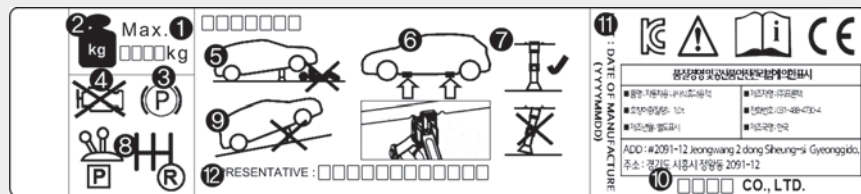

OHYK065011

• Type C



OHYK064002

※ The actual Jack label may differ from the illustration. For more detailed information, check the label on the jack.

1. Model Name
2. Maximum allowable load
3. When using the jack, set your parking brake.
4. When using the jack, stop the engine.
5. Do not go under a vehicle while jacking up the vehicle.
6. The correct jack position under the frame
7. The base plate of jack must be vertical under the lifting point, while jacking up the vehicle.
8. Set the shift lever in R(Reverse) for the manual transmission, or set the shift lever in P(Park) for the automatic transmission.
9. The jack should be used on a firm level ground.
10. Jack manufacturing information
11. Production date
12. Representative company and address

TOWING

Towing service

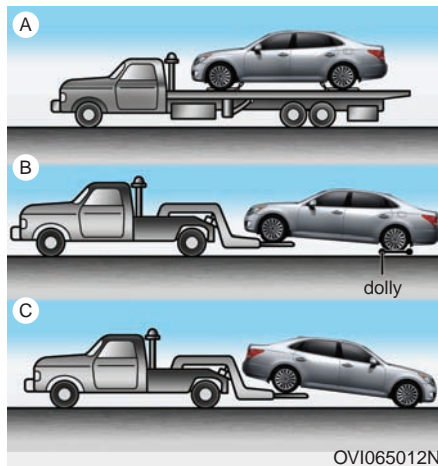

If necessary, we recommend towing your vehicle by an authorized EQUUS dealer or a commercial tow-truck service. Proper lifting and towing procedures are necessary to prevent damage to your vehicle. The use of wheel dollies or flatbed is recommended.

It is acceptable to tow the vehicle with the rear wheels off the ground, while dragging the front wheels (without a dolly).

When any of the loaded wheels or suspension components is damaged, or when the rear wheels have the possibility of dragging on the ground, use a towing dolly under the rear wheels.

When the wheel dolly is not equipped in a tow truck, must lift the rear wheels, not the front wheel.

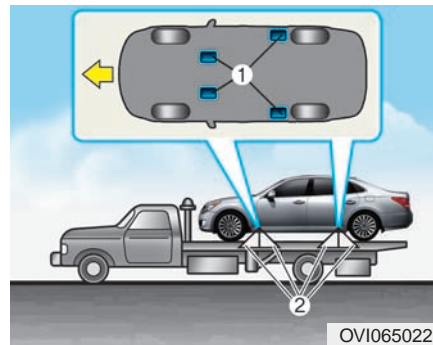

i Information

When you tow the vehicle as shown in the illustration (A), the cable should be secured to the vehicle towing hook as shown in the illustration (1).

When you use chains or cables to lash down your vehicle, the lashing angle must be 45°, as shown in the illustration (2).

Do not over-tighten the lashing strap or cables. Otherwise, this may damage your vehicle.

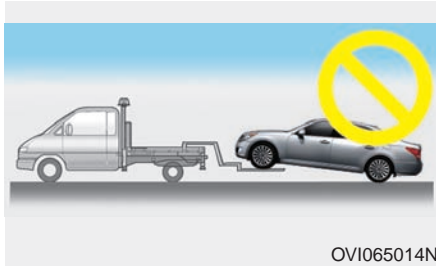

⚠ CAUTION

- Do not tow the vehicle, dragging the rear wheels on the ground. This may damage the vehicle.
- Do not tow with a sling-type equipment. Use a wheel lift or a flatbed.

When emergently towing your vehicle without a wheel dolly:

1. Set the Engine Start/Stop Button in the ACC position.
2. Place the shift lever in N (Neutral).
3. Release the parking brake.

⚠ CAUTION

Failure to set the shift lever in **N(Neutral)** may cause internal damage of the transmission.

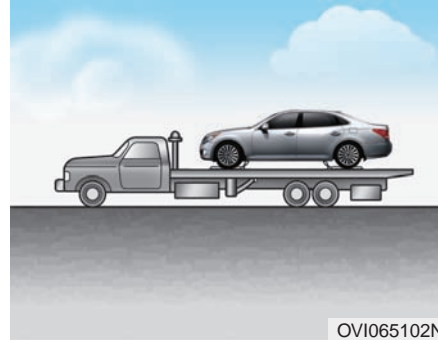

NOTICE

When the ECS malfunction indicator illuminates with no air in the suspension, the vehicle height is very low. Thus, do not drive the vehicle to protect it from any projections on the ground. Tow your vehicle to an authorized EQUUS dealer and have the system checked. You should tow the vehicle as shown in the illustration.

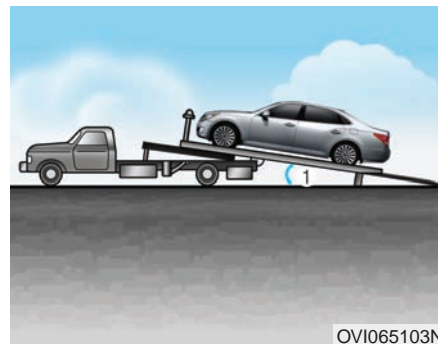

When loading the vehicle onto the tow truck, the loading slope angle (1) should be less than 6°.

Removable towing hook (if equipped)

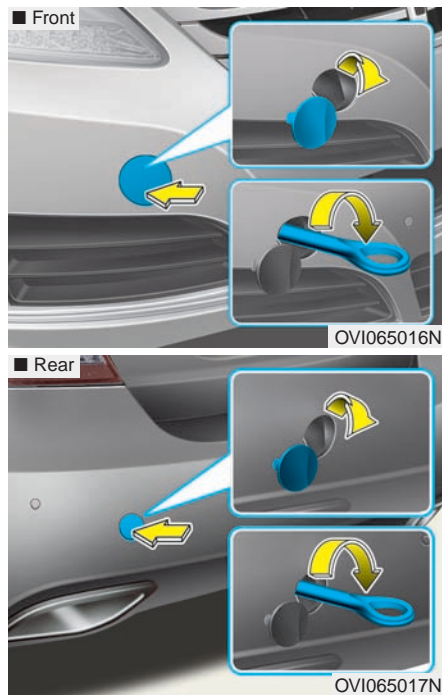

1. Open the trunk, and take the towing hooks out from the tool case.
2. Open the cover by pressing the lower part on the front or rear bumper.
3. Install the towing hook by rotating it in a clockwise wise until it is securely installed.
4. After use, remove the towing hook and close the cover.

Emergency towing

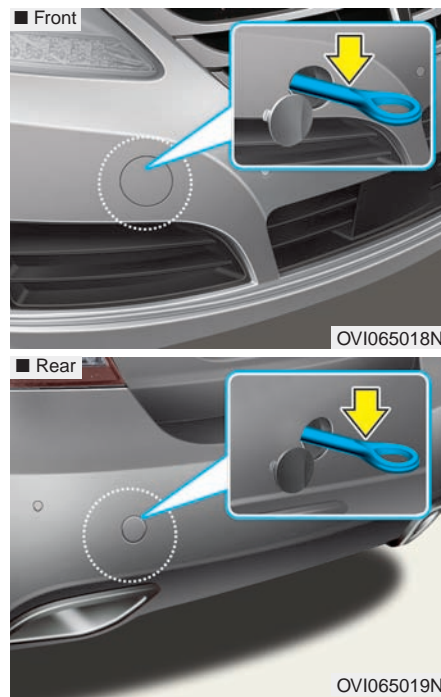

If necessary, we recommend towing your vehicle by an authorized EQUUS dealer or a commercial tow truck service.

When towing service is unavailable in an emergency, your vehicle may be temporarily towed using a cable or chain secured to the emergency towing hook under the front (or the rear) part of the vehicle. Use extreme caution when towing the vehicle. A driver must be in the vehicle to steer the direction and operate the brakes.

Towing in this manner may be done only on a solid ground for a short distance and at a low speed. Also, the wheels, axles, power train, steering and brakes must all be in good condition.

- Do not use the tow hooks to pull a vehicle out of mud, sand or others, from which the vehicle cannot drive out with its own power.
- Avoid towing a vehicle heavier than a towing vehicle.
- The two drivers of the both vehicles should frequently communicate each other.

NOTICE

- **Attach a towing strap to the tow hook.**
 - **Using other parts of the vehicle than the towing hooks while towing may damage the vehicle.**
 - **Use only the authorized cables or chains for towing. Securely fasten the cables or chains to the towing hook.**
-
- Before emergency towing, check that the hook is not broken or damaged.
 - Securely fasten the towing cable or chain to the hook.
 - Do not jerk the hook. Maintain a steady and even force.
 - To avoid damaging the hook, do not pull the hook at a diagonal or vertical angle. Always pull it straight out.

⚠ WARNING

Use extreme caution when towing the vehicle.

- **Avoid a sudden start or abrupt driving maneuvers, which may excessively stress the emergency towing hooks, cables or chains. The towing hooks, cables or chains may break and cause a serious injury or damage.**
- **When you cannot move your damaged or disabled vehicle, do not forcibly try to tow the vehicle. Contact an authorized EQUUS dealer or a commercial tow truck service for assistance.**
- **Tow the vehicle in a straight line.**
- **Keep a distance away from the vehicle while towing.**

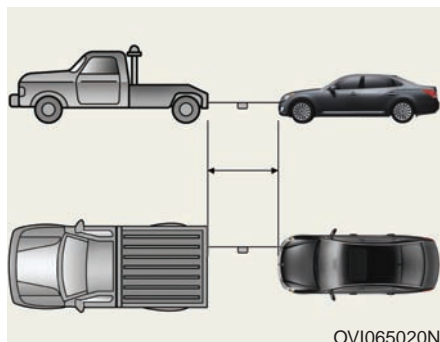

- Use a towing strap, which is 16 feet (5 m) or shorter. Tie a white or red cloth (about 12 inches (30 cm) wide) in the middle of the strap for the better visibility.
- Drive carefully not to loosen the towing strap, while towing.

i Information

Emergency towing is illegal in some states. Contact an authorized EQUUS dealer and tow the vehicle.

Emergency towing precautions

- Set the shift lever in N (Neutral).
- Release the parking brake.
- Depress the brake pedal with extra force, because the brake performance may be reduced.
- Put extra force into the steering wheel operation, because the power steering system may be disabled.
- Driving down a long slope may overheat the brakes, reducing the brake performance. Stop driving at intervals and cool off the brake system.

NOTICE

- Automatic transmission

- When the car is towed, dragging all four wheels on the ground, it should be done only in a forward direction. Be sure to set the shift lever in N(Neutral). Unlock the steering wheel by pressing the Engine Start/Stop button to the ACC position. A driver must be in the towed vehicle to operate both the steering wheel and brakes.
- To avoid a serious damage to the automatic transmission while towing, limit the vehicle speed to 10 mph (15 km/h) and drive shorter than 1 mile (1.5 km).
- Before towing, check any fluid leak of the automatic transmission. When it leaks, flatbed equipment or a towing dolly must be used.

Maintenance

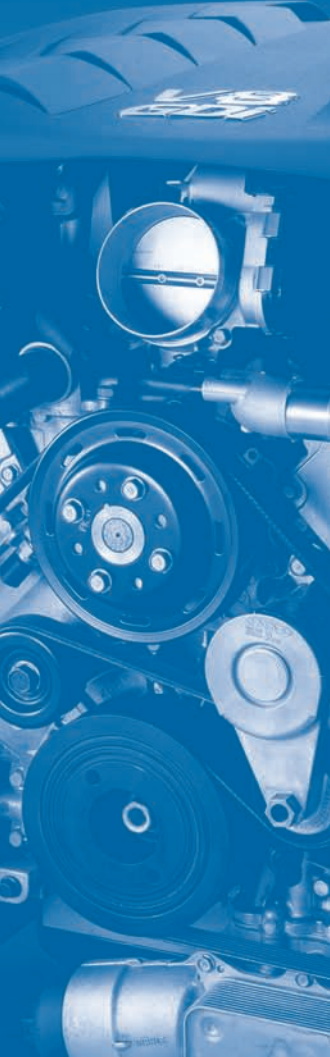

Engine compartment	7-4
Maintenance services	7-5
Owner's responsibility	7-5
Owner's maintenance precautions	7-6
Owner's maintenance	7-7
Owner's maintenance schedule	7-7
Scheduled maintenance service	7-8
Normal maintenance schedule	7-9
Maintenance under severe usage conditions.....	7-22
Explanation of scheduled maintenance items.....	7-23
Engine oil	7-25
Checking the engine oil level	7-25
Changing the engine oil and filter	7-26
Engine coolant.....	7-27
Checking the coolant level	7-27
Changing the coolant.....	7-29
Brake fluid	7-30
Checking the brake fluid level	7-30
Power steering fluid.....	7-31
Checking the power steering fluid level	7-31
Checking the power steering hose.....	7-31
Washer fluid	7-32
Checking the washer fluid level	7-32
Air cleaner	7-33
Filter replacement.....	7-33

Maintenance

Climate control air filter	7-35
Filter inspection	7-35
Filter replacement	7-35
Wiper blades	7-36
Blade inspection	7-36
Blade replacement	7-36
Battery	7-39
For best battery service	7-39
Battery recharging by battery charger	7-41
Battery recharging by vehicle	7-41
Reset items	7-42
Tires and wheels	7-42
Tire care	7-42
Recommended cold tire inflation pressures	7-42
Checking tire inflation pressure	7-44
Tire rotation	7-45
Wheel alignment and tire balance	7-45
Tire replacement	7-46
Wheel replacement	7-47
Tire traction	7-47
Tire maintenance	7-48
Tire sidewall labeling	7-48
Low aspect ratio tire	7-51
Tire terminology and definitions	7-52
All season tires	7-54
Summer tires	7-54
Snow tires	7-54
Tire chains	7-55
Radial-ply tires	7-55



Fuses	7-56
Inner panel fuse replacement.....	7-57
Engine compartment fuse replacement.....	7-59
Fuse/relay panel description	7-60
Light bulbs	7-69
Headlight, position light, turn signal light, side marker light and front fog light bulb replacement.....	7-70
Side repeater light bulb replacement.....	7-74
Rear combination light bulb replacement.....	7-75
High mounted stop light.....	7-75
License plate lamp replacement.....	7-79
Interior light bulb replacement.....	7-82
Appearance care	7-83
Exterior care	7-83
Interior care.....	7-88
Emission control system	7-89
Crankcase emission control system	7-89
Evaporative emission control system.....	7-89
Exhaust emission control system	7-90
California perchlorate notice	7-92

ENGINE COMPARTMENT

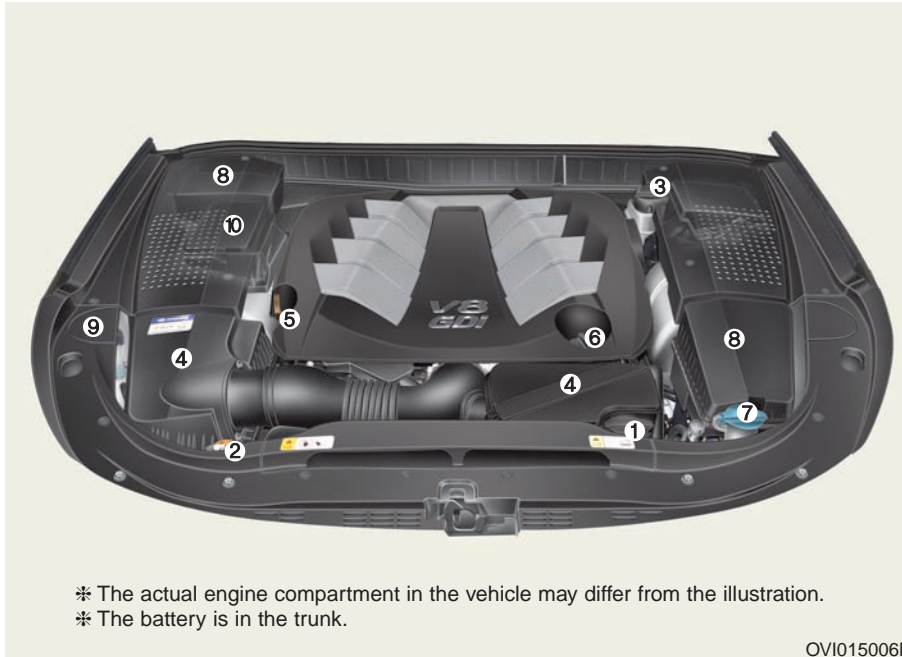

1. Engine coolant reservoir
2. Radiator cap
3. Brake fluid reservoir
4. Air cleaner
5. Engine oil dipstick

6. Engine oil filler cap
7. Windshield washer fluid reservoir
8. Fuse box
9. Power steering fluid reservoir
10. Jumper terminal

MAINTENANCE SERVICES

You should give the utmost care and attention to prevention of a vehicle damage as well as a personal injury, while maintaining or inspecting your vehicle.

When you have any doubts concerning the inspection or the vehicle service, we strongly recommend that you have an authorized EQUUS dealer inspect or maintain your vehicle. An authorized EQUUS dealer has factory-trained technicians and authorized HYUNDAI parts to properly maintain your vehicle. For the quality advices and services, contact an authorized EQUUS dealer.

Inadequate, incomplete or insufficient vehicle maintenance may result in operational problems of your vehicle, possibly leading to a vehicle damage, an accident, or a personal injury.

Owner's responsibility

Information

Maintenance Service and Record Retention are the owner's responsibility.

You should keep the records of your proper maintenance history in accordance with the maintenance service schedule on the following pages. You need to refer to the maintenance schedule information of the following pages in order to satisfy the warranty requirements of your vehicle.

You can find more warranty information in the Owner's Handbook & Warranty Information booklet.

Your vehicle warranty does not cover the repair expenses, incurred by your improper or insufficient maintenance.

We recommend having your vehicle maintained and repaired by an authorized EQUUS dealer.

An authorized EQUUS dealer meets HYUNDAI's high service quality standards and receives technical support from HYUNDAI in order to provide you with a high level of services.

Owner's maintenance precautions

Improper or incomplete maintenance may lead to a vehicle problem. This section is to instruct only the simple maintenance procedures that are easy to perform.

As written above, complex maintenance procedures must be done only by an authorized EQUUS dealer with special tools.

Information

Improper vehicle maintenance may affect your warranty coverage, even before the warranty expires. For more information, refer to the separate Owner's Handbook & Warranty Information booklet. When you are unsure about any services or maintenance procedures, contact an authorized EQUUS dealer.

WARNING

- Vehicle maintenance

- **Vehicle maintenance may be dangerous procedures. You may be seriously injured while performing some maintenance procedures. When you do not have sufficient maintenance knowledge and experience, or you are not equipped with the proper tools, have those done by an authorized EQUUS dealer.**
- **Maintenance, with the hood opened and with the engine running, is dangerous. It becomes even more dangerous, when you wear jewelry or loose clothes. Those items may become entangled in moving parts and result in a injury.**

Therefore, when you must run the engine and open the hood, you must take off all jewelry (i.e. rings, bracelets, watches and necklaces), ties, scarves, and loose clothes before approaching the engine or cooling fans.

OWNER'S MAINTENANCE

The following lists are about the vehicle inspection and maintenance that should be performed by the owner or an authorized EQUUS dealer, as indicated. This will ensure your safety and dependable driving.

Any adverse conditions should immediately be checked by your EQUUS dealer.

These Owner Maintenance Checklists are mostly uncovered by your vehicle warranties. Thus, you may charge you for expenses of labor, parts or lubricants.

Owner's maintenance schedule

While refueling:

- Check the engine oil level.
- Check coolant level in coolant reservoir.
- Check the windshield washer fluid level.
- Check for any low or under-inflated tires.

⚠ WARNING

Carefully check your engine coolant level, when the engine is hot. The hot coolant or steam may blow out under pressure. This may cause a skin burn or other serious injuries.

While driving:

- Check for any changes in the exhaust sounds or the smells.
- Check for any steering wheel vibration. Check whether you feel more tightness or looseness of the steering wheel.
- Check for any slight tilting, or "pulls" to one side, while driving on a flat surface.
- Check for any unusual sounds, tilting, a braking distance, or "hard-to-push" brake pedal while stopping.
- Check the transmission fluid level upon experiencing a skid or a sudden transmission gear change.
- Check the P(Park) function of the auto transmission.
- Check the parking brake.
- Check for any fluid leak (water dripping from the A/C while or after the normal driving).

At least once a month:

- Check the coolant level in the engine coolant reservoir.
- Check the operation of all exterior lights, such as the stoplights, turn signals and hazard warning flashers.
- Check the inflation pressures of all tires including the spare.

At least twice a year (i.e., every spring and fall):

- Check for any leaks or damages from the hoses of the radiator, heater and A/C.
- Check windshield washer spray and wiper operation. Clean wiper blades with a clean cloth with washer fluid.
- Check the headlamp alignment.
- Check the muffler, exhaust pipes, shields and clamps.
- Check the tight fastening and functions of the lap/shoulder belts.
- Check for any tire worn-out and wheel lug nut looseness.

At least once a year:

- Clean the vehicle body and door drain holes.
- Lubricate the door/hood hinges.
- Lubricate the door/hood locks and latches.
- Lubricate the door rubber weather strips.
- Check the A/C system.
- Check the power steering fluid level.
- Check the automatic transmission linkage and controls, and lubricate them.
- Clean the battery and terminals.
- Check the brake fluid level.

SCHEDULED MAINTENANCE SERVICE

Follow the Normal Maintenance Schedule, unless you drive under one of the following conditions. Follow the Maintenance Under Severe Usage Conditions, when you drive under one of the following conditions.

- Repeated short distance driving.
- Driving in dust or on sand.
- Extensive use of brakes.
- Driving in areas where salt or other corrosive materials are abundant.
- Driving on rough or muddy roads.
- Driving in mountainous areas.
- Idling or low-speed driving for an extended period of time.
- Driving in extremely cold or humid weathers for a prolonged period of time.
- 50%-or-more driving in the heavy traffic area at a hot temperature above 90°F (32°C).

When you drive under one of the above conditions, you should more frequently inspect, replace or refill than the following Normal Maintenance Schedule. After driving over 120 months or 150,000 miles (240,000 km), keep following the listed maintenance schedules.

NORMAL MAINTENANCE SCHEDULE

The following maintenance procedures must be performed for good emission control and performance.

Keep the records of all vehicle emission-system maintenance histories to protect your warranty. Between the driving mileage and period, follow the maintenance procedures in accordance with whichever occurs first.

7,500 miles (12,000 km) or 6 months

- Rotate tires
- Inspect air cleaner filter
- Inspect vacuum hose
- Inspect power steering fluid
- Replace engine oil and filter (7,500 miles (12,000 km) or 12 months)
- Add fuel additives *¹ (7,500 miles (12,000 km) or 12 months)

15,000 miles (24,000 km) or 12 months

- Rotate tires
- Inspect air cleaner filter
- Inspect vacuum hose
- Inspect A/C refrigerant
- Inspect brake hoses and lines
- Inspect drive shafts and boots
- Inspect exhaust pipe and muffler
- Inspect front brake disc/pad, calipers
- Inspect propeller shaft
- Inspect rear brake disc/pad
- Inspect steering gear box, linkage & boots/lower arm ball joint, upper arm ball joint
- Inspect suspension mounting bolts
- Inspect power steering fluid
- Inspect EHPS (Electronic Hydraulic Power Steering) motor pump and hoses
- Replace climate control air filter (for evaporator and blower unit)
- Replace engine oil and filter (15,000 miles (24,000 km) or 24 months)
- Add fuel additives *¹ (15,000 miles (24,000 km) or 24 months)

*¹ : When the TOP-TIER Detergent Gasoline is unavailable, adding one bottle of additives is recommended. Additives are available from your authorized EQUUS dealer along with information on how to use them. Do not mix it with other additives.

* Inspect : Inspect and if necessary, adjust, correct, clean or replace.

Maintenance

NORMAL MAINTENANCE SCHEDULE (CONT.)

22,500 miles (36,000 km) or 18 months

- Rotate tires
- Inspect air cleaner filter
- Inspect vacuum hose
- Inspect power steering fluid
- Replace engine oil and filter (22,500 miles (36,000 km) or 36 months)
- Add fuel additives ^{*1} (22,500 miles (36,000 km) or 36 months)

30,000 miles (48,000 km) or 24 months

- Rotate tires
- Inspect vacuum hose
- Inspect A/C refrigerant
- Inspect brake hoses and lines
- Inspect drive shafts and boots
- Inspect exhaust pipe and muffler
- Inspect front brake disc/pads, calipers
- Inspect propeller shaft
- Inspect rear brake disc/pads
- Inspect steering gear box, linkage & boots/lower arm ball joint, upper arm ball joint
- Inspect suspension mounting bolts
- Inspect brake fluid
- Inspect fuel filter ^{*2}
- Inspect fuel lines, fuel hoses and connections
- Inspect fuel tank air filter ^{*2}
- Inspect parking brake
- Inspect vapor hose and fuel filler cap, fuel tank
- Inspect power steering fluid
- Inspect EHPS (Electronic Hydraulic Power Steering) motor pump and hoses
- Replace climate control air filter (for evaporator and blower unit)
- Replace air cleaner filter
- Replace engine oil and filter (30,000 miles (48,000 km) or 48 months)
- Add fuel additives ^{*1} (30,000 miles (48,000 km) or 48 months)

^{*1} : When the TOP-TIER Detergent Gasoline is unavailable, adding one bottle of additives is recommended. Additives are available from your authorized EQUUS dealer along with information on how to use them. Do not mix it with other additives.

^{*2} : Fuel filter & Fuel tank air filter are considered to be maintenance free. However, regular inspection is still recommended, because the maintenance schedule depends on the fuel quality. When there are critical safety problems, such as fuel flow blocking, overflowing, power loss, and hard starting, immediately replace the fuel filter regardless of maintenance schedule, and consult an authorized EQUUS dealer for further information.

* Inspect and if necessary, adjust, correct, clean or replace.

NORMAL MAINTENANCE SCHEDULE (CONT.)**37,500 miles (60,000 km) or 30 months**

- Rotate tires
- Inspect air cleaner filter
- Inspect vacuum hose
- Inspect rear differential oil ^{*3} (40,000 miles (64,000 km) or 48 months)
- Inspect power steering fluid
- Replace engine oil and filter (37,500 miles (60,000 km) or 60 months)
- Add fuel additives ^{*1} (37,500 miles (60,000 km) or 60 months)

45,000 miles (72,000 km) or 36 months

- Rotate tires
- Inspect air cleaner filter
- Inspect vacuum hose
- Inspect A/C refrigerant
- Inspect brake hoses and lines
- Inspect drive shafts and boots
- Inspect exhaust pipe and muffler
- Inspect front brake disc/pads, calipers
- Inspect propeller shaft
- Inspect rear brake disc/pads
- Inspect steering gear box, linkage & boots/lower arm ball joint, upper arm ball joint
- Inspect suspension mounting bolts
- Inspect power steering fluid
- Inspect EHPS (Electronic Hydraulic Power Steering) motor pump and hoses
- Replace climate control air filter (for evaporator and blower unit)
- Replace engine oil and filter (45,000 miles (72,000 km) or 72 months)
- Add fuel additives ^{*1} (45,000 miles (72,000 km) or 72 months)

^{*1} : When the TOP-TIER Detergent Gasoline is unavailable, adding one bottle of additives is recommended. Additives are available from your authorized EQUUS dealer along with information on how to use them. Do not mix it with other additives.

^{*3} : Rear differential oil should be refilled, when the rear differential is submerged in water.

* : Inspect : Inspect and if necessary, adjust, correct, clean or replace.

NORMAL MAINTENANCE SCHEDULE (CONT.)

52,500 miles (84,000 km) or 42 months

- Rotate tires
- Inspect air cleaner filter
- Inspect vacuum hose
- Inspect power steering fluid
- Replace engine oil and filter (52,500 miles (84,000 km) or 84 months)
- Add fuel additives *1 (52,500 miles (84,000 km) or 84 months)

60,000 miles (96,000 km) or 48 months

- Rotate tires
- Inspect vacuum hose
- Inspect A/C refrigerant
- Inspect brake hoses and lines
- Inspect drive shafts and boots
- Inspect exhaust pipe and muffler
- Inspect front brake disc/pads, calipers
- Inspect propeller shaft
- Inspect rear brake disc/pads
- Inspect steering gear box, linkage & boots/lower arm ball joint, upper arm ball joint
- Inspect suspension mounting bolts
- Inspect brake fluid
- Inspect fuel filter *2
- Inspect fuel lines, fuel hoses and connections
- Inspect fuel tank air filter *2
- Inspect parking brake
- Inspect vapor hose and fuel filler cap, fuel tank

(Continued)

*1 : When the TOP-TIER Detergent Gasoline is unavailable, adding one bottle of additives is recommended. Additives are available from your authorized EQUUS dealer along with information on how to use them. Do not mix it with other additives.

*2 : Fuel filter & Fuel tank air filter are considered to be maintenance free. However, regular inspection is still recommended, because the maintenance schedule depends on the fuel quality. When there are critical safety problems, such as fuel flow blocking, overflowing, power loss, and hard starting, immediately replace the fuel filter regardless of maintenance schedule, and consult an authorized EQUUS dealer for further information.

* : Inspect : Inspect and if necessary, adjust, correct, clean or replace.

NORMAL MAINTENANCE SCHEDULE (CONT.)

(Continued)

- Inspect drive belts (First, 60,000 miles (96,000 km) or 72 months after every 15,000 miles (24,000 km) or 24 months) ^{*4}
- Inspect power steering fluid
- Inspect EHPS (Electronic Hydraulic Power Steering) motor pump and hoses
- Replace climate control air filter (for evaporator and blower unit)
- Replace air cleaner filter
- Replace engine oil and filter (60,000 miles (96,000 km) or 96 months)
- Add fuel additives ^{*1} (60,000 miles (96,000 km) or 96 months)

67,500 miles (108,000 km) or 54 months

- Rotate tires
- Inspect air cleaner filter
- Inspect vacuum hose
- Inspect power steering fluid
- Replace engine oil and filter (67,500 miles (108,000 km) or 108 months)
- Add fuel additives ^{*1} (67,500 miles (108,000 km) or 108 months)

^{*1} : When the TOP-TIER Detergent Gasoline is unavailable, adding one bottle of additives is recommended. Additives are available from your authorized EQUUS dealer along with information on how to use them. Do not mix it with other additives.

^{*4} : The drive belt should be replaced, when it has a crack. Otherwise, the tension would be excessively reduced.

* Inspect : Inspect and if necessary, adjust, correct, clean or replace.

NORMAL MAINTENANCE SCHEDULE (CONT.)

75,000 miles (120,000 km) or 60 months

- Rotate tires
- Inspect air cleaner filter
- Inspect vacuum hose
- Inspect A/C refrigerant
- Inspect brake hoses and lines
- Inspect drive shafts and boots
- Inspect exhaust pipe and muffler
- Inspect front brake disc/pads, calipers
- Inspect propeller shaft
- Inspect rear brake disc/pads
- Inspect steering gear box, linkage & boots/lower arm ball joint, upper arm ball joint
- Inspect suspension mounting bolts
- Inspect drive belts (First, 60,000 miles (96,000 km) or 72 months after every 15,000 miles (24,000 km) or 24 months) ^{*4}
- Inspect power steering fluid
- Inspect EHPS (Electronic Hydraulic Power Steering) motor pump and hoses
- Inspect rear differential oil ^{*3} (80,000 miles (128,000 km) or 96 months)
- Replace climate control air filter (for evaporator and blower unit)
- Replace engine oil and filter (75,000 miles (120,000 km) or 120 months)
- Add fuel additives ^{*1} (75,000 miles (120,000 km) or 120 months)

82,500 miles (132,000 km) or 66 months

- Rotate tires
- Inspect air cleaner filter
- Inspect vacuum hose
- Inspect power steering fluid
- Replace engine oil and filter (82,500 miles (132,000 km) or 132 months)
- Add fuel additives ^{*1} (82,500 miles (132,000 km) or 132 months)

^{*1} : When the TOP-TIER Detergent Gasoline is unavailable, adding one bottle of additives is recommended. Additives are available from your authorized EQUUS dealer along with information on how to use them. Do not mix it with other additives.

^{*3} : Rear differential oil should be refilled, when the rear differential is submerged in water.

^{*4} : The drive belt should be replaced, when it has a crack. Otherwise, the tension would be excessively reduced.

* : Inspect : Inspect and if necessary, adjust, correct, clean or replace.

NORMAL MAINTENANCE SCHEDULE (CONT.)**90,000 miles (144,000 km) or 72 months**

- Rotate tires
- Inspect vacuum hose
- Inspect A/C refrigerant
- Inspect brake hoses and lines
- Inspect drive shafts and boots
- Inspect exhaust pipe and muffler
- Inspect front brake disc/pads, calipers
- Inspect propeller shaft
- Inspect rear brake disc/pads
- Inspect steering gear box, linkage & boots/lower arm ball joint, upper arm ball joint
- Inspect suspension mounting bolts
- Inspect brake fluid
- Inspect fuel filter *²
- Inspect fuel lines, fuel hoses and connections
- Inspect fuel tank air filter *²
- Inspect parking brake
- Inspect vapor hose and fuel filler cap, fuel tank
- Inspect drive belts (First, 60,000 miles (96,000 km) or 72 months after every 15,000 miles (24,000 km) or 24 months) *⁴
- Inspect power steering fluid
- Inspect EHPS (Electronic Hydraulic Power Steering) motor pump and hoses
- Replace climate control air filter (for evaporator and blower unit)
- Replace air cleaner filter
- Replace engine oil and filter (90,000 miles (144,000 km) or 144 months)
- Add fuel additives *¹ (90,000 miles (144,000 km) or 144 months)

*¹ : When the TOP-TIER Detergent Gasoline is unavailable, adding one bottle of additives is recommended. Additives are available from your authorized EQUUS dealer along with information on how to use them. Do not mix it with other additives.

*² : Fuel filter & Fuel tank air filter are considered to be maintenance free. However, regular inspection is still recommended, because the maintenance schedule depends on the fuel quality. When there are critical safety problems, such as fuel flow blocking, overflowing, power loss, and hard starting, immediately replace the fuel filter regardless of maintenance schedule, and consult an authorized EQUUS dealer for further information.

*⁴ : The drive belt should be replaced, when it has a crack. Otherwise, the tension would be excessively reduced.

* Inspect : Inspect and if necessary, adjust, correct, clean or replace.

NORMAL MAINTENANCE SCHEDULE (CONT.)

97,500 miles (156,000 km) or 78 months

- Rotate tires
- Inspect air cleaner filter
- Inspect vacuum hose
- Inspect power steering fluid
- Replace engine oil and filter (97,500 miles (156,000 km) or 156 months)
- Add fuel additives *1 (97,500 miles (156,000 km) or 156 months)

105,000 miles (168,000 km) or 84 months

- Rotate tires
- Inspect air cleaner filter
- Inspect vacuum hose
- Inspect A/C refrigerant
- Inspect brake hoses and lines
- Inspect drive shafts and boots
- Inspect exhaust pipe and muffler
- Inspect front brake disc/pads, calipers
- Inspect propeller shaft
- Inspect rear brake disc/pads
- Inspect steering gear box, linkage & boots/lower arm ball joint, upper arm ball joint
- Inspect suspension mounting bolts
- Inspect drive belts (First, 60,000 miles (96,000 km) or 72 months after every 15,000 miles (24,000 km) or 24 months) *4
- Inspect power steering fluid
- Inspect EHPS (Electronic Hydraulic Power Steering) motor pump and hoses
- Replace climate control air filter (for evaporator and blower unit)
- Replace spark plugs (iridium coated)
- Replace engine oil and filter (105,000 miles (168,000 km) or 168 months)
- Add fuel additives *1 (105,000 miles (168,000 km) or 168 months)

*1 : When the TOP-TIER Detergent Gasoline is unavailable, adding one bottle of additives is recommended. Additives are available from your authorized EQUUS dealer along with information on how to use them. Do not mix it with other additives.

*4 : The drive belt should be replaced, when it has a crack. Otherwise, the tension would be excessively reduced.

* Inspect : Inspect and if necessary, adjust, correct, clean or replace.

NORMAL MAINTENANCE SCHEDULE (CONT.)**112,500 miles (180,000 km) or 90 months**

- Rotate tires
- Inspect air cleaner filter
- Inspect vacuum hose
- Inspect power steering fluid
- Replace engine oil and filter (112,500 miles (180,000 km) or 180 months)
- Add fuel additives *¹ (112,500 miles (180,000 km) or 180 months)

120,000 miles (192,000 km) or 96 months

- Rotate tires
- Inspect vacuum hose
- Inspect A/C refrigerant
- Inspect brake hoses and lines
- Inspect drive shafts and boots
- Inspect exhaust pipe and muffler
- Inspect front brake disc/pads, calipers
- Inspect propeller shaft
- Inspect rear brake disc/pads
- Inspect steering gear box, linkage & boots/lower arm ball joint, upper arm ball joint
- Inspect suspension mounting bolts
- Inspect brake fluid
- Inspect fuel filter *²
- Inspect fuel lines, fuel hoses and connections
- Inspect fuel tank air filter *²
- Inspect parking brake
- Inspect vapor hose and fuel filler cap, fuel tank

(Continued)

*¹ : When the TOP-TIER Detergent Gasoline is unavailable, adding one bottle of additives is recommended. Additives are available from your authorized EQUUS dealer along with information on how to use them. Do not mix it with other additives.

*² : Fuel filter & Fuel tank air filter are considered to be maintenance free. However, regular inspection is still recommended, because the maintenance schedule depends on the fuel quality. When there are critical safety problems, such as fuel flow blocking, overflowing, power loss, and hard starting, immediately replace the fuel filter regardless of maintenance schedule, and consult an authorized EQUUS dealer for further information.

* : Inspect : Inspect and if necessary, adjust, correct, clean or replace.

NORMAL MAINTENANCE SCHEDULE (CONT.)

(Continued)

- Inspect drive belts (First, 60,000 miles (96,000 km) or 72 months after every 15,000 miles (24,000 km) or 24 months) ^{*4}
- Inspect power steering fluid
- Inspect EHPS (Electronic Hydraulic Power Steering) motor pump and hoses
- Inspect rear differential oil ^{*3} (120,000 miles (192,000 km) or 144 months)
- Replace climate control air filter (for evaporator and blower unit)
- Replace air cleaner filter
- Replace engine oil and filter (120,000 miles (192,000 km) or 192 months)
- Replace coolant (First, 120,000 miles (210,000 km) or 120 months after every 30,000 miles (48,000 km) or 24 months)
- Add fuel additives ^{*1} (120,000 miles (192,000 km) or 192 months)

127,500 miles (204,000 km) or 102 months

- Rotate tires
- Inspect air cleaner filter
- Inspect vacuum hose
- Inspect power steering fluid
- Replace engine oil and filter (127,500 miles (204,000 km) or 204 months)
- Add fuel additives ^{*1} (127,500 miles (204,000 km) or 204 months)

^{*1} : When the TOP-TIER Detergent Gasoline is unavailable, adding one bottle of additives is recommended. Additives are available from your authorized EQUUS dealer along with information on how to use them. Do not mix it with other additives.

^{*3} : Rear differential oil should be refilled, when the rear differential is submerged in water.

^{*4} : The drive belt should be replaced, when it has a crack. Otherwise, the tension would be excessively reduced.

* Inspect : Inspect and if necessary, adjust, correct, clean or replace.

NORMAL MAINTENANCE SCHEDULE (CONT.)**135,000 miles (216,000 km) or 108 months**

- Rotate tires
- Inspect air cleaner filter
- Inspect vacuum hose
- Inspect A/C refrigerant
- Inspect brake hoses and lines
- Inspect drive shafts and boots
- Inspect exhaust pipe and muffler
- Inspect front brake disc/pads, calipers
- Inspect propeller shaft
- Inspect rear brake disc/pads
- Inspect steering gear box, linkage & boots/lower arm ball joint, upper arm ball joint
- Inspect suspension mounting bolts
- Inspect drive belts (First, 60,000 miles (96,000 km) or 72 months after every 15,000 miles (24,000 km) or 24 months) ^{*4}
- Inspect power steering fluid
- Inspect EHPS (Electronic Hydraulic Power Steering) motor pump and hoses
- Replace climate control air filter (for evaporator and blower unit)
- Replace engine oil and filter (135,000 miles (216,000 km) or 216 months)
- Add fuel additives ^{*1} (135,000 miles (216,000 km) or 216 months)

142,500 miles (228,000 km) or 114 months

- Rotate tires
- Inspect air cleaner filter
- Inspect vacuum hose
- Inspect power steering fluid
- Replace engine oil and filter (142,500 miles (228,000 km) or 228 months)
- Add fuel additives ^{*1} (142,500 miles (228,000 km) or 228 months)

^{*1} : When the TOP-TIER Detergent Gasoline is unavailable, adding one bottle of additives is recommended. Additives are available from your authorized EQUUS dealer along with information on how to use them. Do not mix it with other additives.

^{*4} : The drive belt should be replaced, when it has a crack. Otherwise, the tension would be excessively reduced.

✱ Inspect : Inspect and if necessary, adjust, correct, clean or replace.

NORMAL MAINTENANCE SCHEDULE (CONT.)

150,000 miles (240,000 km) or 120 months

- Rotate tires
- Inspect vacuum hose
- Inspect A/C refrigerant
- Inspect brake hoses and lines
- Inspect drive shafts and boots
- Inspect exhaust pipe and muffler
- Inspect front brake disc/pads, calipers
- Inspect propeller shaft
- Inspect rear brake disc/pads
- Inspect steering gear box, linkage & boots/lower arm ball joint, upper arm ball joint
- Inspect suspension mounting bolts
- Inspect brake fluid
- Inspect fuel filter *²
- Inspect fuel lines, fuel hoses and connections
- Inspect fuel tank air filter *²
- Inspect parking brake
- Inspect vapor hose and fuel filler cap, fuel tank
- Inspect power steering fluid
- Inspect EHPS(Electronic Hydraulic Power Steering) motor pump, belt and hoses
- Inspect rear differential oil *³ (160,000 miles (256,000 km) or 192 months)
- Inspect drive belts (First, 60,000 miles (96,000 km) or 72 months after every 15,000 miles (24,000 km) or 24 months) *⁴
- Replace climate control air filter (for evaporator and blower unit)
- Replace air cleaner filter
- Replace engine oil and filter (150,000 miles (240,000 km) or 240 months)
- Replace coolant (First, 120,000 miles (192,000 km) or 120 months after every 30,000 miles (48,000 km) or 24 months)
- Add fuel additives *¹ (150,000 miles (240,000 km) or 240 months)

*¹ : When the TOP-TIER Detergent Gasoline is unavailable, adding one bottle of additives is recommended. Additives are available from your authorized EQUUS dealer along with information on how to use them. Do not mix it with other additives.

*² : Fuel filter & Fuel tank air filter are considered to be maintenance free. However, regular inspection is still recommended, because the maintenance schedule depends on the fuel quality. When there are critical safety problems, such as fuel flow blocking, overflowing, power loss, and hard starting, immediately replace the fuel filter regardless of maintenance schedule, and consult an authorized EQUUS dealer for further information.

*³ : Rear differential oil should be refilled, when the rear differential is submerged in water.

*⁴ : The drive belt should be replaced, when it has a crack. Otherwise, the tension would be excessively reduced.

* Inspect : Inspect and if necessary, adjust, correct, clean or replace.

NORMAL MAINTENANCE SCHEDULE

No check, No service required

- Automatic transmission fluid ^{*5}

^{*5} : Use only the authorized automatic transmission fluid. (Refer to "Recommended lubricants and capacities" in the chapter 8 or the label in the engine room.)

Maintenance

MAINTENANCE UNDER SEVERE USAGE CONDITIONS

The following maintenance procedures must be performed more frequently, when driving under severe conditions. Refer to the below chart for the appropriate maintenance schedule.

R : Replace

I : Inspect, and, if necessary, clean, adjust, repair or replace.

MAINTENANCE ITEM	MAINTENANCE OPERATION	MAINTENANCE INTERVALS	DRIVING CONDITION
ENGINE OIL AND FILTER	R	EVERY 3,750 MILES (6,000 KM) OR 6 MONTHS	A, B, C, D, E, F, G, H, I, J, K
AIR CLEANER FILTER	I	MORE FREQUENTLY	C, E
SPARK PLUGS	R	MORE FREQUENTLY	A, B, H, I, K
AUTOMATIC TRANSMISSION FLUID	R	EVERY 60,000 MILES (96,000 KM)	A, C, D, E, F, G, H, I
FRONT BRAKE DISC/PADS, CALIPERS	I	MORE FREQUENTLY	C, D, G, H
REAR BRAKE DISC/PADS	I	MORE FREQUENTLY	C, D, G, H
PARKING BRAKE	I	MORE FREQUENTLY	C, D, G, H
STEERING GEAR BOX, LINKAGE & BOOTS/ LOWER ARM BALL JOINT, UPPER ARM BALL JOINT	I	MORE FREQUENTLY	C, D, E, F, G, H, I
DRIVE SHAFTS AND BOOTS	I	EVERY 7,500 MILES (12,000 KM) OR 6 MONTHS	C, D, E, F, G, H, I, J
REAR DIFFERENTIAL OIL	R	EVERY 80,000 MILES (128,000 KM)	C, G, H, I, J
CLIMATE CONTROL AIR FILTER (FOR EVAPORATOR AND BLOWER UNIT)	R	MORE FREQUENTLY	C, E
PROPELLER SHAFT	I	EVERY 7,500 MILES (12,000 KM) OR 6 MONTHS	C, E

SEVERE DRIVING CONDITIONS

A - Repeatedly driving a short distance of less than 5 miles (8 km) at a normal temperature or of less than 10 miles (16 km) at a freezing temperature

B - Extensively idling or slowly driving for a long distance

C - Driving on a rough, dusty, muddy, unpaved, graveled or salt-spread roads

D - Driving in areas where salt or other corrosive materials are abundant or at a freezing temperature

E - Driving in sandy areas

F - Driving in the heavy traffic area at a temperature over 90°F (32°C)

G - Driving on a slope or a mountainous area

H - Towing a trailer, or using a camper or roof rack

I - Driving as a patrol car, taxi, other commercial usages or vehicle towing

J - Driving at a speed over 106 mph (170 km/h)

K - Frequent stopping and starting

EXPLANATION OF SCHEDULED MAINTENANCE ITEMS

Engine oil and filter

The engine oil and filter should be changed at the interval, as specified in the maintenance schedule. After driving in severe conditions, you should more frequently change oil and filters.

Drive belts

Inspect all belts for any cut, crack, excessive wear-out, or oil saturation. If necessary, replace it.

Fuel filter

A clogged filter may limit the accelerating function, damage the emission system and cause other problems, such as hard starting. When an excessive amount of foreign substances accumulate in the fuel tank, you should more frequently replace the filter. After installing a new filter, run the engine for several minutes, and check for any leakage from the connections. Fuel filters should be installed by an authorized EQUUS dealer.

Fuel lines, fuel hoses and connections

Check the fuel lines, fuel hoses and connections for any leakage and damage. Immediately have an authorized EQUUS dealer replace any damaged or leaking parts.

Vapor hose and fuel filler cap

Check the fuel lines, fuel hoses and connections for any leakage and damage. Immediately have an authorized EQUUS dealer replace any damaged or leaking parts.

Air cleaner filter

An authorized HYUNDAI air cleaner filter is recommended.

Spark plugs

Make sure to install new spark plugs of the correct heat range.

Cooling system

Check the cooling system components, such as radiator, coolant reservoir, hoses and connections, for any leakage and damage. If necessary, replace any damaged parts.

Coolant

The coolant should be changed at the interval, as specified in the maintenance schedule.

Automatic transmission fluid

You do not need to check the automatic transmission fluid, when driving under normal conditions. However, after driving in severe conditions, the fluid should be changed by an authorized EQUUS dealer in accordance with the maintenance schedule, as specified in the beginning of this chapter.

i Information

The original color of the automatic transmission fluid is red. However, as you drive the vehicle, the color will become darker. This is normal, and you do not need to change the fluid due to the changed color.

NOTICE

The use of an unauthorized fluid may result in transmission malfunction and failure. Use only the authorized automatic transmission fluid. (Refer to “Recommended lubricants and capacities” in the chapter 8.)

Brake hoses and lines

Confirm the proper installation, and check for any frictions, cracks, deterioration and leakage. If necessary, immediately replace any deteriorated or damaged parts.

Brake fluid

Check the brake fluid level. The level should be between “MIN” and “MAX” marks on the reservoir. Use only the hydraulic brake fluid, which meet the requirements of the DOT3/DOT4 specifications.

Brake discs, pads, calipers and rotors

Check the pads and the disc for any excessive wear-out, and inspect calipers for any fluid leakage.

Exhaust pipe and muffler

Inspect the exhaust pipes, muffler and hangers for any cracks, deteriorations, or damages. Start the engine, and listen carefully for any gas leaking noise. If necessary, tighten connections or replace the damaged parts.

Suspension mounting bolts

Check the suspension connections for any looseness or damage. If necessary, retighten the bolt to the specified torque.

Steering gear box, linkage & boots/lower arm ball joint

After stopping the vehicle and turning off the engine, confirm the steering locking (tightening).

Check the bends for any linkage or damage. Check the dust boots and ball joints for any deterioration, cracks, or damage. If necessary, replace the damaged parts.

Power steering pump, belt and hoses

Check the power steering pump and hoses for any leakage or damage. If necessary, immediately replace any damaged or leaking parts. Inspect the power steering belt (or drive belt) for any cuts, cracks, excessive wear-out, oil saturation or looseness. If necessary, replace or adjust the damaged part.

Drive shafts and boots

Check the drive shafts, boots and clamps for any cracks, deterioration, or damage. If necessary, replace or grease the damaged part.

Air conditioning refrigerant

Check the air conditioning lines and connections for any leakage or damage.

ENGINE OIL

Checking the engine oil level

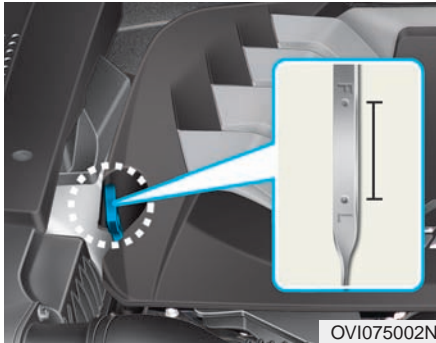

1. Be sure the vehicle is on level ground.
2. Start the engine and allow it to reach a normal operating temperature.
3. Turn the engine off and wait for the oil fluctuation to stabilize in the oil pan (approximately 5 minutes).
4. Pull the dipstick out, wipe it clean, and re-insert it fully.

WARNING

- Radiator hose

Do not touch the radiator hose while checking or adding the engine oil. This may burn your skin.

5. Pull the dipstick out again and check the level. The level should be between F and L.

NOTICE

- Do not overfill the engine oil. This may damage the engine.
- Do not spill out the engine oil, while adding or changing it. If you spill out the engine oil in the engine compartment, immediately wipe it off.



When it is near to or at L, add the engine oil to bring it up to F. **Do not overfill it.**

Use a funnel to prevent oil spillage over the engine components.

Use only the authorized engine oil. (Refer to "Recommended lubricants and capacities" in the chapter 8.)

Changing the engine oil and filter



OVI075161N

Have engine oil and filter changed by an authorized EQUUS dealer in accordance with the Maintenance Schedule, as specified in the beginning of this chapter.

⚠ CALIFORNIA PROPOSITION 65 WARNING

Engine oil contains chemicals known to the State of California to cause cancer, birth defects and reproductive harm. Used engine oil may cause irritation or cancer of the skin if left in contact with the skin for prolonged periods of time. Always protect your skin by washing your hands thoroughly with soap and warm water as soon as possible after handling used oil.

ENGINE COOLANT

The high-pressure cooling system has a reservoir filled with the year-round antifreeze coolant. The reservoir is already filled at the factory.

Check the antifreeze protection and coolant level at least once a year, at the beginning of the winter season, and before traveling to a colder region.

Checking the coolant level

WARNING



Removing the radiator cap

- Never attempt to remove the radiator cap while the engine is running, or when the engine is hot. This may damage the cooling system and the engine, resulting in a serious personal injury due to the hot coolant or steam.
- Turn the engine off and wait until it cools down. Use extreme care when removing the radiator cap. Wrap a thick towel around it, and slowly turn it in a counterclockwise direction to the first stop. Step back while the pressure is released from the cooling system.

When you are sure all the pressure is released, press down on the cap over a thick towel, and turn it in a counterclockwise direction to remove it.

(Continued)

(Continued)

- Even when the engine is not operating, but when the engine and radiator are hot, do not remove the radiator cap or the drain the plug. Hot coolant and steam may blow out under pressure, causing a serious injury.

WARNING



The electric motor (of the cooling fan) is controlled by the engine coolant temperature, refrigerant pressure and driving speed. It may operate, even when the engine is not running. Use extreme caution, when working near the cooling fan blades. So, you are not injured by the fan-blade rotation. As the engine coolant temperature decreases, the electric motor will automatically turn off. This is a normal. When your vehicle is equipped with GDI, the electric motor (of the cooling fan) may operate until the negative battery cable is disconnected.

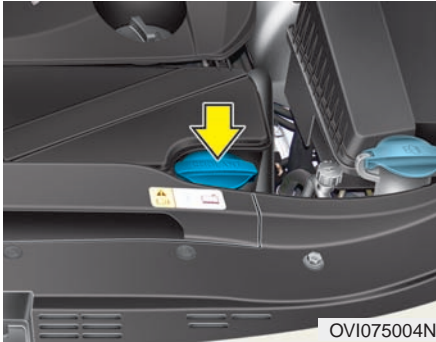

Check all the cooling system hoses and heater hoses. If necessary, replace any swollen or deteriorated one.

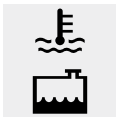

The coolant level should be between F and L marks on the coolant reservoir, when the engine is cool.

When the coolant level is low, add distilled (deionized) water. Bring up the level to F, but do not overfill. When frequent additions are required, have an authorized EQUUS dealer inspect your cooling system.

Recommended engine coolant

- When adding coolant, use the deionized water, distilled water or soft water. Never add hard water in the coolant. An improper coolant mixture may result in serious malfunction or engine damage.
- The engine parts are made of aluminum and must be protected by an ethyleneglycol-based coolant from any corrosion and freezing.
- DO NOT USE alcohol or methanol coolant, nor mix them with the authorized coolant.

- Do not use the solution of which the antifreeze portion is above 60% or below 35%. This may reduce the solution effects.
- Mix the water and antifreeze in the half-and-half ratio. This solution will work in most situations.

For the proper mixture ratio, refer to the following table.

Ambient Temperature	Mixture Percentage (volume)	
	Antifreeze	Water
5°F (-15°C)	35	65
-13°F (-25°C)	40	60
-31°F (-35°C)	50	50
-49°F (-45°C)	60	40

i Information

The half-and-half ratio solution of water and antifreeze is effective at a temperature of -31°F (-35°C) and higher.

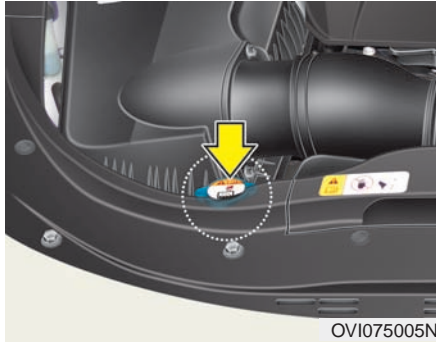
**⚠ WARNING****Radiator cap**

Do not remove the radiator cap, when the engine and radiator are hot. Hot coolant and steam may blow out under pressure and burn your skin, causing a serious injury.

Changing the coolant

Have coolant changed by an authorized EQUUS dealer in accordance with the Maintenance Schedule, as specified in the beginning of this chapter.

NOTICE

Cover a thick cloth around the radiator cap, before refilling the coolant, in order to prevent the coolant spillage over the engine parts, such as the generator.

⚠ WARNING

- Coolant
- Do not fill the radiator coolant or antifreeze in the washer fluid reservoir.
- Radiator coolant may obscure your visibility, when sprayed on the windshield. This may cause loss of vehicle control, or damage the paint and body trim.

BRAKE FLUID

Checking the brake fluid level

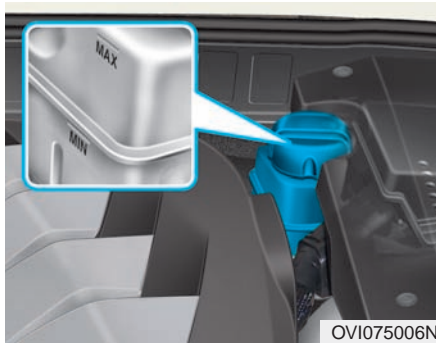

Check the fluid level in the reservoir on a regular basis. The fluid level should be between MAX and MIN marks on the reservoir.

Before opening the reservoir cap to add brake fluid, clean the area around the reservoir cap to prevent brake fluid from being contaminated.

When the level is low, add fluid near to the MAX level. The level decreases, as the vehicle drives. This is a normal, associated with the wear-out of the brake linings. When the fluid level is excessively low, have the brake system checked by an authorized EQUUS dealer.

Use only the authorized brake fluid. (Refer to "Recommended lubricants or capacities" in the chapter 8.)

Never mix different types of fluid.

⚠ WARNING

- Loss of brake fluid
When the brake system requires frequent fluid addition, the vehicle should be inspected by an authorized EQUUS dealer.

⚠ WARNING

- Brake fluid
When changing and adding brake fluid, pay special attention to it. Before washing your hands, do not touch your eyes. When the brake fluid should come in contact with your eyes, immediately wash them with fresh tap water. Immediately have your eyes examined by a doctor.

NOTICE

Do not spill the brake fluid over the body paint. This may damage the paint. The brake fluid, which is exposed in the air for an extended period of time, should not be used, as its quality cannot be guaranteed. It should be disposed in a proper manner. Do not add unauthorized fluid. A few drops of mineral-based oil, such as engine oil, in your brake system may damage brake system parts.

POWER STEERING FLUID

Checking the power steering fluid level

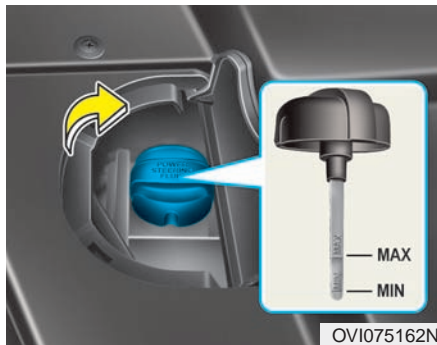

OVI075162N

Check the fluid level in the power steering reservoir on a regular basis, after parking on a level ground. The fluid level should be between MAX and MIN marks on the gauge at a normal temperature.

Before adding power steering fluid, clean the area around the reservoir cap to prevent power steering fluid contamination.

When the level is low, add the fluid near to the MAX level.

When the power steering system requires frequent fluid addition, have the vehicle inspected by an authorized EQUUS dealer.

NOTICE

- To avoid damage to the power steering pump, do not operate the vehicle for a prolonged period of time, when the power steering fluid level is low.
- Never start the engine when the reservoir tank is empty.
- Pay special attention while adding the fluid. So, any dirt does not get into the tank.
- Low level of the fluid may increase the steering effort and noise from the power steering system.
- The use of the unauthorized fluid may reduce the effects of the power steering system and damage it.

Use only the authorized power steering fluid. (Refer to "Recommended lubricants or capacities" in the chapter 8.)

Checking the power steering hose

Check the connections for any oil leakage, damages and twists, before driving.

WASHER FLUID

Checking the washer fluid level

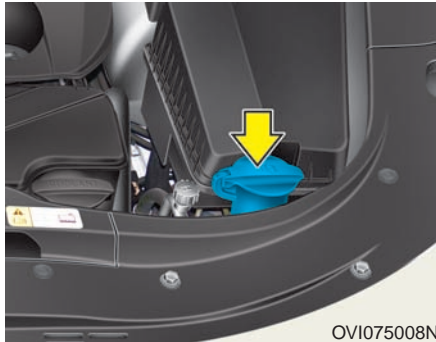

The washer fluid reservoir is transparent, so that you can visually check the washer fluid level.

If necessary, add the washer fluid. Plain water may be used, when the washer fluid is unavailable. However, you may add antifreezing solvents to the fluid to prevent it from freezing, before driving at a cold temperature.

⚠ WARNING

- Coolant

- Do not add the radiator coolant or the antifreeze in the washer fluid reservoir.
- The radiator coolant severely obscures your visibility, when sprayed on the windshield. This may cause loss of vehicle control, or damage the paint and body trim.

(Continued)

(Continued)

- The washer fluid contain some amounts of alcohol. Thus, it is flammable under certain circumstances. Keep the washer fluid or the reservoir away from any sparks or flames. This may damage the vehicle, or injure the occupants.
- The washer fluid is poisonous to humans and animals. Do not drink and avoid contacting with the washer fluid. This may cause a serious injury or death.

AIR CLEANER

Filter replacement

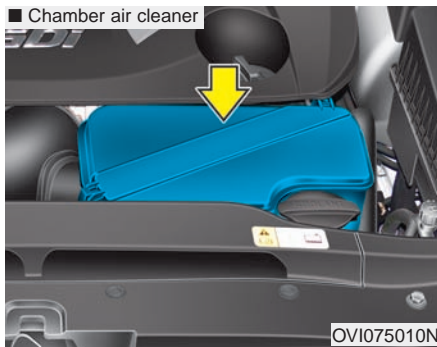
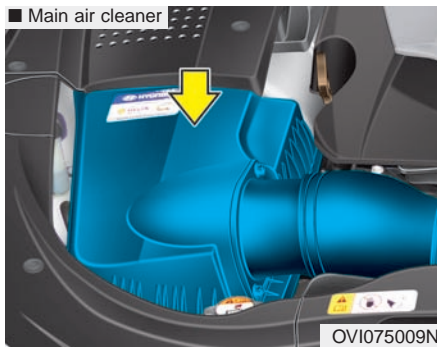

It must be replaced, if necessary, and should not be washed.

After checking the air cleaner element, clean the filter.

Clean the filter by blowing the compressed air.

Main air cleaner



1. Press the top of the fastener to remove the cover.

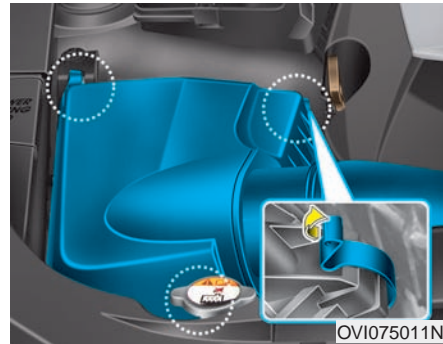

2. Loosen the clips and open the cover.
3. Clean the inside of the air cleaner.

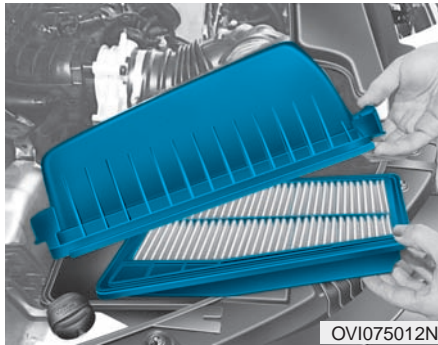

4. Replace the air cleaner filter.
5. Lock the cover with clips.

Chamber air cleaner

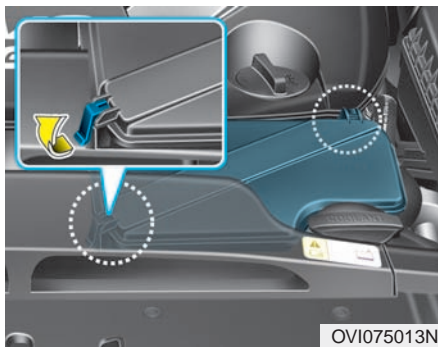

1. Loosen the clips and open the cover.

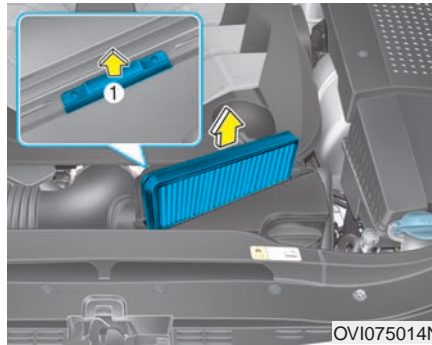

2. Pull up the locking tab (1) and replace the air cleaner filter.
3. Lock the cover with the clips.

Replace the filter in accordance with the Maintenance Schedule.

When the vehicle drives in extremely dusty or sandy areas, replace the filter more often than the recommended interval. (Refer to "Maintenance under severe usage conditions" in this chapter.)

NOTICE

- Do not drive without the air cleaner filter. This may excessively wear out the engine.
- When replacing the air cleaner filter, be careful that dust or dirt does not enter the air intake. Otherwise, this may damage the vehicle.
- Use only an authorized HYUNDAI genuine part. Use of unauthorized parts may damage the air flow sensor.

CLIMATE CONTROL AIR FILTER

Filter inspection

The climate control air filter should be replaced every 15,000 miles (24,000 km). When the vehicle drives in severely air-polluted cities or on dusty rough roads for a long period of time, more frequent filter inspection and replacement should be done. When replacing the climate control air filter, follow the procedures, and be careful not to damage other components.

Filter replacement

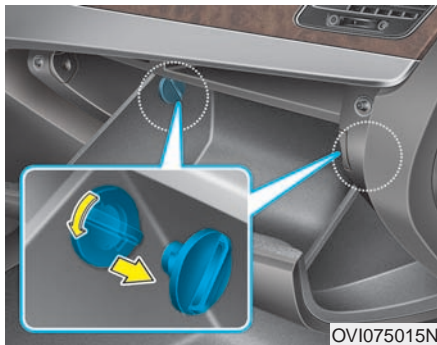

OVI075015N

1. Open the glove box, and remove the stoppers on both sides of the glove box to partially loosen it from the hinges.

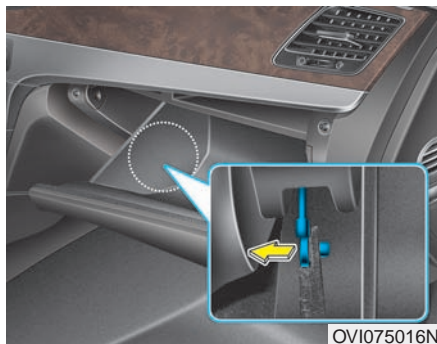

OVI075016N

2. Remove the cylinder in the left side of the glove box.

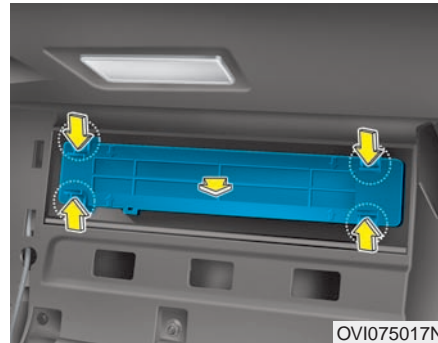

OVI075017N

3. Remove the climate control air filter case by pulling out the both sides.

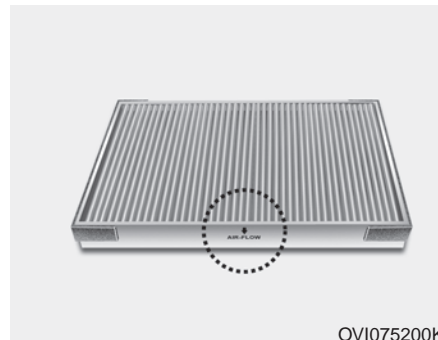

OVI075200K

4. Replace the climate control air filter.
5. Reassemble the parts in the reverse order.

i Information

Install a new climate control air filter in the correct direction with the arrow symbol (↓) facing downwards.

Otherwise, the climate control effects may decrease, possibly with a noise.

WIPER BLADES

Blade inspection



i Information

Hot wax in market may be used in automatic car washes. However, it is known to make it difficult to clean the windshield.

Contamination of either the windshield or the wiper blades with foreign substances may undermine the effects of the windshield wipers. Common contamination sources are insects, tree sap, and hot wax treatments used in some car washes. When the blades do not properly wipe off, clean the window and blades with a good-quality cleaner or mild detergent. Then, thoroughly wash them with clean water.

NOTICE

Do not use gasolines, kerosene, paint thinner, or other solvents on or near the wiper blades to prevent damage.

Blade replacement

When the wipers no longer adequately clean, the blades may be worn out or cracked. Then, replacement is required.

NOTICE

To prevent damage to the wiper arms or other components, do not attempt to manually move the wipers.

NOTICE

The use of a non-specified wiper blade could result in wiper malfunction and failure.

Front windshield wiper blade

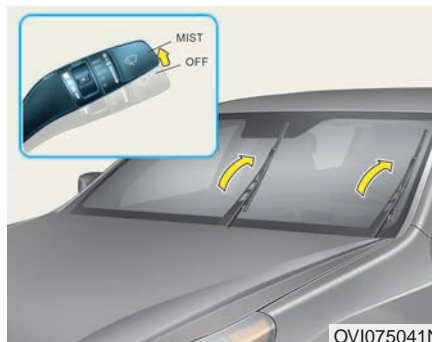

For your convenience, move the windshield wiper blades as illustrated.

Turn off the engine.

Fully raise the wipers by setting the wiper lever in the single wiping (MIST) position less than 20 seconds.

**Type A**

1. Raise the wiper arm.

NOTICE

Be careful that the wiper arm does not fall against the windshield. It may chip off or crack the windshield.

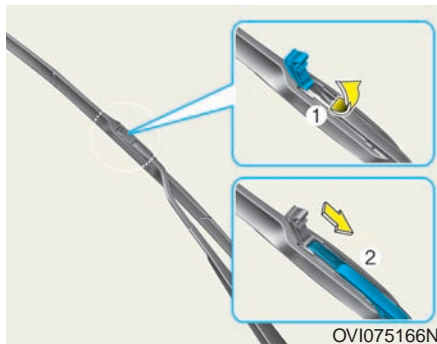

2. Open the cover of the blade. Press the clip behind the wiper arm and remove the blade assembly downward.

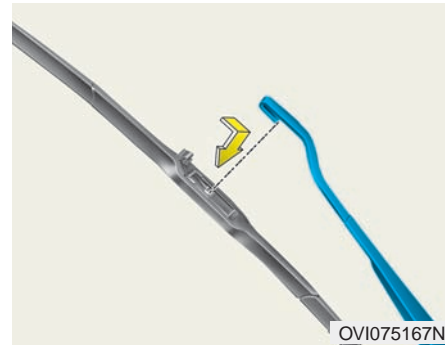

3. Install the new blade assembly in the reverse order.
4. Put the wiper arm back in place on the windshield.
5. Turn on the ignition switch.
6. Check the wiper operation, and then turn it off.

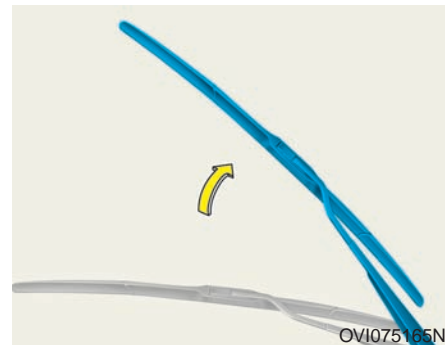
**Type B**

1. Raise the wiper arm.

NOTICE

Be careful that the wiper arm does not fall against the windshield. It may chip off or crack the windshield.

Maintenance

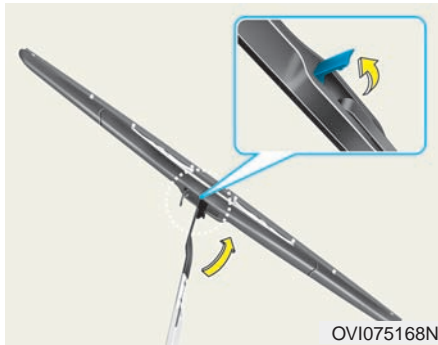

OVI075168N

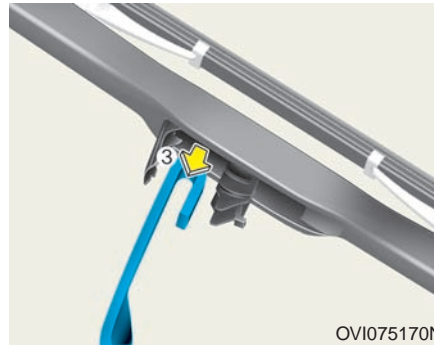

OVI075170N

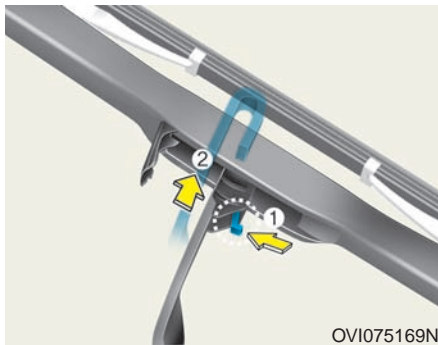

OVI075169N

2. Open the wiper blade clip after loosening it.
3. Press the blade clip (1), push off the wiper blade (2).

4. Push down the blade against the wiper arm (3) and install the new blade assembly in the reverse order.
5. Put the wiper arm back in place on the windshield.

BATTERY

For best battery service



OVI075018N

The battery is located in the trunk.

- Keep the battery securely mounted.
- Keep the top of the battery clean and dry.
- Keep the terminals and connections clean, tight, and coated with petroleum jelly or terminal grease.
- Immediately clean any electrolyte spillage over the battery with baking soda dissolved in water.

NOTICE

Make sure that the clear vent hose is connected between the battery nipple at the back and the vehicle body vent nipple. This ensures the exit of the battery vapors, not remaining inside the trunk, when vaporizing.

WARNING

- Battery dangers



Always carefully follow the below instructions, when handling a battery.



Keep cigarettes lit, sparks, or all other flames away from the battery.



Hydrogen, which is highly combustible, always exists inside the battery, and may explode upon being ignited.



Keep the battery out of the reach of children, as it contains highly corrosive SULFURIC ACID. Do not allow the battery acid to contact your skin, eyes, clothes or the vehicle paint.



When electrolyte gets into your eyes, immediately flush your eyes with clean water for at least 15 minutes and get medical attention. When electrolyte gets on your skin, thoroughly wash the contacted area. When you feel pain or burning sensation, immediately get medical attention.

(Continued)

(Continued)



Wear eye protection when charging the battery or working somewhere near it. Always provide proper ventilation when working in an enclosed space.



An inappropriately disposed battery may be harmful to the environment and human health. Dispose the battery in accordance with your local law(s) or regulations.

- When lifting up the battery in a plastic case, putting excessive pressure on the case may leak the battery acid, resulting in a personal injury. Lift up the battery case by holding the both sides of it.
- Never attempt to recharge the battery when the battery cables are connected.
- The electrical ignition system works with high voltage. Never touch these components, when the engine is running, or when the ignition switch is turned on.

Failure to follow the above warnings may result in a serious bodily injury or death.

⚠ CALIFORNIA PROPOSITION 65 WARNING

Battery posts, terminals, and related accessories contain lead and lead compounds, chemicals known to the State of California to cause cancer, birth defects and reproductive harm. Batteries also contain other chemicals known to the State of California to cause cancer. Wash hands after handling.

NOTICE

- When your vehicle is not driven for a long period of time at a low temperature, remove the battery and keep it indoors.
The power trunk is not completely closed, when the battery is removed. When you remove the battery, refer to "Power trunk" in the chapter 3.
- Always fully charge the battery to prevent a case damage at a low temperature.
- When unauthorized electronic devices are connected with the battery, it may discharge the battery. Never connect unauthorized devices.

⚠ WARNING

Removing the battery from the vehicle should be done at an authorized EQUUS dealer.

Battery recharging by battery charger

Your vehicle has a maintenance-free, calcium-based battery.

- When the battery is discharged in a short period of time (possibly because the headlamps or interior lights remain on, while the vehicle is not in use), slowly recharge it (trickle) for 10 hours.
- When the battery is gradually discharged due to high electric load, while the vehicle is in use, recharge it at 20-30A for 2 hours.

Battery recharging by vehicle

After jump-starting from a good battery, run the engine for 20-30 minutes in either the idle or driving modes, before turning off the engine. Your vehicle may not restart, when the engine is shortly turned off without having an adequate recharging time.

(Continued)

- **Keep paying attention to the battery condition, while recharging. Stop or slow the recharging rate, when the battery gas violently leaks (boiling), or when an electrolyte temperature exceeds 120°F (49°C).**
- **Wear the proper eye protection, while watching the battery recharging conditions.**
- **Disconnect the battery charger in the following order.**
 1. Turn off the main switch of the battery charger.
 2. Unhook the negative clamp from the negative battery terminal.
 3. Unhook the positive clamp from the positive battery terminal.

WARNING

- Recharging battery

When recharging the battery, follow the below precautions:

- The battery must be removed from the vehicle and placed in a well-ventilated area.
- Keep cigarette lits, sparks, or flames away from the battery.

(Continued)

WARNING

- Before maintaining or recharging the battery, turn off all accessories and stop the engine.
- The negative battery cable must be disconnected first, or be connected last.
- Operation related to the battery should be done by an authorized EQUUS dealer.

NOTICE

- **Keep the battery away from water or any other liquid.**
- **The battery is located in the trunk. Thus, be careful when loading a container filled with liquid inside the trunk.**
- **For your safety, use only the genuine HYUNDAI battery, when replacing it.**

Reset items

Items should be reset after either a battery discharge or a battery disconnection.

- Auto up/down window (See the chapter 3)
- Rear door window curtains (See the chapter 3)
- Sunroof (See the chapter 3)
- Driver position memory system (See the chapter 3)
- Trip computer (See the chapter 3)
- Climate control system (See the chapter 3)
- Clock (See DIS manual)
- Audio (See DIS manual)
- Power trunk (See the chapter 3)

TIRES AND WHEELS

Tire care

For the better maintenance, safety, and fuel economy, you must always maintain the recommended tire inflation pressures, and follow the load limits and weight distribution recommendation.

Recommended cold tire inflation pressures

The tire pressure (including the spare) should be measured, when it is cold. A "cold tire" means the vehicle does not drive for the last 3 hours or is driven shorter than 1 mile (1.6 km).

The recommended pressure must be maintained for the best driving, handling, and the minimum tire wear-out. For the information about the recommended inflation pressure, refer to "Tire and wheels" in the chapter 8.

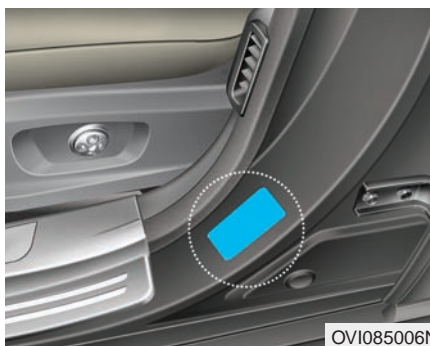

All specifications (sizes and pressures) are specified on the label attached to the central pillar of the driver's door.

⚠ WARNING**- Underinflated tire**

Severe under-inflation of tire may cause severe build-up of heat, causing blowouts, tread separation and other failures. This may result in the loss of vehicle control, leading to a severe injury or death. This risk may increase when the weather is hot, or when the vehicle drives for a long period of time at a high speed.

⚠ CAUTION

- Under-inflation also may result in excessive tire wear-out, poor handling and inferior fuel economy. Also, wheel deformation may be resulted. Maintain your tire pressure at the recommended level. When your tire frequently needs to be inflated, have it checked by an authorized EQUUS dealer.
- Over-inflation may cause harsh driving, excessive tire wear-out, especially for the central tread of a tire, and more possibilities of damage from road hazards.

NOTICE

- The pressure of a warm tire is normally higher than the one of a cold tire by 4 to 6 psi (28 to 41 kPa). Do not release air from a warm tire to adjust the pressure. Otherwise, the tire will be under-inflated.

(Continued)

(Continued)

- Make sure to close the tire inflation valve cap. When the valve is opened, dirt or moisture may get into the valve core and cause air leakage. When a valve cap is lost, immediately buy a new one, and close the valve.

⚠ WARNING**- Tire Inflation**

Over-inflation or under-inflation may reduce tire life, adversely affect vehicle handling, and lead to a sudden tire failure. This may result in a loss of vehicle control and a potential injury.

NOTICE**- Tire pressure**

Always observe the following:

- Measure the tire pressure when it is cold. (When the vehicle does not drive for the last 3 hours, or when it drives shorter than 1 mile (1.6 km), after starting up.)
- Check the pressure of a spare tire whenever checking the pressures of other tires.
- Never overload your vehicle. Be careful not to overload on the luggage rack, when your vehicle is equipped with one.
- Worn-out, old tires may cause an accident. When your tread is badly worn out, or when tires are damaged, replace them.

Checking tire inflation pressure

Check your tires at least once a month.

Also, check the spare tire pressure.

How to check

Use a good-quality gauge to check the tire pressure. You cannot properly measure the tire inflation only with your eyes. A radial tire may look properly inflated, even when it is underinflated.

Check the tire inflation pressure, when it is cold. - A "cold" means your vehicle does not drive for the last 3 hours, or drives shorter than 1 mile (1.6 km).

Open the tire valve cap. Press the tire gauge firmly onto the valve to measure the pressure. When the cold tire is inflated as recommended, as specified on the tire and loading information labels, further adjustment is not needed. When a tire is underinflated, inflate it to the recommended pressure.

When overinflating the tire, release air by pressing the metal stem on the tire valve. Re-measure the tire pressure with the gauge. Make sure to close the valve caps over the valve stems. This prevents air leakage and keeps out dirt and moisture.

WARNING

- **Frequently check your tires, especially inflation pressure, abrasion and damage. Always use a tire pressure gauge.**
- **Overinflated or underinflated tires may unevenly wear out, causing poor handling, a loss of vehicle control, and a sudden tire failure. This may lead to an accident, injury, and even death. The cold tire pressure recommendation of your vehicle is specified in this manual and on the tire label, which is located on the center pillar on the driver's side.**
- **Tire abrasion may cause an accident. Replace the worn-out or damaged tires.**
- **Remember to check the spare tire pressure. It is recommended to check the spare whenever checking the pressures of other tires.**

Tire rotation

To balance worn-out levels of the tire tread, rotating the tire positions is required every 7,500 miles (12,000 km), or sooner, when the irregular abrasion is detected. While rotating the positions, correctly balance the tire positions.

When rotating tires, check for any uneven abrasion and damage. Abnormal tire abrasion is usually caused by improper tire pressure, tilted wheel alignment, unbalanced wheels, severe braking or hard cornering. Check for any bump or bulging from the tire side walls. When finding one of those, replace your tire. Replace the tire, when a tire cord fabric is visible. After rotation, make sure to properly inflate the tires to the recommended pressure, as specified, and check the lug-nut tightness.

Disc brake pads should be inspected for any abrasion, whenever rotating tires.

Without a spare tire

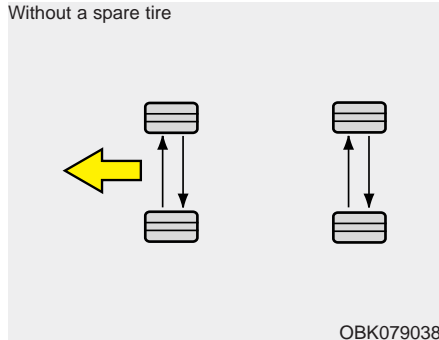

i Information

The front tire size is different from the rear tire size. So when you rotate tires, check sizes of the tires and wheels.

⚠ WARNING

- Do not use the compact spare tire for tire rotation.
- Never mix bias-ply tires and radial-ply tires under any circumstances. This may cause abnormal handling, possibly resulting in a death, severe injury, or property damage.

Wheel alignment and tire balance

The wheels are finely aligned and balanced at the manufacturing factory in order to ensure the longest tire life and the best driving performance. In most cases, you do not need to realign the wheels. However, when detecting unusual tire abrasion or vehicle leaning to one side, the realignment may be needed. When your vehicle vibrates on an even surface, while driving, your wheels may need to be rebalanced.

NOTICE

Improperly overweighted wheel may damage your vehicle's aluminum wheels. Carry only the appropriate wheel weights.

Tire replacement



When a tire unevenly wears out, a tread wear indicator, in a pattern of a solid band, appears over the tread. This indicates that there is less than 1/16 inch (1.6 mm) of tread left. When finding it, replace the tire.

Do not delay the tire replacement, until all the indicators appear over the entire tire tread.

⚠ WARNING

- Replacing tires

To reduce the risk of a serious or fatal injury, caused by a tire failure or a loss of vehicle control, follow the below warnings:

- Replace tires, which are severely worn out, unevenly wear out, or damaged. Worn-out tires may degrade the braking effects, steering control, and traction.
- Do not drive your vehicle with overinflated or underinflated tires. This may cause uneven abrasion or a tire failure.

(Continued)

(Continued)

- When replacing tires of your vehicle, never mix radial-ply tires and bias-ply tires. You must replace all the tires (including the spare) when changing from radial-ply tires to bias-ply tires.
- Tires and wheels in the different sizes may cause abnormal handling and poor vehicle control, resulting in a serious accident.
- Wheels, which do not satisfy the HYUNDAI's specifications, may be unfit and result in a vehicle damage, abnormal handling and poor vehicle control.
- The ABS operates upon comparing the wheel speeds. A tire size determines a wheel speed. When replacing tires, all the tires must be in the same size as the original ones. Installing tires in a different size may cause irregular operation of the ABS (Anti-lock Brake System) and ESC (Electronic Stability Control).

Compact spare tire replacement

A compact spare tire has a shorter tread life than a regular one. Replace it, when a tread wear indicator is found. A compact spare tire should be replaced with the one in the same size as the original one, and should be installed over a tire wheel of the same compact size. A compact spare tire is not designed to be installed over a wheel of the regular size, and a compact spare wheel is not designed for a tire of the regular size.

⚠ WARNING

The compact spare tire is for emergency use only. Do not operate your vehicle on this compact spare at a speed over 50 mph (80 km/h). The original tire should be immediately repaired or replaced to avoid a spare-tire failure and a possible personal injury or death.

Wheel replacement

When replacing the metal wheels for any reason, make sure the new wheels are equivalent to the original wheel in terms of diameter, rim width and offset.

***i* Information**

The front tire size is different from the rear one. While rotating tire positions, check the size of the tires and wheels.

***i* Information**

A wheel in the different size may adversely affect the wheel bearing, braking, stopping, handling, ground clearance, body-to-tire clearance, snow-chain clearance, speedometer, odometer, headlamp angle and bumper height.

Tire traction

Tire traction may decrease when driving with worn-out or improperly-inflated tires on a slippery surface. Tires should be replaced, when a tread wear indicator appears. Slow down the driving speed to lower the risk of losing the vehicle control, when it rains or snows, or when your vehicle drives on a icy surface.

Tire maintenance

In addition to the proper inflation pressure, correct wheel alignment prevents tire abrasion. When you find uneven tire abrasion, have the wheel alignment checked by your EQUUS dealer.

When replacing your tires, make sure they are well balanced. This increases your driving comfort and tire life. Additionally, a tire should be rebalanced after being removed from a wheel.

Tire sidewall labeling

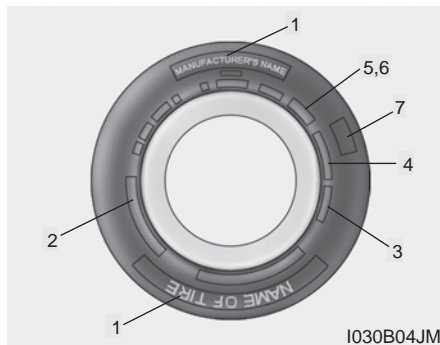

This information identifies and states the fundamental tire specifications and also provides the tire identification number (TIN) for the safety standard certification. The TIN is to identify your tire in case of a recall.

1. Manufacturer or brand name

The manufacturer's or brand name is shown.

2. Tire size designation

A tire side wall is marked with tire size specifications. This information is needed to select the right tire for replacement. The letters and numbers in the tire size designation are interpreted as below.

Example of the tire size designation:
(The following tire size designation is provided as an example only; your tire size designator may vary, depending on your vehicle model.)

P245/45R19 98V

P - Applicable vehicle type (Tires, marked with the prefix "P," are to be used for passenger cars or light trucks. However, this letter is not shown on all tires).

245 - Tire width in millimeters.

45 - Aspect ratio. The ratio of the tire width to the tire height.

R - Tire construction code (Radial).

19 - Rim diameter in inches.

98 - Load Index, a numerical code associated with the maximum load capacity.

V - Speed Rating Symbol. See the speed rating chart in this chapter for further information.

Wheel size designation

Wheels are also marked with important specifications. The following example of the wheel size designation explains how the letters and numbers are interpreted.

Example wheel size designation:

8.0JX19

8.0 - Rim width in inches.

J - Rim contour designation.

19 - Rim diameter in inches.

Tire speed ratings

The below chart lists up different speed ratings for a tire of a passenger vehicle. The speed rating is one part of the tire size designation, specified on the tire side wall. Each symbol represents the maximum driving speed of a tire.

Speed Rating Symbol	Maximum Speed
S	112 mph (180 km/h)
T	118 mph (190 km/h)
H	130 mph (210 km/h)
V	149 mph (240 km/h)
Z	Above 149 mph (240 km/h)

3. Checking tire life (TIN : Tire Identification Number)

Any tires, which are 6 years or older from the manufacturing date (including the spare tire), should be replaced with a new one. The manufacturing date is written on a tire side wall (possibly inside of a wheel) in the DOT Code. The DOT Code is a series of numbers on a tire, which consist of numbers and English letters. The manufacturing date is written in the last four digits (characters) of the DOT code.

DOT : XXXX XXXX OOOO

The front part of the DOT are the plant code, tire size and tread pattern. The last four digits indicate the manufacturing week and the manufacturing year.

For example:

DOT XXXX XXXX 1615 represents that the tire was produced in the 16th week of 2015.

⚠ WARNING**- Tire age**

Tires degrade over time, even when they are not driven. Regardless of the remaining tread, it is recommended to replace tires every 6 years. Heat under the hot weather or frequent overloading may accelerate the aging process. Failure to follow this warning may result in a sudden tire failure, leading to a loss of control, accident, serious injury or death.

4. Tire ply composition and material

There are a number of layers or plies of rubber-coated fabrics in the tire. Tire manufacturers indicate the materials on the tire, such as steel, nylon and polyester. The letter "R" means radial ply construction; the letter "D" means diagonal or bias ply construction; and the letter "B" means belted-bias ply construction.

5. Maximum permissible inflation pressure

This number indicates the air pressure limit of the tire. Do not inflate the tire over the maximum pressure. Refer to "Tire and Loading Information Label" for the recommended inflation pressure.

6. Maximum load rating

This number indicates the maximum loading capacity in kilograms or in pounds that a tire can carry. When replacing the tires, always use the tire of the same load rating as the original one.

7. Uniform tire quality grading

Quality grades can be found where applicable on the tire sidewall between tread shoulder and maximum section width.

For example: TREAD wear 200

TRACTION AA

TEMPERATURE A

Tread wear

The tread wear grade is a comparative rating based on a tire wear-out rating, which is recorded while being tested under a controlled condition on a test course specified by a government. For example, a tire, of which the tread wear grade is 150, would wear out one-and-a half times ($1\frac{1}{2}$) faster than a tire graded 100.

The actual tread wear rating depends on the actual driving conditions. In addition, the actual tread wear rating may significantly vary from the tread wear grade due to a lot of variations, such as driving habits, maintenance conditions, road characteristics and climates.

These grades are written on the tire side wall of a passenger vehicle. The available tires with the standard or optional equipment may vary with respect to this grade.

Traction - AA, A, B & C

The traction grades, from the highest to the lowest, are AA, A, B and C. Those grades represent the stopping performance level of a tire measured on a wet test surface specified by the government under a controlled condition. A tire marked with the letter, C, may have poor traction.

⚠ WARNING

The traction grade of a tire is based on a braking traction test, while driving straight ahead. The test does not include accelerating, cornering, hydroplaning, or towing situations.

Temperature -A, B & C

The temperature grades of a tire are A, B and C, from the highest to the lowest, representing the heat-resisting and the heat-dissipating capability. A tire is tested under a controlled condition on a specified indoor laboratory test wheel.

Continuous driving at a high temperature may degenerate the tire materials and reduce the tire life. Also, a quick temperature increase may cause a sudden tire failure. A tire with the grade C just meets the performance level required by the Federal Vehicle Safety Standard No. 109, which all tires for a passenger vehicle must meet. Grades A and B represent a higher performance level of a tire on the indoor laboratory test wheel, above the minimum law requirement.

WARNING

- Tire temperature

The temperature grade for this tire is established for a tire that is properly inflated and not overloaded. Excessive speed, underinflation, or excessive loading, either separately or in combination, can cause heat build-up and possible sudden tire failure. This can cause loss of vehicle control and serious injury or death.

Low aspect ratio tire (if equipped)

A low aspect ratio tire, of which the aspect ratio is lower than 50, is designed for a sporty-look vehicle. The low aspect ratio is to optimize handling and braking. Thus, it may be uncomfortable to ride and it may generate noises, in comparison with a normal tire.

CAUTION

The side wall of a low aspect ratio tire is shorter than the normal one. Thus, the low-aspect wheel and tire are easily damaged. Follow the below instructions.

- When driving on a rough road or driving off a road, be careful not to damage the tires and wheels. After driving, inspect the tires and wheels.
- When passing over a pothole, speed bump, manhole, or curb stone, slowly drive the vehicle not to damage the tires and wheels.
- When there is an impact on a tire, inspect the tire condition. Or, contact an authorized EQUUS dealer.
- Inspect the tire condition and pressure every 1,800 miles (3,000 km) to prevent a tire damage.

⚠ CAUTION

- **It is difficult to recognize a tire damage only with your eyes. When there is a slight hint of a tire damage, check and replace the tire to prevent the damage caused by air leakage.**
- **When a tire is damaged while driving on a rough road, off a road, or over obstacles, such as a pothole, manhole, or curb stone, your warranty does not cover the damage.**
- **The tire information is specified on the tire side wall.**

Tire terminology and definitions

Air Pressure: The amount of air inside a tire, pressing the inside the tire outwards. Air pressure is measured in pounds per square inch (psi) or kilopascal (kPa).

Accessory Weight: This is the combined weights of optional accessories. Some examples of optional accessories are the automatic transmission, power seats, and air conditioning.

Aspect Ratio: The ratio of a tire width to a height.

Belt: A rubber coated layer of cords that is located between the plies and the tread. Cords may be made from steel or other reinforcing materials.

Bead: The tire bead contains the steel wires wrapped with steel cords. This holds a tire onto a rim.

Bias Ply Tire: This is a pneumatic tire, in which plies are laid at alternate angles less than 90 degrees on the tread centerline.

Cold Tire Pressure: This is the amount of air pressure inside a tire, measured in pounds per square inch (psi) or kilopascals (kPa), before the heat build-up due to driving.

Curb Weight: This is the vehicle weight with standard and optional equipment including the full fuel tank, oil tanks and coolant tanks. However, this excludes the weight of passengers and loads.

DOT Markings: This code is marked on a tire side wall, as an indication of its compliance with the U.S. Department of Transportation motor vehicle safety standards. The DOT code includes the Tire Identification Number (TIN), alphanumeric designator for the manufacturer identification, manufacturing plant, brand and manufacturing date.

GVWR: Gross Vehicle Weight Rating

GAWR FRT: Gross Axle Weight Rating for the Front Axle.

GAWR RR: Gross Axle Weight Rating for the Rear axle.

Intended Outboard Sidewall: This asymmetrical tire side must face outwards, while being installed on a vehicle.

Kilopascal (kPa): The metric unit for air pressure.

Light Truck (LT) Tire: A tire designated by its manufacturer as primarily intended for use on lightweight trucks or multipurpose passenger vehicles.

Load Ratings: The maximum load that a tire is rated to carry for a given inflation pressure.

Load Index: The numerical index, on a scale of 1 to 279, to indicate a tire loading capacity.

Maximum Inflation Pressure: The maximum air pressure to which a cold tire may be inflated. The maximum air pressure information is specified on a tire side wall.

Maximum Load Rating: The loading capacity for a tire, which is inflated to the maximum.

Maximum Loaded Vehicle Weight: The sum of curb weight; accessory weight; vehicle capacity weight; and production options weight.

Normal Occupant Weight: The multiplication of the designated occupant seat number by 150 pounds (68 kg).

Occupant Distribution: Designated seating positions.

Outward Facing Sidewall: The side of a asymmetrical tire that has a particular side that faces outward when mounted on a vehicle. The outward facing sidewall bears white lettering or bears manufacturer, brand, and/or model name molding that is higher or deeper than the same moldings on the inner facing sidewall.

Passenger (P-Metric) Tire: This tire is for a passenger vehicle, a light truck or a multipurpose vehicle.

Ply: A layer of rubber-coated parallel cords

Pneumatic Tire: A mechanical device made of rubber, chemicals, fabric and steel or other materials, that, when mounted on an automotive wheel, provides the traction and contains the gas or fluid that sustains the load.

Production Options Weight: The combined weight of installed regular production options weighing over 5 lb.(2.3 kg) in excess of the standard items which they replace, not previously considered in curb weight or accessory weight, including heavy duty brakes, ride levelers, roof rack, heavy duty battery, and special trim.

Recommended Inflation Pressure: Vehicle manufacturer's recommended pressure to inflate a tire. This is specified on a tire placard.

Radial Ply Tire: A pneumatic tire in which the ply cords that extend to the beads are laid at 90 degrees to the centerline of the tread.

Rim: A metal support for a tire and upon which the tire beads are seated.

Sidewall: The portion of a tire between the tread and the bead.

Speed Rating: An alphanumeric code to indicate the maximum speed to which a tire can operate.

Traction: The friction between a tire and a road surface. The amount of grip provided.

Tread: The contacting portion of a tire with the road.

Treadwear Indicators: This is a narrow band, sometimes called "wear bars." This appears across the tread, when only 2/32 inch of tread remains.

UTQGS: The Uniform Tire Quality Grading Standards is the information of traction, temperature and tread abrasion. A rating is measured by a tire manufacturer in accordance with the government-specified testing procedure. The rating information is specified on the tire side wall.

Vehicle Capacity Weight: The multiplication of the designated occupant seat number by 150 pounds (68 kg) plus the loading weight.

Vehicle Maximum Load on the Tire: Loading capacity for an individual tire. The curb and accessory weights plus the maximum occupant and loading weights.

Vehicle Normal Load on the Tire: Loading capacity for an individual axle. The sum of the curb, accessory, and normal occupant weights is divided by 2.

Vehicle Placard: A label, permanently attached to a vehicle, to indicate the original equipment tire size and the recommended inflation pressure.

All season tires

HYUNDAI designated some models of all-season tires to provide good performance for use all year round, including snowy and icy road conditions. All-season tires are identified by ALL SEASON and/or M+S (Mud and Snow) on the tire side wall. Snow tires have better snow traction than all season tires and may be more appropriate in some areas.

Summer tires

HYUNDAI designated some models of summer tires to provide superior performance on dry roads. Summer tire performance is substantially reduced in snow and ice. Summer tires do not have a tire traction rating mark, M+S (Mud and Snow), on the tire side wall. Before driving in snowy or icy conditions, it is recommended to install snow tires or all-season tires on all four wheels.

Snow tires

When equipping your vehicle with snow tires, the tires should be in the same size and have the same load capacity as the original ones. Snow tires should be installed on all four wheels. Otherwise, it may cause poor handling. Snow tires should be more inflated by 4 psi (28 kPa) than the lesser of the two recommended pressures - one specified on the tire label attached to the central pillar on the driver's side, and the other specified on the tire side wall.

Do not drive faster than 75 mph (120 km/h) when your car is equipped with snow tires.

WARNING

- **Snow or ice**
 - **When driving on a snowy or icy road, drive slower than 20 mph (30 km/h).**
 - **Use the SAE "S" class or wire chains.**
 - **When you hear chain-rattling noise, retighten the chain to avoid its contact with the vehicle body.**
 - **To prevent damage to the vehicle body, retighten the chains after driving 0.3~0.6 miles (0.5~1.0 km).**
 - **Do not use tire chains on a vehicle equipped with aluminum wheels. In unavoidable circumstance, use the wire-type chains.**
 - **Use the wire chains, of which the diameter is less than 0.47 inches (12 mm), to prevent damage to the chain connecting parts.**

Tire chains

Tire chains, if necessary, should be installed on the drive wheels (rear wheels).

Make sure that the chains are installed in accordance with the manufacturer's instructions.

To minimize the abrasion of tires and chains, do not use the chains, when unnecessary.

Radial-ply tires

Radial-ply tires provide longer tread life, better road hazard resistance and smoother riding at a high speed. The radial-ply tires used on this vehicle are of belted construction, and are to improve your driving and handling. Radial-ply tires have the same loading capacity as the bias-ply or bias-belted tires of the same size. Inflate the radial-ply tires to the same recommended inflation pressure. It is not recommended to attempt a cross-combination of radial-ply tires and bias-ply(or bias-belted) tires on the same vehicle. Any cross-combination of radial-ply and bias-ply(or bias-belted) tires on one vehicle will seriously deteriorate vehicle handling. The best rule to follow is: Identical radial-ply tires should always be used for a set of four tires.

A tire, which is driven for a long period of time, is more susceptible to irregular tread abrasion. It is very important to rotate tires, at the interval instructed in this chapter, to use it up to its potential tread life. Any cut and puncture on a radial-ply tire is repairable, only when it is on the tread, because of the side wall flexing. Consult your tire dealer for a radial-ply tire repair.

FUSES

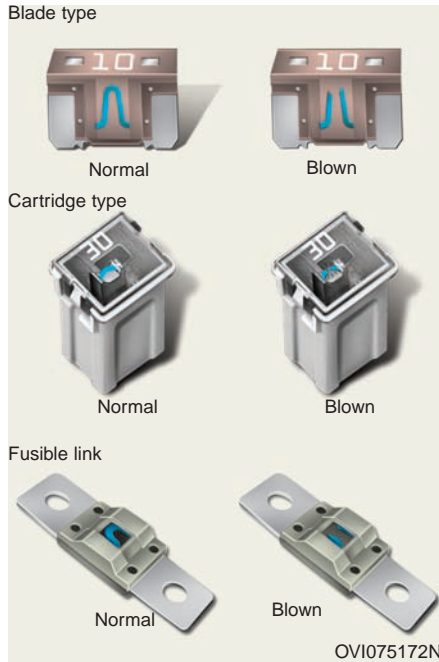

A vehicle's electrical system is protected from a possible electrical overloading damage by fuses.

This vehicle has 4 fuse panels - two on the driver's side, another on the panel bolster of the passenger's side, and the other in the engine compartment.

When any of your lights, accessories, or controls does not operate, check the appropriate circuit fuse. When a fuse is out, some elements may melt inside.

When the electrical system does not operate, check the fuse panel on the driver's side first.

Before replacing the fuse, disconnect the negative battery cable. Always replace it with a fuse of the same rating.

When the newly-replaced fuse blows, there may be an electrical problem. Avoid using any pertinent systems. Immediately consult an authorized EQUUS dealer.

Three kinds of fuses are to be used: a blade type for lower amperage rating, and a cartridge type and a fusible link for higher amperage ratings.

⚠ WARNING

- Fuse replacement

- Never replace a fuse with the one of a different rating.
- A higher capacity fuse may cause damage or a fire.
- Never use a wire or an aluminum foil, instead of a proper fuse - even as an emergent measure. It may damage extensive wirings and cause a fire.

⚠ CAUTION

Do not use a screwdriver or any other metal object to remove a fuse. It may cause a short circuit and damage the system.

i Information

The actual fuse, relay panels, and labels may differ from the equipped items.

NOTICE

- When replacing a blown fuse or relay with a new one, make sure the new fuse or relay fits tightly into the clips. The incomplete fastening of a fuse or relay may cause damage to the vehicle wiring and electric systems and a possible fire.
- Do not remove fuses, relays and terminals fastened with bolts or nuts. The fuses, relays and terminals may be fastened incompletely, and it may cause a possible fire. If fuses, relays and terminals fastened with bolts or nuts are blown, consult an authorized EQUUS dealer.
- Do not input any other objects except fuses or relays into fuse/relay terminals such as a driver or wiring. It may cause contact failure and system malfunction.

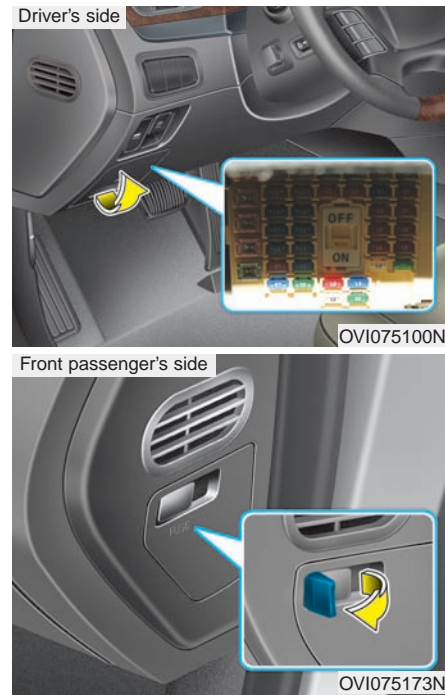
Inner panel fuse replacement

1. Turn OFF the ignition switch and all the other switches.
2. Open the fuse panel cover.

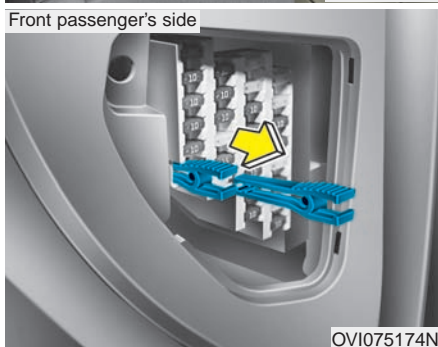
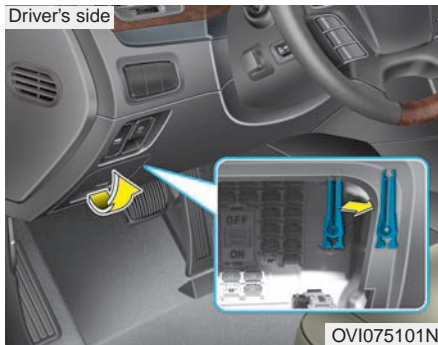

3. Pull straight out a fuse, which is suspected to be out. Use the fuse puller provided in the panels either on the driver's side or the front passenger's side.
4. Check the removed fuse. When the fuse is out, replace it.
Spare fuses are provided in the fuse panels in the front passenger's side. (or in the fuse panel of the engine compartment)
5. Install a new fuse of the same rating, and tightly secure it in the clips.

When it is loosely fit, consult an authorized EQUUS dealer.

When you do not have a spare fuse, use a fuse of the same rating from a circuit, such as a cigarette lighter fuse, which may not be needed to drive.

When the headlamps or other electrical components do not operate, but when the fuses are not blown out, check the fuse panel in the engine compartment. In case that a fuse is blown out, it must be replaced. If a fuse is blown, it must be replaced.

Fuse switch

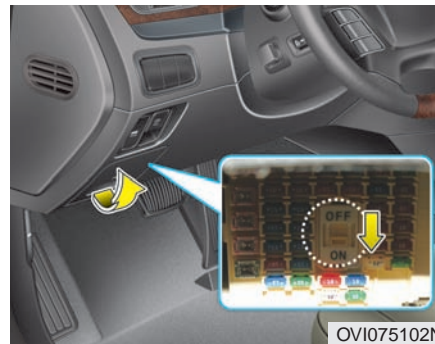

Always set the transportation fuse switch in the "ON" position. When you press it OFF, some devices, such as the audio and the digital clock, must be reset. Also, the Smart Key may not properly operate.

NOTICE

- Always set the transportation fuse switch in the "ON" position while driving.
- Do not repeatedly press the transportation fuse switch. The fuse switch may be worn out.

i Information

When you do not drive your vehicle more than 1 month, press OFF the transportation fuse switch to prevent a battery discharge.

Engine compartment fuse replacement



OVI075175N



OVI075176N

1. Turn OFF the ignition switch and all the other switches.
2. Open the fuse panel cover by pressing the tab.
3. Check the removed fuse. When the fuse is out, replace it. To remove or insert the fuse, use the fuse puller in the panel on the front passenger's side.
4. Install a new fuse of the same rating, and tightly secure it in the clips. When it is loosely fit, consult an authorized EQUUS dealer.

NOTICE

After checking the fuse panel in the engine compartment, securely close the fuse panel cover. If not, electrical failures may occur due to a possible water contact.

Main fuse

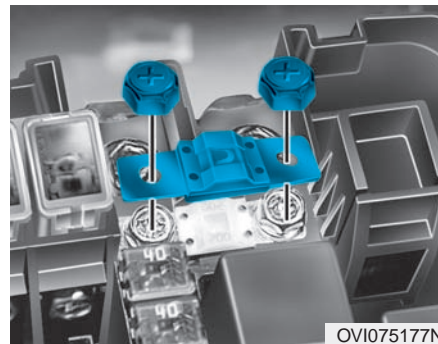

OVI075177N

When the main fuse is out, it must be removed in the following procedure:

1. Open the fuse panel cover on the right side of the engine compartment.
2. Loosen the nuts, as shown in the above illustration.
3. Use a new fuse of the same rating.
4. Install the new fuse in the reverse order.

i Information

When the main fuse is blown out, consult an authorized EQUUS dealer.

Fuse/relay panel description

Under the fuse/relay panel covers, the fuse/relay labels are attached for information, such as fuse/relay name and capacity.

Instrument panel fuse panel



Engine compartment fuse panel



i Information

Some fuse-panel information in this manual may be inapplicable to your vehicle. Information in this manual reflects only the current information at the point of printing. Refer to the fuse label, when inspecting the fuse panel.

Driver's side instrument fuse panel

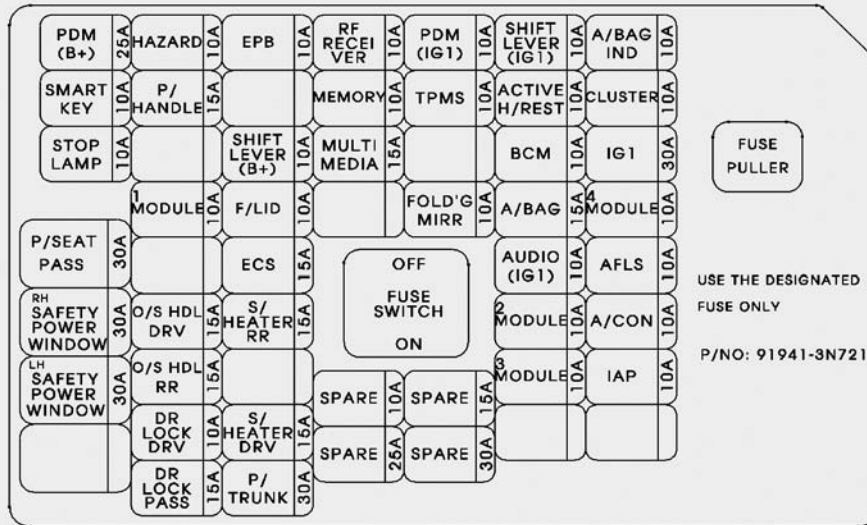

OVI073108N

Instrument panel (Driver's side fuse panel)

Fuse Name	Fuse rating	Circuit Protected
PDM (B+)	25A	Smart Key Control Module
HAZARD	10A	Center Facia Switch
EPB	10A	Electric Parking Brake Switch, Crash Pad Switch
RF RECEIVER	10A	RF Receiver, Security Indicator
PDM (IG1)	10A	Smart Key Control Module
SHIFT LEVER (IG1)	10A	ATM Shift Lever IND.
A/BAG IND.	10A	Instrument Cluster
SMART KEY	10A	Start/Stop Button Switch
P/HANDLE	10A	Steering Tilt & Telescopic Module
MEMORY	10A	Power Trunk Lid Control Module, Relax Module Driver/Passenger Door Module, Rear Door Module LH/RH, Passenger Door Lamp, Passenger Door Mood Lamp, Rear Door Lamp LH/RH, Rear Door Mood Lamp LH/RH Instrument Cluster, Driver IMS Control Module, BCM, Analogue Clock, LCD Panel Switch, A/C Control Module, Data Link Connector
TPMS	10A	Tire Pressure Monitoring Module
ACTIVE H/REST	10A	Active Head Rest Sensor Module
CLUSTER	10A	Instrument Cluster, Head-Up Display
STOP LAMP	10A	Stop Lamp Switch, Smart Key Control Module
SHIFT LEVER (B+)	10A	Sport Mode Switch
MULTI MEDIA	15A	A/V & Navigation Head Unit, Front Monitor, Split Unit, MTS Module, Front DIS Switch, Rear Monitor LH/RH, Rear Console Switch, Rear Audio Switch
BCM	10A	BCM
IG1	30A	E/R Junction Box (Fuse - B/UP LAMP, ESC, EHPS, AFLS, INJECTOR (IG1), CRUISE (IG1), ECU (IG1), TCU)
1 MODULE	10A	Head-Up Display, Rain Sensor, Rear Power Seat Switch LH
F/LID	10A	Fuel Filler Door Switch, Front Console Switch
FOLD'G MIRR	10A	Driver/Passenger Door Module
A/BAG	15A	SRS Control Module, Driver/Passenger Pre-Safe Seat Belt, Center Facia Switch, PODS Module
4 MODULE	10A	E/R Junction Box (FAM), Multifunction Switch Driver/Passenger Door Module
ECS	15A	ECS Control Module
AUDIO (IG1)	10A	A/V & Navigation Head Unit, MTS Module
AFLS	10A	Head Lamp LH/RH, Adaptive Front Lighting Module
O/S HDL DRV	15A	Driver Power Door Latch, Driver Power Seat Switch, Driver Door Lamp, Driver Door Mood Lamp, Driver Smart Key Outside Handle

Fuse Name	Fuse rating	Circuit Protected
S/HEATER RR	15A	Rear CCS Control Module LH, Rear Seat Warmer Module LH
2 MODULE	10A	Power Trunk Lid Control Module, Electro Chromic Mirror, A/T Console Switch
A/CON	10A	A/C Control Module, AQS Sensor, Driver IMS Control Module Relax Module, Driver/Passenger CCS Control Module Driver/Passenger Seat Warmer Module, Rear CCS Control, Module LH/RH, Rear Seat Warmer Module LH/RH, Alternator Resistor (Alternator, Instrument Cluster, USB Jack, Rear Console Switch)
O/S HDL RR	15A	Rear Power Door Latch LH, Rear Door Window Curtain LH, Rear Smart Key Outside Handle LH
3 MODULE	10A	ECS Control Module, Front Console Switch, Crash Pad Switch, Blind Spot Detection Radar LH/RH Tire Pressure Monitoring Module, Stop Lamp Switch, Steering Tilt & Telescopic Module, LDWS Camera Module Electric Parking Brake Module, Front/Rear Parking Assist Sensor LH/RH Front/Rear Parking Assist Sensor LH/RH (Center)
DR LOCK DRV	10A	Driver Door Module
S/HEATER DRV	15A	Driver CCS Control Module, Driver Seat Warmer Module
DR LOCK PASS	15A	Passenger Door Module
P/TRUNK	30A	Power Trunk Lid Control Module
P/SEAT PASS	30A	Relax Module
RH SAFETY POWER WINDOW	30A	Passenger Power Window Module, Rear Power Window Module RH
LH SAFETY POWER WINDOW	30A	Driver Power Window Module, Rear Power Window Module LH

Passenger's side instrument fuse panel

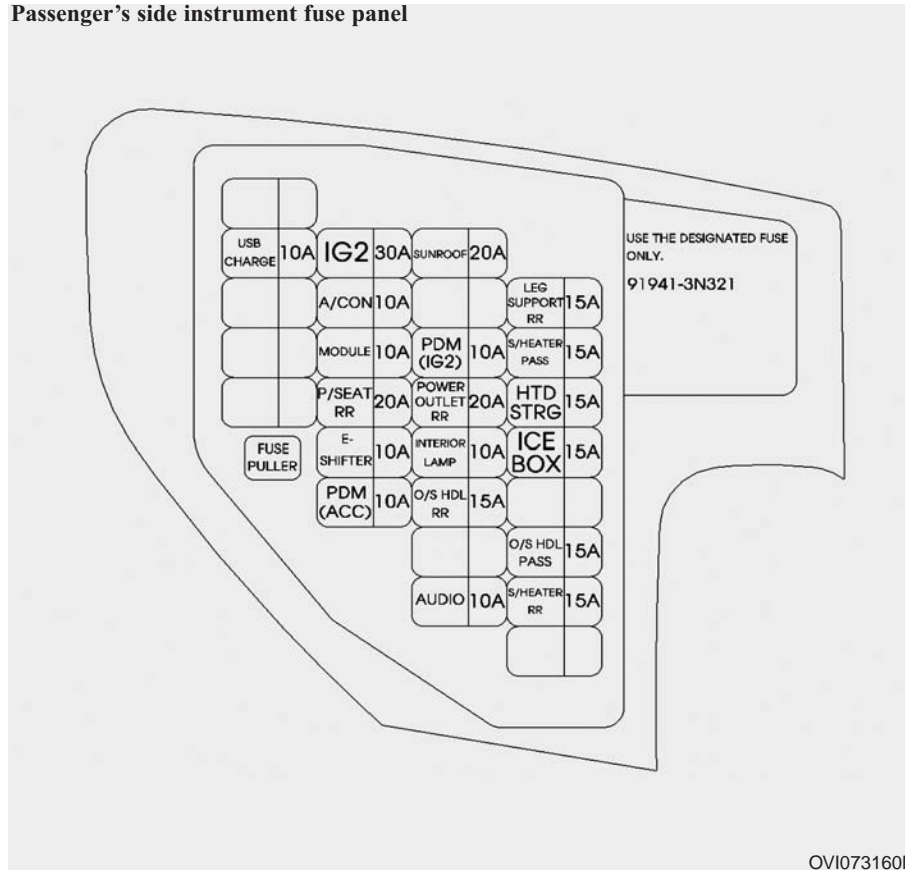

Instrument panel (Passenger's side fuse panel)

Description	Fuse rating	Protected component
USB CHARGE	10A	USB Jack
IG2	30A	E/R Junction Box Fuse (ECW 10A, WASHER 15A)
A/CON	10A	E/R Junction Box (Blower Relay), A/C Control Module, Cluster Ion Gen, LCD Panel Switch
MODULE	10A	Around View Module, Camera Module, Instrument panel LH(Instrument Cluster, Sunroof Module, Head-Up Display)
P/SEAT RR	20A	Rear LH Power Seat Relay Box
E-SHIFTER	10A	USB Jack
PDM(ACC)	10A	BCM, Smart Key Control Module
SUNROOF	20A	Sunroof Module,Sunroof Switch
PDM (IG2)	10A	BCM, Smart Key Control Module
POWER OUTLET RR	20A	Rear Power Outlet (5:5 Seat),Rear Console Lamp (5:5 Seat), Rear Power Outlet #1/#2(6:4 Seat)
INTERIOR LAMP	10A	E/R Junction Box (Power Outlet Relay FR), Front Room Lamp
O/S HDL RR	15A	Rear Power Door Latch RH, Rear Door Curtain RH, Rear Smart Key Outside Handle RH
AUDIO	10A	Analogue Clock, Split Unit, Front Monitor, Around View Module, Camera Module, MTS Module, Front DIS Switch, AMP, Rear Monitor LH/RH, Rear Audio Switch, Rear Console Switch
LEG SUPPORT RR	15A	Rear RH Power Seat Relay Box
S/HEATER PASS	15A	Passenger CCS Control Module, Passenger Seat Warmer Module (W/O CCS)
HTD STRG	15A	Steering Wheel Heated
ICE BOX	15A	Cool box
O/S HDL PASS	15A	Passenger Power Door Latch,Passenger Power Seat Switch, Passenger Smart Key Outside Handle RH
S/HEATER RR	15A	Rear CCS Control Module RH, Rear Seat Warmer Module RH (W/O CCS)

Engine compartment main fuse panel

Fuse Name	Fuse rating	Circuit Protected
WIPER (B+)	30A	Electronic Control Wiper Module
FAM 2 (B+)	40A	FAM
FAM 1 (B+)	40A	FAM
START	30A	Start Relay
WASHER	15A	Washer Relay
WIPER (IG2)	10A	Electronic Control Wiper Module
DEICER	15A	Deicer Relay
CRUISE (B+)	10A	H/Lamp Relay, Smart Cruise Control Module
HORN	15A	Horn Relay
EPB 2	15A	Electric Parking Brake Module
EPB 1	15A	Electric Parking Brake Module
A/CON	10A	A/C Control Module
BLOWER	40A	Blower Relay
PRESAFETY SEAT BELT LH	40A	Driver Pre-Safe Seat Belt
RR HTD	40A	RR HTD Relay
PRESAFETY SEAT BELT RH	40A	Passenger Pre-Safe Seat Belt
ECU (IG1)	10A	ECM, Alternator
ESC	10A	ESC Module, E/R Fuse & Relay Box (Multipurpose Check Connector)
EHPS	10A	EHPS Module
AFLS	10A	Head Lamp LH/RH
TCU	15A	TCM, Transmission Range Switch
HTD MIRR	10A	Driver/Passenger Power Outside Mirror
F/PUMP	20A	F/Pump Relay
ROOM LAMP	10A	Room Lamp Relay
ECU (B+)	15A	ECM, TCM
B/UP LAMP	10A	Steering Angle Sensor, B/UP LP RLY'S'
CRUISE (IG1)	10A	Smart Cruise Control Module
INJECTOR (IG1)	10A	Injector Drive Box
H/LAMP LH	15A	Head Lamp LH
H/LAMP RH	15A	Head Lamp RH
3 SENSOR	10A	ECM, F/Pump Relay, Camshaft Position Sensor (BANK1/BANK2) (Intake/Exhaust)
2 SENSOR	10A	Canister Close Valve, Oil Control Valve #1 ~ #4, E/R Fuse & Relay Box (C/Fan Relay), Purge Control Solenoid Valve
1 SENSOR	10A	ECM, Oxygen Sensor #1 ~ #4
INJECTOR (B+)	15A	Injector Drive Box
IGN COIL	20A	Condenser #1/#2, Ignition Coil #1 ~ #8
ECU	30A	ECU Relay

Engine compartment sub fuse panel

Fuse Name	Fuse rating	Circuit Protected
ALT	200A	Alternator, E/R Fuse & Relay Box (Fuse - I/P POWER RH, EHPS, C/FAN, PDM (ACC), ECS, TRUNK, AMP, POWER OUTLET FRT)
I/P POWER LH	80A	Smart Junction Box LH (Fuse - PDM (B+), HAZARD, EPB, RF RECEIVER, SMART KEY, P/HANDLE, TPMS, STOP LAMP, SHIFT LEVER (B+), P/SEAT PASS, RH SAFETY POWER WINDOW, MULTI MEDIA, LH SAFETY POWER WINDOW, 1 MODULE, F/LID, ECS, O/S HDL DRV, S/HEATER RR, O/S HDL RR, DR LOCK DRV, S/HEATER DRV, DR LOCK PASS, P/TRUNK, Leak Current Autocut Device)
I/P POWER RH	60A	I/P Junction Box RH (Fuse - USB CHARGE, P/SEAT RR, SUNROOF, O/S HDL RR, LEG SUPPORT RR, S/HEATER PASS, O/S HDL PASS, S/HEATER RR)
C/FAN	70A	C/FAN Relay
EHPS	80A	EHPS Module
ESC 1	40A	ESC Module, Multipurpose Check Connector
ESC 2	40A	ESC Module, Multipurpose Check Connector
PDM (IG1)	40A	PDM (IG1) Relay
PDM (IG2)	30A	PDM (IG2) Relay
P/SEAT (DRV)	30A	Driver IMS Control Module, Driver Lumbar Support Valve
ECS	40A	ECS Relay
AMP	30A	AMP
PDM (ACC)	30A	PDM (ACC) Relay
STOP LAMP	15A	Stop Signal Electronic Module
B/UP LAMP	10A	B/UP LAMP Relay
POWER OUTLET FRT	25A	POWER OUTLET FRT Relay
TRUNK	10A	TRUNK Relay

LIGHT BULBS

WARNING

- Working on the lights
Before working on the light, firmly set the parking brake, turn the ignition switch to the LOCK position, and turn OFF the lights. These are to prevent a sudden vehicle movement, burning your fingers or an electric shock.

Use only the bulbs of the specified wattage.

NOTICE

Make sure to replace the burned-out bulb with a new one of the same wattage rating. Otherwise, it may cause damage to a fuse or an electric wiring system.

NOTICE

When you are not equipped with necessary tools, the appropriate bulbs and the expertise, consult an authorized EQUUS dealer. In many cases, it is difficult to replace vehicle light bulbs, because some parts of the vehicle must be disassembled before getting to the bulb. This is especially true when disassembling to replace the headlamp bulb(s). Removing/installing the headlamp assembly may damage your vehicle.

Information

After heavy rain or vehicle washing, headlamp and taillight lenses may appear to be frosty. This is caused by the temperature difference between the lamp inside and outside. This is similar to the dew condensation on your windows inside while raining. This does not indicate a problem with your vehicle. When water penetrates into the lamp circuitry, have the vehicle checked by an authorized EQUUS dealer.

Headlight, position light, turn signal light, side marker light and front fog light bulb replacement



- (1) Position light
- (2) Headlamp (High)
- (3) Headlamp (Low)
- (4) Front side marker light
- (5) Front turn signal light
- (6) Front fog light

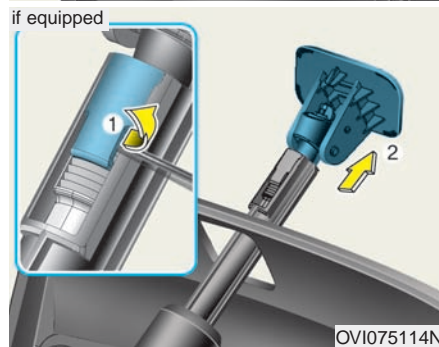
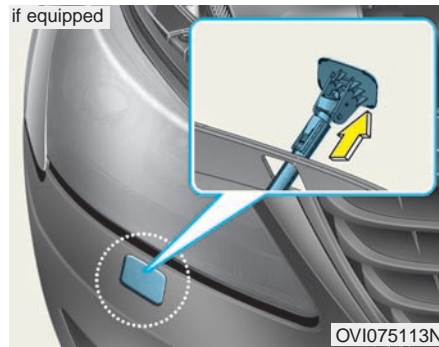

- 5. Pull out the cover (if equipped).
- 6. Insert a screw driver into the hole (1) and lift up the screw driver while pulling out the cover (2).

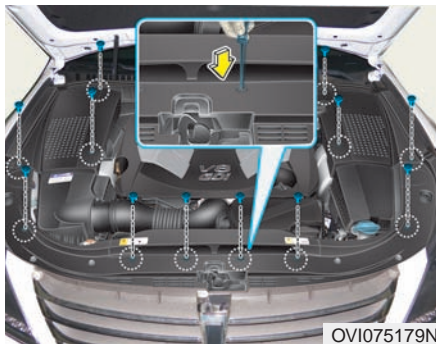

- 1. Open the hood.
- 2. Disconnect the negative battery cable.
- 3. Press the fastener to open the cover.
- 4. Open the cover.

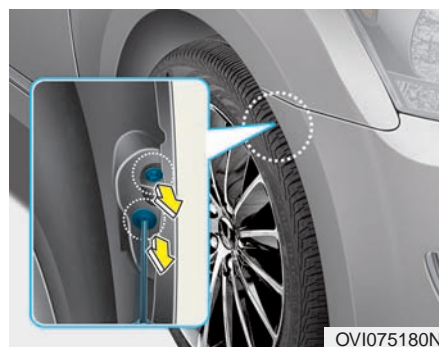

- 7. Remove the fastener and screw under the wheel arch.



8. Pull out the bumper.

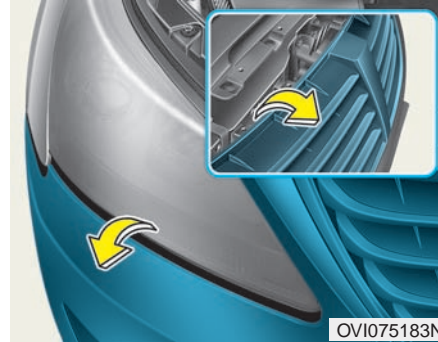

10. Remove the front bumper.

11. Be careful not to damage the clips inside of the front bumper.

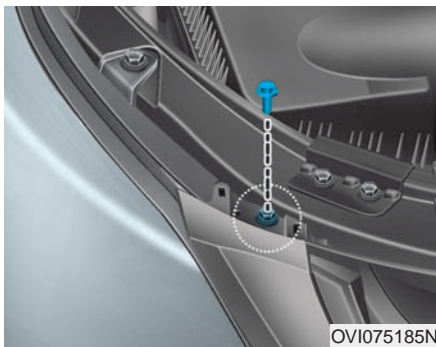
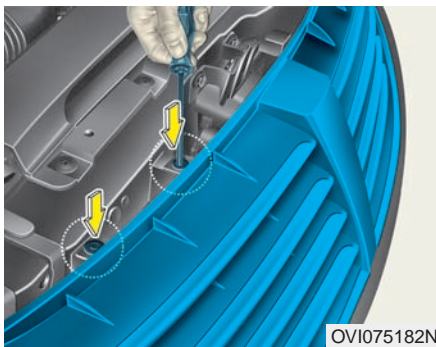

9. Remove 4 fasteners on the grille and the bolt.

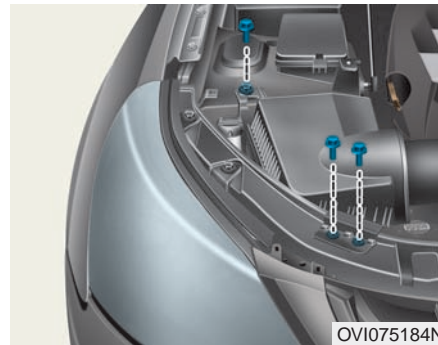

12. When replacing the headlamp on the right side, remove the bolts and the air cleaner.

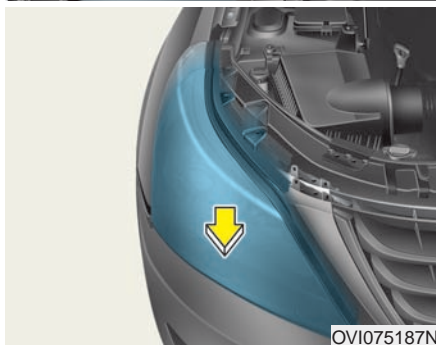
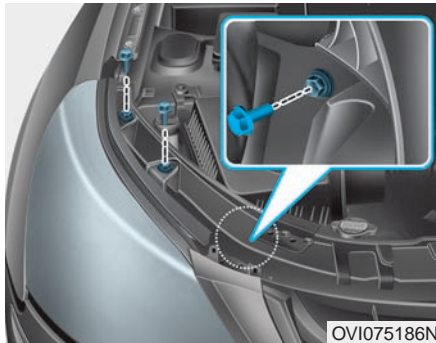

13. Remove the mounting bolts.
14. Pull the headlamp assembly out from the vehicle.

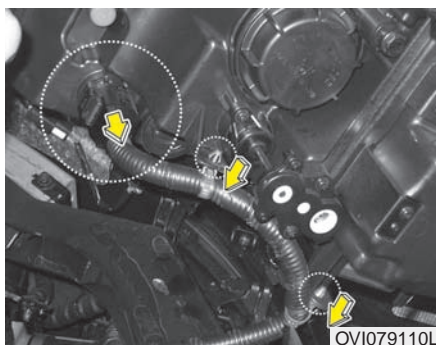

15. Remove the clips.
16. Disconnect the power connector(s) from the back of the headlamp assembly.

Headlight (HID type) bulb replacement (if equipped)

When the headlamp does not operate, have the vehicle checked by an authorized EQUUS dealer.

⚠ WARNING

- HID Headlamp low beam (if equipped)

Do not attempt to replace or inspect the low beam (XENON bulb) to avoid an electric shock danger. When the low beam (XENON bulb) does not operate, have your vehicle checked by an authorized EQUUS dealer.

NOTICE

Your High Intensity Discharge (HID) headlamp, equipped with your vehicle, contains mercury. When scrapping your vehicle, the HID Headlamp should be properly disposed of in advance. The removed HID headlamp should be recycled, re-used or disposed as hazardous waste.

i Information

HID lamps have superior performance in comparison to halogen bulbs. HID lamps are estimated to last twice as long as halogen bulbs, or longer, by the manufacturer, depending on the usage hours. HID lamps need to be replaced at some point within the vehicle life. Frequent turning the headlamps ON and OFF shortens the HID lamp life. HID lamps do not blow out in the same manner as halogen incandescent lamps. When a headlamp blows out after a period of operation, the lamp light gradually fades away after being turned ON. Even when the lamp is turned ON by turning ON the switch, it needs to be replaced. The HID lamp components are more complex than the ones of conventional halogen bulbs. Thus, the repairing costs are more expensive.

Headlight (bulb type), front turn signal, position, side marker and fog light bulbs

When a bulb is out, have the vehicle checked by an authorized EQUUS dealer.

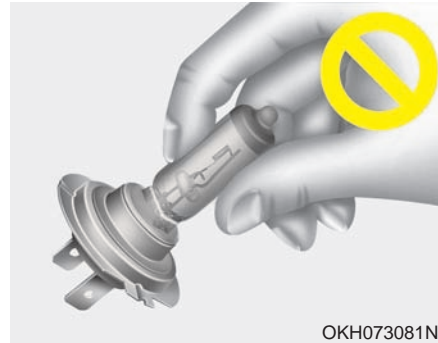
Headlamp bulb

OKH073081N.

⚠ WARNING

- Halogen bulbs
- Halogen bulbs contain pressurized gas. Thus, if broken, it produced fragments of glass.
- Always carefully handle the bulbs to avoid scratches and abrasions. If the bulbs are lit, avoid contact with liquids.
- Never touch the glass with bare hands. Any remaining oil may cause the bulb to overheat and explode upon being lit.
- When a bulb is damaged or cracked, immediately replace it. Then, carefully dispose of it.
- Wear eye protection while replacing a bulb. If hot, cool down the bulb before handling it.

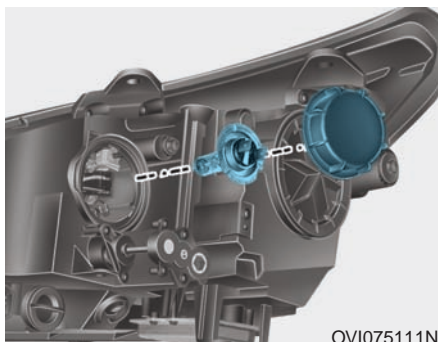

17. Remove the headlamp cover by turning it in a counterclockwise direction.
18. Disconnect the headlamp bulb socket connector.
19. Loosen the wire, which holds the headlamp, by depressing the end and pushing it upward.
20. Remove the bulb from the headlamp assembly.
21. Install a new headlamp, and fasten the headlamp wire by aligning it with the groove.
22. Connect the headlamp socket connector.
23. Close the headlamp cover by turning it in a clockwise direction.
24. Connect the power connector(s) to the back of the headlamp assembly.
25. Reinstall the headlamp assembly to the vehicle.

i Information

Always readjust the headlamp angle, after an accident or the headlamp installment by an authorized EQUUS dealer.

NOTICE

When the headlamp (Low) does not operate, have the vehicle checked by an authorized EQUUS dealer.

Turn signal light - bulb type

When the light bulb does not operate, have the vehicle checked by an authorized EQUUS dealer.

Position light, Front fog light

When the light bulb does not operate, have the vehicle checked by an authorized EQUUS dealer.

Side repeater light bulb replacement (if equipped)



If the light bulb is not operating, have the vehicle checked by an authorized EQUUS dealer.

Rear combination light bulb replacement



- (1) Stop, tail light and side marker
- (2) Rear turn signal light
- (3) Back-up light

Rear back-up light

When the light bulb does not operate, have the vehicle checked by an authorized EQUUS dealer.

Turn signal, stop and tail light

When the light bulb does not operate, have the vehicle checked by an authorized EQUUS dealer.

NOTICE

A skilled technician should check or repair the rear combination light. Otherwise, it may damage related parts of the vehicle.

High mounted stop light

1. Remove the rear seat

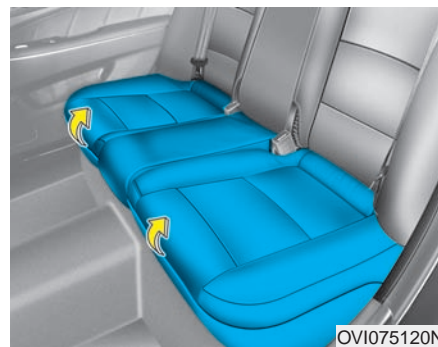

5 Seater

1. Disconnect the negative battery cable.
2. Remove the rear seat cushion.

Maintenance

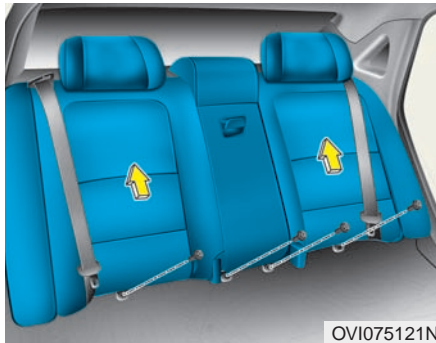

3. Loosen the mounting bolts, and then remove the rear seat back.



5. Push the hook, and disconnect the main connector.

Tightening torque :
34.3~53.9 N.m
3.5~5.5 kgf.m,
25.3~39.8 lb-ft

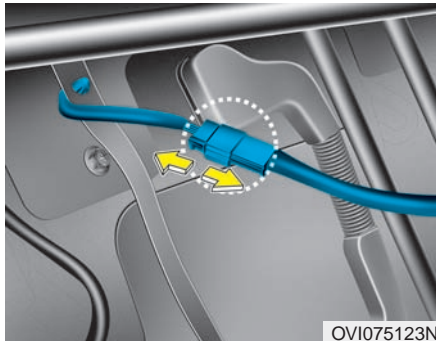

4. Disconnect the connector.

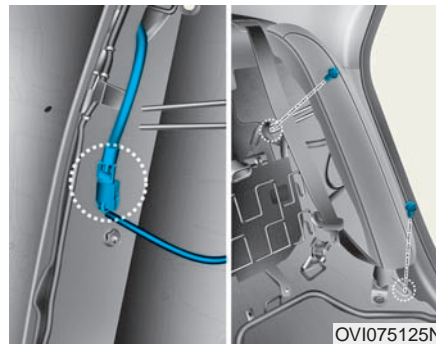

6. Loosen the mounting bolts, and then disconnect the connector.

7. Remove the side seat.



4 Seater

1. Disconnect the negative battery cable.
2. Remove the rear seat cushion.



3. Loosen the mounting bolts, and then remove the rear seat back.

Tightening torque

: 34.3~53.9 N.m

3.5~5.5 kgf.m,

25.3~39.8 lb-ft

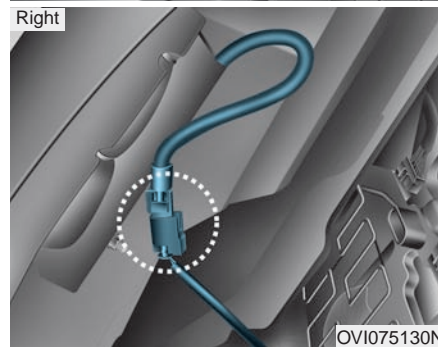
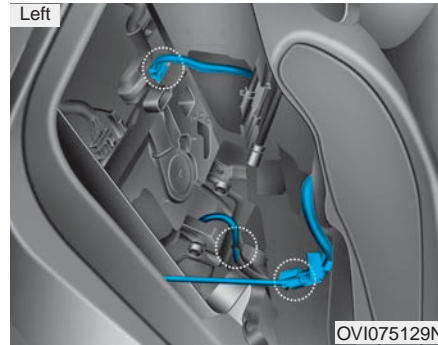

4. Disconnect the connectors and hose.

2. Remove the rear package tray trim

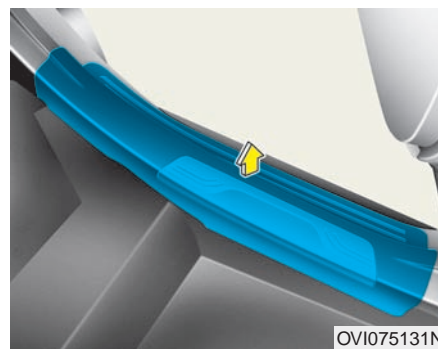

1. Remove the rear door scuff trim.

Maintenance

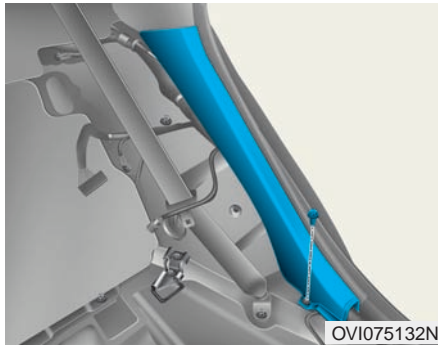

2. Loosen the mounting screw, and then remove the rear wheel house trim.

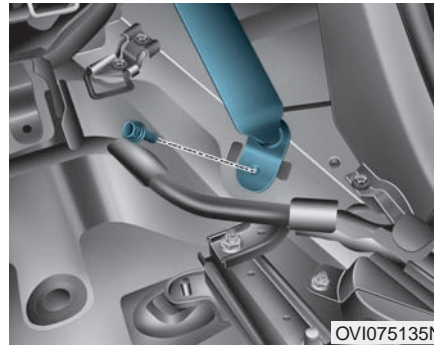

6. Remove the rear seat belt lower anchor.

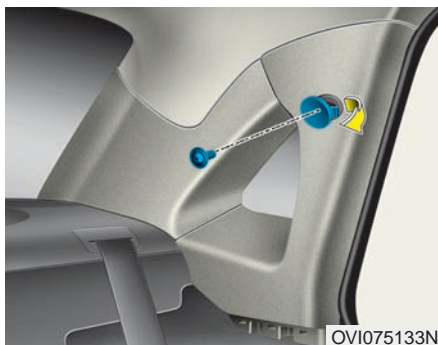

3. Remove the cap, and then loosen the mounting screw.

4. Remove the rear pillar trim.

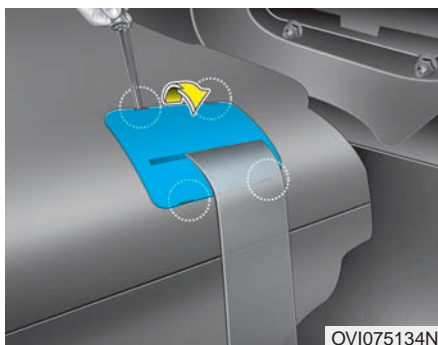

5. Push the hook, and remove the rear seat belt cover.

Tightening torque
: 39.2~53.9 N.m
4.0~5.5 kgf.m
28.9~39.8 lb-ft

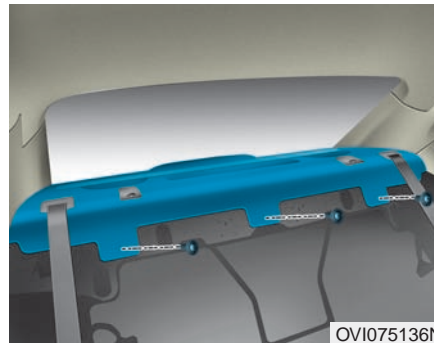

7. Loosen the mounting screws, and then remove the package tray trim.

3. Replace the high mounted stop light

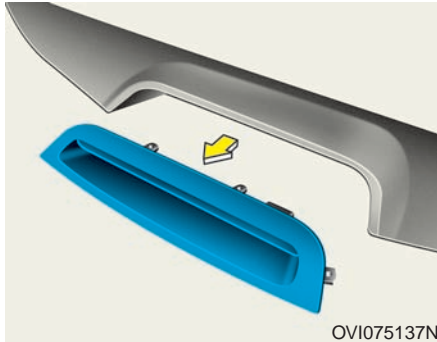

1. Remove the high mounted stop lamp after removing screws.
2. Install a new light.

4. Installation

Reinstall it in the reverse order.

License plate lamp replacement

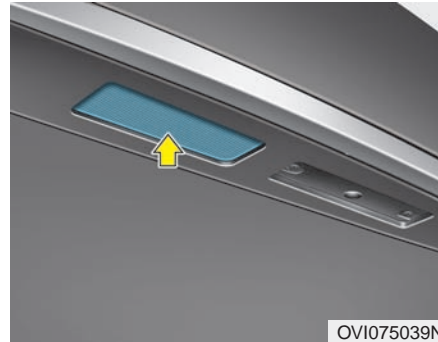

1. Open the trunk.
2. Disconnect the negative battery cable.

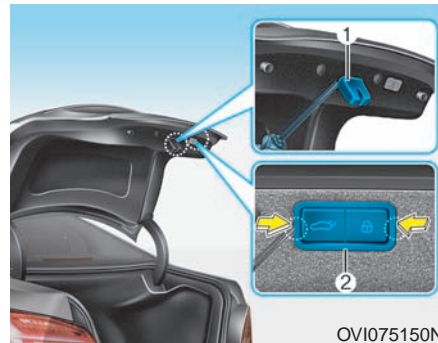

3. Using a screwdriver, open the trunk lid latch cover(1).
4. Using a screwdriver, remove the trunk lid switch(2), and disconnect the connector.

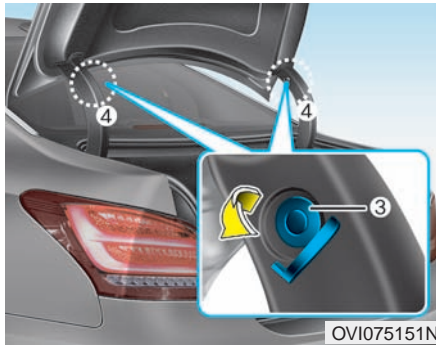

OVI075151N

5. Loosen the clip and fastener(3), and then remove the trunk lid cover(4).



OVI075152N

6. Remove the clips and screws.



OVI075153N

7. Remove the trunk lid trim.

NOTICE

Be careful not to damage the fasteners between the trunk lid trim and trunk lid.

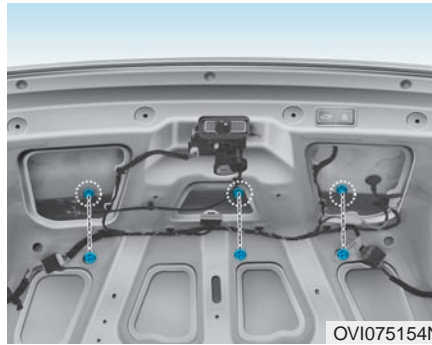

OVI075154N

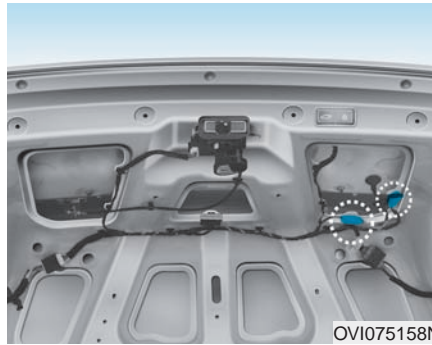

OVI075158N

8. Loosen the nuts and disconnect the connectors.

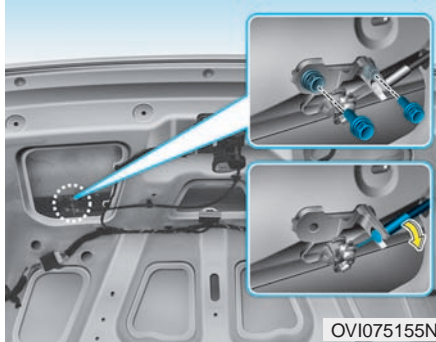

OVI075155N

9. Loosen the bolts and remove the trunk key hold.

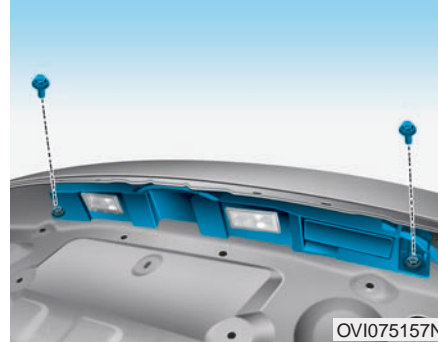

OVI075157N

11. Remove the bolts and the license plate lamp.

12. Install a new light.

13. Reinstall it in the reverse order.

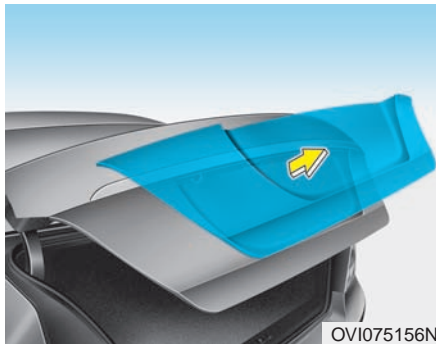

OVI075156N

10. Open the trunk lid panel.

NOTICE

Be careful not to damage the fasteners between the trunk lid panel and trunk lid.

Interior light bulb replacement

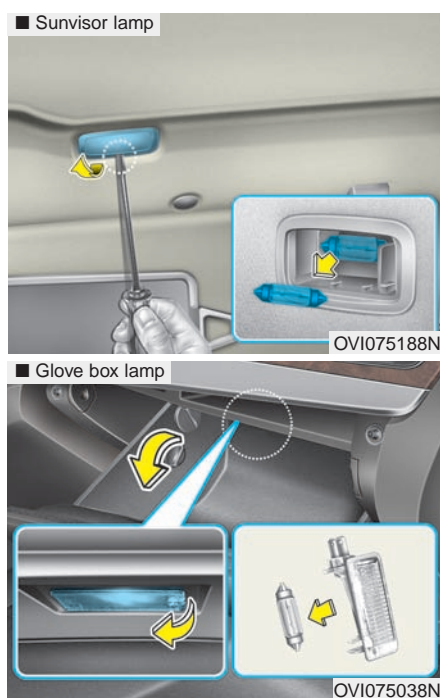

1. Use a flat-blade screwdriver to gently take out the lens from the interior light housing.
2. Pull the bulb straight out.

⚠ WARNING

Before working on the interior lights, surely press OFF the lights to avoid burning your fingers or an electric shock.

3. Install a new bulb in the socket.
4. Align the lens tabs with the interior light housing notches, and secure the lens into place.
5. When the map lamp and room lamp do not operate, have the vehicle checked by an authorized EQUUS dealer.

NOTICE

Be careful not to smear or damage lens, lens tab, and plastic housings.

i Information

When the luggage lamp does not operate, have the vehicle checked by an authorized EQUUS dealer.

APPEARANCE CARE

Exterior care

Exterior general caution

It is very important to follow the label directions when using any chemical cleaner or polish. Read all the warnings and cautions on the label.

High-pressure washing

- When using high-pressure washers, make sure to maintain sufficient distance from the vehicle. Insufficient clearance or excessive pressure can lead to component damage or water penetration.
- Do not spray the camera, sensors or its surrounding area directly with a high pressure washer. Shock applied from high pressure water may cause the device to not operate normally.
- Do not bring the nozzle tip close to boots (rubber or plastic covers) or connectors as they may be damaged if they come into contact with high pressure water.

Finish maintenance

Washing

To protect your vehicle's paint from rust and deterioration, thoroughly wash the vehicle at least once a month with lukewarm or cold water.

After each off-road driving, you should wash the vehicle. Pay special attention to removing any salty and muddy substances. Make sure the drain holes on the lower door edges and on the rocker panels are kept clear and clean.

Insects, tar, tree sap, bird droppings, industrial pollutants and similar deposits damage your vehicle's finish, if not immediately removed.

Even prompt washing with plain water may not completely remove all these deposits. A mild soap, which is safe for a painted surface, may be used.

After soaping, thoroughly rinse the vehicle body with lukewarm or cold water. Do not allow soap to dry on the finish.

⚠ CAUTION

- **Do not use strong soap, chemical detergents or hot water. Do not wash the vehicle when it is under direct sunlight, or when its body is warm.**
- **Be careful when washing the side windows of your vehicle. Especially, with high-pressure water, water may penetrate into the windows and wet the interior.**
- **To prevent damage to plastic parts and lamps, do not wash the vehicle with chemical solvents or strong detergents.**

⚠ WARNING

- Wet brakes

After washing the vehicle, test the brake operations to check whether it is affected by water. When the braking performance is deteriorated, dry the brakes by lightly applying them and driving forward at a slow speed.



⚠ CAUTION

- Washing the engine compartment with the water of high pressure is not recommended. It may fail electrical circuits, engine and any other related part, located in the engine compartment.
- Never allow water or other liquids to contact with electrical/electronic components and the air duct. These may damage them.

Waxing

A good coat of wax bars contamination from the vehicle paint. Maintain a good coat of wax on your vehicle to protect it.

Wax the vehicle when the wax polish vanishes.

Always wash and dry the vehicle before waxing. Use a good quality liquid or paste wax, and follow the manufacturer's instructions. Wax all metal trim to protect it and to maintain its luster.

A spot remover, which removes oil, tar, and other similar materials, peels off the wax coating from the finish. Make sure to re-wax these areas, even when the rest of the vehicle does not need be waxed.

⚠ CAUTION

- Wiping dust or dirt off the body with a dry cloth will scratch the finish.
- Do not use a steel- or wool- abrasive cleaner, or strong detergents, which is high in alkaline or caustic agents on chrome-plated, or which anodizes aluminum parts. This may damage the protective coating and cause discoloration or paint deterioration.

Finish damage repair

Deep scratches or stone chips on the paint must be repaired in a prompt manner. Any exposed metal area quickly gets rusty, and repairing it may cost a lot.

i Information

When your vehicle requires any metal repair or replacement after damage, make sure the body shop applies anti-corrosion materials to the parts to be repaired or to be replaced.

Bright-metal maintenance

- Use a tar remover to remove road tar and insects, not scraping or using a sharp object.
- To protect a bright metal surface from corrosion, apply a coat of wax or chrome preservative, or polish the surface.
- In winter or in coastal areas, apply a bright metal part with a heavy coat of wax or preservative. If necessary, coat the part with non-corrosive petroleum jelly or other protective compound.

Underbody maintenance

Corrosive materials, which are used to remove ice, snow or dusts, may accumulate across the vehicle underbody. When these materials are not promptly removed, rusting process may accelerate across the underbody, such as the fuel lines, frame, floor pan and exhaust system, regardless of the rust-protection treatment.

Thoroughly wash the vehicle underbody and wheel openings with lukewarm or cold water once a month, after driving off a road, or after the winter season. Pay special attention to the underbody areas to find any mud or dirt. Remaining road dirt or grime across the vehicle underbody does more harm than good. The lower edges of doors, rocker panels, and frame members have drain holes, which should not be clogged with dirt; clogging in these areas may cause rusting.

⚠ WARNING

After washing the vehicle, test the brakes by slowly applying them to check whether they are affected by water. When braking performance is impaired, dry the brakes by lightly applying them while driving forward at a slow speed.

Aluminum wheel maintenance

The aluminum wheels are coated with a clear protective finish.

- Do not use any abrasive cleaner, polishing compound, solvent, or wire brushes on aluminum wheels. They may scratch or damage the finish.
- Clean the wheel, while it is cool.
- Use only a mild soap or neutral detergent, and thoroughly rinse with water. Also, always clean the wheels after driving on a salted road. This prevents corrosion.
- Avoid washing the wheels with an automatic high-speed washing brush.
- Do not use any alkaline or acid detergent. It may damage and corrode the aluminum wheels coated with a clear protective finish.

Corrosion protection

Protecting your vehicle from corrosion

HYUNDAI produces a vehicle of the highest quality by using the most advanced design and construction practices to combat corrosion. However, this is only one part of anti-corrosion resistance practices. To achieve a long-term corrosion resistance of your vehicle, your cooperation and assistance are required.

Common causes of corrosion

The followings are the most common causes of corrosion:

- Road salt, dirt and moisture, which accumulate across the vehicle underbody.
- Exposure of an unprotected metal to corrosion due to the removal of paint or protective coat, possibly by a stone, gravel, abrasion, minor scrape, or dent.

High-corrosion areas

In an area, where your vehicle is regularly exposed to corrosive materials, an anti-corrosion measure is particularly important. Some of the common causes of instant vehicle corrosion are road salts, dust, chemicals, salty air and industrial pollutants.

Moisture breeds corrosion

Moisture creates a condition in which corrosion is most likely to occur. For example, a corrosion process is accelerated by high humidity, particularly when a temperature is just above the freezing point. In such condition, the vehicle surface is kept in contact with moisture that is slow to evaporate.

Mud is particularly corrosive because it is slow to dry and holds moisture in contact with the vehicle. Although the mud appears to be dry, it may still retain some moisture inside and promote corrosion.

A high temperature also accelerates a corrosion process, when the air is unventilated, and when the moisture pervades. For all these reasons, it is particularly important to keep your vehicle clean, and remove mud or any other accumulated substances. This applies not only to the visible surfaces but particularly to the vehicle underbody.

To help prevent corrosion

You can prevent corrosion from the start by following the below precautions.

Keep your car clean

The best way to prevent corrosion is to keep your vehicle clean and free of corrosive materials. Constant attention to the underbody is particularly important.

- In an area, which is high in corrosive materials, such as salts on a road, salty air, industrial pollutants, acid rain, you should take extra care to prevent corrosion. In winter, wash off the underbody at least once a month and make sure to clean the underbody when the winter is over.
- When cleaning the vehicle underbody, give particular attention to the components, such as fenders, which are hidden underneath. Thoroughly wash the vehicle. When you just damp the underbody, across which mud is accumulated, without washing off the mud, accelerates corrosion, rather than preventing it. High-pressure water and steam are particularly effective in removing accumulated mud and corrosive materials.
- When cleaning lower door panels, rocker panels and frame members, make sure that drain holes are kept clean. Thus moisture can evaporate, without being trapped inside to accelerate corrosion.

Keep your garage dry

Do not park your vehicle in a damp or unventilated garage. This creates the environment, which is favorable to corrosion. This is particularly true, when you wash your vehicle in a garage, when the garage is still wet, or when the garage is covered with snow, ice, or mud. Even, a high temperature of a garage may accelerate corrosion, until it is properly ventilated, and moisture evaporates.

Keep paint and trim in good condition

Scratches or chips over the finish should be immediately covered with a "touch-up" paint to prevent corrosion. When the bare metal is exposed, it is recommended to visit a qualified body or paint shop.

Bird droppings : Bird droppings are highly corrosive and may damage painted surfaces in just a few hours. Always remove bird droppings as soon as possible.

Don't neglect the interior

Moisture may be dense over the floor mats and carpeting, causing corrosion. Check the floor mats at a regular basis to make sure that it is dry. Pay particular attention, when carrying fertilizers, cleaning materials or chemicals inside the vehicle.

These should be carried only in proper containers. Any spills or leakages should be cleaned up, flushed with clean water and thoroughly dried.

Interior care

Interior general precautions

Do not use chemicals, such as perfume, cosmetic oil, sun cream, hand cleaner, and air freshener, inside the vehicle, because they may damage or discolor the interior. When one of the above materials contacts the interior part, immediately wipe them off. Refer to the vinyl-cleaning instructions for the proper cleaning procedure.

⚠ CAUTION

- **Never allow water or other liquids to come in contact with electrical/electronic components inside the vehicle as this may damage them.**
- **When cleaning leather products (i.e. steering wheel and seats), use a neutral detergent or a low-alcohol solution. When using a solution, which is rich in alcohol, acid or alkaline, the leather color may fade or the surface may get stripped off.**

Cleaning the upholstery and interior trim

Vinyl

Dust the vinyl off with a whisk broom or vacuum cleaner. Clean a vinyl surface with a vinyl cleaner.

Fabric

Dust the fabric off with a whisk broom or vacuum cleaner. Clean it with a mild soap, recommended for upholstery or carpets. Immediately remove a stain with a fabric spot cleaner. When a stain is not immediately removed, the stain may permanently remain, and its color is changed. Also, its fire-resistance capacity is reduced, when the material is not properly maintained.

NOTICE

Unauthorized cleaner or incorrect cleaning procedures may impair the fabric surface and the fire-resistant capacity.

Cleaning the lap/shoulder belt webbing

Clean the belt webbing with a mild soap, recommended for cleaning upholstery or carpet. Follow any instructions of the soap. Do not bleach or re-dye the webbing, as the webbing surface may deteriorate.

Cleaning the interior window glass

When the inner window surface becomes fogged (possibly covered with oily, greasy or waxy film), they should be cleaned with a glass cleaner. Follow any directions of the glass cleaner.

NOTICE

Do not scrape or scratch the inner surfaces of the rear windows. This may damage the defroster grid of the rear windows.

EMISSION CONTROL SYSTEM

The emission control system of your vehicle is covered by a written limited warranty. Please refer to the Owner's Handbook & Warranty Information booklet for more warranty information.

Your vehicle is equipped with an emission control system to meet all applicable emission regulations.

Below are the three emission control systems.

- (1) Crankcase emission control system
- (2) Evaporative emission control system
- (3) Exhaust emission control system

In order to assure the proper operation of the emission control systems, it is recommended that you have your car inspected and maintained by an authorized EQUUS dealer in accordance with the maintenance schedule in this manual.

Caution for the Inspection and Maintenance Test (With Electronic Stability Control (ESC) system)

- **To prevent a misfiring during a dynamometer test, press the Electronic Stability Control (ESC) system OFF.**
- **After a dynamometer test, turn ON the ESC system back.**

1. Crankcase emission control system

The positive crankcase ventilation system is to prevent the gas emission from the crankcase and to reduce the air pollution. This system supplies filtered-out, fresh air to the crankcase through the air intake hose. Inside the crankcase, the filtered-out air mixes with gases, which then pass through the PCV valve into the induction system.

2. Evaporative emission control (including ORVR: Onboard Refueling Vapor Recovery) system

The Evaporative Emission Control System is designed to prevent fuel vapor emission into the atmosphere. (The ORVR system is designed to keep the fuel vapors in a canister while being refueled at the gas station, preventing the fuel vapor emission into the atmosphere.)

Canister

Fuel vapors generated inside the fuel tank are absorbed and stored in the onboard canister. When the engine is running, the fuel vapors are absorbed in the canister, and are drawn into the engine intake manifold through the purge control solenoid valve.

Purge Control Solenoid Valve (PCSV)

The purge control solenoid valve is controlled by the Engine Control Module (ECM). When the engine coolant temperature is low during idling, the PCSV closes to prevent the evaporated fuel from getting into the engine. After warming up the engine in a normal driving condition, the PCSV opens to introduce evaporated fuel to the engine.

3. Exhaust emission control system

The Exhaust Emission Control System is highly effective in controlling exhaust emissions, while maintaining good vehicle performance.

Vehicle modifications

- This vehicle should not be modified. Modification of your vehicle may affect its driving performance, safety or durability. This even may violate safety and emissions regulations of the government.

In addition, damage or performance problems, which is resulted in due to any modification, may not be covered by a warranty.

- Use of unauthorized electric devices may cause abnormal vehicle operation, wire damage, battery discharge and a fire.

Be careful not to damage your vehicle by using an unauthorized electric device.

Engine exhaust gas precautions (carbon monoxide)

- Carbon monoxide is present in exhaust fumes. Therefore, when you smell exhaust fumes of any kinds, inside your vehicle, immediately have it inspected and repaired. When you suspect exhaust fume emission into your vehicle, drive the vehicle only when all windows are fully opened. Immediately have your vehicle checked and repaired immediately.

⚠ WARNING

- Exhaust

Engine exhaust gases contain carbon monoxide (CO). Though colorless and odorless, it is dangerous and is lethal, if inhaled. Follow the instructions on this page to avoid CO poisoning.

⚠ CALIFORNIA PROPOSITION 65 WARNING

Engine exhaust and a wide variety of automobile components and parts, including components found in the interior furnishings in a vehicle, contain or emit chemicals known to the State of California to cause cancer and birth defects and reproductive harm. In addition, certain fluids contained in vehicles and certain products of component wear contain or emit chemicals known to the State of California to cause cancer and birth defects or other reproductive harm.

- Do not operate the engine in confined or closed areas (such as garages) any more than what is necessary to move the vehicle in or out of the area.
- When the vehicle is stopped in an open area, with the engine running, for more than a short period of time, adjust the ventilation system (as needed) to draw the outside air into the vehicle.
- Never sit inside a parked or stopped vehicle for any extended period of time, while the engine is running.
- When the engine stalls or fails to start, excessive attempts to restart the engine may damage the emission control system.

Operating precautions for catalytic converters (if equipped)

⚠ WARNING

- Fire

- **A hot exhaust system can ignite flammable items under your vehicle. Do not park, idle, or drive the vehicle over or near flammable objects, such as grass, vegetation, paper, leaves, etc.**
- **The exhaust system and catalytic system are very hot while the engine is running or immediately after the engine is turned off. Keep away from the exhaust system and catalytic; you may get burned.**

Also, do not remove the heat sink around the exhaust system, do not seal the bottom of the vehicle or do not coat the vehicle for corrosion control. It may present a fire risk under certain conditions.

Your vehicle is equipped with a catalytic converter emission control device.

Therefore, you must observe the following precautions:

- Use only the UNLEADED FUEL for gasoline engines.
- Do not drive the vehicle when there are signs of engine malfunction, such as misfiring or noticeable under-performing.
- Do not misuse or abuse the engine. Examples of the engine misuse are coasting and descending on a steep slope with the ignition in the OFF position.
- Do not idle the engine at a high speed for an extended period of time (5 minutes or more).
- Do not modify any part of the engine or the emission control system. All inspections and adjustments must be done by an authorized EQUUS dealer.
- Avoid driving with a low level of fuels. When your vehicle runs out of gasoline, it may misfire the engine or result in excessive loading of the catalytic converter.

Failure to observe these precautions may damage the catalytic converter as well as your vehicle. Additionally, such actions may void your warranties.

CALIFORNIA PERCHLORATE NOTICE

Perchlorate Material-special handling may apply, See www.dtsc.ca.gov/hazardouswaste/perchlorate.

Notice to California Vehicle Dismantlers:

Perchlorate containing materials, such as air bag inflators, seatbelt pretensioners and keyless remote entry batteries, must be disposed of according to Title 22 California Code of Regulations Section 67384.10 (a).

Specifications, Consumer information and Reporting safety defects

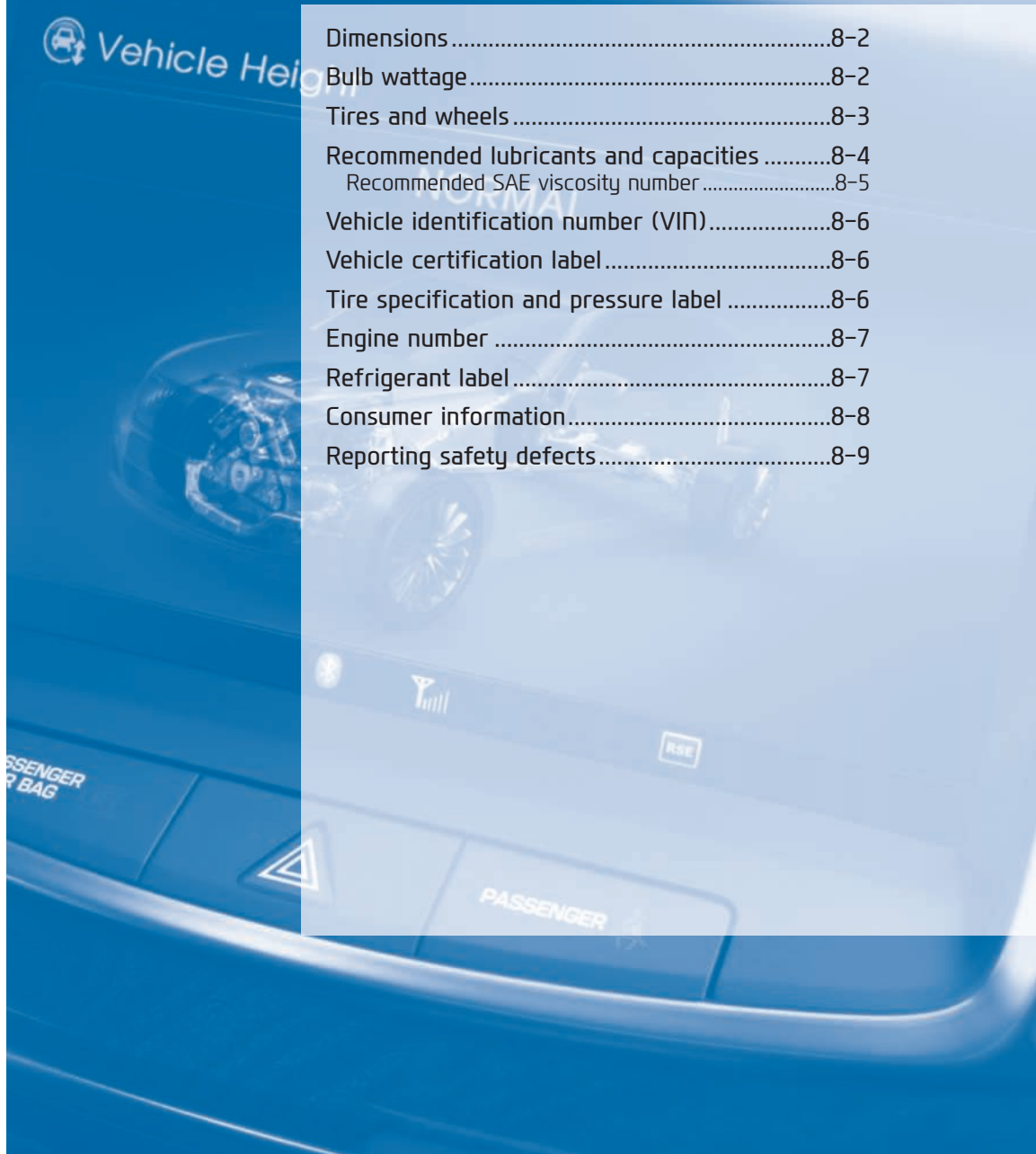

Dimensions	8-2
Bulb wattage	8-2
Tires and wheels	8-3
Recommended lubricants and capacities	8-4
Recommended SAE viscosity number	8-5
Vehicle identification number (VIN)	8-6
Vehicle certification label	8-6
Tire specification and pressure label	8-6
Engine number	8-7
Refrigerant label	8-7
Consumer information	8-8
Reporting safety defects	8-9

DIMENSIONS

Item	in (mm)
Overall length	203.1 (5160)
Overall width	74.4 (1890)
Overall height	58.7 (1490)
Front tread	63.8 (1620)
Rear tread	64.1 (1627)
Wheelbase	119.9 (3045)

BULB WATTAGE

Light Bulb	Wattage	Bulb, Cap
Headlights (Low) (HID)	35	D1S, PK32d-2
Headlights (High)	55	H7, PX26d
Front turn signal lights	LED	-
Position lights	LED	-
Side repeater lights*	LED	-
Front fog lights*	LED	-
Welcome light*	LED	-
Rear fog light*	LED	-
Stop and tail lights	LED	-
Tail light	LED	-
Rear turn signal lights	LED	-
Back-up lights	LED	-
High mounted stop light*	LED	-
License plate lights	LED	-
Map lamps	LED	-
Room lamps	LED	-
Luggage lamp	LED	-
Glove box lamp	LED	-
Vanity mirror lamps*	LED	-
Door courtesy lamps*	LED	-

* : If equipped

TIRES AND WHEELS

Item	Tire size	Wheel size	Inflation pressure kPa (psi)				Wheel lug nut torque lb•ft (kg•m, N•m)
			Normal load *		Maximum load		
			Front	Rear	Front	Rear	
Full size tire	P245/45R19	8.0Jx19	205 (30)	-	205 (30)	-	65~79 (9~11, 88~107)
	P275/40R19	9.0Jx19	-	205 (30)	-	205 (30)	
Compact spare tire	T155/70R19	4.0Tx19	420 (60)	420 (60)	420 (60)	420 (60)	

* Normal load : Up to 3 persons

⚠ CAUTION

While replacing tires, use a new one of the same size as the originally supplied tire. Using tires of a different size may damage the related parts or cause irregular operation.

i Information

It is permissible to increase the tire pressure by 3psi from the standard specification, when a cold temperature is expected soon. A tire typically loses its pressure by 1psi for every 12°F temperature drop. When an extreme temperature variation is expected, frequently check your tire pressure to keep them properly inflated.

RECOMMENDED LUBRICANTS AND CAPACITIES

To assure the proper engine and powertrain performance and durability, use only lubricants of the proper quality.

The proper lubricants also promote engine efficiency, leading to a better fuel economy.

These lubricants and fluids are recommended for use in your vehicle.

Lubricant	Volume	Classification
Engine oil *1 *2 (drain and refill) Recommends 	7.61 US qt. (7.2 l)	API Service SM*3, ILSAC GF-4 or above
Automatic transmission fluid	10.67 US qt. (10.1 l)	GS ATF SP-IV-RR, HYUNDAI genuine ATF SP-IV-RR or other brands meeting the above specification approved by HYUNDAI Motor Co.,
Power steering fluid	0.95 US qt. (0.9 l)	Pentosin CHF 202
Coolant	7.45 US qt. (7.05 l)	Mixture of antifreeze and distilled water (Ethylene glycol base coolant for aluminum radiator)
Brake fluid	0.7 ~ 0.8 US qt. (0.7~0.8 l)	FMVSS116 DOT-3 or DOT-4
Rear differential oil	1.48 US qt. (1.4 l)	Hypoid gear oil API GL-5, SAE 75W/90 (SHELL SPIRAX X Equivalent)
Fuel	20.34 US gal. (77 l)	Unleaded gasoline

*1 Refer to the recommended SAE viscosity numbers on the next page.

*2 Engine oils, labeled as Energy Conserving Oil, are now available. Along with other additional benefits, they contribute to fuel economy by reducing the amount of fuel necessary to overcome engine friction. Often, these improvements are difficult to measure in everyday driving, but in a year's time, they significantly reduce costs and deliver energy savings.

*3 When the API service SM engine oil is not available in your country, you are able to use API service SL.

Recommended SAE viscosity number

NOTICE

Always be sure to clean the filler-plug area, drain plug, or dipstick before checking or draining any lubricant. This is especially important in dusty or sandy areas or after driving on an unpaved road. The practice to maintain the plug and dipstick areas clean prevents dirt and grit from entering the engine or the other mechanisms, which may be damaged.

Engine oil viscosity (thickness) effects the fuel economy and the driving in a cold weather (engine start and engine oil flow). Engine oils of the lower viscosity improves the fuel economy and driving performance in a cold weather. However, engine oil of the higher viscosity are required for sufficient lubrication in a hot weather.

Using oils out of the recommended viscosity may damage the engine. When choosing an oil, consider the range of temperature, in which your vehicle drives. Find the recommended oil viscosity from the chart.

Temperature Range for SAE Viscosity Numbers											
Temperature	°C	-30	-20	-10	0	10	20	30	40	50	
	(°F)	-10	0	20	40	60	80	100	120		
Engine Oil *1		10W-30									
							5W-20, 5W-30				

- For the better fuel economy, it is recommended to use the engine oil of a viscosity grade SAE 5W-20 (API Service SM / ILSAC GF-4). However, when this engine oil is unavailable in your country, select a proper engine, using the engine oil viscosity chart.



VEHICLE IDENTIFICATION NUMBER (VIN)

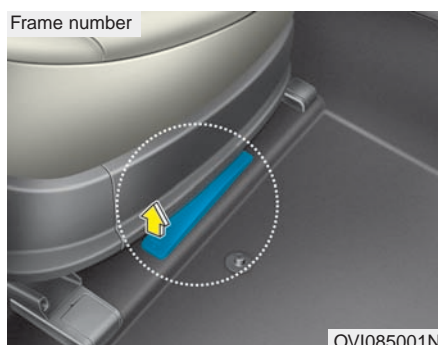

The vehicle identification number (VIN) is the number used in registering your vehicle and in dealing with all legal matters, such as ownership. The number is punched on the floor under the front passenger's seat. To check the number, open the cover.

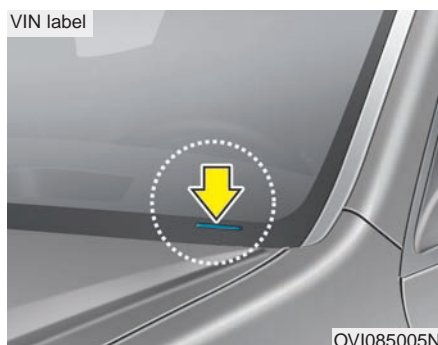

The VIN is also on a plate attached to the top of the dashboard. The number on the plate can easily be seen through the windshield from outside.

VEHICLE CERTIFICATION LABEL

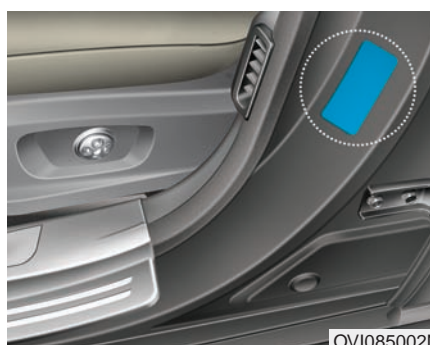

The vehicle certification label attached on the driver's side center pillar has the vehicle identification number (VIN).

TIRE SPECIFICATION AND PRESSURE LABEL

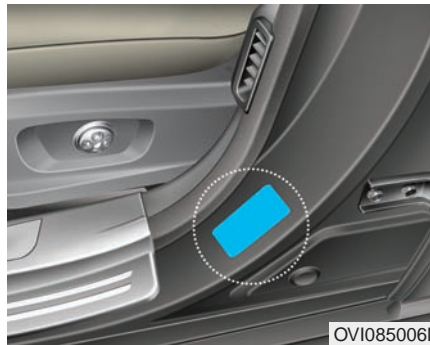

The tires, equipped with your new vehicle, are chosen to provide the best performance in a normal driving condition.

The tire label, located on the driver's side center pillar, gives the tire information, such as the recommended pressure.

ENGINE NUMBER

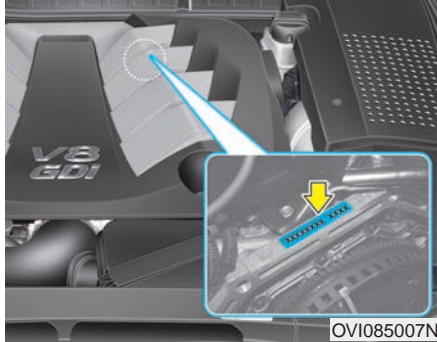

The engine number is stamped on the engine block as shown in the illustration.

REFRIGERANT LABEL

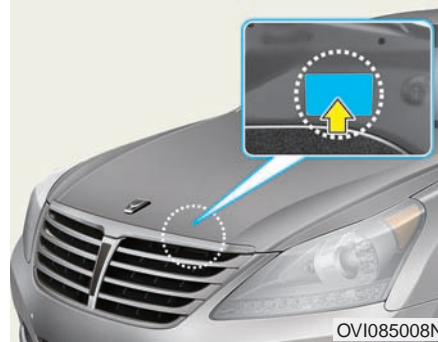

The refrigerant label is located under the hood.

The label contains the following information:

- Type of refrigerant
- Amount of refrigerant

CONSUMER INFORMATION

This consumer information is to meet the regulations issued by the National Highway Traffic Safety Administration of the U.S. Department of Transportation. Your EQUUS dealer will help answer any questions you may have as you read this information.

HYUNDAI motor vehicles are designed and manufactured to satisfy or to go beyond all the applicable safety standards.

For your safety, however, we strongly urge you to read and follow all directions in this Owner's Manual, particularly the information under the headings, "DANGER," "NOTICE," "CAUTION" and "WARNING".

When, after reading this manual, you have any questions regarding the operation of your vehicle, please contact your nearest HYUNDAI Motor America Regional Office as listed below:

Eastern Region: Connecticut, Delaware, Maine, Massachusetts, New Hampshire, New Jersey, New York, Pennsylvania, Rhode Island, Vermont.

Eastern Region
1122 Cranbury South River Road
Jamesburg, NJ 08831
(877) 378-8727

Southern Region: Florida, Georgia, Maryland, North Carolina, South Carolina, Virginia, West Virginia.

Southern Region
3025 Chastain Meadows Parkway
suite 100 Marietta, GA 30066
(877) 378-8727

South Central Region: Alabama, Arkansas, Louisiana, Mississippi, New Mexico, Oklahoma, Tennessee, Texas.

South Central Region
1421 South Beltline Road, Suite
400 Coppell, TX 75019
(877) 378-8727

Central Region: Illinois, Indiana, Iowa, Kentucky, Michigan, Minnesota, Nebraska, North Dakota, South Dakota, Ohio, Wisconsin, Kansas, Missouri.

Central Region
1705 Sequoia Drive
Aurora, Illinois 60506
(877) 378-8727

Western Region: Alaska, Hawaii, Arizona, California, Colorado, Idaho, Montana, Nevada, Oregon, Utah, Washington, Wyoming.

Western Region
10550 Talbert Avenue
P.O.Box 20850
Fountain Valley, California 92728-0850
(877) 378-8727

REPORTING SAFETY DEFECTS

If you believe that your vehicle has a defect which could cause a crash or could cause injury or death, you should immediately inform the National Highway Traffic Safety Administration (NHTSA) in addition to notifying HYUNDAI MOTOR AMERICA. If NHTSA receives similar complaints, it may open an investigation, and if it finds that a safety defect exists in a group of vehicles, it may order a recall and remedy campaign. However, NHTSA cannot become involved in individual problems between you, your dealer, or HYUNDAI MOTOR AMERICA.

To contact NHTSA, you may call the Vehicle Safety Hotline toll-free at 1-888-327-4236 (TTY: 1-800-424-9153); go to <http://www.safercar.gov>; or write to: Administrator, NHTSA, 1200 New Jersey Avenue, SE, Washington, DC 20590. You can also obtain other information about motor vehicle safety from <http://www.safercar.gov>.

Index

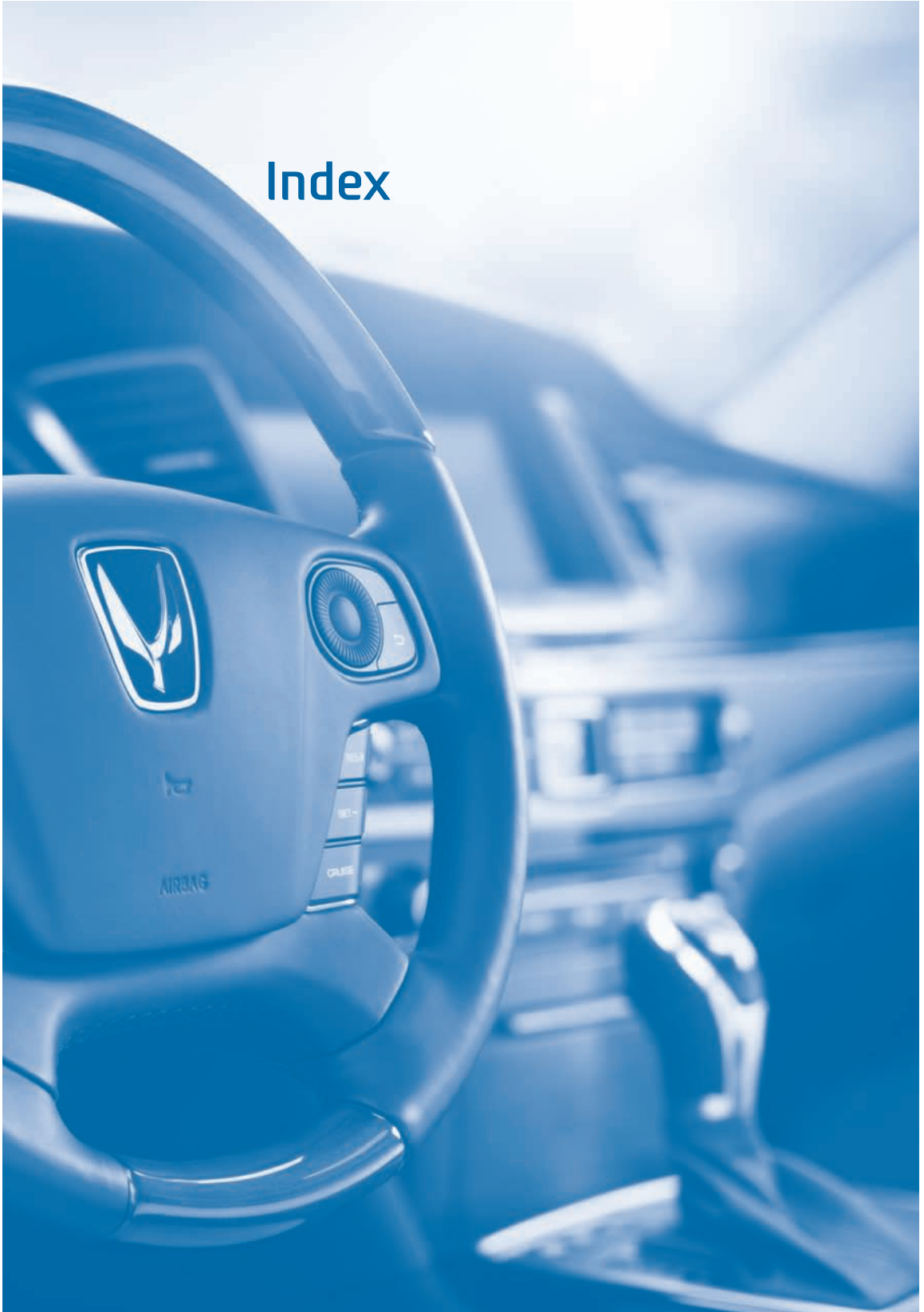

A

A/V Mode.....	3-70
Advanced smart cruise control system	5-38
Advanced vehicle safety management (AVSM).....	5-55
AFLS (Adaptive Front Lighting System)	3-114
Air bag warning label.....	2-68
Air bag warning light	2-46
Air bags	2-42
Air bag warning label.....	2-68
Air bag warning light	2-46
Curtain air bag.....	2-60
Driver's and passenger's front air bag	2-54
Driver's knee air bag.....	2-54
Occupant classification system	2-48
Operation.....	2-43
Side air bag.....	2-58
SRS components and functions.....	2-45
Air cleaner.....	7-33
Air conditioning system	
Automatic climate control system.....	3-123
Alarm system	3-13
Antenna	4-2
Anti-lock brake system (ABS).....	5-26
Appearance care	7-83
Exterior care	7-83
Interior care	7-88
Armrest (rear seat)	2-18
ASCC/LDWS mode	3-70
Ashtray	3-145
Audio remote control	4-3
Audio system	
Steering wheel audio control.....	4-3
Auto defogging system	3-140
Auto hold.....	5-23
Auto light/AFLS position.....	3-110

Automatic climate control system	3-123
3 zone control	3-126
Air conditioning	3-133
Air conditioning refrigerant	3-137
Air intake control	3-131
Air quality system (AQS).....	3-132
Automatic heating and air conditioning.....	3-124
Climate control air filter.....	3-136
Climate information screen selection.....	3-134
Fan speed control	3-133
Manual heating and air conditioning	3-126
Mode selection	3-127
OFF mode.....	3-134
Temperature control	3-130
Automatic transmission.....	5-11
Shift lock override.....	5-15
Shift lock system.....	5-14
Sports mode.....	5-13
Automatic Transmission shift indicator	3-68
Aux, USB and iPod® port	3-153

B

Bag hanger	3-150
Battery	7-39
Battery replacement	
Card key	3-12
Smart key.....	3-12
Battery saver function	3-109
Before driving	5-5
Blind spot detection system (BSD).....	5-58
Brake fluid.....	7-30
Brake system	5-17
Anti-lock brake system (ABS).....	5-26
Auto hold.....	5-23
Electric parking brake (EPB)	5-19
Electronic stability control (ESC).....	5-28
Hill-start assist control (HAC)	5-32
Power brakes	5-17
Bulb replacement	7-69
Bulb wattage.....	8-2
Button start/stop, see engine start/stop button	5-7

C

Camera (Rear view)	3-107
Capacities (Lubricants)	8-4
Card key	3-6
Care	
Exterior care	7-83
Interior care	7-88
Tire care	7-42
Center console storage	3-141
Central door lock switch	3-16
Certification label	8-6
Chains	
Tire chains	5-73
Checking tire inflation pressure	7-44
Child restraint system	2-33
Lower anchor system	2-40
Tether anchor system	2-38
Child-protector rear door lock	3-17
Climate control air filter	7-35
Climate control system seat (front seat)	2-9
Climate control system seat (rear seat)	2-19
Clothes hanger	3-150
Combined instrument, see instrument cluster	3-62
Compact spare tire	6-17
Compact spare tire replacement	7-47
Consumer information	8-8
Cool and warm box	3-143
Coolant	7-27
Cooling fluid, see engine coolant	7-27
Crankcase emission control system	7-89
Cruise control system, see advanced smart cruise control system	5-38
Cup holder	3-146
Curtain air bag	2-60

D

Dashboard illumination, see instrument panel illumination	3-64
Dashboard, see instrument cluster	3-62
Daytime running light	3-113
Defogging (Windshield).....	3-138
Defroster (Rear window)	3-122
Defrosting (Windshield).....	3-138
Dimensions.....	8-2
Display illumination, see instrument panel illumination	3-64
Displays, see instrument cluster.....	3-62
Door courtesy lamp	3-119
Door locks	3-14
Central door lock switch	3-16
Child-protector rear door lock.....	3-17
Drinks holders, see cup holders	3-146
Drive mode integrated control system	
ECO mode	5-34
SNOW mode	5-35
SPORT mode.....	5-35
Driver position memory system.....	3-40
Driver's air bag	2-54
Driving at night	5-69
Driving in flooded areas.....	5-70
Driving in the rain.....	5-70

E

Economical operation.....	5-65
Electric chromic mirror (ECM) with HomeLink® system and compass ..	3-44, 3-51
Electric parking brake (EPB)	5-19
Electronic controlled suspension (ECS)	5-36
Electronic hydraulic power steering (EHPS).....	3-42
Electronic stability control (ESC).....	5-28
Emergency starting.....	6-4
Jump starting	6-4
Emergency towing	6-22
Emergency while driving	6-2

Index

Emission control system	7-89
Crankcase emission control system	7-89
Evaporative emission control system.....	7-89
Exhaust emission control system	7-90
Engine compartment	1-6
Engine compartment fuse.....	7-59
Engine coolant.....	7-27
Engine coolant temperature gauge.....	3-66
Engine number	8-7
Engine oil	7-25
Engine overheating.....	6-6
Engine start/stop button	5-7
Evaporative emission control system.....	7-89
Exhaust emission control system	7-90
Explanation of scheduled maintenance items	7-23
Exterior care	7-83
Exterior overview (Front)	1-2
Exterior overview (Rear)	1-3

F

Flat tire	6-12
Changing tires	6-13
Compact spare tire.....	6-17
Jack and tools	6-12
Removing and storing the spare tire	6-13
Floor mat anchor(s).....	3-150
Fluid	
Brake fluid.....	7-30
Power steering fluid	7-31
Washer fluid	7-32
Fog light	3-113
Front seat adjustment	2-4
Fuel Economy	3-87
Fuel filler lid.....	3-34
Fuel gauge	3-67
Fuel requirements.....	F-8
Fuse switch.....	7-58

Fuses.....	7-56
Engine compartment fuse.....	7-59
Fuse switch.....	7-58
Fuse/relay panel description.....	7-60
Instrument panel fuse.....	7-57

G

Gauges.....	3-65
Glove box.....	3-141
Glove box lamp.....	3-120

H

Hazard warning flasher.....	6-2
Hazardous driving conditions.....	5-67
Head restraint (front seat).....	2-6
Head restraint (rear seat).....	2-17
Head up display (HUD).....	3-100
Headlamp position.....	3-111
Headlight (Headlamp) escort function.....	3-109
Headlight bulb replacement.....	7-70
Headlight leveling device.....	3-113
Headlight welcome.....	3-121
Heated steering wheel.....	3-43
Height adjustment.....	2-24
Heater	
Automatic climate control system.....	3-123
High beam operation.....	3-111
Highway driving.....	5-71
Hill-start assist control (HAC).....	5-32
Hood.....	3-33
Horn.....	3-43
How to use this manual.....	F-6

I

If the engine will not start.....	6-3
Immobilizer system	3-10
Indicator light.....	3-96
Information mode.....	3-71
Instrument cluster.....	3-62
Automatic transmission shift indicator	3-68
Gauges	3-65
Instrument panel illumination	3-64
LCD display control.....	3-64
Instrument panel fuse.....	7-57
Instrument panel overview.....	1-5
Interior care	7-88
Interior features	3-145
Ashtray	3-145
Aux, USB and iPod® port	3-153
Bag hanger.....	3-150
Clothes hanger.....	3-150
Cup holder	3-146
Floor mat anchor(s)	3-150
Luggage net (holder)	3-151
Power outlet.....	3-148
Rear curtain	3-152
Rear vanity mirror	3-147
Sunvisor.....	3-147
Interior light.....	3-118
Door courtesy lamp	3-119
Glove box lamp	3-120
Map lamp (front)	3-118
Map lamp (rear).....	3-119
Room lamp (front).....	3-118
Room lamp (rear)	3-119
Trunk room lamp.....	3-119
Vanity mirror lamp	3-120
Interior light welcome.....	3-121
Interior overview	1-4
Interior rearview mirror	3-44

J

Jack and tools	6-12
Jump starting	6-4

K

Keys	
Battery replacement	3-12
Card key	3-6
Smart key	3-6
Knee air bag	2-54

L

Label	
Air bag warning label	2-68
Certification label	5-80
Refrigerant label	8-7
Tire and loading information label	5-76
Tire sidewall labeling	7-48
Tire specification and pressure label	8-6
Vehicle certification label	8-6
Lane departure warning system (LDWS)	5-51
LCD display	3-69
A/V Mode	3-70
ASCC/LDWS mode	3-70
Information mode	3-71
LCD modes	3-69
Trip computer mode	3-70
Turn by turn mode (TBT)	3-70
User settings mode	3-72
Warning Messages	3-78
LCD display control	3-64
LCD modes	3-69
Light bulbs	7-69

Index

Lighting	3-109
AFLS (Adaptive Front Lighting System)	3-114
Auto light/AFLS position	3-110
Battery saver function	3-109
Daytime running light	3-113
Front fog light.....	3-113
Headlamp position.....	3-111
Headlight (Headlamp) escort function.....	3-109
Headlight leveling device	3-113
High beam operation	3-111
Parking light position	3-111
Turn signals and lane change signals	3-112
Lower anchor system	2-40
Lubricants and capacities	8-4
Luggage net (holder).....	3-151

M

Maintenance	
Explanation of scheduled maintenance items	7-23
Maintenance services	7-5
Owner's maintenance.....	7-7
Scheduled maintenance service.....	7-8
Tire maintenance	7-48
Maintenance services	7-5
Map lamp (front).....	3-118
Map lamp (rear).....	3-119
Mirrors.....	3-44
Electric chromic mirror (ECM) with HomeLink® system and compass.....	3-44, 3-51
Interior rearview mirror.....	3-44
Outside rearview mirror	3-58
Reverse parking aid function	3-61
Moonroof, see sunroof	3-37
Multimedia system.....	4-2
Antenna	4-2
Multi-view camera system.....	3-108

O

Occupant classification system	2-48
Odometer	3-68
Oil (Engine).....	7-25
Outside rearview mirror	3-58
Outside temperature gauge.....	3-68
Overheating	6-6
Owner's maintenance	7-7

P

Parking assist system	3-102
Parking light position	3-111
Passenger's air bag.....	2-54
Power brakes	5-17
Power outlet	3-148
Power steering fluid	7-31
Power trunk	3-19
Power window lock button	3-32
Pre-safe seat belt (PSB)	2-28
Pre-tensioner seat belt.....	2-25
Puddle lamp welcome	3-121

R

Rear console storage	3-142
Rear curtain	3-152
Rear door window curtains	3-31
Rear seat adjustment	2-11
Rear vanity mirror.....	3-147
Rear view camera.....	3-107
Recommended cold tire inflation pressures.....	7-42
Recommended lubricants and capacities	8-4
Recommended SAE viscosity number.....	8-5
Refrigerant label.....	8-7
Replacement light bulb	7-69
Reporting safety defects.....	8-9
Reverse parking aid function	3-61
Road warning	
Hazard warning flasher	6-2

Index

Rocking the vehicle.....	5-68
Room lamp (front).....	3-118
Room lamp (rear).....	3-119
Rotation (Tire).....	7-45

S

Safety messages.....	F-6
Scheduled maintenance service.....	7-8
Seat belt warning.....	2-22
Seat belts.....	2-21
3-point system with emergency locking retractor.....	2-23
Height adjustment.....	2-24
Pre-safe seat belt (PSB).....	2-28
Pre-tensioner seat belt.....	2-25
Seat belt warning.....	2-22
Seat cooler (front seat).....	2-9
Seat cooler (rear seat).....	2-19
Seat warmer (front seat).....	2-9
Seat warmer (rear seat).....	2-19
Seatback pocket.....	2-10
Seats.....	2-2
Armrest (rear seat).....	2-18
Front seat adjustment.....	2-4
Head restraint (front seat).....	2-6
Head restraint (rear seat).....	2-17
Rear seat adjustment.....	2-11
Seat cooler (front seat).....	2-9
Seat cooler (rear seat).....	2-19
Seat warmer (front seat).....	2-9
Seat warmer (rear seat).....	2-19
Seatback pocket.....	2-10
Shift lock system.....	5-14
Side air bag.....	2-58
Smart key.....	3-6
Smart trunk.....	3-24
Smooth cornering.....	5-69
Snow tires.....	5-72

Spare tire	
Changing tires	6-13
Compact spare tire.....	6-17
Compact spare tire replacement	7-47
Removing and storing the spare tire	6-13
Special driving conditions.....	5-67
Driving at night	5-69
Driving in flooded areas.....	5-70
Driving in the rain	5-70
Hazardous driving conditions.....	5-67
Highway driving.....	5-71
Rocking the vehicle.....	5-68
Smooth cornering	5-69
Speedometer.....	3-65
Sports mode.....	5-13
SRS components and functions	2-45
Starting difficulties, see engine will not start	6-3
Steering wheel.....	3-42
Electronic hydraulic power steering (EHPS).....	3-42
Heated steering wheel	3-43
Horn.....	3-43
Tilt steering/Telescope steering.....	3-42
Storage compartment	3-141
Center console storage	3-141
Cool and warm box	3-143
Glove box	3-141
Rear console storage.....	3-142
Sunglass holder	3-142
Sunglass holder	3-142
Sunroof.....	3-37
Sunvisor.....	3-147

T

Tachometer	3-66
Tether anchor system	2-38
Theft-alarm system.....	3-13
Three-point system with emergency locking retractor	2-23
Tilt steering/Telescope steering.....	3-42
Tire and loading information label	5-76
Tire chains	5-73

Index

Tire pressure monitoring system (TPMS).....	6-7
Tire rotation.....	7-45
Tire specification and pressure label.....	8-6
Tires specifications.....	8-3
Tires and wheels.....	7-42
Checking tire inflation pressure	7-44
Compact spare tire replacement	7-47
Low aspect ratio tire.....	7-51
Recommended cold tire inflation pressures	7-42
Tire care.....	7-42
Tire maintenance	7-48
Tire replacement.....	7-46
Tire rotation	7-45
Tire sidewall labeling.....	7-48
Tire terminology and definitions.....	7-52
Tire traction	7-47
Wheel alignment and tire balance.....	7-45
Wheel replacement.....	7-47
Towing.....	6-20
Trailer towing.....	5-81
Transmission	
Automatic transmission.....	5-11
Trip A/B.....	3-86
Trip computer.....	3-86
Fuel Economy	3-87
Trip A/B.....	3-86
Trip computer mode.....	3-70
Trunk	
Emergency trunk safety release	3-23
Non-powered trunk	3-18
Power trunk	3-19
Smart trunk.....	3-24
Trunk room lamp.....	3-119
Turn by turn mode (TBT).....	3-70
Turn signals and lane change signals.....	3-112

U

User settings mode.....	3-72
-------------------------	------

V

Vanity mirror lamp	3-120
Vehicle break-in process	F-11
Vehicle certification label.....	8-6
Vehicle data collection and event data recorders.....	F-12
Vehicle identification number (VIN)	8-6
Vehicle load limit	
Certification label.....	5-80
Tire and loading information label.....	5-76
Vehicle weight.....	5-82

W

Warning light.....	3-89
Warning Messages.....	3-78
Washer fluid	7-32
Welcome system.....	3-121
Headlamp	3-121
Interior light	3-121
Puddle lamp	3-121
Wheel alignment and tire balance.....	7-45
Wheel replacement.....	7-47
Windows.....	3-28
Power window lock button.....	3-32
Rear door window curtains	3-31
Windshield defrosting and defogging	3-138
Windshield washer	3-117
Windshield wipers.....	3-115
Winter driving	5-72
Snow tires	5-72
Tire chains	5-73
Wiper blades.....	7-36
Wipers and washer	3-115
Windshield washer	3-117
Windshield wipers	3-115

MEMO

WARRANTIES FOR YOUR HYUNDAI VEHICLE

Please consult your Owner's Handbook & Warranty Information booklet for your vehicle's specific warranty coverage.

RESPONSIBILITY FOR MAINTENANCE

The maintenance requirements for your new HYUNDAI are found in Chapter 7. As the owner, it is your responsibility to see that all maintenance operations specified by the manufacturer are carried out at the appropriate intervals. When the vehicle is used in severe driving conditions, more frequent maintenance is required for some operations. Maintenance requirements for severe operating conditions are also included in Chapter 7.

This Owner's Manual should be considered a part of the car and remain with it when it is sold for the use of the next owner.

OWNER'S INFORMATION

ORIGINAL OWNER _____

ADDRESS _____

CITY _____ STATE _____ ZIP CODE _____

DELIVERY DATE _____

(Date Sold to Original Retail Purchaser)

DEALER NAME _____ DEALER NO. _____

ADDRESS _____

CITY _____ STATE _____ ZIP CODE _____