

WALK THE CUSTOMER THROUGH EACH OF THE FOLLOWING KEY DELIVERY FEATURES

- ☐ CLIMATE CONTROL – pages 12-13
 - Explain the different air modes to customer.

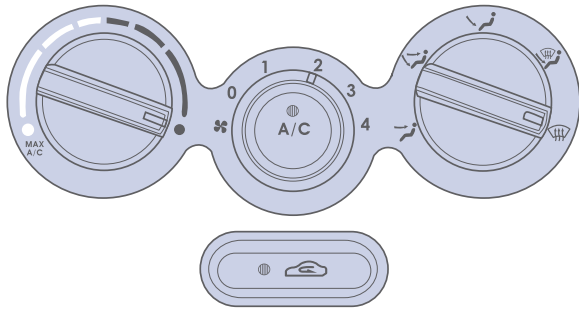

- ☐ TIRE PRESSURE MONITORING SYSTEM (TPMS) – page 22
 - Explain TPMS function to customer.
 - When illuminated, one or more tires are under-inflated.
 - Blinks for approximately one minute then remains illuminated when there is a malfunction with the TPMS.



- ☐ CLOCK ADJUSTMENT – page 20
 - With Radio Off
 - 1. Press and hold the SETUP button until the clock blinks.
 - 2. Rotate the TUNE knob **A** to adjust.
 - 3. Press TUNE knob **A** when done.

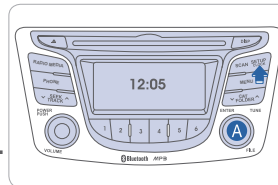

- ☐ VEHICLE SETTINGS – pages 10-11
 - Demonstrate vehicle settings in instrument cluster
 - Show radio presets

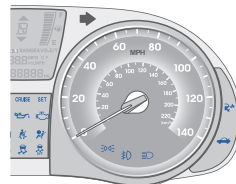

- ☐ BLUETOOTH – page 18
 - Demonstrate phone pairing
 - Refer to www.hyundaiusa.com/bluetooth
 - Demonstrate QR code



MAINTENANCE

Scheduled Maintenance	Normal Usage		Severe Usage*	
Engine Oil and Filter*	Replace	7,500 or 12 mos.	Replace	3,750 or 6 mos.
Fuel Additive *1	Add	7,500 or 12 mos.	Add	Same As Normal
Tire Rotation	Perform	7,500	Perform	7,500
Air Cleaner Filter	Inspect Replace	7,500 30,000	Inspect Replace	Same As Normal More Frequently
Battery Condition	Inspect	7,500	Inspect	Same As Normal
Vacuum Hose	Inspect	7,500	Inspect	Same As Normal
Climate Control Air Filter (For A/C and Heater unit)	Replace	15,000	Replace	More Frequently
Air Conditioning Refrigerant	Inspect	15,000	Inspect	Same As Normal
Brake Hoses & Lines	Inspect	15,000	Inspect	Same As Normal
Front Brake Disc / Pads, Calipers	Inspect	15,000	Inspect	More Frequently
Rear Brake Disc / Pads	Inspect	15,000	Inspect	More Frequently
Drive Shafts & Boots	Inspect	15,000	Inspect	More Frequently
Exhaust Pipe & Muffler	Inspect	15,000	Inspect	Same As Normal
Fuel Tank Air Filter	Inspect	30,000	Inspect	Same As Normal
Steering Gear Box, Linkage & Boots/ Upper & Lower Arm Ball Joints	Inspect	15,000	Inspect	7,500 or 6 mos.
Suspension Mounting Bolts	Inspect	15,000	Inspect	Same As Normal
Brake / Clutch Fluid	Inspect	30,000	Inspect	Same As Normal
Fuel Lines, Fuel Hoses and Connections	Inspect	30,000	Inspect	Same As Normal
Parking Brake	Inspect	30,000	Inspect	More Frequently
Spark Plugs (Iridium Coated)	Replace	105,000	Replace	More Frequently
Vapor Hose & Fuel Filler Cap	Inspect	30,000	Inspect	Same As Normal
Automatic Transaxle Fluid	No check, No service required		Replace	60,000
Manual Transaxle Fluid	Inspect	37,500	Replace	75,000
Fuel Filter	Inspect	30,000	Replace	More Frequently
Valve Clearance	Inspect	60,000	Inspect	Same As Normal
Coolant	1st Replace 120,000 or 120 mos. Add'l Replace 30,000 or 24 mos.		Replace	Same As Normal
Drive Belt	1st Inspect 60,000 or 72 mos. Add'l Inspect 15,000 or 24 mos.		Inspect	Same As Normal

*Check the engine oil regularly between recommended oil change. Hyundai recommends Quaker State oil.
*1 If TOP TIER Detergent Gasoline is not available, one bottle of additive is recommended. Additives are available from your authorized Hyundai dealer along with information on how to use them. Do not mix other additives.

*See Owner's Manual for details.

Looking for more detailed information? This Quick Reference Guide does not replace your vehicle's Owner's Manual. If you require additional information or are unsure of a specific issue, you should always refer to the vehicle's Owner's Manual or contact your authorized Hyundai dealer.

The information contained in this Quick Reference Guide was correct at the time of printing; however, specifications and equipment can change without notice. No warranty or guarantee is being extended in this Quick Reference Guide, and Hyundai reserves the right to change product specifications and equipment at any time without incurring obligations. Some vehicles are shown with optional equipment. Specifications apply to U.S. vehicles only. Please contact your Hyundai dealer for current vehicle specifications.

NP150-Q2015
(REV 06/10/15)
Printed 06/13/15

HYUNDAI

ACCENT

Quick Reference Guide

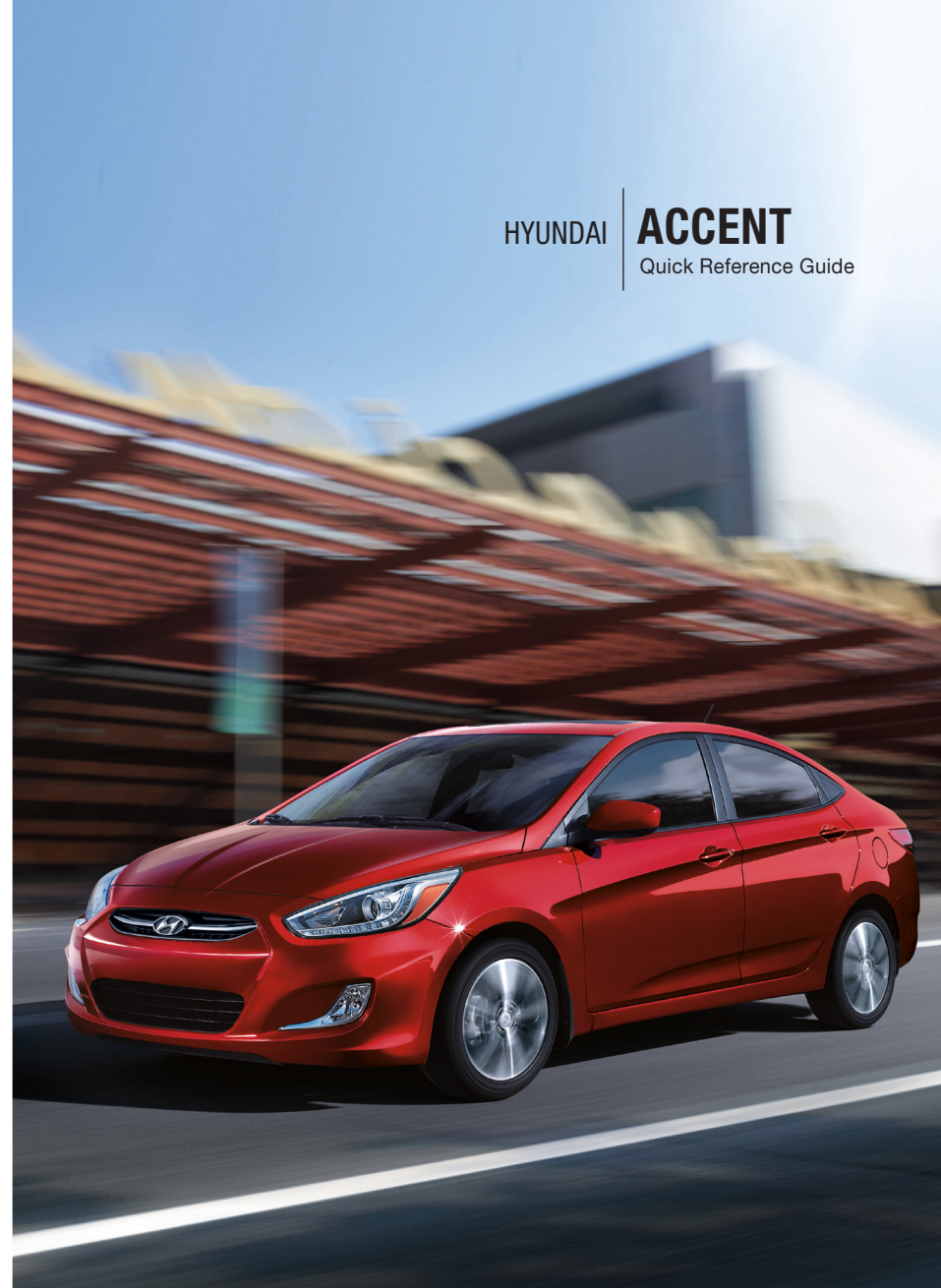

www.hyundai.com

HYUNDAI
NEW THINKING.
NEW POSSIBILITIES.

Roadside Assistance: **1-800-243-7766**
Consumer Affairs: **1-800-633-5151**
XM® Radio: **1-800-967-2346**

Table of contents

GETTING STARTED

Front seat adjustment	02
Headrest adjustment	03
Remote keyless entry	02
Seat belt adjustment	03

FEATURES AND CONTROLS

Active ECO system	23
Central door lock switch	05
Child-protector rear door lock (4Door)	08
Clock adjustment	20
Climate control	12-13
Cruise control	14
Driver's main controls	05
Electronic stability control (ESC)	22
Fuel filler lid	04
Head lights and fog lights	06
Instrument cluster	10-11
Instrument panel illumination	11
Interior lights	08
Rear seat folding	09
Steering wheel adjustment	04
Steering wheel functions	14-15
Tire Pressure Monitoring System (TPMS)	22
Transmission	21
Trip computer	11
Wiper and washer	07

MULTIMEDIA

Audio	19
AUX, USB and iPod port	20
Bluetooth operational tips	16-17
Bluetooth phone pairing	18
Voice recognition tips	17

FREQUENTLY ASKED QUESTIONS

- Pair phone to your vehicle. Refer to page 18.



Head lights and fog lights
Page 06

Instrument cluster
Pages 10-11

Steering wheel adjustment
Page 04

Wiper and washer
Page 07



Audio
Page 19

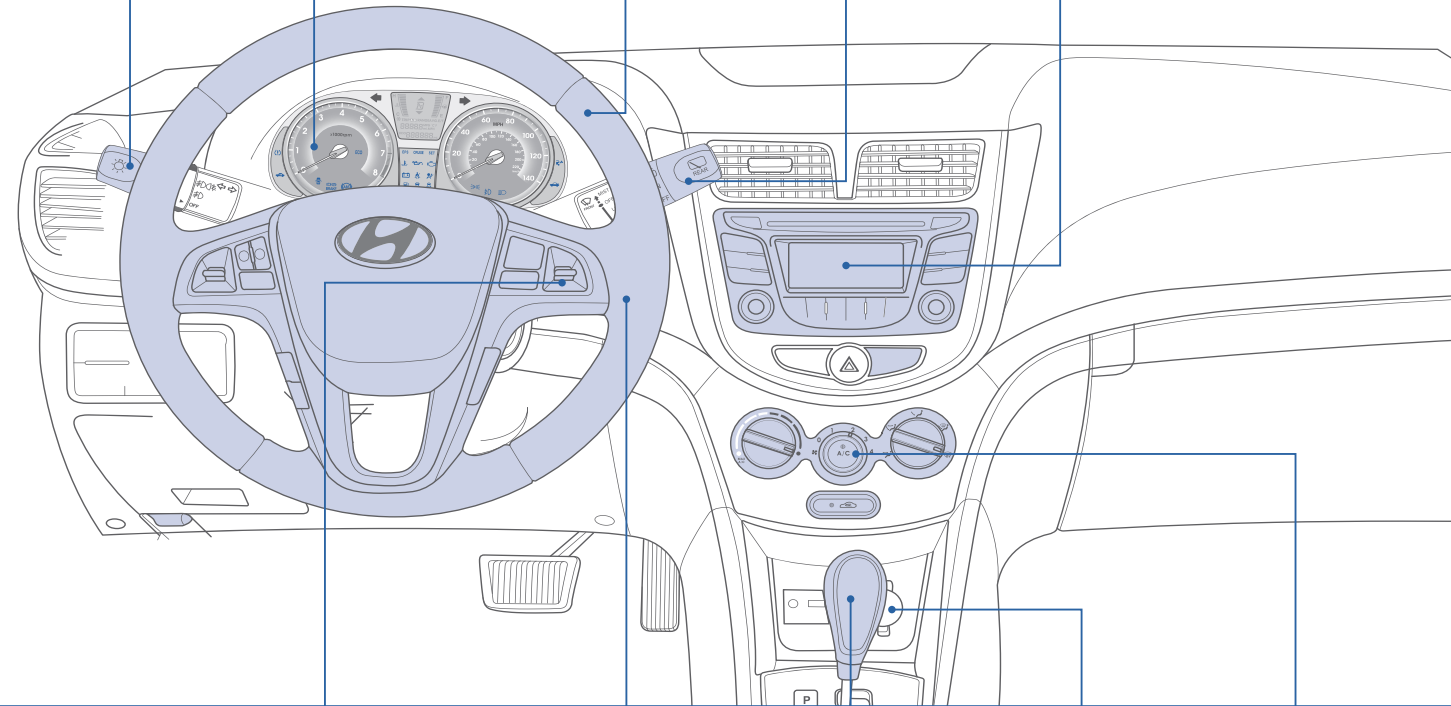

Cruise control system
Page 14

Trip computer**
Page 11



Transmission
Page 21



AUX, USB and iPod port
Page 20



Climate control
Pages 12-13

Use this Quick Reference Guide to learn about the features that will enhance your enjoyment of your Hyundai. More detailed information about these features are available in your Owner's Manual.

WARNING!

To reduce the risk of serious injury to yourself and others, read and understand the important SAFETY INFORMATION in your Owner's Manual.

*Some vehicles may not be equipped with all the listed features.

** behind steering wheel

REMOTE KEYLESS ENTRY

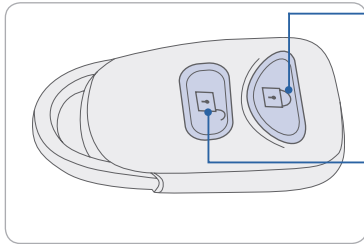

Lock (🔒)

Press the button.
Once - Lock
Twice - Confirmation chirp

Unlock (🔓)

Press the button.
Once - Unlock driver's door
Twice - Unlock all doors

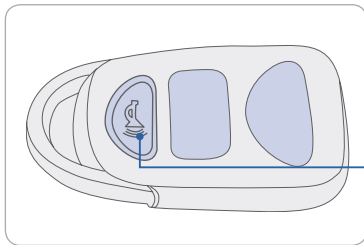

You can change the system to unlock all doors by pressing the button once. If you want this feature, refer to the Owner's Manual.

Panic (📢)

Press and hold.
Press any button to turn off panic.

HEADREST ADJUSTMENT

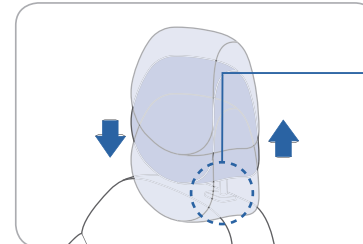

Height adjustment

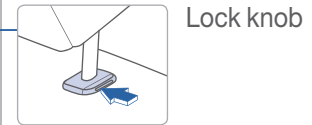

To raise headrest height, pull up on headrest.

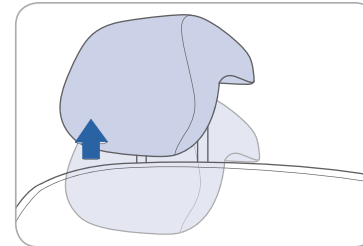

To lower headrest, press lock knob while pushing down on headrest.

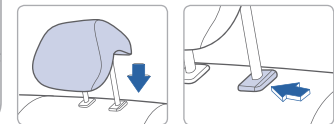

FRONT SEAT ADJUSTMENT

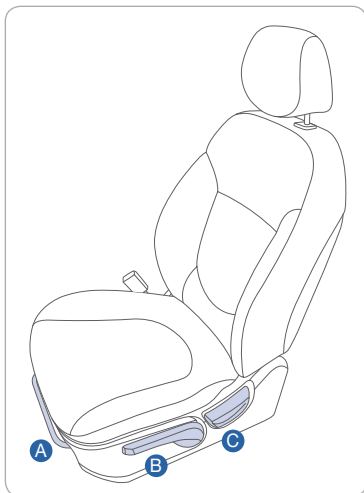

A Forward and backward

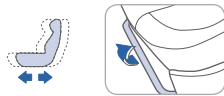

B Seat cushion height (driver's seat only)

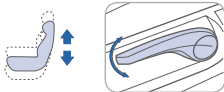

C Seatback angle



SEAT BELT ADJUSTMENT (Front seat)

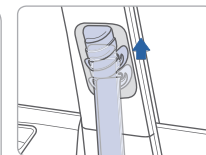
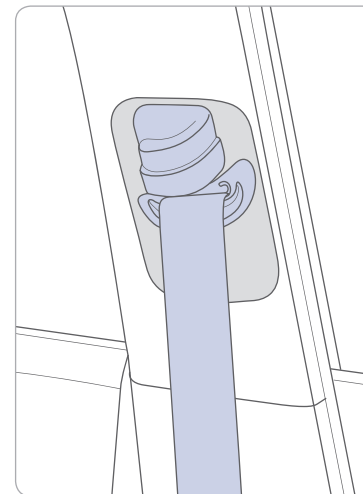

Pull up to raise.

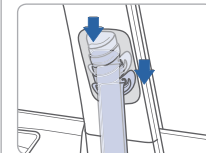

Press button and push down to lower.

STEERING WHEEL ADJUSTMENT

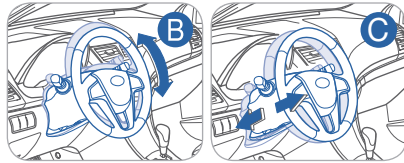
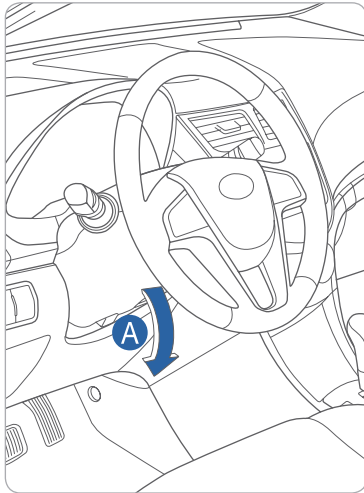

Tilt

Telescopic

1. Pull the lever **A** down.
2. Set the angle **B** and height **C**.
3. Pull the lever **A** upward to lock in place.

NOTE

Do not adjust the steering wheel while driving.

FUEL FILLER LID

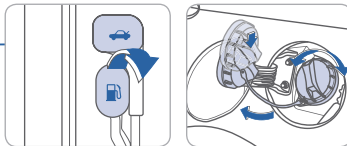
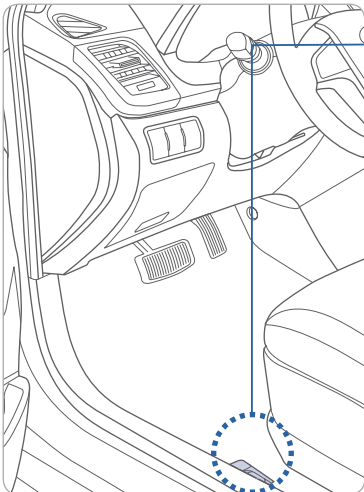

NOTE

After adding fuel, always reinstall the fuel cap onto the filler neck by rotating it clockwise until it clicks one time.

Failure to do this may result in the Check Engine Light illuminating.

Check the engine oil regularly between recommended oil changes.

DRIVER'S MAIN CONTROLS

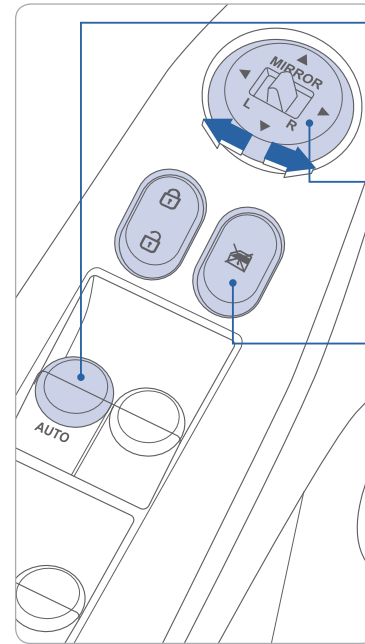

Window Auto down/up (driver's side only)

Press past detent to fully open/close window.

Outside Rearview Mirrors

Press L (left) or R (right) on the switch. Then adjust the mirror by using the directional switch.

Power Window Lock Switch

Disables the power window switches on the passenger doors.



CENTRAL DOOR LOCK SWITCH

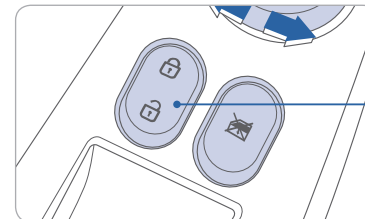

Door Lock

Locks/unlocks all doors.

FEATURES AND CONTROLS

HEAD LIGHTS AND FOG LIGHTS

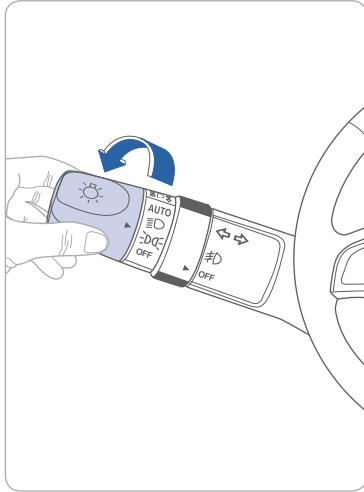

- ▶ | **AUTO** Auto light position
- ▶ | Head light position
- ▶ | Parking light position
- ▶ | **OFF** OFF position

Turn signals and lane change signals

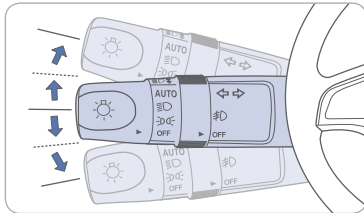

Flashing head lights

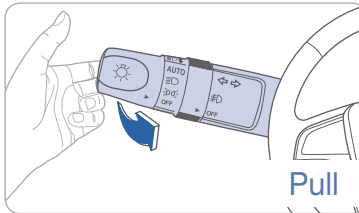

High beam

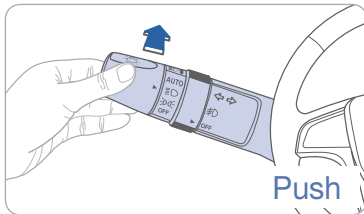

Fog light

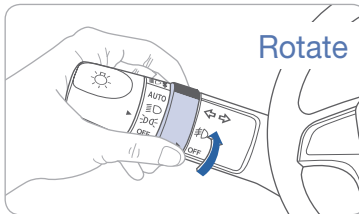

WIPER AND WASHER

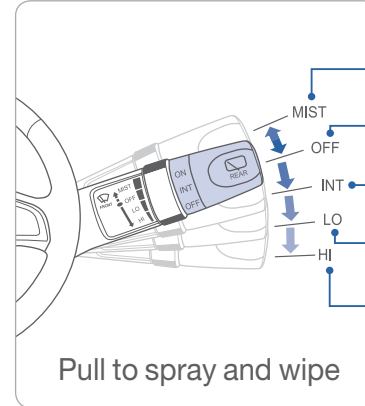

- MIST** - Single wipe
- OFF** - Off
- INT** - Intermittent wipe
- LO** - Low wiper speed
- HI** - High wiper speed

Pull to spray and wipe

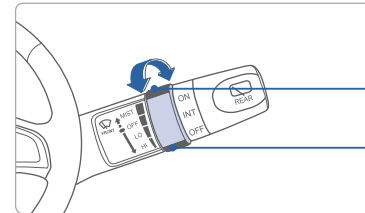

Intermittent wipe time adjustment

- Fast wiper speed
- Slow wiper speed

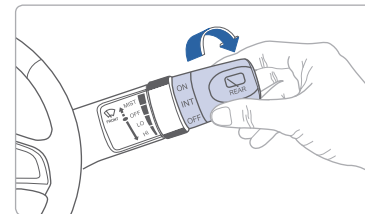

Rear wiper / washer control

- ON** - Continuous wipe
- INT** - Intermittent wipe
- OFF** - Off

Push to spray and wipe.





FEATURES AND CONTROLS

INTERIOR LIGHTS

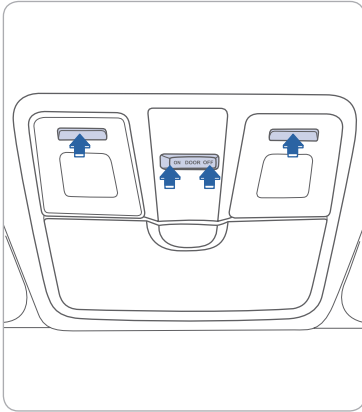

ON

Light will turn on.

DOOR

Light will turn on when any door is open except trunk.

With the ignition switch off, lights will stay on for approximately 30 seconds after door is closed. The lights will turn off immediately if the doors are locked or when the ignition is ON.

NOTE

If the lights are left on for more than 20 minutes with the ignition switch off, they will automatically turn off to prevent a dead battery.

OFF

The lights stay off at all times, except when individually turned on.

CHILD-PROTECTOR REAR DOOR LOCK

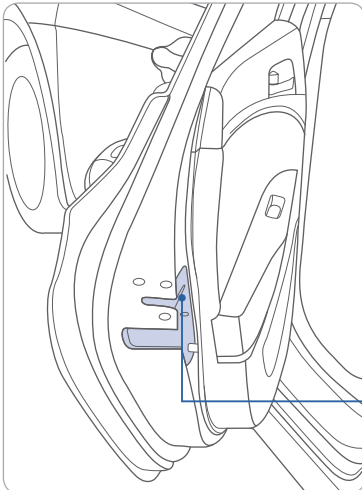

Lock (🔒)

Move the lever to the “🔒” position.

Unlock (←)

Move the lever to the “←” position.

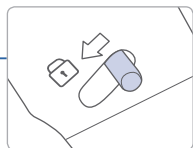

REAR SEAT FOLDING

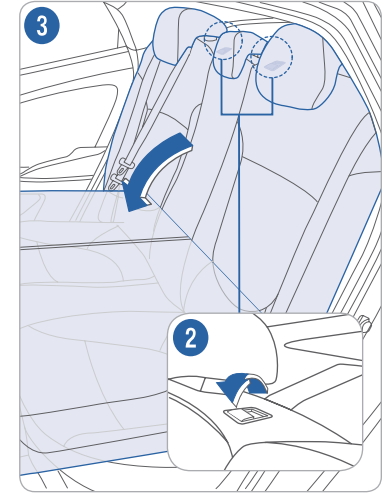
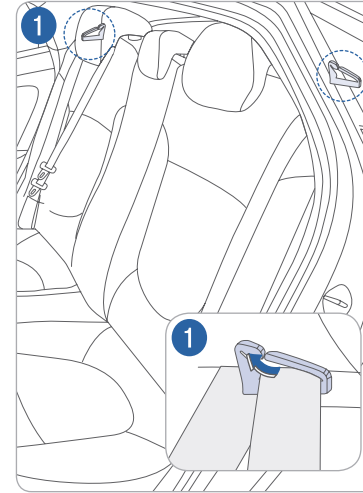

1. Disconnect the shoulder belt.
2. Pull up the release lever.
3. Fold down the seatback.





FEATURES AND CONTROLS

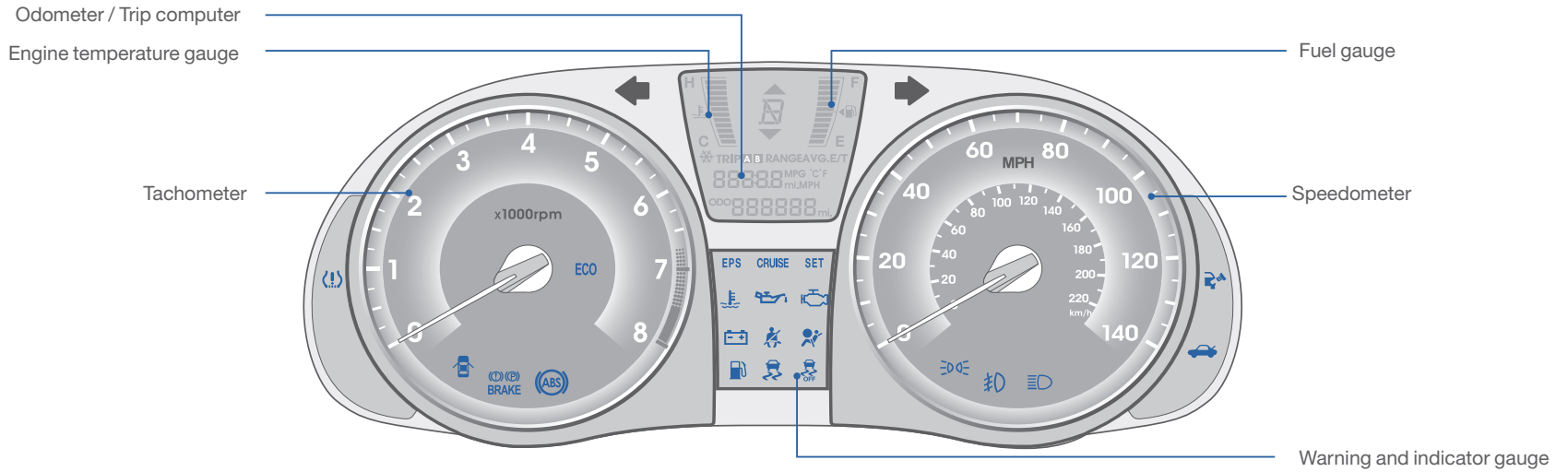

WARNINGS AND INDICATORS

Air bag warning light	Parking brake & Brake fluid warning light	ABS warning light
Seat belt warning light	Low Tire Pressure Indicator / TPMS (Tire Pressure Monitoring System) malfunction indicator	
High beam indicator	Engine oil pressure warning light	Charging system warning light
EPS Electric Power Steering system warning light	Door open position indicator	Turn signal indicator
Trunk lid open warning light	Automatic transmission shift indicator	Manual transmission shift indicator
ESC (Electronic Stability Control) OFF indicator	Low fuel level warning light	ESC (Electronic Stability Control) indicator
Cruise SET indicator	CRUISE Cruise indicator	Malfunction indicator light
Tail light indicator	Front fog light indicator	
Engine coolant temperature warning light	ECO ECO indicator	

INSTRUMENT PANEL ILLUMINATION

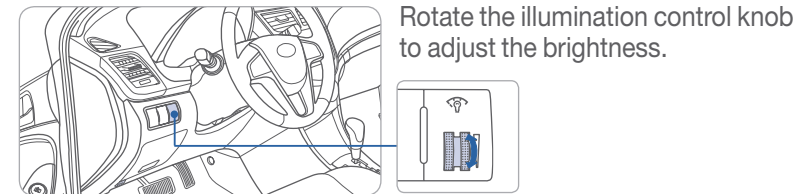

TRIP COMPUTER

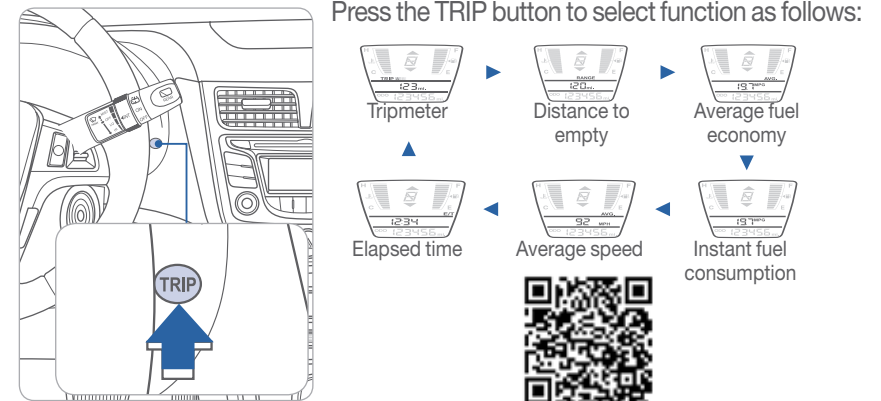

FEATURES AND CONTROLS

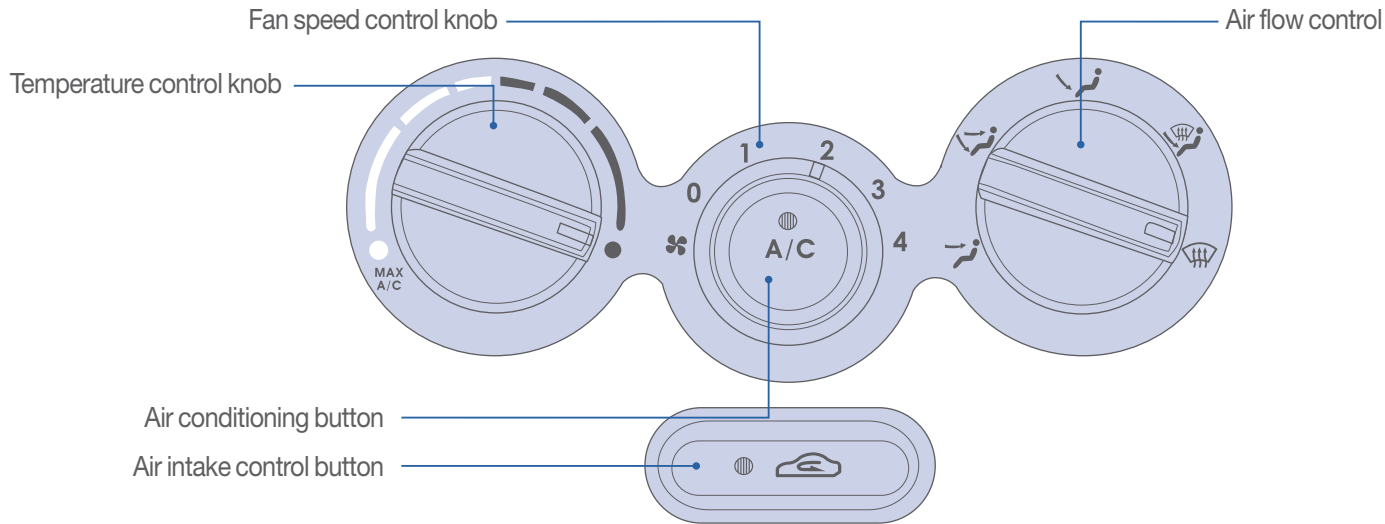

DEFROSTING / DEFOGGING

1. Set the air flow control to the defrost air position.
2. Set the temperature control to the warmest position.
3. Set the fan speed to the highest position.

AIR INTAKE CONTROL

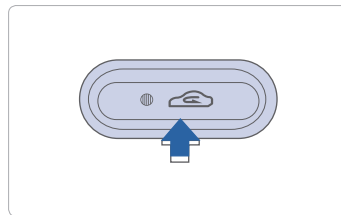

- Outside (fresh) air position
- Recirculated air position

MODE SELECTION

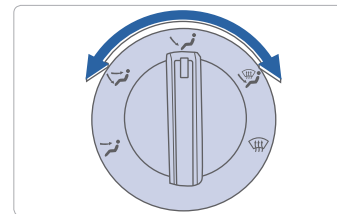

Change the direction of the air flow as follows:

- Face Level
- Bi Level
- Floor Level
- Floor/Defrost Level
- Defrost Level

REAR WINDOW DEFROSTER

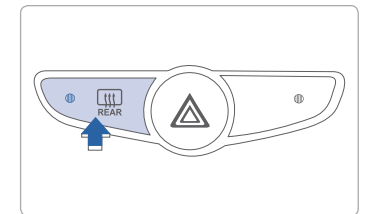

Press to activate/deactivate the rear defroster.

NOTE

To reduce tendency of the glass fogging and also to improve visibility, keep the interior surface of the windshield clean by wiping it with a clean cloth and glass cleaner. In addition, select air intake control to the outside (fresh) air position whenever possible while operating the vehicle.



FEATURES AND CONTROLS

STEERING WHEEL FUNCTIONS

Cruise Control

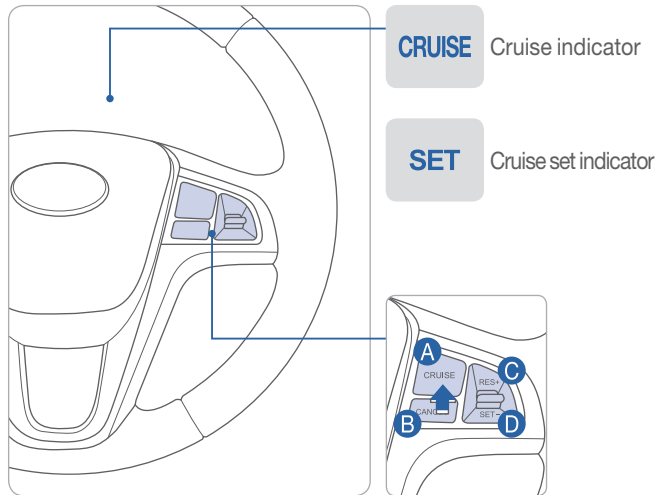

To Set a Cruising Speed

1. Press CRUISE button **A** and the CRUISE indicator will illuminate in the instrument cluster. Accelerate to desired cruising speed (above 25 mph).
2. Toggle SET - button **D** down and remove your foot from the accelerator pedal.

To Accelerate or Decelerate

Toggle RES + button **C** up to increase set cruising speed.
 Toggle SET - button **D** down to decrease set cruising speed.

To Cancel Cruising Speed

Press CANCEL button **B**, or depress brake pedal, or press CRUISE button **A**.

Audio Control

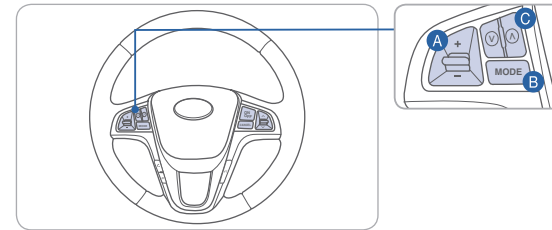

- A VOLUME**
Raises or lowers speaker volume.
- B MODE**
(Press and hold to turn Audio On/OFF.)
Change the audio source.
- C SEEK/PRESET**
Change station

Please refer to your Owner's Manual for more detailed information on how to use your audio system.
 Complimentary XM® subscription ends three months following the vehicle date of sale.
 Please contact XM® Radio at 1-800-XM-RADIO (1-800-967-2346) to renew your XM® subscription.

Bluetooth Control

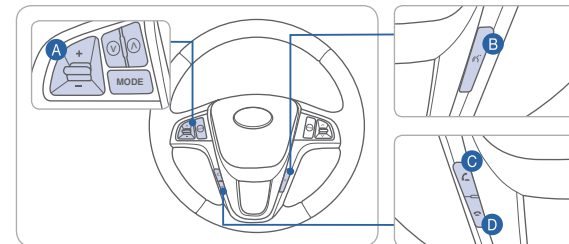

- A VOLUME**
Raises or lowers speaker volume.
- B TALK**
Activates voice recognition.
- C CALL**
Places and transfers calls.
- D END**
Ends calls or cancels functions.

*Bluetooth is a wireless technology that allows multiple devices to be connected in a short range, low powered devices like hands-free, stereo headset, wireless remocom, etc. For more information, visit the website at www.bluetooth.com



MULTIMEDIA



BLUETOOTH OPERATIONAL TIPS

In the following situations you or the other party may have difficulty hearing each other:

1. Keep the Bluetooth volume to a low level. High level volume may result in distortion and echo.
2. When driving on a rough road, high speeds and/or with the window open.
3. When the air conditioning vents are facing the microphone and/or when the air conditioning fan is at the max speed.

Steering wheel bluetooth control

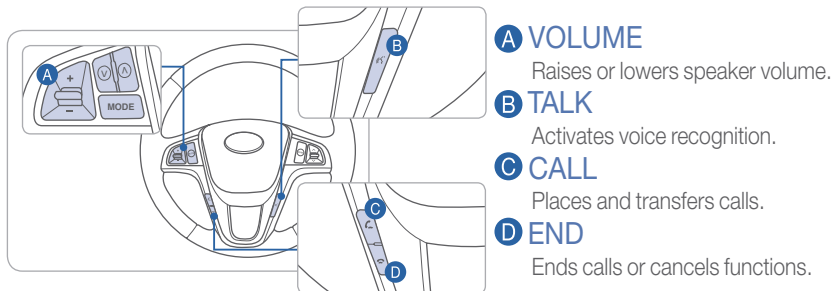

To Answer a Call:

- Press button on the steering wheel.

To Reject a Call:

- Press button on the steering wheel.

To Adjust Ring Volume:

- Use the VOLUME buttons on the steering wheel.

To Transfer a Call to the Phone

(Secret Call):

- Press and hold button on the steering wheel until the audio system transfers a call to the phone.

To Finish a Call:

- Press button on the steering wheel.

Making a call using voice recognition:

The menu tree identifies available voice recognition Bluetooth® functions.

Calling by Name:

1. Press button.
2. Say the following command:
 - “Call <John>”: Connects the call to John.
 - “Call <John> on <Mobile/Home/Office>”: Connects the call to John’s Mobile, Home, or Office phone number.

Dialing by Number:

1. Press button.
2. Say “Call”.
3. Say “By number” when prompted.
4. Say desired phone numbers.
5. Say “Dial” to complete the number and make a call.

For complete list of commands, refer to your Owner’s Manual.

VOICE RECOGNITION TIPS

Your vehicle is equipped with Voice Recognition technology which allows drivers to operate their phones without having to take their eyes off the road to minimize distractions.

Voice recognition performance may be affected if driving with windows and sun roof open; when the heating-cooling system is on; when passing a tunnel or when driving on rugged and uneven roads.

Quick reference on using voice commands

To start voice command. Press the key, the following commands are available:

Command	Function
More Help	Provides guidance on commands that can be used anywhere in the system
Help	Provides guidance on commands that can be used within the current mode.
Calls <Name>	Calls <Name> saved in Contacts. Ex) Call “John”
Dial <Number>	Call can be made by dialing the spoken numbers. Ex) Call “123”
Phone	Provides guidance on Phone related commands. After saying this command, say “Call History”, “Contacts” to execute corresponding functions.
Call History	Displays the Call History screen.
Contacts (Call by Name)	Displays the Contacts screen. After saying this command, say the name of a contact saved in the Contacts to automatically connect the cell.
Dial Number	Display the Dial number screen. After saying this command, you can say the number what you want to call.



MULTIMEDIA

BLUETOOTH PHONE PAIRING

Pairing tutorials, phone compatibility and Operational tips can be found through the Smart QR code using the QR reader application on your Smartphone.



Phone setup (pairing phone) with Audio

1. Push the PHONE button **A**.
2. Select "Phone" item by rotating the TUNE knob **B**, then press TUNE knob **B** to select.

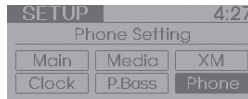
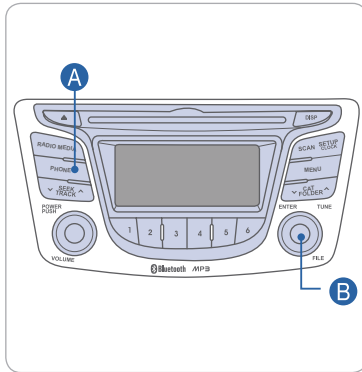

3. Select "Pair" by rotating the TUNE knob **B**, then press TUNE knob **B**.



4. Enable Bluetooth on your mobile phone. Select ACCENT from the Bluetooth device list on your mobile phone.
5. Input passkey displayed on the screen.
6. After pairing is completed, your phone may start to transfer phone/contact list to the audio system.
 - This process may take a few minutes depending on the phone model and number of entries in the phone/contact list.
 - Some phones may request approval to download phone/contact list to the audio system. (If approval is not granted, the phone may frequently disconnect or not download phone/contact list.)

NOTE

Vehicle must be parked to complete pairing process.

- The phone will pair if the ignition is set to ACC or ON.
- If standing outside and the ignition is set to ACC or ON, the phone may pair depending on the phone radio frequency.



AUDIO

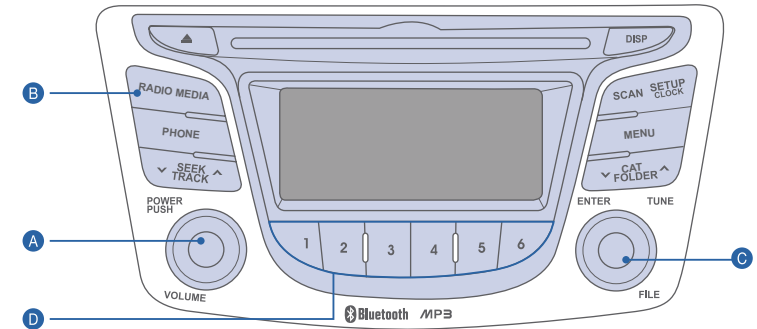

Press POWER button **A** to turn radio on.

- TUNING / LISTENING TO CHANNELS
 1. Press RADIO **B**.
 2. Rotate TUNE knob **C** to desired channel.



NOTE

- A clear view of the southern sky is recommended to ensure XM[®] radio reception.
- SETTING PRESET MEMORY BUTTONS (FM/AM/XM[®])

Press and hold any preset button (1-6) **D** until audible beep is heard to store current channel.
- ADJUSTING THE SOUND CONTROL
 1. Press TUNE knob **C** to select.
 2. Select "Bass / Mid / Tre / Fad / Bal" by rotating TUNE knob **D**, then press TUNE knob **D** to select.
 3. Rotate TUNE knob **D** to adjust, then press TUNE knob **D**.
 4. Press TUNE knob **D** when done.

Please refer to your Owner's Manual for more detailed information on how to use your audio system. Complimentary XM subscription ends three months following the vehicle date of sale. Please contact XM Radio at 1-800-XM-RADIO (1-800-967-2346) to renew your XM subscription.



ELECTRONIC STABILITY CONTROL (ESC)

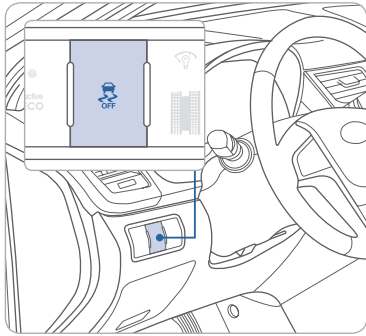

The ESC system is an electronic system designed to help the driver maintain vehicle control under adverse conditions.

- To turn the ESC off, press the ESC OFF button.
- To turn ESC on, press it again.
- System defaults to ON position at start.



ACTIVE ECO SYSTEM

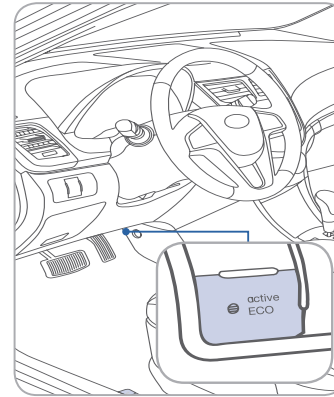

Active ECO system (automatic transmission)

Active ECO system helps to improve fuel efficiency. When the Active ECO system is activated, the vehicle acceleration, gear shift points and air conditioning performance will be reduced to conserve the fuel consumption.

Press the Active ECO button to activate. The LED on the button and the ECO indicator in the instrument cluster will illuminate..

Press again to deactivate.

Active ECO on – For optimal fuel efficiency

Active ECO off – For optimal performance and drivability.

When Active ECO system is activated, the behavior of the vehicle will change to a suppressed acceleration and delayed gear shifts under part throttle operation.



ECO shift (manual transmission)

▲or ▼symbol is displayed along with the recommended gear number, which indicates you should upshift or downshift for higher fuel efficiency.

To improve your fuel efficiency:

- Drive smoothly and accelerate at a moderate rate.
- Avoid heavy accelerations.
- Maintain steady cruising speed.
- Adjust the vehicle speed to the traffic condition and avoid speed changes.
- Avoid unnecessary braking.
- Keep the tires inflated to the recommended tire pressure.
- Don't idle the engine longer than necessary.

TIRE PRESSURE MONITORING SYSTEM (TPMS)

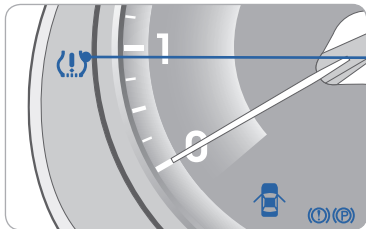

Low Tire Pressure Indicator / TPMS Malfunction Indicator



LOW TIRE PRESSURE INDICATOR

Illuminates if one or more of your tires is significantly under-inflated.

TPMS MALFUNCTION INDICATOR

Blinks for approximately one minute then remains illuminated if there is a malfunction with the TPMS system. Have the system checked by an authorized Hyundai dealer.

NOTE

Tire pressure may vary in colder temperatures causing the low tire pressure light (!) to illuminate.

KEY WEBSITES

Hyundai website - www.hyundai.com

Hyundai owner website - www.myhyundai.com

Bluetooth phone compatibility - www.hyundaiusa.com/bluetooth

