

WALK THE CUSTOMER THROUGH EACH OF THE FOLLOWING KEY DELIVERY FEATURES

- DRIVER SELECTABLE STEERING MODE – pages 35
 - Demonstrate and explain the different steering modes

- BLUETOOTH – pages 22 – 25
 - Show phone compatibility website: www.hyundaiusa.com/bluetooth
 - Make a test call using Bluetooth with the customer's phone
 - Demonstrate Voice Recognition (VR)

- BLUE LINK – page 26 – 27
 - Assist with creating MyHyundai.com account
 - Assist with Blue Link enrollment
 - Show Blue Link Users Manual & tear out Voice Commands/Quick Tip Card
 - Encourage customers to press the Blue link button  after enrollment to initiate Welcome Call

- TIRE PRESSURE MONITORING SYSTEM (TPMS) – page 34
 - Explain TPMS function to customer
 - When illuminated, one or more tires are under-inflated.
 - Blinks for approximately one minute then remains illuminated when there is a malfunction with the TPMS



- VEHICLE SETTINGS – pages 12 – 15 and 29 – 30
 - Demonstrate vehicle settings in instrument cluster
 - Demonstrate navigation use, enter dealer address
 - Show radio presets

- CLOCK – pages 31
 - Demonstrate how to set clock (including daylight savings setting for Navigation equipped vehicles)

MAINTENANCE

Scheduled Maintenance	Normal Usage		Severe Usage*	
Engine Oil and Filter*	Replace	7,500 or 12 mos.	Replace	3,750 or 6 mos.
Fuel Additives	Add	At every Oil and Filter Service	Add	Same As Normal
Tire Rotation	Perform	7,500	Perform	7,500
Fuel System Cleaner Additive	Inspect Replace	7,500 30,000	Inspect Replace	Same As Normal More Frequently
Battery Condition	Inspect	7,500	Inspect	Same As Normal
Vacuum Hose	Inspect	7,500	Inspect	Same As Normal
Climate Control Air Filter	Replace	15,000	Replace	More Frequently
Brake Hoses and Lines	Inspect	15,000	Inspect	Same As Normal
Drive Shafts and Boots	Inspect	15,000	Inspect	7,500 or 6 mos.
Exhaust Pipe and Muffler	Inspect	15,000	Inspect	Same As Normal
Front Brake Disc/Pads, Callipers	Inspect	15,000	Inspect	More Frequently
Rear Brake Disc/Pads	Inspect	15,000	Inspect	More Frequently
Steering Gear Box, Linkage & Boots, Lower/Upper Arm Ball Joint	Inspect	15,000	Inspect	More Frequently
Suspension Mounting Bolts	Inspect	15,000	Inspect	Same As Normal
Propeller Shaft (AWD)	Inspect	15,000	Inspect	7,500 or 6 mos.
Brake Fluid	Inspect	30,000	Inspect	Same As Normal
Fuel Filter	Inspect	30,000	Inspect	Same As Normal
Fuel Lines, Fuel Hoses, and Connections	Inspect	30,000	Inspect	Same As Normal
Fuel Tank Air Filter	Inspect	30,000	Inspect	Same As Normal
Parking Brake	Inspect	30,000	Inspect	More Frequently
Vapor Hose and Fuel Filler Cap, Fuel Tank	Inspect	30,000	Inspect	Same As Normal
Transfer Case Oil (AWD)	Inspect	37,500	Replace	75,000
Rear Axle Oil (AWD)	Inspect	37,500	Replace	75,000
Valve Clearance	Inspect	60,000	Inspect	Same As Normal
Drive Belts	Inspect	1st: 60,000 or 72 mos. Addl.: 15,000 or 24 mos.	Inspect	Same As Normal
Coolant	Replace	1st: 120,000 or 60 mos. Addl.: 30,000 or 24 mos.	Replace	Same As Normal
Spark Plugs	Replace	105,000 or 120 mos.	Replace	More Frequently
Automatic Transaxle Fluid	No Check, No Service required		Replace	60,000

*Check the engine oil regularly between recommended oil change. Hyundai recommends Quaker State oil.
*See Owner's Manual for details.

Looking for more detailed information? This Quick Reference Guide does not replace your vehicle's Owner's Manual. If you require additional information or are unsure of a specific issue, you should always refer to the vehicle's Owner's Manual or contact your authorized Hyundai dealer. The information contained in this Quick Reference Guide was correct at the time of printing; however, specifications and equipment can change without notice. No warranty or guarantee is being extended in this Quick Reference Guide, and Hyundai reserves the right to change product specifications and equipment at any time without incurring obligations. Some vehicles are shown with optional equipment. Specifications apply to U.S. vehicles only. Please contact your Hyundai dealer for current vehicle specifications.

NP150-72014-B
(Rev 10/17/14)
Printing 10/20/14



www.hyundai.com



Roadside Assistance: **1-800-243-7766**
 Consumer Affairs: **1-800-633-5151**
 XM® Radio: **1-800-967-2346**
 Blue Link: **1-855-2BLUELINK (1-855-225-8354)**

Table of contents

GETTING STARTED

Folding key	02
Front seat adjustment	03
Headrest adjustment	04
Rear seat folding	04
Remote keyless entry	02
Seat belt adjustment	04

FEATURES AND CONTROLS

AC 115V plug	36
Active ECO System	36
Blind spot detection system (BSD)	37
Central door lock switch	06
Child-protector rear door lock	32
Climate control – Manual	16 - 17
Climate control – Automatic	18 - 19
Clock adjustments	31
Cruise control system	20
Driver's main controls	06
Driver selectable steering mode	35
Electronic Stability Control (ESC)	35
Fuel filler lid	05
Headlights and fog lights	07
Homelink wireless control system	11
Instrument cluster	12 - 15
Instrument panel illumination	13 & 15
Interior lights	10
Power tailgate	09
Rearview camera	37
Seat warmer and cooler	32
Steering wheel adjustments	05
Steering wheel functions	20 - 21
Sunroof	09
Tire Pressure Monitoring System (TPMS)	34
Transmission	33
Trip computer	13 & 15
Wiper and washer	08

MULTIMEDIA

Audio	28
AUX, USB, and iPod® Port	28
Blue Link Telematics system	26 - 27
Bluetooth operational tips	22 - 23
Bluetooth phone operation	24 - 25
Bluetooth phone pairing	24
Navigation	29 - 30

*Some vehicles may not be equipped with all the listed features.

Frequently Asked Questions

1. Pair phone to your vehicle. Refer to pages 24.
2. Program HomeLink. Refer to page 11.
3. Getting started with Blue Link. Refer to page 26.

WARNING!
To reduce the risk of serious injury to yourself and others, read and understand the important SAFETY INFORMATION in your Owner's Manual.



GETTING STARTED

REMOTE KEYLESS ENTRY

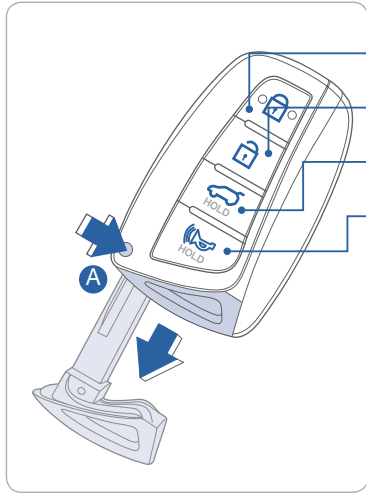

- Lock
- Unlock
- Tailgate unlock (Press and Hold)
- Alarm

Mechanical key

Press and hold the release button **A** and remove the key.

NOTE

User selectable option see Owner's Manual for more detail.

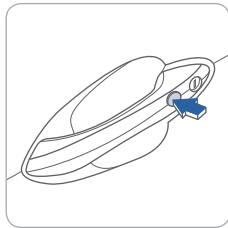

Driver's door Lock / Unlock

Smart key must be within range.

Press:

- Once – Unlock driver door
- Twice – Unlock all doors
- Third – Lock all doors

FOLDING KEY



Unfolding key

Press button **A** to unfold key.

- Lock
- Unlock
- Tailgate unlock (Press and Hold)
- Alarm



FRONT SEAT ADJUSTMENT (Manual)

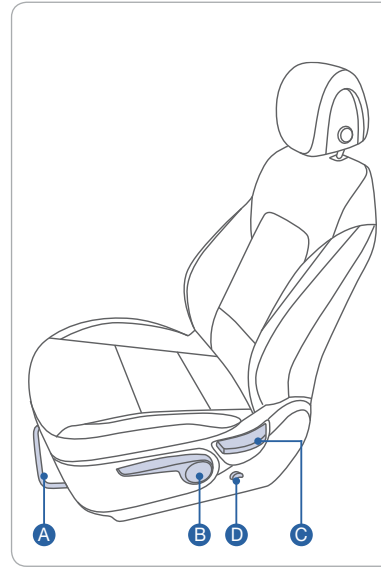

Forward/backward



Seat cushion height (for driver's seat)



Seatback angle



Lumbar support



FRONT SEAT ADJUSTMENT (POWER)



Forward / backward

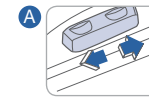

Seat cushion height (for driver's seat)

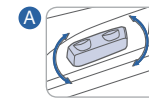

Seatback angle



Lumbar support

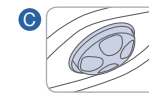

REAR SEAT FOLDING

2nd row seat

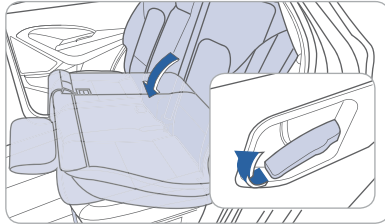

From cargo area (2nd row seat)

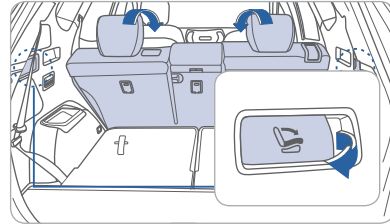

3rd row seat

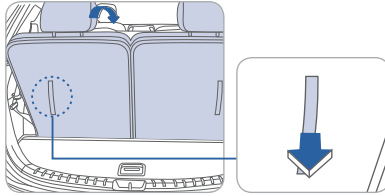

Rear center seatback (2nd row seat)

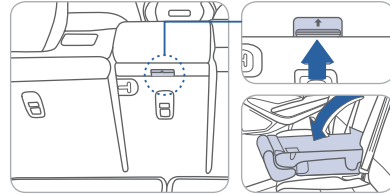

HEADREST ADJUSTMENT

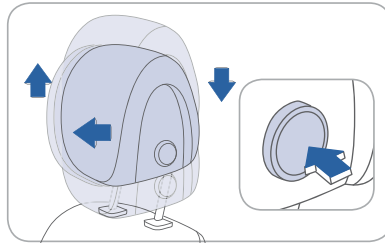

To Raise Headrest:

Pull headrest up.

To Lower Headrest:

Press lock button while pressing down on headrest.

To Adjust Headrest Forward:

Pull forward to 1 of 3 positions

To Adjust Backward:

Press lock button and push headrest backwards.

SEAT BELT ADJUSTMENT (Front seat)

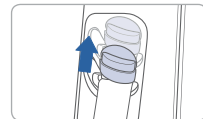
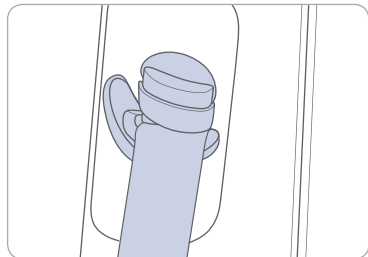

Pull up to raise.

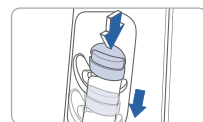

Press button and push down to lower.

STEERING WHEEL ADJUSTMENTS

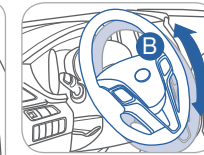
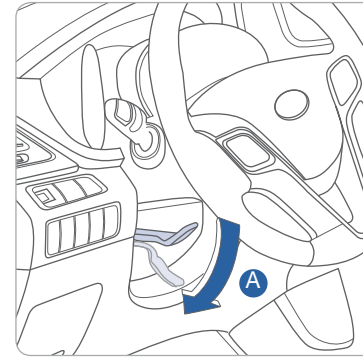

Tilt

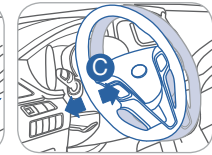

Telescopic

NOTE: Do not adjust while driving.

1. Push the lever **A** down to release.
2. Set the angle **B** and distance **C**.
3. Pull the lever **A** up to lock.

FUEL FILLER LID

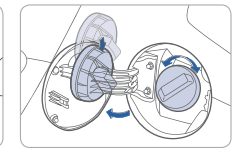
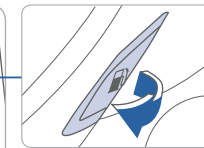
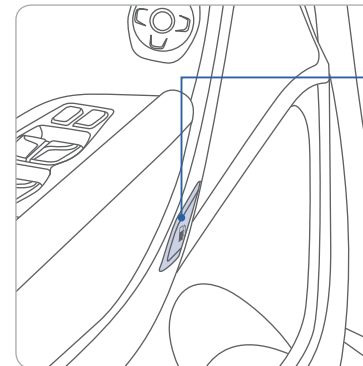

NOTE

After adding fuel, always reinstall the fuel cap onto the filler neck by rotating it clockwise until it clicks one time. Failure to do this may result in the Check Engine Light illuminating.

Check the engine oil regularly between recommended oil changes.



DRIVER'S MAIN CONTROLS

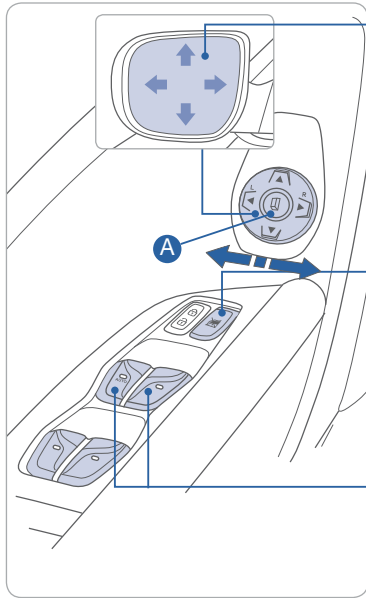

Outside rearview mirrors
Move the lever (A) to L (left) or R (right). Then adjust the mirror by using the directional switch (↕).

Power window lock switch
Disables the power window switches on the rear passenger doors only.

Window auto down/up
Press past detent to fully open/close window.

CENTRAL DOOR LOCK SWITCH



All doors will lock

All doors will unlock

HEADLIGHTS AND FOG LIGHTS

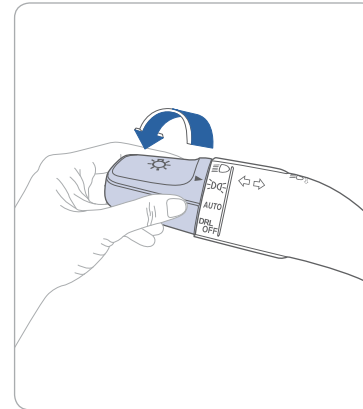

- ▶ | Headlight position
- ▶ | Parking light position
- ▶ | **AUTO** Auto light position
- ▶ | **DRL OFF** DRL OFF position

Headlight delay

Headlights may stay on for 15 seconds after exiting and locking vehicle. Press remote lock button twice to turn headlights off.

See Owner's Manual for more detail.

Turn signals and lane change signals Flashing headlights

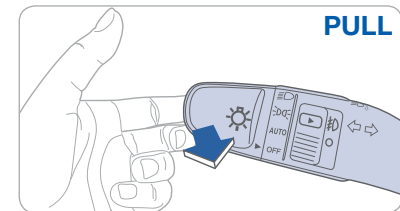
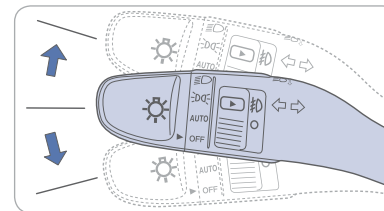

High beam

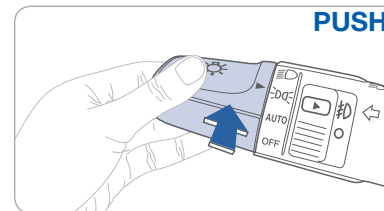

Fog light

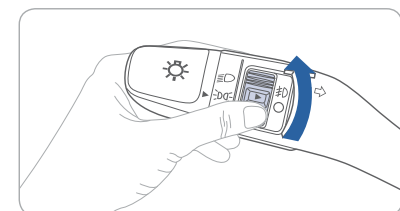



FEATURES AND CONTROLS

WIPER AND WASHER

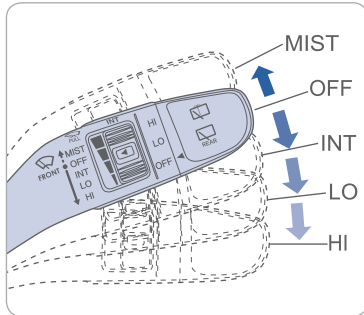

- MIST - Single wipe
- OFF - Off
- INT - Intermittent wipe
- LO - Normal wiper speed
- HI - Fast wiper speed

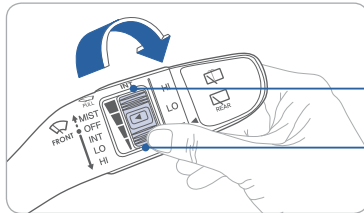

Intermittent wipe time adjustment

- Fast wiper speed
- Slow wiper speed

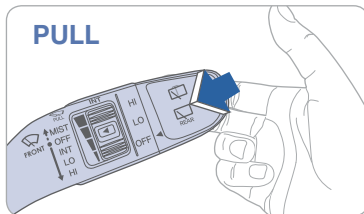

PULL

Front windshield wash with brief wiper

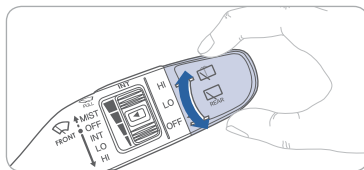

Rear wiper/washer control

- HI - Fast wiper speed
- LO - Normal wiper speed
- OFF - Off

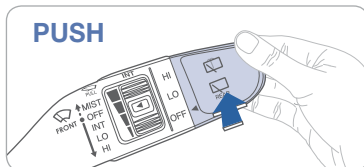

PUSH

Rear window wash with brief wiper



SUNROOF

Sliding the sunroof

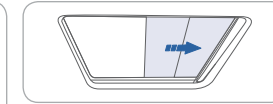
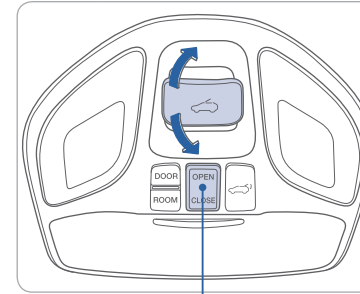

To Open
Slide switch rearward.

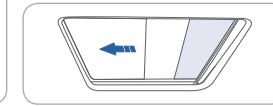

To Close
Slide switch forward.

NOTE

To operate the sunshade, press open or close button.

Tilting the sunroof

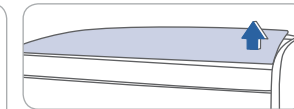
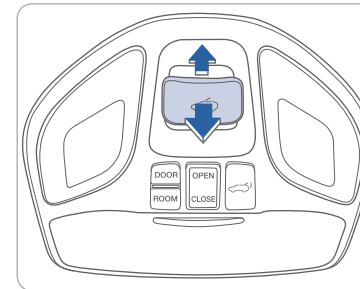

To Tilt
Press the switch up.

To Close
Slide the switch forward or pull the switch down.

POWER LIFTGATE

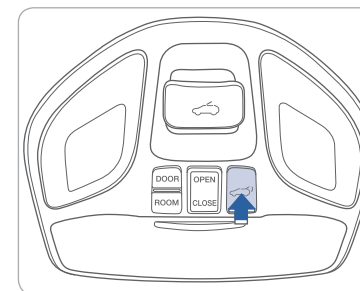

Options for opening liftgate

- Press exterior liftgate soft-touch switch.
- Press and hold key fob liftgate button.
- Press front seat overhead console button.

Options for closing liftgate

- Press button on edge of open liftgate.
- Press front seat overhead console button.

Smart Liftgate

Refer to Owner's Manual for more information on operating Smart Liftgate feature.



FEATURES AND CONTROLS



INTERIOR LIGHTS

Map lamp

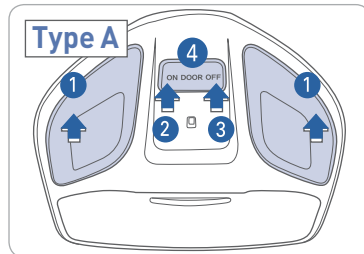

Push the lens **1** to turn the map lamp on or off.

ON 2
Map lamp and room lamp will turn on.

OFF 3
The lights stay off.

DOOR 4
Map lamp and room lamp comes on when any door is opened.

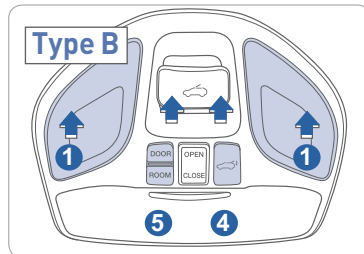

ROOM 5
Map lamp and room lamp come on.

Room lamp

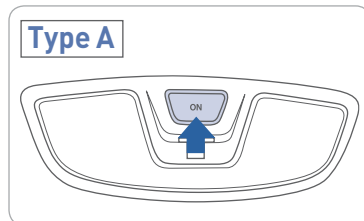

Press the switch to turn the light on or off.

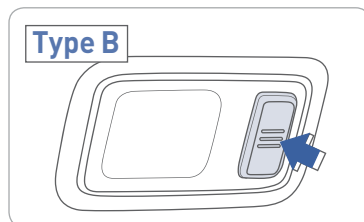

HOMELINK WIRELESS CONTROL SYSTEM

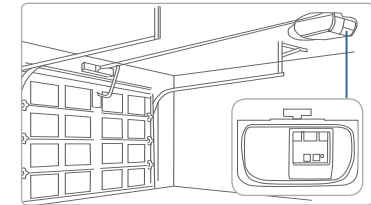
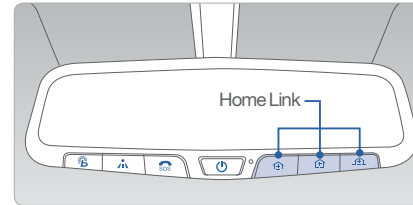

Standard Programming

To train most devices, follow these instructions:

1. For first-time programming, press and hold the two outside buttons, HomeLink® Channel 1 and Channel 3 Buttons, until the indicator light begins to flash (after 20 seconds). Release both buttons. Do not hold the buttons for longer than 30 seconds.
2. Position the end of your hand-held transmitter 1-3 inches (2-8 cm) away from the HomeLink® buttons while keeping the indicator light in view.
3. Simultaneously press and hold both the HomeLink® and hand-held transmitter button. DO NOT release the buttons until step 4 has been completed.
4. While continuing to hold the buttons the red indicator Status LED will flash slowly and then rapidly after HomeLink® successfully trains to the frequency signal from the hand-held transmitter. Release both buttons.

For detail instructions, refer to your Owner's Manual or visit www.homelink.com.



FEATURES AND CONTROLS

Type A

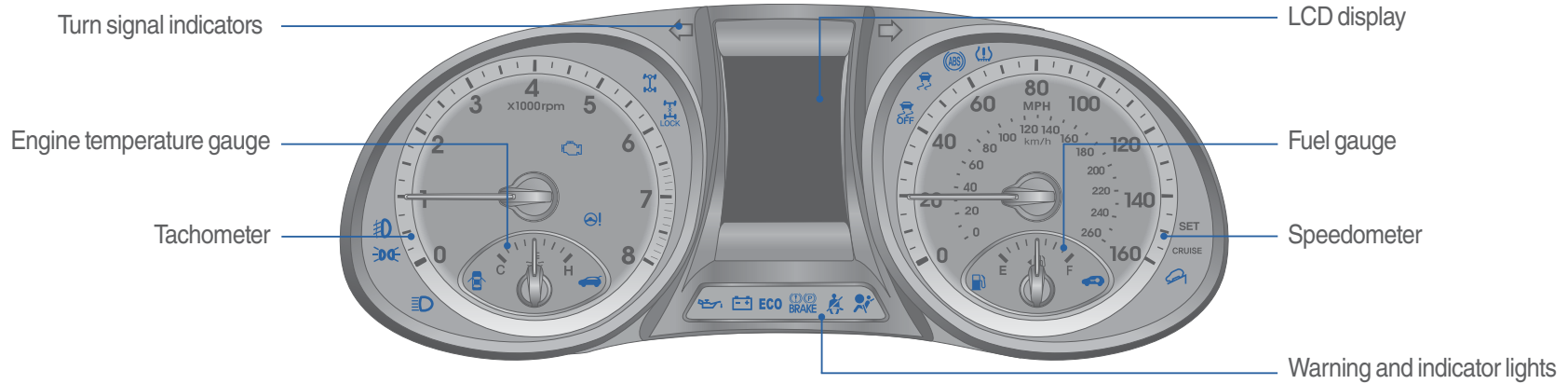

WARNINGS AND INDICATORS

Air bag warning light	Seat belt warning light	Parking brake & Brake fluid warning light
ABS warning light	Electronic Brake force Distribution (EBD) System warning light	
Electric Power Steering (EPS) warning light	Malfunction Indicator Lamp (MIL)	Charging system warning light
Engine coolant temperature warning light	Engine oil pressure warning light	Low fuel level warning light
Low Tire Pressure Warning Light/TPMS system malfunction light	Door open warning light	Tailgate open warning light
AWD warning light	Electronic Stability Control (ESC) indicator	Electronic Stability Control (ESC) OFF indicator
ECO indicator	Immobilizer indicator	Turn signal indicator
High beam indicator	Light ON indicator	Front fog light indicator
AWD LOCK indicator	Cruise ON indicator	Cruise SET indicator
Downhill Brake Control (DBC) indicator		

INSTRUMENT PANEL ILLUMINATION

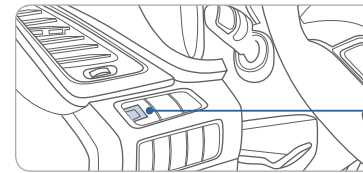

Move the control knob left or right to adjust the brightness.

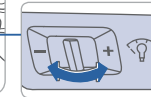

TRIP COMPUTER

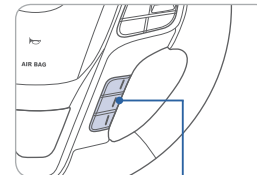

Select "Trip Computer" mode by pressing the MODE button

To change the trip mode as follows, press the MOVE button .

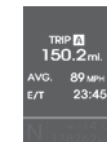
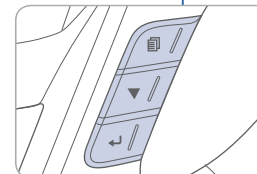

Tripmeter A



Tripmeter B



Fuel Economy



FEATURES AND CONTROLS

Type B

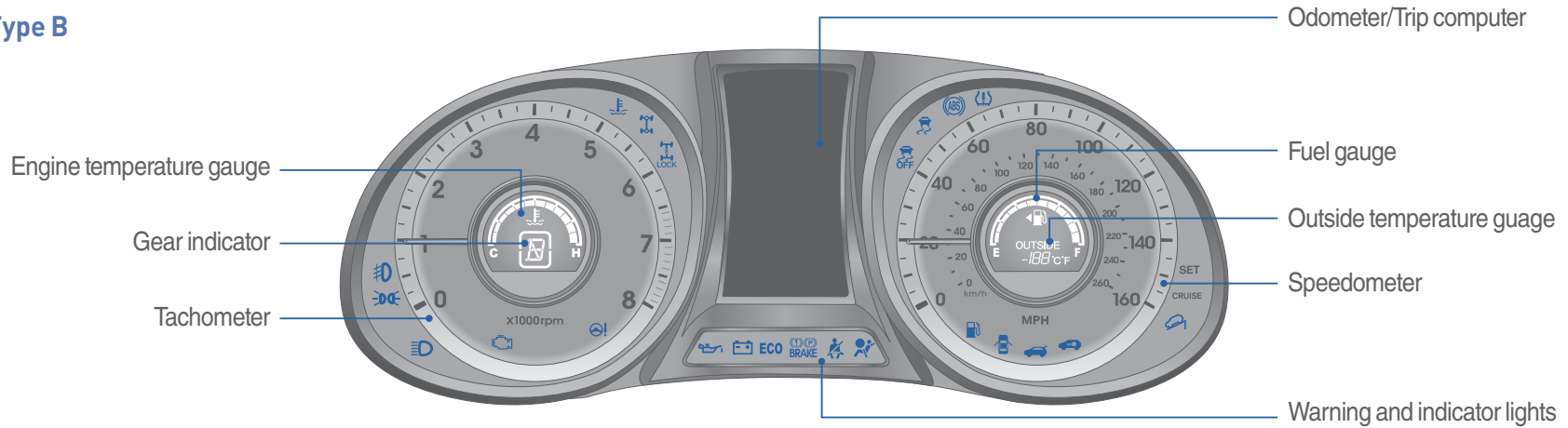

WARNINGS AND INDICATORS

Air bag warning light	Seat belt warning light	Parking brake & Brake fluid warning light
ABS warning light	Electronic Brake force Distribution (EBD) System warning light	
Electric Power Steering (EPS) warning light	Malfunction Indicator Lamp (MIL)	Charging system warning light
Engine coolant temperature warning light	Engine oil pressure warning light	Low fuel level warning light
Low Tire Pressure Warning Light/TPMS system malfunction light	Door open warning light	Tailgate open warning light
AWD warning light	Electronic Stability Control (ESC) indicator	Electronic Stability Control (ESC) OFF indicator
ECO indicator	Immobilizer indicator	Turn signal indicator
High beam indicator	Light ON indicator	Front fog light indicator
AWD LOCK indicator	Cruise indicator	Cruise SET indicator
Downhill Brake Control (DBC) indicator		

INSTRUMENT PANEL ILLUMINATION

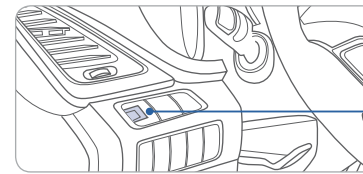

Move the control knob left or right to adjust the brightness.

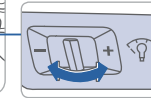

TRIP COMPUTER

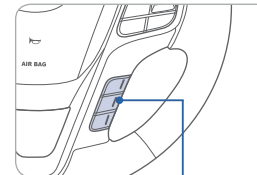

Select "Trip Computer" mode by pressing the MODE button

To change the trip mode as follows, press the MOVE button

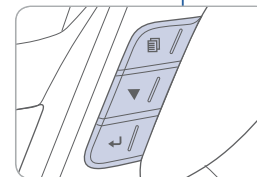

Tripmeter A

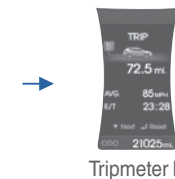

Tripmeter B



Fuel Economy



FEATURES AND CONTROLS

Manual Climate Control Type A

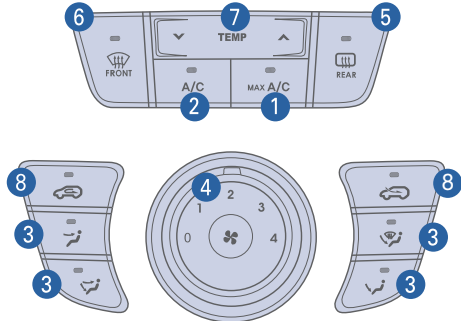

- 1 MAX A/C (Max air conditioning) button
- 2 A/C (Air conditioning) button
- 3 Mode selection buttons
- 4 Fan speed control knob
- 5 Rear window defrost button
- 6 Front windshield defrost button
- 7 Temperature control button

DEFROSTING / DEFOGGING



1. Press the front windshield defrost button.



2. Set the temperature control towards warmer setting.



3. Set the fan speed to the highest setting.

NOTE

To reduce tendency of the glass fogging and also to improve visibility, keep the interior surface of the windshield clean by wiping it with a clean cloth and glass cleaner.

AIR INTAKE CONTROL

Type A

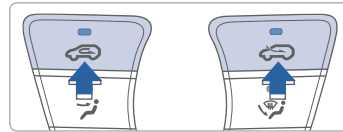

Type B

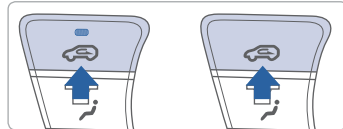

Outside (fresh) air position



Recirculated air position



Manual Climate Control Type B

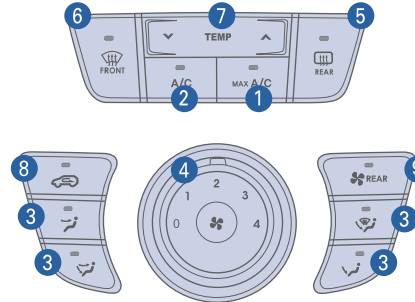

- 8 Air intake control button
- 9 3rd row climate control ON/OFF button
- 10 3rd row fan speed control knob



3rd row air climate control
(for Type B)

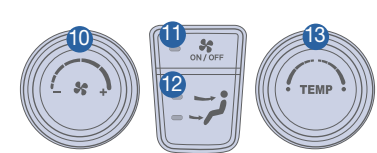

- 11 3rd row blower ON/OFF button
- 12 3rd row mode selection button
- 13 3rd row temperature control knob

MODE SELECTION

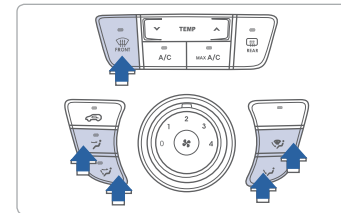

Changing the direction of the air flow as follows:

- Face Level
- Bi-Level
- Floor Level
- Floor/Defrost Level
- Defrost Level

REAR WINDOW AND SIDE MIRRORS DEFROSTER

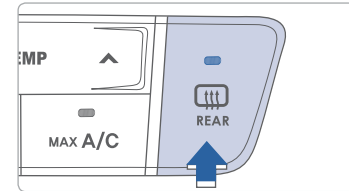

Press to activate/deactivate the rear window defroster.

3rd ROW CLIMATE CONTROL

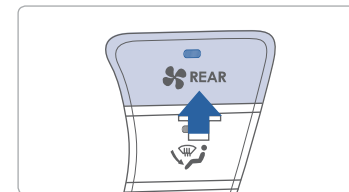

Press to activate/deactivate the 3rd row climate control.



MULTIMEDIA

Automatic Climate Control

Type A,B

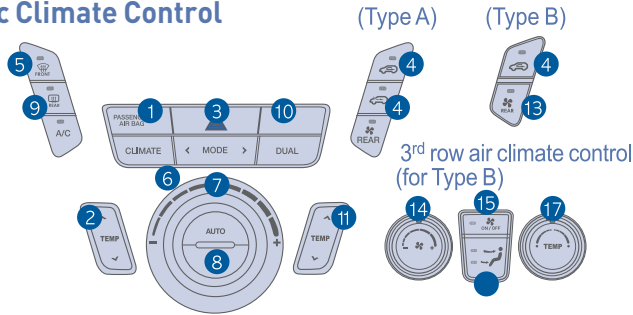

- 1 Air conditioning button
- 2 Driver's temperature control button
- 3 Mode selection button
- 4 Air intake control buttons
- 5 Front windshield defrost button
- 6 Fan speed control knob
- 7 AUTO (automatic control button)
- 8 OFF button
- 9 Rear window defrost button

AUTOMATIC HEATING AND COOLING



1. Press the AUTO button.



2. Set the driver's temperature control to the desired setting.

The modes, fan speeds, air intake, and air-conditioning will be controlled automatically according to the temperature setting.

NOTE

To reduce tendency of the glass fogging and also improve visibility, keep the interior surface of the windshield clean by wiping it with a clean cloth and glass cleaner.

AUTO DEFOGGING SYSTEM



The auto defogging system automatically controls moisture of inside the windshield. To activate or deactivate the system, press the front defroster button 4 times within 2 seconds while pressing the AUTO button.

SYSTEM OFF MODE

Pressing the OFF button will place the system in the off mode.

- Front blower will turn off.
- Outside (fresh) air position selected.
- Vented air at last set temperature.

DEFROSTING / DEFOGGING



1. Press the front windshield defrost.



2. Set the temperature control towards warmer setting.



3. Set the fan speed to the highest setting.



Automatic Climate Control

Type C

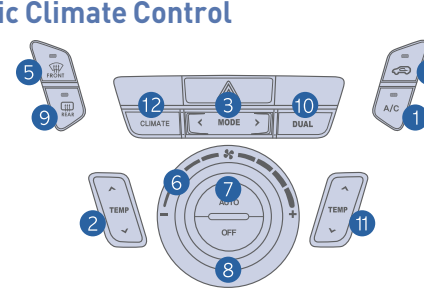

- 10 Dual temperature control selection button
- 11 Passenger's temperature control button
- 12 Climate control information screen selection button
- 13 3rd row blower climate control ON/OFF button
- 14 3rd row fan speed control knob
- 15 3rd blower ON/OFF button
- 16 3rd row mode selection button
- 17 3rd row temperature control knob



AIR INTAKE CONTROL

Type A

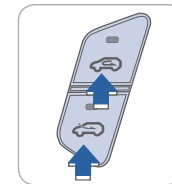

Recirculated air position

Type B,C

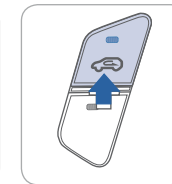

Outside (fresh) air position

DUAL BUTTON

Type A,B

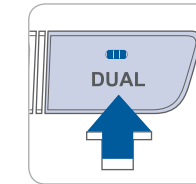

Press the DUAL button to operate the driver and passenger side temperature individually.

Type C

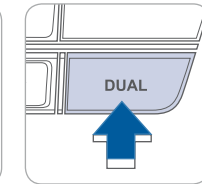

REAR WINDOW DEFROSTER

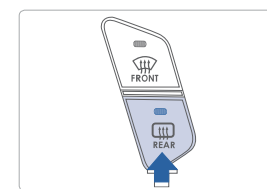

Press to activate/deactivate the rear defroster.

MODE SELECTION

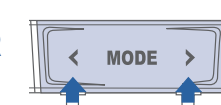

Changing the direction of the air flow as follows:

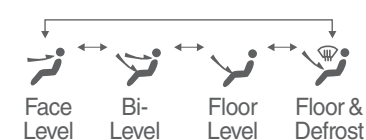



STEERING WHEEL FUNCTIONS

Cruise control

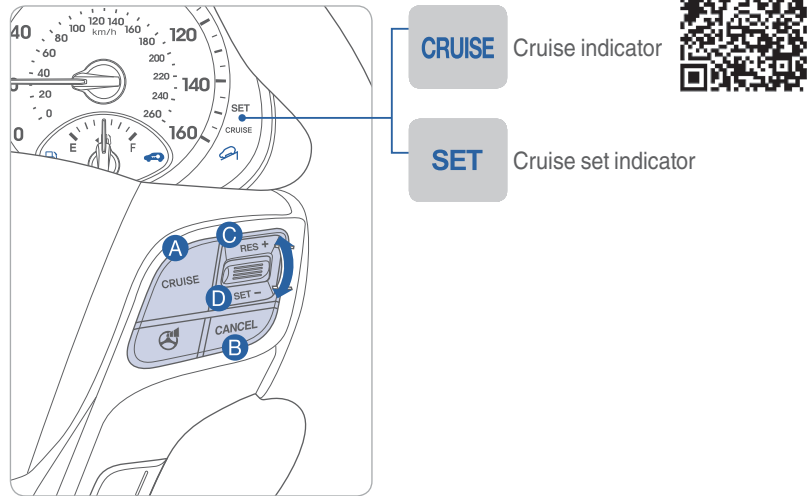

To Set a Cruising Speed

1. Press CRUISE button **A** and the CRUISE indicator will illuminate in the instrument cluster. Accelerate to desired cruising speed (above 25 mph).
2. Move the lever down (to SET-) **D** and remove your foot from the accelerator pedal.

To Accelerate or Decelerate

Move the lever up (to RES+) **C** to increase set cruising speed.
 Move the lever down (to SET-) **D** to decrease set cruising speed.

To Resume Previously Set Speed

Move the lever up (to RES+) **C**

To Cancel Cruising Speed

Press CANCEL button **B**, depress brake pedal, or press CRUISE button **A**.

Audio control

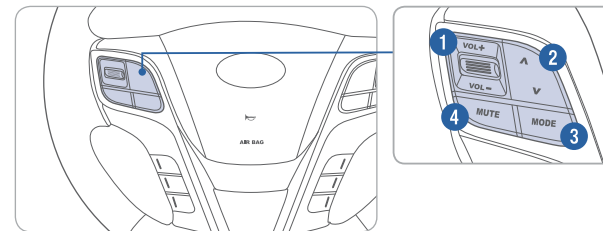

- 1 VOLUME**
Raises or lowers speaker volume.
- 2 SEEK/PRESET**
Press to change presets. Press and hold to seek stations.
- 3 MODE**
Change the audio source. Hold to turn Audio power on/off.
- 4 MUTE**
Mute the sound. Turn off the microphone during a call.

Bluetooth control

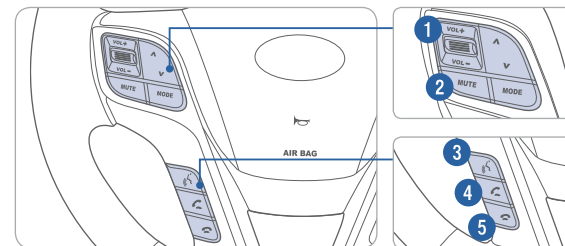

- 1 VOLUME**
Raises or lowers speaker volume.
- 2 MUTE**
Mute the sound.
- 3 TALK**
Activates voice recognition.
- 4 CALL**
Places and transfers calls.
- 5 END**
Ends calls or cancels functions.



BLUETOOTH OPERATIONAL TIPS

In the following situations you or the other party may have difficulty hearing each other:

1. Keep the Bluetooth volume to a low level. High level volume may result in distortion and echo.
2. When driving on a rough road, high speeds and/or with the window open.
3. When the air conditioning vents are facing the microphone and/or when the air conditioning fan is at the max speed.

Steering wheel bluetooth control

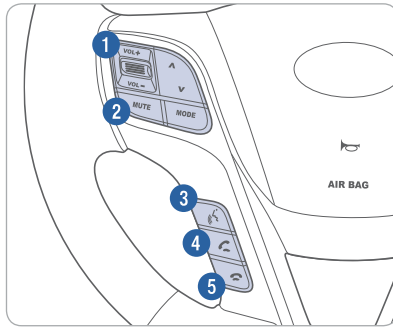

- 1 VOLUME**
Raises or lowers speaker volume.
- 2 MUTE**
Mute the microphone during a call.
- 3 TALK**
Activates voice recognition.
- 4 CALL**
Places and transfers calls.
- 5 END**
Ends calls or cancels functions.

To redial previously dialed number, press and hold **3**.

To Answer a Call:

- Press button on the steering wheel.

To Reject a Call:

- Press button on the steering wheel.

To Adjust Ring Volume:

- Use the VOLUME buttons on the steering wheel.

To Transfer a Call to the Phone

(Private Call):

- Press and hold button on the steering wheel until the audio system transfers a call to the phone.

To Finish a Call:

- Press button on the steering wheel.

VOICE RECOGNITION TIPS

Your vehicle is equipped with Voice Recognition technology which allows drivers to operate their phones without having to take their eyes off the road to minimize distractions.

Voice recognition performance may be affected if driving with windows and sun roof open; when the heating-cooling system is on; when passing in a tunnel or when driving on rugged and uneven roads.



MULTIMEDIA

BLUETOOTH PHONE PAIRING

Pairing tutorials, phone compatibility and Operational tips can be found through the Smart QR code using the QR reader application on your Smartphone.



BLUETOOTH PHONE OPERATION

Vehicle must be in park to complete the pairing process.

Phone setup (pairing phone) with Standard Radio

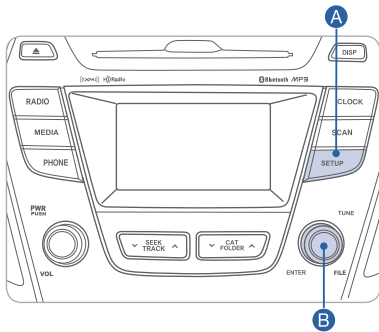

1. Press the SETUP **A** button.
2. Select "Phone" by turning and pressing the TUNE/ENTER **B** knob.
3. Select "Pair Phone" by turning and pressing the TUNE/ENTER **B** knob.
4. Search for the device name as displayed on your mobile phone and connect.
5. Input the passkey displayed on the Audio screen.

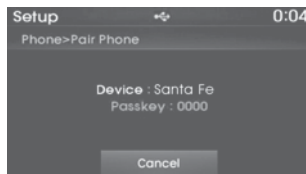

6. Pairing completion is displayed.



Phone setup (Pairing phone) with Navigation

1. Press the call button on the steering wheel remote controller or press the PHONE button.



2. Press Yes button on the screen.
3. Search for the car name and pair the device.
4. Input the passkey.
(The initial passkey is 0000.)

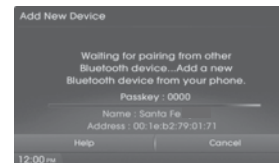

5. Bluetooth® becomes connected.

NOTE

After pairing is completed, transfer of the contact list to the audio system will begin (if your phone is supported.)



MULTIMEDIA

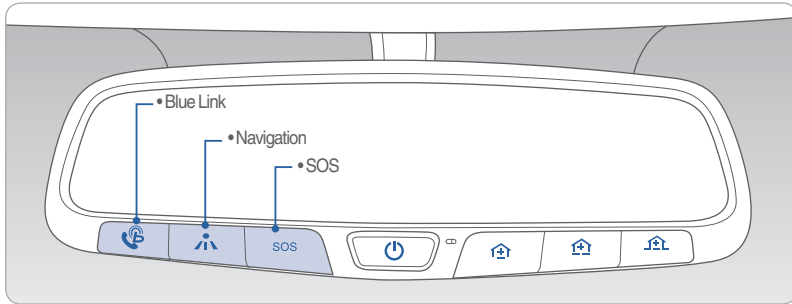

BLUE LINK TELEMATIC SYSTEM

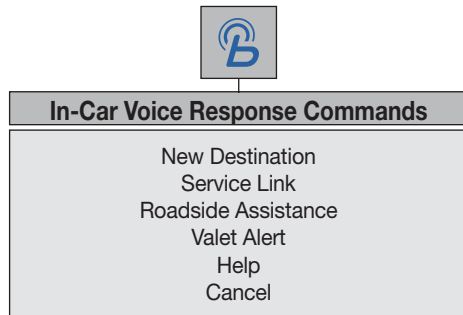

Press the  button for access to the voice-response menu of services. You have two options:

- You can say, "Main Menu" for a listing of main menu choices.
- You can directly select any of the listed menu items by saying its name.



- Press the  button for navigation-related services.
- Press the  button for SOS Emergency Assistance.
- Refer to your Blue Link User's Manual for detailed information on system operation.
- For immediate assistance with subscription services, please call 1-855-2BLUELINK (1-855-225-8354).
- Please register your Blue Link at www.myhyundai.com.



Remote Door Unlock/Lock

Blue Link Mobile App



You can download the Blue Link mobile app to your compatible smart phone from the following sites:

- iPhone® — Apple® App Store
- Android® — Google Play

With this feature, you can lock or unlock your vehicle doors from virtually anywhere by using the Blue Link mobile phone app, by dialing the toll-free number, or by using the Blue Link owner's website.

- To use this feature, you must have a Blue Link Personal Identification Number (PIN). To create or change your PIN, log on to www.MyHyundai.com.

To Activate Remote Door Unlock/Lock

- By Blue Link Mobile App: Select DOOR UNLOCK or DOOR LOCK, as desired.
 - Enter your Blue Link PIN.
 - The command to lock or unlock your doors will be sent to your vehicle.
- By phone: Dial toll-free 1-855-2-BLUELINK (1-855-225-8354).
- By web site: Log on to www.MyHyundai.com, select Blue Link.
 - Select Remote Services, then Remote Door Unlock/Lock.
 - Input your Blue Link PIN. (If you need time to get to your vehicle, specify a time delay before your vehicle will be unlocked.)



MULTIMEDIA

AUDIO

Standard Radio

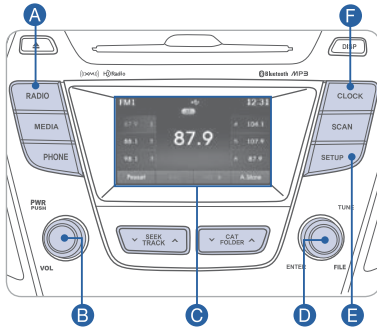

Press **POWER** button **B** to turn radio on.

TUNING / LISTENING TO CHANNELS

1. Press the Radio **A** button.
2. Turn the TUNE/ENTER **D** knob to select the desired channel and press the knob.

NOTE A clear view of the southern sky helps ensure XM[®] radio reception.

SETTING PRESET MEMORY BUTTONS (FM/AM/XM[®])

Press and hold any preset button (1-6) **C** until an audible beep is heard to store current channel.

ADJUSTING THE SOUND CONTROL

1. Press the SETUP **E** button.
2. Select "Sound Settings" by turning and pressing the TUNE/ENTER **D** knob.
3. Select "Bass," "Middle," "Treble," "Fader," or "Balance" by turning and pressing the TUNE/ENTER **D** knob.
4. Adjust the sound by turning and pressing the TUNE/ENTER **D** knob.

Please refer to your Owner's Manual for more detailed information on how to use your audio system. Complimentary XM subscription ends three months following the vehicle date of sale. Please contact XM Radio at 1-800-XM-RADIO (1-800-967-2346) to renew your XM subscription.

AUX, USB, AND iPod[®] PORT

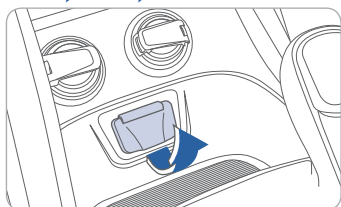

Use the jack to connect an external audio device and listen to it through the audio system speakers in your vehicle.



NAVIGATION

Audio mode

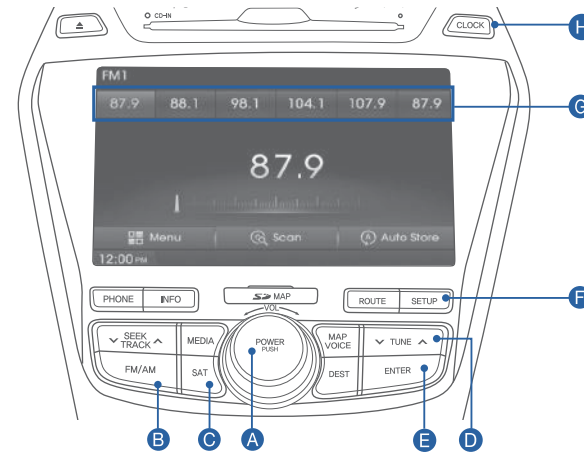

Press **POWER** button **A** to turn radio on.

TUNING/LISTENING TO CHANNELS

1. Press FM/AM **B** or SAT **C** button of XM[®].
2. Press the TUNE **D** button to desired channel.

NOTE A clear view of the southern sky helps ensure XM[®] radio reception.

SETTING PRESET MEMORY BUTTONS (FM/AM/XM[®])

Press and hold any preset button (1-6) **G** on the screen until an audible beep is heard to store current channel.

ADJUSTING THE SOUND CONTROL

1. Press the SETUP **F** button and press the SOUND button to display the Sound Settings screen.
2. Touch on-screen arrows to adjust desired setting.

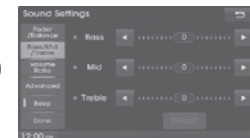

SELECTING TRACK THROUGH SEARCH (CD MODE)

Press the TUNE **D** button to search tracks. Once the desired track name is displayed, press the ENTER button.



MULTIMEDIA

NAVIGATION

Map position

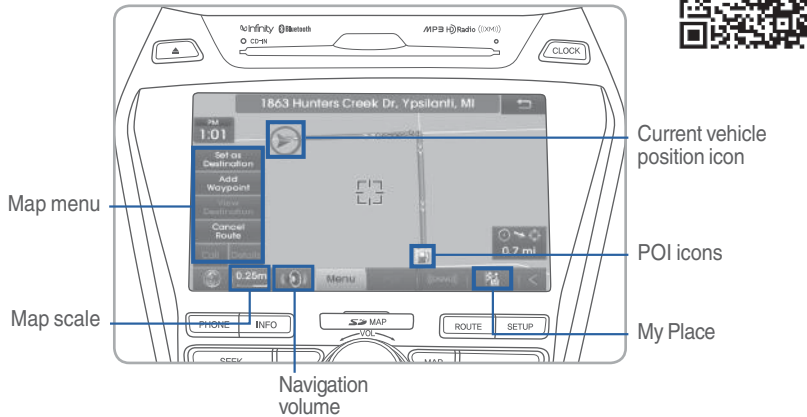

Destination menu



Quick Menu

Press the button on the left side of the map screen to display the Quick Menu.

1. Quick Menu – Display/hide Quick Menus
2. Quick Menu Bar – Menus added to the Quick Menu (possible to set up to 6 menus)
3. Edit - Add/Delete Quick Menus
4. Current Quick Menus – Shows list of current Quick Menus
5. Add/Remove – Add or remove Quick Menus
6. Quick Menu Categories – List of categories that can be added to Quick Menus



FEATURES AND CONTROLS

CLOCK ADJUSTMENTS

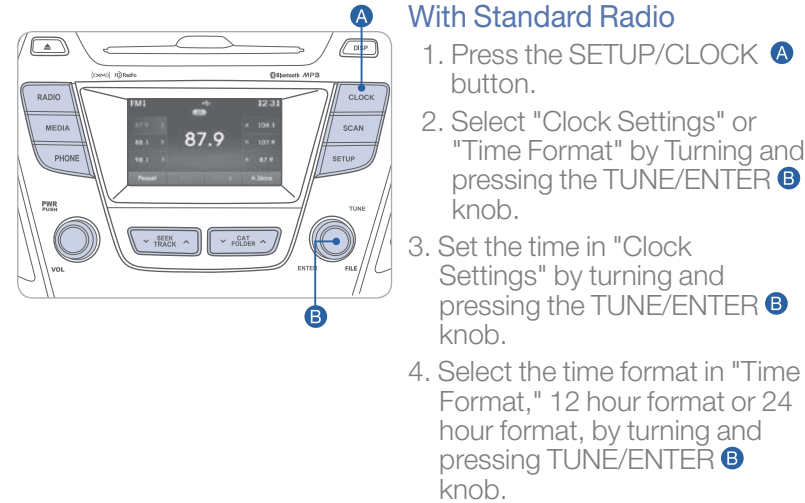

With Standard Radio

1. Press the SETUP/CLOCK **A** button.
2. Select "Clock Settings" or "Time Format" by Turning and pressing the TUNE/ENTER **B** knob.
3. Set the time in "Clock Settings" by turning and pressing the TUNE/ENTER **B** knob.
4. Select the time format in "Time Format," 12 hour format or 24 hour format, by turning and pressing TUNE/ENTER **B** knob.

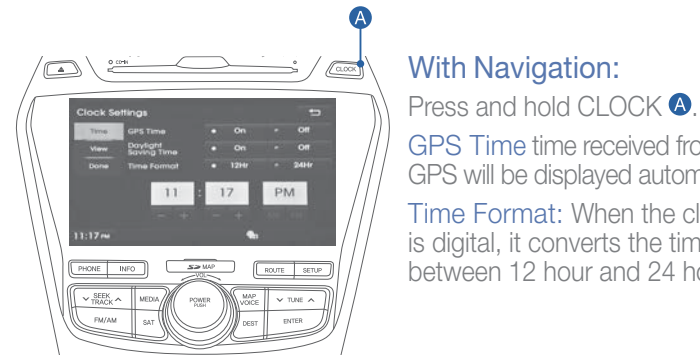

With Navigation:

Press and hold CLOCK **A**.

GPS Time time received from the GPS will be displayed automatically.

Time Format: When the clock type is digital, it converts the time display between 12 hour and 24 hour format.

SEAT WARMER AND COOLER

Front seat

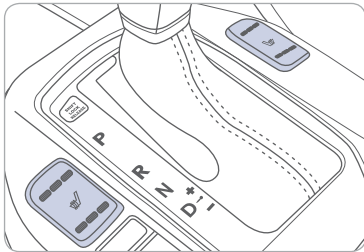

Push the upper portion of the switch to warm or the lower portion to cool.

HIGH (☰) → MIDDLE (☷) → LOW (☶)

↑ OFF ↓

Rear seat

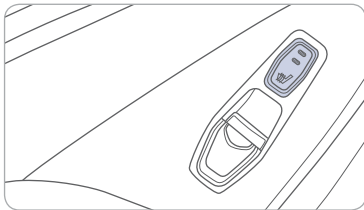

Push the switch to warm the rear seat.

OFF → HIGH (☰) → LOW (☶)

↑ ↓

CHILD-PROTECTOR REAR DOOR LOCK

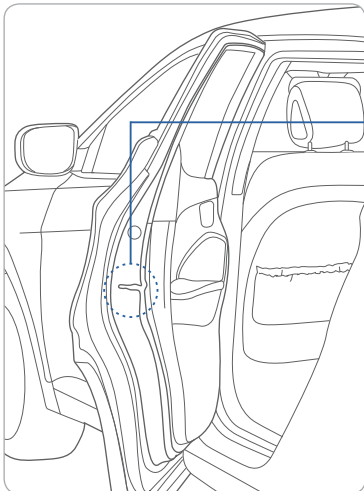

Lock (🔒)

Insert a key into the hole and turn it to the lock (🔒) position.

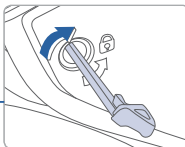

Unlock

Insert a key into the hole and turn it counter clockwise to unlock position.

AUTOMATIC TRANSMISSION

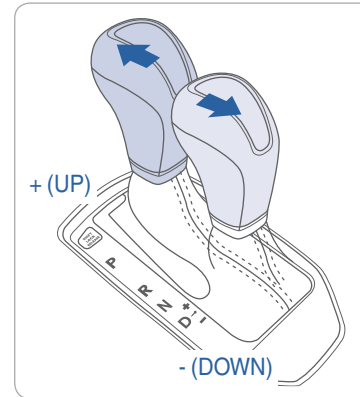

+ (UP)

- (DOWN)

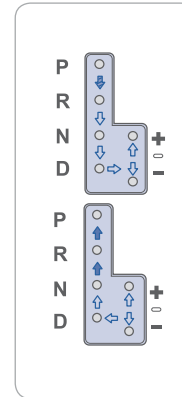

- : Depress the brake pedal and the lock release button when shifting.
- : The lock release button must be pressed while moving the shift lever.
- : The shift lever can be shifted without pressing the lock release button.

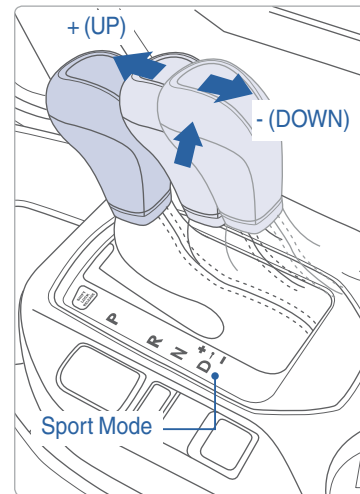

+ (UP)

- (DOWN)

Sport Mode

Sport mode

Move the shift lever from D (Drive) into the manual gate to select.

Move the shift lever forward (+) to upshift or rearward (-) to downshift.

TIRE PRESSURE MONITORING SYSTEM (TPMS)

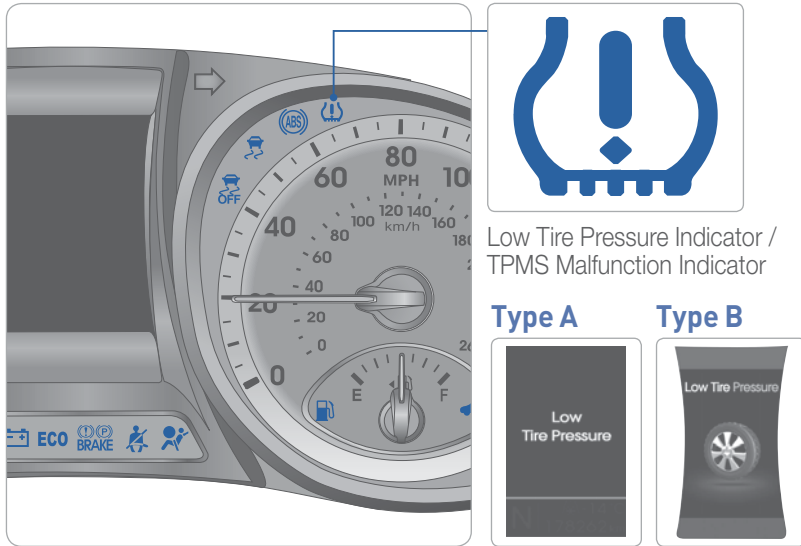

LOW TIRE PRESSURE INDICATOR

Illuminates if one or more of your tires is significantly under-inflated.

TPMS MALFUNCTION INDICATOR

Blinks for approximately one minute, then remains illuminated when there is a malfunction with the TPMS system. Have the system checked by an authorized Hyundai dealer.

NOTE

When the low tire pressure indicator is illuminated, inflate tire to proper tire pressure as soon as possible. Tire pressure may vary in colder temperatures, causing the low tire pressure indicator to illuminate.

ELECTRONIC STABILITY CONTROL (ESC)

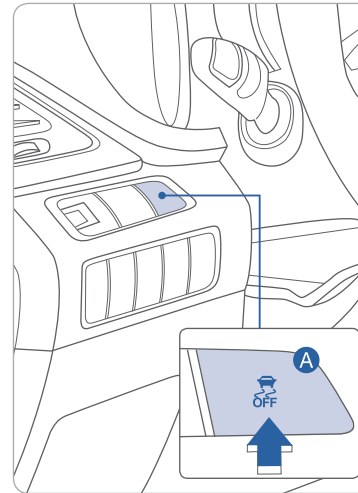

The ESC system is an electronic system designed to help the driver maintain vehicle control under adverse conditions.

Press **A** to turn ESC on/off.

NOTE

It is recommended to always have the ESC system ON.

DRIVER SELECTABLE STEERING MODE

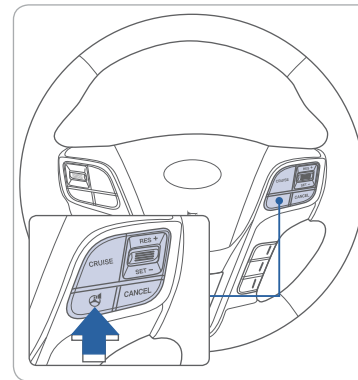

The driver selectable steering mode changes steering effort per driver's preference.

Pushing the button once tells you what the current mode is on the center of the instrument cluster screen. Pressing the button again will scroll through the different modes.

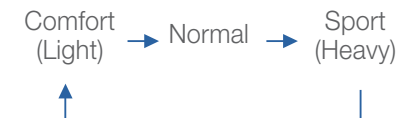



FEATURES AND CONTROLS



ACTIVE ECO SYSTEM

Active ECO system

Active ECO system helps to improve fuel efficiency. When the Active ECO system is activated, the vehicle acceleration, gear shift points and air conditioning performance will be reduced to conserve the fuel consumption.

Press the Active ECO button to activate. The LED on the button and the ECO indicator in the instrument cluster will illuminate.

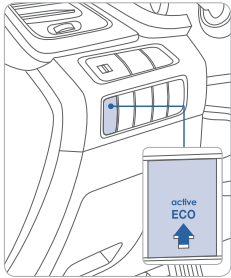

Active ECO on – For optimal fuel efficiency

Active ECO off – For optimal performance and drivability.

To improve your fuel efficiency:

- Drive smoothly and accelerate at a moderate rate.
- Avoid heavy accelerations.
- Maintain steady cruising speed.
- Adjust the vehicle speed to the traffic condition and avoid speed changes.
- Avoid unnecessary braking.
- Keep the tires inflated to the recommended tire pressure.
- Don't idle the engine longer than necessary.

AC 115V PLUG

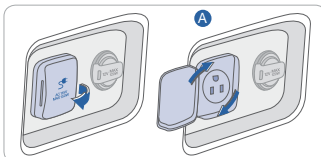
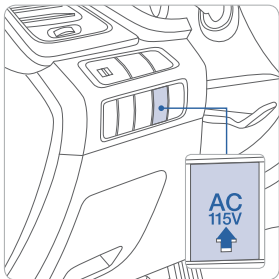

1. Dashboard button must be switched on to use cargo area AC115V plug. Engine should be running when AC 115V plug is in use.
2. Rotate safety plate **A** on outlet for use.

REARVIEW CAMERA

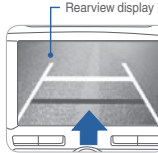
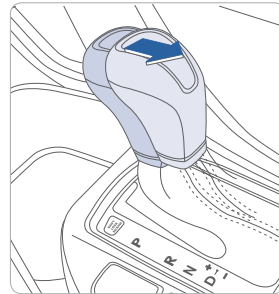

Type B and Navigation radio

The rearview camera will activate when the ignition switch is ON and the shift lever is in the R (Reverse) position.

BLIND SPOT DETECTION SYSTEM (BSD)

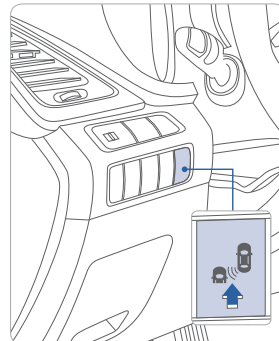

The BSD system sensor senses the rear side territory of the vehicle and provides information to the driver. Press the BSD switch. If vehicle speed exceeds 9.3mph the system will activate. Press the switch again to deactivate the system.

A Blind spot detection (BSD)

Warning range is dependent on your vehicle speed. However, if your vehicle speed differences is 9.3mph above other vehicles, the warning is not active.

B Lane change assist (LCA)

When the vehicle is approaching at high speed, the warning is not active.

C Rear cross-traffic alert (RCTA)

When your vehicle moves (below 6mph) in Reverse, the sensor detects the approaching vehicles and the warning is active.

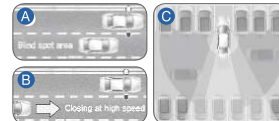

Key Websites:

- Hyundai website - www.hyundai.com
- Hyundai owner website - www.myhyundai.com
- Bluetooth phone compatibility - www.hyundaiusa.com/bluetooth
- Blue Link - www.MyHyundai.com

SANTA FE CUSTOMER DELIVERY CHECK LIST

HYUNDAI OWNER	DEALERSHIP NAME
SALES CONSULTANT	DATE
VIN	PREVIOUS VEHICLE

BEFORE DELIVERY

- CONFIRM "GOOD BATTERY" USING GR8 AND STAPLE TEST TICKET HERE
- SET TIRE PRESURE LF ___ RF ___ RR ___ LR ___
- VERIFY VEHICLE IS CLEAN, IN GOOD CONDITION, FREE OF CHIPS AND SCRATCHES · CLEAN WINDSHIELD AND BACK WINDOW
- ENSURE FLOORMATS ARE SNAPPED INTO PLACE

Sales Consultant	Date	Sales Manager	Date
Customer			Date
Email	@		