

WALK THE CUSTOMER THROUGH EACH OF THE FOLLOWING KEY DELIVERY FEATURES

☐ DEFROST - page 15

- 1 Press the front defrost button.
- 2 Set to warmest temperature setting.
- 3 Set to highest fan speed.

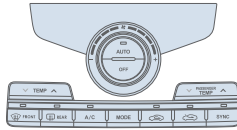

☐ TIRE PRESSURE MONITORING SYSTEM (TPMS) – page 29

Explain TPMS function to customer.

- When illuminated, one or more tires are under-inflated.
- Blinks for approximately one minute then remains illuminated when there is a malfunction with the TPMS.



☐ CLOCK ADJUSTMENT – page 27

- Demonstrate how to adjust the clock.

☐ VEHICLE SETTINGS – pages 12-13 & 24-26

- Demonstrate vehicle settings in instrument cluster
- Demonstrate navigation use, enter dealer address
- Show radio presets

☐ BLUETOOTH – pages 18

- Demonstrate phone pairing
Refer to www.hyundaiusa.com/bluetooth
- Demonstrate QR code



☐ BLUE LINK – pages 21-23

- Assist with creating MyHyundai.com account
- Assist with Blue Link enrollment
- Show Blue Link Users Manual & tear out Voice Commands/Quick Tip Card
- Encourage customers to press the Blue link button after enrollment to initiate Welcome Call

MAINTENANCE

Scheduled Maintenance	Normal Usage		Severe Usage*	
Engine Oil And Filter*	Replace	7,500 or 12 mos.	Replace	3,750 or 6 mos.
Fuel Additives	Add	7,500 or 12 mos.		
Tire Rotation	Perform	7,500	Perform	7,500
Air Cleaner Filter	Inspect Replace	7,500 30,000	Inspect Replace	Same As Normal More Frequently
Battery Condition	Inspect	7,500	Inspect	Same As Normal
Vacuum Hose	Inspect	7,500	Inspect	Same As Normal
Climate Control Air Filter (For Evaporator And Blower Unit)	Replace	15,000	Replace	More Frequently
Air Conditioning Refrigerant	Inspect	15,000	Inspect	Same As Normal
Brake Hoses & Lines	Inspect	15,000	Inspect	Same As Normal
Drive Shafts & Boots	Inspect	15,000	Inspect	7,500 or 6 mos.
Exhaust Pipe & Muffler	Inspect	15,000	Inspect	Same As Normal
Front Disc Brake/Pads	Inspect	15,000	Inspect	More Frequently
Rear Brake Disc/Pads	Inspect	15,000	Inspect	More Frequently
Steering Gear Box, Linkage & Boots/ Lower Arm Ball Joint, Upper Arm Ball Joint	Inspect	15,000	Inspect	More Frequently
Suspension Mounting Bolts	Inspect	15,000	Inspect	Same As Normal
Brake Fluid	Inspect	30,000	Inspect	Same As Normal
Fuel Filter	Inspect	30,000	Inspect	Same As Normal
Fuel Lines, Fuel Hoses and Connections	Inspect	30,000	Inspect	Same As Normal
Fuel Tank Air Filter	Inspect	30,000	Inspect	Same As Normal
Parking Brake	Inspect	30,000	Inspect	More Frequently
Vapor Hose & Fuel Filler Cap	Inspect	30,000	Inspect	Same As Normal
Valve Clearance	Inspect	60,000	Inspect	Same As Normal
Drive Belt (Alt, A/C)	1st Inspect 60,000 or 72 mos. Add. Inspect 15,000 or 24 mos.		Inspect	Same As Normal
Spark Plugs (Iridium Coated)	Replace	105,000 or 10 yrs.	Replace	More Frequently
Coolant	1st Replace 120,000 or 10 yrs. Add Replace 30,000 or 24 mos.		Replace	Same As Normal
Automatic Transaxle Fluid	No check, No service required		Replace	60,000

*Check the engine oil regularly between recommended oil change. Hyundai recommends Quaker State oil.

*See Owner's Manual for details.

Looking for more detailed information? This Quick Reference Guide does not replace your vehicle's Owner's Manual. If you require additional information or are unsure of a specific issue, you should always refer to the vehicle's Owner's Manual or contact your authorized Hyundai dealer.

The information contained in this Quick Reference Guide was correct at the time of printing, however, specifications and equipment can change without notice. No warranty or guarantee is being extended in this Quick Reference Guide, and Hyundai reserves the right to change product specifications and equipment at any time without incurring obligations. Some vehicles are shown with optional equipment. Specifications apply to U.S. vehicles only. Please contact your Hyundai dealer for current vehicle specifications.

NP150-M2015
(Rev 11/20/14)
Printing 11/23/14

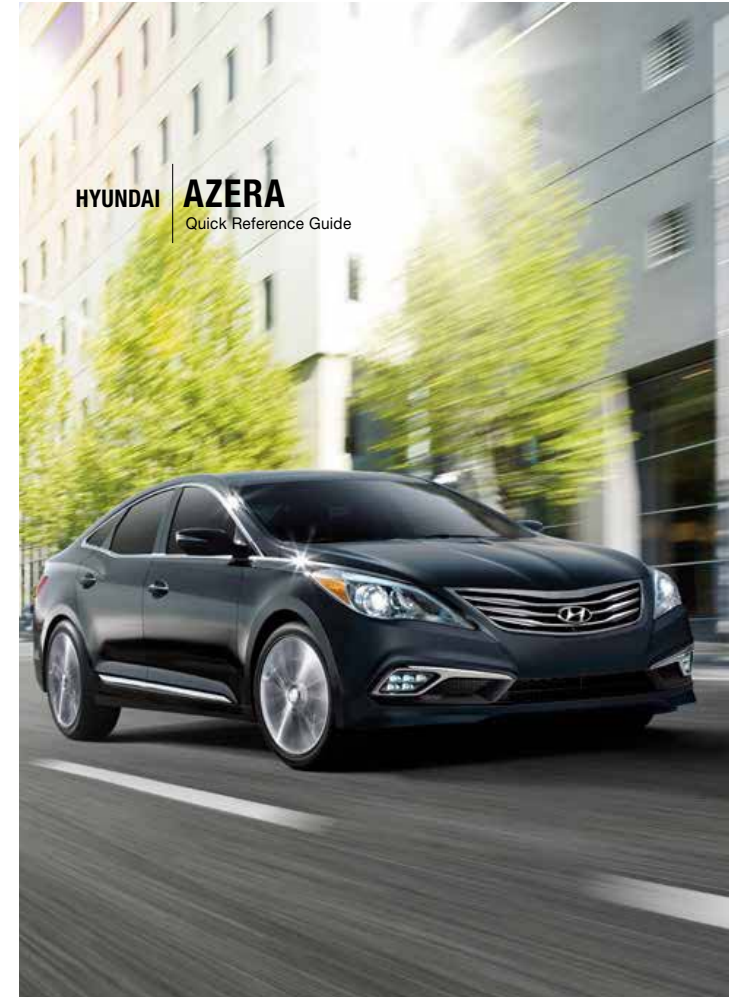

HYUNDAI **AZERA**
Quick Reference Guide

www.hyundai.com

HYUNDAI
NEW THINKING.
NEW POSSIBILITIES.

Roadside Assistance: **1-800-243-7766**
Consumer Affairs: **1-800-633-5151**
SiriusXM® Radio: **1-800-967-2346**
Blue Link: **1-855-2BLUELINK**
(1-855-225-8354)

Table of contents

GETTING STARTED

Engine start/stop button	03
Front seat adjustment	04
Fuel door	06
Headrest adjustment	05
Rear seat folding	06
Remote keyless entry	02
Seat belt adjustments	05
Smart trunk	04
Trunk opening	03

FEATURES AND CONTROLS

Active ECO system	31
Automatic transmission	28
Blind spot detection system (BSC)	30
Central door lock switch	07
Child-protector rear door lock	32
Climate control	14-15
Clock adjustment	27
Driver's main controls	07
Electronic Stability Control (ESC)	31
Head lights and fog lights	08
Homelink wireless control system	11
Instrument cluster	12-13
Instrument panel illumination	13
Interior lights	11
Lane departure warning system (LDWS)	29
Rearview camera	32
Steering wheel adjustments	06
Steering wheel controls	16-17
Sunroof	10
Tire Pressure Monitoring System (TPMS)	29
Trip computer	13
Wiper and washer	09

MULTIMEDIA

AUX, USB, and iPod® Port	27
Blue Link Telematics system	21-23
Bluetooth operation tips	19-20
Bluetooth phone pairing	19
Navigation	24-26
Voice recognition tips	20

How to:

1. Pair phone to your vehicle. Refer to page 18.
2. Get started with Blue Link. Refer to page 21-23.

Steering Wheel Adjustments Page 06

Instrument cluster Pages 12-13

Cruise control system Page 16

Wiper and washer Page 09

Navigation Pages 24-26

Head lights and fog lights Page 08

Trip computer Page 13

Engine start/stop button Page 03

Automatic transmission Page 28

Climate control Pages 14-15

* Some vehicles may not be equipped with all the listed features.

Use this Quick Reference Guide to learn about the features that will enhance your enjoyment of your Hyundai. More detailed information about these features are available in your Owner's Manual.

WARNING!
To reduce the risk of serious injury to yourself and others, read and understand the important SAFETY INFORMATION in your Owner's Manual.



GETTING STARTED





Download QR Code Reader

You can download a QR reader app to your smart phone to take advantage of the QR codes throughout this Quick Reference Guide.

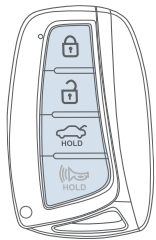
iPhone® - Apple® App Store
Android® - Google Play
BlackBerry® - BlackBerry® App World

REMOTE KEYLESS ENTRY



-  Lock
-  Unlock
-  Trunk open
-  Alarm

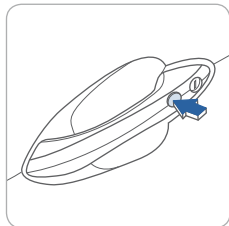

Driver's door Lock / Unlock
Smart key must be within range.

Press:
Once – Unlock driver door
Twice – Unlock all doors
Third – Lock all doors

NOTE: You can activate or deactivate the Two Turn Unlock features in the vehicle. Refer to “LCD display” in the Owner’s Manual section 4.



Remove mechanical key
Press and hold the release **A** button and remove the key.

Reinstall mechanical key
Put the key into the key slot and push it until a click sound is heard.

ENGINE START/STOP BUTTON

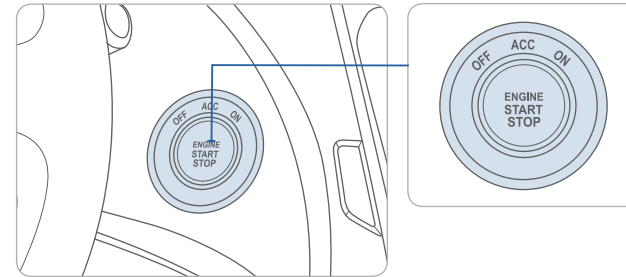

With the ignition OFF, press the engine start/stop button:

- Once for ACC (Accessory) mode.
- Twice for ON mode.
- Three times for OFF.

To start the engine, press the start/stop button while:

- Depressing the brake pedal.

To shut engine OFF, shift to:

- P (Park) and press the engine start/stop button.

Emergency situations

- **Shut off engine while driving:**
Press engine start/stop button for more than 2 seconds or press it 3 times consecutively within 3 seconds.
- **Restart engine while driving:**
Press engine start/stop button with shift lever in N (Neutral).

TRUNK OPENING

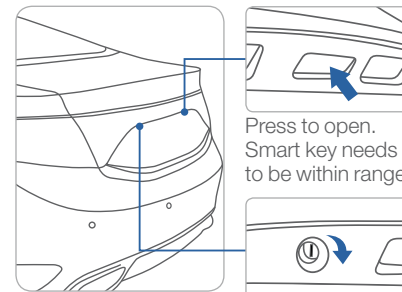

Press to open.
Smart key needs to be within range.

Insert key and turn.

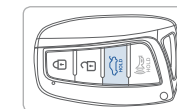

Press and hold to open.

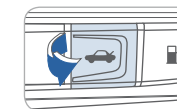

Pull the release button in the vehicle.

GETTING STARTED

SMART TRUNK

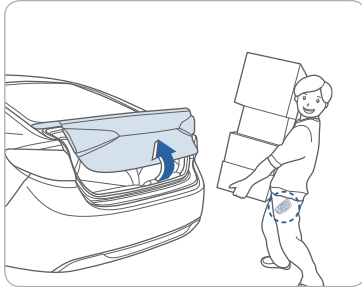

Smart Trunk

Trunk will open automatically when detecting smart key within range near the trunk for more than 3 seconds.

To enable Smart Trunk function:

Vehicle must be in P (Park) to adjust settings in the User Setting mode.

1. Select "Door/Trunk" in the User Settings in the instrument cluster.
2. Check "Smart Trunk".

NOTE:

Function is active after 15 seconds when all doors are closed and locked. The vehicle will also provide an audible and visual alarm while activating. For more details, refer to Owner's Manual.

FRONT SEAT ADJUSTMENT

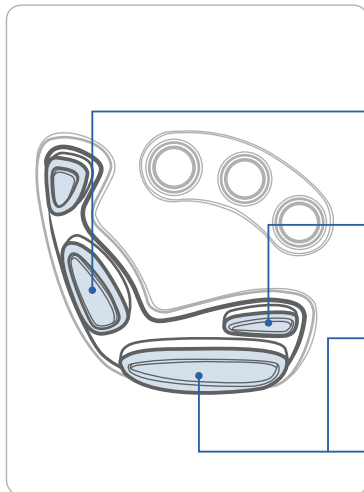

Seatback angle



Cushion extension adjustment (for driver's seat)



Forward and backward



Seat cushion height



HEADREST ADJUSTMENT

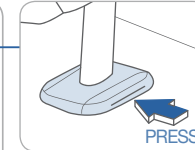
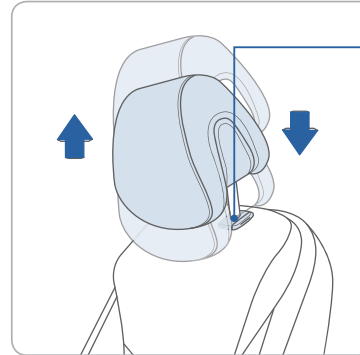

Height adjustment

To Raise Headrest:
Pull headrest up.

To Lower Headrest:
Press lock knob while pressing down on headrest.

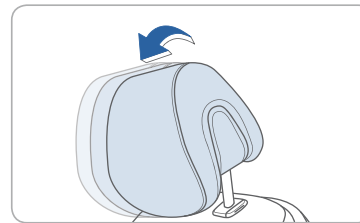

Forward or backward adjustment

To Adjust Headrest Forward:
Pull forward to 1 to 3 positions.

To Adjust Backward :
Pull all the way forward then release.

SEAT BELT ADJUSTMENT (Front seat)

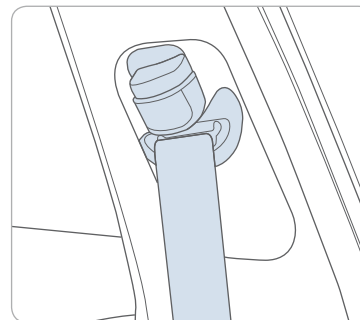

Pull up to raise.



Press button and push down to lower.

FUEL DOOR

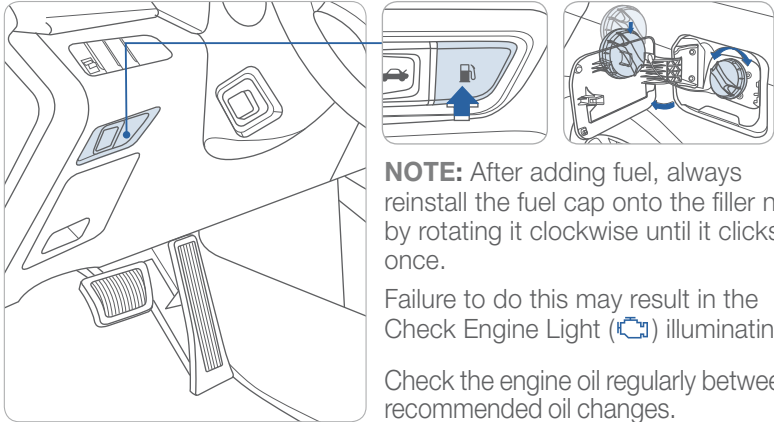

REAR SEAT FOLDING

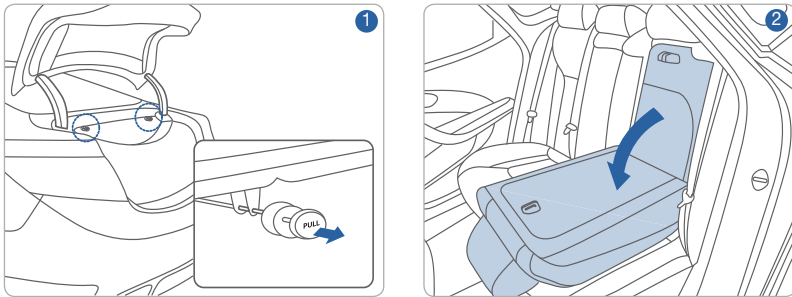

STEERING WHEEL ADJUSTMENTS

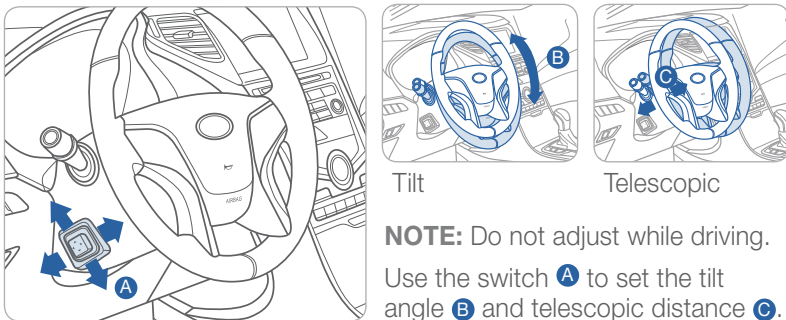

DRIVER'S MAIN CONTROLS

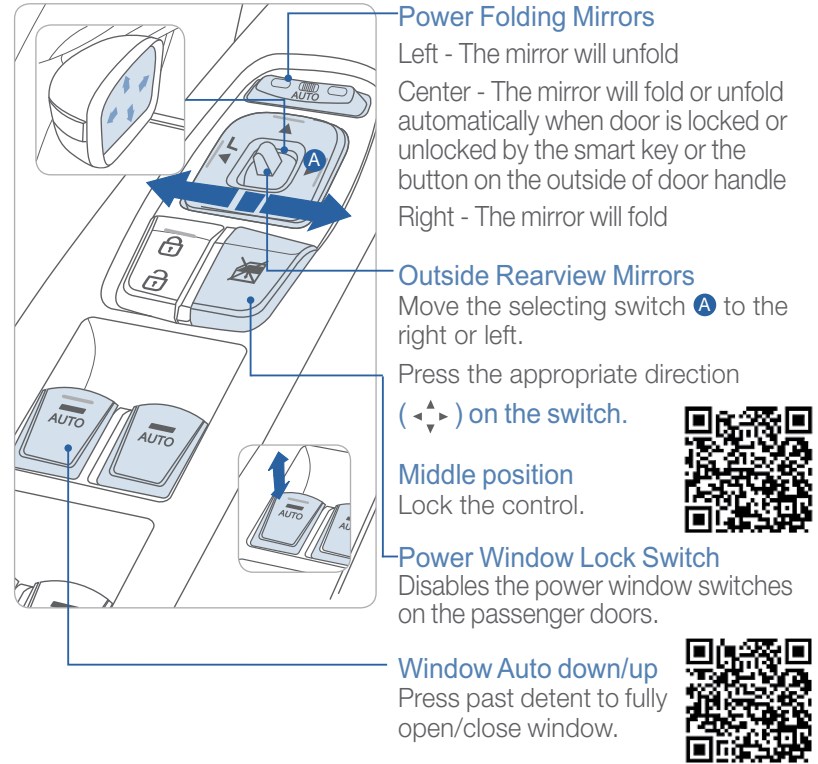

CENTRAL DOOR LOCK SWITCH

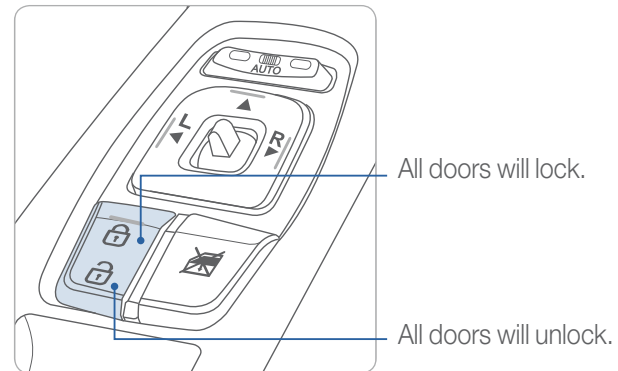



FEATURES AND CONTROLS

HEAD LIGHTS AND FOG LIGHTS

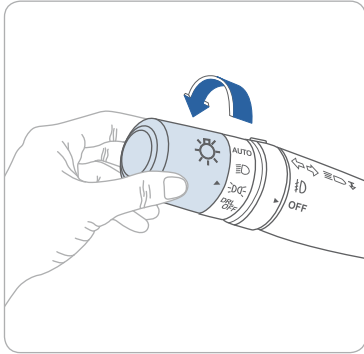

- ▶ | **AUTO** | Auto light
- ▶ | | Head light
- ▶ | | Parking light
- ▶ | **DRL OFF** | OFF

Escort Function

Head lights will stay on for approximately 30 seconds after exiting and locking vehicle. Press the remote lock button twice to turn the head light off. See the Owner's Manual for more detail.

Turn signals and lane change signals

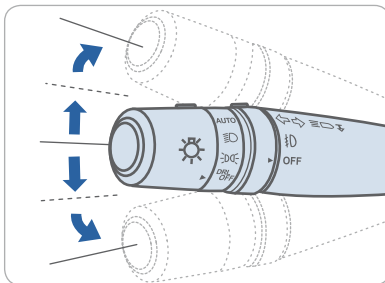

Flashing head lights

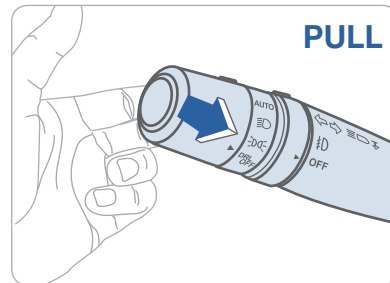

High beam

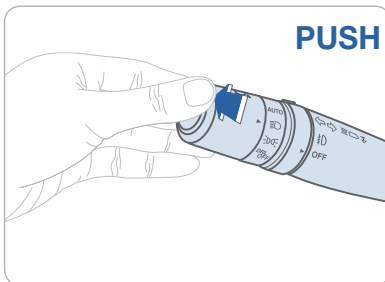

Fog light

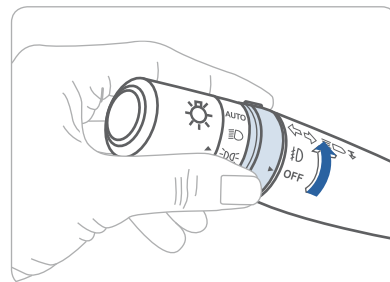

Smart High Beam

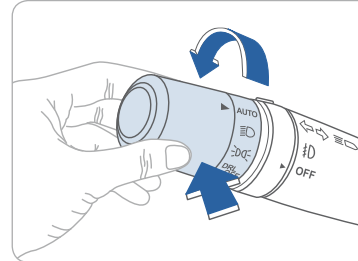

Smart High Beam Function

1. Select auto position on stalk.
2. Push lever forward to engage Auto High beam.
3. Push lever forward again to disengage.

See Owner's Manual for more details.

WIPER AND WASHER

Front Wiper and Washer

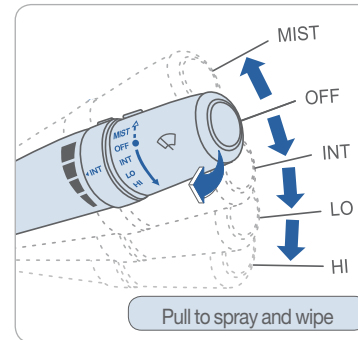

MIST - Single wipe

OFF - Off

INT - Intermittent wipe

LO - Normal wiper speed

HI - Fast wiper speed



Front Intermittent wipe time adjustment

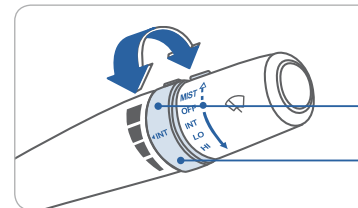

Fast wiper speed

Slow wiper speed

Wash with brief wipes

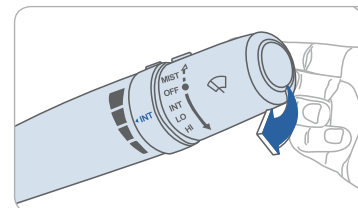

FEATURES AND CONTROLS

SUNROOF

Sliding the sunroof

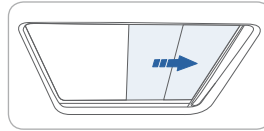
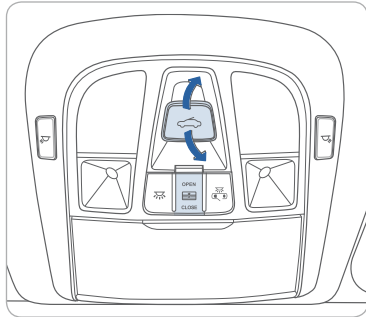

To Open

Press switch rearward.
Press switch rearward past the detent to open completely.

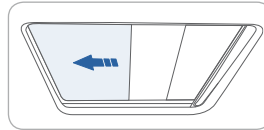

To Close

Press switch forward past the detent to close completely.

Tilting the sunroof

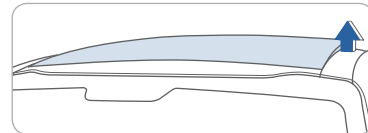
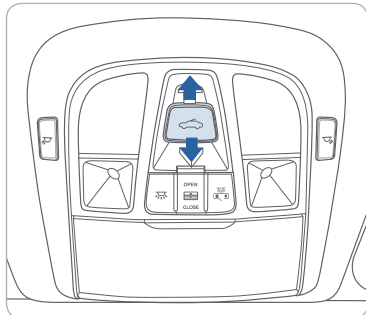

To Tilt

Press the switch up.

To close

Push the switch forward or pull the switch down.

Closing the Sunshade

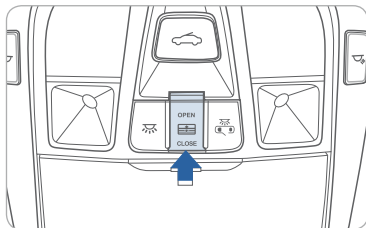

Press the sunshade CLOSE button. The sunroof glass will close then the sunshade will close. To stop the sunroof movement at any point, press the sunshade control switch momentarily.

INTERIOR LIGHTS

Map lamp

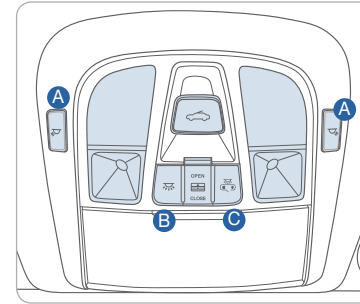

Push the switch **A** to turn the map lamp on or off.

ROOM **B**

Map lamp and room lamp will turn on.

DOOR **C**

Map lamp and room lamp will turn on when any door is open except trunk.

HOMELINK WIRELESS CONTROL SYSTEM

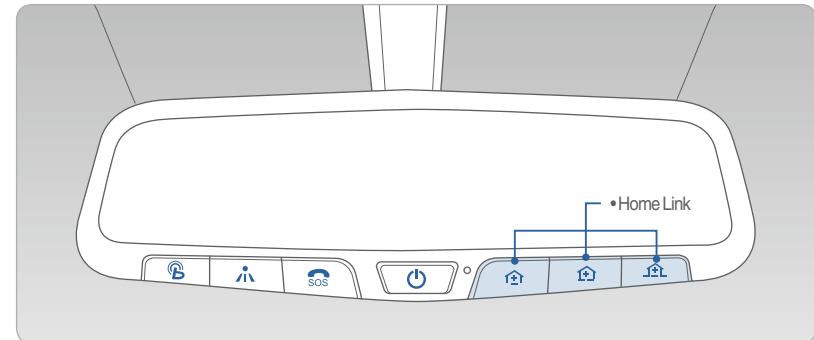

Programming Rolling Code Garage

Press and hold your selected HomeLink button for 20 seconds. Release when light flashes rapidly.

Press and release the “learn” or “smart” button on the garage door opener motor-head unit.

NOTE: 30 second window to initiate next step

Press and hold the desired HomeLink button for 2 seconds and release. Repeat this sequence up to 3 times. If programming is successful, the garage door should open or close during this step.

For detail instructions including “Standard type” garage door, refer to your Owner’s Manual or visit www.homelink.com



FEATURES AND CONTROLS

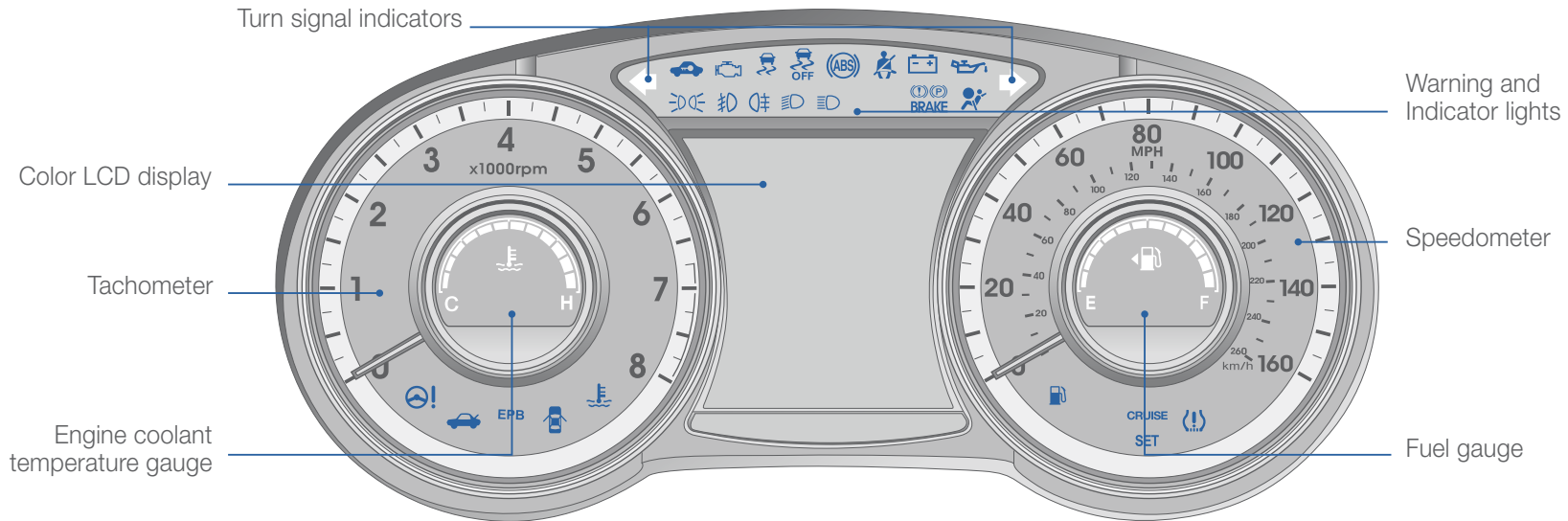

WARNINGS AND INDICATORS

Air bag warning light	Parking brake & Brake fluid warning light	ABS warning light
Seat belt warning light	Low Tire Pressure Indicator / TPMS (Tire Pressure Monitoring System) malfunction indicator	
High beam indicator	Engine oil pressure warning light	Charging system warning light
Electronic Power Steering system warning light	Door open warning light	Turn signal indicator
Immobilizer indicator	Shift pattern indicator	Low beam indicator
Trunk open warning light	Low fuel level warning light	Smart High beam indicator
ESC (Electronic Stability Control) OFF indicator	CRUISE Cruise indicator	ESC (Electronic Stability Control) indicator
Malfunction indicator light	Front fog light indicator	SET Cruise SET indicator
Light on indicator	Engine coolant temperature warning light	ECO Active ECO indicator

INSTRUMENT PANEL ILLUMINATION

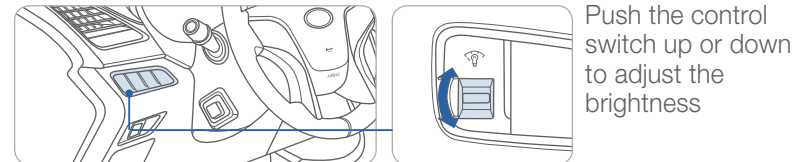

TRIP COMPUTER

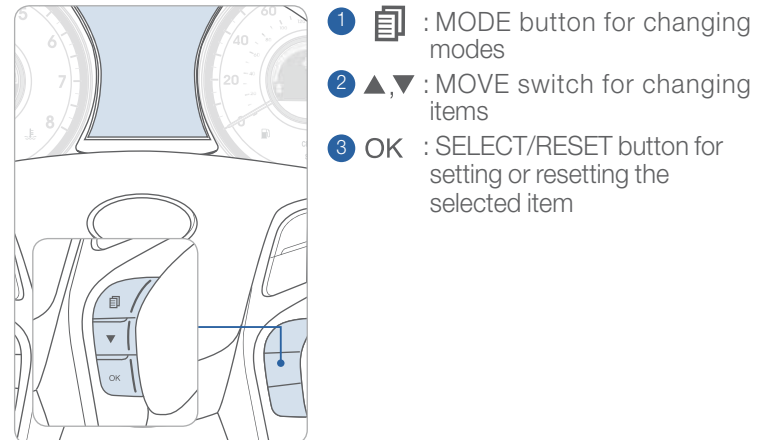

- 1 : MODE button for changing modes
- 2 : MOVE switch for changing items
- 3 : SELECT/RESET button for setting or resetting the selected item



FEATURES AND CONTROLS

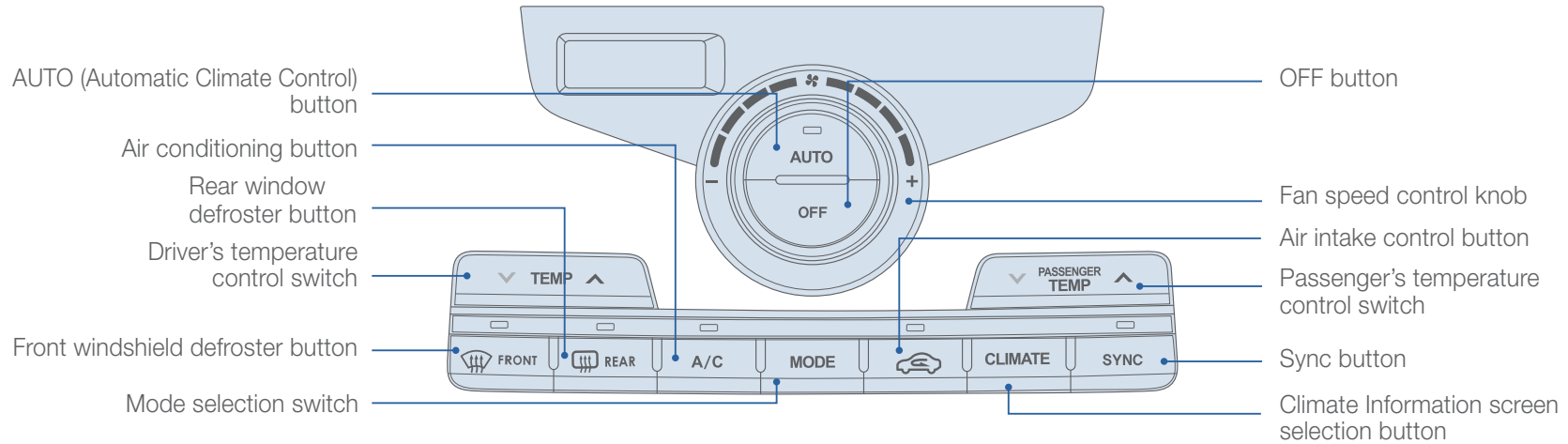

AUTOMATIC HEATING AND COOLING

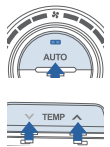

1. Press the AUTO button.
2. Press the temperature button to the desired setting.

The modes, fan speeds, air intake and air-conditioning will be controlled automatically according to the temperature setting.

AIR INTAKE CONTROL

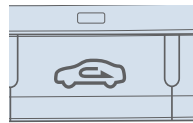

This is used to select outside (fresh) air position or recirculated air position.

- Outside (fresh) air position
- Recirculated air position

DEFROSTING/DEFOGGING

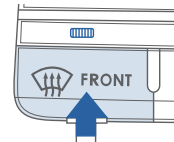

1. Press the front windshield defrost control.

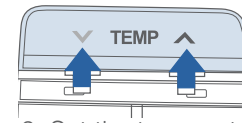

2. Set the temperature control to the warmest setting.

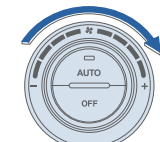

3. Set the fan speed to the highest setting.

NOTE

To reduce the tendency of the glass fogging and improve visibility, keep the interior surface of the windshield clean by wiping it with a clean cloth and glass cleaner.

MODE SELECTION



Face Level



Bi Level



Floor Level



Floor Defrost Level

REAR WINDOW DEFROSTER

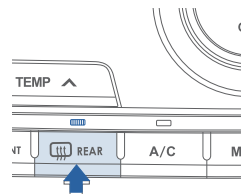

Press to activate / deactivate the rear defroster.

SYNC BUTTON

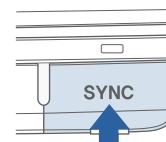

Press the SYNC button to operate the driver and passenger side temperature individually.

CLIMATE BUTTON

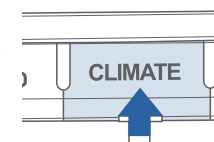

Press the CLIMATE information screen selection button to display climate information on the screen.

STEERING WHEEL CONTROLS

Cruise control system

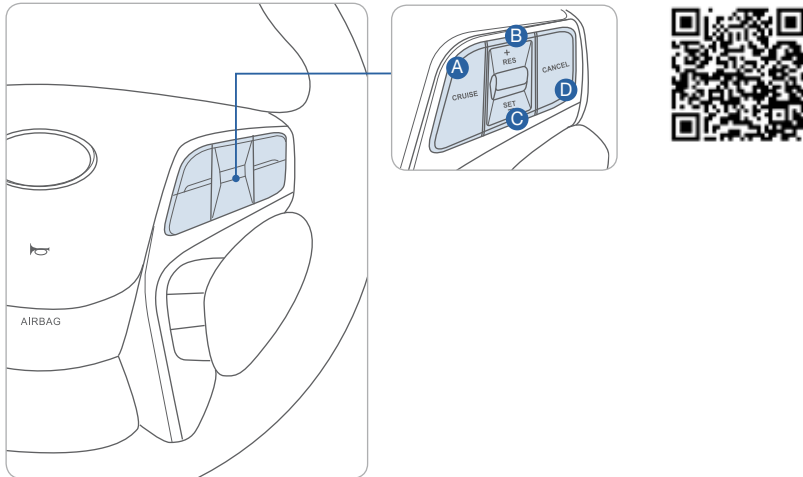

To set a cruising speed

1. Press CRUISE button **A** and the CRUISE indicator will illuminate in the instrument cluster.
2. Accelerate to desired cruising speed (above 25 mph). Press SET- button **C** and remove your foot from the accelerator pedal.

To accelerate or decelerate

Press RES + button **B** up to increase set cruising speed.
 Press SET - button **C** down to decrease set cruising speed.

To cancel cruising speed

Press CANCEL button **D** or depress brake pedal, or press CRUISE button **A**.

Audio control

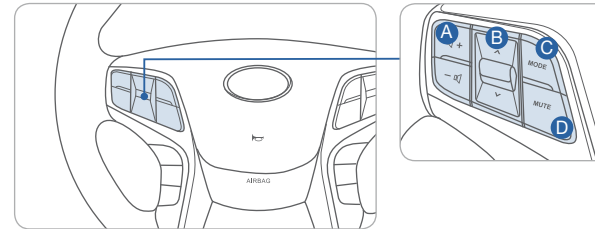

- A VOLUME**
Raise or lower speaker volume.
- B SEEK / PRESET**
Press to change presets.
Press and hold to seek stations.
- C MODE**
Change the audio source.
Hold to turn Audio power ON/OFF.
- D MUTE**
Mute the sound.

Bluetooth control

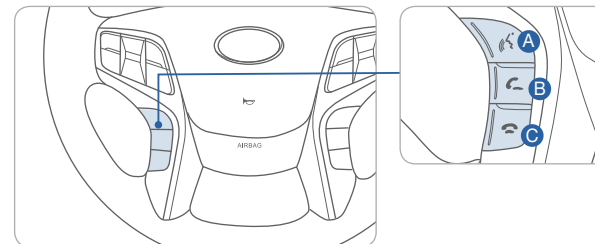

- A TALK**
Activate voice recognition.
- B CALL**
Place and transfer call.
- C END**
End call or cancel function.

If experiencing difficulty using Voice Recognition to place a call, be sure you are using the actual full contact name as entered in your phone book, not a casual or nick-name (e.g., if name was entered as "Robert Smith", say "Call Robert Smith", not "Call Bob Smith").



MULTIMEDIA



BLUETOOTH PHONE PAIRING

Pairing tutorials, phone compatibility and Operational tips can be found through the Smart QR code using the QR reader application on your Smartphone.



Phone setup (pairing phone) with Navigation

NOTE: Vehicle must be parked to complete pairing process.

1. Press PHONE button or on the steering wheel remote control.

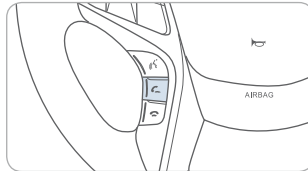
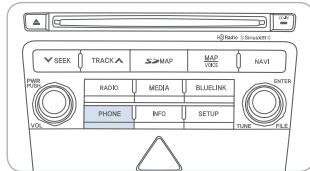

2. Press Yes button the screen.
3. Enable Bluetooth on your mobile phone. Select "AZERA" from the Bluetooth device list on your mobile phone.
4. Input the passkey displayed on the screen when applicable.
5. If your phone prompts a phonebook access request, it is advisable to check box "Always allow" or "Don't ask again".

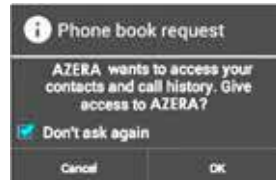

BLUETOOTH OPERATIONAL TIPS

In the following situations you or the other party may have difficulty hearing each other:

1. Keep the Bluetooth volume to a low level. High level volume may result in distortion and echo.
2. When driving on a rough road, high speeds and/or with the window open.
3. When the air conditioning vents are facing the microphone and/or when the air conditioning fan is at the max speed.

Steering wheel bluetooth control

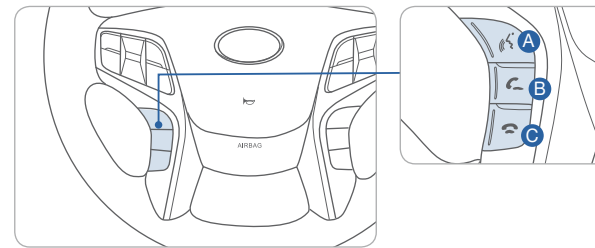

- A TALK**
Activate voice recognition.
- B CALL**
Place and transfer call.
- C END**
End call or cancel function.

To Answer a Call:

- Press button on the steering wheel.

To Reject a Call:

- Press button on the steering wheel.

To Adjust Ring Volume:

- Use the VOLUME buttons on the steering wheel.

To Transfer a Call to the Phone (Secret Call):

- Press and hold button on the steering wheel until the audio system transfers a call to the phone.

To Finish a Call:

- Press button on the steering wheel.

Please visit www.hyundaiusa.com/Bluetooth for a list of compatible phones tested to work with Hyundai's Bluetooth® system.

Making a call using voice recognition: 🗣️

The menu tree identifies available voice recognition Bluetooth® functions.

Calling by Name:

1. Press 🗣️ button.
2. Say the following command:
 - “Call <John>”: Connects the call to John.
 - “Call <John> on <Mobile/Home/Office>”: Connects the call to John’s Mobile, Home, or Office phone number.

Dialing by Number:

1. Press 🗣️ button.
2. Say “Call”.
3. Say “By number” when prompted.
4. Say desired phone numbers.
5. Say “Dial” to complete the number and make a call.

For complete list of commands, refer to your Owner’s Manual.

VOICE RECOGNITION TIPS

Your vehicle is equipped with Voice Recognition technology which allows drivers to operate their phones without having to take their eyes off the road to minimize distractions.

Voice recognition performance may be affected if driving with windows and sun roof open; when the heating-cooling system is on; when passing in a tunnel or when driving on rugged and uneven roads.

Quick reference on using voice commands

To start voice command. Press the 🗣️ key, the following commands are available:

Command	Function
More Help	Provides guidance on commands that can be used anywhere in the system
Help	Provides guidance on commands that can be used within the current mode.
Call <Name>	Calls <Name> saved in Contacts. Ex) Call “John Smith”
Dial <Number>	Call can be made by dialing the spoken numbers. Ex) Call “123”
Phone	Provides guidance on Phone related commands. After saying this command, say “Call History”, “Contacts” to execute corresponding functions.
Call History	Displays the Call History screen.
Contacts (Call by Name)	Displays the Contacts screen. After saying this command, say the name of a contact saved in the Contacts to automatically connect the call.
Dial Number	Display the Dial number screen. After saying this command, you can say the number what you want to call.

BLUE LINK TELEMATICS SYSTEM

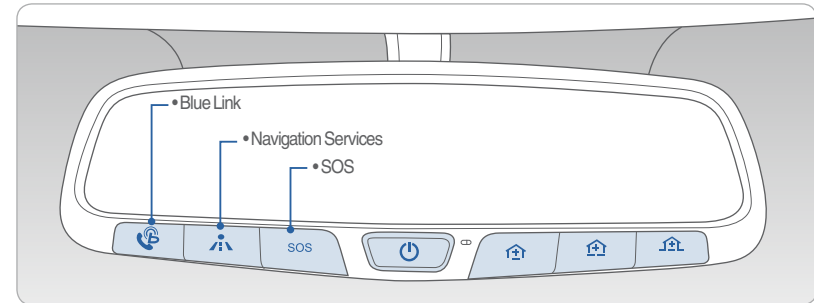

Blue Link subscription is required. To enroll, please visit your dealership or MyHyundai.com.

Press the 🗣️ button for access to the voice-response menu of services.

- You can say:

For Audio equipped	For Navigation equipped
New Destination Service Link Roadside Assistance Valet Alert Help Cancel	Service Link Roadside Assistance Blue Link Account Services Help Cancel

Press the 🗣️ button for Destination Search Powered by Google™.

- For audio equipped vehicles, you will receive turn-by-turn directions once you search for your destination. To hear a list of commands, say, “Help”. For navigation equipped vehicles, state your desired destination after the prompt and select the POI from the touchscreen display to navigate.

Press the SOS button for SOS Emergency Assistance.

Refer to your Blue Link User’s Manual for detailed information on system operation.

For immediate assistance with subscription services, please call 1-855-2BLUELINK (1-855-225-8354).

Google™ is a registered trademark of Google, Inc.

MULTIMEDIA

Remote Start



You can download the Blue Link mobile app to your compatible smart phone from the following sites:

- iPhone® — Apple® App Store
- Android® — Google Play



Scan to see list of compatible devices and to download the app.

Remote Start enables you to remotely start your vehicle from virtually anywhere. For navigation vehicles, you can also enable climate control remotely and turn on the rear-window defroster, ensuring a warm or cool car is ready to go when you are.

- To use this feature, you must have a Blue Link Personal Identification Number (PIN). To create or change your PIN, log on to www.MyHyundai.com.

Remember:

- Remote Start with Climate Control will automatically shut off after 10 minutes or after selected engine timer runs out in navigation vehicles.
- While this feature is active, the parking lights will blink until vehicle is turned off or when vehicle is in operation.
- To continue operation of the vehicle, the proximity key must be inside the vehicle with the driver prior to pressing the brake and being able to move the gearshift from the P (Park) position.

Preconditions:

- Ignition is OFF
- Alarm is armed (i.e., vehicle locked by key fob Remote Door Lock)
- Gearshift level is in the P (Park) position
- Brake pedal is not depressed
- Engine hood is securely closed
- All the doors are closed and locked
- The tailgate or trunk lid is closed
- The security/panic system is not activated
- The proximity key is not inside the vehicle
- The battery power is not low
- Vehicle is located in an open area
- It has been less than 4 days since last vehicle ignition off
- Vehicle located in area with good cell reception

Remote Start will terminate:

- After 10 minutes or after selected engine timer runs out in navigation vehicles
- Brake is pressed without proximity key inside vehicle
- Alarm is triggered without proximity key inside vehicle
- Door/trunk is opened from inside the vehicle

Notice: Laws in some communities may restrict the use of the features that remotely start the engine. For example, some laws may require a person using the remote start feature to have the vehicle in view when doing so or limit the length of time a vehicle engine may idle. Please check local and state regulations for any requirements and restrictions on remote starting of vehicles and engine idling time.

WARNING!

Do not remote start vehicle in an enclosed environment (i.e., closed garage). Prolonged operation of a motor vehicle in an enclosed environment can cause a harmful build-up of carbon monoxide. Carbon monoxide is harmful to your health. Exposure to high levels of carbon monoxide can cause headaches, dizziness or in extreme cases unconsciousness and/or death. Do not leave children or animals unattended in a vehicle while using the remote start function.

CAUTION!

If the vehicle's windshield wipers are left on when the vehicle was last driven, then the wipers will turn on if the remote start function is activated. To avoid damage to the wiper blades (i.e., due to heavy ice or snow accumulated on the windshield), please always turn the vehicle's windshield wipers off when parking the vehicle.

NAVIGATION

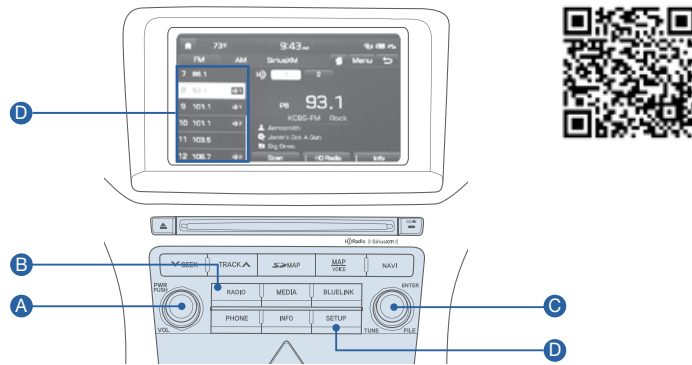

Press POWER button **A** to turn radio on.

- TUNING/LISTENING TO CHANNELS
 1. Press RADIO button **B**.
 2. Rotate TUNE **C** knob to desired channel.

NOTE:

A clear view of the southern sky is recommended to ensure SiriusXM® radio reception.

- SETTING PRESET BUTTONS

Six preset frequencies each for FM1/FM2/AM/SiriusXM modes can be stored manually.

 1. Select the band (FM1, FM2, AM, and SiriusXM) you want to store a station into.
 2. Select the desired station.
 3. Touch and hold one of the preset buttons **D** until audible beep is heard.
- ADJUSTING THE SOUND
 1. Press SETUP button **D**.
 2. Touch the SOUND button on the main screen.
 3. Touch the arrows on the screen to adjust desired sound setting.



Please refer to your Navigation Manual for more detailed information on how to use your audio system. Complimentary SiriusXM® subscription ends three months following the vehicle date of sale.

Please contact SiriusXM® Radio at 1-800-XM-RADIO (1-800-967-2346) to renew your SiriusXM® subscription.

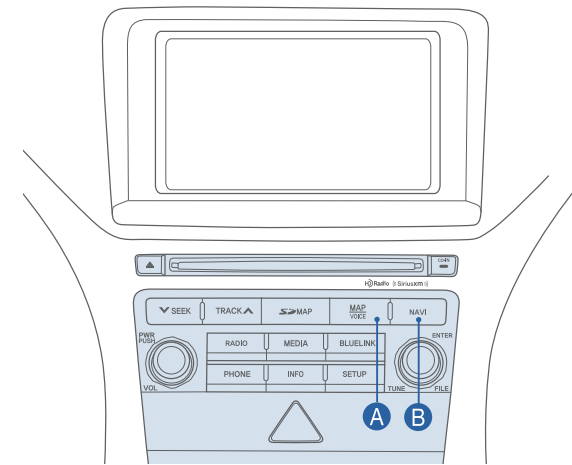

Map position

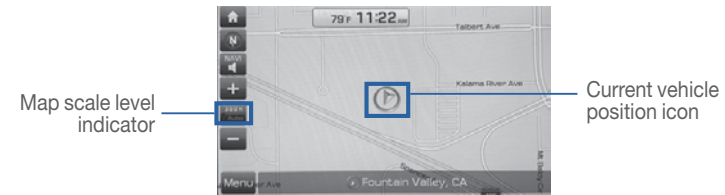

Press MAP button **A** to display map position.

Refer to Digital Navigation System User's Manual for more details.

Destination menu

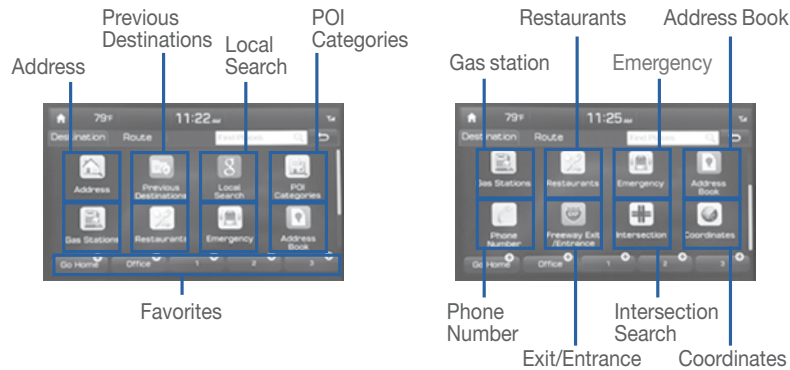

Press the NAVI button **B** to display destination menu.

- Address: Search destinations by selecting specific states/cities/roads.
- Previous Destination: Search and select previous destinations.
- Local Search: Google local search.
- POI Categories: Search by Point of Interest categories.
- Gas Station: Search for gas stations.
- Restaurants: Search for restaurants.
- Emergency: Search for emergency related facilities.
- Address Book: Search in address book.
- Phone Number: Search destinations by entering POI phone number.
- Freeway Exit/Entrance: Search destinations by searching for expressway exits and entrance.
- Intersection: Search destinations by selecting street intersections.
- Coordinates: Search destinations by entering the latitude and longitude coordinates.

AUX, USB, AND iPod® PORT

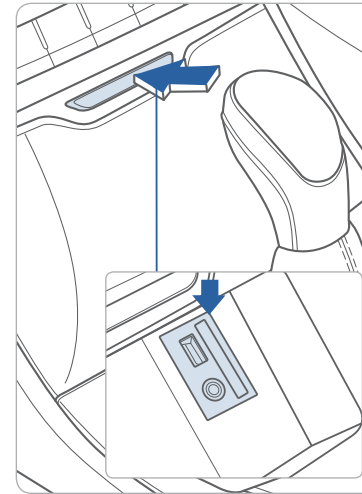

Use the jack to connect an external audio device and listen to it through the audio system in your vehicle.

NOTE

To operate your iPod® through the vehicle's audio system, connect your Apple supplied USB cable to the USB port.

iPod® is a trademark of Apple Inc.

CLOCK ADJUSTMENT

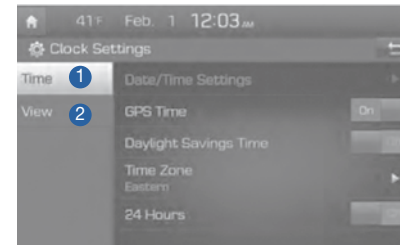

1 Time Settings

Provides the GPS Time, Date/Time Settings, Daylight Savings Time, and 24 Hour Options.

2 View Settings

Provides options to select a digital or analog clock for the screen saver or home screen, and to select the Display Date settings.

AUTOMATIC TRANSMISSION

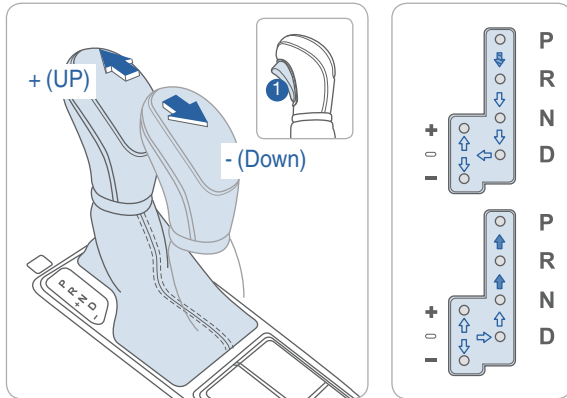

- (➡) : Depress the brake pedal and the lock release button ❶ when shifting.
- (➡) : The lock release button ❶ must be pressed while moving the shift lever.
- (➡) : The shift lever can be shifted without pressing the lock release button ❶.

Sport mode

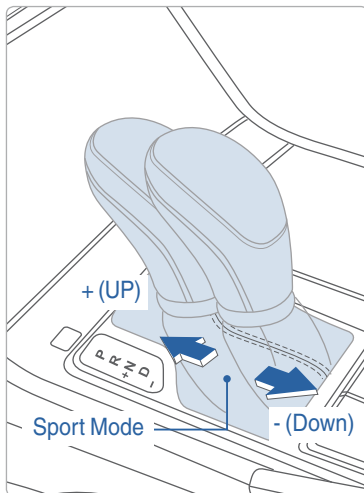

Move the shift lever from D (Drive) to the left gate to select.

Move the shift lever forward (+) to upshift or rearward (-) to downshift.



TIRE PRESSURE MONITORING SYSTEM (TPMS)

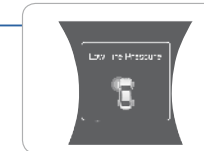
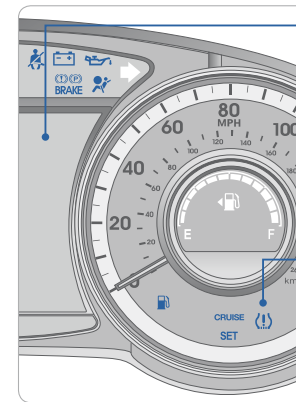

Low tire pressure location indicator



Low tire pressure indicator / TPMS malfunction indicator



Low Tire Pressure Indicator

Illuminates if one or more of your tires is significantly under-inflated.

Low Tire Pressure location indicator

Indicates which tire is significantly under-inflated by illuminating the corresponding position.

TPMS Malfunction Indicator

Blinks for approximately one minute then remains illuminated when there is a malfunction with the TPMS system. Have the system checked by an authorized Hyundai dealer.

LANE DEPARTURE WARNING SYSTEM (LDWS)

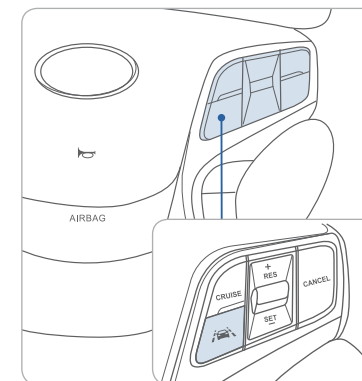

The Lane Departure Warning System detects the lane on the road and warns the driver if the vehicle leaves the lane when the vehicle speed is over 37mph.

- To turn LDWS on, press the LDWS switch
- To turn LDWS off, press the switch again.

BLIND SPOT DETECTION SYSTEM (BSD)

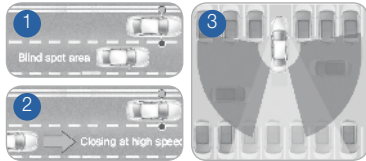

The BSD (Blind Spot Detection) system uses a radar sensor to alert the driver while driving. It senses the rear side territory of the vehicle and provides information to the driver.

- 1 Blind Spot Detection
- 2 Lane Change Assist
- 3 Rear Cross Traffic Alert

- To turn the BSD on, press the BSD button. (indicator illuminated)
- To turn the BSD off, press the BSD button again.

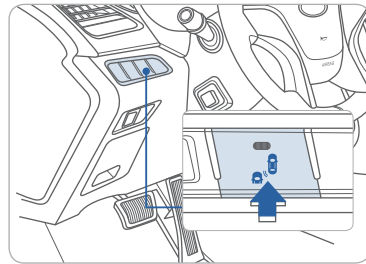

The system will activate if vehicle speed exceeds 20 mph.

Rear Cross Traffic Alert

When the transmission is put in R (Reverse), the system provides an alert if a vehicle is approaching from the sides.

ELECTRONIC STABILITY CONTROL (ESC)

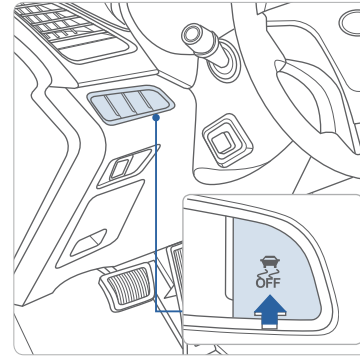

The ESC system is an electronic system designed to help the driver maintain vehicle control under adverse conditions.

Press to turn ESC on or off.

ACTIVE ECO SYSTEM

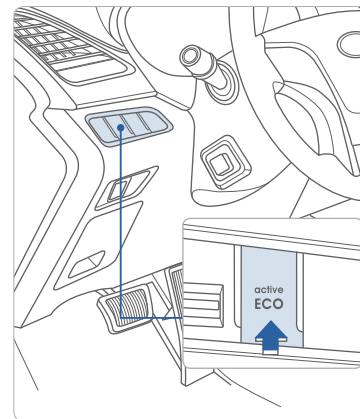

To conserve fuel, drivers can select Active ECO. This feature helps boost fuel efficiency by controlling the engine, transmission and air conditioning while absorbing acceleration response. Turn Active ECO off for sportier acceleration and transmission response. Press the Active ECO button to activate. The LED on the button and the ECO Indicator in the instrument cluster will illuminate.

To improve your fuel efficiency:

- Drive smoothly and accelerate at a moderate rate.
- Avoid heavy accelerations.
- Maintain steady cruising speed.
- Anticipate the traffic conditions ahead and adjust the vehicle speed smoothly.
- Avoid driving short distances after cold start.
- Avoid unnecessary braking.
- Keep the tires inflated to the recommended tire pressure.
- Don't idle the engine longer than necessary.

CHILD-PROTECTOR REAR DOOR LOCK

Allows or prevents opening the rear door from inside of the vehicle.

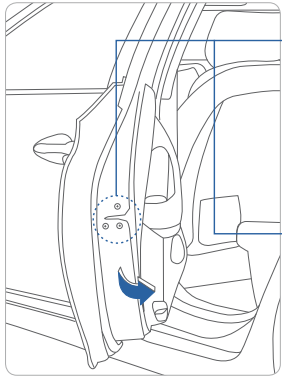

Lock (🔒)
Insert a key into the hole and turn it to the lock (🔒) position.



unlock
Insert a key into the hole and turn it counterclockwise to the unlock position.



REARVIEW CAMERA

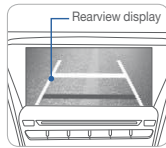
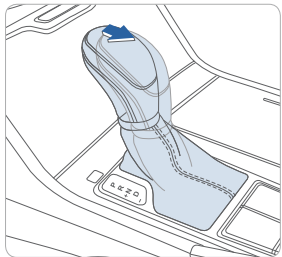

The rearview camera will activate when the ignition switch is ON and the shift lever is in the R (Reverse) position.



Key Websites

Hyundai website - www.hyundai.com

Hyundai owner website - www.myhyundai.com

Bluetooth phone compatibility - www.hyundaiusa.com/bluetooth

Blue Link - www.hyundaiusa.com/technology/bluelink

AZERA CUSTOMER DELIVERY CHECK LIST

Hyundai OWNER	DEALERSHIP NAME
SALES CONSULTANT	DATE
VIN	PREVIOUS VEHICLE

BEFORE DELIVERY

- CONFIRM "GOOD BATTERY" USAGE AND STAPLE TEST TICKET HERE
- SET TIRE PRESSURE LF ___ RF ___ RR ___ LR ___
- VERIFY VEHICLE IS CLEAN, IN GOOD CONDITION, FREE OF CHIPS AND SCRATCHES · CLEAN WINDSHIELD AND BACK WINDOW
- ENSURE FLOORMATS ARE SNAPPED INTO PLACE

Sales Consultant	Date	Sales Manager	Date
Customer			Date
Email	@		