

WALK THE CUSTOMER THROUGH EACH OF THE FOLLOWING KEY DELIVERY FEATURES

❑ DEFROST - page 15

- 1 Press the front defrost button.
- 2 Set to warmest temperature setting.
- 3 Set to highest fan speed.

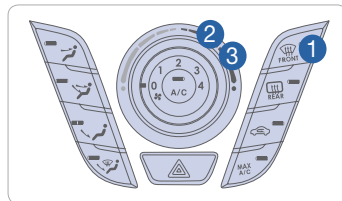

❑ BLUETOOTH – page 20

- Demonstrate phone pairing
- Refer to www.hyundaiusa.com/bluetooth
- Demonstrate QR code



❑ BLUE LINK – pages 21-22

- Assist with creating MyHyundai.com account
- Assist with Blue Link enrollment
- Show Blue Link Users Manual & tear out Voice Commands/Quick Tip Card
- Encourage customers to press the Blue link button  after enrollment to initiate Welcome Call

❑ CLOCK – pages 26

- Demonstrate how to set clock (including daylight savings setting for Navigation equipped vehicles)

❑ ECOSHIFT DUAL CLUTCH TRANSMISSION – pages 27-29

- Explain DCT characteristics

❑ NAVIGATION (if applicable) – page 24

- Demonstrate navigation system POI, enter dealer address

❑ TIRE PRESSURE MONITORING SYSTEM (TPMS) – page 30

- Explain TPMS function of customer
- When illuminated, one or more tires are under-inflated
- Blinks for approximately one minute then remains illuminated when there is a malfunction with the TPMS



❑ VEHICLE SETTINGS – pages 12-13 and 24-25

- Demonstrate vehicle settings in instrument cluster
- Demonstrate navigation use, enter dealer address
- Show radio presets

MAINTENANCE

Scheduled Maintenance	Normal Usage	Severe Usage*
Engine Oil And Filter	Replace 7,500 or 12 mos.	Replace 3,750 or 6 mos.
Fuel Additives *1	Add Every 7,500 or 12 mos.	Add Same as Normal
Tire Rotation	Perform 7,500	Perform 7,500
Air Cleaner Filter	Inspect Replace 7,500 30,000	Inspect Replace Same As Normal More Frequently
Battery Condition	Inspect 7,500	Inspect Same As Normal
Vacuum Hose	Inspect 7,500	Inspect Same As Normal
Climate Control Air Filter (For Evaporator And Blower Unit)	Replace 15,000	Replace More Frequently
Air Conditioning Refrigerant	Inspect 15,000	Inspect Same As Normal
Brake Hoses & Lines	Inspect 15,000	Inspect Same As Normal
Drive Shafts & Boots	Inspect 15,000	Inspect 7,500 or 6 mos.
Electronic Throttle Control	Inspect 15,000	Inspect Same As Normal
Exhaust Pipe & Muffler	Inspect 15,000	Inspect Same As Normal
Front Disc Brake/Pads, Calipers	Inspect 15,000	Inspect More Frequently
Rear Brake Drums/Linings Rear Brake Disc/Pads	Inspect 15,000	Inspect More Frequently
Steering Gear Box, Linkage & Boots/ Lower Arm Ball Joint, Upper Arm Ball Joint	Inspect 15,000	Inspect More Frequently
Suspension Mounting Bolts	Inspect 15,000	Inspect Same As Normal
Brake/Clutch Fluid	Inspect 30,000	Inspect Same As Normal
Fuel Filter	Inspect 30,000	Inspect Same As Normal
Fuel Lines, Fuel Hoses And Connections	Inspect 30,000	Inspect Same As Normal
Fuel Tank Air Filter	Inspect 30,000	Inspect Same As Normal
Parking Brake	Inspect 30,000	Inspect More Frequently
Vapor Hose, Fuel Tank & Fuel Filler Cap	Inspect 30,000	Inspect Same As Normal
Valve Clearance	Inspect 60,000	Inspect Same As Normal
Manual Transmission Fluid	Inspect 37,500	Replace 75,000
EcoShift Dual Clutch Transmission Fluid	Inspect 37,500	Replace 75,000
Drive Belt (Alt, A/C)	1st Inspect 60,000 or 72 mos. Add. Inspect 15,000 or 24 mos.	Inspect Same As Normal
Spark Plugs (Iridium Coated)	Replace 105,000	Replace More Frequently
Coolant	1st Replace 120,000 or 10 yrs. Add Replace 30,000 or 24 mos.	Replace Same As Normal

*1 If TOP TIER Detergent Gasoline is not available, one bottle of additive is recommended. Additives are available from your authorized Hyundai dealer along with information on how to use them. Do not mix other additives.
*See Owner's Manual for details.

Looking for more detailed information? This Quick Reference Guide does not replace your vehicle's Owner's Manual. If you require additional information or are unsure of a specific issue, you should always refer to the vehicle's Owner's Manual or contact your authorized Hyundai dealer.

The information contained in this Quick Reference Guide was correct at the time of printing, however, specifications and equipment can change without notice. No warranty or guarantee is being extended in this Quick Reference Guide, and Hyundai reserves the right to change product specifications and equipment at any time without incurring obligations. Some vehicles are shown with optional equipment. Specifications apply to U.S. vehicles only. Please contact your Hyundai dealer for current vehicle specifications.

NP150-V2014
(Rev 11/19/13)
Printing 11/21/13



HYUNDAI **VELOSTER**
Quick Reference Guide

www.hyundai.com

 **HYUNDAI**
NEW THINKING.
NEW POSSIBILITIES.

Roadside Assistance: 1-800-243-7766
Consumer Affairs: 1-800-633-5151
XM® Radio: 1-800-967-2346
Blue Link: 1-855-2BLUELINK
(1-855-225-8354)

Table of contents

GETTING STARTED

Engine Start/Stop	03
Remote keyless entry	02
Front seat adjustment	04
Headrest adjustment	04
Seat belt adjustment	05

FEATURES AND CONTROLS

Active ECO System	31
Central door lock switch	07
Child-protector rear door lock	11
Climate control	14-15
Clock adjustment	26
Cruise control system	16
Driver's main control	07
Electronic Stability Control (ESC)	31
Fuel door	06
Head lights and fog lights	08
Instrument cluster	12-13
Instrument panel illumination	13
Interior lights	11
Rearview camera	29
Steering wheel adjustments	06
Steering wheel controls	16-17
Sunroof	10
Transmissions	27-29
Trip computer	13
Tire Pressure Monitoring System (TPMS)	30
Wiper and washer	09

MULTIMEDIA

Audio	23
AUX, USB, and iPod® Port	26
Blue Link® Telematics system	21-22
Bluetooth operational tips	18-19
Bluetooth phone pairing	20
Navigation	24-25

How to:

1. Pair phone to your vehicle. Refer to page 20.
2. Get started with Blue Link. Refer to page 21-22.



Steering wheel adjustments
Page 06



Instrument cluster
Pages 12-13

Standard Audio



Audio/
Navigation
Pages 23-25

Navigation Audio



Navigation

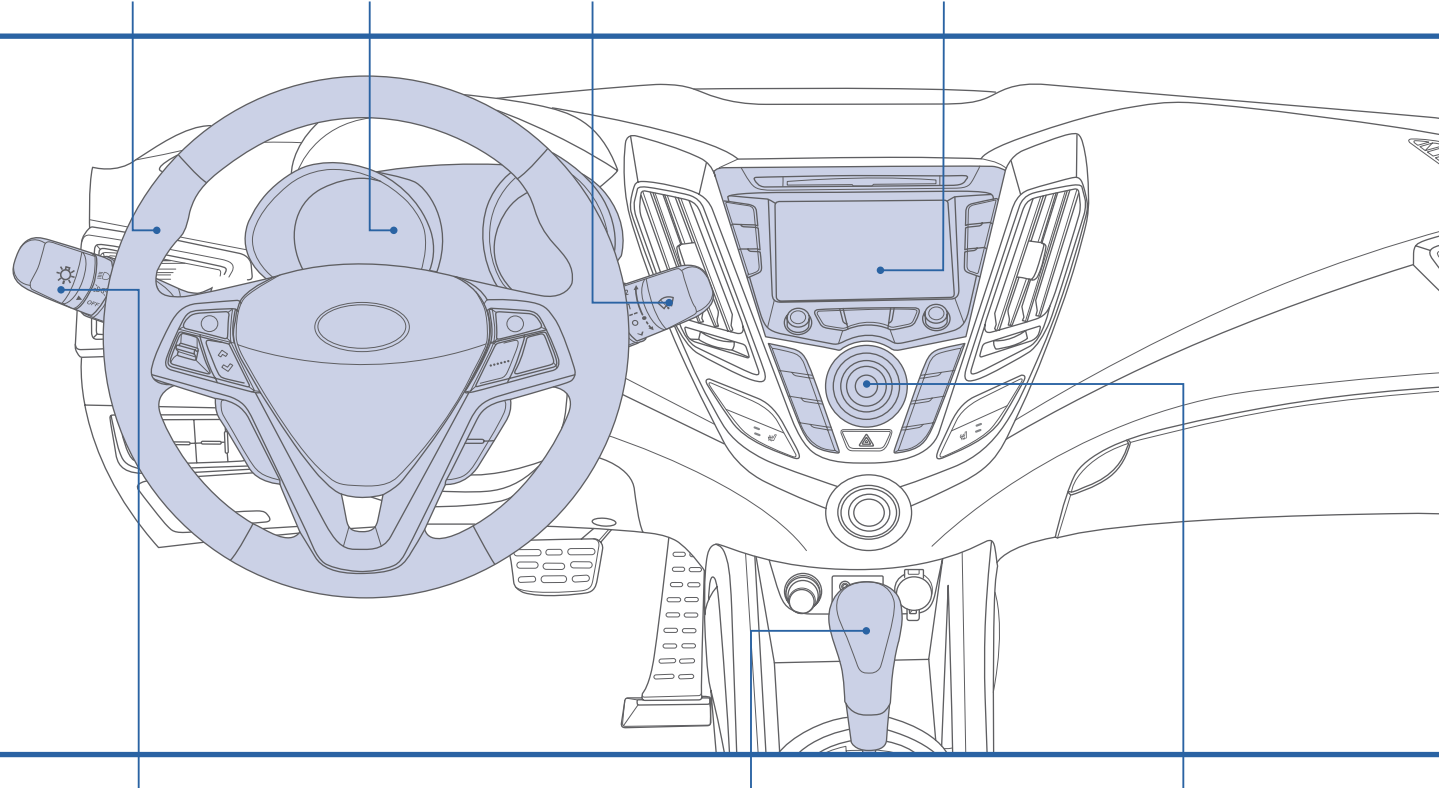

Head lights
and fog lights
Page 08



Transmission
Pages 27-29



Climate
control
Pages 14-15

*Some vehicles may not be equipped with all the listed features.

Use this Quick Reference Guide to learn about the features that will enhance your enjoyment of your Hyundai. More detailed information about these features are available in your Owner's Manual.



WARNING!





To reduce the risk of serious injury to yourself and others, read and understand the important SAFETY INFORMATION in your Owner's Manual.

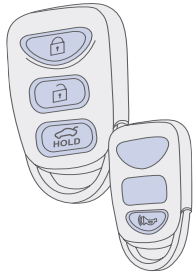

GETTING STARTED

REMOTE KEYLESS ENTRY



-  Lock
-  Unlock
-  Tailgate unlock
-  Panic

Keyless Entry



Smart Key

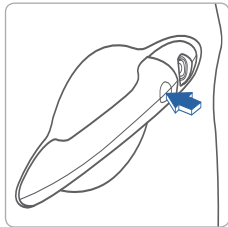

Driver's door Lock/Unlock
Smart key must be within range.

Press:

- Once – Unlock driver door
- Twice – Unlock all doors
- Third – Lock all doors

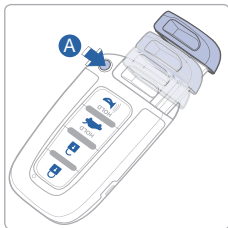

Remove mechanical key

Press and hold the release **A** button and remove the key.

Reinstall mechanical key

Put the key into the key slot and push it until a click sound is heard.

ENGINE START/STOP BUTTON

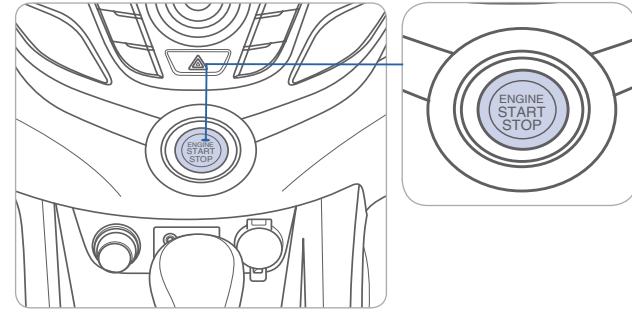

With the ignition OFF, press the engine start/stop button:

- Once for ACC (Accessory) mode.
- Twice for ON mode.
- Three times for OFF.

To start the engine, press the start/stop button while:

- EcoShift Dual Clutch Transmission: depressing the brake pedal.
- Manual Transmission: depressing the clutch and brake pedals.

To shut engine OFF, shift to:

- EcoShift Dual Clutch Transmission: P (Park) and press the start/stop button.
- Manual Transmission: Select 1st gear or Neutral, apply the hand brake, and press the start/stop button.

Emergency situations

Shut off engine while driving:

Press engine start/stop button for more than 2 seconds or press it 3 times consecutively within 3 seconds.

Restart engine while driving:

Press engine start/stop button with shift lever in N (Neutral).



GETTING STARTED

FRONT SEAT ADJUSTMENT

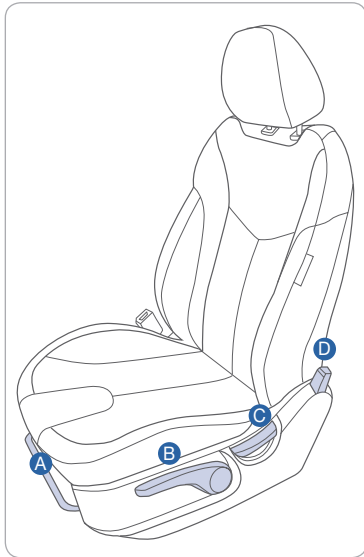

A Forward / backward

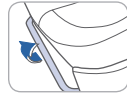

B Seat cushion height (driver's seat only)

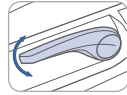

C Seatback angle

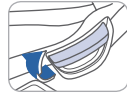

D Folding Lever (driver's seat only)

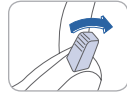

SEAT BELT ADJUSTMENT (Driver's Front seat)

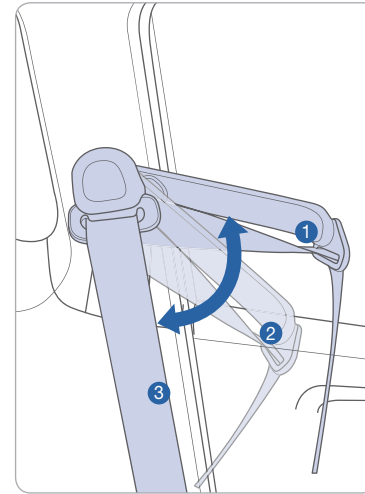

Set the belt extension guide to one of the 3 positions when using the seat belt.

See Owner's Manual for additional seat belt information.

HEADREST ADJUSTMENT

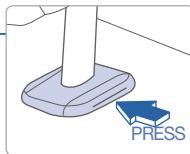
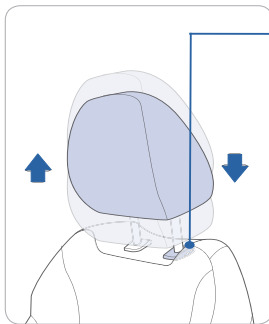

To Raise Headrest:
Pull headrest up.

To Lower Headrest:
Press lock knob while pressing down on headrest.



STEERING WHEEL ADJUSTMENTS

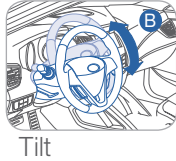
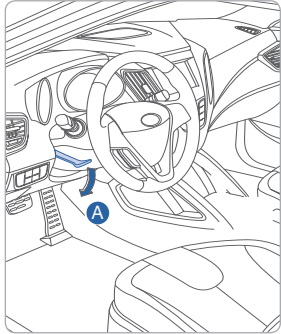

Tilt

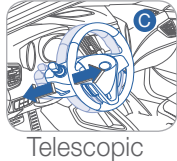

Telescopic



- NOTE:** Do not adjust while driving.
1. Pull the lever **A** down to release.
 2. Set the angle **B** and distance **C**.
 3. Pull the lever **A** up to lock.

FUEL DOOR

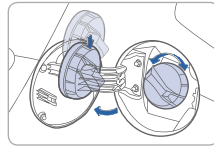
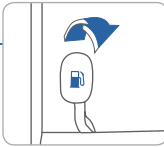
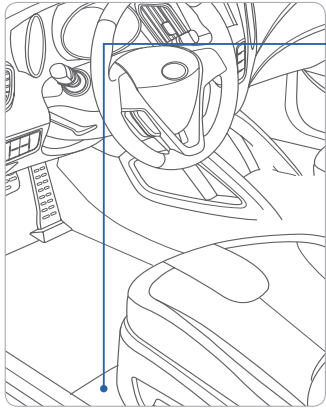

NOTE

After adding fuel, always reinstall the fuel cap onto the filler neck by rotating it clockwise until it clicks once.

Failure to do this may result in the Check Engine Light () illuminating.

DRIVER'S MAIN CONTROLS

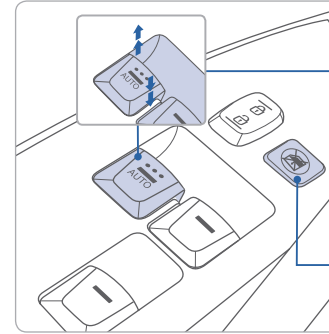

Window Auto down/up (driver's side only)
Press past detent to fully open/close window.



Power Window Lock Switch
Disables the power window switches on the passenger doors.

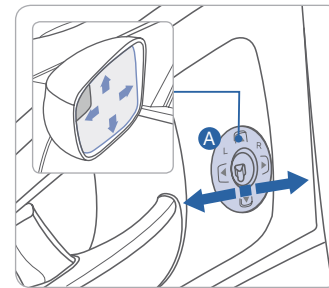

Outside Rearview Mirrors

Move the selecting switch **A** to the right or left for adjusting the outside rearview mirrors.



Depress the appropriate direction () on the switch.

Middle position
Lock the control.

CENTRAL DOOR LOCK SWITCH

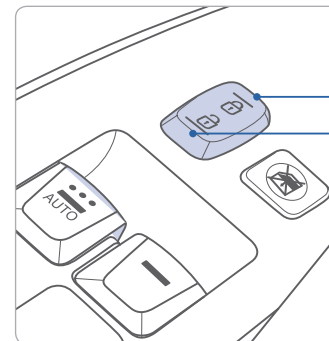

All doors will lock.
All doors will unlock.





FEATURES AND CONTROLS

HEAD LIGHTS AND FOG LIGHTS

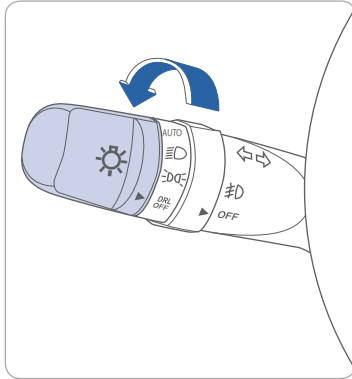

- ▶ **AUTO** Auto light 
- ▶  Head light 
- ▶  Parking light
- ▶ **DRL OFF** DRL OFF

Escort Function

Head lights will stay on for approximately 30 seconds after exiting and locking vehicle. Press remote lock button twice to turn head light off. See Owner's Manual for more detail.

Turn signals and lane change signals Flashing head lights

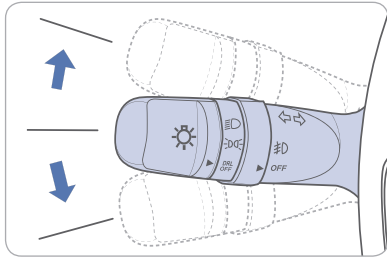

High beam

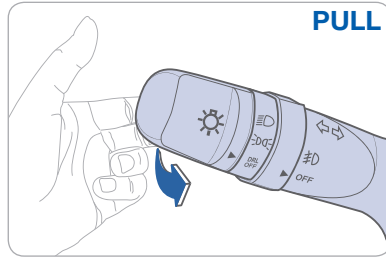
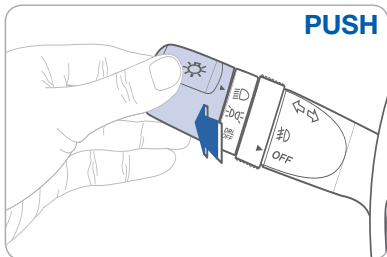

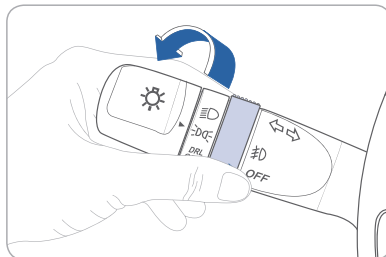

Fog light

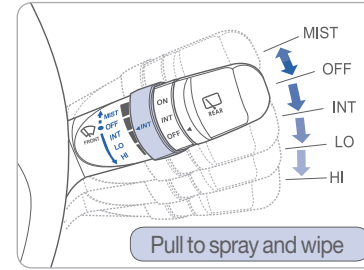

WIPER AND WASHER

Front Wiper and Washer



- MIST** - Single wipe 
- OFF** - Off
- INT** - Intermittent wipe
- LO** - Normal wiper speed
- HI** - Fast wiper speed

Front Intermittent wipe time adjustment



Rear Wiper and Washer

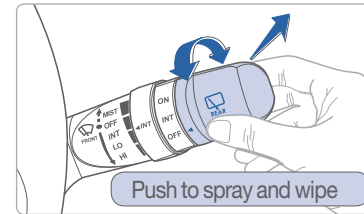

- ON** - Normal wiper operation
- INT** - Intermittent wiper operation
- OFF** - Wiper off



FEATURES AND CONTROLS

SUNROOF

Sliding the sunroof

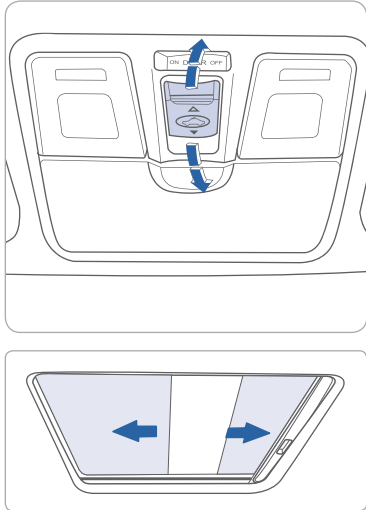

To Open

Press switch backward.
Press switch backward past the detent to open completely.

To Close

Press switch forward and hold.

Tilting the sunroof

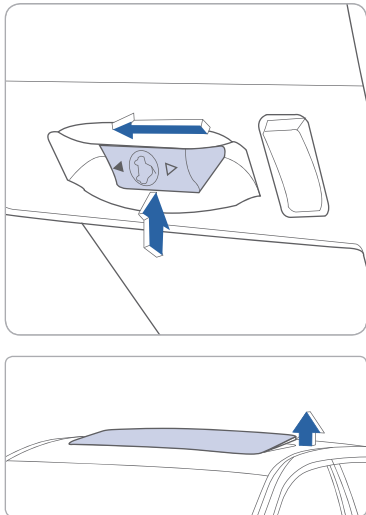

To Tilt

Press or pull switch up or down.

INTERIOR LIGHTS

Map lamp

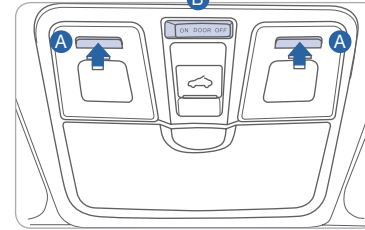

Push the lens **A** to turn the map lamp on or off.
Switch **B**

ON

Map lamp and room lamp will turn on.

DOOR

Map lamp and room lamp will turn on when any door is open except tailgate.

OFF

The lights stay off at all times, except when individually turned on.

Room lamp

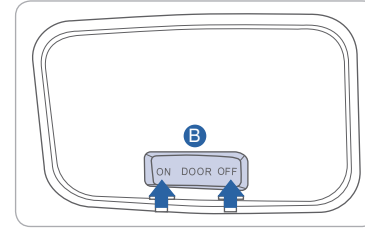

CHILD-PROTECTOR REAR DOOR LOCK

Allows or prevents opening the rear door from inside of the vehicle.

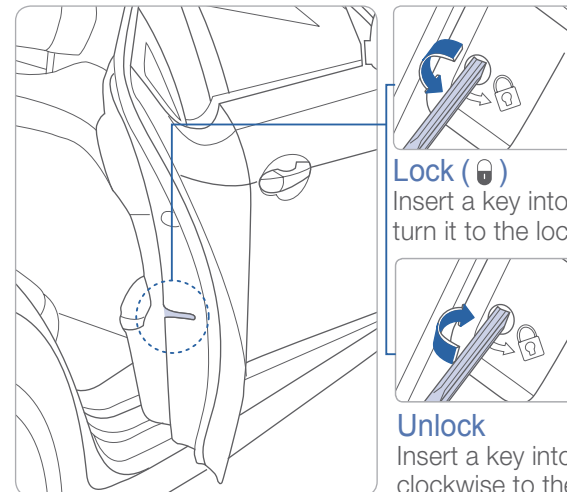

Lock (🔒)

Insert a key into the hole and turn it to the lock (🔒) position.

Unlock

Insert a key into the hole and turn it clockwise to the unlock position.



FEATURES AND CONTROLS

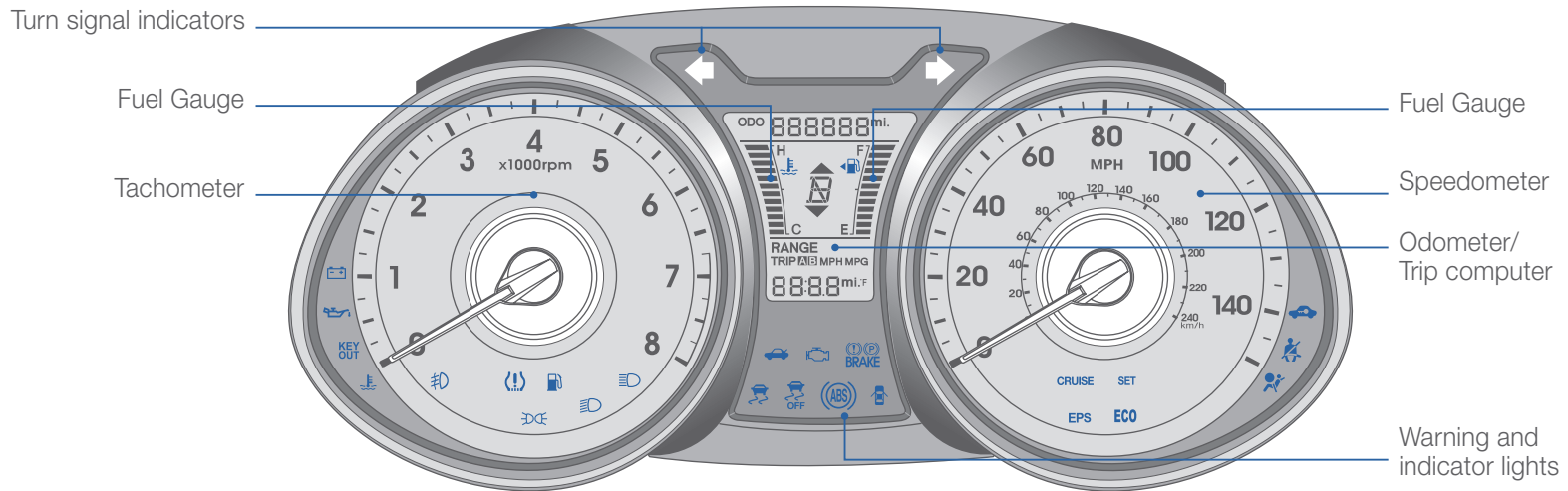

WARNINGS AND INDICATORS

Air bag warning light	Parking brake & Brake fluid warning light	ABS warning light
Seat belt warning light	Low Tire Pressure Indicator / TPMS (Tire Pressure Monitoring System) malfunction indicator	
High beam indicator	Engine oil pressure warning light	Charging system warning light
EPS Electric Power Steering system warning light	Door open warning light	Turn signal indicator
Immobilizer indicator	EcoShift Dual clutch transmission indicator	Manual transmission shift indicator
Tailgate open warning light	Low fuel level warning light	ESC (Electronic Stability Control) indicator
ESC (Electronic Stability Control) OFF indicator	CRUISE Cruise indicator	SET Cruise SET indicator
Malfunction indicator light	Front fog light indicator	ECO Active ECO indicator
Light on indicator	Engine coolant temperature warning light	KEY OUT KEY OUT indicator
Low beam indicator		

INSTRUMENT PANEL ILLUMINATION

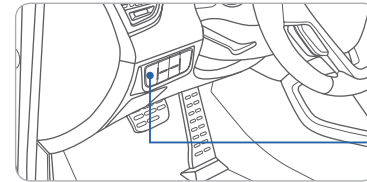

Push the control switch up or down to adjust the brightness

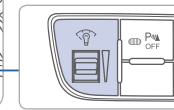

TRIP COMPUTER

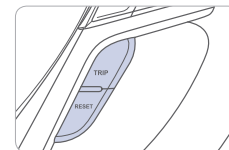

Press the TRIP button to select functions as shown below.

Press and hold the RESET button to reset the Tripmeter.

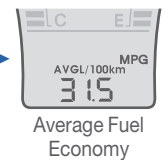
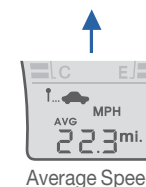
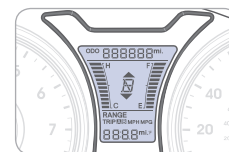



FEATURES AND CONTROLS

CLIMATE CONTROL

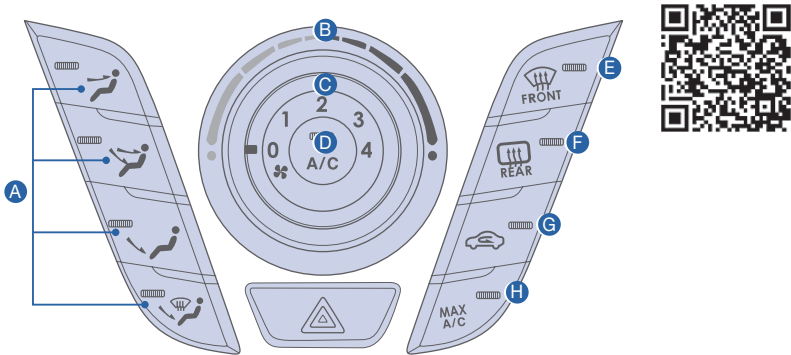

- A** Mode selection buttons
- B** Temperature control knob
- C** Fan speed control knob
- D** Air Conditioning button
- E** Front windshield defrost button
- F** Rear window defroster button
- G** Air intake control button
- H** MAX Air Conditioning button

MODE SELECTION

- Face Level
- Bi Level
- Floor Level
- Floor Defrost Level

AIR INTAKE CONTROL



This is used to select outside (fresh) air position or recirculated air position.

- Outside (fresh) air position
- Recirculated air position

DEFROSTING/DEFOGGING

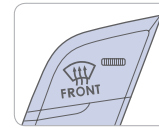

1. Press the front windshield defrost control.

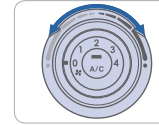

2. Set the temperature control to the warmest setting.

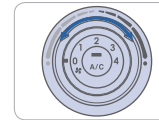

3. Set the fan speed to the highest setting.

NOTE

To reduce the tendency of the glass fogging and improve visibility, keep the interior surface of the windshield clean by wiping it with a clean cloth and glass cleaner.

REAR WINDOW DEFROSTER

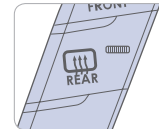

Press to activate / deactivate the rear defroster.



FEATURES AND CONTROLS

STEERING WHEEL CONTROLS

Cruise control system

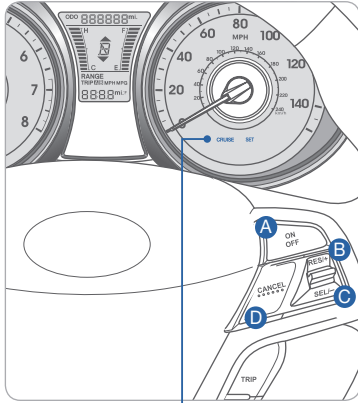

To set a cruising speed

1. Press ON/OFF button **A** and the CRUISE indicator will illuminate in the instrument cluster.
2. Accelerate to desired cruising speed (above 25 mph). Press SET-button **C** and remove your foot from the accelerator pedal.

To accelerate or decelerate

Press RES + button **B** up to increase set cruising speed.

Press SET - button **C** down to decrease set cruising speed.

To cancel cruising speed

Press CANCEL button **D**, depress brake pedal, or press ON/OFF button **A**.

CRUISE

Cruise indicator

SET

Cruise set indicator

Audio control

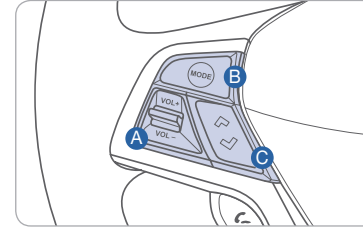

A VOLUME

Raise or lower speaker volume.

B MODE

Change the audio source.
Hold to turn Audio power ON/OFF.

C SEEK/PRESET

Press to change presets.
Press and hold to seek stations.

Bluetooth control

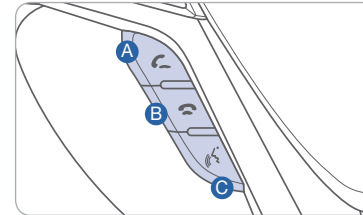

A CALL

Place and transfer call.

B END

End call or cancel function.

C TALK

Activate voice recognition.



BLUETOOTH OPERATIONAL TIPS

In the following situations you or the other party may have difficulty hearing each other:

1. Keep the Bluetooth volume to a low level. High level volume may result in distortion and echo.
2. When driving on a rough road, high speeds and/or with the window open.
3. When the air conditioning vents are facing the microphone and/or when the air conditioning fan is at the max speed.

Bluetooth control

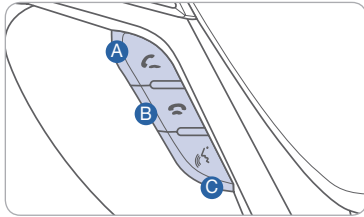

- A CALL**
Place and transfer call.
- B END**
End call or cancel function.
- C TALK**
Activate voice recognition.

To Answer a Call:

- Press button on the steering wheel.

To Reject a Call:

- Press button on the steering wheel.

To Adjust Ring Volume:

- Use the VOLUME buttons on the steering wheel.

To Transfer a Call to the Phone

(Secret Call):

- Press and hold button on the steering wheel until the audio system transfers a call to the phone.

To Finish a Call:

- Press button on the steering wheel.

Making a call using voice recognition:

The menu tree identifies available voice recognition Bluetooth® functions.

Calling by Name:

1. Press button.
2. Say the following command:
 - “Call <John>”: Connects the call to John.
 - “Call <John> on <Mobile/Home/Office>”: Connects the call to John’s Mobile, Home, or Office phone number.

Dialing by Number:

1. Press button.
2. Say “Call”.
3. Say “By number” when prompted.
4. Say desired phone numbers.
5. Say “Dial” to complete the number and make a call.

For complete list of commands, refer to your Owner’s Manual.

VOICE RECOGNITION TIPS

Your vehicle is equipped with Voice Recognition technology which allows drivers to operate their phones without having to take their eyes off the road to minimize distractions.

Voice recognition performance may be affected if driving with windows and sun roof open; when the heating-cooling system is on; when passing in a tunnel or when driving on rugged and uneven roads.

Quick reference on using voice commands

To start voice command. Press the key, the following commands are available:

Command	Function
More Help	Provides guidance on commands that can be used anywhere in the system
Help	Provides guidance on commands that can be used within the current mode.
Calls <Name>	Calls <Name> saved in Contacts. Ex) Call “John”
Dial <Number>	Call can be made by dialing the spoken numbers. Ex) Call “123”
Phone	Provides guidance on Phone related commands. After saying this command, say “Call History”, “Contacts” to execute corresponding functions.
Call History	Displays the Call History screen.
Contacts (Call by Name)	Displays the Contacts screen. After saying this command, say the name of a contact saved in the Contacts to automatically connect the cell.
Dial Number	Display the Dial number screen. After saying this command, you can say the number what you want to call.



MULTIMEDIA

BLUETOOTH PHONE PAIRING

Pairing tutorials, phone compatibility and Operational tips can be found through the Smart QR code using the QR reader application on your Smartphone.



Phone setup (pairing phone)

1. Press PHONE button on the radio or on the steering wheel remote control.
2. Touch “Yes” to search for Bluetooth phones.

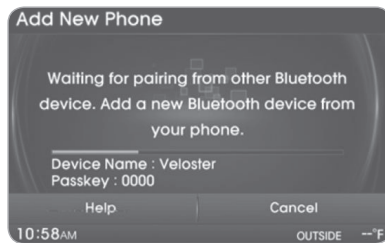
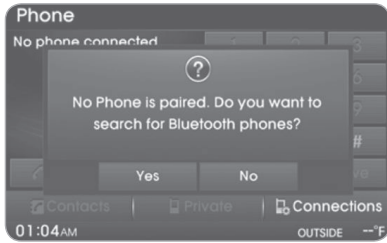

3. In your phone, initiate a search for Bluetooth devices.
4. After search is completed in your phone, select “Veloster”.
5. Input the passkey displayed on screen to your phone.



Please visit www.hyundaiusa.com/Bluetooth for a list of compatible phones tested to work with Hyundai's Bluetooth® system.



BLUE LINK TELEMATIC SYSTEM

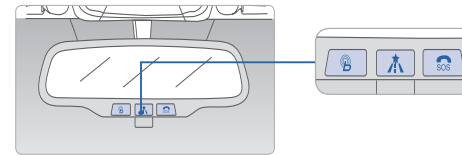

- Press the button for access to the voice-response menu of services. You have two options:
- You can say, “Main Menu” for a listing of main menu choices.
 - You can directly select any of the listed menu items by saying its name.

Navigation	Information	Essentials	Vehicle Assist
New Destination Gas Prices Restaurant Ratings Route Assistance Daily Route Guide Main Menu	Traffic Weather Valet Alert Main Menu	Voice Texting Location Sharing Main Menu	Roadside Assistance Agent Assistance Service Link Quick Tips Main Menu

- Press the button for navigation-related services.
- Press the button for SOS Emergency Assistance.
- Refer to your Blue Link User's Manual for detailed information on system operation.
- For immediate assistance with subscription services, please call 1-855-2BLUELINK (1-855-2225-8354).
- Please register your Blue Link at www.myhyundai.com.

Blue Link feature availability is dependent upon your Blue Link subscription package(s).



MULTIMEDIA



Remote Door Unlock/Lock

Blue Link Mobile App



You can download the Blue Link mobile app to your compatible smart phone from the following sites:

- iPhone® – Apple® App Store
- Android® – Google Play
- BlackBerry® – BlackBerry® App World

With this feature, you can lock or unlock your vehicle doors from virtually anywhere by using the Blue Link mobile phone app, by dialing the toll-free number, or by using the Blue Link owner's website.

- To use this feature, you must have a Blue Link Personal Identification Number (PIN). To create or change your PIN, log on to www.MyHyundai.com.

To Activate Remote Door Unlock/Lock

- By Blue Link Mobile App: Select DOOR UNLOCK or DOOR LOCK, as desired.
 - Enter your Blue Link PIN.
 - The command to lock or unlock your doors will be sent to your vehicle.
- By phone: Dial toll-free 1-855-2-BLUELINK (1-855-225-8354).
- By web site: Log on to www.MyHyundai.com, select Blue Link.
 - Select Remote Services, then Remote Door Unlock/Lock.
 - Input your Blue Link PIN. (If you need time to get to your vehicle, specify a time delay before your vehicle will be unlocked.)

AUDIO

Non-Navigation

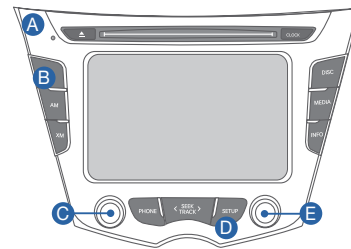

Navigation

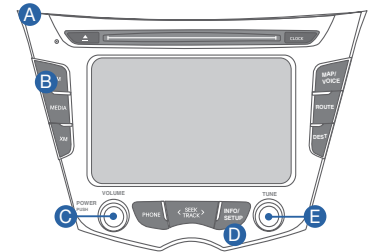

Press POWER button **C** to turn radio on.

- TUNING/LISTENING TO CHANNELS

1. Press FM/AM **A** or XM® **B**.
2. Rotate TUNE **E** to desired channel.

NOTE

A clear view of the southern sky is recommended to ensure XM® radio reception.

- SETTING PRESET BUTTONS

Six preset frequencies each for FM1/FM2/AM modes can be stored manually.

1. Select the band (FM1, FM2, AM) you want to store a station into.
2. Select the desired station.
3. Touch and hold one of the preset buttons until audible beep is heard.



- ADJUSTING THE SOUND

1. Press SETUP **D**.
2. Touch "Sound" on screen.

- Touch the arrows on screen to adjust desired sound setting.



Please refer to your Owner's Manual for more detailed information on how to use your audio system. Complimentary XM® subscription ends three months following the vehicle date of sale. Please contact XM® Radio at 1-800-XM-RADIO (1-800-967-2346) to renew your XM® subscription.



MULTIMEDIA



NAVIGATION

Map position



Destination menu

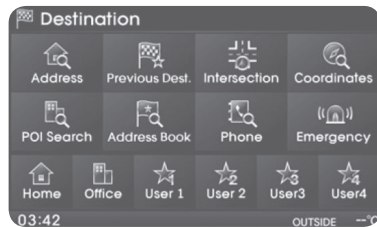

- Address: Finds a destination by setting an address.
- Previous Destinations: Destination you have previously entered.
- POI (Point of Interest) Search: Search for a destination category or name.
- Emergency: Finds a destination by searching for a police station, hospital or Hyundai dealership.

Playing Pandora

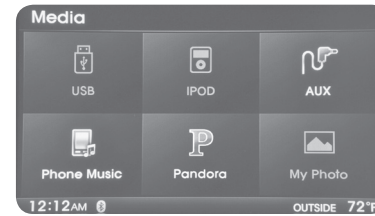

1. Ensure you have Pandora app on your smart phone.
2. Pair your smart phone to the Bluetooth system.
3. Select "Media" on Audio screen.
4. Select "Pandora".
5. Initiate Pandora app on your smartphone.



NOTE Not all smart phones are compatible



AUX, USB AND iPod® PORT

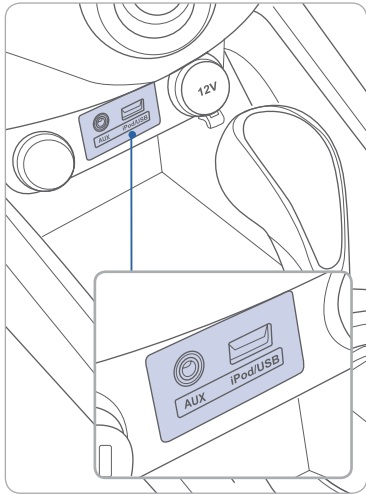

iPod® is a trademark of Apple Inc.



Use these jacks to connect an external USB, audio or video device. To view compatible video, connect the device to the supplied Hyundai RCA adapter video cable. Then connect the RCA adapter cable to the AUX jack.

NOTE

To operate your iPod® through the vehicle's audio system, connect your Apple supplied USB cable to the USB port.

CLOCK ADJUSTMENT



Time Setup

1. Press and hold CLOCK **A**.
2. Touch ▲ or ▼ to set the clock.
3. Touch "Done" when finished.



TRANSMISSIONS

EcoShift Dual Clutch Transmission

EcoShift Dual Clutch Transmission technology provides automatic shifting and excellent fuel economy based on manual transmission efficiency.

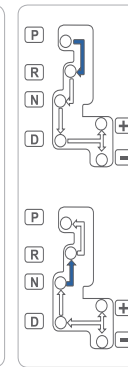
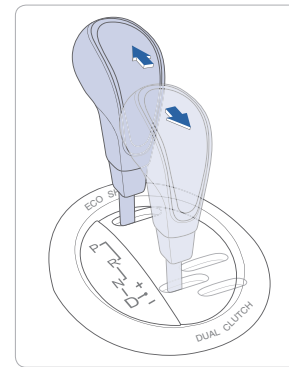

(➡) : Depress the brake pedal when shifting.

(⇄) : The shift lever can be shifted freely.

P : Park

R : Reverse

N : Neutral

D : Drive

Ds : Sport Mode

[+] : Sport Mode Upshift

[-] : Sport Mode Downshift

Paddle shifters

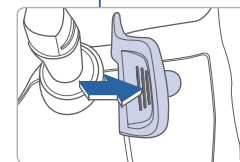

Press [-] to down shift

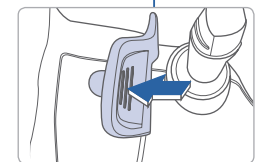

Press [+] to up shift

The paddle shifters operate when the shift lever is in the D position or the Sport Mode.

- When you pull the [+] or [-] paddle shifter once, the system changes from automatic mode to Sport Mode.
- When paddle shifters are no longer used the system changes back to automatic mode.

NOTE

If you pull the [+] and [-] paddle shifters at the same time, the transmission will not change gears.



FEATURES AND CONTROLS

NOTE - EcoShift Dual Clutch Transmission characteristics

The new technology of the ECOShift Dual Clutch Transmission is different than a traditional automatic or manual transmission:

- The EcoShift Dual Clutch Transmission is an automatically shifting manual transmission.
- EcoShift Dual Clutch Transmission utilizes two clutches connected to a computer-controlled manual gearbox. It provides the convenience of a transmission that shifts automatically, with the efficiency of a manual transmission.
- When you turn the ignition on and off, you may hear clicking sounds as the transmission solenoids turn on and off, cycling through a self test. This is a normal sound for the EcoShift Dual Clutch Transmission.
- When you stop on a hill, if you remove your foot from the brake pedal, the vehicle will remain stationary for approximately two seconds to prevent the vehicle from rolling backwards. If you depress the accelerator pedal during the two second interval, the vehicle will accelerate. If you wait more than two seconds, the vehicle will enter creep mode and may roll backwards if the hill is steep.

Caution

- You should always use the foot brake to hold the car on a hill until you are ready to drive. Using creep mode to hold the car on a hill may damage the clutch.
- An overload of the clutch is indicated by a shudder or vibration and a blinking warning light. To prevent clutch damage, the clutch will release. If the clutch is released, apply the foot brake and wait a few of minutes before driving. Ignoring these warnings and wait time can lead to transmission damage.

Sport Mode

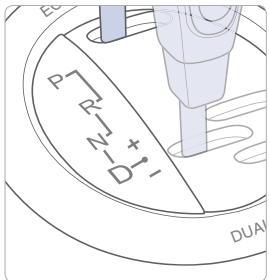

Shift lever from D to DS to activate Sport mode. Sport mode is a recalibrated automatic mode that will hold gears longer and downshift at higher RPM for a more dynamic driving style.

If you use the paddle shifters (or [+] or [-]) to enter the Sport Mode, you will stay in Sport Mode until the shift lever is returned to Drive, giving you full manual control.

Manual Transmission

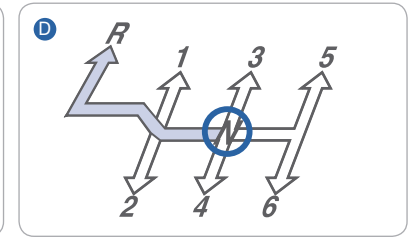
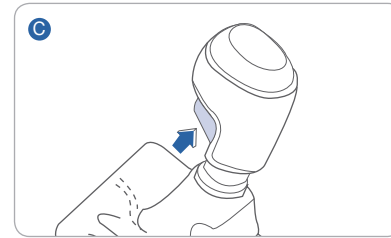
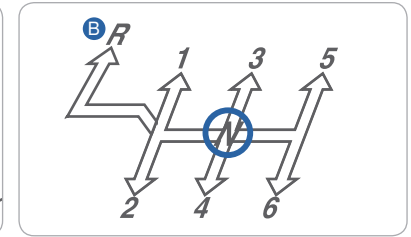
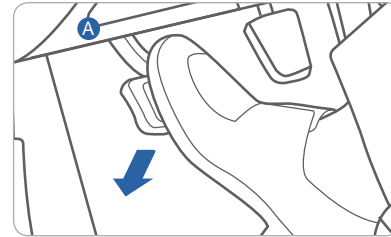

Shifting into Reverse

1. Fully depress the clutch **A**
2. Shift into Neutral **B**
3. Pull the Shift Lever Knob **C**
4. Shift into Reverse **D**

REARVIEW CAMERA

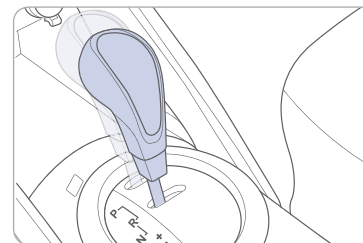

The rearview camera will activate when the ignition switch is ON and the shift lever is in the R (Reverse) position.

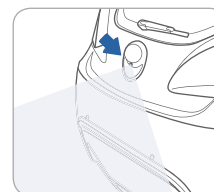
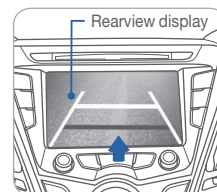



FEATURES AND CONTROLS

TIRE PRESSURE MONITORING SYSTEM (TPMS)

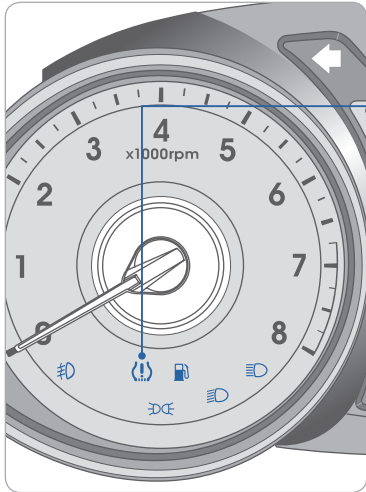

Low Tire Pressure Indicator

Illuminates if one or more of your tires is significantly under-inflated.

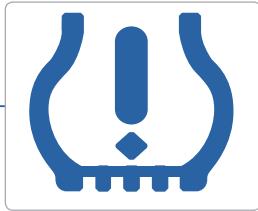

Low tire pressure indicator /
TPMS malfunction indicator



TPMS Malfunction Indicator

Blinks for approximately one minute then remains illuminated when there is a malfunction with the TPMS system. Have the system checked by an authorized Hyundai dealer.

ELECTRONIC STABILITY CONTROL (ESC)

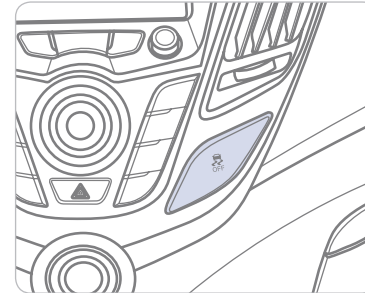

The ESC system is an electronic system designed to help the driver maintain vehicle control under adverse conditions.

Press  to turn ESC on or off.

ACTIVE ECO SYSTEM

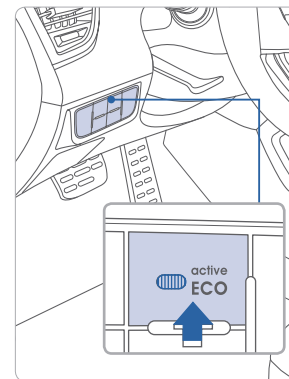

Active ECO System helps improve fuel efficiency by controlling the engine and transmission.

Active ECO on - For optimal fuel efficiency

Active ECO off - For optimal performance and drivability.

When Active ECO system is activated, the behavior of the vehicle will change to a suppressed acceleration and delayed gear shifts under part throttle operation.

To improve your fuel efficiency:

- Accelerate at a moderate rate
- Keep tires inflated to the recommended pressure on the placard
- Be sure the wheels are properly aligned
- Avoid unnecessary braking
- Drive between 55-65 mph on the freeway

Key Websites

Hyundai website - www.hyundai.com

Hyundai owner website - www.myhyundai.com

Bluetooth phone compatibility - www.hyundaiusa.com/bluetooth

Blue Link - www.hyundaiusa.com/technology/bluelink

