

TABLE OF CONTENTS

SECTION		PAGE
1	INTRODUCTION	3
2	THINGS TO KNOW BEFORE STARTING YOUR VEHICLE	11
3	UNDERSTANDING THE FEATURES OF YOUR VEHICLE	77
4	UNDERSTANDING YOUR INSTRUMENT PANEL	161
5	STARTING AND OPERATING	207
6	WHAT TO DO IN EMERGENCIES	301
7	MAINTAINING YOUR VEHICLE	313
8	MAINTENANCE SCHEDULES	369
9	IF YOU NEED CONSUMER ASSISTANCE	391
10	INDEX	399

INTRODUCTION

CONTENTS

■ Introduction	4	■ Warnings And Cautions	8
□ Roll Over Warning	4	■ Vehicle Identification Number	8
■ How To Use This Manual	6	■ Vehicle Modifications / Alterations	9

INTRODUCTION

Thank you for selecting a Jeep® Liberty and welcome to our worldwide family.

This is a specialized utility vehicle designed for both on-road and off-road use. It can go places and perform tasks for which conventional two-wheel drive vehicles were not intended. However, on-road ride and handling will have a different feel from what drivers experience with other vehicles, so take time to become familiar with your vehicle.

The two-wheel drive utility vehicle was designed for on-road use only. It is not intended for off-road driving or use in other severe conditions suited for a four-wheel drive vehicle.

Before you start to drive this vehicle, read this manual. Be sure you are familiar with all vehicle controls, particularly those used for braking, steering and transmission and transfer case shifting. Learn how your vehicle

handles on different road surfaces. Your driving skills will improve with experience. When driving off-road or working the vehicle, don't overload it or expect it to overcome the laws of nature. Always observe federal, state, provincial, and local laws wherever you drive.

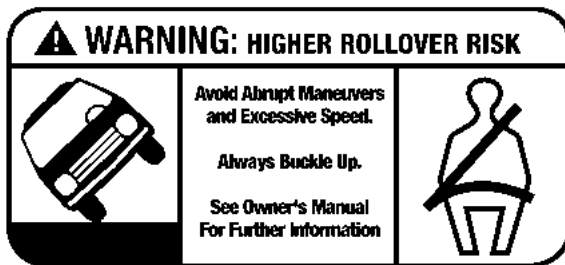
As with other vehicles of this type, failure to operate this vehicle correctly may result in loss of control or an accident. Be sure to read "On-Road/Off-Road Driving Tips" in Section 5 of this manual.

Roll Over Warning

Utility vehicles have a significantly higher roll over rate than other types of vehicles. This vehicle has a higher ground clearance, higher center of gravity, and narrower track than many passenger cars. It is capable of performing better in a wide variety of off-road applications. Driven in an unsafe manner, all vehicles can be caused to go out of control. Because of the higher center of gravity

and the narrower track, if this vehicle is out of control it may roll over when some other vehicles may not.

Do not attempt sharp turns or abrupt maneuvers or other unsafe driving actions that can cause loss of vehicle control. Failure to operate this vehicle safely may result in an accident, roll over of the vehicle, and severe or fatal injury. Drive carefully.



Roll Over Warning Label

60bfe0f0

Failure to use driver and passenger seat belts provided is a major cause of severe or fatal injury. In fact, the U.S. government notes that the universal use of existing seat belts could cut the highway death toll by 10,000 or more each year, and could reduce disabling injuries by 2 million annually. In a roll over crash an unbelted person is significantly more likely to die than a person wearing a seat belt. Always buckle up.

This manual has been prepared with the assistance of service and engineering specialists to acquaint you with the operation and maintenance of your new vehicle. It is supplemented by a Warranty Information Booklet and various customer oriented documents. You are urged to read these publications carefully. Following the instructions and recommendations in this manual will help assure safe and enjoyable operation of your vehicle.

NOTE: After you read the manual, it should be stored in the vehicle for convenient reference and remain with the vehicle when sold so that the new owner will be aware of all safety warnings.

When it comes to service, remember that the manufacturer knows your vehicle best, has the factory-trained technicians and genuine Mopar® parts, and is interested in your satisfaction.

WARNING!

Engine exhaust, some of its constituents, and certain vehicle components contain or emit chemicals known to the State of California to cause cancer and birth defects or other reproductive harm. In addition, certain fluids contained in vehicles and certain products of component wear contain or emit chemicals known to the State of California to cause cancer and birth defects or other reproductive harm.

HOW TO USE THIS MANUAL

Consult the table of contents to determine which section contains the information you desire.

The detailed index, at the rear of this manual, contains a complete listing of all subjects.

Consult the following table for a description of the symbols that may be used on your vehicle or throughout this owner's manual:



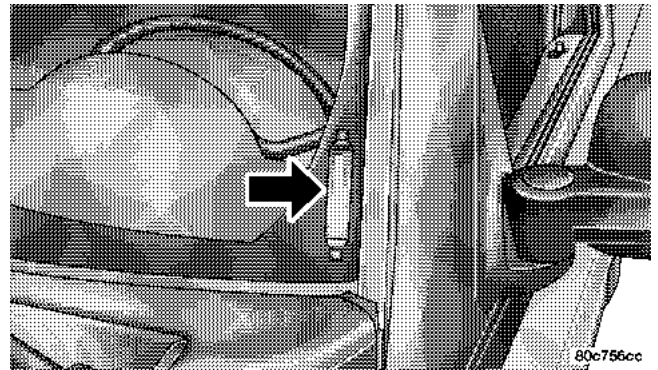
6191e970

WARNINGS AND CAUTIONS

This manual contains **WARNINGS** against operating procedures which could result in an accident or bodily injury. It also contains **CAUTIONS** against procedures which could result in damage to your vehicle. If you do not read this entire manual you may miss important information. Observe all Warnings and Cautions.

VEHICLE IDENTIFICATION NUMBER

The vehicle identification number (VIN) is located on a stamped plate on the bottom of the left front A-Pillar, visible from outside of the vehicle through the windshield. This number also appears on the Automobile Information Disclosure Label affixed to a window on your vehicle. Save this label for a convenient record of your vehicle identification number and optional equipment.



Vehicle Identification Number

NOTE: It is illegal to remove the VIN plate.

VEHICLE MODIFICATIONS / ALTERATIONS**WARNING!**

Any modifications or alterations to this vehicle could seriously affect its roadworthiness and safety and may lead to an accident resulting in serious injury or death.

THINGS TO KNOW BEFORE STARTING YOUR VEHICLE

CONTENTS

■ A Word About Your Keys14	□ Customer Key Programming18
□ Ignition Key Removal14	□ General Information19
□ Key-In-Ignition Reminder16	■ Security Alarm System — If Equipped19
■ Steering Wheel Lock — If Equipped16	□ To Set The Alarm20
□ To Manually Lock The Steering Wheel16	□ To Disarm The System20
□ To Release The Steering Wheel Lock16	■ Illuminated Entry21
■ Sentry Key Immobilizer System16	■ Remote Keyless Entry21
□ Important Note About Service18	□ To Unlock The Doors21
□ Replacement Keys18	□ To Lock The Doors22

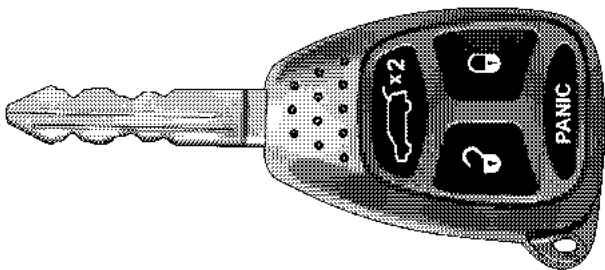
12 THINGS TO KNOW BEFORE STARTING YOUR VEHICLE

□ To Unlatch The Swing Gate Flip-Up Window23	□ Power Rear Windows32
□ Panic Alarm24	□ Wind Buffeting32
□ To Use The Panic Alarm24	■ Rear Swing Gate33
□ To Program Additional Transmitters24	■ Occupant Restraints36
□ General Information25	□ Lap/Shoulder Belts37
□ Transmitter Battery Service26	□ Lap/Shoulder Belt Operating Instructions39
■ Door Locks26	□ Rear Center Lap/Shoulder Belt Retractor Lock-Out43
□ Manual Door Locks28	□ Adjustable Upper Shoulder Belt Anchorage43
□ Power Door Locks — If Equipped29	□ Automatic Locking Mode — If Equipped44
□ Automatic Door Locks — If Equipped29	□ Energy Management Feature45
□ Child Protection Door Lock30	□ Seat Belt Pretensioners46
■ Windows31	□ Enhanced Seat Belt Use Reminder System (BeltAlert)47
□ Power Front Windows31		

<hr/>		THINGS TO KNOW BEFORE STARTING YOUR VEHICLE	13
<input type="checkbox"/> Seat Belts And Pregnant Women48	<input checked="" type="checkbox"/> Safety Tips74
<input type="checkbox"/> Seat Belt Extender48	<input type="checkbox"/> Exhaust Gas74
<input type="checkbox"/> Driver And Front Passenger Supplemental Restraint Systems (SRS) — Airbags49	<input type="checkbox"/> Safety Checks You Should Make Inside The Vehicle75
<input type="checkbox"/> Child Restraint64	<input type="checkbox"/> Safety Checks You Should Make Outside The Vehicle76
<input checked="" type="checkbox"/> Engine Break-In Recommendations74		

A WORD ABOUT YOUR KEYS

The keys for your new vehicle are enclosed in a plastic bag with the key code number on it. If you received your keys without the bag, ask your dealer to give you the number. The key code can also be obtained by the dealer from your vehicle invoice.



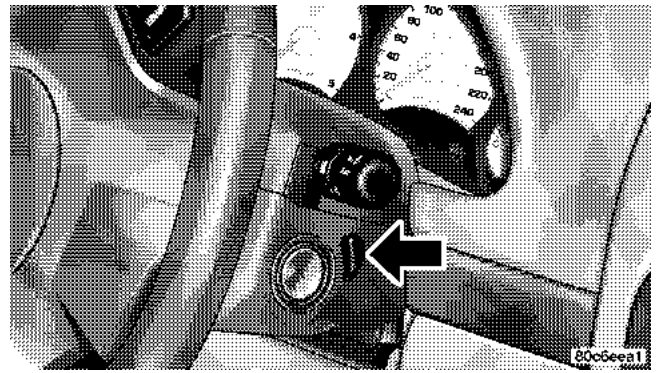
8159413b

Ignition Key

Ignition Key Removal

Manual Transmission

To remove the ignition key, depress and hold the key release button, turn the ignition key to LOCK and remove the key.

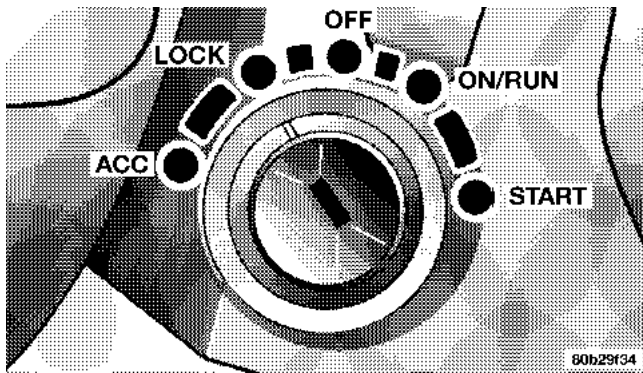


8006eea1

Ignition Key Release Button

Automatic Transmission — If Equipped

To remove the ignition key, place the gearshift lever in P (Park), turn the ignition key to LOCK and remove the key.



Ignition Key Positions

WARNING!

Leaving children in a vehicle unattended is dangerous for a number of reasons. A child or others could be injured. Children should be warned not to touch the parking brake, brake pedal, or the gear selector lever. Do not leave the keys in the ignition. A child could operate power windows, other controls, or move the vehicle.

2

CAUTION!

An unlocked vehicle is an invitation to thieves. Always remove the key from the ignition, and lock all doors when leaving the vehicle unattended.

Key-In-Ignition Reminder

If you open the driver's door and the key is fully inserted in the ignition switch, a chime will sound to remind you to remove the key.

STEERING WHEEL LOCK — IF EQUIPPED

Your vehicle may be equipped with a passive steering wheel lock (manual transmission only). This lock prevents steering the vehicle without the ignition key. If the steering wheel is moved a half turn in either direction and the key is not in the ignition, the steering wheel will lock.

To Manually Lock the Steering Wheel

With the engine running, rotate the steering wheel 1/2 revolution from straight ahead position, turn off the engine and remove the key. Rotate the steering wheel slightly in both directions until the lock engages.

To Release the Steering Wheel Lock

Insert the key in the ignition and turn the wheel slightly to the right or left to disengage the lock.

NOTE: If you turned the wheel to the right to engage the lock, you must turn the wheel slightly to the right to disengage it. If you turned the wheel to the left to engage the lock, turn the wheel slightly to the left to disengage it.

SENTRY KEY IMMOBILIZER SYSTEM

The Sentry Key Immobilizer System (SKIM) prevents unauthorized operation of the vehicle by disabling the engine. The system will shut the engine down after 2 seconds of running if an invalid key is used to start the vehicle. This system utilizes ignition keys which have an electronic chip (transponder) embedded into them. Only keys that have been programmed to the vehicle can be used to start and operate the vehicle for longer than the 2 second validation time period.

The Sentry Key Immobilizer System does not need to be armed or activated. Operation of the system is automatic regardless of whether or not the vehicle is locked or unlocked. During normal operation, the SKIM indicator light will come on for 3 seconds immediately after the ignition switch is turned on for a bulb check. Afterwards, if the bulb remains on, this indicates a malfunction in the electronics. If the bulb begins to flash immediately after the ignition switch is turned on, this indicates that an invalid key is being used to start the vehicle. Both of these conditions will result in the engine being shut down after 2 seconds of running. Keep in mind that a key which has not been programmed is also considered an invalid key even if it is cut to fit the ignition for that vehicle.

If the SKIM indicator light comes on during normal vehicle operation (it has been running for longer than 10 seconds) a fault has been detected in the electronics and the vehicle should be serviced as soon as possible.

NOTE:

- The Sentry Key Immobilizer System is not compatible with remote starting systems. Use of these systems may result in vehicle starting problems and loss of security protection.
- Mobil Speedpass™, additional Sentry Keys, or any other transponder equipped components on the same keychain will not cause a key-related (Transponder) fault unless the additional part is **physically held against the ignition key** being used when starting the vehicle. Also, cell phones, pagers, or other RF electronics will not cause interference with this system.

All of the keys provided with your new vehicle have been programmed to the vehicle electronics.

Important Note About Service

A four digit PIN number is needed to service the Sentry Key Immobilizer System. This number can be obtained from your authorized dealer. However, this number can also be found on your customer invoice that you were given upon receipt of your vehicle.

Replacement Keys

NOTE: Only keys that have been programmed to the vehicle electronics can be used to start the vehicle. Once a Sentry Key has been programmed to a vehicle, it cannot be programmed to any other vehicle.

At the time of purchase, the original owner is provided with a four digit PIN number. This number is required for dealer replacement of keys. Duplication of keys may be performed at an authorized dealer or by using the Customer Key Programming procedure. This procedure consists of programming a blank key to the vehicle electronics. A blank key is one which has never been programmed.

NOTE: When having the Sentry Key System serviced, bring all vehicle keys to the dealer.

Customer Key Programming

You can program new keys to the system if you have two valid keys by doing the following:

1. Cut the additional Sentry Key Transponder blank(s) to match the ignition switch lock cylinder key code.
2. Insert the first valid key into the ignition switch and turn the ignition switch ON for at least 3 seconds but no longer than 15 seconds. Turn the ignition switch OFF and remove the first key.
3. Insert the second valid key and turn the ignition switch ON within 15 seconds. After ten seconds, a chime will sound and the SKIM indicator light will begin to flash. Turn the ignition switch OFF and remove the second key.

4. Insert a blank Sentry Key into the ignition switch and turn the ignition switch ON within 60 seconds. After 10 seconds, a single chime will sound. The SKIM indicator light will stop flashing, turn on for 3 seconds; then turn off.

The new Sentry Key has been programmed. Repeat this process to program up to a total of 8 keys.

General Information

The Sentry Key Immobilizer System complies with FCC rules part 15 and with RSS-210 of Industry Canada. Operation is subject to the following two conditions:

1. This device may not cause harmful interference.
2. This device must accept any interference that may be received, including interference that may cause undesired operation.

SECURITY ALARM SYSTEM — IF EQUIPPED

This system monitors the vehicle doors, swing gate, swing gate flip-up window, and ignition for unauthorized operation. When the alarm is activated, the system provides both audible and visual signals. The horn, headlights, and tail lights will sound/flash repeatedly for three minutes. If disturbance is still present (driver's door, passenger door, other doors, ignition) after three minutes, the headlights and tail lights will flash for an additional 15 minutes.

NOTE: The "Panic" and "Security" alarms are quite different. Please take a moment to activate the "Panic" and the "Security" modes to hear the differences in the horn. In case one should go off in the future, you will need to know which mode has been activated in order to deactivate it.

To Set the Alarm

The alarm will set when you use the remote keyless entry transmitter to lock the doors and swing gate or when you use the power door lock switch while the door is open. After all the doors are locked and closed, the “Sentry Key/Security Alarm Indicator Light” (located in the instrument cluster) will flash rapidly for about 16 seconds to signal that the system is arming. During this 16 second arming period, opening any door or the swing gate will cancel the arming. If the system successfully arms, the “Sentry Key/Security Alarm Indicator Light” will flash at a slower rate to indicate the alarm is set.

To Disarm the System

To disarm the system, you will need to press the “Unlock” button on the remote keyless entry transmitter or turn the ignition key to the RUN position. If something has triggered the system in your absence, the horn will sound three times when you unlock the doors. Check the vehicle for tampering.

NOTE: On vehicles equipped with Remote Keyless Entry (RKE), there will not be a door lock cylinder on the front passenger door, rear doors, or rear swing gate. Therefore, you will be unable to disarm the system with a manual unlock of the passenger or rear doors.

The Security Alarm System is designed to protect your vehicle; however, you can create conditions where the system will arm unexpectedly. If you remain in the vehicle and lock the doors with the transmitter, once the system is armed (after 16 seconds), when you pull the door handle to exit the alarm will sound. If this occurs, press the “Unlock” button on the remote keyless entry transmitter to disarm the system. You may also accidentally disarm the system by unlocking the driver’s door with the key and then locking it. The door will be locked but the Security Alarm will not arm.

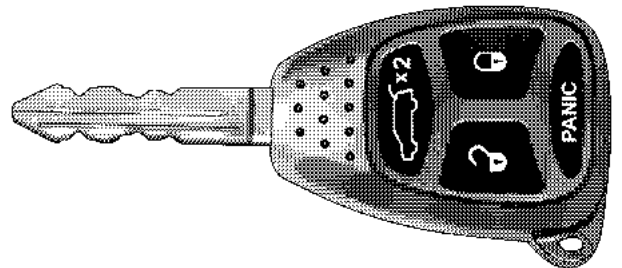
ILLUMINATED ENTRY

The interior lights come on when you open any door. They will remain on for about 30 seconds after all doors are closed then fade to off, unless, the dome inhibit feature was selected on the multi-function control lever. Refer to “Lights” in Section 3 of this manual.

The lights also will fade to off if you turn on the ignition after you close all the doors.

REMOTE KEYLESS ENTRY

This system allows you to lock or unlock the doors, open the swing gate flip-up window, or activate the panic alarm from distances of 23–50 feet (7–15 meters) using a transmitter. You don’t have to point the transmitter at the vehicle to activate the system. Each vehicle comes with two transmitters.



8159413b

Four Button Transmitter**To Unlock the Doors**

Press and release the “Unlock” button once to unlock the driver’s door. Press the button again within 5 seconds to unlock all the doors. If your vehicle is equipped with Illuminated Entry, the interior lights also come on and

22 THINGS TO KNOW BEFORE STARTING YOUR VEHICLE

remain on for about 30 seconds, when you unlock the doors. The park lights will flash twice to acknowledge the unlock signal.

NOTE: The transmitter can be programmed to unlock all the doors upon the first press of the "Unlock" button (within 23–50 feet (7–15 meters) of the vehicle) by performing the following procedure:

1. Press and hold the "Unlock" button on the transmitter.
2. Continue to hold the "Unlock" button, wait at least 4 but no longer than 10 seconds, then press the "Lock" button.
3. Release both buttons.
4. Repeating steps 1–3 will restore original operation.

NOTE: The Light Flash can be enabled or disabled (within 23–50 feet (7–15 meters) of the vehicle) by performing the following procedure:

1. Press and hold the "Lock" button on the transmitter.
2. Continue to hold the "Lock" button, wait at least 4 but no longer than 10 seconds, then press the "Unlock" button.
3. Release both buttons.
4. Repeating steps 1–3 will restore original transmitter operation.

To Lock the Doors

Press and release the "Lock" button once to lock the doors, swing gate flip-up window, and swing gate.

The horn will chirp and the park lights will flash once to acknowledge the lock signal.

NOTE: The horn chirp can be enabled or disabled (within 23–50 feet (7–15 meters) of the vehicle) by the following procedure:

1. Press and hold the "Lock" button on the transmitter.

2. Continue to hold the "Lock" button, wait at least 4 but no longer than 10 seconds, then press the "Panic" button.
3. Release both buttons.
4. Repeating steps 1–3 will restore original transmitter operation.

To Unlatch the Swing Gate Flip-Up Window

Press the "Rear Release" button twice to unlatch the swing gate flip-up window.

WARNING!

To avoid injury stand back when opening. Glass will automatically rise.

NOTE: The transmitter can be programmed to unlatch the flip-up window immediately upon activation of the

"Rear Release" button (without pressing and holding) (within 23–50 feet (7–15 meters) of the vehicle) by performing the following procedure:

1. Press and hold the "Unlock" button on the transmitter.
2. Continue to hold the "Unlock" button, wait at least 4 but no longer than 10 seconds, then press the "Rear Release" button.
3. Release both buttons.
4. Repeating steps 1–3 will restore original transmitter operation.

NOTE: Unlatching the flip-up window will unlock the swing gate. After closing the flip-up window, press the "Lock" button on the transmitter to lock the swing gate.

Panic Alarm

The panic mode flashes the park lights, and sounds the horn for about 3 minutes or until the alarm is turned off.

To Use the Panic Alarm

Press and hold the PANIC button for at least 1 second to activate the panic alarm. Press and hold the PANIC button a second time to deactivate the alarm. The alarm will also shut itself off after starting the vehicle and accelerating to 15 mph (24 km/h).

NOTE: The “Panic” and “Security” alarms are quite different. Please take a moment to activate the “Panic” and the “Security” modes to hear the differences in the horn. In case one should go off in the future, you will need to know which mode has been activated in order to deactivate it.

To Program Additional Transmitters

NOTE: If vehicle is equipped with the optional Electronic Vehicle Information Center (EVIC) in the overhead console, the transmitters may also be programmed through the EVIC display. For additional information, refer to “Overhead Console — If Equipped” in Section 3. (See page 136 for more information.)

Up to 4 transmitters can be programmed to your vehicle. To obtain additional transmitters, contact your authorized dealer. To program a transmitter (within 23–50 feet (7–15 meters) of the vehicle), perform the following procedure:

1. Gather every transmitter that is to be used with the vehicle including any transmitters that are currently programmed.

2. **Enter Program Mode:** Turn the ignition to the ON position, and using a currently programmed transmitter; press and hold the "Unlock" button on the transmitter. Continue to hold the "Unlock" button, wait at least 4 but no longer than 10 seconds, then press and hold the PANIC button for at least 1 second. Release both buttons simultaneously.

3. **Program Each Transmitter:** All transmitters to be used with your vehicle must be programmed as follows:

Press and release the "Lock" and "Unlock" buttons simultaneously, followed by a press and release of ANY button on each transmitter to be programmed. You will hear a chime when a transmitter has been successfully programmed.

General Information

This transmitter complies with FCC rules part 15 and with RSS-210 of Industry Canada. Operation is subject to the following two conditions:

1. This device may not cause harmful interference.
2. This device must accept any interference that may be received, including interference that may cause undesired operation.

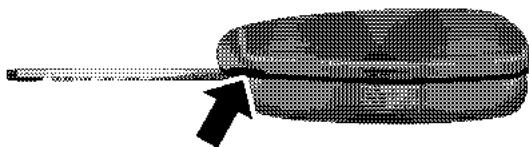
If your Remote Keyless Entry fails to operate from a normal distance, check for these two conditions:

1. Weak batteries in transmitter. The expected life of batteries is from one to two years
2. Closeness to a radio transmitter such as a radio station tower, airport transmitter, and some mobile or CB radios.

Transmitter Battery Service

The recommended replacement battery is the Panasonic CR2032 or equivalent.

1. Pry the transmitter halves apart with a dime or similar object. Make sure not to damage the rubber gasket material during removal.



Separating Transmitter

81182c72

2. Remove and replace the batteries. Avoid touching the new batteries with your fingers. Skin oils may cause battery deterioration. If you touch the battery, clean it with rubbing alcohol.

3. Reassemble the transmitter case. Snap the halves together and test transmitter operation.

DOOR LOCKS

The vacuum fluorescent (VF) display located in the odometer area displays the word "door" as an indication of a door ajar or door not completely closed. When the vehicle is not moving and the door is ajar or not completely closed, the VF display will show the word "door" and then show the odometer/trip odometer mileage (each for 2 seconds). The display will continue to cycle.

NOTE: If vehicle is equipped with the optional Electronic Vehicle Information Center (EVIC) in the overhead console, all warnings including “door”, “GATE”, and “GLASS” will only be displayed in the EVIC display (not in the instrument cluster). For additional information, refer to “Overhead Console — If Equipped” in Section 3.



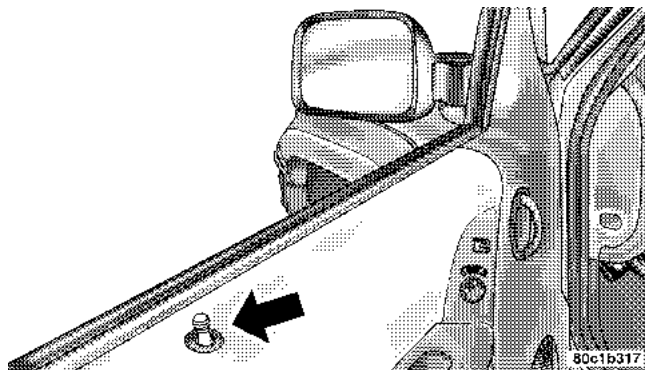
Door Open Display

If any other active warnings including “GATE” or “GLASS” are present, they will be shown in the VF display and will also continue to cycle. If the vehicle is moving, three single chimes will occur (One chime for each complete display cycle (three cycles total). After this, the display will continue to cycle only (no chimes).

If the trip/reset button is pressed while the VF warnings are being displayed, the VF display will revert back to only displaying the odometer/trip odometer mileage.

Manual Door Locks

Use the manual door lock plunger to lock the doors from inside the vehicle. If the plunger is down when the door is closed, the door will lock. Therefore, make sure the keys are not inside the vehicle before closing the door.



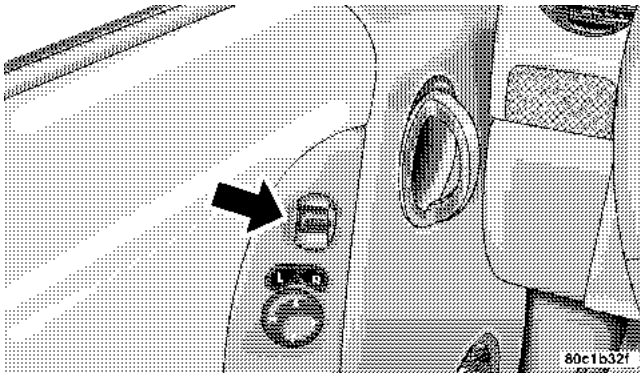
Door Lock Plunger

WARNING!

- For personal security, and safety in the event of an accident, lock the vehicle doors as you drive as well as when you park and leave the vehicle.
- When leaving the vehicle always remove the key from the ignition lock, and lock your vehicle. Do not leave children unattended in the vehicle, or with access to an unlocked vehicle. Unsupervised use of vehicle equipment may cause severe personal injuries and death.

Power Door Locks — If Equipped

A door lock switch is on each front door panel. Press this switch to lock or unlock the doors.



Power Door Lock Switch

If the plunger is down when the door is closed, the door will lock. Therefore, make sure the keys are not inside the vehicle before closing the door.

If you press the door lock switch while the keys are in the ignition switch, and the driver's door is open, the doors will not lock.

The rear doors cannot be opened from inside the vehicle until you pull up the lock plungers.

Automatic Door Locks — If Equipped

The doors will lock automatically if:

1. all doors are closed,
2. vehicle speed is above 15 mph (24 km/h),
3. and the accelerator pedal is depressed.

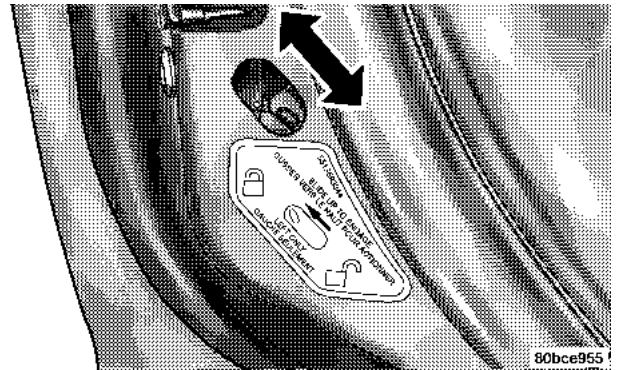
This will occur only once, will not reoccur until a door is opened.

Child Protection Door Lock

The rear doors of your vehicle are equipped with child protection locks. If you push up on the lever on the open edge of the door it cannot be opened from the inside of the vehicle. Push the lever down to disengage the child protection locks.

WARNING!

Avoid trapping anyone in the vehicle in a collision. Remember that the rear doors can only be opened from the outside when the child protection locks are engaged.

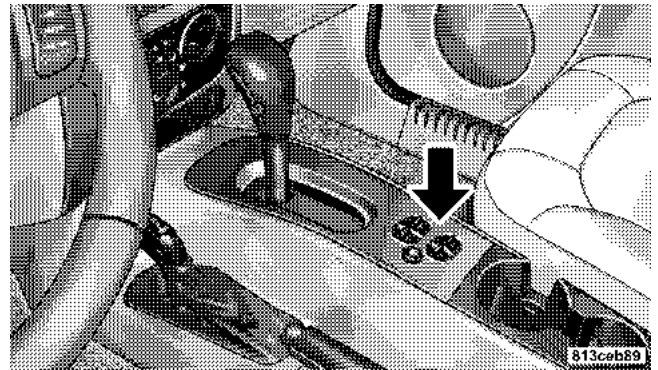


Child Protection Door Lock

WINDOWS

Power Front Windows

The power window switches are located on the center floor console. The top left switch controls the left front window and the top right switch controls the right front window. The lower left switch controls the left rear passenger window, and the lower right switch controls the right rear passenger window. The switches will continue to function for up to 10 minutes after the ignition key has been removed, or until a door is opened.



Power Window Switches

The window lock switch located next to the window switches allows you to disable the rear passenger window switches that are located on the back of the center floor console.

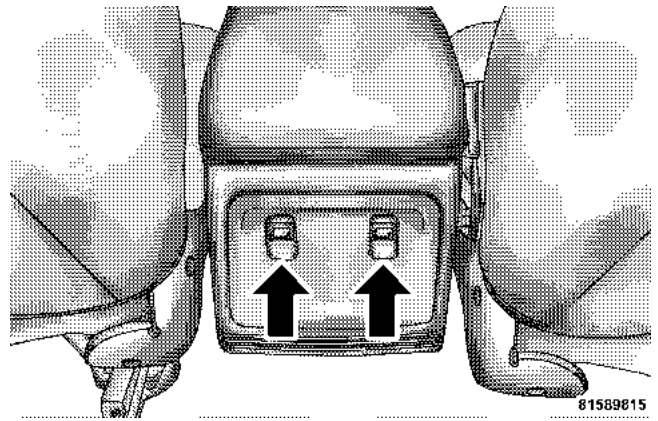
Auto Down Feature — If Equipped

The driver's and passenger's front window switches have an auto down feature. Press the window switch past the detent, release, and the window will go down automatically.

To open the window part way, press the window switch part way and release it when you want the window to stop.

Power Rear Windows

The rear passenger window switches are located on the back of the center floor console.



Rear Window Switches

Wind Buffeting

Wind buffeting can be described as the perception of pressure on the ears or a helicopter type sound in the ears. Your vehicle may exhibit wind buffeting with the

windows down, or the sunroof (if equipped) in certain open or partially open positions. This is a normal occurrence and can be minimized. If the buffeting occurs with the sunroof open, adjust the sunroof opening to minimize the buffeting.

REAR SWING GATE

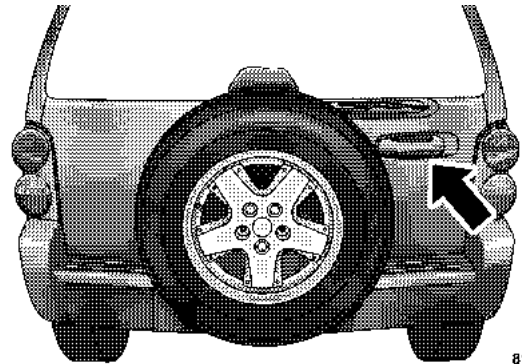
The swing gate can be unlocked using the remote keyless entry, or by activating the power door lock switches located on the front doors.

WARNING!

To avoid injury stand back when opening. Glass will automatically rise.

To open the swing gate, pull the gate handle to its first detent to open just the flip-up window. Pull the handle to its second detent (all the way) to open both the flip-up window and swing gate.

2



8164a8bc

Swing Gate Release Handle

WARNING!

To avoid injury stand back when opening. Glass will automatically rise.

The vacuum fluorescent (VF) display located in the odometer area displays the words "GATE" and/or "GLASS" as an indication of when the swing gate and/or flip-up window, is not completely closed. When the vehicle is not moving and the swing gate and/or flip-up window is not completely closed, the VF display will show the word "GATE" and/or "GLASS" and then show the odometer/trip odometer mileage (each for 2 seconds). The display will continue to cycle.

NOTE: If vehicle is equipped with the optional Electronic Vehicle Information Center (EVIC) in the overhead console, the warnings "door", "GATE", or "GLASS" will

be displayed in the EVIC display (not in the instrument cluster). For additional information, refer to "Overhead Console — If Equipped" in Section 3.



Gate Open Display



Glass Open Display

If any other active warnings including “door” are present, they will be shown in the VF display and will also continue to cycle. If the vehicle is moving, two single chimes will occur if the rear glass is open or three single chimes will occur if the rear swing gate is open (one

chime for each complete display cycle). After this, the VF display will continue to sequence only (no chimes).

If the trip/reset button is pressed while the VF warnings are being displayed, the VF display will revert back to only displaying the odometer/trip odometer mileage.

NOTE: Close swing gate before flip-up window.

CAUTION!

Do not press on rear wiper blade when closing swing gate, as damage to the blade will result.

WARNING!

Driving with the flip-up window open can allow poisonous exhaust gases into your vehicle. You and your passengers could be injured by these fumes. Keep the flip-up window closed when you are operating the vehicle.

NOTE: The rear swing gate will lock while the rear wiper is operating. The gate will stay locked until the wiper is turned off and the gate is unlocked (by key, lock switch, or key fob).

NOTE: The swing gate will lock automatically when the vehicle begins moving.

OCCUPANT RESTRAINTS

Some of the most important safety features in your vehicle are the restraint systems. These include the front and rear seat belts for the driver and all passengers, front airbags for both the driver and front passenger and, if equipped, window bags for the driver and passengers seated next to a window. If you will be carrying children too small for adult-size belts, your seat belts also can be used to hold infant and child restraint systems.

NOTE: The front airbags have a multi stage inflator design. This allows the airbag to have different rates of inflation that are based on collision severity.

Please pay close attention to the information in this section. It tells you how to use your restraint system properly to keep you and your passengers as safe as possible.

WARNING!

In a collision, you and your passengers can suffer much greater injuries if you are not properly buckled up. You can strike the interior of your vehicle or other passengers, or you can be thrown out of the vehicle. Always be sure you and others in your vehicle are buckled up properly.

Buckle up even though you are an excellent driver, even on short trips. Someone on the road may be a poor driver and cause a collision which includes you. This can happen far away from home or on your own street.

Research has shown that seat belts save lives, and they can reduce the seriousness of injuries in a collision. Some of the worst injuries happen when people are thrown from the vehicle. Seat belts reduce the possibility of ejection and the risk of injury caused by striking the inside of the vehicle. **Everyone** in a motor vehicle should be belted at all times.

Lap/Shoulder Belts

All the seats in your vehicle are equipped with lap/shoulder belts.

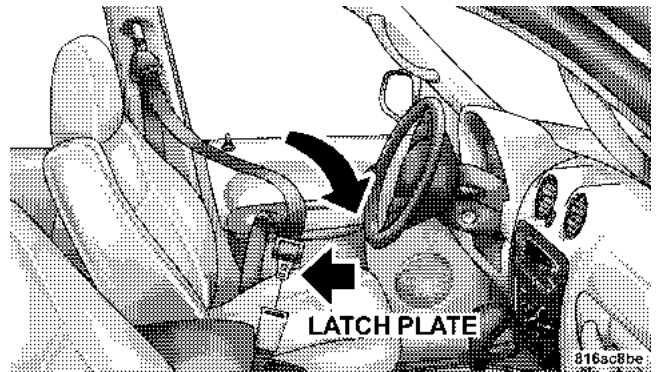
The belt webbing retractor is designed to lock during very sudden stops or collisions. This feature allows the shoulder part of the belt to move freely with you under normal conditions. But in a collision, the belt will lock and reduce the risk of you striking the inside of the vehicle or being thrown out.

WARNING!

- **Wearing a seat belt incorrectly is dangerous. Seat belts are designed to go around the large bones of your body. These are the strongest parts of your body and can take the forces of a collision the best. Wearing your belt in the wrong place could make your injuries in a collision much worse. You might suffer internal injuries, or you could even slide out of part of the belt. Follow these instructions to wear your seat belt safely and to keep your passengers safe, too.**
- **Two people should never be belted into a single seat belt. People belted together can crash into one another in an accident, hurting one another badly. Never use a lap/shoulder belt or a lap belt for more than one person, no matter what their size.**

Lap/Shoulder Belt Operating Instructions

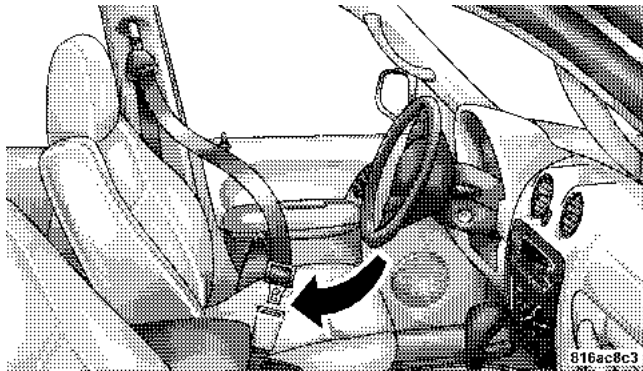
1. Enter the vehicle and close the door. Sit back and adjust the seat.
2. The seat belt latch plate is above the back of your seat. Grasp the latch plate and pull out the belt. Slide the latch plate up the webbing as far as necessary to make the belt go around your lap.



Latch Plate

40 THINGS TO KNOW BEFORE STARTING YOUR VEHICLE

3. When the belt is long enough to fit, insert the latch plate into the buckle until you hear a "click."



Latch Plate To Buckle

WARNING!

A belt that is buckled into the wrong buckle will not protect you properly. The lap portion could ride too high on your body, possibly causing internal injuries. Always buckle your belt into the buckle nearest you.

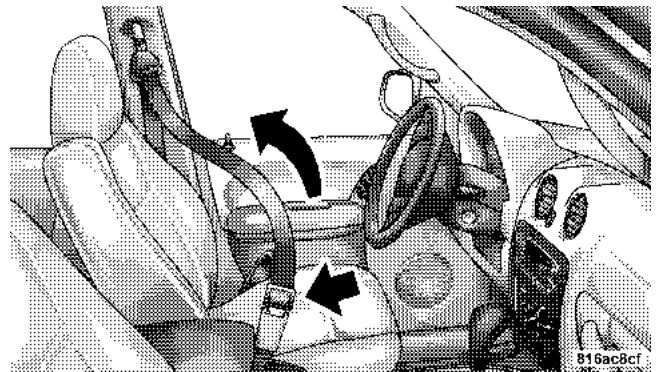
A belt that is too loose will not protect you as well. In a sudden stop you could move too far forward, increasing the possibility of injury. Wear your seat belt snugly.

A belt that is worn under your arm is very dangerous. Your body could strike the inside surfaces of the vehicle in a collision, increasing head and neck injury. A belt worn under the arm can cause internal injuries. Ribs aren't as strong as shoulder bones. Wear the belt over your shoulder so that your strongest bones will take the force in a collision.

A shoulder belt placed behind will not protect you from injury during a collision. You are more likely to hit your head in a collision if you do not wear your shoulder belt. The lap and shoulder belt are meant to be used together.

4. Position the lap belt across your thighs, below your abdomen. To remove slack in the lap portion, pull up a bit on the shoulder belt. To loosen the lap belt if it is too tight, tilt the latch plate and pull on the lap belt. A snug belt reduces the risk of sliding under the belt in a collision.

NOTE: The “Seat Belt Indicator Light” will remain on until the driver’s seat belt is buckled.



Removing Slack From Belt

WARNING!

A lap belt worn too high can increase the risk of injury in a collision. The belt forces won't be at the strong hip and pelvic bones, but across your abdomen. Always wear the lap part of your seat belt as low as possible and keep it snug.

A twisted belt cannot do its job as well. In a collision it could even cut into you. Be sure the belt is straight. If you cannot straighten a belt in your vehicle, take it to your authorized dealer and have it fixed.

5. Position the shoulder belt on your chest so that it is comfortable and not resting on your neck. The retractor will withdraw any slack in the belt.

6. To release the belt, push the red button marked PRESS on the buckle. The belt will automatically retract to its stowed position. If necessary, slide the latch plate down the webbing to allow it to retract fully.

WARNING!

A frayed or torn belt could rip apart in a collision and leave you with no protection. Inspect the belt system periodically, checking for cuts, frays, or loose parts. Damaged parts must be replaced immediately. Do not disassemble or modify the system. Seat belt assemblies must be replaced after an accident if they have been damaged (bent retractor, torn webbing, pretensioner, etc.).

Rear Center Lap/Shoulder Belt Retractor Lock-Out

This feature is designed to lock the retractor whenever the 65% rear seat back is not fully latched. This prevents someone from wearing the rear center lap/shoulder belt when the rear seat back is not fully latched.

NOTE:

- If the rear center lap/shoulder belt cannot be pulled out, check that the rear seat back is fully latched.
- If the rear seat back is properly latched and the rear center lap/shoulder belt still cannot be pulled out, the Automatic-Locking Retractor (ALR) system may be activated. To reset this feature you must let all of the belt webbing return into the retractor. You will not be able to pull out more webbing until all of the webbing has been returned back into the retractor.

WARNING!

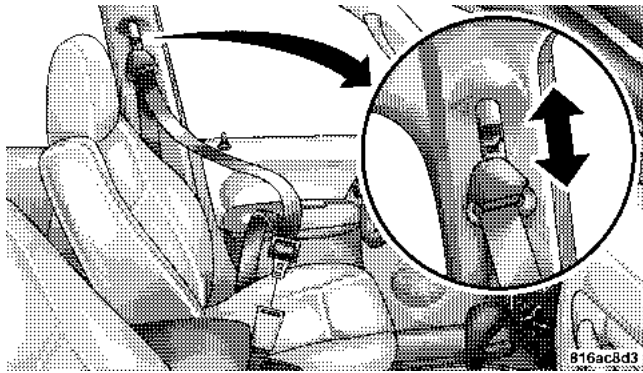
The rear center lap/shoulder belt is equipped with a lock-out feature to ensure that the rear seat back is in the fully upright and locked position when occupied. If the rear seat back is not fully upright and locked and the rear center lap/shoulder belt can be pulled out of the retractor, the vehicle should immediately be taken to your dealer for service. Failure to follow this warning could result in serious or fatal injury.

2

Adjustable Upper Shoulder Belt Anchorage

In the front seat positions, the shoulder belt can be adjusted upward or downward to position the belt away from your neck. To lower the shoulder belt height, push the button and slide the height adjuster down. To raise

the height of the shoulder belt, slide the height adjuster up. Pull down on the height adjuster to make sure it is locked in place.



Adjusting Upper Shoulder Belt

WARNING!

Position the shoulder belt height adjusters so that the belt rests across the middle of your shoulder. Failure to adjust the safety belt properly could reduce the effectiveness of the seat belt and increase the risk of injury in a collision.

As a guide, if you are shorter than average, you will prefer a lower position, and if you are taller than average, you'll prefer a higher position. When you release the anchorage, try to move it up or down to make sure that it is locked in position.

Automatic Locking Mode — If Equipped

In this mode, the shoulder belt is automatically pre-locked. The belt will still retract to remove any slack in the shoulder belt.

When To Use The Automatic Locking Mode

Anytime a child safety seat is installed in a passenger front or outboard rear seating position (if equipped). Children 12 years old and under should be properly restrained in the rear seat whenever possible.

How To Use The Automatic Locking Mode

1. Buckle the combination lap and shoulder belt.
2. Grasp the shoulder portion and pull downward until the entire belt is extracted.
3. Allow the belt to retract. As the belt retracts, you will hear a clicking sound. This indicates the safety belt is now in the automatic locking mode.

How to Disengage The Automatic Locking Mode

Disconnect the combination lap/shoulder belt and allow it to retract completely to disengage the automatic locking mode and activate the vehicle sensitive (emergency) locking mode.

Energy Management Feature

This vehicle has a safety belt system with an energy management feature at the driver and front passenger seating positions to help further reduce the risk of injury in the event of a head-on collision.

This safety belt system has a retractor assembly that is designed to pay out webbing in a controlled manner. This feature is designed to help reduce the belt force acting on the occupant's chest.

WARNING!

- After a vehicle collision, the driver and front passenger outboard seat belt system must be checked by a qualified technician to verify that the “automatic locking retractor” feature for child seats is still functioning properly. In addition, all seat belts should be checked for proper function.
- The belt and retractor assembly must be replaced if the seat belt assembly “automatic locking retractor” feature or any other seat belt function is not working properly when checked according to the procedures in the Service Manual.
- Failure to replace the belt and retractor assembly could increase the risk of injury in collisions.

Seat Belt Pretensioners

The driver and front passenger seat belts are equipped with a pretensioning device that is designed to remove any slack from the seat belt systems in the event of a collision. This device improves the performance of the seat belt by assuring that the belt is tight around the occupant early in a collision. Pretensioners work for all size occupants, including those in child restraints.

NOTE: These devices are not a substitute for proper seat belt placement by the occupant. The seat belt must still be worn snugly and positioned properly.

The pretensioners are triggered by the front Airbag Control Module. Like the front airbags, the pretensioners are a single use item. After a collision that is severe enough to deploy the airbags and pretensioners, they must be replaced.

Enhanced Seat Belt Use Reminder System (BeltAlert)

If the driver's or front passenger seat belt has not been buckled within 60 seconds of starting the vehicle and if the vehicle speed is greater than 5 mph (8 km/h), the Enhanced Warning System (BeltAlert) will alert the driver or front passenger to buckle their seat belt. The driver should also instruct all other occupants to buckle their seat belts. Once the warning is triggered, the Enhanced Warning System (BeltAlert) will continue to chime and flash the Seat Belt Warning Light for 96 seconds or until the driver's or front passenger seat belt is buckled.

The Enhanced Warning System (BeltAlert) will be reactivated if the driver's or front passenger seat belt is unbuckled for more than 10 seconds and the vehicle speed is greater than 5 mph (8 km/h).

The Enhanced Warning System (BeltAlert) can be enabled or disabled by your authorized dealer or by following these steps:

NOTE: The following steps must occur within the first 60 seconds of the ignition switch being turned to the ON or START position. The manufacturer does not recommend deactivating the Enhanced Warning System (BeltAlert).

1. Turn the ignition switch to the OFF position, and buckle the driver's or front passenger seat belt.
2. Turn the ignition key to the ACCESSORY/RUN position (engine does not need to be running), and wait for the Seat Belt Warning Light to turn off.
3. Within 60 seconds of starting the vehicle, unbuckle and then re-buckle the driver's or front passenger seat belt at least three times within 10 seconds, ending with the seat belt buckled.

4. Turn the ignition key to the OFF position. A single chime will sound to signify that you have successfully completed the programming.

The Enhanced Warning System (BeltAlert) can be reactivated by repeating this procedure.

NOTE: Although the Enhanced Warning System (BeltAlert) has been deactivated, the Seat Belt Warning Light will continue to illuminate while the driver's or front passenger seat belt remains unfastened.

Seat Belts and Pregnant Women

We recommend that pregnant women use the seat belts throughout their pregnancy. Keeping the mother safe is the best way to keep the baby safe.

Pregnant women should wear the lap part of the belt across the thighs and as snug across the hips as possible.

Keep the belt low so that it does not come across the abdomen. That way the strong bones of the hips will take the force if there is a collision.

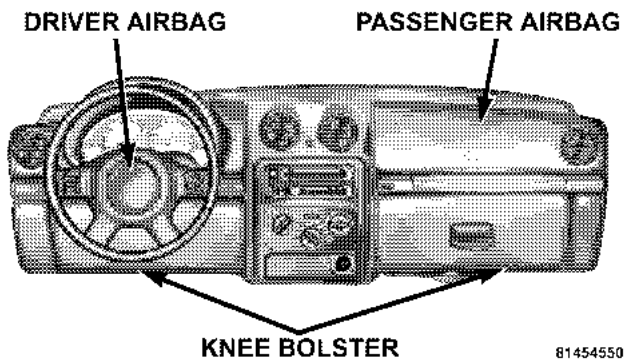
Seat Belt Extender

If a seat belt is too short, even when fully extended and when the adjustable upper shoulder belt anchorage (if equipped) is in its lowest position, your authorized dealer can provide you with a seat belt extender. This extender should be used only if the existing belt is not long enough. When it is not required, remove the extender and store it.

WARNING!

Using a seat belt extender when not needed can increase the risk of injury in a collision. Only use when the lap belt is not long enough when it is worn low and snug, and in the recommended seating positions. Remove and store the extender when not needed.

Driver And Front Passenger Supplemental Restraint Systems (SRS) — Airbags



2

81454550

Front Airbag Components

This vehicle has airbags for both the driver and right front passenger as a supplement to the seat belt restraint systems. The driver's front airbag is mounted in the steering wheel. The passenger side airbag is mounted in

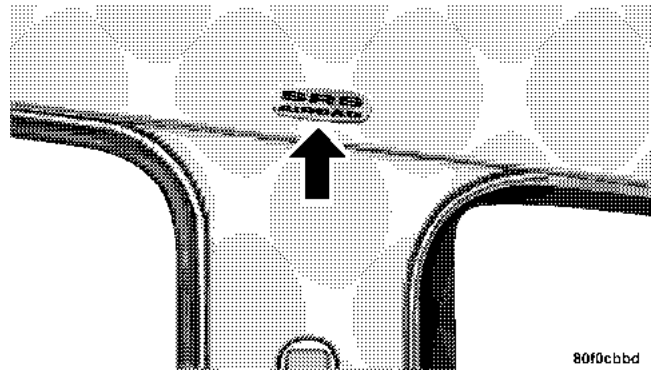
50 THINGS TO KNOW BEFORE STARTING YOUR VEHICLE

the instrument panel, above the glove compartment. The words SRS/AIRBAG are embossed on the airbag covers.

NOTE: The front airbags are certified to the Federal regulations that allow less forceful deployment.

The front airbags have a multi stage inflator design. This may allow the airbag to have different rates of inflation that are based on collision severity and occupant size. Also, the front passenger airbag is certified to the Federal regulations that define Occupant Classification (Refer to "Occupant Classification System" in this section).

This vehicle may also be equipped with window bags to protect the driver, front, and rear passengers sitting next to a window. If the vehicle is equipped with window bags, they are located above the side windows. Their covers are also labeled SRS AIRBAG.



Window Airbag Location

NOTE: Airbag covers may not be obvious in the interior trim; but they will open to allow airbag deployment.

WARNING!

- Do not put anything on or around the front airbag covers or attempt to manually open them. You may damage the airbags and you could be injured because the airbags are no longer functional. These protective covers for the airbag cushions are designed to open only when the airbags are inflating.
- If your vehicle is equipped with window bags, do not stack luggage or other cargo up high enough to block the location of the window bag. The area where the window bag is located should remain free from any obstructions.
- If your vehicle is equipped with window bags, do not have any accessory items installed which will alter the roof, including adding a sunroof to your vehicle. Do not add roof racks that require permanent attachments (bolts or screws) for installation on the vehicle roof. Do not drill into the roof of the vehicle for any reason.

NOTE: Do not use a clothing bar mounted to the coat hooks in this vehicle. A clothing bar will impede the proper performance of the window bags.

Along with the seat belts, front airbags work with the instrument panel knee bolsters to provide improved protection for the driver and front passenger. Window bags also work with seat belts to improve occupant protection.

The seat belts are designed to protect you in many types of collisions. The front airbags deploy in moderate to severe frontal collisions.

NOTE: The passenger front airbag may not deploy even when the driver front airbag has if the Occupant Classification System (refer to "Occupant Classification System" in this section) has determined the seat is empty or is occupied by someone that is classified in the "child" category. This could be a child, a teenager, or even a small adult.

52 THINGS TO KNOW BEFORE STARTING YOUR VEHICLE

If your vehicle is so equipped, the window bag on the crash side of the vehicle is triggered in moderate to severe side collisions. But even in collisions where the airbags work, you need the seat belts to keep you in the right position for the airbags to protect you properly.

Here are some simple steps you can take to minimize the risk of harm from a deploying airbag.

1. Children 12 years and under should always ride buckled up in a rear seat in an appropriate child restraint.

Infants in rear-facing child restraints should **NEVER** ride in the front seat of a vehicle with a passenger front airbag. An airbag deployment can cause severe injury or death to infants in that position.

If a child from 1 to 12 years old must ride in the front passenger seat because the vehicle is crowded, move the seat as far back as possible, and use the proper child restraint. See "Child Restraint" in this section.

You should read the instructions provided with your child restraint to make sure that you are using it properly.

2. All occupants should use their lap and shoulder belts properly.

3. The driver and front passenger seats should be moved back as far as practical to allow the airbag room to inflate.

4. If your vehicle has window bags, do not lean against the door or window, airbags will inflate forcefully into the space between you and the door.

5. If the airbag system in this vehicle needs to be modified to accommodate a disabled person, contact the Customer Center. Phone numbers are provided under "If You Need Assistance" in Section 9 of this manual.

WARNING!

- Relying on the airbags alone could lead to more severe injuries in a collision. The airbags work with your seat belt to restrain you properly. In some collisions the airbags won't deploy at all. Always wear your seat belts even though you have airbags.
- Being too close to the steering wheel or instrument panel during airbag deployment could cause serious injury. Airbags need room to inflate. Sit back, comfortably extending your arms to reach the steering wheel or instrument panel.
- If the vehicle has window bags, they also need room to inflate. Do not lean against the door or window. Sit upright in the center of the seat.

Airbag System Components

The airbag system consists of the following:

- Occupant Restraint Controller
- Remote Acceleration Sensors
- Airbag Warning Light
- Driver Airbag
- Passenger Airbag
- Window Bags above Side Windows (If Equipped)
- Steering Wheel and Column
- Instrument Panel
- Interconnecting Wiring
- Knee Impact Bolsters
- Front Acceleration Sensors

- Driver and Front Passenger Seat Belt Pretensioners
- Front Passenger Seat Occupant Classification System (OCS)
 - Occupant Classification Module
 - Passenger Airbag Disabled (PAD) Indicator Light
 - Interconnecting Wiring
 - Pressure Sensor, Bladder Assembly, and Belt Tension Sensor

How The Airbag System Works

- The **Occupant Restraint Controller (ORC)** determines if a frontal collision is severe enough to require the airbags to inflate. Based on the level of collision severity, the front control module determines the proper rate of inflation. The front airbag inflators are designed to provide different rates of airbag inflation from direction provided by the ORC. The ORC may

modify the rate of inflation based on the occupant size provided by the Occupant Classification Module. The ORC will not detect roll over, or rear impacts.

The ORC monitors the readiness of the electronic parts of the system whenever the ignition switch is in the START or RUN positions. These include all of the items listed above except the steering wheel and column, and knee bolsters. If the key is in the OFF position, in the ACC position, or not in the ignition, the airbags are not on and will not inflate.

Also, the ORC turns on the AIRBAG warning light (located in the instrument cluster) and PAD indicator light (located in the front passenger grab handle) for 6 to 8 seconds for a self-check when the ignition is first turned on. After the self-check, the AIRBAG warning light will turn off. The PAD indicator light will function normally (Refer to “Passenger Airbag Disable (PAD) Indicator Light” in this section). If the ORC detects a malfunction

in any part of the system, it turns on the AIRBAG warning light either momentarily or continuously. A single chime will sound if the light comes on again after initial start up.

WARNING!

Ignoring the AIRBAG warning light in your instrument panel could mean you won't have the airbags to protect you in a collision. If the light does not come on, stays on after you start the vehicle, or if it comes on as you drive, have the airbag system checked right away.

- The **Driver and Passenger Airbag/Inflator Units** are located in the center of the steering wheel and the right side of the instrument panel. When the ORC detects a collision requiring the airbags, it signals the inflator units. A large quantity of nontoxic gas is generated to

inflate the front airbags. Different airbag inflation rates may be possible based on collision severity and occupant size. The steering wheel hub trim cover and the upper right side of the instrument panel separate and fold out of the way as the bags inflate to their full size. The bags fully inflate in about 50–70 milliseconds. This is about half of the time it takes to blink your eyes. The bags then quickly deflate while helping to restrain the driver and front passenger.

The driver's front airbag gas is vented through vent holes in the sides of the airbag. The passenger's front airbag gas is vented through vent holes in the sides of the airbag. In this way the airbags do not interfere with your control of the vehicle.

- The **Side Impact SRS Window Bags** are designed to activate only in certain side collisions. When the ORC (with side impact option) detects a collision requiring the window bags to inflate, it signals the inflators on

the crash side of the vehicle. A quantity of nontoxic gas is generated to inflate the window bag. The inflating window bag pushes the outside edge of the headliner out of the way and covers the window. The airbag inflates in about 30 milliseconds (about one quarter of the time it takes to blink your eyes) with enough force to injure you if you are not belted and seated properly, or if items are positioned in the area where the window bag inflates. This especially applies to children. The window bag is only about 3½ inches (9 cm) thick when it is inflated.

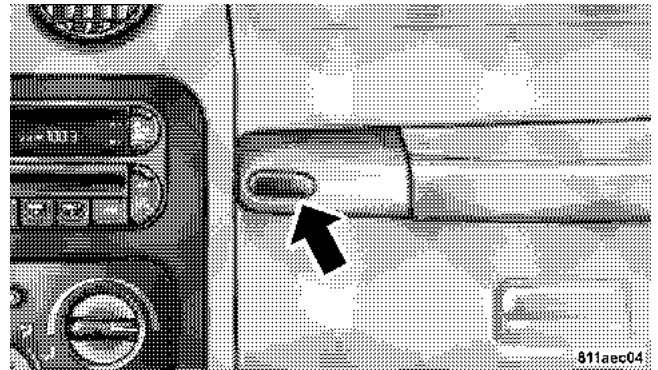
- The **Knee Impact Bolsters** help protect the knees of the driver and the front passenger, and position everyone for the best interaction with the front airbag.
- The **Occupant Classification System (OCS)** will classify an occupant in the front passenger seat into a size category based on sensor readings from within the seat cushion. Occupants should try to remain in a

normally seated position. If the occupant's weight is transferred to another object in the vehicle (i.e. feet on the dashboard), the OCS may not be able to properly approximate occupant size. Furthermore, the occupant size may appear to increase or decrease due to objects hanging on the seat, other passengers pushing on the seat, or objects lodged underneath the seat. If there is a rapid change in temperature or humidity, the OCS may not be able to properly approximate occupant size. If your seat including your trim cover and cushion needs to be serviced in any way, take the vehicle to your authorized dealer. Only manufacturer approved seat accessories may be used.

If there is a fault present in the system, the AIRBAG warning light will light indicating that you should take the vehicle to an authorized dealer. In the presence of an occupant in the passenger seat, if both the PAD indicator light (located in the front passenger

grab handle) and AIRBAG warning light (located in the instrument cluster) are illuminated the airbag will be disabled.

The ORC will not allow front airbag deployment in the event of a collision for occupants classified into the empty or child size categories. The PAD indicator light will illuminate indicating that the Passenger Airbag is OFF when the OCS has determined that the occupant size category is a child. Also, when the seat is empty or an object that weighs less than a predetermined threshold is placed on the seat, the light will remain OFF. (The PAD indicator light is an amber light located on the grab handle in front of the passenger seat.)



Indicator Light Location

For almost all sizes of properly seated adults, the passenger frontal airbag will be enabled in the event of a collision. For small teenagers and some small adults, depending on size, the airbag may or may not be enabled in the event of a collision. Both drivers and passengers

should always use the PAD indicator light as an indication if the front passenger is properly positioned or not. If the PAD indicator light comes on when an adult is in the passenger seat, have the passenger re-position themselves in the seat until the light goes out. Remember, if the PAD indicator light is illuminated the passenger front airbag will not inflate. For most children properly seated on the front seat and most properly installed child restraint systems, the airbag will be disabled and the PAD indicator light will be on. However, under certain conditions even with the child restraint system has been installed properly, the PAD indicator light may not be on even though the air bag is disabled. This can occur if the child restraint is lighter than the threshold weight necessary to turn the PAD indicator light on. If this happens to you, you can check to ensure the airbag is disabled by performing the following simple procedure. Place the ignition key in the RUN position and apply downward pressure to the child restraint on the surface that the child

will be sitting on. Slowly count to 10 and watch the PAD indicator light. The PAD indicator light should turn on. When you release the pressure, the PAD indicator light may stay on or may turn off but the airbag is disabled. If at all possible, place children 12 years and younger in a back seat.

- The **Occupant Classification Module (OCM)** is located beneath the front passenger seat. The OCM classifies the occupant into one of three size categories based on the input from the Bladder Assembly and a Belt Tension Sensor. The size categories include empty, child, and adult. The OCM sends the Occupant Classification to the ORC to determine if a front passenger airbag is allowed. If a fault is present, the AIRBAG warning light is illuminated.

- The **Passenger Airbag Disabled (PAD) Indicator Light** indicates to the driver and passenger when the airbag is turned OFF. In the presence of a properly seated occupant, when the PAD indicator light is illuminated, the airbag is OFF. Also, when the Occupant Classification System detects either an empty seat or a weight less than the predetermined threshold, the ORC will not illuminate the PAD indicator light even though the airbag is turned OFF.
- The **Belt Tension Sensor (BTS)** is located at the outboard passenger lap belt anchor. The BTS creates a signal based on outboard lap belt tension. This signal is sent to the OCM to ensure that the resultant bladder pressure increase due to applied lap belt tension does not cause a small occupant to be classified as a larger occupant.
- The **Bladder Mat and Pressure Sensor** are located beneath the seat cushion foam. The pressure sensor sends a signal to the OCM.

The front passenger seat assembly contains critical components that affect the front passenger airbag deployment. Correctly functioning front passenger seat components are critical for the Occupant Classification System (OCS) to properly classify the front passenger and calculate the proper airbag deployment. Do not make any modifications to the front passenger seat components, assembly, or to the seat cover.

WARNING!

Unapproved modifications or service procedures to the front passenger seat assembly, its related components, or seat cover may inadvertently change the airbag deployment in case of a frontal crash. This could result in death or serious injury to the front seat passenger if the vehicle is involved in an accident. A modified vehicle may not comply with required Federal Motor Vehicle Safety Standards (FMVSS).

The following requirements must be strictly adhered to:

- Do not modify the front passenger seat assembly or components in any way.
- Do not modify the front seat center console or center position seat in any way.
- Do not use prior or future model year seat covers not designated for the specific model being repaired. Always use the correct seat cover specified for the vehicle.
- Do not replace the seat cover with an aftermarket seat cover.
- Do not add a secondary seat cover other than those approved by DaimlerChrysler/Mopar.
- At no time should any supplemental restraint system (SRS) component or SRS related component or fastener be modified or replaced with any part except those which are approved by DaimlerChrysler/Mopar.

If A Deployment Occurs

The airbag system is designed to deploy the airbags when the impact sensors detect a moderate-to-severe frontal collision, to help restrain the driver and front passenger, and then immediately deflate.

NOTE: A frontal collision that is not severe enough to need airbag protection will not activate the system. This does not mean something is wrong with the airbag system.

If you do have a collision which deploys the airbags, any or all of the following may occur:

- The nylon airbag material may sometimes cause abrasions and/or skin reddening to the driver and front passenger as the airbags deploy and unfold. The abrasions are similar to friction rope burns or those you might get sliding along a carpet or gymnasium floor. They are not caused by contact with chemicals. They are not permanent and normally heal quickly.

However, if you haven't healed significantly within a few days, or if you have any blistering, see your doctor immediately. As the airbags deflate you may see some smoke-like particles. The particles are a normal by-product of the process that generates the nontoxic gas used for airbag inflation. These airborne particles may irritate the skin, eyes, nose, or throat. If you have skin or eye irritation, rinse the area with cool water. For nose or throat irritation, move to fresh air. If the irritation continues, see your doctor. If these particles settle on your clothing, follow the garment manufacturer's instructions for cleaning.

- It is not advisable to drive your vehicle after the airbags have deployed. If you are involved in another collision, the airbags will not be in place to protect you.

WARNING!

Deployed airbags and seat belt pretensioners cannot protect you in another collision. Have the airbags, seat belt pretensioners, and the front passenger seat belt retractor assembly, replaced by an authorized dealer as soon as possible. Also, have the Occupant Classification System serviced as well.

Also, the fuel system will shut off immediately upon airbag deployment (gasoline models only). The ignition switch will need to be cycled (i.e. turn the ignition key from the ON position to the LOCK position) after approximately 5 seconds in order to restart the vehicle.

Enhanced Accident Response System (E.A.R.S.)

If the airbags deploy after an impact and the electrical system remains functional, the interior lights will turn on and the power door locks (if equipped) will unlock 5 seconds after airbag deployment.

Maintaining Your Airbag System

WARNING!
<ul style="list-style-type: none"> • Modifications to any part of the airbag system could cause it to fail when you need it. You could be injured if the airbag system is not there to protect you. Do not modify the components or wiring, including adding any kind of badges or stickers to the steering wheel hub trim cover or the upper right side of the instrument panel. Do not modify the front bumper, vehicle body structure, or add aftermarket side steps or running boards. • Do not attempt to modify any part of your advanced airbag system. The airbag may inflate accidentally or may not function properly if modifications are made. Take your vehicle to an authorized dealer for any advanced airbag system service. If your seat including your trim cover and cushion needs to be serviced in any way, take the vehicle to your authorized dealer. Only manufacturer approved seat accessories may be used. If it is necessary to modify an advanced airbag system for persons with disabilities, contact your authorized dealer.

WARNING!
<ul style="list-style-type: none"> • You need proper knee impact protection in a collision. Do not mount or locate any aftermarket equipment on or behind the knee bolsters. • It is dangerous to try to repair any part of the airbag system yourself. Be sure to tell anyone who works on your vehicle that it has an airbag system.

Airbag Warning Light

You will want to have the airbag system ready to inflate for your protection in an impact. The airbag system is designed to be maintenance free. If any of the following occurs, have an authorized dealer service the system promptly:

- Does not come on during the 6 to 8 seconds after the ignition switch is first turned on.
- Remains on after the 6 to 8 second interval.
- Comes on for any period of time while driving.

Child Restraint

Everyone in your vehicle needs to be buckled up all the time — babies and children, too. Every state in the United States and all Canadian provinces require that small children ride in proper restraint systems. This is the law, and you can be prosecuted for ignoring it.

Children 12 years and under should ride properly buckled up in a rear seat, if available. According to crash statistics, children are safer when properly restrained in the rear seats rather than in the front.

WARNING!

In a collision, an unrestrained child, even a tiny baby, can become a missile inside the vehicle. The force required to hold even an infant on your lap can become so great that you could not hold the child, no matter how strong you are. The child and others could be badly injured. Any child riding in your vehicle should be in a proper restraint for the child's size.

Infants and Small Children

There are different sizes and types of restraints for children from newborn size to the child almost large

enough for an adult seat belt. Always check the child seat owner's manual to ensure you have the right seat for your child. Use the restraint that is correct for your child:

- This vehicle is not capable of accommodating the installation of a car bed used for carrying newborn babies at the right front passenger seat position. If a car bed must be used to transport a newborn baby, the car bed must be installed in the second seating row only.
- Safety experts recommend that children ride rearward-facing in the vehicle until they are at least one year old and weigh at least 20 lbs (9 kg). Two types of child restraints can be used rearward facing: infant carriers and "convertible" child seats.
- The infant carrier is only used rearward-facing in the vehicle. It is recommended for children who weigh up to about 20 lbs (9 kg). "Convertible" child seats can be used either rearward-facing or forward-facing in the vehicle. Convertible child seats often have a higher weight limit in the rearward-facing direction than infant carriers do, so they can be used rearward-facing by children who weigh more than 20 lbs (9 kg) but are less than one year old.
- Rearward-facing child seats must **NEVER** be used in the front seat of a vehicle with a front passenger airbag. An airbag deployment could cause severe injury or death to infants in this position.
- Children who weigh more than 20 lbs (9 kg) and who are older than one year can ride forward-facing in the vehicle. Forward-facing child seats and convertible child seats used in the forward-facing direction are for children who weigh 20 to 40 lbs (9 to 18 kg), and are older than one year old. These child seats are also held in the vehicle by the lap/shoulder belt.
- The belt-positioning booster seat is for children weighing more than 40 lbs (18 kg), but who are still too small to fit the vehicle's seat belts properly. If the child

cannot sit with knees bent over the seat cushion while the child's back is against the seatback, they need a belt-positioning booster seat. The child and booster seat are held in the vehicle by the lap/shoulder belt. (Some booster seats are equipped with a front shield and are held in the vehicle by the lap portion.)

- For additional information refer to www.seatcheck.org or call 1-866-SEATCHECK.

WARNING!

- **Improper installation can lead to failure of an infant or child restraint. It could come loose in a collision. The child could be badly injured or killed. Follow the manufacturer's directions exactly when installing an infant or child restraint.**
- **A rearward facing infant restraint should only be used in a rear seat. A rearward facing infant restraint in the front seat may be struck by a deploying passenger airbag which may cause severe or fatal injuries to the infant.**

Here are some tips for getting the most out of your child restraint:

- Before buying any restraint system, make sure that it has a label certifying that it meets all applicable Safety

Standards. The manufacturer recommends that you try a child restraint in the vehicle seats where you will use it before you buy it.

- The restraint must be appropriate for your child’s weight and height. Check the label on the restraint for weight and height limits.
- Carefully follow the instructions that come with the restraint. If you install the restraint improperly, it may not work when you need it.
- The passenger seat belts are equipped with either cinching latch plates or automatic locking retractors, which are designed to keep the lap portion tight around the child restraint so that it is not necessary to use a locking clip. If the seat belt has a cinching latch plate, pulling up on the shoulder portion of the lap/shoulder belt will tighten the belt. The cinching latch plate will keep the belt tight, however, any seat

belt system will loosen with time, so check the belt occasionally and pull it tight if necessary.

If the seat belt has an automatic locking retractor, it will have a distinctive label. Pull the belt from the retractor until there is enough to allow you to pass through the child restraint and slide the latch plate into the buckle. Then, pull the belt until it is all extracted from the retractor. Allow the belt to return to the retractor, pulling on the excess webbing to tighten the lap portion about the child restraint. Refer to “Automatic Locking Mode” earlier in this section.

- Buckle the child into the restraint exactly as the manufacturer’s instructions tell you.
- When your child restraint is not in use, secure it in the vehicle with the seat belt or remove it from the vehicle. Do not leave it loose in the vehicle. In a sudden stop or collision, it could strike the occupants or seat backs and cause serious personal injury.

LATCH — Child Seat Anchorage System (Lower Anchors and Tether for Children)

Your vehicle's rear seat is equipped with the child restraint anchorage system called LATCH. The LATCH system provides for the installation of the child restraint without using the vehicle's seat belts, instead securing the child restraint using lower anchorages and upper tether straps from the child restraint to the vehicle structure.

LATCH-compatible child restraint systems are now available. However, because the lower anchorages are to be introduced over a period of years, child restraint systems having attachments for those anchorages will continue to also have features for installation using the vehicle's seat belts. Child restraints having tether straps and hooks for connection to the top tether anchorages have been available for some time. For some older child restraints, many child restraint manufacturers offer add-on tether strap

kits or retro-fit kits. You are urged to take advantage of all the available attachments provided with your child restraint in any vehicle.

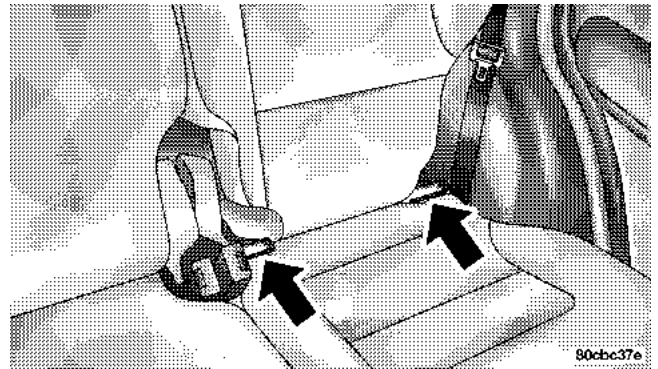
NOTE: When using the LATCH attaching system to install a child restraint, please ensure that all seat belts not being used for occupant restraints are stowed and out of reach of children. It is recommended that before installing the child restraint, buckle the seat belt so the seat belt is tucked behind the child restraint and out of reach. If the buckled seat belt interferes with the child restraint installation, instead of tucking the seat belt behind the child restraint, route the seat belt through the child restraint belt path and then buckle it. This should stow the seat belt out of the reach of an inquisitive child. Remind all children in the vehicle that the seat belts are not toys and should not be played with, and never leave your child unattended in the vehicle.

All three rear seating positions have lower anchorages that are capable of accommodating LATCH-compatible child seats having flexible, webbing-mounted lower attachments. Child seats with fixed lower attachments must be installed in the outboard positions only. Regardless of the specific type of lower attachment, **NEVER** install LATCH-compatible child seats such that two seats share a common lower anchorage. If installing child seats in adjacent rear-seating positions or if your child restraints are not LATCH-compatible, install the restraints using the vehicle's seat belts.

Installing the LATCH-Compatible Child Restraint System

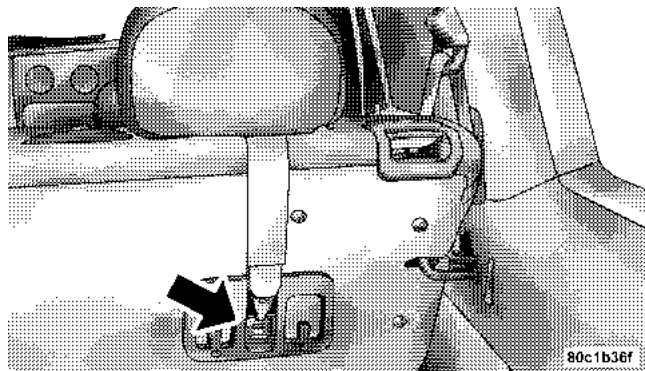
We urge that you carefully follow the directions of the manufacturer when installing your child restraint. Not all child restraint systems will be installed as described here. Again, carefully follow the installation instructions that were provided with the child restraint system.

The rear seat lower anchorages are round bars, located at the rear of the seat cushion where it meets the seat back, and are just visible when you lean into the rear seat to install the child restraint. You will easily feel them if you run your finger along the intersection of the seatback and seat cushion surfaces.



Latch Anchorages

In addition, there are tether strap anchorages behind each rear seating position located on the back of the seat.



Tether Strap Mounting

Many, but not all restraint systems will be equipped with separate straps on each side, with each having a hook or connector for attachment to the lower anchorage and a

means of adjusting the tension in the strap. Forward-facing toddler restraints and some rear-facing infant restraints will also be equipped with a tether strap, a hook for attachment to the tether strap anchorage and a means of adjusting the tension of the strap.

You will first loosen the adjusters on the lower straps and on the tether strap so that you can more easily attach the hooks or connectors to the vehicle anchorages. Next attach the lower hooks or connectors over the top of the anchorage bars, pushing aside the seat cover material. Then lift the tether anchorage cover directly behind the seat where you are placing the child restraint and attach the tether strap to the anchorage, being careful to route the tether strap to provide the most direct path between the anchor and the child restraint. If your vehicle is equipped with adjustable rear head restraints, raise the head restraint and, route the tether strap under the head restraint and between the two posts. Finally, tighten all three straps as you push the child restraint rearward and

downward into the seat, removing slack in the straps according to the child restraint manufacturer's instructions.

WARNING!

Improper installation of a child restraint to the LATCH anchorages can lead to failure of an infant or child restraint. The child could be badly injured or killed. Follow the manufacturer's directions exactly when installing an infant or child restraint.

Installing Child Restraints Using the Vehicle Seat Belt

The passenger seat belts are equipped with either cinching latch plates or automatic locking retractors, which are designed to keep the lap portion tight around the child restraint so that it is not necessary to use a locking clip. If the seat belt has a cinching latch plate, pulling up on the

shoulder portion of the lap/shoulder belt will tighten the belt. The cinching latch plate will keep the belt tight, however, any seat belt system will loosen with time, so check the belt occasionally and pull it tight if necessary.

If the seat belt has an automatic locking retractor, it will have a distinctive label. Pull the belt from the retractor until there is enough to allow you to pass through the child restraint and slide the latch plate into the buckle. Then, pull the belt until it is all extracted from the retractor. Allow the belt to return to the retractor, pulling on the excess webbing to tighten the lap portion about the child restraint. Refer to "Automatic Locking Mode" earlier in this section.

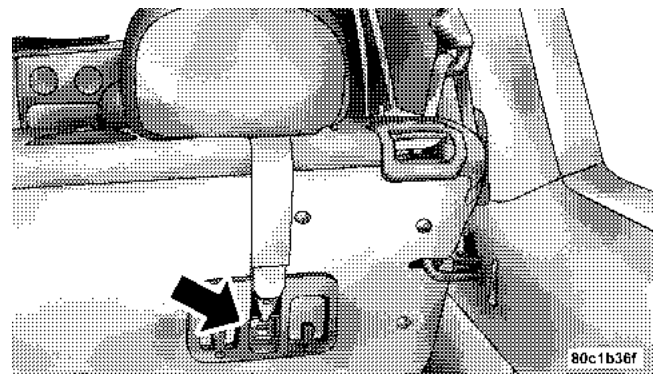
In the rear seat, you may have trouble tightening the lap/shoulder belt on the child restraint because the buckle or latch plate is too close to the belt path opening on the restraint. Disconnect the latch plate from the

buckle and twist the short buckle-end belt several times to shorten it. Insert the latch plate into the buckle with the release button facing out.

If the belt still can't be tightened, or if by pulling and pushing on the restraint loosens the belt, you may need to do something more. Disconnect the latch plate from the buckle, turn the buckle around, and insert the latch plate into the buckle again. If you still can't make the child restraint secure, try a different seating position.

To attach a child restraint tether strap:

Route the tether strap over the seat back and attach the hook to the tether anchor located on the back of the seat. For the outboard seating positions, route the tether under the head restraint between the head restraint posts.



Tether Strap Mounting

WARNING!

An incorrectly anchored tether strap could lead to increased head motion and possible injury to the child. Use only the anchor positions directly behind the child seat to secure a child restraint top tether strap.

Children Too Large for Booster Seats

Children who are large enough to wear the shoulder belt comfortably, and whose legs are long enough to bend over the front of the seat when their back is against the seat back should use the lap/shoulder belt in a rear seat.

- Make sure that the child is upright in the seat.
- The lap portion should be low on the hips and as snug as possible.

- Check belt fit periodically. A child's squirming or slouching can move the belt out of position.
- If the shoulder belt contacts the face or neck, move the child closer to the center of the vehicle. Never allow a child to put the shoulder belt under an arm.

Transporting Pets

Airbags deploying in the front seat could harm your pet. An unrestrained pet will be thrown about and possibly injured, or injure a passenger during panic braking or in a collision.

Pets should be restrained in the rear seat in pet harnesses or pet carriers that are secured by seat belts.

ENGINE BREAK-IN RECOMMENDATIONS

A long break-in period is not required for the engine in your new vehicle.

Drive moderately during the first 300 miles (500 km). After the initial 60 miles (100 km), speeds up to 50 or 55 mph (80 or 90 km/h) are desirable.

While cruising, brief full-throttle acceleration, within the limits of local traffic laws, contributes to a good break-in. Wide open throttle acceleration in low gear can be detrimental and should be avoided.

The engine oil installed in the engine at the factory is a high quality energy conserving type lubricant. Oil changes should be consistent with anticipated climate conditions under which vehicle operations will occur. The recommended viscosity and quality grades are shown in Section 7 of this manual. **NON-DETERGENT OR STRAIGHT MINERAL OILS MUST NEVER BE USED.**

A new engine may consume some oil during its first few thousand miles (kilometers) of operation. This should be considered as a normal part of the break-in and not interpreted as an indication of difficulty.

SAFETY TIPS

Exhaust Gas

WARNING!

Exhaust gases can injure or kill. They contain carbon monoxide (CO) which is colorless and odorless. Breathing it can make you unconscious and can eventually poison you. To avoid breathing (CO) follow the safety tips below.

- Do not inhale exhaust gases. They contain carbon monoxide, a colorless and odorless gas which can kill. Never run the engine in a closed area, such as a

garage, and never sit in a parked vehicle with the engine running for an extended period. If the vehicle is stopped in an open area with engine running for more than a short period, adjust the ventilation system to force fresh, outside air into the vehicle.

- Guard against carbon monoxide with proper maintenance. Have the exhaust system inspected every time the vehicle is raised. Have any abnormal conditions repaired promptly. Until repaired, drive with all side windows fully open.
- Always run the climate control in panel or floor mode when driving with any windows open, even if only slightly, to help keep fresh air circulating inside vehicle. Otherwise poisonous gases could be drawn into the vehicle.

Safety Checks You Should Make Inside The Vehicle

Seat Belts

Inspect the belt system periodically, checking for cuts, frays and loose parts. Damaged parts must be replaced immediately. Do not disassemble or modify the system.

Seat belt assemblies must be replaced after an accident if they have been damaged (bent retractor, torn webbing, pretensioners, etc.). If there is any question regarding belt or retractor condition, replace the belt.

NOTE: The “Seat Belt Indicator Light” will remain on until the driver’s seat belt is buckled.

Airbag Warning Light

The light should come on and remain on for 6 to 8 seconds as a bulb check when the ignition switch is first turned on. If the bulb is not lit during starting, have the system checked by an authorized dealer.

Defrosters

Check operation by selecting the defrost mode and place the blower control on high speed. You should feel the air directed against the windshield.

Safety Checks You Should Make Outside The Vehicle

Tires

Examine tires for excessive tread wear or uneven wear patterns. Check for stones, nails, glass, or other objects lodged in the tread. Inspect for tread cuts or sidewall cracks. Check wheel nuts for tightness and tires (including spare) for proper pressure.

Lights

Have someone observe the operation of all exterior lights while you work the controls. Check turn signal and high beam indicator lights on the instrument panel.

Fluid Leaks

Check area under vehicle after overnight parking for fuel, coolant, oil or other fluid leaks. Also, if gasoline fumes are detected, the cause should be located and corrected immediately.

UNDERSTANDING THE FEATURES OF YOUR VEHICLE

CONTENTS

■ Mirrors81	■ Hands-Free Communication (UConnect™) — If Equipped85
□ Inside Day/Night Mirror81	□ Operations87
□ Automatic Dimming Mirror — If Equipped82	□ Phone Call Features93
□ Outside Mirrors82	□ UConnect™ System Features96
□ Exterior Mirrors Folding Feature83	□ Advanced Phone Connectivity	100
□ Power Remote Control Mirrors — If Equipped83	□ Things You Should Know About Your UConnect™ System	102
□ Heated Remote Control Mirrors — If Equipped84	■ Seats	108
□ Lighted Vanity Mirrors — If Equipped84	□ Front Manual Seat Adjustment	108

78 UNDERSTANDING THE FEATURES OF YOUR VEHICLE

□ Front Seat Adjustment — Recline	109	□ Lights-On Reminder	118
□ 6-Way Driver's Power Seat With Manual Recliner	110	□ Fog Lights — If Equipped	118
□ Head Restraints	111	□ Turn Signals	119
□ Heated Seats — If Equipped	112	□ High Beam Switch	119
□ 65/35 Split Folding Rear Seat	113	□ Passing Light	119
■ To Open And Close The Hood	115	□ Interior Lights	119
■ Lights	117	□ Front Map/Reading Lights	120
□ Multi-Function Control Lever	117	■ Windshield Wipers And Washers	120
□ Battery Saver Feature — Exterior Lights	117	□ Intermittent Wiper System	121
□ Headlights And Parking Lights	117	□ Windshield Washers	121
□ Instrument Panel And Interior Lights	118	■ Tilt Steering Column	122
□ Daytime Running Lights — If Equipped	118	■ Electronic Speed Control	123
		□ To Activate	123

<hr/>		UNDERSTANDING THE FEATURES OF YOUR VEHICLE 79
<input type="checkbox"/> To Set At A Desired Speed	124	<input checked="" type="checkbox"/> Overhead Console — If Equipped
<input type="checkbox"/> To Deactivate	124	<input type="checkbox"/> Dome/Reading Lights
<input type="checkbox"/> To Resume Speed	124	<input type="checkbox"/> Electronic Vehicle Information Center
<input type="checkbox"/> To Vary The Speed Setting	124	<input type="checkbox"/> Customer Programmable Features
<input type="checkbox"/> To Accelerate For Passing	125	<input type="checkbox"/> Mini-Trip Computer
<input checked="" type="checkbox"/> Electronic Brake Control System	125	<input checked="" type="checkbox"/> Garage Door Opener — If Equipped
<input type="checkbox"/> ABS (Anti-Lock Brake System)	126	<input type="checkbox"/> When Your Vehicle Is New
<input type="checkbox"/> TCS (Traction Control System)	127	<input type="checkbox"/> Programming HomeLink
<input type="checkbox"/> BAS (Brake Assist System)	127	<input type="checkbox"/> Gate Operator/Canadian Programming
<input type="checkbox"/> ERM (Electronic Roll Mitigation)	128	<input type="checkbox"/> Using HomeLink
<input type="checkbox"/> ESP (Electronic Stability Program)	129	<input checked="" type="checkbox"/> Power Sunroof — If Equipped
<input type="checkbox"/> ESP/BAS Warning Lamp	132	<input type="checkbox"/> Express Open Feature
		<input type="checkbox"/> Sunroof Maintenance

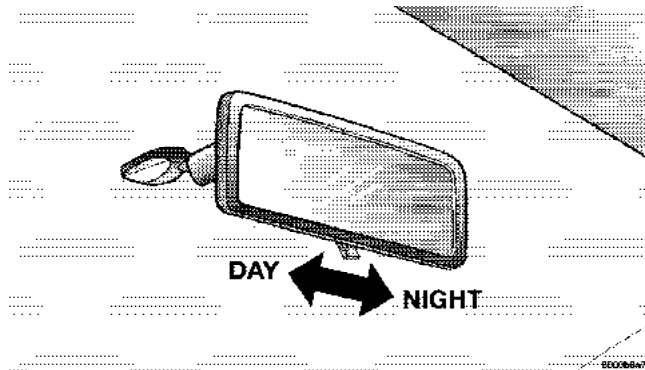
80 UNDERSTANDING THE FEATURES OF YOUR VEHICLE

■ Power Outlet	150	□ Cargo Tie-Down Hooks	155
■ Cup Holders	152	■ Rear Window Features	157
□ Smoker's Package — If Equipped	153	□ Rear Window Wiper/Washer	157
■ Cargo Area Features	154	□ Rear Window Defroster	158
□ Cargo Light	154	■ Roof Luggage Rack	159
□ Retractable Cargo Area Cover — If Equipped	154		

MIRRORS

Inside Day/Night Mirror

The mirror should be adjusted to center on the view through the rear window.



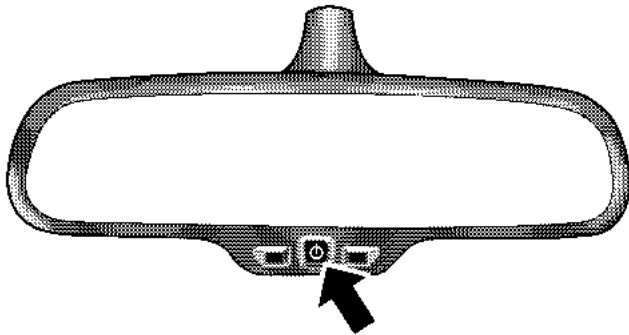
Adjusting Rear View Mirror

A two-point pivot system allows for horizontal and vertical adjustment of the mirror.

Annoying headlight glare from vehicles behind you can be reduced by moving the small control under the mirror to the night position (toward rear of vehicle). The mirror should be adjusted while set in the day position (toward windshield).

Automatic Dimming Mirror — If Equipped

This mirror automatically adjusts for annoying headlight glare from vehicles behind you. You can turn the feature on or off by pressing the button at the base of the mirror. A light in the button will indicate when the dimming feature is activated.



817892c4

Automatic Dimming Mirror

CAUTION!

To avoid damage to the mirror during cleaning, never spray any cleaning solution directly onto the mirror. Apply the solution onto a clean cloth and wipe the mirror clean.

Outside Mirrors

To receive maximum benefit, adjust the outside mirrors to center on the adjacent lane of traffic with a slight overlap of the view obtained on the inside mirror.

WARNING!

Vehicles and other objects seen in the passenger side convex mirror will look smaller and farther away than they really are. Relying too much on your passenger side convex mirror could cause you to collide with another vehicle or other object. Use your inside mirror when judging the size or distance of a vehicle seen in the passenger side convex mirror. Some vehicles will not have a convex passenger side mirror.

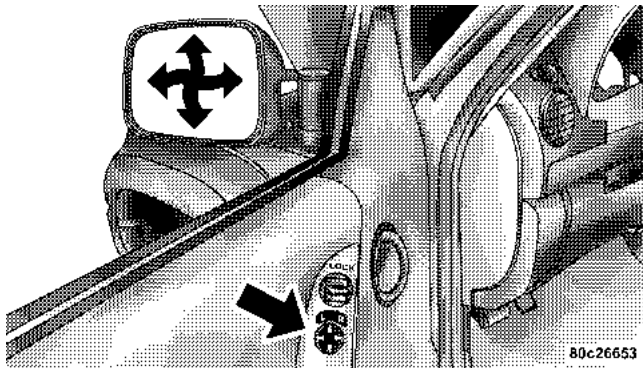
Exterior Mirrors Folding Feature

All exterior mirrors are hinged and may be moved either forward or rearward to resist damage. The hinges have three detent positions; full forward, full rearward, and normal.

Power Remote Control Mirrors — If Equipped


The controls for the power mirrors are located on the driver's door trim panel below the door lock switch.

Set the top switch to the left or right for the left or right mirror, and set it to the center off position to prevent accidentally moving a mirror when you are finished adjusting the mirror. Press one of the four arrows for the direction you want the mirror to move.



Power Mirror Switches

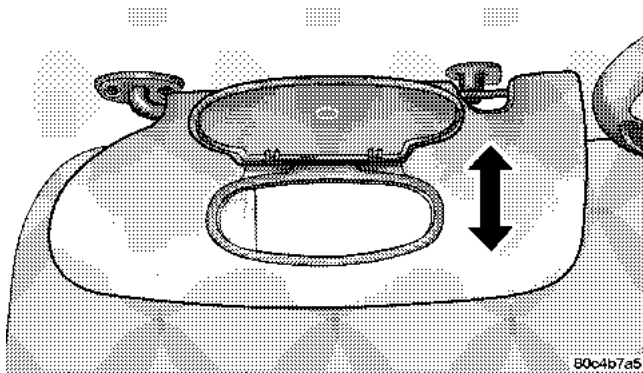
Heated Remote Control Mirrors — If Equipped

 These mirrors are heated to melt frost or ice. This feature is activated whenever you turn on the rear window defrost.

Lighted Vanity Mirrors — If Equipped

An illuminated vanity mirror is on the sun visor. To use the mirror, rotate the sun visor down and swing the mirror cover upward. The lights turn on automatically. Closing the mirror cover turns off the lights.

When the ignition is turned off, the light will turn off automatically (after approximately 8 minutes).



Lighted Vanity Mirror

Sun Visor Extension — If Equipped

This feature has a pull out extension on the sun visor for increased coverage.

HANDS-FREE COMMUNICATION (UConnect™) — IF EQUIPPED

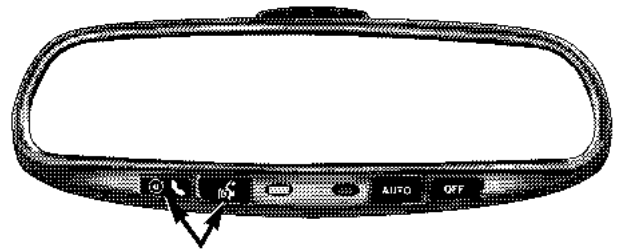
UConnect™ is a voice-activated, hands-free, in-vehicle communications system. UConnect™ allows you to dial a phone number with your cellular phone using simple voice commands (e.g., "Call" ... "Mike" ... "Work" or "Dial" ... "248-555-1212"). Your cellular phone's audio is transmitted through your vehicle's audio system; the system will automatically mute your radio when using the UConnect™ system.

NOTE: The UConnect™ system use requires a cellular phone equipped with the Bluetooth "Hands-Free Profile," version 0.96 or higher. See www.chrysler.com/uconnect for supported phones.

UConnect™ allows you to transfer calls between the system and your cellular phone as you enter or exit your vehicle, and enables you to mute the system's microphone for private conversation.

The UConnect™ phonebook enables you to store up to 32 names and four numbers per name. Each language has a separate 32-name phonebook accessible only in that language. This system is driven through your Bluetooth™ Hands-Free profile cellular phone. UConnect™ features Bluetooth™ technology - the global standard that enables different electronic devices to connect to each other without wires or a docking station, so UConnect works no matter where you stow your cellular phone (be it your purse, pocket, or briefcase), as long as your phone is turned on and has been paired to the vehicle's UConnect™ system. The UConnect™ system allows up to seven cellular phones to be linked to system. Only one linked (or paired) cellular phone can be used with the system at a time. The system is available in English, Spanish, or French languages (as equipped).

The rearview mirror contains the microphone for the system and the control buttons that will enable you to access the system.



8105b20d

UConnect™ Switches

The UConnect™ system can be used with any Hands-Free Profile certified Bluetooth™ cellular phone. See www.chrysler.com/uconnect for supported phones. If your cellular phone supports a different profile (e.g.,

Headset Profile), you may not be able to use any UConnect™ features. Refer to your cellular service provider or the phone manufacturer for details.

The UConnect™ system is fully integrated with the vehicle's audio system. The volume of the UConnect™ system can be adjusted either from the radio volume control knob, or from the steering wheel radio control (right switch), if so equipped.

The radio display will be used for visual prompts from the UConnect™ system such as "CELL" or caller ID on certain radios.

Operations

Voice commands can be used to operate the UConnect™ system and to navigate through the UConnect™ menu structure. Voice commands are required after most UConnect™ system prompts. You will be prompted for a specific command and then guided through the available options.

- Prior to giving a voice command, one must wait for the voice on beep, which follows the "Ready" prompt or another prompt.
- For certain operations, compound commands can be used. For example, instead of saying "Setup" and then "Phone Pairing," the following compound command can be said: "Setup Phone Pairing."
- For each feature explanation in this section, only the combined form of the voice command is given. You can also break the commands into parts and say each part of the command, when you are asked for it. For example, you can use the combined form voice command "Phonebook New Entry," or you can break the combined form command into two voice commands: "Phonebook" and "New Entry." Please remember, the UConnect™ system works best when you talk in a normal conversational tone, as if speaking to someone sitting eight feet away from you.

Voice Command Tree

Refer to "Voice Tree" at the end of this section.

Help Command

If you need assistance at any prompt, or if you want to know your options are at any prompt, say "Help" following the voice on beep. The UConnect™ system will play all the options at any prompt if you ask for help.

To activate the UConnect™ system from idle, simply press the 'Phone' button and follow audible prompts for directions. All UConnect™ system sessions begin with a press of the 'Phone' button on the mirror.

Cancel Command

At any prompt, after the voice on beep, you can say "Cancel" and you will be returned to the main menu. However, in a few instances the system will take you back to the previous menu.

Pair (Link) UConnect™ System to a Cellular Phone

To begin using your UConnect™ system, you must pair your compatible Bluetooth™ enabled cellular phone.

NOTE: The UConnect™ system use requires a cellular phone equipped with the Bluetooth "Hands-Free Profile," version 0.96 or higher. See www.chrysler.com/uconnect for supported phones.

To complete the pairing process, you will need to reference your cellular phone owner's manual. One of the following vehicle specific websites may also provide detailed instructions for pairing with the brand of phone that you have:

NOTE:

- www.chrysler.com/uconnect
- www.dodge.com/uconnect
- www.jeep.com/uconnect

The following are general phone to UConnect™ System pairing instructions:

- Press the 'Phone' button to begin.
- After the "Ready" prompt and the following beep, say "Setup Phone Pairing" and follow the audible prompts.
- When prompted, after the voice on beep, say "Pair a Phone" and follow the audible prompts.
- You will be asked to say a four-digit pin number, which you will later need to enter into your cellular. You can enter any four-digit pin number. You will not need to remember this pin number after the initial pairing process.
- For identification purposes, you will be prompted to give the UConnect™ system a name for your cellular phone. Each cellular phone that is paired should be given a unique phone name.

- You will then be asked to give your cellular phone a priority level between 1 and 7, 1 being the highest priority. You can pair up to seven cellular phones to your UConnect™ system. However, at any given time, only one cellular phone can be in use, connected to your UConnect™ System. The priority allows the UConnect™ system to know which cellular phone to use if multiple cellular phones are in the vehicle at the same time. For example, if priority 3 and priority 5 phones are present in the vehicle, the UConnect™ system will use the priority 3 cellular phone when you make a call. You can select to use a lower priority cellular phone at any time (refer to "Advanced Phone Connectivity").

Call/Dial by Saying a Number

- Press the 'Phone' button to begin.
- After the "Ready" prompt and the following beep, say "Dial."

- System will prompt you to say the number you want call.
- For example, you can say "234-567-8901."
- The UConnect™ system will confirm the phone number and then dial. The number will appear in the display of certain radios.

Call/Dial by Saying a Name

- Press the "Phone" button to begin.
- After the "Ready" prompt and the following beep, say "Dial" or Call."
- System will prompt you to say the name of the person you want call.
- After the "Ready" prompt and the following beep, say the name of the person you want to call. For example,

you can say "John Doe," where John Doe is a previously stored name entry in the UConnect™ phonebook. Refer to "Add Names to Your UConnect™ Phonebook," to learn how to store a name in the phonebook.

- The UConnect™ system will confirm the name and then dial the corresponding phone number, which may appear in the display of certain radios.

Add Names to Your UConnect™ Phonebook

NOTE: Adding names to phonebook is recommended when vehicle is not in motion.

- Press the "Phone" button to begin.
- After the "Ready" prompt and the following beep, say "Phonebook New Entry."

- When prompted, say the name of the new entry. Use of long names helps the voice recognition and is recommended. For example, say "Robert Smith" or "Robert" instead of "Bob."
- When prompted, enter the number designation (e.g., "Home," "Work," "Mobile," or "Pager"). This will allow you to store multiple numbers for each phonebook entry, if desired.
- When prompted, recite the phone number for the phonebook entry that you are adding.

After you are finished adding an entry into the phonebook, you will be given the opportunity to add more phone numbers to the current entry or to return to the main menu.

The UConnect™ system will allow you to enter up to 32 names in the phonebook with each name having up to

four associated phone numbers and designations. Each language has a separate 32-name phonebook accessible only in that language.

Edit Entries in the UConnect™ Phonebook

NOTE: Editing phonebook entries is recommended when vehicle is not in motion.

- Press the 'Phone' button to begin.
- After the "Ready" prompt and the following beep, say "Phonebook Edit."
- You will then be asked for the name of the phonebook entry that you wish to edit.
- Next, choose the number designation (home, work, mobile, or pager) that you wish to edit.
- When prompted, recite the new phone number for the phonebook entry that you are editing.

After you are finished editing an entry in the phonebook, you will be given the opportunities to edit another entry in the phonebook, call the number you just edited, or return to the main menu.

"Phonebook Edit" can be used to add another phone number to a name entry that already exists in the phonebook. For example, the entry John Doe may have a mobile and a home number, but you can add John Doe's work number later using the "Phonebook Edit" feature.

Delete Entries in the UConnect™ Phonebook

NOTE: Editing phonebook entries is recommended when vehicle is not in motion.

- Press the 'Phone' button to begin.
- After the "Ready" prompt and the following beep, say "Phonebook Delete."

- After you enter the Phonebook Delete menu, you will then be asked for the name of the entry that you wish to delete. You can either say the name of a phonebook entry that you wish to delete or you can say "List Names" to hear a list of the entries in the phonebook from which you choose. To select one of the entries from the list, press the "Voice Recognition" button while the UConnect™ system is playing the desired entry and say "Delete."
- After you enter the name, the UConnect™ system will ask you which designation you wish to delete, home, work, mobile, or pager. Say the designation you wish to delete.
- Note that only the phonebook entry in the current language is deleted.

After confirmation, the phonebook entries will be deleted. Note that only the phonebook in the current language is deleted.

Delete All Entries in the UConnect™ Phonebook

- Press the 'Phone' button to begin.
- After the "Ready" prompt and the following beep, say "Phonebook Erase All."
- The UConnect™ system will ask you to verify that you wish to delete all the entries from the phonebook.
- After confirmation, the phonebook entries will be deleted.

List All Names in the UConnect™ Phonebook

- Press the 'Phone' button to begin.
- After the "Ready" prompt and the following beep, say "Phonebook List Names."
- The UConnect™ system will play the names of all the phonebook entries.

- To call one of the names in the list, press the "Voice Recognition" button during the playing of the desired name, and then say "Call." NOTE: the user can also exercise "Edit" or "Delete" operations at this point.
- The UConnect™ system will then prompt you as to number designation you wish to call.
- The selected number will be dialed.

Phone Call Features

The following features can be accessed through the UConnect™ system if the feature(s) are available on your cellular service plan. For example, if your cellular service plan provides three-way calling, this feature can be accessed through the UConnect™ system. Check with your cellular service provider for the features that you have.

Answer or Reject an Incoming Call - No Call Currently in Progress

When you receive a call on your cellular phone, the UConnect™ system will interrupt the vehicle audio system, if on, and will ask if you would like to answer the call. To reject the call, press and hold the 'Phone' button until you hear a single beep indicating that the incoming call was rejected.

Answer or Reject an Incoming Call - Call Currently in Progress

If a call is currently in progress and you have another incoming call, you will hear the same network tones for call waiting that you normally hear when using your cell phone. Press the 'Phone' button to place the current call on hold and answer the incoming call. NOTE: The UConnect™ system compatible phones in market today do not support rejecting an incoming call when another call is in progress. Therefore, the user can only either answer an incoming call or ignore it.

Making a Second Call while Current Call in Progress

To make a second call while you are currently in a call, press the 'Voice Recognition' button and say "Dial" or "Call" followed by the phone number or phonebook entry you wish to call. The first call will be on hold while the second call is in progress. To go back to the first call, refer to "Toggling Between Calls." To combine two calls, refer to "Conference Call."

Place/Retrieve a Call from Hold

To put a call on hold, press the 'Phone' button until you hear a single beep. This indicates that the call is on hold. To bring the call back from hold, press and hold the 'Phone' button until you hear a single beep.

Toggling Between Calls

If two calls are in progress (one active and one on hold), press the 'Phone' button until you hear a single beep

indicating that the active and hold status of the two calls have switched. Only one call can be placed on hold at one time.

Conference Call

When two calls are in progress (one active and one on hold), press and hold the 'Phone' button until you hear a double beep indicating that the two calls have been joined into one conference call.

Three-Way Calling

To initiate three-way calling, press the 'Voice Recognition' button while a call is in progress and make a second phone call as described under "Making a Second Call while Current Call in Progress." After the second call has established, press and hold the 'Phone' button until you hear a double beep indicating that the two calls have been joined into one conference call.

Call Termination

To end a call in progress, momentarily press the 'Phone' button. Only the active call(s) will be terminated and if there is a call on hold, it will become the new active call.

Redial

- Press the 'Phone' button to begin.
- After the "Ready" prompt and the following beep, say "Redial."
- The UConnect™ system will call the last number that was dialed on your cellular phone. Note: this may not be the last number dialed from the UConnect™ system.

Call Continuation

Call continuation is progression of a phone call on UConnect™ system after the vehicle ignition key has been switched to off. Call continuation functionality available on the vehicle can be any one of three types:

- After ignition key is switched off, a call can continue on the UConnect™ system either until the call ends or until the vehicle battery condition dictates cessation of the call on the UConnect™ system and transfer of the call to the mobile phone.
- After ignition key is switched to off, a call can continue on the UConnect™ system for certain duration, after which the call is automatically transferred from the UConnect™ system to the mobile phone.
- An active call is automatically transferred to the mobile phone after ignition key is switched to off.

UConnect™ System Features

Language Selection

To change the language that the UConnect™ system is using,

- Press the 'Phone' button to begin.
- After the "Ready" prompt and the following beep, say the name of the language you wish to switch to (English, Espanol, or Francais, if so equipped).
- Continue to follow the system prompts to complete language selection.

After selecting one of the languages, all prompts and voice commands will be in that language.

NOTE: After every UConnect™ language change operation, only the language specific 32-name phonebook is usable. The paired phone name is not language specific and usable across all languages.

Emergency Assistance

If you are in an emergency and the mobile phone is reachable:

- Pick up the phone and manually dial the emergency number for your area.

If the phone is not reachable and the UConnect™ system is operational, you may reach the emergency number as follows:

- Press the 'Phone' button to begin.
- After the "Ready" prompt and the following beep, say "Emergency" and the UConnect™ system will instruct the paired cellular phone to call the emergency number. This feature is only supported in the USA.

NOTE: The emergency number dialed is based on the Country where the vehicle is purchased (911 for USA and Canada and 060 for Mexico). The number dialed may not be applicable with the available cellular service and area.

The UConnect™ system does slightly lower your chances of successfully making a phone call as to that for the cell phone directly.

Your phone must be turned on and paired to the UConnect™ system to allow use of this vehicle feature in emergency situations when the cell phone has network coverage and stays paired to the UConnect™ system.

Towing Assistance

If you need towing assistance,

- Press the 'Phone' button to begin.
- After the "Ready" prompt and the following beep, say "Towing Assistance."

NOTE: The Towing Assistance number dialed is based on the Country where the vehicle is purchased (1-800-528-2069 for USA, 1-877-213-4525 for Canada, 55-14-3454 for Mexico city and 1-800-712-3040 for outside Mexico city in Mexico).

Please refer to the 24-Hour "Towing Assistance" coverage details in the Warranty information booklet and on the 24-Hour Towing Assistance Card.

Paging

To learn how to page, refer to "Working with Automated Systems." Paging works properly except for pagers of certain companies which time-out a little too soon to work properly with the UConnect™ system.

Voice Mail Calling

To learn how to access your voice mail, refer to "Working with Automated Systems."

Working with Automated Systems

This method is designed to be used in instances where one generally has to press numbers on the cellular phone keypad while navigating through an automated telephone system.

You can use your UConnect™ system to access a voice-mail system or an automated service, such as, paging service or automated customer service. Some services require immediate response selection, in some instances, that may be too quick for use of UConnect™ system.

When calling a number with your UConnect™ system that normally requires you to enter in a touch-tone sequence on your cellular phone keypad, you can push the 'Voice Recognition' button and say the sequence you wish to enter followed by the word "Send." For example, if required to enter your pin number followed with a pound 3 7 4 6 #, you can press the 'Voice Recognition' button and say "3 7 4 6 # Send." Saying a number, or sequence of numbers, followed by "Send" is also to be used to navigate through an automated customer service center menu structure and to leave a number on a pager.

Barge In - Overriding Prompts

The 'Voice Recognition' button can be used when you wish to skip part of a prompt and issue your voice recognition command immediately. For example, if a prompt is playing "Would you like to pair a phone, clear a...," you could press the 'Voice Recognition' button and say "Pair a Phone" to select that option without having to listen to the rest of the voice prompt.

Turning Confirmation Prompts On/Off

Turning confirmation prompts off will stop the system from confirming your choices (e.g., the UConnect™ system will not repeat a phone number before you dial it).

- Press the 'Phone' button to begin.
- After the "Ready" prompt and the following beep, say "Setup Confirmations." The UConnect™ system will play the current confirmation prompt status and you will be given the choice to change it.

Phone and Network Status Indicators

If available on the radio and/or on a premium display such as the instrument panel cluster, and supported by your cell phone, the UConnect™ system will provide notification to inform you of your phone and network status when you are attempting to make a phone call using UConnect™. The status is given for roaming network signal strength, phone battery strength, etc.

Dialing Using the Cellular Phone Keypad

You can dial a phone number with your cellular phone keypad and still use the UConnect™ system (while dialing via the cell phone keypad, the user must exercise caution and take precautionary safety measures). By dialing a number with your paired Bluetooth™ cellular phone, the audio will be played through your vehicle's audio system. The UConnect™ system will work the same as if you dial the number using voice recognition.

NOTE: Certain brands of mobile phones do not send the dial ring to the UConnect™ system to play it on the vehicle audio system, so you will not hear it. Under this situation, after successfully dialing a number, the user may feel that the call did not go through even though the call is in progress. Once your call is answered, you will hear the audio.

Mute/Un-mute (Mute off)

When you mute the UConnect™ system, you will still be able to hear the conversation coming from the other party, but the other party will not be able to hear you. In order to mute the UConnect™ system:

- Press the 'Voice Recognition' button.
- After the "Ready" prompt and the following beep, say "Mute."

In order to un-mute the UConnect™ system:

- Press the 'Voice Recognition' button.

- After the "Ready" prompt and the following beep, say "Mute-off."

Information Service

When using AT&T Wireless Service, dialing to phone number "#121," you can access voice activated automated system to receive news, weather, stocks, traffic, etc. related information.

Advanced Phone Connectivity

Transfer Call to and from Cellular Phone

The UConnect™ system allows on going calls to be transferred from your cellular phone to the UConnect™ system without terminating the call. To transfer an ongoing call from your UConnect™ paired cellular phone to the UConnect™ system or vice-versa, press the 'Voice Recognition' button and say "Transfer Call."

Connect or Disconnect Link Between the UConnect™ System and Cellular Phone

Your cellular phone can be paired with many different electronic devices, but can only be actively "connected" with one electronic device at a time.

If you would like to connect or disconnect the Bluetooth™ connection between a UConnect™ paired cellular phone and the UConnect™ system, then follow the instruction described in your cellular phone user's manual.

List Paired Cellular Phone Names

- Press the 'Phone' button to begin.
- After the "Ready" prompt and the following beep, say "Setup Phone pairing".
- When prompted, say "List Phones."

- The UConnect™ system will play the phone names of all paired cellular phones in order from the highest to the lowest priority. To "select" or "delete" a paired phone being announced, press the 'Voice recognition' button and say "Select" or "Delete." Also, see the next two sections for an alternate way to "select" or "delete" a paired phone.

Select another Cellular Phone

This feature allows you to select and start using another phone with the UConnect™ system. The phone must have been previously paired to the UConnect™ system that you want to use it with.

- Press the 'Phone' button to begin.
- After the "Ready" prompt and the following beep, say "Setup Select Phone" and follow the prompts.

- You can also press the 'Voice Recognition' button anytime while the list is being played, and then choose the phone that you wish to select.
- The selected phone will be used for the next phone call. If the selected phone is not available, the UConnect™ system will return to using the highest priority phone present in or near (approximately within 30 feet) the vehicle.

Delete UConnect™ Paired Cellular Phones

- Press the 'Phone' button to begin.
- After the "Ready" prompt and the following beep, say "Setup Phone Pairing."
- At the next prompt, say "Delete" and follow the prompts.

- You can also press the 'Voice Recognition' button anytime while the list is being played and then choose the phone you wish to delete.

Things You Should Know About Your UConnect™ System

Voice Recognition (VR)

- Always wait for the beep before speaking.
- Speak normally, without pausing, just as you would speak to a person sitting approximately eight (8) feet away from you.
- Make sure that no one other than you is speaking during a voice recognition period.

- Performance is maximized under:
 - low-to-medium blower setting,
 - low-to-medium vehicle speed,
 - low road noise,
 - smooth road surface,
 - fully closed windows,
 - dry weather condition.
- Even though the system is designed for users speaking in North American English, French, and Spanish accents, the system may not always work for some.
- When navigating through an automated system, such as voice mail, or when sending a page at the end of speaking the digit string, make sure to say "send."
- Storing names in phonebook when vehicle is not in motion is recommended.
- It is not recommended to store similar sounding names in the UConnect™ phonebook.
- UConnect™ phonebook nametag recognition rate is optimized for the voice of the person who stored the name in the phonebook.
- You can say "O" (letter "O") for "0" (zero). "800" must be spoken "eight-zero-zero."
- Even though international dialing for most number combinations is supported, some shortcut dialing number combinations may not be supported.

Far End Audio Performance

- Audio quality is maximized under:
 - low-to-medium blower setting,
 - low-to-medium vehicle speed,
 - low road noise,

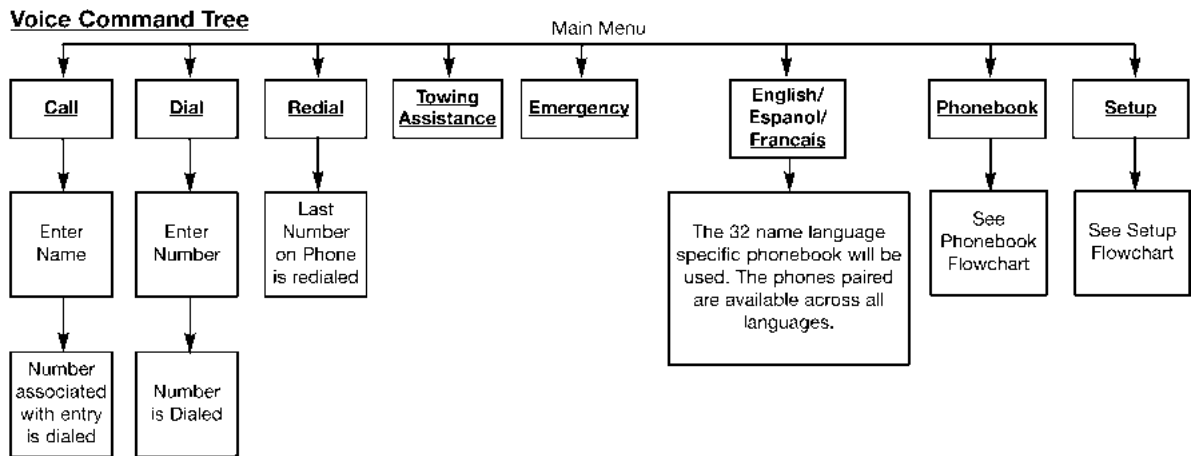
- smooth road surface,
- fully closed windows, and
- dry weather condition.
- Operation from driver seat.
- Performance, such as audio clarity, echo, and loudness to a large degree rely on the phone and network, and not the UConnect™ system.
- Echo at far end can sometime be reduced by lowering the in-vehicle audio volume.

Bluetooth Communication Link

Occasionally, Cellular phones have been found to lose connection to the UConnect™ system. When this happens, the connection can generally be re-established by switching the phone off/on. Your cell phone is recommended to remain in Bluetooth "on" mode.

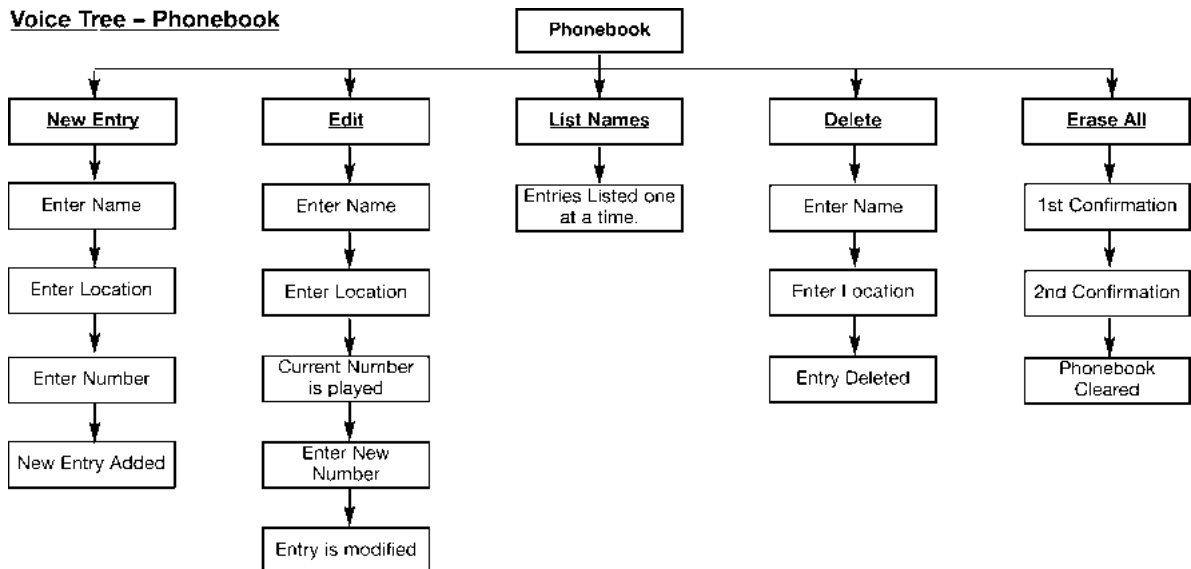
Power-Up

After switching the ignition key from OFF to either ON or ACC position, or after a reset, you must wait at least five (5) seconds prior to using the system.

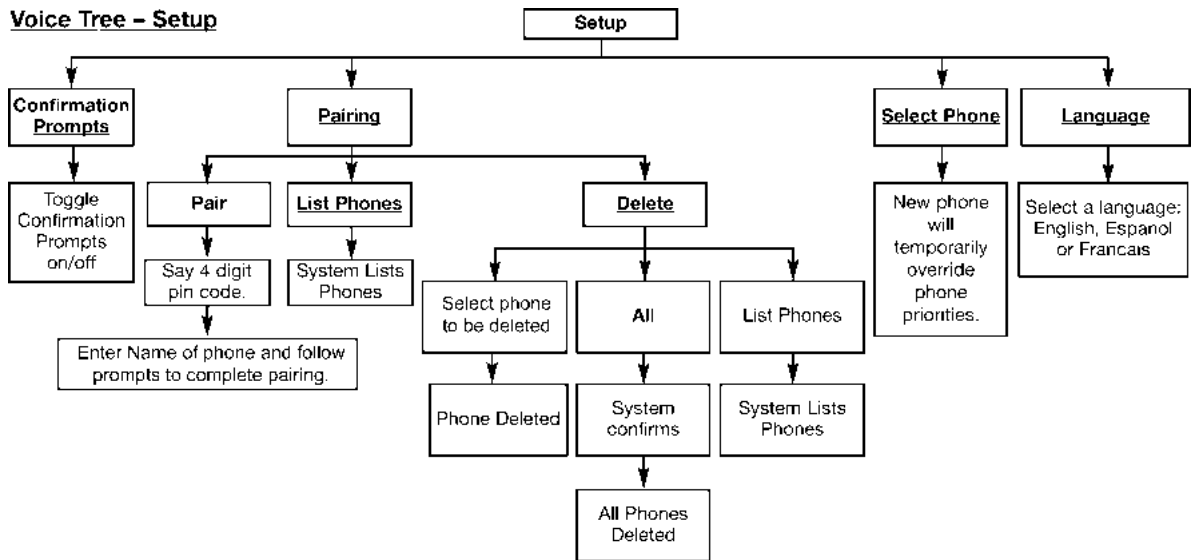


Note: Available Voice commands are shown in bold face and are underlined.

Voice Tree - Phonebook



Note: Available Voice commands are shown in bold face and are underlined.



Note: Available Voice commands are shown in bold face and are underlined.

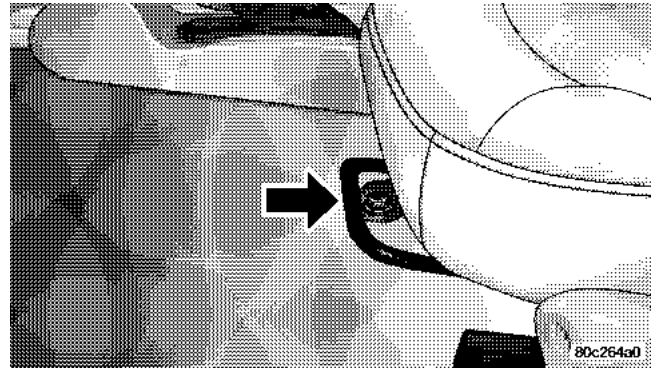
819402e4

	North American English
Primary	Alternate(s)
Zero	Oh
Add location	Add new
All	All of them
Confirmation prompts	Confirmations prompts
Delete a name	Delete
Language	Select language
List names	List all
List paired phones	List phones
Pager	Beeper
Phone pairing	Pairing
Phonebook	Phone book
Return to main menu	Return. Main menu
Select phone	select
Set up	Phone settings phone set up

SEATS

Front Manual Seat Adjustment

Move the seat forward or rearward using the adjustment bar. Lift up on the bar located on the front of the seat near the floor. Position the seat and be sure the latch engages fully.



Manual Seat Adjustment

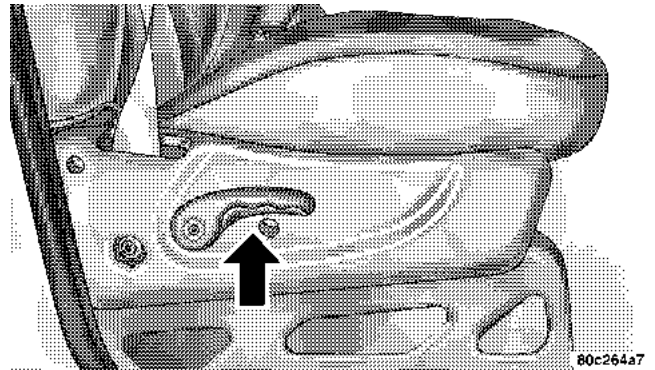
Using body pressure, move forward and rearward on the seat to be sure the seat adjusters have latched.

WARNING!

Adjusting a seat while the vehicle is moving is dangerous. The sudden movement of the seat could cause you to lose control. The seat belt might not be properly adjusted and you could be injured. Adjust any seat only while the vehicle is parked.

Front Seat Adjustment — Recline

To adjust the seatback, lift the lever located on the outboard side of the seat, lean back, and release the lever at the desired position. To return the seatback, lift the lever, lean forward, and release the lever.



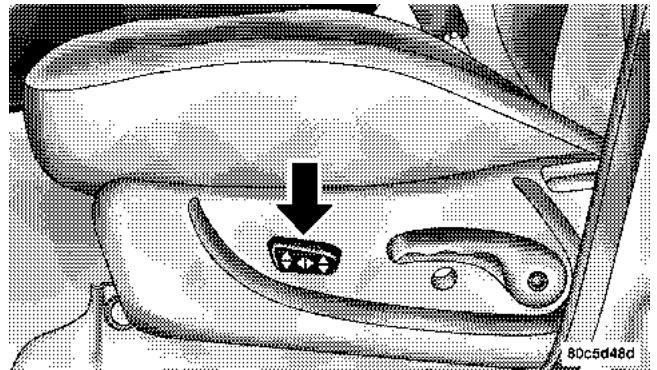
Recline Control Lever

WARNING!

Do not ride with the seatback reclined so that the seat belt is no longer resting against your chest. In a collision you could slide under the seat belt and be seriously or even fatally injured. Use the recliner only when the vehicle is parked.

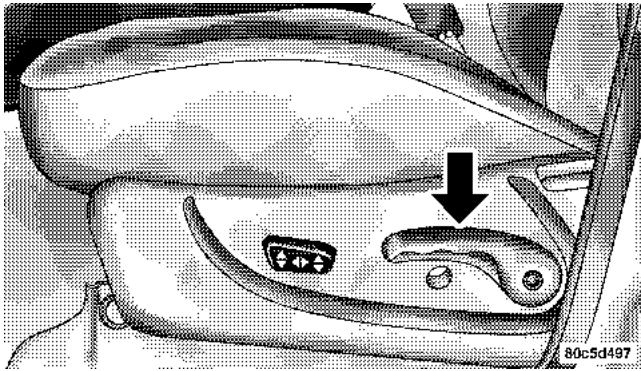
6-Way Driver's Power Seat with Manual Recliner

The seat switch is on the outboard side of the seat near the floor. Use this switch to move the seat up or down, forward or rearward, or to tilt the seat.



Power Seat Switches

This seat also has a manual recline lever located just to the rear of the power seat switch. Pull up on the lever to recline the seat.

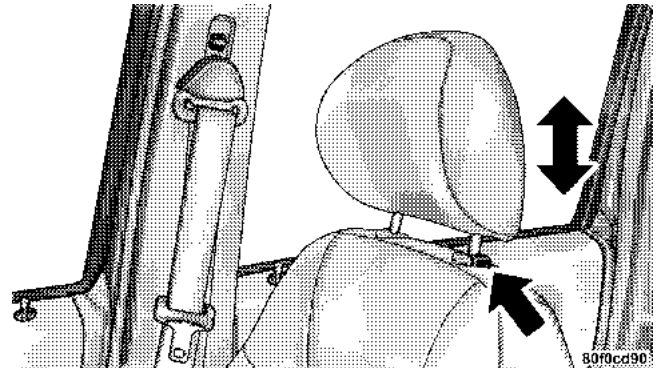


Recline Control Lever

Head Restraints

Head restraints can reduce the risk of whiplash injury in the event of impact from the rear. Adjustable head restraints should be adjusted so that the upper edge is as high as practical. The head restraints have a locking button that must be pushed inward to lower the head restraint. The restraints may be raised without pushing in the button.

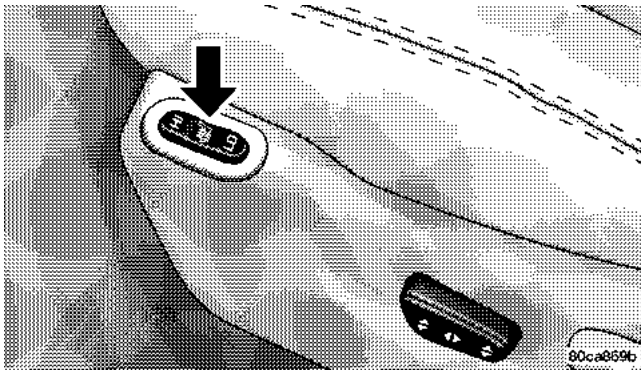
3



Adjustable Head Restraints

Heated Seats — If Equipped

The heated seat switch is located on the outboard side of the front seats. Pressing this switch to its desired setting (HI or LO) will activate the respective heating element for the heated seat.



Heated Seat Switches

Once the heated seat switch is activated, depressing it a second time will de-activate it.

WARNING!

Persons who are unable to feel pain to the skin because of advanced age, chronic illness, diabetes, spinal cord injury, medication, alcohol use, exhaustion or other physical condition must exercise care when using the seat heater. It may cause burns even at low temperatures, especially if used for long periods of time.

Do not place anything on the seat that insulates against heat, such as a blanket or cushion. This may cause the seat heater to overheat.

65/35 Split Folding Rear Seat

To provide additional storage area, each rear seat can be folded flat to allow for extended cargo space and still maintain some rear seating room.

NOTE: Prior to folding the rear seat, it may be necessary to reposition the front seat to its mid-track position.

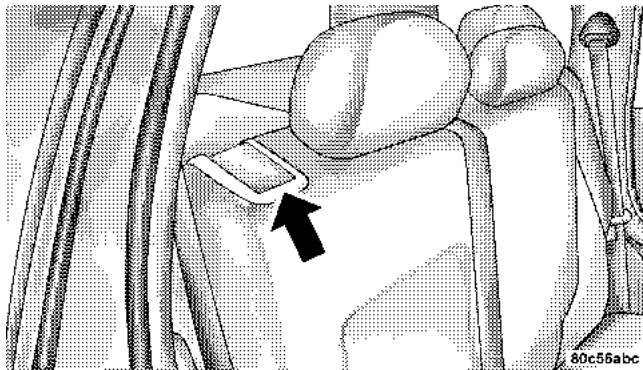
Also, be sure that the front seats are fully upright and positioned forward. This will allow the rear seat to fold down easily.

WARNING!

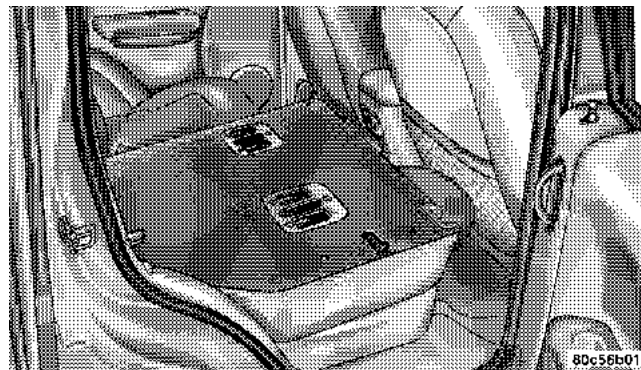
- It is extremely dangerous to ride in a cargo area, inside or outside of a vehicle. In a collision, people riding in these areas are more likely to be seriously injured or killed.
- Do not allow people to ride in any area of your vehicle that is not equipped with seats and seat belts.
- Be sure everyone in your vehicle is in a seat and using a seat belt properly.

To fold the 65/35 rear seat, perform the following steps:

1. Locate the seatback release handle on the outboard top side of each rear seatback; lift up on the handle, and rotate the lever forward until the seatback releases. Fold the seatback completely forward.



Rear Seat Release



Folding Rear Seat

NOTE: When lifting up on the release handle, the seatback will release easier if you do not pull forward on the seatback; only lift up on the release handle until the seatback disengages, then fold the seat forward.

When the seatback is folded completely forward, the head restraints should be flush against the seat cushion.

To restore the 65/35 rear seat to the upright position perform the following steps:

Raise the seatback and lock it into place. If interference from the cargo area prevents the seatback from fully locking, you will have difficulty returning the seat to its proper position. The seat release handle will be flush with the seatback when the seat is fully latched.

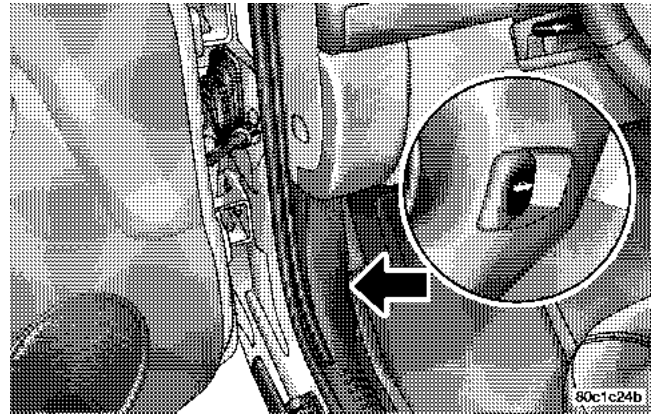
NOTE: If the rear seatback is not fully latched, the center shoulder belt will not be able to be extended for use. If you cannot extend the center shoulder belt, please make sure your seatback is fully latched.

WARNING!

Be certain that the seatback is securely locked into position. If the seatback is not securely locked into position the seat will not provide the proper stability for child seats and/or passengers. An improperly latched seat could cause serious injury.

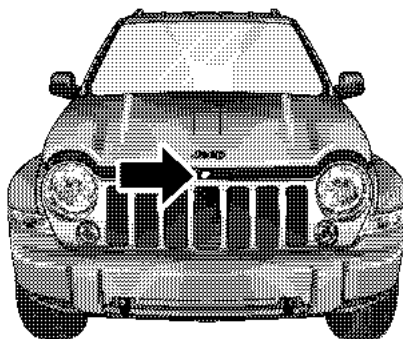
TO OPEN AND CLOSE THE HOOD

To open the hood, two latches must be released. First pull the hood release lever inside your vehicle located under the left side of the instrument panel.



Hood Release Lever

Then, reach under the hood and slide the safety latch to the right and lift the hood.



81464e04

Underhood Safety Latch

To prevent possible damage, do not slam the hood to close it. Lower the hood until it is open approximately 12 inches (30 cm) and then push hood closed. This should

secure both latches. Never drive your vehicle unless the hood is fully closed, with both latches engaged.

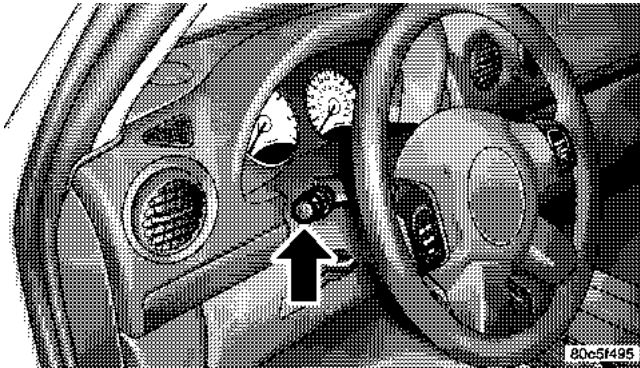
WARNING!

If the hood is not fully latched, it could fly up when the vehicle is moving and block your forward vision. Be sure all hood latches are latched fully before driving.

LIGHTS

Multi-Function Control Lever

The multi-function control lever controls the operation of the park lights, headlights, headlight beam selection, passing light, fog lights, instrument panel light dimming, and turn signals.



Multi-Function Control Lever

Battery Saver Feature — Exterior Lights

If the park lights, headlights, fog lights, or high beams are left on when the ignition switch is in the OFF position, the battery saver feature will automatically turn off the exterior lights after eight minutes. Normal operation will resume when the ignition is turned ON or when the switch is turned to another position.

3

Headlights and Parking Lights

Turn the end cap of the multi-function control lever to the first detent for parking lights and instrument panel lights. Turn to the second detent for headlight operation.

To change the brightness of the instrument panel lights, rotate the center portion of the multi-function control lever up or down.

Instrument Panel and Interior Lights

When the multi-function control lever is in the parklight, or headlight position, rotating the center portion of the lever up and down will increase and decrease the brightness (dimmer control) of the instrument panel lights. Full daytime brightness on all electronic displays (odometer, overhead console, radio, and climate control) is obtained by rotating the center portion of the control to the first detent above the dimmer range. Rotating the control to the second detent above the dimmer range turns the interior lights on. Rotating the control to the "Off" (extreme bottom) position disables all the interior lights, even when the doors and liftgate are open. While in the "Off" position the instrument panel lighting is at the lowest light level and may not be suitable for night driving.


Daytime Running Lights — If Equipped

The high beam headlights come on at a low intensity level after the engine has started. The lights remain on until the ignition switch is turned OFF or the parking brake is engaged. The headlight switch must be used for normal night time driving.

Lights-On Reminder

A chime will sound if the driver's door is left open, and the headlights or parking lights are left on.

Fog Lights — If Equipped

 The front fog light switch is located in the multi-function control lever. To activate the fog lights, turn on the park or low beam headlights and pull out the end of the lever. The "Fog Light Indicator Light" will illuminate when the fog lights are on.

NOTE: The fog lights will only operate with the park lights or the headlights on low beam. Selecting high beam headlights will turn off the fog lights.

Turn Signals

Move the multi-function control lever up or down and the arrows on each side of the instrument cluster flash to show proper operation of the front and rear turn signal lights. You can signal a lane change by moving the lever partially up or down without moving beyond the detent.

If either light flashes at a very fast rate, check for a defective outside light bulb. If an indicator fails to light when the lever is moved, it would suggest that the fuse or indicator is defective.

NOTE: A tone will chime if the turn signals are left on for more than 2 miles (3.2 km).

High Beam Switch

Pull the multi-function control lever towards you to switch the headlights to HIGH beam. Pull the multi-function control lever a second time to switch the headlights to LOW beam. The "High Beam Indicator Light" will illuminate when the high beams are on.

Passing Light

You can signal another vehicle with your headlights by lightly pulling the multi-function control lever toward the steering wheel. This will cause the headlights to turn on at high beam and remain on until the lever is released. The "High Beam Indicator Light" will illuminate when the high beams are on.

Interior Lights

The overhead lights will come on when a door is opened, and when the rotating ring on the multi-function control lever is in a position other than OFF. They may also be turned on by rotating the control for the dimmer switch on the multi-function control lever fully upward or by pressing the "Unlock" button on the keyfob.

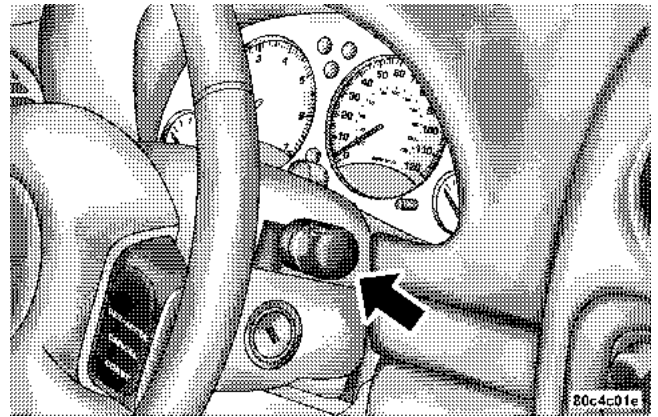
The overhead lights will automatically turn off in about 8 minutes if a door is left open or the dimmer control is left in the dome light position. Turn the ignition switch ON to restore the overhead light operation.

Front Map/Reading Lights

These lights are mounted in the overhead console. Each light can be turned on by pressing the recessed area of the lens. To turn these lights off, press the recessed area of the lens a second time.

WINDSHIELD WIPERS AND WASHERS

The wipers and washers are operated by a switch on the control lever. This control lever is located on the right side of the steering column. For front wiper operation, turn the control lever end cap upward to select the desired wiper speed.



Windshield Wiper/Washer Switch

Intermittent Wiper System

The intermittent feature of this system was designed for use when weather conditions make a single wiping cycle, with a variable pause between cycles, desirable. For maximum delay between cycles, rotate the control knob into the upper end of the delay range.

The delay interval decreases as you rotate the knob until it enters the LOW continual speed position. The delay can be regulated from a maximum of about 15 seconds between cycles, to a cycle every 2 seconds. The delay intervals will double in duration when the vehicle speed is 10 mph (16 km) or less.

WARNING!

Sudden loss of visibility through the windshield could lead to an accident. You might not see other vehicles or other obstacles. To avoid sudden icing of the windshield during freezing weather, warm the windshield with defroster before and during windshield washer use.

3

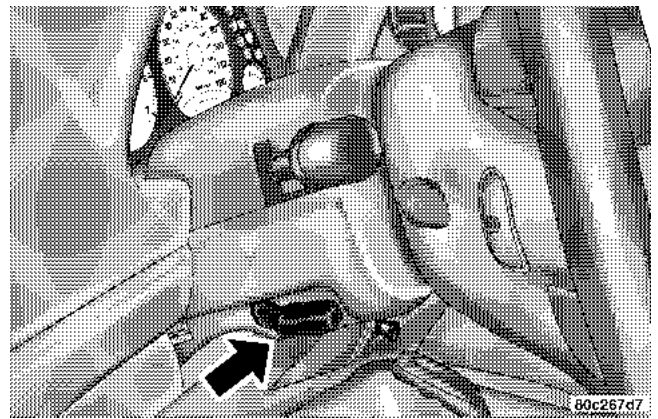
Windshield Washers

To use the washer, pull the lever toward you and hold while spray is desired. If the lever is pulled while in the delay range, the wiper will operate for two wipe cycles after the lever is released, and then resume the intermittent interval previously selected.

If the lever is pulled while in the OFF position, the wipers will operate for several wipe cycles, then turn off.

TILT STEERING COLUMN

To tilt the column, push down on the lever below the turn signal control and move the wheel up or down, as desired. Pull the lever back towards you and firmly push the lever until it is above the lower surface of the shroud to lock the column in place.



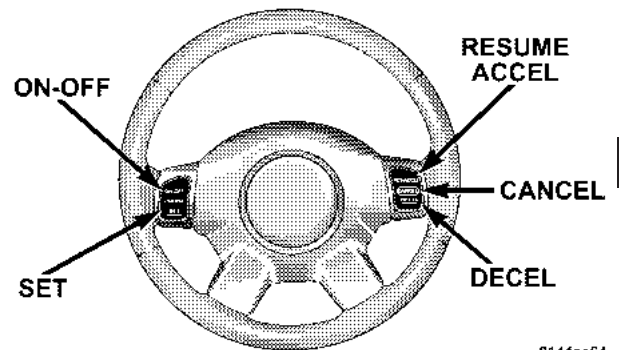
Tilt Steering Column

WARNING!

Tilting the steering column while the vehicle is moving is dangerous. Without a stable steering column, you could lose control of the vehicle and have an accident. Adjust the column only while the vehicle is stopped. Be sure it is locked before driving.

ELECTRONIC SPEED CONTROL

When engaged, this device takes over accelerator operations beginning at speeds of approximately 30 mph (48 km/h). The controls are mounted on the steering wheel and consist of ON·OFF, SET, RES·ACCEL, CANCEL, and DECEL controls.



8144ee64

To Activate

Press and release the ON·OFF button to turn the system on. To turn the system off, press the ON·OFF button again. The system should be turned off when not in use. The CRUISE indicator light in the instrument cluster illuminates when the system is on.

To Set At A Desired Speed

When the vehicle has reached the desired speed, press and release the SET button. Release the accelerator and the vehicle will operate at the selected speed.

To Deactivate

A soft tap on the brake pedal, normal braking, or pressing the CANCEL button will deactivate the Speed Control without erasing the memory. Pressing the ON-OFF button or turning off the ignition erases the memory.

To Resume Speed

To resume a previously set speed, press and release the RES-ACCEL button. Resume can be used at any speed beginning at approximately 30 mph (48 km/h).

To Vary The Speed Setting

When the Speed Control is on and set, speed can be increased by pressing and holding the RES-ACCEL button. When the button is released, a new set speed will be established.

Tapping the RES-ACCEL button once will result in a 2 mph (3 km/h) speed increase. Each time the button is tapped, speed increases, so tapping the button three times will increase speed by 6 mph (9 km/h), etc.

To decrease speed while speed control is on and set, press and hold the DECEL button. Release the button when the desired speed is reached, and the new speed will be set.

Tapping the DECEL button once will result in a 1 mph (2 km/h) speed decrease. Each time the button is tapped, speed decreases.

To Accelerate for Passing

Depress the accelerator as you would normally. When the pedal is released, the vehicle will return to the set speed.

NOTE: When driving uphill, at elevations above 2,000 ft. (610 meters), or when the vehicle is heavily loaded (especially when towing) the vehicle may slow below the SET speed. (If the vehicle speed drops below 35 mph (56 km/h), the Speed Control will automatically disengage). If this happens, you can push down on the accelerator pedal to maintain the desired speed.

A full throttle (high RPM) acceleration, while the system is engaged, will cause the system to disengage.

Vehicles may exhibit several 4-3 downshifts under the above conditions. To reduce the frequency of the downshifts and to improve vehicle performance, it is advisable to lock out overdrive. Press the O/D OFF button on the right side of the shift lever.

WARNING!

Leaving the Speed Control on when not in use is dangerous. You could accidentally set the system or cause it to go faster than you want. You could lose control and have an accident. Always turn the system off when you are not using it.

3**ELECTRONIC BRAKE CONTROL SYSTEM**

Your vehicle is equipped with an advanced electronic brake control system that includes ABS (Anti-Lock Brake System), TCS (Traction Control System), BAS (Brake Assist System), ERM (Electronic Roll Mitigation) and ESP (Electronic Stability Program). All five systems work together to enhance vehicle stability and control in various driving conditions are commonly referred to as ESP.

ABS (Anti-Lock Brake System)

This system aids the driver in maintaining vehicle control under adverse braking conditions. The system controls hydraulic brake pressure to prevent wheel lock-up and help avoid skidding on slippery surfaces during braking. Refer to “Anti-Lock Brake System” in Section 5 of this manual for more information about ABS.

WARNING!

ABS (Anti-Lock Brake System) cannot prevent the natural laws of physics from acting on the vehicle, nor can it increase the traction afforded by prevailing road conditions. ABS cannot prevent accidents, including those resulting from excessive speed in turns, driving on very slippery surfaces, or hydroplaning. Only a safe, attentive, and skillful driver can prevent accidents. The capabilities of an ABS-equipped vehicle must never be exploited in a reckless or dangerous manner which could jeopardize the user’s safety or the safety of others.

TCS (Traction Control System)

This system monitors the amount of wheel spin of each of the driven wheels. If wheel spin is detected, brake pressure is applied to the slipping wheel(s) and engine power is reduced to provide enhanced acceleration and stability. A feature of the TCS system functions similar to a limited slip differential and controls the wheel spin across a driven axle. If one wheel on a driven axle is spinning faster than the other, the system will apply the brake of the spinning wheel. This will allow more engine torque to be applied to the wheel that is not spinning. This feature remains active even if TCS and ESP are in the "Partial Off" mode. Refer to "ESP (Electronic Stability Program)" in this section.

BAS (Brake Assist System)

The BAS is designed to optimize the vehicle's braking capability during emergency braking maneuvers. The system detects an emergency braking situation by sensing the rate and amount of brake application and then applies optimum pressure to the brakes. This can help reduce braking distances. The BAS complements the anti-lock brake system (ABS). Applying the brakes very quickly results in the best BAS assistance. To receive the benefit of the system, you must apply continuous braking pressure during the stopping sequence. Do not reduce brake pedal pressure unless braking is no longer desired. Once the brake pedal is released, the BAS is deactivated.

WARNING!

BAS (Brake Assist System) cannot prevent the natural laws of physics from acting on the vehicle, nor can it increase the traction afforded by prevailing road conditions. BAS cannot prevent accidents, including those resulting from excessive speed in turns, driving on very slippery surfaces, or hydroplaning. Only a safe, attentive, and skillful driver can prevent accidents. The capabilities of a BAS-equipped vehicle must never be exploited in a reckless or dangerous manner which could jeopardize the user's safety or the safety of others.

ERM (Electronic Roll Mitigation)

This system anticipates the potential for wheel lift by monitoring the driver's steering wheel input and the speed of the vehicle. When ERM determines that the rate of change of the steering wheel angle and vehicle speed are sufficient to potentially cause wheel lift, it applies the appropriate brake and may reduce engine power to lessen the chance that wheel lift will occur. ERM will only intervene during very severe or evasive driving maneuvers. ERM can only reduce the chance of wheel lift occurring during severe or evasive driving maneuvers. It can not prevent wheel lift due to other factors such as road conditions, leaving the roadway or striking objects or other vehicles.

WARNING!

Many factors, such as vehicle loading, road conditions and driving conditions, influence the chance that wheel lift or rollover may occur. ERM can not prevent all wheel lift or rollovers, especially those that involve leaving the roadway or striking objects or other vehicles. Only a safe, attentive, and skillful driver can prevent accidents. The capabilities of an ERM-equipped vehicle must never be exploited in a reckless or dangerous manner which could jeopardize the user's safety or the safety of others.

ESP (Electronic Stability Program)

This system enhances directional control and stability of the vehicle under various driving conditions. ESP corrects for over/under steering of the vehicle by applying

the brake of the appropriate wheel to assist in counteracting the over/under steer condition. Engine power may also be reduced to help the vehicle maintain the desired path.

ESP uses sensors in the vehicle to determine the vehicle path intended by the driver and compares it to the actual path of the vehicle. When the actual path does not match the intended path, ESP applies the brake of the appropriate wheel to assist in counteracting the oversteer or understeer condition.

- Oversteer - when the vehicle is turning more than appropriate for the steering wheel position.
- Understeer - when the vehicle is turning less than appropriate for the steering wheel position.

ESP/TCS Indicator Light

The "ESP/TCS Indicator Light" located in the instrument cluster, starts to flash as soon as the tires lose traction and the ESP system becomes active. The "ESP/TCS Indicator Light" also flashes when TCS is active. If the "ESP/TCS Indicator Light" begins to flash during acceleration, ease up on the accelerator and apply as little throttle as possible. Be sure to adapt your speed and driving to the prevailing road conditions.

WARNING!

ESP (Electronic Stability Program) cannot prevent the natural laws of physics from acting on the vehicle, nor can it increase the traction afforded by prevailing road conditions. ESP cannot prevent accidents, including those resulting from excessive speed in turns, driving on very slippery surfaces, or hydroplaning. Only a safe, attentive, and skillful driver can prevent accidents. The capabilities of an ESP-equipped vehicle must never be exploited in a reckless or dangerous manner which could jeopardize the user's safety or the safety of others.

The ESP system has 2 available operating modes in 2WD, 4WD Part Time, 4WD Full Time (Selec-Trac Only), and on 2WD vehicles. The system has a single operating mode in 4WD Low Range.

High Range (4WD Part Time, 4WD Full Time) or 2WD Models

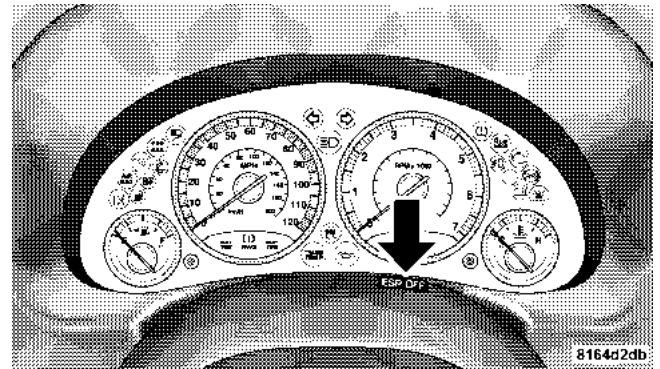
ESP On

This is the normal operating mode for ESP in 2WD, 4WD Part Time, 4WD Full Time (Selec-Trac Only), and on 2WD vehicles. Whenever the vehicle is started or the transfer case (if equipped) is shifted from 4WD low range or neutral back to 4WD high range or 2WD, the ESP system will be in this mode. This mode should be used for most all driving situations. ESP should only be turned off for specific reasons as noted below.

Partial Off

This mode is entered by momentarily depressing the “ESP Control Switch” (located on top of the steering column). When in “Partial Off” mode, the TCS portion of ESP, except for the “limited slip” feature described in the TCS section, has been disabled and the “ESP/TCS Indicator Light” will be illuminated. All other stability features of

ESP function normally. This mode is intended to be used if the vehicle is in deep snow, sand or gravel conditions and more wheel spin than ESP would normally allow is required to gain traction. To turn ESP on again, momentarily depress the “ESP Control Switch”. This will restore the normal “ESP On” mode of operation.



ESP Control Switch

NOTE: To improve the vehicle's traction when driving with snow chains, or starting off in deep snow, sand or gravel, it may be desirable to switch to the "Partial Off" mode by pressing the ESP switch. Once the situation requiring ESP to be switched to the "Partial Off" mode is overcome, turn ESP back on by momentarily depressing the "ESP Control Switch". This may be done while the vehicle is in motion.

4WD Low Range

Partial Off

This is the normal operating mode for ESP in 4WD low range. Whenever the vehicle is started in 4WD low range or the transfer case (if equipped) is shifted from 2WD, 4WD high range, or neutral to 4WD low range, the ESP system will be in this mode. In 4WD low range, ESP and TCS, except for the "limited slip" feature described in the TCS section, are turned off until the vehicle reaches a speed of 30 mph (48 km/h). At 30 mph (48 km/h), the

normal ESP stability function returns but TCS remains off. When the vehicle speed drops below 25 mph (40 km/h) the ESP system shuts off. ESP is off at low vehicle speeds in 4WD low range so that it will not interfere with off-road driving but ESP function returns to provide the stability feature at speeds above 30 mph (48 km/h). The "ESP/TCS Indicator Light" will always be illuminated in 4WD low range when ESP is off.

ESP/BAS Warning Lamp

ESP BAS

The malfunction indicator lamp for the ESP is combined with BAS. The "ESP/BAS Warning Lamp" and the "ESP/TCS Indicator Light" in the instrument cluster both come on when the ignition switch is turned to the "ON" position. They should go out with the engine running. If the "ESP/BAS Warning Lamp" comes on continuously with the engine running, a malfunction has been detected in either the ESP or the BAS system. If this light remains on after several ignition cycles, and the vehicle has been driven

several miles at speeds greater than 30 mph (48 km/h), see your authorized dealer as soon as possible to have the problem diagnosed and corrected.

NOTE:

- "The "ESP/TCS Indicator Light" and the "ESP/BAS Warning Lamp" come on momentarily each time the ignition switch is turned ON.
- Each time the ignition is turned ON, the ESP System will be ON even if it was turned off previously.
- The ESP Control System will make buzzing or clicking sounds when it is active. This is normal; the sounds will stop when ESP becomes inactive following the maneuver that caused the ESP activation.

OVERHEAD CONSOLE — IF EQUIPPED

The overhead console contains dome/reading lights, an optional universal garage door opener (HomeLink®), an optional sunroof switch, and an Electronic Vehicle Information Center (EVIC) that consists of the following:

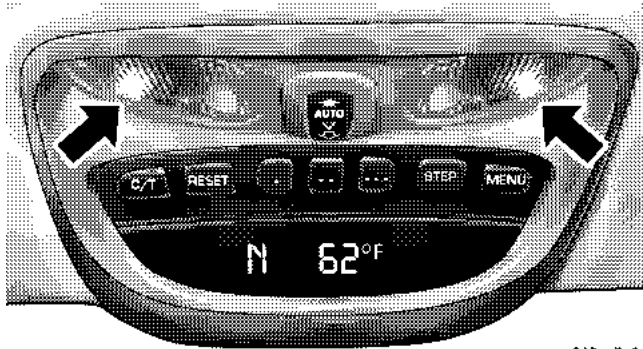
- Compass/temperature display
- Trip information displays
- Vehicle information warning message displays
- Customer programmable features

Pressing the MENU button will change the displayed programming features. Pressing the STEP button will select the available choices. Pressing the C/T (Compass/Temperature) button will return the display to the normal compass/temperature display.

NOTE: Temperature accuracy can be effected from heat soak. For best accuracy, the vehicle should be driven at a speed greater than 20 mph (32 km/h) for several minutes.

Dome/Reading Lights

Located in the overhead console are two dome/reading lights.



810aa7c0

Dome Reading Lamps

The dome/reading lights illuminate when a door or the swing gate is opened or when the interior lights are turned on by rotating the dimmer control located on the multi-function lever.

The reading lights are activated by pressing on the recessed area of the corresponding lens.

NOTE: The dome/reading lights will remain on until the switch is pressed a second time, so be sure they have been turned off before leaving the vehicle.

Electronic Vehicle Information Center

The electronic vehicle information center (EVIC), when the appropriate conditions exist, displays the following messages and symbols. Each message is accompanied by a series of beeps:

- DRIVER DOOR OPEN
- PASSENGER DOOR OPEN
- N DOORS OPEN (N = 2, 3, 4)
- RIGHT REAR DOOR OPEN
- REARGATE OPEN
- LEFT REAR DOOR OPEN
- LIFTGLASS OPEN
- TURN SIGNAL ON (with graphic)
- PERFORM SERVICE
- REMOTE KEY BATTERY LOW
- NO J1850 BUS MSGS RECEIVED
- LEFT FRONT LOW PRESSURE
- RIGHT FRONT LOW PRESSURE
- LEFT REAR LOW PRESSURE
- RIGHT REAR LOW PRESSURE
- SPARE LOW PRESSURE
- CHECK TPM SYSTEM

Customer Programmable Features

Press the MENU button until one of the display choices following appears:

Language?

When in this display you may select one of five languages for all display nomenclature, including the trip computer functions. Press the STEP button while in this display to select English, Francais, Deutsch, Italiana, or Espanol. As you continue the displayed information will be shown in the selected language.

Display U.S. or Metric?

Pressing the STEP button when in this display selects US or Metric. The overhead console and instrument panel displays will be in the selected units.

Auto Door Locks?

When this feature is selected, all doors and the swing gate will lock automatically when the speed of the

vehicle reaches 15 mph (25 km/h). Pressing the STEP button when in this display will select "Yes" or "No."

Auto Unlock On Exit? (Available Only When the AUTO DOOR LOCKS Feature is Turned On)

When this feature is selected all the vehicle's doors will unlock when the driver's door is opened if the vehicle is stopped and the transmission is in P (Park) or N (Neutral) position. Pressing the STEP button when in this display will select "Yes" or "No."

Remote Unlock Driver's Door 1st?

When this feature is selected only the driver's door will unlock on the first press of the remote keyless entry unlock button and require a second press to unlock the remaining locked doors and swing gate. When **REMOTE UNLOCK ALL DOORS** is selected all of the doors and the swing gate will unlock at the first press of the remote keyless entry unlock button. Pressing the STEP button when in this display will select DRIVER'S DOOR 1ST or

ALL DOORS. This can also be programmed using the key fob, refer to “Remote Keyless Entry” earlier in this section.

Train Remote?

Pressing the STEP button when in this display will select “Yes” or “No.”

NOTE: Any time you perform this procedure, it is necessary to retrain all currently trained key fobs.

To Train Additional Key Fobs (using the EVIC module)

1. Press the MENU button until TRAIN REMOTE? NO is displayed. Press the STEP button to change to YES. Then, PRESS A VALID FOB KEY will be displayed. Press either the “Lock” or “Unlock” button on the current key fob.
2. The next display will say PRESS FOB 2 LOCK & UNLOCK. Press both key fob buttons simultaneously.

3. The next display will say PRESS FOB 2 UNLOCK. Press the unlock button on the second key fob.

4. The next display will say FOB 2 TRAINED. At this point, the procedure can be exited by pressing the STEP, RESET, or C/T button.

5. Repeat step 2 — 4 to train additional key fobs. A total of four key fobs can be programmed.

Can also be programmed using the key fob, refer to “Remote Keyless Entry” earlier in this section.

Sound Horn On Lock?

When this feature is selected, a short horn sound will occur when the remote keyless entry “Lock” button is pressed. This feature may be selected with or without the flash lights on lock/unlock feature. Pressing the STEP button when in this display will select “Yes” or “No.” Can also be programmed using the key fob, refer to “Remote Keyless Entry” earlier in this section.

Flash Lights With Locks?

When this feature is selected, the front and rear turn signals will flash when the doors are locked or unlocked using the remote keyless entry transmitter. This feature may be selected with or without the sound horn on lock feature selected. Pressing the STEP button when in this display will select "Yes" or "No." Can also be programmed using the key fob, refer to "Remote Keyless Entry" earlier in this section.

Headlamp Delay

When this feature is selected the driver can choose, when exiting the vehicle, to have the headlamps remain on for 30, 60, or 90 seconds, or not remain on. Pressing the STEP button when in this display will select 30, 60, 90, or OFF.

Service Interval

When this feature is selected a service interval between 2,000 miles (3 200 km) and 6,000 miles (10 000 km) in 500 mile (800 km) increments may be selected. Pressing the

STEP button when in this display will select distances between 2,000 miles (3 200 km) and 6,000 miles (10 000 km) in 500 mile (800 km) increments.

Reset Service Distance (Displays Only if Service Interval was Changed)

When this feature is selected the current accumulated service distance can be reset to the newly selected service interval. Pressing the STEP button when in this display will select "Yes" or "No."

Low Fuel Chime?

When this feature is selected a chime will sound when the "Low Fuel Indicator Light" is displayed in the instrument panel cluster. Pressing the STEP button when in this display will select "Yes" or "No."

Mini-Trip Computer

This feature, located in the overhead console, displays information on outside temperature, compass direction, and trip information.

Reset Button

Use this button to reset the Average Economy, Trip Miles, and Time Elapsed displays. This will occur only if a resettable function is currently being displayed (Average Economy, Trip Miles, and Time Elapsed). A single chime will sound to indicate that a reset has occurred.

Global Reset

If the RESET button is pressed twice within 3 seconds while in any of the three resettable displays, the RESET button will reset all three displays.

A chime (two beeps) will sound to indicate that a reset has occurred.

Menu Button

Press the Menu button to scroll through the following screens: LANGUAGE, DISPLAY U.S. OR METRIC, AUTO DOOR LOCKS, AUTO UNLOCK ON EXIT, REMOTE UNLOCK DRIV DOOR 1ST, SOUND HORN WITH LOCK, FLASH LIGHTS WITH LOCKS, HEADLAMP DELAY, SERVICE INTV, LOW FUEL CHIME, and TRAIN REMOTE.

C/T Button

Press the C/T button to display the outside temperature and one of eight compass readings to indicate the direction the vehicle is facing.

WARNING!

Even if the display still reads a few degrees above 32°F (0°C), the road surface may be icy, particularly in woods or on bridges. Drive carefully under such conditions to prevent an accident and possible personal injury or property damage.

Step Button

Press the STEP button to cycle through all of the displays.

The displays are: Average Miles/GAL, Miles To Empty, Trip Miles, Time Elapsed, Miles To Service, Tire PSI, and Blank Screen.

Average Miles/GAL

Shows the average fuel economy in miles per gallon (MPG), or liters per 100 km (L/100 km) since the last reset.

Miles To Empty

Shows the estimated distance that can be traveled before the fuel gauge shows E (Empty). The distance is calculated by multiplying the amount of fuel remaining by the projected fuel economy. The distance predicted will change every few seconds to a higher or lower number as these factors change. This display cannot be reset.

Trip Miles

Shows the distance traveled since the last reset.

Time Elapsed

Shows the accumulated ignition ON time since the last reset.

Miles To Service

Shows the amount of miles remaining until service is required (owner selected).

Tire PSI

Shows the pressure and location of each tire, except for the spare tire. The tire location will blink when under pressure.

Blank Screen

Shows a blank screen. Pressing the C/T button returns to the Compass and Temperature display. Pressing the STEP button returns you to the Average Miles per Gallon display.

Automatic Compass Calibration

This compass is self-calibrating which eliminates the need to manually set the compass. When the vehicle is new, the compass may appear erratic and the CAL symbol will be displayed.

After completing three 360 degree turns in an area free from large metal or metallic objects, the CAL symbol will turn off and the compass will function normally.

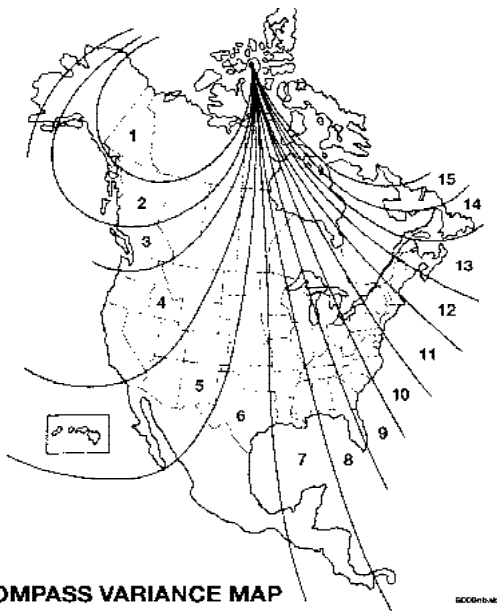
Manual Compass Calibration

If the compass appears erratic and the CAL symbol does not appear, you must manually put the compass into the "Calibration" mode.

To Put Into a Calibration Mode

Turn on the ignition and set the display to "Compass/Temperature." Press and hold the RESET button (more than 10 seconds) to change the display between VARIANCE (compass variance) and CAL (compass calibration) modes. When the CAL symbol is displayed complete three 360 degree turns in an area free from large metal objects or power lines. The CAL symbol will turn off and the compass will function normally.

Compass Variance is the difference between magnetic north and geographic north. In some areas of the country, the difference between magnetic and geographic north is great enough to cause the compass to give false readings. If this occurs, the compass variance must be set according to the Compass Variance Map.



To set the variance: Turn the ignition ON and set the display to "Compass/Temperature." Press and hold the RESET button five seconds (no more than 10 seconds). The last variance zone number will be displayed. Press the STEP button to select the new variance zone and press the RESET button to resume normal operation.

General Information

This transmitter complies with FCC rules part 15 and with RSS-210 of Industry Canada. Operation is subject to the following two conditions:

1. This device may not cause harmful interference
2. This device must accept any interference that may be received, including interference that may cause undesired operation

CAUTION!

Changes or modifications not expressly approved by the party responsible for compliance could void the user's authority to operate this equipment.

GARAGE DOOR OPENER — IF EQUIPPED

Equipped in vehicles that have the optional Electronic Vehicle Information Center (EVIC)

The HomeLink® Wireless Control System provides a convenient way to replace up to three hand-held radio-frequency (RF) transmitters used to activate devices such as gate operators, garage door openers, entry door locks, security systems, even home lighting. Additional HomeLink information can be found at: www.homelink.com or by calling 1-800-355-3515.

WARNING!

Before programming HomeLink to a garage door opener or gate operator, make sure that people and objects are out of the way of the device to prevent potential harm or damage. When programming a garage door opener, it is advised to park outside of the garage. Do not use HomeLink with any garage door opener that lacks safety stop and reverse features as required by U.S. federal safety standards (this includes any garage door opener model manufactured before April 1, 1982). A garage door that cannot detect an object - signaling the door to stop and reverse - does not meet current U.S. federal safety standards. For more information, contact HomeLink at: www.homelink.com or by calling: 1-800-355-3515.

Retain the original transmitter of the RF device you are programming for use in other vehicles as well as for future HomeLink programming. It is also suggested that upon the sale of the vehicle, the programmed HomeLink buttons be erased for security purposes. To erase the programmed buttons, perform the procedure shown below under "When Your Vehicle Is New", or, for assistance, contact HomeLink at: www.homelink.com or by calling: 1-800-355-3515.

When Your Vehicle Is New

Prior to programming HomeLink for the first time the factory test codes must be erased. To erase HomeLink memory, press and hold the two outer HomeLink buttons (buttons one and three). The message CLEARING CHANNELS will appear on the HomeLink display. After approximately 20 seconds, the message CHANNELS CLEARED will appear on the EVIC display. Do not hold the buttons for longer than 30 seconds.

WARNING!

Vehicle exhaust contains carbon monoxide, a dangerous gas. Do not run the vehicle's engine while programming HomeLink. Exhaust gas can cause serious injury or death.

WARNING!

Your motorized door or gate will open and close while you are programming HomeLink. Do not program HomeLink if people or pets are in the path of the door or gate. A moving door or gate can cause serious injury or death to people and pets or damage to objects.

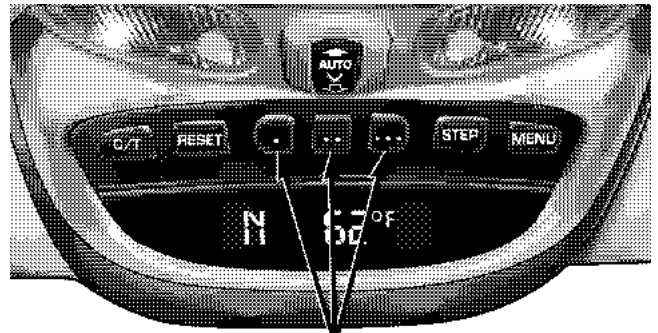
Programming HomeLink

NOTE: It is recommended that a new battery be placed in the hand-held transmitter of the device being programmed to HomeLink for quicker training and accurate transmission of the radio frequency signal.

1. Position the end of your hand-held transmitter 1-3 inches (5-14 cm) away from the lower left corner of the EVIC display while keeping the display in view.

NOTE: Some gate operators and garage door openers may require you to replace the next step with procedures noted in the "Gate Operator/Canadian Programming" section.

2. Simultaneously press and hold both the desired HomeLink button and the hand-held transmitter button. After a short time, the message TRAINING will show on HomeLink display. **Do not release the buttons until the next step has been completed.**



BUTTONS

810aa849

HomeLink Buttons

3. When the message TRAINED appears on the HomeLink display, release both the HomeLink and hand-held transmitter buttons.

NOTE: If the HomeLink display does not change to TRAINED, contact HomeLink at www.homelink.com or call 1-800-355-3515 for assistance.

4. Press and hold the just-trained HomeLink button. TRANSMIT should appear on the display.

If your device activates when the HomeLink button is depressed and released, programming is complete.

NOTE: To program the remaining two HomeLink buttons, simply repeat the "Programming HomeLink" process.

If the message TRANSMIT appears on the HomeLink display but your device does not activate, the device may be equipped with a "rolling code" system. Continue with steps five through seven below to complete the programming of a rolling code equipped device (most commonly a garage door opener).

5. At the garage door opener receiver (motor-head unit) in the garage, locate the "learn" or "smart" button. This can usually be found where the hanging antenna wire is attached to the motor-head unit.

6. Firmly press and release the "learn" or "smart" button. (The name and color of the button may vary by manufacturer.)

NOTE: There are 30 seconds in which to initiate the next step.

7. Return to the vehicle and firmly press, hold for two seconds and release the programmed HomeLink button. Repeat the "press/hold/release" sequence a second time, and, depending on the brand of the garage door opener (or other rolling code equipped device), repeat this sequence a third time to complete the programming process.

HomeLink should now activate your rolling code equipped device.

NOTE: To program the remaining two HomeLink buttons, simply repeat the "Programming Homelink" process.

If, after programming the HomeLink Wireless Control System, the hand-held transmitter and/or other HomeLink units in other vehicles fail to activate the rolling code equipped device, you may need to clear (or "erase") the device's receiver memory. Refer to your garage door opener's Owner's Manual for the procedure or contact HomeLink at 1-800-355-3515 or on the Internet at www.homelink.com. After clearing the receiver, you must reprogram the original hand-held transmitter(s) to the receiver using the procedure in the garage door opener's Owner's Manual. Finally, reprogram the hand-held transmitter(s) to HomeLink using the steps under "Programming HomeLink".

Gate Operator/Canadian Programming

Canadian radio-frequency laws require transmitter signals to "time-out" (or quit) after several seconds of transmission - which may not be long enough for HomeLink to pick up the signal during programming.

Similar to this Canadian law, some U.S. gate operators are designed to "time-out" in the same manner.

If you live in Canada or you are having difficulties programming a gate operator by using the "Programming HomeLink" procedures (regardless of where you live), replace step two with the following:

NOTE: If programming a garage door opener or gate operator, it is advised to unplug the device during the "cycling" process to prevent possible overheating.

Press and hold the HomeLink button while you press and release - every two seconds ("cycle") your hand-held transmitter button until the radio signal has successfully been accepted by HomeLink. (The message TRAINED will appear on the HomeLink display.)

Proceed with the remaining steps under "Programming HomeLink" to complete.

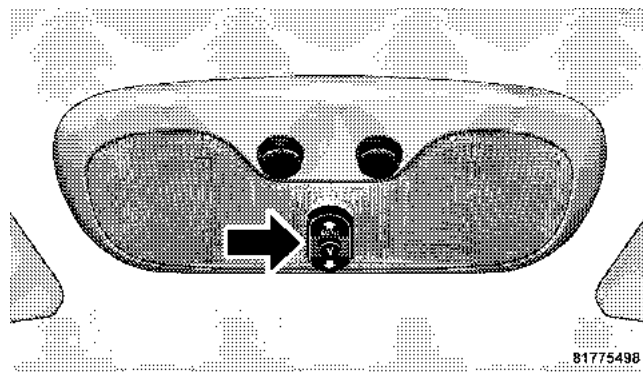
Using HomeLink

To operate, simply press and release the programmed HomeLink button. Activation will now occur for the trained device (i.e. garage door opener, gate operator, security system, entry door lock, home/office lighting, etc.). For convenience, the hand-held transmitter of the device may also be used at any time. In the event that there are still programming difficulties or questions, contact HomeLink at: www.homelink.com or 1-800-355-3515.

POWER SUNROOF — IF EQUIPPED

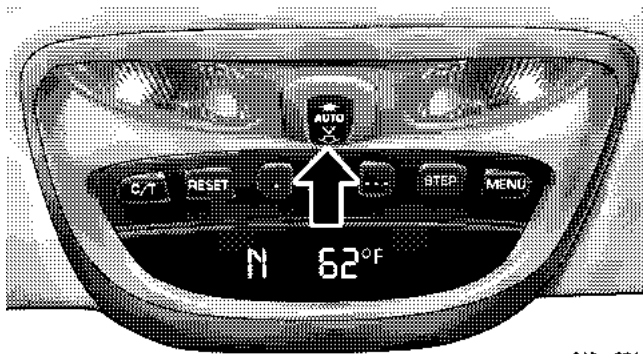
The sunroof control is located on the headliner between the sun visors.

Press and hold the switch rearward to fully open the sunroof. The sunroof can be stopped at any position between closed and full open. Momentarily pressing the switch rearward will activate the Express Open Feature, causing the sunroof to open automatically.



Sunroof Switch (w/o Console)

81775498



810aa974

Sunroof Switch (w/Console)

Press and hold the “V” button in the center of the sunroof switch to open the vent. The sunroof can be stopped at any position between closed and full vent. To close the sunroof from the vent position, press and hold the switch forward. Releasing the switch will stop the movement of

the sunroof and the sunroof will remain in the partial vent position until the switch is pushed forward again.

Express Open Feature

During the Express Open operation, any movement of the switch will stop the sunroof and it will remain in a partial open position. Again, momentarily pressing the switch rearward will activate the Express Open Feature.

To close the sunroof, hold the switch in the forward position. Again, any release of the switch will stop the movement and the sunroof will remain in a partial open condition until the switch is pushed forward again. The sunroof is not completely closed until the rear of the sunroof glass moves upward at the end of its travel.

The sunshade can be opened manually. It will also open as the sunroof opens. The sunshade cannot be closed if the sunroof is open.

WARNING!

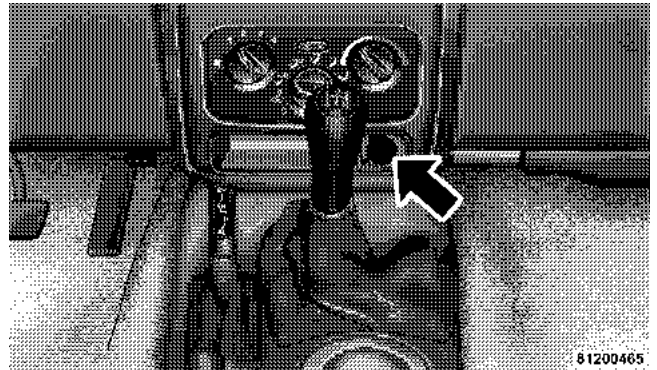
- In an accident, there is a greater risk of being thrown from a vehicle with an open sunroof. You could also be seriously injured or killed. Always fasten your seat belt properly and make sure all passengers are properly secured too.
- Do not allow small children to operate the sunroof. Never allow fingers or other body parts, or any object to project through the sunroof opening. Injury may result.

Sunroof Maintenance

Use only a non-abrasive cleaner and a soft cloth to clean the glass panel.

POWER OUTLET

To the right of the convenience tray (lower center of instrument panel) is an outlet for electrically powered accessories. Pull lightly on the top of the plastic cover to open the outlet.

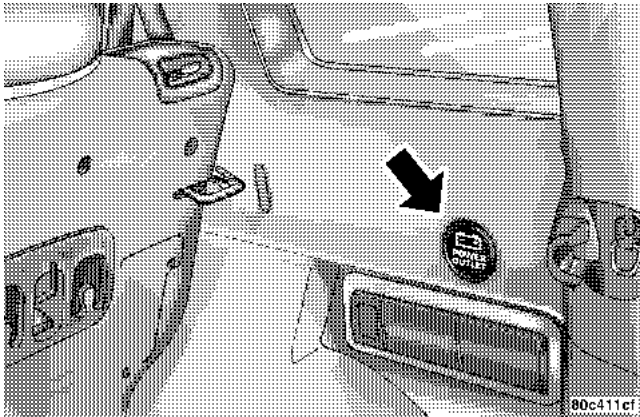


Front Power Outlet

There is a rear power outlet located in the right rear cargo area above the storage cargo net/CD changer (if equipped).

The rear power outlet is a direct feed from the battery so it receives power whether the ignition is in the ON or OFF position.

All accessories connected to this outlet should be removed or turned off when the vehicle is not in use.



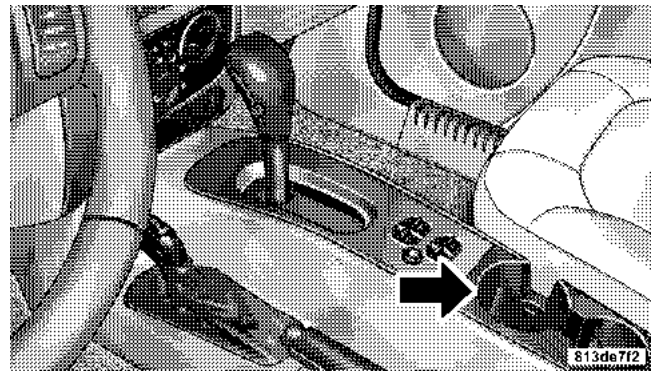
Rear Power Outlet

CAUTION!**Electrical Outlet Use With Engine Off**

- Many accessories that can be plugged in draw power from the vehicle's battery, even when not in use (i.e., cellular phones, etc.). Eventually, if plugged in long enough, the vehicle's battery will discharge sufficiently to degrade battery life and/or prevent engine starting.
- Accessories that draw higher power (i.e., coolers, vacuum cleaners, lights, etc.) will degrade the battery even more quickly. Only use these intermittently and with greater caution.
- After the use of high power draw accessories, or long periods of the vehicle not being started (with accessories still plugged in), the vehicle must be driven a sufficient length of time to allow the alternator to recharge the vehicle's battery.

CUP HOLDERS

In the center console there are two cup holders for the front seat passengers.



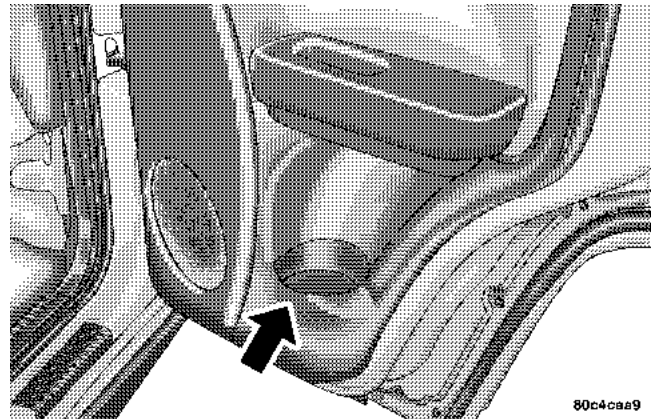
Front Cup Holders

NOTE: The front cup holder insert is removable from the console, for cleaning.

Smoker's Package — If Equipped

With the optional Smoker's package, a removable ash tray is inserted into the front cup holder location.

The rear passengers have access to a cup holder on each rear door trim panel.



Rear Cup Holders

CARGO AREA FEATURES

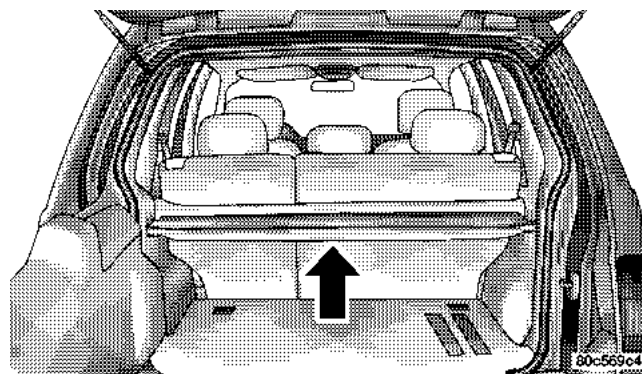
Cargo Light

The cargo area light is activated by opening the swing gate, opening any door, or by rotating the dimmer control on the multi-function control lever to the extreme top position. If all doors are closed and only the swing gate is open, pushing on the cargo light lens surface will turn off all interior lights. Push on the lens surface a second time to restore the interior lights to normal operation.

Retractable Cargo Area Cover — If Equipped

To cover the cargo area:

1. Grasp the center portion of the cover flap. Pull it over the cargo area.
2. Insert the pins on the ends of the cover into the slots in the pillar trim cover.
3. The swing gate may be opened or closed with the cargo cover in place.



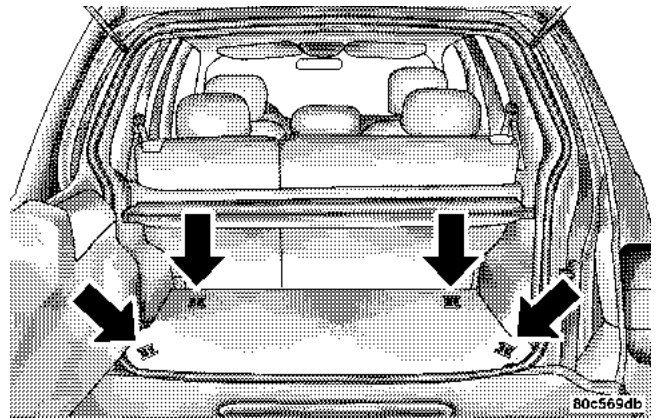
Rear Cargo Cover

WARNING!

In an accident a cargo cover loose in the vehicle could cause injury. It could fly around in a sudden stop and strike someone in the vehicle. Do not store the cargo cover on the cargo floor or in the passenger compartment. Remove the cover from the vehicle when taken from its mounting. Do not store in the vehicle.

Cargo Tie-Down Hooks

The tie-downs located on cargo area floor should be used to safely secure loads when vehicle is moving.



Cargo Tie-Down Hooks

WARNING!

- **Cargo tie-down hooks are not safe anchors for a child seat tether strap. In a sudden stop or collision a hook could pull loose and allow the child seat to come loose. A child could be badly injured. Use only the anchors provided for child seat tethers.**
 - **The weight and position of cargo and passengers can change the vehicle center of gravity and vehicle handling. To avoid loss of control resulting in personal injury, follow these guidelines for loading your vehicle:**
- Always place cargo evenly on the cargo floor. Put heavier objects as low and as far forward as possible.

- Place as much cargo as possible in front of the rear axle. Too much weight or improperly placed weight over or behind the rear axle can cause the rear of the vehicle to sway.
- Do not pile luggage or cargo higher than the top of the seatback. This could impair visibility or become a dangerous projectile in a sudden stop or collision.

WARNING!

To help protect against personal injury, passengers should not be seated in the rear cargo area. The rear cargo space is intended for load carrying purposes only, not for passengers, who should sit in seats and use seat belts.

REAR WINDOW FEATURES

Rear Window Wiper/Washer

A rotary ring switch on the control lever, located on the right side of the steering column, controls operation of the rear wiper/washer function. Rotating the center of the switch up to the DEL (Delay) position or the ON position will activate the wiper. Rotating the switch ring beyond the ON or OFF position will activate the rear washer. The wash pump will continue to operate as long as the lever or ring is engaged. Upon release, the wipers will cycle three times before returning to the set position.

If the rear wiper is operating when the ignition is turned OFF, the wiper will automatically return to the "Park" position. When the vehicle is restarted, the wiper will resume function at whichever position the switch is set at.

If the swing gate flip-up window is open or the swing gate is open, connection to the rear window wiper is


interrupted preventing activation of the rear wiper blade. When the swing gate flip-up window or the swing gate is closed, the rear wiper switch or the ignition switch needs to be turned OFF, and then to ON to restart the rear wiper.

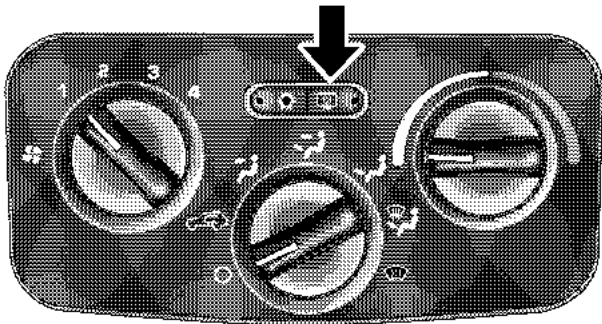
NOTE: The rear swing gate will lock while the rear wiper is operating. The gate will stay locked until the wiper is turned off and the gate is unlocked (by key, lock switch, or key fob).

Adding Washer Fluid

The fluid reservoir for the windshield washers and the rear window washer is shared. It is located in the front of the engine compartment on the passenger side and should be checked for fluid level at regular intervals. Fill the reservoir with windshield washer solvent (not radiator antifreeze) and operate the system for a few seconds to flush out the residual water.

Rear Window Defroster

 On the top of the climate control panel is a push button for rear window defrosting. An amber indicator in the push button will light when the defroster is turned on. Push again to turn off the defroster prior to an automatic time-out.



813d6476

Rear Defroster Switch

The defroster will automatically turn off after about ten minutes. For about five more minutes of operation, push the button again. To prevent excessive battery drain, use the defroster only when the engine is operating. The push button also activates the heated exterior mirrors, if so equipped.

CAUTION!

Use care when washing the inside of the rear window to prevent damage to heating elements. Use a soft cloth and a mild washing solution, wiping parallel to the heating elements. Also, keep all objects a safe distance from the window to prevent damaging the heating elements.

ROOF LUGGAGE RACK

External racks do not increase the total load carrying capacity of the vehicle. Be sure that the total occupant and luggage load inside the vehicle, plus the load on the luggage rack, do not exceed the rated vehicle capacity as shown on the label attached to the drivers door shut face.

CAUTION!

- To avoid damage to the roof rack and vehicle, do not exceed the maximum roof rack load capacity of 150 lbs (68 kg). Always distribute heavy loads as evenly as possible and secure the load appropriately.
- Long loads which extend over the windshield, such as wood panels or surfboards, should be secured to both the front and rear of the vehicle.
- Place a blanket or other protection between the surface of the roof and the load.
- Travel at reduced speeds and turn corners carefully when carrying large or heavy loads on the roof rack. Wind forces, due to natural causes or nearby truck traffic, can add sudden upward loads. This is especially true on large flat loads and may result in damage to the cargo or your vehicle.

WARNING!

Cargo must be securely tied before driving your vehicle. Improperly secured loads can fly off the vehicle, particularly at high speeds, resulting in personal injury or property damage. Follow the roof rack "Cautions" when carrying cargo on your roof rack.

UNDERSTANDING YOUR INSTRUMENT PANEL

CONTENTS

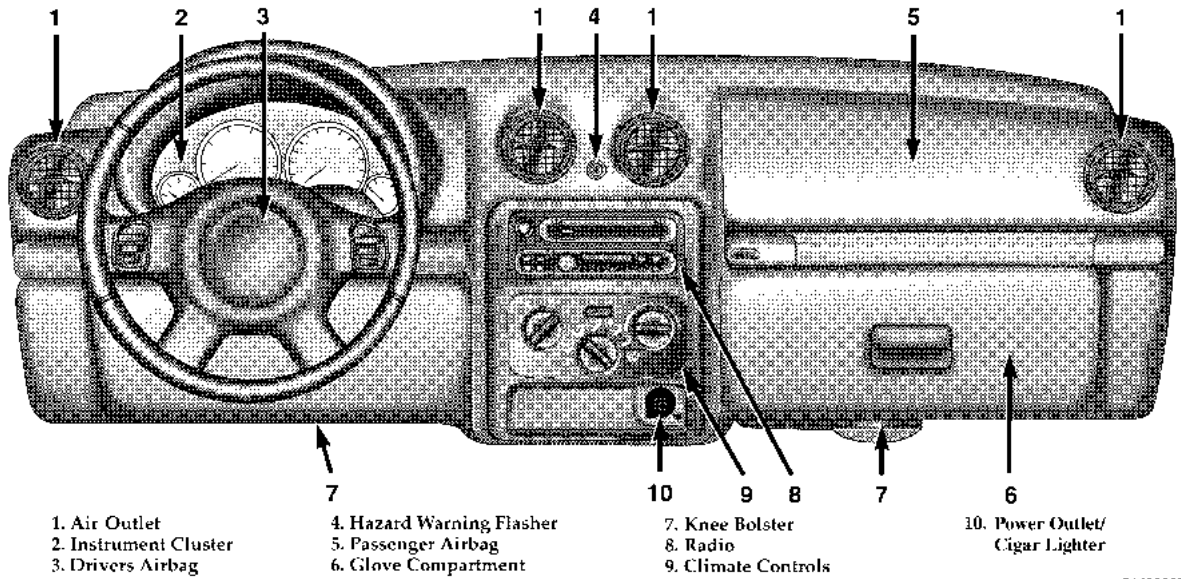
■ Instrument Panel And Controls	164	□ AM Reception	177
■ Instrument Cluster	165	□ FM Reception	177
■ Instrument Cluster Description	166	■ Sales Code RBK — AM/ FM Stereo Radio With CD Player And CD Changer Controls	177
■ Electronic Digital Clock	176	□ Radio Operation	178
□ Clock Setting Procedure	176	□ CD Player Operation	180
■ Radio General Information	176	□ CD Changer Control Capability — If Equipped	182
□ Radio Broadcast Signals	176	■ Sales Code RBQ—AM/FM Stereo Radio With 6 - Disc CD Changer	184
□ Two Types Of Signals	176		
□ Electrical Disturbances	177		

162 UNDERSTANDING YOUR INSTRUMENT PANEL

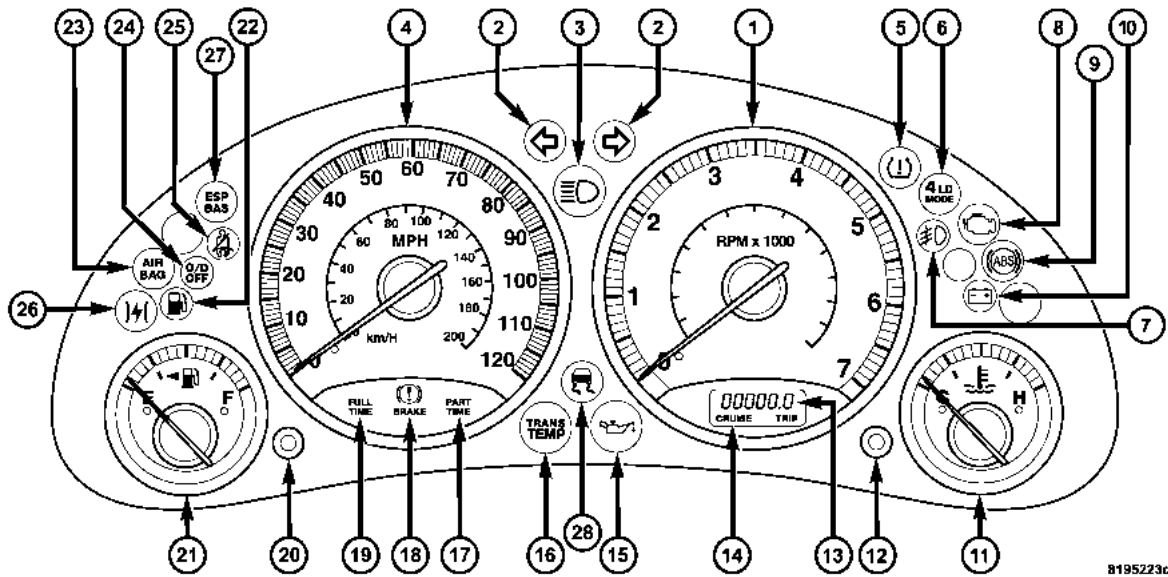
□ Radio Operation	184	□ Selecting Satellite Mode In RBP, RBU, RAZ, RB1 And RBQ Radios	197
□ CD Player Operation	187	□ Selecting a Channel	197
■ Sales Code RB1 — AM/FM Stereo Radio With DVD/GPS Navigation System	191	□ Storing And Selecting Pre-Set Channels	198
□ Clock Setting Procedure	192	□ Using The PTY (Program Type) Button (If Equipped)	198
■ 6-Disc Remote CD Changer — If Equipped	194	□ PTY Button "Scan"	198
□ Loading The CD Changer	194	□ PTY Button "Seek"	198
■ Satellite Radio — If Equipped	195	□ Satellite Antenna	199
□ System Activation	196	□ Reception Quality	199
□ Electronic Serial Number/Sirius Identification Number (ENS/SID)	196	■ Remote Sound System Controls — If Equipped	200
□ Selecting Satellite Mode In RBB, RAH And RBK Radios	197	□ Radio Operation	201
		□ Tape Player	201
		□ CD Player — Single Disc In Radio	201

<hr/>		UNDERSTANDING YOUR INSTRUMENT PANEL 163
□ CD Player — 6 Disc In Cargo Area	201	■ Climate Controls
■ CD/DVD Disc Maintenance	202	□ Manual Air Conditioning And Heating System
■ Radio Operation And Cellular Phones	202	□ Operating Tips
		203
		205

INSTRUMENT PANEL AND CONTROLS




INSTRUMENT CLUSTER




INSTRUMENT CLUSTER DESCRIPTION**1. Tachometer**

Indicates the permissible engine revolutions-per-minute for each gear range. Before reaching the red area, ease up on the accelerator to prevent engine damage.

2. Turn Signal Indicator Light

 The arrows will flash in unison with the exterior turn signals, when using the multi-function control lever. A chime will sound if the turn signals are left on continuously for 2 miles (3 km) until they are deactivated.

3. High Beam Indicator Light

 This light shows that the headlights are on high beam. Pull the multi-function control lever towards the steering wheel to switch the headlights from high to low beam.

4. Speedometer

Indicates vehicle speed.

5. Tire Pressure Monitoring Telltale Light

Each tire, including the spare (if provided), should be checked monthly when cold and inflated to the inflation pressure recommended by the vehicle manufacturer on the vehicle placard or tire inflation pressure label. (If your vehicle has tires of a different size than the size indicated on the vehicle placard or tire inflation pressure label, you should determine the proper tire inflation pressure for those tires.)

As an added safety feature, your vehicle has been equipped with a tire pressure monitoring system (TPMS) that illuminates a "Tire Pressure Monitoring Telltale Light" when one or more of your tires is significantly under-inflated. Accordingly, when the "Tire Pressure Monitoring Telltale Light" illuminates, you should stop

and check your tires as soon as possible, and inflate them to the proper pressure. Driving on a significantly under-inflated tire causes the tire to overheat and can lead to tire failure. Under-inflation also reduces fuel efficiency and tire tread life, and may affect the vehicle's handling and stopping ability.

Please note that the TPMS is not a substitute for proper tire maintenance, and it is the driver's responsibility to maintain correct tire pressure, even if under-inflation has not reached the level to trigger illumination of the "Tire Pressure Monitoring Telltale Light."

The "Tire Pressure Monitoring Telltale Light" will illuminate in the instrument cluster, and an audible chime will be activated when one or more tire pressures is low. The "Tire Pressure Monitoring Telltale Light" will flash on and off for 60 seconds when a system fault is detected. The flash cycle will repeat every ten minutes or until the fault condition is removed and reset.

CAUTION!

The TPMS has been optimized for the original equipment tires and wheels. TPMS pressures and warnings have been established for the tire size equipped on your vehicle. Undesirable system operation or sensor damage may result when using replacement equipment that is not of the same size, type, and/or style. After-market wheels can cause sensor damage. Do not use tire sealant from a can, or balance beads if your vehicle is equipped with a TPMS, as damage to the sensors may result.

4

6. 4LO Mode Indicator Light — If Equipped


**4 LO
MODE**

This light alerts the driver that the vehicle is in the 4 LO four-wheel drive mode. The front and rear driveshafts are mechanically locked together forcing the front and rear wheels to rotate at the same speed.

7. Fog Light Indicator Light — If Equipped

 This light shows when the front fog lights are on.


8. Malfunction Indicator Light

 This light is part of an onboard diagnostic system called OBD II which monitors engine and automatic transmission control systems. This light will illuminate when the ignition is in the ON position before engine start. If the bulb does not come on when turning the ignition key from OFF to ON, have the condition checked promptly.

Certain conditions such as a loose or missing gas cap, poor fuel quality, etc. may illuminate the light after engine start. The vehicle should be serviced if the light stays on through several typical driving cycles. In most situations, the vehicle will drive normally and will not require towing.

When the engine is running, the “Malfunction Indicator Light” may flash to alert of serious conditions that could lead to immediate loss of power or severe catalytic converter damage. The vehicle should be serviced as soon as possible if this occurs.

9. Anti-Lock Warning Light (ABS) — If Equipped

 This light monitors the Anti-Lock Brake System (ABS) described elsewhere in this manual. This light will come on when the ignition switch is turned to the ON position and may stay on for as long as three seconds.

If the light comes back on immediately or comes on during driving, it indicates that the Anti-Lock portion of the brake system is not functioning and that service is required, however, the conventional brake system will continue to operate normally provided that the BRAKE warning light is not on. Also, a chime will sound if the light comes back on.

If the ABS light is on, the brake system should be serviced as soon as possible to restore the benefit of Anti-Lock Brakes.

The operation of the ABS light can be checked by turning the ignition switch from the OFF position to the ON position. The light should illuminate for approximately four seconds. The light should then turn off unless a brake fault is detected. If the light does not illuminate, have the light inspected by an authorized dealer.

10. Charging System Warning Light



This light shows the status of the electrical charging system. The light should come on for three seconds when the ignition is first turned ON. If the light comes back on immediately or comes on while driving, it means that there is a problem with the charging system or the battery is low. Also, a chime will sound if the light comes back on. See your authorized dealer immediately.

11. Temperature Gage



Indicates engine coolant temperature. Any reading within the normal range indicates that the cooling system is operating satisfactorily.

The gage pointer will likely indicate a higher temperature (above center scale) when driving in hot weather, up mountain grades, in heavy stop and go traffic, or when towing a trailer. It should not be allowed to exceed the upper limits of the normal operating range.

If the pointer rises to the red zone (five chimes will occur), pull over and stop the vehicle. Do not turn the engine off. Idle the vehicle with the air conditioning turned off, until the pointer drops back into the normal range. If the engine remains in the high range, turn the engine off and call for service.

12. Reset Button

Press this button to toggle between the odometer and trip odometer display. When in the trip odometer mode,

holding the button in resets the trip odometer. Also, pressing the "Reset" button will clear out any warning messages in the odometer display.

13. Odometer/Trip Odometer

A vacuum fluorescent display indicates the total distance the vehicle has been driven. Also, the cluster will display, replacing the odometer/trip odometer, vehicle warning messages such as: door/gate/glass ajar and low washer fluid. See appropriate sections for more information.

NOTE: If vehicle is equipped with the optional Electronic Vehicle Information Center (EVIC) in the overhead console, the warnings "door", "GATE", "GLASS", and "LOWASH" will be displayed in the EVIC display (not in the instrument cluster). For additional information, refer to "Overhead Console — If Equipped" in Section 3.


NOTE: The warnings "LOCOOL" and "GASCAP" will always be displayed in the odometer display.

U.S. federal regulations require that upon transfer of vehicle ownership, the seller certify to the purchaser the correct mileage that the vehicle has been driven. Therefore, if the odometer reading is changed during repair or replacement, be sure to keep a record of the reading before and after the service so that the correct mileage can be determined.

14. Cruise Indicator Light

CRUISE This indicator lights when the speed control system is turned ON.

15. Oil Pressure Warning Light

 Shows low engine oil pressure. The light will come on and remain on when the ignition switch is turned from the OFF to the ON position, and the light will turn off after the engine is started. If the bulb does not come on, have the system checked by your authorized dealer.

If the warning light comes on and remains on while driving, stop the vehicle and shut off the engine. DO NOT OPERATE THE VEHICLE UNTIL THE CAUSE IS CORRECTED. Also, a single chime will sound.


16. *Transmission Temperature Warning Light*

TRANS TEMP This light indicates that there is excessive transmission fluid temperature that might occur with severe usage such as trailer towing or snow plowing. If this light comes on, stop the vehicle and run the engine at idle or faster, with the transmission in N (Neutral) until the light goes off.

17. *Part Time Indicator Light — If Equipped*

PART TIME This light alerts the driver that the vehicle is in the PART TIME four-wheel drive high range mode, and the front and rear driveshafts are mechanically locked together forcing the front and rear wheels to rotate at the same speed.

18. *Brake Warning Light*

 **BRAKE** This light monitors various brake functions, including brake fluid level and parking brake application. If the light comes on, it may indicate that the parking brake is applied, or there is a low brake fluid level. On vehicles equipped with Anti-Lock brakes (ABS), it may also indicate an ABS malfunction that could lead to reduced braking performance.

WARNING!

Driving a vehicle with the BRAKE warning light on is dangerous. A significant decrease in braking performance or vehicle stability during braking may occur. It will take you longer to stop the vehicle or will make your vehicle harder to control. You could have an accident. Have the vehicle checked immediately.

The operation of the BRAKE warning light can be checked by turning the ignition switch from the OFF position to the ON position. The light should illuminate for approximately two seconds. The light should then turn off unless the parking brake is applied or a brake fault is detected. If the light does not illuminate, have the light inspected by an authorized dealer.

Also, the light will come on when the parking brake is applied with the ignition switch in the ON position.

NOTE: This light shows only that the parking brake is applied. It does not show the degree of brake application.

If the parking brake is off and the light remains on, have the brake system inspected as soon as possible.

19. Full Time Indicator Light — If Equipped

FULL TIME

This light alerts the driver that the vehicle is in the FULL TIME four-wheel drive mode, and employs the inter-axle differential which allows the front and rear wheels to rotate at different speeds.

20. Sentry Key/Security Alarm Indicator Light — If Equipped

Refer to “Sentry Key Immobilizer System” or “Vehicle Security Alarm” in Section 2 of this manual for more information.

21. Fuel Gage

When the ignition key is in the ON position, the pointer will show the level of fuel remaining in the fuel tank. A small arrow indicates the side of the vehicle where the filler cap (gas cap) is located.

22. Low Fuel Warning Light

When the fuel level reaches approximately 2.3 U.S. Gallons (8.7 Liters) this light will come on and remain on until fuel is added. The “Low Fuel Warning Light” may turn on and off again, especially during and after hard braking, accelerations, or turns. This occurs due to the shifting of the fuel in the tank. Also, a single chime will sound.

23. Airbag Warning Light

AIR BAG This indicator lights and remains lit for 6 to 8 seconds when the ignition is first turned on. If the

light doesn't come on, stays on, or comes on while driving, have the airbag system checked by an authorized dealer.

24. O/D (Overdrive) Off Indicator Light

This light will illuminate when the O/D OFF button has been selected. The O/D OFF button is located on the gear shift lever.

25. Seat Belt Indicator Light

When the ignition switch is first turned ON, this light will turn on for 5 to 8 seconds as a bulb check. During the bulb check, if the driver's seat belt is unbuckled, a chime will sound. After the bulb check or when driving, if the driver or front passenger seat belt remains unbuckled, the Seat Belt Warning Light will flash or remain on continuously. Refer to “Enhanced Driver Seat Belt Reminder System (BeltAlert)” in the Occupant Restraints section for more information.

26. *Electronic Throttle Control (ETC) Warning Light — If Equipped*



This light informs you of a problem with the Electronic Throttle Control System. If a problem is detected while the engine is running, the light will either stay on or flash depending on the nature of the problem. Cycle the ignition key when the vehicle is safely and completely stopped and the gear selector is placed in the P (Park) position. The light should turn off. If the light remains on with the engine running, your vehicle will usually be drivable, however, see your dealer for service as soon as possible.

If the light continues to flash when the engine is running, immediate service is required and you may experience reduced performance, an elevated / rough idle, or engine stall and your vehicle may require towing. The light will come on when the ignition is first turned on and remain

on briefly as a bulb check. If the light does not come on during starting, have the system checked by an authorized dealer.

NOTE: “Two-footed” driving is not recommended. Inadvertently driving with the brake pedal depressed for more than a few seconds when the accelerator pedal is held in place can cause the ETC system to assume that a stuck accelerator pedal has occurred. This will result in a loss of power. Returning the brake pedal to its normal position or moving the accelerator pedal will cancel this condition. If the depressed brake pedal and the constant accelerator pedal position are maintained for an extended period of time, the ETC warning light will begin to flash and continue until the ignition switch is cycled in the same manner as above.

27. Electronic Stability Program (ESP) Warning Light/Brake Assist System (BAS) Warning Light — If Equipped

**ESP
BAS**

The ESP/BAS warning light in the instrument cluster comes on when the ignition switch is turned to the “ON” position. The light should go out with the engine running. If the ESP/BAS warning light comes on continuously with the engine running, a malfunction has been detected in either the ESP or the BAS system. If this light stays illuminated, have the ESP and BAS checked at your authorized dealer as soon as possible. Refer to “Electronic Brake Control System” in Section 5 for more information.

28. Electronic Stability Program (ESP) Indicator Light/Traction Control System (TCS) Indicator Light — If Equipped



If this indicator light flashes during acceleration, apply as little throttle as possible. While driving, ease up on the accelerator. Adapt your speed and driving to the prevailing road conditions, and do not switch off the ESP, or TCS — if equipped. The indicator light will flash when the ESP or TCS System is active and helping to improve vehicle stability. If the indicator light is on solid, ESP or TCS may not be able to function normally. Refer to “Electronic Brake Control System” in Section 5 for more information.

ELECTRONIC DIGITAL CLOCK

The clock and radio each use the display panel built into the radio. A digital readout shows the time in hours and minutes whenever the ignition switch is in the ON or ACC position and the time button is pressed.

When the ignition switch is in the OFF position, or when the radio frequency is being displayed, time keeping is accurately maintained.

Clock Setting Procedure

1. Turn the ignition switch to the ON or ACC position and press the time button. Using the tip of a ballpoint pen or similar object, press either the hour (H) or minute (M) buttons on the radio.
2. Press the H button to set hours or the M button to set minutes. The time setting will increase each time you press a button.

RADIO GENERAL INFORMATION

Radio Broadcast Signals

Your new radio will provide excellent reception under most operating conditions. Like any system, however, car radios have performance limitations, due to mobile operation and natural phenomena, which might lead you to believe your sound system is malfunctioning. To help you understand and save you concern about these “apparent” malfunctions, you must understand a point or two about the transmission and reception of radio signals.

Two Types of Signals

There are two basic types of radio signals... AM or Amplitude Modulation, in which the transmitted sound causes the amplitude, or height, of the radio waves to vary... and FM or Frequency Modulation, in which the frequency of the wave is varied to carry the sound.

Electrical Disturbances

Radio waves may pick up electrical disturbances during transmission. They mainly affect the wave amplitude, and thus remain a part of the AM reception. They interfere very little with the frequency variations that carry the FM signal.

AM Reception

AM sound is based on wave amplitude, so AM reception can be disrupted by such things as lightning, power lines and neon signs.

FM Reception

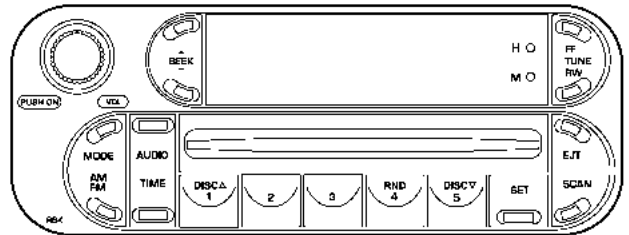
Because FM transmission is based on frequency variations, interference that consists of amplitude variations can be filtered out, leaving the reception relatively clear, which is the major feature of FM radio.

NOTE: The radio, steering wheel radio controls (if equipped), and 6 disc CD/DVD changer (if equipped)

will remain active for up to 10 minutes after the ignition switch has been turned off. Opening a vehicle front door will cancel this feature.

SALES CODE RBK — AM/ FM STEREO RADIO WITH CD PLAYER AND CD CHANGER CONTROLS

NOTE: The radio sales code is located on the lower left side of your radio faceplate.



RBK Radio

813ebac3

Radio Operation

Power/Volume Control

Press the ON/VOL control to turn the radio on. Turn the volume control clockwise to increase the volume.

NOTE: Power to operate the radio is supplied through the ignition switch. It must be in the ON or ACC position to operate the radio.

Seek

Press and release the SEEK button to search for the next station in either the AM or FM mode. Press the top of the button to seek up or the bottom to seek down. The radio will remain tuned to the new station until you make another selection. Holding the button in will bypass stations without stopping until you release it.

Tune

Press the TUNE control up or down to increase or decrease the frequency. If you press and hold the button,

the radio will continue to tune until you release the button. The frequency will be displayed and continuously updated while the button is pressed.

To Set The Radio Push-Button Memory

When you are receiving a station that you wish to commit to push-button memory, press the SET button. SET 1 will show in the display window. Select the "1-5" button you wish to lock onto this station and press and release that button. If a button is not selected within 5 seconds after pressing the SET button, the station will continue to play but will not be locked into push-button memory.

You may add a second station to each push-button by repeating the above procedure with this exception: Press the SET button twice and SET 2 will show in the display window. Each button can be set for SET 1 and SET 2 in both AM and FM. This allows a total of 10 AM and 10 FM stations to be locked into push-button memory. The

stations stored in SET 2 memory can be selected by pressing the push-button twice. Every time a preset button is used a corresponding button number will be displayed.

Audio

The audio button controls the BASS, TREBLE, BALANCE, and FADE.

Press the AUDIO button and BASS will be displayed. Press the SEEK + or SEEK - to increase or decrease the Bass tones.

Press the AUDIO button a second time and TREB will be displayed. Press the SEEK + or SEEK - to increase or decrease the Treble tones.

Press the AUDIO button a third time and BAL will be displayed. Press the SEEK + or SEEK - to adjust the sound level from the right or left side speakers.

Press the AUDIO button a fourth time and FADE will be displayed. Press the SEEK + or SEEK - to adjust the sound level between the front and rear speakers.

Press the AUDIO button again or wait 5 seconds to exit setting tone, balance, and fade.

AM/FM Selection

Press the AM/FM button to change from AM to FM. The operating mode will be displayed next to the station frequency. The display will show ST when a stereo station is received.

Time

Press the TIME button to change the display between radio frequency and time.

General Information

This radio complies with Part 15 of FCC rules and with RSS-210 of Industry Canada. Operation is subject to the following conditions:

1. This device may not cause harmful interference,
2. This device must accept any interference received, including interference that may cause undesired operation.

NOTE: Changes or modifications not expressly approved by the party responsible for compliance could void the user's authority to operate the equipment.

CD Player Operation

NOTE: The ignition switch must be in the ON or ACC position and the volume control ON before the CD player will operate.

Inserting The Compact Disc

CAUTION!
This CD player will accept 4 ¾ inch (12 cm) discs only. The use of other sized discs may damage the CD player mechanism.

You may either insert or eject a disc with the radio OFF.

If you insert a disc with the ignition ON and the radio OFF, the display will show the time of day.

If the power is ON, the unit will switch from radio to CD mode and begin to play when you insert the disc. The display will show the track number and index time in minutes and seconds. Play will begin at the start of track one.

Seek

Press the top of the SEEK button for the next selection on the CD. Press the bottom of the button to return to the beginning of the current selection, or return to the beginning of the previous selection if the CD is within the first second of the current selection.

EJT — Eject

Press the EJT button and the disc will unload and move to the entrance for easy removal. The unit will switch to the radio mode.

If you do not remove the disc within 15 seconds, it will be reloaded. The unit will continue in radio mode.

The disc can be ejected with the radio and ignition OFF (except on convertibles).

FF/TUNE/RW

Press FF (Fast Forward) and the CD player will begin to fast forward until FF is released. The RW (Reverse) button works in a similar manner.

Random Play — RND/Program Button 4

Press the RND (button 4) button while the CD is playing to activate Random Play. This feature plays the tracks on the selected disc in random order to provide an interesting change of pace.

Press the SEEK button to move to the next randomly selected track.

Press the RND (button 4) button a second time to stop Random Play.

Mode

Press the MODE button repeatedly to select between the CD player, the optional remote CD changer and the

Satellite Radio (if equipped). When Satellite Radio (if equipped) is selected "SAT" will appear in your radio display.

A CD or tape may remain in the player while in the Satellite mode.

Time

Press the TIME button to change the display from elapsed CD playing time to time of day.

CD Changer Control Capability — If Equipped

This radio is compatible with a remote mounted CD changer available through Mopar Accessories. The following instructions are for the radio controls that operate this CD changer.

Mode Button

To activate the CD changer, press the MODE button until CD information appears on the display.

Disc Up/Program Button 1

Press the DISC up (button 1) button to play the next available disc.

Disc Down/Program Button 5

Press the DISC down (button 5) button to play the previous disc.

Seek Button

Press the SEEK up or down to select another track on the same disc. A SEEK symbol will appear on the display.

Fast Forward And Rewind Buttons

Press and hold the FF button for fast forward. Press and hold the RW button for fast reverse.

The audio output can be heard when fast forward and fast reverse are activated.

Random Play (RND)

Press the Random button to play the tracks on the selected disc in random order for an interesting change of pace.

Random can be cancelled by pressing the button a second time or by ejecting the CD from the changer.

Operating Instructions - Satellite Radio Mode (If Equipped)

Refer to the Satellite Radio section of the Owner's Manual.

CD Diagnostic Indicators

When driving over a very rough road, the CD player may skip momentarily. Skipping will not damage the disc or the player, and play will resume automatically.

As a safeguard and to protect your CD player, one of the following warning symbols may appear on your display.

A CD HOT symbol indicates the player is too hot.

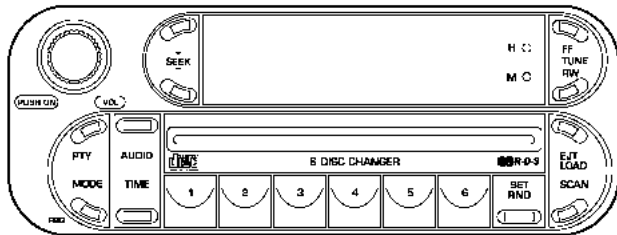
CD HOT will pause the operation. Play can be resumed when the operating temperature is corrected or another MODE is selected.

An ERR symbol will appear on the display if the laser is unable to read the Disc data for the following reasons:

- Excessive vibration
- Disc inserted upside down
- Damaged disc
- Water condensation on optics

SALES CODE RBQ—AM/FM STEREO RADIO WITH 6 - DISC CD CHANGER

NOTE: The radio sales code is located on the lower left side of your radio faceplate.



813ebacd

RBQ Radio

Radio Operation

Power/Volume Control

Press the PWR/VOL control to turn the radio on. Turn the volume control clockwise to increase the volume.

NOTE: Power to operate the radio is controlled by the ignition switch. It must be in the ON or ACC position to operate the radio.

Mode

Press the MODE button repeatedly to select between AM, FM, the CD changer and Sirius Satellite Radio™ (if equipped). The display will show ST when a stereo station is received.

To select Sirius Satellite Radio™ (if equipped), press the MODE button until the word SIRIUS appears. The following will be displayed in this order: After three seconds, the current channel name and number will be displayed for five seconds. The current program type and

channel number will then be displayed for five seconds. The current channel name and number will then be displayed until an action occurs. CD's may remain in the player while in the Satellite Radio mode.

Seek

Press and release the SEEK button to search for the next station in either the AM or FM mode. Press the top of the button to seek up and the bottom to seek down. The radio will remain tuned to the new station until you make another selection. Holding the button in will bypass stations without stopping until you release it.

Tune

Press the TUNE control up or down to increase or decrease the frequency. If the button is pressed and held, the radio will continue to tune until the button is released. The frequency will be displayed and continuously updated while the button is pressed.

To Set The Radio Push-Button Memory

When you are receiving a station that you wish to commit to push-button memory, press the SET RND button. SET 1 will show in the display window. Select the "1-6" button you wish to lock onto this station and press and release that button. If a button is not selected within 5 seconds after pressing the SET RND button, the station will continue to play but will not be locked into push-button memory.

You may add a second station to each push-button by repeating the above procedure with this exception: Press the SET button twice and SET 2 will show in the display window. Each button can be set for SET 1 and SET 2 in both AM and FM. This allows a total of 12 AM and 12 FM stations to be locked into push-button memory. The stations stored in SET 2 memory can be selected by pressing the corresponding push-button twice. Every time a preset button is used, a corresponding button number will be displayed.

Audio

The audio button controls the BASS, TREBLE, BALANCE, and FADE.

Press the AUDIO button and BASS will be displayed. Press the SEEK + or SEEK - to increase or decrease the Bass tones.

Press the AUDIO button a second time and TREB will be displayed. Press the SEEK + or SEEK - to increase or decrease the Treble tones.

Press the AUDIO button a third time and BAL will be displayed. Press the SEEK + or SEEK - to adjust the sound level from the right or left side speakers.

Press the AUDIO button a fourth time and FADE will be displayed. Press the SEEK + or SEEK - to adjust the sound level between the front and rear speakers.

Press the AUDIO button again or wait 5 seconds to exit setting tone, balance, and fade.

Time Button

Press the TIME button to change the display between radio frequency and time.

General Information

This radio complies with Part 15 of FCC rules and with RSS-210 of Industry Canada. Operation is subject to the following conditions:

1. This device may not cause harmful interference,
2. This device must accept any interference received, including interference that may cause undesired operation.

NOTE: Changes or modifications not expressly approved by the party responsible for compliance could void the user's authority to operate the equipment.

CD Player Operation

NOTE: The ignition switch must be in the ON or ACC position and the Power / Volume control pushed ON before the CD player will operate.

Inserting The Compact Disc

CAUTION!
This CD player will accept 4 ¾ inch (12 cm) discs only. The use of other sized discs may damage the CD player mechanism.

You may either insert or eject a disc with the radio OFF.

If you insert a disc with the ignition ON and the radio OFF, the display will show the time of day. If you insert a disc with the ignition OFF, the display will show the time of day for about 5 seconds, then go out.

If you insert a disc with the ignition ON and the radio ON, the unit will switch from radio to CD mode and begin to play when you insert the disc. The display will show the disc number, the track number, and index time in minutes and seconds. Play will begin at the start of track 1.

LOAD/ EJT — Load

Press the LOAD/ EJT button and the button with the corresponding number where the CD is being loaded. After the radio displays “load” insert the CD into the player.

Radio display will show “loading” when it is being loaded.

LOAD / EJT — Eject

Press the LOAD/ EJT button and the button with the corresponding number where the CD was loaded and the disc will unload and move to the entrance for easy removal.

Radio display will show “ejecting” when it is being ejected.

If you have ejected a disc and have not removed it within 15 seconds, it will be reloaded. If the CD is not removed, the radio will continue to play the non-removed CD. If the CD is removed and there are other CD's in the radio, the radio will play the next CD. If the CD is removed and there are no other CD's in the radio, the radio will return to the last selected AM or FM mode.

The disc can be ejected with the radio and ignition OFF.

Seek

Press the top of the SEEK button for the next selection on the CD. Press the bottom of the button to return to the beginning of the current selection, or return to the beginning of the previous selection if the CD is within the first second of the current selection.

Scan

Press the Scan button to scan through each track on the CD currently playing.

FF/TUNE/RW

Press FF (Fast Forward) and the CD player will begin to fast forward until FF is released. The RW (Reverse) button works in a similar manner.

Random Play — SET / RND

Press the RND button while the CD is playing to activate Random Play. This feature plays the tracks on the disc in random order to provide an interesting change of pace.

Press the SEEK button to move to the next randomly selected track.

Press the SET / RND button a second time to stop Random Play.

PTY (Program Type) Button

Pressing this button once will turn on the PTY mode for 5 seconds. If no action is taken during the 5 second time out the PTY icon will turn off. Pressing the PTY button repeatedly within 5 seconds will allow the program format type to be selected. Many radio stations do not currently broadcast PTY information.

Toggle the PTY button to select the following format types:

Program Type	Radio Display
Adult Hits	Adlt Hit
Classical	Classicl
Classic Rock	Cls Rock
College	College
Country	Country
Emergency	ALERT!
Emergency Test	Test

Program Type	Radio Display
Information	Inform
Jazz	Jazz
Foreign Language	Language
News	News
Nostalgia	Nostalga
Oldies	Oldies
Personality	Persnlty
Public	Public
Rhythm and Blues	R & B
Religious Music	Rel Musc
Religious Talk	Rel Talk
Rock	Rock
Soft	Soft
Soft Rock	Soft Rck
Soft Rhythm and Blues	Soft R&B
Sports	Sports

Program Type	Radio Display
Talk	Talk
Top 40	Top 40
Weather	Weather

By pressing the SEEK button when the PTY icon is displayed, the radio will be tuned to the next frequency station with the same selected PTY name. The PTY function only operates when in the FM mode.

The radio display will flash "SEEK" and the selected PTY program type when searching for the next PTY station. If no station is found with the selected PTY program type, the radio will return to the last station.

If a preset button is activated while in the PTY (Program Type) mode, the PTY mode will be exited and the radio will tune to the preset station.

By pressing the SCAN button when the PTY icon is displayed, the radio will stop at every PTY station on the band and list each corresponding program type in the radio display.

Time

Press the TIME button to change the display from elapsed CD playing time to time of day.

Operating Instructions - Satellite Radio Mode (If Equipped)

Refer to the Satellite Radio section of the Owner's Manual.

CD Diagnostic Indicators

When driving over a very rough road, the CD player may skip momentarily. Skipping will not damage the disc or the player, and play will resume automatically.

As a safeguard and to protect your CD player, one of the following warning symbols may appear on your display.

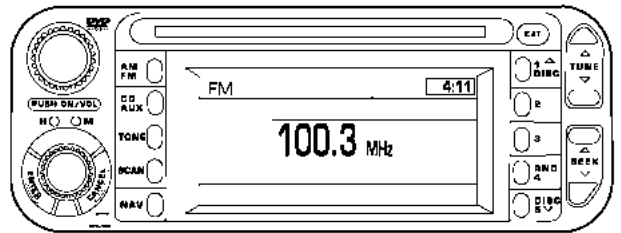
A CD HOT symbol indicates the player is too hot.

CD HOT will pause the operation. Play can be resumed when the operating temperature is corrected or another MODE is selected.

CD ERROR will appear on the display if the laser is unable to read the Disc data for the following reasons:

- Warped disc
- Excessive vibration
- Disc inserted upside down
- Damaged disc
- Water condensation on optics

SALES CODE RB1 — AM/FM STEREO RADIO WITH DVD/GPS NAVIGATION SYSTEM



810774da

RB1 Radio

The navigation system provides maps, turn identification, selection menus and instructions for selecting a

variety of destinations and routes. **Refer to your “Navigation User’s Manual” for detailed operating instructions.**

NOTE: If your vehicle is not equipped with the CD Changer option, you will not be able to use the Navigation system and the CD Player simultaneously. Always remove the Navigation DVD before inserting another disc.

Clock Setting Procedure

The GPS receiver used in this system is synchronized to the time data being transmitted by the GPS satellite. The satellites’ clock is Greenwich Mean Time (GMT). This is the worldwide standard for time. This makes the system’s clock very accurate once the appropriate time zone and daylight savings information is set.

To manually set the clock, change the time zone, or change daylight savings information, use a ball point pen

or similar object to press the hour (H) or minute (M) buttons on the radio. The **Setup** screen appears.

Setting the Clock

1. Press the H button on the faceplate to change the hour or the M button on the faceplate to change the minute. The setting will increase each time you press the button. Holding either button in will fast forward the setting.
2. If no changes are made within 5 seconds of accessing the **Setup** screen, the screen will time out and you will be taken to the last mode.

NOTE: To reset the clock, select the appropriate time zone and press ENTER. The clock will revert to the accurate time based on the time zone you selected.

Changing Time Zone

1. Highlight “Clock Setup” and press ENTER.

2. At the **Clock Setup** screen highlight the box next to "Time Zone" and press ENTER.
3. Highlight the appropriate time zone for your location and press ENTER to store your selection.
4. Select "Done" when finished.

NOTE: When you are traveling and enter a new time zone, the clock must be reset manually for the new zone.

Changing Daylight Savings

1. Highlight the box next to "Time" and press ENTER.

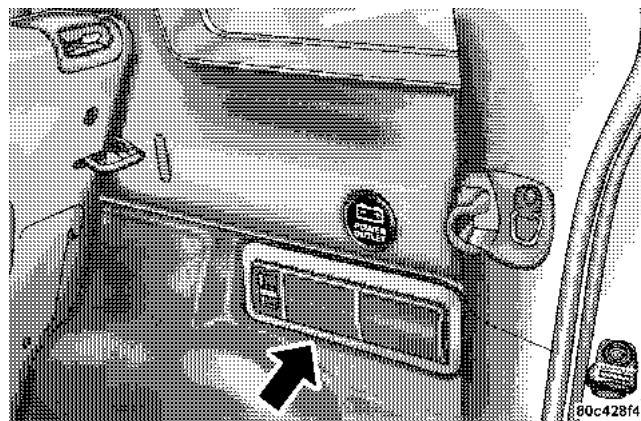
2. Select **Daylight Savings** when Daylight Savings Time is in effect.
3. Select **Standard** if Daylight Savings Time is not being observed.
4. Press ENTER.
5. Select "Done" when finished.
6. Select "Done" to exit from the clock setting mode.

6-DISC REMOTE CD CHANGER — IF EQUIPPED

Loading the CD Changer

Removing the CD Changer Magazine

NOTE: Always keep the CD changer door closed except when ejecting or installing the magazines. The door is designed to keep dust, dirt, and foreign objects out of the CD changer. Handle the magazine with reasonable care. The magazine may crack if dropped or knocked against a hard surface.



1. Slide the CD changer door all the way to the right.
2. Press the green EJECT button.
3. Gently remove the magazine by pulling it out of the CD changer.

4. Close the CD changer door by sliding it to the left.

Loading Discs into the Magazine

Gently pull out a tray from the magazine, and place the disc with the label as indicated on the top of the magazine (up to 6 discs). Slide the tray into the magazine until it locks in place. Do not remove the trays from the magazine. If the discs are installed upside down “CD Err” will be displayed on the radio.

NOTE: Do not use 3 inch (8 cm) discs in the magazine. If a CD adaptor for 3 inch (8 cm) discs is used, the disc will not be ejected.

Removing Discs from the Magazine

To remove the disc, gently pull out the desired disc tray from the magazine and remove the disc. Slide the tray back into the magazine until it locks in place.

NOTE: Do not attempt to disassemble the magazine.

Installing the CD Changer Magazine

1. Slide the CD changer door all the way to the right to access the magazine slot.
2. Insert the magazine into the changer slot in the direction of the arrow on the magazine.
3. Slide the changer door to the left to close the changer door.

SATELLITE RADIO — IF EQUIPPED

Satellite radio uses direct satellite to receiver broadcasting technology to provide clear digital sound, coast to coast. The subscription service provider is Sirius™ Satellite Radio. This service offers up to 100 channels of music, sports, news, entertainment, and programming for children, directly from its satellites and broadcasting studios.

System Activation

To activate your Sirius Satellite Radio service, call the toll-free number 888-539-7474, or visit the Sirius web site at www.sirius.com. Please have the following information available when activating your system:

1. The Electronic Serial Number/Sirius Identification Number (ESN/SID).
2. Credit card information.
3. Your Vehicle Identification Number.

Electronic Serial Number/Sirius Identification Number (ESN/SID)

The Electronic Serial Number/Sirius Identification Number is needed to activate your Sirius Satellite Radio system. To access the ESN/SID, refer to the following steps:

ESN/SID Access With RBB, RAH and RBK Radios

With the ignition switch in the ACCESSORY position and the radio OFF, press the Tape Eject or CD Eject (depending on the radio type) and Time buttons simultaneously for 3 seconds. The first four digits of the twelve-digit ESN/SID number will be displayed. Press the SEEK UP button to display the next four digits. Continue to press the SEEK UP button until all twelve ESN/SID digits have been displayed. The SEEK DOWN will page down until the first four digits are displayed. The radio will exit the ESN/SID mode when any other button is pushed, the ignition is turned OFF, or 5 minutes has passed since any button was pushed.

ESN/SID Access With RBP, RBU, RAZ, RB1 and RBQ Radios

With the ignition switch in the ACCESSORY position and the radio OFF, press the CD Eject and TIME buttons simultaneously for 3 seconds. All twelve ESN/SID numbers will be displayed. The radio will exit the ESN/SID

mode when any other button is pushed, the ignition is turned OFF, or 5 minutes has passed since any button was pushed.

Selecting Satellite Mode in RBB, RAH and RBK Radios

Press the MODE button repeatedly until "S A" appears in the display. A CD or tape may remain in the radio while in the Satellite radio mode.

Selecting Satellite Mode in RBP, RBU, RAZ, RB1 and RBQ Radios

Press the MODE button repeatedly until the word "SIRIUS" appears in the display. These radios will also display the following:

- After 3 seconds, the current channel name and channel number will be displayed for 5 seconds.
- The current program type and channel number will then be displayed for 5 seconds.

- The current channel number will then be displayed until an action occurs.

A CD or tape may remain in the radio while in the Satellite radio mode.

Selecting a Channel

Press and release the SEEK or TUNE buttons to search for the next channel. Press the top of the button to search up and the bottom of the button to search down. Holding the TUNE button causes the radio to bypass channels until the button is released.

Press and release the SCAN button (if equipped) to automatically change channels every 7 seconds. The radio will pause on each channel for 7 seconds before moving on to the next channel. The word "SCAN" will appear in the display between each channel change. Press the SCAN button a second time to stop the search.

NOTE: Channels that may contain objectionable content can be blocked. Contact Sirius Customer Care at 888-539-7474 to discuss options for channel blocking or unblocking. Please have your ESN/SID information available.

Storing and Selecting Pre-Set Channels

In addition to the 10 AM and 10 FM pre-set stations, you may also commit 10 satellite stations to push button memory. These satellite channel pre-set stations will not erase any AM or FM pre-set memory stations. Follow the memory pre-set procedures that apply to your radio.

Using the PTY (Program Type) Button (If Equipped)

Follow the PTY button instructions that apply to your radio.

PTY Button "SCAN"

When the desired program type is obtained, press the "SCAN" button within five seconds. The radio will play 7 seconds of the selected channel before moving to the next channel of the selected program type. Press the "SCAN" button a second time to stop the search.

NOTE: Pressing the "SEEK" or "SCAN" button while performing a music type scan will change the channel by one and stop the search. Pressing a pre-set memory button during a music type scan, will call up the memory channel and stop the search.

PTY Button "SEEK"

When the desired program is obtained, press the "SEEK" button within five seconds. The channel will change to the next channel that matches the program type selected.

Satellite Antenna

To ensure optimum reception, do not place items on the roof around the rooftop antenna location or strap items to the trunk lid around the trunk lid antenna (if equipped). Metal objects placed within the line of sight of the antenna will cause decreased performance. Larger luggage items such as bikes should be placed as far rearward as possible, within the loading design of the rack. Do not place items directly on or above the antenna.

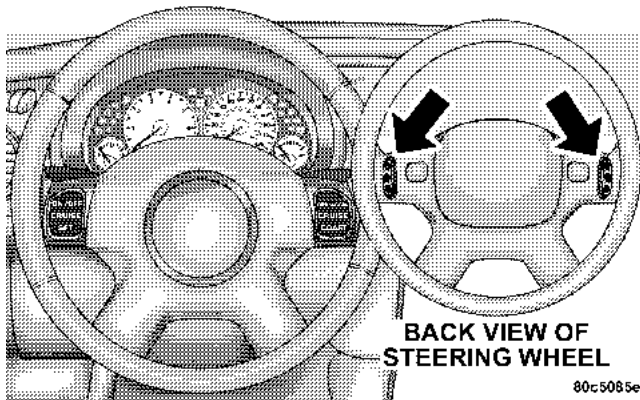
Reception Quality

Satellite reception may be interrupted due to one of the following reasons.

- The vehicle is parked in an underground parking structure or under a physical obstacle.
- Dense tree coverage may interrupt reception in the form of short audio mutes.
- Driving under wide bridges or along tall buildings can cause intermittent reception.
- Placing objects over or too close to the antenna can cause signal blockage.

REMOTE SOUND SYSTEM CONTROLS — IF EQUIPPED

The remote sound system controls are located on the rear surface of the steering wheel. Reach behind the wheel to access the switches.



The right hand control is a rocker type switch with a push-button in the center and controls the volume and mode of the sound system. Pressing the top of the rocker switch will increase the volume and pressing the bottom of the rocker switch will decrease the volume.

Pressing the center button will make the radio switch between the various modes available (AM/FM/TAPE/CD, Etc.).

The left hand control is a rocker type switch with a push-button in the center. The function of the left hand control is different depending on which mode you are in.

The following describes the left hand control operation in each mode.

Radio Operation

Pressing the top of the switch will “Seek” up for the next listenable station and pressing the bottom of the switch will “Seek” down for the next listenable station.

The button located in the center of the left hand control will tune to the next preset station that you have programmed in the radio preset push-button.

Tape Player

Pressing the top of the switch once will go to the next selection on the cassette. Pressing the bottom of the switch once will go to the beginning of the current selection or to the beginning of the previous selection if it is within the first 5 seconds of the current selection.

If you press the switch up or down twice it plays the second selection, three times, it will play the third, etc.

The button in the center of the left hand switch switches the side of the tape to be played.

CD Player — Single Disc in Radio

Pressing the top of the switch once will go to the next track on the CD. Pressing the bottom of the switch once will go to the beginning of the current track or to the beginning of the previous track if it is within one second after the current track begins to play.

If you press the switch up or down twice it plays the second track, three times, it will play the third, etc.

The button in the center of the left hand switch has no function in this mode.

CD Player — 6 Disc in Cargo Area

Pressing the top of the switch once will go to the next track on the CD. Pressing the bottom of the switch once will go to the beginning of the current track or to the beginning of the previous track if it is within one second after the current track begins to play.

If you press the switch up or down twice it plays the second track, three times, it will play the third, etc.

The button in the center of the left hand switch will cause the CD changer to play the next available disc in the 6-disc magazine.

CD/DVD DISC MAINTENANCE

To keep the CD/DVD discs in good condition, take the following precautions:

1. Handle the disc by its edge; avoid touching the surface.
2. If the disc is stained, clean the surface with a soft cloth, wiping from center to edge.
3. Do not apply paper, paper CD labels, or tape to the disc; avoid scratching the disc.
4. Do not use solvents such as benzine, thinner, cleaners, or antistatic sprays.

5. Store the disc in its case after playing.

6. Do not expose the disc to direct sunlight.

7. Do not store the disc where temperatures may become too high.

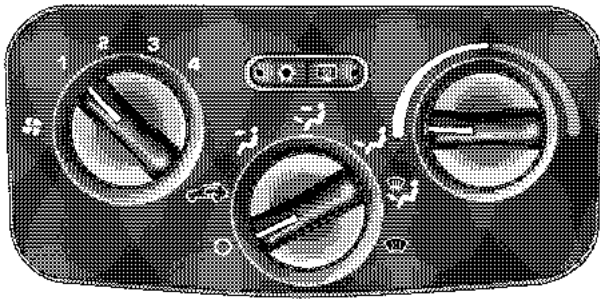
RADIO OPERATION AND CELLULAR PHONES

Under certain conditions, the cellular phone being ON in your vehicle can cause erratic or noisy performance from your radio. This condition may be lessened or eliminated by relocating the cellular phone antenna. This condition is not harmful to the radio. If your radio performance does not satisfactorily "clear" by the repositioning of the antenna, it is recommended that the radio volume be turned down or off during cellular phone operation.

CLIMATE CONTROLS

Manual Air Conditioning and Heating System

The controls for the heating, air conditioning, and ventilation system in this vehicle consist of a series of rotary knobs, and a push-button. These comfort controls can be set to obtain desired interior conditions.



813e0ae2

Manual Climate Control


Blower Control

The rotary knob on the left controls the blower and can be set in one of four positions from Low to High.

Temperature Control

The degree of comfort can be selected by rotating the temperature control knob on the right. The coldest temperature setting is fully counterclockwise and the warmest setting fully clockwise. The knob can be positioned at any detent.

Air Conditioning Operation

 To turn on the Air Conditioning, set the fan control at any speed and press the snowflake button located on the control panel. Conditioned air will be directed through the outlets selected by the mode control. A light in the snowflake button shows that the air conditioning is on.


Slight changes in engine speed or power may be noticed when the air conditioning compressor is on. This is a

normal occurrence as the compressor will cycle on and off to maintain comfort and increase fuel economy.

Mode Control

The mode selector (the center rotary knob and the push-button above it) can be set in any of the following positions:

OFF

 This position turns off the blower motor and outside air will not pass through any outlets.


Recirculate (Max A/C)




Air flows through the outlets located in the instrument panel. Allows for circulation of interior air only which will cool the cabin faster. This setting can be used in very hot weather to maximize the effect of the air conditioner. This mode can also be used to temporarily block out outside

odors, smoke, and dust. Slight airflow from the floor outlets and the defrost outlets, located at the base of the windshield, may be noticed.


Panel

 Air flows through the outlets located in the instrument panel. Slight airflow from the defrost outlet, located at the base of the windshield, may be noticed.

Bi-Level

 Air flows through the outlets located in the instrument panel, on the floor, and in the rear of the center console. Slight airflow from the defrost outlet, located at the base of the windshield, may be noticed.

Floor

 Air flows through the floor outlets located under the instrument panel and through the outlets located in the rear of the center console. Slight airflow from the defrost outlet, located at the base of the windshield, may be noticed. The air conditioning system has been

enabled in Floor mode to provide less humid air, especially when heat is used. This will help you reduce or prevent window fogging in high humidity conditions. This function cannot be disabled. You may still select the desired amount of heat using the temperature control dial. The heated air will simply be drier and less prone to condensing on cold window surfaces.

Mix



Air flows through the floor outlets, the outlets at the base of the windshield, and the side window demister outlets.

Defrost



Air flows through the outlets at the base of the windshield and through the side window demister outlets.

Operating Tips

Window Fogging

Windows will fog on the inside when the humidity inside the vehicle is high. This often occurs in mild or cool temperatures when it's rainy or humid. In most cases turning on the Air-conditioning (pressing the snowflake button) will clear the fog. Adjust the temperature control, air direction and blower speed to maintain comfort.

As the temperature gets colder it may be necessary to direct air onto the windshield. Adjust the temperature control and blower speed to maintain comfort. Higher blower speeds will reduce fogging. Interior fogging on the windshield can be quickly removed by selecting the defrost mode.

Regular cleaning of the inside of the windows with a non-filming cleaning solution (vinegar and water works very well) will help prevent contaminants (cigarette

smoke, perfumes, etc.) from sticking to the windows. Contaminates increase the rate of window fogging.

Winter Operation

When operating the system during the winter months, make sure the air intake, located directly in front of the windshield, is free of ice, slush, snow, or other obstructions.

Vacation Storage

Anytime you store your vehicle, or keep it out of service (i.e. vacation) for two weeks or more, run the air conditioning system at idle for about five minutes in the fresh air and high blower setting. This will insure adequate system lubrication to minimize the possibility of compressor damage when the system is started again.

STARTING AND OPERATING

CONTENTS

■ Starting Procedures	211	□ Clutch Interlocking Ignition System	216
□ Manual Transmission	211	□ 6-Speed Manual Transmission	216
□ Automatic Transmission	211	■ Automatic Transmission — If Equipped	220
□ Normal Starting	212	□ Brake/Transmission Interlock System	220
□ Extreme Cold Weather (Below -20°F (-29°C)	212	□ Automatic Transmission With Overdrive	221
□ If Engine Fails To Start	213	■ Four-Wheel Drive Operation	226
□ After Starting	214	□ Command-Trac® Operating Information/Precautions	226
■ Engine Block Heater — If Equipped	215	□ Shift Positions	228
■ Manual Transmission	216		

□ Shifting Procedure	228	□ After Driving Off-Road	238
□ Selec-Trac® Operating Information/Precautions — If Equipped	229	■ Parking Brake	240
□ Shift Positions	232	■ Anti-Lock Brake System — If Equipped	241
□ Shifting Procedure	232	■ Power Steering	243
■ Trac-Lok™ Rear Axle — If Equipped	234	■ Tire Safety Information	245
■ On-Road Driving Tips	235	□ Tire Markings	245
■ Off-Road Driving Tips	235	□ Tire Identification Number (TIN)	248
□ When To Use 4L Or 4LO (Low) Range	235	□ Tire Loading And Tire Pressure	249
□ Driving Through Water	236	■ Tires — General Information	253
□ Driving In Snow, Mud And Sand	237	□ Tire Pressure	253
□ Hill Climbing	237	□ Tire Inflation Pressures	254
□ Traction Downhill	238	□ Tire Pressures For High Speed Operation	256
		□ Radial-Ply Tires	256

□ Tire Spinning	257	□ General Information	272
□ Tread Wear Indicators	257	■ Fuel Requirements (Gasoline Engines)	273
□ Life Of Tire	258	□ Reformulated Gasoline	274
□ Replacement Tires	259	□ Gasoline/Oxygenate Blends	274
□ Alignment And Balance	260	□ MMT In Gasoline	274
■ Tire Chains	260	□ Materials Added To Fuel	275
■ Tire Rotation Recommendations	261	□ Fuel System Cautions	275
■ Tire Pressure Monitor System (TPMS)	262	□ Carbon Monoxide Warnings	276
□ Base System — If Equipped	264	■ Adding Fuel	277
□ Base System With Electronic Vehicle Information Center (EVIC)– If Equipped	266	□ Fuel Filler Cap (Gas Cap)	277
□ Premium System — If Equipped	268	□ Loose Fuel Filler Cap Message	279
□ Check TPM System	270	■ Vehicle Loading	280
		□ Certification Label	280

210 STARTING AND OPERATING

■ Trailer Towing	282	□ Towing Tips	294
□ Common Towing Definitions	282	■ Recreational Towing (Behind Motorhome, Etc.)	296
□ Trailer Hitch Classification	286	□ Towing – 2WD Models	296
□ Trailer Towing Weights (Maximum Trailer Weight Ratings)	287	□ Towing — 4WD Models	296
□ Trailer And Tongue Weight	289	■ Snow Plow	299
□ Towing Requirements	290		

STARTING PROCEDURES

Before starting your vehicle, adjust your seat, adjust both inside and outside mirrors, and fasten your seat belts.

CAUTION!

Long periods of engine idling, especially at high engine speeds can cause excessive exhaust temperatures which can damage your vehicle. Do not leave your vehicle unattended with the engine running.

WARNING!

Do not leave children or animals inside parked vehicles in hot weather. Interior heat build up may cause serious injury or death.

Manual Transmission

Apply the parking brake, place the gearshift control lever in N (Neutral) and depress the clutch pedal before starting vehicle. This vehicle is equipped with a clutch interlocking ignition system, which requires the clutch to be fully depressed before starting the vehicle.

4WD Models Only

In 4L mode, this vehicle will start regardless of whether or not the clutch pedal is pressed to the floor. This feature enhances off-road performance by allowing the vehicle to start when in 4L without having to depress the clutch pedal. The 4 LO MODE indicator light will illuminate when the transfer case has been shifted into this mode.

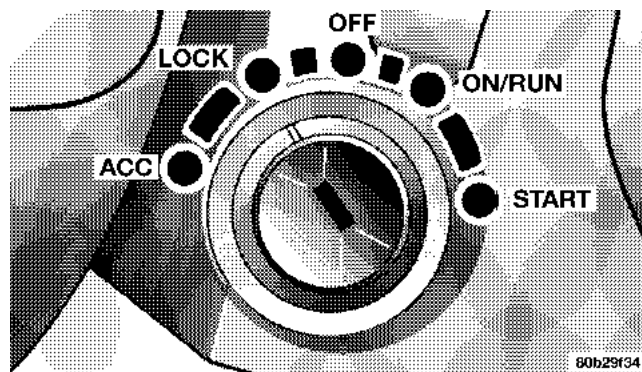
Automatic Transmission

Start the engine with the selector lever in the N (Neutral) or P (Park) position. Apply the brake before shifting to any driving range.

NOTE: This vehicle is equipped with a transmission shift interlocking system. The brake pedal must be depressed to shift out of Park (P).

Normal Starting

Normal starting of either a cold or a warm engine is obtained without pumping or depressing the accelerator pedal. Turn the key to the START position and release when the engine starts. If the engine fails to start within 10 seconds, turn the key to the OFF position, wait 5 seconds, then repeat the normal starting procedure.



Ignition Key Positions

Extreme Cold Weather (below -20°F (-29°C))

To insure reliable starting at these temperatures, use of an externally powered electric engine block heater (available from your authorized dealer) is recommended.

If Engine Fails to Start

If the engine fails to start after you have followed the "Normal Starting" procedure, it may be flooded. Push the accelerator pedal all the way to the floor and hold it there while cranking the engine. This should clear any excess fuel in case the engine is flooded.

CAUTION!

To prevent damage to the starter, do not crank the engine for more than 15 seconds at a time. Wait 10 to 15 seconds before trying again.

WARNING!

Never pour fuel or other flammable liquids into the throttle body air inlet opening in an attempt to start the vehicle. This could result in a flash fire causing serious personal injury.

WARNING!

Do not attempt to push or tow your vehicle to get it started. Vehicles equipped with an automatic transmission cannot be started this way. Unburned fuel could enter the catalytic converter and once the engine has started, ignite and damage the converter and vehicle. If the vehicle has a discharged battery, booster cables may be used to obtain a start from a booster battery or the battery in another vehicle. This type of start can be dangerous if done improperly. Refer to Section 6 of this manual for proper jump starting procedures and follow them carefully.

If the engine has been flooded, it may start to run, but not have enough power to continue running when the key is

released. If this occurs, continue cranking with the accelerator pedal pushed all the way to the floor. Release the accelerator pedal and the key once the engine is running smoothly.

If the engine shows no sign of starting after two 15 second periods of cranking with the accelerator pedal held to the floor, the "Normal Starting" procedure should be repeated.

After Starting

The idle speed is automatically controlled and will decrease as the engine warms up.

CAUTION!

Long periods of engine idling, especially at high engine speeds can cause excessive exhaust temperatures which can damage your vehicle. Do not leave your vehicle unattended with the engine running.

WARNING!

Do not leave children or animals inside parked vehicles in hot weather. Interior heat build up may cause serious injury or death.

ENGINE BLOCK HEATER — IF EQUIPPED

The engine block heater warms engine coolant and permits quicker starts in cold weather. Connect the cord to a standard 110-115 volt AC electrical outlet with a grounded, three wire extension cord.

- The engine block heater cord is found under the hood clipped to the heater line on the left side of the engine (3.7L Engines).

WARNING!

Remember to disconnect the cord before driving. Damage to the 110-115 volt AC electrical cord could cause electrocution.

Use the heater when temperatures below 0°F (-18°C) are expected to last for several days.

MANUAL TRANSMISSION

Clutch Interlocking Ignition System

2WD Models Only — Manual transmission vehicles are equipped with a clutch interlock safety feature. The clutch pedal must be fully depressed to allow cranking of the engine.

4WD Models Only — The exception to this clutch interlock is 4WD models equipped with a manual transmission. For these models, the clutch interlock feature is overridden when the vehicle is operated in 4L to enhance off-road capability. Refer to “Starting Procedures — Manual Transmission (4WD Models Only)” in this section.

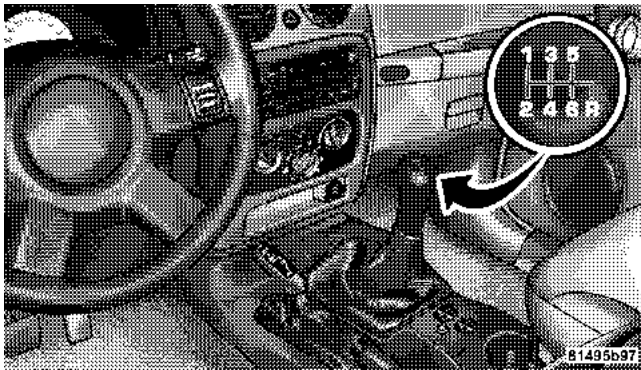
6-Speed Manual Transmission

WARNING!

You or others could be injured if you leave the vehicle unattended without having the parking brake fully applied. The parking brake should always be applied when the driver is not in the vehicle, especially on an incline.

Follow the shift pattern on the gearshift knob.

NOTE: The backup lights will come on when your vehicle is in R (Reverse) gear and the ignition is in the ON position.



Manual Shift Controls

WARNING!

When parking your vehicle, always leave a manual transmission in first gear and apply the parking brake fully to guard against vehicle movement and possible injury or damage. Never use any gear as a substitute for the parking brake.

CAUTION!

To drive as safely as possible and to prolong the life of your manual transmission, follow these tips:

- Before shifting from a forward gear into reverse, or from reverse to a forward gear, stop vehicle completely. Otherwise, accelerated transmission wear may result.

- Do not operate at sustained high engine or road speeds in lower gears. Engine damage may result.
- Do not downshift into a low gear while traveling at too high a speed for that gear. Engine, clutch, or transmission damage may result.
- Do not rest your foot on the clutch pedal. This causes heat buildup and damages the clutch.
- When you slow down or go up a grade, downshift as speed requires or the engine may overheat.
- Never hold the vehicle stopped on a hill by using the clutch pedal. The clutch may be damaged.
- During cold weather, you may experience increased effort in shifting until the transmission fluid warms up. This is normal.
- Push in the clutch pedal completely when shifting. Otherwise, transmission or clutch damage may result.

- When “rocking” a stuck vehicle by shifting between a forward gear and reverse, do not spin wheels faster than 15 mph (24 km/h), or drivetrain damage may result.

Recommended Manual Transmission Shifting Speeds

The manufacturer recommends that you use the shift speeds listed in the chart below.

Manual Transmission Shift Speeds in MPH (KM/H)						
En-gine	Speeds	1 to 2	2 to 3	3 to 4	4 to 5	5 to 6
3.7L	Accel.	15 (24)	24 (39)	34 (55)	47 (76)	56 (90)
	Cruise	10 (16)	19 (31)	27 (43)	37 (60)	41 (66)

Recommended Manual Transmission Downshifting Speeds

To prevent clutch and transmission damage, your vehicle should be downshifted at speeds no greater than those listed in the chart below:

Manual Transmission Downshift Speeds in MPH (KM/H)					
Gear Selection	6th to 5th	5th to 4th	4th to 3rd	3rd to 2nd	2nd to 1st
Maximum Speed	90 mph (144 km/h)	75 mph (120 km/h)	50 mph (80 km/h)	35 mph (56 km/h)	20 mph (32 km/h)

CAUTION!

Failure to follow the recommended downshifting speeds may cause the engine to over speed and/or damage the clutch disc even if the clutch pedal is depressed.

AUTOMATIC TRANSMISSION — IF EQUIPPED**CAUTION!**

Damage to the transmission may occur if the following precautions are not observed:

- Shift into P (Park) only after the vehicle has come to a complete stop.
- Shift into or out of R (Reverse) only after the vehicle has come to a complete stop and the engine is at idle speed.
- Do not shift from R (Reverse), P (Park), or N (Neutral) into any forward gear when the engine is above idle speed.
- Before shifting into any gear, make sure your foot is firmly on the brake pedal.

WARNING!

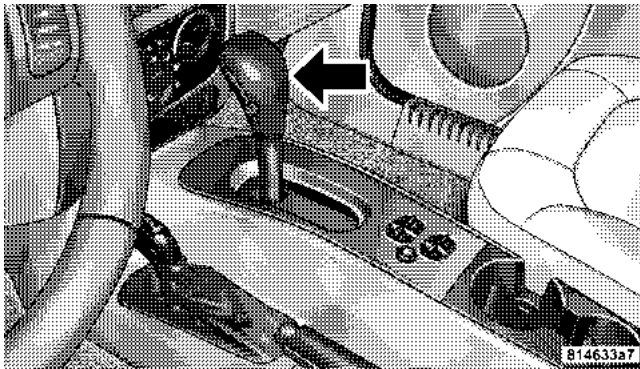
It is dangerous to shift the selector lever out of P (Park) or N (Neutral) if the engine speed is higher than idle speed. If your foot is not firmly on the brake pedal, the vehicle could accelerate quickly forward or in reverse. You could lose control of the vehicle and hit someone or something. Only shift into gear when the engine is idling normally and when your foot is firmly on the brake pedal.

Brake/Transmission Interlock System

This system prevents you from moving the gear shift out of P (Park) and into any gear unless the brake pedal is pressed. This system is active only while the ignition switch is in the ON position. Always depress the **brake pedal first**, before moving the gear selector out of P (Park).

Automatic Transmission with Overdrive

Shifting from D (Drive) to P (Park) or R (Reverse) (or from P or R to D) should be done only after the accelerator pedal is released and the vehicle is stopped. Be sure to keep your foot on the brake when moving the shift lever between these gears.



Automatic Shift Controls

Gear Ranges

P (Park)

This gear position supplements the parking brake by locking the transmission. The engine can be started in this range. Never use P (Park) while the vehicle is in motion. Apply the parking brake when leaving the vehicle in this range. Always apply parking brake first, then place the selector in P (Park) position.

WARNING!

Never use P (Park) position as a substitute for the parking brake. Always apply parking brake fully when parked to guard against vehicle movement and possible injury or damage.

WARNING!

It is dangerous to shift the selector lever out of P (Park) or N (Neutral) if the engine speed is higher than idle speed. If your foot is not firmly on the brake pedal, the vehicle could accelerate quickly forward or in reverse. You could lose control of the vehicle and hit someone or something. Only shift into gear when the engine is idling normally and when your right foot is firmly on the brake pedal.

R (Reverse)

Use this range only after the vehicle has come to a complete stop.

N (Neutral)

Shift into N (Neutral) when the vehicle is standing for prolonged periods with the engine running. The engine may be started in this range. Set the parking brake if you must leave the vehicle.

NOTE: Towing the vehicle, coasting, or driving for any other reason with selector lever in N (Neutral) can result in severe transmission damage. Refer to "Recreational Towing" in Section 5 and "Towing a Disabled Vehicle" in Section 6 of this manual.

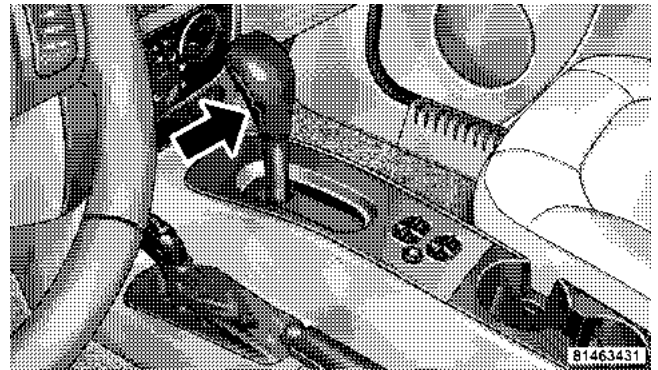
Overdrive (O/D)

For most city and highway driving. The transmission contains an electronically controlled Overdrive, and will automatically shift from D (Drive) to O/D (Overdrive) if the following conditions are present:

- The transmission selector is in D (Drive).
- The O/D OFF button has not been activated.

- Vehicle speed is above approximately 30 mph (48 km/h).
- Transmission has reached normal operating temperature.

When frequent transmission shifting occurs while using Overdrive, such as when operating the vehicle under heavy load conditions (for example, in hilly terrain, strong head winds, or trailer towing), turning off overdrive will improve performance and extend transmission life by reducing excessive shifting and heat buildup.



O/D Off Button

Overdrive can be locked out by pressing the O/D OFF button located on side of the gearshift lever. The O/D OFF indicator light will illuminate to show that the switch has been activated. When the indicator light is on, Overdrive is locked out. Pressing the switch a second

time restores the Overdrive function. The lockout feature is useful when towing a trailer or carrying a heavy load.

NOTE: If the vehicle is started in cold outside temperatures, shifts into Overdrive may be delayed. Normal Overdrive and shifting operation will resume when the temperature of the transmission reaches the appropriate temperature. Refer to the "Note" under "Torque Converter Clutch" later in this section.

If the transmission temperature gets too hot, the transmission may downshift out of Overdrive or engage overdrive at higher vehicle speeds until the transmission cools down. After cooldown, Overdrive will resume normal operation.

2 (Second)

For moderate grades and to assist braking on dry pavement or in mud and snow. Begins at a stop in low gear with automatic upshift to 2nd gear. Will not shift to 3rd.

1 (First)

For hard pulling at low speeds in mud, sand, snow, or on steep grades. Begins and stays in low gear with no upshift. Provides engine compression braking at low speeds.

CAUTION!

- Never press on the accelerator pedal with the engine running, vehicle in gear, and the brakes applied. Always apply the brakes when stopped on an incline. Failure to follow these instructions can cause overheating and damage to the transmission.
- When "rocking" a stuck vehicle by moving between "First" and R (Reverse), do not spin the wheels faster than 15 mph (24 km/h), or drivetrain damage may result.

Over Temperature Mode

The transmission electronics constantly monitor the transmission oil temperature. If the transmission gets too hot, the transmission will change the way it shifts to help control the condition. This may result in a slightly different feeling or response during normal operation in D (Drive) position. If the transmission becomes hot enough the TRANS TEMP warning light in the instrument cluster will come on. After the transmission cools down, it will return to normal operation.

Torque Converter Clutch

A feature designed to improve fuel economy has been added to the automatic transmission of this vehicle. A clutch within the torque converter engages automatically at calibrated speeds. This may result in a slightly different feeling or response during normal operation in high gear. When the vehicle speed drops or during acceleration, the clutch automatically and smoothly disengages.

NOTE:

- The torque converter clutch (TCC) will not engage until the transmission fluid and engine coolant are warm (usually after 1–3 miles (1.6–4.8 km) of driving) and the vehicle speed is above approximately 30 mph (48 km/h). To understand the difference in operation, drive the vehicle so that TCC engagement conditions are correct, and then press and release the “O/D OFF” button once to disengage the TCC. Wait a few seconds, and then press and release the “O/D OFF” button again to engage the TCC. You will notice that the engine runs at a higher RPM when driving at vehicle speeds above approximately 30 mph (48 km/h) with the TCC not engaged. This is a normal condition.
- If the vehicle has not been driven for several days, the first few seconds of operation after shifting the transmission into gear may seem sluggish. This is due to the transmission fluid partially draining from the torque converter into the transmission. This is considered a

normal condition and will not cause damage to the transmission. The torque converter will refill within 5 seconds of shifting from P (Park) into any other gear position.

FOUR-WHEEL DRIVE OPERATION

Command-Trac® Operating Information/Precautions

The Command-Trac® transfer case provides 4 mode positions - 2 (rear) wheel drive high range, 4-wheel drive high range, neutral, and 4-wheel drive low range.

This transfer case is intended to be driven in the 2-wheel drive position (2H) for normal street and highway conditions such as dry hard surfaced roads.

When additional traction is required the transfer case 4H and 4L positions can be used to lock the front and rear driveshafts together and force the front and rear wheels to rotate at the same speed. This is accomplished by

simply moving the shift lever to these positions. The 4H and 4L positions are intended for loose, slippery road surfaces only. Driving in the 4H and 4L positions on dry hard surfaced roads may cause increased tire wear and damage to the driveline components.

The PART TIME indicator light, located in the instrument cluster, illuminates when the transfer case is shifted to the 4H position.

The 4 LO MODE indicator light, located in the instrument cluster, illuminates when the transfer case is shifted to the 4L position. There is no light for the 2H or N (Neutral) positions.

CAUTION!

- Do not attempt to make a shift while only the front or rear wheels are spinning. The Command-Trac transfer case is not equipped with a synchronizer and therefore the front and rear driveshaft speeds must be equal for the shift to take place. Shifting while only the front or rear wheels are spinning can cause damage to the transfer case.
- When operating your vehicle in 4L, the engine speed is approximately three times that of the 2H or 4H positions at a given road speed. Take care not to overspeed the engine and do not exceed 25 mph (40 km/h).

Proper operation of 4-wheel drive vehicles depends on tires of equal size, type and circumference on each wheel. Any difference will adversely affect shifting and can cause damage to the transfer case.

WARNING!

- Because 4-wheel drive provides improved traction, there is a tendency to exceed safe turning and stopping speeds. Do not go faster than road conditions permit.
- You or others could be injured if you leave the vehicle unattended with the transfer case in the Neutral (N) position without first fully engaging the parking brake. The transfer case Neutral (N) position disengages both the front and rear driveshafts from the powertrain and will allow the vehicle to move despite the transmission position. The parking brake should always be applied when the driver is not in the vehicle.

Shift Positions

For additional information on the appropriate use of each transfer case mode position see the information below:

2H

Rear Wheel Drive High Range - Normal street and highway driving. Dry hard surfaced roads.

4H

4-Wheel-Drive High Range - Locks the front and rear driveshafts together. Forces the front and rear wheels to rotate at the same speed. Additional traction for loose, slippery road surfaces only.

N

Neutral - Disengages both the front and rear driveshafts from the powertrain. To be used for flat towing behind another vehicle. Refer to "Recreational Towing" in Section 5 for more information.

4L

4-Wheel-Drive Low Range - Low speed 4 wheel drive. Locks the front and rear driveshafts together. Forces the front and rear wheels to rotate at the same speed. Additional traction and maximum pulling power for loose, slippery road surfaces only. Do not exceed 25 mph (40 km/h). (Allows engine starting without depressing the clutch pedal on vehicles equipped with manual transmission. Refer to "Starting Procedures — Manual Transmission (4WD Models Only)" in this section.

Shifting Procedure**2H to 4H or 4H to 2H**

Shifting between 2H and 4H can be made with the vehicle in motion up to 55 mph (88 km/h). The transfer case will engage/disengage faster if you momentarily release the accelerator pedal after completing the shift. Apply a constant force when shifting the transfer case lever.

4H to 4L or 4L to 4H

With the vehicle rolling at 2 to 3 mph (3 to 5 km/h), shift an automatic transmission to N (Neutral) or depress the clutch on a manual transmission. While the vehicle is coasting at 2 to 3 mph (3 to 5 km/h), shift the transfer case lever firmly to the desired position. Do not pause in transfer case N (Neutral).

NOTE: To shift from 4H to 4L, the shift lever should be pushed away from the driver, and then rearward into 4L. In 4H, there is a neutral stop to prevent shifting into N (Neutral) by accident.

NOTE: Pausing in transfer case N (Neutral) in vehicles equipped with an automatic transmission may require shutting the engine OFF to avoid gear clash while completing the shift. If difficulty occurs, shift automatic transmission to N (Neutral), hold foot on brake, and turn engine OFF. Make shift to the desired mode.

NOTE: Shifting into or out of 4L is possible with the vehicle completely stopped, however difficulty may occur due to the mating clutch teeth not being properly aligned. Several attempts may be required for clutch teeth alignment and shift completion to occur. The preferred method is with the vehicle rolling 2 to 3 mph (3 to 5 km/h). Avoid attempting to engage or disengage 4L with the vehicle moving faster than 2 to 3 mph (3 to 5 km/h).

Selec-Trac® Operating Information/Precautions — If Equipped

The Selec-Trac® transfer case provides 5 mode positions - normal 2-wheel drive mode, part-time 4-wheel drive high range, full-time 4-wheel drive high range, neutral, and 4-wheel drive low range.

This transfer case is equipped with an inter-axle differential which allows driving the vehicle in the 4 FULL TIME position at all times on any given road surface

including dry hard surfaced roads. The 4 FULL TIME mode allows the front and rear wheels to rotate at different speeds which eliminates driveline binding and component wear that is normally associated with driving the vehicle in the 4 PART TIME position on dry hard surfaced roads. This feature provides the safety, security, and convenience of operating in 4-wheel drive at all times regardless of road conditions.

When additional traction is required the 4 PART TIME and 4LO positions can be used to lock the front and rear driveshafts together through the transfer case inter-axle differential and force the front and rear driveshafts to rotate at the same speed. This is accomplished by simply moving the shift lever to these positions. The 4 PART TIME and 4LO positions are intended for loose, slippery road surfaces only. Driving in the 4 PART TIME and 4LO positions on dry hard surfaced roads may cause increased tire wear and damage to driveline components.

The PART TIME indicator light, located on the instrument cluster, illuminates when the transfer case is shifted to the 4 PART TIME position.

The FULL TIME indicator light, located on the instrument cluster, illuminates when the transfer case is shifted to the 4 FULL TIME position.

The 4LO MODE indicator light, located on the instrument cluster, illuminates when the transfer case is shifted to the 4LO position. There is no light for the 2WD, or N (Neutral) positions.

CAUTION!

- Do not attempt to make a shift while only the front or rear wheels are spinning. The Selec-Trac transfer case is not equipped with a synchronizer and therefore the front and rear driveshaft speeds must be equal for the shift to take place. Shifting while only the front or rear wheels are spinning can cause damage to the transfer case.
- When operating your vehicle in 4LO, the engine speed is approximately three times that of the 2WD, 4 PART TIME, or 4 FULL TIME positions at a given road speed. Take care not to overspeed the engine and do not exceed 25 mph (40 km/h).

Proper operation of 4-wheel drive vehicles depends on tires of equal size, type, and circumference on each wheel. Any difference will adversely affect shifting and can cause damage to the transfer case.

WARNING!

- Because 4-wheel drive provides improved traction, there is a tendency to exceed safe turning and stopping speeds. Do not go faster than road conditions permit.
- You or others could be injured if you leave the vehicle unattended with the transfer case in the Neutral (N) position without first fully engaging the parking brake. The transfer case Neutral (N) position disengages both the front and rear drive shafts from the powertrain and will allow the vehicle to move regardless of the transmission position. The parking brake should always be applied when the driver is not in the vehicle.

Shift Positions

For additional information on the appropriate use of each transfer case mode position see the information below:

2WD

Rear Wheel Drive High Range - Normal street and highway driving. Dry hard surfaced roads.

4 PART TIME

Part Time 4-Wheel Drive High Range - Locks the transfer case inter-axle differential. Forces the front and rear wheels to rotate at the same speed. Additional traction for loose, slippery road surfaces only.

4 FULL TIME

Full Time 4-Wheel Drive High Range - Employs an inter-axle differential. This allows front and rear wheels to rotate at different speeds, on all road surfaces.

N

Neutral - Disengages both the front and rear driveshafts from the powertrain. To be used for flat towing behind another vehicle. Refer to "Recreational Towing" in Section 5 for more information.

4LO

Part Time 4-Wheel Drive Low Range - Low speed 4-wheel drive. Locks the transfer case inter-axle differential. Forces the front and rear wheels to rotate at the same speed. Additional traction and maximum pulling power for loose, slippery road surfaces only. Do not exceed 25 mph (40 km/h).

Shifting Procedure**2WD to 4 PART TIME or 4 PART TIME to 2WD**

Shifting between 2WD and 4 PART TIME can be made with the vehicle stopped or in motion. If the vehicle is in motion, shifts can be made up to 55 mph (88 km/h). With the vehicle in motion two momentary releases of the

accelerator pedal may be required after shifting. This will induce a torque interrupt and allow full engagement of the newly selected position. With the vehicle stationary it may be necessary to shift the automatic transmission from D (Drive) to R (Reverse) and back to D (Drive) after shifting. This will allow full engagement of the newly selected position. Apply a constant force when shifting the transfer case lever.

4 PART TIME to 4 FULL TIME or 4 FULL TIME to 4 PART TIME

Shifting between 4 PART TIME and 4 FULL TIME can be made with the vehicle stopped or in motion. If the vehicle is in motion shifts can be made up to 55 mph (88 km/h). With the vehicle in motion two momentary releases of the accelerator pedal may be required after shifting. This will induce a torque interrupt and allow full engagement of the newly selected position. With the vehicle stationary it may be necessary to shift the automatic transmission from D (Drive) to R (Reverse) and back to D (Drive) after

shifting. This will allow full engagement of the newly selected position. Apply a constant force when shifting the transfer case lever.

4 FULL TIME to 4 LO or 4 LO to 4 FULL TIME

With the vehicle rolling at 2 to 3 mph (3 to 5 km/h), shift an automatic transmission to N (Neutral). While the vehicle is coasting at 2 to 3 mph (3 to 5 km/h), shift the transfer case lever firmly to the desired position. Do not pause in transfer case N (Neutral).

NOTE: To shift from 4 FULL TIME to 4LO, the shift lever should be pushed away from the driver, and then rearward into 4LO. In 4 FULL TIME, there is a neutral stop to prevent shifting into N (Neutral) by accident.

NOTE: Pausing in transfer case N (Neutral) in vehicles equipped with an automatic transmission may require shutting the engine OFF to avoid gear clash while

completing the shift. If difficulty occurs, shift transmission to N (Neutral), hold foot on brake, and turn engine OFF. Make shift to desired mode.

NOTE: Shifting into or out of 4LO is possible with the vehicle completely stopped, however difficulty may occur due to the mating clutch teeth not being properly aligned. Several attempts may be required for clutch teeth alignment and shift completion to occur. The preferred method is with the vehicle rolling 2 to 3 mph (3 to 5 km/h). Avoid attempting to engage or disengage 4LO with the vehicle moving faster than 2 to 3 mph (3 to 5 km/h).

TRAC-LOK™ REAR AXLE — IF EQUIPPED

The optional Trac-Lok™ rear axle provides a constant driving force to both rear wheels and reduces wheel spin caused by the loss of traction at one driving wheel. If traction differs between the two rear wheels, the differential automatically proportions the usable torque by providing more torque to the wheel that has traction.

Trac-Lok™ is especially helpful during slippery driving conditions. With both rear wheels on a slippery surface, a slight application of the accelerator will supply maximum traction. When starting with only one rear wheel on an excessively slippery surface, slight application of the parking brake may be necessary to gain maximum traction.

WARNING!

On vehicles equipped with a limited-slip differential, never run the engine with one rear wheel off the ground. The vehicle may drive through the rear wheel remaining on the ground and cause you to lose control of your vehicle.

ON-ROAD DRIVING TIPS

Utility vehicles have higher ground clearance and a narrower track to make them capable of performing in a wide variety of off-road applications. Specific design characteristics give them a higher center of gravity than ordinary cars.

An advantage of the higher ground clearance is a better view of the road, allowing you to anticipate problems. They are not designed for cornering at the same speeds as

conventional 2-wheel drive vehicles any more than low-slung sports cars are designed to perform satisfactorily in off-road conditions. If at all possible, avoid sharp turns or abrupt maneuvers. As with other vehicles of this type, failure to operate this vehicle correctly may result in loss of control or vehicle rollover.

OFF-ROAD DRIVING TIPS**When To Use 4L or 4LO (Low) Range**

When off-road driving, shift to 4L or 4LO for additional traction and control on slippery or difficult terrain, ascending or descending steep hills, and to increase low-speed pulling power. This range should be limited to extreme situations such as deep snow, mud, or sand where additional low speed pulling power is needed. Vehicle speeds in excess of 25 mph (40 km/h) should be avoided when in 4L or 4LO range.

Driving Through Water

Although your vehicle is capable of driving through water, there are a number of precautions that must be considered before entering the water:

CAUTION!

When driving through water, do not exceed 5 mph (8 km/h). Always check water depth before entering as a precaution, and check all fluids afterward. Driving through water may cause damage that may not be covered by the new vehicle limited warranty.

Driving through water more than a few inches deep will require extra caution to ensure safety and prevent damage to your vehicle. If you must drive through water, try to determine the depth and the bottom condition (and location of any obstacles) prior to entering. Proceed with

caution and maintain a steady controlled speed less than 5 mph (8 km/h) in deep water to minimize wave effects.

Flowing Water

If the water is swift flowing and rising (as in storm run-off) avoid crossing until the water level recedes and/or the flow rate is reduced. If you must cross flowing water avoid depths in excess of 9 inches. The flowing water can erode the streambed causing your vehicle to sink into deeper water. Determine exit point(s) that are downstream of your entry point to allow for drifting.

Standing Water

Avoid driving in standing water deeper than 20 inches, and reduce speed appropriately to minimize wave effects. Maximum speed in 20 inches of water is less than 5 mph (8 km/h).

Maintenance

After driving through deep water, inspect your vehicle fluids and lubricants (engine oil, transmission oil, axle, transfer case) to assure the fluids have not been contaminated. Contaminated fluid (milky, foamy in appearance) should be flushed/changed as soon as possible to prevent component damage.

Driving In Snow, Mud and Sand

In heavy snow, when pulling a load, or for additional control at slower speeds, shift the transmission to a low gear and shift the transfer case to 4L or 4LO if necessary. Refer to “Four-Wheel Drive Operation” in this section. Do not shift to a lower gear than necessary to maintain headway. Over-revving the engine can spin the wheels and traction will be lost.

Avoid abrupt downshifts on icy or slippery roads, because engine braking may cause skidding and loss of control.

Hill Climbing

NOTE: Before attempting to climb a hill, determine the conditions at the crest and/or on the other side.

Before climbing a steep hill, shift the transmission to a lower gear and shift the transfer case to 4L or 4LO. Use first gear and 4L or 4LO for very steep hills.

If you stall or begin to lose headway while climbing a steep hill, allow your vehicle to come to a stop and immediately apply the brakes. Restart the engine and shift to R (Reverse). Back slowly down the hill allowing the compression braking of the engine to help regulate your speed. If the brakes are required to control vehicle speed, apply them lightly and avoid locking or skidding the tires.

WARNING!

If the engine stalls or you lose headway or cannot make it to the top of a steep hill or grade, never attempt to turn around. To do so may result in tipping and rolling the vehicle. Always back carefully straight down a hill in R (Reverse) gear. Never back down a hill in N (Neutral) using only the brake.

Remember, never drive diagonally across a hill—always drive straight up or down.

If the wheels start to slip as you approach the crest of a hill, ease off the accelerator and maintain headway by turning the front wheels slowly left and right. This may provide a fresh “bite” into the surface and will usually provide traction to complete the climb.

Traction Downhill

Shift the transmission into a low gear and the transfer case to 4L or 4LO range. Let the vehicle go slowly down the hill with all four wheels turning against engine compression drag. This will permit you to control the vehicle speed and direction.

When descending mountains or hills, repeated braking can cause brake fade with loss of braking control. Avoid repeated heavy braking by downshifting the transmission whenever possible.

After Driving Off-Road

Off-road operation puts more stress on your vehicle than does most on-road driving. After going off-road it is always a good idea to check for damage. That way you can get any problems taken care of right away and have your vehicle ready when you need it.

- Completely inspect the underbody of your vehicle. Check tires, body structure, steering, suspension, and exhaust system for damage.
- Check threaded fasteners for looseness, particularly on the chassis, drivetrain components, steering, and suspension. Retighten them, if required, and torque to the values specified in the Service Manual.
- Check for accumulations of plants or brush. These things could be a fire hazard. They might hide damage to fuel lines, brake hoses, axle pinion seals, and propeller shafts.
- After extended operation in mud, sand, water, or similar dirty conditions, have brake rotors, wheels, brake linings, and axle yokes inspected and cleaned as soon as possible.

WARNING!

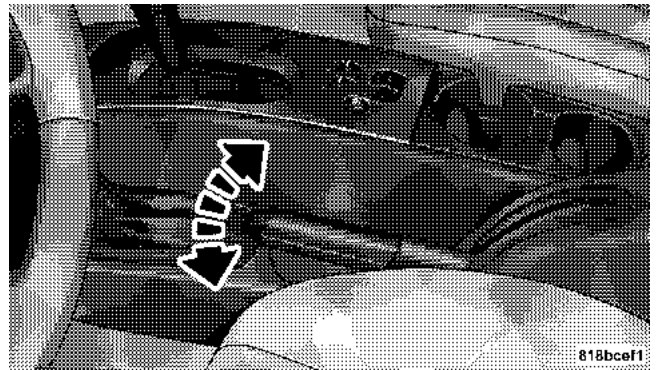
Abrasive material in any part of the brakes may cause excessive wear or unpredictable braking. You might not have full braking power when you need it to prevent an accident. If you have been operating your vehicle in dirty conditions, get your brakes checked and cleaned as necessary.

- If you experience unusual vibration after driving in mud, slush or similar conditions, check the wheels for impacted material. Impacted material can cause a wheel imbalance and freeing the wheels of it will correct the situation.

PARKING BRAKE

To set the parking brake, pull the lever up as firmly as possible. When the parking brake is applied with the ignition ON, the “Brake Warning Light” in the instrument cluster will light. To release the parking brake, pull up slightly, press the center button, then lower the lever completely.

NOTE: The instrument cluster “Brake Warning Light” indicates only that the parking brake is applied. You must be sure the parking brake is fully applied before leaving the vehicle.



Parking Brake

Be sure the parking brake is firmly set when parked, and the gear shift lever is in the P (Park) position (automatic transmission) or R (Reverse) or 1st gear (manual transmission). When parking on a hill, you should apply the parking brake before placing the gear shift lever in P (Park), otherwise the load on the transmission locking mechanism may make it difficult to move the selector out of P (Park).

WARNING!

- Always fully apply the parking brake when leaving your vehicle, or it may roll and cause damage or injury. Also, be certain to leave an automatic transmission in P (Park), a manual transmission in R (Reverse) or 1st gear. Failure to do so may allow the vehicle to roll and cause damage or injury.
- Leaving children in a vehicle unattended is dangerous for a number of reasons. A child or others could be injured. Children should be warned not to touch the parking brake or the gear selector lever. Don't leave the keys in the ignition. A child could operate power windows, other controls, or move the vehicle.
- Be sure the parking brake is fully disengaged before driving, failure to do so can lead to brake problems due to excessive heating of the rear brakes.

When parking on a hill, turn the front wheels toward the curb on a downhill grade and away from the curb on an uphill grade.

The parking brake should always be applied whenever the driver is not in the vehicle.

ANTI-LOCK BRAKE SYSTEM — IF EQUIPPED

The Anti-Lock Brake System is designed to aid the driver in maintaining vehicle control under adverse braking conditions. The system operates with a separate computer to modulate hydraulic pressure to prevent wheel lock-up and help avoid skidding on slippery surfaces.

All vehicle wheels and tires must be the same size and type and tires must be properly inflated to produce accurate signals for the computer.

WARNING!

Significant over or under-inflation of tires, or mixing sizes of tires or wheels on the vehicle can lead to loss of braking effectiveness.

The Anti-Lock Brake System conducts a low speed self-test at about 12 mph (20 km/h). If for any reason, your foot is on the brake when the vehicle reaches 12 mph (20 km/h), this check will be delayed until 25 mph (40 km/h).

The Anti-Lock Brake System pump motor runs during the self-test and during an ABS stop to provide the regulated hydraulic pressure. The motor pump makes a low humming noise during operation, this is normal.

During off-road use, loss of traction can temporarily defeat the system and cause the warning light to illuminate. Turn the ignition OFF and ON again to restore Anti-Lock Brake System function.

WARNING!

Pumping of the Anti-Lock Brakes will diminish their effectiveness and may lead to an accident. Pumping makes the stopping distance longer. Just press firmly on your brake pedal when you need to slow down or stop.

WARNING!

- Anti-lock system (ABS) cannot prevent the natural laws of physics from acting on the vehicle, nor can it increase braking or steering efficiency beyond that afforded by the condition of the vehicle brakes and tires or the traction afforded.
- The ABS cannot prevent accidents, including those resulting from excessive speed in turns, following another vehicle too closely, or hydroplaning. Only a safe, attentive, and skillful driver can prevent accidents.
- The capabilities of an ABS equipped vehicle must never be exploited in a reckless or dangerous manner which could jeopardize the user's safety or the safety of others.

CAUTION!

The Anti-Lock Brake System is subject to possible detrimental effects of electronic interference caused by improperly installed aftermarket radios or telephones.

NOTE: During severe braking conditions, a pulsing sensation may occur and a clicking noise will be heard. This is normal, indicating that the Anti-Lock Brake System is functioning.

POWER STEERING

The standard power steering system will give you good vehicle response and increased ease of maneuverability in tight spaces. The system will provide mechanical steering capability if power assist is lost.

If for some reason the power assist is interrupted, it will still be possible to steer your vehicle. Under these conditions, you will observe a substantial increase in steering effort, especially at very low vehicle speeds and during parking maneuvers.

NOTE: Increased noise levels at the end of the steering wheel travel are considered normal and do not indicate that there is a problem with the power steering system.

Upon initial start-up in cold weather, the power steering pump may make noise for a short amount of time. This is due to the cold, thick fluid in the steering system. This noise should be considered normal, and does not in any way damage the steering system.

WARNING!

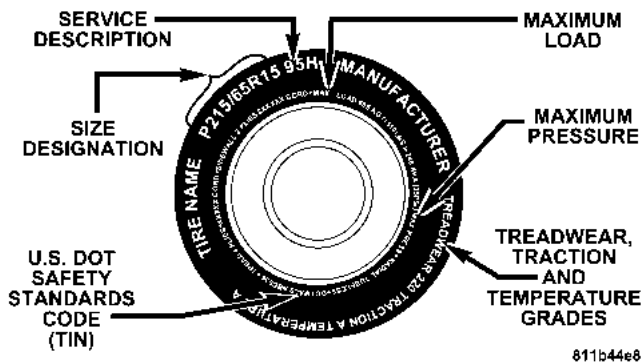
Continued operation with reduced power steering assist could pose a safety risk to yourself and others. Service should be obtained as soon as possible.

CAUTION!

Prolonged operation of the steering system at the end of the steering wheel travel will increase the steering fluid temperature and it should be avoided when possible. Damage to the power steering pump may occur.

TIRE SAFETY INFORMATION

Tire Markings



NOTE:

- P(Passenger)-Metric tire sizing is based on U.S. design standards. P-Metric tires have the letter "P" molded into the sidewall preceding the size designation. Example: P215/65R15 95H.
- European Metric tire sizing is based on European design standards. Tires designed to this standard have the tire size molded into the sidewall beginning with the section width. The letter "P" is absent from this tire size designation. Example: 215/65R15 96H
- LT(Light Truck)-Metric tire sizing is based on U.S. design standards. The size designation for LT-Metric tires is the same as for P-Metric tires except for the letters "LT" that are molded into the sidewall preceding the size designation. Example: LT235/85R16.
- Temporary Spare tires are high pressure compact spares designed for temporary emergency use only. Tires designed to this standard have the letter "T" molded into the sidewall preceding the size designation. Example: T145/80D18 103M.
- High Flotation tire sizing is based on U.S. design standards and begins with the tire diameter molded into the sidewall. Example: 31x10.5 R15 LT.

Tire Sizing Chart

EXAMPLE:	
Size Designation:	
	P = Passenger car tire size based on U.S. design standards
	"...blank..." = Passenger car tire based on European design standards
	LT = Light Truck tire based on U.S. design standards
	T = Temporary Spare tire
	31 = Overall Diameter in Inches (in)
	215 = Section Width in Millimeters (mm)
	65 = Aspect Ratio in Percent (%) —Ratio of section height to section width of tire.
	10.5 = Section Width in Inches (in)
	R = Construction Code —"R" means Radial Construction. —"D" means Diagonal or Bias Construction.
	15 = Rim Diameter in Inches (in)

EXAMPLE:**Service Description:**

95 = Load Index

—A numerical code associated with the maximum load a tire can carry.

H = Speed Symbol

—A symbol indicating the range of speeds at which a tire can carry a load corresponding to its load index under certain operating conditions.

—The maximum speed corresponding to the Speed Symbol should only be achieved under specified operating conditions. (ie. tire pressure, vehicle loading, road conditions and posted speed limits).

Load Identification:

"...blank..." = Absence of any text on sidewall of the tire indicates a Standard Load (SL) Tire

Extra Load (XL) = Extra Load (or Reinforced) Tire

Light Load = Light Load Tire

C,D,E = Load range associated with the maximum load a tire can carry at a specified pressure

Maximum Load — Maximum Load indicates the maximum load this tire is designed to carry.

Maximum Pressure — Maximum Pressure indicates the maximum permissible cold tire inflation pressure for this tire.

Tire Identification Number (TIN)

The TIN may be found on one or both sides of the tire however the date code may only be on one side. Tires with white sidewalls will have the full TIN including date code

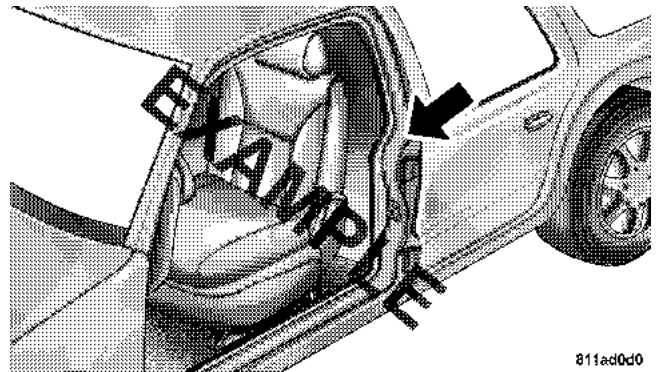
located on the white sidewall side of the tire. Look for the TIN on the outboard side of black sidewall tires as mounted on the vehicle. If the TIN is not found on the outboard side then you will find it on the inboard side of the tire.

EXAMPLE:
DOT MA L9 ABCD 0301
DOT = Department of Transportation —This symbol certifies that the tire is in compliance with the U.S. Department of Transportation tire safety standards, and is approved for highway use.
MA = Code representing the tire manufacturing location.(2 digits)
L9 = Code representing the tire size.(2 digits)
ABCD = Code used by tire manufacturer.(1 to 4 digits)
03 = Number representing the week in which the tire was manufactured.(2 digits) —03 means the 3rd week.
01 = Number representing the year in which the tire was manufactured.(2 digits) —01 means the year 2001. —Prior to July 2000, tire manufacturers were only required to have 1 number to represent the year in which the tire was manufactured. Example: 031 could represent the 3rd week of 1981 or 1991.

Tire Loading and Tire Pressure

Tire Placard Location

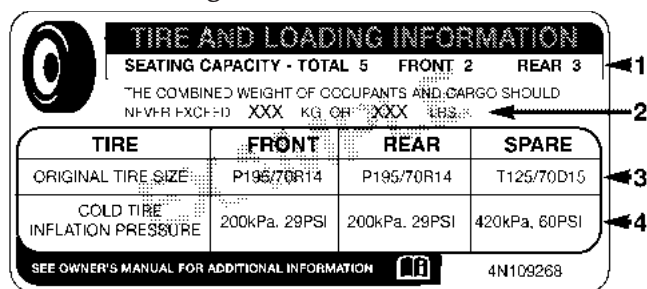
NOTE: The proper cold tire inflation pressure for passenger cars is listed on either the face of the driver's door or the driver's side "B" pillar. For vehicles other than passenger cars, the cold tire inflation pressures are listed on either the shutface of the driver's door, the "B" pillar, the Certification Label or in the Tire Inflation Pressures brochure in the glove compartment.



811ad0d0

Tire Placard Location

Tire and Loading Information Placard



811b5a9a

Tire and Loading Information

This placard tells you important information about the:

- 1) number of people that can be carried in the vehicle
- 2) the total weight your vehicle can carry
- 3) the tire size designed for your vehicle
- 4) the cold tire inflation pressures for the front, rear and spare tires.

Loading

The vehicle maximum load on the tire must not exceed the load carrying capacity of the tire on your vehicle. You will not exceed the tire’s load carrying capacity if you adhere to the loading conditions, tire size and cold tire inflation pressures specified on the Tire and Loading Information placard and the Vehicle Loading section of this manual.

NOTE: Under a maximum loaded vehicle condition, gross axle weight ratings (GAWR’s) for the front and rear axles must not be exceeded. For further information on GAWR’s, vehicle loading and trailer towing, see the Vehicle Loading section of this manual.

To determine the maximum loading conditions of your vehicle, locate the statement “The combined weight of occupants and cargo should never exceed XXX kg or XXX lbs.” on the Tire and Loading Information placard. The

combined weight of occupants, cargo/luggage and trailer tongue weight (if applicable) should never exceed the weight referenced here.

Steps for Determining Correct Load Limit

1. Locate the statement "The combined weight of occupants and cargo should never exceed XXX pounds" on your vehicle's placard.
2. Determine the combined weight of the driver and passengers that will be riding in your vehicle.
3. Subtract the combined weight of the driver and passengers from XXX kilograms or XXX pounds.
4. The resulting figure equals the available amount of cargo and luggage load capacity. For example, if "XXX" amount equals 1400 lbs. and there will be five 150 lb. passengers in your vehicle, the amount of available cargo and luggage load capacity is 650 lb. (since $5 \times 150 = 750$, and $1400 - 750 = 650$ lb.)

5. Determine the combined weight of luggage and cargo being loaded on the vehicle. That weight may not safely exceed the available cargo and luggage load capacity calculated in step 4.

6. If your vehicle will be towing a trailer, load from your trailer will be transferred to your vehicle. Consult this manual to determine how this reduces the available cargo and luggage load capacity of your vehicle.

NOTE: The following table shows examples on how to calculate total load, cargo/luggage and towing capacities of your vehicle with varying seating configurations and number and size of occupants. This table is for illustration purposes only and may not be accurate for the seating and load carry capacity of your vehicle.

NOTE: For the following example the combined weight of occupants and cargo should never exceed 865 lbs. (392 Kg).

252 STARTING AND OPERATING

Occupants			Combined weight of occupants and cargo from Tire Placard	MINUS	Combined Occupant's weight	=	AVAILABLE Cargo/Luggage and Trailer Tongue Weight
TOTAL	FRONT	REAR					
<u>EXAMPLE 1</u>			865 lbs	minus	Occupant 1: 200 lbs Occupant 2: 130 lbs Occupant 3: 160 lbs Occupant 4: 150 lbs Occupant 5: 80 lbs TOTAL WEIGHT: 670 lbs	=	195 lbs
5	2	3					
<u>EXAMPLE 2</u>			865 lbs	minus	Occupant 1: 210 lbs Occupant 2: 180 lbs Occupant 3: 150 lbs TOTAL WEIGHT: 540 lbs	=	325 lbs
3	2	1					
<u>EXAMPLE 3</u>			865 lbs	minus	Occupant 1: 200 lbs Occupant 2: 200 lbs TOTAL WEIGHT: 400 lbs	=	465 lbs
2	2	0					

WARNING!

Overloading of your tires is dangerous. Overloading can cause tire failure, affect vehicle handling, and increase your stopping distance. Use tires of the recommended load capacity for your vehicle. Never overload them.

TIRES — GENERAL INFORMATION**Tire Pressure**

Proper tire inflation pressure is essential to the safe and satisfactory operation of your vehicle. Three primary areas are affected by improper tire pressure:

1. Safety—**WARNING!**

Improperly inflated tires are dangerous and can cause accidents.

- Under inflation increases tire flexing and can result in tire failure.
- Over inflation reduces a tire's ability to cushion shock. Objects on the road and chuck holes can cause damage that results in tire failure.
- Unequal tire pressures can cause steering problems. You could lose control of your vehicle.
- Overinflated or under inflated tires can affect vehicle handling and can fail suddenly, resulting in loss of vehicle control.
- Unequal tire pressures from one side of the vehicle to the other can cause the vehicle to drift to the right or left. Always drive with each tire properly inflated.

2. *Economy*—

Improper inflation pressures can cause uneven wear patterns to develop across the tire tread. These abnormal wear patterns will reduce tread life resulting in a need for earlier tire replacement. Under inflation also increases tire rolling resistance and results in higher fuel consumption.

3. *Ride Comfort and Vehicle Stability*—

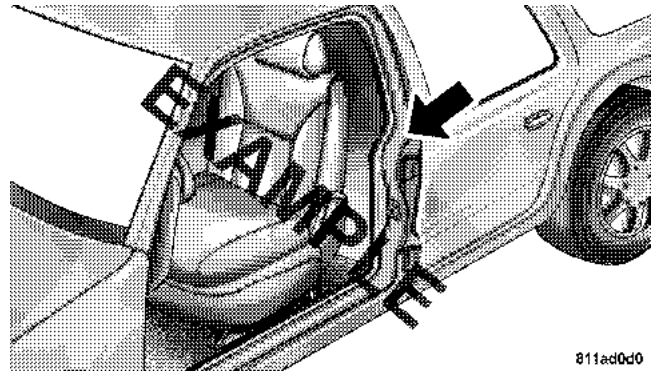
Proper tire inflation contributes to a comfortable ride. Over inflation produces a jarring and uncomfortable ride. Both under inflation and over inflation affect the stability of the vehicle and can produce a feeling of sluggish response or over responsiveness in the steering.

Unequal tire pressures can cause erratic and unpredictable steering response.

Unequal tire pressure from side to side may cause the vehicle to drift left or right.

Tire Inflation Pressures

The proper cold tire inflation pressure is listed on either the face of the driver's door, or the driver's side "B" pillar.



811ad0d0

Tire Placard Location

The pressure should be checked and adjusted as well as inspecting for signs of tire wear or visible damage at least once a month. Use a good quality pocket-type gauge to

check tire pressure. Do not make a visual judgement when determining proper inflation. Radial tires may look properly inflated even when they are under inflated.

CAUTION!

After inspecting or adjusting the tire pressure always reinstall the valve stem cap—if equipped. This will prevent moisture and dirt from entering the valve stem, which could damage the valve stem.

Inflation pressures specified on the placard are always “cold tire inflation pressure”. Cold tire inflation pressure is defined as the tire pressure after the vehicle has not been driven for at least 3 hours, or driven less than 1 mile (1 km) after a 3 hour period. The cold tire inflation pressure must not exceed the maximum inflation pressure molded into the tire side wall.

Check tire pressures more often if subject to a wide range of outdoor temperatures, as tire pressures vary with temperature changes.

Tire pressures change by approximately 1 psi (7 kPa) per 12° F (7° C) of air temperature change. Keep this in mind when checking tire pressure inside a garage especially in the winter.

Example: If garage temperature = 68° F (20° C) and the outside temperature = 32° F (0° C) then the cold tire inflation pressure should be increased by 3 psi (21 kPa), which equals 1 psi (7 kPa) for every 12° F (7° C) for this outside temperature condition.

Tire pressure may increase from 2 to 6 psi (13 to 40 kPa) during operation. DO NOT reduce this normal pressure build up or your tire pressure will be too low.

Tire Pressures for High Speed Operation

The manufacturer advocates driving at safe speeds within posted speed limits. Where speed limits or conditions are such that the vehicle can be driven at high speeds, maintaining correct tire inflation pressure is very important. Increased tire pressure and reduced vehicle loading may be required for high speed vehicle operation. Refer to original equipment or an authorized tire dealer for recommended safe operating speeds, loading and cold tire inflation pressures.

WARNING!

High speed driving with your vehicle under maximum load is dangerous. The added strain on your tires could cause them to fail. You could have a serious accident. Don't drive a vehicle loaded to the maximum capacity at continuous speeds above 75 mph (120 km/h).

Radial-Ply Tires

WARNING!

Combining radial ply tires with other types of tires on your vehicle will cause your vehicle to handle poorly. The instability could cause an accident. Always use radial tires in sets of four. Never combine them with other types of tires.

Cuts and punctures in radial tires are repairable only in the tread area because of sidewall flexing. Consult your dealer for radial tire repairs.

Tire Spinning

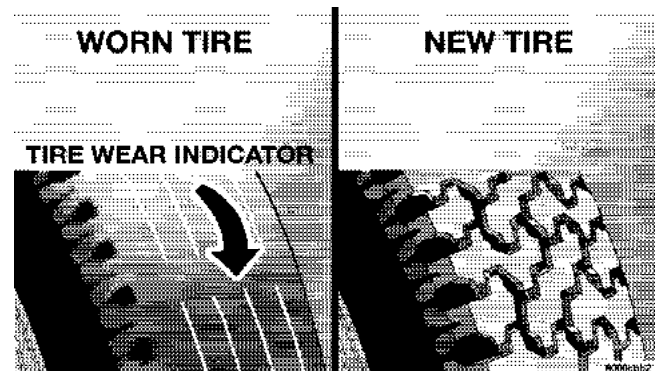
When stuck in mud, sand, snow, or ice conditions, do not spin your vehicle's wheels above 35 mph (55 km/h).

WARNING!

Fast spinning tires can be dangerous. Forces generated by excessive wheel speeds may cause tire damage or failure. A tire could explode and injure someone. Do not spin your vehicle's wheels faster than 35 mph (55 km/h) when you are stuck, and do not let anyone near a spinning wheel no matter what the speed.

Tread Wear Indicators

Tread wear indicators are in the original equipment tires to help you in determining when your tires should be replaced.



These indicators are molded into the bottom of the tread grooves and will appear as bands when the tread depth becomes 1/16 inch (2 mm). When the indicators appear in 2 or more adjacent grooves, the tire should be replaced.

Many states have laws requiring tire replacement at this point.

Life of Tire

The service life of a tire is dependent upon varying factors including but not limited to:

- Driving style
- Tire pressure
- Distance driven

WARNING!

Tires and spare tire should be replaced after six years, regardless of the remaining tread. Failure to follow this warning can result in sudden tire failure. You could lose control and have an accident resulting in serious injury or death.

Keep unmounted tires in a cool, dry place with as little exposure to light as possible. Protect tires from contact with oil, grease and gasoline.

Replacement Tires

The tires on your new vehicle provide a balance of many characteristics. They should be inspected regularly for wear and correct cold tire inflation pressure. The manufacturer strongly recommends that you use tires equivalent to the originals in size, quality and performance when replacement is needed (see the paragraph on tread wear indicators). Refer to the Tire and Loading Information placard for the size designation of your tire. The service description and load identification will be found on the original equipment tire. Failure to use equivalent replacement tires may adversely affect the safety, handling, and ride of your vehicle. We recommend that you contact your original equipment or an authorized tire dealer with any questions you may have on tire specifications or capability.

WARNING!

- Do not use a tire, wheel size or rating other than that specified for your vehicle. Some combinations of unapproved tires and wheels may change suspension dimensions and performance characteristics, resulting in changes to steering, handling, and braking of your vehicle. This can cause unpredictable handling and stress to steering and suspension components. You could lose control and have an accident resulting in serious injury or death. Use only the tire and wheel sizes with load ratings approved for your vehicle.
- Never use a tire with a smaller load index or capacity, other than what was originally equipped on your vehicle. Using a tire with a smaller load index could result in tire overloading and failure. You could lose control and have an accident.
- Failure to equip your vehicle with tires having adequate speed capability can result in sudden tire failure and loss of vehicle control.

CAUTION!

Replacing original tires with tires of a different size may result in false speedometer and odometer readings.

Alignment and Balance

Poor suspension alignment may result in:

- Fast tire wear.
- Uneven tire wear, such as feathering and one-sided wear.
- Vehicle pull to right or left.

Tires may also cause the vehicle to pull left or right. Alignment will not correct this problem. See your authorized dealer for proper diagnosis.

Improper alignment will not cause vehicle vibration. Vibration may be a result of tire and wheel out-of-balance. Proper balancing will reduce vibration and avoid tire cupping and spotty wear.

TIRE CHAINS**CAUTION!**

To avoid damage to your vehicle or tires, observe the following precautions:

- Because of restricted chain clearance between tires and other suspension components, it is important that only chains in good condition are used. Broken chains can cause serious damage. Stop the vehicle immediately if noise occurs that could indicate chain breakage. Remove the damaged parts of the chain before further use.
- Install chains on the rear wheels as tightly as possible and then retighten after driving about ½ mile (0.8 km).
- Do not exceed 30 mph (48 km/h).
- Drive cautiously and avoid severe turns and large bumps, especially with a loaded vehicle.
- Do not drive for prolonged period on dry pavement.
- Observe the tire chain manufacturer's instructions on the method of installation, operating speed, and conditions for use. Always use the lower suggested operating speed of the chain manufacturer if different than the speed recommended by the manufacture.

Tire chains that are recommended for this vehicle are listed below:

- Mopar® P/N 82206828 with P235/70R16 and P235/65R17 tires.
- Mopar® P/N 82207074 with P215/75R16 tires.

NOTE: In order to avoid damage to tires, chains, and your vehicle do not drive for a prolonged period of time on dry pavement. Observe the tire chain manufacturer's instructions on method of installation, operating speed, and conditions for usage.

Always use the lower suggested operating speed if both the chain manufacturer and vehicle manufacturer suggest a maximum speed. This notice applies to all chain traction devices, including link and cable (radial) chains.

TIRE ROTATION RECOMMENDATIONS

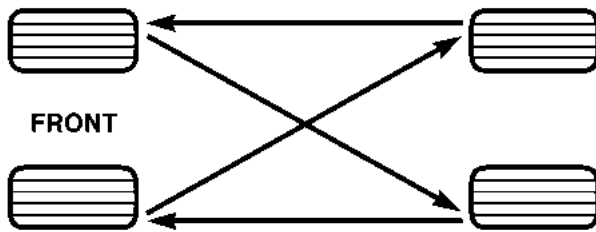
Tires on the front and rear axles of vehicles operate at different loads and perform different steering, handling, and braking functions. For these reasons, they wear at unequal rates, and develop irregular wear patterns.

These effects can be reduced by timely rotation of tires. The benefits of rotation are especially worthwhile with aggressive tread designs such as those on On/Off Road type tires. Rotation will increase tread life, help to maintain mud, snow, and wet traction levels, and contribute to a smooth, quiet ride.

Follow the recommended tire rotation frequency for your type of driving found in the "Maintenance Schedules" Section of this manual. More frequent rotation is permissible if desired. The reasons for any rapid or unusual wear should be corrected prior to rotation being performed.

NOTE: The Premium Tire Pressure Monitor System will automatically locate the pressure values displayed in the correct vehicle position following a tire rotation.

The suggested rotation method is the “forward-cross” shown in the following diagram.



8031e864

TIRE PRESSURE MONITOR SYSTEM (TPMS)

The Tire Pressure Monitoring System (TPMS) will warn the driver of a low tire pressure based on the vehicle recommended cold tire pressure.

The tire pressure will vary with temperature by about 1 psi (7 kPa) for every 12°F (-11°C). This means that when the outside temperature decreases, the tire pressure will decrease. Tire pressure should always be set based on cold inflation tire pressure. This is defined as the tire pressure after a vehicle has not been driven for more than 3 hours - and in outside ambient temperature. **Refer to the “Tires – General Information” in this section for information on how to properly inflate the vehicle’s tires.** The tire pressure will also increase as the vehicle is driven - this is normal and there should be no adjustment for this increased pressure.

The TPM System will warn the driver of a low tire pressure if the tire pressure falls below the low pressure warning threshold for any reason, including low temperature effects.

The TPM System will continue to warn the driver of low tire pressure as long as the condition exists, and will not turn off until the tire pressure is at or above recommended cold tire pressure. Once the "Tire Pressure Monitoring Telltale Light" has been illuminated, the tire pressure must be increased to the recommended cold tire pressure in order for the "Tire Pressure Monitoring Telltale Light" to be turned off. The system will automatically update, and the "Tire Pressure Monitoring Telltale Light" will extinguish once the updated tire pressures have been received. The vehicle may need to be driven for up to 10 minutes above 15 mph (24 km/h) to receive this information.

For example, your vehicle has a recommended cold (parked for more than 3 hours) tire pressure of 33 psi (227 kPa). If the ambient temperature is 68°F (20°C) and the measured tire pressure is 28 psi (193 kPa), a temperature drop to 20°F (-7°C) will decrease the tire pressure to approximately 24 psi (165 kPa). This tire pressure is sufficiently low enough to turn ON the "Tire Pressure Monitoring Telltale Light." Driving the vehicle may cause the tire pressure to rise to approximately 28 psi (193 kPa), but the "Tire Pressure Monitoring Telltale Light" will still be ON. In this situation, the "Tire Pressure Monitoring Telltale Light" will turn OFF only after the tires have been inflated to the vehicle's recommended cold tire pressure value.

NOTE: Seasonal temperature changes will affect tire pressure, and the TPM system will monitor the actual tire pressure in the tire.

Base System — If Equipped

The Tire Pressure Monitor System (TPMS) uses wireless technology with wheel rim mounted electronic sensors to monitor tire pressure levels. Sensors, mounted to each wheel as part of the valve stem, transmit tire pressure readings to the Receiver Module.

NOTE: It is particularly important, for you to check the tire pressure in all of your tires regularly and to maintain the proper pressure.

The Tire Pressure Monitor System (TPMS) consists of the following components:

- Receiver Module
- 4 Tire Pressure Monitoring Sensors
- Tire Pressure Monitoring Telltale Light

A tire pressure monitoring sensor is located in the spare wheel if the vehicle is equipped with a matching full size

spare wheel and tire assembly. The matching full size spare tire can be used in place of any of the four road tires.



The “Tire Pressure Monitoring Telltale Light” will illuminate in the instrument cluster, and an audible chime will be activated when one or more of the four active road tire pressures are low. The audible chime will sound once every ignition cycle for each condition that it detects. Should this occur, you should stop as soon as possible, check the inflation pressure of each tire on your vehicle, and inflate each tire to the vehicle’s recommended cold tire pressure. The system will automatically update, and the “Tire Pressure Monitoring Light” will extinguish once the updated tire pressures have been received. The vehicle may need to be driven for up to 10 minutes above 15 mph (24 km/h) to receive this information. A low spare tire will not cause the “Tire Pressure Monitoring Telltale Light” to illuminate or the chime to sound.

The “Tire Pressure Monitoring Telltale Light” will flash on and off for 60 seconds, and an audible chime will sound when a system fault is detected. The flash cycle will repeat every ten minutes, without an audible chime, until the fault condition no longer exists. If the ignition key is cycled, this sequence will repeat, providing the system fault still exists.

NOTE: In the event that the matching full size spare tire is swapped with a low pressure road tire, the next ignition key cycle will still show the “Tire Pressure Monitoring Telltale Light” to be ON, and a chime to sound. Driving the vehicle for up to 10 minutes above 15 mph (24 km/h) will turn OFF the “Tire Pressure Monitoring Telltale Light” as long as the spare tire or any other road tire(s) are not below the low pressure warning threshold.

CAUTION!

The TPMS has been optimized for the original equipment tires and wheels. TPMS pressures have been established for the tire size equipped on your vehicle. Undesirable system operation or sensor damage may result when using replacement equipment that is not of the same size, type, and/or style. After-market wheels can cause sensor damage. Do not use tire sealant from a can, or balance beads if your vehicle is equipped with a TPMS, as damage to the sensors may result.

CAUTION!

After inspecting or adjusting the tire pressure always reinstall the valve stem cap. This will prevent moisture and dirt from entering the valve stem, which could damage the Tire Pressure Monitoring Sensor.

NOTE:

- The TPMS is not intended to replace normal tire care and maintenance, or to provide warning of a tire failure or condition.
- The TPMS should not be used as a tire pressure gauge while adjusting your tire pressure.
- Driving on a significantly under-inflated tire causes the tire to overheat and can lead to tire failure.

Under-inflation also reduces fuel efficiency and tire tread life, and may affect the vehicle's handling and stopping ability.

- The TPMS is not a substitute for proper tire maintenance, and it is the driver's responsibility to maintain correct tire pressure, even if under-inflation has not reached the level to trigger illumination of the "Tire Pressure Monitoring Telltale Light."

Base System with Electronic Vehicle Information Center (EVIC)– If Equipped

The Tire Pressure Monitor System (TPMS) uses wireless technology with wheel rim mounted electronic sensors to monitor tire pressure levels. Sensors, mounted to each wheel as part of the valve stem, transmit tire pressure readings to the Receiver Module.

NOTE: It is particularly important, for you to check the tire pressure in all of your tires regularly and to maintain the proper pressure.

The Tire Pressure Monitor System (TPMS) consists of the following components:

- Receiver Module
- 4 Wheel Sensors
- Various Tire Pressure Monitoring System Messages, which display in the Electronic Vehicle Information Center (EVIC). Refer to Section 4 of this manual.
- Tire Pressure Monitoring Telltale Light

A tire pressure monitoring sensor is located in the spare wheel if the vehicle is equipped with a matching full size spare wheel and tire assembly. The matching full size spare tire can be used in place of any of the four road tires.



The “Tire Pressure Monitoring Telltale Light” will illuminate in the instrument cluster, and an audible chime will be activated when one or more of

the four active road tire pressures are low. The audible chime will sound once every ignition cycle for each condition that it detects. Should this occur, you should stop as soon as possible, check the inflation pressure of each tire on your vehicle, and inflate each tire to the pressure recommended by the vehicle manufacturer. Once the proper tire pressure is set, the “Tire Pressure Monitoring Telltale Light” will reset automatically after driving the vehicle for at least 10 minutes at or above 15 mph (24 km/h).

NOTE: Your vehicle is equipped with a matching full size spare tire, a low matching full size spare tire will set the “SPARE LOW PRESSURE” text message, but it will not cause the “Tire Pressure Monitoring Telltale Light” to illuminate or the chime to sound.

The “Tire Pressure Monitoring Telltale Light” will flash on and off for 60 seconds, and an audible chime will sound when a system fault is detected. In addition, the

Electronic Vehicle Information Center (EVIC) will display a "CHECK TPM SYSTEM" text message. The flash cycle will repeat every ten minutes, without an audible chime, until the fault condition no longer exists. If the ignition key is cycled, this sequence will repeat, providing the system fault still exists.

NOTE: In the event that the matching full size spare tire is swapped with a low pressure road tire, the next ignition key cycle will still show the "Tire Pressure Monitoring Telltale Light" to be ON, and a chime to sound. Driving the vehicle for up to 10 minutes above 15 mph (24 km/h) will turn OFF the "Tire Pressure Monitoring Telltale Light" as long as the spare tire or any other road tire(s) are not below the low pressure warning threshold. The Electronic Vehicle Information Center (EVIC) will also display a "SPARE LOW PRESSURE" text message.

Premium System — If Equipped

The Tire Pressure Monitor System (TPMS) uses wireless technology with wheel rim mounted electronic sensors to monitor tire pressure levels. Sensors, mounted to each wheel as part of the valve stem, transmit tire pressure readings to the Receiver Module.

NOTE: It is particularly important, for you to check the tire pressure in all of your tires regularly and to maintain the proper pressure.


The Tire Pressure Monitor System (TPMS) consists of the following components:

- Receiver Module
- 4 Tire Pressure Monitoring Sensors
- 3 Trigger Modules (mounted in three of the four wheel wells)

- Various Tire Pressure Monitoring System Messages, which display in the Electronic Vehicle Information Center (EVIC)
- Tire Pressure Monitoring Telltale Light

A tire pressure monitoring sensor is located in the spare wheel if the vehicle is equipped with a matching full size spare wheel and tire assembly. The matching full size spare tire can be used in place of any of the four road tires.


Tire Pressure Monitoring Low Pressure Warnings

 The “Tire Pressure Monitoring Telltale Light” will illuminate in the instrument cluster, and an audible chime will be activated when one or more of the four active road tire pressures are low. The audible chime will sound once every ignition cycle for each condition that it detects. In addition, the Electronic Vehicle Information Center (EVIC) will display one or more Low Pressure messages (Left Front, Left Rear, Right Front, Right Rear) for 3 seconds, and a graphic display of

the pressure value(s) with the low tire(s) flashing. Refer to “Electronic Vehicle Information Center (EVIC)” in Section 4 of this manual.

NOTE: Your vehicle is equipped with a matching full size spare tire, a low matching full size spare tire will set the “SPARE LOW PRESSURE” text message, but it will not cause the “Tire Pressure Monitoring Telltale Light” to illuminate or the chime to sound.

NOTE: Your system can be set to display pressure units in PSI, kPa, or BAR.

TIRE	35		34
PSI	24		34


Should a low tire condition occur on any of the four active road tire(s), you should stop as soon as possible, and inflate the low tire(s) that is flashing on the graphic display to the vehicle's recommended cold tire pressure. The system will automatically update, the graphic display of the pressure value(s) will stop flashing, and the "Tire Pressure Monitoring Telltale Light" will extinguish once the updated tire pressure(s) have been received. The vehicle may need to be driven for up to 10 minutes above 15 mph (24 km/h) to receive this information.

Check TPM System

The "Tire Pressure Monitoring Telltale Light" will flash on and off for 60 seconds, and an audible chime will sound when a system fault is detected. The flash cycle will repeat every ten minutes, without an audible chime, until the fault condition no longer exists. The EVIC will display the "CHECK TPM SYSTEM" message for 3 seconds. This text message is then followed by a graphic,

with "--" displayed for the pressure value(s) indicating which of the Tire Pressure Monitoring Sensor(s) is not being received.

NOTE: Your system can be set to display pressure units in PSI, kPA, or BAR.

TIRE	35		34
PSI	--		34

81971362

If the ignition key is cycled, this sequence will repeat, providing the system fault still exists. If the system fault no longer exists, the "Tire Pressure Monitoring Telltale

Light” will no longer flash, the “CHECK TPM SYSTEM” text message will no longer display, and a pressure value will be displayed instead of dashes.

NOTE: In the event that the matching full size spare tire is swapped with a low pressure road tire, the next ignition key cycle will still show the “Tire Pressure Monitoring Telltale Light” to be ON, a chime to sound, a Low Pressure message to appear in the EVIC, and the graphic display will still show the low tire pressure value flashing. Driving the vehicle for up to 10 minutes above 15 mph (24 km/h) will turn off the “Tire Pressure Monitoring Telltale Light” as long as the matching full size spare tire or any other road tire(s) are not below the low pressure warning threshold. The EVIC will display a “Spare Low Pressure” text message, and the graphic display will show a new tire pressure value in place of the flashing low tire pressure value.

CAUTION!

The TPMS has been optimized for the original equipment tires and wheels. TPMS pressures have been established for the tire size equipped on your vehicle. Undesirable system operation or sensor damage may result when using replacement equipment that is not of the same size, type, and/or style. After-market wheels can cause sensor damage. Do not use tire sealant from a can, or balance beads if your vehicle is equipped with a TPMS, as damage to the sensors may result.

CAUTION!

After inspecting or adjusting the tire pressure always reinstall the valve stem cap. This will prevent moisture and dirt from entering the valve stem, which could damage the wheel rim sensor.

NOTE:

- The TPMS is not intended to replace normal tire care and maintenance, nor to provide warning of a tire failure or condition.
- The TPMS should not be used as a tire pressure gauge while adjusting your tire pressure.
- Driving on a significantly under-inflated tire causes the tire to overheat and can lead to tire failure. Under-inflation also reduces fuel efficiency and tire tread life, and may affect the vehicle’s handling and stopping ability.

- The TPMS is not a substitute for proper tire maintenance, and it is the driver’s responsibility to maintain correct tire pressure, even if under-inflation has not reached the level to trigger illumination of the “Tire Pressure Monitoring Telltale Light.”

General Information

This device complies with part 15 of the FCC rules and RSS 210 of Industry Canada. Operation is subject to the following conditions:

- This device may not cause harmful interference.
- This device must accept any interference received, including interference that may cause undesired operation.

The tire pressure sensors are covered under one of the following licenses:

United States KR5S120123
 Canada 2671-S120123

FUEL REQUIREMENTS (GASOLINE ENGINES)

Your engine is designed to meet all emissions regulations and provide excellent fuel economy and performance when using high quality unleaded gasoline having an octane rating of 87. The use of premium gasoline is not recommended. The use of premium gasoline will provide no benefit over high quality regular gasoline, and in some circumstances may result in poorer performance.

Mid-grade gasoline (89 octane) will enhance engine performance during the following conditions:

- Hot weather
- Towing
- Hard accelerations
- Hilly terrain
- Low humidity

Light spark knock at low engine speeds is not harmful to your engine. However, continued heavy spark knock at high speeds can cause damage and immediate service is required.

Poor quality gasoline can cause problems such as hard starting, stalling and hesitations. If you experience these symptoms, try another brand of “regular” gasoline before considering service for the vehicle.

Over 40 auto manufacturer’s world wide have issued and endorsed consistent gasoline specifications (the World-wide Fuel Charter, WWFC) to define fuel properties necessary to deliver enhanced emissions, performance, and durability for your vehicle. The manufacturer recommends the use of gasoline that meets the WWFC specifications if they are available.

Reformulated Gasoline

Many areas of the country require the use of cleaner burning gasoline referred to as "Reformulated Gasoline."

Reformulated gasolines contain oxygenates, and are specifically blended to reduce vehicle emissions and improve air quality.

The manufacturer supports the use of reformulated gasolines. Properly blended reformulated gasolines will provide excellent performance and durability of engine and fuel system components.

Gasoline/Oxygenate Blends

Some fuel suppliers blend unleaded gasoline with oxygenates such as 10% ethanol, MTBE, and ETBE. Oxygenates are required in some areas of the country during the winter months to reduce carbon monoxide emissions. Fuels blended with these oxygenates may be used in your vehicle.

CAUTION!

DO NOT use gasolines containing Methanol or E85 Ethanol. Use of these blends may result in starting and driveability problems and may damage critical fuel system components.

Problems that result from using methanol/gasoline or E85 Ethanol blends are not the responsibility of the manufacturer. While MTBE is an oxygenate made from Methanol, it does not have the negative effects of Methanol.

MMT In Gasoline

MMT is a manganese containing metallic additive that is blended into some gasoline to increase the octane number. Gasolines blended with MMT offer no performance advantage beyond gasolines of the same octane number without MMT. Gasolines blended with MMT have shown

to reduce spark plug life and reduce emission system performance in some vehicles. The manufacturer recommends using gasolines without MMT. Since the MMT content of gasoline may not be indicated on the pump, you should ask your gasoline retailer whether or not his/her gasoline contains MMT.

It is even more important to look for gasoline without MMT in Canada, because MMT can be used at levels higher than allowed in the United States.

MMT is prohibited in Federal and California reformulated gasolines.

Materials Added To Fuel

All gasoline sold in the United States is required to contain effective detergent additives. Use of additional detergents or other additives are not needed under normal conditions and would result in additional cost. Therefore you should not have to add anything to the fuel.

Fuel System Cautions

CAUTION!

Follow these guidelines to maintain your vehicle's performance:

- The use of leaded gas is prohibited by Federal law. Using leaded gasoline can impair engine performance, damage the emission control system.
- An out-of-tune engine, or certain fuel or ignition malfunctions, can cause the catalytic converter to overheat. If you notice a pungent burning odor or some light smoke, your engine may be out of tune or malfunctioning and may require immediate service. Contact your dealer for service assistance.

- The use of fuel additives which are now being sold as octane enhancers is not recommended. Most of these products contain high concentrations of methanol. Fuel system damage or vehicle performance problems resulting from the use of such fuels or additives is not the responsibility of the manufacturer.

NOTE: Intentional tampering with emissions control systems can result in civil penalties being assessed against you.

Carbon Monoxide Warnings

WARNING!
<p>Carbon monoxide (CO) in exhaust gases is deadly. Follow the precautions below to prevent carbon monoxide poisoning:</p>
<ul style="list-style-type: none">• Do not inhale exhaust gases. They contain carbon monoxide, a colorless and odorless gas which can kill. Never run the engine in a closed area, such as a garage, and never sit in a parked vehicle with the engine running for an extended period. If the vehicle is stopped in an open area with the engine running for more than a short period, adjust the ventilation system to force fresh, outside air into the vehicle.• Guard against carbon monoxide with proper maintenance. Have the exhaust system inspected every time

the vehicle is raised. Have any abnormal conditions repaired promptly. Until repaired, drive with all side windows fully open.

- Keep the swing gate closed when driving your vehicle to prevent carbon monoxide and other poisonous exhaust gases from entering the vehicle.

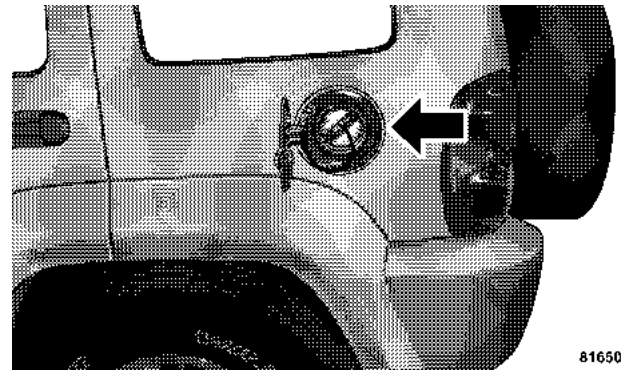
ADDING FUEL

CAUTION!

DO NOT put gasoline in your diesel vehicle (if equipped). If you accidentally put gasoline in your vehicle, **DO NOT** start the engine. This will cause damage to the fuel system. Have the fuel system flushed.

Fuel Filler Cap (Gas Cap)

The gas cap is located behind the fuel filler door, on the driver's side of the vehicle. If the gas cap is lost or damaged, be sure the replacement cap has been designed for use with this vehicle.



81650a5e

Fuel Filler Cap

CAUTION!

Damage to the fuel system or emission control system could result from using an improper fuel cap (gas cap). A poorly fitting cap could let impurities into the fuel system. Also, a poorly fitting aftermarket cap can cause the MIL (Malfunction Indicator Light) to illuminate, due to fuel vapors escaping from the system.

CAUTION!

A poorly fitting gas cap may cause the Malfunction Indicator Light to turn on.

CAUTION!

To avoid fuel spillage and overfilling, do not “top off” the fuel tank after filling.

NOTE: When the fuel nozzle “clicks” or shuts off, the fuel tank is full.

WARNING!

- Never have any smoking materials lit in or near the vehicle when the gas cap is removed or the tank filled.
- Never add fuel when the engine is running. This is in violation of most state and federal fire regulations and will cause the malfunction indicator light to turn on.

NOTE: Tighten the gas cap about 1/4 turn until you hear one click. This is an indication that cap is properly tightened.

If the gas cap is not tighten properly, the Malfunction Indicator Light will come on. Be sure the gas cap is tightened every time the vehicle is refueled.

WARNING!

A fire may result if gasoline is pumped into a portable container that is inside of a vehicle. You could be burned. Always place gas containers on the ground while filling.

Loose Fuel Filler Cap Message

If the vehicle diagnostic system determines that the fuel filler cap is loose, improperly installed, or damaged, a "CHECK GASCAP" message will be displayed in the EVIC (Electronic Vehicle Information Center). Refer to "Electronic Vehicle Information Center" in Section 4 of this manual. Tighten the fuel filler cap until a "clicking" sound is heard. This is an indication that the fuel filler cap is properly tightened. Refer to "Onboard Diagnostic System — OBDII" in Section 7 of this manual for more information.

CAUTION!

Damage to the fuel system or emission control system could result from using an improper fuel tank filler cap (gas cap). A poorly fitting cap could let impurities into the fuel system.

WARNING!

- Never add fuel when the engine is running.
- Never have any smoking materials lit in or near the vehicle when the fuel cap is removed or the tank filled.

VEHICLE LOADING**Certification Label**

As required by National Highway Traffic Safety Administration Regulations, your vehicle has a certification label affixed to the driver's side door or pillar.

This label contains the month and year of manufacture, Gross Vehicle Weight Rating (GVWR), Gross Axle Weight Rating (GAWR) front and rear, and Vehicle Identification Number (VIN). A Month-Day-Hour (MDH) number is included on this label and indicates the Month, Day and

Hour of manufacture. The bar code that appears on the bottom of the label is your Vehicle Identification Number (VIN).

Gross Vehicle Weight Rating (GVWR)

The GVWR is the total permissible weight of your vehicle including driver, passengers, vehicle, options, trailer tongue weight, and cargo. The label also specifies maximum capacities of front and rear axle systems (GAWR). Total load must be limited so GVWR and front and rear GAWR are not exceeded.

Payload

The payload of a vehicle is defined as the allowable load weight a truck can carry, including the weight of the driver, all passengers, options and cargo.

Gross Axle Weight Rating (GAWR)

The GAWR is the maximum permissible load on the front and rear axles. The load must be distributed in the cargo area so that the GAWR of each axle is not exceeded.

Each axle GAWR is determined by the components in the system with the lowest load carrying capacity (axle, springs, tires or wheels). Heavier axles or suspension components sometimes specified by purchasers for increased durability does not necessarily increase the vehicle's GVWR.

Tire Size

The tire size on the Label represents the actual tire size on your vehicle. Replacement tires must be equal to the load capacity of this tire size.

Rim Size

This is the rim size that is appropriate for the tire size listed.

Inflation Pressure

This is the cold tire inflation pressure for your vehicle for all loading conditions up to full GAWR.

Curb Weight

The curb weight of a vehicle is defined as the total weight of the vehicle with all fluids, including vehicle fuel, at full capacity conditions, and with no occupants or cargo loaded into the vehicle. The front and rear curb weight values are determined by weighing your vehicle on a commercial scale before any occupants or cargo are added.

Loading

The actual total weight and the weight of the front and rear of your vehicle at the ground can best be determined by weighing it when it is loaded and ready for operation.

The entire vehicle should first be weighed on a commercial scale to insure that the GVWR has not been exceeded. The weight on the front and rear of the vehicle should then be determined separately to be sure that the load is properly distributed over front and rear axle. Weighing the vehicle may show that the GAWR of either the front or rear axles has been exceeded but the total load is

within the specified GVWR. If so, weight must be shifted from front to rear or rear to front as appropriate until the specified weight limitations are met. Store the heavier items down low and be sure that the weight is distributed equally. Stow all loose items securely before driving.

Improper weight distributions can have an adverse effect on the way your vehicle steers and handles and the way the brakes operate.

CAUTION!

Do not load your vehicle any heavier than the GVWR or the maximum front and rear GAWR. If you do, parts on your vehicle can break, or it can change the way your vehicle handles. This could cause you to lose control. Also overloading can shorten the life of your vehicle.

TRAILER TOWING

In this section you will find safety tips and information on limits to the type of towing you can reasonably do with your vehicle. Before towing a trailer carefully review this information to tow your load as efficiently and safely as possible.

To maintain warranty coverage, follow the requirements and recommendations in this manual concerning vehicles used for trailer towing.

Common Towing Definitions

The following trailer towing related definitions will assist you in understanding the following information:

Gross Vehicle Weight Rating (GVWR)

The GVWR is the total allowable weight of your vehicle. This includes driver, passengers, cargo and tongue weight. The total load must be limited so that you do not exceed the GVWR.

Gross Trailer Weight (GTW)

The gross trailer weight (GTW) is the weight of the trailer plus the weight of all cargo, consumables and equipment (permanent or temporary) loaded in or on the trailer in its "loaded and ready for operation" condition. The recommended way to measure GTW is to put your fully loaded trailer on a vehicle scale. The entire weight of the trailer must be supported by the scale.

Gross Combination Weight Rating (GCWR)

The gross combination weight rating (GCWR) is the total permissible weight of your vehicle and trailer when weighed in combination. (Note that GCWR ratings include a 150 lbs (68 kg) allowance for the presence of a driver).

Gross Axle Weight Rating (GAWR)

The GAWR is the maximum capacity of the front and rear axles. Distribute the load over the front and rear axles evenly. Make sure that you do not exceed either front or rear GAWR.

WARNING!

It is important that you do not exceed the maximum front or rear GAWR. A dangerous driving condition can result if either rating is exceeded. You could lose control of the vehicle and have an accident.

5**Tongue Weight (TW)**

The downward force exerted on the hitch ball by the trailer. In most cases it should not be less than 10% or more than 15% of the trailer load. You must consider this as part of the load on your vehicle.

Frontal Area

The maximum height and maximum width of the front of a trailer.

Trailer Sway Control

The trailer sway control is a telescoping link that can be installed between the hitch receiver and the trailer tongue that typically provides adjustable friction associated with the telescoping motion to dampen any unwanted trailer swaying motions while traveling.

Weight-Carrying Hitch

A weight-carrying hitch supports the trailer tongue weight, just as if it were luggage located at a hitch ball or some other connecting point of the vehicle. These kind of hitches are the most popular on the market today and they're commonly used to tow small- and medium-sized trailers.

Weight-Distributing Hitch

A weight-distributing system works by applying leverage through spring (load) bars. They are typically used for heavier loads, to distribute trailer tongue weight to the tow vehicle's front axle and the trailer axle(s). When used in accordance with the manufacturers' directions, it provides for a more level ride, offering more consistent steering and brake control thereby enhancing towing safety. The addition of a friction/hydraulic sway control also dampens sway caused by traffic and crosswinds and contributes positively to tow vehicle and trailer stability. Trailer sway control and a weight distributing (load equalizing) hitch are recommended for heavier Tongue Weights (TW) and may be required depending on Vehicle and Trailer configuration/loading to comply with gross axle weight rating (GAWR) requirements.

WARNING!

An improperly adjusted Weight Distributing Hitch system may reduce handling, stability, braking performance, and could result in an accident.

Weight Distributing Systems may not be compatible with Surge Brake Couplers. Consult with your hitch and trailer manufacturer or a reputable Recreational Vehicle dealer for additional information.

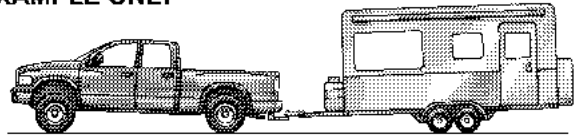
EXAMPLE ONLY

FIG. 1 WITHOUT WEIGHT DISTRIBUTION

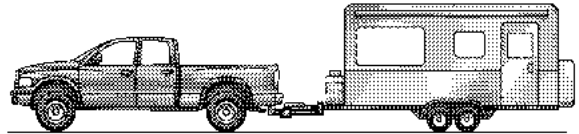
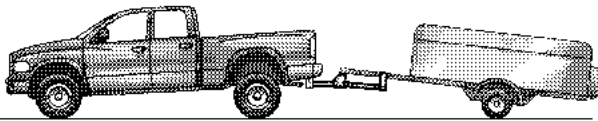


FIG. 2. WITH WEIGHT DISTRIBUTION

8181F965

Weight Distributing Hitch System

EXAMPLE ONLY**FIG. 3 IMPROPER ADJUSTMENT (INCORRECT)**

818196f

Improper Adjustment of Weight Distributing System**Trailer Hitch Classification**

The rear bumper is intended to tow trailers up to 2,000 lbs (907 kg) without added equipment or alterations to the standard equipment. Your vehicle may be factory equipped for safe towing of trailers weighing over 2,000 lbs (907 kg) with the optional Trailer Tow Prep Package. See your dealer for package content.

The following chart provides the industry standard for the maximum trailer weight a given trailer hitch class can tow and should be used to assist you in selecting the correct trailer hitch for your intended towing condition. Refer to the Trailer Towing Weights (Maximum Trailer Weight Ratings) chart for the Max. GTW towable for your given drivetrain.

Trailer Hitch Classification	
Class	Max. GTW (Gross Trailer Wt.)
Class I - Light Duty	2,000 lbs (907 kg)
Class II - Medium Duty	3,500 lbs (1 587 kg)
Class III - Heavy Duty	5,000 lbs (2 268 kg)
Class IV - Extra Heavy Duty	10,000 lbs (4 540 kg)

All trailer hitches should be professionally installed on your vehicle.

Trailer Towing Weights (Maximum Trailer Weight Ratings)

The following chart provides the maximum trailer weight ratings towable for your given drivetrain.

288 STARTING AND OPERATING

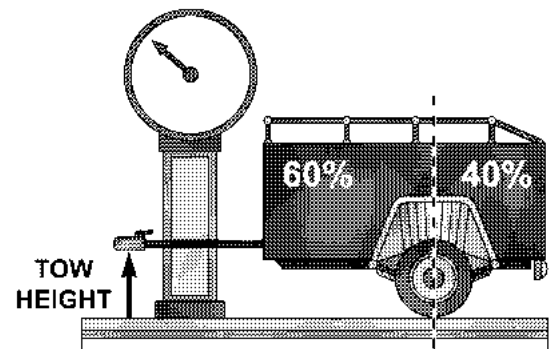
Engine/ Transmission	Model	GCWR (Gross Com- bined Wt. Rating)	Frontal Area	Max. GTW (Gross Trailer Wt.)	Max. Tongue Wt. (See Note 1)
3.7L/6-Speed Manual	4x2	8,500 lbs (3 855 kg)	40 Sq. Ft. (3.72 square meters)	3,500 lbs (1 587 kg)	350 lbs (159 kg)
3.7L/6-Speed Manual	4x4	8,750 lbs (3 969 kg)	40 Sq. Ft. (3.72 square meters)	3,500 lbs (1 587 kg)	350 lbs (159 kg)
3.7L/ Automatic	4x2	7,150 lbs (3 243 kg)	32 Sq. Ft. (2.97 square meters)	2,000 lbs (907 kg)	200 lbs (91 kg)
3.7L/ Automatic	4x4	7,400 lbs (3 356 kg)	32 Sq. Ft. (2.97 square meters)	2,000 lbs (907 kg)	200 lbs (91 kg)
3.7L/ Automatic w/ Cooler	4x2	9,850 lbs (4 468 kg)	60 Sq. Ft. (5.57 square meters)	5,000 lbs (2 268 kg)	500 lbs (227 kg)
3.7L/ Automatic w/Cooler	4x4	10,100 lbs (4 581 kg)	60 Sq. Ft. (5.57 square meters)	5,000 lbs (2 268 kg)	500 lbs (227 kg)
Refer to local laws for maximum trailer towing speeds.					

NOTE: The trailer tongue weight must be considered as part of the combined weight of occupants and cargo, and should never exceed the weight referenced on the Tire and Loading Information placard. Refer to the Tire-Safety Information section in this manual.

Trailer and Tongue Weight

Always load a trailer with 60% to 65% of the weight in the front of the trailer. This places 10% to 15% of the Gross Trailer Weight (GTW) on the tow hitch of your vehicle. Loads balanced over the wheels or heavier in the rear can cause the trailer to sway **severely** side to side which will cause loss of control of vehicle and trailer. Failure to load trailers heavier in front is the cause of many trailer accidents.

Never exceed the maximum tongue weight stamped on your bumper or trailer hitch.



81546c40

Consider the following items when computing the weight on the rear axle of the vehicle:

- The tongue weight of the trailer.
- The weight of any other type of cargo or equipment put in or on your vehicle.
- The weight of the driver and all passengers.

NOTE: Remember that everything put into or on the trailer adds to the load on your vehicle. Also, additional factory-installed options, or dealer-installed options, must be considered as part of the total load on your vehicle. Refer to the Tire and Loading Information placard in the Tire Safety Information section of this manual for the maximum combined weight of occupants and cargo for your vehicle.

Towing Requirements

To promote proper break-in of your new vehicle drivetrain components the following guidelines are recommended:

CAUTION!

- **Avoid towing a trailer for the first 500 miles (805 km) of vehicle operation. Doing so may damage your vehicle.**
- **During the first 500 miles (805 km) of trailer towing, limit your speed to 50 mph (80 km/h).**

Perform the maintenance listed in Section 8 of this manual. When towing a trailer, never exceed the GAWR, or GCWR, ratings.

WARNING!

Improper towing can lead to an injury accident. Follow these guidelines to make your trailer towing as safe as possible:

Make certain that the load is secured in the trailer and will not shift during travel. When trailering cargo that is not fully secured, dynamic load shifts can occur that may be difficult for the driver to control. You could lose control of your vehicle and have an accident.

- When hauling cargo or towing a trailer, do not overload your vehicle or trailer. Overloading can cause a loss of control, poor performance or damage to brakes, axle, engine, transmission, steering, suspension, chassis structure or tires.
- Safety chains must always be used between your vehicle and trailer. Always connect the chains to the frame or hook retainers of the vehicle hitch. Cross the chains under the trailer tongue and allow enough slack for turning corners.
- Vehicles with trailers should not be parked on a grade. When parking, apply the parking brake on the tow vehicle. Put the tow vehicle automatic transmission in P for Park. With a manual transmission, shift the transmission into reverse. And with four-wheel-drive vehicles, make sure the transfer case is not in neutral. Always, block or "chock" the trailer wheels.
- GCWR must not be exceeded.
- **Total weight must be distributed between the tow vehicle and the trailer such that the following four ratings are not exceeded:**
 1. GVWR

2. GTW
3. GAWR
4. Tongue weight rating for the trailer hitch utilized (This requirement may limit the ability to always achieve the 10% to 15% range of tongue weight as a percentage of total trailer weight).

Towing Requirements — Tires

- Do not attempt to tow a trailer while using a compact spare tire.
- Proper tire inflation pressures are essential to the safe and satisfactory operation of your vehicle. Refer to the Tires–General Information section of this manual on Tire Pressures for proper tire inflation procedures.
- Also, check the trailer tires for proper tire inflation pressures before trailer usage.

- Check for signs of tire wear or visible tire damage before towing a trailer. Refer to the Tires–General Information section of this manual on Tread Wear Indicators for the proper inspection procedure.
- When replacing tires, refer to the Tires–General Information section of this manual on Replacement Tires for proper tire replacement procedures. Replacing tires with a higher load carrying capacity will not increase the vehicle’s GVWR and GAWR limits.

Towing Requirements — Trailer Brakes

- Do **not** interconnect the hydraulic brake system or vacuum system of your vehicle with that of the trailer. This could cause inadequate braking and possible personal injury.
- An electronically actuated trailer brake controller is required when towing a trailer with electronically

actuated brakes. When towing a trailer equipped with a hydraulic surge actuated brake system, an electronic brake controller is not required.

- Trailer brakes are recommended for trailers over 1,000 lbs (454 kg) and required for trailers in excess of 2,000 lbs (907 kg).

CAUTION!

If the trailer weighs more than 1,000 lbs (454 kg) loaded, it should have its own brakes and they should be of adequate capacity. Failure to do this could lead to accelerated brake lining wear, higher brake pedal effort, and longer stopping distances.

WARNING!

Do not connect trailer brakes to your vehicle's hydraulic brake lines. It can overload your brake system and cause it to fail. You might not have brakes when you need them and could have an accident.

Towing any trailer will increase your stopping distance. When towing you should allow for additional space between your vehicle and the vehicle in front of you. Failure to do so could result in an accident.

5

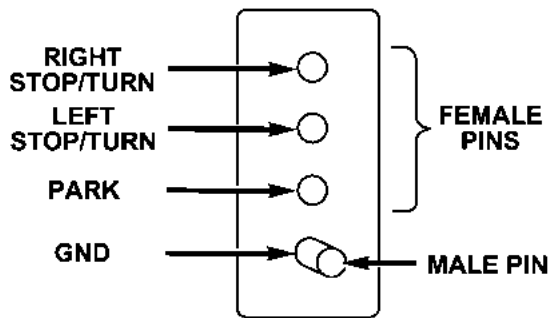
Towing Requirements — Trailer Lights & Wiring

Whenever you pull a trailer, regardless of the trailer size, stop lights and turn signals on the trailer are required for motoring safety.

The Trailer Tow Package may include a 4 and 7 pin wiring harness. Use a factory approved trailer harness and connector.

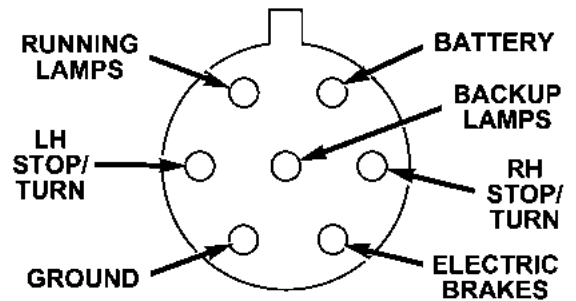
NOTE: Do not cut or splice wiring into the vehicles wiring harness.

The electrical connections are all complete to the vehicle but you must mate the harness to a trailer connector. Refer to the following illustrations.



4 - Pin Connector

813262be



7- Pin Connector

812634c6

Towing Tips

Before setting out on a trip, practice turning, stopping and backing the trailer in an area away from heavy traffic.

If using a manual transmission vehicle for trailer towing, all starts must be in FIRST gear to avoid excessive clutch slippage.

Towing Tips — Automatic Transmission

The “D” range can be selected when towing. However, if frequent shifting occurs while in this range, the “3” range should be selected.

NOTE: Using the “3” range while operating the vehicle under heavy operating conditions will improve performance and extend transmission life by reducing excessive shifting and heat build up. This action will also provide better engine braking.

The automatic transmission fluid and filter should be changed if you REGULARLY tow a trailer for more than 45 minutes of continuous operation. See Schedule “B” in section 8 of this manual for transmission fluid change intervals.

NOTE: Check the automatic transmission fluid level before towing.

Towing Tips — O/D OFF (If Equipped)

To reduce potential for automatic transmission overheating, press the “O/D OFF” button when driving in hilly areas or shift the transmission to Drive position 2 on more severe grades. Refer to “Transmission Shifting” in this section.

Towing Tips — Electronic Speed Control (If Equipped)

- Don’t use in hilly terrain or with heavy loads.
- When using the speed control, if you experience speed drops greater than 10 mph (16 km/h), disengage until you can get back to cruising speed.
- Use speed control in flat terrain and with light loads to maximize fuel efficiency.

Towing Tips — Cooling System

To reduce potential for engine and transmission overheating, take the following actions:

– City Driving

When stopped for short periods of time, put transmission in neutral and increase engine idle speed.

– Highway Driving

Reduce speed.

– Air Conditioning

Turn off temporarily.

- refer to Cooling System Operating information in the Maintenance section of this manual for more information.

RECREATIONAL TOWING (BEHIND MOTORHOME, ETC.)**Towing – 2WD Models**

Recreational towing is not allowed. Towing with the rear wheels on the ground can result in severe transmission damage.

Towing — 4WD Models**CAUTION!**

Front or rear wheel lifts should not be used. Internal damage to the transmission or transfer case will occur if a front or rear wheel lift is used when recreational towing.

NOTE: The transfer case must be shifted into N (Neutral), and the transmission must be shifted into P (Park)

(for automatic transmission) or into any forward gear (for manual transmission) for recreational towing.

Shifting Into Neutral (N)

Use the following procedure to prepare your vehicle for recreational towing.

CAUTION!

It is necessary to follow these steps to be certain that the transfer case is fully in N (Neutral) before recreational towing to prevent damage to internal parts.

1. Depress brake pedal.
2. Shift transmission into N (Neutral).
3. Shift transfer case lever into N (Neutral).
4. Start engine.
5. Shift automatic transmission into D (Drive) or manual transmission into any forward gear.
6. Release brake pedal and ensure that there is no vehicle movement.
7. Shut the engine OFF and place the ignition key into the unlocked OFF position.
8. Shift automatic transmission into P (Park) or ensure manual transmission is in any forward gear.
9. Apply parking brake.
10. Attach vehicle to the tow vehicle with tow bar.
11. Release parking brake.

CAUTION!

Transmission damage may occur if the automatic transmission is shifted into P (Park) with the transfer case in N (Neutral) and the engine running. With the transfer case in N (Neutral) ensure that the engine is OFF prior to shifting the transmission into P (Park) (refer to steps 7 – 8 above).

Shifting Out Of Neutral (N)

Use the following procedure to prepare your vehicle for normal usage.

1. Shift transmission into N (Neutral).
2. Turn engine off.
3. Shift transfer case lever to desired position.
4. Shift automatic transmission into P (Park).

5. Start engine.

6. Shift automatic transmission into D (Drive) or manual transmission into any forward gear.

WARNING!

You or others could be injured if you leave the vehicle unattended with the transfer case in the N (Neutral) position without first fully engaging the parking brake. The transfer case N (Neutral) position disengages both the front and rear driveshafts from the powertrain and will allow the vehicle to move regardless of the transmission position. The parking brake should always be applied when the driver is not in the vehicle.

CAUTION!

Do not use a bumper mounted clamp-on tow bar on your vehicle. The bumper face bar will be damaged.

SNOW PLOW

Snow plows, winches, and other aftermarket equipment should **not** be added to the front end of your vehicle. The airbag crash sensors may be affected by the change in the front end structure. The airbags could deploy unexpectedly or could fail to deploy during a collision.

WARNING!

Do not add a snow plow, winches, or any other aftermarket equipment to the front of your vehicle. This could adversely affect the functioning of the airbag system and you could be injured.

WHAT TO DO IN EMERGENCIES

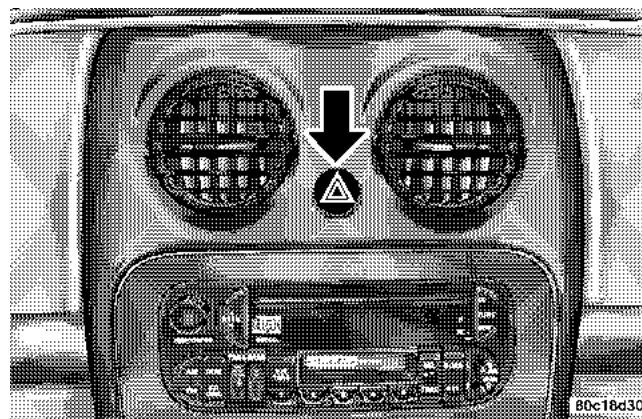
CONTENTS

■ Hazard Warning Flashers	302	□ Jacking Instructions	306
■ If Your Engine Overheats	303	■ Jump Starting	308
■ Jacking And Tire Changing	304	■ Emergency Tow Hooks — If Equipped	311
□ Jack Location	304	■ Towing A Disabled Vehicle	311
□ Spare Tire Stowage	305	□ 2WD Models Only	311
□ Preparations For Jacking	305	□ 4WD Models Only	312

HAZARD WARNING FLASHERS

Your vehicle's hazard warning flasher is an emergency warning system. When you activate it, all front and rear directional signals will flash intermittently. Use it when your vehicle is disabled on or near the road. It warns other drivers to steer clear of you and your vehicle. This is an emergency warning system, not to be used when the vehicle is in motion.

To activate the warning flashers, press the button on the instrument panel (between center air outlets). To turn the warning flashers off, press the button again.



Hazard Warning Switch

NOTE: With extended use, the flashers may run down your battery.

IF YOUR ENGINE OVERHEATS

In any of the following situations, you can reduce the potential for overheating by taking the appropriate action.

- On the highways — Slow down.
- In city traffic — While stopped, put transmission in N (Neutral), but do not increase engine idle speed.

NOTE: There are steps that you can take to slow down an impending overheat condition. If your air conditioner is on, turn it off. The air conditioning system adds heat to the engine cooling system and turning off the A/C removes this heat. You can also turn the Temperature Control to maximum heat, the Mode Control to floor, and the Fan Control to High. This allows the heater core to act as a supplement to the radiator and aids in removing heat from the engine cooling system.

If the pointer rises to the “H” (hot mark) on a vehicle, pull over and stop the vehicle. Do not turn the engine off. Idle the vehicle with the air conditioning turned off, until the pointer drops back into the normal range.

CAUTION!

Driving with a hot cooling system could damage your vehicle. If the temperature gauge reads “H”, pull over and stop the vehicle. Idle the vehicle with the air conditioner turned off until the pointer drops back into the normal range. If the pointer remains on the “H”, and you hear continuous chimes, turn the engine off immediately, and call for service.

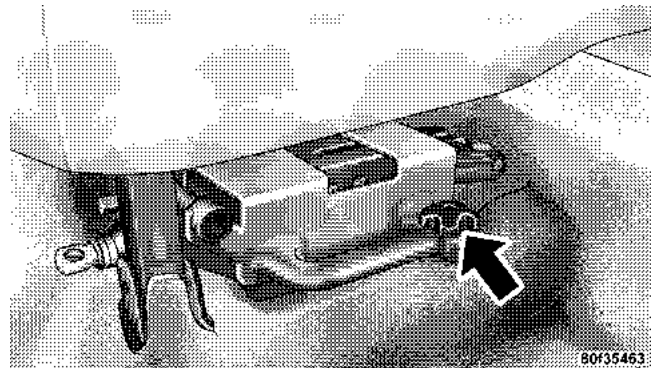
If the overheating condition persists a continuous chime will sound to alert the driver. Reduce the vehicle speed and or stop the vehicle while allowing the engine to idle and cool the engine.

JACKING AND TIRE CHANGING**WARNING!**

- Getting under a jacked-up vehicle is dangerous. The vehicle could slip off the jack and fall on you. You could be crushed. Never get any part of your body under a vehicle that is on a jack. If you need to get under a raised vehicle, take it to a service center where it can be raised on a lift.
- The jack is designed to use as a tool for changing tires only. The jack should not be used to lift the vehicle for service purposes. The vehicle should be jacked on a firm level surface only. Avoid ice or slippery areas.

Jack Location

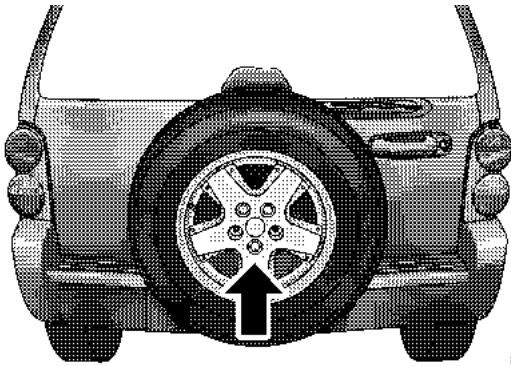
The scissor-type jack, and tire changing tools are stored beneath the right rear seat. To remove the jack from its stowage position, turn the thumb screw counterclockwise to loosen jack assembly and then remove it.



Jack Storage Location

Spare Tire Stowage

To remove the spare tire from the carrier, remove the tire cover, if equipped, and remove the lug nuts with the lug wrench turning them counterclockwise.



80d1f789

Spare Tire Mounting

NOTE: If you have added aftermarket accessories to the spare tire mounted carrier, it cannot exceed a gross weight of 50 lbs (23 kg) including the weight of the spare tire.

Preparations For Jacking

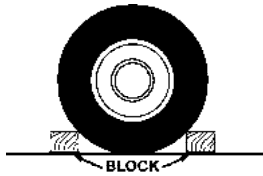
Park the vehicle on a firm level surface, avoid ice or slippery areas, **set the parking brake** and place automatic transmission in P (Park), or manual transmission in R (Reverse). Turn OFF the ignition.

WARNING!

6

Do not attempt to change a tire on the side of the vehicle close to moving traffic. Pull far enough off the road to avoid being hit when operating the jack or changing the wheel.

- Turn on the Hazard Warning Flasher.



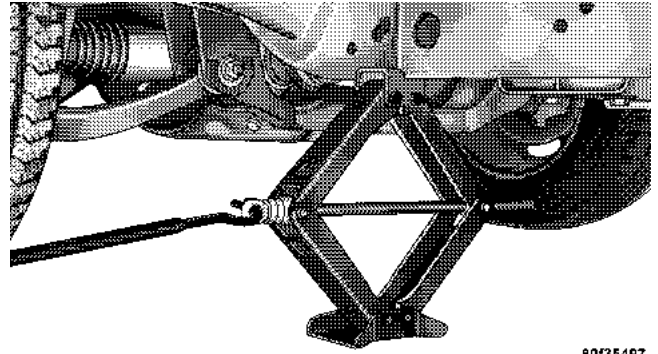
- Block both the front and rear of the wheel diagonally opposite of the jacking position. For example, if changing the right front tire, block the left rear wheel.

- Passengers should not remain in the vehicle when the vehicle is being jacked.

Jacking Instructions

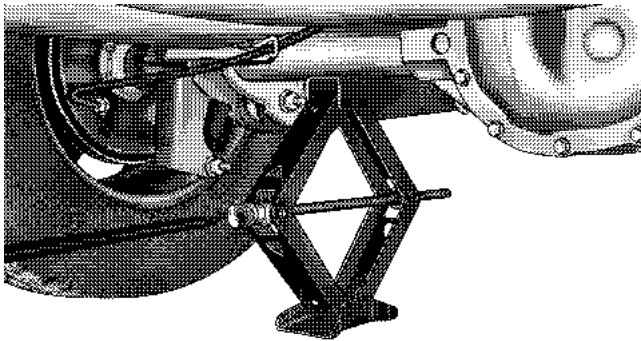
1. Remove spare tire.
2. Loosen (but do not remove) the wheel lug nuts by turning them to the left one turn while the wheel is still on the ground.
3. Remove jack and tools from mounting bracket. Assemble the tools by connecting the driver to the extension, and then to the lug wrench.

4. Locate the jack as shown. For the front tires, place it in the notch on the body weld seam behind wheel to be changed. For the rear tires, place it under the axle by the wheel to be changed. Position the jack handle on the jack. **Do not raise the vehicle until you are sure the jack is fully engaged.**



80F35497

Front Jacking Location



807254b4

Rear Jacking Location

5. Raise the vehicle by turning the jack screw to the right. Raise the vehicle only until the tire just clears the surface and enough clearance is obtained to install the spare tire. Minimum tire lift provides maximum stability.

WARNING!

Raising the vehicle higher than necessary can make the vehicle less stable and cause an accident. It could slip off the jack and hurt someone near it. Raise the vehicle only enough to remove the tire.

6. Remove the lug nuts and wheel.
7. Position the spare wheel/tire on the vehicle and install lug nuts with cone-shaped end toward wheel. Lightly tighten the nuts. To avoid the risk of forcing the vehicle off the jack, do not tighten the nuts fully until the vehicle has been lowered.
8. Lower the vehicle by turning the jack screw to the left, and remove the jack and wheel blocks.
9. Finish tightening the lug nuts. Push down on the wrench while tightening for increased leverage. Alternate

nuts until each nut has been tightened twice. Correct wheel nut tightness is 130 N·m (95 ft. lbs). If in doubt about the correct tightness, have them checked with a torque wrench by your authorized dealer or at a service station.

10. Lower the jack to it's fully closed position.

WARNING!

A loose tire or jack, thrown forward in a collision or hard stop could endanger the occupants of the vehicle. Always stow the jack parts and the spare tire in the places provided.

11. Secure the tire, jack, and tools in their proper locations.

JUMP STARTING

If the vehicle has a discharged battery, booster cables may be used to obtain a start from a booster battery or the battery in another vehicle. This type of start can be dangerous if done improperly, so follow this procedure carefully.

WARNING!

Battery fluid is a corrosive acid solution; do not allow battery fluid to contact eyes, skin or clothing. Don't lean over battery when attaching clamps or allow the clamps to touch each other. If acid splashes in eyes or on skin, flush contaminated area immediately with large quantities of water.

A battery generates hydrogen gas which is flammable and explosive. Keep flame or spark away from the vent holes.

Do not use a booster battery or any other booster source that has a greater than 12 volt system, i.e. Do not use a 24 volt power source.

1. Remove all metal jewelry such as watch bands or bracelets which might make an unintended electrical contact.

2. Park the booster vehicle within cable reach but without letting the vehicles touch. Set the parking brake on both vehicles, place the automatic transmission in P (Park) or the manual transmission in N (Neutral), and turn the ignition OFF.

3. Turn off the heater, radio, and all unnecessary electrical loads.

4. Connect one end of a jumper cable to the positive terminal of the booster battery. Connect the other end of the same cable to the positive terminal of the discharged battery.

WARNING!

Do not permit vehicles to touch each other as this could establish a ground connection and personal injury could result.

5. Connect the other cable, first to the negative terminal of the booster battery and then to the engine of the vehicle with the discharged battery. Make sure you have a good contact on the engine.

WARNING!

- You should not try to start your vehicle by pushing or towing.
- Do not connect the cable to the negative post of the discharge battery. The resulting electrical spark could cause the battery to explode.
- During cold weather when temperatures are below freezing point, electrolyte in a discharged battery may freeze. Do not attempt jump starting because the battery could rupture or explode. The battery temperature must be brought up above freezing point before attempting jump start.

6. Start the engine in the vehicle which has the booster battery, let the engine idle a few minutes, then start the engine in the vehicle with the discharged battery.

7. When removing the jumper cables, reverse the above sequence exactly. Be careful of the moving belts and fan.

WARNING!

- Any procedure other than above could result in:
1. Personal injury caused by electrolyte squirting out the battery vent;
 2. Personal injury or property damage due to battery explosion;
 3. Damage to charging system of booster vehicle or of immobilized vehicle.

EMERGENCY TOW HOOKS — IF EQUIPPED

If your vehicle is equipped with tow hooks, they are mounted in the front and the rear.

CAUTION!

Tow hooks are for emergency use only, to rescue a vehicle stranded off road. Do not use tow hooks for tow truck hookup or highway towing. You could damage your vehicle. Tow straps are recommended when towing the vehicle, chains may cause vehicle damage.

WARNING!

Stand clear of vehicles when pulling with tow hooks. Tow straps and chains may break, causing serious injury.

TOWING A DISABLED VEHICLE**2WD Models Only**

Provided the transmission is operable, tow only in N (Neutral) at speeds not exceeding 30 mph (48 km/h), for distances of not more than 15 miles (24 km). Towing at more than 30 mph (48 km/h) or for more than 15 miles (24 km) can cause severe transmission damage. If the transmission is not operable, or the vehicle must be towed faster than 30 mph (48 km/h) or farther than 15 miles (24 km), tow with all four wheels **OFF** the ground. Acceptable methods are to tow the vehicle on a flatbed or with one end of the vehicle raised and the other end on a towing dolly. Removing the driveshaft for towing is not recommended since this can allow fluid to drain from the transmission.

4WD Models Only

The manufacturer recommends towing with all four wheels **OFF** the ground. Acceptable methods are to tow the vehicle on a flatbed or with one end of the vehicle raised and the other end on a towing dolly.

MAINTAINING YOUR VEHICLE

CONTENTS

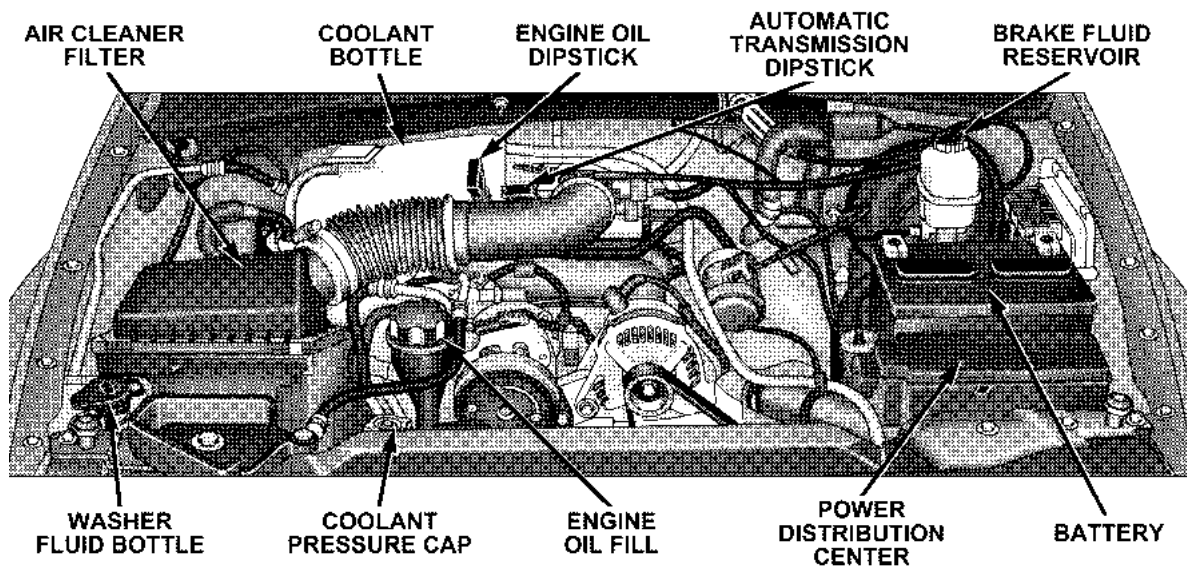
■ Engine Compartment – 3.7L	316	□ Drive Belts — Check Condition And Tension . .	323
■ Onboard Diagnostic System — OBD II	317	□ Spark Plugs	324
□ Loose Fuel Filler Cap Message	317	□ Spark Plug Wires	324
■ Emissions Inspection And Maintenance Programs	318	□ Engine Air Cleaner Filter	324
■ Replacement Parts	319	□ Catalytic Converter	325
■ Dealer Service	319	□ Crankcase Emission Control System	327
■ Maintenance Procedures	320	□ Maintenance-Free Battery	327
□ Engine Oil	320	□ Air Conditioner Maintenance	329
		□ Power Steering Fluid Check	330

314 MAINTAINING YOUR VEHICLE

□ Driveline And Steering Component Lubrication	331	□ Manual Transmission	344
□ Body Lubrication	331	□ Automatic Transmission	345
□ Windshield Wiper Blades	331	□ Appearance Care And Protection From Corrosion	347
□ Windshield Washers	332	■ Fuse Panel	353
□ Exhaust System	333	□ Interior Fuses	353
□ Cooling System	333	□ Underhood Fuses (Power Distribution Center)	356
□ Hoses And Vacuum/Vapor Harnesses	338	■ Vehicle Storage	361
□ Fuel System Connections	339	■ Replacement Bulbs	361
□ Brake System	339	■ Bulb Replacement	362
□ Clutch Hydraulic System — Manual Transmission Only	342	□ Head Light	362
□ Front/Rear Axle Fluid	342	□ Front Turn Signal	363
□ Transfer Case	343	□ Front Fog Light (Front Fascia Mounted)	364

□ Rear Tail, Stop, Turn Signal, And Back-Up Lights	365	■ Fluids, Lubricants, And Genuine Parts	367
□ Center High Mounted Stop Light (CHMSL) . . .	365	□ Engine	367
■ Fluids And Capacities	366	□ Chassis	368

ENGINE COMPARTMENT – 3.7L



ONBOARD DIAGNOSTIC SYSTEM — OBD II

Your vehicle is equipped with a sophisticated onboard diagnostic system called OBD II. This system monitors the performance of the emissions, engine, and automatic transmission control systems. When these systems are operating properly, your vehicle will provide excellent performance and fuel economy, as well as engine emissions well within current government regulations.

If any of these systems require service, the OBD II system will turn on the “Malfunction Indicator Light.” It will also store diagnostic codes and other information to assist your service technician in making repairs. Although your vehicle will usually be drivable and not need towing, see your dealer for service as soon as possible.

CAUTION!

- Prolonged driving with the “Malfunction Indicator Light” on could cause further damage to the emission control system. It could also affect fuel economy and driveability. The vehicle must be serviced before any emissions tests can be performed.
- If the “Malfunction Indicator Light” is flashing while the engine is running, severe catalytic converter damage and power loss will soon occur. Immediate service is required.


Loose Fuel Filler Cap Message

If the vehicle diagnostic system determines that the fuel filler cap is loose, improperly installed, or damaged, a “GAS CAP” message will be displayed in the odometer (located on the instrument cluster). Replace, or tighten

the fuel filler cap properly to turn the message off (light will time out). If the problem continues, the message will appear the next time the vehicle is started.

EMISSIONS INSPECTION AND MAINTENANCE PROGRAMS

In some localities, it may be a legal requirement to pass an inspection of your vehicle's emissions control system. Failure to pass could prevent vehicle registration.

 For states, which have an I/M (Inspection and Maintenance) requirement, this check verifies the following: the MIL (Malfunction Indicator Lamp) is functioning and is not on when the engine is running, and that the OBD (On Board Diagnostic) system is ready for testing.

Normally, the OBD system will be ready. The OBD system may **not** be ready if your vehicle was recently serviced, if you recently had a dead battery, or a battery

replacement. If the OBD system should be determined not ready for the I/M test, your vehicle may fail the test.

Your vehicle has a simple ignition key actuated test, which you can use prior to going to the test station. To check if your vehicle's OBD system is ready, you must do the following:

1. Insert your ignition key into the ignition switch.
2. Turn the ignition to the ON position, but do not crank or start the engine.
3. If you crank or start the engine, you will have to start this test over.
4. As soon as you turn your key to the ON position, you will see your MIL symbol come on as part of a normal bulb check.
5. Approximately 15 seconds later, one of two things will happen:

- a. The MIL will flash for about 10 seconds and then return to being fully illuminated until you turn off the ignition key or start the engine. This means that your vehicle's OBD system is **not ready** and you should **not** proceed to the I/M station.
- b. The MIL will not flash at all and will remain fully illuminated until you turn off the ignition key or start the engine. This means that your vehicle's OBD system is **ready** and you can proceed to the I/M station.

If your OBD system is **not ready**, you should see your authorized dealer or repair facility. If your vehicle was recently serviced or had a battery failure or replacement, you may need to do nothing more than drive your vehicle as you normally would in order for your OBD system to update. A recheck with the above test routine may then indicate that the system is now ready.

Regardless of whether your vehicle's OBD system is ready or not ready, if the MIL symbol is illuminated

during normal vehicle operation, you should have your vehicle serviced before going to the I/M station. The I/M station can fail your vehicle because the MIL symbol is on with the engine running.

REPLACEMENT PARTS

Use of genuine Mopar® parts for normal/scheduled maintenance and repairs is highly recommended to insure the designed performance. Damage or failures caused by the use of non-Mopar® parts for maintenance and repairs will not be covered by the manufacturer's warranty.

DEALER SERVICE

Your dealer has the qualified service personnel, special tools, and equipment to perform all service operations in an expert manner. Service Manuals are available which include detailed service information for your vehicle. Refer to these manuals before attempting any procedure yourself.

NOTE: Intentional tampering with emissions control systems can result in civil penalties being assessed against you.

WARNING!

You can be badly injured working on or around a motor vehicle. Only do service work for which you have the knowledge and the proper equipment. If you have any doubt about your ability to perform a service job, take your vehicle to a competent mechanic.

MAINTENANCE PROCEDURES

The pages that follow contain the **required** maintenance services determined by the engineers who designed your vehicle.

Besides the maintenance items for which there are fixed maintenance intervals, there are other items that should operate satisfactorily without periodic maintenance.

However, if a malfunction of these items does occur, it could adversely affect the engine or vehicle performance. These items should be inspected if a malfunction is observed or suspected.

Engine Oil

Checking Oil Level

To assure proper lubrication of your vehicle's engine, the engine oil must be maintained at the correct level. Check the oil level at regular intervals, such as every fuel stop. The best time to check the engine oil level is about 5 minutes after a fully warmed engine has been shut off, or before starting the engine after it has sat overnight.

Checking the oil while the vehicle is on level ground will improve the accuracy of the oil level readings. Maintain the oil level between the ADD and SAFE markings on the dipstick. Adding 1 U.S. Quart (0.95L) of oil when the reading is at the ADD mark will result in a SAFE reading on these engines.

CAUTION!

Overfilling or underfilling the crankcase will cause aeration or loss of oil pressure. This could damage your engine.

Change Engine Oil

Road conditions as well as your kind of driving affect the interval at which your oil should be changed. Check the following to determine if any apply to you:

- Day or night temperatures are below 32°F (0°C)
- Stop and go driving
- Extensive engine idling
- Driving in dusty conditions
- Short trip driving of less than 10 miles (16.2 km)

- More than 50% of your driving is at sustained high speeds during hot weather, above 90°F (32°C)
- Taxi, Police, or delivery service (commercial service)
- Trailer towing
- Off-road or desert driving

If **ANY** of these apply to you, then change your engine oil at every interval shown in schedule “B” of the “Maintenance Schedules” section of this manual.

If none of these apply to you, then change your engine oil at every interval shown on schedule “A” of the “Maintenance Schedules” section of this manual

NOTE: Under no circumstances should oil change intervals exceed 6,000 miles (10 000 km) or 6 months whichever comes first.

Engine Oil Selection

For best performance and maximum protection for all engines under all types of operating conditions, the manufacturer recommends engine oils that are API Certified and meet the requirements of DaimlerChrysler Material Standard MS-6395.

American Petroleum Institute (API) Engine Oil Identification Symbol



This symbol means that the oil has been certified by the American Petroleum Institute (API). The manufacturer only recommends API Certified engine oils.

Engine Oil Viscosity

SAE 5W-20 engine oil is recommended for all operating temperatures. This engine oil improves low temperature starting and vehicle fuel economy. Your engine oil filler cap also shows the recommended engine oil viscosity for your vehicle.

For information on engine oil filler cap location, see the Engine Compartment illustration in this section.

Lubricants which do not have both, the engine oil certification mark and the correct SAE viscosity grade number should not be used.

Synthetic Engine Oils

You may use synthetic engine oils provided the recommended oil quality requirements are met, and the recommended maintenance intervals for oil and filter changes are followed.

Materials Added To Engine Oils

The manufacturer **strongly recommends** against the addition of any additives (other than leak detection dyes) to engine oil. Engine oil is an engineered product and its performance may be impaired by supplemental additives.

Disposing of Used Engine Oil and Oil Filters

Care should be taken in disposing of used engine oil and oil filters from your vehicle. Used oil and oil filters, indiscriminately discarded, can present a problem to the environment. Contact your authorized dealer, service station, or governmental agency for advice on how and where used oil and oil filters can be safely discarded in your area.

Engine Oil Filter

The engine oil filter should be replaced at every engine oil change.

Engine Oil Filter Selection

All of the manufacturer's engines have a full-flow type disposable oil filter. Use a filter of this type for replacement. The quality of replacement filters varies considerably. Only high quality filters should be used to assure most efficient service. Mopar® engine oil filters are high quality oil filters and are recommended.

Drive Belts — Check Condition and Tension

At the mileage shown in the appropriate "Maintenance Schedule," check all drive belts for condition and proper tension. Improper belt tension can cause belt slippage and failure.

Inspect the drive belt for evidence of cuts, cracks, or glazing and replace them if there is any sign of damage which could result in belt failure. If adjustment is required, adjust the belts according to the specifications and procedures shown in the Service Manual.

Special tools are required to properly measure tension and to restore belt tension to factory specifications. Also, check belt routing to make sure there is no interference between the belts and other engine components.

Spark Plugs

Spark plugs must fire properly to assure engine performance and emission control. New plugs should be installed at the mileage specified in the appropriate maintenance chart. The entire set should be replaced if there is any malfunction due to a faulty spark plug.

Refer to the "Vehicle Emission Control Information" label in the engine compartment for spark plug information.

Spark Plug Wires

The spark plug wires should be kept clean and properly connected. Terminals should be fully seated. Cracked, damaged, or faulty wires should be replaced.

Engine Air Cleaner Filter

Under normal driving conditions, replace the air filter at the intervals shown on "Maintenance Schedule A." If, however, you drive the vehicle frequently under dusty or severe conditions, the filter element should be inspected periodically and replaced if necessary at the intervals shown on "Maintenance Schedule B."

WARNING!

The air induction system (air cleaner, hoses, etc) can provide a measure of protection in the case of engine backfire. Do not remove the air induction system (air cleaner, hoses, etc) unless such removal is necessary for repair or maintenance. Make sure that no one is near the engine compartment before starting the vehicle with the air induction system (air cleaner, hoses, etc) removed. Failure to do so can result in serious personal injury.

Catalytic Converter

The catalytic converter requires the use of unleaded fuel only. Leaded gasoline will destroy the effectiveness of the converter as an emission control device.

Under normal operating conditions, the catalytic converter will not require maintenance. However, it is important to keep the engine properly tuned to assure proper catalyst operation and prevent possible catalyst damage.

CAUTION!

Damage to the catalytic converter can result if your vehicle is not kept in proper operating condition. In the event of engine malfunction, particularly involving engine misfire or other apparent loss of performance, have your vehicle serviced promptly. Continued operation of your vehicle with a severe malfunction could cause the converter to overheat, resulting in possible damage to the converter and vehicle.

NOTE: Intentional tampering with emissions control systems can result in civil penalties being assessed against you.

WARNING!

A hot exhaust system can start a fire if you park over materials that can burn. Such materials might be grass or leaves coming into contact with your exhaust system. Do not park or operate your vehicle in areas where your exhaust system can contact anything that can burn.

In unusual situations involving grossly malfunctioning engine operation, a scorching odor may suggest severe and abnormal catalyst overheating. If this occurs, stop the vehicle, turn off the engine and allow it to cool. Service, including a tune up to manufacturer's specifications, should be obtained immediately.

To minimize the possibility of catalytic converter damage:

- Do not shut off the engine or interrupt the ignition when the transmission is in gear and the vehicle is in motion.
- Do not try to start the engine by pushing or towing the vehicle.
- Do not idle the engine with any spark plug wires disconnected or removed, such as when diagnostic testing, or for prolonged periods during very rough idle or malfunctioning operating conditions.

Crankcase Emission Control System

Proper operation of this system depends on freedom from sticking or plugging due to deposits. As vehicle mileage builds up, the PCV valve and passages may accumulate deposits. If a valve is not working properly, replace it with a new valve. **DO NOT ATTEMPT TO CLEAN THE OLD PCV VALVE!**




Check ventilation hose for indication of damage or plugging deposits. Replace if necessary.

Maintenance-Free Battery

Your vehicle is equipped with a maintenance-free battery. You will never have to add water, nor is periodic maintenance required.

WARNING!

- Battery fluid is a corrosive acid solution and can burn or even blind you. Don't allow battery fluid to contact your eyes, skin or clothing. Don't lean over a battery when attaching clamps. If acid splashes in eyes or on skin, flush the area immediately with large amounts of water.
- Battery gas is flammable and explosive. Keep flame or sparks away from the battery. Don't use a booster battery or any other booster source with an output greater than 12 volts. Don't allow cable clamps to touch each other.
- Battery posts, terminals, and related accessories contain lead and lead compounds. Always wash hands after handling the battery.

BATTERY CONDITION INDICATOR	O.K. TO JUMP START	 	DARKENED INDICATOR WITH GREEN DOT • BATTERY CHARGE OK • FLUID LEVEL OK DARKENED INDICATOR NO GREEN DOT • BATTERY CHARGE LOW • FLUID LEVEL OK
	DO NOT JUMP START		YELLOW OR BRIGHT INDICATOR • BATTERY CHARGE UNKNOWN • FLUID LEVEL LOW (CHARGE MAY STILL BE SUFFICIENT TO START YOUR CAR)

80006bca

To determine the battery charge, check the battery test indicator (if equipped) on top of the battery. Refer to the illustration.

CAUTION!

- It is essential when replacing the cables on the battery that the positive cable is attached to the positive post and the negative cable is attached to the negative post. Battery posts are marked (+) positive and negative (-) and identified on the battery case.
- If a "fast charger" is used while battery is in the vehicle, disconnect both vehicle battery cables before connecting the charger to battery. Do not use a "fast charger" to provide starting voltage.

Air Conditioner Maintenance

For best possible performance, your air conditioner should be checked and serviced by an Authorized Dealer at the start of each warm season. This service should include cleaning of the condenser fins and a performance test. Drive belt tension should also be checked at this time.

WARNING!

- **Use only refrigerants and compressor lubricants approved by the manufacturer for your air conditioning system. Some unapproved refrigerants are flammable and can explode, injuring you. Other unapproved refrigerants or lubricants can cause the system to fail, requiring costly repairs. Refer to Section 3 of the Warranty Information Book for additional warranty information.**
- **The air conditioning system contains refrigerant under high pressure. To avoid risk of personal injury or damage to the system, adding refrigerant or any repair requiring lines to be disconnected should be done by an experienced repairman.**

Refrigerant Recovery and Recycling

R-134a Air Conditioning Refrigerant is a hydrofluorocarbon (HFC) that is endorsed by the Environmental Protection Agency and is an ozone-saving product. However, the manufacturer recommends that air conditioning service be performed by dealers or other service facilities using recovery and recycling equipment.

Power Steering Fluid Check

Checking the power steering fluid level at a defined service interval is not required. The fluid should only be checked if a leak is suspected, abnormal noises are apparent, and/or the system is not functioning as anticipated. Coordinate inspection efforts through a certified "DaimlerChrysler Dealership."

WARNING!

Fluid level should be checked on a level surface with the engine off to prevent injury from moving parts, and to insure accurate fluid level reading. Do not overfill. Use only the manufacturer's recommended fluid.

If necessary, add fluid to restore to the proper indicated level. With a clean cloth, wipe any spilled fluid from all surfaces. Refer to Fluids, Lubricants, and Genuine Parts for correct fluid type.

NOTE: Upon initial start-up in cold weather, the power steering pump may make noise for a short period of time. This is due to the cold, thick fluid in the steering system. This noise should be considered normal, and does not in any way damage the steering system.

Driveline And Steering Component Lubrication

U-joints (cardan joints) are sealed and do not require lubrication. Prop shafts, yokes, ball joints and other driveline and steering components may be provided with grease fittings for lubrication. Lubrication of these components at the intervals specified in the appropriate "Maintenance Schedule" in Section 8 is very important, particularly if your vehicle is subjected to off-road or other heavy-duty use. See your authorized dealer for complete service information.

Body Lubrication

Locks and all body pivot points, including such items as seat tracks, doors, swing gate and hood hinges, should be lubricated periodically to assure quiet, easy operation and to protect against rust and wear. Prior to the application of any lubricant, the parts concerned should be wiped clean to remove dust and grit; after lubricating excess oil and grease should be removed. Particular

attention should also be given to hood latching components to insure proper function. When performing other underhood services, the hood latch, release mechanism and safety catch should be cleaned and lubricated.

The external lock cylinders should be lubricated twice a year, preferably in the fall and spring. Apply a small amount of a high quality lubricant such as Mopar® Lock Cylinder Lubricant directly into the lock cylinder.

Windshield Wiper Blades

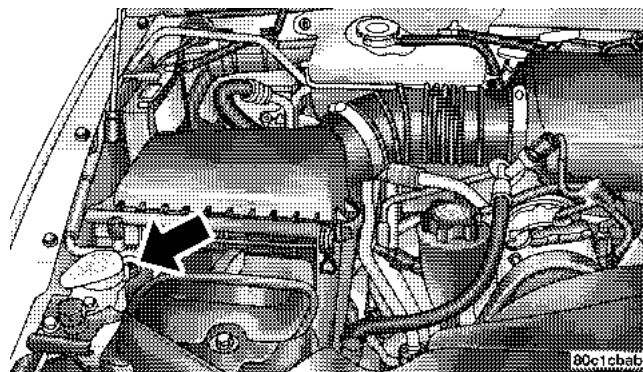
Clean the rubber edges of the wiper blades and the windshield periodically with a sponge or soft cloth and a mild non-abrasive cleaner. This will remove accumulations of salt or road film.

Operation of the wipers on dry glass for long periods may cause deterioration of the wiper blades. Always use washer fluid when using the wipers to remove salt or dirt from a dry windshield.

Avoid using the wiper blades to remove frost or ice from the windshield. Keep the blade rubber out of contact with petroleum products such as engine oil, gasoline, etc.

Windshield Washers

The fluid reservoir for the windshield washers and the rear window washer is shared. It is located in the front of the engine compartment on the passenger side and should be checked for fluid level at regular intervals. Fill the reservoir with windshield washer solvent (not antifreeze/coolant) and operate the system for a few seconds to flush out the residual water.



WARNING!

Commercial windshield washer solvents are flammable. They could ignite and burn you. Care must be exercised when filling or working around the washer solution.

Exhaust System

The best protection against carbon monoxide entry into the vehicle body is a properly maintained engine exhaust system.

If you notice a change in the sound of the exhaust system; or if the exhaust fumes can be detected inside the vehicle; or when the underside or rear of the vehicle is damaged; have an authorized technician inspect the complete exhaust system and adjacent body areas for broken, damaged, deteriorated, or mispositioned parts. Open seams or loose connections could permit exhaust fumes to seep into the passenger compartment. In addition, inspect the exhaust system each time the vehicle is raised for lubrication or oil change. Replace as required.

Cooling System

WARNING!

You or others can be badly burned by hot antifreeze/coolant or steam from your radiator. If you see or hear steam coming from under the hood, don't open the hood until the radiator has had time to cool. Never try to open a cooling system pressure cap when the radiator or coolant bottle is hot.

Engine Coolant Checks

Check antifreeze/coolant protection every 12 months (before the onset of freezing weather, where applicable). If antifreeze/coolant is dirty or rusty in appearance, the system should be drained, flushed and refilled with fresh antifreeze/coolant. Check the front of the A/C condenser (if equipped) or radiator for any accumulation of bugs,

leaves, etc. If dirty, clean by gently spraying water from a garden hose vertically down the face of the A/C condenser (if equipped) or the radiator core.

Check the engine cooling system hoses for brittle rubber, cracking, tears, cuts, and tightness of connection at the coolant recovery bottle and radiator. Inspect the entire system for leaks.

Cooling System — Drain, Flush, And Refill

At the intervals shown on the appropriate "Maintenance Schedule" the system should be drained, flushed, and refilled.

If the coolant solution is dirty or contains a considerable amount of sediment, clean and flush with a reliable cooling system cleaner (see your authorized dealer for recommendations). Follow with a thorough rinsing to remove all deposits and chemicals. Properly dispose of old antifreeze/coolant solution.

Selection Of Coolant

Use only the manufacturer's recommended antifreeze/coolant, refer to Fluids, Lubricants, and Genuine Parts for correct antifreeze/coolant type.

CAUTION!

- **Mixing of antifreeze/coolant other than the specified HOAT antifreeze/coolant may result in decreased corrosion protection and engine damage. If a non-HOAT antifreeze/coolant is introduced into the cooling system in an emergency, it should be replaced with the specified antifreeze/coolant as soon as possible.**
- **Do not use plain water alone or alcohol base antifreeze/coolant products. Do not use additional rust inhibitors or antirust products, as they may not be compatible with the antifreeze/coolant and may plug the radiator.**
- **This vehicle has not been designed for use with Propylene Glycol based antifreeze/coolant. Use of Propylene Glycol base antifreeze/coolant is not recommended.**

Adding Coolant

Your vehicle has been built with an improved antifreeze/coolant that allows extended maintenance intervals. This antifreeze/coolant can be used up to 5 Years or 100,000 miles before replacement. To prevent reducing this extended maintenance period, it is important that you use the same antifreeze/coolant throughout the life of your vehicle. Please review these recommendations for using Hybrid Organic Additive Technology (HOAT) coolant.

When adding antifreeze/coolant, a minimum solution of 50% recommended Mopar® Antifreeze/Coolant 5 Year/100,000 Mile Formula HOAT (Hybrid Organic Additive Technology), or equivalent, in water should be used. Use higher concentrations (not to exceed 70%) if temperatures below -34°F (-37°C) are anticipated.

Use only high purity water such as distilled or deionized water when mixing the water/antifreeze (coolant) solution. The use of lower quality water will reduce the amount of corrosion protection in the engine cooling system.

Please note that it is the owner's responsibility to maintain the proper level of protection against freezing according to the temperatures occurring in the area where the vehicle is operated.

NOTE: Mixing antifreeze/coolant types will decrease the life of the antifreeze/coolant and will require more frequent antifreeze/coolant changes.

Cooling System Pressure Cap

The cap must be fully tightened to prevent loss of antifreeze/coolant, and to insure that antifreeze/coolant will return to the radiator from the coolant recovery bottle.

The cap should be inspected and cleaned if there is any accumulation of foreign material on the sealing surfaces.

WARNING!

- The warning words **DO NOT OPEN HOT** on the cooling system pressure cap are a safety precaution. Never add antifreeze/coolant when the engine is overheated. Do not loosen or remove the cap to cool an overheated engine. Heat causes pressure to build up in the cooling system. To prevent scalding or injury, do not remove the pressure cap while the system is hot or under pressure.
- Do not use a pressure cap other than the one specified for your vehicle. Personal injury or engine damage may result.

Disposal of Used Engine Coolant

Used Hybrid Organic Additive Technology (HOAT) antifreeze/coolant is a regulated substance requiring proper disposal. Check with your local authorities to determine the disposal rules for your community. To prevent ingestion by animals or children, do not store HOAT antifreeze/coolant in open containers, or allow it to remain in puddles on the ground. If ingested by a child, contact a physician immediately. Clean up ground spills immediately.

Coolant Level

The coolant recovery bottle provides a quick visual method for determining that the antifreeze/coolant level is adequate. With the engine idling, and warm to normal operating temperature, the level of the antifreeze/coolant should be between the ranges indicated on the bottle.

The radiator normally remains completely full, so there is no need to remove the radiator cap unless checking for

antifreeze/coolant freeze point or replacing coolant. Advise your service attendant of this. As long as the engine operating temperature is satisfactory, the coolant bottle need only be checked once a month.

When additional antifreeze/coolant is needed to maintain the proper level, it should be added to the coolant recovery bottle. Do not overfill.

Points To Remember

NOTE: When the vehicle is stopped after a few miles (kilometers) of operation, you may observe vapor coming from the front of the engine compartment. This is normally a result of moisture from rain, snow, or high humidity accumulating on the radiator and being vaporized when the thermostat opens, allowing hot water to enter the radiator.

If an examination of your engine compartment shows no evidence of radiator or hose leaks, the vehicle may be safely driven. The vapor will soon dissipate.

- Do not overfill the coolant recovery bottle.
- Check antifreeze/coolant freeze point in the system.
- If frequent antifreeze/coolant additions are required, or if the level in the recovery bottle does not drop when the engine cools, the cooling system should be pressure tested for leaks.
- Maintain engine coolant/anti-freeze concentration to 50% HOAT engine coolant/anti-freeze (minimum) and distilled water for proper corrosion protection of your engine which contains aluminum components.
- Make sure that the radiator and coolant recovery bottle hoses are not kinked or obstructed.

- Keep the front of the radiator clean. Also, if your vehicle is equipped with air conditioning, keep the front of the condenser clean.
- Do not change the thermostat for summer or winter operation. If replacement is ever necessary, install **ONLY** the correct type thermostat. Other designs may result in unsatisfactory cooling performance, poor gas mileage, and increased emissions.

Hoses and Vacuum/Vapor Harnesses

Inspect surfaces of hoses and nylon tubing for evidence of heat and mechanical damage. Hard or soft spots, brittle rubber, cracking, tears, cuts, abrasions, and excessive swelling indicate deterioration of the rubber.

Pay particular attention to the hoses nearest to high heat sources such as the exhaust manifold. Inspect hose routing to be sure hoses do not touch any heat source or moving component that may cause heat damage or mechanical wear.

Insure nylon tubing in these areas has not melted or collapsed. Inspect all hose connections such as clamps and couplings to make sure they are secure and no leaks are present. Components should be replaced immediately if there is any evidence of degradation that could cause failure.

Fuel System Connections

Electronic Fuel Injection high pressure fuel systems are designed with tubes and special connects, connections and clamps which have unique material characteristics to provide adequate sealing and resist attack by deteriorated gasoline.

You are urged to use only the manufactures-specified tubes, connections and clamps, or their equivalent in material and specification, in any fuel system servicing.

Brake System

In order to assure brake system performance, all brake system components should be inspected periodically. Refer to the appropriate "Maintenance Schedule" in Section 8 for suggested service intervals.

WARNING!

Riding the brakes can lead to brake failure and possibly an accident. Driving with your foot resting or riding on the brake pedal can result in abnormally high brake temperatures, excessive lining wear, and possible brake damage. You wouldn't have your full braking capacity in an emergency.

7

Brake and Power Steering System Hoses

When servicing the vehicle for scheduled maintenance, inspect surface of hoses for evidence of heat and mechanical damage. Hard and brittle rubber, cracking, tears,

cuts, abrasion, and excessive swelling suggest deterioration of the rubber. Particular attention should be made to examining those hose surfaces nearest to high heat sources, such as the exhaust manifold.

Inspect all hose clamps and couplings to make sure they are secure and no leaks are present.

NOTE: Often fluids such as oil, power steering fluid, and brake fluid are used during assembly plant operations to ease the assembly of hoses to couplings. Therefore, oil wetness at the hose-coupling area is not necessarily an indication of leakage. Actual dripping of hot fluid when systems are under pressure (during vehicle operation) should be noted before hose is replaced based on leakage.

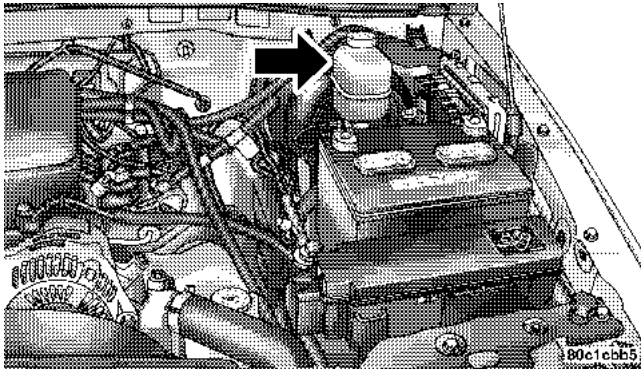
NOTE: Inspection of brake hoses should be done whenever the brake system is serviced and every engine oil change.

WARNING!

Worn brake hoses can burst and cause brake failure. You could have an accident. If you see any signs of cracking, scuffing, or worn spots, have the brake hoses replaced immediately.

Brake Master Cylinder — Brake Fluid Level Check

The fluid level in the master cylinder should be checked when performing under hood services, or immediately if the “Brake Warning Light” shows system failure.



Be sure to clean the top of the master cylinder area before removing the cap. If necessary, add fluid to bring the fluid level up to the requirements described on the brake

fluid reservoir. With disc brakes, fluid level can be expected to fall as the brake pads wear. However, low fluid level may be caused by a leak and a checkup may be needed.

Use only manufacturer’s recommended brake fluid, refer to Fluids, Lubricants, and Genuine Parts for correct fluid type.

WARNING!

Use of a brake fluid that may have a lower initial boiling point or unidentified as to specification, may result in sudden brake failure during hard prolonged braking. You could have an accident.

WARNING!

Overfilling the brake fluid reservoir can result in spilling brake fluid on hot engine parts and the brake fluid catching fire.

Use only brake fluid that has been in a tightly closed container to avoid contamination from foreign matter. Do not allow petroleum base fluid to contaminate the brake fluid as seal damage will result.

Clutch Hydraulic System — Manual Transmission Only

The clutch hydraulic system is a sealed maintenance free system. In the event of leakage or other malfunction, the system must be replaced.

Front/Rear Axle Fluid

The front axle has a threaded “fill plug” on the cover plate, and a threaded “drain plug” on the bottom side of the carrier.

Fluid Level Check

Lubricant should be 1/2” (1 cm) below the oil fill hole.

Adding Fluid

Add lubricant only at the fill hole and only to the level specified above.

Selection of Lubricant

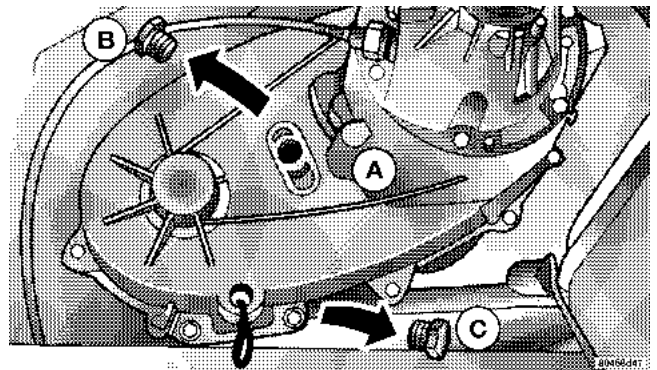
Use only manufacturer’s recommended fluid, refer to Fluids, Lubricants, and Genuine Parts for correct fluid type.

Transfer Case

Fluid Level Check

Inspect the transfer case for fluid leaks. If a fluid leak is evident, the transfer case fluid level can be checked by removing the fill plug (B) located at the back of the transfer case.

The fluid level should be to the bottom edge of the fill hole (A) when the vehicle is in a level position.



Adding Fluid

Only at filler hole until fluid runs out of the hole, when the vehicle is in a level position.

Drain

First remove fill plug (B), then drain plug (C). Recommended tightening torque for drain and fill plugs is 15–25 ft. lbs. (20–34 N·m).

CAUTION!

When installing plugs, do not overtighten. You could damage them and cause them to leak.

Selection of Lubricant

Use only manufacturer's recommended fluid, refer to Fluids, Lubricants, and Genuine Parts for correct fluid type.

Manual Transmission**Selection of Lubricant**

Use only manufacturer's recommended manual transmission fluid, refer to Fluids, Lubricants, and Genuine Parts for correct fluid type.

Fluid Level Check

Check the fluid level by removing the fill plug. The fluid level should be between the bottom of the fill hole and a point not more than 3/16" (4.76 mm) below the bottom of the hole.

Add fluid, if necessary, to maintain the proper level.

Frequency of Fluid Change

Under normal operating conditions, the fluid installed at the factory will give satisfactory lubrication for the life of the vehicle. Fluid changes are not necessary unless the lubricant has become contaminated with water. If contaminated with water, the fluid should be changed immediately.

Automatic Transmission

Selection of Lubricant

It is important that the proper lubricant is used in the transmission to assure optimum transmission performance. Use only manufacturer's recommended transmission fluid, refer to Fluids, Lubricants, and Genuine Parts for correct fluid type. It is important that the transmission fluid be maintained at the prescribed level using the recommended fluid.

CAUTION!

Using a transmission fluid other than the manufacturer's recommended fluid may cause deterioration in transmission shift quality and/or torque converter shudder. Using a transmission fluid other than the manufacturer's recommended fluid will result in more frequent fluid and filter changes. Refer to Fluids, Lubricants, and Genuine Parts for correct fluid type.

Fluid Level Check

This fluid level should be checked when the engine is fully warmed up and the fluid in the transmission is heated to its normal operating temperature. Operation of the transmission with an improper fluid level will greatly reduce the life of the transmission and of the fluid.

To check the automatic transmission fluid level properly, the following procedure must be used:

1. The vehicle must be on level ground.
2. The engine should be running at curb idle speed for a minimum of 60 seconds.
3. Fully apply parking brake.
4. Apply the brakes and shift the transmission into P (Park).
5. The fluid **MUST** be checked with the transmission in P (Park) to be sure that the fluid level is accurate.
6. Wipe the dipstick clean and reinsert until seated. Remove dipstick and note reading.

At normal operating temperature (approximately 180° F (82° C), the fluid level is correct if it is in the HOT region

(cross-hatched area) on the oil level indicator. The fluid level indicator should be in the COLD region at 70° F (21° C) fluid temperature.

If the fluid level is low, add sufficient fluid to bring to the proper level. Refer to Fluids, Lubricants and Genuine Parts for correct fluid type.

Fluid is added through the dipstick tube.

NOTE: To prevent dirt and water from entering the transmission after checking or replenishing fluid, make certain that the dipstick cap is properly reseated.

Special Additives

The manufacturer recommends against the addition of any additives to the transmission. Exception to this policy is the use of special dyes to aid in detecting fluid leaks.

Maintenance After Off-Road Driving

After extended operation in mud, sand or water, or similar dirty conditions, have your brake drums, brake linings, and axle joints inspected and cleaned as soon as possible. This will prevent any abrasive material from causing excessive wear or unpredictable braking action.

After off-road driving, completely inspect the underbody of your vehicle. Check tires, body structure, steering, suspension and exhaust system for damage. Check threaded fasteners for looseness, particularly on the chassis, drivetrain components, steering and suspension. Retighten, if required, to torque values specified in the Service Manual. Also check for accumulations of vegetation or brush that could become a fire hazard, or conceal damage to fuel lines, brake hoses, axle pinion seals, and propeller shafts.

CAUTION!

Under frequent heavy-duty driving conditions, change all lubricants and lubricate body components, all driveline joints and steering linkage more often than in normal service to prevent excessive wear.

Appearance Care And Protection From Corrosion**Protection Of Body And Paint From Corrosion**

Vehicle body care requirements vary according to geographic locations and usage. Chemicals that make roads passable in snow and ice, and those that are sprayed on trees and road surfaces during other seasons, are highly corrosive to the metal in your vehicle. Outside parking, which exposes your vehicle to airborne contaminants, road surfaces on which the vehicle is operated, extreme

hot or cold weather and other extreme conditions will have an adverse effect on paint, metal trim, and underbody protection.

The following maintenance recommendations will enable you to obtain maximum benefit from the corrosion resistance built into your vehicle.

What Causes Corrosion?

Corrosion is the result of deterioration or removal of paint and protective coatings from your vehicle.

The most common causes are:

- Road salt, dirt and moisture accumulation.
- Stone and gravel impact.
- Insects, tree sap and tar.
- Salt in the air near sea-coast localities.
- Atmospheric fallout/industrial pollutants.

Washing

- Wash your vehicle regularly. Always wash your vehicle in the shade using Mopar® Car Wash or a mild car wash soap, and rinse the panels completely with clear water.
- If insects, tar, or other similar deposits have accumulated on your vehicle, use Mopar® Super Kleen Bug and Tar Remover to remove.
- Use Mopar® Cleaner Wax to remove road film, stains, and to protect your paint finish. Take care never to scratch the paint.
- Avoid using abrasive compounds and power buffing that may diminish the gloss or thin out the paint finish.

CAUTION!

Do not use abrasive or strong cleaning materials such as steel wool or scouring powder, which will scratch metal and painted surfaces.

Special Care

- If you drive on salted or dusty roads or if you drive near the ocean, hose off the undercarriage at least once a month.
- It is important that the drain holes in the lower edges of the doors, rocker panels and tailgate must be kept clear and open.
- If you detect any stone chips or scratches in the paint, touch them up immediately. The cost of such repairs is considered the responsibility of the owner.
- If your vehicle is damaged due to an accident or similar cause which destroys the paint and protective coating have your vehicle repaired as soon as possible. The cost of such repairs is considered the responsibility of the owner.
- Aluminum wheels should be cleaned regularly with a mild soap and water to prevent corrosion. To remove heavy soil, use Mopar® Wheel Cleaner or select a nonabrasive, non-acidic cleaner. Do not use scouring pads, steel wool, a bristle brush or metal polishes. Only Mopar® cleaners are recommended. Do not use oven cleaner. Avoid automatic car washes that use acidic solutions or harsh brushes that may damage the wheels' protective finish.
- If you carry special cargo such as chemicals, fertilizers, de-icer salt, etc., assure that such materials are well packaged and sealed.

- If a lot of driving is done on gravel roads, consider mud or stone shields behind each wheel.
- Use Mopar® Touch Up Paint on scratches or chips as soon as possible. Your authorized dealer has touch up paint to match the color of your vehicle.

Wheel and Wheel Trim Care

All wheels and wheel trim, especially aluminum and chrome plated wheels should be cleaned regularly with a mild soap and water to prevent corrosion. To remove heavy soil, use Mopar® Wheel Cleaner or select a non-abrasive, non-acidic cleaner. Do not use scouring pads, steel wool, a bristle brush or metal polishes. Only Mopar® cleaners are recommended. Do not use oven cleaner. Avoid automatic car washes that use acidic solutions or harsh brushes that may damage the wheels' protective finish.

Interior Care

Use Mopar® Total Clean to clean fabric upholstery and carpeting.

Interior Trim should be cleaned starting with a damp cloth, a damp cloth with Mopar® Total Clean, then Mopar® Spot & Stain Remover if absolutely necessary. Do not use harsh cleaners or Armorall. Use Mopar® Total Clean to clean vinyl upholstery.

Leather Seat Care & Cleaning

Mopar® Total Clean is specifically recommended for leather upholstery.

Your leather upholstery can be best preserved by regular cleaning with a damp soft cloth. Small particles of dirt can act as an abrasive and damage the leather upholstery and should be removed promptly with a damp cloth. Stubborn soils can be removed easily with a soft cloth and Mopar® Total Clean. Care should be taken to avoid soaking your leather upholstery with any liquid. Please

do not use polishes, oils, cleaning fluids, solvents, detergents, or ammonia based cleaners to clean your leather upholstery. Application of a leather conditioner is not required to maintain the original condition.

WARNING!

Do not use volatile solvents for cleaning purposes. Many are potentially flammable, and if used in closed areas they may cause respiratory harm.

Cleaning Headlights

Your vehicle has plastic headlights that are lighter and less susceptible to stone breakage than glass headlights.

Plastic is not as scratch resistant as glass and therefore different lens cleaning procedures must be followed.

To minimize the possibility of scratching the lenses and reducing light output, avoid wiping with a dry cloth. To remove road dirt, wash with a mild soap solution followed by rinsing.

Do not use abrasive cleaning components, solvents, steel wool or other aggressive material to clean the lenses.

Glass Surfaces

All glass surfaces should be cleaned on a regular basis with Mopar® Glass Cleaner or any commercial household-type glass cleaner. Never use an abrasive type cleaner. Use caution when cleaning inside rear windows equipped with electric defrosters. Do not use scrapers or other sharp instruments which may scratch the elements.

When cleaning the rear view mirror, spray cleaner on the towel or rag that you are using. Do not spray cleaner directly on the mirror.

Cleaning Plastic Instrument Cluster Lenses

The lenses in front of the instruments in this vehicle are molded in clear plastic. When cleaning the lenses, care must be taken to avoid scratching the plastic.

1. Clean with a wet soft rag. A mild soap solution may be used, but do not use high alcohol content or abrasive cleaners. If soap is used, wipe clean with a clean damp rag.
2. Dry with a soft tissue.

Seat Belt Maintenance

Do not bleach, dye or clean the belts with chemical solvents or abrasive cleaners. This will weaken the fabric. Sun damage will also weaken the fabric.

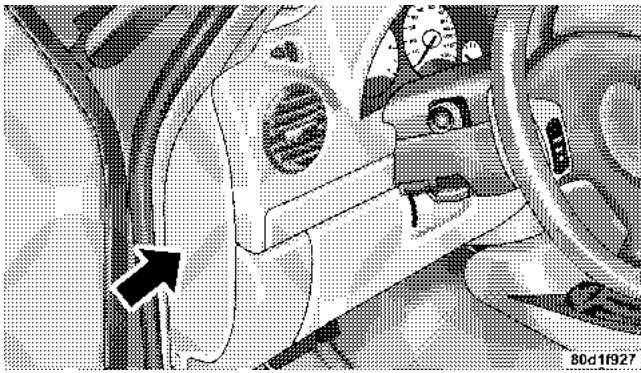
If the belts need cleaning, use Mopar® Total Clean, a mild soap solution, or lukewarm water. Do not remove the belts from the vehicle to wash them.

Replace the belts if they appear frayed or worn or if the buckles do not work properly.

FUSE PANEL

Interior Fuses

The fuse panel is on the left side of the instrument panel. A label is attached to the fuse panel cover to identify each fuse for ease of replacement.



Fuse Panel

Cavity	Fuse	Description
1	15 Amp Blue	Horn Relay, Power Sunroof Relay, Power Window Relay
2	10 Amp Red	Rear Fog Lights (Export Only)
3	20 Amp Yellow	Cigar Lighter
4	10 Amp Red	Headlight Low Beam Right
5	10 Amp Red	Headlight Low Beam Left
6	20 Amp Yellow	Body Control Module/Power Door Locks
7	10 Amp Red	Left Park Light/Left Tail Lamp/License Plate Lamp
8	Spare	
9	10 Amp Red	Right Park Light/Right Tail Lamp/License Plate Lamp/Cluster
10	Spare	
11	15 Amp Blue	Flasher

Cavity	Fuse	Description
12	15 Amp Blue	Stop Lights
13	10 Amp Red	Body Control Module/CMTC/Cluster/Pass. Airbag On,Off Indicator, Auto Daylight Mirror/Light Bar Switch (Renegade Only)
14	10 Amp Red	PDC Fuel Pump/AC Clutch, Starter Relay/Engine Controller/Transmission Controller (Diesel Only)
15	Spare	
16	20 Amp Yellow	Power Outlet (Rear)
17	15 Amp Blue	Rear Wiper
18	20 Amp Yellow	Radio Choke & Relay
19	20 Amp Yellow	Frt Fog Lights/Trailer Tow Stop and Turn Lights

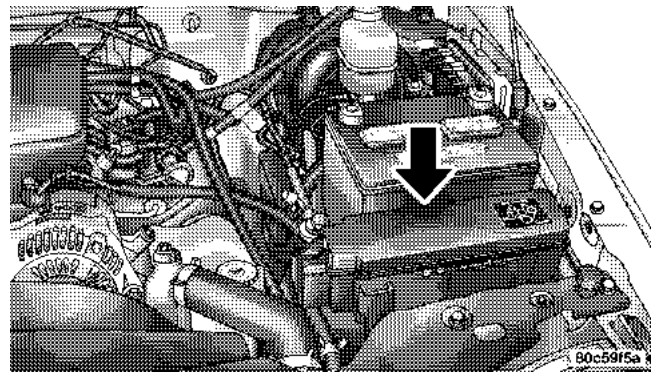
Cavity	Fuse	Description
20	Spare	
21	10 Amp Red	Radio
22	20 Amp Yellow	Power Sunroof Relay/Antenna Module (Export Only)
23	Spare	
24	10 Amp Red	PDC Blower Motor
25	10 Amp Red	Heated Seat Switches/HVAC Control Head/Trailer Tow Battery Charge
26	10 Amp Red	Headlight High Beam Right
27	10 Amp Red	Headlight High Beam Left
28	Spare	
29	10 Amp Red	Heated Mirrors/Rear Window Defroster Indicator
30	15 Amp Blue	Heated Seat Module
31	Spare	

Cavity	Fuse	Description
32	10 Amp Red	Wiper Switch/Front and Rear Wipers
33	10 Amp Red	SKIM Module/Data Link Connector
34	15 Amp Blue	Body Control Module/Cluster/Interior Lights, Hands Free Module/Radio/CMTC/ITM Module & Siren (Export Only)
35	Spare	

Cavity	Fuse	Description
36	10 Amp Red	Airbag Control Module/Occupation Classification Module (Right Front Seat)
37	10 Amp Red	Airbag Control Module
38	10 Amp Red	ABS Controller/Shifter Assembly
39	10 Amp Red	Hazard Flasher (Turn Signals)/Backup Lamp Switch (Manual Transmission Only)/Transmission Range Switch (Automatic Transmission Only)

Underhood Fuses (Power Distribution Center)

Your vehicle is equipped with an electrical power distribution center located in the engine compartment near the battery. This power center houses plug-in "Cartridge" fuses which replace in-line fusible links. The power center also contains "Mini" fuses and plug-in full and micro ISO relays. A label inside the latching cover of the center identifies each component for ease of replacement, if necessary. "Cartridge" fuses and relays can be obtained from your authorized dealer.



Power Distribution Center

Power Distribution Center (Gasoline Engines)

Cavity	Fuse	Description
F1	40 Amp Green	Blower Motor
F2	40 Amp Green	Radiator Fan
F3	50 Amp Red	JB Power
F4	40 Amp Green	ABS Pump
F5	20 Amp Yellow	NGC Trans
F6	30 Amp Pink	ASD
F7	50 Amp Red	JB Power
F8	40 Amp Green	Ign/Start
F9	50 Amp Red	JB Power
F10	30 Amp Pink	Trailer Tow
F11		Open

Cavity	Fuse	Description
F12	30 Amp Pink	Light Bar
F13	40 Amp Green	Windows
F14	40 Amp Green	Ignition Switch
F15	50 Amp Red	JB Power
F16		Open
F17		Open
F18		Open
F19	30 Amp Pink	Rear Window Defogger (HBL)
F20		Open
F21	20 Amp Yellow	A/C Clutch
F22		Open
F23		Open
F24	20 Amp Yellow	Fuel Pump

Cavity	Fuse	Description
F25	20 Amp Yellow	ABS Valves
F26	25 Amp Natural	Injectors
F27		Open
F28	15 Amp Blue	Starter
R29	Half ISO Relay	Fuel Pump
R30	Half ISO Relay	Starter
R31	Half ISO Relay	Wiper On/Off
R32	Half ISO Relay	Wiper Hi/Lo
R33	Full ISO Relay	H. Blower
R34	Full ISO Relay	Rad. Fan Hi

Cavity	Fuse	Description
R35	Half ISO Relay	A/C Clutch
R36		Open
R37	Half ISO Relay	NGC Trans
R38		Open
R39	Full ISO Relay	ASD
R40	Full ISO Relay	Rad. Fan Lo

Power Distribution Center (Diesel Engines)

Cavity	Fuse	Description
F1	40 Amp Green	Blower Motor
F2	40 Amp Green	Radiator Fan
F3	50 Amp Red	JB Power
F4	40 Amp Green	ABS Pump
F5		Open
F6	30 Amp Pink	ASD
F7	50 Amp Red	JB Power
F8	40 Amp Green	Ign/Start
F9	50 Amp Red	JB Power
F10	30 Amp Pink	Trailer Tow
F11	20 Amp Yellow	Fuel Heater

Cavity	Fuse	Description
F12	30 Amp Pink	Light Bar
F13	40 Amp Green	Windows
F14	40 Amp Green	Ignition Switch
F15	50 Amp Red	JB Power
F16	15 Amp Blue	ASD Feed
F17		Open
F18		Open
F19	30 Amp Pink	Rear Window Defogger (HBL)
F20		Open
F21	20 Amp Yellow	A/C Clutch
F22		Open
F23		Open
F24		Open

360 MAINTAINING YOUR VEHICLE

Cavity	Fuse	Description
F25	20 Amp Yellow	ABS Valves
F26	25 Amp Natural	Injectors
F27		Open
F28	15 Amp Blue	Starter
R29	Half ISO Relay	Fuel Heater
R30	Half ISO Relay	Starter
R31	Half ISO Relay	Wiper On/Off
R32	Half ISO Relay	Wiper Hi/Lo
R33	Full ISO Relay	H. Blower
R34	Full ISO Relay	Rad. Fan Hi

Cavity	Fuse	Description
R35	Half ISO Relay	A/C Clutch
R36	Half ISO Relay	Viscous Heat
R37		Open
R38		Open
R39	Full ISO Relay	ASD
R40	Full ISO Relay	Rad. Fan Lo

VEHICLE STORAGE

If you are leaving your vehicle dormant for more than 21 days you may want to take steps to protect your battery. You may:

- Remove Cartridge fuse #15 in the Power Distribution Center labeled Ignition-Off Draw (IOD).
- Store the removed IOD fuse in the Power Distribution Center location #11 labeled "IOD Storage."
- Or, disconnect the negative cable from the battery.
- Anytime you store your vehicle, or keep it out of service (i.e. vacation) for two weeks or more, run the air conditioning system at idle for about five minutes in the fresh air and high blower setting. This will insure adequate system lubrication to minimize the possibility of compressor damage when the system is started again.

REPLACEMENT BULBS

Interior Lights	Bulb Type
A/C Heater	Not Serviceable
Ashtray Receiver Light	161
Climate Control (Manual A/C)	74
Front Reading	192
Rear Cargo Light	214-2
Lighted Vanity Mirror *	P/N 6501966
Underpanel Courtesy Lights	906
Instrument Cluster (General Illumination)	103
Telltale/Hazard Light	74

* Available only from authorized dealers.

Exterior Lights	Bulb Type
Backup Lights	3157 P27/7W
Center High-Mounted Stoplight	921/W16W
Fog Lights (Sport/Limited Only)	9145
Front Park/Turn Lights	3157 P27/7W

Exterior Lights	Bulb Type
Front Side Marker	168
Headlights	9007QL
Rear License Plate Light	168
Rear Stop/Tail Lights	3157 P27/7W
Rear Turn Signal Lights (2)	3757 APY27/7W

NOTE: Numbers refer to commercial bulb types that can be purchased from your authorized dealer.

If a bulb needs to be replaced, visit your authorized dealer.

BULB REPLACEMENT

Head Light

1. Open the hood.
2. Reach behind the headlamp unit in the engine compartment to access the headlamp bulb lock ring.

3. Firmly grasp the lock ring on the back of the headlamp unit housing.
4. Rotate the lock ring on the back of the headlamp housing counter-clockwise to unlock it.

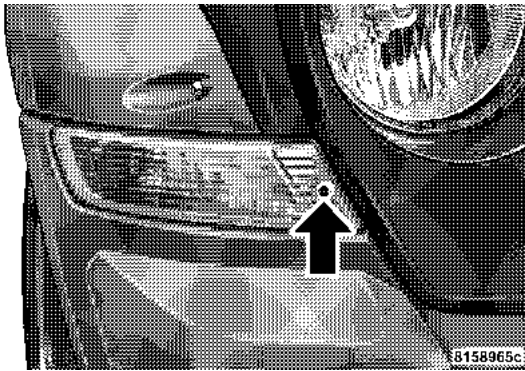
CAUTION!

Do not touch the new bulb with your fingers. Oil contamination will severely shorten bulb life. If the bulb comes in contact with any oily surface, clean the bulb with rubbing alcohol.

5. Disconnect the electrical connector and replace the bulb.

Front Turn Signal

1. Remove the screw from the turn signal/park lamp unit.



2. Pull the inboard side of the lamp away enough to disengage the tab that secures the outboard side of the lamp from the slot in the front bumper fascia.

3. Rotate the bulb socket counter-clockwise to unlock it.

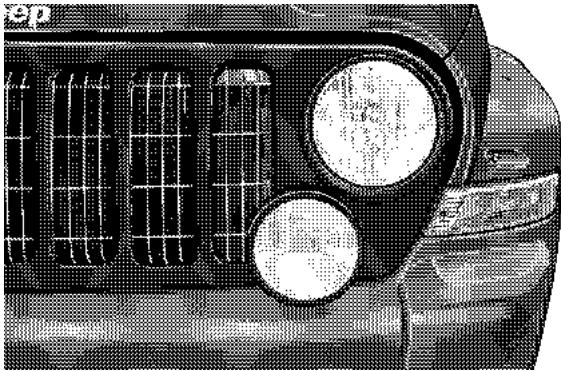
CAUTION!

Do not touch the new bulb with your fingers. Oil contamination will severely shorten bulb life. If the bulb comes in contact with any oily surface, clean the bulb with rubbing alcohol.

4. Disconnect the electrical connector and replace the bulb.

Front Fog Light (Front Fascia Mounted)

1. Remove the three screws from the backside of the lamp housing.



2. Pull the bezel and lens away from the lamp housing far enough to access and disconnect the wiring connector from the bulb pigtail wire.

3. Pinch together the two hooked ends of the bulb retainer clip and disengage them from the slots in the mounting flange on the back of the lens reflector.

4. Pivot the retainer clip up off of the bulb flange and out of the way.

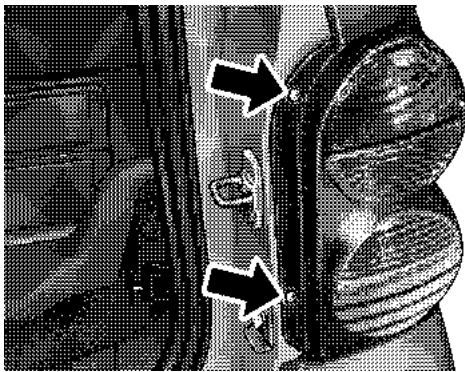
CAUTION!

Do not touch the new bulb with your fingers. Oil contamination will severely shorten bulb life. If the bulb comes in contact with any oily surface, clean the bulb with rubbing alcohol.

5. Pull the bulb straight out of the mounting flange and replace the bulb.

Rear Tail, Stop, Turn Signal, and Back-Up Lights

1. Open the swing gate.
2. Remove the two Torx fasteners.

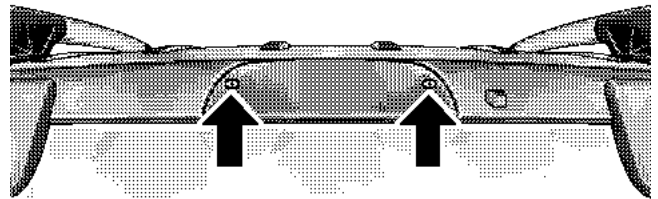


8158966a

3. Remove rear lamp assembly.
4. Rotate the socket on the back of the lamp housing counter-clockwise to unlock it.
5. Replace the bulb.

Center High Mounted Stop Light (CHMSL)

1. Remove the two screws securing the CHMSL.



81589666

2. Twist the bulb socket to remove from the CHMSL housing.
3. Pull the bulb out of the socket.
4. Replace the bulb, reinstall the socket and reattach the CHMSL.

FLUIDS AND CAPACITIES

	U.S.	Metric
Fuel (Approximate)	20.5 Gallons	78 Liters
Engine Oil with Filter		
3.7 Liter Engines (SAE 5W-20, API Certified)	5 Qts	4.7 Liters
Cooling System *		
3.7 Liter Engine (Mopar® Antifreeze/Coolant 5 Year/100,000 Mile Formula)	14 Qts	13.2 Liters

* Includes heater and coolant recovery bottle filled to MAX level.

FLUIDS, LUBRICANTS, AND GENUINE PARTS**Engine**

Component	Fluid, Lubricant, or Genuine Part
Engine Coolant	Mopar® Antifreeze/Coolant 5 Year/100,000 Mile Formula HOAT (Hybrid Organic Additive Technology)
Engine Oil (3.7L Engine)	Use API Certified SAE 5W-20 Engine Oil, meeting the requirements of DaimlerChrysler Material Standard MS-6395.
Oil Filter (3.7L Engine)	Mopar® Oil Filter (P/N 4781452AA or 4781452BB)
Spark Plugs	Refer to the Vehicle Emission Control Information label in the engine compartment.
Fuel Selection	87 Octane (89 Octane should be used for trailer towing purposes)

Chassis

Component	Fluid, Lubricant, or Genuine Part
Automatic Transmission	Mopar® ATF+4 Automatic Transmission Fluid
Manual Transmission	Mopar® Manual Transmission Lubricant or equivalent (meeting the requirements of DaimlerChrysler Material Standard MS-9224)
Transfer Case	Mopar® ATF+4 Automatic Transmission Fluid
Axle Differential (Front)	Mopar® Gear & Axle Lubricant (SAE 80W-90) or equivalent.
Axle Differential (Rear)	Mopar® Synthetic Gear Lubricant (SAE 75W-90) or equivalent. For trailer towing, the lubricant should be replaced with Mopar® Synthetic Gear & Axle Lubricant (SAE 75W-140) or equivalent. Models equipped with Trac-Lok™ require a limited-slip additive.
Brake Master Cylinder	Mopar® DOT 3 Brake Fluid, SAE J1703 should be used. If DOT 3, SAE J1703 brake fluid is not available, then DOT 4 is acceptable. Use only recommended brake fluids.
Power Steering Reservoir	Mopar® ATF+4 Automatic Transmission Fluid

MAINTENANCE SCHEDULES

CONTENTS

■ Emission Control System Maintenance	370	□ Schedule "B"	373
■ Maintenance Schedules	370	□ Schedule "A"	385

EMISSION CONTROL SYSTEM MAINTENANCE

The “Scheduled” maintenance services, listed in **bold type** must be done at the times or mileages specified to assure the continued proper functioning of the emission control system. These, and all other maintenance services included in this manual, should be done to provide best vehicle performance and reliability. More frequent maintenance may be needed for vehicles in severe operating conditions such as dusty areas and very short trip driving.

Inspection and service also should be done any time a malfunction is suspected.

NOTE: Maintenance, replacement, or repair of the emission control devices and systems on your vehicle may be performed by any automotive repair establishment or individual using any automotive part, which has been certified pursuant to U.S. EPA or, in the State of California, California Air Resources Board regulations.

MAINTENANCE SCHEDULES

There are two maintenance schedules that show the **required** service for your vehicle.

First is Schedule “**B**”. It is for vehicles that are operated under the conditions that are listed below and at the beginning of the schedule.

- Day or night temperatures are below 32°F (0°C)
- Stop and go driving
- Excessive engine idling
- Driving in dusty conditions
- Short trips of less than 10 miles (16.2 km)
- More than 50% of your driving is at sustained high speeds during hot weather, above 90°F (32°C)
- Trailer towing
- Taxi, police, or delivery service (commercial service)

- Off-road or desert driving

NOTE: If **ANY** of these apply to you then change your engine oil every 3,000 miles (5 000 km) or 3 months, whichever comes first and follow "Schedule B" of the "Maintenance Schedules" section of this manual.

NOTE: If **ANY** of these apply to you then flush and replace your engine coolant/anti-freeze every 102,000 miles (170 000 km) or 60 months, whichever comes first, and follow "Schedule B" of the "Maintenance Schedules" section of this manual.

NOTE: Most vehicles are operated under the conditions listed for Schedule "B."

Second is Schedule "A". It is for vehicles that are not operated under any of the conditions listed under Schedule "B."

Use the schedule that best describes your driving conditions. Where time and mileage are listed, follow the interval that occurs first.

CAUTION!

Failure to perform the required maintenance items may result in damage to the vehicle.

At Each Stop for Fuel

- Check the engine oil level about 5 minutes after a fully warmed engine is shut off. Checking the oil level while the vehicle is on level ground will improve the accuracy of the oil level reading. Add oil only when the level is at or below the ADD or MIN mark.
- Check the windshield washer solvent, add as required.

372 MAINTENANCE SCHEDULES

Once a Month

- Check the tire pressure and look for unusual wear or damage.
- Inspect the battery and clean and tighten the terminals as required.
- Check the fluid levels of the coolant reservoir, brake master cylinder, and transmission, and add as needed.
- Check all lights and all other electrical items for correct operation.

At Each Oil Change

- Change the engine oil filter.
- Inspect the exhaust system.
- Inspect brake hoses.
- Check the coolant level, hoses, and clamps.
- After completion of off-road operation, the underside of the vehicle should be thoroughly inspected. Examine threaded fasteners for looseness.

Schedule "B"

Follow this schedule if you usually operate your vehicle under one or more of the following conditions.

- Day or night temperatures are below 32°F (0°C)
- Stop and go driving
- Excessive engine idling
- Driving in dusty conditions
- Short trips of less than 10 miles (16.2 km)
- More than 50% of your driving is at sustained high speeds during hot weather, above 90°F (32°C)
- Trailer towing
- Taxi, police, or delivery service (commercial service)

- Off-road or desert driving
- **If equipped for and operated with E-85 (ethanol) fuel.**

NOTE: If **ANY** of these apply to you then change your engine oil every 3,000 miles (5 000 km) or 3 months, whichever comes first and follow "Schedule B" of the "Maintenance Schedules" section of this manual.

NOTE: If **ANY** of these apply to you then flush and replace your engine coolant/anti-freeze every 102,000 miles (170 000 km) or 60 months, whichever comes first, and follow "Schedule B" of the "Maintenance Schedules" section of this manual.

374 SCHEDULE "B"

Miles (Kilometers)	3,000 (5 000)	6,000 (10 000)	9,000 (15 000)	12,000 (20 000)	15,000 (25 000)
Change the engine oil and engine oil filter, if not replaced at 3 months.	X	X	X	X	X
Rotate the tires.		X		X	
Inspect the engine air filter element, replace if necessary.					X
Inspect the brake linings.				X	
Drain and refill the front and rear axle fluid.					X

Miles (Kilometers)	18,000 (30 000)	21,000 (35 000)	24,000 (40 000)	27,000 (45 000)	30,000 (50 000)
Change the engine oil and engine oil filter, if not replaced at 3 months.	X	X	X	X	X
Rotate the tires.	X		X		X
Inspect the engine air filter element, replace if necessary.					X
Inspect the PCV Valve, and replace if necessary. ◇					X
Replace the spark plugs.					X
Inspect the brake linings.			X		
Drain and refill the front and rear axle fluid.					X
Inspect the manual transmission fluid, add as necessary.					X
Inspect the transfer case fluid, add if necessary.					X

376 SCHEDULE "B"

Miles (Kilometers)	33,000 (55 000)	36,000 (60 000)	39,000 (65 000)	42,000 (70 000)	45,000 (75 000)
Change the engine oil and engine oil filter, if not replaced at 3 months.	X	X	X	X	X
Rotate the tires.		X		X	
Inspect the engine air filter element, replace if necessary.					X
Inspect the brake linings.		X			
Drain and refill the front and rear axle fluid.					X
Inspect the drive belt, and replace as needed.					X

Miles (Kilometers)	48,000 (80 000)	51,000 (85 000)	54,000 (90 000)	57,000 (95 000)	60,000 (100 000)
Change the engine oil and engine oil filter, if not replaced at 3 months.	X	X	X	X	X
Rotate the tires.	X		X		X
Inspect the engine air filter element, replace if necessary.					X
Inspect the PCV Valve, and replace if necessary. ◇					X
Replace the spark plugs.					X
Inspect the brake linings.	X				X
Drain and refill the front and rear axle fluid.					X
Inspect manual transmission fluid, add as necessary.					X
Drain and refill the automatic transmission fluid. Replace main sump filter and spin-on cooler return filter (if equipped). ‡					X
Inspect the drive belt, and replace as needed. Not required if belt was previously.					X
Drain and refill the transfer case fluid.					X
Flush and replace the engine coolant/anti-freeze.					X

378 SCHEDULE "B"

Miles (Kilometers)	63,000 (105 000)	66,000 (110 000)	69,000 (115 000)	72,000 (120 000)	75,000 (125 000)
Change the engine oil and engine oil filter, if not replaced at 3 months.	X	X	X	X	X
Rotate the tires.		X		X	
Inspect the engine air filter element, replace if necessary.					X
Inspect the brake linings.				X	
Drain and refill the front and rear axle fluid.					X
Inspect the drive belt, and replace as needed. Not required if belt was previously replaced.					X

Miles (Kilometers)	78,000 (130 000)	81,000 (135 000)	84,000 (140 000)	87,000 (145 000)	90,000 (150 000)
Change the engine oil and engine oil filter, if not replaced at 3 months.	X	X	X	X	X
Rotate the tires.	X		X		X
Inspect the engine air filter element, replace if necessary.					X
Inspect the PCV Valve, and replace if necessary. ◇					X
Replace the spark plugs.					X
Inspect the brake linings.			X		
Drain and refill the front and rear axle fluid.					X
Inspect the drive belt, and replace as needed. Not required if belt was previously replaced.					X
Inspect the manual transmission fluid, add as necessary.					X
Inspect the transfer case fluid, add if necessary.					X

380 SCHEDULE "B"

Miles (Kilometers)	93,000 (155 000)	96,000 (160 000)	99,000 (165 000)	102,000 (170 000)	105,000 (175 000)
Change the engine oil and engine oil filter, if not replaced at 3 months.	X	X	X	X	X
Rotate the tires.		X		X	
Inspect the engine air filter element, replace if necessary.					X
Inspect the brake linings.		X			
Drain and refill the front and rear axle fluid.					X
Inspect the drive belt, and replace as needed. Not required if belt was previously replaced.					X
Flush and replace the engine coolant/anti-freeze, if not done at 60,000 miles (100 000 km).				X	

Miles (Kilometers)	108,000 (180 000)	111,000 (185 000)	114,000 (190 000)	117,000 (195 000)	120,000 (200 000)
Change the engine oil and engine oil filter, if not replaced at 3 months.	X	X	X	X	X
Rotate the tires.	X		X		X
Inspect the engine air filter element, replace if necessary.					X
Inspect the PCV Valve, and replace if necessary. ◇					X
Replace the spark plugs.					X
Inspect the brake linings.	X				X
Drain and refill the front and rear axle fluid.					X
Inspect the manual transmission fluid, add as necessary.					X
Drain and refill the automatic transmission fluid. Replace main sump filter and spin-on cooler return filter (if equipped). ‡					X
Inspect the drive belt, and replace as needed. Not required if belt was previously replaced.					X
Drain and refill the transfer case fluid.					X
Flush and replace the engine coolant/anti-freeze, if not replaced at 102,000 miles (170 000 km).					X

382 SCHEDULE "B"

Miles (Kilometers)	123,000 (205 000)	126,000 (210 000)	129,000 (215 000)	132,000 (220 000)	135,000 (225 000)
Change the engine oil and engine oil filter, if not replaced at 3 months.	X	X	X	X	X
Rotate the tires.		X		X	
Inspect the engine air filter element, replace if necessary.					X
Inspect the brake linings.				X	
Drain and refill the front and rear axle fluid.					X
Inspect the drive belt, and replace as needed. Not required if belt was previously replaced.					X

Miles (Kilometers)	138,000 (230 000)	141,000 (235 000)	144,000 (240 000)	147,000 (245 000)	150,000 (250 000)
Change the engine oil and engine oil filter, if not replaced at 3 months.	X	X	X	X	X
Rotate the tires.		X		X	
Inspect the engine air filter element, replace if necessary.					X
Inspect the PCV Valve, and replace if necessary. ◇					X
Replace the spark plugs.					X
Inspect the brake linings.			X		
Drain and refill the front and rear axle fluid.					X
Inspect the manual transmission fluid, add as necessary.					X
Inspect the transfer case fluid, add if necessary.					X
Inspect the drive belt, and replace as needed. Not required if belt was previously replaced.					X
Flush and replace the engine coolant/anti-freeze, if not done at 120,000 miles (200 000 km).					X

384 SCHEDULE "B"

Inspection and service should also be performed anytime a malfunction is observed or suspected. Retain all receipts.

† Applies only if vehicle is used for frequent trailer towing or fleet/commercial service.

◇ This maintenance is recommended by the manufacturer to the owner, but is not required to maintain emissions warranty.

‡Off-highway operation, trailer towing, taxi, limousine, bus, snow plowing, or other types of commercial service or prolonged operation with heavy loading, especially in hot weather, require front and rear axle service indicated with a ‡ in Schedule "B". Perform these services if the vehicle is usually operated under these conditions.

Schedule "A"

Miles (Kilometers) [Months]	6,000 (10 000) [6]	12,000 (20 000) [12]	18,000 (30 000) [18]	24,000 (40 000) [24]	30,000 (50 000) [30]
Change the engine oil and engine oil filter.	X	X	X	X	X
Rotate the tires.	X	X	X	X	X
Inspect the engine air filter element, and replace if necessary.					X
Replace the spark plugs.					X
Inspect the brake linings.			X		
Inspect the manual transmission fluid, add as necessary.					X
Inspect the transfer case fluid, add as necessary.					X

386 SCHEDULE "A"

Miles (Kilometers) [Months]	36,000 (60 000) [36]	42,000 (70 000) [42]	48,000 (80 000) [48]	54, 000 (90 000) [54]
Change the engine oil and engine oil filter.	X	X	X	X
Rotate the tires.	X	X	X	X
Inspect the brake linings.	X			X

Miles (Kilometers) [Months]	60,000 (100 000) [60]	66,000 (110 000) [66]	72,000 (120 000) [72]	78,000 (130 000) [78]
Change the engine oil and engine oil filter.	X	X	X	X
Rotate the tires.	X	X	X	X
Inspect the engine air filter element, and replace if necessary.	X			
Inspect the PCV Valve, and replace if necessary. ◇	X			
Replace the spark plugs.	X			
Inspect the brake linings.			X	
Inspect the drive belt, and replace as needed.	X			
Inspect the drive belt, and replace as needed. Not required if belt was previously replaced.			X	
Flush and replace the engine coolant/anti-freeze. Where both time and mileage are indicated, follow the interval which occurs first.	X			
Inspect the manual transmission fluid, add as necessary.	X			
Inspect transfer case fluid, add as necessary.	X			

388 SCHEDULE "A"

Miles (Kilometers) [Months]	84,000 (140 000) [84]	90,000 (150 000) [90]	96,000 (160 000) [96]	102, 000 (170 000) [102]
Change the engine oil and engine oil filter.	X	X	X	X
Rotate the tires.	X	X	X	X
Inspect the engine air filter element, and replace if necessary.		X		
Inspect the PCV Valve, and replace if necessary. ◇		X		
Replace the spark plugs.		X		
Inspect the brake linings.		X		
Inspect the drive belt, and replace as needed. Not required if previously replaced.	X		X	
Flush and replace the engine coolant/anti-freeze if not done at 60 months.				X
Inspect the manual transmission fluid, add as necessary.		X		
Inspect the transfer case fluid, add as necessary.		X		

Miles (Kilometers) [Months]	108,000 (180 000) [108]	114,000 (190 000) [114]	120,000 (200 000) [120]	126,000 (210 000) [126]
Change the engine oil and engine oil filter.	X	X	X	X
Rotate the tires.	X	X	X	X
Inspect the engine air filter element, and replace if necessary.			X	
Inspect the PCV Valve, and replace if necessary. ◇			X	
Replace the spark plugs.			X	
Inspect the brake linings.	X			
Inspect the drive belt, and replace as needed. Not required if previously replaced.	X		X	
Inspect the manual transmission fluid, add as necessary.			X	
Drain and refill the transfer case fluid.			X	
Flush and replace the engine coolant/anti-freeze, if not done at 102,000 miles (170 000 km).			X	

390 SCHEDULE "A"

Miles (Kilometers) [Months]	132,000 (220 000) [132]	138,000 (230 000) [138]	144,000 (240 000) [144]	150,000 (250 000) [150]
Change the engine oil and engine oil filter.	X	X	X	X
Rotate the tires.	X	X	X	X
Inspect the engine air filter element, and replace if necessary.				X
Inspect the PCV Valve, and replace if necessary. ◇				X
Replace the spark plugs.				X
Inspect the brake linings.	X			
Inspect the drive belt, and replace as needed. Not required if previously replaced.	X			X
Inspect the manual transmission fluid, add as necessary.				X
Inspect the transfer case fluid, add as necessary.				X
Flush and replace the engine coolant/anti-freeze, if not done at 120,000 miles (200 000 km).				X

Inspection and service should also be performed anytime a malfunction is observed or suspected. Retain all receipts.

◇ This maintenance is recommended by the manufacturer to the owner, but is not required to maintain emissions warranty.

IF YOU NEED CONSUMER ASSISTANCE

CONTENTS

■ Suggestions For Obtaining Service For Your Vehicle392	■ Reporting Safety Defects395
□ Prepare For The Appointment392	□ In Canada395
□ Prepare A List392	■ Publication Order Forms396
□ Be Reasonable With Requests392	■ Department Of Transportation Uniform Tire Quality Grades397
■ If You Need Assistance392	□ Treadwear397
■ Warranty Information (U.S. Vehicles Only)395	□ Traction Grades397
■ Mopar® Parts395	□ Temperature Grades398

SUGGESTIONS FOR OBTAINING SERVICE FOR YOUR VEHICLE**Prepare For The Appointment**

If you're having warranty work done, be sure to have the right papers with you. Take your warranty folder. All work to be performed may not be covered by the warranty, discuss additional charges with the service manager. Keep a maintenance log of your vehicle's service history. This can often provide a clue to the current problem.

Prepare A List

Make a written list of your vehicle's problems or the specific work you want done. If you've had an accident, or work done that is not on your maintenance log, let the service advisor know.

Be Reasonable With Requests

If you list a number of items, and you must have your vehicle by the end of the day, discuss the situation with the service advisor and list the items in order of priority. At many dealers you may obtain a rental vehicle at a minimal daily charge. If you need a rental, it is advisable to make these arrangements when you call for an appointment.

IF YOU NEED ASSISTANCE

The manufacturer and its dealers are vitally interested in your satisfaction. We want you to be happy with our products and services.

Warranty service must be done by an authorized Chrysler, Dodge, or Jeep dealer. We strongly recommend that you take your vehicle to your selling dealer. They know you and your vehicle best, and are most concerned that you get prompt and high quality service. The manufacturer's dealers have the facilities, factory-trained

technicians, special tools, and the latest information to assure your vehicle is fixed correctly and in a timely manner.

This is why you should always talk to your dealer's service manager first. Most matters can be resolved with this process.

- If for some reason you are still not satisfied, talk to the general manager or owner of the dealership. They want to know if you need assistance.
- If your dealership is unable to resolve the concern, you may contact the Manufacturer's Customer Center.

Any communication to the Manufacturer's Customer Center should include the following information:

- Owner's name and address
- Owner's telephone number (home and office)
- Dealership name

- Vehicle identification number
- Vehicle delivery date and mileage

DaimlerChrysler Motors Corporation Customer Center

P.O. Box 21-8004
 Auburn Hills, MI 48321-8004
 Phone: (800) 992-1997

DaimlerChrysler Canada Inc. Customer Center

P.O. Box 1621
 Windsor, Ontario N9A 4H6
 Phone —(800) 465-2001

In Mexico contact:

Av. Prolongacion Paseo de la Reforma, 1240
 Sante Fe C.P. 05109
 Mexico, D. F.
 In Mexico (915) 729-1248 or 729-1240
 Outside Mexico (525) 729-1248 or 729-1240

Customer Assistance For The Hearing Or Speech Impaired (TDD/TTY)

To assist customers who have hearing difficulties, the manufacturer has installed special TDD (Telecommunication Devices for the Deaf) equipment at its Customer Center. Any hearing or speech impaired customer who has access to a TDD or a conventional teletypewriter (TTY) in the United States can communicate with the manufacturer by dialing 1-800-380-CHRY.

Service Contract

You may have purchased a service contract for your vehicle to help protect you from the high cost of unexpected repairs after your manufacturer's new vehicle limited warranty expires. The manufacturer stands behind only the manufacturer's Service Contracts. If you purchased a manufacturer's Service Contract, you will receive Plan Provisions and an Owner Identification Card in the mail within three weeks of your vehicle delivery date. If you have any questions about your service

contract, call the manufacturer's Service Contract National Customer Hotline at 1-800-521-9922.

The manufacturer will not stand behind any service contract that is not the manufacturer's Service Contract. It is not responsible for any service contract other than the manufacturer's Service Contract. If you purchased a service contract that is not a manufacturer's Service Contract, and you require service after your manufacturer's new vehicle limited warranty expires, please refer to your contract documents, and contact the person listed in those documents.

We appreciate that you have made a major investment when you purchased your new vehicle. Your dealer has also made a major investment in facilities, tools, and training to assure that you are absolutely delighted with your ownership experience. You'll be pleased with their sincere efforts to resolve any warranty issues or related concerns.

WARRANTY INFORMATION (U.S. Vehicles Only)

See the Warranty Information Booklet for the terms and provisions of DaimlerChrysler's warranties applicable to this vehicle.

MOPAR® PARTS

Mopar® fluids, lubricants, parts, and accessories are available from your dealer. They will help you keep your vehicle operating at its best.

REPORTING SAFETY DEFECTS

In the 50 United States and Washington D.C.: If you believe that your vehicle has a defect, which could cause a crash or cause injury or death, you should immediately inform the National Highway Traffic Safety Administration (NHTSA) in addition to notifying the manufacturer.

If NHTSA receives similar complaints, it may open an investigation, and if it finds that a safety defect exists in a group of vehicles, it may order a recall and remedy

campaign. However, NHTSA cannot become involved in individual problems between you, your dealer, and the manufacturer.

To contact NHTSA, you may either call the Auto Safety Hotline toll free at 1-888-327-4236 (TTY: 1-800-424-9153), or go to <http://www.NHTSA.gov>. or write to: NHTSA, U.S. Dept. of Transportation, Washington DC 20590. You can also obtain other information about motor vehicle safety from the Hotline.

In Canada:

If you believe that your vehicle has a safety defect, you should contact the Customer Service Department immediately. Canadian customers who wish to report a safety defect to the Canadian government should write to Transport Canada, Motor Vehicle Defect Investigations and Recalls, 2780 Sheffield Road, Ottawa, Ontario K1B 3V9.

PUBLICATION ORDER FORMS

To order the following manuals, you may use either the website or the phone numbers listed below. Visa, Mastercard, American Express, and Discover orders are accepted. If you prefer mailing your payment, please call for an order form.

NOTE: A street address is required when ordering manuals. (No P.O. Boxes).

- *Service Manuals.*

These comprehensive service manuals provide the information that students and professional technicians need in diagnosing/troubleshooting, problem solving, maintaining, servicing, and repairing DaimlerChrysler Corporation vehicles. A complete working knowledge of the vehicle, system, and/or components is written in straightforward language with illustrations, diagrams, and charts.

- *Diagnostic Procedure Manuals.*

Filled with diagrams, charts and detailed illustrations, these practical manuals make it easy for students and technicians to find and fix problems on computer-controlled vehicle systems and features. They show exactly how to find and correct problems the first time, using step-by-step troubleshooting and driveability procedures, proven diagnostic tests and a complete list of all tools and equipment.

- *Owner's Manuals.*

These manuals have been prepared with the assistance of service and engineering specialists to acquaint you with specific Chrysler group vehicles. Included are starting, operating, emergency and maintenance procedures as well as specifications, capabilities and safety tips.

Call Toll Free at:

- 1-800-890-4038 (U.S.)
- 1-800-387-1143 (Canada)

Or

Visit us on the World Wide Web at:

- www.techauthority.daimlerchrysler.com
- www.daimlerchrysler.ca/manuals

DEPARTMENT OF TRANSPORTATION UNIFORM TIRE QUALITY GRADES

The following describes the tire grading categories established by the National Highway Traffic Safety Administration. The specific grade rating assigned by the tire's manufacturer in each category is shown on the sidewall of the tires on your car.

All Passenger Car Tires Must Conform to Federal Safety Requirements in Addition to These Grades.

Treadwear

The treadwear grade is a comparative rating based on the wear rate of the tire when tested under controlled conditions on a specified government test course. For example, a tire graded 150 would wear one and a half (1 1/2) times as well on the government course as a tire graded 100. The relative performance of tires depends upon the actual conditions of their use, however, and may depart significantly from the norm due to variations in driving habits, service practices and differences in road characteristics and climate.

Traction Grades

The traction grades, from highest to lowest, are AA, A, B, and C. Those grades represent the tire's ability to stop on wet pavement as measured under controlled conditions

on specified government test surfaces of asphalt and concrete. A tire marked C may have poor traction performance.

WARNING!

The traction grade assigned to this tire is based on straight-ahead braking traction tests, and does not include acceleration, cornering, hydroplaning, or peak traction characteristics.

Temperature Grades

The temperature grades are A (the highest), B, and C, representing the tire's resistance to the generation of heat and its ability to dissipate heat when tested under controlled conditions on a specified indoor laboratory test wheel. Sustained high temperature can cause the material of the tire to degenerate and reduce tire life, and excessive temperature can lead to sudden tire failure. The

grade C corresponds to a level of performance which all passenger car tires must meet under the Federal Motor Vehicle Safety Standard No. 109. Grades B and A represent higher levels of performance on the laboratory test wheel than the minimum required by law.

WARNING!

The temperature grade for this tire is established for a tire that is properly inflated and not overloaded. Excessive speed, under inflation, or excessive loading, either separately or in combination, can cause heat buildup and possible tire failure.

INDEX

- ABS (Anti-Lock Brake System) 168,241
- Adding Fuel 277
- Adding Washer Fluid 157
- Air Cleaner, Engine (Engine Air Cleaner Filter) . . . 324
- Air Conditioner Maintenance 329
- Air Conditioning 203
- Air Conditioning, Operating Tips 205
- Air Conditioning Refrigerant 330
- Air Conditioning System 203
- Air Filter 324
- Air Pressure, Tires 254
- Airbag 49
- Airbag Deployment 61
- Airbag Light 54,64,173
- Airbag Maintenance 63
- Airbag, Window (Side Curtain) 50
- Alarm, Panic 24
- Alarm (Security Alarm) 19
- Alignment and Balance 260
- Alterations/Modifications, Vehicle 9
- Antenna, Satellite Radio 199
- Antifreeze (Engine Coolant) 366
- Anti-Lock Brake System (ABS) 126,241
- Anti-Lock Warning Light 168
- Appearance Care 347
- Arming Theft System (Security Alarm) 20
- Auto Down Power Windows 32
- Automatic Dimming Mirror 82
- Automatic Door Locks 29
- Automatic Transmission 221,345
- Adding Fluid 346
- Fluid and Filter Changes 345
- Fluid Level Check 345
- Fluid Type 345
- Gear Ranges 221
- Shifting 221
- Special Additives 346
- Torque Converter 225

Auxiliary Electrical Outlet (Power Outlet)	150	Brake/Transmission Interlock	220
Auxiliary Power Outlet	150	Break-In Recommendations, New Vehicle	74
Battery	327	Bulb Replacement	361,362
Emergency Starting	308	Bulbs, Light	361
Keyless Transmitter Replacement (RKE)	26	Calibration, Compass	141
Saving Feature (Protection)	117	Capacities, Fluid	366
Belts, Drive	323	Caps, Filler	
Body Mechanism Lubrication	331	Fuel	277
B-Pillar Location	249	Radiator (Coolant Pressure)	336
Brake Assist System	127	Car Washes	348
Brake Assist Warning Light	175	Carbon Monoxide Warning	144,276
Brake Control System, Electronic	125	Cargo Area Cover	154
Brake System	339	Cargo Area Features	154
Anti-Lock (ABS)	126,168,241	Cargo Compartment	
Hoses	339	Light	154
Master Cylinder	341	Luggage Carrier	159
Parking	240	Cargo Light	154
Warning Light	171	Cargo Tie-Downs	155

- Catalytic Converter 325
Caution, Exhaust Gas 74,144
CD (Compact Disc) Changer 181,182,194
CD (Compact Disc) Player 177,180,184,187
CD (Compact Disc) Player Maintenance 202
Cellular Phone 85,202
Center High Mounted Stop Light 365
Certification Label 280
Chains, Tire 260
Changing A Flat Tire 304
Charging System Light 169
Chart, Tire Sizing 246
Check Engine Light
(Malfunction Indicator Light) 318
Child Restraint 64,69,71
Child Restraint Tether Anchors 68,69
Child Safety Locks 30
Climate Control 203
Clock 176,192
Clutch Interlocking Ignition System 211,216
Command-Trac Operation 226
Compact Disc (CD) Maintenance 202
Compass 141
Compass Calibration 141
Compass Variance 141
Computer, Trip/Travel 139
Console, Overhead 133
Contract, Service 394
Converter, Catalytic 325
Cooling System 333
 Adding Coolant (Antifreeze) 335
 Coolant Capacity 366
 Coolant Level 337
 Disposal of Used Coolant 337
 Drain, Flush, and Refill 334
 Inspection 333
 Points to Remember 337
 Pressure Cap 336

Radiator Cap	336	Disarming, Theft System	20
Selection of Coolant (Antifreeze)	334,366	Disposal	
Temperature Gauge	169	Engine Oil	323
Crankcase Emission Control System	327	Used Engine Fluids	323
Cruise Control (Speed Control)	123	Door Locks	26,28
Cruise Light	170	Door Locks, Automatic	29
Cup Holder	152	Door Opener, Garage	143
Customer Assistance	392	Drive Belts	323
		Driving	235
Daytime Running Lights	118	Off-Pavement	235
Dealer Service	319	Off-Road	235
Defroster, Rear Window	158		
Delay (Intermittent) Wipers	121	Electric Remote Mirrors	83
Diagnostic System, Onboard	317	Electrical Outlet, Auxiliary (Power Outlet)	150
Dimmer Switch, Headlight	119	Electrical Power Outlets	150
Dipsticks		Electronic Brake Control System	125
Oil (Engine)	320	Electronic Speed Control (Cruise Control)	123
Power Steering	330	Electronic Stability Program (ESP)	129
Disabled Vehicle Towing	311	Electronic Throttle Control Warning Light	174

Electronic Vehicle Information Center (EVIC)	135	Fuel Requirements	273,366
Emergency Brake	240	Malfunction Indicator (Check Engine)	168
Emergency, In Case of		Oil	320,366
Hazard Warning Flasher	302	Oil Change Interval	321
Jacking	304	Oil Disposal	323
Jump Starting	308	Oil Filter	323
Tow Hooks	311	Oil Filter Disposal	323
Emission Control System Maintenance	318,370	Oil Selection	322,366
Engine		Oil Synthetic	322
Air Cleaner	324	Overheating	303
Block Heater	215	Starting	211
Break-In Recommendations	74	Temperature Gauge	169
Checking Oil Level	320	Engine Oil Viscosity	322
Compartment	316	Engine Oil Viscosity Chart	322
Compartment Identification	316	Enhanced Accident Response Feature	62
Cooling	333	Entry System, Illuminated	21
Exhaust Gas Caution	276	Exhaust Gas Caution	74,276
Fails to Start	213	Exhaust System	333
Flooded, Starting	213	Exterior Finish Care	348

Filters		Fog Lights	118,364
Air Cleaner	324	Folding Rear Seat	113
Engine Oil	323	Four Wheel Drive	226
Engine Oil Disposal	323	Operation	226
Finish Care	348	Shifting	228,232
Flashers		Systems	226,229
Hazard Warning	302	Four-Way Hazard Flasher	302
Turn Signal	166,363,365	Front Axle (Differential)	342
Flooded Engine Starting	213	Fuel	273
Fluid Capacities	366	Filler Cap (Gas Cap)	277
Fluid Leaks	76	Gasoline	273
Fluid Level Checks	76	Gauge	173
Automatic Transmission	345	Hoses	339
Clutch Fluid	342	Materials Added	275
Engine Oil	320	Octane Rating	273
Manual Transmission	344	Requirements	273,366
Power Steering	330	System Hoses	339
Fluids, Lubricants and Genuine Parts	367	Tank Capacity	366
Fog Light Service	364	Fuel System Caution	275,278,279

Fuses	353	Hands-Free Phone (UConnect™)	85
Garage Door Opener (HomeLink®)	143	Hazard Warning Flasher	302
Gas Cap (Fuel Filler Cap)	277,279,317	Head Restraints	111
Gasoline (Fuel)	273	Head Rests	111
Gasoline, Reformulated	274	Headlights	117
Gasoline/Oxygenate Blends	274	Bulb Replacement	362
Gauges		Cleaning	351
Coolant Temperature	169	High Beam	166
Fuel	173	Passing	119
Odometer	170	Replacing	362
Speedometer	166	Heated Mirrors	84
Tachometer	166	Heated Seats	112
Gear Ranges	218,221	Heater, Engine Block	215
General Information	272	Hitches	
Glass Cleaning	351	Trailer Towing	286
Gross Axle Weight Rating	283	Holder, Cup	152
Gross Vehicle Weight Rating	282	HomeLink® (Garage Door Opener) Transmitter	143
GVWR	280	Hood Release	115
		Hoses	338

Hydraulic Clutch Fluid	342	Intermittent Wipers (Delay Wipers)	121
Identifying Your Engine	316	Introduction	4
Ignition	14	Jack Location	304
Cables (Spark Plug Wires)	324	Jack Operation	304,306
Key	14	Jacking Instructions	306
Wiring System (Spark Plug Wires)	324	Jump Starting	308
Ignition Key Removal	14	Key, Programming	18
Illuminated Entry	21	Key Release Button	14
Inflation Pressure Tires	254	Key, Replacement	18
Information Center, Vehicle	135	Key, Sentry (Immobilizer)	16
Inside Rearview Mirror	81	Key-In Reminder	16
Instrument Cluster	165	Keyless Entry System	21
Instrument Panel and Controls	164	Keys	14
Instrument Panel Lens Cleaning	352	Lane Change and Turn Signals	166
Interior Appearance Care	350	Lap/Shoulder Belts	37
Interior Fuses	353		
Interior Lighting	119		
Interior Lights	118,119		

LATCH (Lower Anchors and Tether for Children)	68,69	Electronic Stability Program (ESP) Indicator	130,175
Lead Free Gasoline	273	Electronic Throttle Control Warning	174
Life of Tires	258	Fog	118,364
Lights	117,361	Four-Wheel Drive Indicator	167
Airbag	64,173	Fuses	353
Anti-Lock	168	Hazard Warning Flasher	302
Back-Up	365	Headlight Switch	117
Battery Saver	117	Headlights	362
Brake Assist Warning	132,175	High Beam Indicator	166
Brake Warning	171	Instrument Cluster	117,118
Bulb Replacement	362	Interior	118,119
Cargo	154	Lights On Reminder	118
Center Mounted Stop	365	Low Fuel	173
Cruise	170	Malfunction Indicator (Check Engine)	168
Daytime Running	118	Map Reading	120
Dimmer Switch, Headlight	117,119	Oil Pressure	170
Dome	134	Passing	119
		Reading	134

Rear Servicing	365	Power Door	29
Rear Tail	365	Steering Wheel	16
Seat Belt Reminder	173	Lower Anchors and Tether for Children (LATCH)	68,69
Security Alarm (Theft Alarm)	172	Lubrication, Body	331
Sentry Key	172	Luggage Carrier	159
Service	362	Luggage Rack (Roof Rack)	159
Side Marker	365	Maintenance Free Battery	327
Tire Pressure Monitoring (TPMS)	166	Maintenance Procedures	320
Traction Control	130,175	Maintenance Schedule	370
Transfer Case	171,172	Schedule "A"	385
Transmission Warning	171	Schedule "B"	373
Turn Signal	117,119,166,363,365	Maintenance Schedules	370
Warning (Instrument Cluster Description)	166	Maintenance, Sunroof	150
Loading Vehicle	280	Malfunction Indicator Light (Check Engine)	168,318
Tires	249	Manual, Service	396
Locks	26	Manual Transmission	216,344
Automatic Door	29	Fluid Level Check	344
Child Protection	30		
Door	26,28		

Lubricant Selection	344	Navigation System	191
Shift Speeds	218	New Vehicle Break-In Period	74
Map/Reading Lights	134	Occupant Classification System (OCS)	56
Master Cylinder (Brakes)	341	Occupant Restraints	36
Mini-Trip Computer	139	Octane Rating, Gasoline (Fuel)	273
Mirrors	81	Odometer	170
Automatic Dimming	82	Trip	170
Electric Remote	83	Off-Pavement Driving (Off-Road)	235,347
Exterior Folding	83	Off-Road Driving (Off-Pavement)	235,347
Heated	84	Oil, Engine	320
Outside	82	Capacity	366
Rearview	81	Change Interval	321
Vanity	84	Checking	320
Modifications/Alterations, Vehicle	9	Dipstick	320
Monitor, Tire Pressure System	262	Disposal	323
Mopar Parts	319,395	Filter Disposal	323
Multi-Function Control Lever	117	Identification Logo	322
Navigation Radio	191	Materials Added to	323

Pressure Warning Light	170	Pets	73
Recommendation	322,366	Phone, Cellular	85
Synthetic	322	Phone, Hands-Free (UConnect™)	85
Viscosity	322,366	Placard, Tire and Loading Information	250
Oil Filter, Selection	323	Polishing and Waxing	348
Oil Pressure Light	170	Power	
Onboard Diagnostic System	317,318	Distribution Center (Fuses)	356
Opener, Garage Door (HomeLink®)	143	Door Locks	29
Outside Rearview Mirrors	82	Mirrors	83
Overhead Console	133	Outlet (Auxiliary Electrical Outlet)	150
Overheating, Engine	303	Steering	243,330
Owner's Manual (Operator Manual)	396	Sunroof	148
		Windows	31,32
Paint Care	347	Pregnant Women and Seat Belts	48
Paint Damage	347	Preparation for Jacking	305
Panic Alarm	24	Pretensioners	
Parking Brake	240	Seat Belts	46
Passing Light	119	Programmable Electronic Features	136
PCV Valve	327		

Programming Transmitters (Remote Keyless Entry)	24	Reformulated Gasoline	274
Radial Ply Tires	256	Refrigerant	330
Radio Broadcast Signals	176	Reminder, Lights On	118
Radio, Navigation	191	Reminder, Seat Belt	47
Radio Operation	178,202	Remote CD Changer	194
Radio, Satellite	195	Remote Keyless Entry (RKE)	21
Radio (Sound Systems)	177,184	Remote Sound System (Radio) Controls	200
Rear Axle (Differential)	234,342	Replacement Parts	319
Rear Swing Gate	33	Replacement Tires	259
Rear Window Defroster	158	Reporting Safety Defects	395
Rear Window Features	157	Restraint, Head	111
Rear Wiper/Washer	157	Restraints, Child	64
Rearview Mirrors	81	Restraints, Infant	64
Reclining Front Seats	109	Restraints, Occupant	36
Recreational Towing	296	Retractable Cargo Area Cover	154
Shifting into Transfer Case Neutral (N)	297	Roof Rack (Luggage Rack)	159
Shifting out of Transfer Case Neutral (N)	298	Rotation, Tires	261
		Safety Checks Inside Vehicle	75

Safety Checks Outside Vehicle	76	Seats	108
Safety Defects, Reporting	395	Adjustment	108
Safety, Exhaust Gas	74	Cleaning	350
Safety Information, Tire	245	Head Restraints	111
Safety Tips	74	Heated	112
Satellite Radio	195	Rear Folding	113
Satellite Radio Antenna	199	Reclining	109
Schedule, Maintenance	370	Security Against Theft	19,28
Seat Belt Reminder	47	Security Alarm (Theft Alarm)	19
Seat Belts		Selection of Oil	322
Adjustable Upper Shoulder Anchorage	43	Selec-Trac Operation	229
And Pregnant Women	48	Sentry Key (Immobilizer)	16
Child Restraint	64,71	Sentry Key Programming	18
Extender	48	Sentry Key Replacement	18
Inspection	75	Service Assistance	392
Maintenance	352	Service Contract	394
Operating Instructions	39	Service Manuals	396
Pretensioners	46	Setting the Clock	176,192
Reminder	173	Shift Speeds, Manual Transmission	218

Shifting	220	Cold Weather	212
Automatic Transmission	220,221	Engine Block Heater	215
Manual Transmission	216	Engine Fails to Start	213
Transfer Case	228,232	Manual Transmission	211
Shoulder Belt Upper Anchorage	43	Steering	
Shoulder Belts	37	Power	243,330
Signals, Turn	119,166,363,365	Wheel Lock	16
Snow Chains (Tire Chains)	260	Wheel, Tilt	122
Snow Plow	299	Steering Wheel Mounted Sound System	
Spare Tire	305	Controls	200
Spark Plug Wires (Ignition Cables/Wires)	324	Storage	361
Spark Plugs	324	Storage, Vehicle	206,361
Specifications		Storing Your Vehicle	361
Fuel (Gasoline)	273	Sun Roof	148
Oil	322	Sun Visor Extension	85
Speed Control (Cruise Control)	123	Sunroof Maintenance	150
Speedometer	166	Supplemental Restraint System - Airbag	49
Starting	211	Swing Gate, Rear	33
Automatic Transmission	211	Synthetic Engine Oil	322

System, Navigation	191	High Speed	256
Tachometer	166	Inflation Pressures	254
Temperature Gauge, Engine Coolant	169	Jacking	304
Tether Anchor, Child Restraint	68	Life of Tires	258
Theft System Arming	20	Load Capacity	249,250
Theft System Disarming	20	Pressure Monitor System (TPMS)	262
Tie Down Hooks, Cargo	155	Pressure Warning Light	166
Tilt Steering Column	122	Quality Grading	397
Tire and Loading Information Placard	249,250	Radial	256
Tire Identification Number (TIN)	248	Replacement	259
Tire Markings	245	Rotation	261
Tire Safety Information	245	Safety	76,245
Tires	253,397	Sizes	246
Air Pressure	254	Spare Tire	305
Alignment and Balance	260	Spinning	257
Chains	260	Tread Wear Indicators	257
Changing	304	Tongue Weight/Trailer Weight	289
General Information	253	Torque Converter Clutch	225
		Tow Hooks, Emergency	311

Towing	282,311	Transmission	
Disabled Vehicle	311	Automatic	221,345
Guide	287	Maintenance	344,345
Recreational	296	Manual	216
Weight	287	Shifting	220
Trac-Lok Rear Axle	234	Warning Light	171
Traction Control	127	Transmitter Battery Service	
Traction Control Light	175	(Remote Keyless Entry)	26
Trailer Towing	282	Transmitter, Garage Door Opener (HomeLink®)	143
Cooling System Tips	296	Transmitter Programming	
Hitches	286	(Remote Keyless Entry)	24
Minimum Requirements	290	Transporting Pets	73
Trailer and Tongue Weight	289	Tread Wear Indicators	257
Wiring	293	Trip Odometer	170
Trailer Towing Guide	287	Turn Signals	119,166,363,365
Trailer Weight	287		
Transfer Case	226,343	UConnect™ (Hands-Free Phone)	85
Four-Wheel-Drive Operation	226	Underhood Fuses	356
Maintenance	343	Uniform Tire Quality Grades	397

- Universal Transmitter 143
 Unleaded Gasoline 273
 Upholstery Care 350

 Vacuum/Vapor Harnesses 338
 Vanity Mirrors 84
 Variance, Compass 141
 Vehicle Identification Number (VIN) 8
 Vehicle Loading 250,280
 Vehicle Modifications/Alterations 9
 Vehicle Storage 206,361
 Viscosity, Engine Oil 322

 Warning Flasher, Hazard 302
 Warning Lights
 (Instrument Cluster Description) 166
 Warnings and Cautions 8
 Warranty Information 395
 Washer, Adding Fluid 157

 Washers, Windshield 121,332
 Washing Vehicle 348
 Waxing and Polishing 348
 Wheel Alignment and Balance 260
 Wheel and Wheel Trim 350
 Wheel and Wheel Trim Care 350
 Wheel Mounting 307
 Wind Buffeting 32
 Window Fogging 205
 Windows 31
 Power 31,32
 Windshield Washers 120,121
 Fluid 120,332
 Windshield Wiper Blades 331
 Windshield Wipers 120
 Wipers, Intermittent 121
 Wiring, Ignition (Spark Plug Wires) 324