

# *2006 Owner's Manual*

## **ELANTRA**



**HYUNDAI**

A010A03A-AAT

## WARRANTIES FOR YOUR HYUNDAI VEHICLE

**Please consult your Owner's Handbook & Warranty Information booklet for your vehicle's specific warranty coverage.**

A020A01A-AAT

## RESPONSIBILITY FOR MAINTENANCE

The maintenance requirements for your new Hyundai are found in Section 5. As the owner, it is your responsibility to see that all maintenance operations specified by the manufacturer are carried out at the appropriate intervals. When the vehicle is used in severe driving conditions, more frequent maintenance is required for some operations. Maintenance requirements for severe operating conditions are also included in Section 5.

# HYUNDAI

# ELANTRA



## OWNER'S MANUAL

A030A03E-AAT

**Operation**  
**Maintenance**  
**Specifications**

HXDFL280

All information in this Owner's Manual is current at the time of publication. However, Hyundai reserves the right to make changes at any time so that our policy of continual product improvement may be carried out.

This manual applies to all Hyundai ELANTRA models and includes descriptions and explanations of optional as well as standard equipment. As a result, you may find material in this manual that does not apply to your specific vehicle.

A070A01A-AAT



### **CAUTION: MODIFICATIONS TO YOUR HYUNDAI**

Your Hyundai should not be modified in any way. Such modifications may adversely affect the performance, safety or durability of your Hyundai and may, in addition, violate conditions of the limited warranties covering the vehicle. Certain modifications may also be in violation of regulations established by the U.S. Department of Transportation and other federal or state agencies.

A080A01S-AAT

### **TWO-WAY RADIO OR CELLULAR TELEPHONE INSTALLATION**

Your vehicle is equipped with electronic fuel injection and other electronic components. It is possible for an improperly installed/adjusted two-way radio or cellular telephone to adversely affect electronic systems. For this reason, we recommend that you carefully follow the radio manufacturer's instructions or consult your Hyundai dealer for precautionary measures or special instructions if you choose to install one of these devices.

## SAFETY AND VEHICLE DAMAGE WARNING

This manual includes information titled as WARNING, CAUTION and NOTE.  
These titles indicate the following:



### **WARNING:**

This indicates that a condition may result in harm, serious injury or death to you or other persons if the warning is not heeded. Follow the advice provided with the warning.



### **CAUTION:**

This indicates that a condition may result in damage to your vehicle or its equipment if the caution is not heeded. Follow the advice provided with the caution.

### **NOTE:**

This indicates that interesting or helpful information is being provided.

## VEHICLE DATA COLLECTION AND EVENT DATA RECORDERS

Your Hyundai vehicle is equipped with many high technology, electronically controlled systems that help to ensure your vehicle operates properly and provides the performance that you expect. These systems utilize computers to monitor the operation of various systems and components and help to control their operation. These computerized system operations are wide-ranging and involve components to reduce emissions, to continuously evaluate the readiness of the airbag and seat belt pretensioner systems, to determine when the airbag and seat belt pre-tensioner systems should be deployed and then to activate the deployment, and if equipped, to operate anti-lock braking, traction control and electrical stability control to assist the driver to control the vehicle in difficult driving situations. These systems electronically store information that is useful to service technicians when they need to diagnose and repair these systems. Additional information is stored only when a crash occurs that results in the deployment of the airbags or seat belt pre-tensioners. This type of data storage is done by devices called event data recorders(EDR).

After a crash event, the airbag and seat belt pre-tensioner computer system, known as the Supplemental Restraint System Control Module (SRSCM) or Airbag Control Unit (ACU), may record some information about the condition of the vehicle and how it was being operated. This information consists of data related to seat belt usage and if there was diagnostic information in the airbag or seat belt systems at the time that a crash occurred, and if the ACU sensed that a crash of sufficient severity occurred to require seat belt pre-tensioner or airbag deployment.

To retrieve this information, special equipment is needed and access to the vehicle or the device that stores the data is required. Hyundai will not access information about a crash event or share it with others except:

- o in response to an official request of police or similar government office, or
- o with the consent of the vehicle owner or, if the vehicle is leased, with the consent of the lessee, or
- o as part of Hyundai's defense of litigation, or
- o as required by law.

## FOREWORD

Thank you for choosing Hyundai. We are pleased to welcome you to the growing number of discriminating people who drive Hyundais. The advanced engineering and high-quality construction of each Hyundai we build is something of which we're very proud.

Your Owner's Manual will introduce you to the features and operation of your new Hyundai. It is suggested that you read it carefully because the information it contains can contribute greatly to the satisfaction you receive from your new car.

The manufacturer also recommends that all service and maintenance on your car be performed by an authorized Hyundai dealer. Hyundai dealers are prepared to provide high-quality service, maintenance and any other assistance that may be required.

## HYUNDAI MOTOR COMPANY

**Note** : Because future owners will also need the information included in this manual, if you sell this Hyundai, please leave the manual in the vehicle for their use. Thank you.



### **CAUTION:**

**Severe engine and transaxle damage may result from the use of poor quality fuels and lubricants that do not meet Hyundai specifications. You must always use high quality fuels and lubricants that meet the specifications listed on Page 9-4 in the Vehicle Specifications section of the Owner's Manual and which also appear in the Service Station Information on the back cover of the Owner's Manual.**

Copyright 2006 Hyundai Motor Company. All rights reserved. No part of this publication may be reproduced, stored in any retrieval system or transmitted in any form or by any means without the prior written permission of Hyundai Motor Company.

## Guide to Hyundai Genuine Parts

### 1. What are Hyundai Genuine Parts?

Hyundai Genuine Parts are the same parts used by Hyundai Motor Company to manufacture vehicles. They are designed and tested for the optimum safety, performance, and reliability to our customers.

### 2. Why should you use genuine parts?

Hyundai Genuine Parts are engineered and built to meet rigid manufacturing requirements. Using imitation, counterfeit or used salvage parts is not covered under the Hyundai New Vehicle Limited Warranty or any other Hyundai warranty. In addition, any damage to or failure of Genuine Hyundai Parts caused by the installation or failure of

an imitation, counterfeit or used salvage part is not covered by any Hyundai Warranty.

### 3. How can you tell if you are purchasing Hyundai Genuine Parts?

Look for the Hyundai Genuine Parts Logo on the package (see below).

Hyundai Genuine Parts exported to the United States are packaged with labels written only in English.

Hyundai Genuine Parts are only sold through authorized Hyundai Dealerships.

To find the closest authorized dealer call  
**1-800-826-CARS**

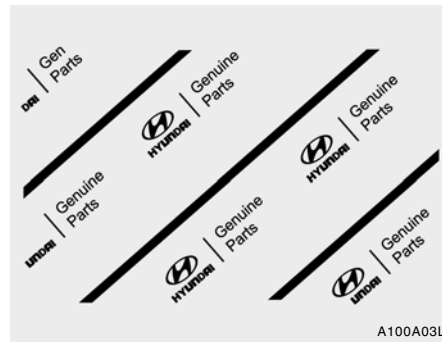

A100A03L



A100A01L



A100A02L

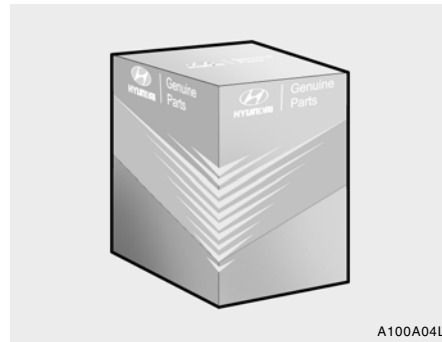

A100A04L



# TABLE OF CONTENTS

*SECTION*

<b>FEATURES OF YOUR HYUNDAI</b>	<b>1</b>
<b>DRIVING YOUR HYUNDAI</b>	<b>2</b>
<b>WHAT TO DO IN AN EMERGENCY</b>	<b>3</b>
<b>CORROSION PREVENTION &amp; APPEARANCE CARE</b>	<b>4</b>
<b>VEHICLE MAINTENANCE REQUIREMENTS</b>	<b>5</b>
<b>DO-IT-YOURSELF MAINTENANCE</b>	<b>6</b>
<b>EMISSION CONTROL SYSTEMS</b>	<b>7</b>
<b>CONSUMER INFORMATION, REPORTING SAFETY DEFECTS &amp; BINDING ARBITRATION OF WARRANTY CLAIMS</b>	<b>8</b>
<b>VEHICLE SPECIFICATIONS</b>	<b>9</b>
<b>INDEX</b>	<b>10</b>

# INSTRUMENTS AND CONTROLS

B250A03E-AAT

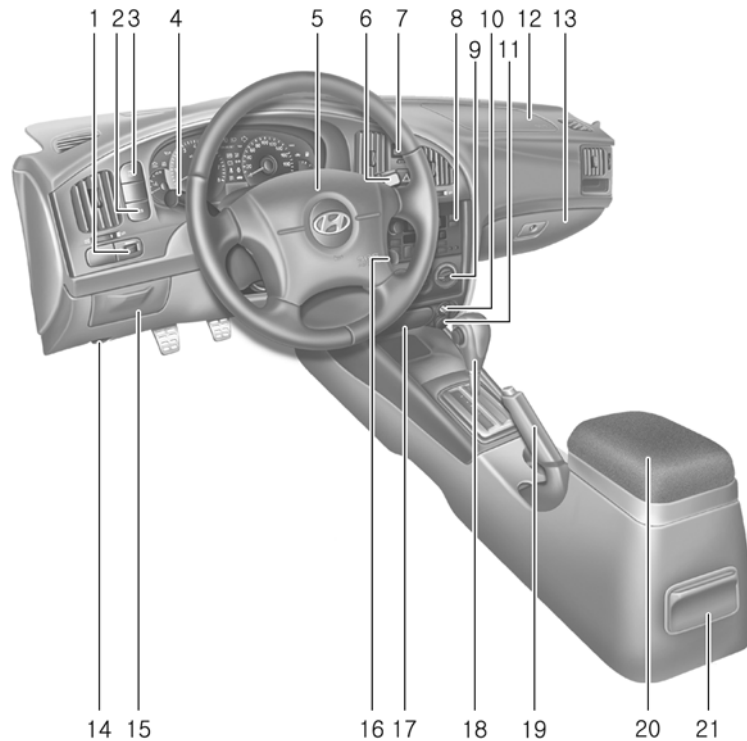

HXDFL002-A

1. Panel Brightness Control Knob
2. TCS Switch (If installed)
3. Trip Computer Switch (If installed)
4. Multi-Function Light Switch
5. Horn and Driver's Airbag
6. Windshield Wiper/Washer Switch
7. Digital Clock
8. Audio System
9. Heating/Air Conditioning Control Panel
10. Cigarette Lighter

11. Power Outlet
12. Passenger's Airbag
13. Glove Box
14. Hood Release Lever
15. Storage compartment
16. Cruise Control Switch (If installed)
17. Front Ashtray
18. Shift Lever
19. Parking Brake
20. Console Box (If installed)
21. Rear Ashtray



**CAUTION:**

**When installing a container of liquid air freshener inside the vehicle, do not place it near the instrument cluster nor on the instrument panel surface. If there is any leakage from the air freshener onto these areas (Instrument cluster, instrument panel or air ventilator), it may damage these parts. If the liquid from the air freshener does leak onto these areas, wash them with water immediately.**

B255A01E-AAT

## INDICATOR SYMBOLS ON THE INSTRUMENT PANEL



SRS (Airbag) Service Reminder Indicator



ABS Service Reminder Indicator



Turn Signal Indicator Lights



High Beam Indicator Light



Low Oil Pressure Warning Light



Parking Brake/Low Brake Fluid Level Warning Light



Charging System Warning Light



Seat Belt Warning Light



Trunk Lid /Tail Gate Open Warning Light



Door Ajar Warning Light and Chime



Low Fuel Level Warning Light



Cruise Indicator Light (If installed)



SET Indicator Light (If installed)



Front Fog Indicator Light (If installed)



Malfunction Indicator Light



TCS OFF Traction Control Indicator Light (If installed)

\* More detailed explanations of these items will be found beginning on page 1-48.

## FEATURES OF YOUR HYUNDAI

Fuel Recommendations .....	1-2
Breaking in Your New Hyundai .....	1-3
Keys .....	1-3
Door .....	1-4
Theft-Alarm System .....	1-7
Window .....	1-10
Seat .....	1-11
Seat Belts .....	1-17
Child Restraint System .....	1-24
Supplemental Restraint (AIRBAG) System .....	1-33
Instrument Cluster and Indicator .....	1-44
Warning and Indicator Lights .....	1-48
Multi-Function Light Switch .....	1-57
Windshield Wiper/Washer Switch .....	1-59
Sunroof .....	1-66
Mirror .....	1-71
Hood Release .....	1-74
Cruise Control .....	1-80
Heating and Cooling Control .....	1-83
Stereo Sound System .....	1-101
Audio System .....	1-103
Antenna .....	1-131

## FUEL RECOMMENDATIONS

B010A04A-AAT

## Use Unleaded Gasoline



Unleaded gasoline with a Pump Octane Rating of 87 (Research Octane Number 91) or higher must be used in your Hyundai.

**WARNING:**

- o Do not "top off" after the nozzle automatically shuts off when refueling.
- o Tighten the cap until it clicks, otherwise the "  " light will illuminate.
- o Always check that the fuel cap is installed securely to prevent fuel spillage in the event of an accident.

B010B01A-AAT

## What About Gasohol?

Gasohol (a mixture of 90% unleaded gasoline and 10% ethanol or grain alcohol) may be used in your Hyundai. However, if your engine develops driveability problems, the use of 100% unleaded gasoline is recommended. Fuels with unspecified quantities of alcohol, or alcohols other than ethanol, should not be used.

B010C01A-AAT

## Use of MTBE

Hyundai recommends that fuels containing MTBE (Methyl Tertiary Butyl Ether) over 15.0% vol. (Oxygen Content 2.7% weight) should not be used in your Hyundai. Fuel containing MTBE over 15.0% vol. (Oxygen Content 2.7% weight) may reduce vehicle performance and produce vapor lock or hard starting.

B010D01A-AAT

## Do Not Use Methanol

Fuels containing methanol (wood alcohol) should not be used in your Hyundai. This type of fuel can reduce vehicle performance and damage components of the fuel system.

**CAUTION:**

Your Hyundai's New Vehicle Limited Warranty may not cover damage to the fuel system and any performance problems that are caused by the use of fuels containing methanol or fuels containing MTBE (Methyl Tertiary Butyl Ether) over 15.0% vol. (Oxygen Content 2.7% weight.).

## BREAKING IN YOUR NEW HYUNDAI

B010E01A-AAT

**Gasolines for Cleaner Air**

To help contribute to cleaner air, Hyundai recommends that you use gasolines treated with detergent additives, which help prevent deposit formation in the engine. These gasolines will help the engine run cleaner and enhance performance of the Emission Control System.

B010F01A-AAT

**Operation in Foreign Countries**

If you are going to drive your Hyundai in another country, be sure to:

- o Observe all regulations regarding registration and insurance.
- o Determine that acceptable fuel is available.

B020A01S-AAT

**During the First 1,200 Miles (2,000 Km)**

No formal "break-in" procedure is required with your new Hyundai. However, you can contribute to the economical operation and durability of your Hyundai by observing the following recommendations during the first 1,200 miles (2,000 km).

- o Don't drive faster than 55 MPH (88 km/h).
- o While driving, keep your engine speed (rpm, or revolutions per minute) between 2,000 rpm and 4,000 rpm.
- o Use moderate acceleration. Don't start quickly or depress the accelerator pedal fully.
- o For the first 200 miles (300 km), try to avoid hard braking.
- o Don't lug the engine (in other words, don't drive so slowly in too high a gear that the engine "bucks"-shift to a lower gear).
- o Whether going fast or slow, vary your speed from time to time.
- o Don't let the engine idle longer than 3 minutes at one time.
- o Don't tow a trailer during the first 1,200 miles (2,000 km) of operation.

## KEYS

B030A01A-AAT



B030A01E

For greater convenience, the same key operates all the locks in your Hyundai. However, because the doors can be locked without a key, carrying a spare key is recommended in case you accidentally lock one key inside the car.

B030B01A-AAT

### Record Your Key Number

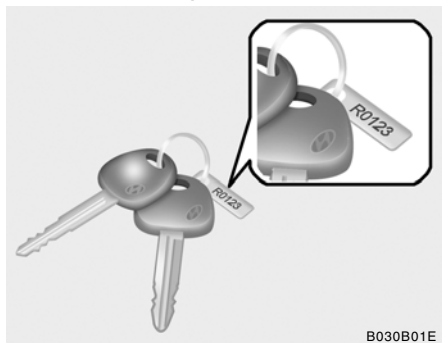

A code number is stamped on the number plate that came with the keys to your Hyundai. This key number plate should not be left with the keys but kept in a safe place, not in the vehicle. The key number should also be recorded in a place where it can be found in an emergency.

If you need additional keys, or if you should lose your keys, your authorized Hyundai dealer can make new keys if you can supply the key number.

## ILLUMINATED IGNITION SWITCH

B030C01Y-AAT

(If installed)



Whenever a door is opened, the ignition switch will be illuminated for your convenience, provided the ignition switch is not in the "ON" position.

The light will go off approximately 10 seconds after closing the door or when the ignition switch is turned on.

## DOOR

B040A01A-AAT

### DOOR LOCKS

**!** **WARNING:**

- o Unlocked doors can be dangerous. Before you drive away (especially if there are children in the car), be sure that all the doors are securely closed and locked so that the doors cannot be opened from the inside. This helps ensure that the doors will not be opened accidentally. Also, when combined with the proper use of seat belts, locking the doors helps keep occupants from being ejected from the car in case of an accident.
- o Before opening the door, always look for and avoid oncoming traffic.



B040B01A-AAT

### Locking and Unlocking Front Doors With a Key

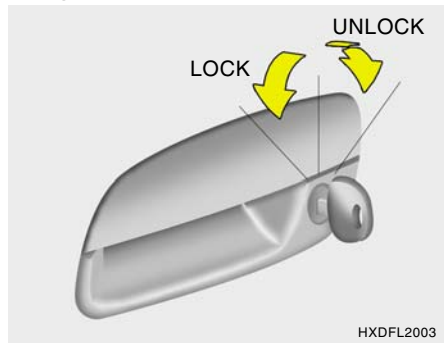

- o The door can be locked or unlocked with a key.
- o Lock the door by turning the key toward the front of the vehicle and unlock it by turning the key toward the rear.

#### NOTE:

The driver's door can be unlocked by turning the key once toward the rear. If you wish to unlock all doors, turn the key again toward the rear within 4 seconds.

B040C02O-AAT

### Locking From the Outside (Driver's side)

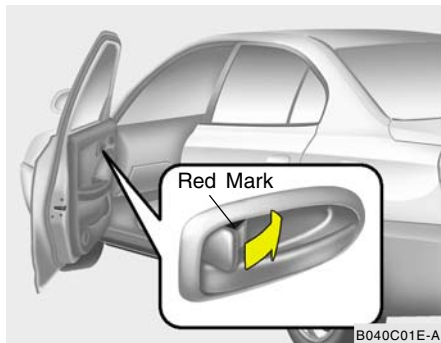

The doors can be locked without a key. To lock the doors, first push the inside lock switch to the "LOCK" position so that the red mark on the switch is not visible, then close the door. If your vehicle is equipped with central door locking system, the door will not lock if the key is left in the ignition switch when the front doors are closed. This is normal operation.

#### NOTE:

- o When pushing the lock switch of the driver's door to the "LOCK" position, only the driver's door can be locked.

- o When locking the door this way, be careful not to lock the door with the ignition key left in the vehicle.
- o To reduce the chances of theft, always remove the ignition key, close all windows, and lock all doors when leaving your vehicle unattended.

B040D01E-AAT

### Locking From the Inside (Driver's side)

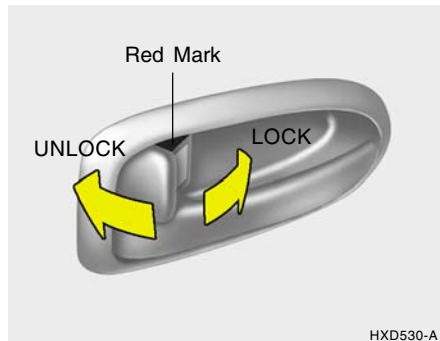

- o To lock the door from the inside, simply close the door and push the lock switch to the "LOCK" position. When this is done, neither the outside nor the inside door handles can be used.

- o The driver's door can be opened by pulling the inside door handle even if the lock switch is depressed.

**NOTE:**

- o When pushing the lock switch of the driver's door to the "LOCK" position, only the driver's door can be locked.
- o When the door is locked, the red mark on the switch is not visible.

B045C020-AAT

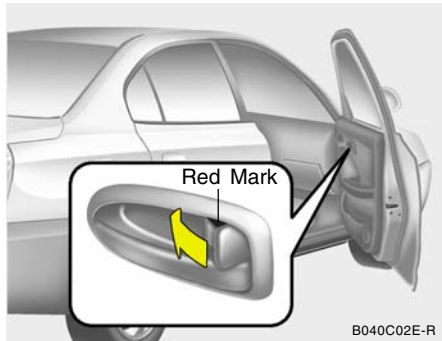
**Locking From the Outside  
(Passenger's side)**

The doors can be locked without a key. To lock the doors, first push the inside lock switch to the "LOCK" position so that the red mark on the switch is not visible, then close the door. If your vehicle is equipped with central door locking system, the door will not lock if the key is left in the ignition switch when the front doors are closed. This is normal.

**NOTE:**

- o When pushing the lock switch of the passenger's door to the "LOCK" position, all doors can be locked.
- o When locking the door this way, be careful not to lock the door with the key left in the vehicle.
- o To reduce the chances of theft, always remove the ignition key, close all windows, and lock all doors when leaving your vehicle unattended.

B045D010-AAT

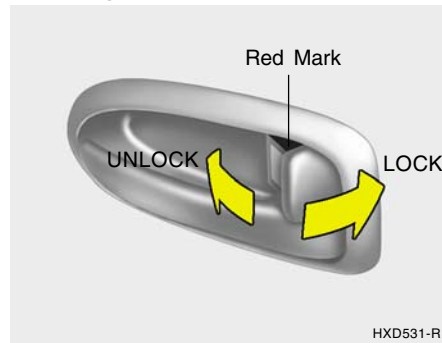
**Locking From the Inside  
(Passenger's side)**

To lock the doors from the inside, simply close the door and push the lock switch to the "LOCK" position. When this is done, neither the outside nor the passenger's inside door handles can be used.

**NOTE:**

- o When pushing the lock switch of the passenger's door to the "LOCK" position all doors can be locked.
- o When the door is locked, the red mark on the switch is not visible.

## CENTRAL DOOR LOCK

B040E04A-AAT

## Child-Protector Rear Door Lock

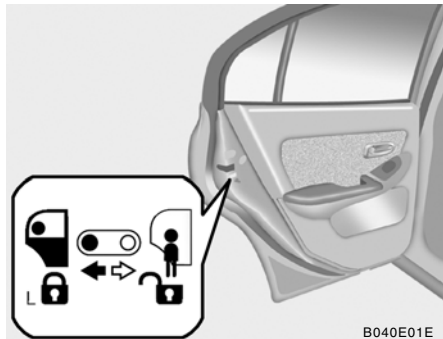

B040E01E

Your Hyundai is equipped with left and right side "child-protector" rear door locks. When the lock mechanism is engaged, the rear door cannot be opened from the inside. Its use is recommended whenever there are small children in the rear seat.

To engage the child-protector feature so that the door cannot be opened from the inside, move the child-protector lever to the "L" position and close the door. Move the lever to the "U" position when normal door operation is desired.

To open the door from the outside, pull the outside door handle.

B040G02Y-AAT

## (If installed)

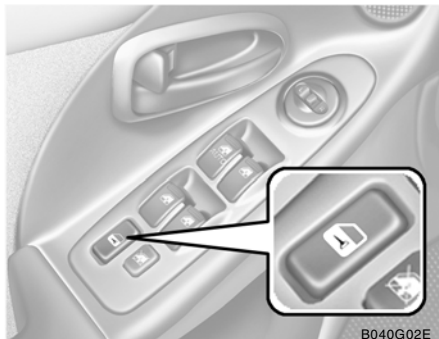

B040G02E

The central door locking switch is located on the driver's arm rest. It is operated by depressing the door lock switch. If any door is open when the switch is depressed to the lock position, the door will remain locked when closed.

## NOTE:

- o When pushing the front portion of the driver's door lock switch, all vehicle doors will lock.
- o When pushing the rear portion of these switches, all vehicle doors will unlock.
- o If the door is locked/unlocked multiple times in rapid succession with either the vehicle key or door lock switch, the system may stop operating temporarily in order to protect the circuit and prevent damage to system components.

## THEFT-ALARM SYSTEM

B070A01A-AAT

## (If installed)

This system is designed to provide protection from unauthorized entry into the car. This system is operated in three stages : the first is the "Armed" stage, the second is the "Alarm" stage and the third is the "Disarmed" stage. If triggered, the system provides an audible alarm with blinking of the turn signal lights.

B070B03E-AAT

## Armed Stage

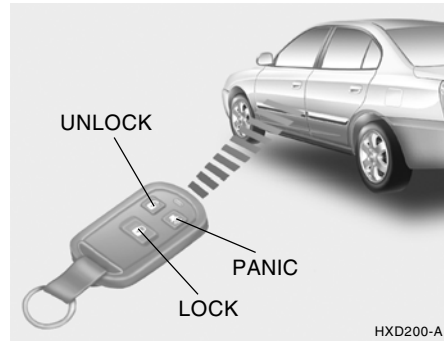

HXD200-A

Park the car and stop the engine. Arm the system as described below.

- 1) Remove the ignition key from the ignition switch.
- 2) Make sure that the hood and trunk lid/ tail gate are closed and latched.
- 3) Lock the doors using the transmitter of the keyless entry system.

After completion of the steps above, the turn signal lights will blink once to indicate that the system is armed.

#### NOTE:

- o If any door, the trunk lid/tail gate or hood remains open, the system will not be armed. If this happens, rearm the system as described previous.
- o If the "LOCK" button is pressed once more within 4 seconds after pushing the "LOCK" button on the transmitter, the siren will sound once to indicate that the system is armed.
- o Do not arm the system until all passengers have left the car. If the system is armed while a passenger(s) remains in the car, the alarm may be activated when the remaining passenger(s) leaves the car.

B070C010-AAT

#### Alarm Stage

The alarm will be activated if any of the following occurs while the car is parked and the system is armed.

- 1) A front or rear door is opened without using the transmitter or the ignition key.
- 2) The trunk lid or tail gate is opened without using the transmitter or the ignition key.
- 3) The hood is opened.

The siren will sound and the turn signal lights will blink continuously for about 30 seconds (This will repeat 3 times). To turn off the system, unlock the door or trunk lid/tail gate using the transmitter or the ignition key.



#### CAUTION:

Avoid trying to start the engine while the system is armed.

B070D030-AAT

#### Disarmed Stage

The system will be disarmed by using the transmitter or the ignition key.

The driver's door is unlocked by depressing once the "UNLOCK" button on the transmitter. If you wish to unlock all doors, press the "UNLOCK" button on the transmitter again within 4 seconds.

Whenever the step above is completed, the turn signal lights will blink twice to indicate that the system is disarmed.

B070E010-AAT

#### Panic Warning

1. Push the "PANIC" button on the transmitter.
2. At the same time, the siren will sound and the turn signal lights will blink for 30 seconds.
3. To turn off the system, push the "PANIC" button again on the transmitter.

B070F030-AAT

#### KEYLESS ENTRY SYSTEM (If installed)

#### NOTE:

This device complies with Part 15 of the FCC rules. Operation is subject to the following two conditions:

(1) This device may not cause harmful interference, and (2) this device must accept any interference received, including interference that may cause undesired operation.



#### CAUTION:

Changes or modifications not expressly approved by the party responsible for compliance could void the user's authority to operate the equipment.

### Locking doors

1. Close all doors.
2. Push the "LOCK" button on the transmitter.
3. At the same time all doors lock, the turn signal lights will blink once to indicate that the system is armed.

### Unlocking doors

1. Push the "UNLOCK" button on the transmitter.
2. At the same time the driver's door unlocks, the turn signal lights will blink twice to indicate that the system is disarmed.

#### NOTE:

If you wish to unlock all doors, press the "UNLOCK" button on the transmitter again within 4 seconds.

#### NOTE:

The transmitter will not work if any of following occur:

- The ignition key is in ignition switch.
- You exceed the operating distance limit (10 m).
- The battery in the transmitter is weak.
- Other vehicles or objects may be blocking the signal.
- The weather is extremely cold.
- The transmitter is close to a radio transmitter such as a radio station or an airport which can interfere with normal operation of the transmitter.

When the transmitter does not work correctly, open and close the door with the ignition key. If you have a problem with the transmitter, contact an authorized Hyundai Dealer.

#### NOTE:

Keep the transmitter away from water or any liquid. If the keyless entry system is inoperative due to exposure to water or liquids, it will not be covered by your manufacturer vehicle warranty.

B070E02HP-AAT

### Replacing the battery

When the transmitter's battery becomes, it may take several pushes on the button to lock or unlock the doors, and the LED will not light. Replace the battery as soon as possible.

Battery type : CR2032

Replacement instructions:

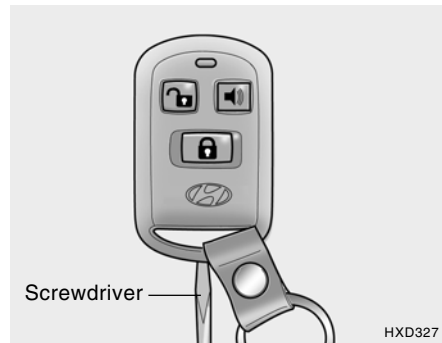

1. Carefully separate the case with a blade screwdriver as shown in the illustration.

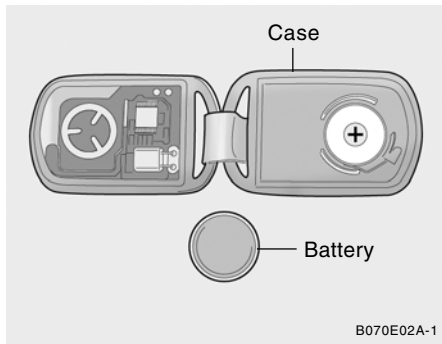

2. Remove the old battery from the case and note the polarity. Make sure the polarity of the new battery is the same(+side facing down), then insert it in the transmitter.

## WINDOW

### B050A01A-AAT WINDOW GLASS

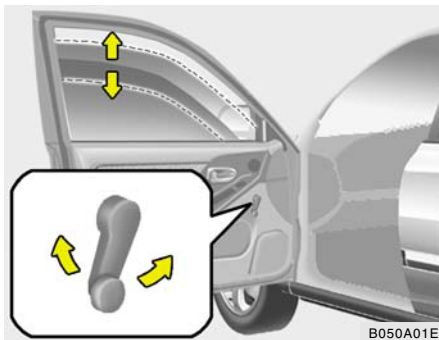

To raise or lower the window, turn the window regulator handle clockwise or counterclockwise.

**!** **WARNING:**  
When opening or closing the windows, make sure your passenger's arms, hands and body are safely out of the way.

### B060A02E-AAT POWER WINDOWS (If installed)

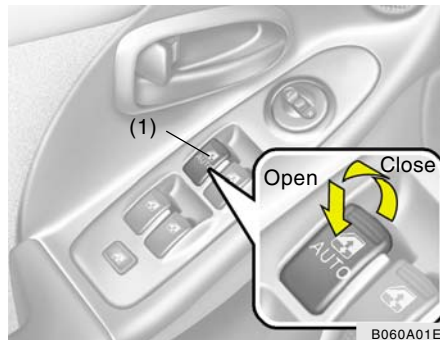

The power windows operate when the ignition key is in the "ON" position. The main switches are located on the driver's armrest and control the front and rear windows on both sides of the vehicle. The windows may be opened by depressing the appropriate window switch and closed by pulling up the switch. To open the window on the driver's side, press the switch(1) down. The window moves as long as the switch is operated.

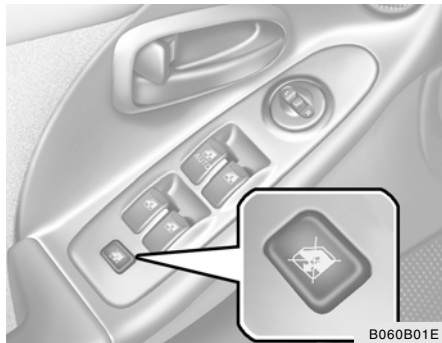

In order to prevent operation of the passenger front and rear windows, a window lock switch is provided on the armrest of the driver's door. To disable the power windows, press the window lock switch.

To return to normal operation, press the window lock switch a second time.

### Auto-Down Window (Driver's Side)

The Auto-Down window is moved to its fully open position by pushing the switch. To stop at the desired location, the switch must be pulled up.



#### WARNING:

- 1) Be careful that someone's head, hands or body are not trapped by a closing window.
- 2) Never try to operate the main switch on the driver's door and the individual door window switch in opposing directions at the same time. If this is done, the window will stop and cannot be opened or closed.
- 3) Do not leave children alone in the car. Always remove the ignition key for their safety.

B080A02A-AAT

### ADJUSTABLE FRONT SEATS



#### WARNING:

- o Never adjust the driver's seat while the vehicle is moving. Any sudden or unexpected movement of the seat could cause you to lose control of the vehicle resulting in an accident. Only adjust the driver's seat when the vehicle is stationary.
- o Do not sit or lean unnecessarily close to the airbag. Position the seat so that you can sit as far back as possible from the airbag and still comfortably reach all controls.

B080B03FC-AAT

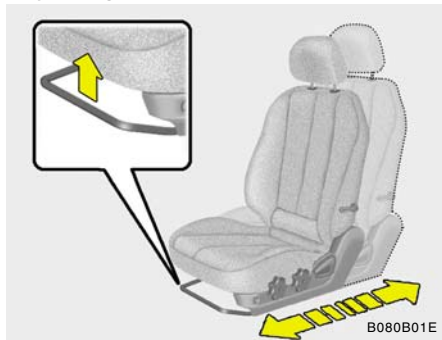
**Adjusting Seat Forward and Rearward**

To move the seat toward the front or rear, pull the lock release lever upward. This will release the seat on its track so you can move it forward or rearward to the desired position. When you find the position you want, release the lever and slide the seat forward or rearward on its track until it locks into the desired position and cannot be moved further.

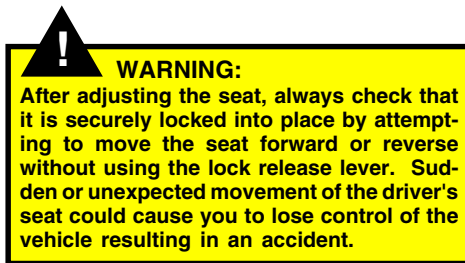

B080C02A-AAT

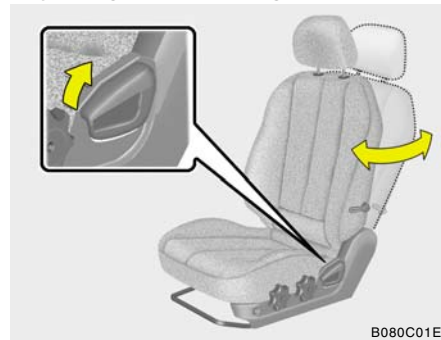
**Adjusting Seatback Angle**

To recline the seatback, lean forward to take your weight off it, then pull up on the recliner control lever at the outside edge of the seat. Now lean back until the desired seatback angle is achieved. To lock the seatback into position, release the recliner control lever.



**WARNING:**

Riding with a reclined seatback increases your chance of serious or fatal injuries in the event of a collision or sudden stop. The protection of your restraint system (seat belts and airbags) is greatly reduced by reclining your seat. Seat belts must be snug against your hips and chest to work properly. The more the seatback is reclined, the greater the chance that an occupant's hips will slide under the lap belt or the occupant's neck will strike the shoulder belt. Drivers and passengers should always sit well back in their seats, properly belted, and with the seatbacks upright.

B080D03A-AAT

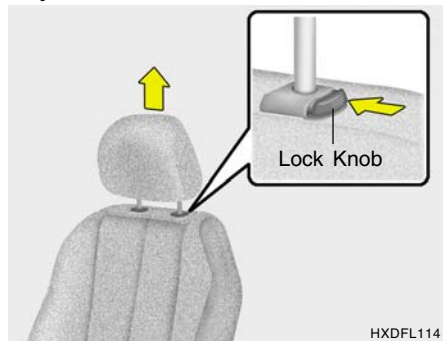
**Adjustable Headrests**

HXDFL114

Headrests are designed to help reduce the risk of neck injuries.

To raise the headrest, pull it up. To lower the headrest, push it down while pressing the lock knob.

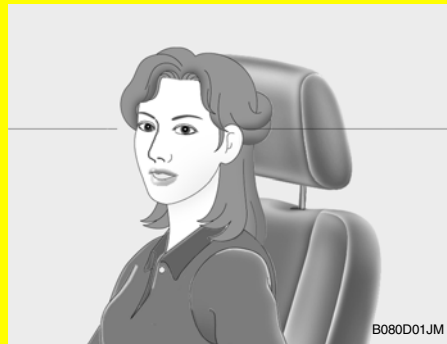
**WARNING:**

B080D01JM

- o For maximum effectiveness in case of an accident, the headrest should be adjusted so the middle of the headrest is at the same height as the top of the occupant's eyes. The use of a cushion that holds the body away from the seatback is not recommended.
- o Do not operate the vehicle with the headrests removed as severe injury to an occupant may occur in the event of an accident. Headrests may provide protection against severe neck injuries when properly adjusted.
- o Do not adjust the headrest height while the vehicle is in motion.

B080E01O-AAT

### Lumbar Support Control (Driver's Seat Only) (If installed)

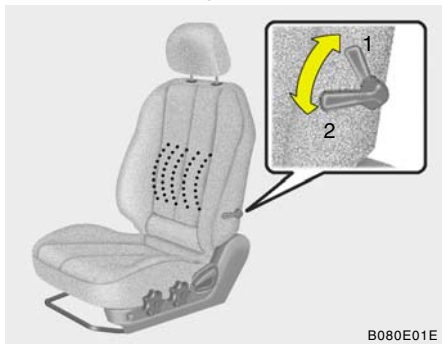

To adjust the lumbar support, turn the handle on the outboard or left side of the seat. To increase the amount of lumbar support, pull the lever forward. To decrease it, push the lever toward the rear.

1. Minimum support
2. Maximum support

B080F01S-AAT

### Seat Cushion Height Adjustment (Driver's Seat Only) (If installed)

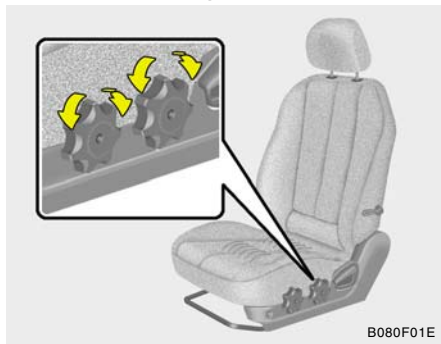

To raise or lower the front part of the seat cushion, turn the front knob forward or rearward. To raise or lower the rear part of the seat cushion, turn the rear knob forward or rearward.

B110A03E-AAT

### Folding Rear Seatbacks (If installed)

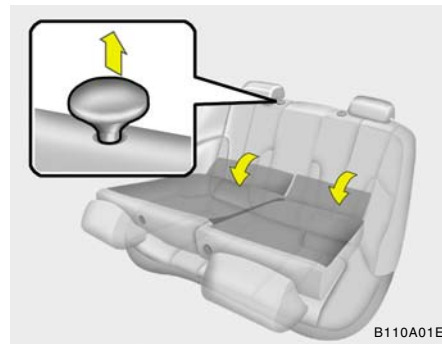

The rear seatbacks may be folded to facilitate carrying long items or to increase the luggage capacity of the vehicle.

- o To unlock the seatback, pull up the seatback locking knob, then fold seat toward the front of the vehicle.
- o When you return the seatback to its upright position, always be sure it has locked into position by pushing on the top of the seatback.

**WARNING:**

When you return the rear seatback to its upright position after being folded down, be careful not to damage the seat belt webbing or buckle. In addition, do not allow the seat belt webbing or buckle to get caught or pinched in the rear seat.

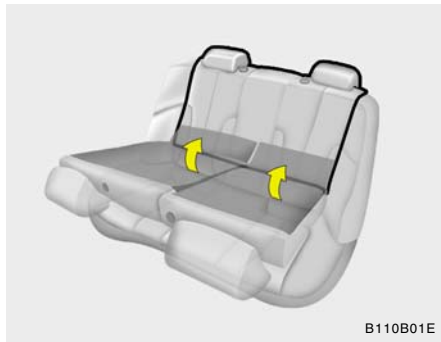

B110B01E

**WARNING:**

The purpose of the fold-down rear seatbacks is to allow you to carry larger items than could otherwise be accommodated. Never allow passengers to sit on top of the folded down seat back while the car is moving as this is not a proper seating position and no seat belts are available for use. This could result in serious injury or death in case of an accident or sudden stop. Objects carried on the folded down seatback should not extend higher than the top of the front seats. This could allow cargo to slide forward and cause injury or damage during sudden stops.

B080G01E-AAT

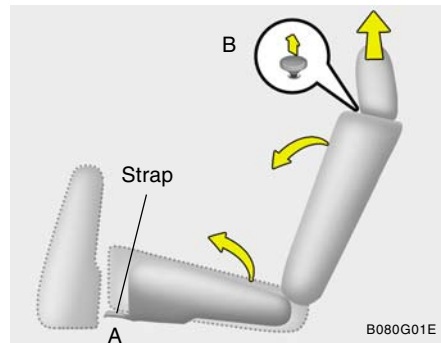
**Folding Rear Seatback and Seat Cushion (5 DOOR)**

B080G01E

For convenience, the seat cushion may be folded forward and the entire seatback folded down.

1. Remove the headrest.
2. Pull the strap of the seat cushion (A) upward to fold up the seat cushion.
3. Pull the seatback locking knob (B) on the seatback to fold-down the seatback.

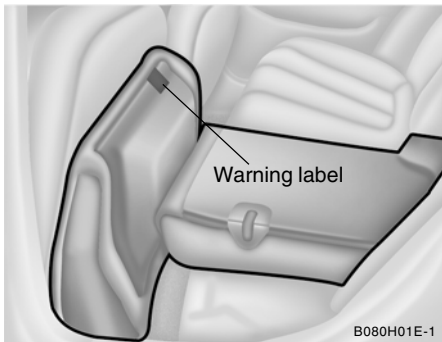

4. Then, pull forward on the seatback panel.



**CAUTION:**

After folding the rear seatback and seat cushion, store the headrests in the luggage room so that they will not be thrown forward in the case of a sudden stop or an accident.

B080H01E-AAT

**Returning The Rear Seatback to an Upright Position (5 DOOR)**

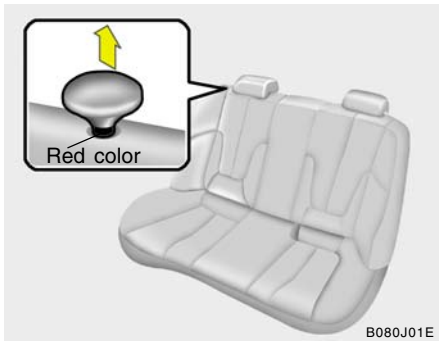

When you return the seatback to its upright position, always be sure it has locked into position by pulling and pushing on the top of the seatback. If the seatback is locked completely, the red color in the seatback locking knob is not visible.

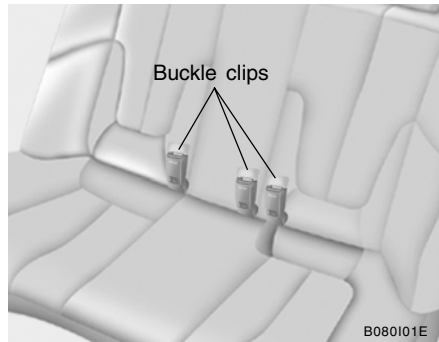

**WARNING:**

- o Before folding the seatback, place the rear seat belt buckles in the buckle clips on the seatback. This will prevent the seat belt buckles from becoming covered by the seat cushion when it is returned to the seating position.
- o When you return the folded down seat back to its upright position, make sure the seat belts are in position to be accessible and to function properly.
- o When returning the seat cushion to the seating position, place the seat belt buckles on top of the cushion.

## REAR SEAT WARNING

**WARNING:**

- o The purpose of the fold down rear seat back and the fold forward rear seat cushion is to increase cargo space. Do not allow passengers to sit in the cargo area while the car is moving. This is not a proper seating position and no seat belts are available for use when the seat back is folded down. Passengers who are not properly seated and wearing seat belts could sustain serious injuries or death in case of an accident or a sudden stop.
- o Objects should not extend higher than the top of the front seatbacks. This could allow cargo to slide forward and cause injury or damage during sudden stops.
- o When you return the folded down seat back to its upright position, always be sure to place the rear seat belt buckles on the seat cushion below the seatback.
- o When you return the folded down seatback to its upright position, always be sure to install the headrests in their proper positions. Headrests are important to the safety of occupants in a rear collision. If the headrests are not installed in their proper position, serious injury or death could result if a rear end collision occurs.

B140A01S-AAT



B140A01E

For the safety of all passengers, luggage or other cargo should not be piled higher than the top of the seatback. In addition, do not place objects on the rear shelf as they may move forward during braking or in an accident and may strike and injure vehicle passengers.

## SEAT BELTS

B150A02E-AAT

**SEAT BELT PRECAUTIONS****WARNING:**

All occupants of the vehicle must wear their seat belts at all times. Seat belts and child restraints reduce the risk of serious or fatal injuries for all occupants in the event of a collision or sudden stop. Without a seat belt, occupants could be shifted too close to a deploying airbag, strike the interior structure or be thrown from the vehicle. Properly worn seat belts greatly reduce these hazards. Even with advanced airbags, unbelted occupants can be severely injured by a deploying airbag. Always follow the precautions about seat belts, airbags and occupant safety contained in this manual.

B150B04Y-AAT

**Infant or Small Child**

All 50 states have child restraint laws. You should be aware of the specific requirements in your state. Child and/or infant safety seats must be properly placed and installed in the rear seat. Information about the use of these restraints begins on page 1-24.

**WARNING:**

Every person in your vehicle needs to be properly restrained at all times, including infants and children. Never hold a child in your arms or lap when riding in a vehicle. The violent forces created during a crash will tear the child from your arms and throw the child against the interior. Always use a child restraint appropriate for your child's height and weight, see page 1-24.

**NOTE:**

Small children are best protected from injury in an accident when properly restrained in the rear seat by a child restraint system that meets the requirements of the Federal Motor Vehicle Safety Standards. Before buying any child restraint system, make sure that it has a label certifying that it meets Federal Motor Vehicle Safety Standard 213. The restraint must be appropriate for your child's height and weight. Check the label on the child restraint for this information. See page 1-24.

B150C03A-AAT

**Larger Children**

Children who are too large for child restraint systems should always occupy the rear seat and use the available lap/shoulder belts. The lap portion should be fastened snug on the hips and as low as possible. Check belt fit periodically. A child's squirming could put the belt out of position. Children are afforded the most safety in the event of an accident when they are restrained by a proper restraint system in the rear seat. If a larger child (over age 13) must be seated in the front seat, the child should be securely restrained by the available lap/shoulder belt and the seat should be placed in the rearmost position. Children under the age of 13 should be restrained securely in the rear seat. NEVER

place a child under the age of 13 in the front seat. NEVER place a rear facing child seat in the front seat of a vehicle.

B150D01S-AAT

**Pregnant Women**

The use of a seat belt is recommended for pregnant women to lessen the chance of injury in an accident. When a seat belt is used, it should be placed as low and snugly as possible on the hips, not across the abdomen. For specific recommendations, consult a physician.

B150E01A-AAT

**Injured Person**

A seat belt should be used when an injured person is being transported. When this is necessary, you should consult a physician for recommendations.

B150F01A-AAT

**One Person Per Belt**

Two people (including children) should never attempt to use a single seat belt. This could increase the severity of injuries in case of an accident.

B150G02A-AAT

**Do Not Lie Down**

To reduce the chance of injuries in the event of an accident and to achieve maximum effectiveness of the restraint system, all passengers should be sitting up and the front seats should be in an upright position when the car is moving. A seat belt cannot provide proper protection if the person is lying down in the rear seat or if the front seat is in a reclined position.

**WARNING:**

Riding with a reclined seatback increases your chance of serious or fatal injuries in the event of a collision or sudden stop. The protection of your restraint system (seat belts and airbags) is greatly reduced by reclining your seat. Seat belts must be snug against your hips and chest to work properly. The more the seatback is reclined, the greater the chance that an occupant's hips will slide under the lap belt causing serious internal injuries or the occupant's neck could strike the shoulder belt. Drivers and passengers should always sit well back in their seats, properly belted (see page 1-21), and with the seatbacks upright.

B160A02A-AAT

**CARE OF SEAT BELTS**

Seat belt systems should never be disassembled or modified. In addition, care should be taken to assure that seat belts and belt hardware are not damaged by seat hinges, doors or other abuse.

**WARNING:**

When you return the rear seatback to its upright position after the rear seatback was folded down, be careful not to damage the seat belt webbing or buckle. Be sure that the webbing or buckle does not get caught or pinched in the rear seat. A seat belt with damaged webbing or buckle will not be as strong and could possibly fail during a collision or sudden stop, resulting in serious injury.

B160B01A-AAT

**Periodic Inspection**

It is recommended that all seat belts be inspected periodically for wear or damage of any kind. Parts of the system that are damaged should be replaced as soon as possible.

B160C01A-AAT

**Keep Belts Clean and Dry**

Seat belts should be kept clean and dry. If belts become dirty, they can be cleaned by using a mild soap solution and warm water. Bleach, dye, strong detergents or abrasives should not be used because they may damage and weaken the fabric.

B160D01A-AAT

**When to Replace Seat Belts**

Entire in-use seat belt assembly or assemblies should be replaced if the vehicle has been involved in an accident. This should be done even if no damage is visible. Additional questions concerning seat belt operation should be directed to your Hyundai Dealer.

B170A05A-AAT

## HEIGHT ADJUSTABLE FRONT SEAT SHOULDER BELT

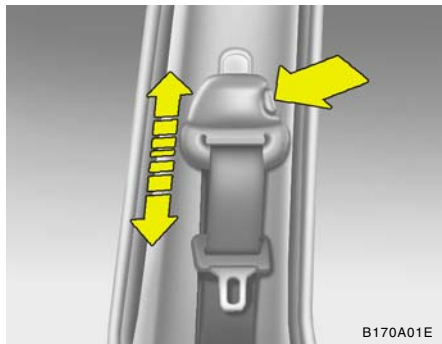

B170A01E

You can adjust the height of the shoulder belt anchor to one of 4 positions for maximum comfort and safety.

If the height of the adjusting seat belt is too near your neck, you will not be getting the most effective protection. The shoulder portion should be adjusted so that it lies across your chest and midway over your shoulder nearest the door and not your neck.

To adjust the height of the seat belt anchor, lower or raise the height adjuster into an appropriate position. To raise the height adjuster, pull it up. To lower it, push it down while pressing the height adjuster button.

Release the button to lock the anchor into position. Try sliding the height adjuster to make sure that it has locked into position.



### WARNING:

- o Verify the shoulder belt anchor is locked into position at the appropriate height. Never position the shoulder belt across your neck or face. Improperly positioned seat belts can cause serious injuries in an accident.
- o Failure to replace seat belts after an accident could leave you with damaged seat belts that will not provide protection in the event of another collision leading to personal injury or death. Replace your seat belts after being in an accident as soon as possible.

B180A01L-AAT

## SEAT BELT-Driver's 3-Point System with Emergency Locking Retractor

To fasten your seat belt, pull it out of the retractor and insert the metal tab into the buckle. There will be an audible "click" when the tab locks into the buckle.

The seat belt automatically adjusts to the proper length only after the lap belt portion is adjusted manually so that it fits snugly around your hips. If you lean forward in a slow, easy motion, the belt will extend and let you move around. If there is a sudden stop or impact, the belt will lock into position. It will also lock if you try to lean forward too quickly. Check to make sure that the belt is properly locked and that the belt is not twisted.

### NOTE:

If the driver's seat belt is not fastened when the ignition key is in the "ON" position, the seat belt warning light will come on and the warning chime will sound for about 6 seconds.



B190A02Y-AAT

### SEAT BELTS-Front Passenger and Rear Seat 3-Point System with Combination Locking Retractor

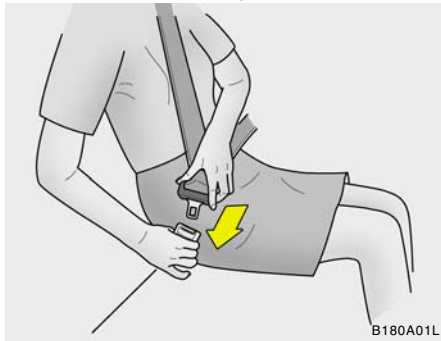

Combination retractor type seat belts are installed in the rear seat outboard positions to help accommodate the installation of child restraint systems. Although a combination retractor is also installed in the front passenger seat position, Hyundai strongly recommends that children always be seated in the rear seat. NEVER place any infant restraint system in the front seat of the vehicle.

This type of seat belt combines the features of both an emergency locking retractor seat belt and an automatic locking retractor seat belt. To fasten your seat belt, pull it out of the retractor and insert the metal tab into the buckle. There will be an audible "click" when the tab locks into the buckle. When not securing a child restraint, the seat belt operates in the same way as the driver's seat belt (Emergency Locking Retractor Type). It automatically adjusts to the proper length only after the lap belt portion of the seat belt is adjusted manually so that it fits snugly around your hips. When the seat belt is fully extended from the retractor to allow the installation of a child restraint system, the seat belt operation changes to allow the belt to retract, but not to extend. (Automatic Locking Retractor Type). See page 1-28.

#### NOTE:

Although the combination retractor provides the same level of protection for seated passengers in either emergency or automatic locking modes, it is recommended that seated passengers use the emergency locking feature for improved convenience. The automatic locking function is intended to facilitate child restraint installation. To convert from the automatic locking feature to the emergency locking operation mode, allow the unbuckled seat belt to fully retract.



#### WARNING:

- o For maximum restraint system protection, seat belts must always be used whenever the car is moving.
- o Seat belts are most effective when seatbacks are in the upright position.
- o Children age 12 and younger must always be properly restrained in the rear seat. Never allow children to ride in the front passenger seat. If a child over 13 must be seated in the front seat, he/she must be properly belted and the seat should be moved as far back as possible.
- o Never wear the shoulder belt under your arm or behind your back. An improperly positioned shoulder belt can cause serious injuries in a crash. The shoulder belt should be positioned midway over your shoulder across your collarbone.
- o Avoid wearing twisted seat belts. A twisted belt can't do its job as well. In a collision, it could even cut into you. Be sure the belt webbing is straight and not twisted.
- o Be careful not to damage the belt webbing or hardware. If the belt webbing or hardware is damaged, replace it.

B200A01A-AAT

### Adjusting Your Seat Belt

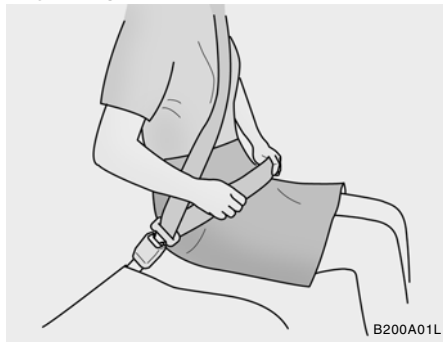

**! WARNING:**  
 You should place the lap belt portion as low as possible and snugly across your hips, not on your waist. If the lap belt is located too high on your waist, it may increase the chance of injury in the event of a collision. Both arms should not be under or over the belt. Rather, one should be over and the other under, as shown in the illustration. Never wear the seat belt under the arm nearest the door.

B210A01A-AAT

### To Release the Seat Belt

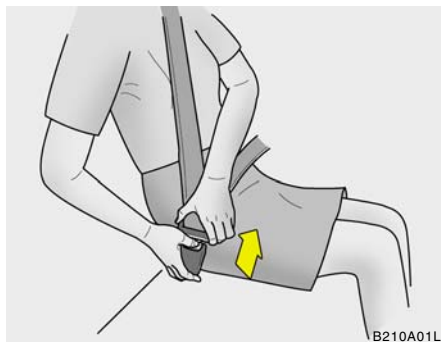

The seat belt is released by pressing the release button in the locking buckle. When it is released, the belt should automatically draw back into the retractor.

If this does not happen, check the belt to be sure it is not twisted, then try again.

B220A03E-AAT

### SEAT BELTS - Center Rear Seat 3-Point System With Combination Locking Retractor

4DOOR

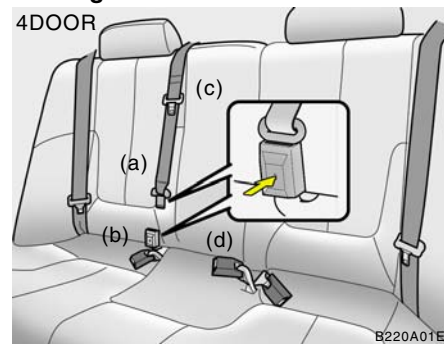

5DOOR

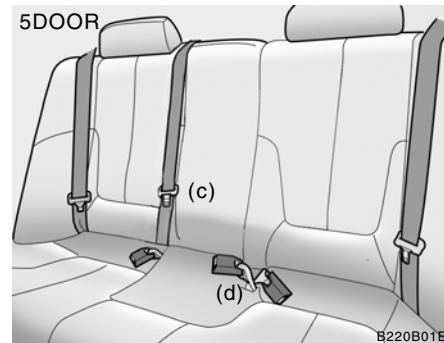

1. Before fastening the rear seat center belt, confirm the metal tab (a) and buckle (b) are latched together.
2. After confirming that (a) and (b) are latched, pull the seat belt out of the retractor and insert the metal tab (c) into the buckle (d).

There will be an audible "click" when the tab locks in the buckle. The seat belt automatically adjusts to the proper length only after the lap belt is adjusted manually so that it fits snugly around your hips. If you lean forward in a slow, easy motion, the belt will extend and let you move around. If there is a sudden stop or impact, the belt will lock into position. It will also lock if you try to lean forward too quickly.

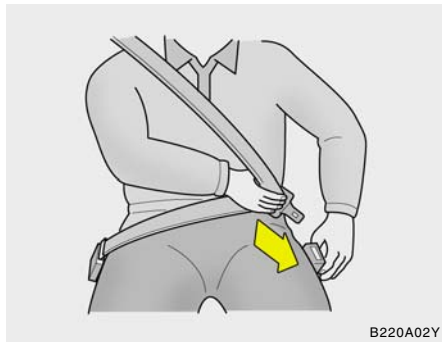

**! WARNING:**

- o Never let anyone ride in the rear center seat without fastening all metal tabs and buckles as described in this section. This seat belt is designed to function as a typical 3-point restraint (lap/shoulder belt). Using only the shoulder portion or lap portion of the belt can result in serious or fatal injuries in the event of a collision or sudden stop.
- o Never unlock the metal tab (a) and the buckle (b) with the following exceptions.
  - 1) In case of folding rear seatbacks down.
  - 2) If transporting an object on the rear seat may cause damage to the rear seat center belt.
- o Always lock metal tab (a) into buckle (b) immediately after returning the rear seatbacks to an upright position. This portion of the rear center seat belt should only be unbuckled when the rear seatback is folded down.

To disconnect the metal tab (a) from the buckle (b), insert a narrow-ended tool into the groove located on the buckle (b). (4 DOOR only)

B220C01Y-AAT

### To Release the Seat Belt

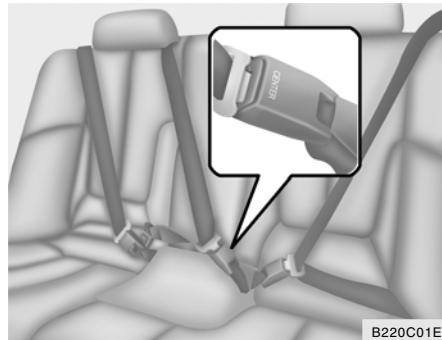

When you want to release the seat belt, press the button in the locking buckle.

**! WARNING:**

The rear seat center belt latching mechanism is different from those for the outboard rear seat shoulder belts. When fastening the outboard rear seat shoulder belts or the rear seat center belt, make sure they are inserted into the correct buckles to obtain maximum protection from the seat belt system and assure proper operation.

## CHILD RESTRAINT SYSTEM

B230A04A-AAT

Children riding in the car should sit in the rear seat and must always be properly restrained to minimize the risk of injury in an accident, sudden stop or sudden maneuver. According to accident statistics provided by the National Highway Traffic Safety Administration (NHTSA), children are safer when properly restrained in the rear seats than in the front seat. Larger children not in a child restraint should use one of the seat belts provided.

All 50 states have child restraint laws. You should be aware of the specific requirements in your state. Child and/or infant safety seats must be properly placed and installed in the rear seat. You must use a commercially available child restraint system that meets the requirements of the Federal Motor Vehicle Safety Standards (FMVSS).

Children could be injured or killed in a crash if their restraints are not properly secured. For small children and babies, a child seat or infant seat must be used. Before buying a particular child restraint system, make sure it fits your car and seat belts, and fits your child. Follow all the instructions provided by the manufacturer when installing the child restraint system.

**WARNING:**

- o A child restraint system must be placed in the rear seat. Never install a child or infant seat on the front passenger's seat. Should an accident occur and cause the passenger side airbag to deploy, it could severely injure or kill an infant or child seated in an infant or child seat. Thus, only use a child restraint in the rear seat of your vehicle.
- o A safety belt or child restraint system can become very hot if it is left in a closed vehicle on a sunny day, even if the outside temperature does not feel hot. Be sure to check the seat cover and buckles before placing a child there.
- o When the child restraint system is not in use, store it in the trunk or fasten it with a safety belt so that it will not be thrown forward in the case of a sudden stop or an accident.
- o Children may be seriously injured or killed by an inflating airbag. All children, even those too large for child restraints, must ride in the rear seat.

**WARNING:**

To reduce the chance of serious or fatal injuries:

- o Children of all ages are safer when restrained in the rear seat. A child riding in the front passenger seat can be forcefully struck by an inflating airbag resulting in serious or fatal injuries.
- o Always follow the instructions for installation and use of the child restraint maker.
- o Always make sure the child seat is secured properly in the car and your child is securely restrained in the child seat.
- o Never hold a child in your arms or lap when riding in a vehicle. The violent forces created during a crash will tear the child from your arms and throw the child against the car's interior.
- o Never put a seat belt over yourself and a child. During a crash, the belt could press deep into the child causing serious internal injuries.
- o Never leave children unattended in a vehicle – not even for a short time. The car can heat up very quickly, resulting in serious injuries to children inside. Even very young children may inadvertently cause the vehicle to move, entangle themselves in the windows, or lock themselves or others inside the vehicle.

**WARNING:**

- o If the seat belt will not properly fit the child, Hyundai recommends the use of an approved booster seat in the rear seat in order to raise the child's seating height so that the seat belt will properly fit the child. Before purchasing a booster seat, make sure that it meets applicable Federal Motor Vehicle Safety Standards (FMVSS) and that it is satisfactory for use with this vehicle.
- o Never allow two children, or any two persons, to use the same seat belt.
- o Children often squirm and reposition themselves improperly. Never let a child ride with the shoulder belt under their arm or behind their back. Always properly position and secure children in rear seat.
- o Never allow a child to stand-up or kneel on the seat or floorboard of a moving vehicle. During a collision or sudden stop, the child can be violently thrown against the vehicle's interior, resulting in serious injury.
- o Never use an infant carrier or a child safety seat that "hooks" over a seatback, it may not provide adequate security in an accident.

**WARNING:**

- o Seat belts can become very hot, especially when the car is parked in direct sunlight. Always check seat belt buckles before fastening them over a child.
- o Always store or secure a child seat, even when it is not in use. During a collision or sudden stop, the child seat could be thrown inside the vehicle.

B230B03A-AAT

**Using a Child Restraint System with the "Tether Anchorage" System**

For small children and babies, the use of a child seat or infant seat is strongly recommended and may be required in your state. This child seat or infant seat should be of appropriate size for the child and should be installed in accordance with the manufacturer's instructions. It is further recommended that the seat be placed in the vehicle's rear seat. Your vehicle is provided with three child restraint hook holders for installing the child seat or infant seat.

B230C03A-AAT

**Installing a Child Restraint System with "Tether Anchorage" System(4 Door)**

Three child restraint hook holders are located on the rear seat package tray.

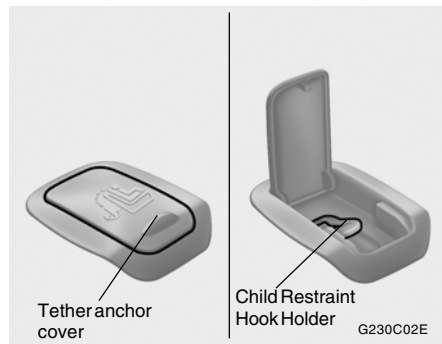

1. Open the tether anchor cover on the rear seat package tray.

REAR SEAT PACKAGE TRAY

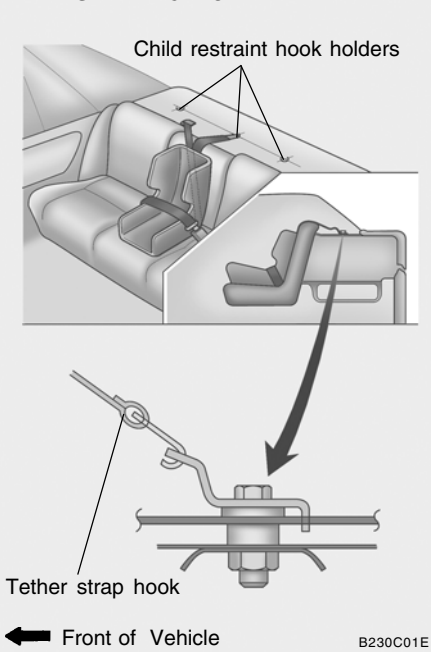

2. Route the child restraint seat strap over the seatback.  
For vehicles with adjustable headrests, route the tether strap under the headrest and between the headrest posts, otherwise route the tether strap over the top of the seatback.
3. Connect the tether strap hook to the child restraint hook holder and tighten to secure the seat.

**!** **WARNING:**

- o A child can be seriously injured or killed in a collision if the child restraint is not properly anchored. Always follow the child seat manufacturer's instructions for installation and use.
- o Never mount more than one child restraint to a single tether or to a single lower anchorage point. The increased load caused by multiple seats may cause the tethers or anchorage points to break, causing serious injury or death.

B230E03E-AAT

**Installing a Child Restraint System with "Tether Anchorage" System (5 Door)**

Three child restraint hook holders are located on the rear luggage compartment floor.

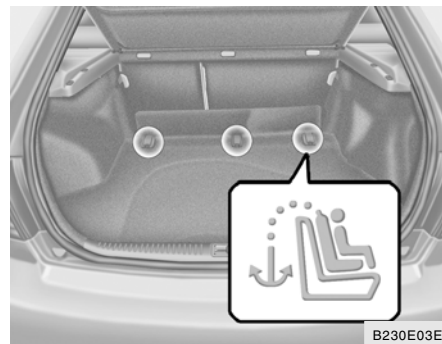

This symbol indicates the location of each user ready tether anchorage.

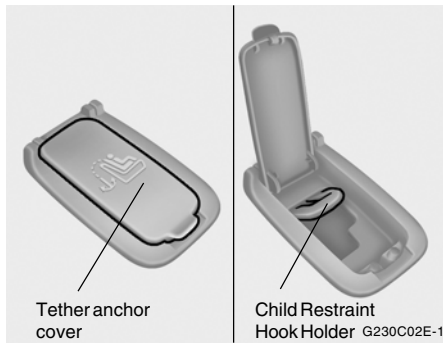

1. Open the tether anchor cover on the rear luggage compartment floor.

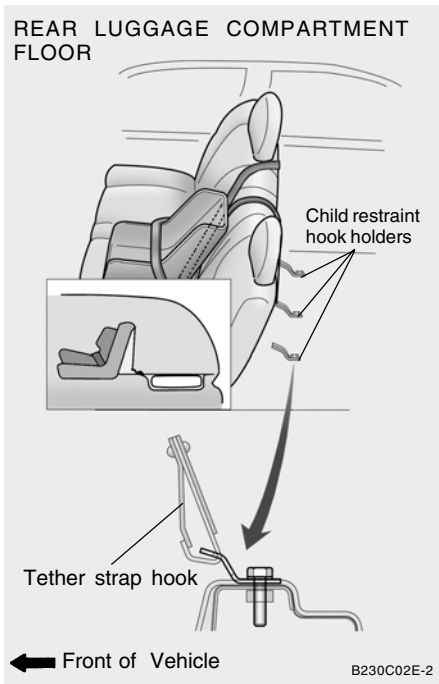

2. Route the child restraint seat strap over the seatback.

- For vehicles with adjustable headrests, route the tether strap under the headrest and between the headrest posts, otherwise route the tether strap over the top of the seatback.
3. Connect the tether strap hook to the child restraint hook holder and tighten to secure the seat.

**!** **WARNING:**

- o A child can be seriously injured or killed in a collision if the child restraint is not properly anchored. Always follow the child seat manufacturer's instructions for installation and use.
- o Never mount more than one child restraint to a single tether or to a single lower anchorage point. The increased load caused by multiple seats may cause the tethers or anchorage points to break, causing serious injury or death.

B230G04Y-AAT

## Child Restraint System Installation on Rear Seats

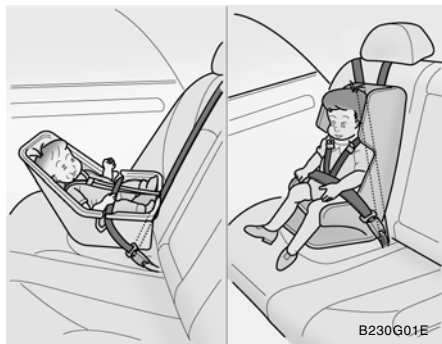

To install a child restraint system in the rear seats, extend the shoulder/lap belt entirely from its retractor until a "click" is felt. This will engage the seat belt retractor automatic locking feature, which allows the seat belt to retract but not extend. Install the child restraint system, buckle the seat belt and allow the seat belt to take up any slack. Make sure that the lap portion of the belt is tight around the child restraint system and the shoulder portion of the belt is positioned so that it cannot interfere with the child's head or neck. Also, double check to be sure that the retractor has engaged the Automatic Locking feature by trying to extend webbing out of the

retractor. If the retractor is in the Automatic Locking mode, the belt will be locked. After installation of the child restraint system, try to move it in all directions to be sure the child restraint system is securely installed. If you need to tighten the belt, pull more webbing toward the retractor. When you unbuckle the seat belt and allow it to retract, the retractor will automatically revert back to its normal seated passenger Emergency Locking usage condition.

### NOTE:

- o Before installing the child restraint system in any seating position, read the instructions supplied by the child restraint system manufacturer.
- o If the seat belt does not operate as described, have the system checked immediately by your authorized Hyundai dealer.



### WARNING:

- o If the retractor is not in the Automatic Locking mode, the child restraint can move when your vehicle turns or stops suddenly. A child can be seriously injured or killed if the child restraint is not properly anchored to the car, including setting the retractor to the Automatic Locking mode.
- o Do not install any child restraint system in the front passenger seat. Should an accident occur and cause the passenger side airbag to deploy, it could severely injure or kill an infant or child seated in an infant or child seat. Therefore, only use a child restraint system in the rear seat of your vehicle.



B230D05E-AAT

### Securing the child Restraint seat with the "ISOFIX" system

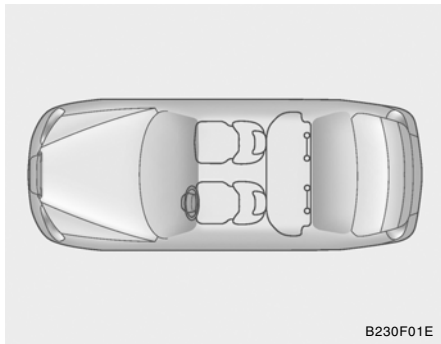

Some child seat manufacturers make safety seats that are labeled as ISOFIX or ISOFIX-compatible child seats. These seats include two rigid or webbing mounted attachments that connect to two ISOFIX anchors at specific seating positions in your vehicle. This type of child seat eliminates the need to use seat belts to attach the child seat for forward-facing child seats.

ISOFIX anchors have been provided in your vehicle. The ISOFIX anchors are located in the left and right outboard rear seating positions. Their locations are shown in the illustration.

There is no ISOFIX anchor provided for the center rear seating position.



#### WARNING:

- o A child can be seriously injured or killed in a collision if the child restraint is not properly anchored. Always follow the child seat manufacturer's instructions for installation and use.
- o Never install a child restraint using the ISOFIX anchors at the center position of the rear seat. In a crash, the ISOFIX anchors may break if a car seat is improperly placed in the center position resulting in serious or fatal injuries. Only place a ISOFIX or ISOFIX-compatible child seat in the left or right out-board rear seating positions (as shown) to the appropriate ISOFIX anchors provided.
- o Never mount more than one child restraint to a single tether or to a single lower anchorage point. The increased load caused by multiple seats may cause the tethers or anchorage points to break, causing serious injury or death.



#### WARNING:

- o When using the vehicle's "ISOFIX" system to install a child restraint system in the rear seat, all unused vehicle rear seat belt metal latch plates or tabs must be latched securely in their seat belt buckles and the seat belt webbing must be retracted behind the child restraint to prevent the child from reaching and taking hold of unretracted seat belts. Unlatched metal latch plates or tabs may allow the child to reach the unretracted seat belts which may result in strangulation and a serious injury or death to the child in the child restraint.

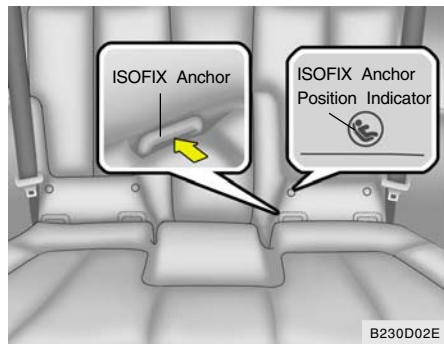

The ISOFIX anchors are located between the seatback and the seat cushion of the rear seat left and right outboard seating positions.

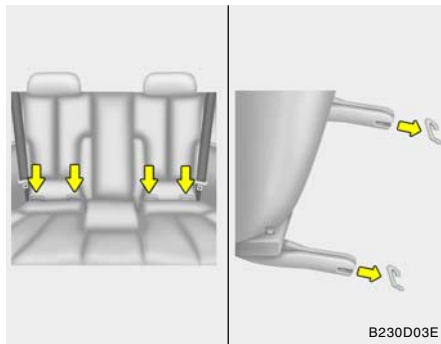

Follow the child seat manufacturer's instructions to properly install safety seats with ISOFIX or ISOFIX-compatible attachments.

Once you have installed the ISOFIX child restraint seat, assure that the seat is properly attached to the ISOFIX and tether anchors. Also, test the safety seat before you place the child in it. Tilt the seat from side to side. Also try to tug the seat forward. Check to see if the anchors hold the seat in place.

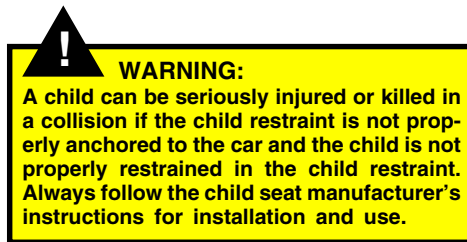

B180C02E-AAT

## Pre-Tensioner Seat Belt

Your Hyundai vehicle is equipped with driver's and front passenger's pre-tensioner seat belts. The purpose of the pre-tensioner is to make sure that the seat belts fit tightly against the occupant's body in certain frontal collisions. The pre-tensioner seat belts can be activated alone or, where the frontal collision is severe enough, together with the airbags.



When the vehicle stops suddenly, or if the occupant tries to lean forward too quickly, the seat belt retractor will lock into position. In certain frontal collisions, the pre-tensioner will activate and pull the seat belt into tighter contact against the occupant's body.

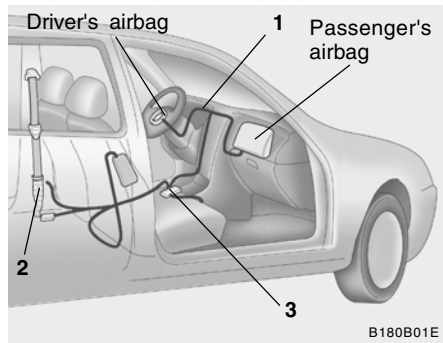

The seat belt pre-tensioner system consists mainly of the following components. Their locations are shown in the illustration.

1. SRS airbag warning light
2. Seat belt pre-tensioner assembly
3. SRS control module



### WARNING:

To obtain maximum benefit from a pre-tensioner seat belt:

- o The seatbelt must be work correctly and adjusted to the proper position (see pages 1-20 and 1-21). Please read and follow all of the important information and precautions about your vehicle's occupant safety features – including seat belts and advanced airbags – that are provided in this manual.
- o Be sure you and your passengers always wear seat belts and wear them properly.

**NOTE:**

- o Both the driver's and front passenger's pre-tensioner seat belts will be activated in certain frontal collisions. The pre-tensioner seat belts can be activated alone or, where the frontal collision is severe enough, together with the airbags. The pre-tensioners will not be activated if the seat belts are not being worn at the time of the collision.
- o When the pre-tensioner seat belts are activated, a loud noise may be heard and fine dust, which may appear to be smoke, may be visible in the passenger compartment. These are normal operating conditions and are not hazardous.
- o Although it is harmless, the fine dust may cause skin irritation and should not be breathed for prolonged periods. Wash your hands and face thoroughly after an accident in which the pre-tensioner seat belts were activated.

**CAUTION:**

- o The sensor that activates the SRS airbag is connected with the pre-tensioner seat belt. The SRS airbag warning light  on the instrument panel will blink for approximately 6 seconds after the ignition key has been turned to the "ON" position, and then it should turn off.
- o If the pre-tensioner seat belt is not working properly, this warning light will illuminate even if there is no malfunction of the SRS airbag system. If the SRS airbag warning light does not illuminate when the ignition key is turned to "ON", or if it remains illuminated after blinking for approximately 6 seconds, or if it illuminates while the vehicle is being driven, please have an authorized Hyundai dealer inspect the pre-tensioner seat belts and SRS airbag system as soon as possible.

**WARNING:**

- o Pre-tensioners are designed to operate only one time. After activation, pre-tensioner seat belts must be replaced. All seat belts, of any type, should always be replaced after they have been worn during a collision.
- o The pre-tensioner seat belt assembly mechanisms become hot during activation. Do not touch the pre-tensioner seat belt assemblies for several minutes after they have been activated.
- o Do not attempt to inspect or replace the pre-tensioner seat belts yourself. This must be done by an authorized Hyundai dealer.
- o Do not strike the pre-tensioner seat belt assemblies.
- o Do not attempt to service or repair the pre-tensioner seat belt system in any manner.
- o Improper handling of the pre-tensioner seat belt assemblies, and failure to heed the warnings to not strike, modify, inspect, replace, service or repair the pre-tensioner seat belt assemblies may lead to improper operation or inadvertent activation and serious injury.
- o Always wear the seat belts when driving or riding in a motor vehicle.

## ADVANCED SUPPLEMENTAL RESTRAINT (AIRBAG) SYSTEM (SRS)

B240A02E-AAT

Driver's Airbag



Your Hyundai is equipped with an advanced Supplemental Restraint (Airbag) System. The indications of the system's presence are the letters "SRS AIRBAG" embossed on the airbag pad cover in the steering wheel and the passenger's side front panel pad above the glove box.

The Hyundai SRS consists of airbags installed under the pad covers in the center of the steering wheel and the passenger's side front panel above the glove box. The purpose of the SRS is to provide the vehicle's driver and/or the front passenger with additional protection than that offered by the seat belt system alone, in case of a frontal impact of sufficient severity.

The SRS uses a collection of sensors to gather information about the driver's and front passenger's seat position, the driver's and front passenger's seat belt usage and impact severity.

The driver's and front passenger's seat track position sensors, which are installed on the seat track, determine if the seats are fore or aft of a reference position. Similarly, the seat belt buckle sensors determine if the driver and front passenger's seat belts are fastened. These sensors provide the ability to control the SRS deployment based on how close the driver's seat is to the steering wheel, how close the passenger's seat is to the instrument panel, whether or not the seat belts are fastened, and how severe the impact is.

The advanced SRS offers the ability to control the airbag inflation with two levels. A first stage level is provided for moderate-severity impacts. A second stage level is provided for more severe impacts.

According to the impact severity, seating position and seat belt usage, the SRSCM (SRS Control Module) controls the airbag inflation. Failure to properly wear seat belts can increase the risk or severity of injury in an accident.

Additionally, your Hyundai is equipped with an occupant classification system in the front passenger's seat. The occupant classification system detects the presence of a passenger in the front passenger's seat and will turn off the front passenger's airbag under certain conditions. For more detail, see "Occupant Classification System" later in this section.



### CAUTION:

If the seat track position sensor is not working properly, the SRS airbag warning light  on the instrument panel will illuminate even if there is no malfunction of the SRS airbag system, because the SRS airbag warning light is connected with the seat track position sensor. If the SRS airbag warning light does not illuminate when the ignition key is turned to the "ON" position, if it remains illuminated after blinking for approximately 6 seconds, or if it illuminates while the vehicle is being driven, have an authorized Hyundai dealer inspect the seat track position sensor and the advanced SRS airbag system as soon as possible.

**WARNING:**

- o Modification to the seat structure can adversely affect the seat track position sensor and cause the airbag to deploy at a different level than should be provided.
- o Do not place any objects underneath the front seats which could damage the seat position sensor or interfere with the occupant classification system.
- o Do not place any objects that may cause magnetic fields near the front seat. These may cause a malfunction of the seat track position sensor.

**NOTE:**

- o Be sure to read information about the SRS on the labels provided on the backside of the sun visor and in the glove box.
- o Advanced airbags are combined with pre-tensioner seat belts to help provide enhanced occupant protection in frontal crashes. Front airbags are not intended to deploy in light collisions in which protection can be provided by the pre-tensioner seat belt.
- o If you are considering modification of your vehicle due to a disability, please contact the Hyundai Customer Assistance Center at 1-800-633-5151.

**WARNING:**

Always use seat belts and child restraints – every trip, every time, everyone! Airbags inflate with considerable force and in the blink of an eye. Seat belts help keep occupants in proper position to obtain maximum benefit from the airbag. Even with advanced airbags, improperly and unbelted occupants can be severely injured when the airbag inflates. Always follow the precautions about seat belts, airbags and occupant safety contained in this manual.

To reduce the chance of serious or fatal injuries and receive the maximum safety benefit from your restraint system:

- o Never place a child in any child or booster seat in the front seat (see child restraints 1-24).
- o ABC – Always Buckle Children in the back seat. It is the safest place for children of any age to ride.
- o Front and side impact airbags can injure occupants improperly positioned in the front seats.
- o Move your seat as far back as practical from the front airbags, while still maintaining control of the vehicle.
- o Never sit or lean unnecessarily close to the front or side airbags.

**WARNING:**

- o Never lean against the door or center console – always sit in an upright position.
- o Do not allow an adult passenger to ride in the front seat when the “Passenger Airbag OFF” indicator is illuminated, because the airbag will not deploy in the event of a moderate or severe frontal crash.
- o Never place objects over or near any airbag module (front or side impact airbags), because these objects can injure passengers in a crash.
- o Never place covers, blankets or aftermarket seat warmers on the passenger seat as these may interfere with the occupant classification system.
- o Do not tamper or disconnect SRS wiring or other components. Injuries could result from inadvertent deployment or failure of the airbag to deploy in a crash.
- o If the SRS airbag warning light (see pg 1-48) remains illuminated while the vehicle is being driven, have an authorized Hyundai dealer inspect the airbag system as soon as possible.
- o Airbags can only be used once – have an authorized Hyundai dealer replace the airbag immediately after deployment.

**WARNING:**

- o The SRS is designed to deploy the front airbags only when an impact is sufficiently severe and when the impact angle is less than 30° from the forward longitudinal axis of the vehicle. The front airbags will not deploy in side, rear or rollover impacts. Additionally, the airbags will only deploy once. Seat belts must be worn at all times.
- o Front airbags are not intended to deploy in side-impact, rear-impact or rollover crashes. In addition, front airbags will not deploy in frontal crashes below the deployment threshold.

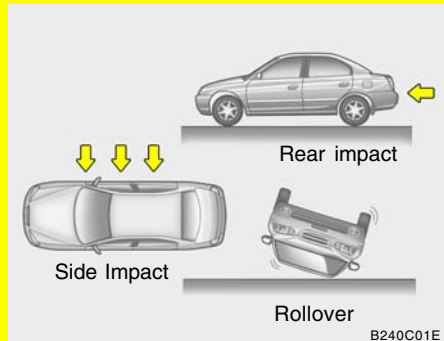
**WARNING:**

- o Move your seat as far back as practical from the front airbags, while still maintaining control of the vehicle. You and your passengers should never sit or lean unnecessarily close to the airbags. Improperly positioned drivers and passengers can be severely injured by inflating airbags.
- o No objects should be placed over or near the airbag modules on the steering wheel, instrument panel, and the front passenger's panel above the glove box, because any such object could cause harm if the vehicle is in a crash severe enough to cause the airbags to deploy.
- o If the airbags deploy, they must be replaced by an authorized Hyundai dealer. Deployed airbags WILL NOT inflate again and will provide no protection in subsequent collisions.
- o Do not tamper with or disconnect SRS wiring or other components of the SRS system. Doing so could result in injury, due to accidental deployment of the airbags or by rendering the SRS inoperative.

**WARNING:**

- o Do not install a child restraint system in the front passenger seat position. A child restraint system must never be placed in the front seat. The infant or child could be severely injured or killed by an airbag deployment in case of an accident.
- o Children younger than 13 years must always be properly restrained in the rear seat. Never allow children to ride in the front passenger seat. If a child over 13 must be seated in the front seat, he or she must be properly belted and the seat should be moved as far back as possible.
- o For maximum safety protection in all types of crashes, all occupants including the driver should always wear their seat belts whether or not an airbag is also provided at their seating position to minimize the risk of severe injury or death in the event of a crash. Do not sit or lean unnecessarily close to the airbag while the vehicle is in motion.
- o Sitting improperly or out of position can result in serious or fatal injury in a crash. All occupants should sit upright in their seats with their feet on the floor until the vehicle is parked and the ignition key is removed.

**WARNING:**

- o The SRS airbag system must deploy very rapidly to provide protection in a crash. If an occupant is out of position because of not wearing a seat belt, the airbag may forcefully contact the occupant causing serious or fatal injuries.

B240B04E-AAT

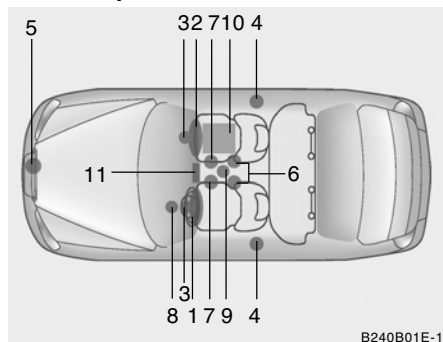
**SRS Components and Functions**

B240B01E-1

The SRS consists of the following components:

1. Driver's Airbag Module
2. Passenger's Airbag Module
3. Knee Bolster
4. Pre-tensioner Seat Belt
5. Front Impact Sensor
6. Driver's and Front Passenger's Seat Belt Buckle Sensors
7. Driver's and Front Passenger's Seat Track Position Sensors
8. SRS Service Reminder Indicator (SRI)
9. SRS Control Module (SRSCM)
10. Occupant Classification System (Front passenger's seat only)
11. Passenger Airbag Off Indicator

The SRSCM continually monitors all elements while the ignition is "ON" to determine if a frontal or near-frontal impact is severe enough to require airbag deployment or pre-tensioner seat belt deployment.

The SRS service reminder indicator (SRI) on the instrument panel will blink for about 6 seconds after the ignition key is turned to the "ON" position or after the engine is started, after which the SRI should go out.



B240B01L

The airbag modules are located both in the center of the steering wheel and in the front passenger's panel above the glove box. When the SRSCM detects a sufficiently severe impact to the front of the vehicle, it will automatically deploy the front airbags.



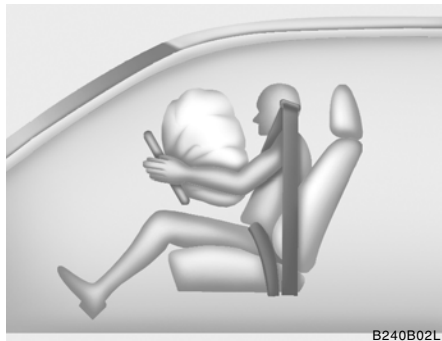

Upon deployment, tear seams molded directly into the pad covers will separate under pressure from the expansion of the airbags. Further opening of the covers then allows full inflation of the airbags.



A fully inflated airbag, in combination with a properly worn seat belt, slows the driver's or the passenger's forward motion, reducing the risk of head and chest injury.

After complete inflation, the airbag immediately starts deflating, enabling the driver to maintain forward visibility, and the ability to steer or operate other controls.



#### CAUTION:

When installing a container of liquid air freshener inside the vehicle, do not place it near the instrument cluster nor on the instrument panel surface. If there is any leakage from the air freshener onto these areas (instrument cluster, instrument panel or air ventilator), it may damage these parts. If the liquid from the air freshener does leak onto these areas, wash them with water immediately.



B240B05L

**WARNING:**

- o If an airbag deploys, there may be a loud noise followed by a fine dust released in the vehicle. These conditions are normal and are not hazardous - the airbags are packed in this fine powder. The dust generated during airbag deployment may cause skin or eye irritation as well as aggravate asthma for some persons. Always wash all exposed skin areas thoroughly with lukewarm water and a mild soap after an accident in which the airbags were deployed.

**WARNING:**

- o The SRS can function only when the ignition key is in the "ON" position. If the SRS SRI does not come on, or continuously remains on after flashing for about 6 seconds when the ignition key is turned to the "ON" position, or after the engine is started, comes on while driving, the SRS is not working properly. If this occurs, have your vehicle immediately inspected by your Hyundai dealer.
- o Before you replace a fuse or disconnect a battery terminal, turn the ignition key to the "LOCK" position and remove the ignition key. Never remove or replace the air bag related fuse(s) when the ignition key is in the "ON" position. Failure to heed this warning will cause the SRS SRI to illuminate.

**NOTE:**

Your vehicle's Supplemental Restraint System Control Module is equipped a recording device which may record the use of the seat belt restraint system by the driver and front passenger in certain collisions.

B990A05E-AAT

**OCCUPANT CLASSIFICATION SYSTEM**

The Occupant Classification system is designed to detect the presence of a properly-seated front passenger and determine if the passenger's front airbag and side impact airbag should be enabled (may inflate) or not. The system is designed to prevent the front passenger's front and side impact airbags from inflating if the passenger seat is occupied by someone of light weight or the seat is occupied by a passenger who is not seated properly. The driver's front airbag and the driver's side impact airbag are not affected or controlled by the Occupant Classification system.



If the front passenger seat is occupied by a person that the system determines to be of adult size, and they are seated properly (sitting upright, centered on the seat cushion, with their seat belt on and legs comfortably extended, feet on the floor, and with the seat in an upright position), the "PASSENGER AIR BAG OFF" indicator will be turned off and the front passenger's airbag will be able to inflate, if necessary, in frontal crashes.



#### WARNING:

Do not allow a passenger to ride in the front seat when the "PASSENGER AIRBAG OFF" indicator is illuminated, because the airbag will not deploy in the event of a crash. If the "PASSENGER AIR BAG OFF" indicator remains illuminated after the passenger repositions themselves properly and the car is restarted, Hyundai recommends that passenger move to the rear seat because the passenger's front airbag will not deploy.

The "PASSENGER AIR BAG OFF" indicator will not change according to the occupants posture after the vehicle has been running for 30 seconds. Front seat passengers must stay properly seated to avoid serious injury from a deploying airbag. For more information see page 1-38.

#### NOTE:

- o The "PASSENGER AIR BAG OFF" indicator illuminates for about 6 seconds after the ignition key is turned to the "ON" position or after the engine is started, and then turns off in a few seconds.
- o If the "PASSENGER AIR BAG OFF" indicator illuminates, the passenger's front airbag will not inflate in frontal crashes. If the "PASSENGER AIR BAG OFF" indicator does not illuminate, the passenger's front airbag will be able to inflate, if necessary, in frontal crashes.
- o If the "PASSENGER AIR BAG OFF" indicator illuminates, the passenger's side impact airbag will not inflate in side impact crashes. If the "PASSENGER AIR BAG OFF" indicator does not illuminate, the passenger's side impact airbag will be able to inflate, if necessary, in side impact crashes.



#### CAUTION:

If the Occupant Classification system is not working properly, the SRS airbag warning light  on the instrument panel will illuminate because the passenger's front and side impact airbags are connected with the Occupant Classification system. If there is a malfunction of the Occupant Classification system, the "PASSENGER AIR BAG OFF" indicator will not illuminate and the passenger's front and side impact airbags will inflate in frontal or side impact crashes even if there is no occupant in the front passenger's seat. If the SRS airbag warning light does not illuminate when the ignition key is turned to the "ON" position, if it remains illuminated after blinking for approximately 6 seconds, or if it illuminates while the vehicle is being driven, have an authorized Hyundai dealer inspect the Occupant Classification system and the SRS airbag system as soon as possible.

**WARNING:**

- o Even though your vehicle is equipped with the occupation classification system, never install a child restraint system in the front passenger's seat. A deploying airbag can forcefully strike a child resulting in serious injuries or death. Any child under 13 years of age should ride in the rear seat. Children too large for child restraints should use the available lap/shoulder belts. No matter what type of crash, children of all ages are safer when restrained in the rear seat.
- o The Occupant Classification system can function only when the ignition key is in the "ON" position. If the "PASSENGER AIR BAG OFF" indicator is illuminated when the front passenger's seat is occupied by an adult and they are seated properly (sitting upright, centered on the seat cushion, with their seat belt on and legs comfortably extended, feet on the floor, and with the seat in an upright position) the Occupant Classification system may not be working properly. If this occurs, have your vehicle immediately inspected by your Hyundai dealer.

**WARNING:**

- o If luggage or other objects are placed on the front passenger's seat or if the temperature of the seat changes, the "PASSENGER AIR BAG OFF" indicator may blink. These conditions do not indicate a problem.
- o If the "PASSENGER AIR BAG OFF" indicator blinks continuously when the front passenger's seat is occupied by an adult and they are seated properly (sitting upright, centered on the seat cushion, with their seat belt on and legs comfortably extended, feet on the floor, and with the seat in an upright position) have that person sit in the rear seat. If this occurs, have the Occupant Classification system checked by an authorized Hyundai dealer as soon as possible.
- o If you change the weight on the seat, the "PASSENGER AIR BAG OFF" indicator may be turned on or off for a few seconds, temporarily disabling or enabling the passenger airbags.

**WARNING:**

- o Do not modify or replace the front passenger seat. Don't place anything on or attach anything to the front passenger seat. This can adversely affect the Occupant Classification system.
- o Do not sit on sharp objects such as tools when occupying the front passenger seat. This can adversely affect the Occupant Classification system.
- o Do not use accessory seat covers on the front seats.

B990B04Y-AAT

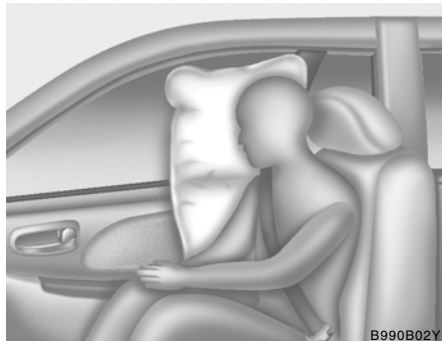
**Side Impact Airbag**

B990B02Y

Your Hyundai is equipped with a side impact airbag in each front seat. The purpose of the airbag is to provide the vehicle's driver and/or front passenger with protection in a side impact in addition to that offered by the seat belt alone. The side impact airbags are designed to deploy only during certain side impact collisions, depending on the crash severity, angle, speed and point of impact. The side impact airbags are not designed to deploy in all side impact situations.

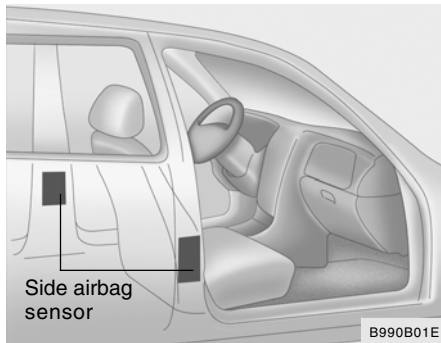

B990B01E

**WARNING:**

- o The side impact airbag is supplemental to the driver's and the passenger's seat belt systems and is not a substitute for them. Your seat belts must be worn at all times while the vehicle is in motion. The airbags deploy only in certain side impact conditions severe enough to cause significant injury to the vehicle occupants.

**WARNING:**

- o To receive the best protection from the side impact airbag system and to avoid being injured by the deploying side impact airbag, both front seat occupants should sit in an upright position with their feet on the floor and the seat belt properly fastened. The driver's hands should be placed on the steering wheel at the 9:00 and 3:00 o'clock positions. The passenger's arms and hands should be placed on their laps.
- o Do not install any accessory seat covers.
- o Use of seat covers could reduce or prevent the effectiveness of the system.
- o Do not install any accessories on the side or near the side impact airbag.
- o Do not place any objects over the airbag or between the airbag and yourself.
- o Do not place any objects (an umbrella, bag, etc.) between the front door and the front seat. Such objects may become dangerous projectiles and cause injury if the supplemental side impact airbag inflates.
- o To prevent unexpected deployment of the side impact air bag that may result in personal injury, avoid impact to the side impact airbag sensor when the ignition key is on.

B240C02JM-AAT

**SRS Care**

- o The SRS is virtually maintenance free and there are no parts you can safely service by yourself. The entire SRS system must be inspected by an authorized Hyundai dealer 10 years after the date that the vehicle was manufactured.
- o Any work on the SRS system, such as removing, installing, repairing, or any work on the steering wheel or front seats must be performed by a qualified Hyundai technician. Improper handling of the airbag system may result in serious personal injury.

**NOTE:**

Your vehicle's Supplemental Restraint System Control Module is equipped a recording device which may record the use of the seat belt restraint system by the driver and front passenger in certain collisions.

**WARNING:**

- o Do not install a child restraint system in the front passenger seat position. A child restraint system must never be placed in the front seat. The infant or child could be severely injured by an airbag deployment in case of an accident.
- o Modification to SRS components or wiring, including the addition of any kind of badges to the pad covers or modifications to the body structure, can adversely affect SRS performance and lead to possible injury.
- o For cleaning the airbag pad covers, use only a soft, dry cloth or one which has been moistened with plain water. Solvents or cleaners could adversely affect the airbag covers and proper deployment of the system.
- o No objects should be placed over or near the airbag modules on the steering wheel, instrument panel, and the front passenger's panel above the glove box, because any such object could cause harm if the vehicle is in a crash severe enough to cause the airbags to inflate.
- o If the airbags inflate, they must be replaced by an authorized Hyundai dealer.

**WARNING:**

- o Do not tamper with or disconnect SRS wiring, or other components of the SRS system. Doing so could result in injury, due to accidental firing of the airbags or by rendering the SRS inoperative.
- o If components of the airbag system must be discarded, or if the vehicle must be scrapped, certain safety precautions must be observed. Your Hyundai dealer knows these precautions and can give you the necessary information. Failure to follow these precautions and procedures could increase the risk of personal injury.
- o If your car was flooded and has soaked carpeting or water on the floor, you shouldn't try to start the engine; have the car towed to an authorized Hyundai dealer.

B240D02JM-AAT

### Additional Safety Precautions

- o **Never let passengers ride in the cargo area (trunk) or on top of a folded-down back seat.** All occupants should sit upright, fully back in their seats with their seat belts on and their feet on the floor.
- o **Passengers should not move out of or change seats while the vehicle is moving.** A passenger who is not wearing a seat belt during a crash or emergency stop can be thrown against the inside of the vehicle, against other occupants, or out of the vehicle.
- o **Each seat belt is designed to restrain one occupant.** If more than one person uses the same seat belt, they could be seriously injured or killed in a collision.
- o **Do not use any accessories on seat belts.** Devices claiming to improve occupant comfort or reposition the seat belt can reduce the protection provided by the seat belt and increase the chance of serious injury in a crash.
- o **Passengers should not place hard or sharp objects between themselves and the airbags.** Carrying hard or sharp objects on your lap or in your mouth can result in injuries if an airbag inflates.

- o **Keep occupants away from the airbag covers.** All occupants should sit upright, fully back in their seats with their seat belts on and their feet on the floor. If occupants are too close to the airbag covers, they could be injured if the airbags inflate.
- o **Do not attach or place objects on or near the airbag covers.** Any object attached to or placed on the front or side impact airbag covers could interfere with the proper operation of the airbags.
- o **Do not modify the front seats.** Modification of the front seats could interfere with the operation of the supplemental restraint system sensing components or side impact airbags.
- o **Do not place items under the front seats.** Placing items under the front seats could interfere with the operation of the supplemental restraint system sensing components and wiring harnesses.
- o **Never hold an infant or child on your lap.** The infant or child could be seriously injured or killed in the event of a crash. All infants and children should be properly restrained in appropriate child safety seats or seat belts in the rear seat.

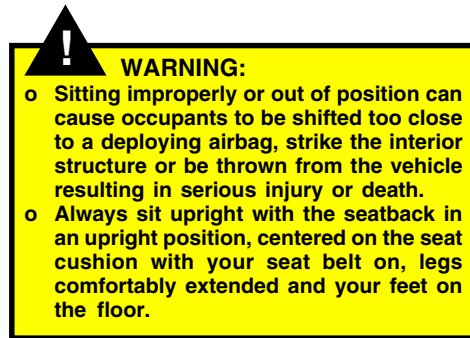

### Adding Equipment to or Modifying Your Airbag-Equipped Vehicle.

If you modify your vehicle by changing your vehicle's frame, bumper system, front end or side sheet metal or ride height, this may affect the operation of your vehicle's airbag system.

**INSTRUMENT CLUSTER AND INDICATOR**

B260A03E-AAT

**(Without Trip Computer)**

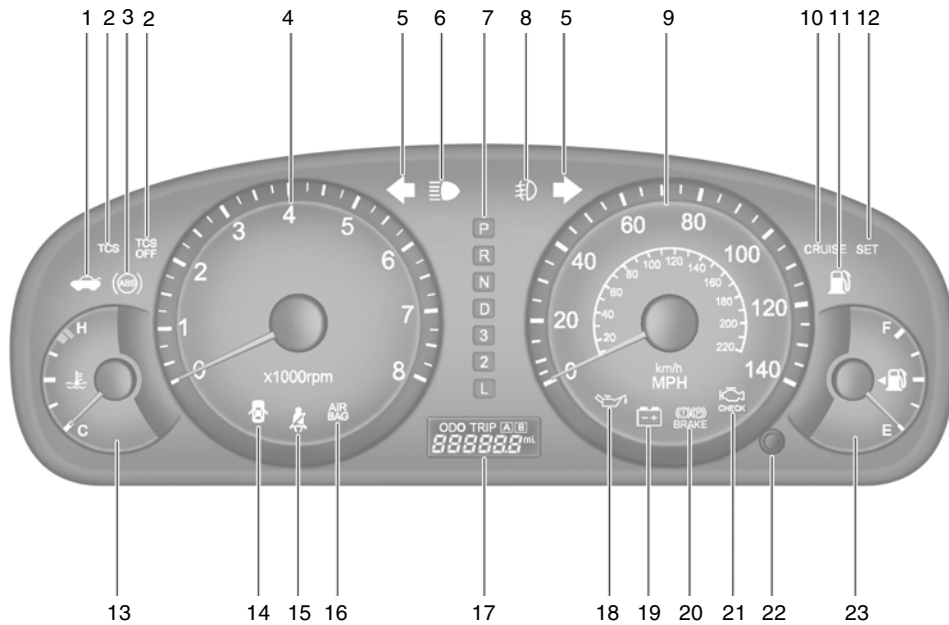



1. Trunk Lid (4 door)/Tail Gate (5 door) Open Warning Light
2. Traction Control Indicator Light (If installed)
3. ABS Warning Light (If installed)
4. Tachometer
5. Turn Signal Indicator Light
6. High Beam Indicator Light
7. Automatic Transaxle Position Indicator Light (Auto T/A only)
8. Front Fog Indicator Light (If installed)
9. Speedometer
10. Cruise Indicator Light (If installed)
11. Low Fuel Warning Light
12. SET Indicator Light (If installed)
13. Temperature Gauge
14. Door Ajar Warning Light
15. Seat Belt Warning Light
16. SRS (Airbag) Warning Light
17. Odometer/Trip Odometer
18. Low Oil Pressure Warning Light
19. Charging System Warning Light
20. Parking Brake/Low Brake Fluid Level Warning Light
21. Check Engine Malfunction Indicator Light (MIL)
22. Trip Odometer Reset Switch
23. Fuel Gauge

B260B03E-AAT  
**(With Trip Computer)**

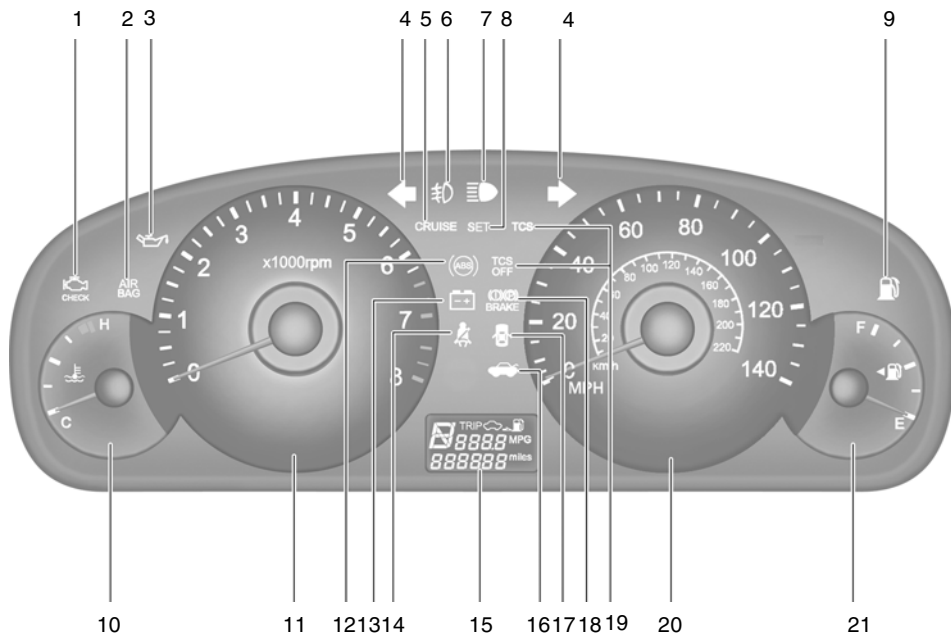

1. Check Engine Malfunction Indicator Light (MIL)
2. SRS (Airbag) Warning Light
3. Low Oil Pressure Warning Light
4. Turn Signal Indicator Light
5. Cruise Indicator Light (If installed)
6. Front Fog Indicator Light (If installed)
7. High Beam Indicator Light
8. SET Indicator Light (If installed)
9. Low Fuel Warning Light
10. Temperature Gauge
11. Tachometer
12. ABS Warning Light (If installed)
13. Charging System Warning Light
14. Seat Belt Warning Light
15. Trip Computer (If installed)
16. Trunk Lid (4 door)/Tail Gate (5 door) Open Warning Light
17. Door Ajar Warning Light
18. Parking Brake/Low Brake Fluid Level Warning Light
19. Traction Control Indicator Light (If installed)
20. Speedometer
21. Fuel Gauge

## WARNING AND INDICATOR LIGHTS

B260B01A-AAT

**SRS (Airbag) Service  
Reminder Indicator (SRI)**

The SRS service reminder indicator (SRI) comes on and flashes for about 6 seconds after the ignition key is turned to the "ON" position or after the engine is started, after which it will go out.

This light also comes on when the SRS is not working properly. If the SRI does not come on, or continuously remains on after flashing for about 6 seconds when you turned the ignition key to the "ON" position or started the engine, or if it comes on while driving, have the SRS inspected by an authorized Hyundai Dealer.

B260P01E-GAT

**ABS Service Reminder  
Indicator (SRI) (If installed)**

When the key is turned to the "ON" position, the Anti-Lock Brake System indicator will come on and then go off after three seconds. If the ABS SRI remains on, comes on while driving, or does not come on when the key is turned to the "ON" position, this indicates that there may be a problem with the ABS.

If this occurs, have your vehicle checked by your Hyundai dealer as soon as possible. The normal braking system will still be operational, but without the assistance of the anti-lock brake system.

**WARNING:**

If both the ABS SRI and Parking Brake/ Brake fluid level warning lights remain "ON" or come on while driving, there may be a problem with E.B.D. (Electronic brake force distribution).

If this occurs, avoid sudden stops and have your vehicle checked by your Hyundai dealer as soon as possible.

B260D01A-AAT

**Turn Signal Indicator Lights**

The blinking green arrows on the instrument panel show the direction indicated by the turn signals. If the arrow comes on but does not blink, blinks more rapidly than normal, or does not illuminate at all, a malfunction in the turn signal system is indicated. Your dealer should be consulted for repairs.

B260F01A-AAT

**High Beam Indicator Light**

The high beam indicator light comes on whenever the headlights are switched to the high beam or flash position.

B260G01A-AAT



### Low Oil Pressure Warning Light



#### CAUTION:

If the oil pressure warning light stays on while the engine is running, serious engine damage may result. The oil pressure warning light comes on whenever there is insufficient oil pressure. In normal operation, it should come on when the ignition switch is turned on, then go out when the engine is started. If the oil pressure warning light stays on while the engine is running, there may be a serious malfunction.

If this happens, stop the car as soon as it is safe to do so, turn off the engine and check the oil level. If the oil level is low, fill the engine oil to the proper level and start the engine again. If the light stays on with the engine running, turn the engine off immediately. In any instance where the oil light stays on when the engine is running, the engine should be checked by a Hyundai dealer before the car is driven again.

B260H03A-AAT



### Parking Brake/Low Brake Fluid Level Level Warning Light



#### WARNING:

If you suspect brake trouble, have your brakes checked by a Hyundai dealer as soon as possible. Driving your car with a problem in either the brake electrical system or brake hydraulic system is dangerous, and could result in a serious injury or death.

#### Warning Light Operation

The parking brake/brake fluid level warning light should come on when the parking brake is applied and the ignition switch is turned to "ON" or "START". After the engine is started, the light should go out when the parking brake is released.

If the parking brake is not applied, the warning light should come on when the ignition switch is turned to "ON" or "START", then go out when the engine starts. If the light comes on at any other time, you should slow the vehicle and bring it to a complete stop in a safe location off the roadway.

The brake fluid level warning light indicates that the brake fluid level in the brake master cylinder is low and hydraulic brake fluid conforming to DOT 3 or DOT 4 specifications should be added. After adding fluid, if no other trouble is found, the car should be immediately and carefully driven to a Hyundai dealer for inspection. If further trouble is experienced, the vehicle should not be driven at all but taken to a dealer by a professional towing service.

Your Hyundai is equipped with dual-diagonal braking systems. This means you still have braking on two wheels even if one of the dual systems should fail. With only one of the dual systems working, more than normal pedal travel and greater pedal pressure are required to stop the car. Also, the car will not stop in as short a distance with only half of the brake system working. If the brakes fail while you are driving, shift to a lower gear for additional engine braking and stop the car as soon as it is safe to do so.

B260J02A-AAT



### Charging System Warning Light

The charging system warning light should come on when the ignition is turned on, then go out when the engine is running. If the light stays on while the engine is running, there is a malfunction in the electrical charging system. If the light comes on while you are driving, stop, turn off the engine and check under the hood. First, make certain the generator drive belt is in place. If it is, check the tension of the belt.

Do this as shown on page 6-18 by pushing down on the center of the belt as soon as possible. Have the system checked by your Hyundai dealer.

B260E020-AAT



### Seat Belt Reminder Light and Chime

The seat belt reminder light blinks until your seat belt is fastened when the ignition key is turned from the "OFF" position to "ON" or "START" and the warning chime will sound for 6 seconds.

B260K01E-AAT



### Trunk Lid (4 door)/Tail Gate (5 door) Open Warning Light

This light remains on unless the trunk lid/tail gate is completely closed and latched.

B260L01Y-AAT



### Door Ajar Warning Light and Chime

The door ajar warning light warns you that a door is not completely closed and the chime warns you that the driver's side front door is not completely closed.

#### NOTE:

**To remind you not to lock the key inside the car, the warning light comes on whenever the key is in the "LOCK" position and a door is open. The warning chime only sounds whenever the key is in the "LOCK" position and the driver's side front door is open. The chime sounds and the light remains on until the key is removed from the ignition.**

B260M01A-AAT



### Low Fuel Level Warning Light

The low fuel level warning light comes on when the fuel tank is approaching empty. When it comes on, you should add fuel as soon as possible. Driving with the fuel level warning light on or with the fuel level below "E" can cause the engine to misfire and damage the catalytic converter.

B260Q01E-GAT



### Cruise Indicator Light (If installed)

The cruise indicator light in the instrument cluster is illuminated when the cruise control main switch on the end of the barrel is pushed. The indicator light does not illuminate when the cruise control main switch is pushed a second time.

Information on the use of cruise control begins on page 1-80.

B260R01E-GAT

**Set Indicator Light  
(If installed)**

The set indicator light in the instrument cluster is illuminated when the cruise control switch is pushed downward to "SET (COAST)".

The set indicator light does not illuminate when the control switch is in the "CANCEL" position.

B260A01B-GAT

**Front Fog Indicator Light  
(If installed)**

Front fog indicator light comes on whenever the fog light switch is on.

B260N01A-AAT

**Check Engine Malfunction Indicator Light**

This light illuminates when there is a malfunction of an exhaust gas related component, and the system is not functioning properly so that the exhaust gas regulation values are not satisfied. This light will also illuminate when the ignition key is turned to the "ON" position, and then it will go out in a few seconds. If it illuminates while driving, or does not illuminate when the ignition key is turned to the "ON" position, take your car to your nearest authorized Hyundai dealer and have the system checked.

B265C01O-AAT

**Traction Control  
Indicator Lights  
(If installed)**

The traction control indicators change operation according to the ignition switch position and whether the system is in operation or not.

They will illuminate when the ignition key is turned to the "ON" position, but should go out after three seconds. If the TCS or TCS-OFF indicator stays on, take your car to your authorized Hyundai dealer and have the system checked. See section 2 for more information about the TCS.

B270A01A-AAT

**BRAKE PAD WEAR WARNING SOUND**

The front disc brake pads have wear indicators that should make a high-pitched squealing or scraping noise when new pads are needed. The sound may come and go or be heard all the time when the vehicle is moving. It may also be heard when the brake pedal is pushed down firmly. Expensive rotor damage will result if the worn pads are not replaced. See your Hyundai dealer immediately.

B280A01A-AAT

**FUEL GAUGE**

Without Trip Computer



HXDFL291

With Trip Computer



HXDFL284

The needle on the gauge indicates the approximate fuel level in the fuel tank.

B290A02E-AAT

**ENGINE COOLANT TEMPERATURE GAUGE**

Without Trip Computer



HXDFL290

With Trip Computer



HXDFL283

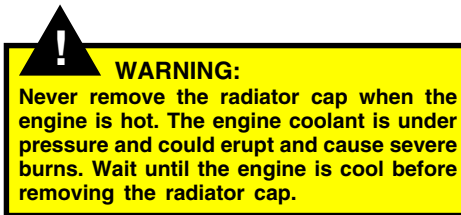

The needle on the engine coolant temperature gauge should stay in the middle between "H" and "C". If it moves across the dial to "H" (Hot), pull over and stop as soon as possible and turn off the engine. Then open the hood and, after the engine has cooled, check the coolant level and the water pump drive belt. If you suspect cooling system trouble, have your cooling system checked by a Hyundai dealer as soon as possible.

B300A01S-AAT

**SPEEDOMETER**

Without Trip Computer



HXDFL030-A

With Trip Computer



HXDFL029-A

Your Hyundai's speedometer is calibrated in miles per hour (on the outer scale) and kilometers per hour (on the inner scale).



B330A01L-AAT

**TACHOMETER**

Without Trip Computer



HXDFL330

With Trip Computer



HXDFL331

The tachometer registers the speed of your engine in revolutions per minute (rpm).

**CAUTION:**

The engine should not be raced to such a speed that the needle enters the red zone on the tachometer face. This can cause severe engine damage and may void your warranty.

B310B04E-AAT

**ODOMETER/TRIP ODOMETER**

Without Trip Computer



HXDFL231-A

**Odometer**

Records the total distance the vehicle has been driven.

**NOTE:**

Federal law forbids alteration of the odometer of any vehicle with the intent to change the mileage registered on the odometer. The alteration of the odometer may void your warranty coverage.

## Function of Digital Odometer/ Trip Odometer

Pushing in the reset switch under the right side of the speedometer when the ignition switch is turned "ON" will display the following sequence:

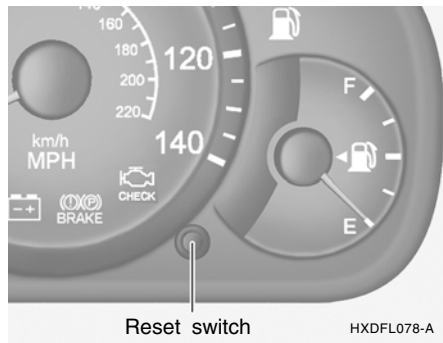
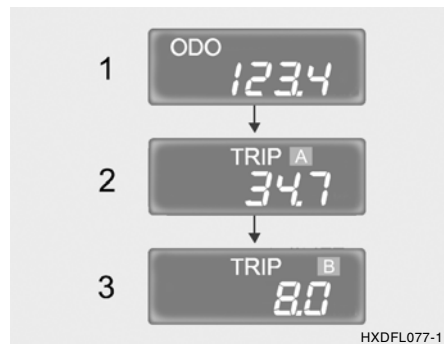

### 1. Odometer

The odometer records the total driving distance in miles or kilometers.

### 2,3. Trip odometer

Records the distance of 2 trips in miles or kilometers.

TRIP A : First distance you have traveled from your origination point to a first destination.

TRIP B : Second distance from the first destination to the final destination.

To shift from TRIP A to TRIP B, press the reset switch. When pressed for 1 second, it will reset to 0.

## B310A01S-AAT ODOMETER

With Trip Computer



The odometer records the total driving distance in miles or kilometers, and is useful for keeping a record for maintenance intervals.

### NOTE:

**Federal law forbids alteration of the odometer of any vehicle with the intent to change the number of the odometer. The alteration of the odometer may void your warranty coverage.**

## TRIP COMPUTER

B400B03E-AAT  
(If installed)

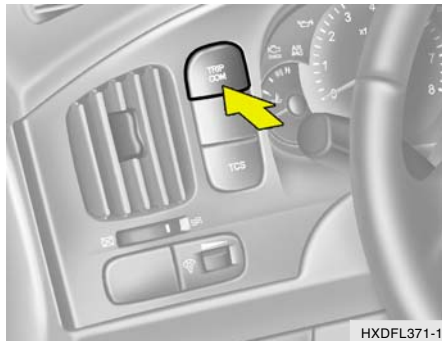

HXDFL371-1

The trip computer is a microcomputer-controlled driver information gauge that displays information related to driving, such as estimated tripmeter, average fuel consumption and distance to empty on the LCD.

### Trip Computer Switch

- o The trip computer switch is used to zero the multi-functional display mode.
- o Pushing in the trip computer switch behind the left side of the steering wheel changes the display as follows;

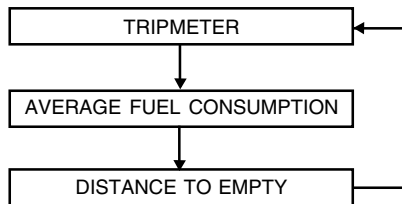

### 1. Tripmeter

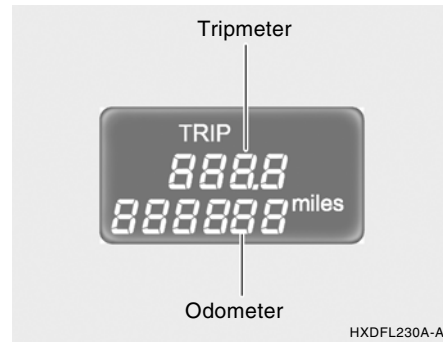

- o This mode provides the total distance travelled since the last tripmeter reset. Total distance is also reset to zero if the battery is disconnected.
- o Pressing the trip computer switch for more than 1 second, when the tripmeter is being displayed, clears the tripmeter to zero.
- o The meter's working range is from 0 to 999.9 miles.

## 2. Average Fuel Consumption

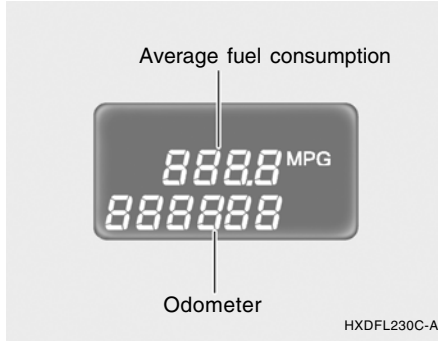

- o This mode calculates the average fuel consumption from the total fuel used and the distance since the last average consumption reset.
- o The total fuel used is calculated from the fuel consumption input.
- o For an accurate calculation, drive more than 0.5 mile.
- o The meter's working range is from 0.0 to 99.9 miles/gallon(MPG).

## 3. Distance to Empty

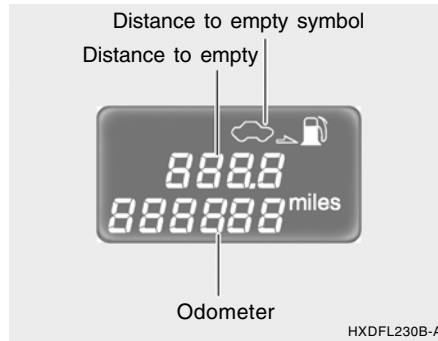

- o This mode provides the estimated distance to empty from the current fuel level in the fuel tank and distance to empty symbol.
- o When refueling with more than 2 gallons, the trip computer will recognize refueling has occurred.
- o For an accurate distance to empty, drive more than 0.5 mile.
- o When the distance to empty is less than 30 miles, the symbol will always come on and the distance to empty digits will indicate "----" with flash until the fuel is added.

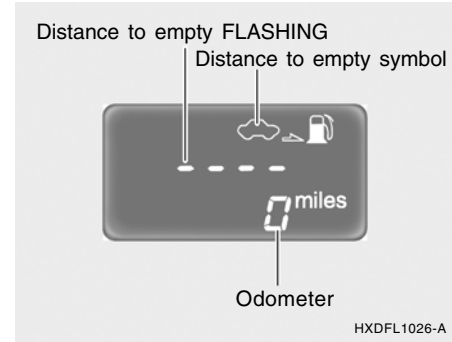

### NOTE:

- o **The distance to empty can differ from the actual tripmeter according to driving condition habits.**
- o **The distance to empty can vary according to the driving conditions, driving pattern or vehicle speed.**

## MULTI-FUNCTION LIGHT SWITCH

B340A01A-AAT

### COMBINATION TURN SIGNAL, HEADLIGHT AND HIGH-BEAM SWITCH

#### Turn Signal Operation

Pulling down on the lever causes the turn signals on the left side of the car to blink. Pushing upwards on the lever causes the turn signals on the right side of the car to blink. As the turn is completed, the lever will automatically return to the center position and turn off the turn signals at the same time. If either turn signal indicator light blinks more rapidly than usual, goes on but does not blink, or does not go on at all, there is a malfunction in the system. Check for a burned-out fuse or bulb or see your Hyundai dealer.

B340B01A-AAT

#### Lane Change Signal

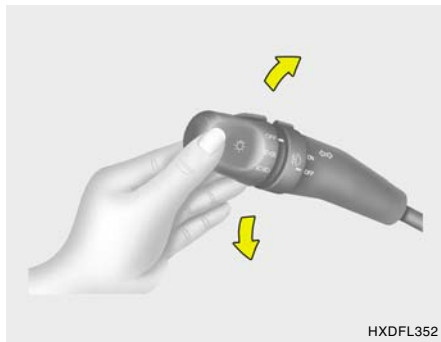

HXDFL352

To indicate a lane change, move the lever up or down to a point where it begins flashing. The lever will automatically return to the center position when released.

B340C03E-AAT

#### Headlight Switch

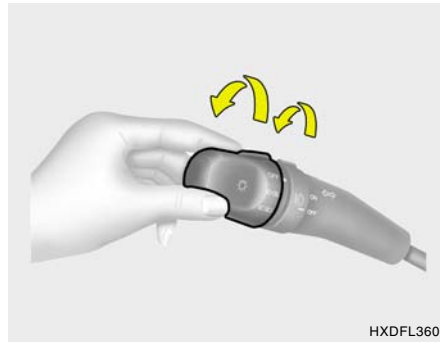

HXDFL360

To operate the headlights, turn the barrel on the end of the multi-function switch. The first position turns on the parking lights, sidelights, tail lights and instrument panel lights. The second position turns on the headlights.

#### NOTE:

The ignition must be in the "ON" position to turn on the headlights.

## Parking Light Auto Off

If you do not turn the parking lights "OFF" key out, the parking lights will automatically shut "OFF" when the driver's door is opened.

To turn them "ON" again you must simply turn the ignition key to the "ON" position.

If necessary, to keep the lights on when the ignition key is removed, perform the following:

- 1) Open the driver-side door.
- 2) Turn the parking lights OFF and ON again using the light switch.

B340D01A-AAT

## High-beam Switch

To turn on the headlight high beams, push the lever forward (away from you). The high beam indicator light will come on at the same time. For low beams, pull the lever back toward you.

B340E01A-AAT

## Headlight Flasher

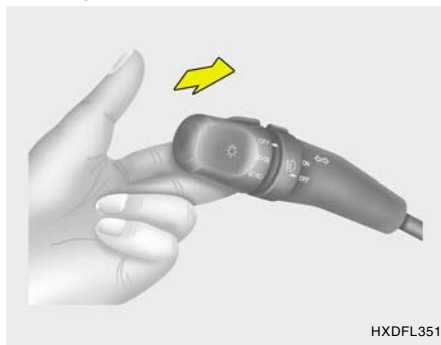

To flash the headlights, pull the switch lever toward you, then release it. The headlights can be flashed even though the headlight switch is in the "OFF" position.

B340G01LZ-AAT

## Auto Light (If installed)

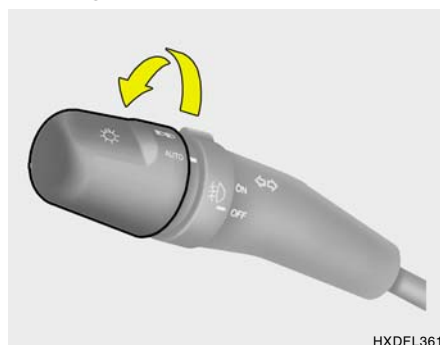

To operate the automatic light feature, turn the barrel on the end of the multi-function switch. If you set the multi-function switch to "AUTO", the tail lights and headlights will be turned automatically on or off according to external illumination conditions.

### NOTE:

Turn on the lights manually in foggy, cloudy and rainy conditions.

B360B01L-AAT

### FRONT FOG LIGHT SWITCH (If installed)

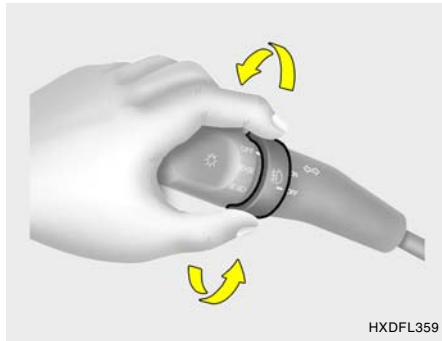

To turn on the front fog lights, place the switch in the "ON" position. They will come on when the headlight switch is in the second position.

#### NOTE:

If you turn on the headlight high beams, the front fog lights will be turned off.

### WINDSHIELD WIPER AND WASHER SWITCH

B350A01A-AAT

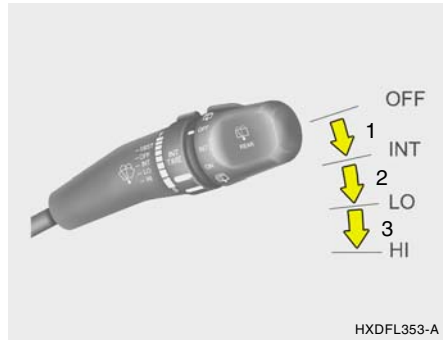

The windshield wiper switch has three positions:

1. Intermittent wiper operation
2. Low-speed operation
3. High-speed operation

#### NOTE:

To prevent damage to the wiper system, do not attempt to wipe away heavy accumulations of snow or ice. Accumulated snow and ice should be removed manually. If there is only a light layer of snow or ice, operate the heater in the defrost mode to melt the snow or ice before using the wiper.

B350C01S-AAT

### Adjustable Intermittent Wiper Operation

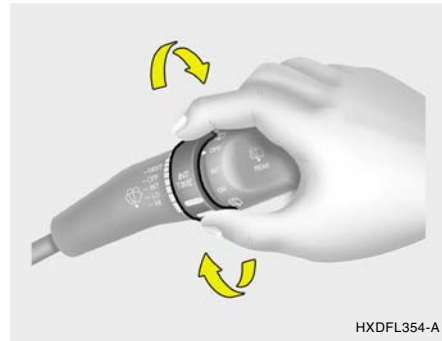

To use the intermittent wiper feature, place the wiper switch in the "INT" position. With the switch in this position, the interval between wipes can be varied from 2 to 10 seconds by turning the interval adjuster barrel.

B350B01A-AAT

### Windshield Washer Operation

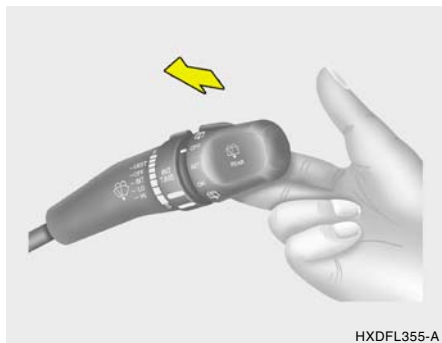

To use the windshield washer, pull the wiper/washer lever toward the steering wheel. When the washer lever is operated, the wipers automatically make two passes across the windshield. The washer continues to operate until the lever is released.

#### NOTE:

- o Do not operate the washer more than 15 seconds at a time or when the fluid reservoir is empty.
- o In icy or freezing weather, be sure the wiper blades are not frozen to the glass prior to operating the wipers.
- o In areas where water freezes in winter, use windshield washer antifreeze.

### Mist Wiper Operation

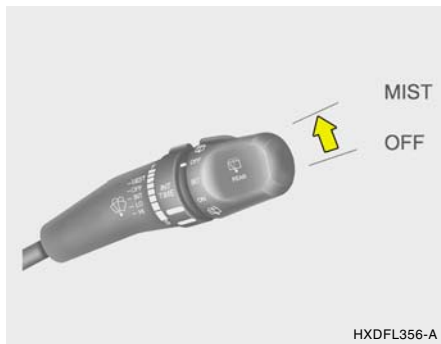



If a single wipe is desired to clear mist, push the windshield wiper and washer control lever upwards.

B390A01E-AAT

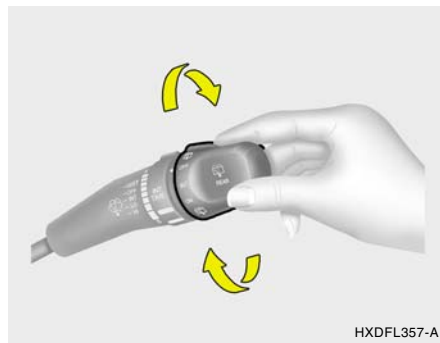
### REAR WINDOW WIPER AND WASHER (If installed)



1.  : The rear window wiper starts to operate three times after the washer fluid sprays onto the rear window.
2. OFF
3. INT : The interval between wipes operates every 5 seconds intermittently.
4. ON : The rear window wiper starts to operate continuously.
5.  : The washer fluid will be sprayed onto the rear window and the wiper operates while the rear window wiper barrel is placed in this position.



## REAR WINDOW DEFROSTER SWITCH

Do not operate the washer continuously for more than 15 seconds or when the fluid reservoir is empty; this could damage the system. Do not operate the wiper when the window is dry; this can result in scratching as well as premature wiper blade wear.

For the reason stated above, do not operate the washer when the washer fluid reservoir is empty.

B380A01E-AAT

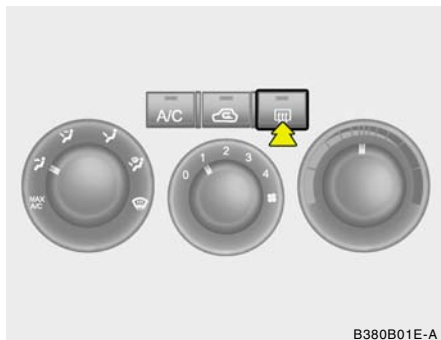

The rear window defroster and heated outside rearview mirrors are turned on by pushing in the switch. To turn the defroster off, push the switch a second time. The rear window defroster automatically turns itself off after about 20 minutes. To restart the defroster cycle, push in the switch again after it has turned itself off.

**CAUTION:**

Do not clean the inner side of the rear window glass with an abrasive type of glass cleaner or use a scraper to remove foreign deposits from the inner surface of the glass as this may cause damage to the defroster elements.

**NOTE:**

The engine must be running for the rear window defroster to operate.

## HAZARD WARNING SYSTEM

B370A01A-AAT

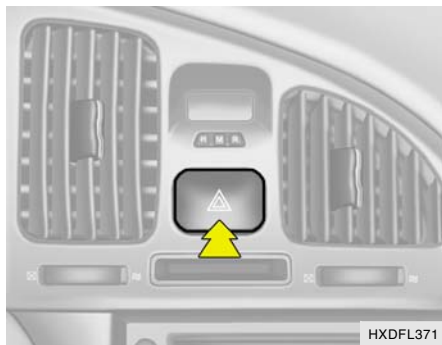

The hazard warning system should be used whenever you find it necessary to stop the car in a hazardous location. When you must make such an emergency stop, always pull off the road as far as possible.

The hazard warning lights are turned on by pushing in the hazard switch. This causes all turn signal lights to blink. The hazard warning lights will operate even though the key is not in the ignition.

To turn the hazard warning lights off, push the switch a second time.

## DIGITAL CLOCK

B400A01A-AAT



There are three control buttons for the digital clock. Their functions are:

**HOUR** - Push "H" to advance the hour indicated.

**MIN** - Push "M" to advance the minute indicated.

**RESET** - Push "R" to reset minutes to ":00" to facilitate resetting the clock to the correct time.

When this is done:

Pressing "R" between 10 : 30 and 11 : 29 changes the readout to 11 : 00.

Pressing "R" between 11 : 30 and 12 : 29 changes the readout to 12 : 00.

## INSTRUMENT PANEL LIGHT CONTROL (RHEOSTAT)

B410A01A-AAT



The instrument panel lights can be made brighter or dimmer by turning the instrument panel light control knob.

**CIGARETTE LIGHTER**

B420A01A-AAT



HXDFL420

For the cigarette lighter to work, the key must be in the "ACC" position or the "ON" position. To use the cigarette lighter, push it all the way into its socket. When the element has heated, the lighter will pop out to the "ready" position. Do not hold the cigarette lighter pressed in. This can damage the heating element and create a fire hazard.

If it is necessary to replace the cigarette lighter, use only a genuine Hyundai replacement or its approved equivalent.

**POWER OUTLET**

B500D080-AAT

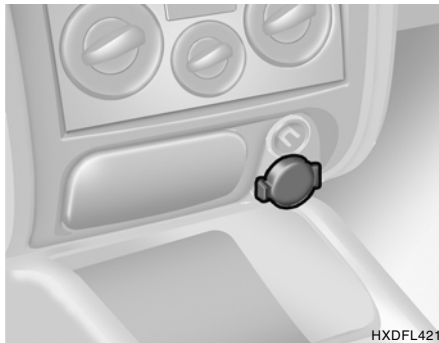

HXDFL421

These supply 12V electric power to operate electric accessories or equipment only when the key is in the "ON" or "ACC" position.

**CAUTION:**

- o Use the power outlet only when the engine is running and remove the plug from the power outlet after using the electric device. Using the power outlet when the engine stops or keeping the electric device with plugged in for many hours may cause the battery to discharge.
- o Do not use the power outlet to connect electric accessories or equipment that are not designed to operate on 12 volts.
- o Some electronic devices can cause electronic interference when plugged into the power outlet. These devices may cause excessive audio noise and malfunctions in other electronic systems or devices in your vehicle.

## ASHTRAY

B430A01B-AAT

### Front Ashtray

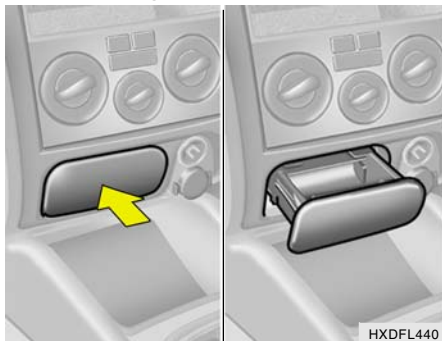

The front ashtray may be opened by pushing and releasing the ashtray lid. To remove the ashtray to empty or clean it, lift the metal ash receptacle upward and pull it out. The ashtray light will only illuminate when the external lights are on (if installed).

B440A01E-AAT

### Rear Ashtray

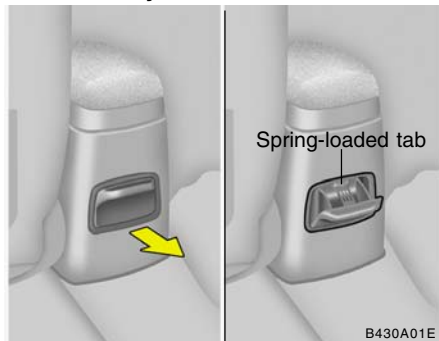

The rear ashtray may be opened by pulling the lid out by its top edge. To remove the ashtray to empty or clean it, press down on the spring-loaded tab inside the ashtray and lift the ashtray upward and pull it all the way out.

## PARKING BRAKE

B530A02A-AAT

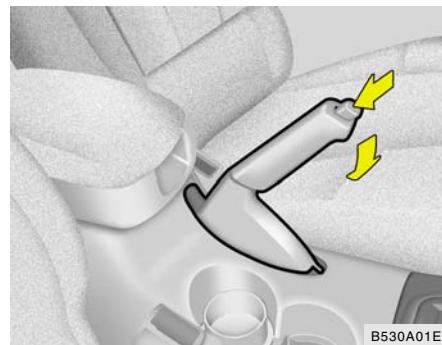

Always engage the parking brake before leaving the vehicle. This also turns on the parking brake indicator light when the key is in the "ON" or "START" position. Before driving away, be sure that the parking brake is fully released and the indicator light is off.

- o To engage the parking brake, pull the lever up as far as possible.
- o To release the parking brake, pull up the lever and press the thumb button. Then, while holding the button in, lower the brake lever.

**DRINK HOLDER****WARNING:**

Whenever leaving vehicle or parking always set the parking brake as far as possible and fully engage the vehicle's transaxle into the park position. Vehicles not fully engaged in park with the parking brake set are at risk for moving inadvertently and injuring yourself or others.

B450A02E-AAT

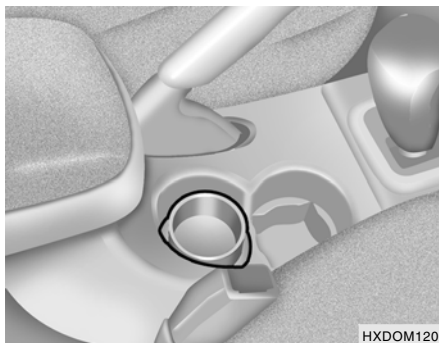
**Front Drink Holder**

The front drink holder for holding cups is located on the right side of the parking brake.

B450B02E-AAT

**Rear Drink Holder (If installed)**

4DOOR

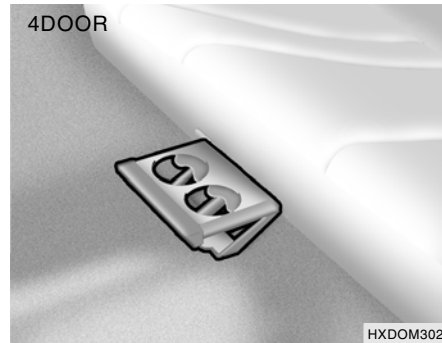

5DOOR

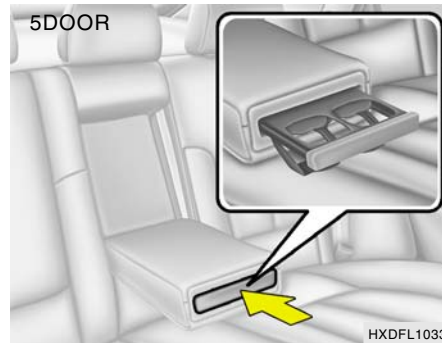

The rear drink holder for holding cups is located in the rear seat center (center of the rear seat arm rest- 5 door). The drink holder can be used by pushing it in first and then releasing it.



**CAUTION:**  
Place the drink holder in its stored position while not in use.



**WARNING:**

- o Use caution when using the drink holders. A spilled hot beverage that is very hot can injure you or your passengers. Spilled liquids can damage interior trim and electrical components.
- o Do not place objects other than cups or cans on the drink holder. These objects can be thrown out in the event of a sudden stop or an accident, possibly injuring the passengers in the vehicle.

## SEATBACK POCKET

B540B01E-GAT  
**(If installed)**

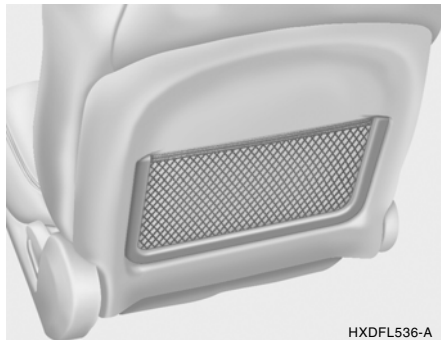

HXDFL536-A

The seatback pockets for holding papers are located on the backside of the front seats.

## SUNROOF

B460A01S-AAT  
**(If installed)**

The sunroof can be operated with the ignition key in the "ON" position.

B470A02S-AAT  
**SUNSHADE**

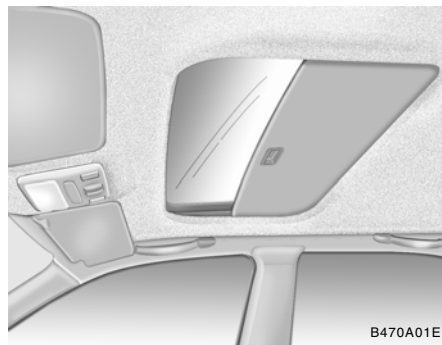

B470A01E

The sunshade can be opened and closed by sliding it forward or rearward when the sunroof is closed. The sunshade will be opened automatically when the sunroof is opened, but it must be closed manually.



**WARNING:**  
Never adjust the sunshade while driving.

B460B04E-AAT

**OPERATING THE SUNROOF****Opening or Closing the Sunroof**

B460B02E-A

The sunroof can be electrically opened or closed with the ignition key in the "ON" position. The sunroof is moved to its fully open position by pushing and holding the "OPEN" button. Release the button when the sunroof reaches the desired position. To close, press and hold the "CLOSE" button.

**WARNING:**

- o Do not close a sunroof if anyone's hands, arms or body are between the sliding glass and the sunroof sash, as this could result in an injury.
- o Do not place your head or arms out of the sunroof opening at any time.
- o While the vehicle is moving, always keep the head, hands and other parts of the body of all occupants away from the roof opening. Otherwise, you could be seriously injured if the vehicle stops suddenly or if the vehicle is involved in an accident.
- o Do not press any sunroof control button longer than necessary. **Damage to the motor or system components could occur.**

**CAUTION:**

- o Do not open the sunroof in severely cold temperatures or when it is covered with ice or snow.
- o Periodically remove any dirt that may have accumulated on the guide rails.

B460C02S-AAT

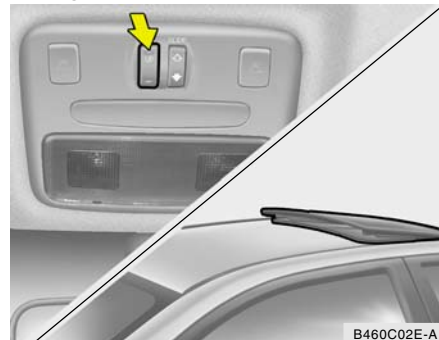
**Tilting the Sunroof**

B460C02E-A

The sunroof can be tilted by pushing the "UP" button with the sunroof closed. Release the button when the sunroof reaches the desired position. To close the sunroof, press the "DOWN" button.

**NOTE:**

**After washing the car or after there is rain, be sure to wipe off any water that is on the sunroof before operating it.**

B460D03E-AAT

### Manual Operation of Sunroof

If the sunroof does not operate electrically:



1. Remove the rectangular plastic interior light lenses in the front overhead console by using a flat blade screwdriver.
2. Remove the front overhead console with a



flat blade screwdriver.

3. Insert the hexagonal head wrench provided

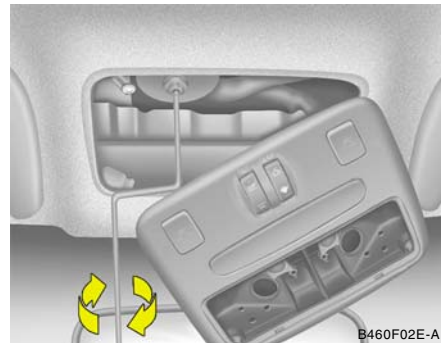

with the vehicle into the socket. This wrench can be found in the vehicle's trunk or glove box.

4. Turn the wrench clockwise to open or counterclockwise to close.



## INTERIOR LIGHT

B480A01E-AAT

### FRONT INTERIOR LIGHT

#### Map Light

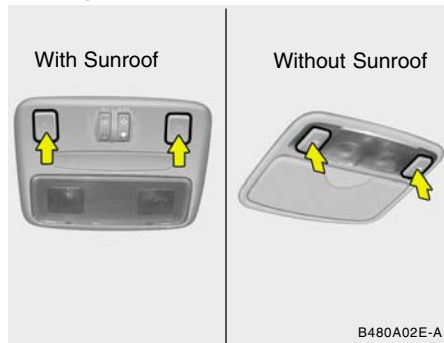

The two map light buttons are located on both sides of the front overhead console. Push in the map light button to turn the light on or off. This light produces a spot beam for convenient use as a map light at night or as a personal light for the driver and the passenger.

B490A03E-AAT

### Interior light

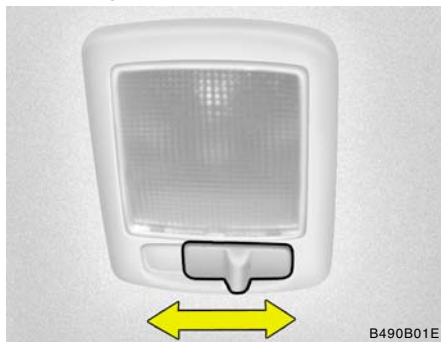

The interior courtesy light switch has three positions. The three positions are:

#### o DR

In the "DR" position, the interior courtesy light comes on when any door is opened regardless of the ignition key position. The light goes out when the door is closed.

#### NOTE:

**If your vehicle is equipped with the delay-out interior light, the light goes out gradually within 6 seconds after the door is closed.**

#### o ON

In the "ON" position, the light stays on at all times.



#### CAUTION:

**Do not leave the switch in this position for an extended period time when the vehicle is not running.**

#### o OFF

In the "OFF" position, the light stays off at all times even though a door is open.

## SUNGLASS HOLDER

B491A03O-AAT  
(If Installed)

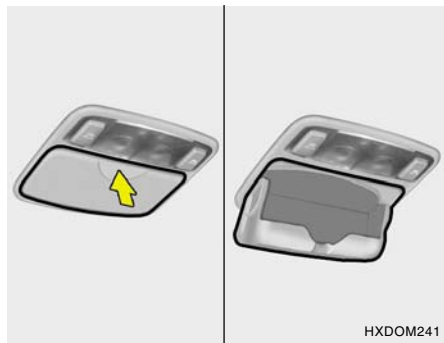

The sunglasses holder is located on the front overhead console. Push the end of the cover to open the sunglasses holder.



### WARNING:

- o Do not keep objects except sunglasses inside the sunglasses holder. Such objects can be thrown from the holder in the event of a sudden stop or an accident, possibly injuring the passengers in the vehicle.
- o Do not open the sunglasses holder while the vehicle is moving. The rear view mirror of the vehicle can be blocked by an open sunglasses holder.

## GLOVE BOX

B500A01A-AAT

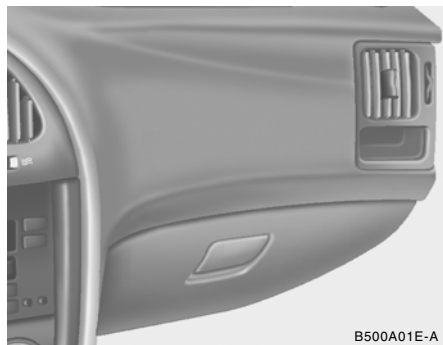

To open the glove box, pull on the glove box release lever.



### WARNING:

To avoid the possibility of injury in case of an accident or a sudden stop, the glove box door should be kept closed when the car is in motion.

## STORAGE COMPARTMENT

B500B02E-GAT

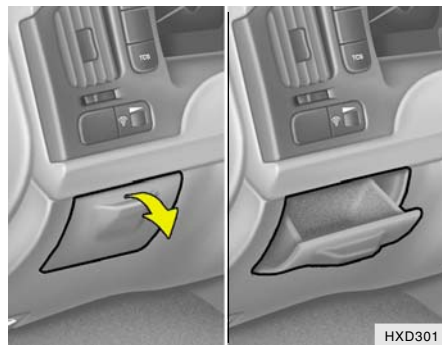

The storage compartment may be opened by pulling it out by its grip.

It is used for storing small articles.

If the storage compartment is removed, the fuse box for the lights and other electrical accessories will be exposed.

## MIRROR

B510A01S-AAT

## OUTSIDE REARVIEW MIRROR

## Manual Type

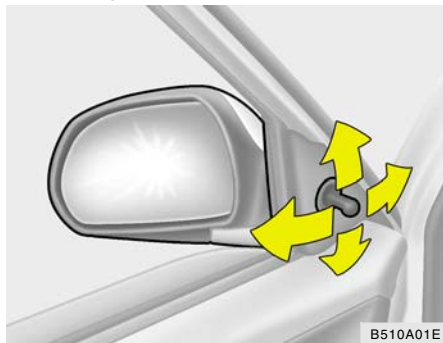

B510A01E

The outside rearview mirror on the driver's side is equipped with a remote control for your convenience. It is operated by the control lever in the bottom front corner of the window.

Before driving away, always check that your mirrors are positioned so you can see behind you, both to the left and right sides, as well as directly behind your vehicle. When using the mirror, always exercise caution when attempting to judge the distance of vehicles behind or along side of you.

## NOTE:

If the mirror control is jammed with ice, do not attempt to break it free using the control handle or by manipulating the face of the mirror. Use an approved spray de-icer (not radiator antifreeze) to release the frozen mechanism or move the vehicle to a warm place and allow the ice to melt.

B510B01Y-AAT

## Electric Type (If installed)



B510C01E

The outside rearview mirrors can be adjusted to your preferred rear vision, both directly behind the vehicle, and to the rear of the left and right sides.

The remote control outside rearview mirror switch controls the adjustments for both right and left outside mirrors.

## To adjust the position of either mirror:

1. Move the selecting switch to the right or left to activate the adjustable mechanism for the corresponding door mirror.
2. Adjust mirror angle by depressing the appropriate directional switch as illustrated.

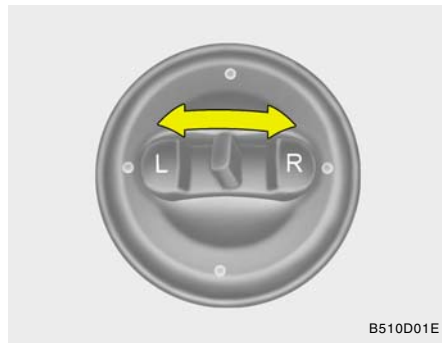

B510D01E

**CAUTION:**

- o Do not operate the switch continuously for an unnecessary length of time.
- o Scraping ice from the mirror face could cause permanent damage. To remove any ice, use a sponge, soft cloth or approved de-icer.

**WARNING:**

Be careful when judging the size or distance of any object seen in the passenger side rear view mirror. It is a convex mirror with a curved surface, and objects seen in this mirror are closer than they appear.

B510D01E-AAT

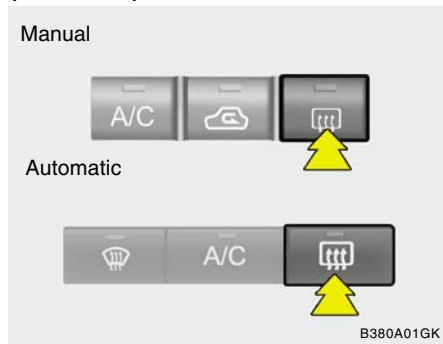
**OUTSIDE REARVIEW MIRROR HEATER  
(If installed)**

The outside rearview mirror heater is actuated in connection with the rear window defroster. To heat the outside rearview mirror glass, push in the switch for the rear window defroster. The rearview mirror glass will be heated for defrosting or defogging and will give you improved rear vision in inclement weather conditions. Push the switch again to turn the heater off. The outside rearview mirror heater automatically turns itself off after 20 minutes.

B510C01A-AAT

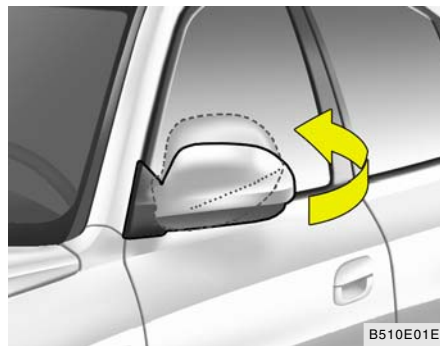
**FOLDING THE OUTSIDE REARVIEW  
MIRRORS**

To fold the outside rearview mirrors, push them towards the rear.  
The outside rearview mirrors can be folded rearward for parking in narrow areas.

**WARNING:**

Do not adjust or fold the outside rearview mirrors while the vehicle is moving. This could result in loss of control, and an accident which could cause serious injury or death.

B520A01A-AAT

## DAY/NIGHT INSIDE REARVIEW MIRROR

### Manual type

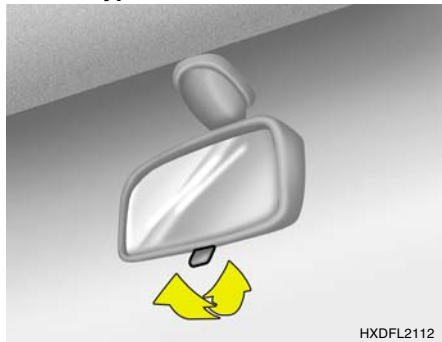

HXDFL2112

Your Hyundai is equipped with a day/night inside rearview mirror. The "night" position is selected by flipping the tab at the bottom of the mirror toward you. In the "night" position, the glare of headlights of cars behind you is reduced.



B520B02O-GAT

### Electric type (If installed)



HLZ2068-1

The electric type day/night inside rearview mirror automatically controls the glare of headlights of the car behind you.

1. Pressing the  button turns the auto-dimming function OFF which is indicated by the green Status Indicator LED turning off.
2. Pressing the  button again turns the auto-dimming function ON which is indicated by the green Status Indicator LED turning on.

#### NOTE:

The mirror defaults to the "ON" position each time the vehicle is started.

## SUN VISOR

B580A01L-GAT

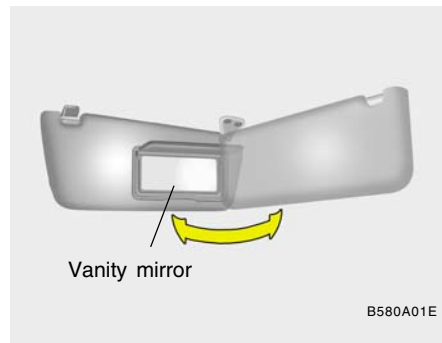

B580A01E

Your Hyundai is equipped with sun visors to give the driver and front passenger either frontal or sideward shade. To reduce glare or to shut out direct rays of the sun, turn the sun visor down. A vanity mirror is provided on the back of the sun visor for the driver and front passenger.

#### NOTE:

The Supplemental Restraint System (SRS) label containing useful information can be found on the back of each sun visor.



#### WARNING:

Do not place the sun visor in such a manner that it obscures visibility of the roadway, traffic or other objects.

## HIGH-MOUNTED REAR STOP LIGHT

B550A01S-GAT  
(If installed)

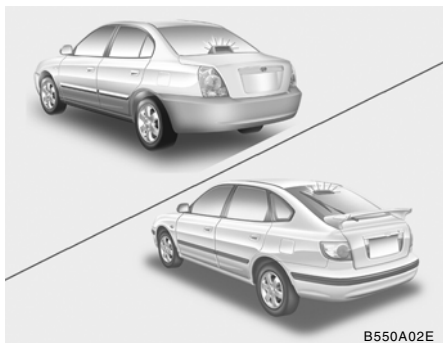

In addition to the lower-mounted rear stop lights on either side of the car, the high mounted rear stop light in the center of the rear window or inserted in the rear spoiler also lights when the brakes are applied.

## FRONT DOOR EDGE WARNING LIGHT

B620A01S-AAT  
(If installed)

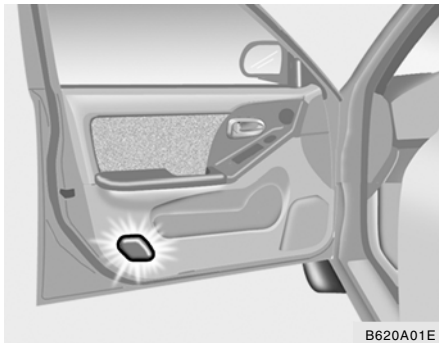

A red light turns on when the front door is opened. The purpose of this light is to assist when you get in or out and also to warn passing vehicles.

## HOOD RELEASE

B570A02E-AAT

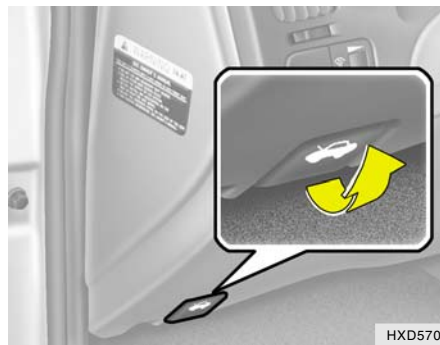

1. Pull the release knob to unlatch the hood.



2. Pull the secondary latch lever up and lift the hood.

3. Hold the hood open with the support rod.

Before closing the hood, return the support rod to its clip to prevent it from rattling. Lower the hood until it is about 1 ft. (30 cm) above the closed position and let it drop. Make sure that it locks into place.

**CAUTION:**

Make sure that the support rod has been released prior to closing the hood.

**WARNING:**

- o Always double check to be sure that the hood is firmly latched before driving away. If it is not latched, the hood could open while the vehicle is being driven, causing a total loss of visibility, which might result in an accident.
- o The support rod must be inserted completely into the hole in the hood whenever you inspect the engine compartment. This will prevent the hood from falling and possibly injuring you.
- o Do not move the vehicle with the hood in the raised position, as vision is obstructed and the hood could fall or be damaged.

**FLOOR MAT ANCHOR**

B990A03Y-AAT

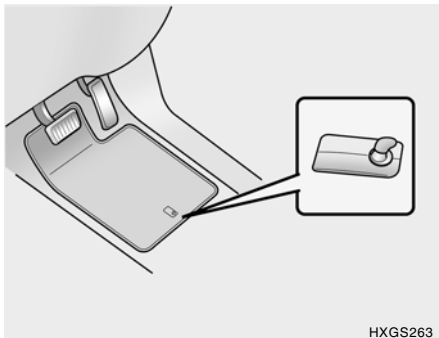

HXGS263

When using a floor mat on the front floor carpet, make sure it attaches to the floor mat anchor in your vehicle. This keeps the floor mat from sliding forward.

**WARNING:**

- o Make sure the floor mat is properly placed on the floor carpet. If the floor mat slips and interferes with the movement of the pedals during driving, it may cause an accident.
- o Don't put an additional floor mat on the top of the anchored floor, otherwise the additional mat may slide forward and interfere with the movement of the pedals.

**REMOTE FUEL-FILLER LID RELEASE**

B560A03E-AAT

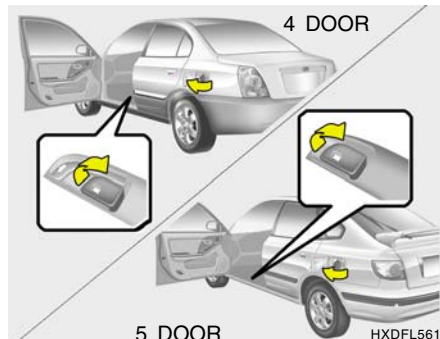

The fuel-filler lid may be opened from inside the vehicle by pulling up on the fuel-filler lid opener located on the front floor area on the left side of the vehicle.

**NOTE:**

If the fuel-filler lid will not open because ice has formed around it, tap lightly or push on the lid to break the ice and release the lid. Do not pry on the lid. If necessary, spray around the lid with an approved deicer fluid (do not use radiator anti-freeze) or move the vehicle to a warm place and allow the ice to melt.

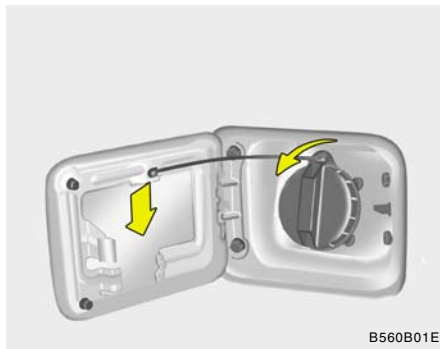

B560B01E

**WARNING:**

- o The fuel cap must be tightened at least 3 clicks, otherwise  light will illuminate.
- o Gasoline vapors are dangerous. Before refueling, always stop the engine and never allow sparks or open flames near the filler area. If you need to replace the filler cap, use a genuine Hyundai replacement part.

**WARNING:**

- o If you open the fuel filler cap during high ambient temperatures, a slight "pressure sound" may be heard. This is normal and not a cause for concern. Whenever you open the fuel filler cap, turn it slowly.
- o Make sure the fuel filler cap is replaced and securely seated after fueling. Failure to replace or fully seat the fuel filler cap will result in fuel vapors escaping into the atmosphere and the MIL indicator illuminating.
- o Do not "top off" after the nozzle automatically shuts off when refueling.
- o Automotive fuels are flammable/explosive materials. When refueling, please note the following guidelines carefully.
- o Before touching the fuel nozzle or fuel filler cap, have one's hands in contact with metal parts away from the filler neck to discharge static electricity.
- o Do not get back in the vehicle while refueling. Do not operate anything that can produce static electricity. Static electricity discharge can ignite fuel vapors resulting in an explosion.

**WARNING:**

- o When using a portable fuel container, be sure to place the container on the ground while refueling. Static electricity discharge from the container can ignite fuel vapors causing a fire. While starting refueling contact should be maintained until the filling is complete.
- o Do not use cellular phones around a gas station. The electric current or electronic interference from cellular phones can ignite fuel vapors causing a fire.
- o When refueling, always turn the engine off. Sparks by engine compartment electrical equipment can ignite fuel vapors causing a fire. After refueling, check to make sure the fuel filler cap is securely closed, and then start the engine.
- o Do not smoke or try to light cigarettes around a gas station. Automotive fuels are flammable.



## TRUNK LID / TAIL GATE

B540A01E-GAT

### TRUNK LID (4 DOOR)

#### Remote Trunk Lid Release

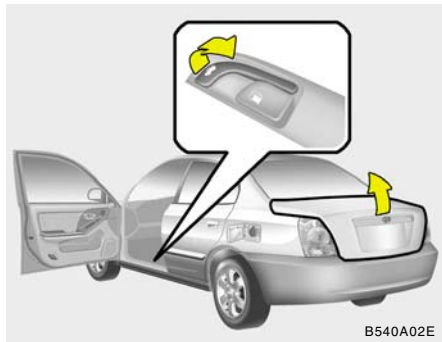

To open the trunk lid without using the key, pull up the lid release lever.

To close, lower the trunk lid, then press down on it until it locks. To be sure the trunk lid is securely fastened try to pull it up again.



#### WARNING:

The trunk lid should always be kept completely closed while the vehicle is in motion. If it is left open or ajar, poisonous exhaust gases may enter the car resulting in serious illness or death to the occupants. See additional warnings concerning exhaust gases on page 2-2.

B540C01S-AAT

### To Unlock Using the Key

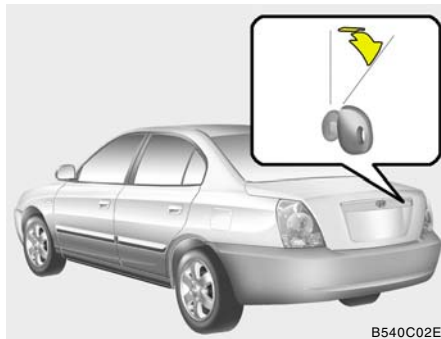

To open the trunk lid, insert the key and turn it clockwise to unlock. The trunk lid compartment light illuminates when the trunk lid is opened.

B540B03E-AAT

### Trunk Lid Emergency Latch Release

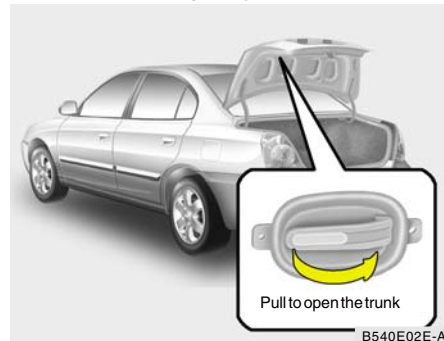

Your vehicle is equipped with a glow-in-the-dark emergency trunk release lever located inside the trunk. It will glow after the trunk is closed. When pulled, this lever will release the trunk latch mechanism and open the trunk.

**NOTE:**

- o If a person is locked in the trunk, pull the emergency trunk release lever on the driver's side of the inside panel of the trunk to open the trunk lid.
- o HYUNDAI recommends that cars be kept locked and keys be kept out of the reach of children, and that parents teach their children about the dangers of playing in trunks.

**WARNING:**

- o If a person becomes locked in the trunk, pull the emergency trunk release lever of the inside panel in the trunk to open the trunk lid.
- o Keep cars locked and keys out of the reach of children. HYUNDAI recommends parents teach children about the emergency trunk release lever in their vehicle and how to open the trunk lid if they are accidentally locked in the trunk.

B540F03E-GAT

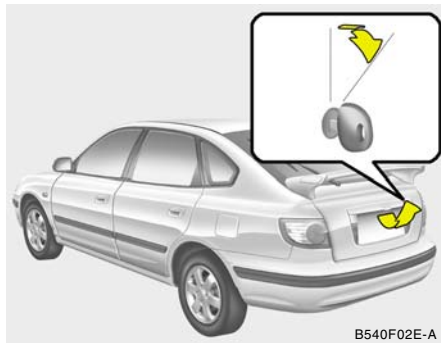
**TAIL GATE (5 DOOR)****Operation From Outside The Vehicle**

To open the tail gate, only need the key if the tailgate is locked. If the tailgate is unlocked, pull the outside handle toward you.

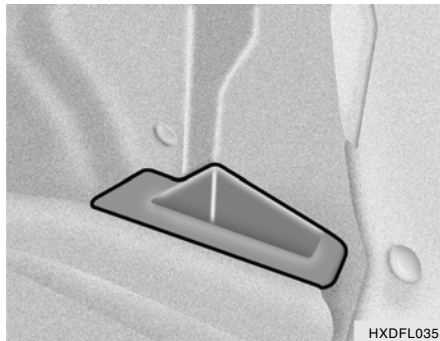
**Storage Box**

The storage box is located in the right side of the luggage compartment floor.

## LUGGAGE NET

B540D01E-GAT

(If installed)



HXDFL1025-1

When loading objects in the luggage compartment, use the four rings located in the luggage compartment floor to attach the luggage net as shown illustration. This will help prevent the objects from sliding.

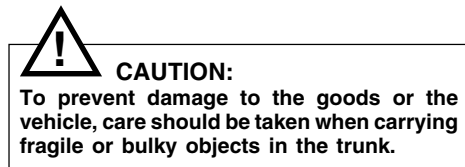
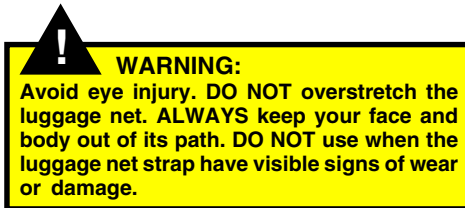

## STEERING WHEEL TILT LEVER

B600A01A-AAT

(If installed)

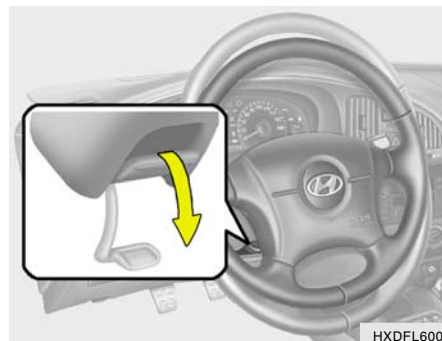

HXDFL600

## To Adjust the Steering Wheel:

1. Push the lever downward to unlock.
2. Raise or lower the steering wheel to the desired position.
3. After adjustment, securely tighten the lever by pulling it upward.

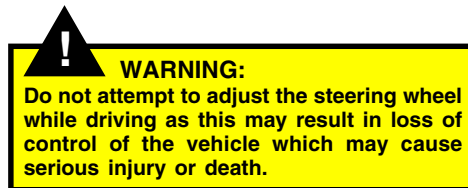

## HORN

B610A01Y-AAT



B610A01E

Press the pad on the steering wheel to sound the horn.

## CRUISE CONTROL

B660A02S-AAT

(If installed)

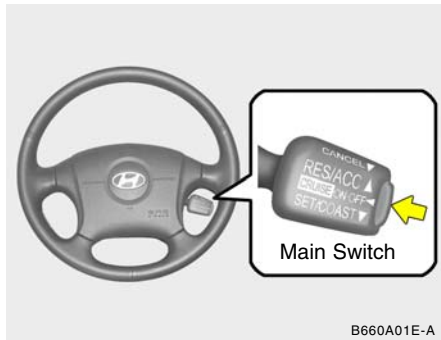

B660A01E-A

The cruise control system provides automatic speed control for your comfort when driving on straight, open freeways, toll roads, or other noncongested highways. This system is designed to function above approximately 25 mph (40 km/h).

### NOTE:

**Cruise control is not recommended for city driving, winding roads, slippery roads, heavy rain, or other bad weather conditions.**

B660B02E-AAT

To Set the Cruise Speed



B660B01E-A

1. Push in the cruise control main switch on the end of the barrel. The "CRUISE" indicator light in the instrument cluster will be illuminated. This turns the system on.
2. Accelerate to the desired cruising speed above 25 mph (40 km/h).
3. Push the cruise control switch downward to "SET (COAST)" and release it. If the "SET" (COAST)" switch is selected the "CRUISE" and "SET"(COAST) indicator light in the instrument cluster will be illuminated simultaneously.
4. Remove your foot from the accelerator pedal and the desired speed will automatically be maintained.

5. To momentarily increase speed, depress the accelerator pedal enough for the vehicle to exceed the preset speed. When you remove your foot from the accelerator pedal, the vehicle will return to the speed you have set.



### WARNING:

To avoid accidental cruise control engagement, keep the cruise control main switch off when not using the cruise control.

B660C04E-AAT

### To Cancel the Cruise Speed



To disengage the cruise control system, pull the control switch toward the steering wheel to the "CANCEL" position. Additionally, the following actions will disengage the system:

- o Depress the brake pedal.
- o Depress the clutch pedal (Manual transaxle).
- o Shift the selector lever to "P" or "N" position (Automatic transaxle).
- o Decrease the vehicle speed to less than 25 mph (40 km/h).
- o Release the main switch.

B660D01E-AAT

### To Resume the Preset Speed

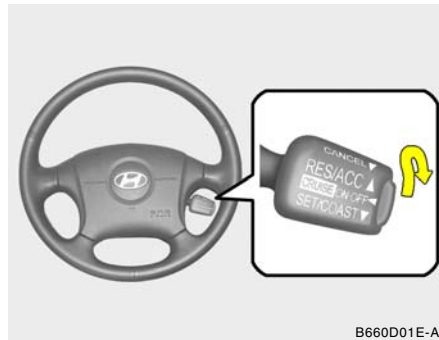

The vehicle will automatically resume the speed set prior to cancellation when you push the control switch upward to the "RESUME (ACCEL)" position and release it, providing the vehicle speed is above 25 mph (40 km/h).

B660E01E-AAT

### To Reset at a Faster Speed

1. Push the control switch upward to the "RESUME (ACCEL)" position and hold it.
2. Accelerate to desired speed and release the control switch. While the control switch is held, the vehicle will gradually gain speed.

B660F03E-AAT

**To Reset at a Slower Speed**

1. Push the control switch downward to "SET (COAST)" and hold it. The vehicle will decelerate.
2. When the desired speed is obtained, release the control switch. While the control switch is pushed, the vehicle speed will gradually decrease.

**WARNING:**

- o Keep the cruise control ON/OFF switch off when not using the cruise control to avoid inadvertently setting a speed.
- o Use the cruise control system only when traveling on open highways in good weather.
- o Do not use the cruise control when it may not be safe to keep the car at a constant speed, for instance, driving in heavy or varying traffic, or on slippery (rainy, icy or snow-covered) or winding roads or over 6% up-hill or down-hill roads.
- o Pay particular attention to the driving conditions whenever using the cruise control system.
- o During cruise-control driving with a manual transaxle vehicle, do not shift into neutral without depressing the clutch pedal, or the engine will be overrevved. If this happens, depress the clutch pedal or release the main switch.
- o With the cruise control engaged, when the brake pedal is applied, it is normal to hear the cruise control system deactivate. This is an indication of normal system operation.

- o During normal cruise control operation, when the "SET(COAST)" is activated or reactivated after applying the brakes, the cruise control will energize after approximately 3 seconds. This delay is normal.

## HEATING AND COOLING CONTROL

B710A01E-GAT

(If Installed)

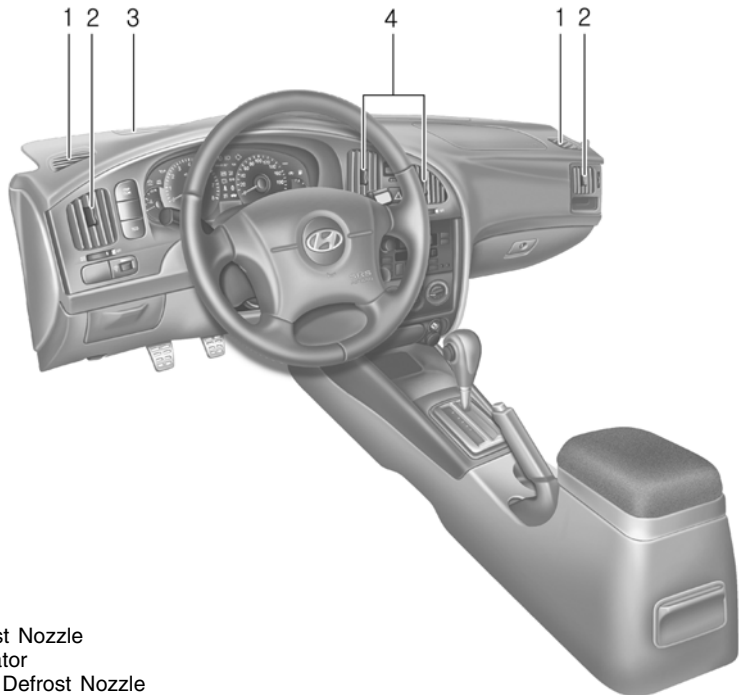

1. Side Defrost Nozzle
2. Side Ventilator
3. Windshield Defrost Nozzle
4. Center Ventilator

B710B01S-AAT

**CENTER VENTILATOR**

The center ventilators are located in the middle of the dashboard. The direction of air flow from the vents in the center of the dashboard is adjustable.

To control the direction of the air flow, move the knob in the center of the vent up-and-down and side-to-side.

B710C02HP-AAT

**SIDE VENTILATOR**

The side ventilators are located on each side of the dashboard. To change the direction of the air flow, move the knob in the center of the vent up-and-down and side-to-side. The vents are opened when the vent knob is moved to "☞" position. The vents are closed when the vent knob is moved to "☒". Keep these vents clear of any obstructions.

B710A02E-A

HEATING AND VENTILATION

B670A01A-AAT

Rotary type (If installed)

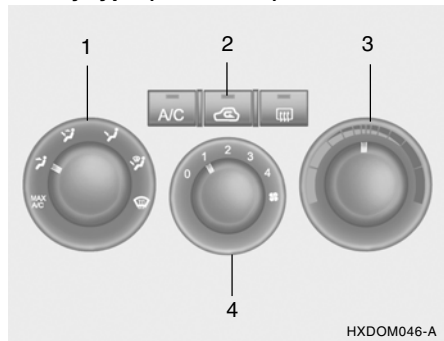

This model has four controls for the heating and cooling system. They are:

1. Air flow control
2. Air intake control
3. Temperature control
4. Fan speed control

B670D01E-AAT

Air Flow Control

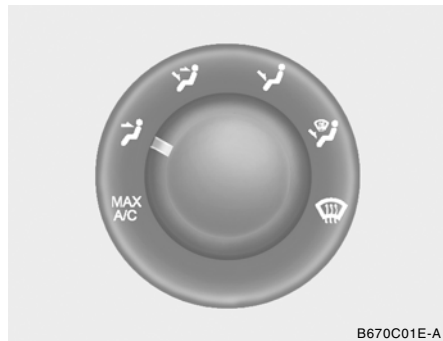

This is used to direct the flow of air. Air can be directed to the floor, dashboard outlets, or windshield. Five symbols are used to represent Face, Bi-Level, Floor, Floor-Defrost and Defrost air position.

The MAX A/C mode is used to cool the inside of the vehicle faster.



Face-Level

Selecting the "Face" mode will cause air to be discharged through the face level vents.





### Bi-Level

Air is discharged through the face vents and the floor vents.

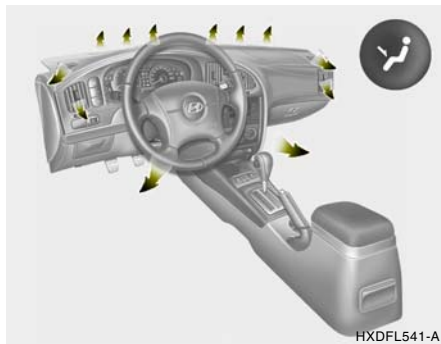

### Floor-Level

Air is discharged through the floor vents, windshield defroster nozzle, side defroster nozzle and side ventilator.  
If the "Floor" mode is selected, the "Fresh" mode will be activated.

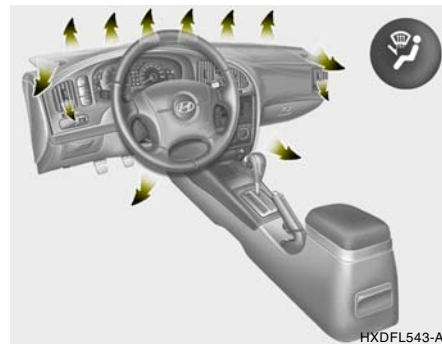

### Floor-Defrost Level

Air is discharged through the windshield defroster nozzle, the floor vents, side defroster nozzle and side ventilator.  
If the "Floor-Defrost" mode is selected, the A/C will turn on automatically and "Fresh" mode will be activated.

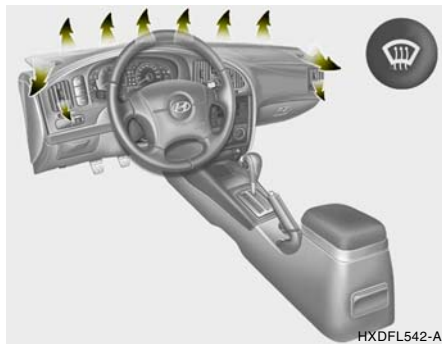

### Defrost-Level

Air is discharged through the windshield defroster nozzle, side defroster nozzle and side ventilator.

If the "Defrost" mode is selected, the A/C will turn on automatically and "Fresh" mode will be activated to improve windshield defrosting.

#### NOTE:

If the "Floor-Defrost" or "Defrost" mode is selected, the air conditioning will not turn off by pushing the A/C button.

If the air flow control is set to the defrost or the floor-defrost mode, the A/C will be on automatically and the A/C will not turn off until the air flow control is set to the another

mode except the defrost mode and the floor-defrost mode. Although the A/C switch indicator is turned off, this is normal operation.



### MAX A/C-Level

Air is discharged through the face level vents. If the "MAX A/C" mode is selected, the A/C will turn on automatically and "Recirculation" mode will be activated.

#### NOTE:

When you change to another mode from MAX A/C, the A/C and the air intake control switch are set as shown in the following chart.

	A/C	Air Intake Control Switch
	ON	or  *
	ON or OFF *	
	ON or OFF *	
	ON	
	ON	

\* The A/C or the air intake control switch returns to its former setting.

B670C03E-AAT

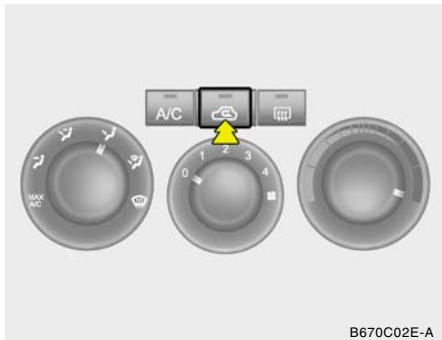
**Air Intake Control**

This is used to select fresh outside air or recirculating of inside air.

To change the air intake control mode, (Fresh mode, Recirculation mode) push the control button.

**FRESH MODE** (  ): The indicator light on the button goes off when the air intake control is in fresh mode.

**RECIRCULATION MODE** (  ): The indicator light on the button is illuminated when the air intake control is in recirculation mode.

With the "Fresh" mode selected, air enters the vehicle from the outside and is heated or cooled according to the function selected.

With the "Recirculation" mode selected, air from within the passenger compartment will be drawn through the heating system and heated or cooled according to the function selected.

**NOTE:**

It should be noted that prolonged operation of the heating in "Recirculation" mode may result in fogging of the windshield and side windows and the air within the passenger compartment will become stale. In addition, prolonged use of the air conditioning with the "Recirculation" mode selected may result in the air within the passenger compartment becoming excessively dry.

B670E02A-AAT

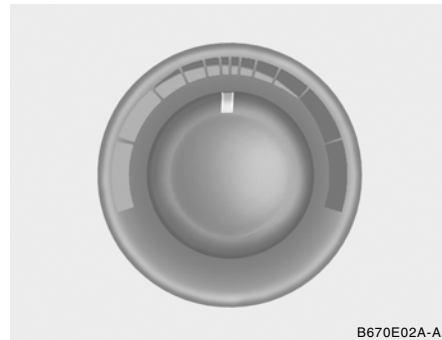
**Temperature Control**

This control is used to adjust the degree of heating or cooling desired.

B670B03E-AAT

### Fan Speed Control (Blower Control)

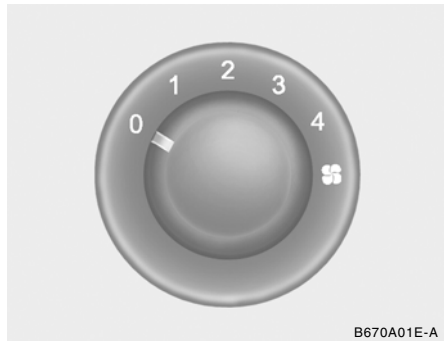

B670A01E-A

This is used to turn the blower fan on or off and to select the fan speed.

This blower fan speed, and therefore the volume of air delivered from the system, may be controlled manually by setting the blower control between the "1" and "4" positions.

"1" is lowest and "4" is the highest fan speed.

**NOTE:**



**If the blower fan is off, the air intake control is set to the fresh mode automatically.**

## HEATING CONTROLS

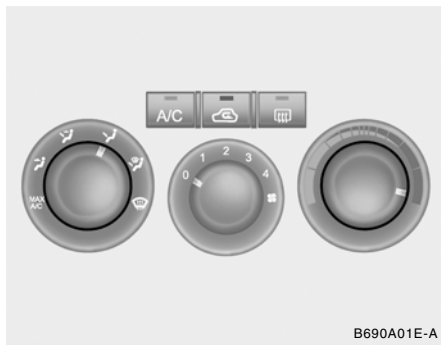
B690A01E-AAT



B690A01E-A

For normal heating operation, set the air intake control to the fresh air (  ) position and the air flow control to the floor (  ) position.

For faster heating, the air intake control should be set in the recirculate (  ) position.

If the windows fog up, set the air flow control to the defrost (  ) position. (The A/C will be on automatically and "Fresh" mode will be activated.)

For maximum heat, rotate the temperature control to "Warm".

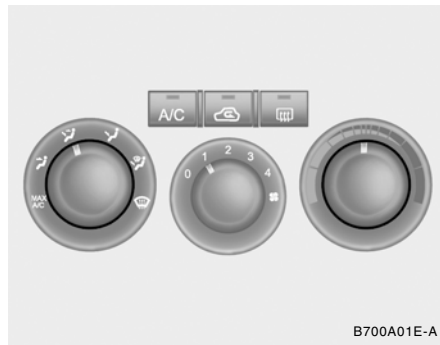

## BI-LEVEL HEATING

B700A01E-AAT



B700A01E-A

Your Hyundai is equipped with bi-level heating controls.

- o Set the air intake control to the fresh air (  ) position.
- o Set the air flow control at the bi-level (  ) position.
- o Adjust the fan speed control to the desired speed.
- o Set the temperature control between "Cool" and "Warm".

## VENTILATION

B710A01S-AAT

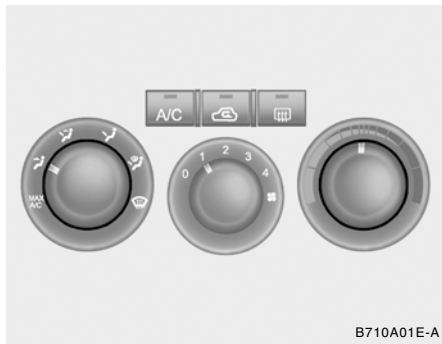

To operate the ventilation system:

- o Set the air intake control to "Fresh" mode (Fresh icon).
- o To direct all intake air to the dashboard vents, set the airflow control to "Face".
- o Adjust the fan speed control to the desired speed.
- o Set the temperature control between "Cool" and "Warm".

B730A01L-AAT

### Operation Tips

- o To keep dust or unpleasant fumes from entering the car through the ventilation system, temporarily set the air intake control to (Recirculation icon).  
Be sure to return the control to (Fresh icon) when the irritation has passed to keep fresh air in the vehicle. This will help keep the driver alert and comfortable.
- o Air for the heating/cooling system is drawn in through the grilles just ahead of the windshield. Care should be taken that these are not blocked by leaves, snow, ice or other obstructions.
- o To prevent interior fog on the windshield, set the air intake control to the fresh air (Fresh icon) position, fan speed to the desired position, turn on the air conditioning system, and adjust temperature control to desired temperature.

## AIR CONDITIONING SYSTEM

89

B740A01S-AAT

### Air Conditioning Switch

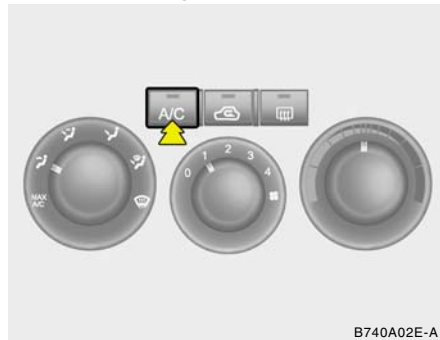

The air conditioning is turned on or off by pushing the A/C button on the heating/air conditioning control panel.

B740B01E-AAT

## Air Conditioning Operation

### Cooling

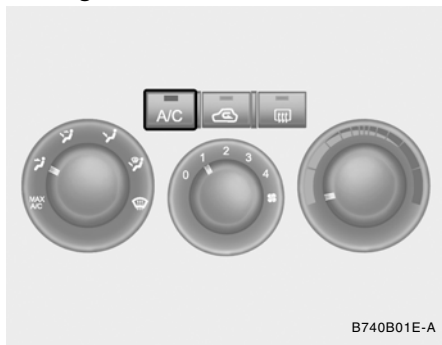

To use the air conditioning to cool the interior:

- o Turn on the fan control switch.
- o Turn on the air conditioning switch by pushing in on the switch. The air conditioning indicator light should come on at the same time.
- o Set the air intake control to the "Fresh" mode (☁️).
- o Set the temperature control to "Cool". ("Cool" provides maximum cooling. The temperature may be moderated by moving the control toward "Warm".)

- o Adjust the fan control to the desired speed. For greater cooling, turn the fan control to one of the higher speeds or temporarily select the "Recirculation" position on the air intake control.

B720A01E-AAT

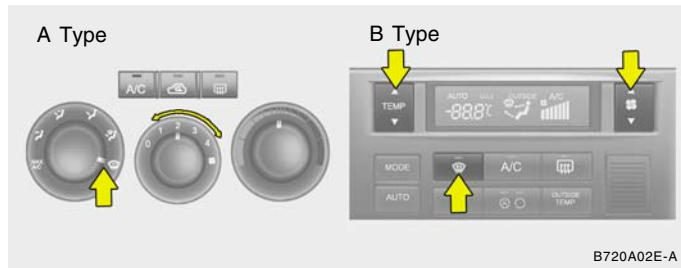
**DEFROSTING/DEFOGGING**

B720A02E-A

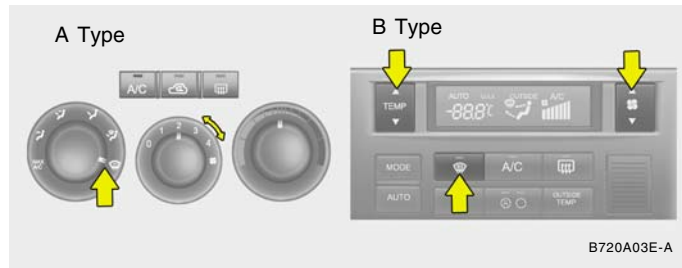

B720A03E-A

Use the heating/ventilation system to defrost or defog the windshield:

**To remove interior fog on the windshield;**

- o Set the air flow control to the defrost (☹) position.  
(The A/C will turn on automatically and "Fresh" mode will be activated.)
- o Set the temperature control to the desired position.
- o Set the fan speed control between "1" and "4" position.

**NOTE:**

**When the A/C is operated continuously on the floor-defrost level (☹) or defrost level (☹), it may cause fog to form on the exterior windshield. If this occurs set the air flow control to the face level position (☹) and fan speed control to the low position.**

**To remove frost or exterior fog on the windshield;**

- o Set the air flow control to the defrost (☹) position.  
(The A/C will turn on automatically and "Fresh" mode will be activated.)
- o Set the temperature control to warm.
- o Set the fan speed control to position "3" or "4".

B740C01S-AAT

## Dehumidified Heating

### For dehumidified heating:

- o Turn on the fan control switch.
- o Turn on the air conditioning switch. The air conditioning indicator light should come on at the same time.
- o Set the air intake control to the "Fresh" mode (  ).
- o Set the air flow control to "Face".
- o Adjust the fan control to the desired speed.
- o For more rapid action, set the fan at one of the higher speeds.
- o Adjust the temperature control to provide the desired amount of warmth.

B740D01A-AAT

## Operation Tips

- o If the interior of the car is hot when you first get in, open the windows for a few minutes to expel the hot air.
- o When you are using the air conditioning system, keep all windows closed to keep hot air out.
- o When moving slowly, as in heavy traffic, shift to a lower gear. This increases engine speed, which in turn increases the speed of the air conditioning compressor.
- o On steep grades, turn the air conditioning off to avoid the possibility of the engine overheating.
- o During winter months or in periods when the air conditioning is not used regularly, run the air conditioning once every month for a few minutes. This will help circulate the lubricants and keep your system in peak operating condition.



## AUTOMATIC HEATING AND COOLING CONTROL SYSTEM

B970A01Y-AAT

### (If Installed)

Your Hyundai is equipped with an automatic heating and cooling control system controlled by simply setting the desired temperature.

B970B01E-GAT

### Heating and Cooling Controls

1. Temperature Control Switch
2. Display Window
3. Blower Fan Control Switch
4. Air Flow Control Switch
5. AUTO (Automatic Control) Switch
6. Defroster Switch
7. OFF Switch
8. Air Conditioning Switch
9. Air Intake Control Switch/Air Quality System Switch (If installed)
10. Rear Window Defroster Switch
11. Ambient Temperature Switch

### TYPE A (Without A.Q.S: Air Quality System)

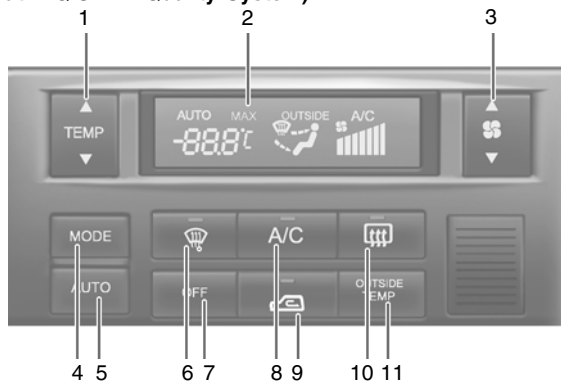

HXDOM118

### TYPE B (With A.Q.S: Air Quality System)

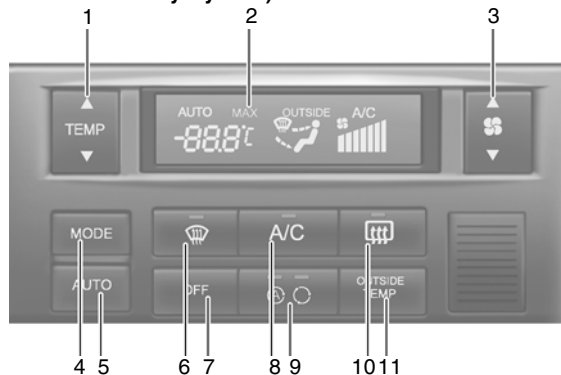

HXDOM119

B970C02E-AAT

### Automatic Operation

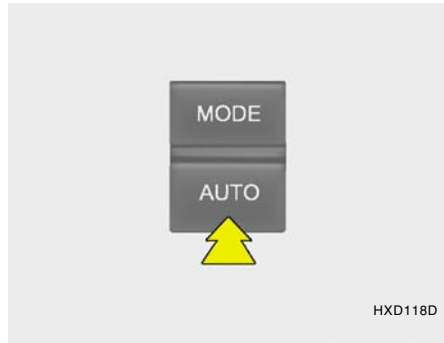

The FATC (Full Automatic Temperature Control) system automatically controls heating and cooling by doing as follows:

1. Push the "AUTO" button. The indicator light will illuminate confirming that the Face, Floor and/or Bi-Level modes as well as the blower speed and air conditioner will be controlled automatically.

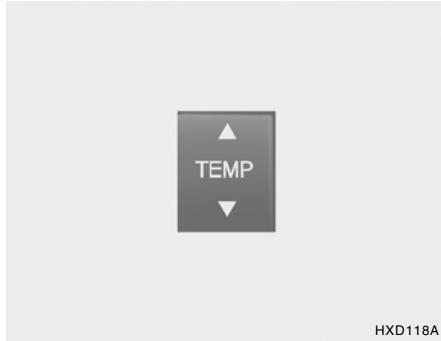

2. Push the "TEMP" button to set the desired temperature. The temperature will increase to the maximum 90°F(32°C) by pushing on the " ▲ " button. Each push of the button will cause the temperature to increase by 1°F(0.5°C). The temperature will decrease to the minimum 62°F(17°C) by pushing on the " ▼ " button. Each push of the button will cause the temperature to decrease by 1°F(0.5°C).

### NOTE:

If the battery has been discharged or disconnected, the temperature mode will reset to Centigrade degrees.

This is a normal condition and you can change the temperature mode from Centigrade to Fahrenheit as follows;

Press the **TEMP** button down 3 seconds or more with the **OUTSIDE TEMP** button held down. The display shows that the unit of temperature is adjusted to Centigrade or Fahrenheit. (°C → °F or °F → °C)

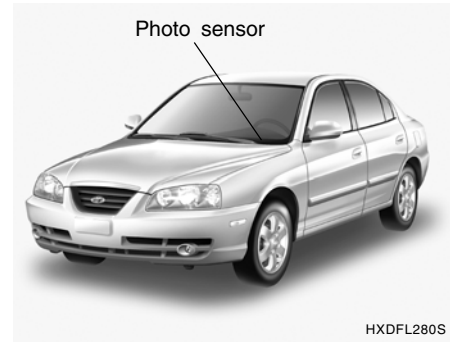

### NOTE:

Never place anything over the sensor which is located on the instrument panel to ensure better control of the heating and cooling system.

B995A01Y-GAT

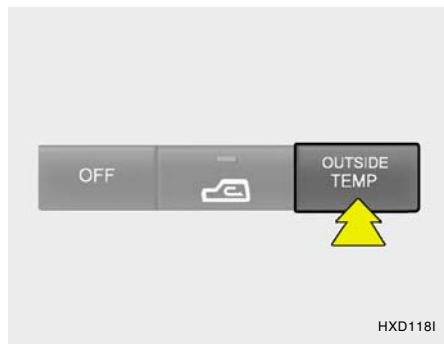
**AMBIENT TEMPERATURE SWITCH**

Pressing the **OUTSIDE TEMP** button displays the ambient temperature on the display.

B980A01Y-AAT

**MANUAL OPERATION**

The heating and cooling system can be controlled manually as well by pushing buttons other than the "AUTO" button. In this state, the system sequentially works according to the order of buttons selected.

The function of the buttons which are not selected will be controlled automatically. Press the "AUTO" button in order to convert to automatic control of the system.

B980B01Y-AAT

**Fan Speed Control Switch**

The fan speed can be set to the desired speed by pressing the appropriate fan speed control button. The higher the fan speed is, the more air is delivered. Pressing the "OFF" button turns off the fan.

B670C02E-AAT

### Air Intake Control Switch (Without A.Q.S)

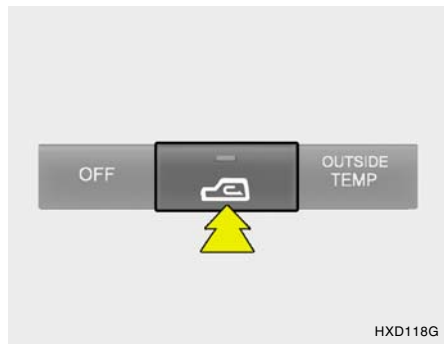

This is used to select fresh outside air or recirculation of inside air.

To change the air intake control mode, (Fresh mode, Recirculation mode) push the control button.

**FRESH MODE** (  ): The indicator light on the button goes off when the air intake control is in fresh mode.

**RECIRCULATION MODE** (  ): The indicator light on the button is illuminated when the air intake control is in recirculation mode.

With the "Fresh" mode selected, air enters the vehicle from the outside and is heated or cooled according to the function selected.

With the "Recirculation" mode selected, air from within the passenger compartment will be drawn through the heating system and heated or cooled according to the function selected.

**NOTE:**



It should be noted that prolonged operation of the heating system in "Recirculation" mode will give rise to fogging of the windshield and side windows and the air within the passenger compartment will become stale. In addition, prolonged use of the air conditioning with the "Recirculation" mode selected may result in the air within the passenger compartment becoming excessively dry.

B980C04E-GAT

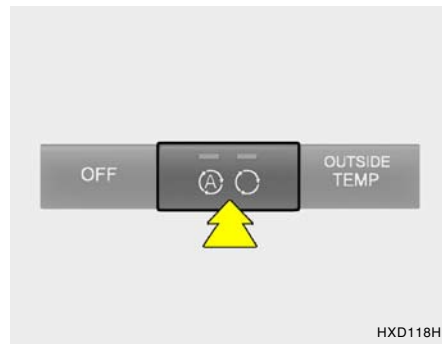
### Air Intake Control Switch (With A.Q.S) (If installed)



This is used to select fresh outside air or recirculate inside air automatically.

-  : OFF
-  : ON

  **Fresh Mode :**

Air enters the vehicle from the outside and is heated or cooled according to the function selected.





### Recirculation Mode :

Air from within the passenger compartment will be drawn through the heating system and heated or cooled according to the function selected.





### Exhaust Gas Cutoff Mode :

Air enters the vehicle from the outside.

But if exhaust gas enters the vehicle from the outside, the exhaust gas cutoff mode (  ) is automatically converted to the (  ) mode, to prevent exhaust gas from entering the vehicle.

#### NOTE:

It should be noted that prolonged operation of the heating system in recirculation mode (  ) may result in misting of the windshield and side windows and the air within the passenger compartment will become stale. In addition, prolonged use of the air conditioning with the recirculation mode (  ) selected may result in the air within the passenger compartment becoming excessively dry.



#### CAUTION:

If the windows fog up with the Recirculation or A.Q.S mode selected, set the air intake control to the Fresh air position or A.Q.S control to "OFF".

B980D01Y-AAT

#### Heating and Cooling System Off

Press the "OFF" button to stop the operation of the heating and cooling system.

B980E01E-GAT

#### Air Flow Control

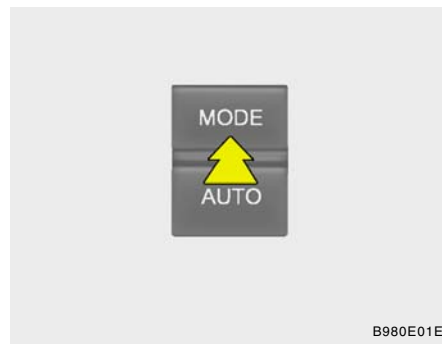

This is used to direct the flow of air. Air can be directed to the floor, dashboard outlets, or windshield. Four symbols are used to represent Face, Bi-Level, Floor and Floor-Defrost air position.



### Face-Level

When selecting the "Face" mode, the indicator light will come on, causing air to be discharged through the face level vents.



### Bi-Level

When selecting the "Bi-Level" mode, the indicator light will come on and the air will be discharged through the face vents and the floor vents.

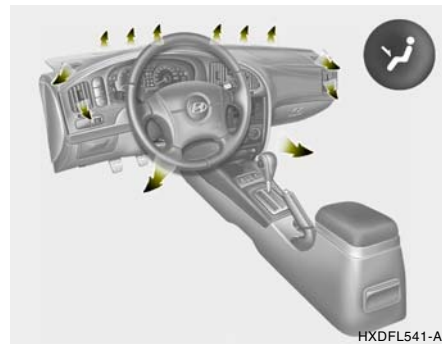

### Floor-Level

When selecting the "Floor-Level" mode, the indicator light will come on and the air will be discharged through the floor vents, windshield defrost nozzle, side defroster nozzle and side ventilator.

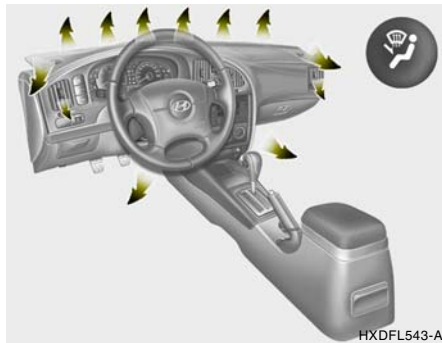



### Floor-Defrost Level

When selecting the "Floor-Defrost" mode, the indicator light will come on and the air will be discharged through the windshield defrost vents, the floor vents and side defroster nozzle side ventilator .

B980F02E-AAT

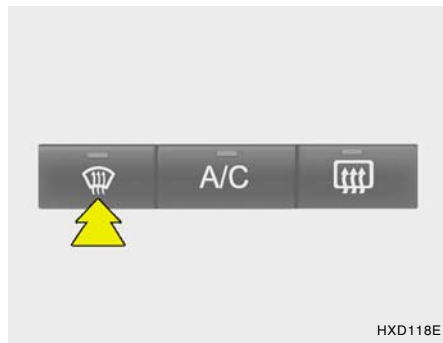
### Defrost Switch



When the "Defrost" button is pressed, the (  ) mode will be automatically selected and the air will be discharged through the windshield defrost nozzle, side defroster nozzle and side ventilator. To assist in defrosting, the air conditioning will operate if ambient temperature is higher than 38.3°F, and automatically turns off if the ambient temperature drops below 38.3°F.

### CLIMATE CONTROL AIR FILTER (IN FRONT OF BLOWER UNIT)

B760A04E-AAT

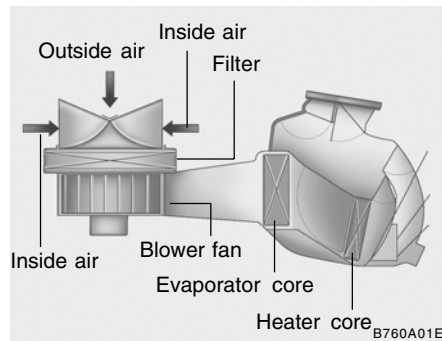

The climate control air filter is located in front of the blower unit behind the glove box. It operates to decrease the amount of pollutants entering the car. To replace the climate control air filter, refer to page 6-17.



**CAUTION:**

- o Replace the filter every 10,000 miles (15,000 km) or once a year. If the car is being driven in severe conditions such as dusty, rough roads, more frequent climate control air filter inspections and changes are required.
- o When the air flow rate is decreased, the system should be checked at an authorized dealer.
- o If your vehicle is not equipped with this filter, it can be installed by your dealer. Check with your dealer for details.



## STEREO SOUND SYSTEM

B750A02A-AAT

## How Car Audio Works

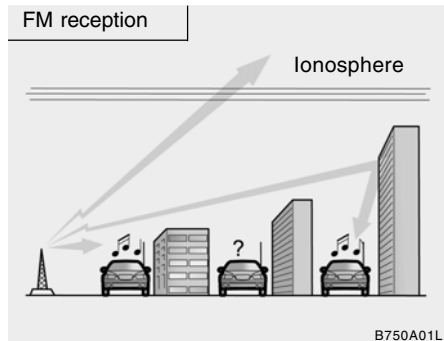

AM and FM radio signals are broadcast from transmitter towers located around your city. They are intercepted by the radio antenna on your car. This signal is then received by the radio and sent to your car speakers.

When a strong radio signal has reached your vehicle, the precise engineering of your audio system ensures the best possible quality reproduction. However, in some cases the signal coming to your vehicle may not be strong and clear. This can be due to factors such as the distance from the radio station, closeness of other strong radio stations or the presence of buildings, bridges or other large obstructions in the area.

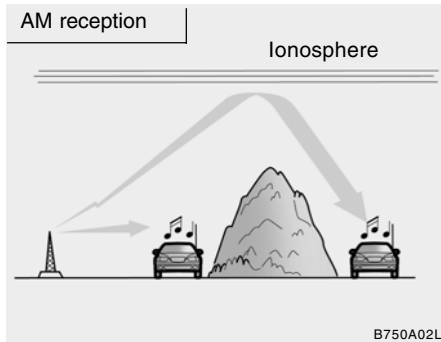

AM broadcasts can be received at greater distances than FM broadcasts. This is because AM radio waves are transmitted at low frequencies. These long, low frequency radio waves can follow the curvature of the earth rather than travelling straight out into the atmosphere. In addition, they curve around obstructions so that they can provide better signal coverage.

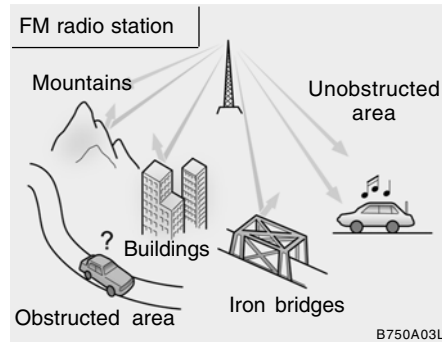

FM broadcasts are transmitted at high frequencies and do not bend to follow the earth's surface. Because of this, FM broadcasts generally begin to fade at short distances from the station. Also, FM signals are easily affected by buildings, mountains, or other obstructions. These can result in certain listening conditions which might lead you to believe a problem exists with your radio. The following conditions are normal and do not indicate radio trouble:

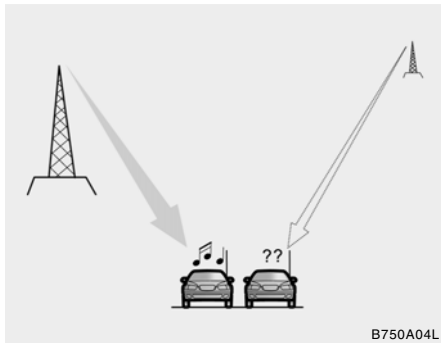

- o Fading - As your car moves away from the radio station, the signal will weaken and sound will begin to fade. When this occurs, we suggest that you select another stronger station.
- o Flutter/Static - Weak FM signals or large obstructions between the transmitter and your radio can disturb the signal causing static or fluttering noises to occur. Reducing the treble level may lessen this effect until the disturbance clears.

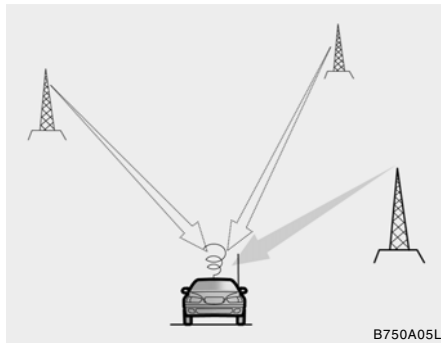

- o Station Swapping - As an FM signal weakens, another more powerful signal near the same frequency may begin to play. This is because your radio is designed to lock onto the clearest signal. If this occurs, select another station with a stronger signal.
- o Multi-Path Cancellation - Radio signals being received from several directions can cause distortion or fluttering. This can be caused by a direct and reflected signal from the same station, or by signals from two stations with close frequencies. If this occurs, select another station until the condition has passed.

B750B05Y-AAT

### Using a cellular phone or a two-way radio

When a cellular phone is used inside the vehicle, noise may be produced from the audio equipment. This does not mean that something is wrong with the audio equipment. In such a case, use the cellular phone at a place as far as possible from the audio equipment.



#### WARNING:

**Hyundai recommends that you never use a cell phone while driving. This could result in loss of control, and an accident that may cause death, serious injury, or property damage. You must stop at a safe place to use a cellular phone.**

#### NOTE:

**Some states and cities have regulations prohibiting the use of cell phones while driving. You should be aware of the specific requirements in your area.**

## AUDIO SYSTEM

H240A010-GAT

## STEREO RADIO OPERATION (H240) (If installed)

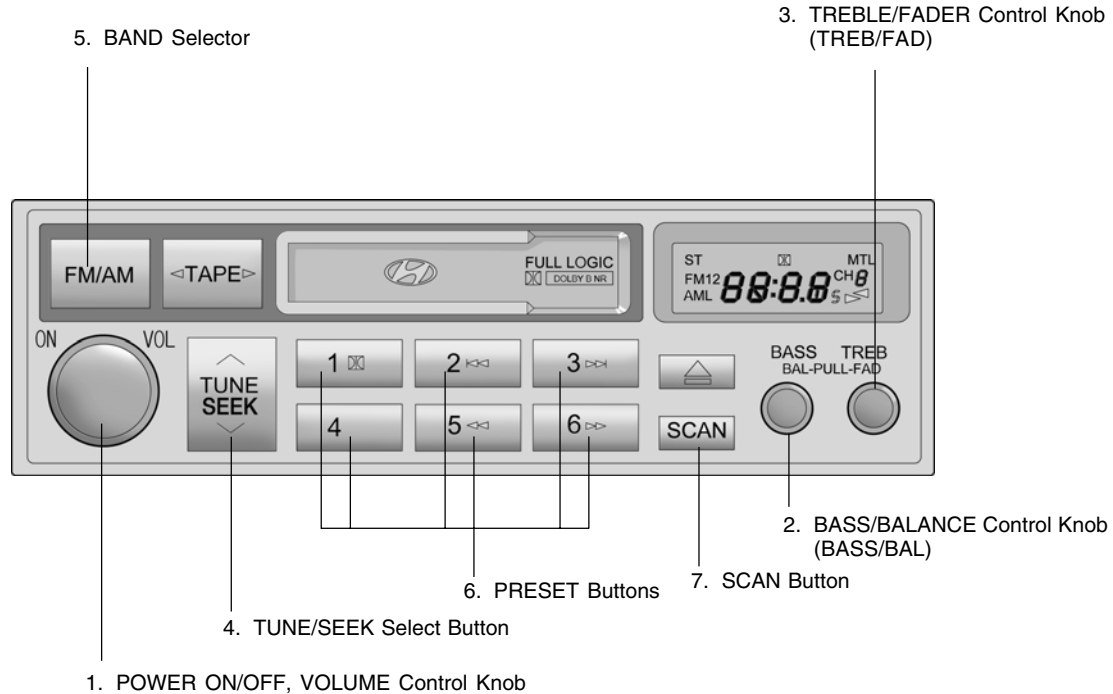

H240B04O-AAT

**1. POWER ON-OFF Control Knob**

The radio unit may be operated when the ignition key is in the "ACC" or "ON" position. Press the knob to switch the power on. The LCD shows the radio frequency in the radio mode or the tape direction indicator in the tape mode. To switch the power off, press the knob again.

**VOLUME Control**

Rotate the knob clockwise to increase the volume and turn the knob counterclockwise to reduce the volume.

**2. BASS Control Knob**

Press to pop the knob out and turn to the left or right for the desired bass tone.

**BAL (Balance Control) Knob**

Pull the bass control knob further out. Turn the control knob clockwise to emphasize right speaker sound (left speaker sound will be attenuated).

When the control knob is turned counterclockwise, left speaker sound will be emphasized (right speaker sound will be attenuated).

**3. TREB (Treble Control) Knob**

Press to pop the knob out and turn to the left or right for the desired treble tone.

**FAD (Fader Control) Knob**

Pull the treble control knob further out.

Turn the control knob counterclockwise to emphasize front speaker sound (rear speaker sound will be attenuated).

When the control knob is turned clockwise, rear speaker sound will be emphasized (front speaker sound will be attenuated).

**4. TUNE (Manual) Select Button**

Press the (^) side or (v) side to increase or to decrease the frequency. Press either button and hold down to continuously scroll. Release button once the desired station is reached.

**SEEK Operation****(Automatic Channel Selection)**

Press the TUNE select button 0.5 sec or more. Releasing it will automatically tune to the next available station with a beep sound.

When the (^) side is pressed longer than 0.5 second, releasing will automatically tune to the next higher frequency and when the (v) side is pressed longer than 0.5 second, releasing will automatically tune to the next lower frequency.

**5. BAND Selector**

Pressing the FM/AM button changes the AM, FM1 and FM2 bands. The mode selected is displayed on LCD.

**6. PRESET STATION SELECT Button**

Six (6) stations for AM, FM1 and FM2 respectively can be preset in the electronic memory circuit on this unit.

## HOW TO PRESET STATIONS

Six AM and twelve FM stations may be programmed into the memory of the radio. Then, by simply pressing the band select button and/or one of the six station select buttons, you may recall any of these stations instantly. To program the stations, follow these steps:

- o Press band selector to set the band for AM, FM1, or FM2.
- o Select the desired station to be stored by seek or manual tuning.
- o Determine the preset station select button you wish to use to access that station.
- o Press the station select button for more than two seconds. A select button indicator will show in the display indicating which select button you have depressed. The frequency display will flash after it has been stored into the memory with a beep sound. You should then release the button, and proceed to program the next desired station. A total of 18 stations can be programmed by selecting one AM and two FM stations per button.
- o When completed, any preset station may be recalled by selecting AM, FM1 or FM2 band and the appropriate station button.

## 7. SCAN Button

When the scan button is pressed, the frequency will increase and the receivable stations will be tuned in one after another, receiving each station for 5 seconds. To stop scanning, press the scan button again.



### CAUTION:

- o **Do not place beverages close to the audio system. The playback mechanism may be damaged if you spill them.**
- o **Do not impact or strike the audio system, or the playback mechanism could be damaged.**

H240C010-GAT

**CASSETTE TAPE PLAYER OPERATION (H240) (If installed)**

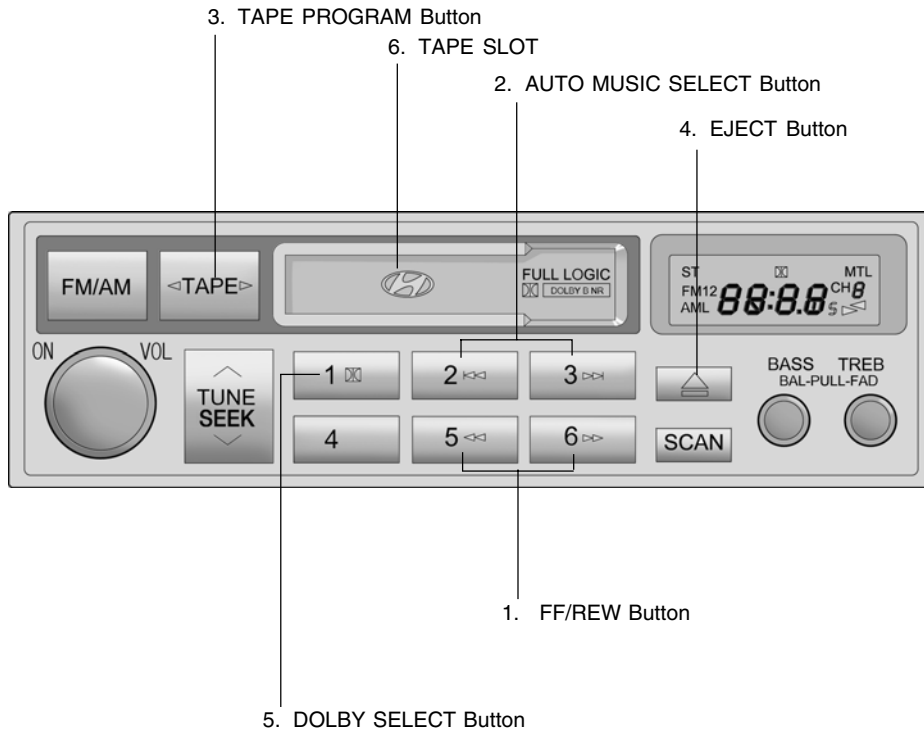

H240A030-GAT

**1. FF/REW Button**

- o The FF (fast forward tape winding) starts when the ►► button is pressed during the PLAY or REW.
- o The play starts when the ►► button is pressed again during the FF.
- o The REW (rewinding) starts when the ◀◀ button is pressed during the PLAY or FF.
- o The play starts when the ◀◀ button is pressed again during the REW.

**2. AUTO MUSIC SELECT Button**

Press the button to find the starting point of each song in a prerecorded music tape. The quiet space between songs (must have at least a 4 sec. gap) can be identified by the AUTO MUSIC SELECT button.

- o Pressing the ►► button will play the beginning of the next music segment.
- o Pressing the ◀◀ button will start replay at the beginning of the music just listened to.

**3. TAPE PROGRAM Button**

This allows you to play the reverse side of the tape by merely depressing the program button. An arrow will appear in the display to show tape direction.

**NOTE:**

**When tape operation is abnormal or ER8 fault code is displayed, press the eject button more than 5 seconds to reset the deck function.**

**4. EJECT Button**

- o When the EJECT button is pressed with the cassette loaded, the cassette is ejected.
- o When the EJECT button is pressed during the FF/REW, the cassette is ejected.

**5. DOLBY SELECT Button**

If you get background noise during PLAY, you can reduce this considerably by merely pressing DOLBY SELECT button.

If you want to release, press the button again.

**CAUTION:**

- o Do not insert anything like coins into the player slot as damage to the unit may occur.
- o Do not place beverages close to the audio system. The playback mechanism may be damaged if you spill them.
- o Do not impact or strike the audio system, or the playback mechanism could be damaged.

H260A01O-AAT

**STEREO RADIO OPERATION (H260) (If installed)**

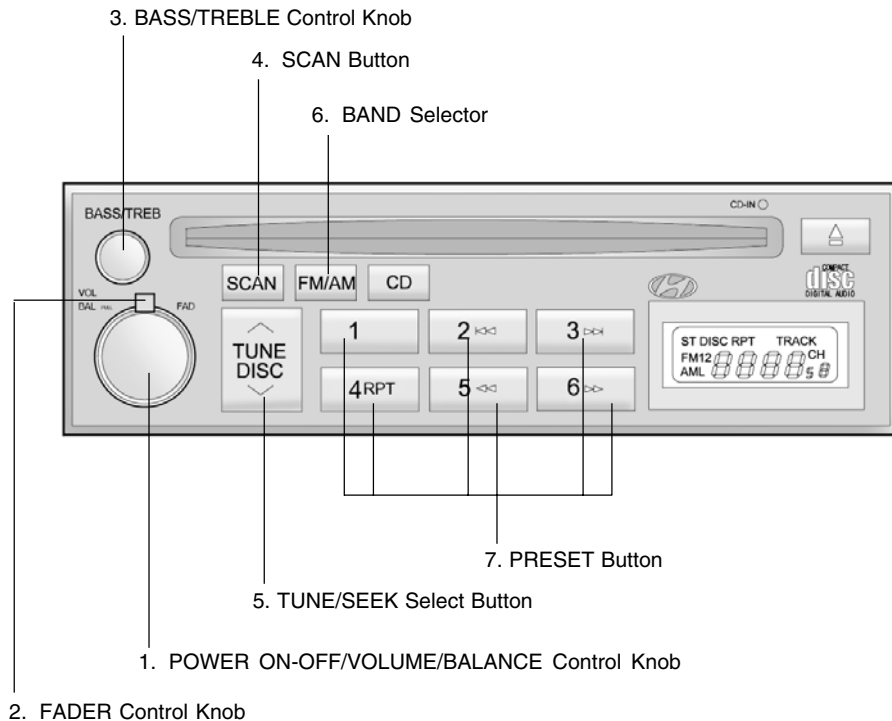



H260B03E-AAT

## 1. POWER ON-OFF Control Knob

The radio unit may be operated when the ignition key is in the "ACC" or "ON" position. Press the knob to switch the power on. The LCD shows the radio frequency in the radio mode or the CD track indicator in either the CD mode or CD AUTO CHANGER mode. To switch the power off, press the knob again.

## VOLUME Control

Rotate the knob clockwise to increase the volume and turn the knob counterclockwise to reduce the volume.

## BALANCE Control

Pull and turn the control knob clockwise to emphasize right speaker sound (left speaker sound will be attenuated). When the control knob is turned counterclockwise, left speaker sound will be emphasized (right speaker sound will be attenuated).

## 2. FAD (Fader Control) Knob

Turn the control knob counterclockwise to emphasize front speaker sound (rear speaker sound will be attenuated). When the control knob is turned clockwise, rear speaker sound will be emphasized (front speaker sound will be attenuated).

## 3. BASS Control Knob

Press to pop the knob out and turn to the left or right for the desired bass tone.

## TREB (Treble Control) Knob

Pull the bass control knob further out. Turn to the left or right for the desired treble tone.

## 4. SCAN Button

When the scan button is pressed, the frequency will increase and the receivable stations will be tuned in one after another, receiving each station for 5 seconds. To stop scanning, press the scan button again.

## 5. TUNE (Manual) Select Button

Press the (^) side or (v) side to increase or to decrease the frequency. Press either button and hold down to continuously scroll. Release button once the desired station is reached.

## SEEK Operation

### (Automatic Channel Selection)

Press the TUNE select button for 0.5 sec or more. Releasing it will automatically tune to the next available station with a beep sound.

When the (^) side is pressed longer than 0.5 second, releasing will automatically tune to the next higher frequency and when the (v) side is pressed longer than 0.5 second, releasing will automatically tune to the next lower frequency.

## 6. BAND Selector

Pressing the FM/AM button changes the AM, FM1 and FM2 bands. The mode selected is displayed on LCD.

## 7. PRESET STATION SELECT Button

Six (6) stations for AM, FM1 or FM2 respectively can be preset in the electronic memory circuit on this unit.

## HOW TO PRESET STATIONS

Six AM and twelve FM stations may be programmed into the memory of the radio. Then, by simply pressing the band select button and/or one of the six station select buttons, you may recall any of these stations instantly.

To program the stations, follow these steps:

- o Press band selector to set the band for AM, FM1 or FM2.
- o Select the desired station to be stored by seek, scan or manual tuning.
- o Determine the preset station select button you wish to use to access that station.
- o Press the station select button for more than two seconds. A select button indicator will show in the display indicating which select button you have depressed. The frequency display will flash after it has been stored into the memory.

You should then release the button, and proceed to program the next desired station.

A total of 18 stations can be programmed by selecting one AM and two FM stations per button.

- o When completed, any preset station may be recalled by selecting AM, FM1 or FM2 band and the appropriate station button.



### CAUTION:

- o Do not place beverages close to the audio system. The playback mechanism may be damaged if you spill them.
- o Do not impact or strike the audio system, or the playback mechanism could be damaged.

H260B010-AAT

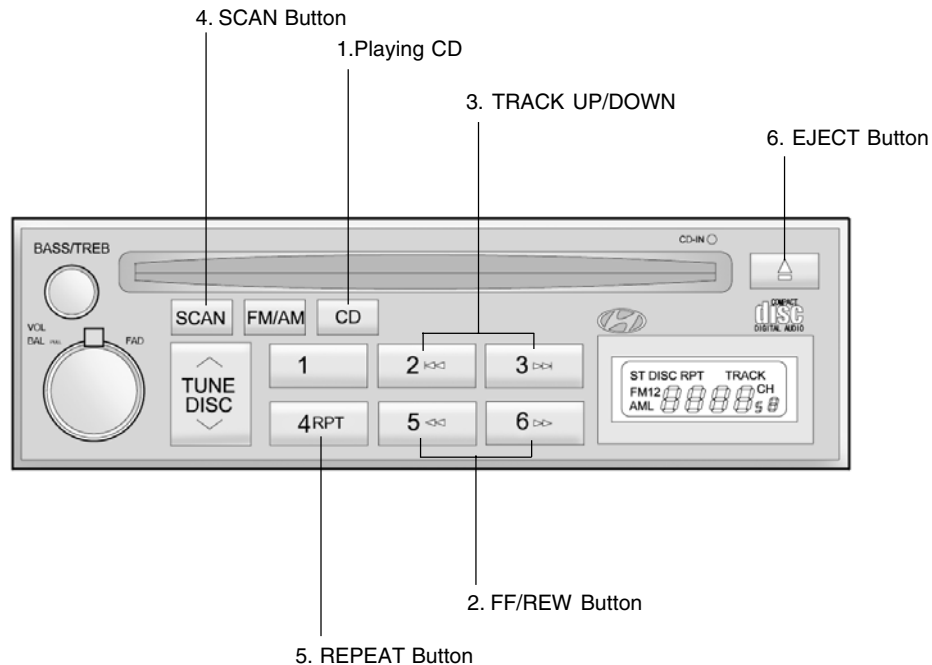
**COMPACT DISC PLAYER OPERATION (H260) (If installed)**

H260A010

B260D040-AAT

### 1. Playing CD

- o Insert the CD with the label facing upward.
- o Insert the CD to start CD playback, during radio operation.
- o When a disc is in the CD deck, if you press the play button, the CD player will begin playing even if the radio is being used.
- o The CD player can be used when the ignition switch is in either the "ON" or "ACC" position.

### 2. FF/REW (▶▶/◀◀)

If you want to fast forward or reverse through the compact disc track, push and hold in the FF (▶▶) or REW (◀◀) button.

When you release the button, the compact disc player will resume playing.

### 3. TRACK UP/DOWN

- o The desired track on the disc currently being played can be selected using the track number.
- o Press ▶▶ once to skip forward to the beginning of the next track. Press ◀◀ once to skip back to the beginning of the track.

### 4. SCAN Button

- o Press the SCAN button to playback the first 10 seconds of each track.
- o Press the SCAN button again within 10 sec. for the desired track.

### 5. REPEAT Button

- o To repeat the track you are listening to, press the RPT button. To cancel, press again.
- o If you do not release RPT operation, when the track ends, it will automatically be re-played.  
This process will be continued until you push the button again.

### 6. EJECT Button

When the EJECT button  is pressed with the CD loaded, the CD is ejected.

### NOTE:

- o If the CD does not operate properly or if the ER2 fault code is displayed, use one of two methods to reset the CD deck function.
  - Remove the audio fuse for 5 minutes. Then, reinstall the audio fuse.
  - Disconnect the negative terminal of the battery and wait 5 minutes. Then reconnect the negative battery terminal.
- o To assure proper operation of the unit, keep the vehicle interior temperature within a normal range by using the vehicle's air conditioning or heating system.
- o When replacing the fuse, replace it with a fuse having the correct capacity.
- o The preset station frequencies are all erased when the car battery is disconnected. Therefore, all data will have to be set again if this should occur.
- o Do not add any oil to the rotating parts. Keep magnets, screwdrivers and other metallic objects away from the tape mechanism and head.

- o This equipment is designed to be used only in a 12 volt DC battery system with negative ground.
- o This unit is made of precision parts. Do not attempt to disassemble or adjust any parts.
- o When driving your vehicle, be sure to keep the volume of the unit set low enough to allow you to hear sounds coming from the outside.
- o Do not expose this equipment (including the speakers) to water or excessive moisture.

**CAUTION:**

- o Do not insert warped or poor quality discs into the CD player as damage to the unit may occur.
- o Do not insert anything like coins into the player slot as damage to the unit may occur.
- o Do not place beverages close to the audio system. The playback mechanism may be damaged if you spill them.
- o Do not impact or strike the audio system, or the playback mechanism could be damaged.
- o Driving on the off-roads or other vibrations may skip your compact disc. Do not use the audio system on off-roads as the discs could be scratched and damaged.
- o Do not grip or pull out the disc with your hand while the disc is being pulled into the unit by the self loading mechanism. These can cause poor disc scratching to occur or damage the compact disc player.
- o Avoid using CD-Recordable or CD-Rewritable as the player could not be operated in recording way of the CD maker. When using the compact disc player, professionally recorded CDs are recommended.

B260E01E-AAT

**CD AUTO CHANGER (H260) (If installed)**

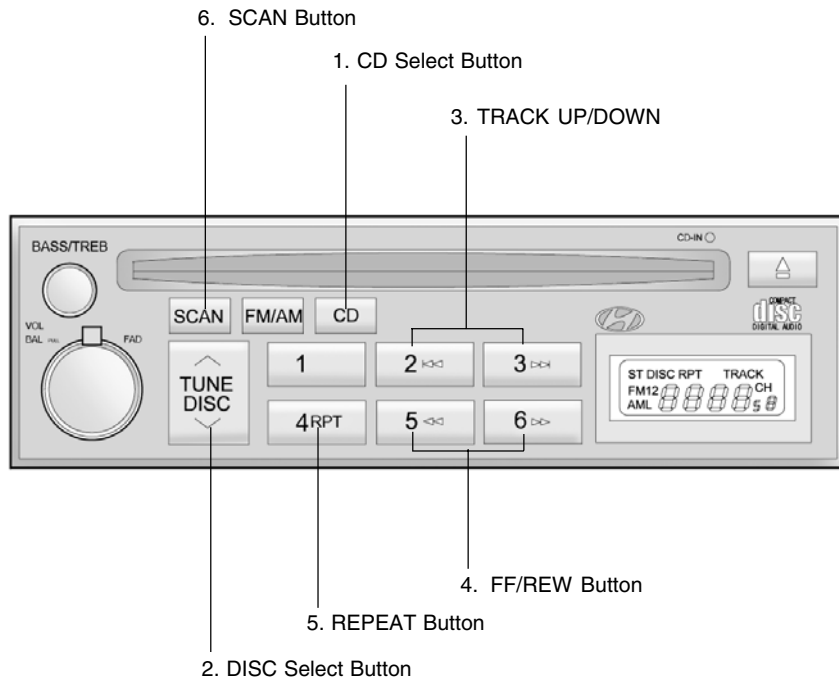

B260F03E-AAT

### The CD auto changer is located in the left side of the trunk.

- o To use the CD auto changer.
  1. Open the sliding lid of the CD auto changer.
  2. To eject the compact disc magazine, press the EJECT button located inside the CD auto changer.
  3. Insert the discs into the magazine.
  4. Push the magazine into the CD auto changer and close the sliding lid.
- o The CD auto changer can be used when the ignition switch is in either the "ON" or "ACC" position.

### 1. CD Select Button

When the CD changer magazine contains discs, press the CD button and the CD changer can be used even if the radio is being used. The Hyundai CD changer can hold up to eight discs. The disc number will be lit, and the track number, and elapsed time will be displayed.

### 2. DISC Select Button

To select the CD you want, push  to change the disc number.

### 3. TRACK UP/DOWN

- o The desired track on the disc currently being played can be selected using the track number.
- o Press ►► once to skip forward to the beginning of the next track. Press ◄◄ once to skip back to the beginning of the track.

### 4. FF/REW (►► / ◄◄)

If you want to fast forward or reverse through the compact disc track, push and hold in the FF (►►) or REW (◄◄) button.

When you release the button, the compact disc player will resume playing.

### 5. REPEAT

- o To repeat the track you are listening to, press the RPT button. To cancel , press again.
- o If you do not release RPT operation when the track ends, it will automatically be replayed. This process will be continued until you push the button again.

### 6. SCAN Button

- o Press the SCAN button to playback the first 10 seconds of each track.
- o Press the SCAN button again within 10 sec. for the desired track.

#### NOTE:

- o **When replacing the fuse, replace it with a fuse having the correct capacity.**
- o **This equipment is designed to be used only in a 12 volt DC battery system with negative ground.**
- o **This unit is made of precision parts. Do not attempt to disassemble or adjust any parts.**
- o **When driving your vehicle, be sure to keep the volume of the unit set low enough to allow you to hear sounds coming from the outside.**

**CAUTION:**

- o Do not insert warped or poor quality discs into the CD changer as damage to the unit may occur.
- o Do not insert anything like coins into the changer slot as damage to the unit may occur.
- o Do not place beverages close to the audio system. The playback mechanism may be damaged if you spill them.
- o Do not impact or strike the audio system, or the playback mechanism could be damaged.
- o Driving on the off-roads or other vibrations may skip your compact disc. Do not use the audio system on off-roads as the discs could be scratched and damaged.
- o Do not grip or pull out the disc with your hand while the disc is being pulled into the unit by the self loading mechanism. These can cause poor disc scratching to occur or damage the compact disc player.
- o Avoid using CD-Recordable or CD-Rewritable as the player could not be operated in recording way of the CD maker. When using the compact disc player, professionally recorded CDs are recommended.

**WARNING:**

Never attempt to change CDs the already inserted in the CD changer magazine while the vehicle is moving. This could result in loss of control or an accident that may cause death, serious injury, or property damage.

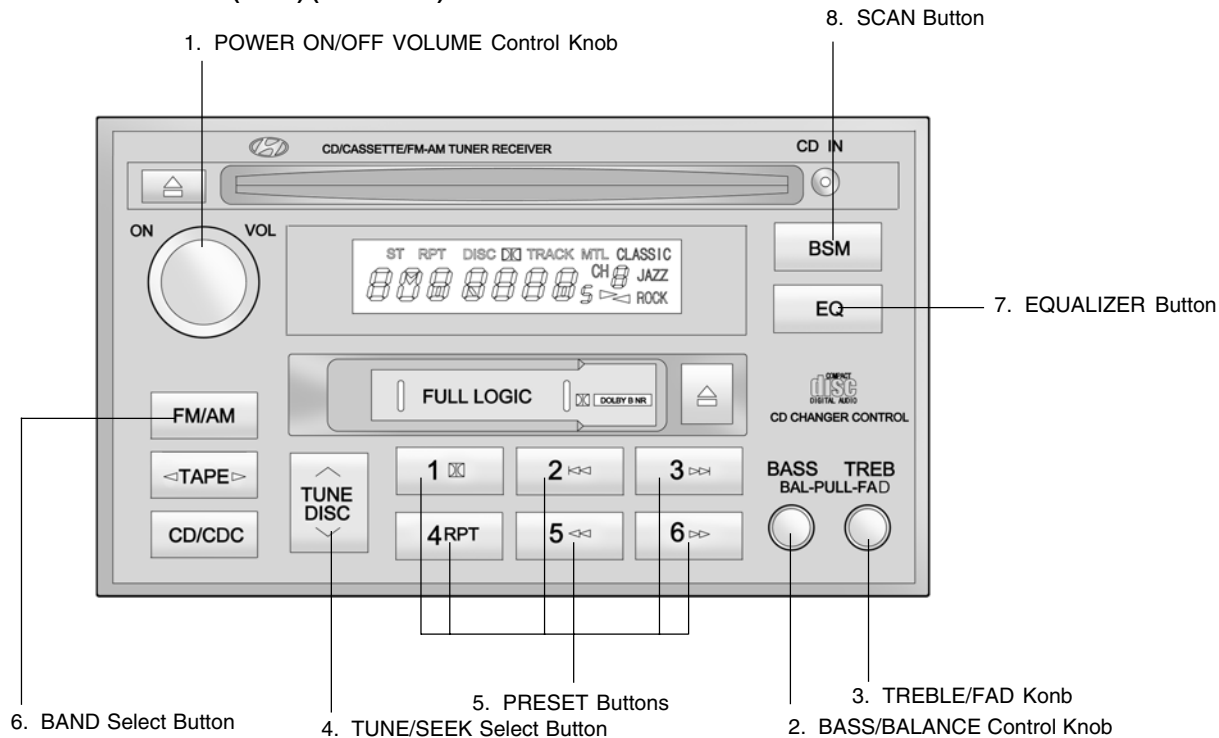

H290A010-AAT

**STEREO RADIO OPERATION (H290) (If installed)**

H290A010

H290B04E-GAT

**1. POWER ON-OFF Control Knob**

The radio unit may be operated when the ignition key is in the "ACC" or "ON" position. Press the button to switch the power on. The display shows the radio frequency in the radio mode, the tape direction indicator in the tape mode or CD track in either the CD mode or CD AUTO CHANGER mode. To switch the power off, press the button again.

**VOLUME Control**

Rotate the knob clockwise to increase the volume and turn the knob counterclockwise to reduce the volume.

**2. BASS/BALANCE Control Knob  
BASS Control Knob**

Press to pop the knob out. To increase the bass, rotate the knob clockwise, while to decrease the bass, rotate the knob counterclockwise.

**BALANCE Control knob**

Pull the Bass control knob out further. Rotate the knob clockwise to emphasize right speaker sound (left speaker sound will be attenuated). When the control knob is turned counterclockwise, left speaker sound will be emphasized (right speaker sound will be attenuated).

**3. TREBLE/FAD Knob  
TREBLE Control Knob**

Press to pop the knob out and turn to the left or right for the desired treble tone.

**FAD (Fader Control) Knob**

Pull the Treble control knob out further. Turn the control knob counterclockwise to emphasize front speaker sound (rear speaker sound will be attenuated). When the control knob is turned clockwise, rear speaker sound will be emphasized (front speaker sound will be attenuated).

**4. TUNE (Manual) Select Button**

Press the (∧) side or (∨) side to increase or to decrease the frequency. Press either button and hold down to continuously scroll. Release button once the desired station is reached.

**SEEK Operation  
(Automatic Channel Selection)**

Press the TUNE select button for 0.5 sec or more. Releasing it will automatically tune to the next available station with a beep sound. When the (∧) side is pressed longer than 0.5 second, releasing will automatically tune to the next higher frequency and when the (∨) side is pressed longer than 0.5 second and releasing will automatically tune to the next lower frequency.

**5. PRESET STATION Select Buttons**

Six (6) stations for AM, FM1 and FM2 respectively can be preset in the electronic memory circuit.

## HOW TO PRESET STATIONS

Six AM and twelve FM stations may be programmed into the memory of the radio. Then, by simply pressing the band select button and/or one of the six station select buttons, you may recall any of these stations instantly. To program the stations, follow these steps:

- o Press band selector to set the band for AM, FM1 or FM2.
- o Select the desired station to be stored by seek or manual tuning.
- o Determine the preset station select button you wish to use to access that station.
- o Press the station select button for more than two seconds. A select button indicator will show in the display indicating which select button you have depressed. The frequency display will flash after it has been stored into the memory with a beep sound. You should then release the button, and proceed to program the next desired station. A total of 18 stations can be programmed by selecting one AM and two FM station per button.
- o When completed, any preset station may be recalled by selecting AM, FM1 or FM2 band and the appropriate station button.

## 6. BAND Selector

Pressing the  button changes the AM, FM1 and FM2 bands. The mode selected is shown on the display.

## 7. EQUALIZER Button

Press the EQ button to select the CLASSIC, JAZZ, ROCK and DEFEAT MODE for the desired tone quality. Each press of the button changes the display as follows;

CLASSIC → JAZZ → ROCK → DEFEAT



## 8. SCAN Button

When the scan button is pressed, the frequency will increase and the receivable stations will be tuned in one after another, receiving each station for 5 seconds. To stop scanning, press the scan button again.



### CAUTION:

- o Do not place beverages close to the audio system. The playback mechanism may be damaged if you spill them.
- o Do not impact or strike the audio system, or the playback mechanism could be damaged.

H290C010-AAT

### CASSETTE TAPE PLAYER OPERATION (H290) (If installed)

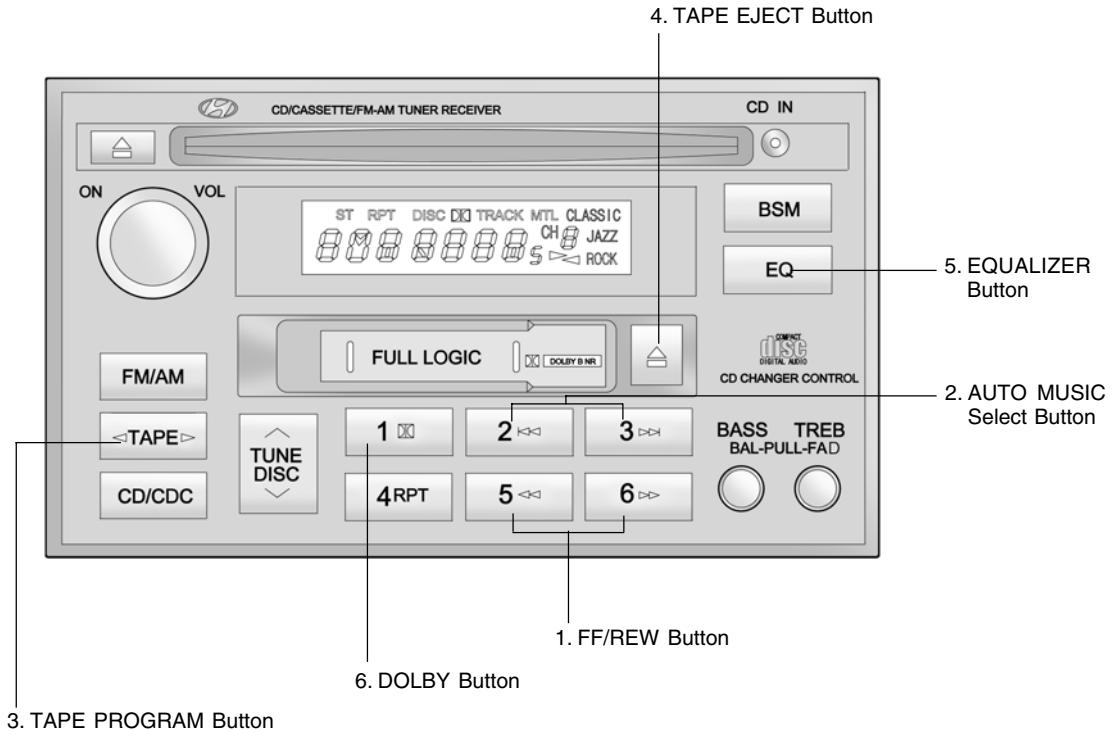

H290D02O-GAT

### 1. FF/REW Button

- o Fast forward tape winding starts when the FF (▶▶) button is pressed during PLAY or REW mode.
- o Tape PLAY starts when the FF (◀◀) button is pressed again during FF mode.
- o Tape rewinding starts when the REW (▶▶) button is pressed during PLAY or FF mode.
- o Tape PLAY starts when the REW (◀◀) button pressed again during REW mode.

### 2. AUTO MUSIC Select Button



Press the button to find the starting point of each song in a prerecorded music tape. The quiet space between songs (must have at least a 4 sec. gap) can be identified by the AUTO MUSIC Select button.

- o Pressing the ▶▶ button will play the beginning of the next music segment.
- o Pressing the ◀◀ button will start replay at the beginning of the music just listened to.

### 3. TAPE PROGRAM Button

This allows you to play the reverse side of the tape by merely depressing the program button. An arrow will appear in the display to show tape direction.

### 4. TAPE EJECT button

- o When the  button is pressed with a cassette loaded, the cassette will eject.
- o When the  button is pressed during FF/REW mode, the cassette will eject.

### 5. EQ Button

Press the EQ button to select the CLASSIC, JAZZ, ROCK and DEFEAT MODE for the desired tone quality. Each press of the button changes the display as follows;

CLASSIC → JAZZ → ROCK → DEFEAT  

### 6. DOLBY Button

If you get background noise during tape PLAY, you can reduce this considerably by merely pressing the DOLBY button. If you want to cancel the DOLBY feature, press the button again.



#### CAUTION:

- o Do not insert anything like coins into the player slot as damage to the unit may occur.
- o Do not place beverages close to the audio system. The playback mechanism may be damaged if you spill them.
- o Do not impact or strike the audio system, or the playback mechanism could be damaged.

H290E010-AAT

### COMPACT DISC PLAYER OPERATION (H290) (If installed)

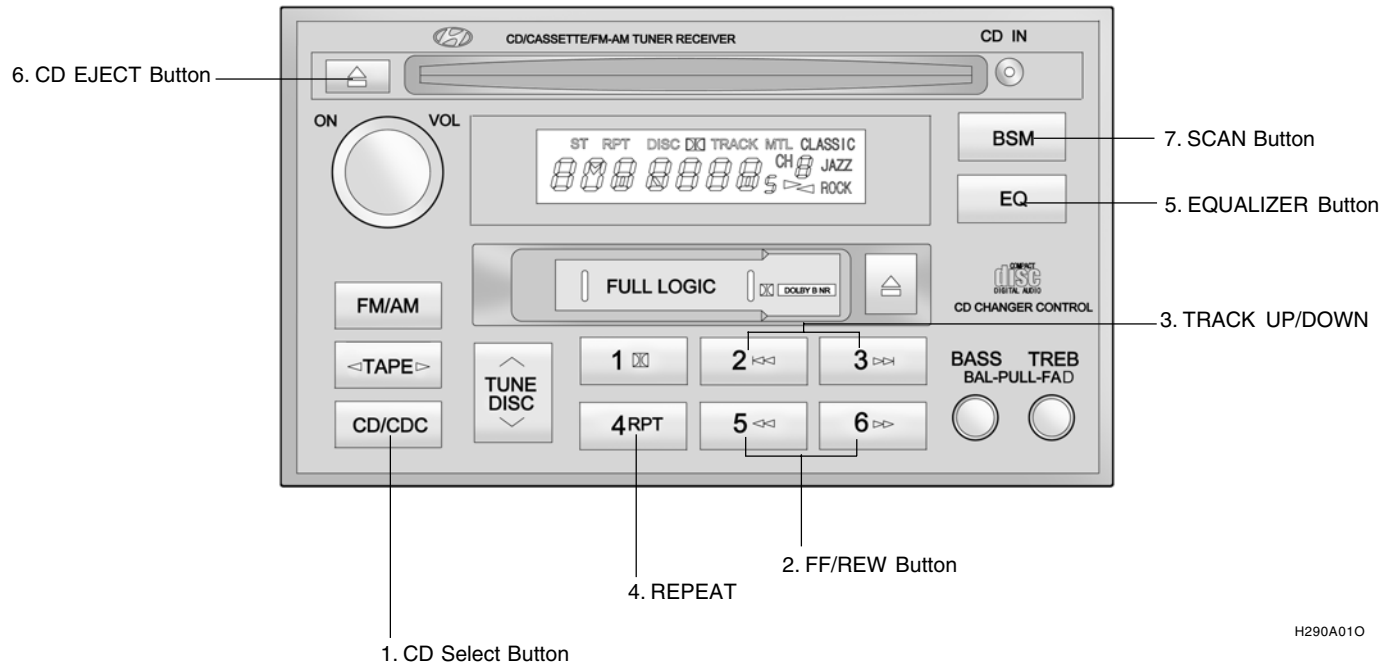

H290F03O-GAT

### 1. CD Select Button

- o Insert the CD with the label facing upward.
- o Insert the CD to start CD playback, during radio operation or cassette tape playing.
- o When a disc is in the CD deck, if you press the CD button the CD player will begin playing even if the radio or cassette player is being used.
- o The CD player can be used when the ignition switch is in either the "ON" or "ACC" position.

### 2. FF/REW (▶▶/◀◀)

If you want to fast forward or reverse through the compact disc track, push and hold the FF (▶▶) or REW (◀◀) button.

When you release the button, the compact disc player will resume playing.

### 3. TRACK UP/DOWN

- o The desired track on the disc currently being played can be selected using the track number.
- o Press ▶▶ button once to skip forward to the beginning of the next track. Press ◀◀ button once to skip back to the beginning of the track.

### 4. REPEAT

- o To repeat the track you are currently listening to, press the RPT button. To cancel, press again.
- o If you do not release RPT operation when the track ends, it will automatically be replayed. This process will be continued until you push the button again.

### 5. EQUALIZER Button

Press the EQ button to select the CLASSIC, JAZZ, ROCK and DEFEAT MODE for the desired tone quality. Each press of the button changes the display as follows;

CLASSIC → JAZZ → ROCK → DEFEAT

### 6. CD EJECT Button

When the  button is pressed with a CD loaded, the CD will eject.

### 7. SCAN Button

- o Press the SCAN button to playback the first 10 seconds of each track.
- o Press the SCAN button again within 10 sec. When you have reached the desired track.

#### NOTE:

- o To assure proper operation of the unit, keep the vehicle interior temperature within a normal range by using the vehicle's air conditioning or heating system.
- o When replacing the fuse, replace it with a fuse having the correct capacity.
- o The preset station frequencies are all erased when the car battery is disconnected. Therefore, all data will have to be set again if this should occur.
- o Do not add any oil to the rotating parts. Keep magnets, screwdrivers and other metallic objects away from the tape mechanism and head.

- o This equipment is designed to be used only in a 12 volt DC battery system with negative ground.
- o This unit is made of precision parts. Do not attempt to disassemble or adjust any parts.
- o When driving your vehicle, be sure to keep the volume of the unit set low enough to allow you to hear sounds coming from the outside.
- o Do not expose this equipment (including the speakers and tape) to water or excessive moisture.

**CAUTION:**

- o Do not insert warped or poor quality discs into the CD player as damage to the unit may occur.
- o Do not insert anything like coins into the player slot as damage to the unit may occur.
- o Do not place beverages close to the audio system. The playback mechanism may be damaged if you spill them.
- o Do not impact or strike the audio system, or the playback mechanism could be damaged.
- o Driving on the off-roads or other vibrations may skip your compact disc. Do not use the audio system on off-roads as the discs could be scratched and damaged.
- o Do not grip or pull out the disc with your hand while the disc is being pulled into the unit by the self loading mechanism. These can cause poor disc scratching to occur or damage the compact disc player.
- o Avoid using CD-Recordable or CD-Rewritable as the player could not be operated in recording way of the CD maker. When using the compact disc player, professionally recorded CDs are recommended.

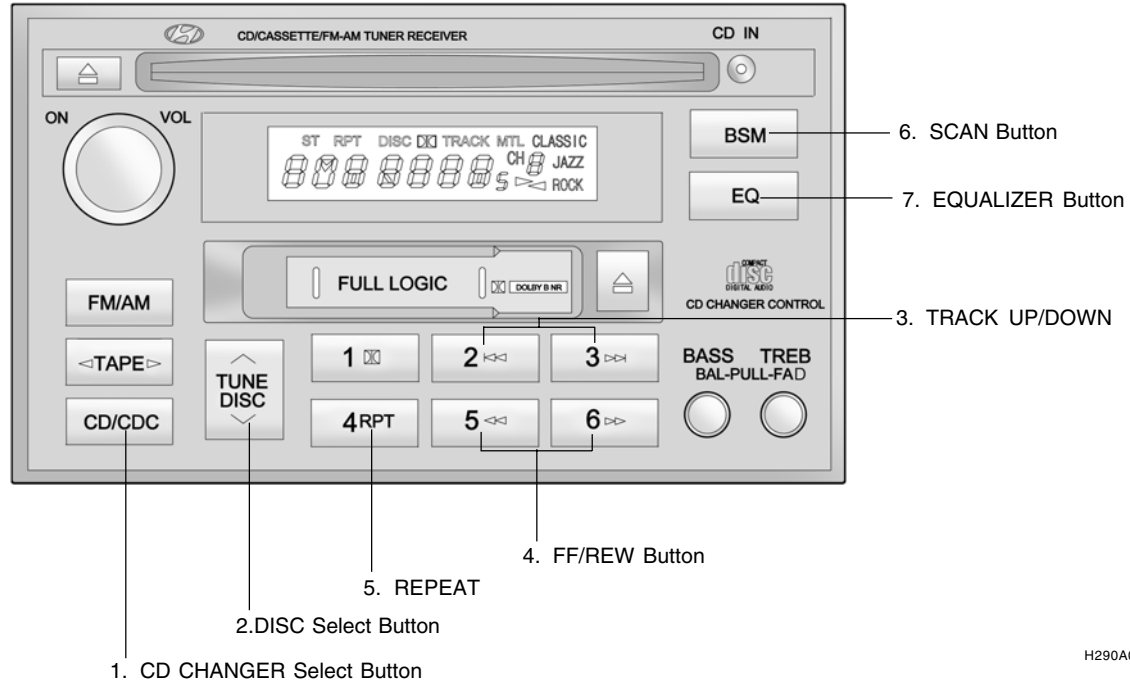

H290G01E-AAT

**CD AUTO CHANGER (H290) (If installed)**

H290A010

## B290H03E-AAT

The CD auto changer is located in the left side of the trunk.

- o To use the CD auto changer.
  1. Open the sliding lid of the CD auto changer.
  2. To eject the compact disc magazine, press the EJECT button located inside the CD auto changer.
  3. Insert the discs into the magazine.
  4. Push the magazine into the CD auto changer and close the sliding lid.
- o The CD auto changer can be used when the ignition switch is in either "ON" or "ACC" position.

### 1. CD CHANGER Select Button

When the CD changer magazine contains discs, press the "CD/CDC" button and the CD changer can be used even if the radio or cassette player is being used. The Hyundai CD changer can hold up to eight discs. The disc number will be lit, and the track number, and elapsed time will be displayed.

### 2. DISC Select Button

To select the CD you want, push  to change the disc number.

### 3. TRACK UP/DOWN

- o The desired track on the disc currently being played can be selected using the track number.
- o Press ►► once to skip forward to the beginning of the next track. Press ◄◄ once to skip back to the beginning of the track.

### 4. FF/REW (►► / ◄◄)

If you want to fast forward or reverse through the compact disc track, push and hold in the FF (►►) or REW (◄◄) button. When you release the button, the compact disc player will resume playing.

### 5. REPEAT

- o To repeat the track you are currently listening to, press the RPT button. To cancel, press again.
- o If you do not release RPT operation when the track ends, it will automatically be replayed. This process will be continued until you push the button again.

### 6. SCAN Button

- o Press the SCAN button to playback the first 10 seconds of each track.
- o Press the SCAN button again within 10 sec. When you have reached the desired track.

### 7. EQUALIZER Button

Press the EQ button to select the CLASSIC, JAZZ, ROCK and DEFEAT MODE for the desired tone quality. Each press of the button changes the display as follows;

CLASSIC → JAZZ → ROCK → DEFEAT  

### NOTE:

- o When replacing the fuse, replace it with a fuse having the correct capacity.
- o This equipment is designed to be used only in a 12 volt DC battery system with negative ground.
- o This unit is made of precision parts. Do not attempt to disassemble or adjust any parts.
- o When driving your vehicle, be sure to keep the volume of the unit set low enough to allow you to hear sounds coming from the outside.

**CAUTION:**

- o Do not insert warped or poor quality discs into the CD changer as damage to the unit may occur.
- o Do not insert anything like coins into the changer slot as damage to the unit may occur.
- o Do not place beverages close to the audio system. The playback mechanism may be damaged if you spill them.
- o Do not impact or strike the audio system, or the playback mechanism could be damaged.
- o Driving on the off-roads or other vibrations may skip your compact disc. Do not use the audio system on off-roads as the discs could be scratched and damaged.
- o Do not grip or pull out the disc with your hand while the disc is being pulled into the unit by the self loading mechanism. These can cause poor disc scratching to occur or damage the compact disc player.
- o Avoid using CD-Recordable or CD-Rewritable as the player could not be operated in recording way of the CD maker. When using the compact disc player, professionally recorded CDs are recommended.

**WARNING:**

Never attempt to change CDs the already inserted in the CD changer magazine while the vehicle is moving. This could result in loss of control or an accident that may cause death, serious injury, or property damage.

## AUDIO FAULT CODE

B890A01Y-AAT

If you see any error indication in the display while using the system in the CD or Tape mode, find the cause in the chart below.  
If you cannot clear the error indication, take the car to your Hyundai dealer.

INDICATION	CAUSE	SOLUTION
Er2	CD DECK MECHANICAL ERROR (EJECT ERROR, LOADING ERROR)	After resetting the audio system, push the eject button. If disc is not ejected, consult your Hyundai dealer.
Er3	FOCUS ERROR DATA READ ERROR	Make sure the disc is not scratched or damaged. Press the eject button and pull out the disc. Then insert a normal CD disc.
Er6	DISC ERROR	Check if the disc is inserted correctly in the CD player. Make sure the disc is not scratched or damaged.
Er8	TAPE DECK ERROR TAPE EJECT ERROR	After resetting the audio system, push the eject button. If tape does not eject, consult your Hyundai dealer.
HHH	TEMPERATURE IS TOO HIGH	Fault code will reset automatically when the temperature returns to normal.
no CD	NO DISC IN MAGAZINE NO CD MAGAZINE IN THE AUTO CHANGER	Insert disc in magazine or insert CD magazine in the auto changer.

## CARE OF DISC

B850A02F-AAT

### Proper Handling

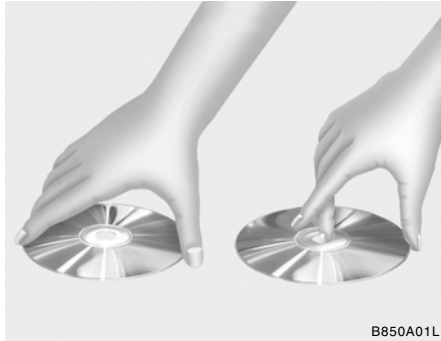

B850A01L

Handle your disc as shown. Do not drop the disc. Hold the disc so you will not leave fingerprints on the surface. If the surface is scratched, it may cause the pickup to skip signal tracks. Do not affix tape, paper, or gummed labels on the disc. Do not write on the disc.

### Damaged Disc

Do not attempt to play damaged, warped or cracked discs. These could severely damage the playback mechanism.

### Storage

When not in use, place your discs in their individual case and store them in a cool place away from the sun, heat, and dust. Do not grip or pull out the disc with your hand while the disc is being pulled into the unit by the self loading mechanism.

### Keep Your Discs Clean

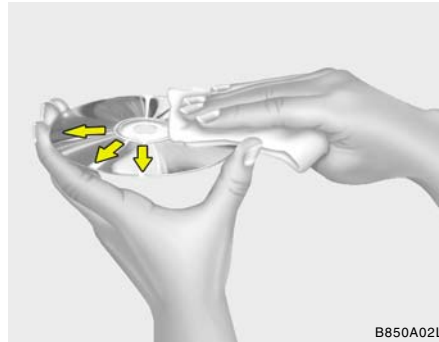

B850A02L

Fingerprints, dust, or soil on the surface of a disc could cause the pickup to skip signal tracks. Wipe the surface clean with a clean soft cloth. If the surface is heavily soiled, dampen a clean soft cloth in a solution of mild neutral detergent to wipe it clean.

## CARE OF CASSETTE TAPES

B860A01A-AAT

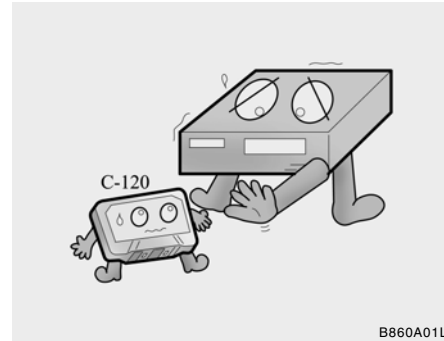

B860A01L

Proper care of your cassette tapes will extend the tape life and increase your listening enjoyment. Always protect your tapes and cassette cases from direct sunlight, severely cold and dusty conditions. When not in use, cassettes should always be stored in the original protective cassette case. When the vehicle is very hot or cold, allow the interior temperature to become more comfortable before listening to your cassettes.

- o Never leave a cassette inserted in the player when not being played. This could damage the tape player unit and the cassette tape.
- o We strongly recommend against the use of tapes longer than C-60 (60 minutes total). Tapes such as C-120 or C-180 are very thin and do not perform as well in the automotive environment.



- o Be sure that the cassette label is not loose or peeling off or tape ejection may be difficult.
- o Never touch or soil the actual audio tape surfaces.
- o Keep all magnetized objects, such as electric motors, speakers or transformers away from your cassette tapes and tape player unit.

- o Store cassettes in a cool, dry place with the open side facing down to prevent dust from settling in the cassette body.
- o Avoid repeated fast reverse usage to replay one given tune or tape section. This can cause poor tape winding to occur, and eventually cause excessive internal drag and poor audio quality in the cassette. If this occurs, it can sometimes be corrected by fast winding the tape from end to end several times. If this does not correct the problem, do not continue to use the tape in your vehicle.

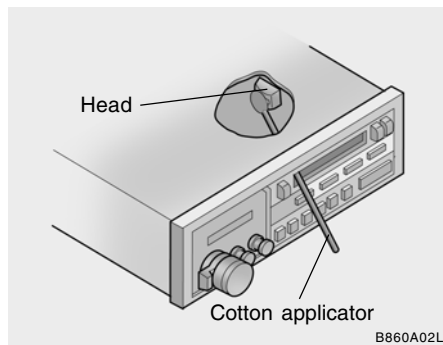

- o The playback head, capstan and pinch rollers will develop a coating of tape residue that can result in deterioration of sound quality, such as a wavering sound. They should be cleaned monthly using a commercially available head cleaning tape or special solution available from audio specialty shops. Follow the supplier's directions carefully and never oil any part of the tape player unit.
- o Always be sure that the tape is tightly wound on its reel before inserting in the player. Rotate a pencil in the drive sprockets to wind up any slack.

## ANTENNA

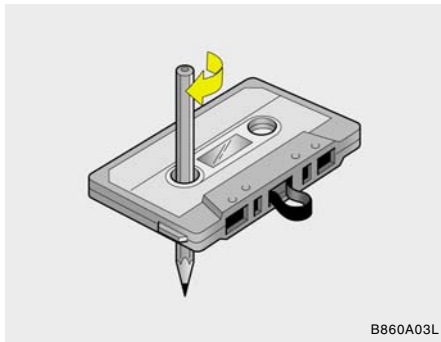

B860A03L

**NOTE:**

Look at a tape before you insert it. If the tape is loose, tighten it by turning one of the hubs with a pencil or your finger. If the label is peeling off, do not put it in the drive mechanism.

Do not leave tapes sitting where they are exposed to hot, warm, or high humidity, such as on top of the dashboard or in the player.

If a tape is exposed to excessively hot or cold, let it reach a moderate temperature before putting it in the player.

B870A01A-AAT

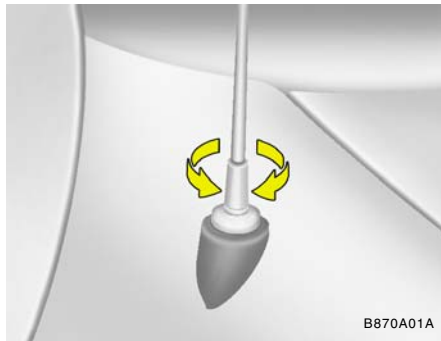
**Fixed Rod Antenna**

B870A01A

Your car uses a fixed rod antenna to receive both AM and FM broadcast signals. This antenna is a removable type. To remove the antenna, turn it counterclockwise. To install the antenna, turn it clockwise.

**CAUTION:**

- o Be sure to remove the antenna before washing the car in an automatic car wash or it may be damaged.
- o When reinstalling your antenna, it is important that it is fully tightened to ensure proper reception.

B870B01Y-AAT

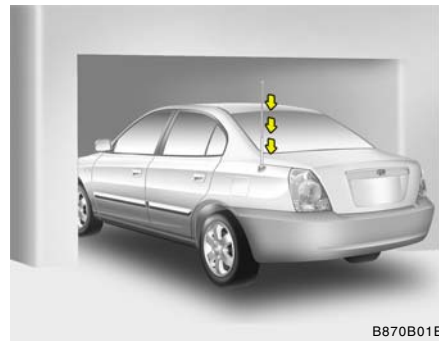
**Power Antenna (If installed)**

B870B01E

The antenna will automatically be extended when the radio power switch is turned on while the ignition key is in either the "ON" or "ACC" position. The antenna will automatically be retracted and stored when either the radio power switch is turned off or the ignition key is set to the "LOCK" position.

**CAUTION:**

- o Before turning on the radio, make sure that no one is near the antenna.
- o Before entering an automatic car wash or a place with a low height clearance, turn off the radio and be sure that the antenna is retracted and stored.
- o If the antenna is dirty, be sure to clean it in order to avoid an operation malfunction.

B870D02Y-GAT

**Glass Antenna (If installed)**

When the radio power switch is turned on while the ignition key is in either the "ON" or "ACC" position, your car will receive both AM and FM broadcast signals through the antenna in the rear window glass.

**CAUTION:**

- o Do not clean the inner side of the rear window glass with an abrasive type of glass cleaner or use a scraper to remove foreign deposits from the inner surface of the glass as this may cause damage to the antenna elements.
- o Avoid adding metallic coating (Some aftermarket window tinting has metallic contents). These can disturb receiving AM and FM broadcast signals.



## DRIVING YOUR HYUNDAI

Before Starting the Engine .....	2-3
To Start The Engine .....	2-3
Key Positions .....	2-4
Starting .....	2-5
Operating the Manual Transaxle .....	2-6
Automatic Transaxle .....	2-8
Anti-Lock Brake System (ABS) .....	2-12
Traction Control System (TCS) .....	2-12
Driving for Economy .....	2-15
Smooth Cornering .....	2-16
Winter Driving .....	2-16
Trailer or Vehicle Towing .....	2-18
Vehicle Load Limit .....	2-22

**WARNING: ENGINE EXHAUST CAN BE DANGEROUS!**

C0110A02A-AAT

Engine exhaust fumes can be extremely dangerous. If, at any time, you smell exhaust fumes inside the vehicle, open the windows immediately.

**o Do not inhale exhaust fumes.**

Exhaust fumes contain carbon monoxide, a colorless, odorless gas that can cause unconsciousness and death by asphyxiation.

**o Be sure the exhaust system does not leak.**

The exhaust system should be checked whenever the vehicle is raised to change the oil or for any other purpose. If you hear a change in the sound of the exhaust or if you drive over something that strikes the underneath side of the car, have the exhaust system checked as soon as possible by your Hyundai dealer.

**o Do not run the engine in an enclosed area.**

Letting the engine idle in your garage, even with the garage door open, is a hazardous practice. Never run the engine in your garage any longer than it takes to start the engine and back the car out.

**o Avoid idling the engine for prolonged periods with people inside the car.**

If it is necessary to idle the engine for a prolonged period with people inside the car, be sure to do so only in an open area with the air intake set at "Fresh" and fan operating at one of the higher speeds so fresh air is drawn into the interior.

If you must drive with the trunk /tail gate open because you are carrying objects that make this necessary:

1. Close all windows.
2. Open side vents.
3. Set the air intake control at "Fresh", the air flow control at "Floor" or "Face" and the fan at one of the higher speeds.

To assure proper operation of the ventilation system, be sure the ventilation air intakes located just in front of the windshield are kept clear of snow, ice, leaves or other obstructions.

**PROPOSITION 65 WARNING:**

Engine exhaust and a wide variety of automobile components and parts, including components found in the interior furnishings in a vehicle, contain or emit chemicals known to the State of California to cause cancer and birth defects and reproductive harm. In addition, certain fluids contained in vehicles and certain products of component wear contain or emit chemicals known to the State of California to cause cancer and birth defects or other reproductive harm.

**BEFORE STARTING THE ENGINE**

C020A02A-AAT

Before you start the engine, you should always:

1. Look around the vehicle to be sure there are no flat tires, puddles of oil, water or other indications of possible trouble.
2. After entering the car, check to be sure the parking brake is engaged.
3. Check that all windows and lights are clean.
4. Check that the interior and exterior mirrors are clean and in position.
5. Check your seat, seatback and headrest to be sure they are in their proper positions.
6. Lock all the doors.
7. Fasten your seat belt and be sure that all other occupants have fastened theirs.
8. Turn off all lights and accessories that are not needed.
9. When you turn the ignition switch to "ON", check that all appropriate warning lights are operating and that you have sufficient fuel.
10. Check the operation of warning lights and all bulbs when key is in the "ON" position.



**WARNING:**

- o All passengers must be properly belted whenever the vehicle is moving. Refer to pages: 1-17 through 1-23 for more information on their proper use.
- o Always check the surrounding areas near your vehicle for people, especially children, before putting a car into 'drive.'



**WARNING:**

Always wear appropriate shoes when operating your vehicle. Unsuitable shoes (high heels, ski boots, etc.) may interfere with your ability to use the brake and accelerator pedal, and the clutch (if installed).

**TO START THE ENGINE**

C030A01A-AAT

**COMBINATION IGNITION SWITCH**

- o If your Hyundai is equipped with a manual transaxle, place the shift lever in neutral and depress the clutch pedal fully.
- o If your Hyundai has an automatic transaxle, place the shift lever in "P" (park).
- o To start the engine, insert the ignition key and turn it to the "START" position. Release it as soon as the engine starts. Do not hold the key in the "START" position for more than 15 seconds.

**NOTE:**

- o For safety, the engine will not start if the clutch pedal is not depressed fully (Manual Transaxle) or the shift lever is not in "P" or "N" Position (Automatic Transaxle).
- o The ignition key cannot be turned from "ACC" position to "LOCK" position unless the shift lever is in the "P" (Park) position or the negative battery terminal is disconnected from the battery. To remove the key, always confirm that the shift lever is securely positioned in "P" (Park) (For Automatic Transaxle)
- o For additional information about starting, see page 2-5.

## KEY POSITIONS

C040A01A-AAT

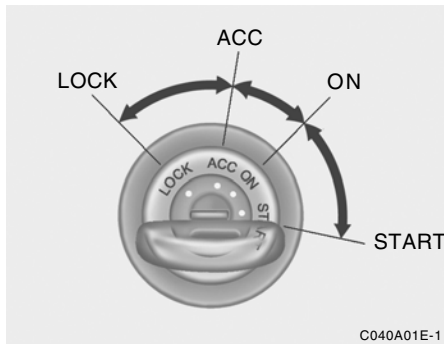
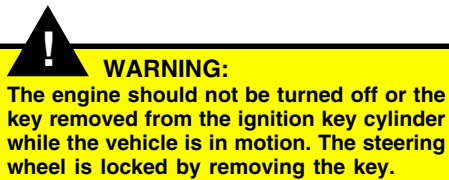

## o "START"

The engine is started in this position. It will crank until you release the key.

**NOTE:**

Do not hold the key in the "START" position for more than 15 seconds.

## o "ON"

When the key is in the "ON" position, the ignition is on and all accessories may be turned on. If the engine is not running, the key should not be left in the "ON" position. This will discharge the battery and may also damage the ignition system.

## o "ACC"

With the key in the "ACC" position, some electrical accessories (radio, etc.) may be operated.

## o "LOCK"

The key can be removed or inserted in this position. To protect against theft, the steering wheel locks by removing the key.

**NOTE:**

To unlock the steering wheel, insert the key, and then turn the steering wheel and key simultaneously.

C070C01A-AAT

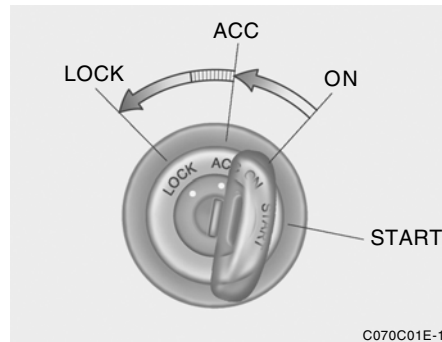
**To Remove the Ignition Key**

1. Turn the ignition key to the "ACC" position.
2. Simultaneously push and turn the ignition key counterclockwise from the "ACC" position to the "LOCK" position.
3. The key can be removed in the "LOCK" position.

## STARTING

C050A01A-AAT

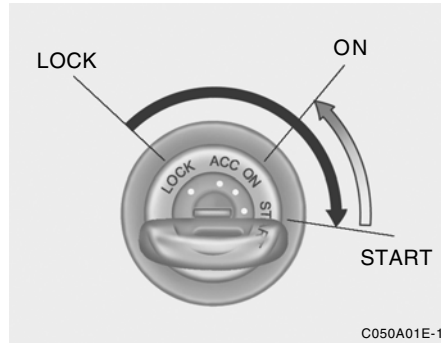

C050A01E-1

**WARNING:**

Never run the engine in a closed or poorly ventilated area any longer than is needed to move your car in or out of the area. The carbon monoxide gas emitted is odorless and can cause serious injury or death.

C050B02A-AAT

**Normal Conditions:**

The Starting Procedure:

1. Insert key, and fasten the seat belt.
2. Depress the clutch pedal fully and place the gearshift lever (manual transaxle) in neutral or the selector lever (automatic transaxle) in "P" (park) position.
3. After turning the ignition key to the "ON" position, make certain all warning lights and gauges are functioning properly before starting the engine.

**WARNING:**

Be sure that the clutch is fully depressed when starting a manual transaxle vehicle. Your manual transaxle equipped vehicle will not start unless the clutch pedal is fully depressed. On a manual transaxle equipped vehicle that can be started without depressing the clutch, there is the potential to cause damage to the vehicle or injury to someone inside or outside the vehicle as a result of the forward or backward movement of the vehicle that will occur if the clutch is not depressed when the vehicle is started.

4. Turn the ignition key to the "START" position and release it when the engine starts.

After the engine has started, allow the engine to run for 10 to 20 seconds prior to placing the vehicle in gear.

The starter should not be operated for more than 15 seconds at a time. Wait 15-30 seconds between starting attempts to protect the starter from overheating.

**WARNING:**

Always fully depress the brake pedal before and while shifting out of the "P" Park position into another position to avoid inadvertent motion of the vehicle which could injure persons in or around the car.

## MANUAL TRANSAXLE

C070A03A-AAT

## OPERATING THE MANUAL TRANSAXLE

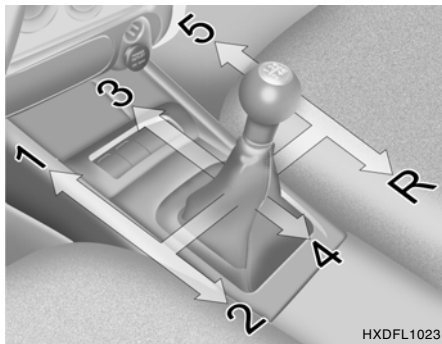

Your Hyundai's manual transaxle has a conventional shift pattern. This shift pattern is imprinted on the shift knob. The transaxle is fully synchronized in all forward gears so shifting to either a higher or a lower gear is easily accomplished.

## NOTE:

- o To shift into reverse, rest the lever in neutral for at least 3 seconds after your car is completely stopped. Then move the lever into the reverse position.
- o During cold weather, shifting may be difficult until the transaxle lubricant has warmed up. This is normal and not harmful to the transaxle.
- o If you 've come to a complete stop and it's hard to shift into 1st or R(Reverse), put the shift lever in N(Neutral) position and release the clutch. Press the clutch pedal down, and then shift into 1st or R(Reverse) gear position.
- o Do not use the shift lever as a handrest during driving, as this can result in premature wear of the transaxle shift forks.



## CAUTION:

- o Do not downshift more than 2 gears or downshift the gear when the engine is running at high speed (5,000 RPM or higher). Such a downshifting may damage the engine.
- o When downshifting from fifth gear to fourth gear, caution should be taken not to inadvertently press the gear shift lever sideways in such a manner that second gear is engaged. Such a drastic downshift may cause the engine speed to increase to the point that the tachometer will enter the red-zone. Such over-revving of the engine may possibly cause engine damage.

C070B03A-AAT

## Using the Clutch

The clutch should be pressed all the way to the floor before shifting, then released slowly. The clutch pedal should always be fully released while driving. Do not rest your foot on the clutch pedal while driving. This can cause unnecessary wear.

Do not partially engage the clutch to hold the car on an incline. This causes unnecessary wear. Use the foot brake or parking brake to hold the car on an incline. Do not operate the clutch pedal rapidly and repeatedly.

C070E03A-AAT

## Recommended Shift Points

Shift from-to	Recommended mph (km/h)
1-2	15 (20)
2-3	25 (40)
3-4	35 (55)
4-5	45 (75)

The shift points as shown above are recommended for optimum fuel economy and performance.

C070D05O-AAT

## Good Driving Practices

- o Never take the car out of gear and coast down a hill. This is extremely hazardous. Always leave the car in gear.
- o Don't "ride" the brakes. This can cause them to overheat and malfunction. Instead, when you are driving down a long hill, slow down and shift to a lower gear. When you do this, engine braking will help slow the car.
- o Slow down before shifting to a lower gear. This will help avoid over-revving the engine, which can cause damage.
- o Slow down when you encounter cross winds. This gives you much better control of your car.
- o Be sure the car is completely stopped before you attempt to shift into reverse. The transaxle can be damaged if you do not. To shift into reverse, depress the clutch, move the shift lever to neutral, wait three seconds, then shift to the reverse position.
- o Exercise extreme caution when driving on a slippery surface. Be especially careful when braking, accelerating or shifting gears. On a slippery surface, an abrupt change in vehicle speed can cause the drive wheels to lose traction and the vehicle to go out of control.
- o Optimum vehicle performance and economy is obtained by smoothly depressing and releasing the accelerator pedal.

**WARNING:**

- o Always buckle-up! In a collision, an unbelted occupant is significantly more likely to be seriously injured or killed than a properly belted occupant.
- o Avoid high speeds when cornering or turning.
- o Do not make quick steering wheel movements, such as sharp lane changes or fast, sharp turns.
- o The risk of rollover is greatly increased if you lose control of your vehicle at highway speeds.
- o Loss of control often occurs if two or more wheels drop off the roadway and the driver oversteers to reenter the roadway.
- o In the event your vehicle leaves the roadway, do not steer sharply. Instead, slow down before pulling back into the travel lanes.
- o Never exceed posted speed limits.

**WARNING:**

- o If your vehicle becomes stuck in snow, mud, sand, etc., then you may attempt to rock the vehicle free by moving it forward and backward. Do not attempt this procedure if people or objects are anywhere near the vehicle. During the rocking operation the vehicle may suddenly move forward or backward as it becomes unstuck, causing injury to nearby people or damage to objects.

**AUTOMATIC TRANSAXLE**

C090A02Y-AAT

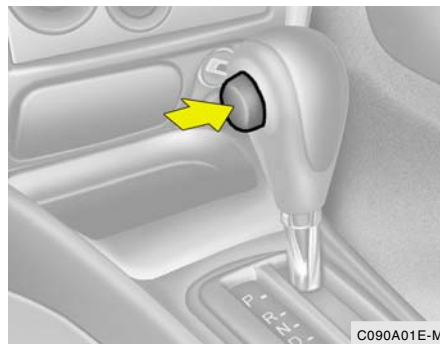

C090A01E-M

The highly efficient Hyundai automatic transaxle has four forward speeds and one reverse speed. It has a conventional shift pattern as shown in the illustration. At night, with the multi-function switch turned on to the parking light or headlight position, the appropriate symbol on the shift pattern indicator will be illuminated according to the range selected.

**CAUTION:**



Never shift into "R" or "P" position while the vehicle is moving.

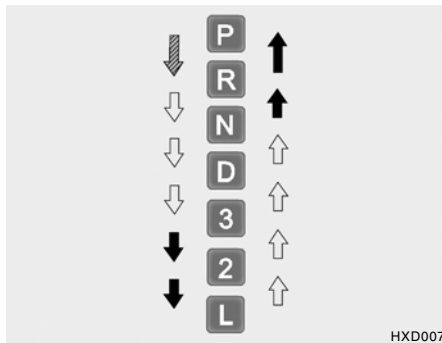



HXD007

**NOTE:**

-  Depress the brake pedal and push the button when shifting.
-  Push the button when shifting.
-  The selector lever can be shifted freely.

The first few shifts on a new vehicle, or if the battery has been disconnected, may be somewhat abrupt. This is a normal condition, and the shifting sequence will adjust after shifts are cycled a few times by the T.C.M (Transaxle Control Module.)

C090B01A-AAT

**The function of each position is as follows:**

**o P (Park):**

Use to hold the vehicle in place when parked or while starting the engine; shift the selector lever to the "P" (Park) position. Whenever parking the car, apply the parking brake and shift the selector lever to the "P" (Park) position.

**CAUTION:**

**Never place the selector lever in the "P" (Park) position unless the vehicle is fully stopped. Failure to observe this caution will cause severe damage to the transaxle.**

C090C01A-AAT

**o R (Reverse):**

Use for backing up the vehicle. Bring the car to a complete stop before shifting the selector lever to "R" position.

C090D02A-AAT

**o N (Neutral):**

In the "N" position, the transaxle is in neutral, which means that no gears are engaged. The engine can be started with the shift lever in "N" position, although this is not recommended except if the engine stalls while the car is moving.

C090E01A-AAT

**o D (Drive):**

Use for normal driving. The transaxle will automatically shift through a four-gear sequence. Never downshift manually to "2" position or "L" position when vehicle speed is more than 60 mph (96 km/h).

C090Q01A-GAT

**o 3 (Third gear):**

Use for towing a trailer during hill climbing or to use engine braking downhill. "3" automatically shifts between 1st, 2nd and 3rd gears. This means that no shift-up to 4th gear is performed. However, the shift-up to 4th gear is done when the car speed exceeds a certain value to prevent the engine from over-revving. Manually move the selector to "D" when returning to normal driving condition.

C090F01A-AAT

**o 2 (Second gear):**

Use for driving on a slippery road, hill climbing or engine braking downhill. "2" automatically shifts between first and second gears.

This means that no shift-up to 3rd gear is performed. However, the shift-up to third gear is done when the car speed exceeds a certain value to prevent the engine from over-revving. Manually move the selector to "D" returning to normal driving condition.

C090G01A-AAT

**o L (Low gear):**

Use for driving up a very steep grade or for engine braking when descending steep hills. When downshifting to "L", the transaxle will temporarily remain in second gear until the vehicle has slowed enough for low gear to engage. Do not exceed 31 mph (50 km/h) in low gear.

C090H01Y-AAT

**NOTE:**

- o For smooth and safe operation, depress the brake pedal when shifting from "N"(Neutral) position or "P"(Park) position to a forward or "R"(Reverse) gear.
- o The ignition key must be in the "ON" position and the brake pedal fully depressed in order to move the shift lever from the "P" (Park) position to any of the other positions.
- o It is always possible to shift from "R", "N", "D", "3", "2", "L" position to "P" position. The vehicle must be fully stopped to avoid transaxle damage.

C090I02Y-AAT

**CAUTION:**

- o Shift into "R" and "P" position only when the vehicle has completely stopped.
- o Do not accelerate the engine in reverse or any of the forward positions with the brakes applied.
- o Always apply the footbrake when shifting from "P" or "N", to "R", "D", "3", "2" or "L" position.
- o Do not use the "P" (Park) position in place of the parking brake. Always set the parking brake, shift the transaxle into "P" (Park) position and turn off the ignition when you leave the vehicle, even momentarily. Never leave the vehicle unattended while the engine is running.
- o Check the automatic transaxle fluid level regularly, and add fluid as necessary. See the maintenance schedule for the proper fluid recommendation.

C090N040-AAT

**Good Driving Practices**

- o Never move the gear selector lever from "P" or "N" to any other position with the accelerator pedal depressed.
- o Never move the gear selector lever into "P" when the vehicle is in motion.
- o Be sure the car is completely stopped before you attempt to shift into "R".
- o Never take the car out of gear and coast down a hill. This may be extremely hazardous. Always leave the car in gear when moving.
- o Do not "ride" the brakes. This can cause them to overheat and malfunction. Instead, when you are driving down a long hill, slow down and shift to a lower gear. When you do this, engine braking will help slow the car.
- o Slow down before shifting to a lower gear. Otherwise, the lower gear may not be engaged.
- o Always use the parking brake. Do not depend on placing the transaxle in "P" to keep the car from moving.
- o Exercise extreme caution when driving on a slippery surface. Be especially careful when braking, accelerating or shifting gears. On a slippery surface, an abrupt change in vehicle speed can cause the drive wheels to lose traction and the vehicle to go out of control.

- o Optimum vehicle performance and economy is obtained by smoothly depressing and releasing the accelerator pedal.

**WARNING:**

- o **Avoid high cornering speeds.**
- o **Do not make quick steering wheel movements, such as sharp lane changes or fast, sharp turns.**
- o **Always wear your seat belts.**  
In a collision, unbelted person is significantly more likely to be seriously injured or killed than a person wearing a seat belt.
- o **The risk of rollover is greatly increased if you lose control of your vehicle at highway speeds.**
- o **The risk of rollover is greatly increased if you lose control of your vehicle at highway speeds.**
- o **Loss of control often occurs if two or more wheels drop off the roadway and the driver oversteers to reenter the roadway.**

- o **In the event your vehicle leaves the roadway, do not steer sharply. Instead, slow down before pulling back into the travel lanes.**
- o **In a collision, an unbelted person is significantly more likely to die than a person wearing a seat belt.**
- o **Never exceed posted speed limits.**
- o **If your vehicle becomes stuck in snow, mud, sand, etc., then you may attempt to rock the vehicle free by moving it forward and backward. Do not attempt this procedure if people or objects are anywhere near the vehicle. During the rocking operation the vehicle may suddenly move forward or backward as it becomes unstuck, causing injury or damage to nearby people or objects.**

## ANTI-LOCK BRAKE SYSTEM (ABS)

C120A01FC-AAT  
(If installed)

The Anti-Lock Brake System (ABS) is designed to prevent wheel lock-up during sudden braking or on hazardous road surfaces. The ABS control module monitors the wheel speed and controls the pressure applied to each brake. Thus, in emergency situations or on slick roads, ABS will increase vehicle control during braking.

### NOTE:

- o A click sound may be heard in the engine compartment when the vehicle begins to move after the engine is started. These conditions are normal and indicate that the anti-lock brake system (Traction Control System) is functioning properly.
- o During ABS (TCS) operation, a pulsation may be felt in the brake pedal when the brakes are applied. Also, a noise may be heard in the engine compartment while braking. These conditions are normal and indicate that the anti-lock brake system (Traction Control System) is functioning properly.



**WARNING:**

**ABS (TCS) will not prevent accidents due to improper or dangerous driving maneuvers. Even though vehicle control is improved during emergency braking, always maintain a safe distance between you and objects ahead. Vehicle speeds should always be reduced during extreme road conditions.**

**The braking distance for cars equipped with an anti-lock braking system (Traction Control System) may be longer than for those without it in the following road conditions.**

**During these conditions the vehicle should be driven at reduced speeds:**

- o Rough, gravel or snow-covered roads.
- o With tire chains installed.
- o On roads where the road surface is pitted or has different surface height.

**The safety features of an ABS (TCS) equipped vehicle should not be tested by high speed driving or cornering. This could endanger the safety of yourself or others.**

## TRACTION CONTROL SYSTEM (TCS)

C300A02Y-GAT  
(If installed)

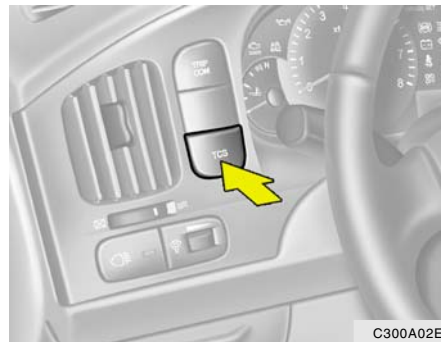

On slippery road surfaces, the traction control system (TCS) limits the drive wheels from spinning excessively, thus helping the car to accelerate. It also helps to provide sufficient driving force and steering performance as the car turns.

## SLIP Control

Limits the drive wheels from spinning excessively during starting or while making accelerated turns on slippery roads to avoid losing the driving force of the front wheels.

### Driving hints

TCS does not actively apply brakes. Be sure to decelerate the car sufficiently before entering curves.



#### CAUTION:

When the TCS indicator blinks, SLIP control has been activated. It also means that the road is slippery or your car is accelerating excessively. In this situation, release foot pressure from the accelerator pedal and maintain moderate speed.



#### WARNING:

Traction control is only a driving aid; all normal precautions for driving in inclement weather and on slippery driving surfaces should be observed.

C310D010-AAT

## TCS ON/OFF Mode

When the TCS is operating, the TCS indicator in the instrument cluster will blink.

If you turn the system off by pressing the TCS switch, the TCS-OFF indicator will come on and stay on. In the TCS-OFF mode, the SLIP control will be deactivated. Adjust you driving accordingly. To turn the system back on, press the switch again. The TCS-OFF indicator should go off.

#### NOTE:

- 1) The TCS mode will automatically be turned "ON" after the engine is turned off and restarted.
- 2) When the traction control system is operating properly, you can feel a slight pulsation in the vehicle. This is only the effect of brake control and indicates nothing unusual.
- 3) When the engine starts, a click may be heard from the engine compartment; this is the sound of the traction control being checked.
- 4) When moving out of the mud or fresh snow, pressing the accelerator pedal may not cause the engine speed to increase due to TCS operation.

C310D010-AAT

## Indicators and Warning

The TCS indicators should illuminate when the ignition key is turned to "ON" or "START" but should go out after three seconds.

If the indicators do not illuminate, or the TCS or TCS-OFF indicator does not go out after 3 seconds, have the system checked by an authorized dealer.

Should there be any unusual conditions in the TCS system while driving, TCS-OFF indicator illuminates as a warning.

If TCS-OFF indicator illuminates, pull your car to a safe place and stop the engine.

Then, start the engine again to check if the TCS-OFF indicator goes out.

If the indicator remains lit even after the engine has been started, have your car checked by an authorized Hyundai dealer.

#### NOTE:

- 1) When the TCS-OFF indicator illuminates, traction control is automatically deactivated.
- 2) This warning function is not provided when the driver selects the TCS-OFF mode.

C130A02A-AAT

**Good braking practices****WARNING:**

- o Whenever leaving vehicle or parking, always set the parking brake as far as possible and fully engage the vehicle's transaxle into the park position. Vehicles not fully engaged in park with the parking brake set are at risk for moving inadvertently and injuring yourself or others.
- o All vehicles should always have the parking brake fully engaged when parking to avoid inadvertent movement of the car which can injure occupants or pedestrians.
- o Nothing should be carried on top of the shelf panel behind the rear seat. If there were an accident or a sudden stop, such objects could move forward and cause damage to the vehicle or injure the occupants.

- o After being parked, check to be sure the parking brake is not engaged and that the parking brake indicator light is out before driving away.
- o Driving through water may get the brakes wet. They can also get wet when the car is washed. Wet brakes can be dangerous! Your car will not stop as quickly if the brakes are wet. Wet brakes may cause the car to pull to one side. To dry the brakes, apply the brakes lightly while driving slowly until the braking action returns to normal, taking care to keep the car under control at all times. If the braking action does not return to normal, stop as soon as it is safe to do so and call your Hyundai dealer for assistance.
- o Don't coast down hills with the car out of gear. This is extremely hazardous. Keep the car in gear at all times, use the brakes to slow down, then shift to a lower gear so that engine braking will help you maintain a safe speed.
- o Don't "ride" the brake pedal. Resting your foot on the brake pedal while driving can be dangerous because it can result in the brakes overheating and losing their effectiveness. It also increases the wear of the brake components.
- o If a tire goes flat while you are driving, apply the brakes gently and keep the car pointed straight ahead while you slow down. When you are moving slowly enough for it to be safe to do so, pull off the road and stop in a safe place.
- o If your car is equipped with an automatic transaxle, don't let your car creep forward. To avoid creeping forward, keep your foot on the brake pedal when the car is stopped.
- o Use caution when parking on a hill. Firmly engage the parking brake and place the gear selector lever in "P" (automatic transaxle) or in first or reverse gear (manual transaxle). If your car is facing downhill, turn the front wheels into the curb to help keep the car from rolling. If your car is facing uphill, turn the front wheels away from the curb to help keep the car from rolling. If there is no curb or if it is required by other conditions to keep the car from rolling, block the wheels.
- o Under some conditions your parking brake can freeze in the engaged position. This is most likely to happen when there is an accumulation of snow or ice around or near the rear brakes or if the brakes are wet. If there is a risk that the parking brake may freeze, apply it only temporarily while you put the gear selector lever in "P" (automatic) or in first or reverse gear (manual transaxle) and block the rear wheels so the car cannot roll. Then release the parking brake.
- o Do not hold the vehicle on the upgrade with the accelerator pedal. This can cause the transmission to overheat. Always use the brake pedal or parking brake.

## DRIVING FOR ECONOMY

C140A02A-AAT

You can save fuel and get more miles from your car if you follow these suggestions:

- o Drive smoothly. Accelerate at a moderate rate. Don't make "jack-rabbit" starts or full-throttle shifts and maintain a steady cruising speed. Don't race between stoplights. Try to adjust your speed to that of the other traffic so you don't have to change speeds unnecessarily. Avoid heavy traffic whenever possible. Always maintain a safe distance from other vehicles so you can avoid unnecessary braking. This also reduces brake wear.
- o Drive at a moderate speed. The faster you drive, the more fuel your car uses. Driving at a moderate speed, especially on the highway, is one of the most effective ways to reduce fuel consumption.
- o Don't "ride" the brake or clutch pedal. This can increase fuel consumption and also increase wear on these components. In addition, driving with your foot resting on the brake pedal may cause the brakes to overheat, which reduces their effectiveness and may lead to more serious consequences.
- o Take care of your tires. Keep them inflated to the recommended pressure. Incorrect inflation, either too much or too little, results in unnecessary tire wear. Check the tire pressures at least once a month.
- o Be sure that the wheels are aligned correctly. Improper alignment can result from hitting curbs or driving too fast over irregular surfaces. Poor alignment causes faster tire wear and may also result in other problems as well as greater fuel consumption.
- o Keep your car in good condition. For better fuel economy and reduced maintenance costs, maintain your car in accordance with the maintenance schedule in Section 5. If you drive your car in severe conditions, more frequent maintenance is required (see Section 5 for details).
- o Keep your car clean. For maximum service, your Hyundai should be kept clean and free of corrosive materials. It is especially important that mud, dirt, ice, etc. not be allowed to accumulate on the underside of the car. This extra weight can result in increased fuel consumption and also contribute to corrosion.
- o Travel lightly. Don't carry unnecessary weight in your car. Weight reduces fuel economy.
- o Don't let the engine idle longer than necessary. If you are waiting (and not in traffic), turn off your engine and restart only when you're ready to go.
- o Remember, your Hyundai does not require extended warm-up. After the engine has started, allow the engine to run for 10 to 20 seconds prior to placing the vehicle in gear. In very cold weather, however, give your engine a slightly longer warm-up period.
- o Don't "lug" or "over-rev" the engine. Lugging is driving too slowly in too high a gear resulting in the engine bucking. If this happens, shift to a lower gear. Over-revving is racing the engine beyond its safe limit. This can be avoided by shifting at the recommended speeds.
- o Use your air conditioning sparingly. The air conditioning system is operated by engine power so your fuel economy is reduced when you use it.

## SMOOTH CORNERING

C150A01A-AAT

Avoid braking or gear changing in corners, especially when roads are wet. Ideally, corners should always be taken under gentle acceleration. If you follow these suggestions, tire wear will be held to a minimum.

## WINTER DRIVING

C160A01A-AAT

The more severe weather conditions of winter result in greater wear and other problems. To minimize the problems of winter driving, you should follow these suggestions:

C160B01A-AAT

**Snowy or Icy Conditions**

To drive your vehicle in deep snow, it may be necessary to use snow tires or to install tire chains on your tires. If snow tires are needed, it is necessary to select tires equivalent in size and type to the original equipment tires. Failure to do so may adversely affect the safety and handling of your car. Speeding, rapid acceleration, sudden brake applications, and sharp turns are potentially very hazardous practices. During deceleration, use engine braking to the fullest extent. Sudden brake applications on snowy or icy roads may cause skids to occur. You need to keep sufficient distance between the vehicle in front and your vehicle. Also, apply the brake gently. It should be noted that installing tire chains on the tire will provide a greater driving force, but will not prevent side skids.

**NOTE:**

**Tire chains are not legal in all states. Check state laws before fitting tire chains.**

C160C01A-AAT

**Use High Quality Ethylene Glycol Coolant**

Your Hyundai is delivered with high quality ethylene glycol coolant in the cooling system. It is the only type of coolant that should be used because it helps prevent corrosion in the cooling system, lubricates the water pump and prevents freezing. Be sure to replace or replenish your coolant in accordance with the maintenance schedule in Section 5. Before winter, have your coolant tested to assure that its freezing point is sufficient for the temperatures anticipated during the winter.

C160D01A-AAT

**Check Battery and Cables**

Winter puts additional burdens on the battery system. Visually inspect the battery and cables as described in Section 6. The level of charge in your battery can be checked by your Hyundai dealer or a service station.



C160E01A-AAT

### **Change to "Winter Weight" Oil if Necessary**

In some climates it is recommended that a lower viscosity "winter weight" oil be used during cold weather. See Section 9 for recommendations. If you aren't sure what weight oil you should use, consult your Hyundai dealer.

C160F01A-AAT

### **Check Spark Plugs and Ignition System**

Inspect your spark plugs as described in Section 6 and replace them if necessary. Also check all ignition wiring and components to be sure they are not cracked, worn or damaged in any way.

C160G01A-AAT

### **To Keep Locks from Freezing**

To keep the locks from freezing, squirt an approved de-icer fluid or glycerine into the key opening. If a lock is covered with ice, squirt it with an approved de-icing fluid to remove the ice. If the lock is frozen internally, you may be able to thaw it out by using a heated key. Handle the heated key with care to avoid injury.

C160H02A-AAT

### **Use Approved Window Washer Anti-Freeze in System**

To keep the water in the window washer system from freezing, add an approved window washer anti-freeze solution in accordance with instructions on the container. Window washer anti-freeze is available from Hyundai dealers and most auto parts outlets. Do not use engine coolant or other types of anti-freeze as these may damage the paint finish.

C160I01A-AAT

### **Don't Let Your Parking Brake Freeze**

Under some conditions your parking brake can freeze in the engaged position. This is most likely to happen when there is an accumulation of snow or ice around or near the rear brakes or if the brakes are wet. If there is a risk the parking brake may freeze, apply it only temporarily while you put the gear selector lever in "P" (automatic) or in first or reverse gear (manual transaxle) and block the rear wheels so the car cannot roll. Then release the parking brake.

C160J01A-AAT

### **Don't Let Ice and Snow Accumulate Underneath**

Under some conditions, snow and ice can build up under the fenders and interfere with the steering. When driving in severe winter conditions where this may happen, you should periodically check underneath the car to be sure the movement of the front wheels and the steering components is not obstructed.

C160K01A-AAT

### **Carry Emergency Equipment**

Depending on the severity of the weather where you drive your car, you should carry appropriate emergency equipment. Some of the items you may want to carry include tire chains, tow straps or chains, flashlight, emergency flares, sand, a shovel, jumper cables, a window scraper, gloves, ground cloth, coveralls, a blanket, etc.

C170A01A-AAT

**HIGHER SPEED MOTORING****Pre-Trip Inspections**

## 1. Tires:

Adjust the tire inflation pressures to specification. Low tire inflation pressures will result in overheating and possible failure of the tires. Avoid using worn or damaged tires which may result in reduced traction or tire failure.

**NOTE:**

Never exceed the maximum tire inflation pressure shown on the tires.



**WARNING:**

- o Underinflated or overinflated tires can cause poor handling, loss of vehicle control, and sudden tire failure leading to accidents, injuries, and even death. Always check tires are properly inflated before driving. Refer to pages 2-22 and 8-3 for proper tire pressures and further information.
- o Driving on tires with no or insufficient tread is dangerous. Worn-out tires can result in loss of vehicle control, collisions, injury, and even death. Worn-out tires should be replaced as soon as possible and should never be used for driving. Always check tire tread before driving your car. Refer to 8-10 for further information and tread limits.

## 2. Fuel, engine coolant and engine oil:

High speed travel consumes more fuel than urban motoring. Do not forget to check both engine coolant and engine oil.

## 3. Drive belt:

A loose or damaged drive belt may result in overheating of the engine.

**TRAILER OR VEHICLE TOWING**

C190A02S-AAT

If you are considering towing with your car, you should first check with your State's Department of Motor Vehicles to determine their legal requirements.

Since laws vary from State to State, the requirements for towing trailers, cars, other types of vehicles, or apparatus may differ. Ask your Hyundai dealer for further details before towing.

**CAUTION:**

Do not do any towing with your car during its first 1,200 miles (2,000 km) in order to allow the engine to properly break in. Failure to heed this caution may result in serious engine or transaxle damage.

C180A01A-AAT

**USE OF LIGHTS**

Check your lights regularly for correct operation and always keep them clean. When driving during the day in conditions of poor visibility, it is helpful to drive with headlights on low beam. This enables you to be seen as well as to see.

C190B01S-AAT

### Trailer Hitches

Select the proper hitch and ball combination, making sure that its location is compatible with that of the trailer or vehicle being towed. Use a quality non-equalizing hitch which distributes the tongue load uniformly throughout the chassis.

The hitch should be bolted securely to the car and installed by a qualified technician. DO NOT USE A HITCH DESIGNED FOR TEMPORARY INSTALLATION AND NEVER USE ONE THAT ATTACHES ONLY TO THE BUMPER.

C190C03S-AAT

### Trailer Brakes

If your trailer is equipped with a braking system, make sure it conforms to federal and/or local regulations and that it is properly installed and operating correctly.

#### NOTE:

**If you tow a trailer or vehicle, your car will require more frequent maintenance due to the additional load. See "Maintenance Under Severe Usage Conditions" on page 5-6.**



#### CAUTION:

- o Never connect a trailer brake system directly to the vehicle brake system.
- o When towing a trailer on steep grades (in excess of 6%) pay close attention to the engine coolant temperature gauge to ensure the engine does not overheat. If the needle of the coolant temperature gauge moves across the dial towards "H" (HOT), pull over and stop as soon as it is safe to do so, and allow the engine to idle until it cools down. You may proceed once the engine has cooled sufficiently.

C190D01S-AAT

### Safety Chains

Should the hitch connection between your vehicle and the trailer or vehicle you are towing fail, the trailer or vehicle could wander dangerously across other lanes of traffic and ultimately leave the roadway. To eliminate this potentially dangerous situation, safety chains, attached between your car and the trailer or towed vehicle, are required in most states.

C190E03E-AAT

### Trailer Weight Limit

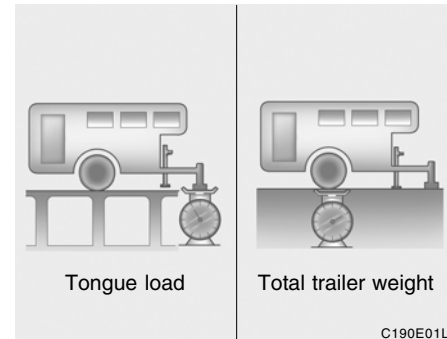

- o Keep the tongue load 10% of the total trailer load.  

$$\frac{\text{Tongue load}}{\text{Total trailer weight}} \times 100 = 10\% \text{ (MAX)}$$
- o Tongue loads can be increased or decreased by redistributing the load in the trailer.  
 This can be verified by checking the total weight of the loaded trailer and then checking the load on the tongue.

**NOTE:**

1. Never load the trailer with more weight in the back than in the front. About 60% of the trailer load should be in the front half on the trailer and the remaining 40% in the rear.
2. The total gross vehicle weight with trailer must not exceed the Gross Vehicle Weight Rating (GVWR) shown on the vehicle identification plate (see page 8-2). The total gross vehicle weight is the combined weight of the vehicle, driver, all passengers and their luggage, cargo, hitch, trailer tongue load and other optional equipment.
3. The front or rear axle weight must not exceed the Gross Axle Weight Rating (GAWR) shown on the vehicle identification plate (see page 8-2). It is possible that your towing package does not exceed the GVWR but exceeds the GAWR. Improper trailer loading and/or too much luggage in the trunk can overload the rear axle. Redistribute the load and check the axle weight again.

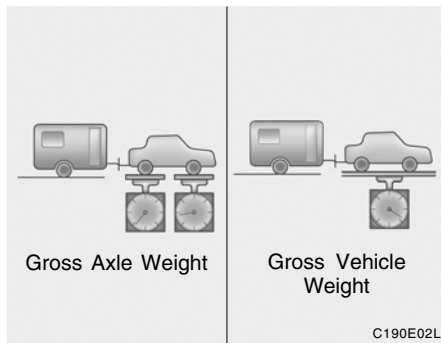
**CAUTION:**

The following specifications are recommended when towing a trailer. The loaded trailer weight cannot safely exceed the values in the following chart.

Lbs. (kg)

	Maximum Towable Weight	
	Trailer	Tongue
With Brake	2000(907)	200(90.7)
Without Brake	1000(453)	100(45.3)

**WARNING:**

- o Improperly loading your vehicle and trailer can seriously affect its steering and braking performance causing a crash which could cause serious injury or death.
- o Towing a trailer affects vehicle handling and braking.
- o Drive more slowly when towing a trailer and allow more distance when braking.
- o Be careful when driving in slippery and windy conditions.
- o Be careful when turning and while driving up and down hills.
- o Do not exceed 45 mph or the posted towing speed limit, whichever is lower.

C190F01S-AAT

## Trailer or Vehicle Towing Tips

1. Before towing, check hitch and safety chain connections as well as proper operation of the trailer running lights, brake lights, and turn signals.
2. Always drive your vehicle at a moderate speed. (Less than 60 mph)
3. Trailer towing requires more fuel than normal conditions.
4. To maintain engine braking efficiency and electrical charging performance, do not use fifth gear (manual transaxle) or overdrive (automatic transaxle).
5. Always secure items in the trailer to prevent load shift while driving.
6. Check the condition and air pressure of all tires on the trailer and your vehicle. Low tire pressure can seriously affect the handling. Also check the spare tire.
7. The vehicle/trailer combination is more affected by crosswind and buffeting. When being passed by a large vehicle, keep a constant speed and steer straight ahead. If there is too much wind buffeting, slow down to get out of the other vehicle's air turbulence.

8. When parking your car and trailer, especially on a hill, be sure to follow all the normal precautions. Turn your front wheel into the curb, set the parking brake firmly, and put the transaxle in 1st or Reverse (manual) or Park (automatic). In addition, place wheel chocks at each of the trailer's tires.
9. If the trailer has electric brakes, start your vehicle and trailer moving, and then apply the trailer brake controller by hand to be sure the brakes are working. This lets you check your electrical connection at the same time.
10. During your trip, occasionally check to be sure that the load is secure, and that the lights and any trailer brakes are still working.
11. Avoid jerky starts, sudden acceleration or sudden stops.
12. Avoid sharp turns and rapid lane changes.
13. Avoid holding the brake pedal down too long or too frequently. This could cause the brakes to overheat, resulting in reduced braking efficiency.
14. When going down a hill, shift into a lower gear and use the engine braking effect. When ascending a long grade, downshift the transaxle to a lower gear and reduce speed to reduce chances of engine overloading and/or overheating.

15. If you have to stop while going uphill, do not hold the vehicle in place by pressing on the accelerator. This can cause the automatic transaxle to overheat. Use the parking brake or footbrake.

### NOTE:

When towing check transaxle fluid more frequently.



### CAUTION:

If overheating should occur when towing, (the temperature gauge reads near the red zone), taking the following actions may reduce or eliminate the problem.

1. Turn off the air conditioner.
2. Reduce highway speed.
3. Select a lower gear when going uphill.
4. While in stop and go traffic, place the gear selector in park or neutral and idle the engine at a higher speed.

## VEHICLE LOAD LIMIT

C190F02E-AAT

## Tire and Loading Information Label

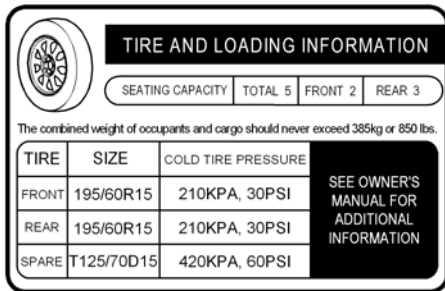

I030A03E

The tire label located on the driver's side of the center pillar outer panel gives the original tire size, cold tire pressures recommended for your vehicle, the number of people that can be in your vehicle and vehicle capacity weight.

**Vehicle capacity weight:**

850 lbs (385 kg)

Vehicle capacity weight is the maximum combined weight of occupants and cargo. If your vehicle is equipped with a trailer, the combined weight includes the tongue load.

**Seating capacity:**

Total: 5 persons

(Front seat: 2 persons,  
Rear seat: 3 persons)

Seating capacity is the maximum number of occupants including a driver, your vehicle may carry. However the seating capacity may be reduced based upon the weight of all of the occupants, and the weight of the cargo being carried or towed. Do not overload the vehicle as there is a limit to the total weight, or load limit including occupants and cargo, the vehicle can carry.

**Towing capacity:**

Towing capacity is the maximum trailer weight including its cargo weight, your vehicle can tow. See the section "Trailer or Vehicle Towing" for specifications about the trailer weight.

**Cargo capacity:**

The cargo capacity of your vehicle will increase or decrease depending on the weight and the number of occupants and the tongue load, if your vehicle is equipped with a trailer.

### Steps for Determining Correct Load Limit

- (1) Locate the statement "The combined weight of occupants and cargo should never exceed XXX pounds" on your vehicle's placard.
- (2) Determine the combined weight of the driver and passengers that will be riding in your vehicle.
- (3) Subtract the combined weight of the driver and passengers from XXX kilograms or XXX pounds.
- (4) The resulting figure equals the available amount of cargo and luggage load capacity. For example, if the "XXX" amount equals 1400 lbs, and there will be five 150 lb. passengers in your vehicle, the amount of available cargo and luggage load capacity is 650 lbs. (1400-750 (5 x 150) = 650 lbs.)
- (5) Determine the combined weight of luggage and cargo being loaded on the vehicle. That weight may not safely exceed the available cargo and luggage load capacity calculated in Step 4.
- (6) If your vehicle will be towing a trailer, load from your trailer will be transferred to your vehicle. Consult this manual to determine how this reduces the available cargo and luggage load capacity of your vehicle.

### Example 1

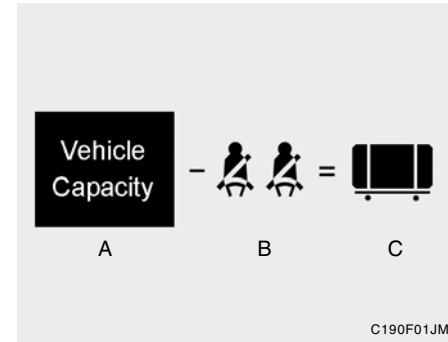

Item	Description	Total
A	Vehicle Capacity Weight	1400 lbs (640 kg)
B	Subtract Occupant Weight 150 lbs (70 kg) × 2	300 lbs (140 kg)
C	Available Cargo and Luggage weight	1100 lbs (500 kg)

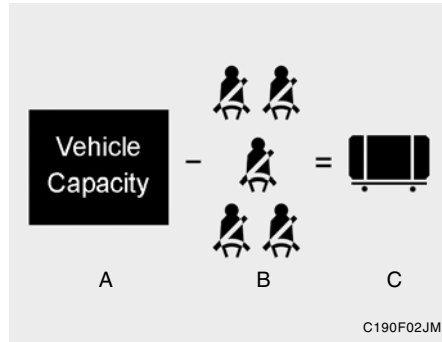
**Example 2**

Item	Description	Total
A	Vehicle Capacity Weight	1400 lbs (640 kg)
B	Subtract Occupant Weight 150 lbs (70 kg) x 5	750 lbs (350 kg)
C	Available Cargo and Luggage Weight	650 lbs (290 kg)

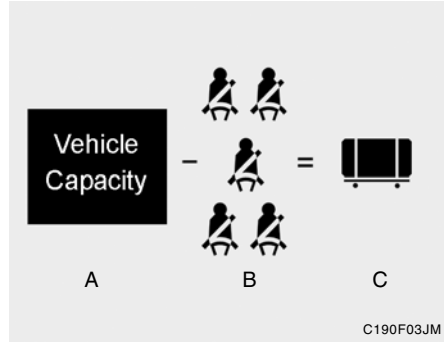
**Example 3**

Item	Description	Total
A	Vehicle Capacity Weight	1400 lbs (640 kg)
B	Subtract Occupant Weight 172 lbs (78 kg) x 5	860 lbs (390 kg)
C	Available Cargo Weight	540 lbs (250 kg)

Refer to your vehicle's tire and loading information label for specific information about your vehicle's capacity weight and seating positions. The combined weight of the driver, passengers and cargo should never exceed your vehicle's capacity weight.

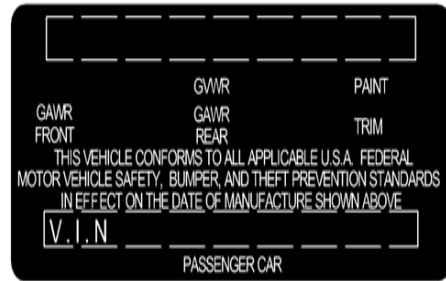

C190G03JM-AAT

**Compliance Label**

C190G01A

The compliance label is located on the driver's side of the center pillar outer panel.

The label shows the maximum allowable weight of the fully loaded vehicle. This is called the GVWR (Gross Vehicle Weight Rating). The GVWR includes the weight of the vehicle, all occupants, fuel and cargo.

This label also tells you the maximum weights that can be supported by the front and rear axles, called Gross Axle Weight Rating (GAWR). To find out the actual loads on your front and rear axles, you need to go to a weigh station and weigh your vehicle. Your dealer can help you with this. Be sure to spread out your load equally on the left and right sides of the centerline.

**WARNING:**

- o **Never exceed the GVWR for your vehicle, the GAWR for either the front or rear axle and vehicle capacity weight. Exceeding these ratings can cause an accident or vehicle damage. You can calculate the weight of your load by weighing the items (or people) before putting them in the vehicle. Be careful not to overload your vehicle.**

**WARNING:**

- o **Do not load your vehicle any heavier than the GVWR, either the maximum front or rear GAWR and vehicle capacity weight. If you do, parts, including tires on your vehicle can break, and it can change the way your vehicle handles and braking ability. This could cause you to lose control and crash. Also, overloading can shorten the life of your vehicle.**

**WARNING:**

- o Overloading your vehicle can cause heat buildup in your vehicle's tires and possible tire failure that could lead to a crash.
- o Overloading your vehicle can cause increased stopping distances that could lead to a crash.
- o A crash resulting from poor handling vehicle damage, tire failure, or increased stopping distances could result in serious injury or death.

**NOTE:**

- o Overloading your vehicle may cause damage. Repairs would not be covered by your warranty. Do not overload your vehicle.
- o Using heavier suspension components to get added durability might not change your weight ratings. Ask your dealer to help you load your vehicle the right way.

The label will help you decide how much cargo and installed equipment your vehicle can carry.

If you carry items inside your vehicle – like suitcases, tools, packages, or anything else – they move as fast as the vehicle goes. If you have to stop or turn quickly, or if there is a crash, the items will keep going and can cause an injury if they strike the driver or a passenger.

**WARNING:**

Items you carry inside your vehicle can strike and injure people in a sudden stop or turn, or in a crash.

- o Put things in the cargo area of your vehicle. Try to spread the weight evenly.
- o Never stack items, like suitcases, inside the vehicle above the tops of the seats.
- o Do not leave an unsecured child restraint in your vehicle.
- o When you carry something inside the vehicle, secure it.
- o Do not drive with a seat folded down unless necessary.

## WHAT TO DO IN AN EMERGENCY

If the Engine will not Start .....	3-2
Jump Starting .....	3-3
If the Engine Overheats .....	3-4
Spare Tire .....	3-5
If You Have a Flat Tire .....	3-6
Changing A Flat Tire .....	3-6
If Your Vehicle Must be Towed .....	3-11
Emergency Towing .....	3-13
If You Lose Your Keys .....	3-13

## IF THE ENGINE WILL NOT START

D010A01A-AAT



### WARNING:

If the engine will not start, do not push or pull the car to start it. This could result in a collision or cause other damage. In addition, push or pull starting may cause the catalytic converter to be overloaded and create a fire hazard.

D010B02A-AAT

### If Engine Doesn't Turn Over or Turns Over Slowly

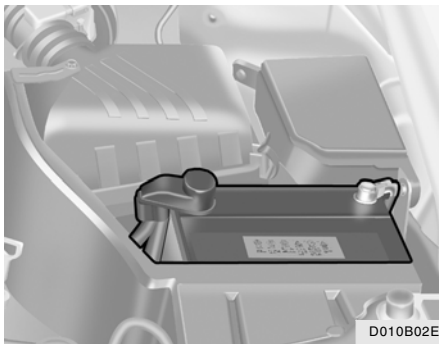

1. If your car has an automatic transaxle, be sure the gear selector lever is in "N" or "P" and the emergency brake is set.
2. Check the battery connections to be sure they are clean and tight.
3. Turn on the interior light. If the light dims or goes out when you operate the starter, the battery is discharged.
4. Check the starter connections to be sure they are securely tightened.
5. Do not push or pull the vehicle to start it. See instructions for "Jump Starting".

D010C02A-AAT

### If Engine Turns Over Normally but Does Not Start

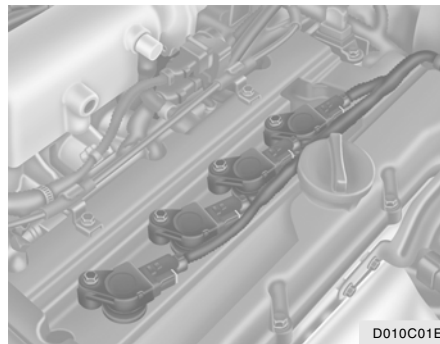

1. Check fuel level.
2. With the key in the "OFF" position, check all connectors at ignition, coils and spark plugs. Reconnect any that may be disconnected or loose.
3. Check the fuel line in the engine compartment.
4. If the engine still does not start, call a Hyundai dealer or seek other qualified assistance.

## JUMP STARTING

D010D01A-AAT

**If the Engine Stalls While Driving**

1. Reduce your speed gradually, keeping a straight line. Move cautiously off the road to a safe place.
2. Turn on your emergency flashers.
3. Try to start the engine again. If your vehicle will not start, contact a Hyundai dealer or seek other qualified assistance.

D020A03A-AAT

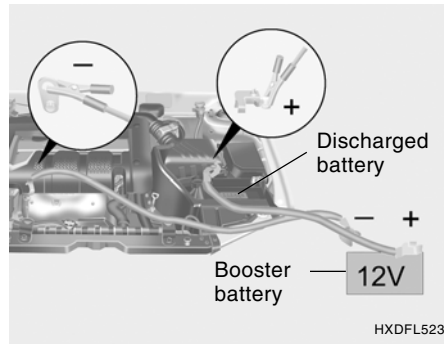

HXDFL523

**WARNING:**

The gas produced by the battery during the jump-start operation is highly explosive. If these instructions are not followed exactly, serious personal injury and damage to the vehicle may occur! If you are not sure how to follow this procedure, seek qualified assistance. Automobile batteries contain sulfuric acid. This is poisonous and highly corrosive. When jump starting, wear protective glasses and be careful not to get acid on yourself, your clothing or on the car.

- o If you should accidentally get acid on your skin or in your eyes, immediately remove any contaminated clothing and flush the area with clean water for at least 15 minutes. Then promptly obtain medical attention. If you must be transported to an emergency facility, continue to apply water to the affected area with a sponge or cloth.
- o The gas produced by the battery during the jump-start operation is highly explosive. Do not smoke or allow a spark or an open flame in the vicinity.
- o The battery being used to provide the jump start must be 12-volt. If you cannot determine that it is a 12-volt battery, do not attempt to use it for the jump start.
- o To jump start a car with a discharged battery, follow this procedure exactly:
  1. If the booster battery is installed in another vehicle, be sure the two vehicles are not touching.
  2. Turn off all unnecessary lights and accessories in both vehicles.
  3. Attach the clamps of the jumper cable in the exact location shown in the illustration. First, attach one clamp of the jumper cable to the positive (+) post or cable of the discharged battery. Then attach the other end of the same cable to the positive (+) post or cable of the booster battery.

Next, using the other cable, attach one clamp to the negative (-) post or cable of the booster battery. Then attach the other end of that cable to a solid metal part of the engine of the vehicle with the discharged battery away from the battery. Do not connect the cable to any moving part.

4. Start the engine in the car with the booster battery and let it run for a few minutes. This will help to assure that the booster battery is fully charged. During the jumping operation, run the engine in this vehicle at about 2,000 rpm.
5. Start the engine in the car with the discharged battery using the normal starting procedure. After the engine starts, leave the jumper cables connected and let the engine run at fast idle or about 2,000 rpm for several minutes.
6. Carefully remove the jumper cables in the reverse order of attachment.

If you do not know why your battery became discharged (because the lights were left on, etc.), have the charging system checked by your Hyundai dealer.

## IF THE ENGINE OVERHEATS

D030A01A-AAT

If your temperature gauge indicates overheating, you experience a loss of power, or hear loud pinging or knocking and the engine is probably too hot. If this happens and, you should:

1. Pull off the road and stop as soon as it is safe to do so.
2. Place the gear selector lever in "P" (automatic) or neutral (manual transaxle) and set the parking brake. If the air conditioning is on, turn it off.
3. If engine coolant is running out under the car or steam is coming out from the hood, stop the engine. Do not open the hood until the engine coolant has stopped running or the steaming has stopped. If there is no visible loss of engine coolant and no steam, leave the engine running and check to be sure the engine cooling fan is operating. If the fan is not running, turn the engine off.
4. Check to see if the water pump drive belt is missing. If it is not missing, check to see that it is tight. If the drive belt seems to be satisfactory, check for engine coolant leaking from the radiator, hoses or under the car. (If the air conditioning had been in use, it is normal for cold water to be draining from it when you stop).



### WARNING:

**While the engine is running, keep hair, hands, and clothing away from moving parts such as the fan and drive belts to prevent injury.**

5. If the water pump drive belt is broken or engine coolant is leaking out, stop the engine immediately and call the nearest Hyundai dealer for assistance.



### WARNING:

**Do not remove the radiator cap when the engine is hot. This can allow coolant to be blown out of the opening and cause serious burns.**

6. If you cannot find the cause of the overheating, wait until the engine temperature has returned to normal. Then, if coolant has been lost, carefully add coolant to the reservoir (page 6-8) to bring the fluid level in the reservoir up to the halfway mark.
7. Proceed with caution, keeping alert for further signs of overheating. If overheating happens again, call a Hyundai dealer for assistance.

**CAUTION:**

Serious loss of engine coolant indicates there is a leak in the cooling system and this should be checked as soon as possible by a Hyundai dealer.

**SPARE TIRE**

D040A01E-AAT

**TEMPORARY SPARE TIRE**

The following instructions for the temporary spare tire should be observed:

1. Check inflation pressure as soon as possible after installing the spare tire, and adjust to the specified pressure. The tire pressure should be periodically checked and maintained at the specified pressure while the tire is stored.

**Spare Tire Pressure**

Tire Size	T125/70D(R)15
Inflation Pressure	60 psi (420 kPa)

2. The spare tire should only be used temporarily and should be returned to the luggage compartment as soon as the original tire can be repaired or replaced.
3. Continuous use at speeds of over 50 mph (80 km/h) is not recommended.

4. As the temporary spare tire is specifically designed for your car, it should not be used on any other vehicle.
5. The temporary spare tire should not be used on any other wheels, nor should standard tires, snow tires, wheel covers or trim rings be used with the temporary spare wheel. If such use is attempted, damage to these items or other car components may occur.
6. The temporary spare tire pressure should be checked once a month while the tire is stored.

**CAUTION:**

- o Do not use snow chains with your temporary spare tire.
- o Do not use more than one temporary spare tire at a time.
- o Do not tow a trailer while the temporary spare tire is installed.

D040B01A-AAT

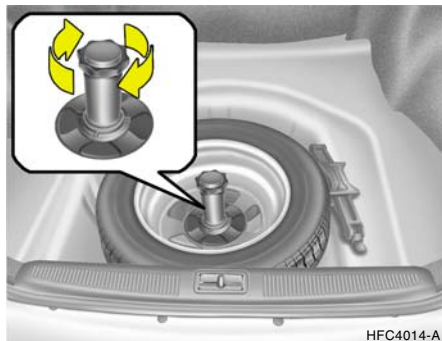
**Handling the Spare Tire**

HFC4014-A

Remove the installation bolt to remove the spare tire. To replace the spare tire in its storage compartment, tighten the bolt firmly with your fingers until there is no more play in the spare tire.

**IF YOU HAVE A FLAT TIRE**

D050A01A-AAT

If a tire goes flat while you are driving:

1. Take your foot off the accelerator pedal and let the car slow down while driving straight ahead. Do not apply the brakes immediately or attempt to pull off the road as this may cause a loss of control. When the vehicle has slowed to such a speed that it is safe to do so, brake carefully and pull off the road. Drive off the road as far as possible and park on firm, level ground. If you are on a divided highway, do not park in the median area between the two traffic lanes.
2. When the vehicle is stopped, turn on your emergency hazard flashers, set the parking brake and put the transaxle in "P" (automatic) or "R" (manual transaxle).
3. Have all passengers get out of the vehicle. Be sure they all get out on the side of the car that is away from traffic.
4. Change the tire following the instructions provided on the following pages.

**CHANGING A FLAT TIRE**

D060A01A-AAT



D060A01E

The procedure described on the following pages can be used to rotate tires as well as to change a flat tire. When preparing to change a flat tire, check to be sure the gear selector lever is in "P" (automatic) or reverse gear (manual transaxle) and that the parking brake is set, then:

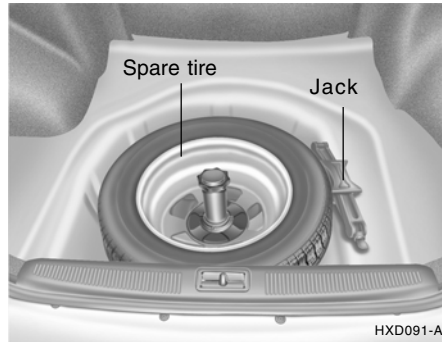

D060B01E-AAT

**1. Obtain Spare Tire and Tool**

Remove the spare tire and take out the jack and tool bag from the trunk.

**NOTE:**

**The jack is located beneath the luggage mat in the vehicle trunk.**

D060C01A-AAT

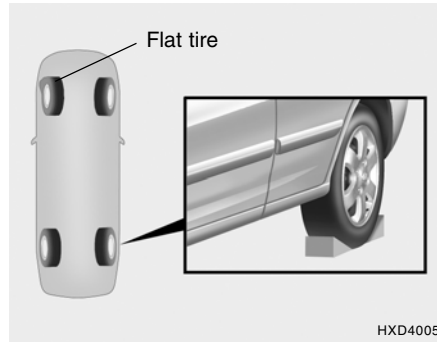
**2. Block the Wheel**

Block the wheel that is diagonally opposite from the flat to keep the vehicle from rolling when the vehicle is raised on the jack.

D060D02A-AAT

**3. Loosen Wheel Nuts**

The wheel nuts should be loosened slightly before raising the car. To loosen the nuts, turn the wrench handle counterclockwise. When doing this, be sure that the socket is seated completely over the nut so it cannot slip off. For maximum leverage, position the wrench so the handle is to the right as shown in the drawing. Then, while holding the wrench near the end of the handle, push down on it with steady pressure. Do not remove the nuts at this time. Just loosen them about one-half turn.

D060E01A-AAT

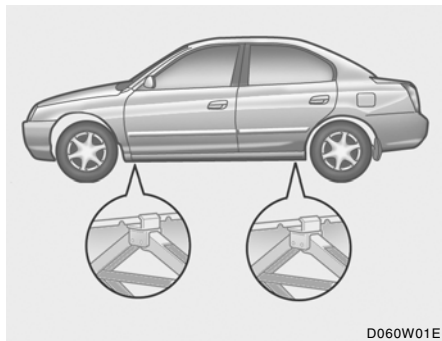
**4. Put the Jack in Place**

D060W01E

The base of the jack should be placed on firm, level ground. The jack should be positioned as shown in the drawing.

D060F03E-AAT

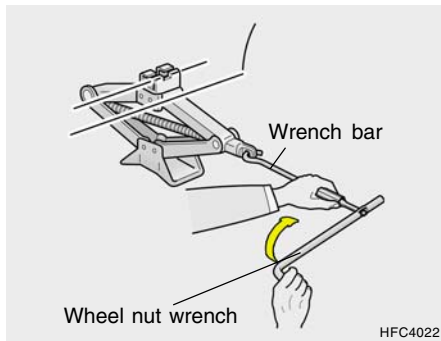
**5. Raising the Vehicle**

HFC4022

After inserting a wrench bar into the wheel nut wrench, install the wrench bar into the jack as shown in the drawing. To raise the vehicle, turn the wheel nut wrench clockwise. As the jack begins to raise the vehicle, double check that it is properly positioned and will not slip. If the jack is on soft ground or sand, place a board, brick, flat stone or other object under the base of the jack to keep it from sinking.

Raise the car high enough so that the fully inflated spare tire can be installed. To do this, you will need more ground clearance than is required to remove the flat tire.

**WARNING:**

**Do not get under the vehicle when it is supported by the jack! This is very dangerous as the vehicle could fall and cause serious injury or death. No one should stay in the vehicle while the jack is being used.**

D060G03Y-AAT

## 6. Changing Wheels

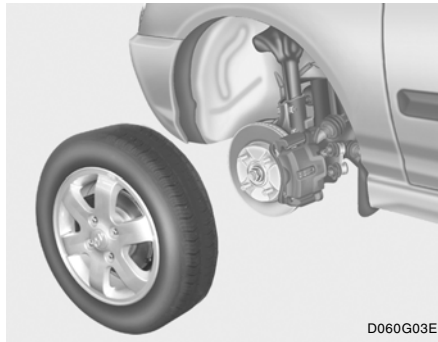

Loosen the wheel nuts and remove them with your fingers. Slide the wheel off the studs and lay it flat so it cannot roll away. To put the wheel on the hub, pick up the spare tire, line up the holes with the studs and slide the wheel onto them. If this is difficult, tip the wheel slightly and get the top hole in the wheel lined up with the top stud. Then jiggle the wheel back and forth until the wheel can be slid over the other studs.

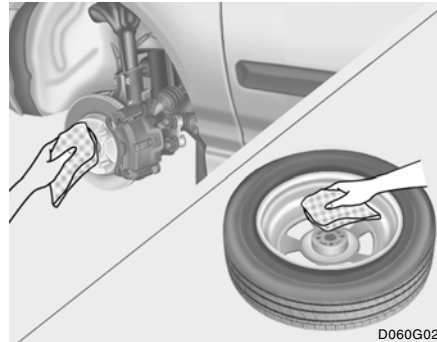

**!** **WARNING:**  
 If the vehicle has been driven recently, some pieces may be very hot. Use caution.

**!** **WARNING:**  
 Wheel and wheel covers may have sharp edges. Handle them carefully to avoid possible severe injury. Before putting the wheel into place, be sure that there is nothing on the hub or wheel (such as mud, tar, gravel, etc.) that interferes with the wheel from fitting solidly against the hub. If there is, remove it. If there is not good contact on the mounting surface between the wheel and hub, the wheel nuts could loosen and cause the loss of a wheel. Loss of a wheel may result in loss of control of the vehicle. This may cause serious injury or death.

D060H02A-AAT

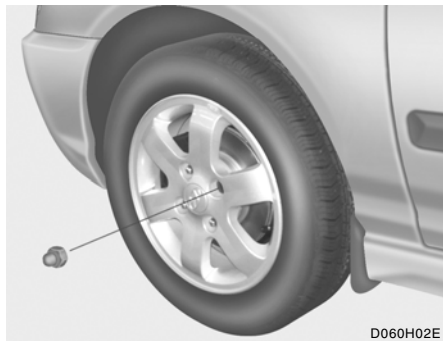
**7. Reinstall Wheel Nuts**

To reinstall the wheel cover, hold it on the studs, put the wheel nuts on the studs and tighten them finger tight. The nuts should be installed with their small diameter ends directed inward. Jiggle the tire to be sure it is completely seated, then tighten the nuts as much as possible with your fingers again.

D060I01E-AAT

**8. Lower Vehicle and Tighten Nuts**

Lower the car to the ground by turning the wheel nut wrench counterclockwise. Then position the wrench as shown in the drawing and tighten the wheel nuts. Be sure the socket is seated completely over the nut. Do not stand on the wrench handle or use an extension pipe over the wrench handle. Go around the wheel tightening every other nut until they are all tight. Then double-check each nut for tightness.

After changing wheels, have a technician tighten the wheel nuts to their proper torque as soon as possible.

**Wheel nut tightening torque:**

Steel wheel & aluminium alloy wheel:  
65-80 lb.ft (900-1,100 kg.cm)

D060J01E-AAT

**After Changing Wheels**

HXDFL4007

If you have a tire gauge, remove the valve cap and check the air pressure. If the pressure is lower than recommended, drive slowly to the nearest service station and inflate to the correct pressure. If it is too high, adjust it until it is correct. Always reinstall the valve cap after checking or adjusting tire pressure. If the cap is not replaced, air may leak from the tire. If you lose a valve cap, buy another and install it as soon as possible.

After you have changed wheels, always secure the flat tire in its place in the trunk and return the jack and tools to their proper storage locations.

**IF YOUR VEHICLE MUST BE TOWED**

D080A01O-GAT

If your vehicle has to be towed, it should be done by your Hyundai dealer or a commercial tow truck service. This will help assure that your vehicle is not damaged in towing. Also, professionals are generally aware of local laws governing towing. In any case, rather than risk damage to your car, it is suggested that you show this information to the tow truck operator. Be sure that a safety chain system is used and that all local laws are observed.

It is recommended that your vehicle be towed with a wheel lift and dollies or flatbed equipment with all the wheels off the ground.

**CAUTION:**

- o Your vehicle can be damaged if towed incorrectly!
- o Be sure the transaxle is in neutral.
- o When the engine will not start, be sure the steering is unlocked by placing the key in the "ACC" position.

D080B01O-GAT

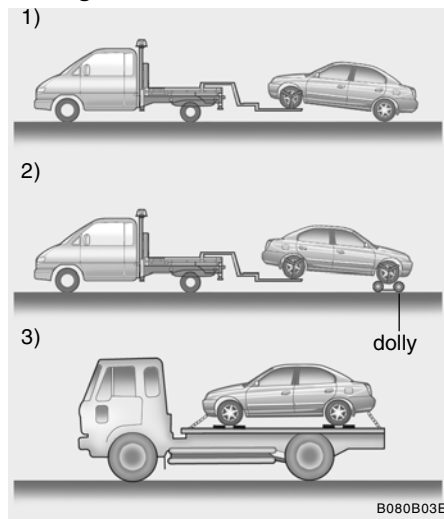
**Towing the Vehicle**

Your vehicle can be towed by wheel lift type truck (1), (2) or flatbed equipment (3).

**CAUTION:**

- o When towing the vehicle, take care not to cause damage to the bumper or underbody of the vehicle.

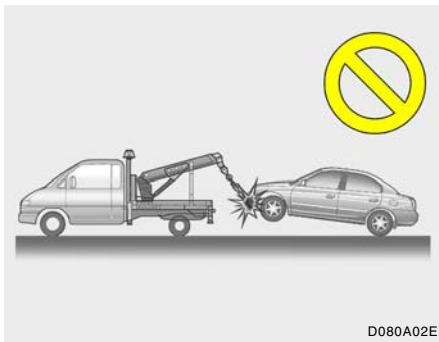

- o Do not tow with sling type truck as this may cause damage to the bumper or underbody of the vehicle.

- 1) If the vehicle is being towed with the rear wheels on the ground, be sure the parking brake is released.

**NOTE:**

Before towing, check the level of the automatic transaxle fluid. If it is below the "HOT" range on the dipstick, add fluid. If you cannot add fluid, a towing dolly must be used.

- 2) If any of the loaded wheels or suspension components are damaged or the vehicle is being towed with the front wheels on the ground, use a towing dolly under the front wheels.

- o Manual Transaxle:  
If you do not use a towing dolly, place the ignition key in the "ACC" position and put the transaxle in "N (Neutral)".

**CAUTION:**

Do not tow with the key removed or in the "LOCK" position when towing from the rear without a towing dolly.

## EMERGENCY TOWING

- o Automatic Transaxle:  
Be sure to use a towing dolly under the front wheels.

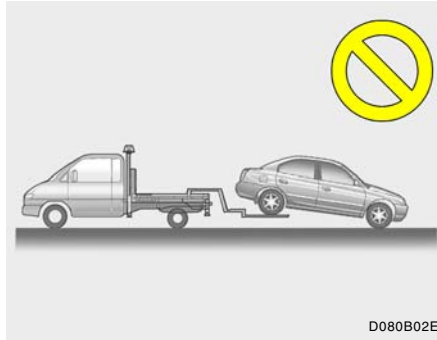
**CAUTION:**

**A vehicle with an automatic transaxle should never be towed from the rear with the front wheels on the ground. This can cause serious damage to the transaxle.**

- 3) It is recommended that your vehicle be towed with all the wheels off the ground.

D080D04A-AAT

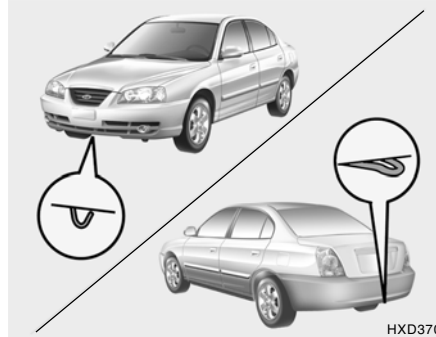

For emergency towing when no commercial tow vehicle is available, attach a tow cable, chain or strap to one of the towing hooks under the front/rear of your vehicle. Do not attempt to tow your vehicle in this manner on any unpaved surface. This could result in serious damage to your vehicle.

Nor should towing be attempted if the wheels, drive train, axles, steering or brakes are damaged. Before towing, be sure the transaxle is in neutral and the key is in "ACC" (with the engine off) or in the "ON" position (with the engine running). A driver must be in the towed vehicle to steer it and operate the brakes.

**NOTE:**

Before towing, check the level of the automatic transaxle fluid. If it is below the "HOT" range on the dipstick, add fluid. If you cannot add fluid, a towing dolly must be used.

**CAUTION:**

If the car is being towed with all four wheels on the ground, it can be towed only from the front. Be sure that the transaxle is in neutral. Do not tow at speeds greater than 30 mph (50 km/h) and for more than 15 miles (25 km). Be sure the steering is unlocked by placing the key in the "ACC" position. A driver must be in the towed vehicle to operate the steering and brakes.

**IF YOU LOSE YOUR KEYS**

D120A01A-AAT

If you lose your keys, many Hyundai dealers can make you a new key if you have your key number.

If you lock the keys inside your vehicle and you cannot obtain a new key, many Hyundai dealers can use special tools to open the door for you.



## CORROSION PREVENTION & APPEARANCE CARE

Corrosion Protection .....	4-2
To Help Prevent Corrosion .....	4-2
Washing and Waxing .....	4-3
Cleaning the Interior .....	4-5

# 4

## CORROSION PROTECTION

E010A01A-AAT

**Protecting Your Hyundai from Corrosion**

By using the most advanced design and construction practices to combat corrosion, Hyundai produces cars of the highest quality. However, this is only part of the job. To achieve long-term corrosion resistance your Hyundai can deliver, the owner's cooperation and assistance is also required.

E010B01A-AAT

**Common Causes of Corrosion**

The most common causes of corrosion on your car are:

- o Road salt, dirt and moisture that is allowed to accumulate underneath the car.
- o Removal of paint or protective coatings by stones, gravel, abrasion or minor scrapes and dents which leave unprotected metal exposed to corrosion.

E010C01A-AAT

**High-Corrosion Areas**

If you live in an area where your car is regularly exposed to corrosive materials, corrosion protection is particularly important. Some of the common causes of accelerated corrosion are road salts, dust control chemicals, ocean air and industrial pollution.

E010D01A-AAT

**Moisture Breeds Corrosion**

Moisture creates the conditions in which corrosion is most likely to occur. For example, corrosion is accelerated by high humidity, particularly when temperatures are just above freezing. In such conditions, the corrosive material is kept in contact with the car surfaces by moisture that is slow to evaporate.

Mud is particularly corrosive because it is slow to dry and holds moisture in contact with the vehicle. Although the mud appears to be dry, it can still retain the moisture and promote corrosion.

High temperatures can also accelerate corrosion of parts that are not properly ventilated so the moisture can be dispersed. For all these reasons, it is particularly important to keep your car clean and free of mud or accumulations of other materials. This applies not only to the visible surfaces but particularly to the underside of the car.

## TO HELP PREVENT CORROSION

E020A01A-AAT

You can help prevent corrosion from getting started by observing the following:

E020B01A-AAT

**Keep Your Car Clean**

The best way to prevent corrosion is to keep your car clean and free of corrosive materials. Attention to the underside of the car is particularly important.

- o If you live in a high-corrosion area — where road salts are used, near the ocean, areas with industrial pollution, acid rain, etc.—, you should take extra care to prevent corrosion. In winter, hose off the underside of your car at least once a month and be sure to clean the underside thoroughly when winter is over.
- o When cleaning underneath the car, give particular attention to the components under the fenders and other areas that are hidden from view. Do a thorough job; just dampening the accumulated mud rather than washing it away will accelerate corrosion rather than prevent it. Water under high pressure and steam are particularly effective in removing accumulated mud and corrosive materials.

- o When cleaning lower door panels, rocker panels and frame members, be sure that drain holes are kept open so that moisture can escape and not be trapped inside to accelerate corrosion.

E020C01A-AAT

### Keep Your Garage Dry

Don't park your car in a damp, poorly ventilated garage. This creates a favorable environment for corrosion. This is particularly true if you wash your car in the garage or drive it into the garage when it is still wet or covered with snow, ice or mud. Even a heated garage can contribute to corrosion unless it is well ventilated so moisture is dispersed.

E020D02A-AAT

### Keep Paint and Trim in Good Condition

Scratches or chips in the finish should be covered with "touch-up" paint as soon as possible to reduce the possibility of corrosion. If bare metal is showing through, the attention of a qualified body and paint shop is recommended.

**Bird droppings :** Bird droppings are highly corrosive and may damage painted surfaces in just a few hours. Always remove bird droppings as soon as possible.

E020E01A-AAT

### Don't Neglect the Interior

Moisture can collect under the floor mats and carpeting to cause corrosion. Check under the mats periodically to be sure the carpeting is dry. Use particular care if you carry fertilizers, cleaning materials or chemicals in the car. These should be carried only in proper containers and any spills or leaks should be cleaned up, flushed with clean water and thoroughly dried.

E030A01A-AAT

### Washing Your Hyundai

Never wash your car when the surface is hot from being in the sun. Always wash your car in the shade.

Wash your car frequently. Dirt is abrasive and can scratch the paint if it is not removed. Air pollution or acid rain may damage the paint and trim through chemical action if pollutants are allowed to remain in contact with the surface. If you live near the ocean or in an area where road salts or dust control chemicals are used, you should pay particular attention to the underside of the car. Start by rinsing the car to remove dust and loose dirt. In winter, or if you have driven through mud or muddy water, be sure to thoroughly clean the underside as well. Use a hard direct stream of water to remove accumulated mud or corrosive materials. Use a good quality car-washing solution and follow the manufacturer's directions on the package. These are available at your Hyundai dealer or auto parts outlet. Don't use strong household detergents, gasoline, strong solvents or abrasive cleaning powders as these may damage the finish.

Use a clean sponge or cloth, rinse it frequently and don't damage the finish by rubbing too hard. For stubborn spots, dampen them frequently and remove them a little at a time.

To clean whitewall tires, use a stiff brush or soapy steel-wool scouring pad.

To clean plastic wheel covers, use a clean sponge or soft cloth and water.

To clean cast aluminum alloy wheels, use a mild soap or neutral detergent. Do not use abrasive cleaners. Protect the bare-metal surfaces by cleaning, polishing and waxing. Because aluminum is subject to corrosion, be sure to give aluminum alloy wheels special attention in winter. If you drive on salted roads, clean the wheels thoroughly afterwards.

After washing, be sure to rinse thoroughly. If soapy water dries on the finish, streaking will result.

When the weather is warm and the humidity low, you may find it necessary to rinse each section immediately after washing to avoid streaking.

After rinsing, dry the car using a damp chamois or soft, absorbent cloth. The reason for drying the car is to remove water from the car so it will dry without water spots. Don't rub, this can damage the finish.

If you find any nicks or scratches in the paint, use touch-up paint to cover them to prevent corrosion. To protect the paintwork of the car against corrosion, you must clean your Hyundai (at least once a month). Give special attention to the removal of salt, mud and other substances on the underside of the splashboards of the car. Make sure that the outlets and the underside of the doors are open. Paint damage can be caused by small accumulation of tar, industrial precipitation, tree resin, insects and bird droppings, when not removed immediately. If water alone is not strong enough to remove the accumulated dirt, use a mild car washing solution. Be sure to rinse the surface after washing to remove the solution. Never allow the solution to dry on the painted surfaces.

E030B01A-AAT

### Spot Cleaning

Don't use gasoline, strong solvents or corrosive cleaning agents. These can damage the finish of the car. To remove road tar, use turpentine on a clean, soft cloth or commercially available bug and tar remover. Be gentle.

To remove dead insects or tree sap, use warm water and mild soap or car-washing solution. Soak the spot and rub gently. If the paint has lost its luster, use a commercial car-cleaning polish.

E030C01A-AAT

### Polishing and Waxing

Always wash and dry the car before polishing or waxing or using a combination cleaner and wax. Use a good quality commercial product and follow the manufacturer's directions on the container. Polish and wax the bright trim pieces as well as the paint.

## CLEANING THE INTERIOR

E030D01A-AAT

### When to Wax Again

You should polish and wax the car again when water no longer beads on a clean surface but spreads out over a larger area.

E030E01A-AAT

### Maintaining Bumpers

Special precautions must be observed to preserve the appearance of the bumpers on your Hyundai. They are:

- o Be careful not to spill battery electrolyte or hydraulic brake fluid on the bumpers. If you do, wash it off immediately with clear water.
- o Be gentle when cleaning the bumper surfaces. They are made of soft plastic and the surface can be damaged if mistreated. Do not use abrasive cleaners. Use warm water and mild soap or car-washing solution.
- o Do not expose the bumpers to high temperatures. For example, if you have your car repainted, do not leave the bumpers on the car if the car is going to be placed in a high-temperature paint booth.

E040A01A-AAT

### To Clean the Vinyl Upholstery

To clean the vinyl upholstery, first remove loose dirt and dust with a vacuum cleaner. Then apply a solution of mild soap or detergent and water using a clean sponge or soft cloth. Allow this to stay on the surface to loosen the dirt, then wipe with a clean damp sponge or cloth. If all the dirt stains are not removed, repeat this procedure until the upholstery is clean. Do not use gasoline, solvent, paint thinner or other strong cleaners.

E040C01A-AAT

### Cleaning the Carpets

Use a foam-type carpet cleaner. Cleaners of this type are available in aerosol cans in liquid form or powder. Read the instructions and follow them exactly. Using a vacuum cleaner with the appropriate attachment, remove as much dirt from the carpets as possible. Apply the foam following the manufacturer's directions, then rub in overlapping circles. Do not add water. These cleaners work best when the carpet is kept as dry as possible.

E040D01A-AAT

### Cleaning the Seat Belts

To clean the seat belts, use a cloth or sponge with mild soap or detergent and warm water. Do not use strong detergents, dye, bleach or abrasive materials on the seat belts as this may weaken the fabric.

While cleaning the belts, inspect them for excessive wear, cuts, fraying or other signs of damage and replace them if necessary.

E040E01A-AAT

### Cleaning the Windows

You may use any household window cleaner on the windows. However, when cleaning the inside of the rear window be careful not to damage the rear window defroster wiring.

E050A01A-AAT

### Any Questions?

If you have any questions about the care of your car, consult your Hyundai dealer.

## VEHICLE MAINTENANCE REQUIREMENTS

Maintenance Intervals .....	5-2
Scheduled Maintenance .....	5-4
Maintenance under Severe Usage Conditions .....	5-6
Explanation of Scheduled Maintenance Items .....	5-7

## MAINTENANCE INTERVALS

F010A01A-AAT

### Service Requirements

To ensure that you receive the greatest number of miles of satisfying operation from your Hyundai, certain maintenance procedures must be performed. Although careful design and engineering have reduced these to a minimum, those that are required are of the utmost importance.

It is your responsibility to have these maintenance procedures performed to comply with the terms of the warranties covering your new Hyundai. The Owner's Handbook supplied with your new vehicle provides further information about these warranties.

F010B01A-AAT

### Maintenance Requirements

The maintenance required for your Hyundai can be divided into three main areas:

- o Specified scheduled procedures
- o General checks
- o Do-it-yourself maintenance

F010C01A-AAT

### Specified Scheduled Procedures

These are the procedures such as inspections, adjustments and replacements that are listed in the maintenance charts starting on page 5-4. These procedures must be performed at the intervals shown in the maintenance schedule to assure that your warranty remains in effect.

Although it is strongly recommended that they be performed by the trained technicians at your Hyundai dealer, these procedures may be performed at any qualified service facility.

It is suggested that genuine Hyundai service parts be used for any required repairs or replacements. Other parts of equivalent quality such as engine oil, engine coolant, manual or auto transaxle oil, brake fluid and so on which are not supplied by Hyundai Motor Company or its distributor may be used without affecting your warranty coverage but you should always be sure these are equivalent to the quality of the original Hyundai parts. Your Owner's Handbook provides further information about your warranty coverage.

F010D01A-AAT

### General Checks

These are the regular checks you should perform when you drive your Hyundai or you fill the fuel tank. A list of these items will be found on page 6-3.

F010E01A-AAT

### Do-It-Yourself Maintenance

If you are mechanically inclined, own a few tools that are required and want to take the time to do so, you can inspect and service a number of items. For more information about doing it yourself, see Section 6.

F010F01A-AAT

**A Few Tips**

- o Whenever you have your Hyundai serviced, keep copies of the service records in your glove box. This will help assure you can document the required procedures being performed to keep your warranties in effect. This is especially important when service is not performed by an authorized Hyundai dealer.
- o If you choose to do your own maintenance and repairs, you may find it helpful to have an official Hyundai Shop Manual. A copy of this publication may be purchased at your Hyundai dealer's parts department.

F020A02S-AAT

**SCHEDULED MAINTENANCE  
REQUIREMENTS**

- o Inspection should be performed any time a malfunction is experienced or suspected.
- o Receipts for all emission control system services should be retained to demonstrate compliance with conditions of the emissions system warranty.
- o After 120 months or 150,000 miles (240,000 km), continue to follow the prescribed maintenance intervals.
- o For severe usage maintenance requirements, see page 5-6 of this section.



**SCHEDULED MAINTENANCE**

F030A02A-AAT

The following maintenance services must be performed to ensure good emission control and performance. Keep receipts for all vehicle emission services to protect your emission warranty. Where both mileage and time are shown, the frequency of service is determined by whichever occurs first.

F030B06E-AAT

R :Replace I : Inspect and, after inspection, clean, adjust, repair or replace if necessary.

No.	DESCRIPTION	MILES X 1000	7.5	15	22.5	30	37.5	45	52.5	60	67.5	75	82.5	90	97.5	105	112.5	120	127.5	135	142.5	150
		KILOMETERS X 1000	12	24	36	48	60	72	84	96	108	120	132	144	156	168	180	192	204	216	228	240
		MONTHS	6	12	18	24	30	36	42	48	54	60	66	72	78	84	90	96	102	108	114	120
EMISSION CONTROL ITEMS																						
1	ENGINE OIL AND FILTER		R	R	R	R	R	R	R	R	R	R	R	R	R	R	R	R	R	R	R	R
2	FUEL FILTER								R							R						
3	FUEL LINES, FUEL HOSES AND CONNECTIONS					I				I				I				I				I
	INSULATOR OF FUEL INJECTOR (2.0 L SULEV Only)					I*				R				I*				R				I*
4	VACUUM AND CRANKCASE VENTILATION HOSES								I							I						
5	VAPOR HOSE AND FUEL FILLER CAP					I				I				I				I				I
6	AIR CLEANER FILTER					R				R				R				R				R
7	FUEL TANK AIRFILTER			I		R		I		R		I		R		I		R		I		R
8	SPARK PLUGS	PLATINUM COATED (2.0L CVVT)								R								R				
		IRIDIUM COATED (2.0L SULEV)	See Note *2																			
9	SPARK PLUG CABLE (2.0 L SULEV Only)	See Note *3																				
10	VALVE CLEARANCE									I								I				

Note : \*1 - IN CASE OF REMOVING INJECTOR FOR INSPECTION, IF AN INJECTOR IS REMOVED FOR INSPECTION, THE INSULATOR AND O-RING OF THE INJECTOR SHOULD BE REPLACED WITH NEW PARTS.

\*2 - REPLACE EVERY 100,000 MILES (160,000 KM) OR 10 YEARS.

\*3 - INSPECT EVERY 60,000 MILES (96,000 KM) OR 5 YEARS AND REPLACE IF NECESSARY.

F030C06E-AAT

R : Replace I : Inspect and, after inspection, clean, adjust, repair or replace if necessary

No.	DESCRIPTION	MILES X 1000	7.5	15	22.5	30	37.5	45	52.5	60	67.5	75	82.5	90	97.5	105	112.5	120	127.5	135	142.5	150	
		KILOMETERS X 1000	12	24	36	48	60	72	84	96	108	120	132	144	156	168	180	192	204	216	228	240	
		MONTHS	6	12	18	24	30	36	42	48	54	60	66	72	78	84	90	96	102	108	114	120	
GENERAL ITEMS																							
1	DRIVE BELT (WATER PUMP, ALTERNATOR AND A/CON)				I					I					I				I				I
2	COOLANT				R					R					R				R				R
3	TIMING BELT				I					R					I				R				I
4	MANUAL TRANSAXLE OIL				I					I					I				I				I
5	AUTOMATIC TRANSAXLE FLUID		I		I		I		I		I		I		I	R		I		I		I	I
6	BRAKE FLUID				I					I					I				I				I
7	BRAKE HOSES AND LINES		I		I		I		I		I		I		I		I		I		I		I
8	REAR BRAKE DRUMS/LININGS, PARKING BRAKE				I					I					I				I				I
9	BRAKE PADS, CALIPERS AND ROTORS		I		I		I		I		I		I		I		I		I		I		I
10	EXHAUST PIPE AND MUFFLER		I		I		I		I		I		I		I		I		I		I		I
11	CYLINDER HEAD COVER GASKET (2.0L SULEV Only)	See Note *1																					
12	OIL PAN LIQUID GASKET (2.0L SULEV Only)	See Note *1																					
13	IN-MANI GASKET (2.0L SULEV Only)															I							
14	SUSPENSION MOUNTING BOLTS		I		I		I		I		I		I		I		I		I		I		I
15	STEERING GEAR BOX, LINKAGE & BOOTS/LOWER ARM BALL JOINT		I		I		I		I		I		I		I		I		I		I		I
16	POWER STEERING PUMP, BELT AND HOSES				I				I						I				I				I
17	DRIVESHAFTS AND BOOTS		I		I		I		I		I		I		I		I		I		I		I
18	AIR CONDITIONING REFRIGERANT		I		I		I		I		I		I		I		I		I		I		I
19	CLIMATE CONTROL AIR FILTER (IN FRONT OF BLOWER UNIT)	See Note *2																					
20	THERMOSTAT	See Note *1																					

Note : \*1 - AFTER 105,000 MILES (168,000 KM) OR 84 MONTHS, INSPECT EVERY 15,000 MILES (24,000 KM) OR 12 MONTHS.

\*2 - FOR EVERY 10,000 MILES (15,000 KM) OR 12 MONTHS, WHICHEVER OCCURS FIRST: R

**MAINTENANCE UNDER SEVERE USAGE CONDITIONS**

F040A04E-AAT

The following items must be serviced more frequently on cars normally used under severe driving conditions. Refer to the chart below for the appropriate maintenance intervals.

R : Replace      I : Inspect and, after inspection, clean, adjust, repair or replace if necessary

MAINTENANCE ITEM	MAINTENANCE OPERATION	MAINTENANCE INTERVALS	DRIVING CONDITION
ENGINE OIL AND FILTER	R	EVERY 3,000 MILES (4,800 KM) OR 3 MONTHS	A, B, C, D, E, F, G, H, I, K
AIR CLEANER FILTER	R	MORE FREQUENTLY	C, E
SPARK PLUGS	R	MORE FREQUENTLY	B, H
BRAKE PADS, CALIPERS AND ROTORS	I	MORE FREQUENTLY	C, D, G, H
REAR BRAKE DRUMS/LININGS/PADS, PARKING BRAKE	I	MORE FREQUENTLY	C, D, G, H
STEERING GEAR RACK, LINKAGE & BOOTS/ LOWER ARM BALL JOINT	I	MORE FREQUENTLY	C, D, E, F, G
DRIVESHAFTS AND BOOTS	I	EVERY 7,500 MILES (12,000 KM) OR 6 MONTHS	C, D, E, F
MANUAL TRANSAXLE OIL	R	EVERY 60,000 MILES (96,000 KM)	A, C, D, E, F, G, H, I, J
AUTOMATIC TRANSAXLE FLUID	R	EVERY 30,000 MILES (48,000 KM)	A, C, E, F, G, H, I
CLIMATE CONTROL AIR FILTER (IN FRONT OF BLOWER UNIT)	R	MORE FREQUENTLY	C, E

**SEVERE DRIVING CONDITIONS**

- A - Repeatedly driving short distance of less than 5miles(8km) in normal temperature or less than 10miles(16km) in freezing temperature
- B - Extensive engine idling or low speed driving for long distances
- C - Driving on rough, dusty, muddy, unpaved, graveled or salt-spread roads

- D - Driving in areas using salt or other corrosive materials or in very cold weather
- E - Driving in sandy areas
- F - Driving in heavy traffic area over 90°F(32°C)
- G - Driving on uphill, downhill, or mountain road
- H - Towing a Trailer, or using a camper, or roof rack
- I - Driving as a patrol car, taxi, other commercial use or vehicle towing
- J - Driving over 100 MPH(170 Km/h)
- K - Frequently driving in stop-and-go conditions

**EXPLANATION OF SCHEDULED MAINTENANCE ITEMS**

F060M01A-AAT

**o Engine Oil and Filter**

The engine oil and filter should be changed at the intervals specified in the maintenance schedule. If the car is being driven in severe conditions, more frequent oil and filter changes are required.

F060C01A-AAT

**o Fuel Filter**

A clogged filter can limit the speed at which the vehicle may be driven, damage the emission system and cause hard starting. If an excessive amount of foreign matter accumulates in the fuel tank, the filter may require replacement more frequently.

After installing a new filter, run the engine for several minutes, and check for leaks at the connections. Fuel filters should be installed by trained technicians.

F060D01TB-AAT

**o Fuel Lines, Fuel Hoses and Connections**

Check the fuel lines, fuel hoses and connections for leakage and damage. Replace any damaged or leaking parts immediately.

F060F01A-AAT

**o Vacuum, Crankcase Ventilation Hoses**

Inspect the surface of hoses for evidence of heat and/or mechanical damage. Hard and brittle rubber, cracking, tears, cuts, abrasions, and excessive swelling indicate deterioration. Particular attention should be paid to examine those hose surfaces nearest to high heat sources, such as the exhaust manifold.

Inspect the hose routing to assure that the hoses do not come in contact with any heat source, sharp edges or moving component which might cause heat damage or mechanical wear. Inspect all hose connections, such as clamps and couplings, to make sure they are secure, and that no leaks are present. Hoses should be replaced immediately if there is any evidence of deterioration or damage.

F060G01A-AAT

**o Vapor Hose and Fuel Filler Cap**

The vapor hose and fuel filler cap should be inspected at those intervals specified in the maintenance schedule. Make sure that a new vapor hose or fuel filler cap is correctly replaced.

F060H01A-AAT

**o Air Cleaner Filter**

A Genuine Hyundai air cleaner filter is recommended when the filter is replaced.

F060J01A-AAT

**o Spark Plugs**

Make sure to install new spark plugs of the correct heat range.

F060N02E-AAT

**o Valve Clearance**

Inspect excessive valve noise and/or engine vibration and adjust if necessary. A qualified technician should perform the operation.

F060B01A-AAT

**o Drive Belts**

Inspect all drive belts for evidence of cuts, cracks, excessive wear or oil saturation and replace if necessary. Drive belts should be checked periodically for proper tension and adjusted as necessary.

F070C01A-AAT

**o Engine Coolant**

The coolant should be changed at the intervals specified in the maintenance schedule.

F060E01A-AAT

**o Timing Belt**

Inspect all parts related to the timing belt for damage and deformation. Replace any damaged parts immediately.

F070D01A-AAT

**o Manual Transaxle oil**

Inspect the manual transaxle oil according to the maintenance schedule.

**NOTE:**

**If the oil level is low, check for possible leaks before adding oil. Do not overfill.**

F070E06A-AAT

**o Automatic Transaxle Fluid**

The fluid level should be in the "HOT" range of the dipstick, after the engine and transaxle are at normal operating temperature. Check the automatic transaxle fluid level with the engine running and the transaxle in neutral, with the parking brake properly applied. Use HYUNDAI GENUINE ATF SP III, DIAMOND ATF SP III, SK ATF SP III or other brands meeting the SP III specification approved by Hyundai Motor Co. when adding or changing fluid. Using the wrong ATF may result in damage to the ATM.

F070G02A-AAT

**o Brake Fluid**

Check brake fluid level in the brake fluid reservoir. The level should be between "MIN" and "MAX" marks on the side of the reservoir. Use only hydraulic brake fluid conforming to DOT 3 or DOT 4.

F070F01A-AAT

**o Brake Hoses and Lines**

Visually check for proper installation, chafing, cracks, deterioration and any leakage. Replace any deteriorated or damaged parts immediately.

F070H01A-AAT

**o Rear Brake Drums/Linings, Parking Brake**

Check the rear brake drums and linings for scoring, burning, leaking fluid, broken parts, and excessive wear. Inspect the parking brake system including the parking brake lever and cables. For detailed service procedures, refer to the Shop Manual.

F070J01A-AAT

**o Brake Pads, Calipers and Rotors**

Check the pads for excessive wear, discs for run out and wear, and calipers for fluid leakage.

F070K01A-AAT

**o Exhaust Pipe and Muffler**

Visually inspect the exhaust pipes, muffler and hangers for cracks, deterioration, or damage. Start the engine and listen carefully for any exhaust gas leakage. Tighten connections or replace parts as necessary.

F070L01A-AAT

**o Suspension Mounting Bolts**

Check the suspension connections for looseness or damage. Retighten to the specified torque.

F070M01A-AAT

**o Steering Gear Box, Linkage & Boots/  
Lower arm Ball Joint**

With the vehicle stopped and engine off, check for excessive free-play in the steering wheel. Check the linkage for bends or damage. Check the dust boots and ball joints for deterioration, cracks, or damage. Replace any damaged parts.

F070N01A-AAT

**o Power Steering Pump, Belt and Hoses**

Check the power steering pump and hoses for leakage and damage. Replace any damaged or leaking parts immediately. Inspect the power steering belt for evidence of cuts, cracks, excessive wear, oiliness and proper tension. Replace or adjust it if necessary.

F070P01A-AAT

**o Driveshafts and Boots**

Check the drive shafts, boots and clamps for cracks, deterioration, or damage. Replace any damaged parts and, if necessary, repack the grease.

F070Q01A-AAT

**o Air Conditioning Refrigerant**

Check the air conditioning lines and connections for leakage and damage. Check air conditioning performance according to the relevant shop manual if necessary.

F070R01E-AAT

**o Cylinder Head Cover Gasket  
(2.0L SULEV Only)****NOTE:**

**Check the contact surface between the cylinder head cover and head for oil leaks and replace the gasket with a new one, if necessary.**

**Remove the upper timing belt cover and check the engine parts including the cam cap for oil leaks.**

F070S01E-AAT

**o Oil Pan Liquid Gasket  
(2.0L SULEV Only)****NOTE:**

**Check the oil mounted surface for oil leaks. If the oil pan has been removed, apply a new gasket before reinstalling the oil pan.**

## DO-IT-YOURSELF MAINTENANCE

Engine Compartment .....	6-2
General Checks .....	6-3
Checking the Engine Oil .....	6-4
Changing the Oil and Filter .....	6-5
Checking and Changing the Engine Coolant .....	6-7
Changing the Air Cleaner Filter .....	6-9
Checking the Transaxle Oil (Manual) .....	6-12
Checking the Transaxle Fluid (Automatic) .....	6-12
Checking the Brakes .....	6-14
Checking the Clutch Fluid .....	6-15
Air Conditioning Care .....	6-16
Changing The Climate Control Air Filter .....	6-17
Checking Drive Belts .....	6-20
Checking and Replacing Fuses .....	6-20
Checking the Battery .....	6-22
Power Steering Fluid Level .....	6-24
Replacement of Light Bulbs .....	6-26
Bulb Wattage .....	6-34
Fuse Panel Description .....	6-35

# 6

## ENGINE COMPARTMENT

G010A02E-GAT

(2.0L CVVT/SULEV)

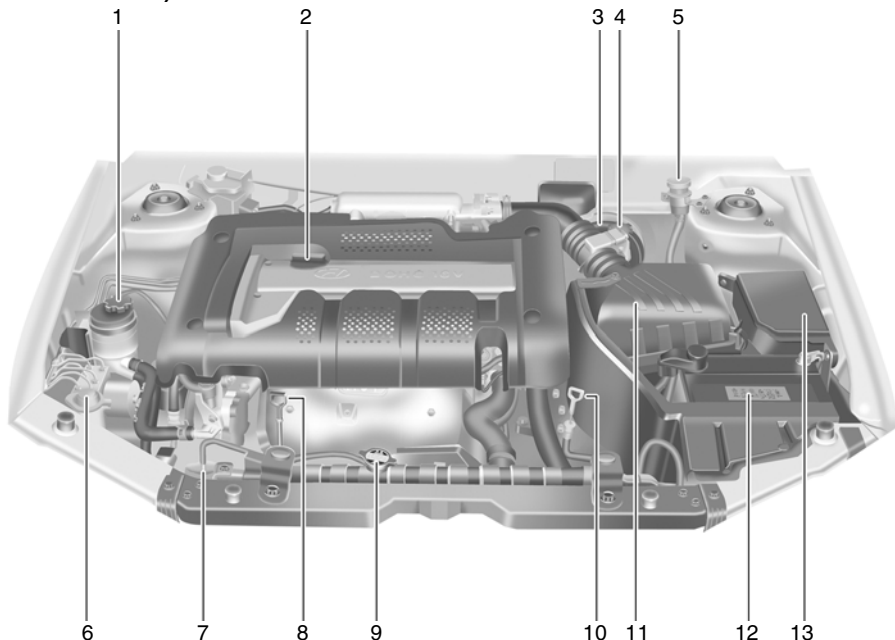

1. Power steering fluid reservoir
2. Engine oil filler cap
3. Brake booster
4. Brake fluid reservoir

5. Clutch fluid reservoir (If installed)
6. Windshield washer fluid reservoir cap
7. Engine coolant reservoir
8. Engine oil level dipstick
9. Radiator cap

10. Automatic transaxle fluid level dipstick
11. Air cleaner filter
12. Battery
13. Relay box

**CAUTION:**

When inspecting or servicing the engine, you should handle tools and other heavy objects carefully so that the plastic cover of the engine is not damaged.

G010A02E



## GENERAL CHECKS

G020A02A-AAT

### Engine Compartment

The following should be checked regularly:

- o Engine oil level and condition
- o Transaxle fluid level and condition
- o Brake fluid level
- o Clutch fluid level
- o Engine coolant level
- o Windshield washer fluid level
- o Accessory drive belt condition
- o Engine coolant hose condition
- o Fluid leaks (on or below components)
- o Power steering fluid level
- o Battery condition
- o Air filter condition

G020B01A-AAT

### Vehicle Exterior

The following should be checked monthly:

- o Overall appearance and condition
- o Wheel condition and wheel nut torque
- o Exhaust system condition
- o Light condition and operation
- o Windshield glass condition
- o Wiper blade condition
- o Paint condition and body corrosion
- o Fluid leaks
- o Door and hood lock condition
- o Tire pressure and condition (including spare tire)

G020C01A-AAT

### Vehicle Interior

The following should be checked each time when the vehicle is driven:

- o Lights operation
- o Windshield wiper operation
- o Horn operation
- o Defroster, heating system operation (and air conditioning, if installed)
- o Steering operation and condition
- o Mirror condition and operation
- o Turn signal operation
- o Accelerator pedal operation
- o Brake operation, including parking brake
- o Manual transaxle operation, including clutch operation
- o Automatic transaxle operation, including "PARK" mechanism operation
- o Seat control condition and operation
- o Seat belt condition and operation
- o Sunvisor operation

If you notice anything that does not operate correctly or appears to be functioning incorrectly, inspect it carefully and seek assistance from your Hyundai dealer if service is needed.

## CHECKING THE ENGINE OIL

G030A01A-AAT

Engine oil is essential to the performance and service of the engine. It is suggested that you check the oil level at least once a week in normal use and more often if you are on a trip or driving in severe conditions.

G030B01O-AAT

## Recommended Oil

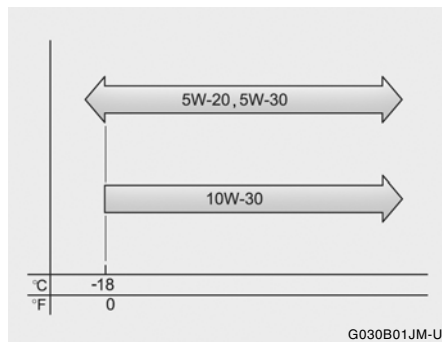

The engine oil quality should meet the following classification.

API SJ, SL or ABOVE,  
ILSAC GF-3 or ABOVE

## NOTE:

- o For good fuel economy, SAE 5W-20 (5W-30), ILSAC GF-3 engine oil is preferred regardless of regional option and engine variation.
- o If SAE 5W-20, ILSAC GF-3 engine oil is not available, secondary recommended engine oil for corresponding temperature range can be used.



G030C02JM-AAT

## To Check the Oil Level

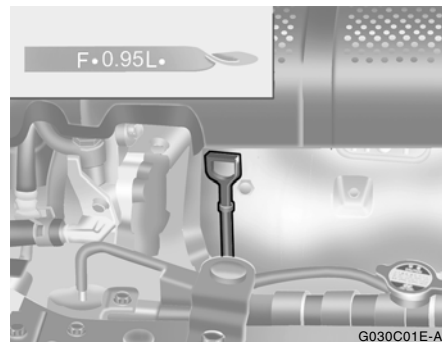

Before checking the oil, warm up the engine to the normal operating temperature and be sure your vehicle is parked on level ground. Turn the engine off.

Wait a minute, then remove the dipstick, wipe it off, fully reinsert the dipstick and withdraw it again. Then note the highest level the oil has reached on the dipstick. It should be between the upper ("F") and lower ("L") range.

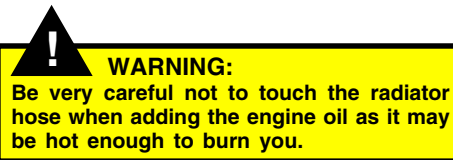

## CHANGING THE OIL AND FILTER

G030D01O-AAT

## Adding Oil

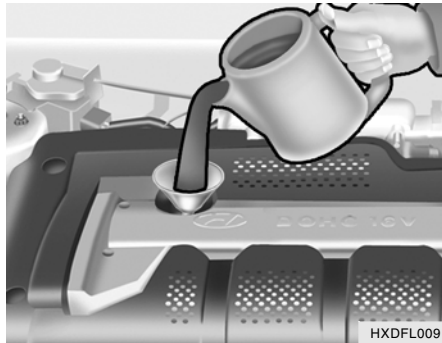

If the oil level is close to or below the "L" mark, add oil until it reaches the "F" mark. To add oil:

1. Remove the oil filler cap by turning it counter-clockwise.
2. Add oil, then check the level again. Do not overfill.
3. Replace the cap by turning it clockwise.

The distance between the "F" and "L" marks is equal to about 1 quart of oil.

**CAUTION:**

Slowly pour the recommended oil into a funnel. Do not overfill not to damage engine.

**WARNING:**

Be very careful not to touch the radiator hose when adding the engine oil as it may be hot enough to burn you.

G040A04E-AAT

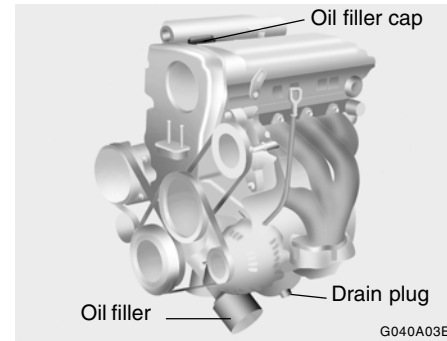

The engine oil and filter should be changed at those intervals specified in the maintenance schedule in Section 5. If the vehicle is being driven in severe conditions, more frequent oil and filter changes are required.

The procedure for changing the oil and filter is as follows:

1. Park the vehicle on level ground and set the parking brake. Start the engine and let it warm up until the needle on the coolant temperature gauge moves above the lowest mark. Turn the engine off and place the gear selector lever in "P" (automatic) or reverse gear (manual transaxle). Set the parking brake.

- Open the hood and remove the engine oil filler cap.
- Slide underneath the car and loosen the drain plug by turning it counterclockwise with a wrench of the proper size. Be sure that a drain pan is in position to catch the oil as it drains out, then remove the drain plug.

 **WARNING:**  
Be very careful when draining the engine oil as it may be hot enough to burn you!

- When the oil has stopped draining, replace the drain plug using a new gasket and re-tighten by turning it clockwise.

**Drain plug tightening torque:**  
4.0 ~ 4.5 kgf.m

- Remove the oil filter. You should be able to unscrew the filter with your hands. (If your hands are slippery, try to use a cloth between your hands and the filter to give yourself a better grip.) A certain amount of oil will come out when you remove the filter, so be sure to have your drain pan in place underneath it.

- Install a new oil filter in accordance with the instructions on the carton or on the filter itself. Do not over-tighten.

**Oil filter tightening torque :**  
1.2 ~ 1.6 kgf.m

Be sure that the mounting surface on the engine is clean and that the old gasket is removed completely. Lubricate the new gasket on the filter with clean engine oil before installation.

- Remove the engine oil level dipstick.
- Refill the crankcase with the recommended engine oil. Refer to the specification in chapter 9 for engine oil capacity.

 **CAUTION:**  
Slowly pour the recommended oil into a funnel. Do not overfill! Engine damage may occur if overfilled.

- Start the engine and check to be sure no oil is leaking from the drain plug or oil filter.
- Shut off the engine and recheck the oil level.

**NOTE:**

Always dispose of used engine oil in an environmentally acceptable manner. It is suggested that it be placed in a sealed container and taken to a service station for reclamation. Do not pour the oil on the ground or put it into the household trash.

 **PROPOSITION 65 WARNING:**  
This product contains a chemical known to the State of California to cause cancer. Used engine oil may cause irritation or cancer of the skin if left in contact with the skin for prolonged periods of time. Used engine oil contains chemicals that have caused cancer in laboratory animals. Always protect your skin by washing your hands thoroughly with soap and warm water as soon as possible after handling used oil.

## CHECKING AND CHANGING THE ENGINE COOLANT

G050A01A-AAT



### WARNING:

Do not remove the radiator cap when the engine is hot. When the engine is hot, the engine coolant is under pressure and may erupt through the opening if the cap is removed. You could be seriously burned if you do not observe this precaution. Do not remove the radiator cap until the radiator is cool to the touch.

G050B01A-AAT

### Recommended Engine Coolant

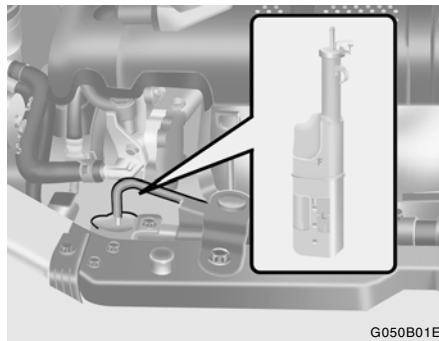

G050B01E

Use a high quality ethylene-glycol coolant in a 50/50 mix with water. The engine coolant should be compatible with aluminum engine parts. Additional corrosion inhibitors or additives should not be used. The cooling system must be maintained with the correct concentration and type of engine coolant to prevent freezing and corrosion. Never allow the concentration of antifreeze to exceed the 60% level or go below the 35% level, or damage to the cooling system may result. For proper concentration when adding or replacing the engine coolant, refer to the following table.

Ambient temperature °F (°C)	Engine Coolant concentration	
	Antifreeze solution	Water
-5 (15)	35%	65%
-13 (-25)	40%	60%
-31 (-35)	50%	50%
-49 (-45)	60%	40%

G050C01A-AAT

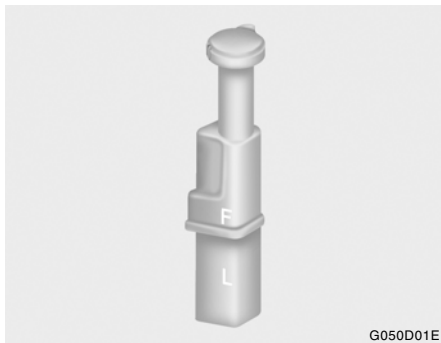
**To Check the Coolant Level**

G050D01E

The coolant level can be seen on the side of the plastic coolant reservoir. The level of the coolant should be between the "L" and "F" lines on the reservoir when the engine is cold. If the level is below the "L" mark, add engine coolant to bring it up between "L" and "F". If the level is low, inspect for coolant leaks and recheck the fluid level frequently. If the level drops again, visit your Hyundai dealer for an inspection and diagnosis of the reason.

G050D03A-AAT

**To Change the Engine Coolant**

The engine coolant should be changed at those intervals specified in the vehicle maintenance schedule in Section 5.

**CAUTION:**

Engine coolant can damage the finish of your car. If you spill engine coolant on the car, wash it off thoroughly with clean water.

1. Park the car on level ground, set the parking brake and remove the radiator cap when cool.
2. Be sure your drain receptacle is in place. Open the drain cock on the radiator. Allow all the engine coolant to drain from the cooling system, then securely close the drain cock.
3. Check Section 9 for the capacity of the cooling system in your car. Then, following the manufacturer's directions on the engine coolant container, add the appropriate quantity of coolant to the radiator.

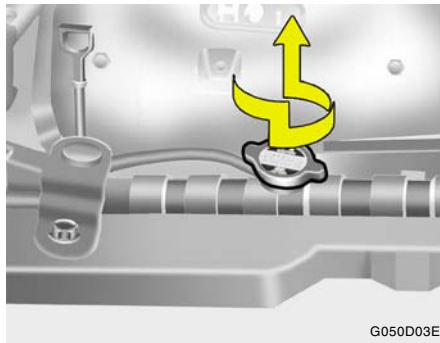

G050D03E

4. Turn the radiator cap counterclockwise without pressing down on it, until it stops. This relieves any pressure remaining in the cooling system. And remove the radiator cap by pushing down and turning counterclockwise.  
Now fill the radiator with clean demineralized or distilled water. Continue to add clean demineralized or distilled water in small quantities until the fluid level stays up in the radiator neck.

**WARNING:**

Remove the radiator cap when the radiator is cool.

## CHANGING THE AIR CLEANER FILTER

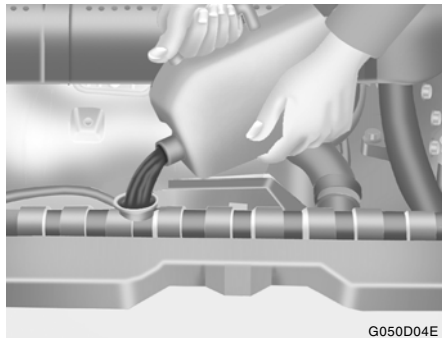

G050D04E

5. Start the engine, top off the radiator with water and then add engine coolant to the reservoir until the level is between "L" and "F".
6. Replace the radiator and reservoir caps and check to be sure the drain cocks are fully closed and not leaking.



### WARNING:

The cooling fan is controlled by engine coolant temperature and may sometimes operate even when the engine is not running. Use extreme caution when working near the blades of the cooling fan so that you are not injured by a rotating fan blade. As the engine coolant temperature decreases, the fan will automatically shut off. This is a normal condition.

G070A01E--AAT

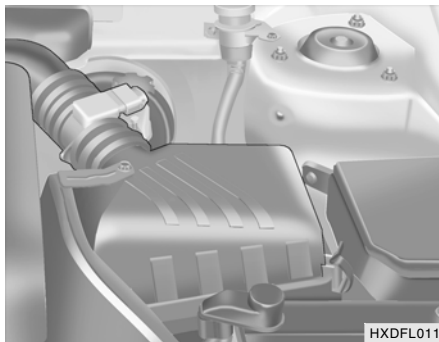

HXDFL011

To change the filter, unsnap the clips around the cover. When this is done, the cover can be lifted off, the old filter removed and the new filter put in its place. Genuine Hyundai Replacement Parts are recommended.



### CAUTION:

- o Operating your vehicle without a proper air filter in place can result in excessive engine wear.
- o When removing the air cleaner filter, be careful that dust or dirt does not enter the air intake. These may result in damage to the air cleaner filter.

## WINDSHIELD WIPER BLADES

G080A02A-AAT

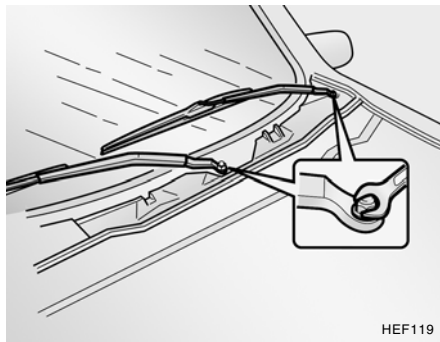

HEF119

The wiper blades should be carefully inspected from time to time and cleaned to remove accumulations of road film or other debris. To clean the wiper blades and arms, use a clean sponge or cloth with a mild soap or detergent and water. If the wipers continue to streak or smear the glass, replace them with Genuine Hyundai Replacement Parts or their equivalent.



### CAUTION:

- o Do not operate the wipers on dry glass. This can result in more rapid wear of the wiper blades and may scratch the glass.
- o Keep the blade rubber out of contact with petroleum products such as engine oil, gasoline, etc.

G080B01HR-GAT

## Replacing the Wiper Blades

To replace the wiper blades, raise the wiper to the vertical.

### To remove the wiper blade

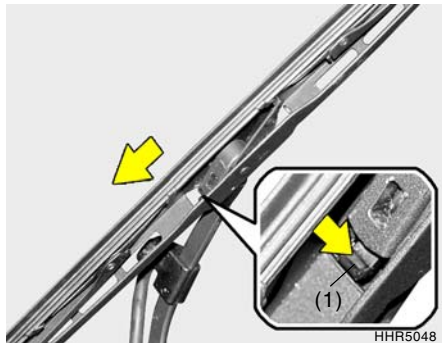

1. Push down the wiper blade with the locking clip (1) pressed to detach it from the wiper arm.

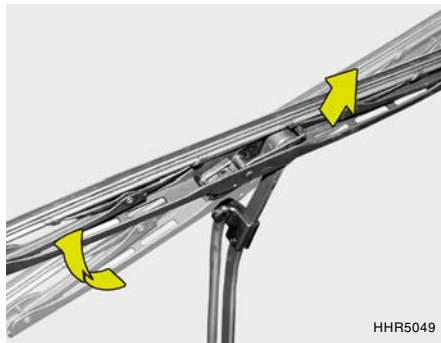

2. Raise the wiper blade lightly and pull up it.

### To install the wiper blade

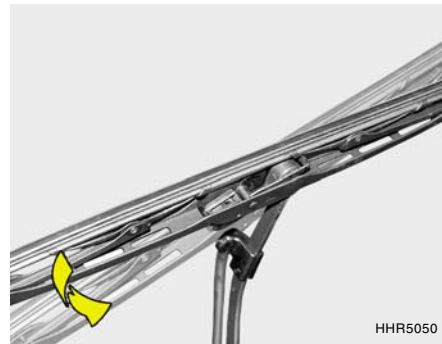

1. Put a new wiper blade onto the wiper arm and lower the wiper blade at the level of the wiper arm as shown in the drawing.



## FILLING THE WASHER RESERVOIR



2. Pull up the wiper blade until you hear an audible "click" to engage in the end of the wiper arm.

**NOTE:**

Do not allow the wiper arm to fall against the windshield.

G090A02A-AAT

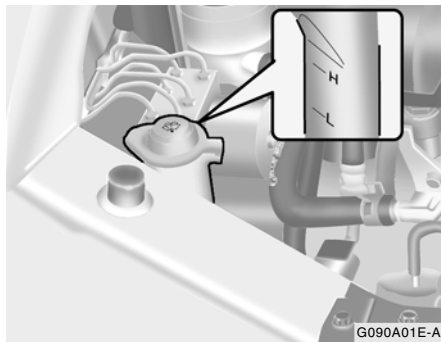

The washer fluid reservoir supplies fluid to the windshield washer systems.

A good quality washer fluid should be used to fill the washer reservoir. The fluid level should be checked more frequently during inclement weather or whenever the washer system is in more frequent use.

The capacity of the washer reservoir is 3.2 U.S. quarts (3.0 Liters).

**CAUTION:**

- o Radiator anti-freeze (engine coolant) should not be used in the washer system because it will damage the car's finish.
- o The washer should not be operated if the washer reservoir is empty. This can damage the washer fluid pump.

**WARNING:**

- o Windshield washer fluid agents contain some amounts of alcohol and can be flammable under certain circumstances. Do not allow sparks or flame to contact the washer fluid or the washer fluid reservoir. Damage to the vehicle or its occupants could occur.
- o Windshield washer fluid is poisonous to humans and animals. Do not drink windshield washer fluid. Serious injury or death could occur.

## CHECKING THE TRANSAXLE OIL

G100A06A-AAT

## MANUAL TRANSAXLE

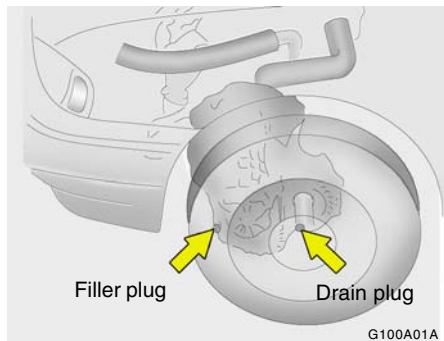

Transaxle lubricant in the manual transaxle should be checked at those intervals specified in the vehicle maintenance schedule in Section 5.

## Recommended Oil

Use only HYUNDAI GENUINE PARTS MTF 75W/85 (API GL-4) or equivalent in the manual transaxle.

## Manual Transaxle Oil Capacity

The oil capacity of the manual transaxle is 2.27 U.S. quarts (2.15 liters).

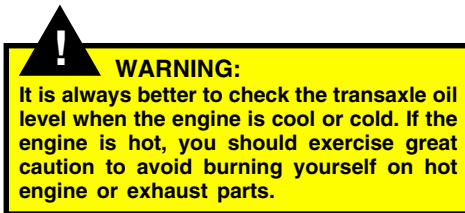
**WARNING:**

It is always better to check the transaxle oil level when the engine is cool or cold. If the engine is hot, you should exercise great caution to avoid burning yourself on hot engine or exhaust parts.

**NOTE:**

It is recommended that the manual transaxle fluid should be checked by an authorized Hyundai dealer.

G110A02E-AAT

## AUTOMATIC TRANSAXLE

Transaxle fluid in the automatic transaxle should be changed at those intervals specified in the vehicle maintenance schedule in Section 5.

**NOTE:**

Automatic transaxle fluid is a red in color. As driving distance increases, the fluid color turns darkish red gradually. It is a normal condition and you should not judge the need to replace based upon the changing color.

You must replace the automatic transaxle fluid in accordance with intervals specified in the vehicle maintenance schedule in section 5.

G110B05A-AAT

**Recommended Fluid**

Your Hyundai automatic transaxle is specially designed to operate with HYUNDAI GENUINE ATF SP III, DIAMOND ATF SP III, SK ATF SP III or other brands meeting the SP III specification approved by Hyundai Motor Co.. Damage caused by a nonspecified fluid is not covered by your new vehicle limited warranty.

**CAUTION:**

Use of aftermarket ATF additives may cause damage to the automatic transaxle. Only use HYUNDAI GENUINE ATF SP III, DIAMOND ATF SP III, SK ATF SP III or other brands meeting the SP III specification approved by Hyundai Motor Co.. If you are having your vehicle serviced at a facility other than a Hyundai dealer, verify ATF is used for your vehicle.

G110C01E-AAT

**Transaxle Fluid Capacity**

The fluid capacity of the automatic transaxle is 8.2 U.S. quarts (7.8 liters).

**WARNING:**

The transaxle fluid level should be checked when the engine is at normal operating temperature. This means that the engine, radiator, exhaust system etc., are very hot. Exercise great care not to burn yourself during this procedure.

G110D03A-AAT

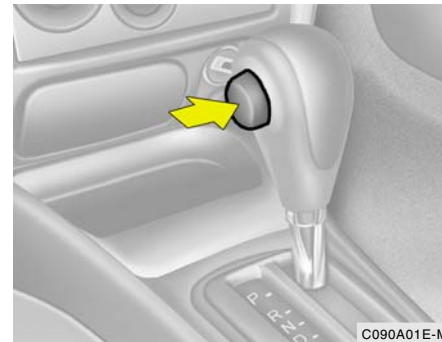
**To Check the Transaxle Fluid Level**

Park the car on level ground with the parking brake engaged. When the transaxle fluid level is checked, the transaxle fluid should be at normal operating temperature and the engine idling.

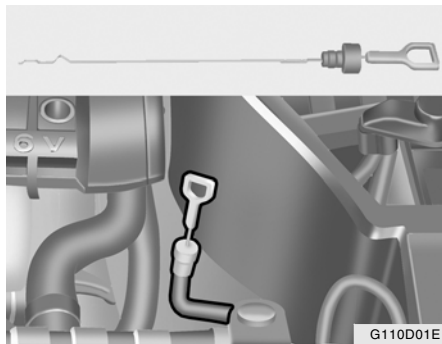

While the engine is idling, apply the brakes and move the gear selector lever from "P" to each of its other positions -- "R", "N", "D", "3", "2", "L" -- and then return to "N" or "P" with the engine still idling:

1. Open the hood, being careful to keep hands, hair and clothing clear of any moving parts.
2. Remove the transaxle dipstick, wipe it clean, reinsert the dipstick as far as it will go, then remove it again. Now check the fluid level on the dipstick. It should be in the "HOT" range on the dipstick.

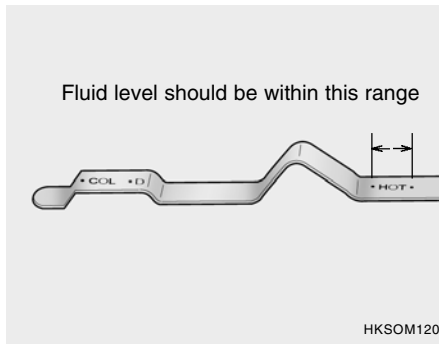

3. If the transaxle fluid level is low, use a funnel to add transaxle fluid through the dipstick tube until the level reaches the "HOT" range. Do not overfill.

**! WARNING:**  
 The cooling fan is controlled by the engine coolant temperature and may sometimes operate even when the engine is not running. Use extreme caution when working near the blades of the cooling fan so that you are not injured by a rotating fan blade. As the engine coolant temperature decreases, the fan will automatically shut off. This is a normal condition.

## CHECKING THE BRAKES

G120A01A-AAT



### CAUTION:

Because brakes are essential to the safe operation of the car, it is suggested that they be checked and inspected by your Hyundai dealer. The brakes should be checked and inspected for wear at those intervals specified in the vehicle maintenance schedule in Section 5.

G120B01A-AAT

### Checking the Brake Fluid Level



### WARNING:

Use caution when handling brake fluid. It can damage your vision if it gets into your eyes. It will also damage your vehicle's paint if spilled on it and not removed immediately.

G120C02A-AAT

### Recommended Brake Fluid

Use only hydraulic brake fluid conforming to DOT 3 or DOT 4 specifications in your braking system. Follow the instructions printed on the container.

G120D01A-AAT

### To Check the Fluid Level

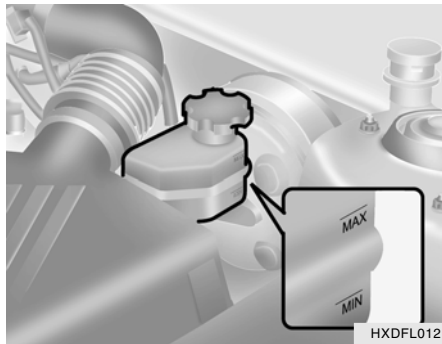

The fluid level in the brake fluid reservoir should be checked periodically. The level should be between the "MIN" and "MAX" marks on the side of the reservoir. If the level is at or below the "MIN" mark, carefully add fluid to bring it up to "MAX". Do not overfill.

G120E02A-AAT

### Adding Brake Fluid

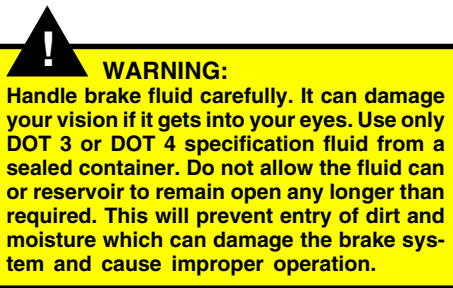

To add brake fluid, first wipe away any dirt then unscrew the fluid reservoir cap. Slowly pour the recommended fluid into the reservoir. Do not overfill. Carefully replace the cap on the reservoir and tighten.

## CHECKING THE CLUTCH FLUID

G130A01S-AAT

### To Check the Clutch Fluid

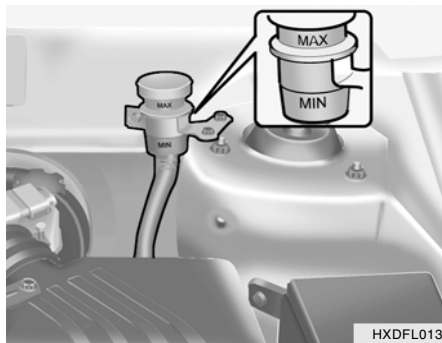

The clutch fluid level in the master cylinder should be checked when performing other under hood services. The system should be checked for leakage at the same time. Check to make certain that the clutch fluid level is always between the "MAX" and "MIN" level markings on the fluid reservoir. Fill as required. Fluid loss indicates a leak in the clutch system which should be inspected and repaired immediately. Consult your Hyundai dealer.

## AIR CONDITIONING CARE

G130B02A-AAT

**To Replace the Fluid**

Recommended brake fluid conforming to DOT 3 or DOT 4 specification should be used. The reservoir cap must be fully tightened to avoid contamination from foreign matter or moisture.

**NOTE:**

**Do not allow any other liquids to contaminate the brake fluid. Seal damage will result.**

**WARNING:**

Use caution when handling brake fluid. It can damage your vision if you get it in your eyes. It will also damage your vehicle's paint if spilled on it and not removed immediately.

G140A01A-AAT

**Keeping the Condenser Clean**

The air conditioning condenser (and engine radiator) should be checked periodically for accumulation of dirt, dead insects, leaves, etc. These can interfere with maximum cooling efficiency. When removing such accumulations, brush or hose them away carefully to avoid bending the cooling fans.

G140B01A-AAT

**Checking the Air Conditioning Operation**

1. Start the engine and let it run at a fast idle for several minutes with the air conditioning set at the maximum cold setting.
2. If the air coming out of the in-dash vents is not cold, have the air conditioning system inspected by your Hyundai dealer.

**CAUTION:**

Running the air conditioning system for extended periods of time with a low refrigerant level may damage the compressor.

G140C01A-AAT

**Lubrication**

To lubricate the compressor and the seals in the system, the air conditioning should be run for at least 10 minutes each week. This is particularly important during cool weather when the air conditioning system is not otherwise in use.

G140D01A-AAT

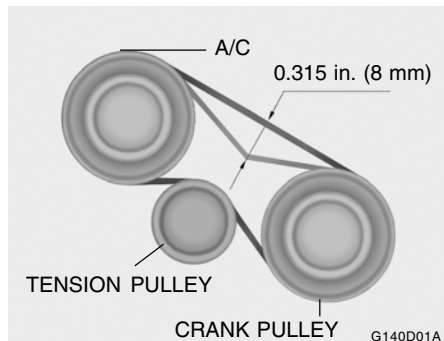
**Checking the Compressor Drive Belt**

When the air conditioning is being used regularly, the compressor drive belt tension should be checked at least once a month with the engine turned off.

To check the drive belt tension, press down on the belt halfway between the engine crankshaft and compressor pulleys. Pressing with your finger, you should not be able to deflect this belt anymore than 1/3 of an inch. If you have the instruments to check it, with a force of 22 lb. (98N), the deflection should be 0.315 inches (approx 8.0 mm). If the belt is too loose, have it adjusted by your Hyundai dealer.

**CHANGING THE CLIMATE CONTROL AIR FILTER**

B140E02E-AAT

**(For Evaporator and Blower Unit)**

The climate control air filter is located in front of the evaporator unit behind the glove box. It helps to decrease pollutants from entering the car.

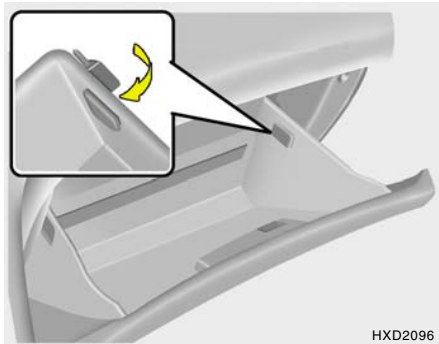

1. Open the glove box and remove the adjusting pins on both sides of the glove box.

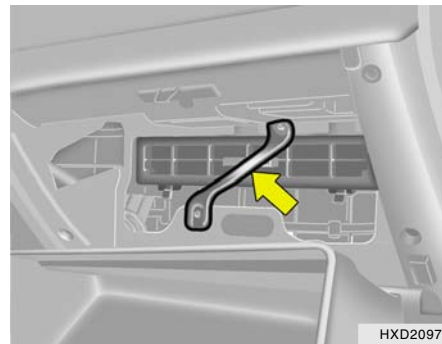

2. Remove the protective padding from the mounting bracket.
3. Remove the mounting bolts with the socket wrench, and then detach the mounting bracket.

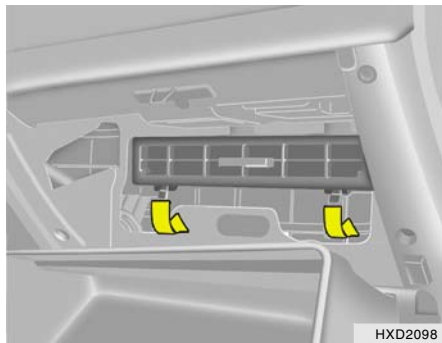

4. Remove the filter cover by pushing the two hooks of the filter cover.

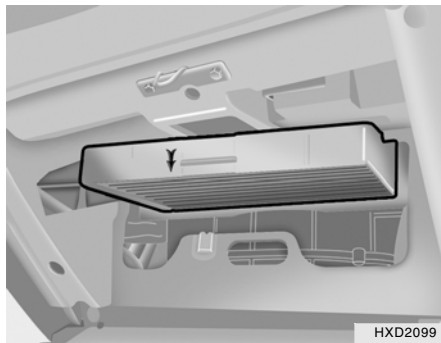

5. Replace the climate control air filter with a new one.  
6. Installation is the reverse order of disassembly.

**CAUTION:**

Be sure to install the climate control air filter in the direction of the arrow sign. Otherwise, noise or filter damage may result.

**CHECKING THE FREEPLAY**

G150A01A-AAT

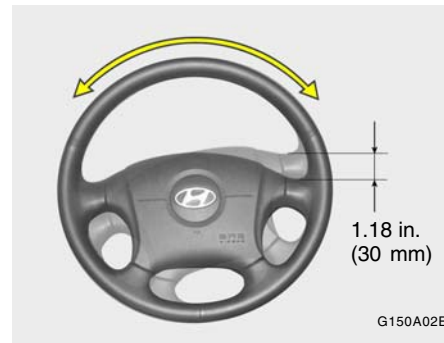
**Steering wheel**

To check the steering wheel free-play, stop the car with the wheels pointed straight ahead and gently move the steering wheel back and forth. Use very light finger pressure and be sensitive to changes in resistance that mark the limits of the free-play. If the free-play is greater than specified, have it inspected by your Hyundai dealer and adjusted or repaired if necessary.

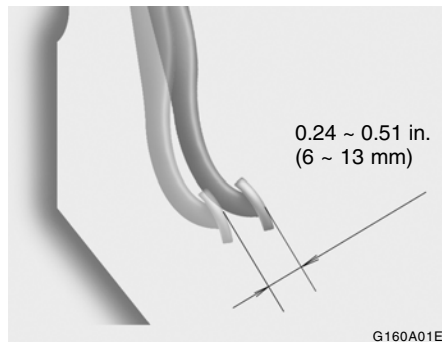

G160A01A-AAT

**Clutch Pedal Free Play**

With the engine off, press lightly on the clutch pedal until you feel a change in resistance. This is the clutch pedal free-play. The free-play should be within the limits specified in the illustration. If it is not, have it inspected by your Hyundai dealer and adjusted or repaired if necessary.

G170A01A-AAT

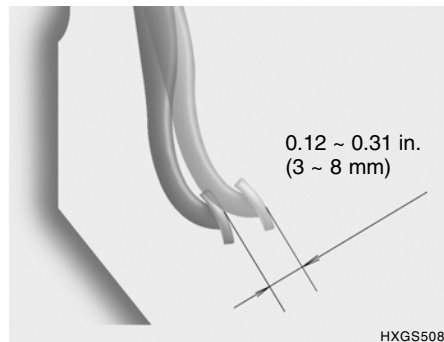
**Brake Pedal Free Play**

With the engine off, press down on the brake pedal several times to reduce the vacuum in the brake booster. Then, using your hand, press down slowly on the brake pedal until you feel a change in resistance. This is the brake pedal freeplay. The freeplay should be within the limits specified in the illustration. If it is not, have it inspected by your Hyundai dealer and adjusted or repaired if necessary.

G180A01A-AAT

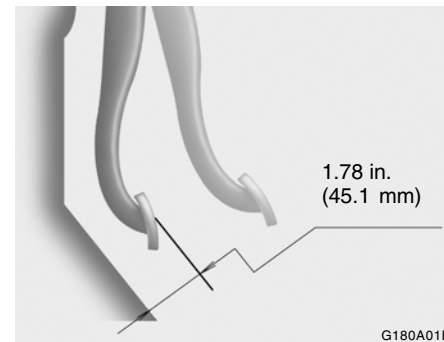
**Checking Brake Pedal Clearance**

You need a helper to check the brake pedal clearance. With the engine running, have your helper press down on the brake pedal several times and then hold it down with a force of about 110 lbs (50 kg, 490 N). The brake pedal clearance is the distance from the top surface of the brake pedal to the asphalt sheeting under the floor mat.

If the brake pedal clearance is not within the limits specified in the illustration, have it inspected by your Hyundai dealer and adjusted or repaired if necessary.

## CHECKING DRIVE BELTS

G190A01A-AAT

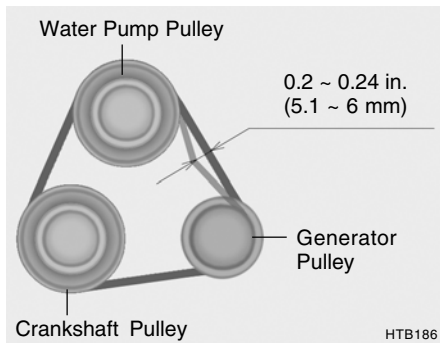

Drive belts should be checked periodically for proper tension and adjusted if necessary. At the same time, belts should be examined for cracks, wear, fraying or other evidence of deterioration and replaced if necessary.

Belt routing should also be checked to be sure there is no interference between the belts and other parts of the engine. After a belt is replaced, the new belt should be adjusted again after two or three weeks to eliminate slack resulting from initial stretching after use.

## CHECKING AND REPLACING FUSES

G200A03A-AAT

## Replacing a Fusible Link

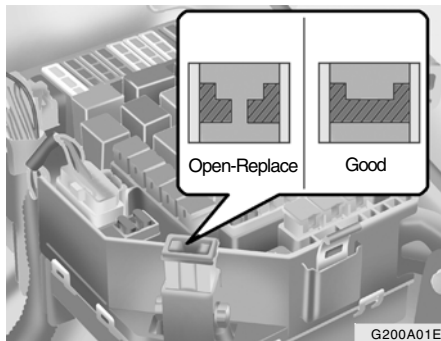

A fusible link will melt if the electrical circuits from the battery are ever overloaded, thus preventing damage to the entire wiring harness. (This could be caused by a short in the system drawing too much current.) If this ever happens, have a Hyundai dealer determine the cause, repair the system and replace the fusible link. The fusible links are located in a relay box in the engine compartment for easy inspection.

**CAUTION:**

When replacing a fusible link, never use anything but a new fusible link with the same or lower amperage rating. Never use a piece of wire or a higher-rated fusible link. This could result in serious damage and create a fire hazard.

G200B02E-AAT

## Replacing Accessory Fuses



The fuse box for the lights and other electrical accessories will be found behind the storage box located on the instrument panel to the left side of the driver. On the backside of the multi box, you will find a list showing the circuits protected by each fuse.

If any of your car's lights or other electrical accessories stop working, a blown fuse could be the reason. If the fuse has burned out, you will see that the metal strip inside the fuse has melted through. If you suspect a blown fuse, follow this procedure:

1. Turn off the ignition and all other switches.
2. Open the fuse box and examine each fuse. Remove each fuse by pulling it toward you (a small "fuse puller" tool is contained in the fuse box to simplify this operation).
3. Be sure to check all other fuses even if you find one that appears to have opened.

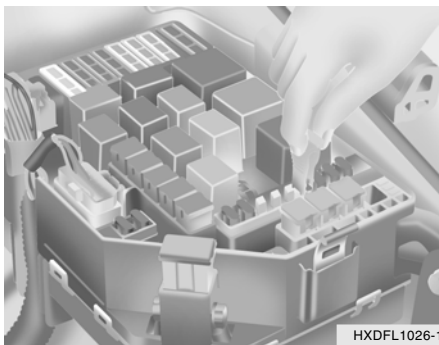

4. Replace the blown fuse by pressing a new fuse of the same rating into place. The fuse should be a snug fit. If it is not, have the fuse clip repaired or replaced by a Hyundai dealer. If you do not have a spare fuse, you may be able to borrow a fuse of the same or lower rating from an accessory you can temporarily get along without (the radio or cigarette lighter, for example). Always remember to replace the borrowed fuse.

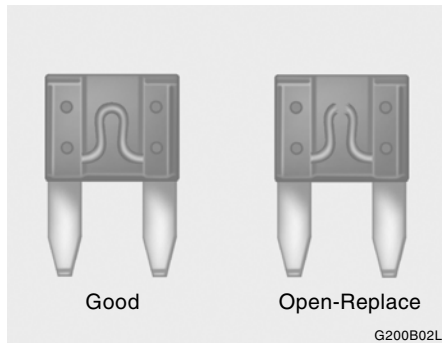

### CAUTION:

An open fuse indicates that there is a problem in the electrical circuit. If you replace a fuse and it blows as soon as the accessory is turned on, the problem is serious and should be referred to a Hyundai dealer for diagnosis and repair. Never replace a fuse with anything except a fuse with the same or a lower amperage rating. A higher capacity fuse could cause damage and create a fire hazard.

### NOTE:

See page 6-35 for the fuse panel descriptions.

## CHECKING THE BATTERY

G210A01A-AAT

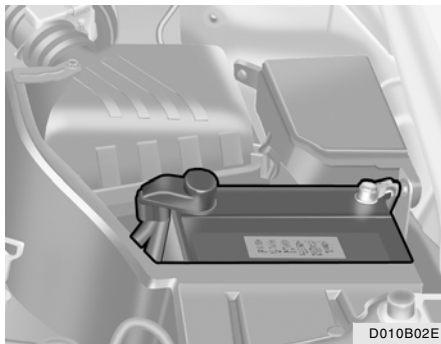
**WARNING:**

**Batteries can be dangerous! When working with batteries, carefully observe the following precautions to avoid serious injuries.**

The fluid in the battery contains a strong solution of sulfuric acid, which is poisonous and highly corrosive. Be careful not to spill it on yourself or the car. If you do spill battery fluid on yourself, immediately do the following:

- o If battery fluid is on your skin, flush the affected areas with water for at least 15 minutes and then seek medical assistance.
- o If battery fluid is in your eyes, rinse out your eyes with water and get medical assistance as soon as possible. While you are being driven to get medical assistance, continue to rinse your eyes by using a sponge or soft cloth saturated with water.
- o If you swallow battery fluid, drink a large quantity of water or milk followed by milk of magnesia, eat a raw egg or drink vegetable oil. Get medical assistance as soon as possible.

While batteries are being charged (either by a battery charger or by the vehicle's generator), they produce explosive gases. Always observe these warnings to prevent injuries from occurring:

- o Charge batteries only in a well ventilated area.
- o Do not permit flames, sparks or smoking in the area.
- o Keep children away from the area.

G210B04A-AAT

**Checking the Battery**

Keep the battery clean. Any evidence of corrosion around the battery posts or terminals should be removed using a solution of household baking soda and warm water. After the battery terminals are dry, cover them with a light coating of grease.

**PROPOSITION 65 WARNING:**

**Battery posts, terminals, and related accessories contain lead and lead compounds, chemicals known to the state of California to cause cancer and reproductive harm. Batteries also contain other chemicals known to the State of California to cause cancer. Wash hands after handling.**

## CHECKING ELECTRIC COOLING FANS

G220A01A-AAT



### WARNING:

The cooling fan is controlled by engine coolant temperature and may sometimes operate even when the engine is not running. Use extreme caution when working near the blades of the cooling fan, so that you are not injured by a rotating fan blade. As the engine coolant temperature decreases the fan will automatically shut off. This is a normal condition.

G220B01A-AAT

### Checking Engine Cooling Fan

The engine cooling fan should come on automatically if the engine coolant temperature is high.

G220C01A-AAT

### Checking Condenser Cooling Fan

The condenser cooling fan should come on automatically whenever the air conditioning is in operation.



### WARNING:

Always read the following instructions carefully when handling a battery.



Keep lighted cigarettes and all other flames or sparks away from the battery.



Hydrogen, which is a highly combustible gas, is always present in battery cells and may explode if ignited.



Keep batteries out of the reach of children because batteries contain highly corrosive SULFURIC ACID. Do not allow battery acid to contact your skin, eyes, clothing or paint finish.



If any electrolyte gets into your eyes, flush your eyes with clean water for at least 15 minutes and get immediate medical attention. If possible, continue to apply water with a sponge or cloth until medical attention is received.



### WARNING:

If electrolyte gets on your skin, thoroughly wash the contacted area.

If you feel a pain or a burning sensation, get medical attention immediately.



Wear eye protection when charging or working near a battery. Always provide ventilation when working in an enclosed space.

- o When lifting a plastic-cased battery, excessive pressure on the case may cause battery acid to leak, resulting in personal injury. Lift with a battery carrier or with your hands on opposite corners.
- o Never attempt to charge the battery when the battery cables are connected.
- o The electrical ignition system works with high voltage. Never touch these components with the engine running or the ignition switched on.

## POWER STEERING FLUID LEVEL

G230A03A-AAT

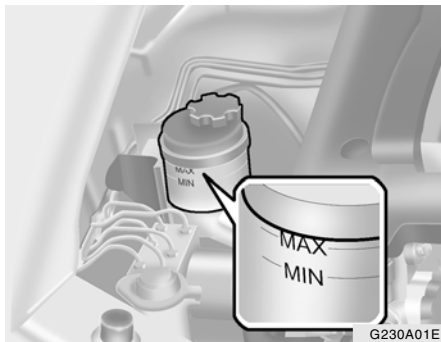

G230A01E

The power steering fluid level should be checked regularly. To check the power steering fluid level, be sure the engine is "OFF", then check to make certain that the power steering fluid level is between the "MAX" and "MIN" level markings on the fluid reservoir.

**NOTE:**

Grinding noise from the power steering pump may be heard immediately after the engine is started in extremely cold conditions (below - 4°F). If the noise stops during warm up, there is no abnormal function in the system. It is due to a power steering fluid characteristic in extremely cold conditions.

**Recommended Fluid**

Use PSF-3 type fluid

**NOTE:**

Do not start the engine when the power steering oil reservoir is empty.

G240A01A-AAT

## POWER STEERING HOSES

It is suggested that you check the power steering hose connections for fluid leakage at regular intervals. The power steering hoses should be replaced if there is severe surface cracking, scuffing or worn spots. Deterioration of the hose could cause premature failure.

G250A01A-AAT

**FOR MORE INFORMATION ABOUT YOUR HYUNDAI**

If you desire additional information about maintaining and servicing your Hyundai, you may purchase a factory Shop Manual at your Hyundai dealer's parts department. This is the same manual used by dealership technicians and while it is highly technical it can be useful in obtaining a better understanding of your car and how it works.

## HEADLIGHT AIMING ADJUSTMENT

G290A03E-AAT

Before performing aiming adjustment, make sure of the following.

1. Keep all tires inflated to the correct pressure.
2. Place the vehicle on level ground and press the front bumper & rear bumper down several times. Place the vehicle at a distance of 118 in. (3,000 mm) from the test wall.
3. See that the vehicle is unloaded (except for full levels of coolant, engine oil and fuel, and spare tire, jack, and tools). Have the driver or equivalent weight placed in driver's seat.
4. Clean the head light lenses and turn on the headlights (Low beam).

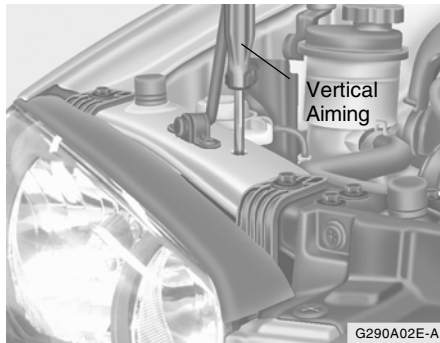

G290A02E-A

5. Open the hood.
6. Draw a vertical line (through the center of each headlight beam pattern) and a horizontal line (through the center of each headlight beam pattern) on the aiming screen.

And then, draw the horizontal parallel line at 0.8 in. (21 mm) under the horizontal line.

7. Adjust each cut-off line of the low beam to the parallel line with a phillips screwdriver  
- VERTICAL AIMING

**WARNING:**  
Horizontal aiming should be adjusted by an authorized Hyundai Dealer.

G290B03E-AAT

### Adjustment After Headlight Assembly Replacement

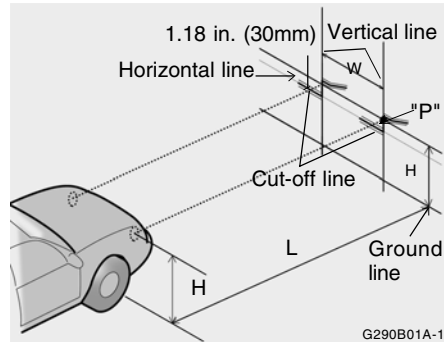

If the vehicle has had front body repair and the headlight assembly has been replaced, the headlight aiming should be checked using an aiming screen as shown in the illustration. Turn on the headlight switch. (Low Beam Position)

1. Adjust headlights so that main axis of light is parallel to the center line of the body and is aligned with point "P" shown in the illustration.
2. Dotted lines in the illustration show the center of the headlights.

### Specification:

"H"  
Horizontal center line of headlights from ground.

Low beam : 25.2 in. (639 mm)  
High beam : 23.3 in. (619 mm)

"W"  
Distance between each headlight center.  
Low beam : 44.2 in. (1124 mm)  
High beam : 33.0 in. (840 mm)

"L"  
Distance between the headlights and the wall that the lights are tested against.  
: 118 in. (3,000 mm).

## REPLACEMENT OF LIGHT BULBS

G260A04A-AAT

Before attempting to replace a headlight bulb, be sure the switch is turned to the "OFF" position. The next paragraph shows how to reach the headlight bulbs so they may be changed. Be sure to replace the burned-out bulb with one of the same number and wattage rating. See page 6-34 for the wattage description.

**CAUTION:**

- o Keep the lamps out of contact with petroleum products, such as oil, gasoline, etc.
- o After heavy, driving rain or washing, headlight and taillight lenses could appear frosty. This condition is caused by the temperature difference between the lamp inside and outside. This is similar to the condensation on your windows inside your vehicle during the rain and doesn't indicate a problem with your vehicle. If the water leaks into the lamp bulb circuitry, have the vehicle checked by an Authorized Hyundai Dealer.

G270A01A-AAT

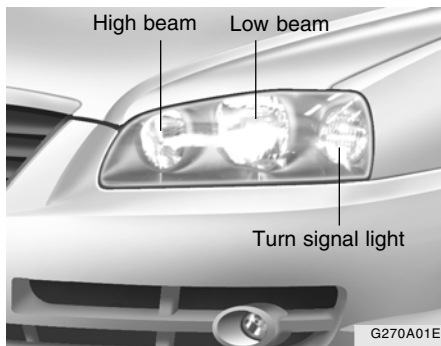
**HEADLIGHT AND FRONT TURN SIGNAL LIGHT**

Replacement instructions:

1. Allow the bulb to cool. Wear eye protection.
2. Open the engine hood.
3. Always grasp the bulb by its plastic base, avoid touching the glass.

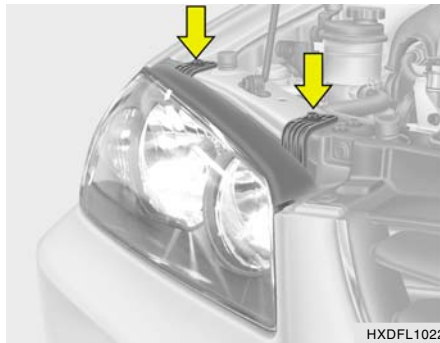

4. Using a socket wrench of the correct size, remove the headlight assembly mounting bolts.



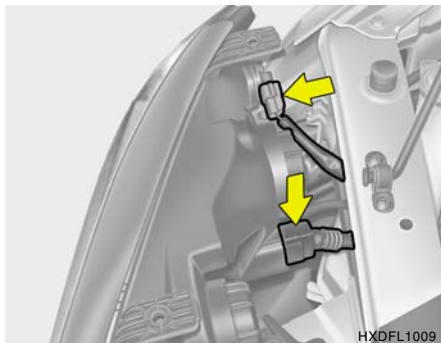

HXDFL1009

5. Disconnect the power cord from the back of the headlight.

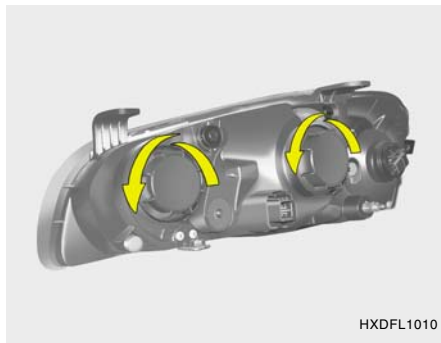

HXDFL1010

6. Turn the plastic cover counterclockwise and remove it.

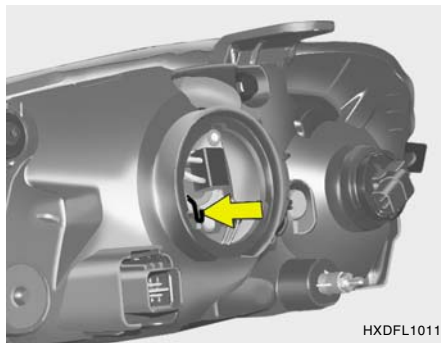

HXDFL1011

7. Push the bulb spring to remove the headlight bulb.

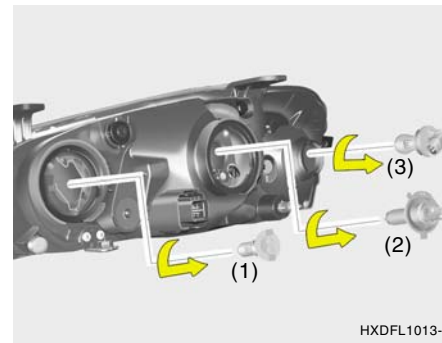

HXDFL1013-1

8. Remove the protective cap from the replacement bulb and install the new bulb by matching the plastic base with the headlight hole. Retighten the bulb spring and reconnect the power cord.
9. Use the protective cap and carton to promptly dispose of the old bulb.
10. Check for proper headlight aim.

- (1) High beam  
 (2) Low beam  
 (3) Front turn signal light

**WARNING:**

This halogen bulb contains gas under pressure and if impacted could shatter, resulting in flying fragments. Always wear eye protection when servicing the bulb. Protect the bulb against abrasions or scratches and against liquids when lighted. Turn the bulb on only when installing in a headlight. Replace the headlight if damaged or cracked. Keep the bulb out of the reach of children and dispose of the used bulb with care.

G270D01E-AAT

### REAR COMBINATION LIGHT (Stop/Tail Light, Back up light and Rear Turn Signal Light)

► 4 Door

1. Open the trunk lid.

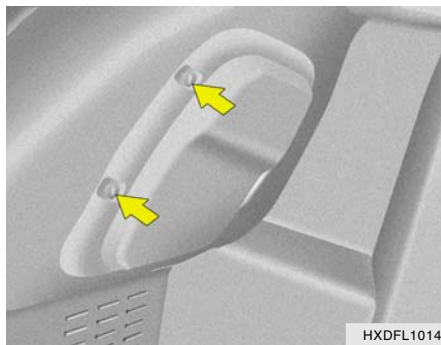

2. Unscrew and remove the cover on the inside of the rear luggage trim.

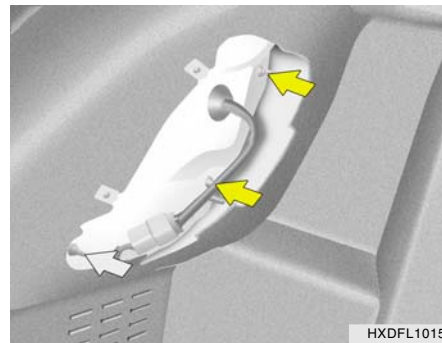

3. Remove the mounting screws of the rear combination light with a socket wrench.

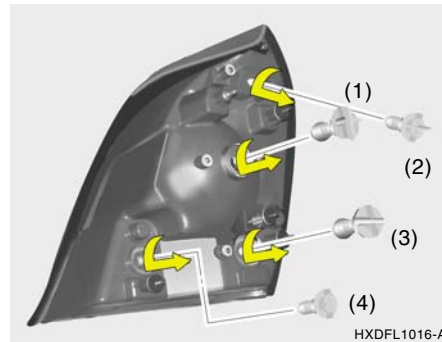

4. To replace the rear combination light, remove it from the bulb holder and install the new bulb.

- (1) Stop/Tail light
- (2) Side marker light
- (3) Rear turn signal light
- (4) Back up light

#### ► 5 Door (Luggage compartment)

1. Open the tail gate.

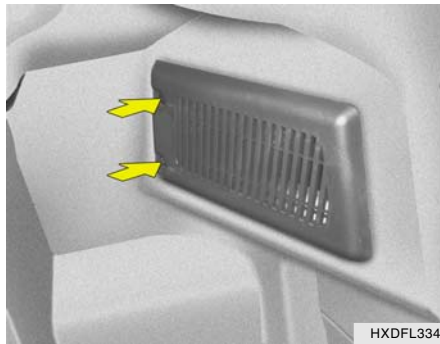

2. Remove the mounting screws of the rear combination light with a flat blade screwdriver.

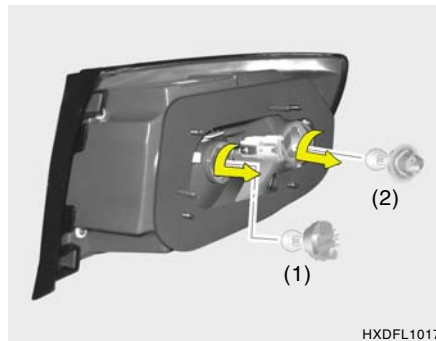
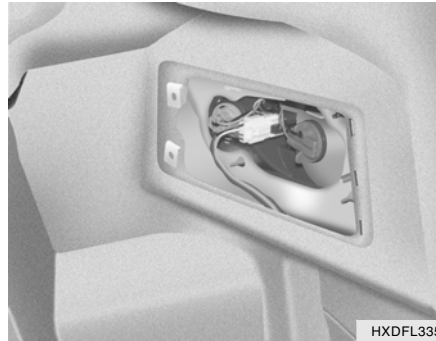

3. To replace the rear combination light, remove it from the bulb holder and install the new bulb.

- (1) Stop/Tail light
- (2) Rear turn signal light

#### ► 5 Door (Tail gate)

1. Open the tail gate.

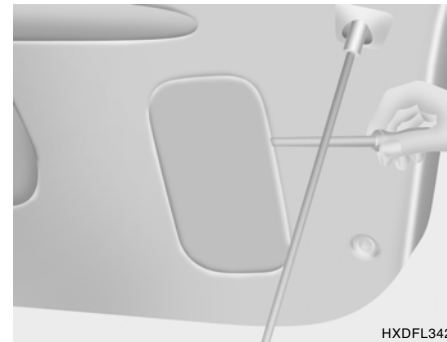

2. Remove the cover with a flat blade screwdriver.

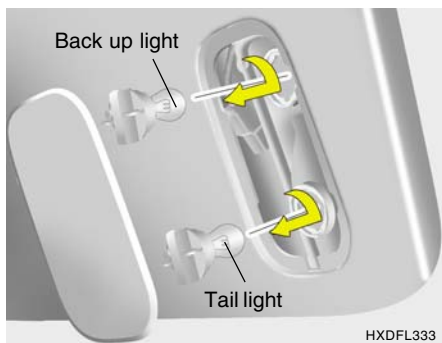

3. To replace the rear combination light, remove it from the bulb holder and install the new bulb.

G270C01L-GAT

**LUGGAGE COMPARTMENT LIGHT****► 4 Door**

1. Open the trunk lid.

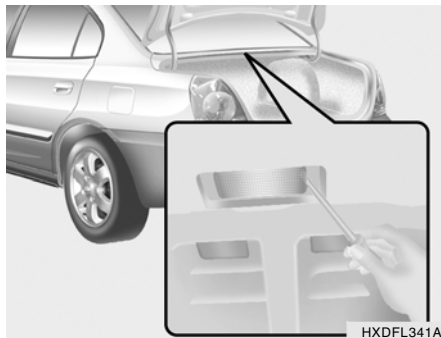

2. Remove the plastic cover with a flat blade screwdriver.

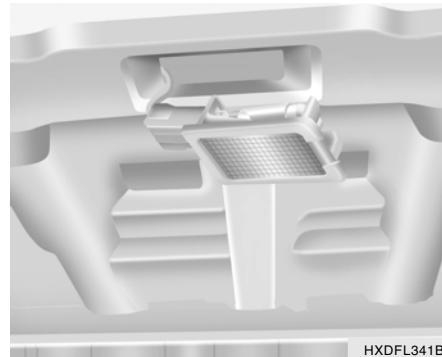

3. Disconnect the power cord.

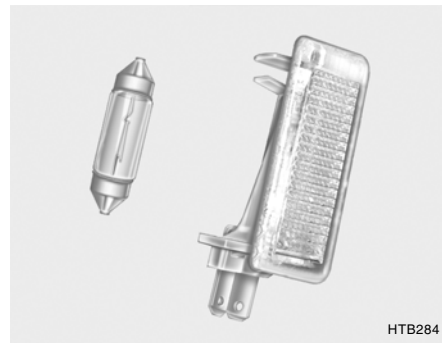

4. Replace with a new bulb.

## ► 5Door

1. Open the tail gate.

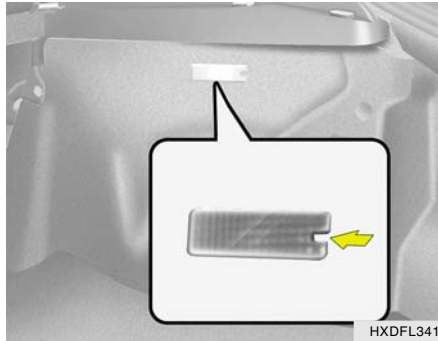

2. Remove the luggage compartment light cover on the right side package tray panel with pushing it.

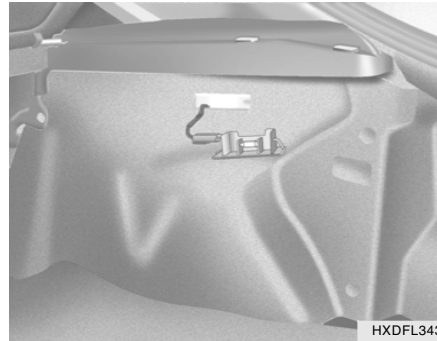

3. Disconnect the power cord.

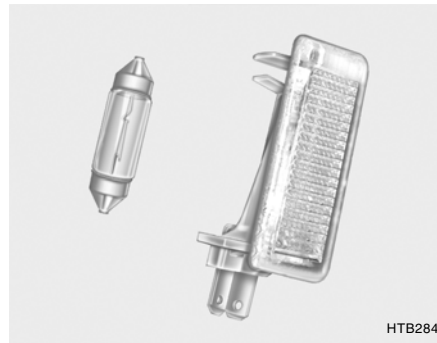

4. Replace with a new bulb.

G270E01E-AAT

## SIDE MARKER LIGHT

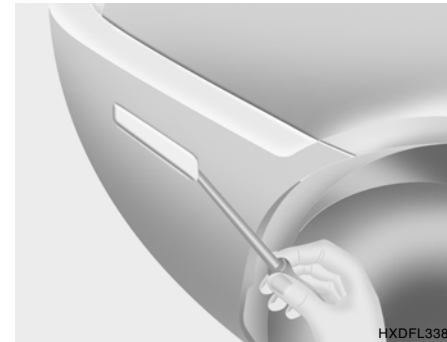

1. Remove the cover with a flat blade screwdriver.

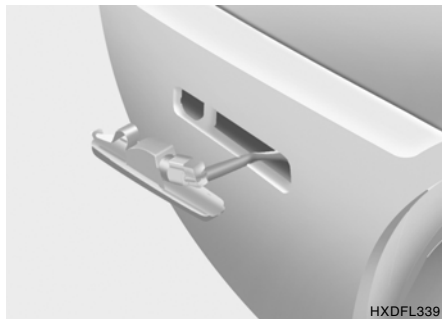

2. Disconnect the power cord.

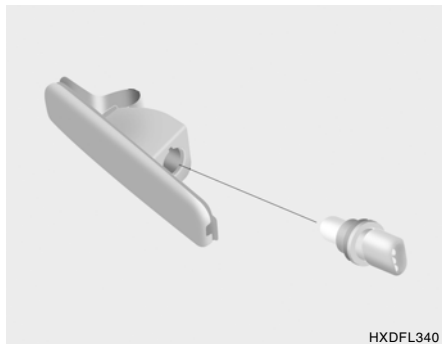

3. Replace with a new bulb.

G270G01E-GAT  
**INTERIOR LIGHT**  
**Room Light**

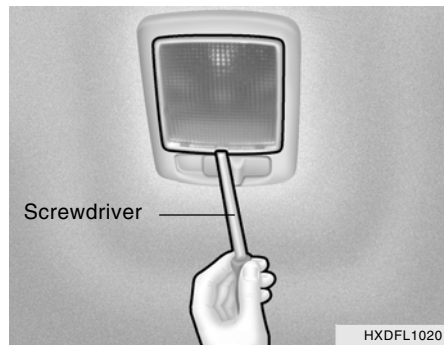

1. Remove the plastic cover with a flat blade screwdriver.



2. Replace with a new bulb.

G270H01E-GAT

**Map Light (If installed)**

1. Remove the plastic cover with a flat blade screwdriver.



2. Replace with a new bulb.

**BULB WATTAGE**

G280A04E-AAT

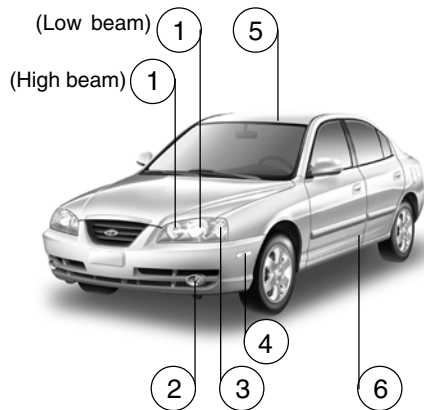

4 DOOR

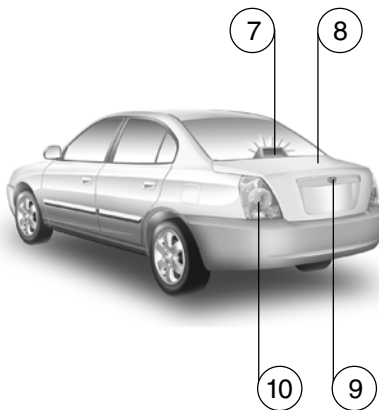

5 DOOR

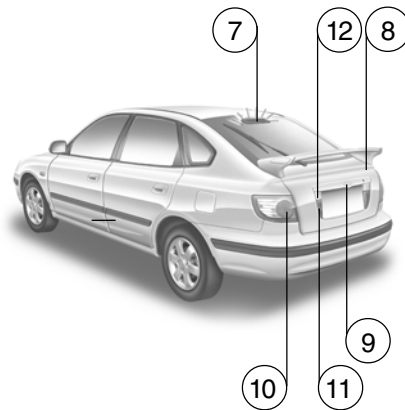

G280A03E-A

No.	Part Name		Wattage		Socket type	No.	Part Name		Wattage		Socket type
1	Head Light (High/Low)		55/55		P14.5s/PX 26d	7	High Mounted Stop Light		5 Door	2.6(LED)	-
2	Front Fog Light		51		P22d	8	Luggage Compartment Light		5		S8.5/8.5
3	Front Turn Signal Light		27		BA15s	9	License Plate Light		5		S8.5/8.5
4	Side Marker Light		5		W2.1x9.5d	10	Rear	Turn Signal Light	27		BA 15s
5	Interior	Map Light	10		W2.1x9.5D		Combination Light	Stop/Tail Light	27/8		BAY 15d
		Room Light	10		S8.5/8.5	11	Tail Light		8		BAY 15d
6	Front Door Edge Warning Light		5		W2.1x9.5d	12	Back-up Light		4 Door	16	W2.1 x 9.5D
7	High Mounted Stop Light		4 Door	16	BA 15s				5 Door	27	BA 15s



## FUSE PANEL DESCRIPTION

G200B01E-AAT

## Engine Compartment

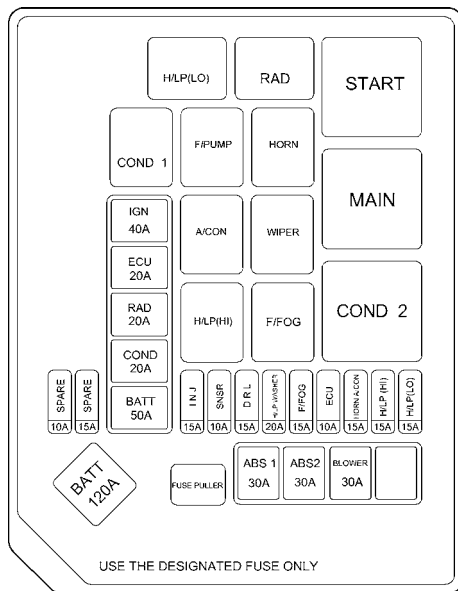

DESCRIPTION		FUSE RATING	PROTECTED COMPONENTS
FUSIBLE LINK	BATT	120A	Generator
	BATT	50A	Fusible link (P/WDW), Tail lamp relay, Power connector
	COND	20A	Condenser fan relay.1
	RAD	20A	Radiator fan relay
	ECU	20A	Generator, Engine control relay, Fuel pump relay, PCM
	IGN	40A	Ignition switch, Start relay
	ABS.1	30A	ABS control (Motor)
	ABS.2	30A	ABS control (Solenoid)
	BLOWER	30A	Blower relay
FUSE	INJ.	15A	Injectors
	SNSR	10A	PCM, Heated oxygen sensor, SMATRA, Heater relay, Glow plug relay
	DRL	15A	DRL control
	H/LP WASHER	20A	Head lamp washer
	F/FOG	15A	Front fog lamp relay
	ECU	10A	Siren, PCM
	HORN & A/C	15A	A/C relay, Horn relay
	H/LP (HI)	15A	Head lamp (High)
	H/LP (LO)	15A	Head lamp (Low)

G280B01E

**NOTE:**

Not all fuse panel descriptions in this manual may be applicable to your vehicle. It is accurate at the time of printing. When you inspect the fuse box on your vehicle, refer to the fuse box label.

G200D01E-GAT

## Inner Panel

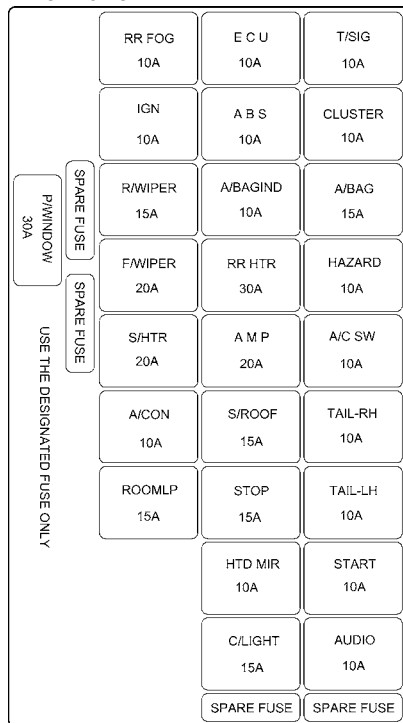

G280D01E

	DESCRIPTION	FUSE RATING	PROTECTED COMPONENTS
FUSE	T/SIG	10A	Turn signal lamps, Back-up lamp
	CLUSTER	10A	Pre-excitation resistor, Instrument cluster (IND)
	A/BAG	15A	SRS control
	HAZARD	10A	Hazard relay, Hazard lamps
	A/C SW	10A	A/C Control
	TAIL-RH	10A	Short connector, Illumination lamps, Tail lamp (RH), Head lamp washer
	TAIL-LH	10A	Tail lamp (LH), Exterior lamps
	START	10A	B/Alarm relay
	AUDIO	10A	Digital clock, Power outside mirror & mirror folding, Audio
	E C U	10A	Cruise control, PCM, Vehicle speed sensor, Ignition coil
	A B S	10A	ABS control
	A/BAG IND	10A	Instrument cluster (Air bag IND)
	RRHTR	30A	Defogger relay
	A M P	20A	Power antenna
	S/ROOF	15A	Power door lock control, Sunroof
	STOP	15A	Stop lamps, Power window, Power outside mirror folding
	HTD MIR	10A	Rear window & outside mirror defogger, A/C control
	C/LIGHT	15A	Cigarette lighter, Power outlet
	RR FOG	10A	Rear fog lamps
	I G N	10A	Head lamp, Head lamp washer, Fuel filter heating
R/WIPER	15A	Rear wiper & washer	
F/WIPER	20A	Front wiper & washer	
SHTR	20A	Seat warmer	
A/CON	10A	Blower & A/C control, ETACM, Sunroof controller, Electronic chrome mirror	
ROOM LP	15A	Door lamps, Instrument cluster, Data link connector, Multipurpose check connector, Room lamps, ETACM, Audio, Power connector	
FUSIBLE LINK	P/WINDOW	30A	Power window

# EMISSION CONTROL SYSTEMS

Emission Control System .....	7-2
Catalytic Converter .....	7-3

# 7

## EMISSION CONTROL SYSTEM

H010A01A-AAT

Your Hyundai is equipped with an emission control system to meet all requirements of the U.S. Environmental Protection Agency or California Air Resources Board.

There are three emission control systems which are as follows.

- 1) Crankcase Emission Control System
- 2) Evaporative Emission Control System
- 3) Exhaust Emission Control System

In order to ensure the proper function of the emission control systems, it is recommended that you have your car inspected and maintained by an authorized Hyundai dealer in accordance with the maintenance schedule in this manual.

H010B01A-AAT

### 1. Crankcase Emission Control System

The Positive Crankcase Ventilation System is employed to prevent air pollution caused by blow-by gases being emitted from the crankcase. This system supplies fresh filtered air to the crankcase through the air intake hose. Inside the crankcase, the fresh air mixes with blow-by gases, which then pass through the PCV valve and into the induction system.

H010C01S-AAT

### 2. Evaporative Emission Control (Including ORVR: Onboard Refueling Vapor Recovery) System

The Evaporative Emission Control System is designed to prevent fuel vapors from escaping into the atmosphere.

(The ORVR system is designed to allow the vapors from the fuel tank to be loaded into a canister while refueling at the gas station, preventing the escape of fuel vapors into the atmosphere.)

### Canister

Fuel vapors generated inside the fuel tank are absorbed and stored in the onboard canister. When the engine is running, the fuel vapors absorbed in the canister are drawn into the induction system through the purge control solenoid valve.

### Purge Control Solenoid Valve (PCSV)

The purge control solenoid valve is controlled by the Engine Control Module (ECM); when the engine coolant temperature is low during idling, the PCSV closes so that evaporated fuel is not taken into the engine. After the engine warms-up during ordinary driving, the PCSV opens to introduce evaporated fuel to the engine.

H010D01A-AAT

### 3. Exhaust Emission Control System

The Exhaust Emission Control System is a highly effective system which controls exhaust emissions while maintaining good vehicle performance.

## CATALYTIC CONVERTER

H020A01S-AAT

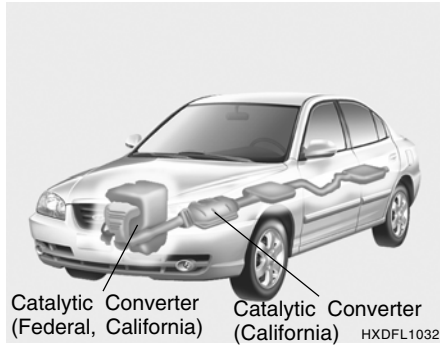

All Hyundai vehicles are equipped with one or two monolith type three-way catalytic converters to reduce the carbon monoxide, hydrocarbons and nitrogen oxides contained in the exhaust gas. Exhaust gases passing through the catalytic converter cause it to operate at a very high temperature. The introduction of large amounts of unburned gasoline into the exhaust may cause the catalytic converter to overheat and create a fire hazard. This risk may be reduced by observing the following:

### ! WARNING:

- o Use unleaded fuel only.
- o Maintain the engine in good operating condition. Extremely high catalytic converter temperatures can result from improper operation of the electrical, ignition or multipoint electronic fuel injection.
- o If your engine stalls, pings, knocks, or is hard to start, have your Hyundai dealer inspect and repair the problem as soon as possible.
- o Avoid driving with a very low fuel level. Running out of gasoline may cause the engine to misfire and result in damage to the catalytic converter.
- o Avoid idling the engine for periods longer than 10 minutes.
- o The vehicle should not be pushed or pulled to get started. This may cause the catalytic converter to overheat and create a fire hazard.
- o Do not touch the catalytic converter or any other part of the exhaust system while the catalytic converter is hot. Shut off the engine, wait for at least one hour before touching the catalytic converter or any other part of the exhaust system.
- o Remember that your Hyundai dealer is your best source of assistance.

### ! WARNING:

- o Do not stop your Hyundai over any combustible material such as grass, paper, leaves or rags. These materials might contact the hot catalytic converter and a fire might result.

# CONSUMER INFORMATION, REPORTING SAFETY DEFECTS & BINDING ARBITRATION OF WARRANTY CLAIMS

Vehicle Identification Number (VIN) .....	8-2
Engine Number .....	8-2
Recommended Cold Tire Inflation Pressures .....	8-3
Checking Tire Inflation Pressure .....	8-5
Tire Sidewall Labeling .....	8-5
All Season Tires .....	8-8
Summer Tires .....	8-8
Snow Tires .....	8-8
Tire Chains .....	8-9
Tire Rotation .....	8-9
Tire Balancing .....	8-10
Tire Traction .....	8-10
When to Replace Tires .....	8-11
Spare Tire and Tools .....	8-12
Warranties for Your Hyundai Vehicle .....	8-13
Consumer Information .....	8-13
Reporting Safety Defects .....	8-15
Binding Arbitration (U.S.A only) .....	8-16

# 8

2

## VEHICLE IDENTIFICATION NUMBER (VIN)

I010A01A-AAT

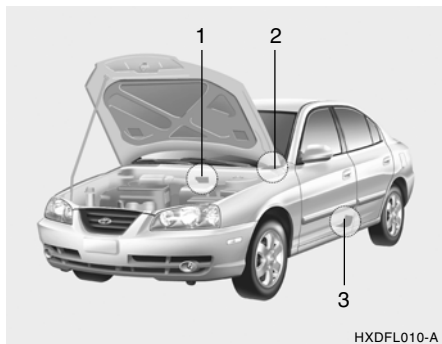

The vehicle identification number (VIN) is the number used in registering your car and in all legal matters pertaining to its ownership, etc. It can be found in three different places on your car:

1. On the bulkhead between the engine and passenger compartments.
2. On the left top side of the instrument panel where it can be seen by looking down through the windshield.
3. On the lower side of the center pillar outer panel.

I010B01A-AAT

## Engine Number

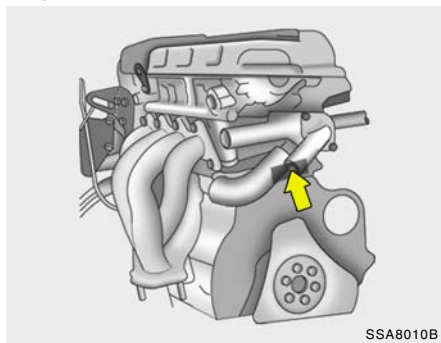

The engine number is stamped on the engine block as shown in the drawing.

## TIRES

I020A02A-AAT

### TIRE INFORMATION

The tires supplied on your new Hyundai are chosen to provide the best performance for normal driving.

If you ever have questions about your tire warranty and where to obtain service, see the tire manufacturer's booklet included with your vehicle's Owner's Manual Literature Kit.

I030A02JM-AAT

## RECOMMENDED COLD TIRE INFLATION PRESSURES



HXDFL6002

Tire label located on the driver's side of the center pillar outer panel gives the cold tire pressures recommended for your vehicle with the original tire size, the number of people that can be in your vehicle and vehicle capacity weight.

TIRE AND LOADING INFORMATION			
SEATING CAPACITY		TOTAL 5	FRONT 2 REAR 3
The combined weight of occupants and cargo should never exceed 385kg or 850 lbs.			
TIRE	SIZE	COLD TIRE PRESSURE	SEE OWNER'S MANUAL FOR ADDITIONAL INFORMATION
FRONT	195/60R15	210KPA, 30PSI	
REAR	195/60R15	210KPA, 30PSI	
SPARE	T125/70D15	420KPA, 60PSI	

I030A03E

These pressures were chosen to provide the most satisfactory combination of ride comfort, tire wear and stability under normal conditions. Tire pressures should be checked at least monthly. Proper tire inflation pressures should be maintained for these reasons:

- ! WARNING:**
- o Inspect your tires frequently for proper inflation as well as wear and damage. Always use a tire pressure gauge.
  - o Tires with too much or too little pressure wear unevenly causing poor handling, loss of vehicle control, and sudden tire failure leading to accidents, injuries, and even death. The recommended cold tire pressure for your vehicle can be found in this manual and on the tire label located on the driver's side of the center pillar.
  - o Worn tires can cause accidents. Replace tires that are worn, show uneven wear, or are damaged. See page 8-11.
  - o Remember to check the pressure of your spare tire. Hyundai recommends that you check the spare every time you check the pressure of the other tires on your vehicle.



**NOTE:**

- o Underinflation also results in excessive wear, poor handling and reduced fuel economy. Wheel deformation also is possible. Keep your tire pressures at the proper levels. If a tire frequently needs refilling, have it checked by your Hyundai Dealer.
- o Overinflation produces a harsh ride, excessive wear at the center of the tire tread, and a greater possibility of damage from road hazards.



**WARNING:**  
Overinflation or underinflation can reduce the tire life, adversely affect vehicle handling, and lead to sudden tire failure. This could result in loss of vehicle control and potential injury.



**CAUTION:**  
Always observe the following:

- o Check pressures when the tires are cold. (After the vehicle has been parked for at least three hours or hasn't been driven more than one mile or 1.6 km since starting up.)
- o Check the pressure of your spare tire each time you check the pressure of other tires.
- o Never overload your vehicle. Be especially careful about overloading if you equip your vehicle with a luggage rack.
- o Worn, old tires can cause accidents. If your tread is badly worn, or if your tires have been damaged, replace them.

I035A01JM-AAT

## CHECKING TIRE INFLATION PRESSURE

Check your tires once a month or more. Also, check the tire pressure of the spare tire.

### How to Check

Use a good quality gauge to check tire pressure. You cannot tell if your tires are properly inflated simply by looking at them. Radial tires may look properly inflated even when they're underinflated. Check the tire's inflation pressure when the tires are cold. - "Cold" means your vehicle has been sitting for at least three hours or driven no more than 1 mile (1.6 km).

Remove the valve cap from the tire valve stem. Press the tire gage firmly onto the valve to get a pressure measurement. If the cold tire inflation pressure matches the recommended pressure on the tire and loading information label, no further adjustment is necessary. If the pressure is low, add air until you reach the recommended amount. If you overfill the tire, release air by pushing on the metal stem in the center of the tire valve. Recheck the tire pressure with the tire gauge. Be sure to put the valve caps back on the valve stems. They help prevent leaks by keeping out dirt and moisture.

I030B01E-AAT

## TIRE SIDEWALL LABELING

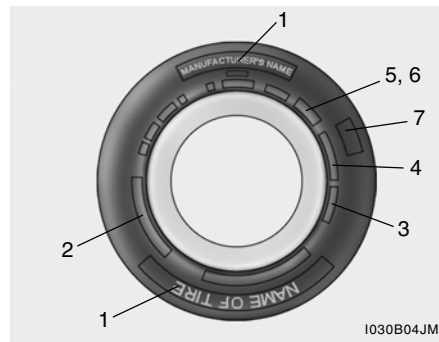

Federal law requires tire manufacturers to place standardized information on the sidewall of all tires. This information identifies and describes the fundamental characteristics of the tire and also provides the tire identification number (TIN) for safety standard certification. The TIN can be used to identify the tire in case of a recall.

**1. Manufacturer or Brand name**

- o Manufacturer or Brand name is shown.

**2. Tire size** (example: P195/60R1587H)

- o The "P" indicates the tire is designed for passenger vehicles. A "T" is the designation for a temporary spare tire.
- o Three-digit number (195): This number gives the width in millimeters of the tire from sidewall edge to sidewall edge.
- o Two-digit number (60): This number, known as the aspect ratio, gives the tire's ratio of height to width.
- o R: The "R" stands for radial.
- o Two-digit number (15): This number is the wheel or rim diameter in inches.
- o Two (or three) digit number (87): This number is the tire's load index. It is a measurement of how much weight each tire can support.

- o H: Speed Rating. The speed rating denotes the speed at which a tire is designed to be driven for extended periods of time. The ratings range from "A" to "Z" (98 to 186 MPH).

**3. TIN** (Tire Identification Number) for new tire (example: DOT XX XX XXX XXXX)

- o DOT: Abbreviation for the "Department of Transportation". The symbol can be placed above, below or to the left or right of the Tire Identification Number. It indicates the tire is in compliance with the U.S. Department of Transportation Motor Vehicle Safety Standards.
- o 1st two-digit code: Manufacturer's identification mark
- o 2nd two-digit code: Tire size
- o 3rd three-digit code: Tire type code (Optional)
- o 4th four-digit code: Date of Manufacture

- o Four numbers represent the week and year the tire was built. For example, the numbers 3105 means the 31st week of 2005.

**4. Tire ply composition and material**

The number of layers or plies of rubbercoated fabric in the tire. Tire manufacturers also must indicate the materials in the tire, which include steel, nylon, polyester, and others. The letter "R" means radial ply construction; the letter "D" means diagonal or bias ply construction; and the letter "B" means belted-bias ply construction.

**5. Maximum permissible inflation pressure**

This number is the greatest amount of air pressure that should be put in the tire. Do not exceed the maximum permissible inflation pressure. Refer to the Tire and Loading Information label for recommended inflation pressure.

## 6. Maximum load rating

This number indicates the maximum load in kilograms and pounds that can be carried by the tire. When replacing the tires on the vehicle, always use a tire that has the same load rating as the factory installed tire.

## 7. Uniform Tire Quality Grading (UTQG):

Tire manufacturers are required to grade tires based on three performance factors: treadwear, traction and temperature resistance. For more information, see Uniform Tire Quality Grading on page 8-13.

**Occupant Distribution:** Designated seating positions.

**Outward Facing Sidewall:** The side of an asymmetrical tire that has a particular side that faces outward when mounted on a vehicle. The side of the tire that contains a whitewall, bears white lettering or bears manufacturer, brand and or model name molding that is higher or deeper than the same moldings on the other sidewall of the tire.

**Passenger (P-Metric) Tire:** A tire used on passenger cars and some light duty trucks and multipurpose vehicles.

**Recommended Inflation Pressure:** Vehicle manufacturer's recommended tire inflation pressure as shown on the tire placard.

**Radial Ply tire:** A pneumatic tire in which the ply cords that extend to the beads are laid at 90 degrees to the centerline of the tread.

**Rim:** A metal support for a tire upon which the tire beads are seated.

**Sidewall:** The portion of a tire between the tread and the bead.

**Speed Rating:** An alphanumeric code assigned to a tire indicating the maximum speed at which a tire can operate.

**Traction:** The friction between the tire and the road surface. The amount of grip provided.

**Tread:** The portion of a tire that comes into contact with the road.

**Treadwear Indicators:** Narrow bands, sometimes called "wear bars," that show across the tread of a tire when only 2/32 inch of tread remains.

**UTQGS:** Uniform Tire Quality Grading Standards, a tire information system that provides consumers with ratings for a tire's traction, temperature and treadwear. Ratings are determined by tire manufacturers using government testing procedures. The ratings are molded into the sidewall of the tire.

**Vehicle Capacity Weight:** The number of designated seating positions multiplied by 150 lbs. (68 kg) plus the rated cargo and luggage load.

**Vehicle Maximum Load on the Tire:** Load on an individual tire due to curb and accessory weight plus maximum occupant and cargo weight.

**Vehicle Normal Load on the Tire:** That load on an individual tire that is determined by distributing to each axle its share of the curb weight, accessory weight, and normal occupant weight and dividing by 2.

**Vehicle Placard:** A label permanently attached to a vehicle showing the original equipment tire size and recommended inflation pressure.

I040B01JM-AAT

### ALL SEASON TIRES

Hyundai specifies all season tires on some models to provide good performance for use all year round, including snowy and icy road conditions. All season tires are identified by ALL SEASON and/or M+S (Mud and Snow) on the tire sidewall. Snow tires have better snow traction than all season tires and may be more appropriate in some areas.

I040C01JM-AAT

### SUMMER TIRES

Hyundai specifies summer tires on some models to provide superior performance on dry roads. Summer tire performance is substantially reduced in snow and ice. Summer tires do not have the tire traction rating M+S (Mud and Snow) on the tire side wall. If you plan to operate your vehicle in snowy or icy conditions, Hyundai recommends the use of snow tires or all season tires on all four wheels.

I040A01S-AAT

### SNOW TIRES

If you equip your car with snow tires, they should be the same size and have the same load capacity as the original tires. Snow tires should be installed on all four wheels; otherwise, poor handling may result.

Snow tires should carry 4 psi (28 kPa) more air pressure than the pressure recommended for the standard tires on the tire label on the driver side center pillar outer panel, or up to the maximum pressure shown on the tire sidewall whichever is less.

Do not drive faster than 75 mph (120 km/h) when your car is equipped with snow tires.

I050A03O-AAT

**TIRE CHAINS**

Tire chains, if necessary, should be installed on the front wheels. Be sure that the chains are the proper size and that they are installed in accordance with the manufacturer's instructions. To minimize tire and chain wear, do not continue to use tire chains when they are no longer needed.

**WARNING:**

- o When driving on roads covered with snow or ice, drive at less than 20 mph.
- o Use the SAE "S" class or wire & plastic chains.
- o Don't use a tire chains on a vehicle equipped with aluminium wheels. If it is unavoidable use wire-type chains.

**WARNING:**

- o Use wire chains less than 15mm to prevent damage to the chain's connection.
- o If you have noise caused by chains contacting the body, retighten the chain to avoid contact with the vehicle body.
- o To prevent body damage, retighten the chains after driving 0.3~0.6 miles.

I060A02A-AAT

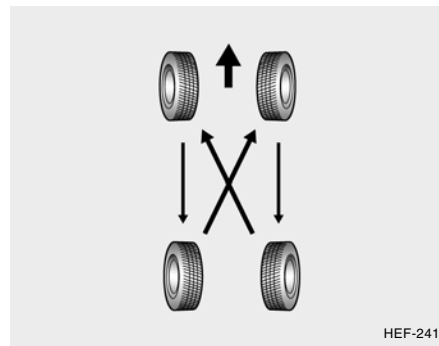
**TIRE ROTATION**

Tires should be rotated every 7,500 miles (12,000 km). If you notice that tires are wearing unevenly between rotations, have the car checked by a Hyundai dealer so the cause may be corrected.

After rotating, adjust the tire pressures and be sure to check the wheel nut torque.

**WARNING:**

- o Do not use the temporary spare tire for tire rotation.
- o Do not mix bias ply and radial ply tires under any circumstances. This may cause unusual handling characteristics that could result in death, serious injury, or property damage.

I070A01A-AAT

**TIRE BALANCING**

A tire that is out of balance may affect handling and tire wear. The tires on your Hyundai were balanced before the car was delivered but may need balancing again during the years you own the car. Whenever a tire is dismounted for repair, it should be rebalanced before being reinstalled on the car.

I080A01A-AAT

**TIRE TRACTION**

Tire traction can be reduced if you drive on worn tires, tires that are improperly inflated or on slippery road surfaces. Tires should be replaced when tread wear indicators appear. To reduce the possibility of losing control, slow down whenever there is rain, snow or ice on the road.

1090A03JM-AAT

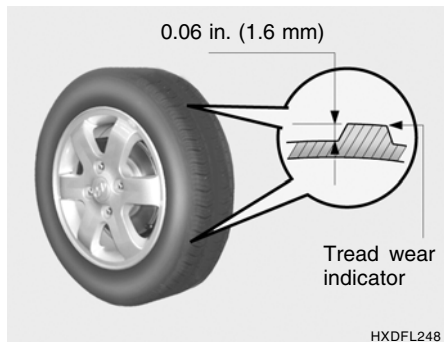
**WHEN TO REPLACE TIRES**

The original tires on your car have tread wear indicators. The location of tread wear indicators is shown by the "TWI" or "△" marks, etc., The tread wear indicators appear when the tread depth is 0.06 in. (1.6 mm). The tire should be replaced when these appear as a solid bar across two or more grooves of the tread. Always replace your tires with those of the recommended size. If you change wheels, the new wheel's rim width and offset must meet Hyundai specification.

**WARNING:**

To reduce the chance of serious or fatal injuries from an accident caused by tire failure or loss of vehicle control:

- o Replace tires that are worn, show uneven wear, or are damaged. Worn tires can cause loss of braking effectiveness, steering control, and traction.
- o Do not drive your vehicle with too little or too much pressure in your tires. This can lead to uneven wear and tire failure.
- o When replacing tires, never mix radial and bias-ply tires on the same car. You must replace all tires (including the spare) if moving from radial to bias-ply tires.

**WARNING:**

- o Using tires and wheel other than the recommended sizes could cause unusual handling characteristics and poor vehicle control, resulting in a serious accident.
- o Wheels that do not meet Hyundai's specifications may fit poorly and result in damage to the vehicle or unusual handling and poor vehicle control.



1090B02JM-AAT

**TIRE MAINTENANCE**

In addition to proper inflation, correct wheel alignment helps to decrease tire wear. If you find a tire is worn unevenly, have your dealer check the wheel alignment.

When you have new tires installed, make sure they are balanced. This will increase vehicle ride comfort and tire life. Additionally, a tire should always be rebalanced if it is removed from the wheel.

**WARNING:**

- o **Underinflated or overinflated tires can cause poor handling, loss of vehicle control, and sudden tire failure leading to accidents, injuries, and even death. Always check tires are properly inflated before driving. Refer to pages 2-22 and 8-3 for proper tire pressures and further information.**
- o **Driving on tires with no or insufficient tread is dangerous. Worn-out tires can result in loss of vehicle control, collisions, and injury and even death. Worn-out tires should be replaced as soon as possible and should never be used for driving. Always check tire tread before driving your car. Refer to this page for further information and tread limits.**

**SPARE TIRE AND TOOLS**

I100A02E-AAT

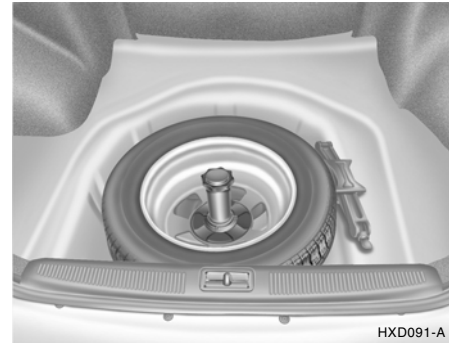

Your Hyundai is delivered with the following:

Spare tire and wheel  
Wheel nut wrench, Wrench bar  
Jack

## CONSUMER INFORMATION

I110A01A-AAT

**SHOP MANUAL**

A Hyundai Shop Manual is available from your authorized Hyundai dealer. It's written for professional technicians, but is simple enough for most mechanically-inclined owners to understand.

I120A03A-AAT

**WARRANTIES FOR YOUR HYUNDAI VEHICLE**

**Please consult your Owner's Handbook & Warranty Information booklet for your vehicle's specific warranty coverage.**

I130A01A-AAT

This consumer information has been prepared in accordance with regulations issued by the National Highway Traffic Safety Administration of the U.S. Department of Transportation. It provides the purchasers and/or prospective purchasers of Hyundai automobiles with information on uniform tire quality grading. Your Hyundai dealer will help answer any questions you may have as you read this information.

I130B04A-AAT

**Tire Quality Grading**

Department of Transportation quality grades - All passenger vehicle tires must conform to Federal Safety Standards in addition to these grades. These quality grades are molded on the sidewall.

**Treadwear** - The treadwear grade is a comparative rating based on the wear rate of the tire when tested under controlled conditions on a specified government test course. For example, a tire graded 150 would wear one and a half (1 - 1/2) times as well on the government course as a tire graded 100. The relative performance of tires depends upon the actual conditions of their use, however, and may depart significantly from the norm due to variations in driving habits, service practices and differences in road characteristics and climate.

**Traction AA, A, B, C** - The traction grades, from highest to lowest, are AA, A, B, and C. Those grades represent the tire's ability to stop on wet pavement as measured under controlled conditions on specified government test surfaces of asphalt and concrete. A tire marked C may have poor traction performance.



**WARNING:**

**The traction grade assigned to this tire is based on straight-ahead braking traction tests, and does not include acceleration, cornering, hydroplaning, or peak traction characteristics.**

**Temperature A, B, C** - The temperature grades are A (the highest), B, and C, representing the tire's resistance to the generation of heat and its ability to dissipate heat when tested under controlled conditions on a specified indoor laboratory test wheel. Sustained high temperature can cause the material of the tire to degenerate and reduce tire life, and excessive temperature can lead to sudden tire failure. The grade C corresponds to a level of performance which all passenger car tires must meet under the Federal Motor Vehicle Safety Standard No. 109. Grades B and A represent higher levels of performance on the laboratory test wheel than the minimum required by law.



**WARNING:**

**The temperature grade for this tire is established for a tire that is properly inflated and not overloaded. Excessive speed, underinflation, or excessive loading, either separately or in combination, can cause heat buildup and possible tire failure.**

**Uniform Tire Quality Grading** - Quality grades can be found on the tire sidewall between the tread shoulder and the maximum section width.

For example :

Treadwear 200 Traction AA Temperature A

I130D04A-AAT

Hyundai motor vehicles are designed and manufactured to meet or exceed all applicable safety standards.

For your safety, however, we strongly urge you to read and follow all directions in this Owner's Manual, particularly the information under the headings "**NOTE**", "**CAUTION**" and "**WARNING**".

If, after reading this manual, you have any questions regarding the operation of your vehicle, please contact your nearest Hyundai Motor America Regional Office as listed below:

**Eastern Region** : Connecticut, Delaware, Maine, Maryland, Massachusetts, New Hampshire, New Jersey, New York, Pennsylvania, Rhode Island, Vermont, Virginia, West Virginia.

Hyundai Eastern Region  
1100 Cranbury South River Road  
Jamesburg, NJ 08831  
(800) 633-5151

**Southern Region:** Florida, Georgia, North Carolina, South Carolina.

Southern Region  
270 Riverside Parkway, Suite A  
Austell, GA 30168  
(800) 633-5151

**South Central Region:** Alabama, Arkansas, Colorado, Kansas, Louisiana, Mississippi, Missouri, New Mexico, Oklahoma, Tennessee, Texas, Wyoming.

South Central Region  
1421 South Beltline Road, Suite 400  
Coppell, TX 75019  
(800) 633-5151

**Central Region:** Illinois, Indiana, Iowa, Kentucky, Michigan, Minnesota, Nebraska, North Dakota, South Dakota, Ohio, Wisconsin.

Central Region  
1705 Sequoia Drive  
Aurora, Illinois 60506  
(800) 633-5151

**Western Region:** Alaska, Hawaii, Arizona, California, Idaho, Montana, Nevada, Oregon, Texas, Utah, Washington.

Western Region  
10550 Talbert Avenue  
P.O.Box 20850  
Fountain Valley, California 92728-0850  
(800) 633-5151

I130C02A-AAT

If you believe that your vehicle has a defect which could cause a crash or could cause injury or death, you should immediately inform the National Highway Traffic Safety Administration (NHTSA) in addition to notifying HYUNDAI MOTOR AMERICA. If NHTSA receives similar complaints, it may open an investigation, and if it finds that a safety defect exists in a group of vehicles, it may order a recall and remedy campaign. However, NHTSA cannot become involved in individual problems between you, your dealer, or HYUNDAI MOTOR AMERICA.

To contact NHTSA, you may call the Vehicle Safety Hotline toll-free at 1-888-327-4236 (TTY: 1-800-424-9153); go to <http://www.safercar.gov>; or write to: Administrator, NHTSA, 400 Seventh Street, SW., Washington, DC 20590. You can also obtain other information about motor vehicle safety from <http://www.safercar.gov>.

**BINDING ARBITRATION  
(U.S.A only)**

I140A01A-AAT

Any claim or dispute you may have related to your vehicle's warranty or the duties contemplated under the warranty, including claims related to the refund or partial refund of your vehicle's purchase price (excluding personal injury or product liability claims), shall be resolved by binding arbitration. Binding arbitration shall be administered by and through the National Arbitration Forum (NAF) or the American Arbitration Association (AAA), under the Code of Procedure of the entity you select.

You will not be responsible for paying filing and hearing fees above \$275.00. All other arbitration costs shall be borne by Hyundai Motor America. You are not responsible to pay any of the costs Hyundai incurs.

This Binding Arbitration Agreement shall not deprive you of any remedies available to you under applicable law. The parties are waiving their right to seek remedies in court, including the right to a jury trial.

This Binding Arbitration Agreement shall be governed by and interpreted under the Federal Arbitration Act, 9 U.S.C. sections 1-16. Judgment upon any award may be entered in any court having jurisdiction.

You may revoke this Arbitration Agreement by (1) written notice or (2) electronic notice. Written notice must be delivered (via certified mail) to Hyundai Motor America, Attn: Consumer Affairs, 10550 Talbert Avenue, P.O. Box 20849, Fountain Valley, CA 92728-0849. Electronic notice must be submitted at the following website address: <http://warranty-arbitration.hyundaiUSA.com>. Notice must be received within 90 days after you purchase your vehicle.

## VEHICLE SPECIFICATIONS

Measurement .....	9-2
Engine .....	9-3
Lubrication Chart .....	9-4

# 9

J010A02E-GAT

**MEASUREMENT**

in. (mm)

	4 Door	5 Door
Overall length	178.1 (4525)	177.9 (4520)
Overall width	67.9 (1725)	67.7 (1720)
Overall height (unladen)	56.1 (1425)	
Wheel base	102.8 (2610)	
Wheel tread	Front	58.5 (1485)
	Rear	58.1 (1475)

J020A01E-AAT

**POWER STEERING**

Type	Rack and pinion
Wheel free play	0 ~ 1.18 in. (0 ~ 30 mm)
Rack stroke	5.67 in. (144 mm)
Oil pump type	Vane type

J060A01S-AAT

**FUEL SYSTEM**

Fuel tank capacity	US.gal	Imp.gal	Liter
	14.5	12	55

J030A03E-AAT

**TIRE**

psi (kpa)

Tire	Size	Tire pressure
Standard	P185/65 R15,P195/60 R15	30(210)
Spare	T125/70(R)D15	60(420)

J040A02E-AAT

**ELECTRICAL**

Item	
Battery	MF60AH (12V)
Alternator	90A (13.5V)

J050A01E-AAT

**BRAKE**

Type	Dual hydraulic with brake booster
Front brake type	Ventilated disc
Rear brake type	Solid disc (With ABS)
	Drum (Without ABS)
Parking brake	Cable

## ENGINE

J070A06E-AAT

ITEMS		SPECIFICATIONS	
		2.0 DOHC CVVT	2.0 SULEV
Engine Type		2.0L 4 Cylinder in-line DOHC	
Idle Speed (RPM)		700 ± 100 (A/CON OFF)	
		750 ± 100 (A/CON ON)	
Valve Clearance (Cold engine : 20±5°C)	For adjusting	Intake	0.0067 ~ 0.0091 in. (0.17 ~ 0.23 mm)
		Exhaust	0.0098 ~ 0.0122 in. (0.25 ~ 0.31 mm)
	For checking	Intake	0.0047 ~ 0.011 in. (0.12 ~ 0.28 mm)
		Exhaust	0.0079 ~ 0.015 in. (0.20 ~ 0.38 mm)
Ignition Timing (Base)		BTDC 8° ± 5°	BTDC 9° ± 5°
Firing Order		1 - 3 - 4 - 2	
Oil Grade		SH(API) or GF-1 (ILSAC) and ABOVE multigrade and fuel-efficient oil	



## LUBRICATION CHART

J080A09E-AAT

Item		Oil & Grease Standard		Q'ty
Engine Oil Recommends 		API SJ, SL or ABOVE, ILSAC GF-3 or ABOVE	SAE 5W-20, 5W-30 SAE 10W-30 (ABOVE 0°F(-18°C))	Drain and refill With oil filter 4.2 US.QTS (3.5 Imp.qts, 4.0 liter)
Transaxle	Manual	HYUNDAI GENUINE PARTS MTF 75W/85 (API GL-4)		2.3 US. QTS. (1.86 Imp. qts., 2.15 liter)
	Auto	HYUNDAI GENUINE ATF SP III, DIAMOND ATF SP III, SK ATF SP III or other brands meeting the SP III specification approved by Hyundai Motor Co..		8.2 US. QTS. (6.8 Imp.qts., 7.8 liter)
Power Steering		PSF-3		0.95 US. QTS. (0.79 Imp.qts., 0.9 liter)
Brake Fluid		DOT 3, DOT 4 or equivalent		As required
Coolant		Ethylene glycol base for aluminum radiator		6.4 US.QTS (5.31 Imp.qts., 6.0 liter)

# INDEX

# 10



- A**
- Air bag ..... 1-33
  - Air Cleaner Filter ..... 6-9
  - Air Conditioning
    - Care ..... 6-16
    - Operation ..... 1-90, 6-16
    - Switch ..... 1-89
  - Antenna ..... 1-131
  - Ashtray ..... 1-64
  - Audio System
    - Cassete tape player operation (H240, H290) ..... 1-106, 1-120
    - CD auto changer (H260, H290) ..... 1-114, 1-125
    - Compact disc player operation (H260, H290) ..... 1-111, 1-122
    - Stereo radio operation (H240, H260, H290) ..... 1-103, 1-108, 1-117
- B**
- Battery ..... 6-22
  - Binding Arbitration (U.S.A only) ..... 8-16
  - Brake
    - Anti-lock brake system ..... 2-12
    - Checking the brakes ..... 6-14
    - Fluid ..... 6-14
    - Pedal clearance ..... 6-19
    - Pedal freeplay ..... 6-19
  - Breaking-In your New Hyundai ..... 1-3
- C**
- Care of Cassette Tapes ..... 1-129
  - Care of Disc ..... 1-129
  - Catalytic Converter ..... 7-3
  - Changing the Climate Control Air Filter ..... 6-17
  - Child-Protector Rear Door Lock ..... 1-7
  - Child Restraint System ..... 1-24
    - Installing a Child Restraint System with  
"Tether Anchorage" System ..... 1-25
    - Securing the Child Restraint Seat with the "ISOFIX" System ..... 1-29
  - Cigarette Lighter ..... 1-63
  - Clock ..... 1-62
  - Clutch
    - Checking fluid ..... 6-15
    - Pedal freeplay ..... 6-19
  - Combination Light
    - Auto light ..... 1-58
    - Headlight flasher ..... 1-58
    - Headlight switch ..... 1-57
    - High-beam switch ..... 1-58
    - Lane change signal ..... 1-57
    - Parking light auto off ..... 1-58
    - Turn signal operation ..... 1-57
  - Consumer Information ..... 8-13
  - Cooling Fans ..... 6-23
  - Corrosion protection
    - Cleaning the interior ..... 4-5
    - Protecting your Hyundai from corrosion ..... 4-2
    - Washing and waxing ..... 4-3
  - Cruise Control ..... 1-80

- D**
- Defrosting / Defogging ..... 1-91
  - Door
    - Locking, unlocking front door with a key ..... 1-5
  - Drink Holder ..... 1-65
  - Drive Belts ..... 6-20
  - Driving
    - Driving for economy ..... 2-15
    - Smooth cornering ..... 2-16
    - Winter driving ..... 2-16
- E**
- Emission Control System ..... 7-2
  - Engine
    - Before starting the engine ..... 2-3
    - Compartment ..... 6-2
    - Coolant ..... 6-7
    - Coolant temperature gauge ..... 1-52
    - If the engine overheats ..... 3-4
    - Number ..... 8-2
    - Oil ..... 6-4
    - Starting ..... 2-5
  - Engine Exhaust Can Be Dangerous ..... 2-2
- F**
- Fan Speed Control ..... 1-88
  - Floor Mat Anchor ..... 1-75
  - Fog Light
    - Front ..... 1-59
- Front Seats
  - Adjustable front seats ..... 1-11
  - Adjustable headrests ..... 1-13
  - Adjusting seat forward and rearward ..... 1-12
  - Adjusting seatback angle ..... 1-12
- Fuel
  - Capacity ..... 9-2
  - Gauge ..... 1-51
  - Recommendations ..... 1-2
- Fuel Filler Lid
  - Remote release ..... 1-75
- Fuses ..... 6-20
- Fuse Panel Description ..... 6-35
- G**
- General Checks ..... 6-3
  - Glove Box ..... 1-70
- H**
- Hazard Warning System ..... 1-62
  - Headlight Aiming Adjustment ..... 6-24
  - Heating and Cooling Control ..... 1-83
  - Heating and Ventilation
    - Air flow control ..... 1-84
    - Air intake control ..... 1-87
    - Bi-level heating ..... 1-88
    - Defrosting / Defogging ..... 1-91
    - Fan speed control (Blower control) ..... 1-88
    - Temperature control ..... 1-87

High-Mounted Rear Stoplight .....	1-74
Hood Release .....	1-74
Horn .....	1-80

**I**

Ignition Switch .....	2-3
Instrument Cluster and Indicator Lights .....	1-44
Instrument Panel Light Control (Rheostat) .....	1-62

**J**

Jump Starting .....	3-3
---------------------	-----

**K**

Key .....	1-3
If you lose your keys .....	3-13
Positions .....	2-4

**L**

Luggage Net .....	1-79
-------------------	------

**M**

Maintenance Intervals	
Explanation of scheduled maintenance items .....	5-7
Maintenance under severe usage conditions .....	5-6
Scheduled maintenance .....	5-4
Service requirements .....	5-2

**Mirrors**

Day-night inside rearview mirror .....	1-73
Outside rear view mirror .....	1-71
Outside rear view mirror heater .....	1-72

**O**

Odometer / Trip Odometer .....	1-53
--------------------------------	------

**P**

Parking Brake .....	1-64
Power Outlet .....	1-63
Power Steering Fluid Level .....	6-24
Power Window .....	1-10

**R****Rear Seat**

Adjusting seatback angle .....	1-12
Folding rear seatback and seat cushion .....	1-15
Rear Window Defroster Switch .....	1-61
Replacement of Light Blubs .....	6-26
Reporting Safety Defects .....	8-15

**S****Seat**

Adjustable front seats .....	1-11
folding rear seatbacks .....	1-14

- Seat Belts
  - 3-point system ..... 1-20
  - Pretensioner seat belt ..... 1-31
  - Adjusting your seat belt ..... 1-22
  - Care of seat belts ..... 1-19
- Shop Manual ..... 8-13
- Speedometer ..... 1-52
- Starting Procedure ..... 2-5
- Steering Wheel Freeplay ..... 6-18
- Steering Wheel Tilt Lever ..... 1-79
- Stereo Sound System ..... 1-101
- Sunglass Holder ..... 1-70
- Sunroof ..... 1-66
- Sun visor ..... 1-73
  
- T**
- Tachometer ..... 1-53
- Tail Gate (5Door) ..... 1-78
- Theft-Alarm System ..... 1-7
- Tires
  - All season tires ..... 8-8
  - Balancing ..... 8-10
  - Chains ..... 8-9
  - Changing a flat tire ..... 3-6
  - If you have a flat tire ..... 3-6
  - Information ..... 8-2
  - Pressure ..... 8-3
  - Replacement ..... 8-11
  - Rotation ..... 8-9
  - Snow tires ..... 8-8
  - Spare tire ..... 3-5
  - Summer tires ..... 8-8
  - Tire sidewall labeling ..... 8-5
  - Traction ..... 8-10
- Towing
  - A trailer (or vehicle) ..... 2-18
  - Emergency ..... 3-13
  - If your car must be towed ..... 3-11
- Traction Control System ..... 2-12
- Transaxle
  - Automatic ..... 2-8
  - Automatic transaxle fluid checking ..... 6-12
  - Manual ..... 2-6
  - Manual transaxle fluid checking ..... 6-12
  
- V**
- Vehicle Identification Number ..... 8-2
- Vehicle Specifications
  - Engine ..... 9-3
  - Lubrication chart ..... 9-4
  - Measurement ..... 9-2
  
- W**
- Warning Lights and Indicator Lights ..... 1-48
- Windshield Wiper and Washer ..... 1-59
- Windshield Wiper Blades ..... 6-9

This Owner's Manual should be considered a part of the car and remain with it when it is sold for the use of the next owner.

OWNER'S I.D.

ORIGINAL OWNER \_\_\_\_\_

ADDRESS \_\_\_\_\_

CITY \_\_\_\_\_ STATE \_\_\_\_\_ ZIP CODE \_\_\_\_\_

DELIVERY DATE \_\_\_\_\_

(Date Sold to Original Retail Purchaser)

DEALER NAME \_\_\_\_\_ DEALER NO. \_\_\_\_\_

ADDRESS \_\_\_\_\_

CITY \_\_\_\_\_ STATE \_\_\_\_\_ ZIP CODE \_\_\_\_\_

**SERVICE STATION INFORMATION FUEL:**

UNLEADED gasoline only  
Pump Octane Rating of 87 (Research Octane Number 91) or higher.

**FUEL TANK CAPACITY**

Original, US.gal (Imp.gal., liter) 14.5 (12, 55)

**TIRE PRESSURE:**

See the label on the driver's side of the center pillar outer panel.

**OTHER TIRE INFORMATION:**

See pages 8-2 through 8-11

**HOOD RELEASE:**

Pull handle under left side of dash.

**ENGINE OIL:**

API grade SJ, SL or ABOVE / ILSAC grade GF-3 or ABOVE and fuel efficient oil. Use SAE 5W-20, 5W-30 or 10W-30 if normal temperatures are above 0°F (-18°C). For other viscosity recommendations, see page 6-4 or 9-4.

**MANUAL TRANSAXLE:**

HYUNDAI GENUINE PARTS MTF 75W/85 (API GL-4) Oil level should be up to filler-bolt hole in housing beside differential.

**AUTOMATIC TRANSAXLE:**

Apply the parking brake, with the engine running, shift the selector lever through all ranges and return to “N” (Neutral) position. Then check the level of fluid on the dipstick. Use only HYUNDAI GENUINE ATF SP III, DIAMOND ATF SP III, SK ATF SP III or other brands meeting the SP III specification approved by Hyundai Motor Co..

**QUICK INDEX**

- o Car will not start..... 3-2
- o Flat tire ..... 3-6
- o Warning light/chime comes on ..... 1-46 ~ 1-49
- o Engine overheats ..... 3-4
- o Towing of your vehicle ..... 3-11
- o Starting the engine ..... 2-4
- o Driving tips for first 1,200 miles (2,000 km) ..... 1-3
- o Scheduled maintenance ..... 5-4
- o Reporting safety defects ..... 8-14