

TABLE OF CONTENTS

SECTION		PAGE
1	INTRODUCTION	3
2	THINGS TO KNOW BEFORE STARTING YOUR VEHICLE	9
3	UNDERSTANDING THE FEATURES OF YOUR VEHICLE	85
4	UNDERSTANDING YOUR INSTRUMENT PANEL	195
5	STARTING AND OPERATING	301
6	WHAT TO DO IN EMERGENCIES	365
7	MAINTAINING YOUR VEHICLE	393
8	MAINTENANCE SCHEDULES	447
9	IF YOU NEED CONSUMER ASSISTANCE	473
10	INDEX	481

INTRODUCTION

CONTENTS

■ Introduction	4	■ Vehicle Identification Number	6
■ How To Use This Manual	4	■ Vehicle Modifications / Alterations	7
■ Warnings And Cautions	6		

INTRODUCTION

This manual has been prepared with the assistance of service and engineering specialists to acquaint you with the operation and maintenance of your new vehicle. It is supplemented by a Warranty Information Booklet and various customer oriented documents. You are urged to read these publications carefully. Following the instructions and recommendations in this manual will help assure safe and enjoyable operation of your vehicle.

NOTE: After you read the manual, it should be stored in the vehicle for convenient reference and remain with the vehicle when sold, so that the new owner will be aware of all safety warnings.

When it comes to service, remember that your dealer knows your vehicle best, has the factory-trained technicians and genuine Mopar® parts, and is interested in your satisfaction.

WARNING!

Engine exhaust, some of its constituents, and certain vehicle components contain or emit chemicals known to the State of California to cause cancer and birth defects or other reproductive harm. In addition, certain fluids contained in vehicles and certain products of component wear contain or emit chemicals known to the State of California to cause cancer and birth defects or other reproductive harm.

HOW TO USE THIS MANUAL

Consult the table of contents to determine which section contains the information you desire.

The detailed index, at the rear of this manual, contains a complete listing of all subjects.

Consult the following table for a description of the symbols that may be used on your vehicle or throughout this owner's manual:

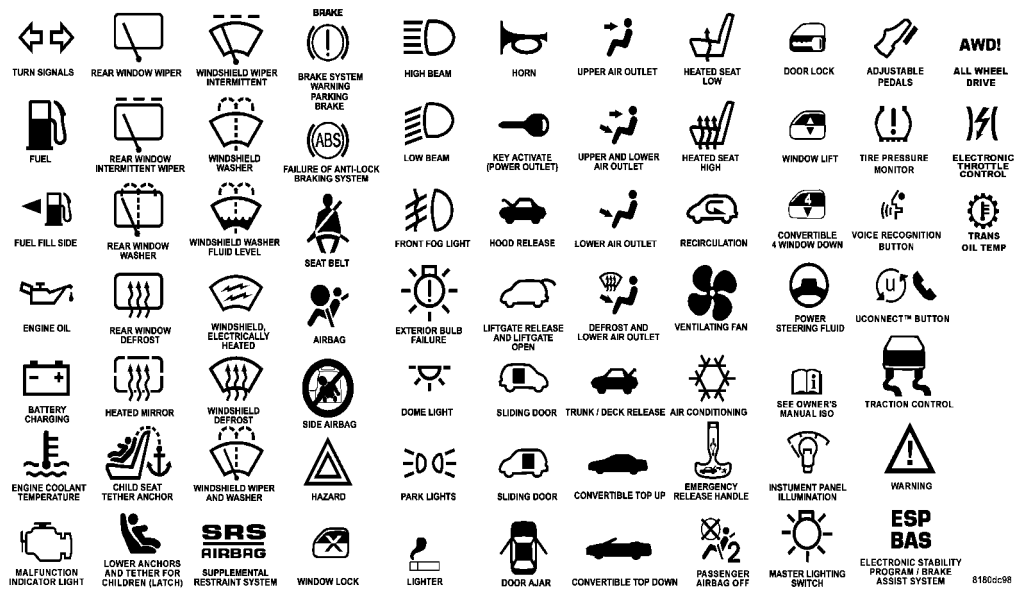

WARNINGS AND CAUTIONS

This manual contains **WARNINGS** against operating procedures which could result in an accident or bodily injury. It also contains **CAUTIONS** against procedures which could result in damage to your vehicle. If you do not read this entire manual you may miss important information. Observe all Warnings and Cautions.

VEHICLE IDENTIFICATION NUMBER

The vehicle identification number (VIN) is found on the left front corner of the instrument panel, visible from outside of the vehicle through the windshield. This number also appears on the Automobile Information Disclosure Label affixed to a window on your vehicle. Save this label for a convenient record of your vehicle identification number and optional equipment.

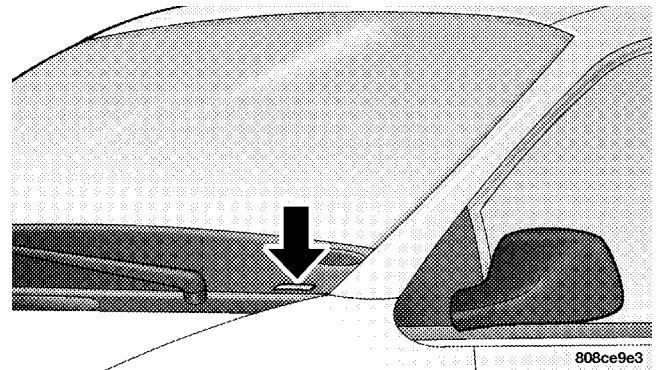

Vehicle Identification Number

NOTE: It is illegal to remove the VIN plate.

VEHICLE MODIFICATIONS / ALTERATIONS**WARNING!**

Any modifications or alterations to this vehicle could seriously affect its roadworthiness and safety and may lead to an accident resulting in serious injury or death.

THINGS TO KNOW BEFORE STARTING YOUR VEHICLE

CONTENTS

■ A Word About Your Keys12	□ Manual Door Locks17
□ Ignition Key Removal12	□ Power Door Locks — If Equipped18
□ Key-In-Ignition Reminder13	■ Remote Keyless Entry — If Equipped20
■ Sentry Key13	□ To Unlock The Doors And Liftgate22
□ Replacement Keys15	□ To Lock The Doors And Liftgate22
□ Customer Key Programming15	□ Using The Panic Alarm23
□ General Information16	□ To Program Transmitters23
■ Illuminated Entry System — If Equipped16	□ General Information25
■ Door Locks17	□ Transmitter Battery Service25

10 THINGS TO KNOW BEFORE STARTING YOUR VEHICLE

■ Vehicle Theft Alarm — If Equipped	26	□ Power Vent Windows — If Equipped	40
■ Sliding Side Door	28	□ Power Windows — If Equipped	41
□ Sliding Door Open Flash	30	■ Occupant Restraints	42
□ Power Sliding Door — If Equipped	30	□ Lap/Shoulder Belts	43
□ Child Protection Door Lock	33	□ Lap/Shoulder Belt Untwisting Procedure	49
■ Liftgate	34	□ Center Lap Belts	51
□ Power Liftgate — If Equipped	35	□ Seat Belt Pretensioners	51
■ Seat Storage Bin Safety Warning	38	□ Enhanced Seat Belt Use Reminder System (BeltAlert)	52
□ Storage Bin Cover Emergency Release	38	□ Seat Belts And Pregnant Women	53
□ Reinstalling Storage Bin Cover Emergency Release	39	□ Seat Belt Extender	53
■ Windows	40	□ Driver And Front Passenger Supplemental Restraint Systems (SRS) — Airbags	54
□ Manual Rear Vent Windows	40		

<hr/>		THINGS TO KNOW BEFORE STARTING YOUR VEHICLE	11
<input type="checkbox"/>	DaimlerChrysler Corporation Integrated Child Seat — If Equipped	.69	
<input type="checkbox"/>	Child Restraint	.69	
<input checked="" type="checkbox"/>	Rear Seat Delete Feature (Commercial Vehicles Only) — If Equipped	.78	
<input type="checkbox"/>	Restraining Infants And Small Children With Seat Delete Feature (Commercial Vehicles Only)	.79	
<input checked="" type="checkbox"/>	Engine Break-In Recommendations	.82	
<input checked="" type="checkbox"/>	Safety Tips	.83	
<input type="checkbox"/>	Exhaust Gas	.83	
<input type="checkbox"/>	Safety Checks You Should Make Inside The Vehicle	.83	
<input type="checkbox"/>	Periodic Safety Checks You Should Make Outside The Vehicle	.84	

A WORD ABOUT YOUR KEYS

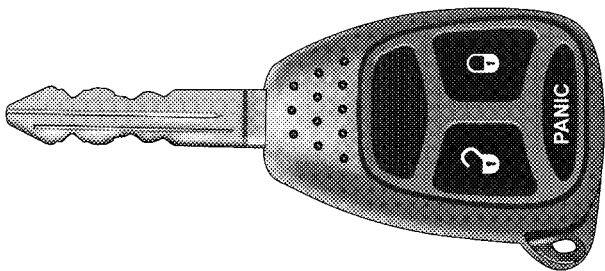

81182d3d

Vehicle Key

You can insert the double sided keys into the locks with either side up.

The dealer that sold you your new vehicle has the key code numbers for your vehicle locks. These numbers can

be used to order duplicate keys from your dealer. Ask your dealer for these numbers and keep them in a safe place.

Ignition Key Removal

The shift lever must be in PARK. Turn the key to the OFF position, then the LOCK position. Remove the key.

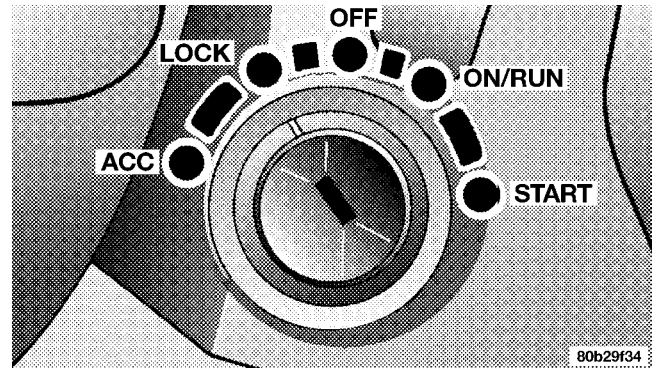

80b29f34

Ignition Key Position

NOTE: The power window switches, radio, power outlets, and removable console (if equipped), will remain active for up to 45 seconds after the ignition switch has been turned off. Opening a vehicle front door will cancel this feature.

WARNING!
<p>Leaving children in a vehicle unattended is dangerous for a number of reasons. A child or others could be injured. Children should be warned not to touch the parking brake, brake pedal or the gear selector lever. Don't leave the keys in the ignition. A child could operate power windows, other controls, or move the vehicle.</p>

CAUTION!
<p>An unlocked car is an invitation to thieves. Always remove key from the ignition and lock all doors when leaving the vehicle unattended.</p>

Key-In-Ignition Reminder

If you open the driver's door and the key is in the ignition switch, a chime will sound to remind you to remove the key.

SENTRY KEY

The Sentry Key Immobilizer System prevents unauthorized operation of the vehicle by disabling the engine. The system will shut the engine off after 2 seconds of running if an invalid key is used to start the vehicle. This system utilizes ignition keys which have an electronic

14 THINGS TO KNOW BEFORE STARTING YOUR VEHICLE

chip (transponder) embedded into them. Only keys that have been programmed to the vehicle can be used to start and operate the vehicle.

The Sentry Key Immobilizer System does not need to be armed or activated. Operation of the system is automatic regardless of whether or not the vehicle is locked or unlocked. During normal operation, the Theft Alarm/Immobilizer Light will come on for three (3) seconds immediately after the ignition switch is turned on for a bulb check. Afterwards, if the bulb remains on, this indicates a problem with the electronics.

If the bulb begins to flash after the bulb check, this indicates that an invalid key has been used to start the vehicle. Both of these conditions will result in the engine being shut off after two (2) seconds of running.

Keep in mind that a key which has not been programmed is also considered an invalid key even if it is cut to fit the ignition lock cylinder for that vehicle.

If the Theft Alarm/Immobilizer Light comes on during normal vehicle operation (vehicle has been running for longer than 10 seconds), a fault has been detected in the electronics and the vehicle should be serviced as soon as possible.

NOTE:

- The Sentry Key Immobilizer System is not compatible with remote starting systems. Use of these systems may result in vehicle starting problems and loss of security protection.
- Exxon/Mobil Speed Pass,[™] additional Sentry Keys, or any other transponder equipped components on the same keychain will **not** cause a key-related (transponder) fault unless the additional part is **physically held against the ignition key** being used when starting the vehicle. Cell phones, pagers, or other RF electronics will not cause interference with this system.

All of the keys provided with your new vehicle have been programmed to the vehicle electronics.

Replacement Keys

NOTE: Only keys that have been programmed to the vehicle electronics can be used to start the vehicle. Once a Sentry Key has been programmed to a vehicle, it can not be programmed to any other vehicle.

At the time of purchase, the original owner is provided with a four digit PIN number. This number is required for dealer replacement of keys. Duplication of keys may be performed at an authorized dealer or by using the Customer Key Programming procedure. This procedure consists of programming a blank key to the vehicle electronics. A blank key is one which has never been programmed.

NOTE: When having the Sentry Key Immobilizer System serviced, bring all vehicle keys with you to the dealer.

Customer Key Programming

You can program new sentry keys to the system if you have two valid sentry keys by performing the following procedure:

1. Cut the additional Sentry Key Transponder blank(s) to match the ignition switch lock cylinder key code.
2. Insert the first valid key into the ignition switch and turn the ignition switch ON for at least 3 seconds but no longer than 15 seconds. Turn the ignition switch OFF and remove the first key.
3. Insert the second valid key and turn the ignition switch ON within 15 seconds. After ten seconds a chime will sound and the Theft Alarm Light will begin to flash. Turn the ignition switch OFF and remove the second key.

4. Insert a blank Sentry Key into the ignition switch and turn the ignition switch ON within 60 seconds. After 10 seconds a single chime will sound. The Theft Alarm Light will stop flashing, turn on for 3 seconds; then turn off.

The new Sentry Key has been programmed. **The Keyless Entry Transmitter will also be programmed during this procedure.**

Repeat this procedure to program up to a total of 8 keys. If you do not have a programmed sentry key, contact your dealer for details.

NOTE: If a programmed key has been lost, see your dealer to have all remaining keys erased from the systems memory. The remaining keys must then be reprogrammed. This will prevent the lost key from starting your vehicle. All vehicle keys must be taken to the dealer at the time of service to be reprogrammed.

General Information

The Sentry Key system complies with FCC rules part 15 and with RSS-210 of Industry Canada. Operation is subject to the following conditions:

- This device may not cause harmful interference.
- This device must accept any interference that may be received, including interference that may cause undesired operation.

ILLUMINATED ENTRY SYSTEM — IF EQUIPPED

The courtesy lights will turn on when you use the keyless entry transmitter or open the doors. This feature is only available if you have Remote Keyless Entry.

The lights will fade to off after about 30 seconds or they will immediately fade to off once the ignition switch is turned on.

NOTE:

- The front courtesy overhead console, door courtesy and liftgate lights do not turn on if the dimmer control is in the interior lights ON position (extreme top position).
- The illuminated entry system will not operate if the dimmer control is in the “defeat” position (extreme downward position).

DOOR LOCKS**Manual Door Locks**

Lock the doors by pushing down on the lock plungers on each door trim panel.

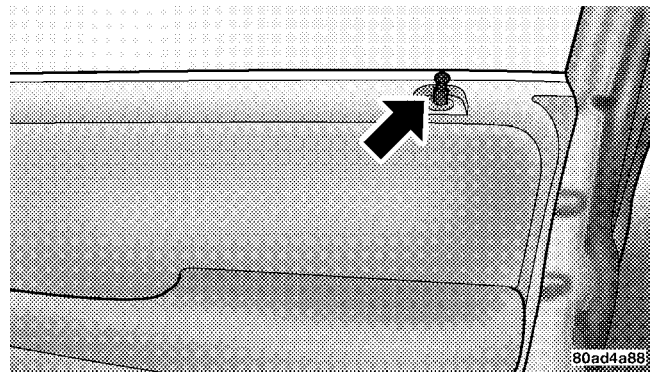

2

Door Lock Plunger

If the lock plunger is down when you shut the door, the door will lock. Therefore, make sure the keys are not inside the vehicle before closing the door.

WARNING!

- For personal security and safety in the event of an accident, lock the vehicle doors as you drive as well as when you park and leave the vehicle.
- When leaving the vehicle always remove the key from the ignition lock, and lock your vehicle. Do not leave children unattended in the vehicle, or with access to an unlocked vehicle. Unsupervised use of vehicle equipment may cause severe personal injuries and death.

Power Door Locks — If Equipped

A power door lock switch is on each front door trim panel. Use this switch to lock or unlock the doors.

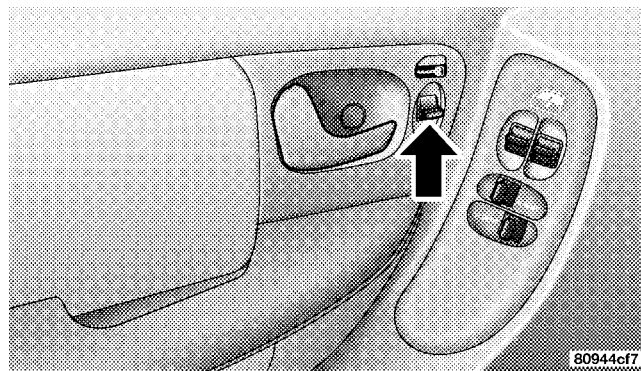

Power Door Lock switch

If you press the power door lock switch while the key is in the ignition, and any front door is open, the power locks will not operate. This prevents you from accidentally locking your keys in the vehicle. Removing the key or closing the door will allow the locks to operate. A chime will sound if the key is in the ignition switch and a door is open, as a reminder to remove the key.

If you press the power door lock switch while the sliding door is open, the sliding door will lock.

Auto Door Locks — If Equipped

The doors will lock automatically on vehicles with power door locks if:

1. The transmission is in gear,
2. all doors are closed,
3. the vehicle speed is above 18 mph (29 km/h) and
4. the doors were not previously locked using the power door lock switch or remote keyless entry transmitter.

The Automatic Door Locks can be enabled or disabled by performing the following procedure:

1. Close all doors and place the key in the ignition switch.
2. Cycle the ignition switch ON/OFF four times ending in the OFF position. (do not start the engine)
3. Within 10 seconds of the final cycle, press the interior driver's door lock switch to the LOCK position.
4. A single chime will sound to signify that you have successfully completed the programming.

You can turn the feature back on by repeating the above mentioned procedure or by performing the procedure in the Electronic Vehicle Information Center (EVIC), Customer Programmable Features section on vehicles so equipped. (See page 164 for more information.)

Auto Unlock On Exit— If Equipped

The doors will unlock automatically on vehicles with power door locks if:

1. The Auto Door Locks feature is enabled and the Auto Unlock On Exit feature is enabled,
2. the transmission was in gear and the vehicle speed returned to 0 mph (0 km/h),
3. the transmission is in NEUTRAL or PARK,
4. any door is opened (excluding liftgate) and
5. the vehicle speed is 0 mph (0 km/h).

The Auto Unlock On Exit feature can be enabled or disabled by performing the procedure in the Electronic Vehicle Information Center (EVIC), Customer Programmable Features section on vehicles so equipped. (See page 164 for more information.)

NOTE: Use the Auto Door Locks and Auto Unlock features in accordance with local laws.

REMOTE KEYLESS ENTRY — IF EQUIPPED

This system allows you to lock or unlock the doors and liftgate, and activate the panic alarm, optional power liftgate, left power sliding door, and right power sliding door from distances up to about 23 feet (7 meters) using a hand held radio transmitter. The transmitter need not be pointed at the vehicle to activate the system.

NOTE: If the key is in the ignition switch, then all buttons on that transmitter will be disabled. The buttons on the remaining transmitters will work. If the vehicle is shifted out of PARK, all the transmitter buttons are disabled for all keys.

Two (2) transmitters may be supplied with the vehicle. Vehicles built without the powered options will be equipped from the factory with three button transmitters and those built with power options will be equipped with six button transmitters.

Three button transmitters will provide basic UNLOCK, LOCK and PANIC functions.

options of the system allow you to turn ON/OFF the Sound Horn On Lock, Remote Unlock Driver's Door 1st, and Flash Lights On Lock/Unlock features.

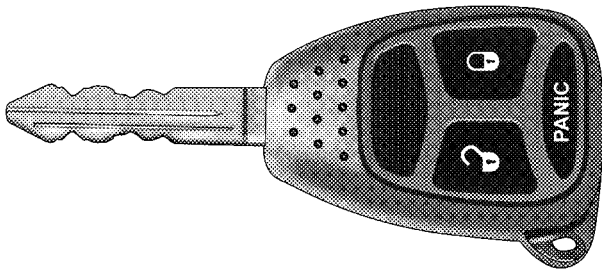

81182d3d

Three Button Transmitter

Six button transmitters will provide functions that allow the same basic operation as the three button, but may also be used to Open/Close the optional power liftgate, left power sliding door, or right power sliding door. Other

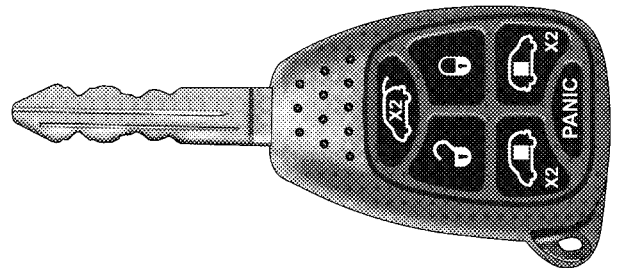

81182c6b

Six Button Transmitter

To unlock the doors and liftgate:

Press and release the UNLOCK button on the transmitter once to unlock the driver's door side of the vehicle, or twice to unlock all doors and liftgate. The illuminated entry system also turns on.

The Remote Unlock Driver's Door 1st feature can be enabled or disabled by performing the following procedure:

1. Press the UNLOCK button for 5 to 10 seconds.
2. While the UNLOCK button is pressed, (after 5 seconds) press the LOCK button. Release both buttons.

The "Remote Unlock Driver's Door 1st" feature can be reactivated by repeating the above mentioned procedure or by performing the procedure in the Electronic Vehicle Information Center (EVIC), Customer Programmable Features section on vehicles so equipped. (See page 164 for more information.)

To lock the doors and liftgate:

Press and release the LOCK button on the transmitter to lock all doors and liftgate. The horn will chirp once to acknowledge the signal.

If desired, the "Sound Horn On Lock" feature can be turned on and off by performing the following procedure:

1. Press the LOCK button for 5 to 10 seconds.
2. While the LOCK button is pressed (after 5 seconds), press the PANIC button. Release both buttons.

The "Sound Horn On Lock" feature can be reactivated by repeating this procedure or by performing the procedure in the Electronic Vehicle Information Center (EVIC), Customer Programmable Features section on vehicles so equipped. (See page 164 for more information.)

Using The Panic Alarm:

To turn the panic alarm feature ON or OFF, press and hold the PANIC button on the transmitter for at least one second and release. When the panic alarm is on, the headlights and park lights will flash, the horn will pulse on and off and the interior lights will turn on.

The panic alarm will stay on for 3 minutes unless you turn it off by pressing the PANIC button a second time or by turning the ignition switch to the ON position.

NOTE: When you turn off the panic alarm by pressing the PANIC button a second time, you may have to be closer to the vehicle due to the radio frequency noises of the system.

To Program Transmitters:

Refer to SENTRY KEY "Customer Key Programming." (See page 15 for more information.)

If you do not have a programmed transmitter, contact your dealer for details.

To Open/Close Power Liftgate — If Equipped

Press the LIFTGATE button twice within five seconds to open/close the power liftgate. The liftgate will beep for 2 seconds and then open/close. If the button is pushed while the liftgate is being power closed, the liftgate will reverse to the full open position.

If the liftgate is locked and is not equipped with a powered liftgate, pressing the button twice will result in the liftgate becoming unlocked for 30 seconds allowing you to manually access the liftgate area.

To Open/Close Left Power Sliding Door — If Equipped

Press the LEFT button twice within five seconds to open/close the left power sliding door. If the button is pushed while the door is being power closed, the door will reverse to the full open position.

If the vehicle is not equipped with a left power sliding door and the door is closed and locked, pressing the button twice will result in the left side doors becoming unlocked.

To Open/Close Right Power Sliding Door — If Equipped

Press the RIGHT button twice within five seconds to open/close the right power sliding door. If the button is pushed while the door is being power closed, the door will reverse to the full open position.

If the vehicle is not equipped with a right power sliding door and the door is closed and locked, pressing the button twice will result in the right side doors becoming unlocked.

To Turn Off “Flash Lights On Lock/Unlock” — If Equipped

If desired, the “Flash Lights On Lock/Unlock” feature can be turned on and off by performing the following procedure:

1. Press the LOCK button for 5 to 10 seconds.
2. While the LOCK button is pressed, (after 5 seconds) press the UNLOCK button. Release both buttons.

The “Flash Lights On Lock/Unlock” feature can be reactivated by repeating this procedure or by performing the procedure in the Electronic Vehicle Information Center (EVIC), Customer Programmable Features section on

vehicles so equipped. The table below explains the Lamp Flash options. (See page 164 for more information.)

Function	Which Turn Signal Lamps	Number of Flashes
Lock	All	1
Unlock 1st Press	Left Side	2
Unlock All Doors	All	2
Left Side	Left Side	2
Right Side	Right Side	2
Liftgate	All	2

General Information

This device complies with part 15 of the FCC rules and RSS 210 of Industry Canada. Operation is subject to the following conditions:

- This device may not cause harmful interference.

- This device must accept any interference received, including interference that may cause undesired operation.

If your Remote Keyless Entry transmitter fails to operate from a normal distance, check for these two conditions.

1. A weak battery in the transmitter. The expected life of the battery is a minimum of three years.
2. Closeness to a radio transmitter such as a radio station tower, airport transmitter, and some mobile or CB radios.

Transmitter Battery Service

The recommended replacement battery is one CR2032 battery.

NOTE: Do not touch the battery terminals that are on the back housing or the printed circuit board.

1. With the transmitter buttons facing down, use a thin coin to pry the two halves of the transmitter apart. Make sure not to damage the rubber gasket during removal.

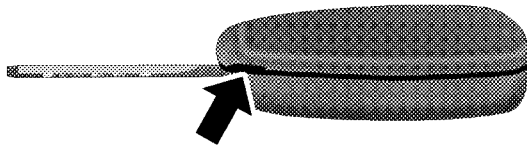

Separating Transmitter Halves

81182c72

2. Remove and replace the batteries. Avoid touching the new batteries with your fingers. Skin oils may cause battery deterioration. If you touch a battery, clean it with rubbing alcohol.

3. To reassemble the transmitter case snap two halves together. Make sure there is an even “gap” between the two halves. Test transmitter operation.

VEHICLE THEFT ALARM — IF EQUIPPED

This system monitors the vehicle doors and ignition switch for unauthorized entry or operation. When the alarm is activated, the system provides both audible and visual signals. The horn will pulse, headlights/park lights will flash, the Vehicle Theft Alarm/Immobilizer light, located in the instrument cluster, will flash, and the vehicle will not start. If the alarm is triggered and no action is taken to disarm it, the system will turn off the horn after three minutes and after 15 minutes of light only operation the system will then rearm itself.

To arm the system: Remove the key from the ignition switch and either:

1. Press a power door lock button while the driver's or passenger's door is open.
2. Press the LOCK button on the keyless entry transmitter.

After the last door is closed, or if all doors are closed, the system will arm itself in about 16 seconds. During that time, the Vehicle Theft Alarm/Immobilizer light will flash. If it does not illuminate, the system is not arming. If you open a door during this arming period, the system will cancel the arming process. You must repeat one of the previously described arming sequences to rearm the system.

To disarm the system: Press the UNLOCK button on the keyless entry transmitter. Also, using a valid sentry key

and moving the ignition switch to the ON/START position will disarm the system. If you disarm the system and access the liftgate area, the system must be rearmed, as described previously, when closing the liftgate. If something has triggered the system in your absence, the horn will sound three times when you disarm the system. Check the vehicle for tampering.

NOTE:

- The driver's door and liftgate key cylinders cannot arm or disarm the system.
- Once the alarm is set, and the liftgate button on the keyless entry transmitter is pressed, on a non-power liftgate vehicle, you have a 30 second one time access into the liftgate area. If the liftgate is not opened within 30 seconds the liftgate will remain locked.

- The system remains armed during liftgate entry, pressing the liftgate button will not disarm the system, if someone enters the vehicle through the liftgate and opens any door the alarm will sound.
- When the system is armed, the doors can not be unlocked from the interior power door lock switches.

The Vehicle Theft Alarm system is designed to protect your vehicle, however, you can create conditions where the system will give you a false alarm. If one of the previously described arming sequences has occurred, the system will arm regardless of whether you are in the vehicle or not. If you remain in the vehicle and open a door, the alarm will sound. If this occurs, disarm the system.

The alarm system will be activated when the battery is connected if the system was previously armed. The exterior lights will flash, the horn will sound, and the ignition will not start the vehicle. If this occurs, disarm the system.

SLIDING SIDE DOOR

The sliding door may be opened from the inside or the outside. Pull out on the outside handle to open the sliding door from the outside. To open the sliding door from the inside, press the button on the grab handle and open the door.

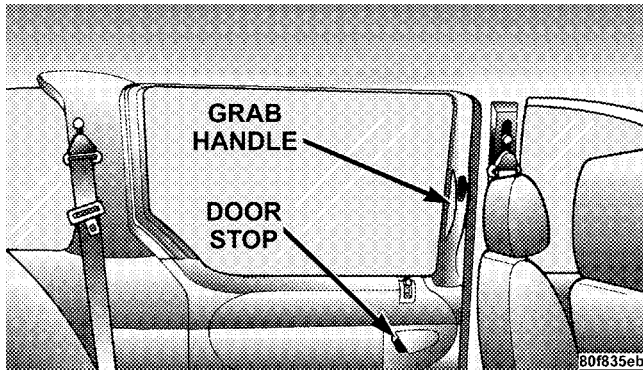

Sliding Door Hardware

To keep your door operating properly, observe the following guidelines:

- Always open the door smoothly.

- Avoid high impacts against the door stop when opening the door. This is very important when your vehicle is parked on an incline as the door will slide faster in the downhill direction.
- There is a hold-open latch that is activated when the sliding door is fully opened. This latch will keep your sliding door open on any incline. To close the sliding door after the hold-open latch is activated, you must push the button on the inside grab handle or pull out on the outside sliding door handle.
- Use the grab handle on the inside of the sliding door to assist you in closing and securing the door.

Always make sure that the sliding door is fully latched any time the vehicle is in motion.

NOTE: The driver's side sliding door cannot be opened while the fuel door is open. This feature operates only when the sliding door is fully closed prior to opening the fuel door.

Sliding Door Open Flash

When the sliding door(s) are opened, the left and right exterior hazard lights will flash for 12 seconds to alert other drivers in the area that passenger(s) could be entering or exiting the vehicle.

The Sliding Door Open Flash can be enabled or disabled by performing the following procedure:

1. Place the key in the ignition switch.
2. Cycle the ignition switch ON/OFF four times ending in the OFF position. (do not start the engine)
3. Within 10 seconds of the final cycle, press the hazard switch.

4. A single chime will sound to signify that you have successfully completed the programming.

You can turn the feature back on by repeating the above mentioned procedure or by performing the procedure in the Electronic Vehicle Information Center (EVIC), Customer Programmable Features section on vehicles so equipped.

Power Sliding Door — If Equipped

NOTE: The power sliding door must be unlocked before the switches located on the trim panel, just in front of the power sliding door will operate.

The power sliding door may be opened manually or by using the buttons on the remote keyless entry transmitter.

Press the buttons on the remote keyless entry transmitter twice within five seconds, to open a power sliding door. Once the door is fully open, pressing the button twice within five seconds a second time will close the door.

The power sliding door may also be opened by pressing the switches on the overhead console or the switch located on the trim panel just in front of the sliding door. To keep your door operating properly, observe the following guidelines.

- Always open the door smoothly.
- Avoid high impacts against the door stop when opening the door manually. This is very important when your vehicle is parked on an incline as the door will slide faster in the downhill direction.
- There is a hold-open latch that is activated when the sliding door is fully opened. This latch will keep your sliding door open on any incline. To close the power sliding door after the hold-open latch is activated, you must press any one of the power sliding door switches, push the button on the inside grab handle or pull out on the outside sliding door handle.

There are power sliding door switches located on the trim panel just in front of the power sliding door for the rear seat passengers. Pressing the switch once will open the power sliding door, once the door is fully open pressing the switch a second time will close the door.

2

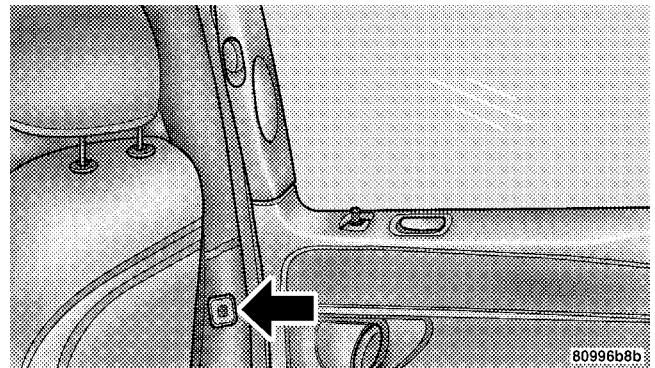

Power Sliding Door Switch

32 THINGS TO KNOW BEFORE STARTING YOUR VEHICLE

If the inside or outside door handles are used while the power sliding door is activated, the power sliding door feature will be canceled and the door must be opened or closed manually.

To avoid unintentional operation of the power sliding door from the rear seats, press the button located in the overhead console to disable the switches for the rear seat passengers.

NOTE:

- If anything obstructs the power sliding door while it is closing or opening, the door will automatically reverse to the closed or open position, provided it meets sufficient resistance.
 - The driver's side sliding door cannot be opened while the fuel door is open. This feature operates only when the sliding door is fully closed prior to opening the fuel door.
- If the power sliding door is not in the full open or close position, it will fully open when a power sliding door switch is pressed. To close the door, wait until it is fully open and then press the switch again.
 - The power sliding door switches will not operate if the vehicle is in gear or the vehicle speed is above 0 mph (0 km/h).
 - If the power sliding door encounters multiple obstructions within the same cycle, the system will automatically stop and must be opened or closed manually.

WARNING!

You or others could be injured if caught in the path of the sliding door. Make sure the door path is clear before closing the door.

Child Protection Door Lock

To provide a safer environment for small children riding in the rear seats, the sliding doors are equipped with a child protection door lock system.

WARNING!

To avoid trapping anyone in the vehicle in a collision. Remember that the sliding doors can only be opened from the outside door handle or the switches located on the trim panel just in front of the power sliding door when the child protection locks are engaged.

To activate the system, open the sliding door and move the child lock control, located near the door's rear latch, to the ON position.

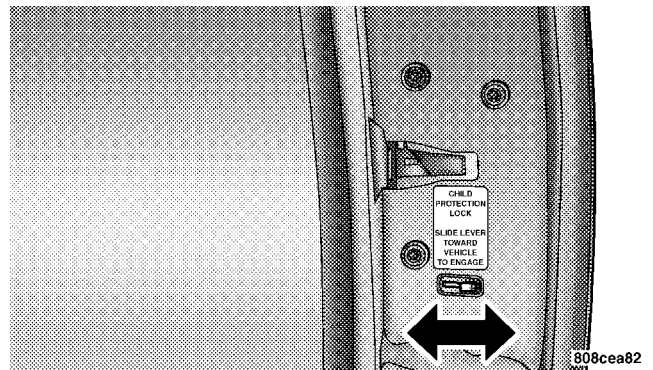

Child Lock Control

When the child lock system is engaged the door can be opened only by using the outside door handle, remote keyless entry transmitter, switches on the overhead console or the switches located on the trim panel just in front of the power sliding door, even though the inside door lock is in the unlocked position.

The power sliding door will operate from the switches located on the trim panel just in front of the power sliding door, regardless of the child lock lever position. To avoid unintentional operation of the power sliding door from the rear seats, press the button located in the overhead console to disable the switches for the rear seat passengers.

NOTE:

- The power sliding door switches will not operate if the vehicle is in gear or the vehicle speed is above 0 mph (0 km/h).
- The power sliding door will operate from the remote keyless entry transmitter, if the vehicle is in Park, regardless of the child lock lever position.

LIFTGATE

NOTE: The key that is used to start the vehicle is also used to lock or unlock the doors and open the liftgate.

To open the liftgate, insert the key into the lock and turn to the right. On vehicles equipped with power locks the liftgate can also be unlocked using the remote keyless entry or by activating the power door lock switches located on the front doors.

Once unlocked, on vehicles equipped with power locks, the liftgate can be opened or closed without using the key. To open the liftgate, depress the liftgate release switch located on the underside of the license plate bar and pull the liftgate open with one fluid motion.

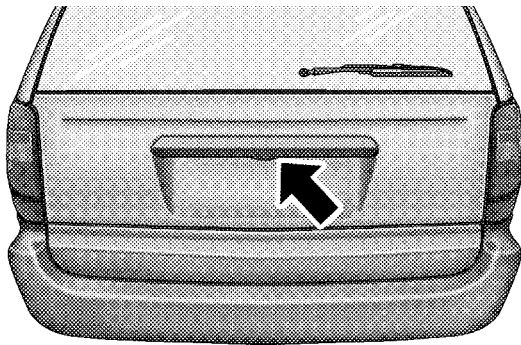

816509d7

Liftgate Release Switch

If the liftgate is locked and is not equipped with a powered liftgate, pressing the button on the remote keyless entry transmitter will result in the liftgate becoming unlocked for 30 seconds allowing you to manually access the liftgate area.

NOTE: On vehicles without power locks, the liftgate can only be opened using the vehicle keys. The key must be held in the unlocked position for the liftgate to open.

Power Liftgate — If Equipped

The power liftgate may be opened manually or by using the button on the remote keyless entry transmitter. Press the button on the remote keyless entry transmitter twice within five seconds, to open the power liftgate. Once the liftgate is fully open, pressing the button twice within five seconds a second time will close the liftgate.

The power liftgate may also be opened by pressing the button located on the overhead console.

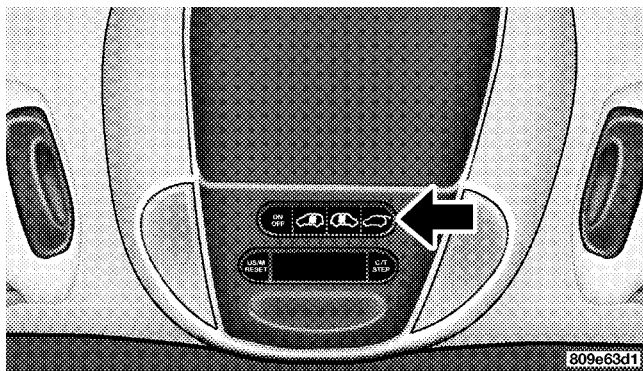

Power Liftgate Switch

When the remote keyless entry transmitter button is pressed and the “Lamp Flash” feature is enabled, the tail lights will flash to signal that the liftgate is opening or closing.

WARNING!

During power operation, personal injury or cargo damage may occur. Ensure the liftgate travel path is clear. Make sure the liftgate is closed and latched before driving away.

NOTE:

- If anything obstructs the power liftgate while it is closing or opening, the liftgate will automatically reverse to the closed or open position, provided it meets sufficient resistance.
- There are also pinch sensors attached to the side of the liftgate opening. Light pressure anywhere along these strips will cause the liftgate to return to the open position.

- The power liftgate must be in the full open or close positions for any of the buttons to operate. If the liftgate is not in the full open or close positions it must be opened or closed manually.
- If the liftgate release button is activated while the power liftgate is closing, the liftgate will reverse to the full open position.
- The power liftgate buttons will not operate if the vehicle is in gear or the vehicle speed is above 0 mph (0 km/h).
- The power liftgate will not operate in temperatures below -12°F (-24°C) or temperatures above 143°F (62°C). Be sure to remove any build-up of snow or ice from the liftgate before pressing any of the power liftgate buttons.
- If the power liftgate encounters multiple obstructions within the same cycle, the system will automatically stop and must be opened or closed manually.

WARNING!

- Driving with the liftgate open can allow poisonous exhaust gases into your vehicle. You and your passengers could be injured by these fumes. Keep the liftgate closed when you are operating the vehicle.
- If you are required to drive with the liftgate open, make sure that all windows are closed, and the climate control blower switch is set at high speed. **DO NOT** use the recirculation mode.

Gas props support the liftgate in the open position. However, because the gas pressure drops with temperature, it may be necessary to assist the props when opening the liftgate in cold weather.

SEAT STORAGE BIN SAFETY WARNING

WARNING!

Always close the storage bin covers when your vehicle is unattended. Do not allow children to have access to the 2nd row seat storage bins. Once in the storage bin, young children may not be able to escape. If trapped in the storage bin, children can die from suffocation or heat stroke.

Storage Bin Cover Emergency Release

As a security measure, a Storage Bin Cover Emergency Release strap is built into the storage bin cover latching mechanism.

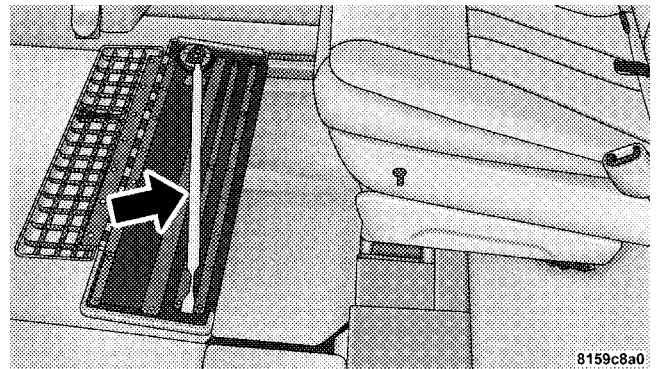

Storage Bin Cover Emergency Release

NOTE: In the event of an individual being locked inside the storage bin, the storage bin cover can be opened from inside of the bin by pulling on the glow-in-the-dark strap attached to the storage bin cover latching mechanism.

Reinstalling Storage Bin Cover Emergency Release

If the storage bin cover strap disengages from the latch, it can be reinstalled by inserting the loose end of the strap into the latch mechanism.

Push the strap into the latch mechanism until it engages around the latch post.

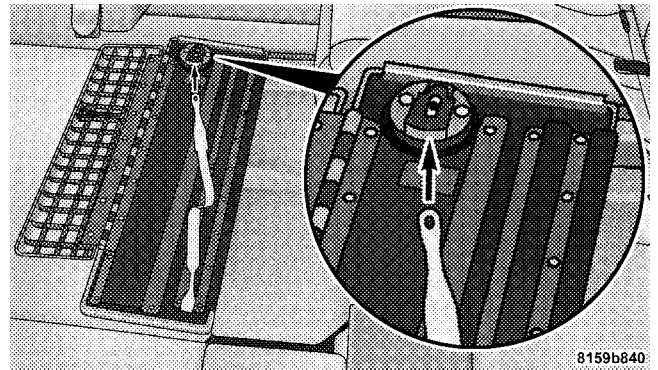

Reinstall Cover Strap

NOTE: Do not use the storage bin emergency release to lift the storage bin cover. The strap is intended for emergency release only.

WINDOWS

Manual Rear Vent Windows

A lever at the rear of each window releases the window so that it can be pushed out for ventilation.

Power Vent Windows — If Equipped

Switches on the driver's door trim panel let the driver operate the two vent windows from the front seat.

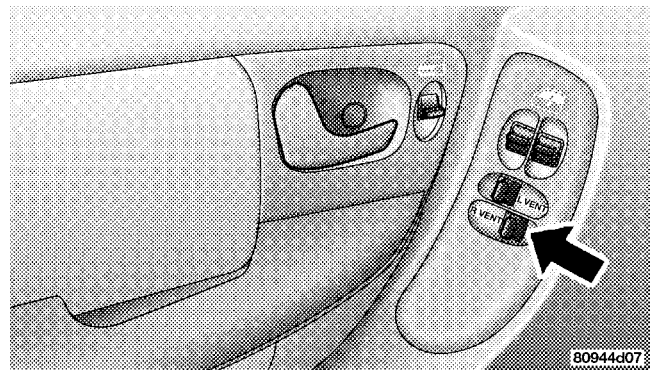

Power Vent Window Switches

Power Windows — If Equipped

You can control either front window using switches on the driver's door trim panel. There is a single switch on the passenger's door trim panel which operates the passenger door window. The switches will operate only when the ignition switch is in the ON or ACCESSORY position.

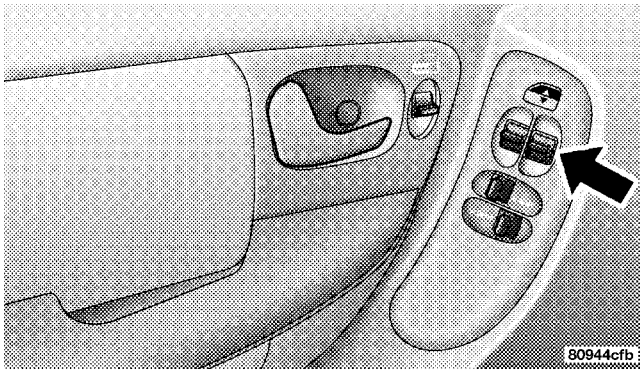

Power Window Switches

Auto Down Feature — If Equipped

The driver's window switch has an auto down feature. Press the window switch past the detent, release, and the window will go down automatically.

To open the window part way, press the window switch part way and release it when you want the window to stop.

The power window switches remain active for up to 45 seconds after the ignition switch has been turned off. Opening a vehicle front door will cancel this feature.

Wind Buffeting

Wind buffeting can be described as the perception of pressure on the ears or a helicopter type sound in the ears. Your vehicle may exhibit wind buffeting with the windows down, or the sunroof (if equipped) in certain open or partially open positions. This is a normal occurrence and can be minimized. If the buffeting occurs with the rear windows open, open the front and rear windows

together to minimize the buffeting. If the buffeting occurs with the sunroof open, adjust the sunroof opening to minimize the buffeting.

OCCUPANT RESTRAINTS

Some of the most important safety features in your vehicle are the restraint systems. These include the front and rear seat belts for the driver and all passengers, front airbags for both the driver and front passenger, driver inflatable knee blocker and if equipped, window bags for the driver and passengers seated next to a window. If you will be carrying children too small for adult-size seat belts, your seat belts or the LATCH feature (Lower Anchors and Tether for CHildren) also, can be used to hold infant and child restraint systems.

If your vehicle is equipped with the Occupant Classification System (OCS) there will be a Passenger Airbag Disabled (PAD) Indicator Light located on the center of the instrument panel.



812a6ab3

Passenger Airbag Disabled Light

NOTE: The front airbags have a multi stage inflator design. This allows the airbag to have different rates of inflation that are based on collision severity.

Please pay close attention to the information in this section. It tells you how to use your restraint system properly to keep you and your passengers as safe as possible.

WARNING!

In a collision, you and your passengers can suffer much greater injuries if you are not properly buckled up. You can strike the interior of your vehicle or other passengers, or you can be thrown out of the vehicle. Always be sure you and others in your vehicle are buckled up properly.

Buckle up even though you are an excellent driver, even on short trips. Someone on the road may be a poor driver and cause a collision that includes you. This can happen far away from home or on your own street.

Research has shown that seat belts save lives, and they can reduce the seriousness of injuries in a collision. Some of the worst injuries happen when people are thrown from the vehicle. Seat belts reduce the possibility of

ejection and the risk of injury caused by striking the inside of the vehicle. **Everyone** in a motor vehicle should be belted at all times.

Lap/Shoulder Belts

All the outboard seats in your vehicle are equipped with Lap/Shoulder Belts.

The belt webbing retractor is designed to lock during very sudden stops or collisions. This feature allows the shoulder part of the belt to move freely with you under normal conditions. But in a collision, the belt will lock and reduce the risk of your striking the inside of the vehicle or being thrown out.

WARNING!

- It is extremely dangerous to ride in a cargo area, inside or outside of a vehicle. In a collision, people riding in these areas are more likely to be seriously injured or killed.
- Do not allow people to ride in any area of your vehicle that is not equipped with seats and seat belts.
- Be sure everyone in your vehicle is in a seat and using a seat belt properly.

WARNING!

- Wearing a seat belt incorrectly is dangerous. Seat belts are designed to go around the large bones of your body. These are the strongest parts of your body and can take the forces of a collision the best.
- Wearing your belt in the wrong place could make your injuries in a collision much worse. You might suffer internal injuries, or you could even slide out of part of the belt. Follow these instructions to wear your seat belt safely and to keep your passengers safe, too.
- Two people should never be belted into a single seat belt. People belted together can crash into one another in a collision, hurting one another badly. Never use a lap/shoulder belt or lap belt for more than one person, no matter what their size.

Lap/Shoulder Belt Operating Instructions

1. Enter the vehicle and close the door. Sit back and adjust the seat.
2. The seat belt latch plate is near the seatback of the front seats and next to your arm in the rear seats. Grasp the latch plate and pull out the belt. Slide the latch plate up the webbing as far as necessary to allow the belt to go around your lap.

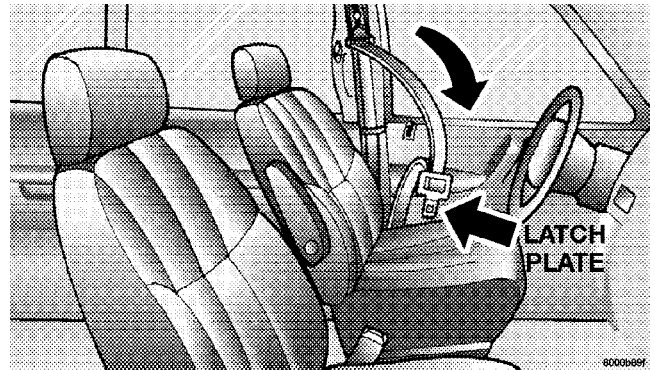

Latch Plate

3. When the belt is long enough to fit, insert the latch plate into the buckle until you hear a “click”.

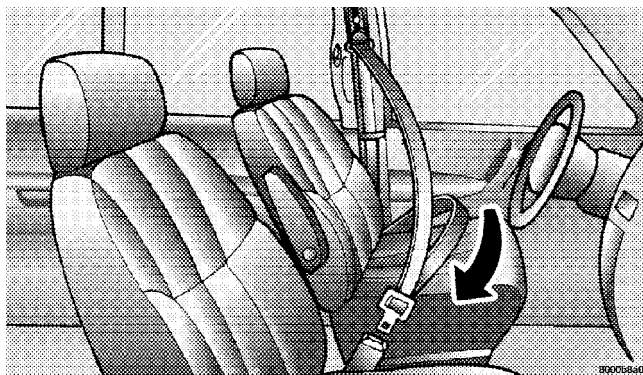

Latch Plate To Buckle

WARNING!

- A belt that is buckled into the wrong buckle will not protect you properly. The lap portion could ride too high on your body, possibly causing internal injuries. Always buckle your belt into the buckle nearest you.
- A belt that is too loose will not protect you as well. In a sudden stop you could move too far forward, increasing the possibility of injury. Wear your seat belt snugly.
- A belt that is worn under your arm is very dangerous. Your body could strike the inside surfaces of the vehicle in a collision, increasing head and neck injury. A belt worn under the arm can cause internal injuries. Ribs aren't as strong as shoulder bones. Wear the belt over your shoulder so that your strongest bones will take the force in a collision.
- A shoulder belt placed behind you will not protect you from injury during a collision. You are more likely to hit your head in a collision if you do not wear your shoulder belt. The lap and shoulder belt are meant to be used together.

4. Position the lap belt across your thighs, below your abdomen. To remove slack in the lap belt portion, pull up on the shoulder belt. To loosen the lap belt if it is too tight, tilt the latch plate and pull on the lap belt. A snug belt reduces the risk of sliding under the belt in a collision.

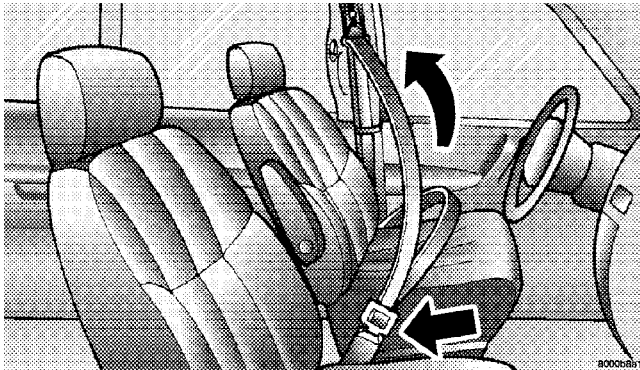

Removing Slack From Belt

WARNING!

- A lap belt worn too high can increase the risk of internal injury in a collision. The belt forces won't be at the strong hip and pelvic bones, but across your abdomen. Always wear the lap belt as low as possible and keep it snug.
- A twisted belt can't do its job as well. In a collision it could even cut into you. Be sure the belt is straight. If you can't straighten a belt in your vehicle, take it to your dealer and have it fixed.

5. Position the shoulder belt on your chest so that it is comfortable and not resting on your neck. The retractor will withdraw any slack in the belt.

6. To release the belt, push the red button on the buckle. The belt will automatically retract to its stowed position. If necessary, slide the latch plate down the webbing to allow the belt to retract fully.

WARNING!

A frayed or torn belt could rip apart in a collision and leave you with no protection. Inspect the belt system periodically, checking for cuts, frays, or loose parts. Damaged parts must be replaced immediately. Do not disassemble or modify the system. Seat belt assemblies must be replaced after a collision if they have been damaged (bent retractor, torn webbing, etc.).

Adjustable Upper Shoulder Belt Anchorage

In the front seats and the second row outboard seats, the shoulder belt anchorage can be adjusted upward or

downward to help position the belt away from your neck. The upper anchorage can be adjusted upward by pushing anywhere on the anchorage. To move the anchorage downward, press the actuation button while simultaneously pushing down on the anchorage assembly.

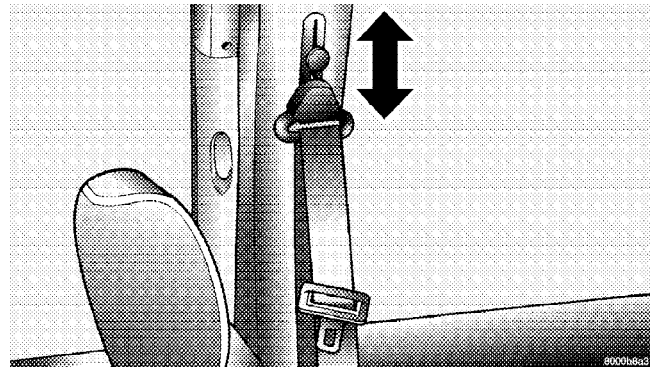

Adjusting Upper Shoulder Belt

As a guide, if you are shorter than average, you will prefer a lower position, and if you are taller than average, you'll prefer a higher position. When you release the anchorage, try to move it up or down to make sure that it is locked in position.

Lap/Shoulder Belt Untwisting Procedure

Use the following procedure to untwist a twisted lap/shoulder belt.

1. Position the latch plate as close as possible to the anchor point.

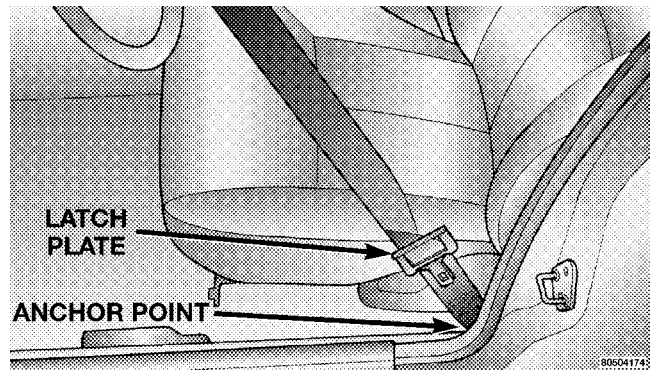

Positioning Latch Plate

2. At about 6 to 12 inches (15 to 30 cm) above the latch plate, grasp and twist the belt webbing 180° to create a fold that begins immediately above the latch plate.

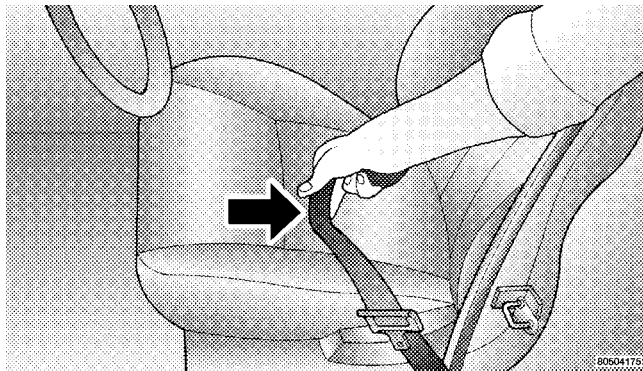

Creating A Fold

3. Slide the latch plate upward over the folded webbing. The folded webbing must enter the slot at the top of the latch plate.

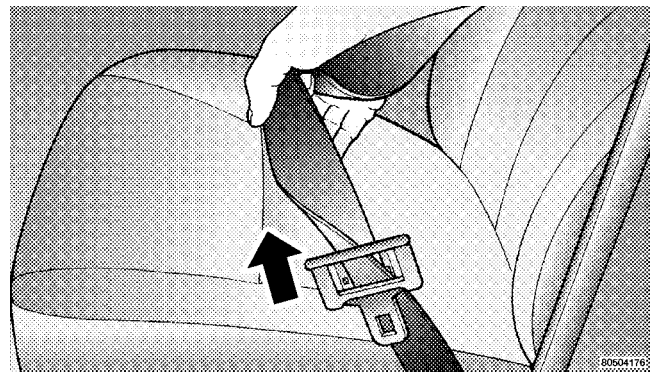

Sliding The Latch Plate

4. Continue to slide the latch plate up until it clears the folded webbing.

Center Lap Belts

The center seating positions have a lap belt only. To fasten the lap belt, slide the latch plate into the buckle until you hear a “click”. To lengthen the lap belt, tilt the latch plate and pull. To remove slack, pull the loose end of the webbing.

Wear the lap belt snug against the hips. Sit back and erect in the seat, then adjust the belt as tightly as is comfortable.

WARNING!

- A lap belt worn too loose or too high is dangerous.
- A belt worn too loose can allow you to slip down and under the belt in a collision.
- A belt that is too high will apply crash forces to the abdomen, not to the stronger hip bones. In either case, the risk of internal injuries is greater. Wear a lap belt low and snug.

2

Seat Belt Pretensioners

The seat belt buckles for both front seating positions are equipped with pretensioning devices that are designed to remove slack from the seat belt in the event of a collision. These devices improve the performance of the seat belt by assuring that the belt is tight about the occupant early in a collision. Pretensioners are designed to work for all size occupants.

NOTE: These devices are not a substitute for proper seat belt placement by the occupant. The seat belt still must be worn snugly and positioned properly.

The pretensioners are triggered by the front airbag control module (see Front Airbag Section). Like the front airbags, the pretensioners are single use items. After a collision that is severe enough to deploy the front airbags and pretensioners, both must be replaced.

Enhanced Seat Belt Use Reminder System (BeltAlert)

If the driver's or front passenger's seat belt has not been buckled within 60 seconds of starting the vehicle and if the vehicle speed is greater than 5 mph (8 km/h), the Enhanced Warning System (BeltAlert) will alert the driver or front passenger to buckle their seat belt. The driver should also instruct all other occupants to buckle their seat belts. Once the warning is triggered, the Enhanced Warning System (BeltAlert) will continue to

chime and flash the Seat Belt Warning Light for 96 seconds or until the driver's or front passenger's seat belt is buckled.

The Enhanced Warning System (BeltAlert) will be reactivated if the driver's or front passenger's seat belt is unbuckled for more than 10 seconds and the vehicle speed is greater than 5 mph (8 km/h).

The Enhanced Warning System (BeltAlert) can be enabled or disabled by your authorized dealer or by following these steps:

NOTE: The following steps must occur within the first 60 seconds of the ignition switch being turned to the ON or RUN position. DaimlerChrysler does not recommend deactivating the Enhanced Warning System (BeltAlert).

1. Turn the ignition switch to the OFF position, and buckle the driver's seat belt.

2. Turn the ignition switch to the RUN position (engine does not need to be running), and wait for the Seat Belt Warning Light to turn off.
3. Within 60 seconds of turning the ignition switch to the RUN position, unbuckle and then re-buckle the driver's seat belt at least three times within 10 seconds, ending with the seat belt buckled.

NOTE: Watch for the Seat Belt Warning Light to turn on while unbuckling and off while re-buckling the seat belt. It may be necessary to retract the seat belt.

4. Turn the ignition switch to the OFF position. A single chime will sound to signify that you have successfully completed the programming.

The Enhanced Warning System (BeltAlert) can be reactivated by repeating this procedure.

NOTE: Although the Enhanced Warning System (BeltAlert) has been deactivated, the Seat Belt Warning

Light will continue to illuminate while the driver's or front passenger's seat belt remains unbuckled.

Seat Belts and Pregnant Women

We recommend that pregnant women use the seat belts throughout their pregnancies. Keeping the mother safe is the best way to keep the baby safe.

Pregnant women should wear the lap part of the belt across the thighs and as snug across the hips as possible. Keep the belt low so that it does not come across the abdomen. That way the strong bones of the hips will take the force if there is a collision.

Seat Belt Extender

If a seat belt is too short, even when fully extended and when the adjustable upper shoulder belt anchorage (if equipped) is in its lowest position, your dealer can provide you with a seat belt extender. This extender

should be used only if the existing belt is not long enough. When it is not required, remove the extender and stow it.

WARNING!

Using a seat belt extender when not needed can increase the risk of injury in a collision. Only use when the lap belt is not long enough when it is worn low and snug, and in the recommended seating positions. Remove and store the extender when not needed.

Driver And Front Passenger Supplemental Restraint Systems (SRS) — Airbags

This vehicle has airbags for both the driver and front passenger as a supplement to the seat belt restraint systems. The driver's front airbag is mounted in the center of the steering wheel. The passenger's front airbag

is mounted in the instrument panel, above the glove compartment. The words SRS AIRBAG are embossed on the airbag covers.

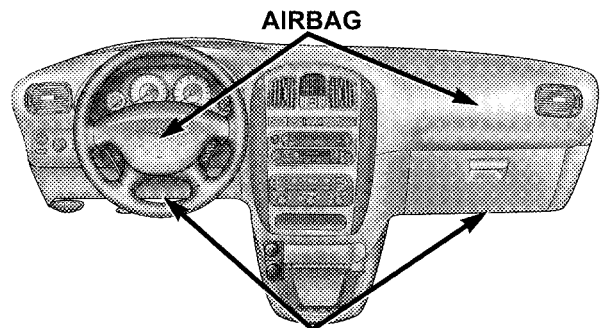

KNEE BOLSTERS

80f92.1f9

Front Airbag Components

NOTE: The front airbags are certified to the Federal regulations that allow less forceful deployment in low speed collisions.

The front airbags have a multi stage inflator design. This may allow the airbag to have different rates of inflation that are based on collision severity and occupant size. Also, the front passenger airbag is certified to the Federal regulations that define Occupant Classification (Refer to “Occupant Classification System” in this section).

This vehicle may also be equipped with a driver inflatable knee blocker located on the instrument panel below the steering column.

This vehicle may also be equipped with window bags to protect the driver, front, and rear passengers sitting next to a window. If the vehicle is equipped with window bags, they are located above the side windows. Their covers are also labeled SRS AIRBAG.

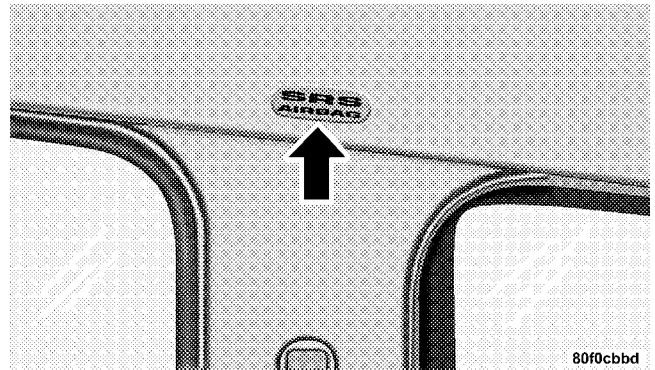

2

Window Bags

NOTE: Airbag covers may not be obvious in the interior trim; but they will open to allow airbag deployment.

WARNING!

- Do not put anything on or around the airbag covers or attempt to manually open them. You may damage the airbags and you could be injured because the airbags are not there to protect you. These protective covers for the airbag cushions are designed to open only when the airbags are inflating.
- If your vehicle is equipped with window bags, do not stack luggage or other cargo up high enough to block the location of the window bag. The area where the window bag is located should remain free from any obstructions.
- If your vehicle is equipped with window bags, do not have any accessory items installed which will alter the roof, including adding a sunroof to your vehicle. Do not add roof racks that require permanent attachments (bolts or screws) for installation on the vehicle roof. Do not drill into the roof of the vehicle for any reason.

NOTE: Do not use a clothing bar mounted to the coat hooks in this vehicle. A clothing bar will impede the proper performance of the window bags.

Along with the seat belts and front seat belt buckle pretensioners, front airbags work with the instrument panel knee bolsters to provide improved protection for the driver and front passenger. Window bags also work with seat belts to improve occupant protection.

The seat belts are designed to protect you in many types of collisions. The front airbags deploy in moderate to severe frontal collisions.

NOTE: The passenger front airbag may not deploy even when the driver front airbag has if the Occupant Classification System (refer to “Occupant Classification System” in this section) has determined the seat is empty or is occupied by a child.

If your vehicle is equipped, the window bag on the crash side of the vehicle is triggered in moderate to severe side collisions. But even in collisions where the airbags inflate, you need the seat belts to keep you in the right position for the airbags to protect you properly.

Here are some simple steps you can take to minimize the risk of harm from a deploying airbag.

1. Children 12 years old and under should always ride buckled up in a rear seat.

Infants in rear facing child restraints should **NEVER** ride in the front seat of a vehicle with a passenger front airbag. An airbag deployment can cause severe injury or death to infants in that position.

Children that are not big enough to properly wear the vehicle seat belt (refer to section on Child Restraint) should be secured in the rear seat, in a child restraint or belt-positioning booster seat. Older children who do not use child restraints or belt-positioning booster seats should ride properly buckled up in the rear seat, and in the outboard seat if possible. Never allow children to slide the shoulder belt behind them or under their arm.

If a child from 1 to 12 years old must ride in the front passenger seat because the vehicle is crowded, move the seat as far back as possible, and use the proper child restraint. See the section on Child Restraint.

You should read the instructions provided with your child restraint to make sure that you are using it properly.

2. All occupants should wear their lap and shoulder belts properly.
3. The driver and front passenger seats should be moved back as far as practical to allow the front airbags room to inflate.
4. If your vehicle has window bags, do not lean against the door, airbags will inflate forcefully into the space between you and the door.

WARNING!

- Relying on the airbags alone could lead to more severe injuries in a collision. The airbags work with your seat belt to restrain you properly. In some collisions the airbags won't deploy at all. Always wear your seat belts even though you have airbags.
- Being too close to the steering wheel or instrument panel during front airbag deployment could cause serious injury. Airbags need room to inflate. Sit back, comfortably extending your arms to reach the steering wheel or instrument panel.
- If the vehicle has window bags, they also need room to inflate. Do not lean against the door or window. Sit upright in the center of the seat.

The Airbag System consists of the following:

- Occupant Restraint Controller (ORC)
- AIRBAG Readiness Light
- Driver Airbag
- Front Passenger Airbag
- Window Bags above Side Windows (If Equipped)
- Front Impact Sensors
- Side Impact Sensors (If Equipped)
- Steering Wheel and Column
- Instrument Panel
- Seat Belt Readiness Light
- Front Seat Belt Buckle Pretensioners
- Interconnecting Wiring

- Knee Impact Bolster
- Driver Inflatable Knee Blocker
- Front Passenger Seat Occupant Classification System (OCS) — If Equipped
 - Occupant Classification Module
 - Passenger Airbag Disabled (PAD) Indicator Light
 - Interconnecting Wiring
 - Bladder Assembly
 - Belt Tension Sensor

How The Airbag System Works

- The **Occupant Restraint Controller (ORC)** determines if a frontal collision is severe enough to require the airbags to inflate. Based on the level of collision severity, the front control module determines the

proper rate of inflation. The front airbag inflators are designed to provide different rates of airbag inflation.

- The ORC may modify the rate of inflation based on the occupant size provided by the Occupant Classification Module.
- The ORC will not detect side, roll over, or rear impacts.
- The ORC monitors the readiness of the electronic parts of the system whenever the ignition switch is in the START or RUN positions. These include all of the items listed above except the steering wheel and column, instrument panel and passenger knee bolsters. If the key is in the OFF position, in the ACC position, or not in the ignition, the airbags are not on and will not inflate.
 - Also, the ORC turns on the AIRBAG warning light and PAD indicator light in the center of the instrument panel for 6 to 8 seconds for a self-check when the ignition is



first turned on. After the self-check, the AIRBAG warning light will turn off. The PAD indicator light will function normally (Refer to “Passenger Airbag Disable (PAD) Indicator Light” in this section). If the ORC detects a malfunction in any part of the system, it turns on the AIRBAG warning light either momentarily or continuously. A single chime will sound if the light comes on again after initial start up.

WARNING!

Ignoring the AIRBAG warning light in your instrument panel could mean you won't have the airbags to protect you in a collision. If the light does not come on, stays on after you start the vehicle, or if it comes on as you drive, have the airbag system checked right away.

- The **Driver and Passenger Airbag/Inflator Units** are located in the center of the steering wheel and the right side of the instrument panel. When the ORC and impact sensors detect a collision requiring the airbags, it signals the inflator units. A large quantity of nontoxic gas is generated to inflate the front airbags. Different airbag inflation rates may be possible based on collision severity and occupant size. The steering wheel hub trim cover and the upper right side of the instrument panel separate and fold out of the way as the airbags inflate to their full size. The airbags fully inflate in about 50–70 milliseconds. This is about half of the time it takes to blink your eyes. The airbags then quickly deflate while helping to restrain the driver and front passenger.
- The **Side Impact SRS Window Bags** are designed to activate only in certain side collisions. When the ORC and the side impact sensors (with side impact option) detect a collision requiring the window bags to inflate, it signals the inflators on the crash side of the vehicle. A quantity of nontoxic gas is generated to inflate the window bag. The inflating window bag pushes the outside edge of the headliner out of the way and covers the window. The airbag inflates in about 30 milliseconds (about one quarter of the time it takes to blink your eyes) with enough force to injure you if you are not belted and seated properly, or if items are positioned in the area where the window bag inflates. This especially applies to children. The window bag is only about 3½ inches (9 cm) thick when it is inflated.

The driver's and passenger's front airbag gas is vented through the airbag material towards the instrument panel. In this way the airbags do not interfere with your control of the vehicle.

- When the ORC and the side impact sensors (with side impact option) detects a collision requiring the **Driver Inflatable Knee Blocker**, it signals the inflator unit. A quantity of nontoxic gas is generated to inflate the Driver Inflatable Knee Blocker. The Driver Inflatable Knee Blocker inflates rearward towards the driver's knees to help protect the knees and position you for the best interaction with the front airbag. The Driver Inflatable Knee Blocker fully inflates in about 50 milliseconds, this is only about half of the time it takes you to blink your eyes. It then quickly deflates while helping to protect the driver's knees.
- The **Knee Impact Bolsters** help protect the knees, and position everyone for the best interaction with the front airbag.
- If your vehicle contains a Passenger Airbag Disable indicator light, it will be equipped with the **Occupant Classification System (OCS)**. The OCS system will

classify an occupant into a size category based on sensor readings from within the seat cushion. Occupants should try to remain in a normally seated position. If the occupant's weight is transferred to another object in the vehicle (i.e. feet on the dashboard), the OCS may not be able to properly approximate occupant size. Furthermore, the occupant size may appear to increase or decrease due to objects hanging on the seat, other passengers pushing on the seat, or objects lodged underneath the seat. Ensure that the front passenger seat back does not touch anything placed on the back seat because this can also affect occupant classification. Also, if you fold down the rear seat, check to be sure it doesn't touch the front passenger seat.

If there is a rapid change in temperature or humidity, the OCS may not be able to properly approximate occupant size. If your seat including your trim cover and cushion needs to be serviced in any way (including

removal or loosening/tightening of seat attachment bolts), take the vehicle to your authorized dealer. Only manufacturer approved seat accessories may be used.

If there is a fault present in the system, the AIRBAG warning light will illuminate indicating that you should take the vehicle to an authorized dealer. In the presence of an occupant in the passenger seat, if both the PAD indicator light and AIRBAG warning light are illuminated the airbag will be disabled.

The ORC will not allow front airbag deployment in the event of a collision for occupants classified into the empty or child size categories. The PAD indicator light will illuminate indicating that the Passenger Airbag is OFF when the OCS has determined that the occupant size category is a child. Also, when the seat is empty or an object that weighs less than a predetermined threshold is placed on the seat, the light will remain OFF. (The PAD indicator light is an amber light located on the center of the instrument panel above the radio.)



812a6ab3

2

Passenger Airbag Disabled Light

For almost all sizes of properly seated adults, the airbag will be enabled in the event of a collision. For small teenagers and some small adults, depending on size, the airbag may or may not be enabled in the event of a collision. Both drivers and passengers should always use the PAD indicator light as an indication if the front passenger is properly positioned or not. If the PAD indicator light comes on when an adult is in the passenger seat, have the passenger re-position themselves in the seat until the light goes out.

Remember, if the PAD indicator light is illuminated the passenger front airbag will not inflate. For almost all properly installed child restraints, the “PAD Indicator Light” will be illuminated indicating that the front passenger airbag is turned off and will not inflate. If the “PAD Indicator Light” is not illuminated, DO NOT assume the airbag is turned off and move the child restraint to the rear seat. A deploying passenger airbag can cause death or serious injury to a child in a rear facing infant seat.

NOTE: Even though this vehicle is equipped with an Occupant Classification System, children 12 years and under should always ride buckled up in a rear seat in an appropriate child restraint.

- **The Occupant Classification Module (OCM) — If Equipped** is located beneath the front passenger seat. The OCM classifies the occupant into one of three size

categories based on the input from the Bladder Assembly and Belt Tension Sensor. The size categories include empty, child, and adult. The OCM sends the Occupant Classification to the ORC to identify if a front passenger airbag is allowed. If a fault is present, the AIRBAG warning light is illuminated.

- **The Passenger Airbag Disabled (PAD) Indicator Light — If Equipped** indicates to the driver and passenger when the airbag is turned OFF in the presence of a properly seated occupant. When the PAD indicator light is illuminated, the airbag is OFF. Also, when the Occupant Classification System detects either an empty seat or a weight less than the predetermined occupant threshold, the ORC will not illuminate the PAD indicator light even though the airbag is turned OFF. When the ocs system detects an adult the PAD indicator light will be off, and the airbag will be enabled.

- The **Belt Tension Sensor (BTS) — If Equipped** is located at the outboard passenger lap belt anchor. The BTS generates a signal based on outboard lap belt tension. This signal is sent to the OCM to ensure that the resultant bladder pressure increase due to applied lap belt tension does not cause a small occupant to be classified as a larger occupant.
- The **Bladder Assembly — If Equipped** is located beneath the seat cushion foam. The pressure sensor sends a signal to the OCM.

The front passenger seat assembly contains critical components that affect the front passenger airbag deployment. Correctly functioning front passenger seat components are critical for the Occupant Classification System (OCS) to properly classify the front passenger and calculate the proper airbag deployment. Do not make any modifications to the front passenger seat components, assembly, or to the seat cover.

WARNING!

Unapproved modifications or service procedures to the front passenger seat assembly, its related components, or seat cover may inadvertently change the airbag deployment in case of a frontal crash. This could result in death or serious injury to the front seat passenger if the vehicle is involved in an accident. A modified vehicle may not comply with required Federal Motor Vehicle Safety Standards (FMVSS).

2

The following requirements must be strictly adhered to:

- Do not modify the front passenger seat assembly or components in any way.
- Do not modify the front seat center console or center position seat in any way.

- Do not use prior or future model year seat covers not designated for the specific model being repaired. Always use the correct seat cover specified for the vehicle.
- Do not replace the seat cover with an aftermarket seat cover.
- Do not add a secondary seat cover other than those approved by DaimlerChrysler/Mopar.
- At no time should any supplemental restraint system (SRS) component or SRS related component or fastener be modified or replaced with any part except those which are approved by DaimlerChrysler/Mopar.
- For replacement of the bladder or seat cover assembly, always use the DaimlerChrysler service kit which includes the seat cover and bladder riveted together.

If A Deployment Occurs

The airbag system is designed to deploy the airbags when the ORC and impact sensors detect a moderate-to-severe collision, to help restrain the vehicle passengers, and then immediately deflate.

NOTE: A collision that is not severe enough to need airbag protection will not activate the system. This does not mean something is wrong with the airbag system.

If you do have a collision which deploys the airbags, any or all of the following may occur:

- The nylon airbag material may sometimes cause abrasions and/or skin reddening to the driver and front passenger as the airbags deploy and unfold. The abrasions are similar to friction rope burns or those you might get sliding along a carpet or gymnasium floor. They are not caused by contact with chemicals. They are not permanent and normally heal quickly.

However, if you haven't healed significantly within a few days, or if you have any blistering, see your doctor immediately.

- As the airbags deflate you may see some smoke-like particles. The particles are a normal by-product of the process that generates the nontoxic gas used for airbag inflation. These airborne particles may irritate the skin, eyes, nose, or throat. If you have skin or eye irritation, rinse the area with cool water. For nose or throat irritation, move to fresh air. If the irritation continues, see your doctor. If these particles settle on your clothing, follow the garment manufacturer's instructions for cleaning.
- It is not advisable to drive your vehicle after the airbags have deployed. If you are involved in another collision, the airbags will not be in place to protect you.

WARNING!

Deployed airbags, front seat belt buckle pretensioners and driver inflatable knee blocker cannot protect you in another collision. Have the airbags, front seat belt buckle pretensioners and driver inflatable knee blocker replaced by an authorized dealer as soon as possible. Also, have the Occupant Classification System serviced as well.

2

Enhanced Accident Response

If the airbags and seat belt pretensioners deploy after an impact and the electrical system remains functional, vehicles equipped with power door locks will unlock automatically. In addition, approximately 10 seconds after the vehicle has stopped moving, the interior lights will illuminate until the ignition switch is turned off.

Maintaining Your Airbag System

WARNING!

- Modifications to any part of the airbag system could cause it to fail when you need it. You could be injured because the airbags are not there to protect you. Do not modify the components or wiring, including adding any kind of badges or stickers to the steering wheel hub trim cover or the upper right side of the instrument panel. Do not modify the front bumper, vehicle body structure, or frame.
- Do not attempt to modify any part of your advanced airbag system. The airbag may inflate accidentally or may not function properly if modifications are made. Take your vehicle to an authorized dealer for any advanced airbag system service. If your seat including your trim cover and cushion needs to be serviced in any way (including removal or loosening/tightening of seat attachment bolts), take the vehicle to your authorized dealer. Only manufacturer approved seat accessories may be used. If it is necessary to modify an advanced airbag system for persons with disabilities, contact your authorized dealer.

WARNING!

- You need proper knee impact protection in a collision. Do not mount or locate any aftermarket equipment on or behind the knee bolsters.
- It is dangerous to try to repair any part of the airbag system yourself. Be sure to tell anyone who works on your vehicle that it has airbags.

Airbag Light



You will want to have the airbags ready to inflate for your protection in a collision. While the airbag system is designed to be maintenance free, if any of the following occurs, have an authorized dealer service the system immediately.

- The AIRBAG light does not come on or flickers during the 6 to 8 seconds when the ignition switch is first turned on.

- The light remains on or flickers after the 6 to 8 second interval.
- The light flickers or comes on and remains on while driving.

DaimlerChrysler Corporation Integrated Child Seat — If Equipped

Operating instructions for this seat are included with the seat. If the instructions are not with the seat or in the Owner's Manual Package, replacement instructions can be obtained.

To obtain Integrated Child Seat replacement instructions:

Use the order form at the back of this manual and specify publication number 81-016-1950.

Child Restraint

Everyone in your vehicle needs to be buckled up at all times — babies and children, too. Every state in the United States and all Canadian provinces require that small children ride in proper restraint systems. This is the law, and you can be prosecuted for ignoring it.

Children 12 years and under should ride properly buckled up in a rear seat. According to crash statistics, children are safer when properly restrained in the rear seats, rather than in the front.

WARNING!

In a collision, an unrestrained child, even a tiny baby, can become a missile inside the vehicle. The force required to hold even an infant on your lap could become so great that you could not hold the child, no matter how strong you are. The child and others could be badly injured. Any child riding in your vehicle should be in a proper restraint for the child's size.

There are different sizes and types of restraints for children from newborn size to the child almost large enough for an adult safety belt. Always check the child seat owner's manual to ensure you have the right seat for your child. Use the restraint that is correct for your child.

Infants and Child Restraints

- Safety experts recommend that children ride rearward-facing in the vehicle until they are at least one year old and weigh at least 20 lbs (9 kg). Two types of child restraints can be used rearward-facing: infant carriers and "convertible" child seats. Both types of child restraints are held in the vehicle by the lap/shoulder belt or the LATCH child restraint anchorage system. Refer to "Lower Anchors and Tether for Children (LATCH)" later in this section.
- The infant carrier is only used rearward-facing in the vehicle. It is recommended for children who weigh up to about 20 lbs (9 kg). "Convertible" child seats can be used either rearward-facing or forward-facing in the vehicle. Convertible child seats often have a higher weight limit in the rearward-facing direction than

infant carriers do, so they can be used rearward-facing by children who weigh more than 20 lbs (9 kg) but are less than one year old.

- Rearward-facing child seats must **NEVER** be used in the front seat of a vehicle with a front passenger airbag. An airbag deployment could cause severe injury or death to infants in this position.

Older Children and Child Restraints

- Children who weigh more than 20 lbs (9 kg) and who are older than one year can ride forward-facing in the vehicle. Forward-facing child seats and convertible child seats used in the forward-facing direction are for children who weigh 20 to 40 lbs (9 to 18 kg) and who are older than one year. These child seats are also held in the vehicle by the lap/shoulder belt or the LATCH child restraint anchorage system. Refer to “Lower Anchors and Tether for CHildren (LATCH)” later in this section.

- The belt-positioning booster seat is for children weighing more than 40 lbs (18 kg), but who are still too small to fit the vehicle’s seat belts properly. If the child can not sit with knees bent over the vehicle’s seat cushion while the child’s back is against the seat back, they should use a belt-positioning booster seat. The child and booster seat are held in the vehicle by the lap/shoulder belt.

Children Too Large For Booster Seats

Children who are large enough to wear the shoulder belt comfortably, and whose legs are long enough to bend over the front of the seat when their back is against the seatback, should use the lap/shoulder belt in a rear seat.

- Make sure that the child is upright in the seat.
- The lap portion should be low on the hips and as snug as possible.

72 THINGS TO KNOW BEFORE STARTING YOUR VEHICLE

- Check belt fit periodically. A child's squirming or slouching can move the belt out of position.
- If the shoulder belt contacts the face or neck, move the child closer to the center of the vehicle. If this doesn't help, move the child to the center rear seating position and use the lap belt. Never allow a child to put the shoulder belt under an arm or behind their back.

NOTE: For additional information, refer to www.seatcheck.org or call 1-866-SEATCHECK.

WARNING!

- Improper installation can lead to failure of an infant or child restraint. It could come loose in a collision. The child could be badly injured or killed. Follow the manufacturer's directions exactly when installing an infant or child restraint.
- A rearward facing child restraint should only be used in a rear seat. A rearward facing child restraint in the front seat may be struck by a deploying passenger airbag which may cause severe or fatal injury to the infant.

Here are some tips on getting the most out of your child restraint:

- Before buying any restraint system, make sure that it has a label certifying that it meets all applicable Safety Standards. We also recommend that you make sure

that you can install the child restraint in the vehicle where you will use it, before you buy it.

- The restraint must be appropriate for your child's weight and height. Check the label on the restraint for weight and height limits.
- Carefully follow the instructions that come with the restraint. If you install the restraint improperly, it may not work when you need it.

The passenger seat belts are equipped with cinching latch plates, which are designed to keep the lap portion tight around the child restraint so that it is not necessary to use a locking clip. Pulling up on the shoulder portion of the lap/shoulder belt will tighten the belt. The cinching latch plate will keep the belt tight, however, any seat belt system will loosen with time, so check the belt occasionally and pull it tight if necessary.

- In the rear seat, you may have trouble tightening the lap/shoulder belt on the child restraint because the buckle or latch plate is too close to the belt path opening on the restraint. Disconnect the latch plate from the buckle and twist the short buckle end of the belt several times to shorten it. Insert the latch plate into the buckle with the release button facing out.
- If the belt still can't be tightened, or if pulling and pushing on the restraint loosens the belt, disconnect the latch plate from the buckle, turn the buckle around, and insert the latch plate into the buckle again. If you still can't make the child restraint secure, try a different seating position.
- Buckle the child into the seat according to the child restraint manufacturer's directions.
- When your child restraint is not in use, secure it in the vehicle with the seat belt or remove it from the vehicle.

Don't leave it loose in the vehicle. In a sudden stop or collision, it could strike the occupants or seatbacks and cause serious personal injury.

Lower Anchors and Tether for Children (LATCH)

Each vehicle, except commercial cargo vehicles, is equipped with the child restraint anchorage system called LATCH, which stands for Lower Anchors and Tether for Children. Two LATCH child restraint anchorage systems are installed on all second-row seats and in the center position on all 3rd row fold-in-floor seats. Second-row seats also feature tether strap anchorages, located in the rear surface of the seatback. In addition, all 3-passenger bench seats and 3rd row fold-in-floor seats are equipped with a child restraint tether anchor at the center seating position.

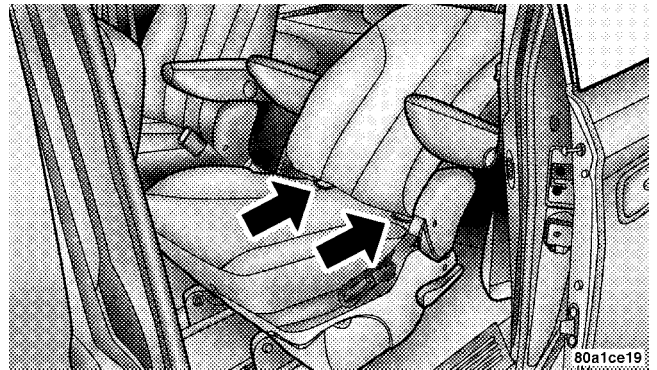

Latch Anchorages

When using the tether anchorages in the outboard seating positions, ensure that the strap is routed over the top of the seatback and under the head restraint between the head restraint posts. Except for bench seats with split seatbacks, when the tether anchorage is used in the center seating position, the strap should be positioned straight

over the top of the seatback. For bench seats with split seatbacks, route the tether between the seatbacks.

When using the tether anchorages in the center position on 3rd row fold-in-floor seating, ensure that the strap is routed over the top of the seatback and under the head restraint between the head restraint posts.

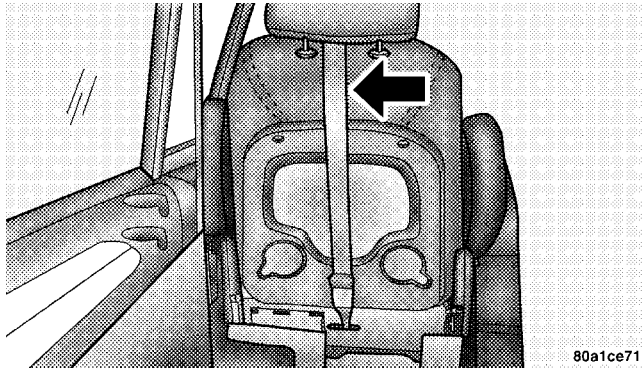

Tether Strap Mounting

WARNING!

An incorrectly anchored tether strap could lead to increased head motion and possible injury to the child. Use only the anchor positions directly behind the child seat to secure a child restraint top tether strap.

2

Child restraint systems having attachments designed to connect to the lower anchorages are now available. Child restraints having tether straps and hooks for connection to the seatback tether anchorage have been available for some time. In fact, many child restraint manufacturers will provide add-on tether strap kits for some of their older products.

NOTE: If your child restraint seat is not LATCH compatible, install the restraint using the vehicle seat belts.

Fleet vehicles equipped with the LATCH system on the 3-passenger bench seat must have the seat adjusted to the full rear position on the tracks when the LATCH system is used. Also, when using the LATCH system, be sure the seatback is two clicks rear of its full upright position.

Because the lower anchorages are to be introduced to passenger carrying vehicles over a period of years, child restraint systems having attachments for those anchorages will continue to have features for installation in vehicles using the lap or lap/shoulder belt. They will also have tether straps, and you are urged to take advantage of all of the available attachments provided with your child restraint in any vehicle.

NOTE: When using the LATCH attaching system to install a child restraint, please ensure that all seat belts not being used for occupant restraints are stowed and out of reach of children. It is recommended that before installing the child restraint, buckle the seat belt so the

seat belt is tucked behind the child restraint and out of reach. If the buckled seat belt interferes with the child restraint installation, instead of tucking the seat belt behind the child restraint, route the seat belt through the child restraint belt path and then buckle it. This should stow the seat belt out of the reach of an inquisitive child. Remind all children in the vehicle that the seat belts are not toys and should not be played with, and never leave your child unattended in the vehicle.

Installing the Child Restraint System

If your fleet vehicle is equipped with LATCH anchorages on the 3-passenger bench seat, do not install three child restraints at the same time in this seat. The anchorages in this seat are not designed to restrain three child restraints at one time. Instead, you may install one child restraint at the center position, or one child restraint at each of the right and left positions.

WARNING!**Fleet Vehicles Only:**

Do not install child restraint systems equipped with LATCH attachments at all three seating positions in the seat at one time. The LATCH anchorages in this seat are designed to restrain no more than two child restraints at a time in the event of a collision. Failure to follow this may result in serious or fatal injury.

We urge that you carefully follow the directions of the manufacturer when installing your child restraint. Many, but not all, restraint systems will be equipped with separate straps on each side, with each having a hook or connector and a means for adjusting the tension in the strap. Forward-facing toddler restraints and some rearward-facing infant restraints will also be equipped with a tether strap, a hook and means for adjusting the tension in the strap.

In general, you will first loosen the adjusters on the lower straps and tether straps so that you can more easily attach the hook or connector to the lower anchorages and tether anchorages. Then tighten all three straps as you push the child restraint rearward and downward into the seat.

Not all child restraint systems will be installed as we have described here. Again, carefully follow the instructions that come with the child restraint system.

WARNING!

Improper installation of a child restraint to the LATCH anchorages can lead to failure of an infant or child restraint. The child could be badly injured or killed. Follow the manufacturer's directions exactly when installing an infant or child restraint.

Transporting Pets

Airbags deploying in the front seat could harm your pet. An unrestrained pet could be thrown about and possibly injured, or injure a passenger during panic braking or in a collision.

Pets should be restrained in the rear seat in pet harnesses or pet carriers that are secured by seat belts.

REAR SEAT DELETE FEATURE (COMMERCIAL VEHICLES ONLY) — IF EQUIPPED

Commercial cargo vehicles are not designed for use as a family vehicle and are not intended for carrying children in the front passenger seat. However, if you must carry a child in a vehicle without a rear seat, the passenger seat should be moved to the full rearward position and the child must be in a proper restraint system based on it's age, size and weight. NEVER carry a child in a rear facing

infant carrier in a vehicle without rear seats. In an accident, serious injury or death may occur from the deploying passenger air bag.

This vehicle is equipped with a child restraint tether anchor located on the floor, behind the front passenger seat. Use this tether anchor to secure only forward facing child restraints equipped with an upper tether strap.

WARNING!
Rear Facing Infant restraints must never be secured in the passenger seat of a vehicle with a passenger airbag. In an accident a passenger airbag may deploy causing severe injury or death to infants riding in rear facing infant restraints.

Restraining Infants and Small Children with Seat Delete Feature (Commercial Vehicles Only)

There are different sizes and types of restraints for children from newborn size to the child almost large enough for an adult safety belt. Use the restraint that is correct for your child:

- The rearward-facing infant carrier is for babies weighing up to about 20 lbs (9 kg), and less than one year old. **THIS TYPE OF SEAT CANNOT BE USED IN A VEHICLE EQUIPPED WITH THE REAR SEAT DELETE FEATURE (Commercial Vehicles Only).**
- The forward-facing child seat is for children from about 20 to 40 lbs (9 to 18 kg), and more than one year old.
- A “convertible” child seat, one that is designed to be used for children who are too heavy for a rear facing infant seat, may be used **IN THE FORWARD FACING POSITION ONLY, IT MUST NEVER BE INSTALLED FACING TO THE REAR IN A VEHICLE EQUIPPED WITH THE REAR SEAT DELETE FEATURE (Commercial Vehicles Only).** When a convertible seat is properly installed forward facing, the vehicle seat should be adjusted to the **rear most position**.
- Children more than 40 lbs (18 kg) should be secured in the passenger seat in a child restraint or belt-positioning booster seat with the seat adjusted to the **rear most position**. Older children who do not use child restraints or belt-positioning booster seats should ride properly buckled in the passenger seat with the seat adjusted to the rear most position. Never allow children to slide the shoulder belt behind them or under their arm.

Tether Installation For Commercial Vehicles With Rear Seat Delete

To secure the child restraint upper tether strap to the vehicle, follow the instructions shown:

1. Locate the child restraint tether anchor on the floor just behind the front passenger seat.

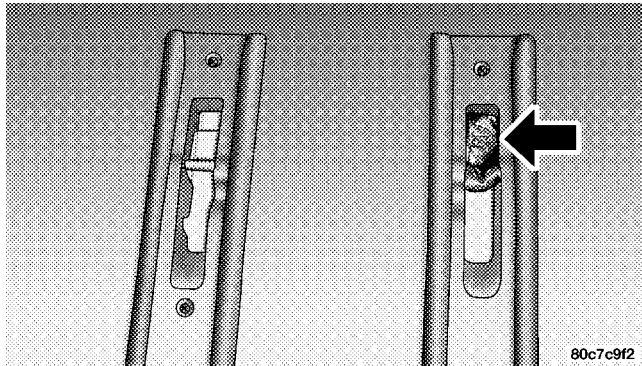

Tether Anchor Location

2. Extend the child restraint tether anchor forward towards the front passenger seat.

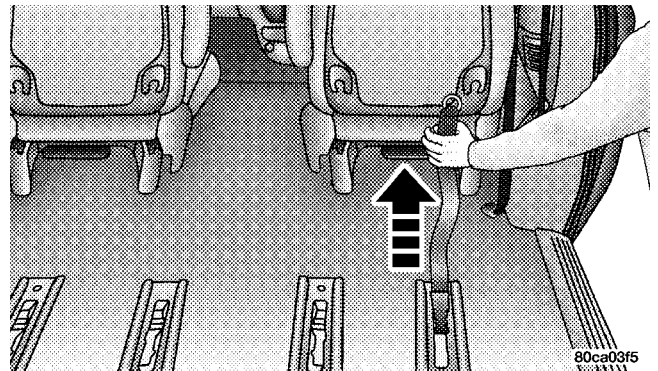

Tether To Anchor

3. Follow the child restraint manufacturer's directions for proper use of connecting the child restraint to the extended tether strap.

4. If necessary, raise the passenger seat head restraint to allow the tether strap to be routed under the head restraint.
5. Route the tether strap beneath the head restraint between the two head restraint posts. Ensure that the child restraint tether strap is centered between the two head restraint posts.

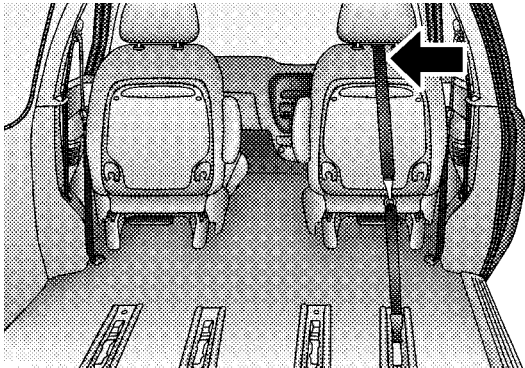

80c7c9de

Tether Strap Mounting

6. Using the hook attached to the child restraint tether strap, attach the child restraint tether strap to the metal ring on the vehicle tether anchor.
7. Following the child seat manufacturer's instructions, tighten the child restraint tether strap.
8. If necessary, reposition the seat head restraint.
9. Inspect the tether anchor strap for nicks, abrasions, discoloration, and loose threads. If these, or any other condition that might effect the performance of the strap is observed, DO NOT USE. Contact your local DaimlerChrysler dealership for a replacement part.

NOTE: Stow the child restraint tether strap in its original position when not in use.

WARNING!

The vehicle tether anchor is designed to be used with a child restraint only. It should not be used for any other purpose. Before use inspect the tether anchor strap for nicks, abrasions, discoloration, and loose threads. If these or any other condition that might effect the performance of the strap is observed, **DO NOT USE**, personal injury may result. Contact your local DaimlerChrysler dealership for a replacement part.

ENGINE BREAK-IN RECOMMENDATIONS

A long break-in period is not required for the engine in your new vehicle.

Drive moderately during the first 300 miles (500 km). After the initial 60 miles (100 km), speeds up to 50 or 55 mph (80 or 90 km/h) are desirable.

While cruising, brief full-throttle acceleration, within the limits of local traffic laws, contributes to a good break-in. Wide open throttle acceleration in low gear can be detrimental and should be avoided.

The engine oil installed in the engine at the factory is a high quality energy conserving type lubricant. Oil changes should be consistent with anticipated climate conditions under which vehicle operations will occur. The recommended viscosity and quality grades are shown in Section 7 of this manual. **NON-DETERGENT OR STRAIGHT MINERAL OILS MUST NEVER BE USED.**

A new engine may consume some oil during its first few thousand miles (kilometers) of operation. This should be considered as a normal part of the break-in and not interpreted as an indication of difficulty.

SAFETY TIPS

Exhaust Gas

WARNING!
Exhaust gases can injure or kill. They contain carbon monoxide (CO) which is colorless and odorless. Breathing it can make you unconscious and can eventually poison you. To avoid breathing (CO) follow the safety tips below.

Do not run the engine in a closed garage or in confined areas any longer than needed to move your vehicle in or out of the area.

If it is necessary to sit in a parked vehicle with the engine running, adjust your heating or cooling controls to force outside air into the vehicle. Set the blower at high speed.

WARNING!
If you are required to drive with the deck lid/liftgate open, make sure that all windows are closed, and the climate control blower switch is set at high speed. DO NOT use the recirculation mode.

If you are required to drive with the deck lid/liftgate open, make sure that all windows are closed, and the climate control blower switch is set at high speed. **DO NOT** use the recirculation mode.

2

Safety Checks You Should Make Inside The Vehicle

Seat Belts

Inspect the belt system periodically, checking for cuts, frays and loose parts. Damaged parts must be replaced immediately. Do not disassemble or modify the system.

Front seat belt buckle pretensioners must be replaced after a collision. Rear seat belt assemblies must be replaced after a collision if they have been damaged (bent retractor, torn webbing, etc. If there is any question regarding belt or retractor condition, replace the belt.

Airbag Light

The light should come on and remain on for 6 to 8 seconds as a bulb check when the ignition switch is first turned ON. If the LED is not lit during starting, have it checked. If the light stays on or comes on while driving, have the system checked by an authorized dealer.

Defroster

Check operation by selecting the defrost mode and place the blower control on high speed. You should be able to feel the air directed against the windshield.

Periodic Safety Checks You Should Make Outside The Vehicle**Tires**

Examine tires for excessive tread wear or uneven wear patterns. Check for stones, nails, glass, or other objects

lodged in the tread. Inspect tread and sidewall for cuts or cracks. Check wheel nuts for tightness, and tires (including spare) for proper pressure.

Lights

Have someone observe the operation of exterior lights while you work the controls. Check turn signal and high beam indicator lights on the instrument panel.

Fluid Leaks

Check area under vehicle after overnight parking for fuel, engine coolant, oil or other fluid leaks. Also, if gasoline fumes are detected or fuel, power steering fluid or brake fluid leaks are suspected, the cause should be located and corrected immediately.

UNDERSTANDING THE FEATURES OF YOUR VEHICLE

CONTENTS

■ Mirrors90	□ Heated Remote Control Mirrors — If Equipped93
□ Inside Day/Night Mirror90	□ Illuminated Vanity Mirrors — If Equipped93
□ Automatic Dimming Mirror — If Equipped90	■ Hands-Free Communication (UConnect™) — If Equipped94
□ Driver's Side Outside Mirror Auto Dimmer — If Equipped91	□ Operations95
□ Exterior Mirrors Folding Feature91	□ Phone Call Features102
□ Outside Mirror — Driver's Side92	□ UConnect™ System Features105
□ Outside Mirror — Passenger's Side92	□ Advanced Phone Connectivity109
□ Power Remote-Control Mirrors — If Equipped92		

<ul style="list-style-type: none"> □ Things You Should Know About Your UConnect™ System 111 ■ Seats 117 <ul style="list-style-type: none"> □ Manual Front & Second Row Seat Adjuster . . . 117 □ 8-Way Driver's Power Seat — If Equipped . . . 118 □ 6-Way Passenger's Power Seat — If Equipped . 118 □ Adjustable Head Restraints — If Equipped . . . 119 □ Heated Seats — If Equipped 119 □ Manual Reclining Seats — If Equipped 120 □ Manual Lumbar — If Equipped 122 □ Middle Rear Bench Seat Recline — If Equipped 122 □ Stow 'n Go Seating 123 □ Easy Access Seating 129 	<ul style="list-style-type: none"> □ Middle Quad Fold & Tumble Seat Removal . . . 131 □ 50/50 Fold & Tumble Rear Seat Removal 133 □ 2 - Passenger And 3 - Passenger Bench Seats . 135 □ Plastic Grocery Bag Retainer 136 □ Rear-Most Bench Seat 137 □ Rear Seat Descriptions 137 □ Rear Bench Seating Flexibility 138 □ Rear Quad And 50/50 Seating Flexibility 139 ■ To Open And Close The Hood 141 ■ Lights 142 <ul style="list-style-type: none"> □ Interior Lights 143 □ Park Lights 143 □ Headlights 143
---	---

<ul style="list-style-type: none"> <input type="checkbox"/> Automatic Headlights — If Equipped145 <input type="checkbox"/> Daytime Running Lights (Canada/Fleet Vehicles Only)145 <input type="checkbox"/> Lights-On Reminder145 <input type="checkbox"/> Battery Protection145 <input type="checkbox"/> Headlamp Delay — If Equipped146 <input type="checkbox"/> Front Fog Lights — If Equipped146 ■ Multifunction Lever147 <ul style="list-style-type: none"> <input type="checkbox"/> Turn Signals147 <input type="checkbox"/> Headlight Low/High Beam Selector Switch . . .148 <input type="checkbox"/> Passing Light148 <input type="checkbox"/> Windshield Wipers And Washers148 ■ Tilt Steering Column — If Equipped150 	<ul style="list-style-type: none"> ■ Traction Control Switch — If Equipped150 ■ Rear Park Assist System — If Equipped151 ■ Adjustable Pedals — If Equipped153 ■ Electronic Speed Control — If Equipped155 <ul style="list-style-type: none"> <input type="checkbox"/> To Activate155 <input type="checkbox"/> To Set At A Desired Speed156 <input type="checkbox"/> To Deactivate156 <input type="checkbox"/> To Resume Speed156 <input type="checkbox"/> To Vary The Speed Setting156 <input type="checkbox"/> To Accelerate For Passing157 ■ Overhead Console — If Equipped158 <ul style="list-style-type: none"> <input type="checkbox"/> Courtesy/Reading Lights158 <input type="checkbox"/> Sunglass Storage159
---	---

88 UNDERSTANDING THE FEATURES OF YOUR VEHICLE

□ Compass/Temperature Display	159	□ Express Open Feature	174
□ Mini-Trip Computer	162	□ Wind Buffeting	175
□ Electronic Vehicle Information Center (EVIC) — If Equipped	163	□ Sunroof Maintenance	175
□ Customer Programmable Features — If Equipped	164	■ Electrical Power Outlets — If Equipped	175
■ Garage Door Opener — If Equipped	167	□ Electrical Outlet Use With Engine Off	177
□ Programming Homelink	169	■ Convenience Tray Drawer And Cup Holders	177
□ Canadian Programming/Gate Programming	171	□ Instrument Panel Cup Holders	177
□ Using Homelink	172	□ Convenience Tray And Optional Smoker's Package Kit	178
□ Erasing Homelink Buttons	172	□ Rear Cupholders	179
□ Reprogramming a Single Homelink Button	172	■ Storage	180
□ Security	173	□ Front Seat Storage Bin — If Equipped	180
■ Power Sunroof — If Equipped	173	□ Second Row Seat Storage Bins — If Equipped	181

- Overhead Rail System — If Equipped182
- Removable Floor Console With Fold-In-Floor Seating — If Equipped184
- Removable Floor Console Without Fold-In-Floor Seating — If Equipped185
- Rear Compartment Storage Bins189

UNDERSTANDING THE FEATURES OF YOUR VEHICLE 89

- Cargo/Tub Nets189
- Coat Hooks189
- Cargo Area Storage189
- Roof Luggage Rack — If Equipped190
- Load Leveling System193

MIRRORS

Inside Day/Night Mirror

Adjust the mirror to center on the view through the rear window. A two point pivot system allows for horizontal and vertical adjustment of the mirror.

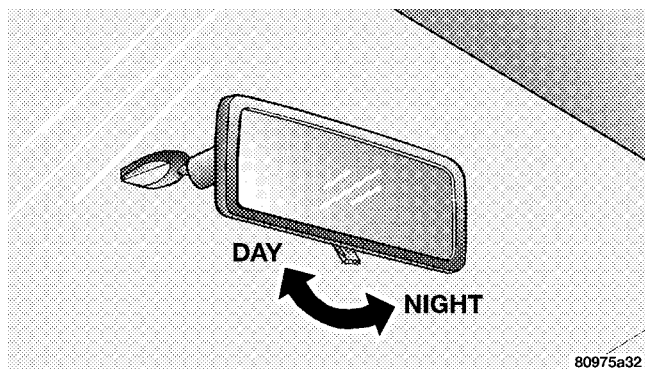

MANUAL REARVIEW MIRROR

Annoying headlight glare can be reduced by moving the small control under the mirror to the night position (toward rear of vehicle). The mirror should be adjusted while set in the day position (toward windshield).

Automatic Dimming Mirror — If Equipped

If the switch is in the “Auto” position the mirror will automatically adjust for annoying headlight glare from vehicles behind you. You can turn the feature on or off by pressing the button at the base of the mirror. A light in the button will illuminate to indicate when this feature is on.

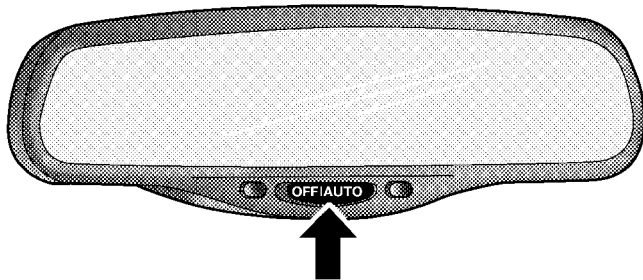

AUTO MIRROR

81074fc3

CAUTION!

To avoid damage to the mirror during cleaning, never spray any cleaning solution directly onto the mirror. Apply the solution onto a clean cloth and wipe the mirror clean.

3

Driver's Side Outside Mirror Auto Dimmer — If Equipped

This mirror automatically adjusts for annoying headlight glare from vehicles behind you. You can turn this feature on or off by pressing the button at the base of the Rearview Mirror.

Exterior Mirrors Folding Feature

All exterior mirrors are hinged and may be moved either forward or rearward to resist damage. The hinges have three detent positions; full forward, full rearward, and normal.

Outside Mirror — Driver’s Side

Adjust the outside mirror to center on the adjacent lane of traffic, with a slight overlap of the view obtained on the inside mirror.

Outside Mirror — Passenger’s Side

Adjust the convex outside mirror so you can just see the side of your vehicle in the portion of the mirror closest to the vehicle. This type of mirror will give a much wider view to the rear, and especially of the lane next to your vehicle.

WARNING!

Vehicles and other objects seen in the right side convex mirror will look smaller and farther away than they really are. Relying too much on your right side mirror could cause you to collide with another vehicle or other object.

Use your inside mirror when judging the size or distance of a vehicle seen in this convex mirror.

Power Remote-Control Mirrors — If Equipped

Use the mirror select switch, located on the instrument panel to the left of the steering column, to adjust the view obtained in the outside mirrors. Press the rocker switch to the L or R for Left or Right mirror selection. Use the center off position to guard against accidentally moving a mirror position.

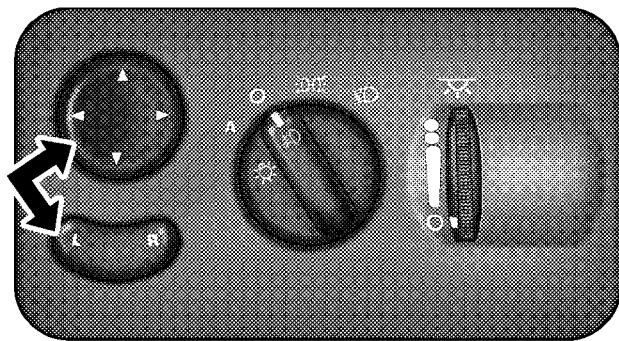

8097c4dd

Power Mirror Switches

Select a mirror and press one of the four arrows for the direction you want the mirror to move.

Heated Remote Control Mirrors — If Equipped

These mirrors are heated to melt frost or ice. This feature is activated whenever you turn on the Rear Window Defrost.

Illuminated Vanity Mirrors — If Equipped

An illuminated vanity mirror is on the sun visor. To use the mirror, rotate the sun visor down and swing the mirror cover upward. The lights turn on automatically. Closing the mirror cover turns off the lights.

Sun Visor Extension — If Equipped

This feature has a pull out extension on the sun visor for increased coverage.

HANDS-FREE COMMUNICATION (UConnect™) — IF EQUIPPED

UConnect™ is a voice-activated, hands-free, in-vehicle communications system. UConnect™ allows you to dial a phone number with your cellular phone using simple voice commands (e.g., "Call" ... "Mike" ... "Work" or "Dial" ... "248-555-1212"). Your cellular phone's audio is transmitted through your vehicle's audio system; the system will automatically mute your radio when using the UConnect™ system.

NOTE: The UConnect™ system use requires a cellular phone equipped with the Bluetooth "Hands-Free Profile," version 0.96 or higher. See www.chrysler.com/uconnect for supported phones.

UConnect™ allows you to transfer calls between the system and your cellular phone as you enter or exit your vehicle, and enables you to mute the system's microphone for private conversation.

The UConnect™ phonebook enables you to store up to 32 names and four numbers per name. Each language has a separate 32 name phonebook accessible only in that language. This system is driven through your Bluetooth™ Hands-Free profile cellular phone. UConnect™ features Bluetooth™ technology - the global standard that enables different electronic devices to connect to each other without wires or a docking station, so UConnect works no matter where you stow your cellular phone (be it your purse, pocket, or briefcase), as long as your phone is turned on and has been paired to the vehicle's UConnect™ system. The UConnect™ system allows up to seven cellular phones to be linked to system. Only one linked (or paired) cellular phone can be used with the system at a time. The system is available in English, Spanish, or French languages (as equipped).

The rearview mirror contains the microphone for the system and the control buttons that will enable you to access the system.

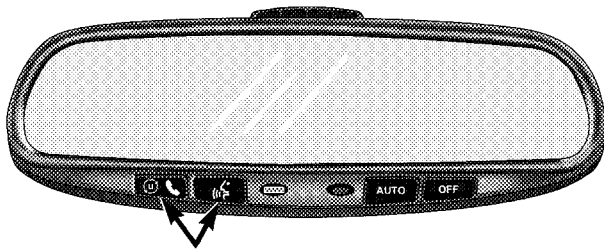

8105b20d

UConnect™ Switches

The UConnect™ system can be used with any Hands-Free Profile certified Bluetooth™ cellular phone. See www.chrysler.com/uconnect for supported phones. If your cellular phone supports a different profile (e.g.,

Headset Profile), you may not be able to use any UConnect™ features. Refer to your cellular service provider or the phone manufacturer for details.

The UConnect™ system is fully integrated with the vehicle's audio system. The volume of the UConnect™ system can either be adjusted from the radio volume control knob, or from the steering wheel radio control (right switch), if so equipped.

The radio display will be used for visual prompts from the UConnect™ system such as "CELL" or caller ID on certain radios.

Operations

Voice commands can be used to operate the UConnect™ system and to navigate through the UConnect™ menu structure. Voice commands are required after most UConnect™ system prompts. You will be prompted for a specific command and then guided through the available options.

- Prior to giving a voice command, one must wait for the voice on beep, which follows the "Ready" prompt or another prompt.
- For certain operations, compound commands can be used. For example, instead of saying "Setup" and then "Phone Pairing," the following compound command can be said: "Setup Phone Pairing."
- For each feature explanation in this section, only the combined form of the voice command is given. You can also break the commands into parts and say each part of the command, when you are asked for it. For example, you can either use the combined form voice command "Phonebook New Entry," or you can break the combined form command into two voice commands: "Phonebook" and "New Entry." Please remember, the UConnect™ system works best when you talk in a normal conversational tone, as if speaking to someone sitting eight feet away from you.

Voice Command Tree

Refer to "Voice Tree" at the end of this section.

Help Command

If you need assistance at any prompt or if you want to know what your options are at any prompt, say "Help" following the voice on beep. The UConnect™ system will play all the options at any prompt if you ask for help.

To activate the UConnect™ system from idle, simply press the 'Phone' button and follow audible prompts for directions. All UConnect™ system sessions begin with a press of the 'Phone' button on the mirror.

Cancel Command

At any prompt, after the voice on beep, you can say "Cancel" and you will be returned to the main menu. However, in a few instances the system will take you back to the previous menu.

Pair (Link) UConnect™ System to a Cellular Phone
To begin using your UConnect™ system, you must pair your compatible Bluetooth™ enabled cellular phone.

NOTE: The UConnect™ system use requires a cellular phone equipped with the Bluetooth "Hands-Free Profile," version 0.96 or higher. See www.chrysler.com/uconnect for supported phones.

To complete the pairing process, you will need to reference your cellular phone owner's manual. One of the following vehicle specific websites may also provide detailed instructions for pairing with the brand of phone that you have:

NOTE:

- www.chrysler.com/uconnect
- www.dodge.com/uconnect
- www.jeep.com/uconnect

The following are general phone to UConnect™ System pairing instructions:

- Press the 'Phone' button to begin.
- After the "Ready" prompt and the following beep, say "Setup Phone Pairing."
- When prompted, after the voice on beep, say "Pair a Phone."
- You will be asked to say a four-digit pin number which you will later need to enter into your cellular. You can enter any four-digit pin number. You will not need to remember this pin number after the initial pairing process.
- The UConnect™ system will then prompt you to begin the cellular phone pairing process on your cellular phone. Before attempting to pair phone, please see your cellular phone's user manual (Bluetooth section) for instructions on how to complete this step.

- For identification purposes, you will be prompted to give the UConnect™ system a name for your cellular phone. Each cellular phone that is paired should be given a unique phone name.
- You will then be asked to give your cellular phone a priority level between 1 and 7, 1 being the highest priority. You can pair up to seven cellular phones to your UConnect™ system. However, at any given time, only one cellular phone can be in use, connected to your UConnect™ System. The priority allows the UConnect™ system to know which cellular phone to use if multiple cellular phones are in the vehicle at the same time. For example, if priority 3 and priority 5 phones are present in the vehicle, the UConnect™ system will use the priority 3 cellular phone when you make a call. You can select to use a lower priority cellular phone at any time (refer to "Advanced Phone Connectivity").

Dial by Saying a Number

- Press the 'Phone' button to begin.
- After the "Ready" prompt and the following beep, say "Dial."
- System will prompt you to say the number you want call.
- For example, you can say "234-567-8901." The phone number that you enter must be of valid length and combination. The UConnect™ limits the user from dialing invalid combination of numbers. For example, 234-567-890 is nine digits long, which is not a valid phone number - the closest valid phone number has ten digits.
- The UConnect™ system will confirm the phone number and then dial. The number will appear in the display of certain radios.

Call by Saying a Name

- Press the "Phone" button to begin.
- After the "Ready" prompt and the following beep, say "Call."
- System will prompt you to say the name of the person you want call.
- After the "Ready" prompt and the following beep, say the name of the person you want to call. For example, you can say "John Doe," where John Doe is a previously stored name entry in the UConnect™ phonebook. Refer to "Add Names to Your UConnect™ Phonebook," to learn how to store a name in the phonebook.
- The UConnect™ system will confirm the name and then dial the corresponding phone number, which may appear in the display of certain radios.

Add Names to Your UConnect™ Phonebook

NOTE: Adding names to phonebook is recommended when vehicle is not in motion.

- Press the "Phone" button to begin.
- After the "Ready" prompt and the following beep, say "Phonebook New Entry."
- When prompted, say the name of the new entry. Use of long names helps the voice recognition and is recommended. For example, say "Robert Smith" or "Robert" instead of "Bob."
- When prompted, enter the number designation (e.g.: "Home," "Work," "Mobile," or "Pager"). This will allow you to store multiple numbers for each phonebook entry, if desired.
- When prompted, recite the phone number for the phonebook entry that you are adding.

After you are finished adding an entry into the phonebook, you will be given the opportunity to add more phone numbers to the current entry or to return to the main menu.

The UConnect™ system will allow you to enter up to 32 names in the phonebook with each name having up to four associated phone numbers and designations. Each language has a separate 32 name phonebook accessible only in that language.

Edit Entries in the UConnect™ Phonebook

NOTE: Editing phonebook entries is recommended when vehicle is not in motion.

- Press the 'Phone' button to begin.
- After the "Ready" prompt and the following beep, say "Phonebook Edit."

- You will then be asked for the name of the phonebook entry that you wish to edit.
- Next, choose the number designation (home, work, mobile, or pager) that you wish to edit.
- When prompted, recite the new phone number for the phonebook entry that you are editing.

After you are finished editing an entry in the phonebook, you will be given the opportunities to edit another entry in the phonebook, call the number you just edited, or return to the main menu.

"Phonebook Edit" can be used to add another phone number to a name entry that already exists in the phonebook. For example, the entry John Doe may have a mobile and a home number, but you can add John Doe's work number later using the "Phonebook Edit" feature.

Delete Entries in the UConnect™ Phonebook

NOTE: Editing phonebook entries is recommended when vehicle is not in motion.

- Press the 'Phone' button to begin.
- After the "Ready" prompt and the following beep, say "Phonebook Delete."
- After you enter the Phonebook Delete menu, you will then be asked for the name of the entry that you wish to delete. You can either say the name of a phonebook entry that you wish to delete or you can say "List Names" to hear a list of the entries in the phonebook from which you choose. To select one of the entries from the list, press the "Voice Recognition" button while the UConnect™ system is playing the desired entry and say "Delete."
- After you enter the name, the UConnect™ system will ask you which designation you wish to delete: home, work, mobile or pager. Say the designation you wish to delete.
- Note that only the phonebook entry in the current language is deleted.

After confirmation, the phonebook entries will be deleted. Note that only the phonebook in the current language is deleted.

Delete All Entries in the UConnect™ Phonebook

- Press the 'Phone' button to begin.
- After the "Ready" prompt and the following beep, say "Phonebook Erase All."
- The UConnect™ system will ask you to verify that you wish to delete all the entries from the phonebook.

- After confirmation, the phonebook entries will be deleted.

List All Names in the UConnect™ Phonebook

- Press the 'Phone' button to begin.
- After the "Ready" prompt and the following beep, say "Phonebook List Names."
- The UConnect™ system will play the names of all the phonebook entries.
- To call one of the names in the list, press the "Voice Recognition" button during the playing of the desired name and say "Call." NOTE: the user can also exercise "Edit" or "Delete" operations at this point.
- The UConnect™ system will then prompt you as to number designation you wish to call.
- The selected number will be dialed.

Phone Call Features

The following features can be accessed through the UConnect™ system if the feature(s) are available on your cellular service plan. For example, if your cellular service plan provides three-way calling, this feature can be accessed through the UConnect™ system. Check with your cellular service provider for the features that you have.

Answer or Reject an Incoming Call - No Call Currently in Progress

When you receive a call on your cellular phone, the UConnect™ system will interrupt the vehicle audio system, if on, and will ask if you would like to answer the call. To reject the call, press and hold the 'Phone' button until you hear a single beep indicating that the incoming call was rejected.

Answer or Reject an Incoming Call - Call Currently in Progress

If a call is currently in progress and you have another incoming call, you will hear the same network tones for call waiting that you normally hear when using your cell phone. Press the 'Phone' button to place the current call on hold and answer the incoming call. NOTE: The UConnect™ system compatible phones in market today do not support rejecting an incoming call when another call is in progress. Therefore, the user can only either answer an incoming call or ignore it.

Making a Second Call while Current Call in Progress

To make a second call while you are currently in a call, press the 'Voice Recognition' button and say "Dial" or "Call" followed by the phone number or phonebook entry you wish to call. The first call will be on hold while the

second call is in progress. To go back to the first call, refer to "Toggling Between Calls." To combine two calls, refer to "Conference Call."

Place/Retrieve a Call from Hold

To put a call on hold, press the 'Phone' button until you hear a single beep which will indicate that the call has been placed on hold. To bring the call back from hold, press and hold the 'Phone' button until you hear a single beep.

Toggling Between Calls

If two calls are in progress (one active and one on hold), press the 'Phone' button until you hear a single beep indicating that the active and hold status of the two calls have switched. Only one call can be placed on hold at one time.

Conference Call

When two calls are in progress (one active and one on hold), press and hold the 'Phone' button until you hear a double beep indicating that the two calls have been joined into one conference call.

Three-Way Calling

To initiate three-way calling, press the 'Voice Recognition' button while a call is in progress and make a second phone call as described under "Making a Second Call while Current Call in Progress." After the second call has established, press and hold the 'Phone' button until you hear a double beep indicating that the two calls have been joined into one conference call.

Call Termination

To end a call in progress, momentarily press the 'Phone' button. Only the active call(s) will be terminated and if there is a call on hold, it will become the new active call.

Redial

- Press the 'Phone' button to begin.
- After the "Ready" prompt and the following beep, say "Redial."
- The UConnect™ system will call the last number that was dialed on your cellular phone. Note: this may not be the last number dialed from the UConnect™ system.

Call Continuation

Call continuation is progression of a phone call on UConnect™ system after the vehicle ignition key has been switched to off. Call continuation functionality available on the vehicle can be any one of three types:

- After ignition key is switched off, a call can continue on the UConnect™ system either until the call ends or

until the vehicle battery condition dictates cessation of the call on the UConnect™ system and transfer of the call to the mobile phone.

- After ignition key is switched to off, a call can continue on the UConnect™ system for certain duration, after which the call is automatically transferred from the UConnect™ system to the mobile phone.
- An active call is automatically transferred to the mobile phone after ignition key is switched to off.

UConnect™ System Features

Language Selection

To change the language that the UConnect™ system is using,

- Press the 'Phone' button to begin.

- After the "Ready" prompt and the following beep, say the name of the language you wish to switch to (English, Espanol, or Francais, if so equipped).
- Continue to follow the system prompts to complete language selection.

After selecting one of the languages, all prompts and voice commands will be in that language.

NOTE: After every UConnect™ language change operation, only the language specific 32 name phonebook is usable. The paired phone name is not language specific and usable across all languages.

Emergency Assistance

If you are in an emergency and the mobile phone is reachable:

- Pick up the phone and manually dial the emergency number for your area.

If the phone is not reachable and the UConnect™ system is operational, you may reach the emergency number as follows:

- Press the 'Phone' button to begin.
- After the "Ready" prompt and the following beep, say "Emergency" and the UConnect™ system will instruct the paired cellular phone to call the emergency number. This feature is only supported in the USA.

NOTE: The emergency number dialed is based on the Country where the vehicle is purchased (911 for USA and Canada and 060 for Mexico). The number dialed may not be applicable with the available cellular service and area.

The UConnect™ system does slightly lower your chances of successfully making a phone call as to that for the cell phone directly.

Your phone must be turned on and paired to the UConnect™ system to allow use of this vehicle feature in

emergency situations when the cell phone has network coverage and stays paired to the UConnect™ system.

Towing Assistance

If you need towing assistance,

- Press the 'Phone' button to begin.
- After the "Ready" prompt and the following beep, say "Towing Assistance."

NOTE: The Towing Assistance number dialed is based on the Country where the vehicle is purchased (1-800-528-2069 for USA, 1-877-213-4525 for Canada, 55-14-3454 for Mexico city and 1-800-712-3040 for outside Mexico city in Mexico).

Please refer to the 24-Hour "Towing Assistance" coverage details in the Warranty information booklet and on the 24-Hour Towing Assistance Card.

Paging

To learn how to page, refer to "Working with Automated Systems." Paging works properly except for pagers of certain companies which time-out a little too soon to work properly with the UConnect™ system.

Voice Mail Calling

To learn how to access your voice mail, refer to "Working with Automated Systems."

Working with Automated Systems

This method is designed to be used in instances where one generally has to press numbers on the cellular phone keypad while navigating through an automated telephone system.

You can use your UConnect™ system to access a voice-mail system or an automated service, such as, paging service or automated customer service. Some services require immediate response selection, in some instances, that may be too quick for use of UConnect™ system.

When calling a number with your UConnect™ system that normally requires you to enter in a touch-tone sequence on your cellular phone keypad, you can push the 'Voice Recognition' button and say the sequence you wish to enter followed by the word "Send." For example, if required to enter your pin number followed with a pound 3 7 4 6 #, you can press the 'Voice Recognition' button and say "3 7 4 6 # Send." Saying a number, or sequence of numbers, followed by "Send" is also to be used to navigate through an automated customer service center menu structure and to leave a number on a pager.

Barge In - Overriding Prompts

The 'Voice Recognition' button can be used when you wish to skip part of a prompt and issue your voice recognition command immediately. For example, if a prompt is playing "Would you like to pair a phone, clear a...," you could press the 'Voice Recognition' button and say "Pair a Phone" to select that option without having to listen to the rest of the voice prompt.

Turning Confirmation Prompts On/Off

Turning confirmation prompts off will stop the system from confirming your choices (e.g. the UConnect™ system will not repeat a phone number before you dial it).

- Press the 'Phone' button to begin.
- After the "Ready" prompt and the following beep, say "Setup Confirmations." The UConnect™ system will play the current confirmation prompt status and you will be given the choice to change it.

Phone and Network Status Indicators

If available on the radio and/or on a premium display such as the instrument panel cluster, and supported by your cell phone, the UConnect™ system will provide notification to inform you of your phone and network status when you are attempting to make a phone call using UConnect™. The status is given for roaming network signal strength, phone battery strength, etc.

Dialing Using the Cellular Phone Keypad

You can dial a phone number with your cellular phone keypad and still use the UConnect™ system (while dialing via the cell phone keypad, the user must exercise caution and take precautionary safety measures). By dialing a number with your paired Bluetooth™ cellular phone, the audio will be played through your vehicle's audio system. The UConnect™ system will work the same as if you dial the number using voice recognition.

NOTE: Certain brands of mobile phones do not send the dial ring to the UConnect™ system to play it on the vehicle audio system, so you will not hear it. Under this situation, after successfully dialing a number, the user may feel that the call did not go through even though the call is in progress. Once your call is answered, you will hear the audio.

Mute/Un-mute (Mute off)

When you mute the UConnect™ system, you will still be able to hear the conversation coming from the other party, but the other party will not be able to hear you. In order to mute the UConnect™ system:

- Press the 'Voice Recognition' button.
- After the "Ready" prompt and the following beep, say "Mute."

In order to un-mute the UConnect™ system:

- Press the 'Voice Recognition' button.
- After the "Ready" prompt and the following beep, say "Mute-off."

Information Service

When using AT&T Wireless Service, dialing to phone number "#121," you can access voice activated automated system to receive news, weather, stocks, traffic, etc. related information.

Advanced Phone Connectivity**Transfer Call to and from Cellular Phone**

The UConnect™ system allows on going calls to be transferred to your cellular phone to the UConnect™ system without terminating the call. To transfer an ongoing call from your UConnect™ paired cellular phone to the UConnect™ system or vice-versa, press the 'Voice Recognition' button and say "Transfer Call."

Connect or Disconnect Link Between the UConnect™ System and Cellular Phone

Your cellular phone can be paired with many different electronic devices, but can only be actively "connected" with one electronic device at a time.

If you would like to connect or disconnect the Bluetooth™ connection between a UConnect™ paired cellular phone and the UConnect™ system, follow the instruction described in your cellular phone user's manual.

List Paired Cellular Phone Names

- Press the 'Phone' button to begin.
- After the "Ready" prompt and the following beep, say "Setup Phone pairing".
- When prompted, say "List Phones."
- The UConnect™ system will play the phone names of all paired cellular phones in order from the highest to the lowest priority. To "select" or "delete" a paired phone being announced, press the 'Voice recognition' button and say "Select" or "Delete." Also, see the next two sections for an alternate way to "select" or "delete" a paired phone.

Select another Cellular Phone

This feature allows you to select and start using another phone with the UConnect™ system. The phone must have been previously paired to the UConnect™ system that you want to use it with.

- Press the 'Phone' button to begin.
- After the "Ready" prompt and the following beep, say "Setup Select Phone."
- The phone names along with priority numbers will be announced.
- When prompted say the priority number of the cellular phone you wish to select. You can also press the 'Voice Recognition' button anytime while the list is being played, then say the priority number of the phone that you wish to select.

- The selected phone will be used for the next phone call. If the selected phone is not available, the UConnect™ system will return to using the highest priority phone present in or near (approximately within 30 feet) the vehicle.

Delete UConnect™ Paired Cellular Phones

- Press the 'Phone' button to begin.
- After the "Ready" prompt and the following beep, say "Setup Phone Pairing."
- At the next prompt, say "Delete."
- The phone names along with priority numbers will be announced.
- When prompted say the priority number of the cellular phone you wish to delete. You can also press the

'Voice Recognition' button anytime while the list is being played and say the priority number of the phone you wish to delete.

Things You Should Know About Your UConnect™ System

3

Voice Recognition (VR)

- Always wait for the beep before speaking.
- Speak normally, without pausing, just as you would speak to a person sitting approximately eight (8) feet away from you.
- Make sure that no one other than you is speaking during a voice recognition period.
- Performance is maximized under:
 - low-to-medium blower setting,
 - low-to-medium vehicle speed,

- low road noise,
- smooth road surface,
- fully closed windows,
- dry weather condition.
- Even though the system is designed for users speaking in North American English, French, and Spanish accents, the system may not always work for some.
- When navigating through an automated system, such as, voice mail, or when sending a page, at the end of speaking the digit string, make sure to say "send."
- Storing names in phonebook when vehicle is not in motion is recommended.
- It is not recommended to store similar sounding names in the UConnect™ phonebook.
- UConnect™ phonebook name tag recognition rate is optimized for the voice of the person who stored the name in the phonebook.
- You can say "O" (letter "O") for "0" (zero). "800" must be spoken "eight-zero-zero."
- Even though international dialing for most number combinations is supported, some shortcut dialing number combinations may not be supported.

Far End Audio Performance

- Audio quality is maximized under:
 - low-to-medium blower setting,
 - low-to-medium vehicle speed,
 - low road noise,
 - smooth road surface,

- fully closed windows, and
- dry weather condition.
- Operation from driver seat.
- Performance, such as, audio clarity, echo, and loudness to a large degree, rely on the phone and network, and not the UConnect™ system.
- Echo at far end can sometime be reduced by lowering the in-vehicle audio volume.

Bluetooth Communication Link

Cellular phones have been found to occasionally lose connection to the UConnect™ system. When this happens, the connection can generally be re-established by switching the phone off/on. Your cell phone is recommended to remain in Bluetooth "on" mode.

Power-Up

After switching the ignition key from OFF to either ON or ACC position, or after a reset, you must wait at least five (5) seconds prior to using the system.

Voice Command Tree

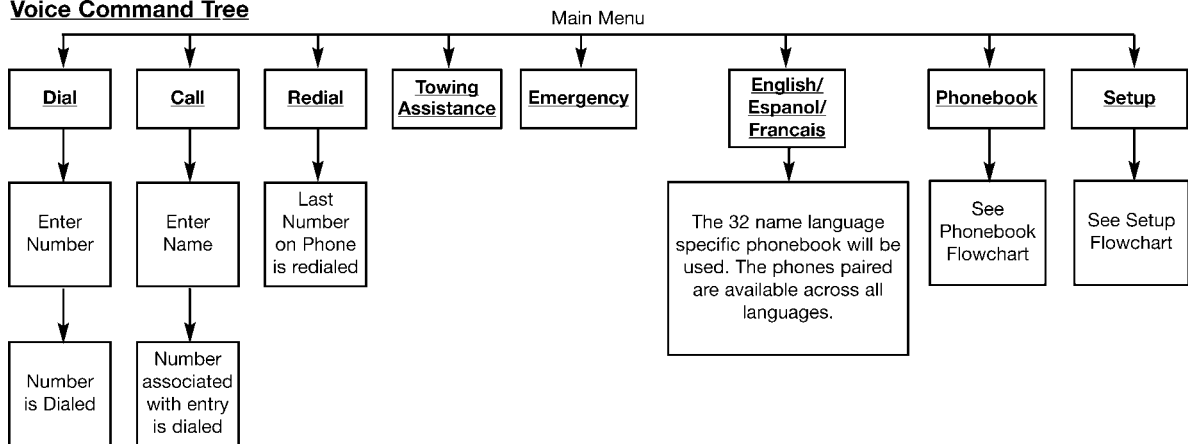

Note: Available Voice commands are shown in bold face and are underlined.

Voice Tree – Phonebook

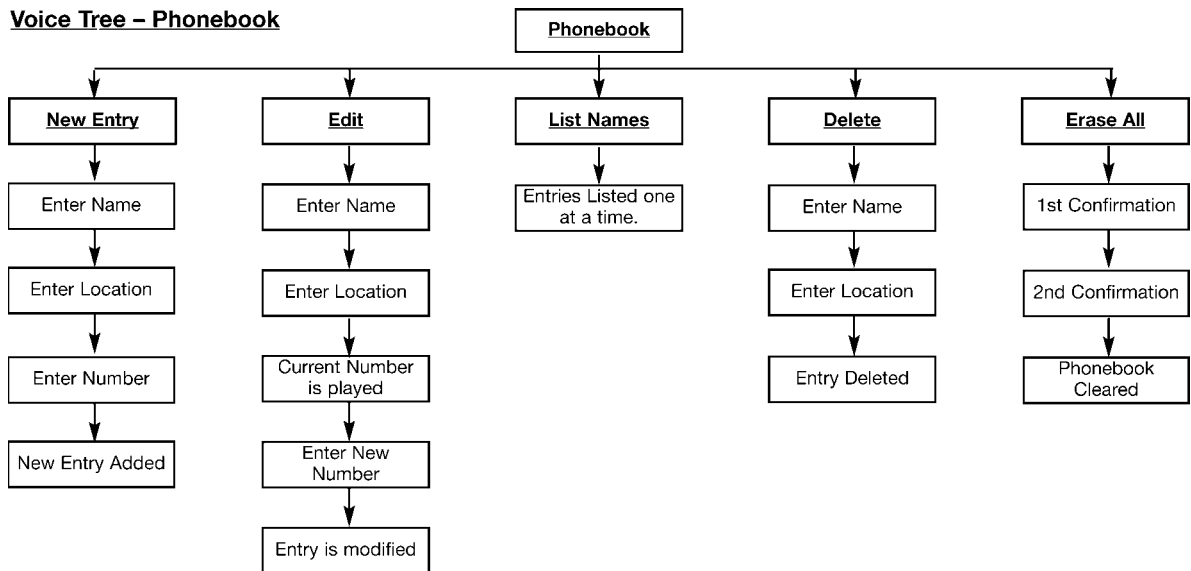

Note: Available Voice commands are shown in bold face and are underlined.

8131b294

Voice Tree – Setup

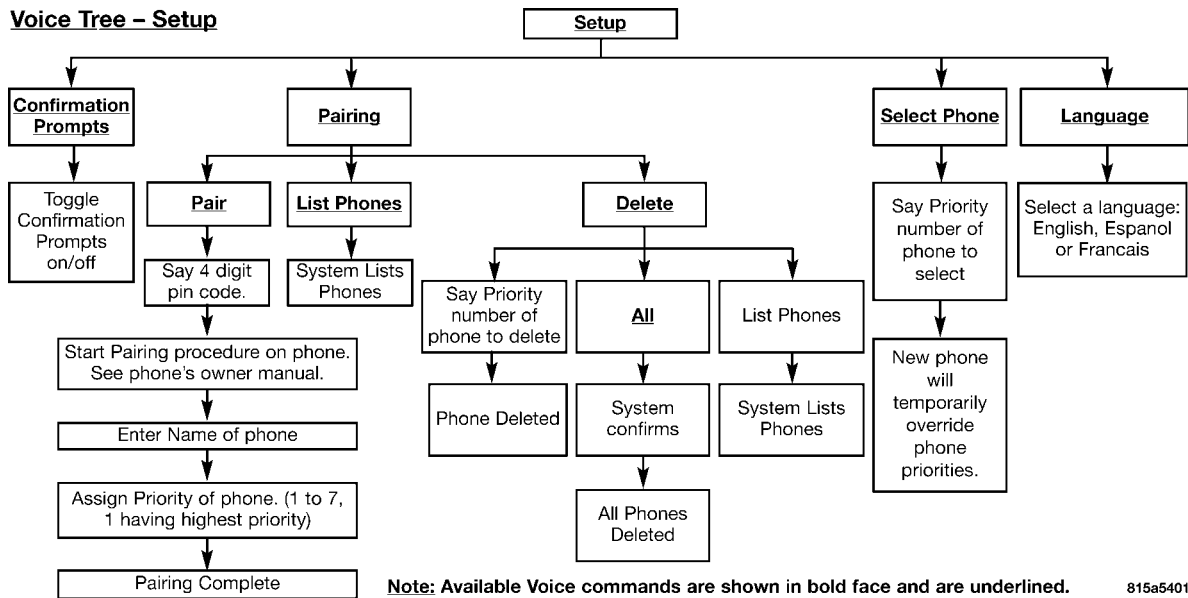

Note: Available Voice commands are shown in bold face and are underlined.

	North American English
Primary	Alternate(s)
Zero	Oh
Add location	Add new
All	All of them
Confirmation prompts	Confirmations prompts
Delete a name	Delete
Language	Select language
List names	List all
List paired phones	List phones
Pager	Beeper
Phone pairing	Pairing
Phonebook	Phone book
Return to main menu	Return. Main menu
Select phone	select
Set up	Phone settings phone set up

SEATS

Manual Front & Second Row Seat Adjuster

The adjusting bar is located under the front of the seat. Pull the bar up and move the seat to the desired position. Release the bar to lock the seat into position.

3

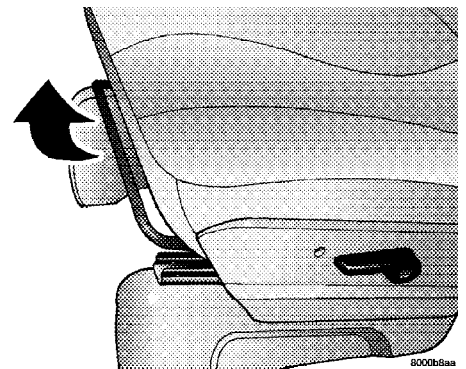

Manual Seat Adjuster

Using body pressure, move forward and rearward on the seat to be sure the seat adjusters have latched.

WARNING!

Adjust the seat only while the vehicle is parked. Adjusting a seat while the vehicle is moving is dangerous. The sudden movement of the seat could cause you to lose control. The seat belt might not be properly adjusted and you could be injured.

8-Way Driver's Power Seat — If Equipped

The driver's power seat switches are located on the outboard side of the seat. The front switch controls up/down, forward/rearward, and tilt adjustment. The rear switch controls the seatback recline adjustment.

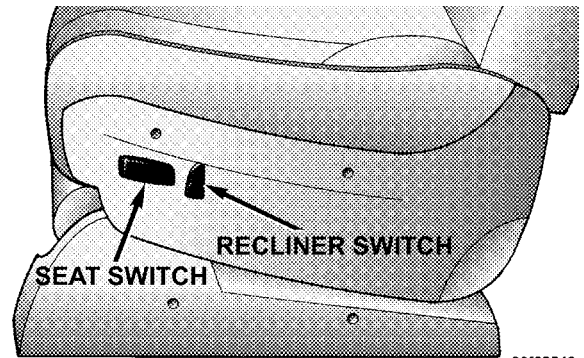

80f62542

Driver Power Seat Switch

6-Way Passenger's Power Seat — If Equipped

The front passenger's power seat switches are located on the outboard side of the seat. The front switch controls forward, rearward and vertical up and down adjustment of the front of the seat only. The rear switch controls the seatback recline adjustment.

CAUTION!

Do not place any article under a power seat or impede its ability to move as it may cause damage to the seat controls. Seat travel may become limited if movement is stopped by an obstruction in the seat's path.

Adjustable Head Restraints — If Equipped

Head restraints can reduce the risk of whiplash injury in the event of impact from the rear. Pull up or push down on the head restraint so that the upper edge is as high as practical. To raise the head restraint, pull up on the head restraint. To lower the head restraint, depress the release tab located at the base of the head restraint and push down on the head restraint.

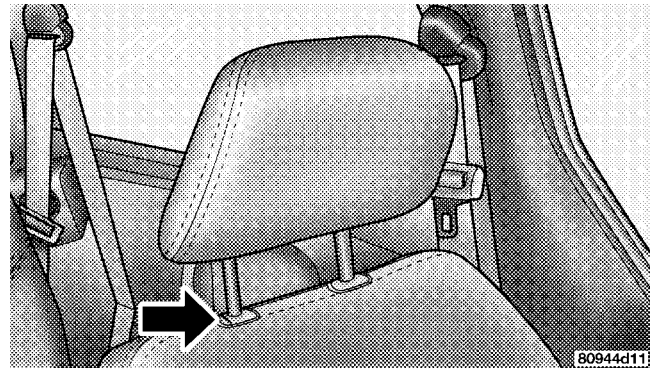

Adjustable Head Restraints

Heated Seats — If Equipped

This feature heats the front driver and passenger seats. The controls for the heated seats are located on the instrument panel above the radio. You may choose LOW,

HIGH or No Heat. The switch position as well as an indicator light will show when the LOW or HIGH heat is ON.

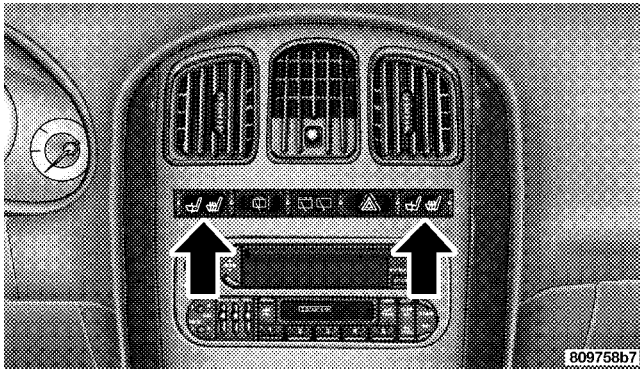

Heated seat switches

Manual Reclining Seats — If Equipped

The recliner mechanism control is on the outboard side of the seat. To recline, lean forward slightly, lift the lever, then push back to the desired position and release the lever. Lean forward and lift the lever to return the seatback to its normal position. Using body pressure, lean forward and rearward on the seat to be sure the seatback has latched.

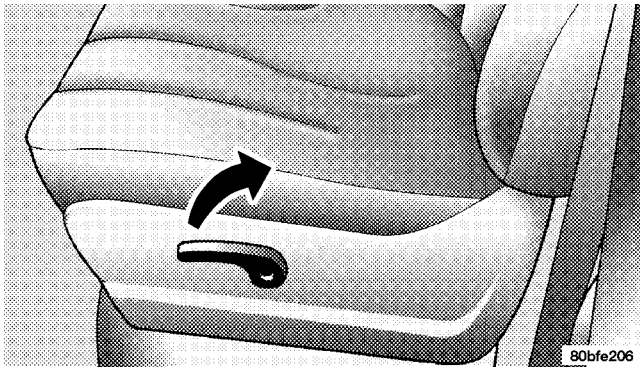

Manual Reclining Seat Control

WARNING!

Do not ride with the seatback reclined so that the shoulder belt is no longer resting against your chest. In a collision you could slide under the seat belt and be seriously or fatally injured. Use the recliner only when the vehicle is parked.

Manual Lumbar — If Equipped

The lumbar adjustment handle is located inboard under the armrest. To increase the support, rotate the handle down.

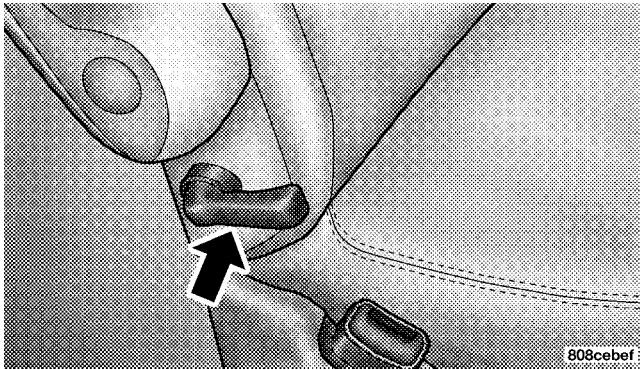

Manual Lumbar Control

Middle Rear Bench Seat Recline — If Equipped

Pull up on the handle located on the side of the seat to release the seatback. This allows the seatback to be either reclined or folded forward.

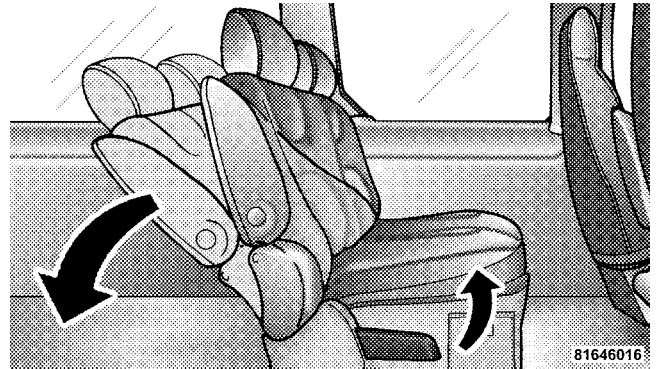

Manual Reclining Seat Control

Stow 'n Go Seating

On vehicles equipped with Stow 'n Go seating, the second and third row seats may be folded into the floor for convenient storage.

To Fold Second Row Seats

1. Lower the head restraint and raise the armrests on the second row seat.
2. Slide storage bin locking mechanism to the "Locked" position and then pull up on the storage bin latch to open cover.

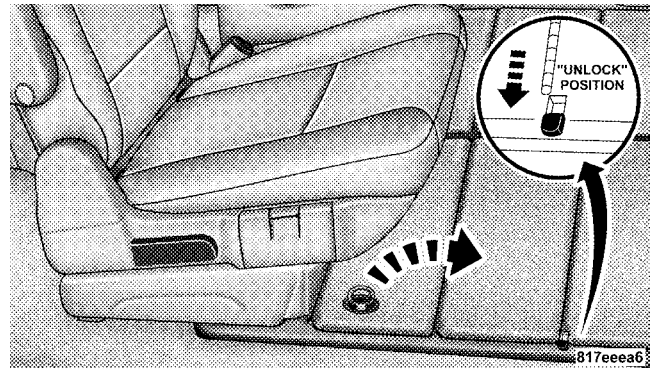

Load Floor Handle

3. Pull up on the seatback recliner lever located on the outboard side of the seat and fold the seatback down.

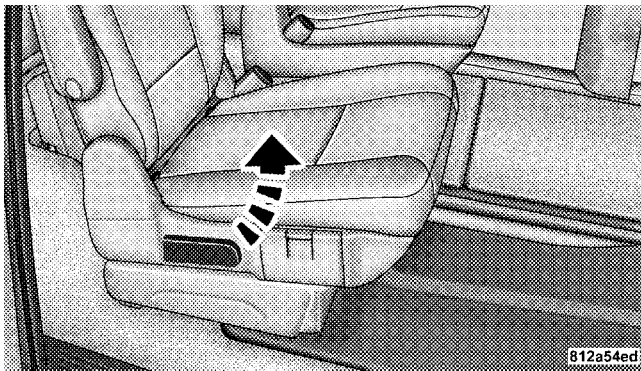

Seatback Release Lever

NOTE: The cupholder must be in the closed position before the seat can be tumbled into the floor.

4. Pull rearward on the release strap located at the rear of the seat and tumble the seat forward into the storage bin.

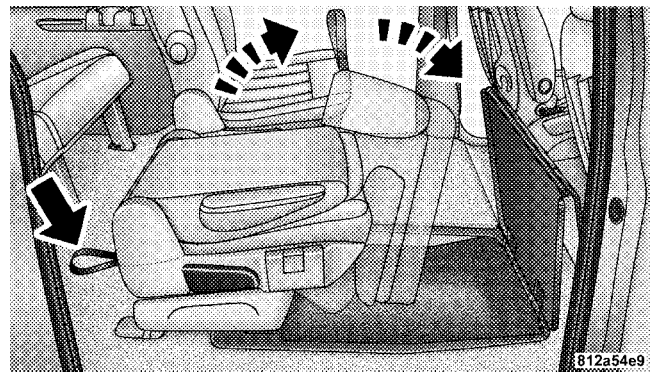

Seat Release Strap

5. Close the storage bin cover.

To Unfold Second Row Seats

1. Slide storage bin locking mechanism to the "Locked" position and then pull up on the storage bin latch to open cover.

2. Pull up on the handle to lift the seat out of the storage bin and push the seat rearward to latch the seat anchors.

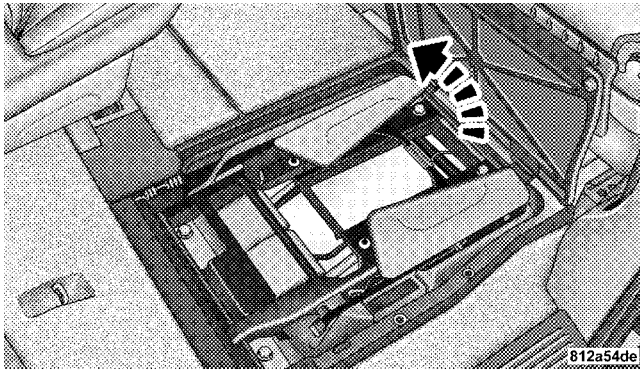

Seat Handle

3. Pull up on the seatback recliner lever located on the outboard side of the seat, to return the seatback to its full upright position.

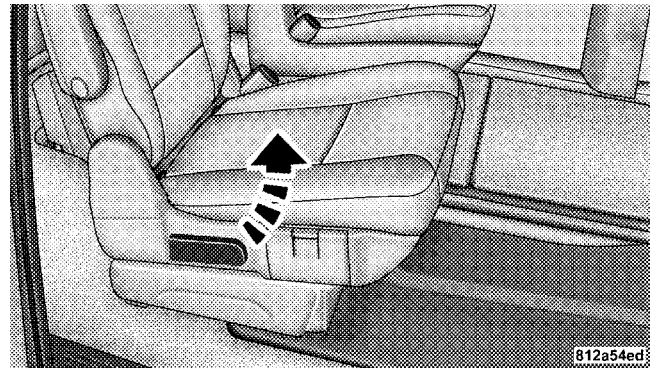

Seatback Release Lever

4. Close the storage bin cover and adjust the head restraint to the desired position.

To Fold Third Row Seats

1. Lower the head restraint to its full down position.
2. Pull release strap marked "1" located on the rear of the seat to lower the seatback.

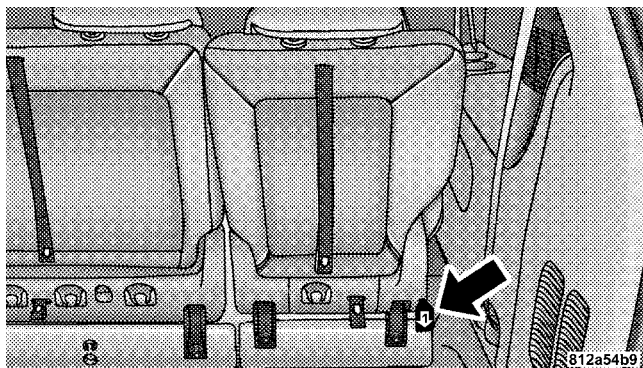

Release Strap 1

3. Pull release strap marked "2" to release the anchors.

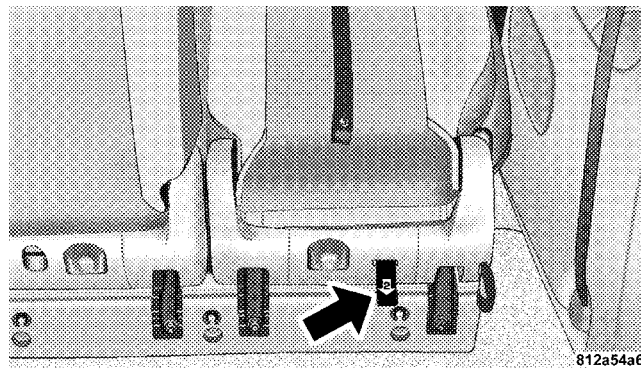

Release Strap 2

4. Pull release strap marked “3” and tumble the seat rearward into the storage bin.

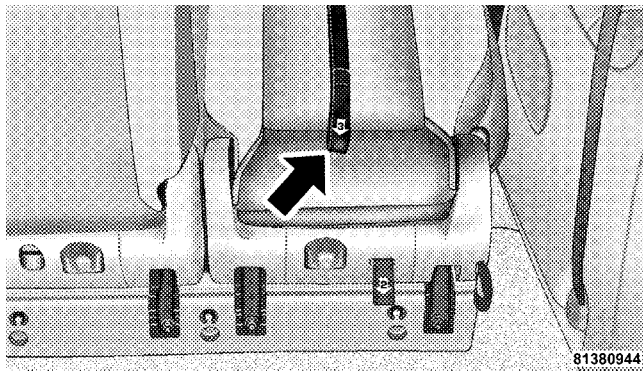

Release Strap 3

To Unfold Third Row Seats

1. Pull up on the assist strap to lift the seat out of the storage bin and push the seat forward until the anchors latch.

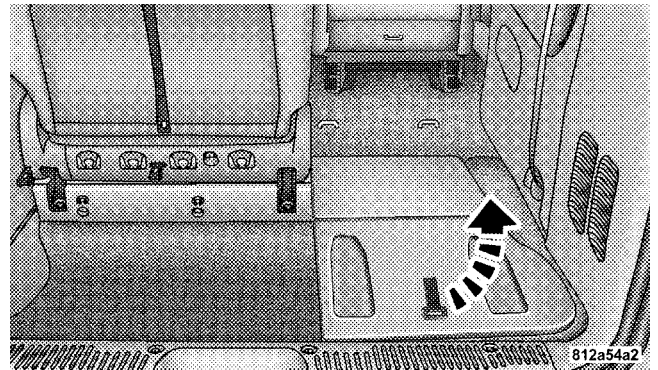

Assist Strap

2. Pull release strap marked "1" to unlock the recliner.
3. Pull release strap marked "3" to return the seatback to its full upright position.

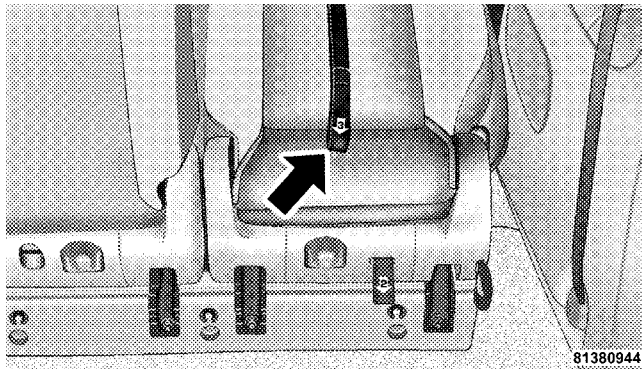

Release Strap 3

4. Adjust the head restraint to the desired position.

WARNING!

In a collision, you or others in your vehicle could be injured if seats are not properly latched to their floor attachments. Always be sure the seats are fully latched.

Tailgate Mode

1. Pull release strap “2”, then pull release strap “3” to rotate the entire seat rearward.

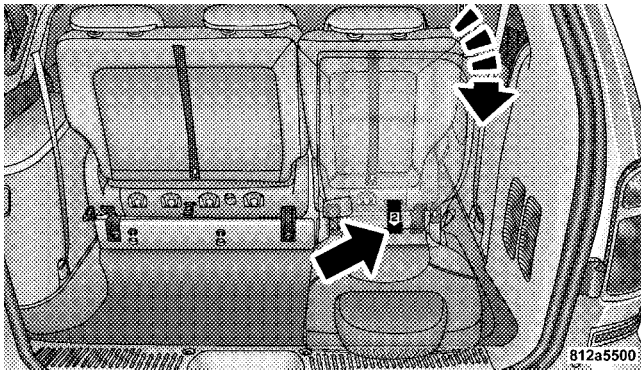

Release Straps 2 & 3

2. To restore the seat to its upright position, lift up on the seatback and push forward until the anchors latch.

WARNING!

To avoid serious injury or death, never operate the vehicle with occupants in the third row seat, while in the tailgate mode.

3

Easy Access Seating

The passenger’s and driver’s side second row seats can be tilted forward for easy access to the third row seat or rear cargo area.

To tilt the seat on vehicles equipped with quad seats, pull up on the release handle located on the outboard side of the seat and tilt the seat fully forward. To return the seat, lower the seat and ensure that it is fully latched.

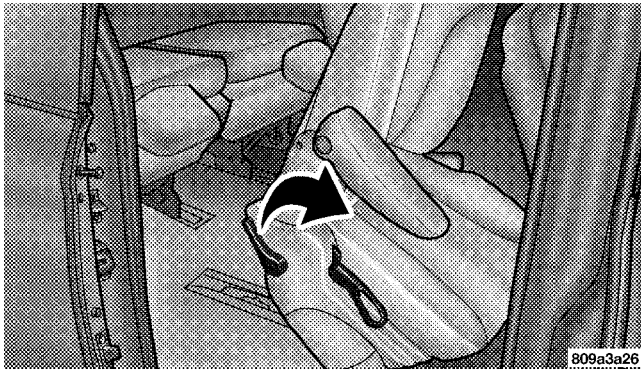

Tilting Quad Seat

To tilt the seat on vehicles equipped with Stow 'n Go seating, pull forward on the release strap located on the front of the seat between the seat back and seat cushion and tilt the seat fully forward. To return the seat, lower the seat and ensure that it is fully latched.

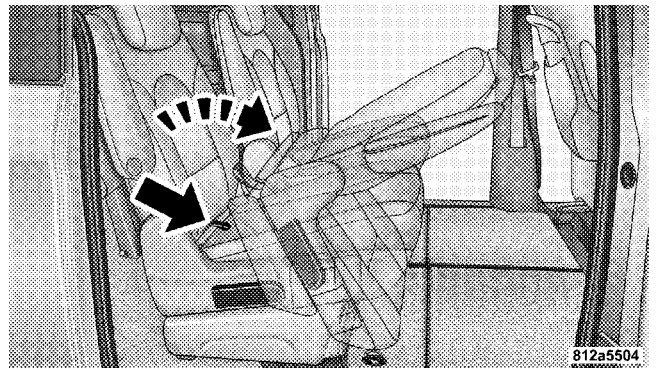

Tilting Stow 'n Go Seat

WARNING!

In the event of a collision you could be injured if the seat is not fully latched.

Middle Quad Fold & Tumble Seat Removal

1. Remove any obstructions from the floor in front of the seat.
2. Lower the head restraint to its full downward position and ensure that the cupholder is closed.
3. Pull up on the seatback release lever located on the outboard side of the seat and fold the seatback down. If the head restraint contacts the rear of the front seat, move the front seat forward on its tracks.

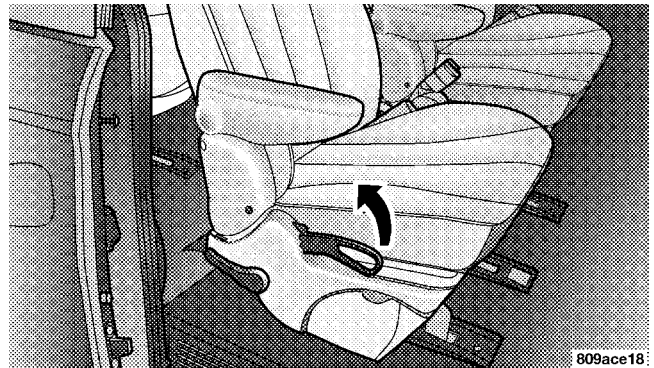

Seatback Release Lever

4. Pull up on the release handle and tumble the seat fully forward.

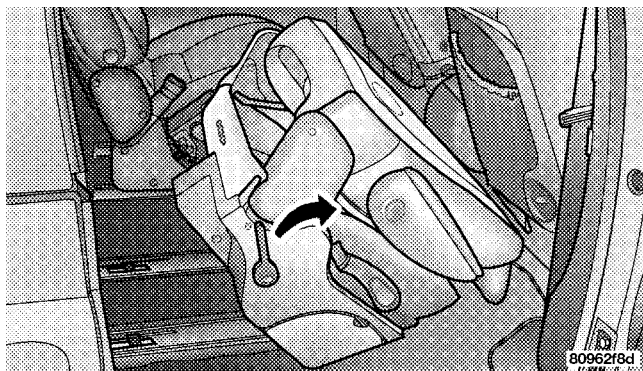

Seat Release Handle

5. Pull the release bar located at the bottom front edge of the seat to disengage the front attachments.

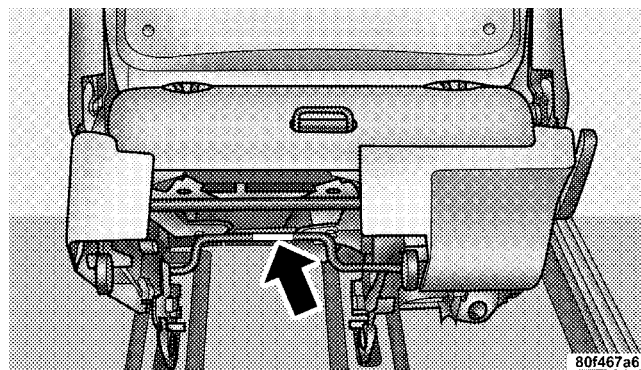

Release Bar Location

6. The seat assembly can now be removed from the vehicle and moved on its Easy Out® Rollers.

To reinstall the seat, remove any obstructions from the floor in front of the seat and ensure the head restraint is in its full downward position. Align the seat in the floor tracks and tilt the seat forward to engage the front floor attachments, then tilt the seat rearward and push down to engage the rear attachments. Pull the seatback release lever to return the seatback to its full upright position. Ensure that the seatback is fully latched in the upright position.

WARNING!

In a collision, you or others in your vehicle could be injured if seats are not properly latched to their floor attachments. Always be sure the seats are fully latched.

50/50 Fold & Tumble Rear Seat Removal

1. Lower the head restraint and pull up on release lever "1" to fold the seatback down.

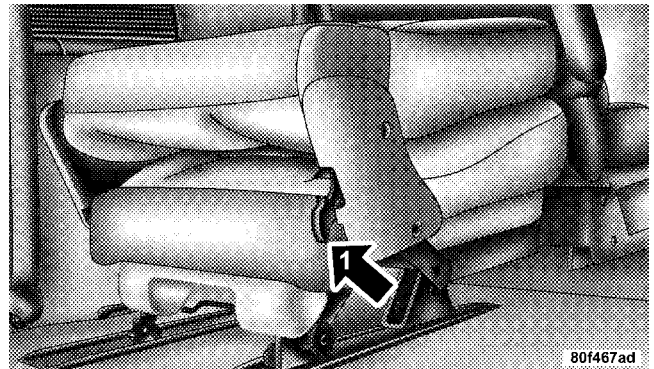

Release Lever Location

134 UNDERSTANDING THE FEATURES OF YOUR VEHICLE

2. Pull up on release lever “2” and tumble the seat fully forward.

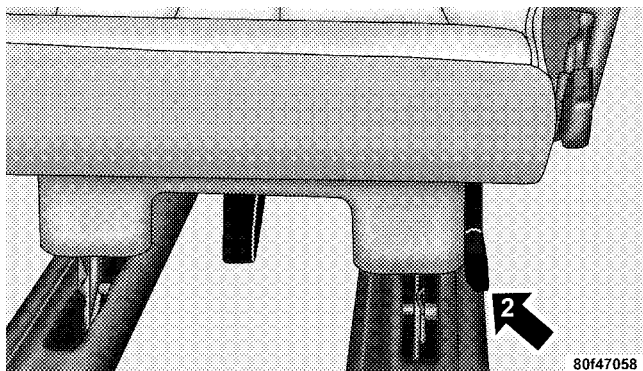

Release Lever 2 Location

3. Pull the release strap “3” located at the bottom of the seat to disengage the front attachments.

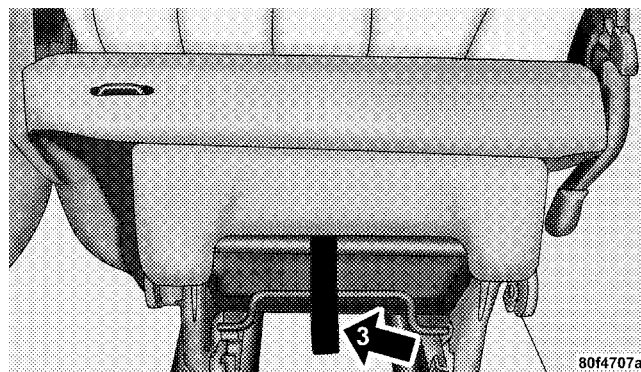

Release Strap Location

4. The seat assembly can now be removed from the vehicle and moved on its Easy Out® Rollers.

To reinstall the 50/50 rear seat, lower the head restraint to the full down position, tilt the seat forward and engage the front floor attachments, then tilt the seat rearward to engage the rear attachments. Pull the seatback release lever to return the seatback to its full upright position. Ensure that the seatback is fully latched in the upright position.

WARNING!

In a collision, you or others in your vehicle could be injured if seats are not properly latched to their floor attachments. Always be sure the seats are fully latched.

2 – Passenger and 3 – Passenger Bench Seats

Release levers are located on the rear leg assemblies, near the floor. To remove the seat, squeeze each release handle and rotate downwards to deploy the wheels. A lock indicator button pops up when the seat is unlocked. The seat assembly can now be removed from the vehicle and moved on its Easy Out® Rollers.

3

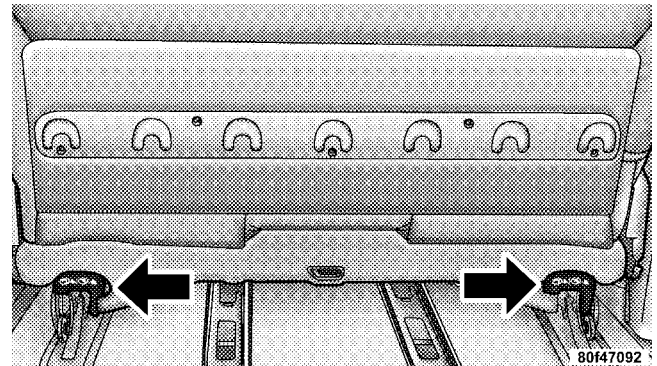

Release Levers

To reinstall the seat, align the seat into the detent positions on the floor. Squeeze the release handle and rotate upward until the lock indicator button returns into the handle.

WARNING!

If not properly latched, the bench seats could become loose. Personal injuries could result. After reinstalling these seats, be sure the red indicator button on the release handles return into the handles.

Plastic Grocery Bag Retainer

Retainer hooks which will hold plastic grocery bag handles are built into the seatbacks of all rear seats and some front seats. The floor supports the partial weight of the bagged goods.

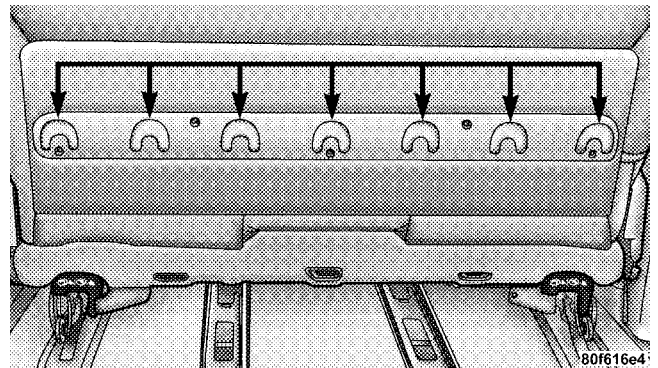

Grocery Bag Holders

Rear-Most Bench Seat

The seat position can be adjusted fore and aft to any of three positions - normal (rearward), intermediate, and full forward. In this way varying needs for legroom and cargo space behind the seat can be accommodated.

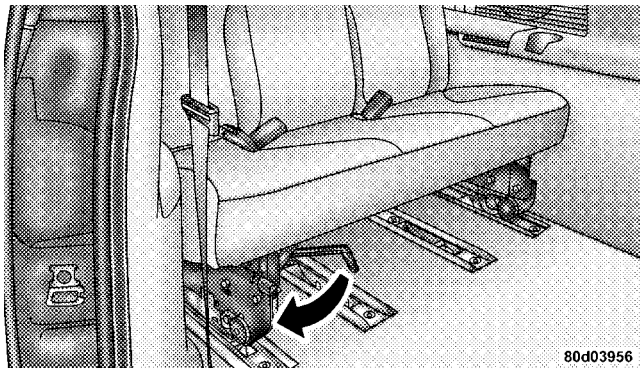

Release Lever Location

The release lever is below the seat and is accessible from the front and back of the seat.

Rear Seat Descriptions

7 Passenger Model — 2- passenger bench or bucket seats in the second position and 3- passenger bench seat or 50/50 bench seat in the third position. All rear seats are removable.

Rear Bench Seating Flexibility

The 3- passenger bench seat may be adjusted to any of 3 positions on its tracks while installed in the vehicle. The bench seat may also be moved to the second seating position or removed from the vehicle.

1. Normal Seating—

The 2nd and 3rd row seats are installed. The 3rd row bench seat is in the full rear position on the tracks.

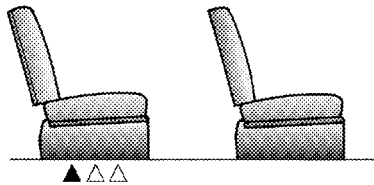

80de80fe

2. Increased Storage—

Increased storage area is provided by adjusting 3rd row bench seat to the intermediate track position. Rear seating for 3 passengers (children) is still provided.

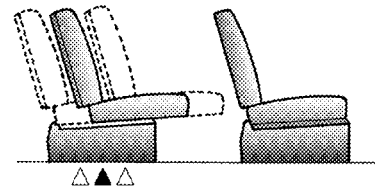

80de80c7

3. Additional Storage—

The 2nd and 3rd row seats installed. The 3rd row bench seat is in the full forward position on the tracks and one or both of the rear seatbacks are folded down.

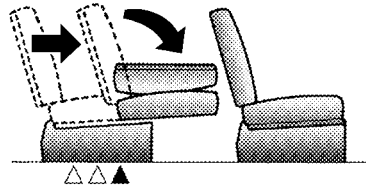

80de8049

4. Auxiliary Seating—

The middle quad seats are removed from the vehicle. The 3- passenger bench seat can be installed in either the second or third row.

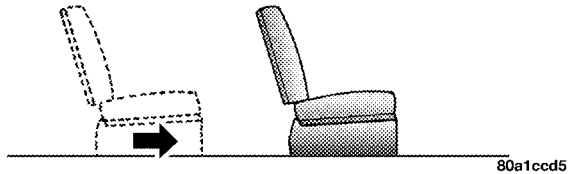

80a1ccd5

Rear Quad and 50/50 Seating Flexibility

The seats may be used with either or both seatbacks folded forward for additional storage space, or with either or both seats removed from the vehicle. Both 50/50 seats may also be moved to the 2nd row seating position when the middle quad seats are removed.

1. Normal Seating—

The 2nd and 3rd row seats are installed. Both seatbacks are in the upright position.

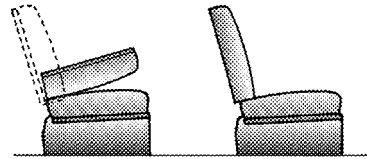

80a1cd79

3

2. Increased Storage—

Increased storage area is provided by folding either or both seatbacks. With one seatback folded forward, rear seating for another occupant is still provided. Either or both seats may Fold and Tumble forward for more storage space. For maximum storage, remove the head restraint and place on the seat cushion, then fold the seatback over the head restraint by lifting lever "1" and tumble the seat forward by lifting lever "2".

NOTE:

Driving with the 2nd-row seats in the tumbled position is not recommended when passengers occupy the 3rd row seats. This position is intended only to increase available cargo area without requiring removal of the seats.

Do not leave the head restraint stored between the cushions for extended periods of time or inadvertent damage to the seat cover or head restraint may occur.

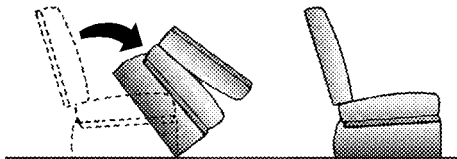

80a1cd44

3. Additional Storage—

The 2nd row seats are installed in the middle seating position. Either or both of the rear seats are removed from the vehicle.

4. Auxiliary Seating—

The 2nd row seats are removed from the vehicle. Then the third row seats can be installed in either the rear or middle seat position.

If the seat is not occupied, the seatback can be folded forward to obtain additional cargo space. To fold the seatback forward, pull the handle labeled “1” located behind the seat on the passenger side.

The seatback will latch in the folded position. To assure the seatback is latched in the folded position, additional downward pressure on the seatback may be required when folding.

The same lever is used to return the seatback to the upright position.

NOTE: The head restraints are removable, if needed. To remove them, press the release tab on the right side of the base of the head restraint.

WARNING!

- Not all head restraints in this vehicle are the same. Head restraints from one seating position should not be removed and installed in any other seating position. In a collision, serious injury or death may result if the proper head restraint is not installed on each seat.
- The cargo area in the rear of the vehicle should not be used as a play area by children. They could be seriously injured in a collision. Children should be seated and using the proper restraint system.
- It is extremely dangerous to ride in a cargo area, inside or outside of a vehicle. In a collision, people riding in these areas are more likely to be seriously injured or killed.
- Do not allow people to ride in any area of your vehicle that is not equipped with seats and seat belts.
- Be sure everyone in your vehicle is in a seat and using a seat belt properly.

TO OPEN AND CLOSE THE HOOD

To open the hood, two latches must be released. First pull the hood release lever located under the left side of the instrument panel.

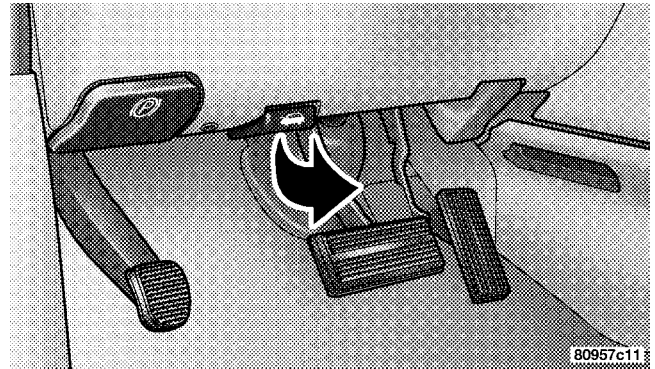

Hood Release Lever

Next, push to the left the safety catch located under the front edge of the hood, near the center.

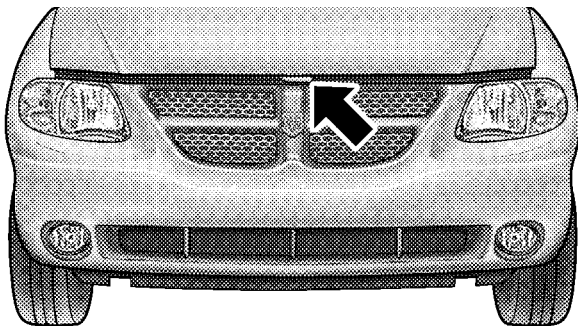

809ace14

Hood Safety Catch

Use the hood prop rod to secure the hood in the open position.

To prevent possible damage, do not slam the hood to close it. Lower the hood until it is open approximately 30

cm (12 inches) and then drop it. This should secure both latches. Never drive your vehicle unless the hood is fully closed, with both latches engaged.

WARNING!

If the hood is not fully latched, it could fly up when the vehicle is moving and block your forward vision. You could have a collision. Be sure all hood latches are fully latched before driving.

LIGHTS

All of the lights, except the hazard warning lights, are controlled by switches to the left of the steering column on the instrument panel.

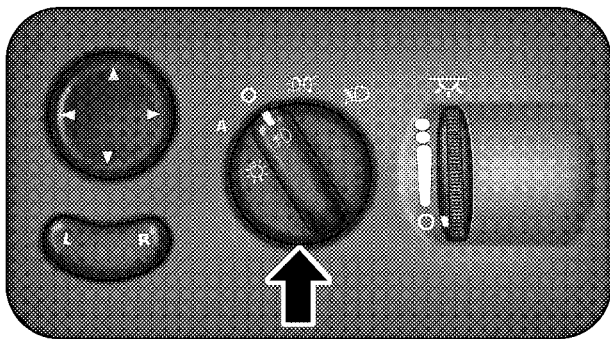

Headlight Switch

Interior Lights

Interior lights are turned on when a door or liftgate is opened, the keyless entry transmitter is activated, or when the dimmer control is moved to the extreme top.

The interior lights will automatically turn off in about 15 minutes if any of the following occur.

- A door, sliding door or the liftgate is left open.
- Any overhead reading light is left on.
- If the dimmer control is in the extreme top position.

NOTE: The key must be out of the ignition switch or the ignition switch must be in the OFF position for this feature to operate.

3

Park Lights

 Turn this switch to the first detent to turn the park lights on. This also turns on all instrument panel lighting.

Headlights



Turn the headlight switch to the 2nd detent to turn the headlights and park lights on. This also turns on all instrument panel lighting.

To change the brightness of the instrument panel lights, rotate the dimmer control up or down.

Dimmer Control

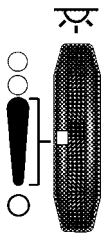

80944d81

With the park lights or headlights on, rotating the dimmer control for the interior lights on the instrument panel upward will increase the brightness of the instrument panel lights.

Interior light Defeat (OFF)

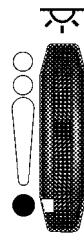

80944d62

Rotate the dimmer control to the OFF position (extreme bottom). The interior lights will remain off when the doors or liftgate are open.

Dome Light Position

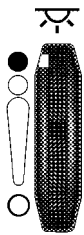

80944d6c

Rotate the dimmer control completely upward to the second detent (extreme top position) to turn on the interior lights, except the front reading/courtesy lights. The interior lights will remain on when the dimmer control is in this position.

Parade Mode (Daytime Brightness Feature)

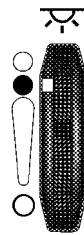

80944d8e

Rotate the dimmer control to the first detent. This feature brightens the odometer, radio and overhead displays when the park lights or headlights are on.

Automatic Headlights — If Equipped

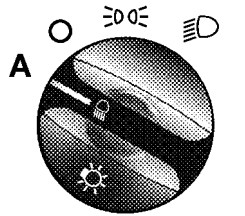

809ad55a

This system automatically turns your headlights ON or OFF based on ambient light levels. To turn the system ON, turn the headlight switch to the extreme counter-clockwise position. When the system is ON, the Headlight Time

Delay feature is also ON. This means your headlights will stay ON for up to 90 seconds after you turn the ignition switch OFF. To turn the Automatic System OFF, turn the headlight switch clockwise to the OFF position.

NOTE: The engine must be running before the headlights will come ON in the Automatic mode.

Daytime Running Lights (Canada/Fleet Vehicles Only)

The Daytime Running Lights will come on whenever the vehicle is running, the headlights are off, and the parking brake is off. The headlight switch must be used for normal night time driving.

Lights-on Reminder

If the headlights or the park lights are left on, or if the dimmer control is in the extreme top position after the ignition switch is turned off, a chime will sound when the driver's door is opened.

Battery Protection

This feature provides battery protection to avoid wearing down the battery if the headlights, park lights, or front fog lights are left on for extended periods of time when the ignition switch is in the LOCK position. After 3 minutes of the ignition switch being in the LOCK position and the headlight switch in any position other than

OFF or AUTO, the lights will turn off automatically until the next cycle of the ignition switch or headlight switch.

The battery protection feature will be disabled if the ignition switch is turned to any other position other than LOCK during the 3 minute delay.

Headlamp Delay — If Equipped

This feature provides the safety of headlight illumination for up to 90 seconds, when leaving your vehicle in an unlighted area.

To activate the delay feature, turn off the ignition switch while the headlights are still on. Then turn off the headlights within 45 seconds. The 90 second delay interval begins when headlight switch is turned off. If the headlights or park lights are turned back on or the ignition switch is turned on, the delay will be cancelled.

The driver can choose, when exiting the vehicle, to have the headlamps remain on for 30, 60, or 90 seconds, or not

remain on. refer to Electronic Vehicle Information Center (EVIC) “Customer Programmable Features” for more information.

If the headlights are turned off before the ignition, they will turn off in the normal manner.

NOTE: The headlights must be turned off within 45 seconds of turning the ignition off to activate this feature.

Front Fog Lights — If Equipped

 To activate the front fog lights, turn on the park lights or the low beam headlights and pull out on the headlight switch control knob. An indicator in the headlight switch shows that the front fog lights are on. Pressing the headlight switch control knob in will turn the front fog lights off.

MULTIFUNCTION LEVER

Turn Signals

Move the Multifunction Lever up or down and the arrows on each side of the base instrument cluster or Information Center flash to indicate proper operation of the front and rear turn signal lights. You can signal a lane change by moving the lever partially up or down.

If either indicator flashes at a rapid rate, check for a defective outside turn signal light bulb. If one of the indicators fails to light when the lever is moved, it would suggest that the indicator light is defective.

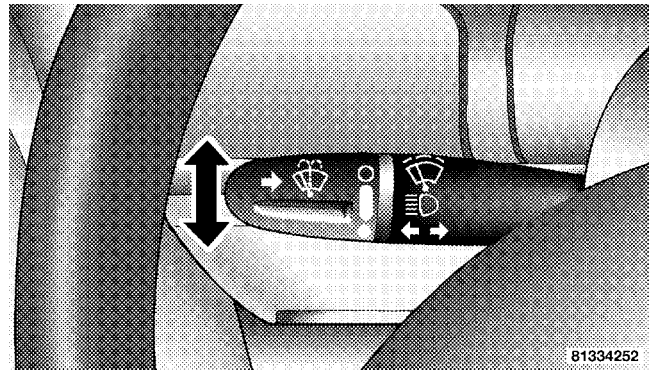

Turn Signal Switch

Turn Signal Warning

If the vehicle electronics sense that the vehicle has traveled at over 18 mph (29 km/h) for about one mile with the turn signals on, a chime will sound to alert the driver.

Headlight Low/High Beam Selector Switch

Pull the multifunction lever toward the steering wheel to switch the headlights between HIGH and LOW beam.

Passing Light

You can signal another vehicle with your headlights by lightly pulling the multifunction lever toward the steering wheel. This will cause the headlights to turn on at high beam and remain on until the lever is released.

Windshield Wipers and Washers

The wipers and washers are operated by a switch in the multifunction lever. Rotate the end of the lever to select the desired wiper speed.

NOTE: Always remove any build-up of snow that prevents the windshield wiper blades from returning to the OFF position. If the windshield wiper switch is turned OFF and the blades cannot return to the OFF position, damage to the wiper motor may occur.

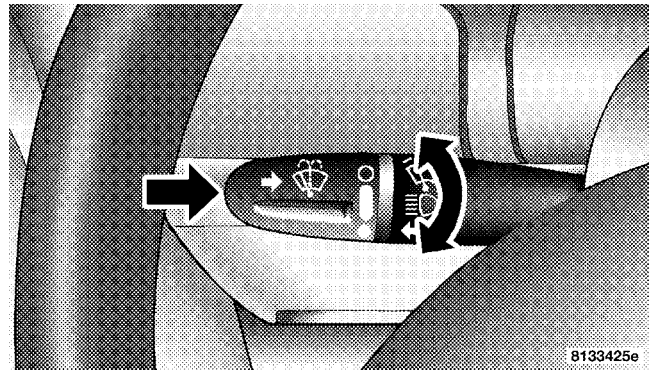

Windshield Wiper/Washer Control

To use the washer, press the end of the multifunction lever in when spray is desired, the washers will spray for a maximum of 20 seconds or until the lever is released. If another washer cycle is desired the end of the lever must be pressed again to get another 20 second washer cycle. If the lever is depressed while in the delay range, the

wipers will operate for several seconds after the lever is released, and then resume the intermittent interval previously selected.

If the end of the lever is depressed while in the OFF position, the wipers will operate for approximately two wipe cycles, then turn OFF.

WARNING!

Sudden loss of visibility through the windshield could lead to an accident. You might not see other vehicles or other obstacles. To avoid sudden icing of the windshield during freezing weather, warm the windshield with defroster before and during windshield washer use.

Intermittent Wiper System

Use the intermittent wipers when weather conditions make a single wiping cycle, with a variable pause between cycles, desirable.

Rotate the end of the lever to the first detent position, then turn the end of the lever to select the desired delay interval. The delay can be regulated from a maximum of about 20 seconds between cycles, to a cycle every 2 seconds. The time delay will be doubled if the vehicle speed is less than 10 mph (16 km/h).

TILT STEERING COLUMN — IF EQUIPPED

To tilt the column, pull the small lever, located behind the turn signal control, toward you and move the wheel up or down, as desired. Release the lever to lock the wheel firmly in place.

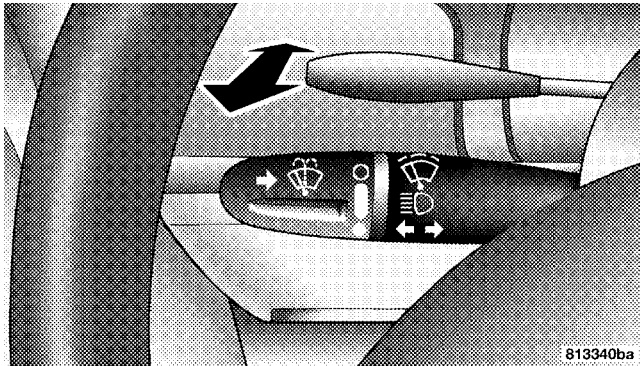

Tilt Steering Column Control

WARNING!

Tilting the steering column while the vehicle is moving is dangerous. Without a stable steering column, you could lose control of the vehicle and have an accident. Adjust the column only while the vehicle is stopped. Be sure it is locked before driving.

TRACTION CONTROL SWITCH — IF EQUIPPED

The TRAC indicator, located below the instrument cluster odometer, will light up when the Traction Control is in use.

To turn the system OFF, press the TRAC OFF switch located on the steering column, until the TRAC OFF indicator below the instrument cluster odometer lights up.

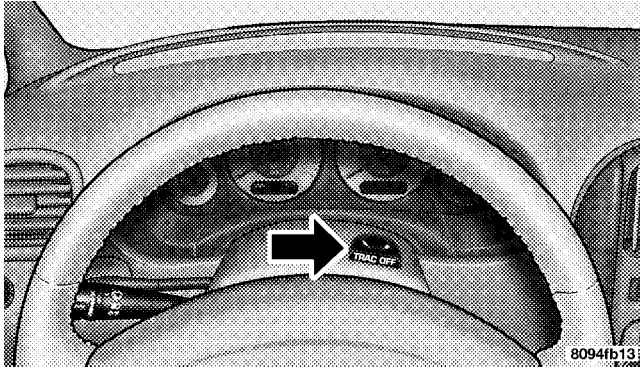

Traction Control Switch

To turn the system back ON, press the switch a second time until the TRAC OFF indicator turns OFF.

NOTE:

- The Traction Control System indicator comes on each time the ignition switch is turned ON. This will occur even if you used the switch to turn the system OFF.
- The Traction Control will make buzzing or clicking sounds when in operation.

REAR PARK ASSIST SYSTEM — IF EQUIPPED

This system is used to help drivers determine if an obstacle is in the way of the vehicle while it is backing up in addition to the use of inside rearview and outside mirrors.

When the driver selects Reverse the system scans for objects behind the vehicle using four sensors located in the rear bumper. Objects can be detected from up to 59 inches (150cm). A warning display above the rear window provides both visible and audible warnings indicating the range of the object.

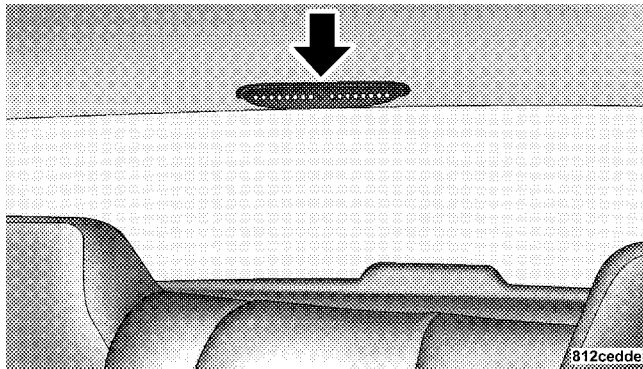

Rear Park Assist Indicator

WARNING!

Drivers must be careful when backing up even when using the Rear Park Assist System. Always check carefully behind your vehicle, look behind you, and be sure to check for pedestrians, other vehicles, obstructions, and blind spots before backing up. Failure to do so can result in serious personal injury or death.

The display contains two sets of yellow and red LEDs that the driver can see in the rear view mirror. Each side of the vehicle has its own warning LEDs. The system provides a visual warning by illuminating one or more yellow LEDs as the vehicle gets closer to the object. As the vehicle continues to approach the object, one red LED is illuminated and the system emits a series of short beeps. The tone will remain constant and both red LEDs are illuminated once the vehicle is within 12 inches (30.5 cm) of the object.

The system can be turned on or off through the electronic vehicle information center (EVIC) when the vehicle is in PARK. If the rear park assist system is turned off, a single chime will sound and the EVIC will display the following message “PARK ASSIST DISABLED”, when the vehicle is in reverse.

NOTE:

- Ensure that the rear bumper is free of dirt and debris to keep the system operating properly.
- Jackhammers, large trucks, and other vibrations could affect the performance of the system.

If Service Park Assist System appears in the EVIC after making sure the rear bumper is clean please see your authorized dealer.

ADJUSTABLE PEDALS — IF EQUIPPED

This feature allows both the brake and accelerator pedals to move toward or away from the driver to provide improved position with the steering wheel. The adjustable pedal system is designed to allow a greater range of driver comfort for steering wheel tilt and seat position. The switch is located on the right side of the steering column.

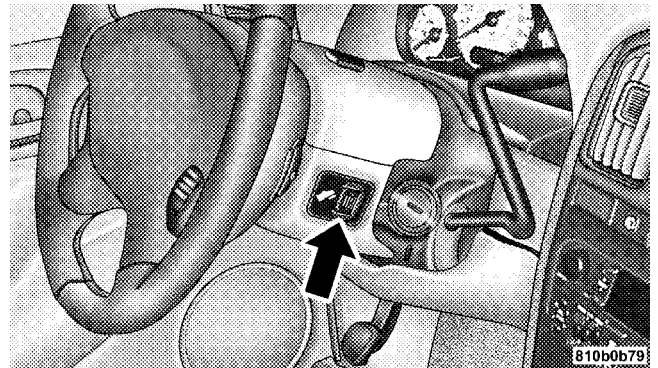

Adjustable Pedal Switch

Press the button forward to move the pedals forward (toward the front of the vehicle).

Press the button rearward to move the pedals rearward (toward the driver).

- The pedals can be adjusted with the ignition OFF.
- The pedals can be adjusted while driving.
- The pedals **cannot** be adjusted when the vehicle is in R (Reverse) or when the Speed Control System is ON. The following messages will be displayed on vehicles equipped with the Electronic Vehicle Information System (EVIC) if the pedals are attempted to be adjusted when the system is locked out (“Adjustable Pedal Disabled — Cruise Control Engaged” or “Adjustable Pedal Disabled — Vehicle In Reverse”).

CAUTION!

Do not place any article under the adjustable pedals or impede its ability to move as it may cause damage to the pedal controls. Pedal travel may become limited if movement is stopped by an obstruction in the adjustable pedal’s path.

ELECTRONIC SPEED CONTROL — IF EQUIPPED

When engaged, this device takes over the accelerator operation at speeds greater than 30 mph (50 km/h).

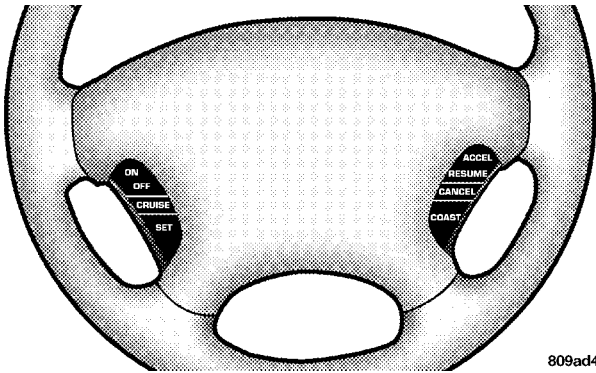

809ad4b1

Speed Control Switches

To Activate:

Push the “ON/OFF” button once and the CRUISE indicator located below the instrument cluster odometer will illuminate showing the electronic speed control system is on. To turn the system OFF, push the “ON/OFF” button again and the system and indicator will turn off.

3

WARNING!

Leaving the Electronic Speed Control system on when not in use is dangerous. You could accidentally set the system or cause it to go faster than you want. You could lose control and have an accident. Always leave the system OFF when you aren't using it.

To Set At A Desired Speed:

When the vehicle has reached the desired speed, press and release the “SET” button. Release the accelerator and the vehicle will operate at the selected speed.

To Deactivate:

A soft tap on the brake pedal, pushing the “CANCEL” button or normal braking while slowing the vehicle will deactivate the speed control without erasing the set speed memory. Pushing the “ON/OFF” button to the OFF position or turning off the ignition erases the set speed memory.

To Resume Speed:

To resume a previously set speed, push and release the “RESUME/ACCEL” button. Resume can be used at any speed above 25 mph (40 km/h).

To Vary the Speed Setting:

When the speed control is set, speed can be increased by pressing and holding the “RESUME/ACCEL” button. When the button is released, a new set speed will be established.

Tapping the “RESUME/ACCEL” button once will result in a 2 mph (3 km/h) speed increase. Each time the button is tapped, speed increases so that tapping the button three times will increase speed by 6 mph (10 km/h), etc.

To decrease speed while speed control is set, press and hold the “COAST” button. Release the button when the desired speed is reached, and the new speed will be set.

Tapping the “COAST” button once will result in a 1 mph (2 km/h) speed decrease. Each time the button is tapped, speed decreases.

To Accelerate For Passing:

Depress the accelerator as you would normally. When the pedal is released, the vehicle will return to the set speed.

NOTE: The speed control system maintains speed up and down hills. A slight speed change on moderate hills is normal.

Your vehicle will experience a downshift to 3rd gear while climbing uphill or descending downhill. This downshift to 3rd gear is necessary to maintain vehicle set speed.

On steep hills a greater speed loss or gain may occur so it may be preferable to drive without speed control.

WARNING!

Speed Control can be dangerous where the system can't maintain a constant speed. Your vehicle could go too fast for the conditions, and you could lose control. An accident could be the result. Don't use Speed Control in heavy traffic or on roads that are winding, icy, snow-covered, or slippery.

OVERHEAD CONSOLE — IF EQUIPPED

The overhead console can contain courtesy/reading lights, an optional universal garage door opener (HomeLink®), storage for sunglasses, compass/temperature display, a mini-trip computer, optional electronic vehicle information center (EVIC), power sliding door switches and an optional power liftgate switch.

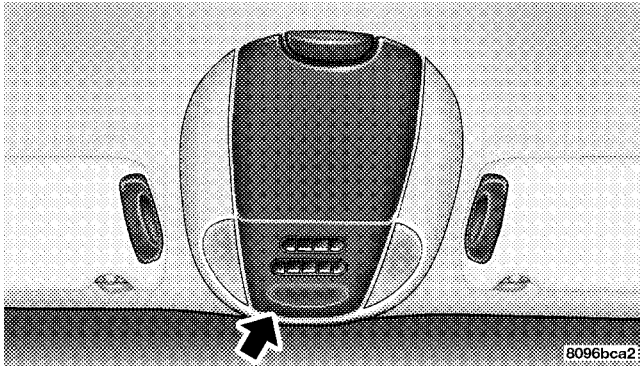

Overhead Console

Courtesy/Reading Lights

At the forward end of the console are two courtesy/reading lights.

Press the lens to turn these lights on. Press a second time to turn the lights off.

The lights also turn on when a front door, a sliding door or the liftgate is opened. If your vehicle is equipped with Remote Keyless Entry, the lights will also turn on when the unlock button on the transmitter is pressed.

The area around the instrument panel cupholders is also illuminated from a light in the overhead console. This light is turned on when the headlight switch is on and will adjust in brightness when the dimmer control is rotated up or down.

Sunglass Storage

At the rear of the overhead console, a compartment is provided for the storage of two pair of sunglasses.

Press the door latch to open the compartment. The door will slowly rotate to an open position.

Compass/Temperature Display

This display provides the outside temperature and one of eight compass readings to indicate the direction the vehicle is facing.

WARNING!

Even if the display still reads a few degrees above 32°F (0°C), the road surface may be icy, particularly in woods or on bridges. Drive carefully under such conditions to prevent an accident and possible personal injury or property damage.

Automatic Compass Calibration

This compass is self calibrating which eliminates the need to manually set the compass. When the vehicle is new, the compass may appear erratic and the “CAL” symbol will be displayed. After completing three 360° turns in an area free from large metal or metallic objects, the “CAL” symbol will turn off and the compass will function normally.

Manual Compass Calibration

If the compass appears erratic and the “CAL” symbol does not appear, you must put the compass into the Calibration Mode manually.

To put into a Calibration Mode: Turn on the ignition switch and set the display to Comp/Temp. Press the RESET button on vehicles equipped with a Compass/Mini Trip Computer for at least 10 seconds until the “CAL” symbol appears. On vehicles equipped with Compass/Temp press and hold the C/T and US/M buttons for 10 seconds. Release the RESET button and complete three 360° turns in an area free from large metal objects. The “CAL” symbol will turn off and the compass will function normally.

CAUTION!

Do not place any external magnets, such as magnetic roof mount antennas, in the vicinity of the compass. Do not use magnetic tools when servicing the overhead console.

Compass Variance

Compass Variance is the difference between magnetic North and Geographic North. In some areas of the country, the difference between magnetic and geographic North is great enough to cause the compass to give false readings. If this occurs, the compass variance must be set.

NOTE: Magnetic materials should be kept away from the overhead console.

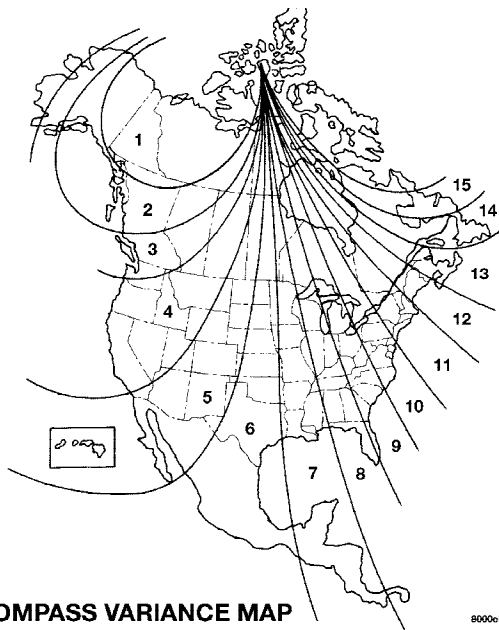

COMPASS VARIANCE MAP

8000cbbab

To set the variance: Turn the ignition switch ON and set the display to Comp/Temp. On vehicles equipped with a Compass/Mini Trip Computer press the RESET button for approximately 5 seconds. On vehicles equipped with Compass/Temp press and hold the C/T and US/M buttons for 5 seconds. The “VAR” symbol will light and the last variance zone number will be displayed. Press the STEP button on vehicles equipped with a Compass/Mini Trip Computer or the US/M button on vehicles equipped with Compass/Temp to select the proper variance zone as shown in the map. Press the RESET button on vehicles equipped with a Compass/Mini Trip Computer or the C/T button on vehicles equipped with Compass/Temp to set the new variance zone and resume normal operation.

Mini-Trip Computer

This displays information on the following:

- *Average Fuel Economy (ECO AVG)*
Shows the average fuel economy since the last reset.
- *Distance To Empty (DTE)*
Shows the estimated distance that can be travelled with the fuel remaining in the tank. This estimated distance is determined using the MPG for the last few minutes.
- *Trip Odometer (ODO)*
Shows the distance travelled since the last reset.
- *Elapsed Time (ET)*
Shows the accumulated ignition ON time since the last reset.
- *Off Mode*
Shows a blank display.

- *Step Button*

Push this button to cycle through all the Compass/Mini-trip Computer displays.

- *US/M Button*

Press this button to convert the display from U.S. to metric.

To Reset The Display

Pressing the Reset button once will clear the resettable function currently being displayed. Resettable functions are average fuel economy, trip odometer and elapsed time. Pressing the reset button twice within four seconds will clear all resettable functions. Reset will only occur if a resettable function is currently being displayed.

Electronic Vehicle Information Center (EVIC) — If Equipped

The Electronic Vehicle Information Center, when the appropriate conditions exist, displays the following WARNING messages and symbols. Each message is accompanied by a single chime:

- TURN SIGNALS ON (with graphic)
- PERFORM SERVICE
- DOOR AJAR (one or more, with graphic)
- LIFTGATE AJAR (with graphic)
- WASHER FLUID LOW (with graphic)
- 1,2,3 OR 4 LOW TIRE(S) PRESSURE (Refer to "Tire Pressure Monitor System" in the "Starting And Operating, Tire Section")
- CHECK TPM SYSTEM (Refer to "Tire Pressure Monitor System" in the "Starting And Operating, Tire Section")
- MEMORY SEAT DISABLED (Not in Park) — If Equipped
- ADJUSTABLE PEDAL DISABLED/CRUISE ENGAGED
- ADJUSTABLE PEDAL DISABLED/VEHICLE IN REVERSE
- REAR PARK ASSIST (Shown in Reverse only with a single chime) — If Equipped

NOTE: Tire pressure menu items are available only on vehicles equipped with the Tire Pressure Monitor System.

Customer Programmable Features — If Equipped

Press the “MENU” button until one of the display choices following appears:

Language

When in this display you may select one of five languages for all display nomenclature, including the trip computer functions. Press the “STEP” button while in this display selects English, Francaise, Deutsch, Italiano, or Espanol. As you continue the displayed information will be shown in the selected language.

Rear Park Assist — If Equipped

When this feature is selected the system scans for objects behind the vehicle using four sensors located in the rear bumper. Objects can be detected from up to 71 inches (180 cm). Pressing the “STEP” button while in this display will disable/enable the Rear Park Assist System.

US or Metric

Pressing the “STEP” button when in this display selects US or Metric. The overhead console and climate control displays will be in the selected units.

Service Interval

When this feature is selected a service interval between 2,000 miles (3 200 km) and 6,000 miles (9 600 km) in 500 mile (800 km) increments may be selected. Pressing the “STEP” button when in this display will select distances between 2,000 miles (3 200 km) and 6,000 miles (9 600 km) in 500 mile (800 km) increments.

Reset Service Distance (Displays Only if Service Interval was Changed)

When this feature is selected the current accumulated service distance can be reset to the newly selected service interval. Pressing the “STEP” button when in this display will select “Yes” or “No.”

Use Factory Settings

If “Yes” is selected, all of the customer programmable features will be set to the factory default and not displayed. If “No” is selected you can program the Vehicle Information Center to your own personal preferences.

Auto Door Locks

When this feature is selected, all doors and the liftgate lock automatically when the speed of the vehicle reaches 18 mph (29 km/h). Pressing the “STEP” button when in this display will select “Yes” or “No.”

Auto Unlock On Exit (Available Only When the AUTO DOOR LOCKS Feature is Turned On)

When this feature is selected all the vehicle’s doors will unlock whenever any door is opened if the vehicle is stopped and the transmission is in “P” (Park) or “N” (Neutral) position. Pressing the “STEP” button when in this display will select “Yes” or “No.”

Remote Unlock Driver’s Door 1st

When this feature is selected only the driver’s door will unlock on the first press of the remote keyless entry unlock button and require a second press to unlock the remaining locked doors and liftgate. When “REMOTE UNLOCK ALL DOORS” is selected all of the doors and the liftgate will unlock at the first press of the remote keyless entry unlock button. Pressing the “STEP” button when in this display will select “DRIVER’S DOOR 1ST” or “ALL DOORS”.

Remote Linked To Memory (Available with Memory Seat and Pedals Only)

When this feature is selected, pressing the Unlock button on any Remote Keyless Entry transmitter already linked to memory will return the driver’s seat, driver’s outside mirror, adjustable brake and accelerator pedals, and radio station presets to their memory set positions.

If this feature is not selected, the driver's seat, driver's mirror, adjustable pedals, and radio settings can only return to their memory set positions using the memory recall buttons (1or 2) on the driver's door panel.

Any transmitter linked to memory will remain linked, but will not recall the memory positions. The transmitter memory recall function will operate again when this feature is selected. Refer to Driver Memory System for more information. Pressing the "STEP" button when in this mode will select between "Yes" or "No".

Sound Horn On Lock

When this feature is selected a short horn sound will occur when the remote keyless entry "Lock" button is pressed. This feature may be selected with or without the flash lights on LOCK/UNLOCK feature. Pressing the "STEP" button when in this display will select "Yes" or "No."

Flash Lights On Lock/Unlock?

When this feature is selected, the front and rear turn signals will flash when the doors are locked or unlocked using the remote keyless entry transmitter. This feature may be selected with or without the sound horn on lock feature selected. Pressing the "STEP" button when in this display will select "Yes" or "No."

Sliding Door Open Flash?

When this feature is selected, and the sliding door(s) are opened, the left and right exterior hazard lights will flash for 12 seconds to alert other drivers in the area that passenger(s) could be entering or exiting the vehicle. Pressing the "STEP" button when in this display will select "Yes" or "No."

Headlamp Delay

When this feature is selected the driver can choose, when exiting the vehicle, to have the headlamps remain on for 30, 60, or 90 seconds, or not remain on. Pressing the “STEP” button when in this display will select 30, 60, 90, or “OFF.”

Headlamp On With Wipers (Available with Auto Headlights Only)

When this feature is selected and the headlight switch has been moved to the “AUTO” position, the engine is running and, the front wipers are turned on for 10 seconds, the headlights will turn ON. The display will remain on Parade Mode (Daytime Brightness) for ease of viewing. Pressing the “STEP” button when in this display will select “Yes” or “No.”

Power Accessory Delay

When this feature is selected, accessory power will be supplied for up to 45 seconds for the power windows,

radio, power vent windows, power outlets, and removable center console, when the ignition switch is turned off or until the key is removed and either front door is opened.

GARAGE DOOR OPENER — IF EQUIPPED

The HomeLink® Universal Transceiver replaces up to three remote controls (hand held transmitters) that operate devices such as garage door openers, motorized gates, or home lighting. It triggers these devices at the push of a button. The Universal Transceiver operates off your vehicle’s battery and charging system; no batteries are needed.

For additional information on HomeLink®, call 1-800-355-3515, or on the internet at www.homelink.com.

WARNING!

A moving garage door can cause injury to people and pets in the path of the door. People or pets could be seriously or fatally injured. Only use this transceiver with a garage door opener that has a "stop and reverse" feature as required by federal safety standards. This includes most garage door opener models manufactured after 1982. Do not use a garage door opener without these safety features it could cause injury or death. Call toll-free 1-800-355-3515 or, on the Internet at www.homelink.com for safety information or assistance.

WARNING!

Vehicle exhaust contains carbon monoxide, a dangerous gas. Do not run the vehicle's exhaust while training the transceiver. Exhaust gas can cause serious injury or death.

WARNING!

Your motorized door or gate will open and close while you are training the Universal Transceiver. Do not train the transceiver if people or pets are in the path of the door or gate. A moving door or gate can cause serious injury or death to people and pets or damage to objects.

Programming HomeLink

NOTE: When programming a garage door opener, it is advised to park outside the garage. Some vehicles may require the ignition switch to be turned to the second (or "accessories") position for programming and/or operation of HomeLink. It is also recommended that a new battery be placed in the hand-held transmitter of the device being programmed to HomeLink for quicker training and accurate transmission of the radio-frequency signal.

1. Press and hold the two outer HomeLink buttons, and release only when the indicator light begins to flash (after 20 seconds). **Do not** hold the buttons for longer than 30 seconds and **do not** repeat step one to program a second and/or third hand-held transmitter to the remaining two HomeLink buttons.

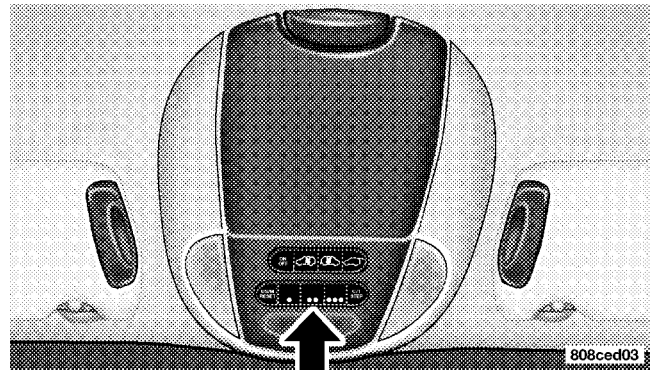

HomeLink Buttons

2. Position the end of your hand-held transmitter 1-3 inches (3-8 cm) away from the HomeLink buttons while keeping the indicator light in view.

3. Simultaneously press and hold both the HomeLink button that you want to train and the hand-held transmitter buttons. **Do not release the buttons until step 4 has been completed.**

NOTE: Some gate operators and garage door openers may require you to replace this Programming Step 3 with procedures noted in the "Gate Operator/Canadian Programming" section.

4. The HomeLink indicator light will flash slowly and then rapidly after HomeLink successfully receives the frequency signal from the hand-held transmitter. Release both buttons after the indicator light changes from the slow to the rapid flash.

5. Press and hold the just trained HomeLink button and observe the indicator light. **If the indicator light stays on constantly, programming is complete** and your device should activate when the HomeLink button is pressed and released.

NOTE: To program the remaining two HomeLink buttons, begin with "Programming" step two. **Do not repeat step one.**

If the indicator light blinks rapidly for two seconds and then turns to a constant light, continue with "Programming" steps 6 - 8 to complete the programming of a rolling code equipped device (most commonly a garage door opener).

6. At the garage door opener receiver (motor-head unit) in the garage, locate the "learn" or "smart" button. This can usually be found where the hanging antenna wire is attached to the motor-head unit.

7. Firmly press and release the "learn" or "smart" button. (The name and color of the button may vary by manufacturer.)

NOTE: There are 30 seconds in which to initiate step eight.

8. Return to the vehicle and firmly **press, hold for two seconds and release** the programmed HomeLink button. Repeat the "**press/hold/release**" sequence a second time, and, depending on the brand of the garage door opener (or other rolling code equipped device), repeat this sequence a third time to complete the programming.

HomeLink should now activate your rolling code equipped device.

NOTE: To program the remaining two HomeLink buttons, begin with "Programming" **step two**. **Do not repeat step one**. For questions or comments, please contact HomeLink at www.homelink.com or 1-800-355-3515.

Canadian Programming/Gate Programming

Canadian radio-frequency laws require transmitter signals to "time-out" (or quit) after several seconds of transmission which may not be long enough for HomeLink to pick up the signal during programming.

Similar to this Canadian law, some U.S. gate operators are designed to "time-out" in the same manner.

If you live in Canada or you are having difficulties programming a gate operator by using the "Programming" procedures (regardless of where you live), **replace "Programming HomeLink" step 3** with the following:

NOTE: If programming a garage door opener or gate operator, it is advised to unplug the device during the "cycling" process to prevent possible overheating.

3. Continue to press and hold the HomeLink button while you **press and release every two seconds** ("cycle") your hand-held transmitter until the frequency signal has successfully been accepted by HomeLink. (The indicator light will flash slowly and then rapidly.) Proceed with "Programming" step four to complete.

Using HomeLink

To operate, simply press and release the programmed HomeLink button. Activation will now occur for the trained device (i.e. garage door opener, gate operator, security system, entry door lock, home/office lighting, etc.). For convenience, the hand-held transmitter of the device may also be used at any time. In the event that there are still programming difficulties or questions, contact HomeLink at: www.homelink.com or 1-800-355-3515.

Erasing HomeLink Buttons

To erase programming from the three buttons (individual buttons cannot be erased but can be "reprogrammed" - note below), follow the step noted:

- Press and hold the two outer HomeLink buttons until the indicator light begins to flash-after 20 seconds. Release both buttons. Do not hold for longer than 30

seconds. HomeLink is now in the train (or learning) mode and can be programmed at any time beginning with "Programming" - step 2.

Reprogramming a Single HomeLink Button

To program a device to HomeLink using a HomeLink button previously trained, follow these steps:

1. Press and hold the desired HomeLink button. Do NOT release the button.
2. The indicator light will begin to flash after 20 seconds. Without releasing the HomeLink button, proceed with "Programming" step 2

For questions or comments, contact HomeLink at: www.homelink.com or 1-800-355-3515.

Security

If you sell your vehicle, be sure to erase the frequencies by following the “Erasing HomeLink Buttons” instructions in this section.

This device complies with part 15 of FCC rules and with RSS-210 of Industry Canada. Operation is subject to the following conditions:

- This device may not cause harmful interference.
- This device must accept any interference that may be received including interference that may cause undesired operation.

NOTE: Changes or modifications not expressly approved by the party responsible for compliance could void the user’s authority to operate the equipment.

HomeLink® is a trademark owned by Johnson Controls, Inc.

POWER SUNROOF — IF EQUIPPED

The power sunroof control is located between the sun visors on the overhead console.

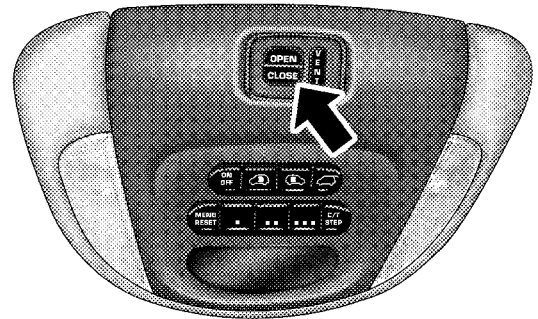
**3**

80ec7b49

Power Sunroof Controls

Press and hold the switch rearward to fully open the sunroof. The sunroof can be stopped at any position between closed and full open. Momentarily pressing the

switch rearward will activate the Express Open Feature, causing the sunroof to open automatically.

Press and hold the button located to the right of the sunroof switch, to open the vent. The sunroof can be stopped at any position between closed and full vent. To close the sunroof from the vent position, press and hold the switch forward. Releasing the switch will stop the movement of the sunroof and the sunroof will remain in the partial vent position until the switch is pushed forward again.

Express Open Feature

During the Express Open operation, any movement of the switch will stop the sunroof and it will remain in a partial open position. Again, momentarily pressing the switch rearward will activate the Express Open Feature.

To close the sunroof, hold the switch in the forward position. Again, any release of the switch will stop the

movement and the sunroof will remain in a partial open condition until the switch is pushed forward again.

The sunshade can be opened manually. It will also open as the sunroof opens. The sunshade cannot be closed if the sunroof is open.

WARNING!

Never leave children in a vehicle, with the keys in the ignition switch. Occupants, particularly unattended children, can become entrapped by the power sunroof while operating the power sunroof switch. Such entrapment may result in serious injury or death.

WARNING!

In an accident, there is a greater risk of being thrown from a vehicle with an open sunroof. You could also be seriously injured or killed. Always fasten your seat belt properly and make sure all passengers are properly secured too.

Do not allow small children to operate the sunroof. Never allow fingers or other body parts, or any object to project through the sunroof opening. Injury may result.

Wind Buffeting

Wind buffeting can be described as the perception of pressure on the ears or a helicopter type sound in the ears. Your vehicle may exhibit wind buffeting with the windows down, or the sunroof (if equipped) in certain open or partially open positions. This is a normal occurrence and can be minimized. If the buffeting occurs with

the rear windows open, open the front and rear windows together to minimize the buffeting. If the buffeting occurs with the sunroof open, adjust the sunroof opening to minimize the buffeting or open any window.

Sunroof Maintenance

Use only a non-abrasive cleaner and a soft cloth to clean the glass panel.

ELECTRICAL POWER OUTLETS — IF EQUIPPED

To the left of the instrument panel cup holder are two 12 volt power outlets. The upper outlet is controlled by the ignition switch and the lower outlet is connected directly to the battery. The upper outlet will also operate a conventional cigar lighter unit (if equipped with an optional Smoker's Package).

A third outlet is located on the driver's side, just to the rear of the sliding door and is also controlled by the ignition switch. The lower and rear outlets will not accommodate a conventional cigar lighter unit.

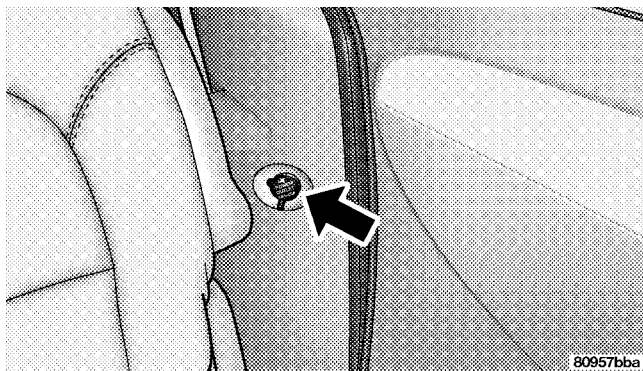

Rear Power Outlet

The outlets include tethered caps labeled with a key or battery symbol indicating the power source. The lower instrument panel outlet is powered directly from the battery, items plugged into this outlet may discharge the battery and/or prevent engine starting.

The lower outlet is protected by an automatic reset circuit breaker. The automatic circuit breaker restores power when the overload is removed. The circuit breaker also supplies power to the outlet in the removable floor console, when in the front position. Refer to section 3 "Removable Floor Console" in this manual.

NOTE: If desired, all of the power outlets can be converted by your authorized dealer to provide power with the ignition switch in the OFF position.

Electrical Outlet Use With Engine Off**CAUTION!**

- Many accessories that can be plugged in draw power from the vehicle's battery, even when not in use (i.e. cellular phones, etc.). Eventually, if plugged in long enough, the vehicle's battery will discharge sufficiently to degrade battery life and/or prevent engine starting.
- Accessories that draw higher power (i.e. coolers, vacuum cleaners, lights, etc.), will degrade the battery even more quickly. Only use these intermittently and with greater caution.
- After the use of high power draw accessories, or long periods of the vehicle not being started (with accessories still plugged in), the vehicle must be driven a sufficient length of time to allow the alternator to recharge the vehicle's battery.
- Power outlets are designed for accessory plugs only. Do not hang any type of accessory or accessory bracket from the plug. Improper use of the power outlet can cause damage.

CONVENIENCE TRAY DRAWER AND CUP HOLDERS**Instrument Panel Cup Holders**

The instrument panel cupholders are located in a pull out drawer just below the climate controls.

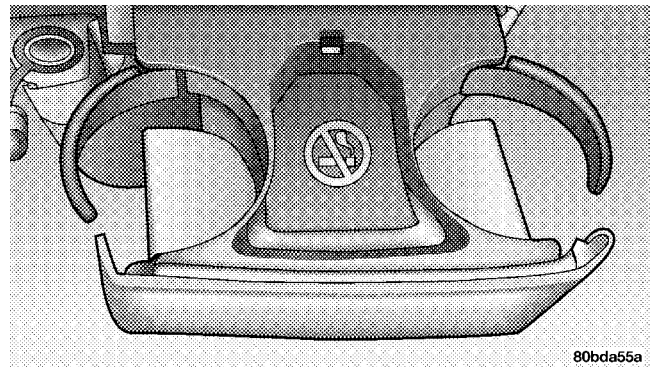

Front Cupholders

When the drawer is pulled out firmly, the arms of the cupholders will spring out. Place the container to be held into one of the cupholders and then push the arm toward the container until the container is held stable. There are adjustable positions for the arm so the cupholder can accommodate a wide variety of container types and sizes, including those with handles. The arms of the cupholder can be adjusted in or out without damaging the detent mechanism.

NOTE: Be sure the drawer is pulled out completely, otherwise the adjustable arm detents will not engage and the container will not be held stable.

Convenience Tray And Optional Smoker's Package Kit

Located between the instrument panel cupholders is a convenience tray that has been designed to hold miscellaneous small items.

NOTE: The convenience tray should never be used for ashes without the optional ash receiver in place. Permanent burn marks may result.

With the optional dealer installed Smoker's package, a removable ash receiver is inserted into the convenience tray location. To install the ash receiver, slide the forward edge into the convenience tray opening and push down to lock it into position. For cleaning of the ash receiver, its removal is accomplished by inserting the end of a key in the pry slot that is molded into the rear edge of the ash receiver and then twisting the key slightly.

Rear Cupholders

There are dual stationary cupholders located in the passenger side rear trim panel and a single stationary cup holder on the driver side rear trim panel.

There are also dual underseat cupholders for the 2nd seat passengers. With a bench seat in the 2nd seat position these cupholders slide out from under the center of the seat.

If your vehicle is equipped with quad seats in the 2nd seat position, these cupholders are located on the out-board side of the seat pedestal.

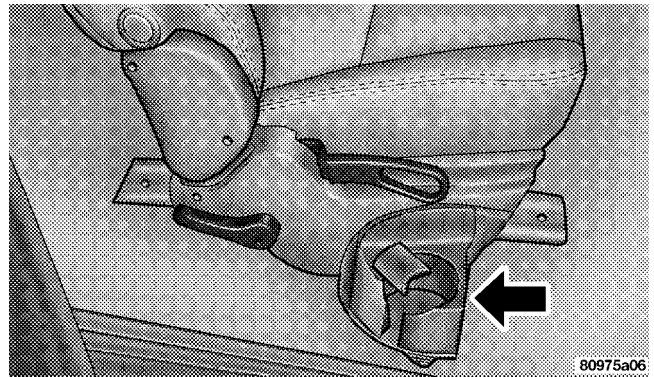

Quad Seat Cupholder

NOTE:

- The quad seat cupholders will remain upright if the seat is tilted forward.
- The quad seat cupholders are designed to break away if stepped on. To return the cupholder to its normal position, simply push the cupholder up to snap it into place.
- The floor mat must be in position for optimum cupholder operation.

There are also two cupholders and a flat tray on the seat back of the quad seats. These can be used when the seat back is folded forward.

STORAGE

Front Seat Storage Bin — If Equipped

The storage bin is located under the front passenger's seat. If equipped with a lock, it can be locked with the ignition key.

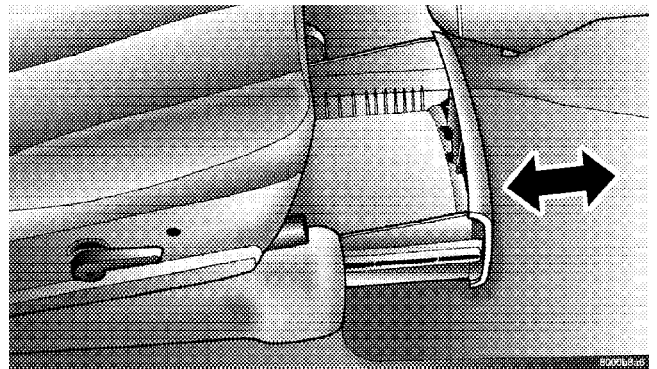

Front Seat Storage Bin

Second Row Seat Storage bins — If Equipped

The Seat Storage Bins are located on the floor in front of the second row seats, the area below the covers can be used for storage when the second row seat is in the upright position.

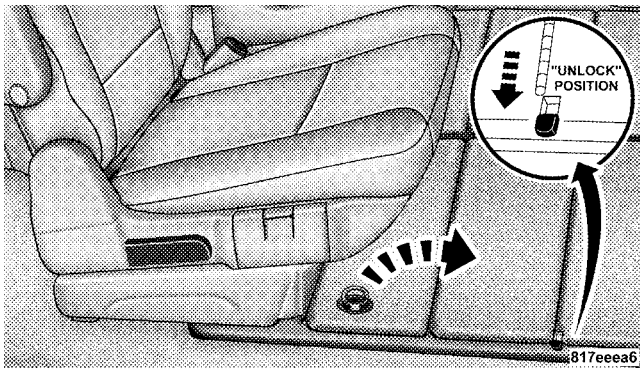

Storage Bin Cover

Pull up on the storage bin latch to open the cover. Slide the storage bin locking mechanism to the "Unlocked" position to allow greater access to the storage bin.

WARNING!

In an accident, serious injury could result if the seat storage bin covers are not properly latched. Do not drive the vehicle with the storage bin cover open. Keep the storage bin cover closed and latched while the vehicle is in motion. Do not operate the storage bin cover while the vehicle is in motion.

Overhead Rail System — If Equipped

The overhead rail system contains provisions for three movable and removable overhead storage bins. The storage bins may be placed anywhere on the overhead rail system.

CAUTION!

Do not load objects over 1.5 lbs (0.68 kg) in the storage bins. Failure to follow this could cause damage to the Overhead Rail System.

To Remove Storage Bins

1. Support the bin with one hand and pull the latch handles out.

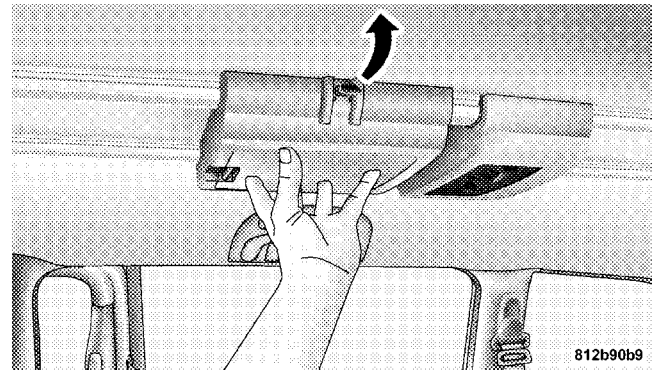

2. Twist the latch handles a $\frac{1}{4}$ turn and pull outward to disengage the bin from the rail.

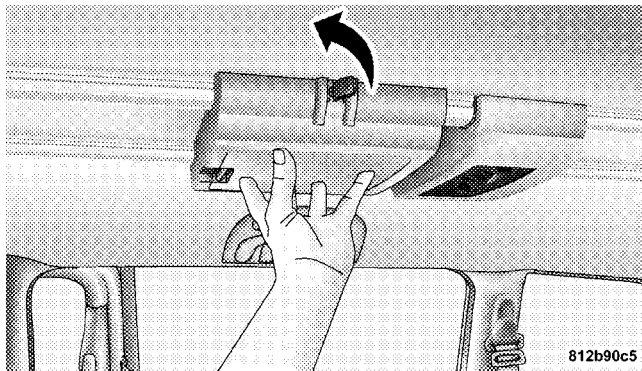

3. Remove the storage bin.

NOTE: Make sure the latch handle pops out before removing the storage bin.

To reinstall the storage bins, place the bin in the desired location on the overhead rail, push firmly upward on the bin with one hand, while pushing in on the latch handle, twist a $\frac{1}{4}$ turn to attach the bin to the rail. Push the latch handle down to lock the storage bin in place.

WARNING!

In a collision, you or others in your vehicle could be injured if the storage bins are not properly latched to the Overhead Rail System. Always be sure the storage bins are fully latched.

Removable Floor Console With Fold-in-Floor Seating — If Equipped

The removable floor console has a two power outlets, storage tray, light, removable cell phone holder, tissue holder, pen holder and a map holder. It can be removed from the vehicle by pulling the release handle inside the floor console.

To remove the console use the following procedure:

1. Open the console lid and remove the storage tray.
2. Pull up on the release handle located inside the floor console, and slide the console rearward to disengage from the floor.

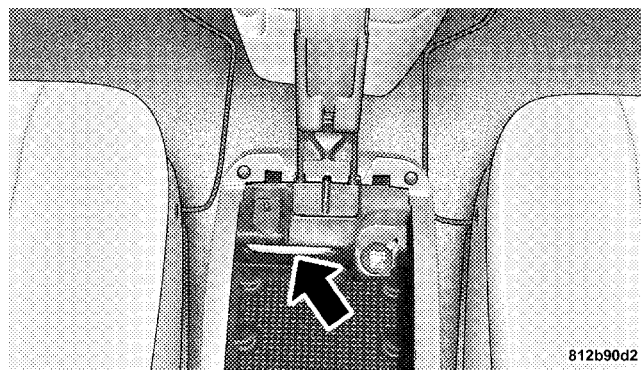

Release Handle

3. Remove the floor console.

To reinstall the console, open the console lid and remove the storage tray. Pull up on the release handle and slide the console forward to engage the front of the console into the floor tray. Pivot the floor console down until it is seated on the floor tray and release the handle. Pull up on the console to be sure it is firmly attached.

WARNING!

In an accident, serious injury could result if the removable floor console is not properly installed. Always be sure the removable floor console is fully latched.

Cell Phone Holder Removal

1. Open the floor console lid and lift the cell phone holder upward.
2. Squeeze the legs together to disengage the holder from the floor console and remove the cell phone holder.

To reinstall the cell phone holder, align the pivot legs into the guides and push forward to snap the legs into place.

Removable Floor Console Without Fold-in-Floor Seating — If Equipped

The removable floor console has a power outlet, storage tray, light, cell phone holder, tissue holder, and a map holder. It can be placed between either the front seats or middle seats.

NOTE: When the console is located between the front seats the outlet is protected by an automatic circuit breaker and is powered directly from the battery, items plugged into this outlet may discharge the battery and/or prevent engine starting.

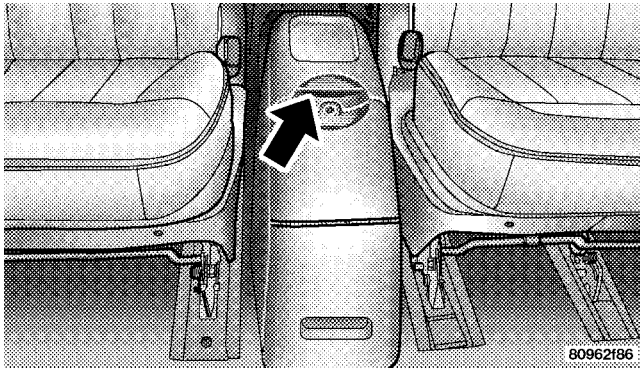

Removable Floor Console

To remove the console use the following procedure:

1. Open the rear lid and remove the storage tray.
2. Pull up on the release handle located inside the floor console, reinstall the storage tray and close the rear lid.

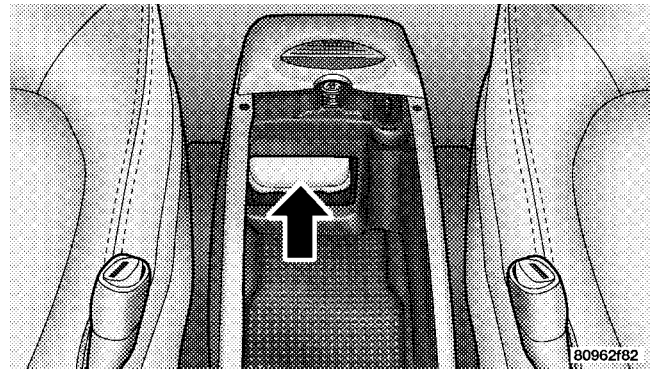

Release Handle

3. Using the front and rear grab handles, slide the console rearward to disengage the front of the console and lift up to remove the console from the floor.

4. Place the rubber mat on the floor tray.

To reinstall the console, remove the rubber mat and relocate to the alternate floor tray, slide the console forward to engage the front of the console into the floor tray. Rapidly push down on the rear of the console with enough force to engage the latch, you should hear the latch “snap” into place. Pull up on the console to be sure it is firmly attached.

WARNING!

In an accident, serious injury could result if the removable floor console is not properly installed. Always be sure the removable floor console is fully latched.

NOTE: When the removable floor console is located between the middle seats, the power outlet only has power supplied to it when the ignition switch is ON.

Cell Phone Holder

1. Open the front lid and remove the cell phone holder by pulling rearward and up on the lower edge of the holder.

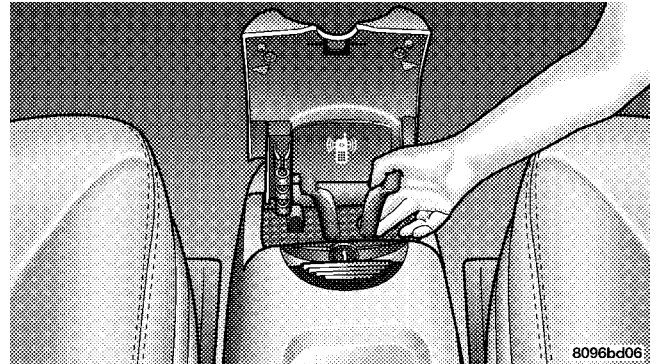

Cell Phone Holder

2. Plug in the power cord for the cellular phone into the outlet located in the bottom of the forward console bin and reinstall the cell phone holder.
3. Place the cell phone into the holder.

CAUTION!

- Many accessories that can be plugged in draw power from the vehicle's battery, even when not in use (i.e. cellular phones, etc.). Eventually, if plugged in long enough, the vehicle's battery will discharge sufficiently to degrade battery life and/or prevent engine starting.
- Accessories that draw higher power (i.e. coolers, vacuum cleaners, lights, etc.), will degrade the battery even more quickly. Only use these intermittently and with greater caution.
- After the use of high power draw accessories, or long periods of the vehicle not being started (with accessories still plugged in), the vehicle must be driven a sufficient length of time to allow the generator to recharge the vehicle's battery.

Rear Compartment Storage Bins

Your vehicle may be equipped with open storage bins located in each rear trim panel.

Cargo/Tub Nets

Two cargo/tub nets are available on vehicles equipped with Fold-in-Floor Seating. The cargo nets fit in the second row storage bin and the third row tub. The nets are supported by hooks located in these areas. Refer to instructions provided in the net kit.

Coat Hooks

Coat hooks are located along the headliner for the second and third row seating positions. The coat hook load limit is 10 lbs (4.5 kg). Exceeding the recommended load limit can cause the coat hooks to break or disengage from the vehicle.

Cargo Area Storage

The seats in your vehicle are in-line which enables you to stow long objects, such as lumber or skis, on the floor without moving the seats.

NOTE: With all rear seat backs folded, a 4x8 foot sheet of building material may be stored in the long-wheelbase body style on top of the folded seats with the liftgate closed. The front seats must be moved slightly forward of the rearmost position. If the rear seats are removed no front seat adjustment is needed and more than one 4x8 sheet of building material may be stored.

The liftgate sill plate has a raised line with the statement "Load To This Line". This line indicates how far rearward cargo can be placed without interfering with liftgate closing.

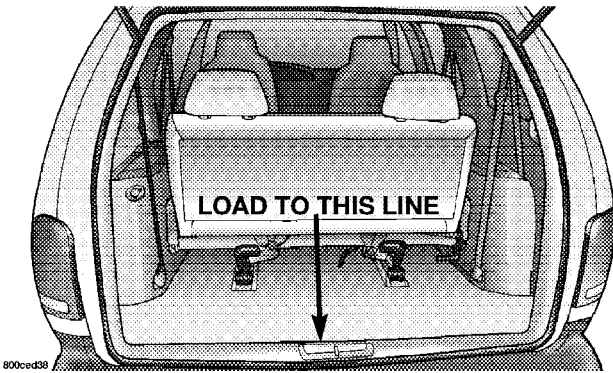

Loading Limit

ROOF LUGGAGE RACK — IF EQUIPPED

The crossbars and siderails are designed to carry the weight on vehicles equipped with a luggage rack. The load must not exceed 68 kg (150 lbs), and should be uniformly distributed over the luggage rack crossbars.

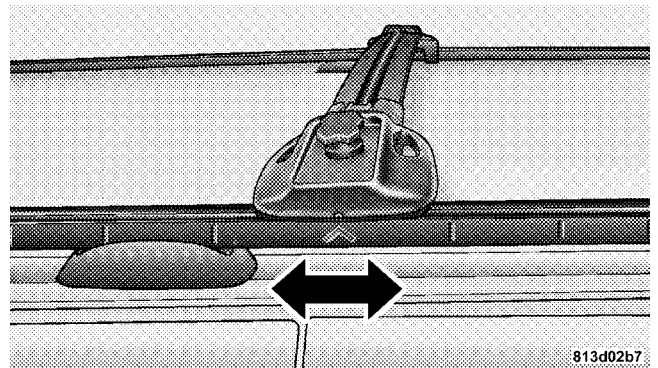

Roof Rack

Distribute cargo weight evenly on the roof rack crossbars. The roof rack does not increase the total load carrying capacity of the vehicle. Be sure the total load of cargo inside the vehicle plus that on the external rack does not exceed the maximum vehicle load capacity.

To move the cross bars, loosen the thumb screws located at the upper edge of each cross bar approximately six turns, then move the cross bar to the desired position, keeping the crossbars parallel to the rack frame. Once the cross bar is in place, retighten the thumb screws to lock the cross bar into position.

Attempt to move the crossbar again to ensure that it has properly locked into position.

NOTE: To help control wind noise when installing the cross bars make sure that the arrows marked on the front side of the cross bars are facing the front of the vehicle. Also, when the cross bars are not in use the notch on the cross bars should be aligned with the arrows on the side rails. This will help reduce the amount of wind noise when the crossbars are not in use.

The tie down holes on the cross bar ends should always be used to tie down the load. Check the straps frequently to be sure that the load remains securely attached.

CAUTION!

- Crossbars should remain equally spaced or parallel at any luggage rack position for proper function. Noncompliance could result in damage to the luggage rack, cargo and/or vehicle.
- To avoid damage to the roof rack and vehicle, do not exceed the maximum roof rack load capacity of 68 kg (150 lbs). Always distribute heavy loads as evenly as possible and secure the load appropriately.
- Long loads which extend over the windshield, such as wood panels or surfboards, or loads with large frontal area should be secured to both the front and rear of the vehicle.
- Travel at reduced speeds and turn corners carefully when carrying large or heavy loads on the roof rack. Wind forces, due to natural causes or nearby truck traffic, can add sudden upward lift to loads. This is especially true on large flat loads and may result in damage to the cargo or your vehicle.

WARNING!

Cargo must be securely tied before driving your vehicle. Improperly secured loads can fly off the vehicle, particularly at high speeds, resulting in personal injury or property damage. Follow the Roof Rack Cautions when carrying cargo on your roof rack.

LOAD LEVELING SYSTEM

The automatic load leveling system will provide a level riding vehicle under most passenger and cargo loading conditions.

A hydraulic pump contained within the shock absorbers raises the rear of the vehicle to the correct height. It takes approximately 1 mile (1.6 km) of driving for the leveling to complete depending on road surface conditions.

If the leveled vehicle is not moved for approximately 15 hours, the leveling system will bleed itself down. The vehicle must be driven to reset the system.

WARNING!

Do not install the load leveling system on vehicles that are not equipped with Anti-Lock Brakes. Vehicles without Anti-Lock Brakes (ABS) have a height-sensing proportioning valve. Installing a leveling system will render this system ineffective, inappropriately reducing rear brake pressure, resulting in increased stopping distances. You could have an accident.

UNDERSTANDING YOUR INSTRUMENT PANEL

CONTENTS

■ Instruments And Controls	201	□ Electrical Disturbances	213
■ Base Instrument Cluster	202	□ AM Reception	213
■ Instrument Cluster With Tach	203	□ FM Reception	213
■ Instrument Cluster Descriptions	204	■ Sales Code RAZ—AM/ FM Stereo Radio With Cassette Tape Player, CD Player And CD Changer Controls	214
■ Electronic Digital Clock	212	□ Operating Instructions — Radio	214
□ Clock Setting Procedure	212	□ Power Switch, Volume Control	214
■ Radio General Information	212	□ Seek Button (Radio Mode)	214
□ Radio Broadcast Signals	212	□ Tuning	215
□ Two Types Of Signals	213		

□ Radio Data System (RDS)	215	□ Tape Eject	219
□ PTY (Program Type) Button	215	□ Scan Button	219
□ Balance	217	□ Changing Tape Direction	219
□ Fade	217	□ Metal Tape Selection	219
□ Tone Control	217	□ Pinch Roller Release	220
□ AM/FM Selection	217	□ Noise Reduction	220
□ Scan Button	217	□ Operating Instructions — CD Player	220
□ To Set The Radio Push-Button Memory	218	□ Inserting The Compact Disc	220
□ To Change From Clock To Radio Mode	218	□ Seek Button	221
□ Operating Instructions — Tape Player	218	□ EJT CD (Eject) Button	221
□ Seek Button	218	□ FF/Tune/RW	222
□ Fast Forward (FF)	219	□ Program Button 4 (Random Play)	222
□ Rewind (RW)	219	□ Mode	222

<ul style="list-style-type: none"> □ Tape CD Button 222 □ Time Button 223 □ Scan Button 223 □ CD Changer Control Capability — If Equipped 223 ■ Sales Code Rev AM & FM Stereo Radio With CD Player And CD/DVD Changer Controls 224 <ul style="list-style-type: none"> □ Radio Operation 225 □ CD Player Operation 228 □ CD/DVD Changer Operation 230 □ Notes On Playing MP3 Files 230 □ Operation Instructions - (CD Mode For MP3 Audio Play) 233 	<ul style="list-style-type: none"> ■ Sales Code RBP—AM & FM Stereo Radio With Cassette Tape Player, CD Player, And Optional CD/DVD Changer Controls 234 <ul style="list-style-type: none"> □ Radio Operation 234 □ Tape Player Operation 238 □ CD Player Operation 240 □ CD/DVD Changer Operation — If Equipped 242 ■ Sales Code RBQ—AM/FM Stereo Radio With 6 - Disc CD Changer 244 <ul style="list-style-type: none"> □ Radio Operation 244 □ CD Player Operation 247 ■ Sales Code RBK—AM/ FM Stereo Radio With CD Player And CD Changer Controls 251 <ul style="list-style-type: none"> □ Radio Operation 252
--	---

□ CD Player Operation	254	□ Prog Up/Down Buttons (10, 11)	261
□ CD Changer Control Capability — If Equipped	256	□ Slow Button (12)	261
■ Sales Code RB1—AM/FM Stereo Radio With DVD/GPS Navigation System	257	□ Stop Button (13)	261
■ Remote Control Operating Instructions	258	□ Menu Button (14)	261
□ Headphone Transmitter Button (1)	259	□ Next/Prev Buttons (2, 15)	261
□ Arrow Buttons (2, 3, 15, 16)	259	□ FF/RW Buttons (3, 16)	261
□ Rtn Button (4)	260	□ Enter Button (17)	261
□ Setup Button (5)	260	□ Light Button (18)	262
□ Pause/Play Button (6)	260	□ Remote Control Battery Service	262
□ Mute Button (7)	260	□ Operating Instructions — Video Screen	262
□ Disp Button (8)	260	□ Operating Instructions — Headphones	264
□ Mode Button (9)	260	□ Operating Instructions — MP3 Player, Portable Walkman	266

<ul style="list-style-type: none"> □ Operating Instructions — Video Games/Camcorders266 ■ Satellite Radio — If Equipped266 <ul style="list-style-type: none"> □ System Activation266 □ Electronic Serial Number/Sirius Identification Number (ENS/SID)267 □ Selecting Satellite Mode In RBB, Rev And RBK Radios267 □ Selecting Satellite Mode In RBP, RBU, RAZ, RB1 And RBQ Radios268 □ Selecting a Channel268 □ Storing And Selecting Pre-Set Channels269 □ Using The PTY (Program Type) Button (If Equipped)269 □ PTY Button "Scan"269 	<ul style="list-style-type: none"> □ PTY Button "Seek"269 □ Satellite Antenna269 □ Reception Quality270 ■ Remote Sound System Controls — If Equipped . . .270 <ul style="list-style-type: none"> □ Radio Operation271 □ Tape Player271 □ CD Player272 ■ Cassette Tape And Player Maintenance272 ■ CD/DVD Disc Maintenance273 ■ Radio Operation And Cellular Phones274 ■ Climate Controls274 <ul style="list-style-type: none"> □ Manual Air Conditioning And Heating System274
---	--

200 UNDERSTANDING YOUR INSTRUMENT PANEL

□ Front Mode Control	276	□ Rear Wiper Operation — Automatic Temperature Control Only	298
□ Manual Air Conditioning Operation	279	□ Intermittent Rear Wiper Operation — Automatic Temperature Control Only	298
□ Manual Rear Zone Climate Control — If Equipped	282	□ Rear Washer Operation — Automatic Temperature Control Only	298
□ Automatic Temperature Control — If Equipped	284	□ Electric Rear Window Defroster — If Equipped	300
■ Rear Window Features	296		
□ Intermittent Rear Wiper Operation — Manual Temperature Control Only	296		
□ Rear Washer Operation — Manual Temperature Control Only	297		

INSTRUMENTS AND CONTROLS

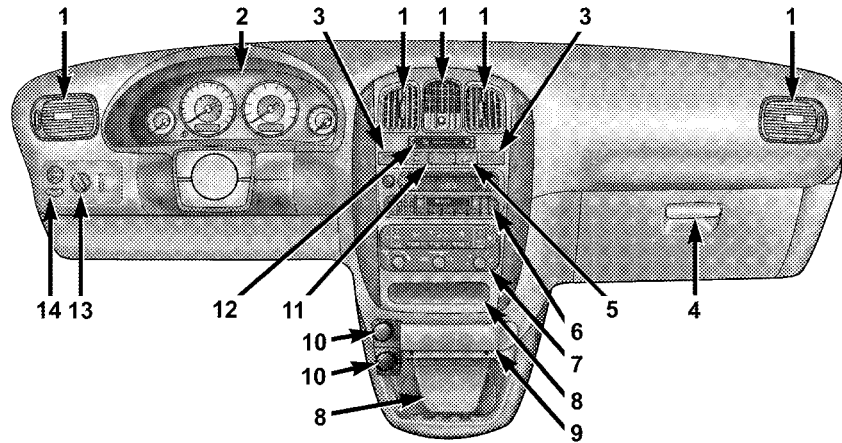

- | | | |
|--------------------------|-------------------------------|-------------------------------------|
| 1. Air Outlets | 6. Radio | 11. Rear Window Features |
| 2. Instrument Cluster | 7. Climate Controls | 12. Passenger Airbag Disabled Light |
| 3. Heated Seat Switches* | 8. Storage Bins* | 13. Light Controls |
| 4. Glove Box | 9. Convenience Tray/Cupholder | 14. Power Mirror Control |
| 5. Hazard Switch | 10. Power Outlets | *If Equipped |

812b4f67

BASE INSTRUMENT CLUSTER

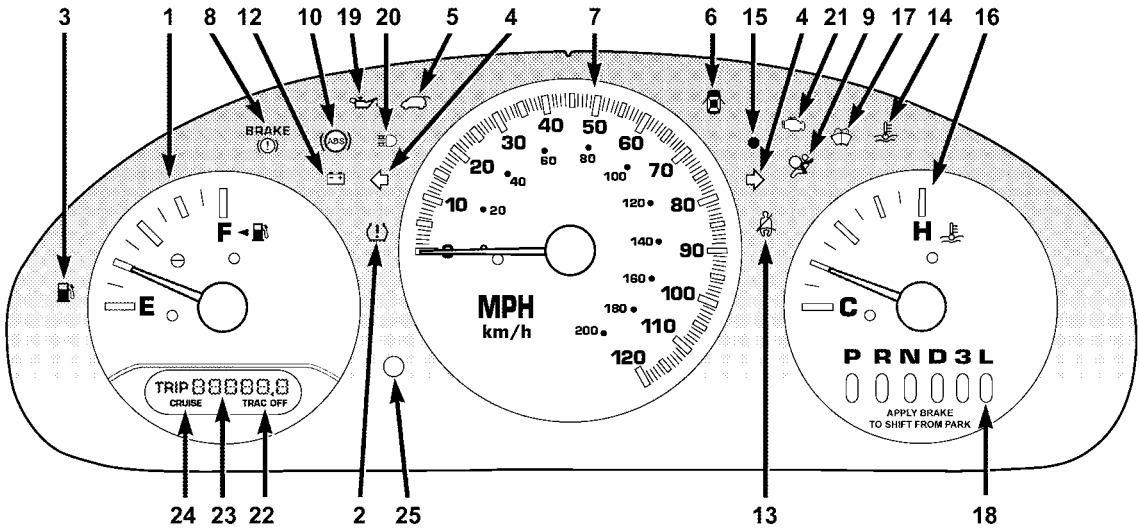

INSTRUMENT CLUSTER WITH TACH

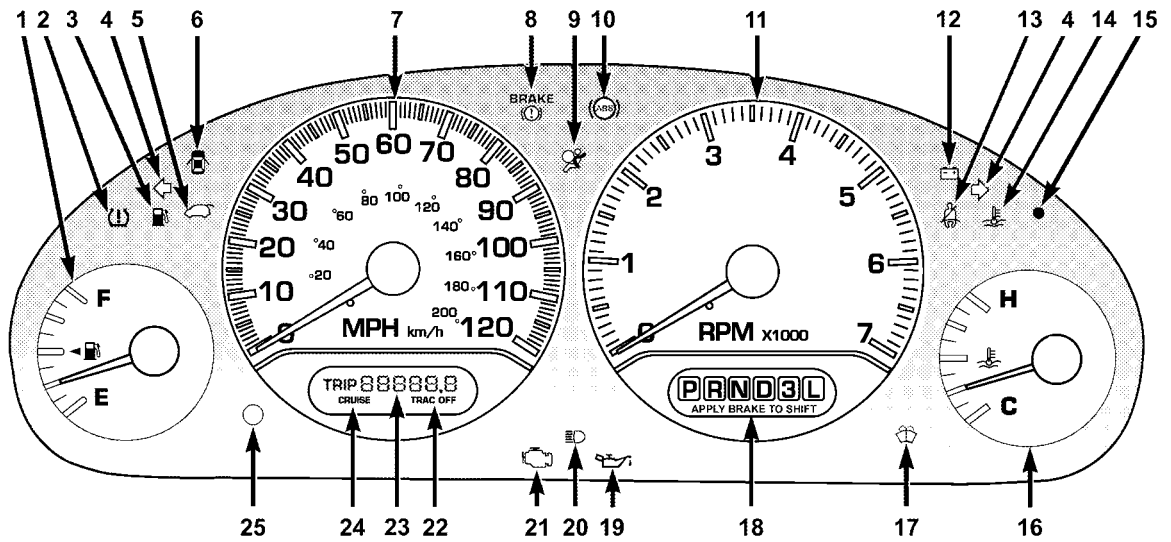

INSTRUMENT CLUSTER DESCRIPTIONS**1. Fuel Gauge**

The pointer shows the level of fuel in the fuel tank when the ignition switch is in the ON position.

2. Tire Pressure Monitoring Telltale Lamp — If Equipped

Each tire, including the spare (if provided), should be checked monthly when cold and inflated to the inflation pressure recommended by the vehicle manufacturer on the vehicle placard or tire inflation pressure label. (If your vehicle has tires of a different size than the size indicated on the vehicle placard or tire inflation pressure label, you should determine the proper tire inflation pressure for those tires.)

As an added safety feature, your vehicle has been equipped with a tire pressure monitoring system (TPMS) that illuminates a low tire pressure telltale when one or

more of your tires is significantly under-inflated. Accordingly, when the low tire pressure telltale illuminates, you should stop and check your tires as soon as possible, and inflate them to the proper pressure. Driving on a significantly under-inflated tire causes the tire to overheat and can lead to tire failure. Under-inflation also reduces fuel efficiency and tire tread life, and may affect the vehicle's handling and stopping ability.

Please note that the TPMS is not a substitute for proper tire maintenance, and it is the driver's responsibility to maintain correct tire pressure, even if under-inflation has not reached the level to trigger illumination of the TPMS low tire pressure telltale.

3. Low Fuel Light

When the fuel level reaches approximately 3.0 gallons (11.0 liters) this light will turn on and remain on until fuel is added.

4. Turn Signal Indicators

 The arrow will flash with the exterior turn signal when the turn signal lever is operated.

If the vehicle electronics sense that the vehicle has traveled about one mile with the turn signals on, a chime will sound to alert you to turn the signals off. If either indicator flashes at a rapid rate, check for a defective outside light bulb.

5. Liftgate Ajar



This light turns on if the liftgate is not completely closed.

6. Door Ajar Light



This light turns on if a door is not completely closed.

7. Speedometer

Indicates vehicle speed.

8. Brake System Warning Light



This light monitors various brake functions, including brake fluid level and parking brake application. If the brake light turns on, it may indicate that the parking brake is applied, there is a low brake fluid level or there is a problem with the anti-lock brake system.

The dual brake system provides a reserve braking capacity in the event of a failure to a portion of the hydraulic system. Failure of either half of the dual brake system is indicated by the Brake Warning Light which will turn on when the brake fluid level in the master cylinder has dropped below a specified level.

The light will remain on until the cause is corrected.

NOTE: The light may flash momentarily during sharp cornering maneuvers which change fluid level conditions. The vehicle should have service performed.

If brake failure is indicated, immediate repair is necessary.

WARNING!

Driving a vehicle with the brake light on is dangerous. Part of the brake system may have failed. It will take longer to stop the vehicle. You could have an accident. Have the vehicle checked immediately.

Vehicles equipped with Anti-Lock brakes (ABS), are also equipped with Electronic Brake Force Distribution (EBD). In the event of an EBD failure, the Brake Warning Light will turn on along with the ABS Light. Immediate repair to the ABS system is required.

The operation of the Brake Warning Light can be checked by turning the ignition switch from the OFF position to

the ON position. The light should illuminate for approximately four seconds. The light should then turn off unless the parking brake is applied or a brake fault is detected. If the light does not illuminate, have the light inspected by an authorized dealer.

The light also will turn on when the parking brake is applied with the ignition switch in the ON position.

NOTE: This light shows only that the parking brake is applied. It does not show the degree of brake application.

9. Airbag Light



This light turns on and remains on for 6 to 8 seconds as a bulb check when the ignition switch is first turned ON. If the light is not on during starting, stays on, or turns on while driving, have the system inspected by an authorized dealer as soon as possible.

10. Anti-Lock Light

This light monitors the Anti-Lock Brake System. The light will turn on when the ignition switch is turned to the ON position and may stay on for as long as four seconds.

If the ABS light remains on or turns on while driving, it indicates that the Anti-Lock portion of the brake system is not functioning and that service is required. However, the conventional brake system will continue to operate normally if the BRAKE warning light is not on.

If the ABS light is on, the brake system should be serviced as soon as possible to restore the benefits of Anti-Lock brakes. If the ABS light does not turn on when the Ignition switch is turned to the ON position, have the light inspected by an authorized dealer. (See page 315 for more information.)

11. Tachometer — If Equipped

The red segments indicate the maximum permissible engine revolutions-per-minute (r.p.m. x 1000) for each gear range. Before reaching the red area, ease up on the accelerator.

12. Voltage Light

This light monitors the electrical system voltage. The light should turn on momentarily as the engine is started. If the light stays on or turns on while driving, it indicates a problem with the charging system. Immediate service should be obtained.

4**13. Seat Belt Reminder Light**

When the ignition switch is first turned ON, this light will turn on for 5 to 8 seconds as a bulb check. During the bulb check, if the driver's seat belt is unbuckled, a chime will sound. After the bulb check or when driving, if the driver seat belt remains unbuckled, the Seat Belt Warning Light will flash or remain on

continuously. Refer to "Enhanced Driver Seat Belt Reminder System (BeltAlert™)" in the Occupant Restraints section for more information.

14. Engine Temperature Warning Light



This light warns of an overheated engine condition. If the engine is critically hot, a continuous chime will sound for 4 minutes. After the chime turns off, the engine will still be critically hot until the light turns off.

15. Vehicle Theft Alarm Light — If Equipped



This light will flash for approximately 15 seconds when the vehicle theft alarm is arming. (See page 26 for more information.)

16. Temperature Gauge

The temperature gauge shows engine coolant temperature. Any reading within the normal range indicates that the engine cooling system is operating satisfactorily.

The gauge pointer will likely indicate a higher temperature when driving in hot weather, up mountain grades, or when towing a trailer. It should not be allowed to exceed the upper limits of the normal operating range.

CAUTION!

Driving with a hot engine cooling system could damage your vehicle. If temperature gauge reads (H), pull over and stop the vehicle. Idle the vehicle with the air conditioner turned off until the pointer drops back into the normal range. If the pointer remains on the "H", and you hear continuous chimes, turn the engine off immediately, and call for service.

WARNING!

A hot engine cooling system is dangerous. You or others could be badly burned by steam or boiling coolant. You may want to call a service center if your vehicle overheats. If you decide to look under the hood yourself, see Section 7 of this manual. Follow the warnings under the Cooling System Pressure Cap paragraph.

17. Washer Fluid Light

This light turns on when the washer fluid level falls below approximately 1/4 filled. The light will remain on until fluid is added.

18. Transmission Range Indicator

This display indicator shows the automatic transaxle gear selection.

NOTE: You must apply the brakes before shifting from Park.

19. Oil Pressure Warning Light

This light shows low engine oil pressure. The light should turn on momentarily when the engine is started. If the light turns on while driving, stop the vehicle and shut off the engine as soon as possible. A chime will sound for 4 minutes when this light turns on.

Do not operate the vehicle until the cause is corrected. This light does not show how much oil is in the engine. The engine oil level must be checked under the hood.

20. High Beam Light

This light shows that the headlights are on high beam. Pull the turn signal lever towards the steering wheel to switch the headlights from high or low beam.

21. Malfunction Indicator Light



This light is part of an onboard diagnostic system called OBD that monitors engine and automatic transmission control systems. The light will illuminate when the key is in the ON position before engine start. If the bulb does not come when turning the key from OFF to ON, have the condition checked promptly.

Certain conditions such as a loose or missing gas cap, poor fuel quality, etc. may illuminate the light after engine start. The vehicle should be serviced if the light stays on through several of your typical driving cycles. In most situations the vehicle will drive normally and will not require towing.

The Malfunction Indicator Light flashes to alert to serious conditions that could lead to immediate loss of power or severe catalytic converter damage. The vehicle should be serviced as soon as possible if this occurs. (See page 399 for more information.)

22. Trac Off Indicator — If Equipped

This display indicator should illuminate for approximately four seconds as a bulb check when the ignition switch is first turned ON.

The “TRAC OFF” Indicator will flash if the traction control is in use.

The “TRAC OFF” Indicator will illuminate if:

- The Traction Control switch has been used to turn the system OFF.
- There is a Traction Control System malfunction
- The system has been deactivated to prevent damage to the brake system due to overheated brake temperatures.

NOTE: Extended heavy use of Traction Control may cause the system to deactivate and turn on the TRAC and the OFF indicators located in the instrument cluster.

This is to prevent overheating of the brake system and is a normal condition. The system will remain disabled for about 4 minutes until the brakes have cooled. The system will automatically reactivate and turn off the TRAC and the OFF indicators.

If your vehicle becomes stuck in mud, ice, or snow, turn the Traction Control System OFF before attempting to “rock” the vehicle free.

23. Odometer/Trip Odometer

The odometer shows the total distance the vehicle has been driven.

U.S. federal regulations require that upon transfer of vehicle ownership, the seller certify to the purchaser the correct mileage that the vehicle has been driven. Therefore, if the odometer reading is changed during repair or replacement, be sure to keep a record of the reading before and after the service so that the correct mileage can be determined.

The trip odometer shows individual trip mileage. To switch from odometer to trip odometer, press the Trip Odometer button.

Loose Fuel Filler Cap

If the vehicle diagnostic system determines that the fuel filler cap is loose, improperly installed, or damaged, GASCAP will be displayed in the instrument cluster odometer. Tighten the fuel filler cap properly and press the odometer reset button to turn the GASCAP message off. If the problem continues, the message will appear the next time the vehicle is started. See Section 7 of this manual for more information.

24. Cruise Indicator

This display indicator shows that the Speed Control System is ON.

25. *Trip Odometer Button*

Press this button to change the display from odometer to trip odometer. The word TRIP will appear when in the trip odometer mode.

Push in and hold the button for two seconds to reset the trip odometer to 0 miles or kilometers. The odometer must be in trip mode to reset.

ELECTRONIC DIGITAL CLOCK

The clock and radio each use the display panel built into the radio. A digital readout shows the time in hours and minutes whenever the ignition switch is in the ON or ACC position and the time button is pressed.

When the ignition switch is in the OFF position, or when the radio frequency is being displayed, time keeping is accurately maintained.

Clock Setting Procedure

1. Turn the ignition switch to the ON or ACC position and press the time button. Using the tip of a ballpoint pen or similar object, press either the hour (H) or minute (M) buttons on the radio.
2. Press the H button to set hours or the M button to set minutes. The time setting will increase each time you press a button.

RADIO GENERAL INFORMATION

Radio Broadcast Signals

Your new radio will provide excellent reception under most operating conditions. Like any system, however, car radios have performance limitations, due to mobile operation and natural phenomena, which might lead you to believe your sound system is malfunctioning. To help

you understand and save you concern about these “apparent” malfunctions, you must understand a point or two about the transmission and reception of radio signals.

Two Types of Signals

There are two basic types of radio signals... AM or Amplitude Modulation, in which the transmitted sound causes the amplitude, or height, of the radio waves to vary... and FM or Frequency Modulation, in which the frequency of the wave is varied to carry the sound.

Electrical Disturbances

Radio waves may pick up electrical disturbances during transmission. They mainly affect the wave amplitude, and thus remain a part of the AM reception. They interfere very little with the frequency variations that carry the FM signal.

AM Reception

AM sound is based on wave amplitude, so AM reception can be disrupted by such things as lightning, power lines and neon signs.

FM Reception

Because FM transmission is based on frequency variations, interference that consists of amplitude variations can be filtered out, leaving the reception relatively clear, which is the major feature of FM radio.

NOTE: On vehicles so equipped the radio, steering wheel radio controls and 6 disc CD/DVD changer will remain active for up to 45 seconds after the ignition switch has been turned off. Opening a vehicle front door will cancel this feature.

SALES CODE RAZ—AM/ FM STEREO RADIO WITH CASSETTE TAPE PLAYER, CD PLAYER AND CD CHANGER CONTROLS

NOTE: The radio sales code is located on the lower left side of your radio faceplate.

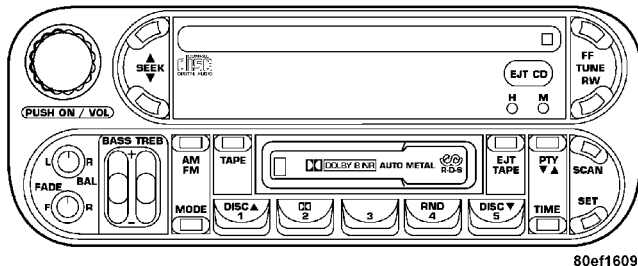

RAZ Radio

Operating Instructions — Radio

NOTE: Power to operate the radio is controlled by the ignition switch. It must be in the ON or ACC position to operate the radio.

Power Switch, Volume Control

Press the ON/VOL control to turn the radio on. Turn the volume control clockwise to increase the volume. The volume will be displayed and continuously updated while the button is pressed.

Seek Button (Radio Mode)

Press and release the Seek button to search for the next station in either the AM or FM mode. Press the top of the button to seek up and the bottom to seek down. Holding the button will by pass stations until you release the button.

Tuning

Press the TUNE control up or down to increase or decrease the frequency. If you press and hold the button, the radio will continue to tune until you release the button. The frequency will be displayed and continuously updated while the button is pressed.

Radio Data System (RDS)

The Radio Data System allows radio broadcasting stations to send data signals on a subcarrier frequency which is added to the stereo signal. RDS was developed to give FM receivers user-friendly features, such as Program Service name (PS) and Program Type (PTY). Program Service name is typically used by the broadcaster to display the station's name or call letters, for example "WNIC". Typically these are 8 characters in length and are displayed by the radio for those stations

which are broadcasting this information. PTY (Program Type) is used to characterize the station's program material, for example "Rock Music".

PTY (Program Type) Button

Pressing this button once will turn on the PTY mode for 5 seconds. If no action is taken during the 5 second time out the PTY icon will turn off. Pressing the PTY button within 5 seconds will allow the program format type to be selected. Many radio stations do not currently broadcast PTY information.

Toggle the PTY button to select the following format types:

Program Type	Radio Display
Adult Hits	Adlt Hit
Classical	Classicl
Classic Rock	Cls Rock
College	College

Program Type	Radio Display
Country	Country
Information	Inform
Jazz	Jazz
Foreign Language	Language
News	News
Nostalgia	Nostalga
Oldies	Oldies
Personality	Persnlty
Public	Public
Rhythm and Blues	R & B
Religious Music	Rel Musc
Religious Talk	Rel Talk
Rock	Rock
Soft	Soft
Soft Rock	Soft Rck
Soft Rhythm and Blues	Soft R&B

Program Type	Radio Display
Sports	Sports
Talk	Talk
Top 40	Top 40
Weather	Weather

By pressing the SEEK button when the PTY icon is displayed, the radio will be tuned to the next frequency station with the same selected PTY name. The PTY function only operates when in the FM mode.

The radio display will flash "SEEK" and the selected PTY program type when searching for the next PTY station. If no station is found with the selected PTY program type, the radio will return to the last preset station.

If a preset button is activated while in the PTY (Program Type) mode, the PTY mode will be exited and the radio will tune to the preset station.

Pressing PTY, then SCAN will scan the FM Band and stop at all RDS stations. Each RDS station will be played for a 5 second scan once around the FM Band and stop at the last station. The PTY icon will then turn off.

Balance

The Balance control adjusts the left-to-right speaker balance. Push in the button and it will pop out. Adjust the balance and push the button back in. The balance will be displayed and continuously updated while the button is turned.

Fade

The Fade control provides for balance between the front and rear speakers. Push in the button and it will pop out. Adjust the balance and push the button back in. The fade will be displayed and continuously updated while the button is turned.

Tone Control

Slide the Bass and/or Treble controls up or down to adjust the sound for the desired tone. The treble, and bass will be displayed and continuously updated while the slide is moved.

AM/FM Selection

Press the AM/FM button to change from AM to FM. The operating mode will be displayed next to the station frequency. The display will show ST when a stereo station is received.

Scan Button

Pressing the SCAN button causes the tuner to search for the next station, in either AM or FM, pausing for 5 seconds at each listenable station before continuing to the next.

Pressing the AM/FM button continues the search in the alternate frequency band.

To stop the search, press SCAN a second time.

To Set The Radio Push-button Memory

When you are receiving a station that you wish to commit to push-button memory, press the SET button. SET 1 will show in the display window. Select the push-button you wish to lock onto this station and press and release that button. If a station is not selected within 5 seconds after pressing the SET button, the station will continue to play but will not be locked into push-button memory.

You may add a second station to each push-button by repeating the above procedure with this exception: Press the SET button twice and SET 2 will show in the display window. Each button can be set for SET 1 and SET 2 in both AM and FM. This allows a total of 10 AM and 10 FM stations to be locked into memory. You can recall the stations stored in SET 2 memory by pressing the push-button twice.

To Change From Clock To Radio Mode

Press the Time button to change the display between radio frequency and time.

Operating Instructions — Tape Player

Insert the cassette with the exposed tape side toward the right and the mechanical action of the player will gently pull the cassette into the play position.

NOTE: When subjected to extremely cold temperatures, the tape mechanism may require a few minutes to warm up for proper operation. Sometimes poor playback may be experienced due to a defective cassette tape. Clean and demagnetize the tape heads at least twice a year.

Seek Button

Press the SEEK button up for the next selection on the tape and down to return to the beginning of the current selection.

Press the SEEK button up or down to move the track number to skip forward or backward 1 to 6 selections. Press the SEEK button once to move 1 selection, twice to move 2 selections, etc.

Fast Forward (FF)

Press the FF button up momentarily to advance the tape in the direction that it is playing. The tape will advance until the button is pressed again or the end of the tape is reached. At the end of the tape, the tape will play in the opposite direction.

Rewind (RW)

Press the RW button momentarily to reverse the tape direction. The tape will reverse until the button is pressed again or until the end of the tape is reached. At the end of the tape, the tape will play in the opposite direction.

Tape Eject

Press the EJT Tape button and the cassette will disengage and eject from the radio.

Scan Button

Press this button to play 10 seconds of each selection. Press the scan button a second time to cancel the feature.

Changing Tape Direction

If you wish to change the direction of tape travel (side being played), press the PTY button. The lighted arrow in the display window will show the new direction.

Metal Tape Selection

If a standard metal tape is inserted into the player, the player will automatically select the correct equalization and the 70 symbol will appear in the display window.

Pinch Roller Release

If ignition power or the radio ON/OFF switch are turned off, the pinch roller will automatically retract to protect the tape from any damage. When power is restored to the tape player, the pinch roller will automatically reengage and the tape will resume play.

Noise Reduction

The Dolby Noise Reduction System* is on whenever the tape player is on, but may be switched off.

To turn off the Dolby Noise reduction System: Press the Dolby button (button 2) after you insert the tape. The NR light in the display will go off when the Dolby System is off. The Dolby System is automatically reactivated each time a tape is inserted.

* "Dolby" noise reduction manufactured under license from Dolby Laboratories Licensing Corporation. Dolby and the double-D symbol are trademarks of Dolby Laboratories Licensing Corporation.

Operating Instructions — CD Player

NOTE: The ignition switch must be in the ON or ACC position and the volume control ON before the CD player will operate.

CAUTION!

This CD player will accept 4 ¾ inch (12 cm) discs only. The use of other sized discs may damage the CD player mechanism.

Inserting The Compact Disc

The CD player contained within the radio is not a multi-disc changer, and will only accept one CD. Gently insert one CD into the CD player with the CD label facing up. The CD will automatically be pulled into the CD Player.

If the volume control is ON, the unit will switch from radio to CD mode and begin to play. The display will show the track number and index time in minutes and seconds. Play will begin at the start of track one.

NOTE:

- You may eject a disc with the radio OFF. The ignition switch must be in the ON or ACC position to insert a disc with the radio OFF.
- If you insert a disc with the ignition ON and the radio OFF, the CD will automatically be pulled into the CD Player and the display will show the time of day. If you insert a disc with the ignition OFF, the display will show the time of day for about 5 seconds, then go out.

Seek Button

Press the top of the SEEK button for the next selection on the CD. Press the bottom of the button to return to the beginning of the current selection, or return to the beginning of the previous selection if the CD is within the first 10 seconds of the current selection.

EJT CD (Eject) Button

Press this button and the disc will unload and move to the entrance for easy removal. The unit will switch to the radio mode.

If you do not remove the disc within 15 seconds, it will be reloaded. The radio mode will continue to appear.

The disc can be ejected with the radio OFF.

FF/TUNE/RW

Press FF (Fast Forward) and the CD player will begin to fast forward until FF is released. The RW (Reverse) button works in a similar manner.

Program Button 4 (Random Play)

Press this button while the CD is playing to activate Random Play. This feature plays the tracks on the selected disc in random order to provide an interesting change of pace.

Press the SEEK button to move to the next randomly selected track.

Press TUNE FF to fast forward through the tracks. Press the FF button a second time to stop the fast forward feature. If TUNE RW is pressed, the current track will reverse to the beginning of the track and begin playing.

Press button 4 a second time to stop Random Play.

MODE

Press the MODE button to select between the tape player, CD player, or satellite radio (if equipped).

To select Satellite Radio (if equipped), press the MODE button until the word SIRIUS appears. The following will be displayed in this order: After three seconds, the current channel name and number will be displayed for five seconds. The current program type and channel number will then be displayed for five seconds. The current channel name and number will then be displayed until an action occurs. A CD or tape may remain in the player while in the Satellite Radio mode.

Tape CD Button

Press this button to select between CD player and Tape player.

Time Button

Press this button to change the display from elapsed CD playing time to time of day.

Scan Button

Press this button to play the first 10 seconds of each track. To stop the scan function, press the button a second time.

CD Changer Control Capability — If Equipped

This radio is compatible with a remote mounted CD changer available through Mopar Accessories. The following instructions are for the radio controls that operate this CD changer.

Mode Button

To activate the CD changer, press the MODE button until CD information appears on the display.

Disc Up/Program Button 1

Press the DISC up (button 1) button to play the next available disc.

Disc Down/Program Button 5

Press the DISC down (button 5) button to play the previous disc.

Seek Button

Press the SEEK up or down to select another track on the same disc. A SEEK symbol will appear on the display.

Fast Forward And Rewind Buttons

Press and hold the FF button for fast forward. Press and hold the RW button for fast reverse.

The audio output can be heard when fast forward and fast reverse are activated.

Random Play (RND)

Press the Random button to play the tracks on the selected disc in random order for an interesting change of pace.

Random can be cancelled by pressing the button a second time or by ejecting the CD from the changer.

CD Diagnostic Indicators

When driving over a very rough road, the CD player may skip momentarily. Skipping will not damage the disc or the player, and play will resume automatically.

As a safeguard and to protect your CD player, one of the following warning symbols may appear on your display.

A CD HOT symbol indicates the player is too hot.

CD HOT will pause the operation. Play can be resumed when the operating temperature is corrected or another MODE is selected.

An ERR symbol will appear on the display if the laser is unable to read the Disc data for the following reasons:

- Excessive vibration
- Disc inserted upside down
- Damaged disc
- Water condensation on optics

SALES CODE REV AM & FM STEREO RADIO WITH CD PLAYER AND CD/DVD CHANGER CONTROLS

NOTE: The radio sales code is located on the lower left side of your radio faceplate.

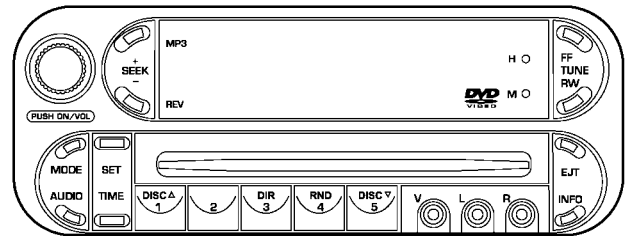

817a88ea

REV Radio

Radio Operation

Power/Volume Control

Press the ON/VOL control to turn the radio on. Turn the volume control clockwise to increase the volume.

NOTE: Power to operate the radio is supplied through the ignition switch. It must be in the ON or ACC position to operate the radio.

PTY (Program Type)

Pressing the INFO button once while in FM mode will turn on the PTY mode for 5 seconds. If no action is taken during the 5 second time out, the PTY icon will turn off. Pressing the TUNE button within 5 seconds will allow the program format type to be selected. Many radio stations do not currently broadcast PTY information.

Toggle the TUNE button to select the following format types:

Program Type	Radio Display
Adult Hits	Adlt Hit
Classical	Classicl
Classic Rock	Cls Rock
College	College
Country	Country
Information	Inform
Jazz	Jazz
Foreign Language	Language
News	News
Nostalgia	Nostalga
Oldies	Oldies
Personality	Persnlty
Public	Public
Rhythm and Blues	R & B
Religious Music	Rel Musc
Religious Talk	Rel Talk

Program Type	Radio Display
Rock	Rock
Soft	Soft
Soft Rock	Soft Rck
Soft Rhythm and Blues	Soft R&B
Sports	Sports
Talk	Talk
Top 40	Top 40
Weather	Weather

By pressing the SEEK button when the PTY icon is displayed, the radio will be tuned to the next frequency station with the same selected PTY name. The PTY function only operates when in the FM and Satellite (if equipped) modes.

The radio display will flash "SEEK" and the selected PTY program type when searching for the next PTY station. If no station is found with the selected PTY program type, the radio will return to the last preset station.

If a preset button is activated while in the PTY (Program Type) mode, the PTY mode will be exited and the radio will tune to the preset station.

Mode

Press the MODE button to select between, AM, FM, CD, CD/DVD changer or the Satellite Radio (if equipped). When the Satellite Radio (if equipped) is selected "SA" will appear in your radio display.

A disc may remain in the radio while in the Satellite or radio mode.

Seek

Press and release the SEEK button to search for the next station in either the AM, FM or Satellite mode. Press the top of the button to seek up and the bottom to seek down. The radio will remain tuned to the new station until you make another selection. Holding the button in will bypass stations without stopping until you release it.

Tuning

Press the TUNE control up or down to increase or decrease the frequency. If you press and hold the button, the radio will continue to tune until you release the button. The frequency will be displayed and continuously updated while the button is pressed.

Balance

The Balance control adjusts the left-to-right speaker balance. Press the AUDIO button, select BALANCE, then press SEEK + or SEEK - to adjust the balance.

Fade

The Fade control provides for balance between the front and rear speakers. Press the AUDIO button, select FADE, then press SEEK + or SEEK - to adjust the fade balance.

Tone Control

The Bass and/or Treble controls sound for the desired tone. Press the AUDIO button, select Bass or TREBLE, then press SEEK + or SEEK - to increase or decrease amplification of the band.

To Set The Radio Push-Button Memory

When you are receiving a station that you wish to commit to push-button memory, press the SET button. SET 1 will show in the display window. Select the push-button you wish to lock onto this station and press and release that button. If a station is not selected within 5 seconds after pressing the SET button, the station will continue to play but will not be locked into push-button memory.

You may add a second station to each push-button by repeating the above procedure with this exception: Press the SET button twice and SET 2 will show in the display window. Each button can be set for SET 1 and SET 2 in

both AM and FM. This allows a total of 10 AM and 10 FM stations to be locked into memory. You can recall the stations stored in SET 2 memory by pressing the push-button twice.

To Change From Clock To Radio Mode

Press the TIME button to change the display between radio frequency and time.

General Information

This radio complies with Part 15 of FCC rules and with RSS-210 of Industry Canada. Operation is subject to the following conditions:

1. This device may not cause harmful interference,
2. This device must accept any interference received, including interference that may cause undesired operation.

NOTE: Changes or modifications not expressly approved by the party responsible for compliance could void the user's authority to operate the equipment.

CD Player Operation**NOTE:**

- The ignition switch must be in the ON or ACC position and the volume control ON before the CD player will operate.
- This Radio is capable of playing compact discs (CD), recordable compact discs (CD-R), rewritable compact discs (CD-RW) compact discs with MP3 tracks and multisession compact discs with CD and MP3 tracks.

Inserting The Compact Disc

CAUTION!

This CD player will accept only 4-3/4 inch (12cm) discs only. The use of other sized discs may damage the CD player mechanism.

You may either insert or eject a disc with the radio OFF.

If you insert a disc with the ignition ON and the radio OFF, the display will show the time of day. If you insert a disc with the ignition OFF, the display will show the time of day for about 5 seconds, then go out.

If the power is ON, the unit will switch from radio to CD mode and begin to play when you insert the disc. The display will show the track number and index time in minutes and seconds. Play will begin at the start of track one.

Seek

Press the top of the SEEK button for the next selection on the CD. Press the bottom of the button to return to the beginning of the current selection, or return to the beginning of the previous selection if the CD is within the first 10 seconds of the current selection.

EJT — Eject

Press the EJT button and the disc will unload and move to the entrance for easy removal. The unit will switch to the radio mode.

If you do not remove the disc within 15 seconds, it will be reloaded. The radio mode will continue to appear.

The disc can be ejected with the radio OFF.

FF/TUNE/RW

Press FF (Fast Forward) and the CD player will begin to fast forward until FF is released. The RW (Reverse) button works in a similar manner.

RND — Random Play

Press the RND button while the CD is playing to activate Random Play. This feature plays the selections on the compact disc in random order to provide an interesting change of pace.

Press the SEEK button to move to the next randomly selected track.

Press TUNE FF to fast forward through the tracks. Press the FF button a second time to stop the fast forward feature. If TUNE RW is pressed, the current track will reverse to the beginning of the track and begin playing.

Press the RND button a second time to stop Random Play.

CD/DVD Changer Operation

Press the MODE button to select between the CD player and the optional remote CD/DVD changer.

Time

Press the TIME button to change the display from elapsed CD or DVD playing time to time of day.

Notes On Playing MP3 Files

The radio can play MP3 files, however, acceptable MP3 file recording media and formats are limited. When writing MP3 files, pay attention to the following restrictions.

Supported media (disc types)

The MP3 file recording media supported by the radio are CD-ROM, CD-R and CD-RW.

Supported medium formats (file systems)

The medium formats supported by the radio are ISO 9660 Level 1 and Level 2 and includes the Joliet extension.

When reading discs recorded using formats other than ISO 9660 Level 1 and Level 2, the radio may fail to read files properly and may be unable to play the file normally. UDF and Apple HFS formats are not supported.

The radio uses the following limits for file systems:

- Maximum number of directory levels: 15
- Maximum number of files: 255
- Maximum number of folders: 100
- Maximum number of characters in file/folder names:
 - Level 1: 12 (including a separator "." and a 3-character extension)
 - Level 2: 31 (including a separator "." and a 3-character extension)

Multisession disc formats are supported by the radio. Multisession discs may contain combinations of normal

CD audio tracks and computer files (including MP3 files). Discs created with an option such as "keep disc open after writing" are most likely multisession discs. The use of multisession for CD audio or MP3 playback may result in longer disc loading times.

Supported MP3 file formats

The radio will recognize only files with the *.mp3 extension as MP3 files. Non-MP3 files named with the *.mp3 extension may cause playback problems. The radio is designed to recognize the file as an invalid MP3 and will not play the file.

When using the MP3 encoder to compress audio data to an MP3 file, the bit rate and sampling frequencies in the following table are supported. In addition, variable bit rates (VBR) are also supported. The majority of MP3 files use a 44.1 kHz sampling rate and a 192, 160, 128, 96 or VBR bit rates.

MPEG Specification	Sampling Frequency (kHz)	Bit rate (kbps)
MPEG-1 Audio Layer 3	48, 44.1, 32	320, 256, 224, 192, 160, 128, 112, 96, 80, 64, 56, 48, 40, 32
MPEG-2 Audio Layer 3	24, 22.05, 16	160, 128, 144, 112, 96, 80, 64, 56, 48, 40, 32, 24, 16, 8

ID3 Tag information for artist, song title and album title are supported for version 1 ID3 tags. ID3 version 2 is not supported by the radios.

Playlist files are not supported. MP3 Pro files are not supported.

Playback of MP3 files

When a medium containing MP3 data is loaded, the radio checks all files on the medium. If the medium contains a lot of folders or files, the radio will take more time to start playing the MP3 files.

Loading times for playback of MP3 files may be affected by the following:

- Media - CD-RW media may take longer to load than CD-R media
- Medium formats - Multisession discs may take longer to load than non-multisession discs
- Number of files and folders - Loading times will increase with more files and folders

To increase the speed of disc loading, it is recommended to use CD-R media and single-session discs. To create a single-session disc, enable the Disc at Once option before writing to the disc.

Operation Instructions - (CD Mode For MP3 Audio Play)**SEEK Button (CD Mode For MP3 Play)**

Pressing the SEEK + button plays the next MP3 File. Pressing the SEEK – button plays the beginning of the MP3 file. Pressing the button within the first ten seconds plays the previous file.

INFO Button (CD Mode For MP3 Play)

Press and INFO button while playing MP3 disc. The radio scrolls through the following TAG information: Song Title, Artist, File Name, and Folder Name (if available).

Press the INFO button once more to return to "elapsed time" priority mode.

RW/FF (CD Mode For MP3 Play)

Press the FF side of the button to move forward through the MP3 selection. Press the RW side of the button to move back through the MP3 selection.

AM/FM Button (CD Mode For MP3 Play)

Switches back to Radio mode.

RND Button (CD Mode For MP3 Play)

Pressing this button plays files randomly.

DIR Button (CD Mode For MP3 Play)

Press the DIR Button to display folders, when playing an MP3 discs that have a file/folder structure. Press DISC up (button 1) or DISC down (button 5) to move through the folders. Press the SET button to select a folder

Operating Instructions - Hands Free Phone (If Equipped)

Refer to Hands Free Phone section of the Owner's Manual.

Operating Instructions - Satellite Radio Mode (If Equipped)

Refer to the Satellite Radio section of the Owner's Manual.

Operating Instructions - Video Entertainment System (VES®) (If Equipped)

Refer to 6 Disc CD/DVD Changer Manual.

SALES CODE RBP—AM & FM STEREO RADIO WITH CASSETTE TAPE PLAYER, CD PLAYER, AND OPTIONAL CD/DVD CHANGER CONTROLS

NOTE: The radio sales code is located on the lower left side of your radio faceplate.

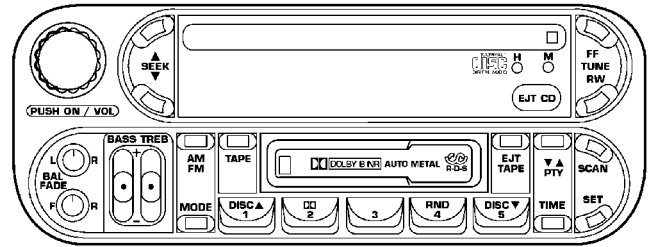

80e7c9a0

RBP Radio

Radio Operation

Power/Volume Control

Press the ON/VOL control to turn the radio on. Turn the volume control to the right to increase the volume.

NOTE: Power to operate the radio is supplied through the ignition switch. It must be in the ON or ACC position to operate the radio.

PTY (Program Type) Button

Pressing this button once will turn on the PTY mode for 5 seconds. If no action is taken during the 5 second time out the PTY icon will turn off. Pressing the PTY button within 5 seconds will allow the program format type to be selected. Many radio stations do not currently broadcast PTY information.

Toggle the PTY button to select the following format types:

Program Type	Radio Display
Adult Hits	Adlt Hit
Classical	Classicl
Classic Rock	Cls Rock
College	College

Program Type	Radio Display
Country	Country
Information	Inform
Jazz	Jazz
Foreign Language	Language
News	News
Nostalgia	Nostalgia
Oldies	Oldies
Personality	Persnlty
Public	Public
Rhythm and Blues	R & B
Religious Music	Rel Musc
Religious Talk	Rel Talk
Rock	Rock
Soft	Soft
Soft Rock	Soft Rck
Soft Rhythm and Blues	Soft R&B

Program Type	Radio Display
Sports	Sports
Talk	Talk
Top 40	Top 40
Weather	Weather

By pressing the SEEK button when the PTY icon is displayed, the radio will be tuned to the next frequency station with the same selected PTY name. The PTY function only operates when in the FM and Satellite (if equipped) modes.

The radio display will flash “SEEK” and the selected PTY program type when searching for the next PTY station. If no station is found with the selected PTY program type, the radio will return to the last preset station.

If a preset button is activated while in the PTY (Program Type) mode, the PTY mode will be exited and the radio will tune to the preset station.

Pressing PTY, then SCAN will scan the FM Band and stop at all RDS stations that broadcast the station type. Each RDS station will be played for a 5 second scan once around the FM Band and stop at the last station. The PTY icon will then turn off.

Seek

Press and release the SEEK button to search for the next station in either the AM or FM mode. Press the top of the button to seek up and the bottom to seek down. The radio will remain tuned to the new station until you make another selection. Holding the button in will bypass stations without stopping until you release it.

Scan

Press and release the SCAN button to search for the next station in either the AM or FM mode. The radio will pause for 5 seconds at each listenable station before continuing to the next. To stop the search, press the SCAN button a second time.

Tune

Press the TUNE control up or down to increase or decrease the frequency. If you press and hold the button, the radio will continue to tune until you release the button. The frequency will be displayed and continuously updated while the button is pressed.

Balance — BAL

The Balance control adjusts the left-to-right speaker balance. Press the BAL button in and it will pop out. Adjust the balance and push the button back in.

Fade

The Fade control provides for balance between the front and rear speakers. Press the FADE button in and it will pop out. Adjust the balance and push the button back in.

Tone Control

The tone controls affect the BASS and TREBLE frequency bands. Each is controlled by a slider control with a detent

at the mid position. Moving a control up or down increases or decreases amplification of the band. The mid position provides a balanced output.

AM/FM Selection

Press the AM/FM button to toggle between AM and FM mode. The operating mode will be displayed next to the station frequency. The display will show “ST” when a stereo station is received (FM only).

To Set The Radio Push-Button Memory

When you are receiving a station that you wish to commit to push-button memory, press the SET button. SET 1 will now show in the display window. Select the “1–5” button you wish to lock onto this station and press and release that button. If a button is not selected within 5 seconds after pressing the SET button, the station will continue to play but will not be locked into push-button memory.

You may add a second station to each push-button by repeating the above procedure with this exception: Press the SET button twice and SET 2 will show in the display window. Each button can be set for SET 1 and SET 2 in both AM and FM. This allows a total of 10 AM and 10 FM stations to be locked into push-button memory. The stations stored in SET 2 memory can be selected by pressing the push-button twice.

Time

Press the TIME button to change the display between radio frequency and time.

To set the clock, use a ballpoint pen or similar object to press the hour (H) or minute (M) buttons on the radio. The time setting will increase each time you press the button. Press any other button to exit from the clock setting mode.

General Information

This radio complies with Part 15 of FCC rules and with RSS-210 of Industry Canada. Operation is subject to the following conditions:

1. This device may not cause harmful interference,
2. This device must accept any interference received, including interference that may cause undesired operation.

NOTE: Changes or modifications not expressly approved by the party responsible for compliance could void the user's authority to operate the equipment.

Tape Player Operation

Insert the cassette with the exposed tape side toward the right and the mechanical action of the player will gently pull the cassette into the play position.

NOTE: When subjected to extremely cold temperatures, the tape mechanism may require a few minutes to warm

up for proper operation. Sometimes poor playback may be experienced due to a defective cassette tape. Clean and demagnetize the tape heads at least twice a year.

Tape Side — $\nabla\Delta$ /PTY

Pressing the $\nabla\Delta$ button during tape mode will cause the other side of the tape to be played. The display will confirm the selected tape play direction. The time is always displayed.

Tape

Press the TAPE button to select the Tape mode.

Seek

Press the SEEK button up for the next selection on the tape and down to return to the beginning of the current selection.

Press the SEEK button up or down to move the track number to skip forward or backward 1 to 7 selections. Press the SEEK button once to move 1 selection, twice to

move 2 selections, etc. the display will show the total number of times the SEEK button was pushed. The SEEK function will be cancelled by pressing either the FF/RW or AM/FM button.

Fast Forward — FF

Press the FF button up momentarily to advance the tape in the direction that it is playing. The tape will advance until the button is pressed again or the end of the tape is reached. At the end of the tape, the tape will play in the opposite direction.

Rewind — RW

Press the RW button down momentarily to reverse the tape direction. The tape will rewind until the button is pressed again or until the beginning of the tape is reached. At the beginning of the tape, the tape will play in the opposite direction.

EJT Tape

Press the EJT TAPE button and the cassette will disengage and eject from the radio.

Metal Tape Selection (70µs)

If a standard 70 µ (metal) tape is inserted into the player, the player will automatically select the correct equalization.

Pinch Roller Release

If ignition power or the radio ON/OFF switch are turned off, the pinch roller will automatically retract to protect the tape from any damage. When power is restored to the tape player, the pinch roller will automatically reengage and the tape will resume play.

Dolby Noise Reduction

 The Dolby Noise Reduction System* is on whenever the tape player is on, but may be switched on/off.

To turn the Dolby Noise Reduction System on/off: Press the Dolby NR button (button 2) after you insert the tape. The NR light in the display will go off when the Dolby System is off.

* "Dolby" noise reduction manufactured under license from Dolby Laboratories Licensing Corporation. Dolby and the double-D symbol are trademarks of Dolby Laboratories Licensing Corporation.

CD Player Operation

NOTE: The ignition switch must be in the ON or ACC position and the volume control ON before the CD player will operate.

Inserting The Compact Disc

You may either insert or eject a disc with the radio OFF.

If you insert a disc with the ignition ON and the radio off, the display will show CD and the time of day will be displayed.

If the power is on, the unit will switch from radio to CD mode and begin to play when you insert the disc. The display will show the track number and index time in minutes and seconds. Play will begin at the start of track one.

Seek

Press the top of the SEEK button for the next selection on the CD. Press the bottom of the button to return to the beginning of the current selection, or return to the beginning of the previous selection if the CD is within the first second of the current selection.

Scan

Press the SCAN button to play 10 seconds of each selection. Press the SCAN button a second time to cancel this feature.

EJT CD

Press the EJT CD button and the disc will unload and move to the entrance for easy removal. The unit will switch to the radio mode.

If you do not remove the disc within 15 seconds, it will be reloaded. The unit will continue in radio mode.

The disc can be ejected with the radio and ignition off.

FF/TUNE/RW

Press FF (Fast Forward) and the CD player will begin to fast forward until FF is released. The RW (Reverse) button works in a similar manner.

Random Play — RND/Program Button 4

Press the RND (button 4) button while the CD is playing to activate Random Play. This feature plays the selections on the compact disc in random order to provide an interesting change of pace.

Press the top of the SEEK button to move to the next randomly selected track.

Press the RND (button 4) button a second time to stop Random Play.

MODE

Press the MODE button to select between the CD player, remote CD/DVD changer (if equipped), or satellite radio (if equipped).

To select Satellite Radio (if equipped), press the MODE button until the word SIRIUS™ appears. The following will be displayed in this order: After three seconds, the current channel name and number will be displayed for five seconds. The current program type and channel number will then be displayed for five seconds. The current channel name and number will then be displayed until an action occurs. A CD or tape may remain in the player while in the Satellite Radio mode.

Time

Press the TIME button to change the display from elapsed CD playing time to time of day.

CD/DVD Changer Operation — If Equipped

MODE

Press the MODE button to select between the CD player, and the CD/DVD changer (if equipped).

Disc Up/Program Button 1

Press the DISC (button 1) button to play the next available disc.

Random Play — RND/Program Button 4

Press the RND (button 4) button while the CD is playing to activate Random Play. This feature plays the selections on the currently playing compact disc in random order to provide an interesting change of pace.

Press the top of the SEEK button to move to the next randomly selected track.

Press the RND (button 4) button a second time to stop Random Play.

FF/RW — TUNE

Press and hold the FF button for fast forward. Press and hold the RW button for fast reverse. The audio output can be heard when fast forward and fast reverse are activated.

Disc Down/Program Button 5

Press the DISC (button 5) button to play the previous disc.

Seek

Press the top of the SEEK button for the next selection on the CD. Press the bottom of the button to return to the beginning of the current selection, or return to the beginning of the previous selection if the CD is within the first second of the current selection.

Time

Press the TIME button to switch between time of day and CD track time.

Scan

Press the SCAN button to play 10 seconds of each track. Press the SCAN button a second time to cancel the feature.

SALES CODE RBQ—AM/FM STEREO RADIO WITH 6 - DISC CD CHANGER

NOTE: The radio sales code is located on the lower left side of your radio faceplate.

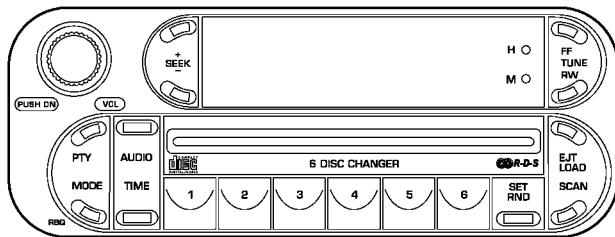

813ebacd

RBQ Radio

Radio Operation

Power/Volume Control

Press the PWR/VOL control to turn the radio on. Turn the volume control clockwise to increase the volume.

NOTE: Power to operate the radio is controlled by the ignition switch. It must be in the ON or ACC position to operate the radio.

Mode

Press the MODE button repeatedly to select between AM, FM, the CD changer and Sirius Satellite Radio™ (if equipped). The display will show ST when a stereo station is received.

To select Sirius Satellite Radio™ (if equipped), press the MODE button until the word SIRIUS appears. The following will be displayed in this order: After three seconds, the current channel name and number will be displayed for five seconds. The current program type and

channel number will then be displayed for five seconds. The current channel name and number will then be displayed until an action occurs. CD's may remain in the player while in the Satellite Radio mode.

Seek

Press and release the SEEK button to search for the next station in either the AM or FM mode. Press the top of the button to seek up and the bottom to seek down. The radio will remain tuned to the new station until you make another selection. Holding the button in will bypass stations without stopping until you release it.

Tune

Press the TUNE control up or down to increase or decrease the frequency. If the button is pressed and held, the radio will continue to tune until the button is released. The frequency will be displayed and continuously updated while the button is pressed.

To Set The Radio Push-Button Memory

When you are receiving a station that you wish to commit to push-button memory, press the SET RND button. SET 1 will show in the display window. Select the "1-6" button you wish to lock onto this station and press and release that button. If a button is not selected within 5 seconds after pressing the SET RND button, the station will continue to play but will not be locked into push-button memory.

You may add a second station to each push-button by repeating the above procedure with this exception: Press the SET button twice and SET 2 will show in the display window. Each button can be set for SET 1 and SET 2 in both AM and FM. This allows a total of 12 AM and 12 FM stations to be locked into push-button memory. The stations stored in SET 2 memory can be selected by pressing the corresponding push-button twice. Every time a preset button is used, a corresponding button number will be displayed.

Audio

The audio button controls the BASS, TREBLE, BALANCE, and FADE.

Press the AUDIO button and BASS will be displayed. Press the SEEK + or SEEK - to increase or decrease the Bass tones.

Press the AUDIO button a second time and TREB will be displayed. Press the SEEK + or SEEK - to increase or decrease the Treble tones.

Press the AUDIO button a third time and BAL will be displayed. Press the SEEK + or SEEK - to adjust the sound level from the right or left side speakers.

Press the AUDIO button a fourth time and FADE will be displayed. Press the SEEK + or SEEK - to adjust the sound level between the front and rear speakers.

Press the AUDIO button again or wait 5 seconds to exit setting tone, balance, and fade.

Time Button

Press the TIME button to change the display between radio frequency and time.

General Information

This radio complies with Part 15 of FCC rules and with RSS-210 of Industry Canada. Operation is subject to the following conditions:

1. This device may not cause harmful interference,
2. This device must accept any interference received, including interference that may cause undesired operation.

NOTE: Changes or modifications not expressly approved by the party responsible for compliance could void the user's authority to operate the equipment.

CD Player Operation

NOTE: The ignition switch must be in the ON or ACC position and the Power / Volume control pushed ON before the CD player will operate.

Inserting The Compact Disc

CAUTION!
This CD player will accept 4 ¾ inch (12 cm) discs only. The use of other sized discs may damage the CD player mechanism.

You may either insert or eject a disc with the radio OFF.

If you insert a disc with the ignition ON and the radio OFF, the display will show the time of day. If you insert a disc with the ignition OFF, the display will show the time of day for about 5 seconds, then go out.

If you insert a disc with the ignition ON and the radio ON, the unit will switch from radio to CD mode and begin to play when you insert the disc. The display will show the disc number, the track number, and index time in minutes and seconds. Play will begin at the start of track 1.

LOAD/ EJT — Load

Press the LOAD/ EJT button and the button with the corresponding number where the CD is being loaded. After the radio displays “load” insert the CD into the player.

Radio display will show “loading” when it is being loaded.

LOAD / EJT — Eject

Press the LOAD/ EJT button and the button with the corresponding number where the CD was loaded and the disc will unload and move to the entrance for easy removal.

Radio display will show “ejecting” when it is being ejected.

If you have ejected a disc and have not removed it within 15 seconds, it will be reloaded. If the CD is not removed, the radio will continue to play the non-removed CD. If the CD is removed and there are other CD's in the radio, the radio will play the next CD. If the CD is removed and there are no other CD's in the radio, the radio will return to the last selected AM or FM mode.

The disc can be ejected with the radio and ignition OFF.

Seek

Press the top of the SEEK button for the next selection on the CD. Press the bottom of the button to return to the beginning of the current selection, or return to the beginning of the previous selection if the CD is within the first second of the current selection.

Scan

Press the Scan button to scan through each track on the CD currently playing.

FF/TUNE/RW

Press FF (Fast Forward) and the CD player will begin to fast forward until FF is released. The RW (Reverse) button works in a similar manner.

Random Play — SET / RND

Press the RND button while the CD is playing to activate Random Play. This feature plays the tracks on the disc in random order to provide an interesting change of pace.

Press the SEEK button to move to the next randomly selected track.

Press the SET / RND button a second time to stop Random Play.

PTY (Program Type) Button

Pressing this button once will turn on the PTY mode for 5 seconds. If no action is taken during the 5 second time out the PTY icon will turn off. Pressing the PTY button repeatedly within 5 seconds will allow the program format type to be selected. Many radio stations do not currently broadcast PTY information.

Toggle the PTY button to select the following format types:

Program Type	Radio Display
Adult Hits	Adlt Hit
Classical	Classicl
Classic Rock	Cls Rock
College	College
Country	Country
Emergency	ALERT!
Emergency Test	Test

Program Type	Radio Display
Information	Inform
Jazz	Jazz
Foreign Language	Language
News	News
Nostalgia	Nostalga
Oldies	Oldies
Personality	Persnlty
Public	Public
Rhythm and Blues	R & B
Religious Music	Rel Musc
Religious Talk	Rel Talk
Rock	Rock
Soft	Soft
Soft Rock	Soft Rck
Soft Rhythm and Blues	Soft R&B
Sports	Sports

Program Type	Radio Display
Talk	Talk
Top 40	Top 40
Weather	Weather

By pressing the SEEK button when the PTY icon is displayed, the radio will be tuned to the next frequency station with the same selected PTY name. The PTY function only operates when in the FM mode.

The radio display will flash “SEEK” and the selected PTY program type when searching for the next PTY station. If no station is found with the selected PTY program type, the radio will return to the last station.

If a preset button is activated while in the PTY (Program Type) mode, the PTY mode will be exited and the radio will tune to the preset station.

By pressing the SCAN button when the PTY icon is displayed, the radio will stop at every PTY station on the band and list each corresponding program type in the radio display.

Time

Press the TIME button to change the display from elapsed CD playing time to time of day.

Operating Instructions - Satellite Radio Mode (If Equipped)

Refer to the Satellite Radio section of the Owner's Manual.

CD Diagnostic Indicators

When driving over a very rough road, the CD player may skip momentarily. Skipping will not damage the disc or the player, and play will resume automatically.

As a safeguard and to protect your CD player, one of the following warning symbols may appear on your display.

A CD HOT symbol indicates the player is too hot.

CD HOT will pause the operation. Play can be resumed when the operating temperature is corrected or another MODE is selected.

CD ERROR will appear on the display if the laser is unable to read the Disc data for the following reasons:

- Warped disc
- Excessive vibration
- Disc inserted upside down
- Damaged disc
- Water condensation on optics

SALES CODE RBK—AM/ FM STEREO RADIO WITH CD PLAYER AND CD CHANGER CONTROLS

NOTE: The radio sales code is located on the lower left side of your radio faceplate.

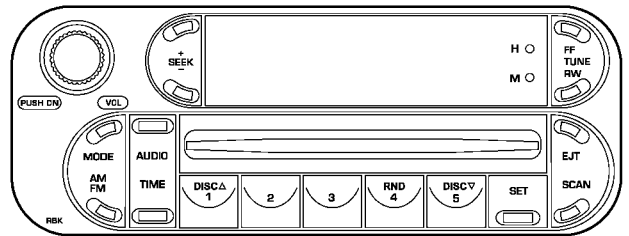

4

813ebac3

RBK Radio

Radio Operation

Power/Volume Control

Press the ON/VOL control to turn the radio on. Turn the volume control clockwise to increase the volume.

NOTE: Power to operate the radio is supplied through the ignition switch. It must be in the ON or ACC position to operate the radio.

Seek

Press and release the SEEK button to search for the next station in either the AM or FM mode. Press the top of the button to seek up or the bottom to seek down. The radio will remain tuned to the new station until you make another selection. Holding the button in will bypass stations without stopping until you release it.

Tune

Press the TUNE control up or down to increase or decrease the frequency. If you press and hold the button,

the radio will continue to tune until you release the button. The frequency will be displayed and continuously updated while the button is pressed.

To Set The Radio Push-Button Memory

When you are receiving a station that you wish to commit to push-button memory, press the SET button. SET 1 will show in the display window. Select the "1-5" button you wish to lock onto this station and press and release that button. If a button is not selected within 5 seconds after pressing the SET button, the station will continue to play but will not be locked into push-button memory.

You may add a second station to each push-button by repeating the above procedure with this exception: Press the SET button twice and SET 2 will show in the display window. Each button can be set for SET 1 and SET 2 in both AM and FM. This allows a total of 10 AM and 10 FM stations to be locked into push-button memory. The

stations stored in SET 2 memory can be selected by pressing the push-button twice. Every time a preset button is used a corresponding button number will be displayed.

Audio

The audio button controls the BASS, TREBLE, BALANCE, and FADE.

Press the AUDIO button and BASS will be displayed. Press the SEEK + or SEEK - to increase or decrease the Bass tones.

Press the AUDIO button a second time and TREB will be displayed. Press the SEEK + or SEEK - to increase or decrease the Treble tones.

Press the AUDIO button a third time and BAL will be displayed. Press the SEEK + or SEEK - to adjust the sound level from the right or left side speakers.

Press the AUDIO button a fourth time and FADE will be displayed. Press the SEEK + or SEEK - to adjust the sound level between the front and rear speakers.

Press the AUDIO button again or wait 5 seconds to exit setting tone, balance, and fade.

AM/FM Selection

Press the AM/FM button to change from AM to FM. The operating mode will be displayed next to the station frequency. The display will show ST when a stereo station is received.

Time

Press the TIME button to change the display between radio frequency and time.

General Information

This radio complies with Part 15 of FCC rules and with RSS-210 of Industry Canada. Operation is subject to the following conditions:

1. This device may not cause harmful interference,
2. This device must accept any interference received, including interference that may cause undesired operation.

NOTE: Changes or modifications not expressly approved by the party responsible for compliance could void the user's authority to operate the equipment.

CD Player Operation

NOTE: The ignition switch must be in the ON or ACC position and the volume control ON before the CD player will operate.

Inserting The Compact Disc**CAUTION!**

This CD player will accept 4 ¾ inch (12 cm) discs only. The use of other sized discs may damage the CD player mechanism.

You may either insert or eject a disc with the radio OFF.

If you insert a disc with the ignition ON and the radio OFF, the display will show the time of day.

If the power is ON, the unit will switch from radio to CD mode and begin to play when you insert the disc. The display will show the track number and index time in minutes and seconds. Play will begin at the start of track one.

Seek

Press the top of the SEEK button for the next selection on the CD. Press the bottom of the button to return to the beginning of the current selection, or return to the beginning of the previous selection if the CD is within the first second of the current selection.

EJT — Eject

Press the EJT button and the disc will unload and move to the entrance for easy removal. The unit will switch to the radio mode.

If you do not remove the disc within 15 seconds, it will be reloaded. The unit will continue in radio mode.

The disc can be ejected with the radio and ignition OFF (except on convertibles).

FF/TUNE/RW

Press FF (Fast Forward) and the CD player will begin to fast forward until FF is released. The RW (Reverse) button works in a similar manner.

Random Play — RND/Program Button 4

Press the RND (button 4) button while the CD is playing to activate Random Play. This feature plays the tracks on the selected disc in random order to provide an interesting change of pace.

Press the SEEK button to move to the next randomly selected track.

Press the RND (button 4) button a second time to stop Random Play.

Mode

Press the MODE button repeatedly to select between the CD player, the optional remote CD changer and the Satellite Radio (if equipped). When Satellite Radio (if equipped) is selected “SAT” will appear in your radio display.

A CD or tape may remain in the player while in the Satellite mode.

Time

Press the TIME button to change the display from elapsed CD playing time to time of day.

CD Changer Control Capability — If Equipped

This radio is compatible with a remote mounted CD changer available through Mopar Accessories. The following instructions are for the radio controls that operate this CD changer.

Mode Button

To activate the CD changer, press the MODE button until CD information appears on the display.

Disc Up/Program Button 1

Press the DISC up (button 1) button to play the next available disc.

Disc Down/Program Button 5

Press the DISC down (button 5) button to play the previous disc.

Seek Button

Press the SEEK up or down to select another track on the same disc. A SEEK symbol will appear on the display.

Fast Forward And Rewind Buttons

Press and hold the FF button for fast forward. Press and hold the RW button for fast reverse.

The audio output can be heard when fast forward and fast reverse are activated.

Random Play (RND)

Press the Random button to play the tracks on the selected disc in random order for an interesting change of pace.

Random can be cancelled by pressing the button a second time or by ejecting the CD from the changer.

Operating Instructions - Satellite Radio Mode (If Equipped)

Refer to the Satellite Radio section of the Owner's Manual.

CD Diagnostic Indicators

When driving over a very rough road, the CD player may skip momentarily. Skipping will not damage the disc or the player, and play will resume automatically.

As a safeguard and to protect your CD player, one of the following warning symbols may appear on your display.

A CD HOT symbol indicates the player is too hot.

CD HOT will pause the operation. Play can be resumed when the operating temperature is corrected or another MODE is selected.

An ERR symbol will appear on the display if the laser is unable to read the Disc data for the following reasons:

- Excessive vibration
- Disc inserted upside down
- Damaged disc
- Water condensation on optics

SALES CODE RB1—AM/FM STEREO RADIO WITH DVD/GPS NAVIGATION SYSTEM

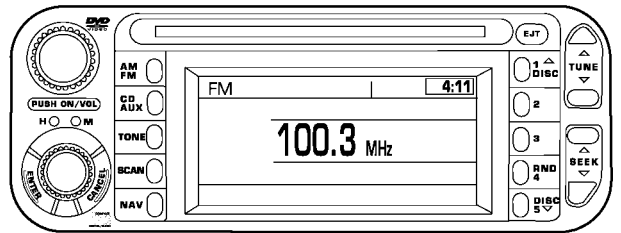

810774da

RB1 Radio

The navigation system provides maps, turn identification, selection menus and instructions for selecting a variety of destinations and routes. Refer to your “Navigation User’s Manual” for detailed operating instructions.

NOTE: If your vehicle is not equipped with the CD Changer option, you will not be able to use the Navigation system and the CD Player simultaneously. Always remove the Navigation DVD before inserting another disc.

Remote Control Operating Instructions

NOTE: Aim the remote control at the radio located on the center of the instrument panel and press the desired button. Direct sunlight or objects blocking the line of sight may affect the function of the remote control.

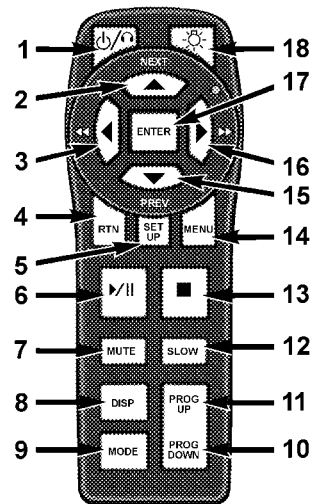

Remote Control

Remote Control Buttons
1. Headphone Transmitter
2. Menu Up/Next Track/Chapter
3. Menu Left/Fast Rewind
4. Return
5. Setup
6. Pause/Play
7. Mute
8. Display
9. Mode
10. Program Down - Previous Disc
11. Program Up - Next Disc
12. Slow
13. Stop
14. Menu
15. Menu Down/Previous Track/Chapter
16. Menu Right/Fast Forward

Remote Control Buttons
17. Enter
18. Light

Headphone Transmitter Button (1)

The headphone transmitter button on the remote control and the power button on the headphones must be turned ON before sound can be heard from the headphones. On some radios the headphone symbol will flash for approximately 5 seconds in the radio display, indicating the headphones are in use.

ARROW Buttons (2, 3, 15, 16)

These arrow buttons only function in CD/ DVD mode. Use the arrow buttons to toggle through the disc menu screen options.

RTN Button (4)

This button only functions in CD/DVD mode. Press this button to return to the previous menu when in the disc menu mode.

SETUP Button (5)

This button only functions in CD/DVD mode. Press the button after pressing the STOP button to access the set up menu. Use the right and left arrows to move between tabs for language, rating, mark, audio and aspect. Use the up and down arrows to move between options within each tab.

To change an item highlighted in blue, press ENTER. This should cause the highlight to turn yellow. Again, using the up and down arrows will cause the arrow to move up or down. Once the arrow is on the desired selection, press ENTER. When finished, press setup or play to return to playing the CD/DVD or Menu to return to the disc menu.

PAUSE/PLAY Button (6)

This button only functions in DVD video mode. Press this button once to pause the video, press a second time to play the video.

MUTE Button (7)

No function.

DISP Button (8)

This button only functions in DVD video mode. When a DVD video is playing, press this button to display the play menu options.

MODE Button (9)

This button changes between available modes and can be heard in the headphones.

PROG UP/DOWN Buttons (10, 11)

PROG UP selects the next disc loaded in the changer. PROG DOWN selects the previous disc loaded in the changer.

SLOW Button (12)

This button only functions in DVD video mode. Press this button to advance the video. If the DVD is paused, pressing this button will advance the video frame by frame.

STOP Button (13)

This button only functions in DVD video mode. Press this button to stop the DVD.

MENU Button (14)

This button only functions in DVD video mode. Press this button to select the DVD disc menu.

NEXT/PREV Buttons (2, 15)

Press the up arrow or the NEXT button for the next chapter or track on the disc. Press the down arrow or PREV button to return to the beginning of the current chapter or track. Press the down arrow or PREV button twice within two seconds to return to the previous chapter or track. Each press of the NEXT/PREV button up or down will toggle through the chapters or tracks.

FF/RW Buttons (3, 16)

Press and hold FF (Fast Forward) once and the CD/DVD changer will begin to fast forward until the FF button is released. The RW (Reverse) button works in a similar manner.

ENTER Button (17)

This button only functions in DVD video mode. Use the ENTER button to enter selections from the menu screens. Use the arrow buttons to toggle through the menu screen options.

Light Button (18)

Pressing this button illuminates the buttons on the remote control.

Remote Control Battery Service

- To replace the batteries for the remote control slide the cover rearward.

The replacement batteries for the remote control are two AAA batteries.

Operating Instructions — Video Screen

Push up on the release button to lower the video screen.

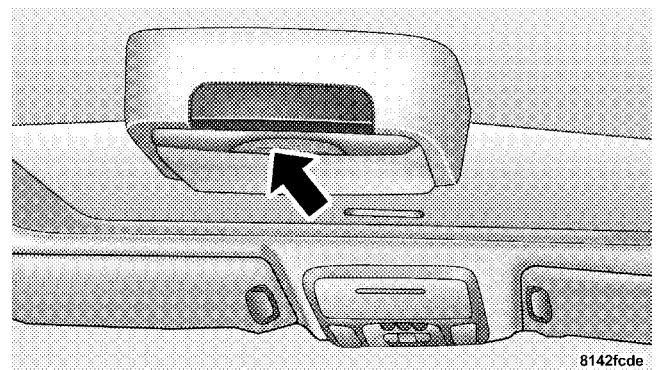

8142fcde

Lowering Video Screen

1. Screen Width Button

Changes the width of the screen picture.



2. Enter Button

This button will enter the selection from the on-screen menu.



3. Brightness Button

Changes the brightness of the screen picture.

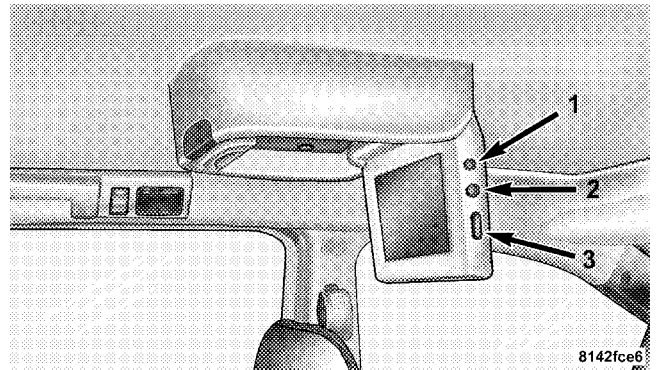

Video Screen Controls

Operating Instructions — Headphones

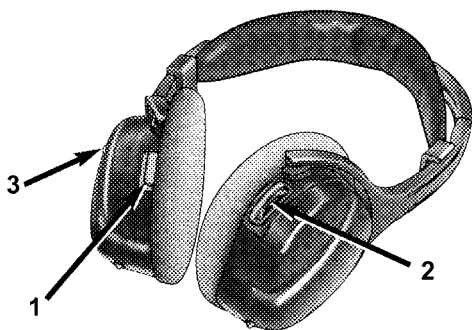

Headphone Controls

1. Power Button
2. Volume Control
3. Power Indicator

Power Button

Pressing the power button will turn the headphones ON/OFF. An indicator light will illuminate on the headphone earpiece to indicate the headphones are ON.

NOTE:

- The headphones will turn off automatically in approximately 3 minutes if they lose the signal from the system or when the radio or rear audio/video system is turned off.

Volume Control

Rotate the volume control to adjust the volume to the desired listening level.

812cd573

Headphone Battery Service

- Press the button at the bottom of each headphone earpiece and lift the cover upward.

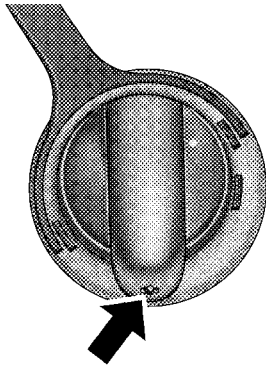

812cd563

Headphone Battery Service

- Replace the battery in each earpiece and reinstall the cover. The headphones require two AAA batteries.

General Information

This device complies with part 15 of the FCC rules and RSS 210 of Industry Canada. Operation is subject to the following two conditions: (1) This device may not cause harmful interference and (2) This device must accept any interference received, including interference that may cause undesired operation.

If you do not hear sound coming from the headphones, check for the following conditions:

1. Rear Seat Audio/Video System and headphones are on. Press the headphone transmitter button (1) on the remote control and the power button on the headphones. An indicator light will illuminate on the headphone earpiece to indicate the headphones are ON.
2. Weak batteries in the headphones.
3. Direct sunlight or objects blocking the line of sight between the headphone transmitter on the video screen and the headphones.

Operating Instructions — MP3 Player, Portable Walkman

An MP3 player can be connected to the audio system. Connect the cables to the RCA jacks located on the front of the CD/DVD changer.

NOTE: Follow the manufactures instructions for the correct colors when connecting the RCA cables.

Operating Instructions — Video Games/Camcorders

A video game unit or camcorder can be connected to the rear audio/video system. Connect the cables to the RCA jacks located on the front of the CD/DVD changer.

NOTE: To operate a video game unit a DC to AC adapter may be required, plug the adapter into any power outlet.

Follow the manufactures instructions for the correct colors when connecting the RCA cables.

NOTE: MP3 player's, video game systems, camcorders connected to the RCA jacks and CD's or DVD's inserted into the radio, can be heard through the headphones or the cabin when AUX Mode is selected.

SATELLITE RADIO — IF EQUIPPED

Satellite radio uses direct satellite to receiver broadcasting technology to provide clear digital sound, coast to coast. The subscription service provider is Sirius™ Satellite Radio. This service offers up to 100 channels of music, sports, news, entertainment, and programming for children, directly from its satellites and broadcasting studios.

System Activation

To activate your Sirius Satellite Radio service, call the toll-free number 888-539-7474, or visit the Sirius web site at www.sirius.com. Please have the following information available when activating your system:

1. The Electronic Serial Number/Sirius Identification Number (ESN/SID).

2. Credit card information.
3. Your Vehicle Identification Number.

Electronic Serial Number/Sirius Identification Number (ENS/SID)

The Electronic Serial Number/Sirius Identification Number is needed to activate your Sirius Satellite Radio system. To access the ENS/SID, refer to the following steps:

ENS/SID Access With RBB, REV and RBK Radios

With the ignition switch in the ACCESSORY position and the radio OFF, press the Tape Eject or CD Eject (depending on the radio type) and Time buttons simultaneously for 3 seconds. The first four digits of the twelve-digit ENS/SID number will be displayed. Press the SEEK UP button to display the next four digits. Continue to press the SEEK UP button until all twelve ENS/SID digits have been displayed. The SEEK DOWN will page down until the first four digits are displayed. The radio will exit the

ENS/SID mode when any other button is pushed, the ignition is turned OFF, or 5 minutes has passed since any button was pushed.

ENS/SID Access With RBP, RBU, RAZ, RB1 and RBQ Radios

With the ignition switch in the ACCESSORY position and the radio OFF, press the CD Eject and TIME buttons simultaneously for 3 seconds. All twelve ENS/SID numbers will be displayed. The radio will exit the ENS/SID mode when any other button is pushed, the ignition is turned OFF, or 5 minutes has passed since any button was pushed.

Selecting Satellite Mode in RBB, REV and RBK Radios

Press the MODE button repeatedly until "S A" appears in the display. A CD or tape may remain in the radio while in the Satellite radio mode.

Selecting Satellite Mode in RBP, RBU, RAZ, RB1 and RBQ Radios

Press the MODE button repeatedly until the word "SIRIUS" appears in the display. These radios will also display the following:

- After 3 seconds, the current channel name and channel number will be displayed for 5 seconds.
- The current program type and channel number will then be displayed for 5 seconds.
- The current channel number will then be displayed until an action occurs.

A CD or tape may remain in the radio while in the Satellite radio mode.

Selecting a Channel

Press and release the SEEK or TUNE buttons to search for the next channel. Press the top of the button to search up and the bottom of the button to search down. Holding the TUNE button causes the radio to bypass channels until the button is released.

Press and release the SCAN button (if equipped) to automatically change channels every 7 seconds. The radio will pause on each channel for 7 seconds before moving on to the next channel. The word "SCAN" will appear in the display between each channel change. Press the SCAN button a second time to stop the search.

NOTE: Channels that may contain objectionable content can be blocked. Contact Sirius Customer Care at 888-539-7474 to discuss options for channel blocking or unblocking. Please have your ESN/SID information available.

Storing and Selecting Pre-Set Channels

In addition to the 10 AM and 10 FM pre-set stations, you may also commit 10 satellite stations to push button memory. These satellite channel pre-set stations will not erase any AM or FM pre-set memory stations. Follow the memory pre-set procedures that apply to your radio.

Using the PTY (Program Type) Button (If Equipped)

Follow the PTY button instructions that apply to your radio.

PTY Button "SCAN"

When the desired program type is obtained, press the "SCAN" button within five seconds. The radio will play 7 seconds of the selected channel before moving to the next channel of the selected program type. Press the "SCAN" button a second time to stop the search.

NOTE: Pressing the "SEEK" or "SCAN" button while performing a music type scan will change the channel by one and stop the search. Pressing a pre-set memory button during a music type scan, will call up the memory channel and stop the search.

PTY Button "SEEK"

When the desired program is obtained, press the "SEEK" button within five seconds. The channel will change to the next channel that matches the program type selected.

Satellite Antenna

To ensure optimum reception, do not place items on the roof around the rooftop antenna location. Metal objects placed within the line of sight of the antenna will cause decreased performance. Larger luggage items should be placed as far forward as possible. Do not place items directly on or above the antenna.

Reception Quality

Satellite reception may be interrupted due to one of the following reasons.

- The vehicle is parked in an underground parking structure or under a physical obstacle.
- Dense tree coverage may interrupt reception in the form of short audio mutes.
- Driving under wide bridges or along tall buildings can cause intermittent reception.
- Placing objects over or too close to the antenna can cause signal blockage.

REMOTE SOUND SYSTEM CONTROLS — IF EQUIPPED

The remote sound system controls are located on the rear surface of the steering wheel at the 3 and 9 O'clock positions.

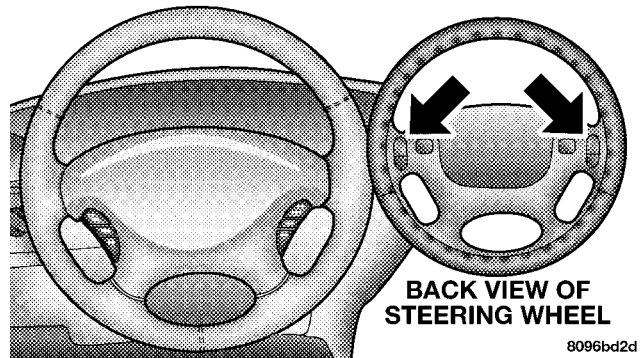

Remote Sound System Controls

The right hand rocker switch has a push button in the center and controls the volume and mode of the sound system. Pressing the top of the rocker switch will increase the volume and pressing the bottom of the rocker switch will decrease the volume. Pressing the center button changes the operation of the radio from AM to FM to Tape or CD mode depending on which radio is in the vehicle.

The left hand rocker switch has a push button in the center. The function of the left hand switch is different depending on which mode you are in.

The following describes the left hand rocker switch operation in each mode:

Radio Operation

Pressing the top of the switch will SEEK up for the next listenable station and pressing the bottom of the switch will SEEK down for the next listenable station.

The button located in the center of the left hand switch will tune to the next pre-set station that you have programmed in the radio pre-set push-button.

Tape Player

Pressing the top of the switch once will go to the next selection on the cassette. Pressing the bottom of the switch once will go to the beginning of the current selection or to the beginning of the previous selection if it is within the first 5 seconds of the current selection.

If you press the switch up or down twice it plays the second selection, three times, it will play the third, etc.

The button in the center of the left hand switch has no function in this mode.

CD Player

Pressing the top of the switch once will go to the next track on the CD. Pressing the bottom of the switch once will go to the beginning of the current track or to the beginning of the previous track if it is within one second after the current track begins to play.

If you press the switch up or down twice it plays the second track, three times, it will play the third, etc.

The button in the center of the left hand switch has no function in this mode.

CASSETTE TAPE AND PLAYER MAINTENANCE

To keep the cassette tapes and player in good condition, take the following precautions:

1. Do not use cassette tapes longer than C-90; otherwise, sound quality and tape durability will be greatly diminished.

2. Keep the cassette tape in its case to protect from slackness and dust when it is not in use.

3. Keep the cassette tape away from direct sunlight, heat and magnetic fields such as the radio speakers.

4. Before inserting a tape, make sure that the label is adhering flat to the cassette.

5. A loose tape should be corrected before use. To rewind a loose tape, insert the eraser end of a pencil into the tape drive gear and twist the pencil in the required directions.

Maintain your cassette tape player. The head and capstan shaft in the cassette player can pick up dirt or tape deposits each time a cassette is played. The result of deposits on the capstan shaft may cause the tape to wrap around and become lodged in the tape transport. The other adverse condition is low or "muddy" sound from one or both channels, as if the treble tone control were

turned all the way down. To prevent this, you should periodically clean the head with a commercially available WET cleaning cassette.

As preventive maintenance, clean the head about every 30 hours of use. If you wait until the head becomes very dirty (noticeably poor sound), it may not be possible to remove all deposits with a simple WET cleaning cassette.

CD/DVD DISC MAINTENANCE

To keep the CD/DVD discs in good condition, take the following precautions:

1. Handle the disc by its edge; avoid touching the surface.
2. If the disc is stained, clean the surface with a soft cloth, wiping from center to edge.
3. Do not apply paper, paper CD labels, or tape to the disc; avoid scratching the disc.
4. Do not use solvents such as benzine, thinner, cleaners, or antistatic sprays.
5. Store the disc in its case after playing.
6. Do not expose the disc to direct sunlight.
7. Do not store the disc where temperatures may become too high.

RADIO OPERATION AND CELLULAR PHONES

Under certain conditions, the cellular phone being On in your vehicle can cause erratic or noisy performance from your radio. This condition may be lessened or eliminated by relocating the cellular phone antenna. This condition is not harmful to the radio. If your radio performance does not satisfactorily “clear” by the repositioning of the antenna, it is recommended that the radio volume be turned down or off during cellular phone operation.

CLIMATE CONTROLS

The Air Conditioning and Heating System is designed to make you comfortable in all types of weather.

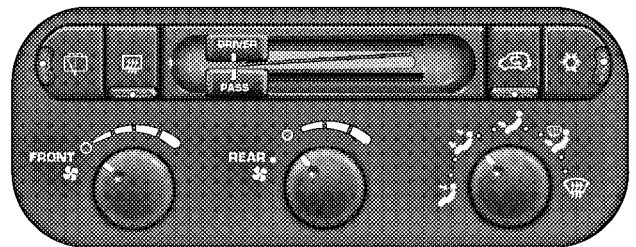
Manual Air Conditioning and Heating System

811a44f0

Manual Air Conditioning and Heating Controls**Front Blower Control**

 The Front Blower Control selects whether the Climate Control System is ON or OFF. When the blower control is set to the O (OFF) position the front blower will turn off and the system will be placed in the Recirculation

mode. When the blower control is set to any position other than off, it selects the amount of air delivered to the passenger compartment. There are four blower speeds.

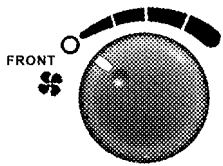

811a44f8

The fan speed increases as you move the control clockwise.

Dual Zone Temperature Control — If Equipped

With the Dual Zone Temperature Control System, each front seat occupant can independently control the temperature of air coming from the outlets on their side of the vehicle.

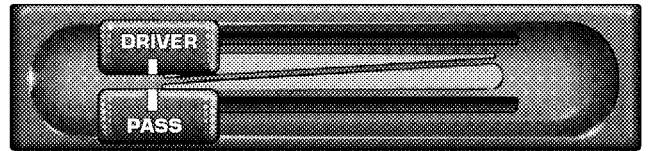

8096321c

Dual Zone Temperature Control

This is accomplished by having a separate temperature control lever for both the driver and front seat passenger. The blue area of the scale indicates cooler temperatures while the red area indicates warmer temperatures.

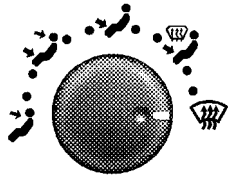
Front Mode Control

809630dd

The mode control allows you to choose from several patterns of air distribution.

NOTE: To improve your selection choices, the system allows you to operate at intermediate positions between the major modes. These intermediate positions are identified by the small dots.

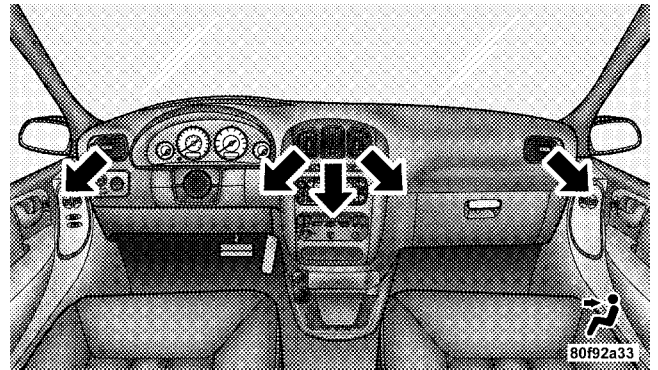
Panel Mode

80f92a33

Panel Outlets

Air comes from the outlets in the instrument panel. Each of these outlets can be individually adjusted to direct the flow of air. Moving the air vane knob on the center outlets down, will close off the air flow from the center outlets. The thumbwheel next to the outboard outlets can be rotated to regulate or shut off the air flow from these outlets.

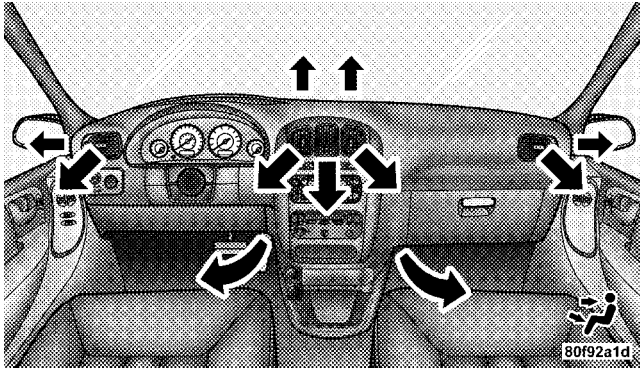
Bi-Level Mode**Bi-Level Outlets**

Air comes from both the instrument panel outlets, floor outlets and defrost. A slight amount of air is also directed through the side window demister outlets.

NOTE: In many temperature lever positions, the bi-level mode is designed to provide cooler air out of the panel outlets and warmer air from the floor outlets.

Floor Mode

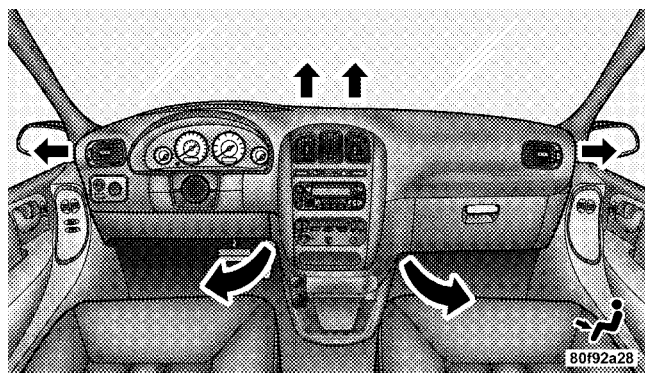

Floor Outlets

Air comes from the floor outlets. A slight amount of air is directed through the defrost and side window demister outlets.

Mix Mode

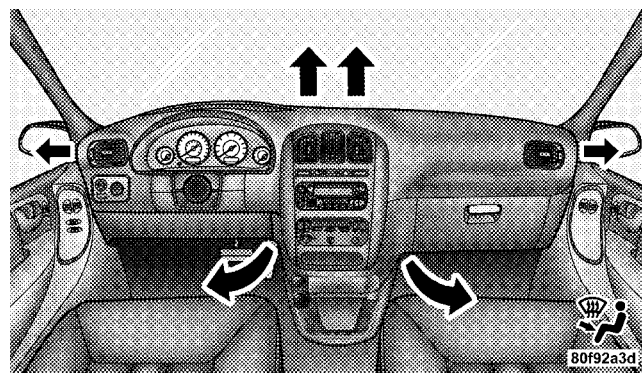

Mix Outlets

Air comes from the floor, defrost and side window demister outlets. This mode works best in cold or snowy conditions. It allows you to stay comfortable while keeping the windshield clear.

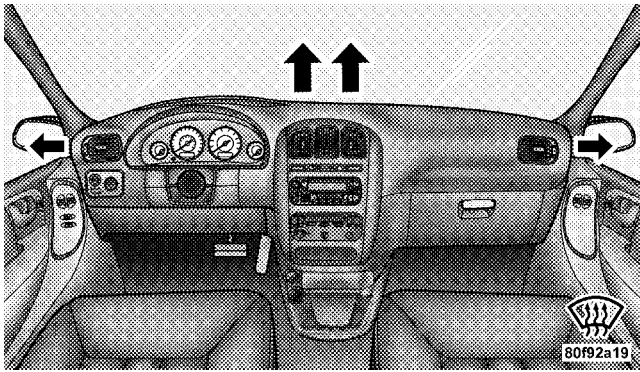
Defrost Mode**Defrost Outlets**

Air comes from the windshield and side window demist outlets. Use this setting when necessary to defrost your windshield and side windows.

NOTE: For improved safety, the compressor is activated and the recirculation mode is deactivated when Mix or

Defrost modes are selected. This is done to assist in drying the air and it will help in keeping the windows from fogging.

Manual Air Conditioning Operation

 To turn on the air conditioning, set the front blower control to any position except O (OFF) and press the A/C button which is located next to the recirculation button. An indicator light on the A/C button shows that the air conditioning is on.

Cool dehumidified air comes through the outlets selected by the Mode Control. To turn off the air conditioning, press the A/C button a second time. The indicator light will turn off.

NOTE:

- The compressor will not engage until the engine has been running for a few seconds.

- If your air conditioning performance seems lower than expected, check the A/C air filter, if so equipped, and the front of the A/C condenser for an accumulation of dirt or insects. The A/C condenser is located in front of the radiator. The A/C air filter is located under the instrument panel on the passenger side.
- Fabric type fascia protectors tend to block the amount of air to the condenser and may reduce air conditioning performance.

Economy Mode

If economy mode is desired, press the A/C button to turn off the indicator light, and the A/C compressor. Move the temperature control lever to the desired temperature.

Recirculation Control



Press the recirculation button to recirculate the air inside the vehicle. This is located next to the A/C button. An indicator light on the button shows that air is being recirculated. Use the

recirculation mode to rapidly cool the inside of the vehicle. The recirculation mode can also be used to temporarily block out outside odors, smoke, and dust.

NOTE:

- When the ignition switch is turned OFF, the recirculation feature will be cancelled.
- In cold weather, use of the Recirculation mode may lead to excessive window fogging. The Recirculation mode is not allowed in the Mix and Defrost modes to improve window clearing operation. Recirculation will be disabled automatically if these modes are selected.
- If the recirculation button is pressed while in the Mix or Defrost mode, the indicator light in the recirculation button will flash 3 times indicating that recirculation is not allowed.

A/C Recirculation Programming

The recirculation control is programmed to cancel the recirculation mode when the ignition key is turned OFF and will reset to outside air mode when the ignition key is turned ON. The frequent use of outside air will help keep odors from building up within the air conditioner-heater housing. It is recommended that the recirculation mode be used as little as possible, especially in humid climates.

For hot and dry climates, or people who are allergic to pollen and find frequent use of the recirculation mode necessary, the recirculation mode can be programmed to not automatically reset to the outside mode by using the following procedures:

- Turn the ignition switch to the OFF position.
- Set the mode control to "PANEL".

- Depress and hold in the "Rear Wipe/Wash" button.
- Start the engine, and continue to hold in the "Rear Wipe/Wash" button until the indicator light starts flashing repeatedly.
- Press the recirculation button until the indicator light remains lit.
- The selection will be stored when the ignition switch is turned OFF or if the "Rear Wipe/Wash" button is pressed.

If the recirculation indicator light is lit, the recirculation mode will not reset when the engine is started. If the recirculation indicator light is not lit, the recirculation mode will reset to the outside air mode when the engine is started. The programmed status can be changed back and forth by following the above mentioned procedure.

Manual Rear Zone Climate Control — If Equipped

The Manual Rear Zone Climate Control system has floor air outlets to the rear of the right side sliding door and overhead outlets at each outboard rear seating position. The unit provides warm or cool air through the floor and upper outlets.

The rear blower and temperature controls for the rear seat passengers are located in the headliner near the center of the vehicle.



8094fa17

Manual Rear Zone Climate Control

Rear Blower Control

The primary control for the rear blower is on the front climate control unit located on the instrument panel.

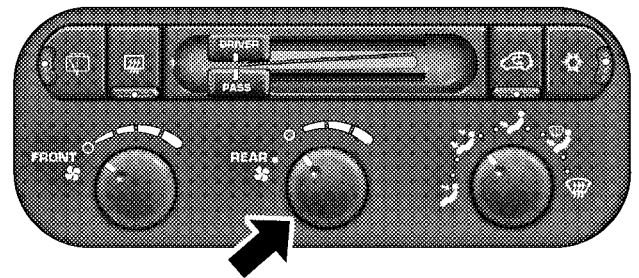

812b0f10

Rear Blower Control

The center knob on the front climate control unit has five positions, "REAR", "OFF", and a range of blower speeds. Only when the primary control for the rear blower is in the "REAR" position do the second seat occupants have control of the rear blower speed.

The rear blower control, located in the headliner near the center of the vehicle has an OFF position and 3 blower speed positions. This allows the second seat occupants to control the volume of air circulated in the rear of the vehicle.

CAUTION!

Interior air enters the Manual Rear Zone Climate Control system through an intake grille located in the passenger side trim panel behind the third seat. The heater outlets are located in the passenger side trim panel just behind the sliding door. Do not block or place objects directly in front of the inlet grille or heater outlets. The electrical system could overload causing damage to the blower motor.

Rear Temperature And Mode Control

When the center knob on the front climate control unit is set to the “REAR” position, the second seat occupants have control of the rear temperature and modes as follows:

- The rear temperature knob controls both the rear temperature and mode. When the temperature knob is in the cold position, cold air will be delivered from the headliner outlets. As the rear temperature knob is turned towards hot, the air will get warmer, and the air will be delivered from both the headliner and floor outlets. When the rear temperature knob reaches the full hot position, all of the air will be delivered from the floor outlets.
- When the center knob on the front climate control unit is set to any position other than “REAR”, the rear

temperature selection follows the setting of the driver’s temperature control on the front climate control unit. The rear mode selection follows the setting of the front mode control.

Rear Economy Mode

If rear economy mode is desired, set the center knob on the front control unit to the “REAR” position. Turn the A/C button OFF and select any mode except “MIX” or “DEFROST”.

The rear temperature knob and the rear blower speed can be adjusted as desired by the second seat occupants.

Automatic Temperature Control — If Equipped

The Infrared Three-Zone Automatic Temperature Control System automatically maintains the interior comfort level desired by the driver and all passengers. This is accomplished by using two infrared sensors, located in the center of the instrument panel. The two infrared sensors independently measure the surface temperature of the

driver and passenger. Based on the sensor input, the system automatically adjusts the air temperature, the air flow volume, and amount of outside air recirculation. This maintains a comfortable temperature even under changing conditions.

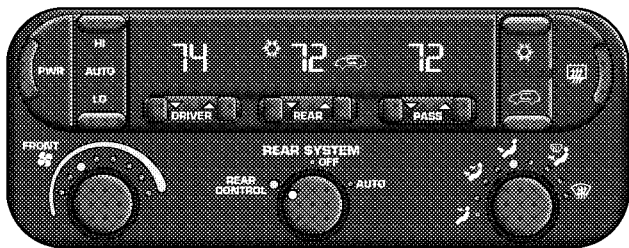

80944b30

Three-Zone Automatic Temperature Control

Operation of the system is quite simple. Begin by pressing the auto rocker switch to the “HI” or “LO” position, the word “AUTO” will illuminate in the front ATC display along with “HI” or “LO”. The system will then

automatically regulate the amount of air flow. Next, dial in the temperature you would like the system to maintain by pressing the driver’s or passenger’s temperature control button. The rear temperature can only be adjusted from the front when the “REAR SYSTEM” knob on the front ATC unit is in the “AUTO” position. Once the desired temperature is displayed, the system will achieve and maintain that comfort level automatically. When the system is set up for your comfort level, it is not necessary to change the settings. You will experience the greatest efficiency by simply allowing the system to function automatically.

NOTE:

- It is not necessary to move the temperature settings for cold or hot vehicles. The system automatically adjusts the temperature, mode and fan speed to provide comfort as quickly as possible.

- The temperature can be displayed in U.S. or Metric by selecting the US/M customer programmable feature. Refer to the “Overhead Console-Customer Programmable Features” in Section 3 of this manual.

To provide you with maximum comfort in the automatic mode, during cold start-ups the blower fan will remain off and “DELAY” will appear in the front ATC display until the engine warms up. Also, an estimate of the time remaining until the “DELAY” is over will appear periodically in the display. However, the fan will engage immediately if the defrost mode is selected or by rotating the blower control to any fixed blower speed.

This feature may be disabled using the following procedure:

- Press and hold the Heated Rear Window and Auto LO buttons for 5 seconds.

- The “DELAY” symbol will flash to indicate that the feature has been disabled.

This feature may be enabled using the following procedure:

- Press and hold the Heated Rear Window and Auto HI buttons for 5 seconds.
- The “DELAY” symbol will flash to indicate that the feature has been enabled.

Power Button

This button turns the entire system ON/OFF. When the system is turned on it will return to the previous settings.

Manual Operation

This system offers a full complement of manual override features. The “AUTO” symbol in the front ATC display will be turned off when the system is being used in the manual mode.

NOTE: Each of these features operate independently from each other. If any one feature is controlled manually, the remaining features will continue to operate automatically.

The left blower control knob can be set to any fixed blower speed by rotating the knob from low to high. The fan will now operate at a fixed speed until additional speeds are selected or either the "Auto HI" or "Auto LO" buttons are pressed. This allows the front occupants to control the volume of air circulated in the vehicle and cancel the "AUTO" mode.

The operator can also select the direction of the air by rotating the right mode control knob to one of the following positions.

Panel Mode

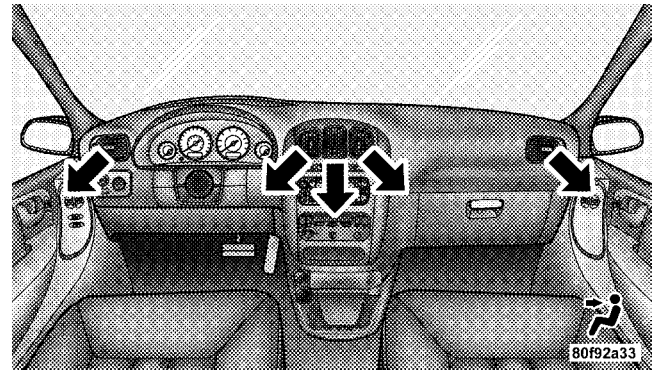

Panel Outlets

Air comes from the outlets in the instrument panel. Each of these outlets can be individually adjusted to direct the flow of air. Moving the air vane knob on the center outlets down, will close off the air flow from the center outlets. The thumbwheel next to the outboard outlets can be rotated to regulate or shut off the air flow from these outlets.

Bi-Level Mode

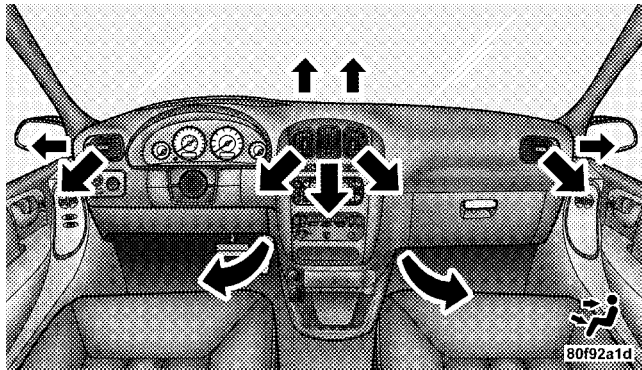

Bi-Level Outlets

Air comes from both the instrument panel outlets, floor outlets and defrost. A slight amount of air is also directed through the side window demister outlets.

NOTE: In many temperature positions, the bi-level mode is designed to provide cooler air out of the panel outlets and warmer air from the floor outlets.

Floor Mode

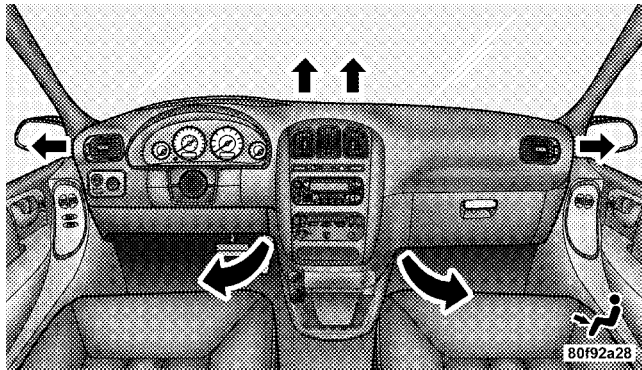

Floor Outlets

Air comes from the floor outlets. A slight amount of air is directed through the defrost and side window demister outlets.

Mix Mode

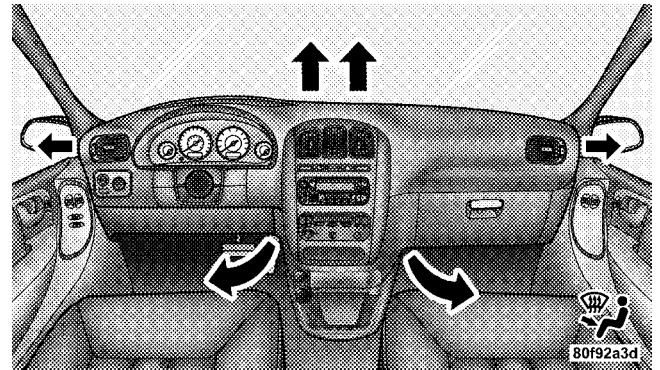

Mix Outlets

Air comes from the floor, defrost and side window demister outlets. This mode works best in cold or snowy conditions. It allows you to stay comfortable while keeping the windshield clear.

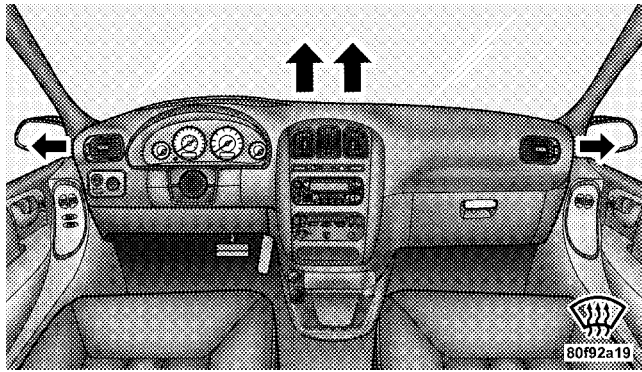
Defrost Mode**Defrost Outlets**

Air comes from the windshield and side window demist outlets. Use this setting when necessary to defrost your windshield and side windows.

NOTE: While operating in either "Auto HI" or "Auto LO", the system will not automatically sense the presence of fog, mist, or ice on the windshield. "Defrost" mode must be manually selected to clear the windshield and side glass.

 The "snowflake" or "a/c" button allows the operator to manually activate or deactivate the air conditioning system. When the snowflake symbol in the ATC display is on, cool, dehumidified air flows through the air outlets. If economy mode is desired, press the snowflake button to turn off the snowflake icon in the ATC display and deactivate the air conditioning system. Note: While operating in "auto hi" or "auto lo", the air conditioning system is always activated. If fog, or mist appears on the windshield or side glass, select "defrost" mode and increase blower speed.

Recirculation Control



When outside air contains smoke, odors, high humidity, or if rapid cooling is desired, you may wish to recirculate interior air by pressing the recirculation button. The recirculation mode should only be used temporarily. The recirculation symbol will illuminate in the display when this button is selected. Push the button a second time to turn off the recirculation icon in the display and allow outside air into the vehicle.

NOTE: In cold weather, use of the Recirculation mode may lead to excessive window fogging. The Recirculation mode is not allowed in the Mix and Defrost modes to improve window clearing operation. Recirculation will be disabled automatically if these modes are selected.

Auxiliary Rear Automatic Temperature Control — If Equipped

The Rear Automatic Temperature Control System has floor air outlets to the rear of the right side sliding door and overhead outlets at each outboard rear seating position. The system provides heated air through the floor outlets or cool, dehumidified air through the headliner outlets.

The “REAR SYSTEM” knob for the Rear Automatic Temperature Control System is on the front ATC control unit located on the instrument panel.

Selecting the “AUTO” position for the Rear Automatic Temperature Control System from the front ATC control unit, illuminates a “LOCK” symbol in the rear display. The rear temperature and air source are controlled from the front ATC control unit.

The “REAR SYSTEM” knob on the front ATC control unit has three positions, “REAR CONTROL”, “OFF”, and

“AUTO”. Only when the “REAR SYSTEM” knob is in the “REAR CONTROL” position do the second seat occupants have control of the Rear Automatic Temperature Control System.

The Rear Automatic Temperature Control System is located in the headliner near the center of the vehicle.

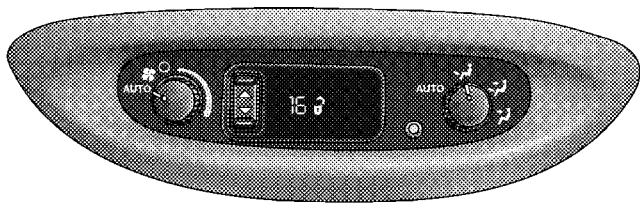

80cb5567

Rear Automatic Temperature Control

Operation of the rear system is quite simple. Begin by rotating the rear system center control knob on the front ATC control unit to the “REAR CONTROL” position, this illuminates an “UNLOCK” symbol in the rear display. Next, rotate the Rear Blower Control and the Rear Mode Control to the “AUTO” positions. Select the temperature you would like the system to maintain by pressing the Rear Temperature Control button. Once the desired temperature is displayed, the system will achieve and maintain that comfort level automatically. When the system is set up for your comfort level, it is not necessary to change the settings. You will experience the greatest efficiency by simply allowing the system to function automatically.

NOTE:

- It is not necessary to move the temperature settings for cold or hot vehicles. The system automatically adjusts the temperature, mode and fan speed to provide comfort as quickly as possible.

- The temperature can be displayed in U.S. or Metric by selecting the US/M customer programmable feature. Refer to the “Overhead Console-Customer Programmable Features” in Section 3 of this manual.

Rear Blower Control

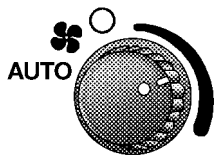

The rear blower control, located in the headliner near the center of the vehicle has an “OFF”, “AUTO” and a range of blower speeds.

The rear blower control knob can be manually set to “OFF” or any fixed blower speed by rotating the knob from low to high. This allows the rear seat occupants to control the volume of air circulated in the rear of the vehicle.

CAUTION!

Interior air enters the Rear Automatic Temperature Control System through an intake grille located in the passenger side trim panel behind the third seat. The heater outlets are located in the passenger side trim panel just behind the sliding door. Do not block or place objects directly in front of the inlet grille or heater outlets. The electrical system could overload causing damage to the blower motor.

4

Rear Temperature Control

To change the temperature in the rear of the vehicle, press the temperature control button down for cold and up for heated air.

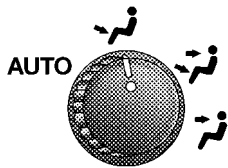
Rear Mode Control

The Rear Mode Control, located in the headliner near the center of the vehicle can be used to select between Auto, Headliner, Bi-Level and Floor modes.

Auto Mode

The rear system automatically maintains the correct mode and comfort level desired by the rear seat occupants.

Floor Mode

 Air comes from the floor outlets.

Bi-Level Mode

 Air comes from both the headliner outlets and the floor outlets.

NOTE: In many temperature positions, the bi-level mode is designed to provide cooler air out of the headliner outlets and warmer air from the floor outlets.

Headliner Mode

 Air comes from the outlets in the headliner. Each of these outlets can be individually adjusted to direct the flow of air. Moving the air vane knob on the outlets to one side will shut off the air flow.

Summer Operation

The engine cooling system in air conditioned vehicles must be protected with a high-quality antifreeze coolant to provide proper corrosion protection and to protect against engine overheating. A 50% solution of ethylene

glycol antifreeze coolant in water is recommended. Refer to section 7, Maintenance Procedures, of this manual for proper coolant selection.

Winter Operation

To insure the best possible heater and defroster performance, make sure the engine cooling system is functioning properly and the proper amount, type, and concentration of coolant is used. Refer to section 7, Maintenance Procedures, of this manual for proper coolant selection. Use of the air Recirculation mode during winter months is not recommended because it may cause window fogging.

Vacation Storage

Anytime you store your vehicle, or keep it out of service (i.e. vacation) for two weeks or more, run the air conditioning system at idle for about five minutes in the fresh air and high blower setting. This will insure adequate

system lubrication to minimize the possibility of compressor damage when the system is started again.









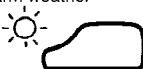

Window Fogging

Vehicle windows tend to fog on the inside in mild rainy or humid weather. To clear the windows, select "defrost" or "mix" mode and increase the front blower speed. Do not use the Recirculation mode without A/C for long periods as fogging may occur.

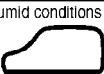
Outside Air Intake

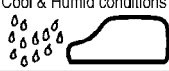
Make sure the air intake, located directly in front of the windshield, is free of obstructions such as leaves. Leaves collected in the air intake may reduce airflow and if they enter the plenum they could plug the water drains. In winter months make sure the air intake is clear of ice, slush and snow.

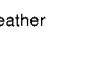
Operating Tips

WEATHER	CONTROL SETTINGS
Hot weather and vehicle interior is very hot 	Set the mode control to  ,  on, and blower on high. Roll down the windows for a minute to flush out the hot air. Once comfort is achieved adjust controls for comfort.
Warm weather 	Turn  on and set the mode control to the  position.
Cool Sunny 	Operate in  position.
Cool & Humid conditions 	Set the mode control to  and turn on  to keep windows clear.
Cold Weather 	Set the mode control to the  position. If windshield fogging starts to occur, move the control towards the  position.

8000eb71

A/C Air Filter — If Equipped

The climate control system filters out dust, pollen and some odors from the air. Strong odors can not be totally filtered out. Refer to MAINTAINING YOUR VEHICLE, “Air Conditioner Maintenance” for filter replacement instructions.

REAR WINDOW FEATURES

Intermittent Rear Wiper Operation — Manual Temperature Control Only

 The controls are located on the Manual Temperature Control head above the front blower control.

When the button is pressed and released and the Ignition Switch in ON, the rear wiper will operate at a fixed interval of about 8 seconds. As vehicle speed increases, the time delay will shorten. The LED indicator will light when the wiper is ON. Pressing and releasing the button again will turn the wiper off.

Rear Washer Operation — Manual Temperature Control Only

 The controls are located on the Manual Temperature Control head above the front blower control.

Press and hold the button for as long as spray is desired. If the button is depressed and held while the Intermittent wiper is on, the wiper will operate for a few seconds after the button is released, then resume intermittent operation. If the button was pressed and held when the intermittent wiper is off, the wiper will operate for two cycles, then turn off. The LED will not illuminate when Washer is selected and Intermittent is OFF.

NOTE: The washer will stop spraying if the switch is pressed longer than 10 seconds.

Vehicles equipped with Automatic Temperature Control, the controls for these features are located in the middle of the instrument panel above the radio.

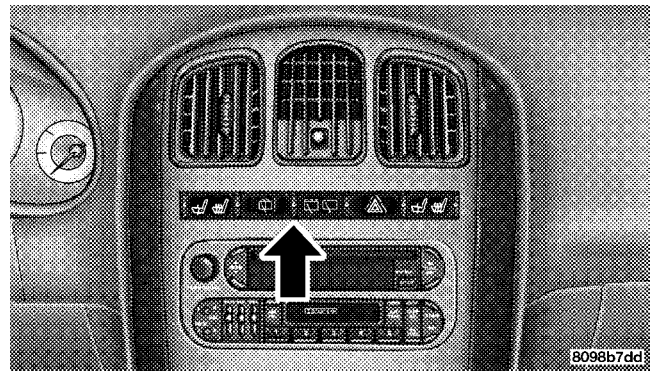

Rear Wiper/Washer Controls

Rear Wiper Operation — Automatic Temperature Control Only

 Press this button to have the rear wiper have a continuous wipe. When the ignition switch is in the ON/RUN position, the rear wiper switch position as well as an indicator light will show that the wiper is ON.

Intermittent Rear Wiper Operation — Automatic Temperature Control Only

 When this button is pressed and the ignition switch is in the ON position, the rear wiper will operate at a fixed interval of about 8 seconds. As vehicle speed increases, the time delay will shorten. The switch position as well as an indicator light will show when the wiper is ON.

Rear Washer Operation — Automatic Temperature Control Only

 Press and hold the button as long as spray is desired. If the switch is depressed while the wipers are on, the wipers will operate for a few seconds after the switch is released then resume the previously set mode of intermittent wiper or continuous wipe. If the switch is depressed when the wipers are off, the wipers will operate for two cycles, then turn off.

NOTE: The washers will stop spraying if the switch is pressed longer than 10 seconds.

Adding Washer Fluid

The fluid reservoir for the windshield washers and the rear window washer is shared. It is located in the front of the engine compartment on the passenger side and should be checked for fluid level at regular intervals. Fill the reservoir with windshield washer solvent (not radiator antifreeze) and operate the system for a few seconds to flush out the residual water.

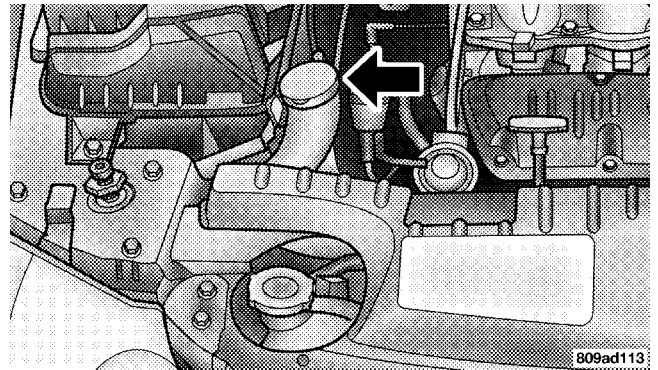

Washer Fluid Reservoir

The washer fluid reservoir will hold a full gallon of fluid when the Low Washer Fluid Light illuminates.

Electric Rear Window Defroster — If Equipped



Press this button to turn on the rear window defroster and the optional heated mirrors. A light will show that the defroster is on. The defroster automatically turns off after about 10 minutes of operation.

If your vehicle is equipped with Infrared Three-Zone Automatic Temperature Control the rear defroster symbol will show in the display screen when the rear window defroster is on.

CAUTION!

To avoid damaging the electrical conductors of the rear window defroster, do not use scrapers, sharp instruments, or abrasive window cleaners on the interior surface of the window.

Labels can be peeled off after soaking with warm water.

STARTING AND OPERATING

CONTENTS

■ Starting Procedures	304	■ Parking Brake	313
□ 2.4L Engine	304	■ Brake System	314
□ 3.3L And 3.8L Engine	306	□ Anti-Lock Brake System — If Equipped	315
■ Engine Block Heater — If Equipped	309	■ Power Steering	317
■ Automatic Transmission	309	■ Traction Control — If Equipped	318
□ Brake/Transmission Interlock System	310	■ Tire Safety Information	320
□ Automatic Transmission Ignition Interlock System	310	□ Tire Markings	320
□ Four Speed Automatic Transmission	310	□ Tire Identification Number (TIN)	323
		□ Tire Loading And Tire Pressure	324

302 STARTING AND OPERATING

■ Tires—General Information	328	□ Check TPM System	337
□ Tire Pressure	328	□ General Information	339
□ Tire Inflation Pressures	329	■ Tire Chains	339
□ Radial-Ply Tires	331	■ Snow Tires	340
□ Compact Spare Tire — If Equipped	332	■ Tire Rotation Recommendations	341
□ Limited Use Spare — If Equipped	333	■ Fuel Requirements	342
□ Tire Spinning	333	□ Reformulated Gasoline	342
□ Tread Wear Indicators	334	□ Gasoline/Oxygenate Blends	343
□ Life Of Tire	335	□ MMT In Gasoline	343
□ Replacement Tires	335	□ Materials Added To Fuel	344
□ Alignment And Balance	336	□ Fuel System Cautions	344
■ Tire Pressure Monitor System — If Equipped	337	□ Carbon Monoxide Warnings	345
□ 1,2,3, Or 4 Tire(s) Low Pressure	337	■ Adding Fuel	346

□ Fuel Filler Cap (Gas Cap)	346	□ Trailer Hitch Classification	353
■ Vehicle Loading	348	□ Trailer Towing Weights (Maximum Trailer Weight Ratings)	353
□ Vehicle Certification Label	348	□ Trailer And Tongue Weight	356
□ Gross Vehicle Weight Rating (GVWR)	348	□ Towing Requirements	358
□ Gross Axle Weight Rating (GAWR)	348	□ Towing Tips	362
□ Overloading	349	■ Recreational Towing (Behind Motorhome, Etc.)	363
□ Loading	349	□ Towing This Vehicle Behind Another Vehicle (Flat Towing With All Four Wheels On The Ground)	363
■ Trailer Towing	350		
□ Common Towing Definitions	351		

STARTING PROCEDURES**CAUTION!**

Long periods of engine idling, especially at high engine speeds, can cause excessive exhaust temperatures which can damage your vehicle. Do not leave your vehicle unattended with the engine running.

WARNING!

Do not leave animals or children inside parked vehicles in hot weather; interior heat build up may cause serious injury or death.

The gear selector must be in the NEUTRAL or PARK position before you can start the engine. Apply the brakes before shifting into any driving gear.

2.4L Engine

Normal Starting of either a cold or a warm engine is obtained without pumping or depressing the accelerator pedal. Turn the key to the "START" position and release when the engine starts. If the engine has not started within 3 seconds, slightly depress the accelerator pedal while continuing to crank. If the engine fails to start within 15 seconds, turn the key to the "OFF" position, wait 10 to 15 seconds, then repeat the normal starting procedure.

Cold Weather (Below 0° C or 32° F) or **High Altitude** (Above 4,000 feet at all temperatures). If engine has not been started within past 3 to 4 hours, slightly depress and hold the accelerator pedal before attempting to start a cold engine. Turn the key to the "START" position. When the engine starts, release first the key, then the accelerator pedal. If the engine fails to start within 15 seconds, discontinue cranking and return the key to the "OFF" position. Repeat the starting procedure.

Extremely Cold Weather (below -29°C or -20°F). To insure reliable starting at these temperatures, use of an externally powered electric engine block heater (available from your dealer) is recommended.

WARNING!

Do not attempt to push or tow your vehicle to get it started. Vehicles equipped with an automatic transmission cannot be started this way. Unburned fuel could enter the catalytic converter and once the engine has started, ignite and damage the converter and vehicle. If the vehicle has a discharged battery, booster cables may be used to obtain a start from a booster battery or the battery in another vehicle. This type of start can be dangerous if done improperly. See section 6 of this manual for the proper jump starting procedures and follow them carefully.

WARNING!

Never pour fuel or other flammable liquid into the throttle body air inlet opening in an attempt to start the vehicle. This could result in flash fire causing serious personal injury.

If Engine Fails to Start

If the engine fails to start after you have followed the "NORMAL STARTING", "COLD WEATHER" or "HIGH ALTITUDE" procedures, it may be flooded. Push the accelerator pedal all the way to the floor and hold it there while cranking the engine. This should clear any excess fuel in case the engine is flooded.

CAUTION!

To prevent damage to the starter, do not crank the engine for more than 15 seconds at a time. Wait 10 to 15 seconds before trying again.

If the engine has been flooded, it may start to run, but not have enough power to continue running when the key is released. If this occurs, continue cranking with the accelerator pedal pushed all the way to the floor. Release the accelerator pedal and the key once the engine is running smoothly. Do not overspeed engine.

If the engine shows no sign of starting after two 15 second periods of cranking with the accelerator pedal held to the floor, the "NORMAL STARTING", "COLD WEATHER" or "HIGH ALTITUDE" procedure should be repeated.

After Starting

The idle speed will automatically decrease as the engine warms up.

3.3L and 3.8L Engine

Normal Starting of either a cold or a warm engine is obtained without pumping or depressing the accelerator pedal. Turn the key to the "START" position and release when the engine starts. If the engine has not started within 3 seconds, slightly depress the accelerator pedal while continuing to crank. If the engine fails to start within 15 seconds, turn the key to the "OFF" position, wait 10 to 15 seconds, then repeat the normal starting procedure.

Extremely Cold Weather (below -29°C or -20°F) To insure reliable starting at these temperatures, use of an externally powered electric engine block heater (available from your dealer) is recommended.

WARNING!

Do not attempt to push or tow your vehicle to get it started. Vehicles equipped with an automatic transmission cannot be started this way. Unburned fuel could enter the catalytic converter and once the engine has started, ignite and damage the converter and vehicle. If the vehicle has a discharged battery, booster cables may be used to obtain a start from a booster battery or the battery in another vehicle. This type of start can be dangerous if done improperly. See section 6 of this manual for the proper jump starting procedures and follow them carefully.

WARNING!

Never pour fuel or other flammable liquid into the throttle body air inlet opening in an attempt to start the vehicle. This could result in flash fire causing serious personal injury.

If Engine Fails to Start

If the engine fails to start after you have followed the "NORMAL STARTING" procedure, it may be flooded. Push the accelerator pedal all the way to the floor and hold it there while cranking the engine. This should clear any excess fuel in case the engine is flooded.

CAUTION!

To prevent damage to the starter, do not crank the engine for more than 15 seconds at a time. Wait 10 to 15 seconds before trying again.

If the engine has been flooded, it may start to run, but not have enough power to continue running when the key is released. If this occurs, continue cranking up to 15 seconds with the accelerator pedal pushed all the way to the floor. Release the accelerator pedal and the key once the engine is running smoothly. Do not overspeed engine.

If the engine shows no sign of starting after two 15 second periods of cranking with the accelerator pedal held to the floor, the “NORMAL STARTING” procedure should be repeated.

After Starting

The idle speed will automatically decrease as the engine warms up.

ENGINE BLOCK HEATER — IF EQUIPPED

The engine block heater warms engine coolant and permits quicker starts in cold weather. Connect the cord to a standard 110-115 volt AC electrical outlet with a grounded, three-wire extension cord.

The engine block heater cord is routed under the hood on the driver side of the vehicle. It has a removable cap that is located on the driver side of the Integrated Power Module.

WARNING!

Remember to disconnect the cord before driving. Damage to the 110-115 volt electrical cord could cause electrocution.

AUTOMATIC TRANSMISSION**CAUTION!**

Damage to the transmission may occur if the following precautions are not observed:

- Shift into PARK only after the vehicle has come to a complete stop.
- Shift into or out of REVERSE only after the vehicle has come to a complete stop and the engine is at idle speed.
- Do not shift from REVERSE, PARK, or NEUTRAL into any forward gear when the engine is above idle speed.
- Before shifting into any gear, make sure your foot is firmly on the brake pedal.

WARNING!

It is dangerous to shift the selector lever out of "P" or "N" if the engine speed is higher than idle speed. If your foot is not firmly on the brake pedal, the vehicle could accelerate quickly forward or in reverse. You could lose control of the vehicle and hit someone or something. Only shift into gear when the engine is idling normally and when your right foot is firmly on the brake pedal.

Brake/Transmission Interlock System

This system prevents you from moving the gear shift out of Park and into any gear unless the brake pedal is pressed. This system is active only while the ignition switch is in the ON position. Always depress the **brake pedal first**, before moving the gear selector out of PARK.

Automatic Transmission Ignition Interlock System

This system prevents the key from being removed unless the shift lever is in PARK. It also prevents shifting out of PARK unless the key is in the OFF or ON positions.

NOTE: If a malfunction occurs, the system will trap the key in the ignition cylinder to warn you that this safety feature is inoperable. The engine can be started and stopped but the key cannot be removed until you obtain service.

Four Speed Automatic Transmission

The electronically controlled transmission provides a precise shift schedule. The transmission electronics are self-calibrating; therefore, the first few shifts on a new vehicle, may be somewhat abrupt. This is a normal condition, and precision shifts will develop within a few hundred miles.

Reset Mode - Electronic Transmission

The transmission is monitored electronically for abnormal conditions. If a condition is detected that could cause damage, the transmission automatically shifts into second gear. The transmission remains in second gear despite the forward gear selected. Park (P), Reverse (R), and Neutral (N) will continue to operate. This Reset feature allows the vehicle to be driven to a dealer for service without damaging the transmission.

In the event that the problem has been momentary, the transmission can be reset to regain all forward gears.

- Stop the vehicle and shift into Park (P).
- Turn the key to OFF then restart the engine.
- Shift into the desired range and resume driving.

NOTE: Even if the transmission can be reset, it is recommended that you visit a dealer at your earliest

possible convenience. Your dealer has diagnostic equipment to determine if the problem could recur.

If the transmission cannot be reset, dealer service is required.

Gear Ranges

DO NOT race the engine when shifting from PARK or NEUTRAL positions into another gear range.

Transmission Gear Ranges***"P" Park***

Supplements the parking brake by locking the transmission. The engine can be started in this range. Never attempt to use PARK while vehicle is in motion.

Apply parking brake when leaving vehicle in this range.

"R" Reverse

Shift into this range only after the vehicle has come to a complete stop.

"N" Neutral

Engine may be started in this range.

"D" Overdrive

For most city and highway driving, it provides smoothest upshifts and downshifts and best fuel economy. When frequent transmission shifting occurs while using the "D" Overdrive position, such as when operating the vehicle under heavy loading conditions, (i.e. in hilly terrain, traveling into strong head winds or while towing heavy trailers), using the "3" position will improve performance and extend transmission life by reducing excessive shifting and heat build-up.

"3" Drive

This range eliminates shifts into Overdrive. The transmission will operate normally in First, Second and Third

while in this range. The "3" position should also be used when descending steep grades to prevent brake system distress.

NOTE: Using the "3" range while operating the vehicle under heavy operating conditions will improve performance and extend transmission life by reducing excessive shifting and heat build up.

"L" Low

This range should be used for engine braking when descending very steep grades. In this range, upshifts will occur only to prevent engine overspeed while downshifts occur earlier than other gear range selections.

NOTE: The vehicle computer will over ride Overdrive and "3" Drive ranges by changing shift points if the transmission operating temperature exceeds acceptable limits. This is done to prevent transmission damage due to overheating.

PARKING BRAKE

When the parking brake is applied with the ignition switch on, the brake light in the instrument cluster will turn on.

NOTE: This light only shows that the parking brake is applied. It does not show the degree of brake application.

Before leaving the vehicle, make sure that the parking brake is fully applied and place the gear selector in the Park position. To release the parking brake, pull out on the parking brake release located on the left side of the instrument panel.

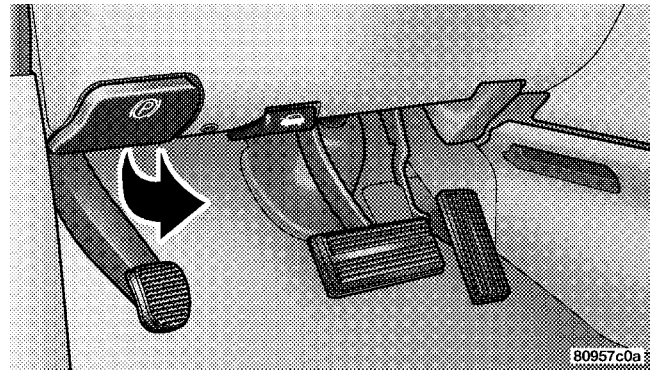

Parking Brake Release

When parking on a hill, it is important to set the parking brake before placing the gear selector in Park, otherwise the load on the transmission locking mechanism may make it difficult to move the selector out of park. As an

added precaution, turn the front wheels toward the curb on a downhill grade and away from the curb on an uphill grade.

The parking brake should always be applied when the driver is not in the vehicle.

WARNING!

Leaving children in a vehicle unattended is dangerous for a number of reasons. A child or others could be injured. Children should be warned not to touch the parking brake, brake pedal or the gear selector lever. Don't leave the keys in the ignition. A child could operate power windows, other controls, or move the vehicle.

WARNING!

Be sure the parking brake is fully disengaged before driving; failure to do so can lead to brake failure, and an accident.

BRAKE SYSTEM

In the event power assist is lost for any reason (for example, repeated brake applications with the engine off), the brakes will still function. The effort required to brake the vehicle will be much greater than that required with the power system operating.



Your vehicle is equipped with dual hydraulic brake systems. If either of the two hydraulic systems lose normal capability, the remaining system will still function. There will be some loss of overall braking effectiveness. This may be evident

by increased pedal travel during application, greater pedal force required to slow or stop, and potential activation of the Brake Warning Lamp.

Anti-Lock Brake System — If Equipped

The Anti-Lock Brake System provides increased vehicle stability and brake performance under most braking conditions. The system automatically “pumps” the brakes during severe braking conditions to prevent wheel lock-up.

WARNING!

Pumping of the Anti-Lock Brakes will diminish their effectiveness and may lead to an accident. Pumping makes the stopping distance longer. Just press firmly on your brake pedal when you need to slow down or stop.



The ABS light monitors the Anti-Lock Brake System. The light will come on when the ignition switch is turned to the ON position and may stay on for as long as four seconds.

If the ABS light remains on or comes on while driving, it indicates that the Anti-Lock portion of the brake system is not functioning and that service is required. However, the conventional brake system will continue to operate normally if the BRAKE warning light is not on.

If the ABS light is on, the brake system should be serviced as soon as possible to restore the benefits of Anti-Lock brakes. If the ABS light does not come on when the Ignition switch is turned to the ON position, have the bulb repaired as soon as possible.

If both the Brake Warning Light and the ABS Light remain on, the Anti-Lock brakes (ABS) and Electronic Brake Force Distribution (EBD) systems are not functioning. Immediate repair to the ABS system is required.

When the vehicle is driven over approximately 15 mph (25 km/h), you may also hear a slight clicking sound as well as some related motor noises. These noises are the system performing its self check cycle to ensure that the ABS system is working properly. This self check occurs each time the vehicle is started and accelerated past approximately 15 mph (25 km/h).

ABS is activated during braking under certain road or stopping conditions. ABS-inducing conditions can include ice, snow, gravel, bumps, railroad tracks, loose debris, or panic stops.

You also may experience the following when the brake system goes into Anti-lock:

- The ABS motor running (it may continue to run for a short time after the stop),
- the clicking sound of solenoid valves,

- brake pedal pulsations,
- and a slight drop or fall away of the brake pedal at the end of the stop.

These are all normal characteristics of ABS.

WARNING!

The Anti-Lock Brake System contains sophisticated electronic equipment that may be susceptible to interference caused by improperly installed or high output radio transmitting equipment. This interference can cause possible loss of anti-lock braking capability. Installation of such equipment should be performed by qualified professionals.

WARNING!

- Anti-lock system (ABS) cannot prevent the natural laws of physics from acting on the vehicle, nor can it increase braking or steering efficiency beyond that afforded by the condition of the vehicle brakes and tires or the traction afforded.
- The ABS cannot prevent accidents, including those resulting from excessive speed in turns, following another vehicle too closely, or hydroplaning. Only a safe, attentive, and skillful driver can prevent accidents.
- The capabilities of an ABS equipped vehicle must never be exploited in a reckless or dangerous manner which could jeopardize the user's safety or the safety of others.

All vehicle wheels and tires must be the same size and type and tires must be properly inflated to produce accurate signals for the computer.

POWER STEERING

The standard power steering system will give you good vehicle response and increased ease of maneuverability in tight spaces. The system will provide mechanical steering capability if power assist is lost.

If for some reason, the power assist is interrupted, it will still be possible to steer your vehicle. Under these conditions you will observe a substantial increase in steering effort, especially at very low vehicle speeds and during parking maneuvers.

NOTE: Increased noise levels at the end of the steering wheel travel are considered normal and does not indicate that there is a problem with the power steering system.

Upon initial start-up in cold weather, the power steering pump may make noise for a short period of time. This is due to the cold, thick fluid in the steering system. This noise should be considered normal, and does not in any way damage the steering system.

WARNING!

Continued operation with reduced power steering assist could pose a safety risk to yourself and others. Service should be obtained as soon as possible.

CAUTION!

Prolong operation of the steering system at the end of the steering wheel travel will increase the steering fluid temperature and should be avoided when possible. Damage to the power steering pump may occur.

TRACTION CONTROL — IF EQUIPPED

The Traction Control System reduces wheel slip and maintains traction at the driving (front) wheels. The system reduces wheel slip by engaging the brake on the wheel that is losing traction (spinning). The system operates at speeds below 35 mph (56 km/h).

The system is always in the “stand by” mode unless,

- The Traction Control Switch has been used to turn the system OFF

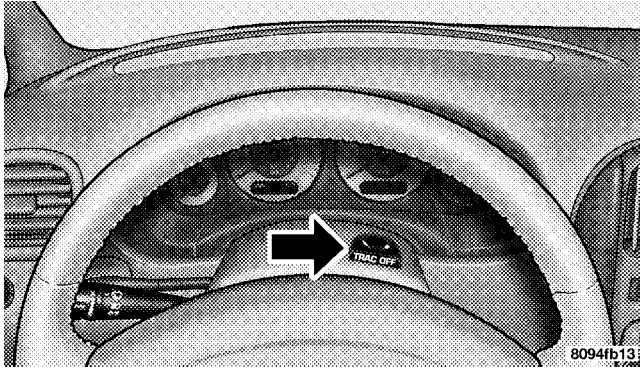

Traction Control Switch

- There is a Traction Control System malfunction

- The system has been deactivated to prevent damage to the brake system due to overheated brake temperatures

NOTE: The Traction Control will make buzzing or clicking sounds when in operation.

NOTE: Extended heavy use of Traction Control may cause the system to deactivate and turn on the TRAC and the OFF indicators located in the instrument cluster.

This is to prevent overheating of the brake system and is a normal condition. The system will remain disabled for about 4 minutes until the brakes have cooled. The system will automatically reactivate and turn off the TRAC and the OFF indicators.

If your vehicle becomes stuck in mud, ice, or snow, turn the Traction Control System OFF before attempting to “rock” the vehicle free.

TIRE SAFETY INFORMATION

Tire Markings

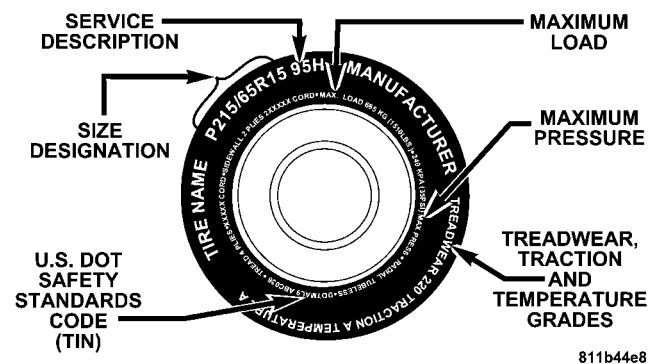

NOTE:

- P (Passenger)-Metric tire sizing is based on U.S. design standards. P-Metric tires have the letter "P" molded into the sidewall preceding the size designation. Example: P215/65R15 95H.

- European Metric tire sizing is based on European design standards. Tires designed to this standard have the tire size molded into the sidewall beginning with the section width. The letter "P" is absent from this tire size designation. Example: 215/65R15 96H
- LT (Light Truck)-Metric tire sizing is based on U.S. design standards. The size designation for LT-Metric tires is the same as for P-Metric tires except for the letters "LT" that are molded into the sidewall preceding the size designation. Example: LT235/85R16.
- Temporary Spare tires are high pressure compact spares designed for temporary emergency use only. Tires designed to this standard have the letter "T" molded into the sidewall preceding the size designation. Example: T145/80D18 103M.
- High Flotation tire sizing is based on U.S. design standards and begins with the tire diameter molded into the sidewall. Example: 31x10.5 R15 LT.

Tire Sizing Chart

EXAMPLE:	
Size Designation:	
	P = Passenger car tire size based on U.S. design standards
	"...blank..." = Passenger car tire based on European design standards
	LT = Light Truck tire based on U.S. design standards
	T = Temporary Spare tire
	31 = Overall Diameter in Inches (in)
	215 = Section Width in Millimeters (mm)
	65 = Aspect Ratio in Percent (%) —Ratio of section height to section width of tire.
	10.5 = Section Width in Inches (in)
	R = Construction Code —"R" means Radial Construction. —"D" means Diagonal or Bias Construction.
	15 = Rim Diameter in Inches (in)

EXAMPLE:	
Service Description:	
95 = Load Index	—A numerical code associated with the maximum load a tire can carry.
H = Speed Symbol	—A symbol indicating the range of speeds at which a tire can carry a load corresponding to its load index under certain operating conditions. —The maximum speed corresponding to the Speed Symbol should only be achieved under specified operating conditions. (i.e. tire pressure, vehicle loading, road conditions and posted speed limits).
Load Identification:	
"...blank..." = Absence of any text on sidewall of the tire indicates a Standard Load (SL) Tire	
Extra Load (XL) = Extra Load (or Reinforced) Tire	
Light Load = Light Load Tire	
C,D,E = Load range associated with the maximum load a tire can carry at a specified pressure	
Maximum Load — Maximum Load indicates the maximum load this tire is designed to carry.	
Maximum Pressure — Maximum Pressure indicates the maximum permissible cold tire inflation pressure for this tire.	

Tire Identification Number (TIN)

The TIN may be found on one or both sides of the tire however the date code may only be on one side. Tires with white sidewalls will have the full TIN including date code

located on the white sidewall side of the tire. Look for the TIN on the outboard side of black sidewall tires as mounted on the vehicle. If the TIN is not found on the outboard side then you will find it on the inboard side of the tire.

EXAMPLE:	
DOT MA L9 ABCD 0301	
DOT = Department of Transportation	—This symbol certifies that the tire is in compliance with the U.S. Department of Transportation tire safety standards, and is approved for highway use.
MA = Code representing the tire manufacturing location. (2 digits)	
L9 = Code representing the tire size. (2 digits)	
ABCD = Code used by tire manufacturer. (1 to 4 digits)	
03 = Number representing the week in which the tire was manufactured. (2 digits)	—03 means the 3rd week.
01 = Number representing the year in which the tire was manufactured. (2 digits)	—01 means the year 2001. —Prior to July 2000, tire manufacturers were only required to have 1 number to represent the year in which the tire was manufactured. Example: 031 could represent the 3rd week of 1981 or 1991.

Tire Loading and Tire Pressure

Tire Placard Location

NOTE: The proper cold tire inflation pressure is listed on either the face of the driver's door or the driver's side "B" pillar.

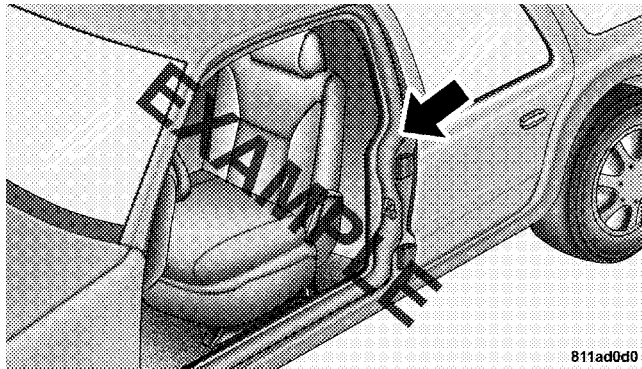

Tire Placard Location

Tire and Loading Information Placard

TIRE AND LOADING INFORMATION			
SEATING CAPACITY - TOTAL 5 FRONT 2 REAR 3			
THE COMBINED WEIGHT OF OCCUPANTS AND CARGO SHOULD NEVER EXCEED XXX KG OR XXX LBS.			
TIRE	FRONT	REAR	SPARE
ORIGINAL TIRE SIZE	P195/70R14	P195/70R14	T125/70D15
COLD TIRE INFLATION PRESSURE	200kPa, 29PSI	200kPa, 29PSI	420kPa, 60PSI
SEE OWNER'S MANUAL FOR ADDITIONAL INFORMATION			4N109268

811b5a9a

Tire and Loading Information

This placard tells you important information about the:

- 1) number of people that can be carried in the vehicle
- 2) the total weight your vehicle can carry

- 3) the tire size designed for your vehicle
- 4) the cold tire inflation pressures for the front, rear and spare tires.

Loading

The vehicle maximum load on the tire must not exceed the load carrying capacity of the tire on your vehicle. You will not exceed the tire's load carrying capacity if you adhere to the loading conditions, tire size, and cold tire inflation pressures specified on the "Tire and Loading Information" placard and in the "Vehicle Loading" section of this manual.

NOTE: Under a maximum loaded vehicle condition, gross axle weight ratings (GAWR's) for the front and rear axles must not be exceeded. For further information on GAWR's, vehicle loading, and trailer towing, refer to the "Vehicle Loading" section of this manual.

To determine the maximum loading conditions of your vehicle, locate the statement "The combined weight of occupants and cargo should never exceed XXX kg or XXX lbs." on the Tire and Loading Information placard. The combined weight of occupants, cargo/luggage and trailer tongue weight (if applicable) should never exceed the weight referenced here.

Steps for Determining Correct Load Limit

1. Locate the statement "The combined weight of occupants and cargo should never exceed XXX pounds" on your vehicle's placard.
2. Determine the combined weight of the driver and passengers that will be riding in your vehicle.
3. Subtract the combined weight of the driver and passengers from XXX kilograms or XXX pounds.

4. The resulting figure equals the available amount of cargo and luggage load capacity. For example, if “XXX” amount equals 1400 lbs. and there will be five 150 lb. passengers in your vehicle, the amount of available cargo and luggage load capacity is 650 lb. (since $5 \times 150 = 750$, and $1400 - 750 = 650$ lb.)

5. Determine the combined weight of luggage and cargo being loaded on the vehicle. That weight may not safely exceed the available cargo and luggage load capacity calculated in Step 4.

6. If your vehicle will be towing a trailer, load from your trailer will be transferred to your vehicle. Consult this

manual to determine how this reduces the available cargo and luggage load capacity of your vehicle.

NOTE: The following table shows examples on how to calculate total load, cargo/luggage and towing capacities of your vehicle with varying seating configurations and number and size of occupants. This table is for illustration purposes only and may not be accurate for the seating and load carry capacity of your vehicle.

NOTE: For the following example the combined weight of occupants and cargo should never exceed 865 lbs. (392 Kg).

Occupants			Combined weight of occupants and cargo from Tire Placard	MINUS	Combined Occupant's weight	=	AVAILABLE Cargo/Luggage and Trailer Tongue Weight
TOTAL	FRONT	REAR					
EXAMPLE 1			865 lbs	minus	670 lbs	=	195 lbs
5	2	3					
EXAMPLE 2			865 lbs	minus	540 lbs	=	325 lbs
3	2	1					
EXAMPLE 3			865 lbs	minus	400 lbs	=	465 lbs
2	2	0					

EXAMPLE

Occupant 1: 200 lbs
 Occupant 2: 130 lbs
 Occupant 3: 160 lbs
 Occupant 4: 100 lbs
 Occupant 5: 80 lbs
 TOTAL WEIGHT: 670 lbs

Occupant 1: 210 lbs
 Occupant 2: 180 lbs
 Occupant 3: 150 lbs
 TOTAL WEIGHT: 540 lbs

Occupant 1: 200 lbs
 Occupant 2: 200 lbs
 TOTAL WEIGHT: 400 lbs

WARNING!

Overloading of your tires is dangerous. Overloading can cause tire failure, affect vehicle handling, and increase your stopping distance. Use tires of the recommended load capacity for your vehicle. Never overload them.

TIRES—GENERAL INFORMATION**Tire Pressure**

Proper tire inflation pressure is essential to the safe and satisfactory operation of your vehicle. Three primary areas are affected by improper tire pressure:

1. Safety—**WARNING!**

Improperly inflated tires are dangerous and can cause accidents.

- Under inflation increases tire flexing and can result in tire failure.
- Over inflation reduces a tire's ability to cushion shock. Objects on the road and chuck holes can cause damage that results in tire failure.
- Unequal tire pressures can cause steering problems. You could lose control of your vehicle.
- Over inflated or under inflated tires can affect vehicle handling and can fail suddenly, resulting in loss of vehicle control.
- Unequal tire pressures from one side of the vehicle to the other can cause the vehicle to drift to the right or left. Always drive with each tire inflated to the recommended cold tire inflation pressure.

2. *Economy*—

Improper inflation pressures can cause uneven wear patterns to develop across the tire tread. These abnormal wear patterns will reduce tread life resulting in a need for earlier tire replacement. Underinflation also increases tire rolling resistance and results in higher fuel consumption.

3. *Ride Comfort and Vehicle Stability*—

Proper tire inflation contributes to a comfortable ride. Overinflation produces a jarring and uncomfortable ride.

Tire Inflation Pressures

The proper cold tire inflation pressure is listed on either the face of the driver's door or the driver's side "B" pillar.

Some vehicles may have Supplemental Tire Pressure Information for vehicle loads that are less than the maximum loaded vehicle condition. These pressure conditions will be found in the "Supplemental Tire Pressure Information" section of this manual.

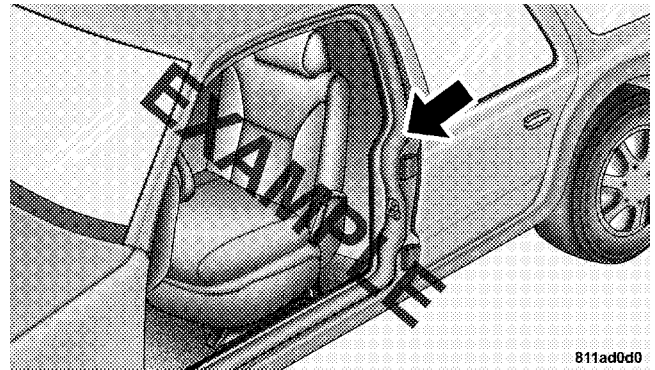

Tire Placard Location

The pressure should be checked and adjusted as well as inspecting for signs of tire wear or visible damage at least once a month. Use a good quality pocket-type gauge to check tire pressure. Do not make a visual judgement when determining proper inflation. Radial tires may look properly inflated even when they are under inflated.

CAUTION!

After inspecting or adjusting the tire pressure, always reinstall the valve stem cap—if equipped. This will prevent moisture and dirt from entering the valve stem, which could damage the valve stem.

Inflation pressures specified on the placard are always “cold tire inflation pressure”. Cold tire inflation pressure is defined as the tire pressure after the vehicle has not been driven for at least 3 hours, or driven less than 1 mile (1 km) after a 3 hour period. The cold tire inflation pressure must not exceed the maximum inflation pressure molded into the tire side wall.

Check tire pressures more often if subject to a wide range of outdoor temperatures, as tire pressures vary with temperature changes.

Tire pressures change by approximately 1 psi (7 kPa) per 12° F (7° C) of air temperature change. Keep this in mind when checking tire pressure inside a garage, especially in the winter.

Example: If garage temperature = 68° F (20° C) and the outside temperature = 32° F (0° C) then the cold tire inflation pressure should be increased by 3 psi (21 kPa), which equals 1 psi (7 kPa) for every 12° F (7° C) for this outside temperature condition.

Tire pressure may increase from 2 to 6 psi (13 to 40 kPa) during operation. DO NOT reduce this normal pressure build up or your tire pressure will be too low.

Tire Pressures for High Speed Operation

The manufacturer advocates driving at safe speeds within posted speed limits. Where speed limits or conditions are such that the vehicle can be driven at high speeds, maintaining correct tire inflation pressure is very important. Increased tire pressure and reduced vehicle

loading may be required for high speed vehicle operation. Refer to original equipment or an authorized tire dealer for recommended safe operating speeds, loading and cold tire inflation pressures.

WARNING!

High speed driving with your vehicle under maximum load is dangerous. The added strain on your tires could cause them to fail. You could have a serious accident. Don't drive a vehicle loaded to the maximum capacity at continuous speeds above 75 mph (120 km/h).

Radial-Ply Tires**WARNING!**

Combining radial ply tires with other types of tires on your vehicle will cause your vehicle to handle poorly. The instability could cause an accident. Always use radial ply tires in sets of four (or 6, in case of trucks with dual rear wheels). Never combine them with other types of tires.

Cuts and punctures in radial tires are repairable only in the tread area because of sidewall flexing. Consult your authorized tire dealer for radial tire repairs.

Compact Spare Tire — If Equipped

The compact spare is for temporary emergency use with radial tires. It is engineered to be used on your style vehicle only. Since this tire has limited tread life, the original tire should be repaired (or replaced) and reinstalled at the first opportunity.

WARNING!

Temporary use spare tires are for emergency use only. With these tires, do not drive more than 50 mph (80 km/h). Temporary-use spare tires have limited tread life. When the tread is worn to the tread wear indicators, the temporary use spare tire needs to be replaced. Be sure to follow the warnings which apply to your spare. Failure to do so could result in spare tire failure and loss of vehicle control.

Do not install a wheel cover or attempt to mount a conventional tire on the compact spare wheel, since the wheel is designed specifically for the compact spare.

Do not install more than one compact spare tire/wheel on the vehicle at any given time.

CAUTION!

Because of the reduced ground clearance, do not take your vehicle through an automatic car wash with the compact spare installed. Damage to the vehicle may result.

Limited Use Spare — If Equipped

The limited use spare tire is for temporary emergency use on your vehicle. This tire is identified by a limited use spare tire warning label located on the limited use spare tire and wheel assembly. This tire may look like the original equipped tire on the front or rear axle of your vehicle, but it is not. Installation of this limited use spare tire affects vehicle handling. Since it is not the same tire, replace (or repair) the original tire and reinstall on the vehicle at the first opportunity.

WARNING!

The limited use spare tires are for emergency use only. Installation of this limited use spare tire affects vehicle handling. With this tire, do not drive more than 60 mph (100 km/h). Keep inflated to the cold tire inflation pressure listed on either your tire placard or limited use spare tire and wheel assembly. Replace (or repair) the original tire at the first opportunity and reinstall it on your vehicle. Failure to do so could result in loss of vehicle control.

5**Tire Spinning**

When stuck in mud, sand, snow, or ice conditions, do not spin your vehicle's wheels above 35 mph (55 km/h).

See the paragraph on Freeing A Stuck Vehicle in Section 6 of this manual.

WARNING!

Fast spinning tires can be dangerous. Forces generated by excessive wheel speeds may cause tire damage or failure. A tire could explode and injure someone. Do not spin your vehicle's wheels faster than 35 mph (55 km/h) when you are stuck. And don't let anyone near a spinning wheel, no matter what the speed.

Tread Wear Indicators

Tread wear indicators are in the original equipment tires to help you in determining when your tires should be replaced.

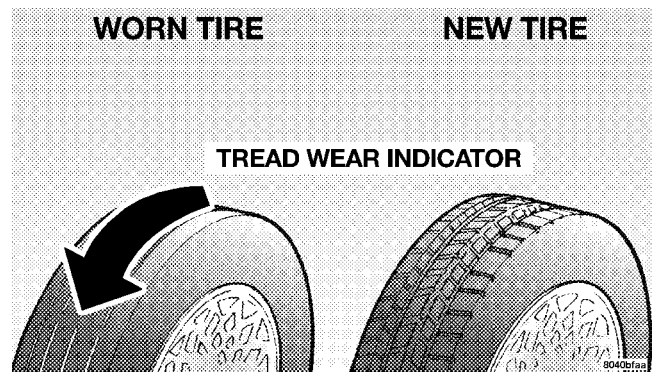

These indicators are molded into the bottom of the tread grooves and will appear as bands when the tread depth becomes 1/16 inch (2 mm). When the tread is worn to the tread wear indicators, the tire should be replaced.

Many states have laws requiring tire replacement at this point.

Life of Tire

The service life of a tire is dependent upon varying factors including but not limited to:

- Driving style
- Tire pressure
- Distance driven

WARNING!

Tires and spare tire should be replaced after six years, regardless of the remaining tread. Failure to follow this warning can result in sudden tire failure. You could lose control and have an accident resulting in serious injury or death.

Keep unmounted tires in a cool, dry place with as little exposure to light as possible. Protect tires from contact with oil, grease and gasoline.

Replacement Tires

The tires on your new vehicle provide a balance of many characteristics. They should be inspected regularly for wear and correct cold tire inflation pressure. The manufacturer strongly recommends that you use tires equivalent to the originals in size, quality and performance when replacement is needed (see the paragraph on tread wear indicators). Refer to the Tire and Loading Information placard for the size designation of your tire. The service description and load identification will be found on the original equipment tire. Failure to use equivalent replacement tires may adversely affect the safety, handling, and ride of your vehicle. We recommend that you contact your original equipment or an authorized tire dealer with any questions you may have on tire specifications or capability.

WARNING!

- Do not use a tire, wheel size or rating other than that specified for your vehicle. Some combinations of unapproved tires and wheels may change suspension dimensions and performance characteristics, resulting in changes to steering, handling, and braking of your vehicle. This can cause unpredictable handling and stress to steering and suspension components. You could lose control and have an accident resulting in serious injury or death. Use only the tire and wheel sizes with load ratings approved for your vehicle.
- Never use a tire with a smaller load index or capacity, other than what was originally equipped on your vehicle. Using a tire with a smaller load index could result in tire overloading and failure. You could lose control and have an accident.
- Failure to equip your vehicle with tires having adequate speed capability can result in sudden tire failure and loss of vehicle control.

CAUTION!

Replacing original tires with tires of a different size may result in false speedometer and odometer readings.

Alignment And Balance

Poor suspension alignment may result in:

- Fast tire wear.
- Uneven tire wear, such as feathering and one-sided wear.
- Vehicle pull to right or left.

Tires may also cause the vehicle to pull to the left or right. Alignment will not correct this condition. See your dealer for proper diagnosis.

Improper alignment will not cause vehicle vibration. Vibration may be a result of tire and wheel out-of-balance. Proper balancing will reduce vibration and avoid tire cupping and spotty wear.

TIRE PRESSURE MONITOR SYSTEM — IF EQUIPPED

The Tire Pressure Monitor System (TPMS) system uses wireless technology with wheel rim mounted electronic sensors to monitor tire pressure levels (EXCLUDING THE SPARE TIRE). Sensors, mounted to each wheel as part of the valve stem, transmit tire pressure readings to a receiver located in the instrument panel.

NOTE: The tire pressure monitoring system on your vehicle will warn you when one of your tires is significantly underinflated and when some combinations of your tires are significantly underinflated. It is particularly important, therefore, for you to check the tire pressure in all of your tires regularly and maintain proper pressure.

1,2,3, OR 4 TIRE(S) LOW PRESSURE

Low tire pressure levels of 28 psi [1.9 bars] (193 kPa) or less detected in one or more tires.

Inspect all tires for proper inflation pressure, once proper tire pressure has been set the TPMS system warning will reset automatically once ignition switch has been turned ON.

CHECK TPM SYSTEM

The Tire Pressure Monitor System (TPMS) system requires service.

See your authorized dealer for service.

CAUTION!

The TPMS system has been optimized for the original equipment tires and wheels. TPMS system pressures have been established for the tire size equipped on your vehicle. Undesirable operation or sensor damage may result when using replacement equipment that is not of the same size, type, and/or style. After-market wheels can cause sensor damage. Do not use tire sealant or balance beads if your vehicle is equipped with TPMS system as damage to the sensors may result.

NOTE:

- The TPMS system can inform the driver of a low tire pressure condition of 28 psi [1.9 bars] (193 kPa) or less.

The TPMS system is not intended to replace normal tire care and maintenance, nor to provide warning of a tire failure or condition.

- The TPMS system should not be used as a tire pressure gauge while adjusting your tire pressure.

CAUTION!

After inspecting or adjusting the tire pressure always reinstall the valve stem cap. This will prevent moisture and dirt entry into the valve stem, which could damage the wheel rim sensor.

General Information

This device complies with part 15 of the FCC rules and RSS 210 of Industry Canada. Operation is subject to the following conditions:

- This device may not cause harmful interference.
- This device must accept any interference received, including interference that may cause undesired operation.

The tire pressure sensors are covered under one of the following licenses:

United States KR5S120123
 Canada 2671-S120123

TIRE CHAINS

Use only compact chains, or other traction aids that meet SAE type “Class S” specifications. Chains must be the proper size for the vehicle, as recommended by the chain manufacturer.

NOTE: Do not use tire chains on a compact spare tire.

CAUTION!

To avoid damage to your vehicle or tires, observe the following precautions:

- Because of restricted chain clearance between tires and other suspension components, it is important that only chains in good condition are used. Broken chains can cause serious damage. Stop the vehicle immediately if noise occurs that could indicate chain breakage. Remove the damaged parts of the chain before further use.
- Install chains on the front wheels as tightly as possible and then retighten after driving about ½ mile (0.8 km).
- Do not exceed 45 mph (70 km/h).
- Drive cautiously and avoid severe turns and large bumps, especially with a loaded vehicle.
- Do not drive for prolonged period on dry pavement.
- Observe the tire chain manufacturer's instructions on the method of installation, operating speed, and conditions for use. Always use the lower suggested operating speed of the chain manufacturer if different than the speed recommended by the manufacture.

NOTE: In order to avoid damage to tires, chains, and your vehicle do not drive for a prolonged period of time on dry pavement. Observe the tire chain manufacturer's instructions on method of installation, operating speed, and conditions for usage.

Always use the lower suggested operating speed if both the chain manufacturer and vehicle manufacture suggest a maximum speed. This notice applies to all chain traction devices, including link and cable (radial) chains.

SNOW TIRES

Some areas of the country require the use of snow tires during winter. Standard tires are of the all season type and satisfy this requirement as indicated by the M+S designation on the tire side wall.

If you need snow tires, select tires equivalent in size and type to the original equipment tires. Use snow tires only in sets of 4, failure to do so may adversely affect the safety and handling of your vehicle.

Snow tires generally have lower speed ratings than what was originally equipped with your vehicle and should not be operated at sustained speeds over 75 mph (120 km/h).

TIRE ROTATION RECOMMENDATIONS

Tires on the front and rear axles of vehicles operate at different loads and perform different steering, driving, and braking functions. For these reasons, they wear at unequal rates, and tend to develop irregular wear patterns.

These effects can be reduced by timely rotation of tires. The benefits of rotation are especially worthwhile with aggressive tread designs such as those on all season type tires. Rotation will increase tread life, help to maintain mud, snow, and wet traction levels, and contribute to a smooth, quiet ride.

Follow the recommended tire rotation frequency for your type of driving found in the “Maintenance Schedules” Section of this manual. More frequent rotation is permissible if desired. The reasons for any rapid or unusual wear should be corrected prior to rotation being performed.

The suggested rotation method is the “forward-cross” shown in the following diagram.

TIRE ROTATION PATTERN

← FRONT OF VEHICLE

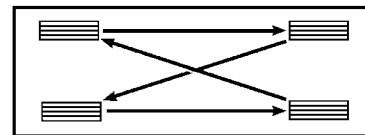

4 TIRE ROTATION

80ba79fe

FUEL REQUIREMENTS

Your vehicle is designed to meet all emission regulations and provide excellent fuel economy when using high quality regular unleaded gasoline with an octane rating of 87. The use of premium gasoline is not recommended. The use of premium gasoline will provide no benefit over high quality regular gasolines, and in some circumstances, may result in poorer performance.

Light spark knock at low engine speeds is not harmful to your engine. However, continued heavy spark knock at high speeds can cause damage and immediate service is required.

Poor quality gasoline can cause problems such as hard starting, stalling and hesitations. If you experience these symptoms, try another brand of “regular” gasoline before considering service for the vehicle.

Over 40 automobile manufacturers around the world have issued and endorsed consistent gasoline specifications (the World Wide Fuel Charter, WWFC) to define fuel properties necessary to deliver enhanced emissions, engine performance, and durability for your vehicle. The manufacturer recommends the use of gasolines that meet the WWFC specifications if they are available.

Reformulated Gasoline

Many areas of the country require the use of cleaner burning gasoline referred to as “Reformulated Gasoline”.

Reformulated gasolines contain oxygenates, and are specifically blended to reduce vehicle emissions and improve air quality.

The manufacturer supports the use of reformulated gasolines. Properly blended reformulated gasolines will provide excellent performance and durability of engine and fuel system components.

Gasoline/Oxygenate Blends

Some fuel suppliers blend unleaded gasoline with oxygenates such as 10% ethanol, MTBE, and ETBE. Oxygenates are required in some areas of the country during the winter months to reduce carbon monoxide emissions. Fuels blended with these oxygenates may be used in your vehicle.

CAUTION!

DO NOT use gasolines containing Methanol. Use of these blends may result in starting and driveability problems and may damage critical fuel system components.

Problems that result from using methanol/gasoline blends are not the responsibility of the manufacturer. While MTBE is an oxygenate made from Methanol, it does not have the negative effects of Methanol.

MMT In Gasoline

MMT is a manganese containing metallic additive that is blended into some gasoline to increase the octane number. Gasolines blended with MMT offer no performance advantage beyond gasolines of the same octane number without MMT. Gasolines blended with MMT have shown to reduce spark plug life and reduce emission system performance in some vehicles. The manufacturer recommends using gasolines without MMT. Since the MMT content of gasoline may not be indicated on the pump, you should ask your gasoline retailer whether or not his/her gasoline contains MMT.

It is even more important to look for gasolines without MMT in Canada, because MMT can be used at levels higher than those allowed in the United States.

MMT is prohibited in Federal and California reformulated gasolines.

Materials Added to Fuel

All gasoline sold in the United States is required to contain effective detergent additives. Use of additional detergents or other additives are not needed under normal conditions and would result in additional cost. Therefore you should not have to add anything to the fuel.

Fuel System Cautions**CAUTION!**

Follow these guidelines to maintain your vehicle's performance:

- The use of leaded gas is prohibited by Federal law. Using leaded gasoline can impair engine performance, damage the emission control system.

- An out-of-tune engine, or certain fuel or ignition malfunctions, can cause the catalytic converter to overheat. If you notice a pungent burning odor or some light smoke, your engine may be out of tune or malfunctioning and may require immediate service. Contact your dealer for service assistance.
- The use of fuel additives which are now being sold as octane enhancers is not recommended. Most of these products contain high concentrations of methanol. Fuel system damage or vehicle performance problems resulting from the use of such fuels or additives is not the responsibility of the manufacturer.

NOTE: Intentional tampering with emissions control systems can result in civil penalties being assessed against you.

Carbon Monoxide Warnings**WARNING!**

Carbon monoxide (CO) in exhaust gases is deadly. Follow the precautions below to prevent carbon monoxide poisoning:

- Do not inhale exhaust gases. They contain carbon monoxide, a colorless and odorless gas which can kill. Never run the engine in a closed area, such as a garage, and never sit in a parked vehicle with the engine running for an extended period. If the vehicle is stopped in an open area with the engine running for more than a short period, adjust the ventilation system to force fresh, outside air into the vehicle.
- Guard against carbon monoxide with proper maintenance. Have the exhaust system inspected every time the vehicle is raised. Have any abnormal conditions repaired promptly. Until repaired, drive with all side windows fully open.
- Keep the liftgate closed when driving your vehicle to prevent carbon monoxide and other poisonous exhaust gases from entering the vehicle.

ADDING FUEL

Fuel Filler Cap (Gas Cap)

The gas cap is behind the fuel filler door on the left side of the vehicle. If the gas cap is lost or damaged, be sure the replacement cap is for use with this vehicle.

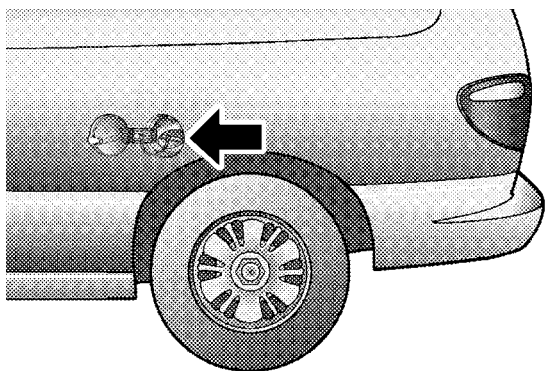

Fuel Filler Cap (Gas Cap)

80904e2e

CAUTION!

Damage to the fuel system or emission control system could result from using an improper fuel tank filler tube cap (gas cap). A poorly fitting cap could let impurities into the fuel system.

NOTE: The driver's side sliding door cannot be opened while the fuel door is open. This feature operates only when the sliding door is fully closed prior to opening the fuel door.

CAUTION!

To avoid fuel spillage and overfilling, do not "top off" the fuel tank after filling has stopped.

NOTE:

- Tighten the fuel filler cap until you hear a “clicking” sound. This is an indication that the fuel filler cap is properly tightened. If the vehicle diagnostic system determines that the fuel filler cap is loose, improperly installed, or damaged, GASCAP will be displayed in the instrument cluster odometer. Tighten the fuel filler cap properly and press the odometer reset button to turn the GASCAP message off. If the problem continues, the message will appear the next time the vehicle is started. See Section 7 of this manual for more information. Make sure that the fuel filler cap is tightened each time the vehicle is refueled.
- When the fuel nozzle “clicks” or shuts off, the fuel tank is full.

WARNING!

- Never have any smoking materials lit in or near the vehicle when the gas cap is removed or the tank filled.
- Never add fuel to the vehicle when the engine is running.
- A fire may result if gasoline is pumped into a portable container that is inside of a vehicle. You could be burned. Always place gas containers on the ground while filling.

VEHICLE LOADING

The load carrying capacity of your vehicle is shown in the charts that follow. This information should be used for passenger and luggage loading as indicated.

If seats are removed for carrying cargo, do not exceed the specified GVWR and GAWR.

Vehicle Certification Label

Your vehicle has a certification label attached to the driver's door pillar.

The label contains the following information:

- Name of manufacturer
- Month and year of manufacture
- Gross Vehicle Weight Rating (GVWR)
- Gross Axle Weight Rating (GAWR) front
- Gross Axle Weight Rating (GAWR) rear

- Vehicle Identification Number (VIN)
- Type of Vehicle
- Month Day and Hour of Manufacture (MDH)

The bar code allows a computer scanner to read the Vehicle Identification Number (VIN).

Gross Vehicle Weight Rating (GVWR)

The GVWR is the total allowable weight of your vehicle. This includes driver, passengers, and cargo. The total load must be limited so that you do not exceed the GVWR.

Gross Axle Weight Rating (GAWR)

The GAWR is the maximum capacity of the front and rear axles. Distribute the load over the front and rear axles evenly. Make sure that you do not exceed either front or rear GAWR.

WARNING!

Because the front wheels drive and steer the vehicle, it is important that you do not exceed the maximum front or rear GAWR. A dangerous driving condition can result if either rating is exceeded. You could lose control of the vehicle and have an accident.

Overloading

The load carrying components (axle, springs, tires, wheels, etc.) of your vehicle will provide satisfactory service as long as you do not exceed the GVWR and front and rear GAWR.

The best way to figure out the total weight of your vehicle is to weigh it when it is fully loaded and ready for operation. Weigh it on a commercial scale to insure that it is not over the GVWR.

Figure out the weight on the front and rear of the vehicle separately. It is important that you distribute the load evenly over the front and rear axles.

Overloading can cause potential safety hazards and shorten useful service life. Heavier axles or suspension components do not necessarily increase the vehicle's GVWR.

Loading

To load your vehicle properly, first figure out its empty weight, axle by axle and side by side. Store heavier items down low and be sure you distribute their weight as evenly as possible. Stow all loose items securely before driving. If weighing the loaded vehicle shows that you have exceeded either GAWR, but the total load is within the specified GVWR, you must redistribute the weight. Improper weight distribution can have an adverse effect on the way your vehicle steers and handles and the way the brakes operate.

A loaded vehicle is shown in the illustration. Note that neither the GVWR or the GAWR capacities have been exceeded.

**GROSS VEHICLE WEIGHT RATING (GVWR) 5050 LBS.
(Example Only)**

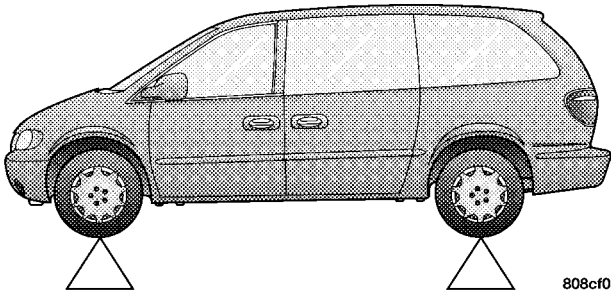

808cf051

Example Only	Front Axle	Rear Axle
Empty Weight	2140 lbs	1470 lbs
Load (Including driver, passengers and cargo)	360 lbs	980 lbs
Total	2500 lbs	2450 lbs
GAWR	2544 lbs	2544 lbs

TRAILER TOWING

In this section you will find safety tips and information on limits to the type of towing you can reasonably do with your vehicle. Before towing a trailer carefully review this information to tow your load as efficiently and safely as possible.

To maintain warranty coverage, follow the requirements and recommendations in this manual concerning vehicles used for trailer towing.

Common Towing Definitions

The following trailer towing related definitions will assist you in understanding the following information:

Gross Vehicle Weight Rating (GVWR)

The GVWR is the total allowable weight of your vehicle. This includes driver, passengers, cargo and tongue weight. The total load must be limited so that you do not exceed the GVWR.

Gross Trailer Weight (GTW)

The gross trailer weight (GTW) is the weight of the trailer plus the weight of all cargo, consumables and equipment (permanent or temporary) loaded in or on the trailer in its "loaded and ready for operation" condition. The recommended way to measure GTW is to put your fully loaded trailer on a vehicle scale. The entire weight of the trailer must be supported by the scale.

Gross Combination Weight Rating (GCWR)

The gross combination weight rating (GCWR) is the total permissible weight of your vehicle and trailer when weighed in combination. (Note that GCWR ratings include a 150 lbs (68 kg) allowance for the presence of a driver).

Gross Axle Weight Rating (GAWR)

The GAWR is the maximum capacity of the front and rear axles. Distribute the load over the front and rear axles evenly. Make sure that you do not exceed either front or rear GAWR.

WARNING!

It is important that you do not exceed the maximum front or rear GAWR. A dangerous driving condition can result if either rating is exceeded. You could lose control of the vehicle and have an accident.

Tongue Weight (TW)

The downward force exerted on the hitch ball by the trailer. In most cases it should not be less than 10% or more than 15% of the trailer load. You must consider this as part of the load on your vehicle.

Frontal Area

The maximum height and maximum width of the front of a trailer.

Trailer Sway Control

The trailer sway control is a telescoping link that can be installed between the hitch receiver and the trailer tongue

that typically provides adjustable friction associated with the telescoping motion to dampen any unwanted trailer swaying motions while traveling.

Weight-Carrying Hitch

A weight-carrying hitch supports the trailer tongue weight, just as if it were luggage located at a hitch ball or some other connecting point of the vehicle. These kind of hitches are the most popular on the market today and they're commonly used to tow small- and medium-sized trailers.

Weight-Distributing Hitch

A weight-distributing hitch includes a receiver attached to the tow vehicle, plus a removable hitch head and spring bar assembly that fits into the receiver opening and hook up brackets that connect the spring bars to the trailer frame.

Trailer Hitch Classification

Your vehicle may be factory equipped for safe towing of trailers weighing over 2,000 lbs (907 kg) with the optional Trailer Tow Prep Package. See your dealer for package content.

The following chart provides the industry standard for the maximum trailer weight a given trailer hitch class can tow and should be used to assist you in selecting the correct trailer hitch for your intended towing condition. Refer to the Trailer Towing Weights (Maximum Trailer Weight Ratings) chart for the Max. GTW towable for your given drivetrain.

Trailer Hitch Classification	
Class	Max. GTW (Gross Trailer Wt.)
Class I - Light Duty	2,000 lbs (907 kg)
Class II - Medium Duty	3,500 lbs (1587 kg)
Class III - Heavy Duty	5,000 lbs (2268 kg)
Class IV - Extra Heavy Duty	10,000 lbs (4540 kg)

All trailer hitches should be professionally installed on your vehicle.

Trailer Towing Weights (Maximum Trailer Weight Ratings)

The following chart provides the maximum trailer weight ratings towable for your given drivetrain.

354 STARTING AND OPERATING

Engine/Transmission	GCWR (Gross Combined Wt. Rating)	Frontal Area	Max. GTW (Gross Trailer Wt.)	Max. Tongue Wt.
2.4L Automatic	5,200 lbs (2358 kg)	40 SQ. FT. (3.72 square meters)	Up to 2 persons & Luggage 850 lbs (385 kg)	85 lbs (39 kg)
	5,200 lbs (2358 kg)	40 SQ. FT. (3.72 square meters)	3 to 5 persons & Luggage 400 lbs (181 kg)	40 lbs (18 kg)
	5,200 lbs (2358 kg)	40 SQ. FT. (3.72 square meters)	6 to 7 persons & Luggage Not Recommended	N/A

Engine/Transmission	GCWR (Gross Combined Wt. Rating)	Frontal Area	Max. GTW (Gross Trailer Wt.)	Max. Tongue Wt.
3.3L & 3.8L Automatic	6,600 lbs (2993 kg)	40 SQ. FT. (3.72 square meters)	Up to 2 persons & Luggage 1,800 lbs (816 kg)	180 lbs (82 kg)
	6,600 lbs (2993 kg)	40 SQ. FT. (3.72 square meters)	3 to 5 persons & Luggage 1,350 lbs (612 kg)	135 lbs (61 kg)
	6,600 lbs (2993 kg)	40 SQ. FT. (3.72 square meters)	6 to 7 persons & Luggage 1,000 lbs (454 kg)	100 lbs (45 kg)

Engine/Transmission	GCWR (Gross Combined Wt. Rating)	Frontal Area	Max. GTW (Gross Trailer Wt.)	Max. Tongue Wt.
3.3L & 3.8L Automatic with trailer tow package	8,600 lbs (3900 kg)	40 SQ. FT. (3.72 square meters)	Up to 2 persons & Luggage 3,800 lbs (1723 kg)*	380 lbs (172 kg)
	8,600 lbs (3900 kg)	40 SQ. FT. (3.72 square meters)	3 to 5 persons & Luggage 3,350 lbs (1519 kg)*	335 lbs (152 kg)
	8,600 lbs (3900 kg)	40 SQ. FT. (3.72 square meters)	6 to 7 persons & Luggage 3,000 lbs (1360 kg)*	300 lbs (136 kg)
* For vehicles equipped with Fold-in-Floor seating, the Gross Trailer Weight must be reduced by 100 lbs (45 kg). Refer to local laws for maximum trailer towing speeds.				

NOTE: The trailer tongue weight must be considered as part of the combined weight of occupants and cargo, and should never exceed the weight referenced on the Tire and Loading Information placard. Refer to the Tire-Safety Information Section in this manual.

Trailer and Tongue Weight

Always load a trailer with 60% to 65% of the weight in the front of the trailer. This places 10% to 15% of the Gross Trailer Weight (GTW) on the tow hitch of your vehicle. Loads balanced over the wheels or heavier in the rear can cause the trailer to sway **severely** side to side

which will cause loss of control of the vehicle and trailer. Failure to load trailers heavier in front is the cause of many trailer accidents.

Never exceed the maximum tongue weight stamped on your bumper or trailer hitch.

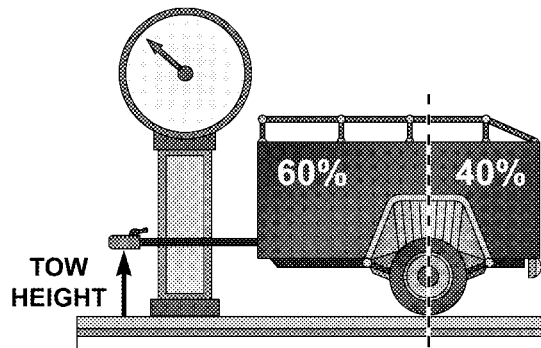

81546c40

Consider the following items when computing the weight on the rear axle of the vehicle:

- The tongue weight of the trailer.
- The weight of any other type of cargo or equipment put in or on your vehicle.
- The weight of the driver and all passengers.

NOTE: Remember that everything put into or on the trailer adds to the load on your vehicle. Also, additional factory-installed options, or dealer-installed options, must be considered as part of the total load on your vehicle. Refer to the Tire and Loading Information placard in the Tire Safety Information Section of this manual for the maximum combined weight of occupants and cargo for your vehicle.

Towing Requirements

To promote proper break-in of your new vehicle drivetrain components the following guidelines are recommended:

CAUTION!

- Avoid towing a trailer for the first 500 miles (805 km) of vehicle operation. Doing so may damage your vehicle.
- During the first 500 miles (805 km) of trailer towing, limit your speed to 50 mph (80 km/h).

Perform the maintenance listed in Section 8 of this manual. When towing a trailer, never exceed the GAWR, or GCWR, ratings.

WARNING!

Improper towing can lead to an injury accident. Follow these guidelines to make your trailer towing as safe as possible:

Make certain that the load is secured in the trailer and will not shift during travel. When trailering cargo that is not fully secured, dynamic load shifts can occur that may be difficult for the driver to control. You could lose control of your vehicle and have an accident.

- When hauling cargo or towing a trailer, do not overload your vehicle or trailer. Overloading can cause a loss of control, poor performance or damage to brakes, axle, engine, transmission, steering, suspension, chassis structure or tires.

- Safety chains must always be used between your vehicle and trailer. Always connect the chains to the frame or hook retainers of the vehicle hitch. Cross the chains under the trailer tongue and allow enough slack for turning corners.
- Vehicles with trailers should not be parked on a grade. When parking, apply the parking brake on the tow vehicle. Put the tow vehicle automatic transmission in P for Park. Always, block or "chock" the trailer wheels.
- GCWR must not be exceeded.
- **Total weight must be distributed between the tow vehicle and the trailer such that the following four ratings are not exceeded:**
 1. GVWR
 2. GTW
 3. GAWR
 4. Tongue weight rating for the trailer hitch utilized (This requirement may limit the ability to always achieve the 10% to 15% range of tongue weight as a percentage of total trailer weight).

Towing Requirements — Tires

- Do not attempt to tow a trailer while using a compact spare tire.
- Proper tire inflation pressures are essential to the safe and satisfactory operation of your vehicle. Refer to the Tires-General Information section of this manual on Tire Pressures for proper tire inflation procedures.
- Also, check the trailer tires for proper tire inflation pressures before trailer usage.
- Check for signs of tire wear or visible tire damage before towing a trailer. Refer to the Tires-General Information section of this manual on Tread Wear Indicators for the proper inspection procedure.

- When replacing tires refer to the Tires–General Information section of this manual on Replacement Tires for proper tire replacement procedures. Replacing tires with a higher load carrying capacity will not increase the vehicle’s GVWR and GAWR limits.
- Trailer brakes are recommended for trailers over 1,000 lbs (454 kg) and required for trailers in excess of 2,000 lbs (907 kg).

Towing Requirements — Trailer Brakes

- Do **not** interconnect the hydraulic brake system or vacuum system of your vehicle with that of the trailer. This could cause inadequate braking and possible personal injury.
- An electronically actuated trailer brake controller is required when towing a trailer with electronically actuated brakes. When towing a trailer equipped with a hydraulic surge actuated brake system, an electronic brake controller is not required.

CAUTION!

If the trailer weighs more than 1,000 lbs (454 kg) loaded, it should have its own brakes and they should be of adequate capacity. Failure to do this could lead to accelerated brake lining wear, higher brake pedal effort, and longer stopping distances.

WARNING!

Do not connect trailer brakes to your vehicle's hydraulic brake lines. It can overload your brake system and cause it to fail. You might not have brakes when you need them and could have an accident.

Towing any trailer will increase your stopping distance. When towing you should allow for additional space between your vehicle and the vehicle in front of you. Failure to do so could result in an accident.

Towing Requirements — Trailer Lights & Wiring
Whenever you pull a trailer, regardless of the trailer size, stop lights and turn signals on the trailer are required for motoring safety.

The Trailer Tow Package may include a 4 and 7 pin wiring harness. Use a factory approved trailer harness and connector.

NOTE: Do not cut or splice wiring into the vehicles wiring harness.

The electrical connections are all complete to the vehicle but you must mate the harness to a trailer connector. Refer to the following illustrations.

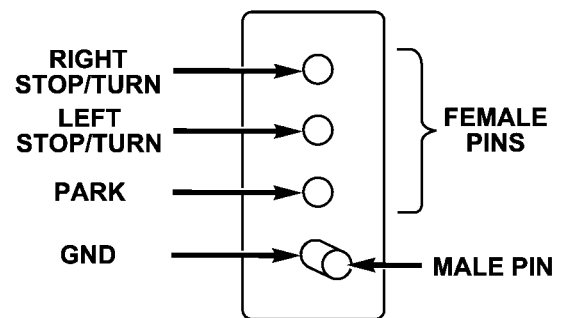

4 - Pin Connector

813262be

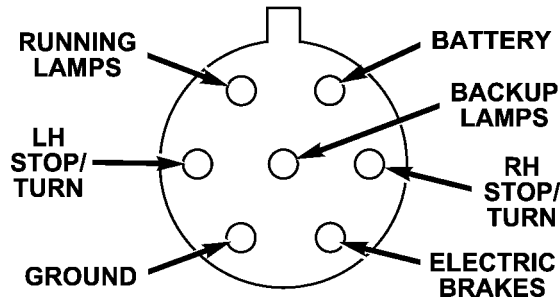

812634c6

7 - Pin Connector

Towing Tips

Before setting out on a trip, practice turning, stopping and backing the trailer in an area away from heavy traffic.

Towing Tips — Automatic Transmission

The “D” range can be selected when towing. However, if frequent shifting occurs while in this range, the “3” range should be selected.

NOTE: Using the “3” range while operating the vehicle under heavy operating conditions will improve performance and extend transmission life by reducing excessive shifting and heat build up. This action will also provide better engine braking.

The automatic transmission fluid and filter should be changed if you **REGULARLY** tow a trailer for more than 45 minutes of continuous operation. See Schedule “B” in section 8 of this manual for transmission fluid change intervals.

NOTE: Check the automatic transmission fluid level before towing.

Towing Tips — Electronic Speed Control (If Equipped)

- Don't use in hilly terrain or with heavy loads.
- When using the speed control, if you experience speed drops greater than 10 mph (16 km/h), disengage until you can get back to cruising speed.
- Use speed control in flat terrain and with light loads to maximize fuel efficiency.

Towing Tips — Cooling System

To reduce potential for engine and transmission overheating, take the following actions:

- *City Driving*
When stopped for short periods of time, put transmission in neutral but do not increase engine idle speed.
- *Highway Driving*
Reduce speed.

– *Air Conditioning*

Turn off temporarily.

- refer to Cooling System Operating information in the Maintenance section of this manual for more information.

RECREATIONAL TOWING (BEHIND MOTORHOME, ETC.)**TOWING THIS VEHICLE BEHIND ANOTHER VEHICLE (Flat towing with all four wheels on the ground)**

Recreational towing for this vehicle is not recommended.

NOTE: If the vehicle requires towing make sure all four wheels are off the ground.

WHAT TO DO IN EMERGENCIES

CONTENTS

■ Hazard Warning Flasher	366	□ Traction	389
■ If Your Engine Overheats	367	■ Freeing A Stuck Vehicle	390
■ Jacking And Tire Changing	368	■ Towing A Disabled Vehicle	391
□ Jacking Instructions — Stow 'n Go Seating . . .	369	□ With Ignition Key	391
□ Jacking Instructions — Non Stow 'n Go Seating	381	□ Without The Ignition Key	392
■ Jump-Starting Procedures If Battery Is Low	387	□ Towing This Vehicle Behind Another Vehicle (Flat Towing With All Four Wheels On The Ground)	392
■ Driving On Slippery Surfaces	389	□ Towing This Vehicle Behind Another Vehicle With A Tow Dolly	392
□ Acceleration	389		

HAZARD WARNING FLASHER

The hazard flasher switch is located in the center of the instrument panel above the radio.

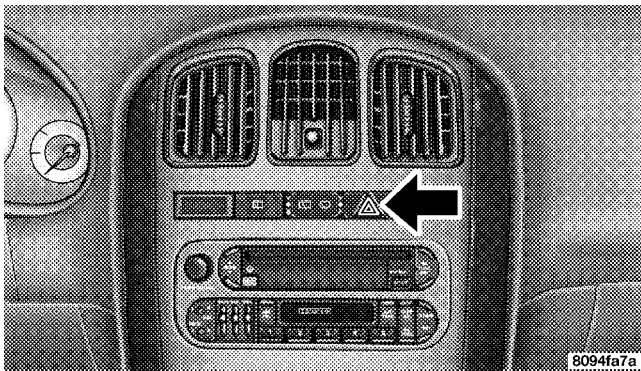

Hazard Flasher Switch

To engage the Hazard Warning Flashers, depress the switch on the instrument panel. When the Hazard Warning Switch is activated, all directional turn signals will flash on and off to warn oncoming traffic of an emergency. Push the switch a second time to turn off the flashers.

This is an emergency warning system and should not be used when the vehicle is in motion. Use it when your vehicle is disabled and is creating a safety hazard for other motorists.

When you must leave the vehicle to seek assistance, the Hazard Warning Flashers will continue to operate even though the ignition switch is OFF.

NOTE: With extended use, the Hazard Warning Flashers may wear down your battery.

IF YOUR ENGINE OVERHEATS

In any of the following situations, you can reduce the potential for overheating by taking the appropriate action.

- On the highways — Slow down.
- In city traffic — While stopped, put transaxle in neutral, but do not increase engine idle speed.

NOTE: There are steps that you can take to slow down an impending overheat condition. If your air conditioner is on, turn it off. The air conditioning system adds heat to the engine cooling system and turning off the A/C removes this heat. You can also turn the Temperature control to maximum heat, the Mode control to floor, and the fan control to High. This allows the heater core to act as a supplement to the radiator and aids in removing heat from the engine cooling system.

CAUTION!

Driving with a hot cooling system could damage your vehicle. If temperature gauge reads "H", pull over and stop the vehicle. Idle the vehicle with the air conditioner turned off until the pointer drops back into the normal range. If the pointer remains on the "H", turn the engine off immediately, and call for service.

WARNING!

A hot engine cooling system is dangerous. You or others could be badly burned by steam or boiling coolant. You may want to call a service center if your vehicle overheats. If you decide to look under the hood yourself, see Section 7, Maintenance, of this manual. Follow the warnings under the Cooling System Pressure Cap paragraph.

JACKING AND TIRE CHANGING**WARNING!**

- Getting under a jacked-up vehicle is dangerous. The vehicle could slip off the jack and fall on you. You could be crushed. Never get any part of your body under a vehicle that is on a jack. If you need to get under a raised vehicle, take it to a service center where it can be raised on a lift.
- The jack is designed to use as a tool for changing tires only. The jack should not be used to lift the vehicle for service purposes. The vehicle should be jacked on a firm level surface only. Avoid ice or slippery areas.
- For vehicles equipped with Stow 'n Go seating, if it is necessary to retrieve the spare tire from under the vehicle on the side of the vehicle close to moving traffic. Pull far enough off the road to avoid the danger of being hit.

Jacking Instructions — Stow 'n Go Seating

Preparations For Jacking

Park the vehicle on a firm level surface, avoid ice or slippery areas, set the parking brake and place the gear selector in PARK. Turn OFF the ignition.

WARNING!

Do not attempt to change a tire on the side of the vehicle close to moving traffic. Pull far enough off the road to avoid the danger of being hit when operating the jack or changing the wheel.

- Turn on the Hazard Warning Flasher.

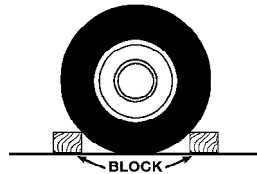

- Block both the front and rear of the wheel diagonally opposite the jacking position. For example, if changing the right front tire, block the left rear wheel.
- Passengers should not remain in the vehicle when the vehicle is being jacked.

Jack Location — Stow 'n Go Seating

The jack, jack handle and winch handle tools are stowed behind the rear left side trim panel in the rear cargo area. Pull up on the lever to release the cover.

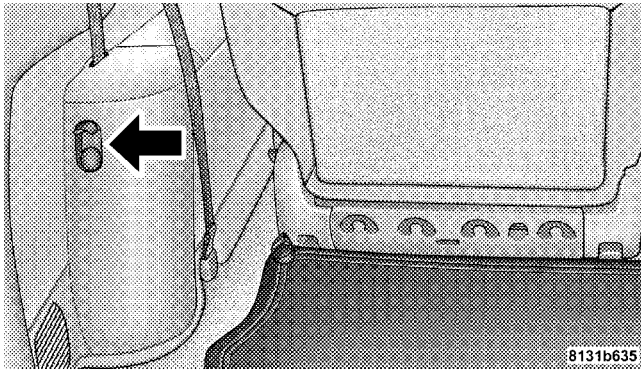

Jack Location

Remove the scissors jack and jack handle by rotating the small wing nut to the left. Also remove the tool pouch containing the spare tire winch handle tools, which is located next to the jack and jack handle.

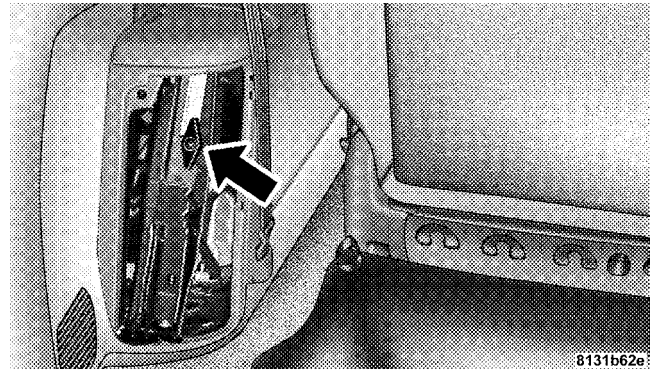

Jack Removal/Installation

Spare Tire Stowage — Stow 'n Go Seating

For vehicles equipped with Stow 'n Go seating, the spare tire is stowed inside a protective cover located under the center of the vehicle by means of a cable winch mechanism. The “spare tire drive” nut is located on the floor, under a plastic cap between the front seats.

The tool pouch contains three pieces and can be assembled into a Spare Tire Hook to remove the compact spare tire/cover assembly from under the vehicle or a Winch “T” Handle to raise/lower the compact spare tire/cover assembly.

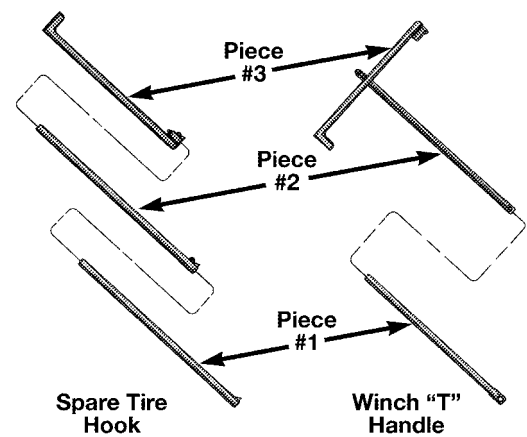

Stow 'n Go Tools

814acba6

Jacking Instructions — Stow 'n Go Seating

1. Loosen (but do not remove) the wheel lug nuts by turning them to the left one turn while the wheel is still on the ground.
2. To remove the compact spare tire/cover assembly, assemble the winch handle extensions to form a "T" and fit the winch "T" handle over the drive nut. Rotate the nut to the left approximately 33 turns until the winch mechanism stops turning freely, this will allow enough slack in the cable to allow you to pull the spare tire out from under the vehicle.

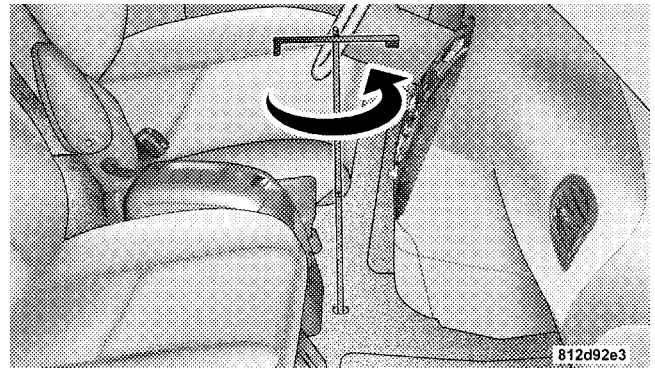

Spare Tire Removal

CAUTION!

The winch mechanism is designed for use with the winch "T" handle only. Use of an air wrench or other power tools is not recommended and can damage the winch.

3. Assemble the winch handle extensions to form the Spare Tire Hook and pull the compact spare tire/cover assembly from under the vehicle.

WARNING!

Getting under a jacked-up vehicle is dangerous. The vehicle could slip off the jack and fall on you. You could be crushed. Never get any part of your body under a vehicle that is on a jack. If you need to get under a raised vehicle, take it to a service center where it can be raised on a lift.

NOTE: If either front tire is flat, it may be necessary to jack up the vehicle to remove the compact spare tire/cover assembly from under the vehicle. Refer to jack engagement locations in the following steps for proper jack placement.

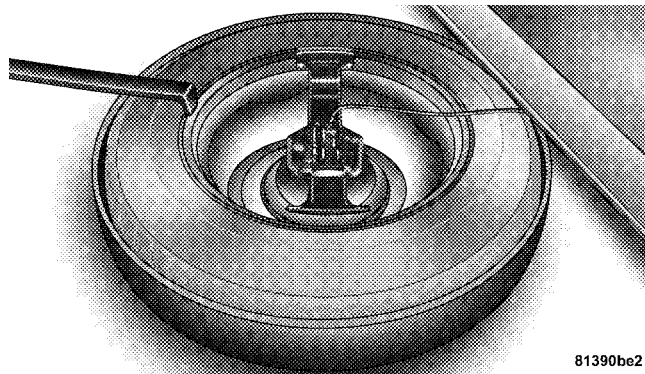

Spare Tire/Cover Removal

4. When the compact spare tire/cover assembly is clear of the vehicle, stand the tire/cover assembly upright and remove the wheel spacer by squeezing the two retaining tabs together.

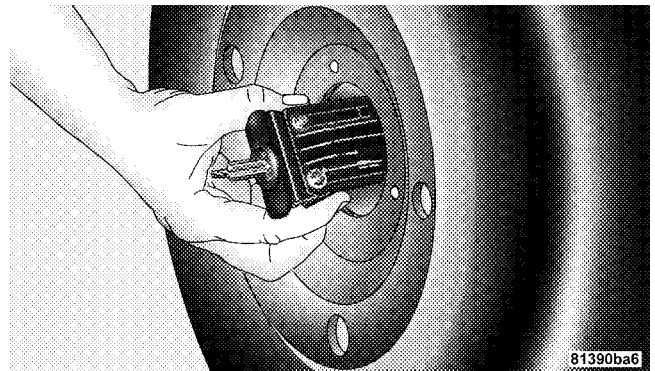

Wheel Spacer Removal

5. There are two jack engagement locations on each side of the body, refer to the following illustration.

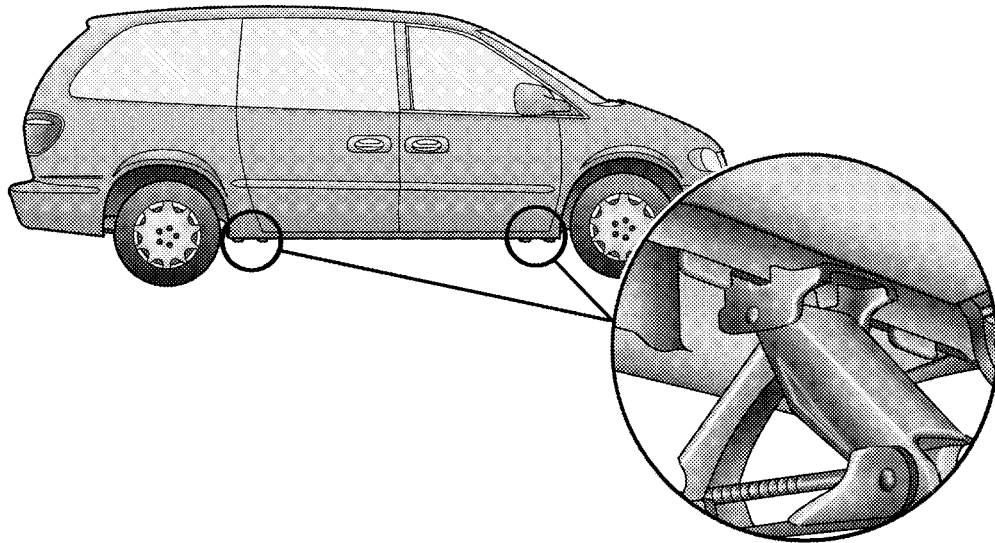

Jack Engagement Locations

81390b4a

6. These locations are on the sill flange of the body and consist of a pair of downstanding tabs. The jack is to be located, engaging the flange, between the pair of tabs closest to the wheel to be changed. Place the wrench on the jack screw and turn to the right until the jack head is properly engaged in the described location. **Do not raise the vehicle until you are sure the jack is securely engaged.**

7. Raise the vehicle by turning the jack screw to the right, using the swivel wrench. Raise the vehicle only until the tire just clears the surface and enough clearance is obtained to install the spare tire. Minimum tire lift provides maximum stability.

WARNING!

Raising the vehicle higher than necessary can make the vehicle less stable. It could slip off the jack and hurt someone near it. Raise the vehicle only enough to remove the tire.

8. Remove the wheel lug nuts, for vehicles with wheel covers, remove the cover from the wheel by hand. Do not pry the wheel cover off. Then pull the wheel off the hub.

9. Install the compact spare tire. Lightly tighten the lug nuts. To avoid the risk of forcing the vehicle off the jack, do not tighten the lug nuts fully until the vehicle has been lowered.

NOTE: Do not install the wheel cover on the compact spare.

Do not use a hammer or force to install the wheel covers.

10. Lower the vehicle by turning the jack screw to the left.

11. Finish tightening the lug nuts. Push down on the wrench while tightening for increased leverage. Alternate lug nuts until each nut has been tightened twice. Correct wheel nut tightness is 130 N·m (95 ft. lbs). If in doubt about the correct tightness, have them checked with a torque wrench by your dealer or at a service station.

12. Lower the jack to its fully closed position.

13. Secure the flat tire as follows:

- Place the deflated (flat) tire and compact spare tire cover assembly in the rear cargo area, have the tire repaired or replaced as soon as possible.

WARNING!

A loose deflated (flat) tire thrown forward in a collision or hard stop could injure the occupants in the vehicle. Have the deflated (flat) tire repaired or replaced immediately.

CAUTION!

Vehicle damage will occur if the compact spare tire cover assembly is installed without the compact spare tire in position. Place the deflated (flat) tire and compact spare tire cover assembly in the rear cargo area.

14. Stow the cable and wheel spacer before driving the vehicle, reassemble the winch handle extensions to form a "T" and fit the winch "T" handle over the drive nut. Rotate the nut to the right approximately 33 turns until the winch mechanism clicks at least three times.

15. Stow the jack, jack handle and winch handle tools.

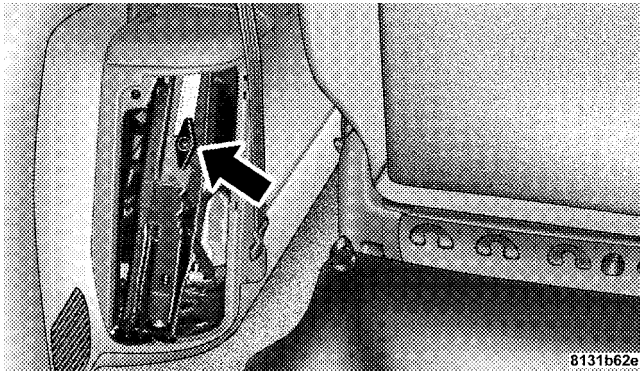

Jack Removal/Installation

WARNING!

A loose jack, thrown forward in a collision or hard stop could endanger the occupants of the vehicle. Always stow the jack parts in the place provided.

16. Check the compact spare tire pressure as soon as possible. Correct pressure as required.

Secure The Spare Tire As Follows:

1. To stow the compact spare tire/cover assembly on vehicles equipped with Stow 'n Go seating, assemble the winch handle extensions to form a "T" and fit the winch "T" handle over the drive nut. Rotate the nut to the left approximately 33 turns until the winch mechanism stops turning freely, this will allow enough slack in the cable to allow you to pull the wheel spacer out from under the vehicle.

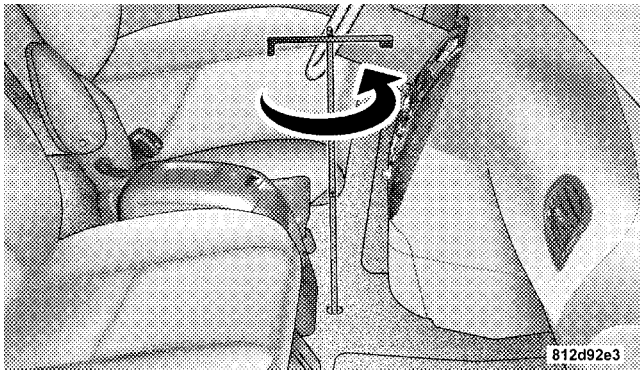

Spare Tire Removal

WARNING!

A loose compact spare tire/cover assembly, thrown forward in a collision or hard stop could endanger the occupants of the vehicle. Always stow the compact spare tire with the cover assembly in the place provided.

CAUTION!

The winch mechanism is designed for use with the winch "T" handle only. Use of an air wrench or other power tools is not recommended and can damage the winch.

2. Assemble the winch handle extensions to form the Spare Tire Hook and pull the wheel spacer from under the vehicle.

3. Turn the compact spare tire so that the valve stem is down and place the tire into the spare tire cover assembly. Slide the wheel spacer through the center of the wheel and spare tire cover assembly so that the two retainer tabs snap out and engage the spare tire cover on the opposite side.

CAUTION!

The compact spare tire cover assembly must be used when the compact spare tire is stored. Failure to use this cover could drastically reduce the life of the compact spare tire.

WARNING!

Verify that 'both' retainer tabs of the wheel spacer have been properly extended through the center of the wheel and spare tire cover assembly. Failure to properly engage both retainer tabs could result in loss of the spare tire & cover assembly, which will cause vehicle damage and may cause loss of control of the vehicle.

4. Using the winch "T" handle, rotate the drive nut to the right until the compact spare tire/cover assembly is drawn into place against the underside of the vehicle.
5. Continue to rotate the nut approximately 33 turns until you hear the winch mechanism click three times. It cannot be overtightened. Check under the vehicle to ensure the compact spare tire/cover assembly is positioned correctly against the underside of the vehicle.

CAUTION!

For vehicles equipped with Stow 'n Go seating, the Winch Mechanism is designed specifically to stow a COMPACT Spare Tire ONLY. Do not attempt to use the Winch to stow the Full Size 'Flat' Tire, or any other Full Size Tire. Vehicle damage may result.

Jacking Instructions — Non Stow 'n Go Seating**Preparations For Jacking**

Park the vehicle on a firm level surface, avoid ice or slippery areas, set the parking brake and place the gear selector in PARK. Turn OFF the ignition.

WARNING!

Do not attempt to change a tire on the side of the vehicle close to moving traffic. Pull far enough off the road to avoid the danger of being hit when operating the jack or changing the wheel.

- Turn on the Hazard Warning Flasher.

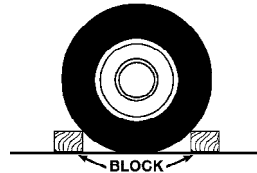

- Block both the front and rear of the wheel diagonally opposite the jacking position. For example, if changing the right front tire, block the left rear wheel.

- Passengers should not remain in the vehicle when the vehicle is being jacked.

Jack Location — Non Stow 'n Go Seating

The jack, jack handle are stowed behind the rear left side trim panel in the rear cargo area. Pull up on the lever to release the cover.

Remove the spare wheel, scissors jack and jack handle from stowage by rotating the wing nut to the left.

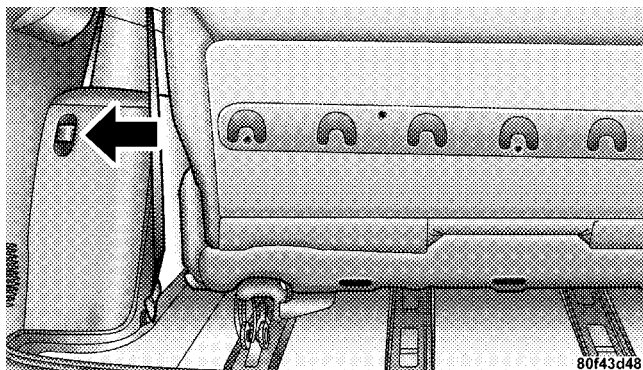

Jack Location

Spare Tire Stowage — Non Stow 'n Go Seating

For vehicles not equipped with Stow 'n Go seating the spare tire is stowed under the rear of the vehicle by means of a cable winch mechanism. To remove or stow the spare, use the jack handle to rotate the "spare tire drive" nut. The nut is located under the plastic cover at the center rear of the cargo floor area, just inside the liftgate opening.

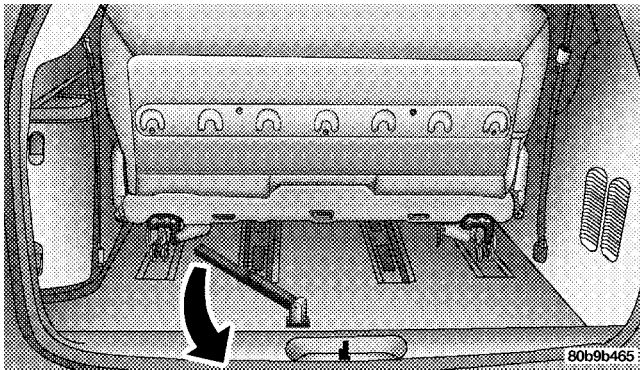

Lowering Spare Tire

Jacking Instructions — Non Stow 'n Go Seating

1. Loosen (but do not remove) the wheel lug nuts by turning them to the left one turn while the wheel is still on the ground.

2. Fit the jack handle over the drive nut. Rotate the nut to the left until the spare is on the ground with enough slack cable to allow you to pull the tire out from under the vehicle.

CAUTION!

The winch mechanism is designed for use with the jack handle only. Use of an air wrench or other power tools is not recommended and can damage the winch.

6

3. When the spare is clear, tilt the retainer at the end of the cable and pull it through the center of the wheel.

4. There are two jack engagement locations on each side of the body — refer to the following illustration.

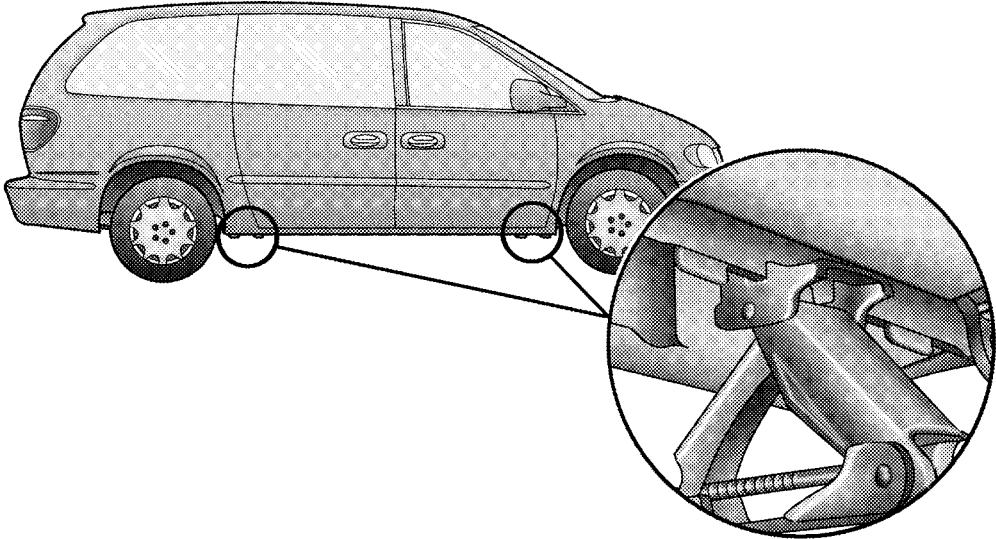

Jack Engagement Locations

81390b4a

5. These locations are on the sill flange of the body and consist of a pair of downstanding tabs. The jack is to be located, engaging the flange, between the pair of tabs closest to the wheel to be changed. Place the wrench on the jack screw and turn to the right until the jack head is properly engaged in the described location. **Do not raise the vehicle until you are sure the jack is securely engaged.**

6. Raise the vehicle by turning the jack screw to the right, using the swivel wrench. Raise the vehicle only until the tire just clears the surface and enough clearance is obtained to install the spare tire. Minimum tire lift provides maximum stability.

WARNING!

Raising the vehicle higher than necessary can make the vehicle less stable. It could slip off the jack and hurt someone near it. Raise the vehicle only enough to remove the tire.

7. Remove the wheel lug nuts, for vehicles with wheel covers, remove the cover from the wheel by hand. Do not pry the wheel cover off. Then pull the wheel off the hub.

8. Install the spare wheel, for vehicles with wheel covers, align the notch in the wheel cover with the valve stem on the wheel. Install the cover on the wheel by hand only and install the wheel lug nuts with the cone shaped end of the nut toward the wheel. Lightly tighten the lug nuts. To avoid the risk of forcing the vehicle off the jack, do not tighten the lug nuts fully until the vehicle has been lowered.

NOTE: Do not install the wheel cover on the compact spare.

Do not use a hammer or force to install the wheel covers.

9. Lower the vehicle by turning the jack screw to the left.

10. Finish tightening the lug nuts. Push down on the wrench while tightening for increased leverage. Alternate lug nuts until each nut has been tightened twice. Correct wheel nut tightness is 130 N·m (95 ft. lbs). If in doubt about the correct tightness, have them checked with a torque wrench by your dealer or at a service station.

11. Lower the jack to its fully closed position.

WARNING!

A loose tire or jack, thrown forward in a collision or hard stop could endanger the occupants of the vehicle. Always stow the jack parts and the spare tire in the places provided.

12. Secure the flat or spare tire as follows:

- If your vehicle is equipped with cast aluminum wheels, the center cap of the wheel must be removed prior to flat tire stowage. Store the center cap inside the glove box or other storage compartment.
- Turn the wheel so that the valve stem is down. Slide the wheel retainer through the center of the wheel and position it properly across the wheel opening.

- For convenience in checking the spare tire inflation, stow with the valve stem toward the rear of the vehicle.
- Using the jack handle, rotate the drive nut to the right until the wheel is drawn into place against the underside of the vehicle.
- Continue to rotate the nut until you hear the mechanism click three times. It cannot be overtightened. Push against the tire several times to be sure it is securely in place.

13. Stow the jack and jack handle.

14. Check the tire pressure as soon as possible. Correct pressure as required.

JUMP-STARTING PROCEDURES IF BATTERY IS LOW

WARNING!

Take care to avoid the radiator cooling fan whenever the hood is raised. It can start anytime the ignition switch is on. You can be hurt by the fan.

WARNING!

- Do not attempt to push or tow your vehicle to get it started. Vehicles equipped with an automatic transmission cannot be started this way. Unburned fuel could enter the catalytic converter and once the engine has started, ignite and damage the converter and vehicle. If the vehicle has a discharged battery, booster cables may be used to obtain a start from another vehicle. This type of start can be dangerous if done improperly, so follow this procedure carefully.
- Battery fluid is a corrosive acid solution; do not allow battery fluid to contact eyes, skin or clothing. Don't lean over battery when attaching clamps or allow the clamps to touch each other. If acid splashes in eyes or on skin, flush contaminated area immediately with large quantities of water.
- A battery generates hydrogen gas which is flammable and explosive. Keep flame or spark away from the vent holes. Do not use a booster battery or any other booster source with an output that exceeds 12 volts.

1. Wear eye protection and remove any metal jewelry such as watch bands or bracelets that might make an inadvertent electrical contact.
2. When boost is provided by a battery in another vehicle, park that vehicle within booster cable reach and without letting the vehicles touch. Set the parking brake, place the automatic transmission in PARK and turn the ignition switch to the OFF position for both vehicles.
3. Turn off the heater, radio and all unnecessary electrical loads.
4. Connect one end of a jumper cable to the positive terminal of the discharged battery. Connect the other end of the same cable to the positive terminal of the booster battery.

5. Connect the other cable, first to the negative terminal of the booster battery and **then to the engine of the vehicle with the discharged battery**. Make sure you have a good contact on the engine.
6. Start the engine in the vehicle which has the booster battery, let the engine idle a few minutes, then start the engine in the vehicle with the discharged battery.
7. When removing the jumper cables, reverse the above sequence exactly. Be careful of the moving belts and fan.

DRIVING ON SLIPPERY SURFACES

Acceleration

Rapid acceleration on snow covered, wet, or other slippery surfaces may cause the front wheels to pull erratically to the right or left. This phenomenon occurs when there is a difference in the surface traction under the front (driving) wheels.

WARNING!

Rapid acceleration on slippery surfaces is dangerous. Unequal traction can cause sudden pulling of the front wheels. You could lose control of the vehicle and possibly have an accident. Accelerate slowly and carefully whenever there is likely to be poor traction (ice, snow, wet mud, loose sand, etc.).

Traction

When driving on wet or slushy roads, it is possible for a wedge of water to build up between the tire and road surface. This is known as hydroplaning and may cause partial or complete loss of vehicle control and stopping ability. To reduce this possibility, the following precautions should be observed:

1. Slow down during rainstorms or when roads are slushy.

2. Slow down if road has standing water or puddles.
3. Replace tires when tread wear indicators first become visible.
4. Keep tires properly inflated.
5. Maintain sufficient distance between your vehicle and the vehicle in front to avoid a collision in a sudden stop.

FREEING A STUCK VEHICLE

If your vehicle becomes stuck in mud, sand or snow, it can often be moved by a rocking motion. Turn your steering wheel right and left to clear the area around the front wheels. Then shift back and forth between Reverse and Drive. Usually the least accelerator pedal pressure to maintain the rocking motion without spinning the wheels is most effective.

WARNING!

Fast spinning tires can be dangerous. Forces generated by excessive wheel speeds may cause tire damage or failure. A tire could explode and injure someone. Do not spin your vehicle's wheels faster than 35 mph (55 km/h) when you are stuck. And don't let anyone near a spinning wheel, no matter what the speed.

CAUTION!

Racing the engine or spinning the wheels too fast may lead to transmission overheating and failure. It can also damage the tires. Do not spin the wheels above 35 mph (55 km/h).

TOWING A DISABLED VEHICLE

With Ignition Key

Your vehicle may be towed under the following conditions: The gear selector must be in NEUTRAL, the distance to be traveled must not exceed 100 miles (160 km), and the towing speed must not exceed 44 mph (72 km/h). Exceeding these towing limits may cause a transmission geartrain failure. If the transmission is not operative, or if the vehicle is to be towed more than 100 miles (160 km), the vehicle must be towed with the front wheels off the ground.

CAUTION!

- Do not attempt to tow this vehicle from the front with sling type towing equipment. Damage to the front fascia will result.
- Always use wheel lift equipment when towing from the front. The only other approved method of towing is with a flat bed truck.
- Do not tow the vehicle from the rear. Damage to the rear sheet metal, liftgate and fascia will occur.
- Do not push or tow this vehicle with another vehicle as damage to the bumper fascia and transmission may result.
- If the vehicle being towed requires steering, the ignition switch must be in the OFF position, not in the LOCK or ACCESSORY positions.

If it is necessary to use the accessories while being towed (wipers, defrosters, etc.), the key must be in the ON position, not the ACCESSORY position. Make certain the transmission remains in NEUTRAL.

Without The Ignition Key

Special care must be taken when the vehicle is towed with the ignition in the LOCK position. The only approved method of towing with out the ignition key is with a flat bed truck. Proper towing equipment is necessary to prevent damage to the vehicle.

TOWING THIS VEHICLE BEHIND ANOTHER VEHICLE (Flat towing with all four wheels on the ground)

Flat towing of vehicles equipped with an automatic transmission, is only permitted within the limitations described in this section.

TOWING THIS VEHICLE BEHIND ANOTHER VEHICLE WITH A TOW DOLLY

The manufacturer **does not recommend** that you tow a front wheel drive vehicle on a tow dolly. Vehicle damage may occur.

MAINTAINING YOUR VEHICLE

CONTENTS

■ 2.4L Engine	396	□ Engine Oil Filter	405
■ 3.3L/3.8L Engines	397	□ Drive Belts — Check Condition And Tension . .	405
■ Onboard Diagnostic System — OBD II	398	□ Spark Plugs	406
■ Emissions Inspection And Maintenance Programs	399	□ Engine Air Cleaner Filter	406
■ Replacement Parts	400	□ Catalytic Converter	407
■ Dealer Service	400	□ Maintenance-Free Battery	409
■ Maintenance Procedures	401	□ Air Conditioner Maintenance	410
□ Engine Oil	401	□ Power Steering — Fluid Check	412
		□ Front Suspension Ball Joints	412

394 MAINTAINING YOUR VEHICLE

□ Steering Shaft Seal	413	□ Front And Rear Wheel Bearings	428
□ Steering Linkage	413	□ Appearance Care And Protection From Corrosion	428
□ Drive Shaft Universal Joints	413	□ Cleaning The Instrument Panel And Underseat Cup Holders	432
□ Body Lubrication	413	■ Integrated Power Module (IPM)	434
□ Windshield Wiper Blades	414	■ Vehicle Storage	436
□ Windshield And Rear Window Washers	414	■ Replacement Light Bulbs	437
□ Exhaust System	415	■ Bulb Replacement	438
□ Cooling System	416	□ Headlights	438
□ Hoses And Vacuum/Vapor Harnesses	421	□ Front Park/Turn Signal And Sidemarker Lights	439
□ Brakes	421	□ Front Fog Light	440
□ Master Cylinder — Brake Fluid Level Check	423		
□ Fuel System Hoses	424		
□ Automatic Transmission	424		

□ Rear Tail, Stop, Turn Signal, Side Marker And Back-Up Lights	441	■ Fluids, Lubricants And Genuine Parts	444
□ Center High Mounted Stop Light (CHMSL)	442	□ Engine	444
□ License Light	442	□ Chassis	445
■ Fluids And Capacities	443		

2.4L ENGINE

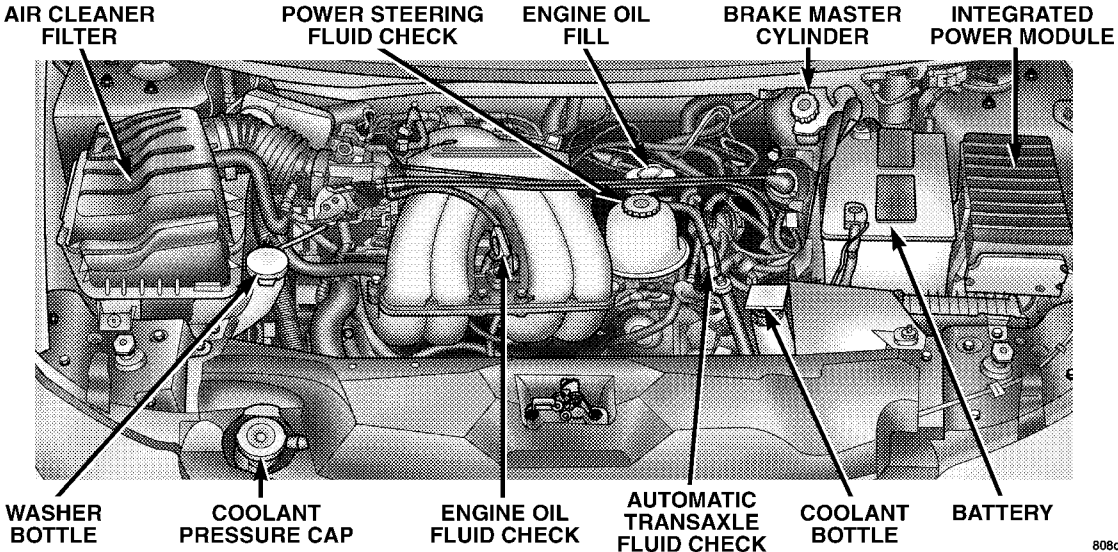

808cf148

Engine Compartment 2.4L Engine

3.3L/3.8L ENGINES

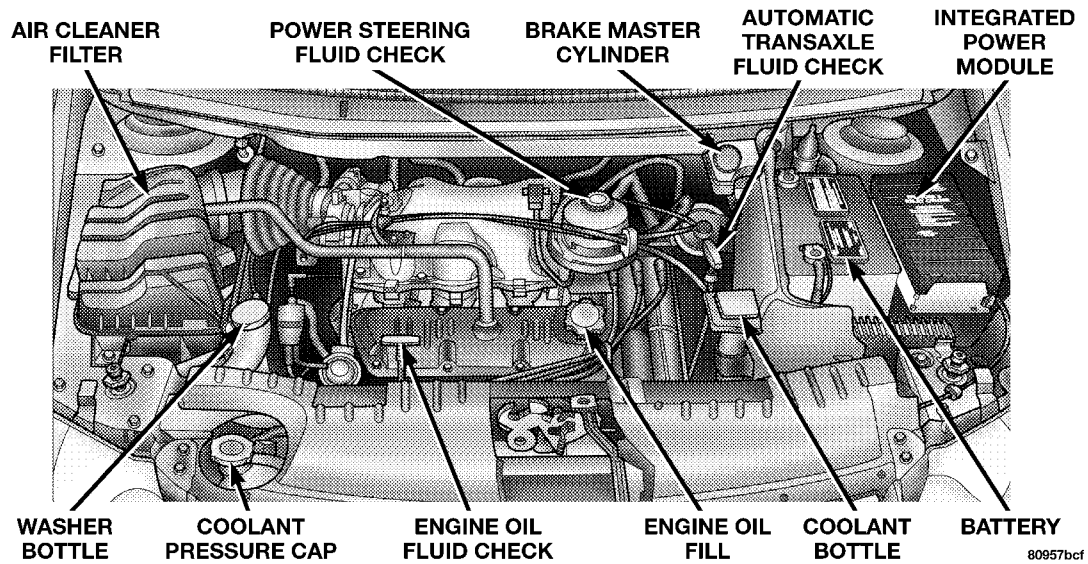

Engine Compartment 3.3L/3.8L Engines

ONBOARD DIAGNOSTIC SYSTEM — OBD II

Your vehicle is equipped with a sophisticated onboard diagnostic system called OBD II. This system monitors the performance of the emissions, engine, and automatic transmission control systems. When these systems are operating properly, your vehicle will provide excellent performance and fuel economy, as well as engine emissions well within current government regulations.

If any of these systems require service, the OBD II system will turn on the “Malfunction Indicator Light.” It will also store diagnostic codes and other information to assist your service technician in making repairs. Although your vehicle will usually be drivable and not need towing, see your dealer for service as soon as possible.

CAUTION!

- Prolonged driving with the “Malfunction Indicator Light” on could cause further damage to the emission control system. It could also affect fuel economy and driveability. The vehicle must be serviced before any emissions tests can be performed.
- If the “Malfunction Indicator Light” is flashing while the engine is running, severe catalytic converter damage and power loss will soon occur. Immediate service is required.

EMISSIONS INSPECTION AND MAINTENANCE PROGRAMS

In some localities, it may be a legal requirement to pass an inspection of your vehicle's emissions control system. Failure to pass could prevent vehicle registration.



For states which have an I/M (Inspection and Maintenance) requirement, this check verifies the following: the MIL (Malfunction Indicator Lamp) is functioning and is not on when the engine is running, and that the OBD (On Board Diagnostic) system is ready for testing.

Normally, the OBD system will be ready. The OBD system may **not** be ready if your vehicle was recently serviced, if you recently had a dead battery, or a battery replacement. If the OBD system should be determined not ready for the I/M test, your vehicle may fail the test.

Your vehicle has a simple ignition key actuated test which you can use prior to going to the test station. To check if your vehicle's OBD system is ready, you must do the following:

1. Insert your ignition key into the ignition switch.
2. Turn the ignition to the ON position, but do not crank or start the engine.
3. If you crank or start the engine, you will have to start this test over.
4. As soon as you turn your key to the ON position, you will see your MIL symbol come on as part of a normal bulb check.
5. Approximately 15 seconds later, one of two things will happen:
 - a. The MIL will flash for about 10 seconds and then return to being fully illuminated until you turn off the

ignition key or start the engine. This means that your vehicle's OBD system is **not ready** and you should **not** proceed to the I/M station.

b. The MIL will not flash at all and will remain fully illuminated until you turn off the ignition key or start the engine. This means that your vehicle's OBD system is **ready** and you can proceed to the I/M station.

If your OBD system is **not ready**, you should see your authorized dealer or repair facility. If your vehicle was recently serviced or had a battery failure or replacement, you may need to do nothing more than drive your vehicle as you normally would in order for your OBD system to update. A recheck with the above test routine may then indicate that the system is now ready.

Regardless of whether your vehicle's OBD system is ready or not ready, if the MIL symbol is illuminated during normal vehicle operation, you should have your

vehicle serviced before going to the I/M station. The I/M station can fail your vehicle because the MIL symbol is on with the engine running.

REPLACEMENT PARTS

Use of genuine Mopar® parts for normal/scheduled maintenance and repairs is highly recommended to insure the designed performance. Damage or failures caused by the use of non-Mopar® parts for maintenance and repairs will not be covered by the manufacturer's warranty.

DEALER SERVICE

Your dealer has the qualified service personnel, special tools and equipment to perform all service operations in an expert manner. Service Manuals are available which include detailed service information for your vehicle. Refer to these manuals before attempting any procedure yourself.

NOTE: Intentional tampering with emissions control systems can result in civil penalties being assessed against you.

WARNING!

You can be badly injured working on or around a motor vehicle. Do only that service work for which you have the knowledge and the proper equipment. If you have any doubt about your ability to perform a service job, take your vehicle to a competent mechanic.

MAINTENANCE PROCEDURES

The pages that follow contain the **required** maintenance services determined by the engineers who designed your vehicle.

Besides the maintenance items for which there are fixed maintenance intervals, there are other items that should operate satisfactorily without periodic maintenance. However, if a malfunction of these items does occur, it could adversely affect the engine or vehicle performance. These items should be inspected if a malfunction is observed or suspected.

Engine Oil

Checking Oil Level

To assure proper engine lubrication, the engine oil must be maintained at the correct level. Check the oil level at regular intervals, such as every fuel stop.

The best time to check the engine oil level is about 5 minutes after a fully warmed engine is shut off or before starting the engine after it has sat overnight.

Checking the oil while the vehicle is on level ground will improve the accuracy of the oil level readings. Maintain the oil level between the MIN and MAX markings on the dipstick. Adding one quart of oil when the reading is at the MIN mark will result in a MAX reading on these engines.

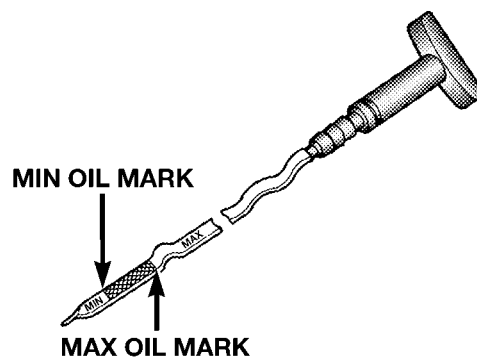

80975a64

Engine Oil Dipstick

CAUTION!

Overfilling or underfilling will cause oil aeration or loss of oil pressure. This could damage your engine.

Change Engine Oil

Road conditions and your kind of driving affects the interval at which your oil should be changed. Check the following list to see if any apply to you.

- Day or night temperatures are below 32°F (0°C).
- Stop and Go driving.
- Extensive engine idling.
- Driving in dusty conditions.
- Short trips of less than 10 miles (16 km).
- More than 50% of your driving is at sustained high speeds during hot weather, above 90°F (32°C).
- Trailer towing.
- Taxi, Police or delivery service (commercial service).
- Off-Road or desert operation.

If ANY of these apply to you, then change your engine oil at every interval shown in schedule “B” of the “Maintenance Schedules” section of this manual.

If none of these apply to you, then change your engine oil at every interval shown on schedule “A” of the “Maintenance Schedules” section of this manual

NOTE: Under no circumstances should oil change intervals exceed 6000 miles (10 000 km) or 6 months whichever comes first.

Engine Oil Selection

For best performance and maximum protection under all types of operating conditions, the manufacturer only recommends engine oils that are API certified and meet the requirements of DaimlerChrysler Material Standard MS-6395.

American Petroleum Institute (API) Engine Oil Identification Symbol



This symbol means that the oil has been certified by the American Petroleum Institute (API). The manufacturer only recommends API Certified engine oils.

Engine Oil Viscosity (SAE Grade) — 2.4 Liter Engines

SAE 5W-30 engine oil is recommended for all operating temperatures. This engine oil improves low temperature starting and vehicle fuel economy. Your engine oil filler cap also shows the recommended engine oil viscosity for your vehicle.

For information on engine oil filler cap location, refer to the Engine Compartment illustration in this section.

Lubricants which do not have both, the engine oil certification mark and the correct SAE viscosity grade number should not be used.

Engine Oil Viscosity (SAE Grade) — 3.3/3.8 Liter Engines

SAE 5W-20 engine oil is recommended for all operating temperatures. This engine oil improves low temperature starting and vehicle fuel economy. Refer to your engine oil filler cap for the recommended engine oil viscosity for your vehicle.

For information on engine oil filler cap location, refer to the Engine Compartment illustration in this section.

Lubricants which do not have both, the engine oil certification mark and the correct SAE viscosity grade number should not be used.

Synthetic Engine Oils

There are a number of engine oils being promoted as either synthetic or semi-synthetic. If you chose to use such a product, use **only** those oils that are American Petroleum Institute (API) Certified and have the recommended SAE viscosity grade. Follow the maintenance schedule that describes your driving type.

Materials Added to Engine Oil

The manufacture strongly recommends against the addition of any additives (other than leak detection dyes) to the engine oil. Engine oil is an engineered product and it's performance may be impaired by supplemental additives.

Disposing of Used Engine Oil And Oil Filters

Care should be taken in disposing of used engine oil and oil filters from your vehicle. Used oil and oil filters, indiscriminately discarded, can present a problem to the environment. Contact your dealer, service station, or

governmental agency for advice on how and where used oil and oil filters can be safely discarded in your area.

Engine Oil Filter

The engine oil filter should be replaced at every engine oil change.

Engine Oil Filter Selection

All the manufacturers engines have a full-flow type oil filter. Use a filter of this type for replacement. The quality of replacement filters varies considerably. Only high quality filters should be used to assure most efficient service. Mopar Engine Oil Filters are a high quality oil filter and are recommended.

Drive Belts — Check Condition and Tension

At the mileage indicated in the maintenance schedule, all belts should be checked for condition and proper tension. Improper belt tension can cause belt slippage and failure.

Belts should be inspected for evidence of cuts, cracks, or glazing, and replaced if there is indication of damage which could result in belt failure. If adjustment is required, the belts must be adjusted according to the specifications and procedures described in the Service Manual. Low generator belt tension can cause battery failure. A special tool is required to properly measure tension and to restore belt tension to factory specifications.

Also check belt routing to make sure there is no interference between the belts and other engine components.

Spark Plugs

Spark plugs must fire properly to assure engine performance and emission control. New plugs should be installed at the specified mileage. The entire set should be replaced if there is any malfunction due to a faulty spark

plug, malfunctioning spark plugs can damage the catalytic converter. For proper type of replacement spark plugs, refer to the "Vehicle Emission Control Information" label in the engine compartment.

Engine Air Cleaner Filter

Under normal driving conditions, replace the air filter at the intervals shown on Schedule "A". If, however, you drive the vehicle frequently under dusty or severe conditions, the filter element should be inspected periodically and replaced if necessary at the intervals shown on Schedule "B".

WARNING!

The air cleaner can provide a measure of protection in the case of engine backfire. Do not remove the air cleaner unless such removal is necessary for repair or maintenance. Make sure that no one is near the engine compartment before starting the vehicle with the air cleaner removed. Failure to do so can result in serious personal injury.

Catalytic Converter

The catalytic converter requires the use of unleaded fuel only. Leaded gasoline will destroy the effectiveness of the catalyst as an emission control device.

Under normal operating conditions, the catalytic converter will not require maintenance. However, it is important to keep the engine properly tuned to assure proper catalyst operation and prevent possible catalyst damage.

CAUTION!

Damage to the catalytic converter can result if your vehicle is not kept in proper operating condition. In the event of engine malfunction, particularly involving engine misfire or other apparent loss of performance, have your vehicle serviced promptly. Continued operation of your vehicle with a severe malfunction could cause the converter to overheat, resulting in possible damage to the converter and the vehicle.

NOTE: Intentional tampering with emissions control systems can result in civil penalties being assessed against you.

WARNING!

A hot exhaust system can start a fire if you park over materials that can burn. Such materials might be grass or leaves coming into contact with your exhaust system. Do not park or operate your vehicle in areas where your exhaust system can contact anything that can burn.

In unusual situations involving grossly malfunctioning engine operation, a scorching odor may indicate severe and abnormal catalyst overheating. If this occurs, the vehicle should be stopped, the engine shut off and the

vehicle allowed to cool. Thereafter, service, including a tune-up to manufacturer's specifications, should be obtained immediately.

To minimize the possibility of catalyst damage:

- Do not shut off the engine or interrupt the ignition when the transmission is in gear and the vehicle is in motion.
- Do not try to start engine by pushing or towing the vehicle.
- Do not idle the engine with any spark plug wires disconnected or removed, such as when diagnostic testing, or for prolonged periods during very rough idling or malfunctioning operating conditions.

Maintenance-Free Battery

The top of the MAINTENANCE-FREE battery is permanently sealed. You will never have to add water, nor is periodic maintenance required.

WARNING!

- Battery fluid is a corrosive acid solution and can burn or even blind you. Don't allow battery fluid to contact your eyes, skin or clothing. Don't lean over a battery when attaching clamps. If acid splashes in eyes or on skin, flush the area immediately with large amounts of water.
- Battery gas is flammable and explosive. Keep flame or sparks away from the battery. Don't use a booster battery or any other booster source with an output greater than 12 volts. Don't allow cable clamps to touch each other.
- Battery posts, terminals and related accessories contain lead and lead compounds. Wash hands after handling.

CAUTION!

- It is essential when replacing the cables on the battery that the positive cable is attached to the positive post and the negative cable is attached to the negative post. Battery posts are marked positive (+) and negative (-) and identified on the battery case. Cable clamps should be tight on the terminal posts and free of corrosion.
- If a "fast charger" is used while battery is in vehicle, disconnect both vehicle battery cables before connecting the charger to battery. Do not use a "fast charger" to provide starting voltage.

Air Conditioner Maintenance

For best possible performance, your air conditioner should be checked and serviced by an Authorized Dealer at the start of each warm season. This service should include cleaning of the condenser fins and a system performance check. Drive belt tension should also be checked at this time.

WARNING!

- Use only refrigerants and compressor lubricants approved by the manufacturer for your air conditioning system. Some unapproved refrigerants are flammable and can explode, injuring you. Other unapproved refrigerants or lubricants can cause the system to fail, requiring costly repairs. Refer to Section 3 of the Warranty Information book for further warranty information.
- The air conditioning system contains refrigerant under high pressure. To avoid risk of personal injury or damage to the system, adding refrigerant or any repair requiring lines to be disconnected should be done by an experienced repairman.

Refrigerant Recovery And Recycling

R-134a Air Conditioning Refrigerant is a hydrofluorocarbon (HFC) that is endorsed by the Environmental Protection Agency and is an ozone-saving product. However, the manufacturer recommends that air conditioning service be performed by dealers or other service facilities using recovery and recycling equipment.

NOTE: Use only manufacturer approved A/C System Sealers, Stop Leak Products, Seal Conditioners, Compressor Oil, or Refrigerants.

A/C Air Filter — If Equipped

The A/C Air Filter — if so equipped, is found behind the filter access door located under the instrument panel on the passenger side. To replace the filter slide the lock toward the rear of the vehicle (unlock position). Remove the access door and pull the filter downward. When installing a new filter, ensure its proper orientation. Align

the black arrow on the bottom of the filter frame with the direction of airflow (away from the blower motor and towards the center of the car).

Refer to the "Maintenance Schedules" section of this manual for the recommended air conditioning filter replacement intervals.

Power Steering — Fluid Check

Checking the power steering fluid level at a defined service interval is not required. The fluid should only be checked if a leak is suspected, abnormal noises are apparent, and/or the system is not functioning as anticipated. Coordinate inspection efforts through a certified DaimlerChrysler Dealership."

WARNING!

Fluid level should be checked on a level surface and with the engine off to prevent injury from moving parts and to insure accurate fluid level reading. Do not overfill. Use only manufacturers recommended power steering fluid.

If necessary, add fluid to restore to the proper indicated level. With a clean cloth, wipe any spilled fluid from all surfaces. Refer to Fluids, Lubricants, and Genuine Parts for correct fluid type.

Front Suspension Ball Joints

The front suspension ball joints are permanently sealed. No regular maintenance is required for these components.

Steering Shaft Seal

The steering shaft seal, at the point where the shaft passes through the bulkhead, is lubricated when it is installed. If the seal becomes noisy when the steering shaft is turned, it should be lubricated with a multi-purpose grease. Mopar multi-purpose lubricant is recommended.

Steering Linkage

The tie rod end ball joints are permanently lubricated and do not require periodic maintenance.

Drive Shaft Universal Joints

Your vehicle has constant velocity universal joints. Periodic lubrication of these joints is not required. However, the joint boots should be inspected for external leakage or damage when other maintenance is performed. If leakage or damage is evident, the universal joint boot and grease should be replaced immediately.

Continued operation could result in failure of the universal joint due to water and dirt contamination of the grease. This would require complete replacement of the joint assembly.

Body Lubrication

Locks and all body pivot points, including such items as seat tracks, doors, liftgate, sliding doors and hood hinges, should be lubricated periodically to assure quiet, easy operation and to protect against rust and wear. Prior to the application of any lubricant, the parts concerned should be wiped clean to remove dust and grit; after lubricating excess oil and grease should be removed. Particular attention should also be given to hood latching components to insure proper function. When performing other underhood services, the hood latch, release mechanism and safety catch should be cleaned and lubricated.

The external lock cylinders should be lubricated twice a year, preferably in the fall and spring. Apply a small amount of a high quality lubricant such as Mopar® Lock Cylinder Lubricant directly into the lock cylinder.

Windshield Wiper Blades

The rubber edges of the wiper blades and the windshield should be cleaned periodically with a sponge or soft cloth and a mild nonabrasive cleaner. This will remove accumulations of salt or road film.

Operation of the wipers on dry glass for long periods may cause deterioration of the wiper blades. Always use washer fluid when using the wipers to remove salt or dirt from a dry windshield.

Avoid using the wiper blades to remove frost or ice from the windshield. Keep the blade rubber out of contact with petroleum products such as engine oil, gasoline, etc.

Windshield and Rear Window Washers

The fluid reservoir for the windshield washers and the rear window washer is shared. It is located in the engine compartment and should be checked for fluid level at regular intervals. Fill the reservoir with windshield washer solvent (not radiator antifreeze) and operate the system for a few seconds to flush out the residual water.

The washer fluid reservoir will hold a full gallon of fluid when the Low Washer Fluid Light illuminates.

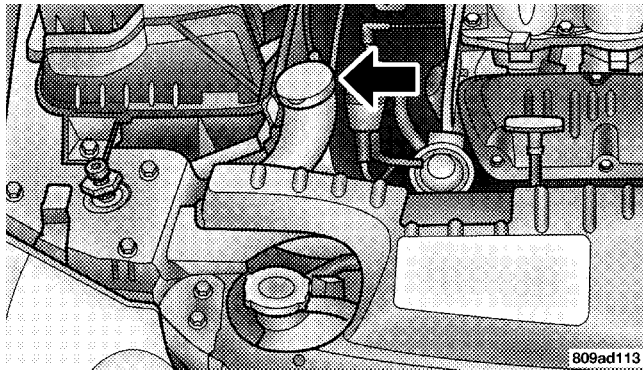

Washer Fluid Reservoir

Exhaust System

The best protection against carbon monoxide entry into the vehicle body is a properly maintained engine exhaust system.

Whenever a change is noticed in the sound of the exhaust system, when exhaust fumes can be detected inside the

vehicle, or when the underside or rear of the vehicle is damaged, have a competent mechanic inspect the complete exhaust system and adjacent body areas for broken, damaged, deteriorated, or mispositioned parts. Open seams or loose connections could permit exhaust fumes to seep into the passenger compartment. In addition, inspect the exhaust system each time the vehicle is raised for lubrication or oil change. Replace as required.

WARNING!

Exhaust gases can injure or kill. They contain carbon monoxide (CO) which is colorless and odorless. Breathing it can make you unconscious and can eventually poison you. To avoid breathing CO, refer to "Exhaust Gas" in the Safety Tips section of this manual.

Cooling System

WARNING!

- When working near the radiator cooling fan, disconnect the fan motor lead or turn the ignition switch to the OFF position. The fan is temperature controlled and can start at any time the ignition switch is in the ON position.
- You or others can be badly burned by hot coolant or steam from your radiator. If you see or hear steam coming from under the hood, don't open the hood until the radiator has had time to cool. Never try to open a cooling system pressure cap when the radiator is hot.

Engine Coolant Checks

Check the engine coolant (antifreeze) protection every 12 months (before the onset of freezing weather, where

applicable). If coolant is dirty or rusty in appearance, the system should be drained, flushed and refilled with fresh coolant. Check the front of the A/C condenser for any accumulation of bugs, leaves, etc. If dirty, clean by gently spraying water from a garden hose vertically down the face of the condenser.

Check the coolant recovery bottle tubing for brittle rubber, cracking, tears, cuts and tightness of the connection at the bottle and radiator. Inspect the entire system for leaks.

With the engine at normal operating temperature (but not running), check the cooling system pressure cap for proper vacuum sealing by draining a small amount of coolant from the radiator drain cock. If the cap is sealing properly, the engine coolant (antifreeze) will begin to drain from the coolant recovery bottle. **DO NOT REMOVE THE COOLANT PRESSURE CAP WHEN THE COOLING SYSTEM IS HOT.**

Cooling System — Drain, Flush and Refill

At the intervals shown on the Maintenance Schedules, the system should be drained, flushed and refilled.

If the solution is dirty or contains a considerable amount of sediment, clean and flush with a reliable cooling system cleaner. Follow with a thorough rinsing to remove all deposits and chemicals. Properly dispose of old antifreeze solution.

Selection Of Engine Coolant

Use only the manufacturers recommended coolant, refer to Fluids, Lubricants and Genuine Parts for correct coolant type.

CAUTION!

Mixing of coolants other than specified HOAT engine coolants, may result in engine damage and may decrease corrosion protection. If a non-HOAT coolant is introduced into the cooling system in an emergency, it should be replaced with the specified coolant as soon as possible.

Do not use plain water alone or alcohol base engine coolant (antifreeze) products. Do not use additional rust inhibitors or antirust products, as they may not be compatible with the radiator engine coolant and may plug the radiator.

This vehicle has not been designed for use with Propylene Glycol based coolants. Use of Propylene Glycol based coolants is not recommended.

Adding Engine Coolant

Your vehicle has been built with an improved engine coolant that allows extended maintenance intervals. This coolant can be used up to 5 Years or 100,000 miles before replacement. To prevent reducing this extended maintenance period, it is important that you use the same coolant throughout the life of your vehicle. Please review these recommendations for using Hybrid Organic Additive Technology (HOAT) coolant.

When adding coolant, a minimum solution of 50% recommended Mopar Antifreeze/ Coolant 5 Year/100,000 Mile Formula HOAT (Hybrid Organic Additive Technology), or equivalent, in water should be used. Use higher concentrations (not to exceed 70%) if temperatures below -34°F (-37°C) are anticipated.

Use only high purity water such as distilled or deionized water when mixing the water/engine coolant solution.

The use of lower quality water will reduce the amount of corrosion protection in the engine cooling system.

Please note that it is the owner's responsibility to maintain the proper level of protection against freezing according to the temperatures occurring in the area where the vehicle is operated.

NOTE: Mixing coolant types will decrease the life of the engine coolant and will require more frequent coolant changes.

Cooling System Pressure Cap

The cap must be fully tightened to prevent loss of coolant, and to insure that coolant will return to the radiator from the coolant recovery bottle.

The cap should be inspected and cleaned if there is any accumulation of foreign material on the sealing surfaces.

WARNING!

- The warning words “DO NOT OPEN HOT” on the cooling system pressure cap are a safety precaution. Never add coolant when the engine is overheated. Do not loosen or remove the cap to cool an overheated engine. Heat causes pressure to build up in the cooling system. To prevent scalding or injury, do not remove the pressure cap while the system is hot or under pressure.
- Do not use a pressure cap other than the one specified for your vehicle. Personal injury or engine damage may result.

Disposal of Used Engine Coolant

Used ethylene glycol based engine coolant is a regulated substance requiring proper disposal. Check with your local authorities to determine the disposal rules for your community. To prevent ingestion by animals or children

do not store ethylene glycol based engine coolant in open containers or allow it to remain in puddles on the ground. If ingested by a child, contact a physician immediately. Clean up any ground spills immediately.

Engine Coolant Level

The coolant bottle provides a quick visual method for determining that the coolant level is adequate. With the engine cold, the level of the coolant in the coolant recovery bottle should be between the ranges indicated on the bottle.

The radiator normally remains completely full, so there is no need to remove the radiator cap unless checking for coolant freeze point or replacing coolant. Advise your service attendant of this. As long as the engine operating temperature is satisfactory, the coolant bottle need only be checked once a month.

When additional coolant is needed to maintain the proper level, it should be added to the coolant bottle. Do not overfill.

Points To Remember

NOTE: When the vehicle is stopped after a few miles (a few kilometers) of operation, you may observe vapor coming from the front of the engine compartment. This is normally a result of moisture from rain, snow, or high humidity accumulating on the radiator and being vaporized when the thermostat opens, allowing hot coolant to enter the radiator.

If an examination of your engine compartment shows no evidence of radiator or hose leaks, the vehicle may be safely driven. The vapor will soon dissipate.

- Do not overfill the coolant recovery bottle.
- Check coolant freeze point in the radiator and in the coolant recovery bottle. If antifreeze needs to be added, contents of coolant recovery bottle must also be protected against freezing.
- If frequent coolant additions are required, or if the level in the coolant recovery bottle does not drop when the engine cools, the cooling system should be pressure tested for leaks.
- Maintain coolant concentration at 50% HOAT engine coolant (minimum) and distilled water for proper corrosion protection of your engine which contains aluminum components.
- Make sure that the radiator and coolant recovery bottle overflow hoses are not kinked or obstructed.
- Keep the front of the radiator clean. If your vehicle is equipped with air conditioning, keep the front of the condenser clean, also.

- Do not change the thermostat for summer or winter operation. If replacement is ever necessary, install ONLY the correct type thermostat. Other designs may result in unsatisfactory coolant performance, poor gas mileage, and increased emissions.

Hoses And Vacuum/Vapor Harnesses

Inspect surfaces of hoses and nylon tubing for evidence of heat and mechanical damage. Hard or soft spots, brittle rubber, cracking, tears, cuts, abrasions, and excessive swelling indicate deterioration of the rubber.

Pay particular attention to those hoses nearest to high heat sources such as the exhaust manifold. Inspect hose routing to be sure hoses do not come in contact with any heat source or moving component which may cause heat damage or mechanical wear.

Insure nylon tubing in these areas has not melted or collapsed.

Inspect all hose connections such as clamps and couplings to make sure they are secure and no leaks are present.

Components should be replaced immediately if there is any evidence of wear or damage that could cause failure.

Brakes

In order to assure brake system performance, all brake system components should be inspected periodically. Suggested service intervals can be found in the Maintenance Schedules.

WARNING!

Riding the brakes can lead to brake failure and possibly an accident. Driving with your foot resting or riding on the brake pedal can result in abnormally high brake temperatures, excessive lining wear, and possible brake damage. You wouldn't have your full braking capacity in an emergency.

Brake And Power Steering Hoses

When the vehicle is serviced for scheduled maintenance, inspect surface of hoses and nylon tubing for evidence of heat and mechanical damage. Hard and brittle rubber, cracking, tears, cuts, abrasion, and excessive swelling indicate deterioration of the rubber. Particular attention should be made to examining those hose surfaces nearest to high heat sources, such as the exhaust manifold.

Insure nylon tubing in these areas has not melted or collapsed.

Inspect all hose connections such as clamps and couplings to make sure they are secure and no leaks are present.

NOTE: Often, fluid such as oil, power steering fluid, and brake fluid are used during assembly plant operations to facilitate the assembly of hoses to couplings. Therefore, oil wetness at the hose-coupling area is not necessarily an indication of leakage. Actual dripping of hot fluid when systems are under pressure (during vehicle operation), should be noted before hose is replaced based on leakage.

NOTE: Inspection of brake hoses should be performed whenever the brake system is serviced and every engine oil change. Inspect hydraulic brake hoses for surface cracking, scuffing, or worn spots. If there is any evidence of cracking, scuffing, or worn spots, the hose should be

replaced immediately! Eventual deterioration of the hose can take place resulting in a possibility of a burst failure.

WARNING!

Worn brake hoses can burst and cause brake failure. You could have an accident. If you see any signs of cracking, scuffing, or worn spots, have the brake hoses replaced immediately.

Master Cylinder — Brake Fluid Level Check

The fluid level in the master cylinder should be checked when performing underhood services, or immediately if the brake system warning light indicates system failure.

Clean the top of the master cylinder area before removing the cap. Add fluid to bring the level up to the top of the “FULL” mark on the side of the master cylinder reservoir.

Overfilling of fluid is not recommended because it may cause leaking in the system.

Add enough fluid to bring the level up to the requirements described on the brake fluid reservoir. With disc brakes, fluid level can be expected to fall as the brake pads wear. However, low fluid level may be caused by a leak and a checkup may be needed.

Use only manufacturers recommended brake fluid, refer to Fluids, Lubricants and Genuine Parts for correct fluid type.

WARNING!

Use of brake fluid that may have a lower initial boiling point or unidentified as to specification, may result in sudden brake failure during hard prolonged braking. You could have an accident.

WARNING!

Overfilling the brake fluid reservoir can result in spilling brake fluid on hot engine parts and the brake fluid catching fire.

Use only brake fluid that has been in a tightly closed container to avoid contamination from foreign matter or moisture.

CAUTION!

Do not allow petroleum base fluid to contaminate the brake fluid, all brake seal components could be damaged causing partial or complete brake failure.

Fuel System Hoses

Electronic Fuel Injection high pressure fuel systems are designed with hoses which have unique material characteristics to provide adequate sealing and resist attack by deteriorated gasoline.

Use only the manufacturers specified hoses in any fuel system servicing. It is mandatory to replace all clamps that have been loosened or removed during service. Care should be taken in installing new clamps to insure they are properly torqued.

Automatic Transmission

The automatic transmission and differential assembly are contained within a single housing.

All automatic transmissions are equipped with a conventional filler tube and dipstick. If fluid is added, it should be added through the dipstick hole in the case.

The dipstick is located just behind the radiator, lower right side.

Selection of Lubricant

It is important that the proper lubricant is used in the transmission to assure optimum transmission performance. Use only manufacturers recommended transmission fluid, refer to Fluids, Lubricants and Genuine Parts for correct fluid type. It is important that the transmission fluid be maintained at the prescribed level using the recommended fluid.

CAUTION!

Using a transmission fluid other than the manufacturers recommended fluid may cause deterioration in transmission shift quality and/or torque converter shudder. Using a transmission fluid other than the manufacturers recommended fluid will result in more frequent fluid and filter changes. Refer to Fluids, Lubricants and Genuine Parts for correct fluid type.

4 SPEED DIPSTICK

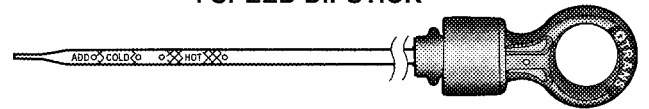

80f34e48

Procedure For Checking Fluid Level

The fluid level in the automatic transmission should be checked whenever the vehicle is serviced. Operation with an improper fluid level will greatly reduce the life of the transmission and of the fluid.

To properly check the automatic transmission fluid level, the following procedure must be used:

1. The vehicle must be on level ground.
2. The engine should be running at curb idle speed for a minimum of 60 seconds.
3. Fully apply parking brake.
4. Place the gear selector momentarily in each gear position ending with the lever in P (PARK). Wipe the area around the dipstick clean to eliminate the possibility of dirt entering the transmission.

5. Remove the dipstick and determine if the fluid is hot or warm. Hot fluid is approximately 180°F (82°C), which is the normal operating temperature after the vehicle has been driven at least 15 miles (24 km). The fluid cannot be comfortably held between the finger tips. Cold is when the fluid is below 80°F (27°C).

6. Wipe the dipstick clean and reinsert until seated. Remove dipstick and note reading.

a. If the fluid is hot, the reading should be in the crosshatched area marked "HOT" (between the upper two holes in the dipstick).

b. If the fluid is cold, the fluid level should be between the lower two holes in the area marked "COLD".

If the fluid level indicates low, add sufficient fluid to bring to the proper level.

CAUTION!

Do not overfill. Dirt and water in the transmission can cause serious damage. To prevent dirt and water from entering the transmission after checking or replenishing fluid, make certain that the dipstick cap is reseated properly.

Fluid and Filter Changes

Automatic transmission fluid should be changed on all transmissions as follows:

Normal Usage — No change necessary

Severe Usage (fluid and filter) — Refer to Maintenance Schedule "B"

Severe Usage is defined as:

- Police, taxi, limousine, commercial type operation, or trailer towing where the vehicle is driven regularly for more than 45 minutes of continuous operation.

NOTE: Refer to Section 8 of this manual for Maintenance Schedules.

If the transmission is disassembled for any reason, the fluid and filter should be changed.

Special Additives

Do not add any fluid additives to the transmission. The only exception to this policy is the use of special dyes to aid in detecting fluid leaks. The use of transmission sealers should be avoided as they may adversely affect seals.

Front And Rear Wheel Bearings

Front and rear wheel bearings are permanently sealed. No regular maintenance is required for these components.

Appearance Care and Protection from Corrosion**Protection of Body and Paint from Corrosion**

Vehicle body care requirements vary according to geographic locations and usage. Chemicals that make roads passable in snow and ice, and those that are sprayed on trees and road surfaces during other seasons, are highly corrosive to the metal in your vehicle. Outside parking, which exposes your vehicle to airborne contaminants, road surfaces on which the vehicle is operated, extreme hot or cold weather and other extreme conditions will have an adverse effect on paint, metal trim, and underbody protection.

The following maintenance recommendations will enable you to obtain maximum benefit from the corrosion resistance built into your vehicle.

What Causes Corrosion?

Corrosion is the result of deterioration or removal of paint and protective coatings from your vehicle.

The most common causes are:

- Road salt, dirt and moisture accumulation.
- Stone and gravel impact.
- Insects, tree sap and tar.
- Salt in the air near seacoast localities.
- Atmospheric fallout/industrial pollutants.

Washing

- Wash your vehicle regularly. Always wash your vehicle in the shade using Mopar Car Wash or a mild car wash soap, and rinse the panels completely with clear water.
- If insects, tar or other similar deposits have accumulated on your vehicle, use Mopar Super Kleen Bug and Tar Remover to remove.
- Use Mopar Cleaner Wax to remove road film, stains and to protect your paint finish. Take care never to scratch the paint.
- Avoid using abrasive compounds and power buffing that may diminish the gloss or thin out the paint finish.

CAUTION!

Do not use abrasive or strong cleaning materials such as steel wool or scouring powder, which will scratch metal and painted surfaces.

Special Care

- If you drive on salted or dusty roads or if you drive near the ocean, hose off the undercarriage at least once a month.
- It is important that the drain holes in the lower edges of the doors, rocker panels and trunk be kept clear and open.
- If you detect any stone chips or scratches in the paint, touch them up immediately. The cost of such repairs is considered the responsibility of the owner.

- If your vehicle is damaged due to an accident or similar cause which destroys the paint and protective coating, have your vehicle repaired as soon as possible. The cost of such repairs is considered the responsibility of the owner.
- All wheels and wheel trim, especially aluminum and chrome plated wheels should be cleaned regularly with a mild soap and water to prevent corrosion. To remove heavy soil, use Mopar Wheel Cleaner or select a nonabrasive, non-acidic cleaner. Do not use scouring pads, steel wool, a bristle brush or metal polishes. Only Mopar cleaners are recommended. Do not use oven cleaner. Avoid automatic car washes that use acidic solutions or harsh brushes that may damage the wheels' protective finish.
- If you carry special cargo such as chemicals, fertilizers, de-icer salt, etc., be sure that such materials are well packaged and sealed.
- If a lot of driving is done on gravel roads, consider mud or stone shields behind each wheel.
- Use Mopar touch up paint on scratches as soon as possible. Your dealer has touch up paint to match the color of your vehicle.

Interior Care

Use Mopar Total Clean to clean fabric upholstery and carpeting.

Interior Trim should be cleaned starting with a damp cloth, a damp cloth with Mopar Total Clean, then Mopar Spot & Stain Remover if absolutely necessary. Do not use harsh cleaners or Armorall. Use Mopar Total Clean to clean vinyl upholstery

Mopar Total Clean is specifically recommended for leather upholstery.

Your leather upholstery can be best preserved by regular cleaning with a damp soft cloth. Small particles of dirt can act as an abrasive and damage the leather upholstery and should be removed promptly with a damp cloth. Stubborn soils can be removed easily with a soft cloth and Mopar Total Clean. Care should be taken to avoid soaking your leather upholstery with any liquid. Please do not use polishes, oils, cleaning fluids, solvents, detergents, or ammonia based cleaners to clean your leather upholstery. Application of a leather conditioner is not required to maintain the original condition.

WARNING!

Do not use volatile solvents for cleaning purposes. Many are potentially flammable, and if used in closed areas they may cause respiratory harm.

Cleaning High Gloss Front Door B-pillar Appliques

When cleaning the front door B-pillar appliques, care must be taken to avoid scratching the plastic.

1. Remove all dirt with a wet soft rag. A mild soap solution may be used, do not use high alcohol content or abrasive cleaners. Glass cleaners are not recommended. If soap is used, wipe clean with a clean damp rag.
2. To maintain the high gloss shine, apply a scratch and swirl remover onto a damp cloth and apply to door applique. Rub the applique with a firm pressure then buff lightly with a clean cotton cloth until a high gloss shine is achieved.

Glass Surfaces

All glass surfaces should be cleaned on a regular basis with Mopar Glass Cleaner or any commercial household-type glass cleaner. Never use an abrasive type cleaner. Use caution when cleaning the inside rear window

equipped with electric defrosters or the right rear quarter window equipped with the radio antenna. Do not use scrapers or other sharp instruments which may scratch the elements.

When cleaning the rear view mirror, spray cleaner on the towel or rag that you are using. Do not spray cleaner directly on the mirror.

Cleaning Plastic Instrument Cluster Lenses

The lenses in front of the instruments in this vehicle are molded in clear plastic. When cleaning the lenses, care must be taken to avoid scratching the plastic.

1. Clean with a wet soft rag. A mild soap solution may be used, but do not use high alcohol content or abrasive cleaners. If soap is used, wipe clean with a clean damp rag.
2. Dry with a soft tissue.

Seat Belt Maintenance

Do not bleach, dye or clean the belts with chemical solvents or abrasive cleaners. This will weaken the fabric. Sun damage can also weaken the fabric.

If the belts need cleaning, use a mild soap solution or lukewarm water. Do not remove the belts from the car to wash them.

Replace the belts if they appear frayed or worn or if the buckles do not work properly.

Cleaning The Instrument Panel and Underseat Cup Holders

Removal

Remove the ash receiver from the convenience tray if there is a smoker's package in your vehicle. With your index finger, locate the stop tab located at the rear of the convenience tray.

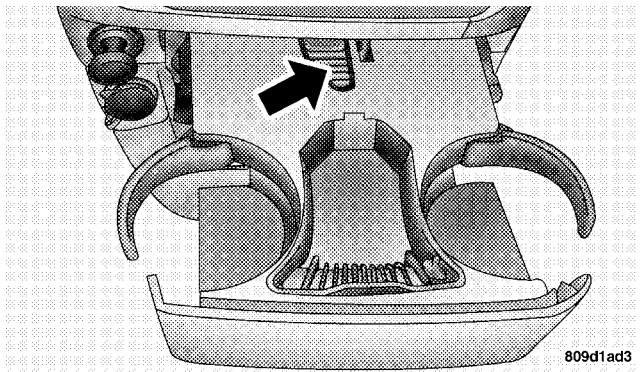

Removing Front Cupholder

Press the stop tab, slide the entire drawer out and remove it from the instrument panel.

Cleaning

Soak the drawer, with the drawer front facing up, in a mixture of medium hot tap water and one teaspoon of mild liquid dish soap. Let soak for approximately one hour. After one hour pull the drawer from the water and dip it back into the water about six times. This will loosen any remaining debris. Rinse the drawer thoroughly under warm running water. Shake the excess water from the drawer and dry the outer surfaces with a clean soft cloth. Let the drawer sit in a dish drainer overnight to allow the inside mechanism to dry.

Installation

Align the drawer so the plastic tracks on the drawer fit into the steel retainer in the instrument panel. Push the drawer forward. You may want to cycle the drawer open and closed a few times to ensure proper operation.

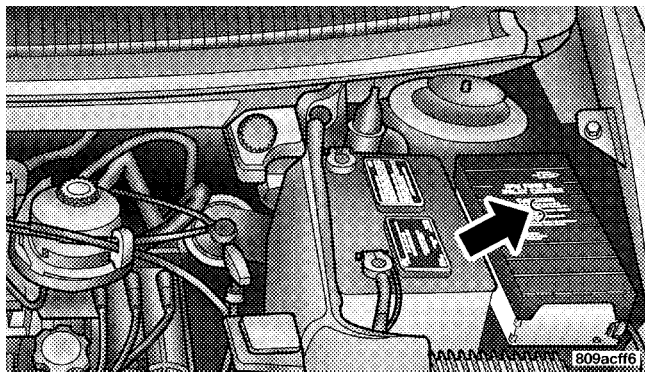
INTEGRATED POWER MODULE (IPM)**Integrated Power module (IPM)**

An Integrated Power Module is located in the engine compartment near the battery. This center contains maxi fuses, mini fuses and relays. A label that identifies each component is printed on the inside of the cover.

Cavity	Maxi Fuse	Description
F4	30 Amp Pink	Front Wipers
F9	40 Amp Green	Anti-Lock Brake System (ABS) Pump
F10	40 Amp Green	Front Blower
F13	40 Amp Green	Electronic Back Light (EBL)
F19	40 Amp Green	Body Control Module (BCM) Feed 1
F20	30 Amp Pink	Central Amplifier
F22	30 Amp Pink	Seats
F27	40 Amp Green	Radiator Fan
F28	40 Amp Green	Power Windows
F30	40 Amp Green	Headlight Washers (Export Only)
F31	40 Amp Green	Power Sliding Door
F32	40 Amp Green	Power Liftgate

Cavity	Mini Fuse	Description
F1	20 Amp Yellow	Fog Lights
F2	15 Amp Blue	Left Park/Tail Light
F3	15 Amp Blue	Right Park/Tail Light
F5	20 Amp Yellow	RDO/IP Ignition
F6	20 Amp Yellow	12 Volt Out Ignition or Battery
F8	20 Amp Yellow	Horn
F11	20 Amp Yellow	EWD/ Rear Wiper
F12	25 Amp Natural	Rear Blower
F14	20 Amp Yellow	Ignition Off Draw (IOD)
F15	20 Amp Yellow	Electronic Automatic Transaxle (EATX) Battery
F15	25 Amp Natural	ASD
F17	20 Amp Yellow	Fuel Pump
F18	15 Amp Blue	A/C Clutch

Cavity	Mini Fuse	Description
F21	25 Amp Natural	Anti-Lock Brake System (ABS) Module
F23	10 Amp Red	Ignition Switch
F24	20 Amp Yellow	Hazard
F26	20 Amp Yellow	Stop Lamp
F33	15 Amp Blue	Front/Rear Washer
	20 Amp Yellow	Spare (IOD)

CAUTION!

- When installing the Integrated Power Module cover, it is important to ensure the cover is properly positioned and fully latched. Failure to do so may allow water to get into the Integrated Power Module, and possibly result in a electrical system failure.
- When replacing a blown fuse, it is important to use only a fuse having the correct amperage rating. The use of a fuse with a rating other than indicated may result in a dangerous electrical system overload. If a properly rated fuse continues to blow, it indicates a problem in the circuit that must be corrected.

The Heated Mirrors, Lower Instrument Panel Power Outlet and Removable Floor Console, when in the front

position are fused with self resetting fuses that are only serviceable by an authorized dealer. The power seats are fused by a 30 Amp circuit breaker located under the driver's seat. The Power Windows are fused by a 25 Amp circuit breaker located under the instrument panel near the steering column. If you experience temporary or permanent loss of these systems see your authorized dealer for service.

VEHICLE STORAGE

If you are leaving your vehicle dormant for more than 21 days you may want to take steps to protect your battery. You may:

- Remove the 20 Amp mini fuse in the Integrated Power Module labeled Ignition-Off Draw (IOD).
- Or, disconnect the negative cable from the battery.
- Anytime you store your vehicle, or keep it out of service (i.e. vacation) for two weeks or more, run the

air conditioning system at idle for about five minutes in the fresh air and high blower setting. This will insure adequate system lubrication to minimize the possibility of compressor damage when the system is started again.

NOTE: For lighted switches, see your dealer for replacement instructions.

All of the interior bulbs are glass wedge base or glass cartridge types. Aluminum base bulbs are not approved and should not be used for replacement.

REPLACEMENT LIGHT BULBS

LIGHT BULBS — Interior	Bulb Number
Center & Rear Dome Light	578
Center & Rear Reading Lights	578
Front Door Courtesy Light	578
Front Header Reading Lights — If Equipped	578
Instrument Cluster Lights	PC74
Liftgate Light(s)	578
Overhead Console Reading Lights	PC579
Removable Console Light — If Equipped	194
Visor Vanity Lights	6501966

LIGHT BULBS — Exterior	Bulb Number
Back-up, Tail, Stop, Turn Signal, & Sidemarker	3057
Center High-Mounted Stop Light	921
Fog Light — If Equipped	9145
Front Side marker, Park/Turn Signal	3457AK
Headlight	9007
Headlight (Long Wheel Base)	H13
License	168

BULB REPLACEMENT

Headlights

1. Remove the three screws securing the headlight module.

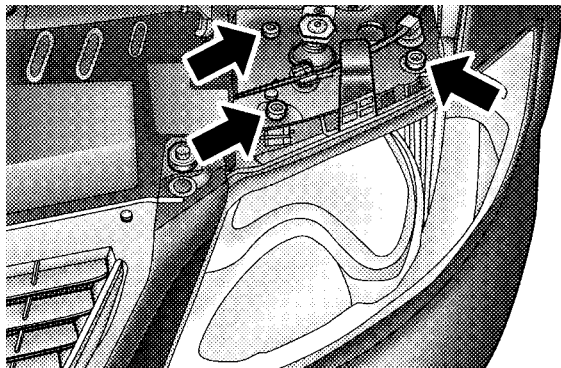

809c0b2e

2. Turn the bulb socket retaining ring or the bulb assembly counterclockwise.

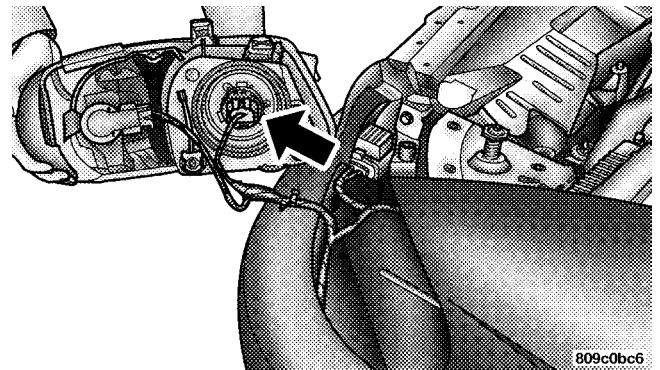

809c0bc6

3. Disconnect the electrical connector and replace the bulb.

NOTE: On some vehicles it may be necessary to slide the red release lock rearward and push forward on the connector while depressing the release tab.

CAUTION!

Do not touch the new bulb with your fingers. Oil contamination will severely shorten bulb life. If the bulb comes in contact with an oily surface, clean the bulb with rubbing alcohol.

Front Park/Turn Signal and Sidemarker Lights

1. Remove the three screws securing the headlight module.

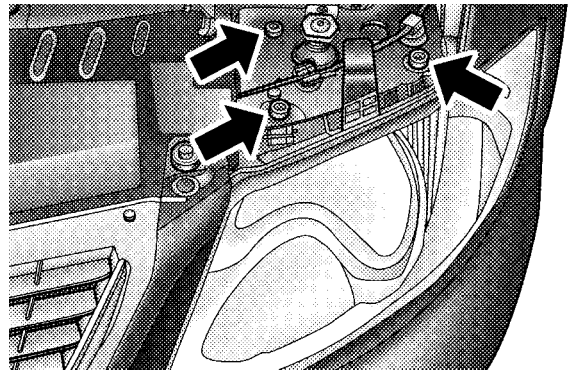

2. Twist the turn signal socket to remove from the headlight module and pull bulb from socket.

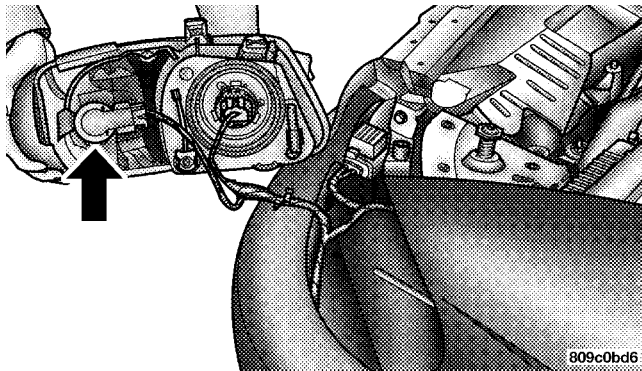

3. Replace bulb, reinstall socket and then reinstall the headlight module.

Front Fog Light

1. Reach behind the front fascia from under the vehicle.
2. Twist the front fog light bulb to remove from the fog light housing.
3. Disconnect the electrical connector and replace the bulb.

CAUTION!

Do not touch the new bulb with your fingers. Oil contamination will severely shorten bulb life. If the bulb comes in contact with an oily surface, clean the bulb with rubbing alcohol.

Rear Tail, Stop, Turn Signal, Side Marker and Back-up Lights

1. Raise the liftgate.
2. Remove the two tail light assembly push-in type fasteners, by prying under the fastener head with a large flat screwdriver.

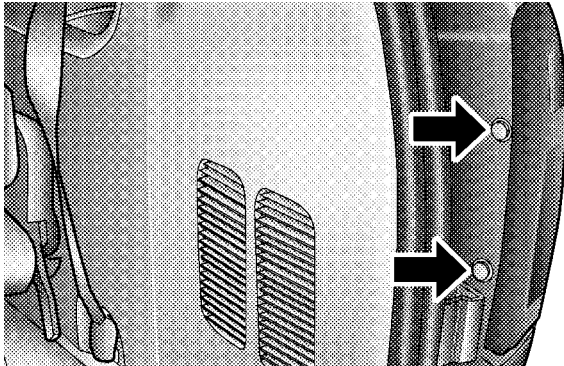

809c0bf2

3. Squeeze the socket assembly tabs to remove it from the housing.

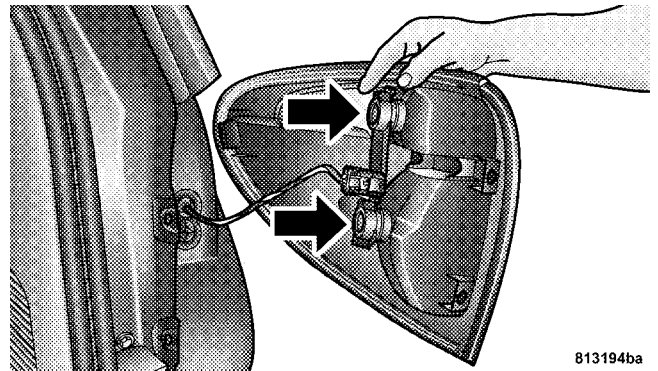

813194ba

7

4. Pull the bulb to remove it from the socket.
5. Replace the bulb, reinstall the socket, and reattach the light assembly.

Center High Mounted Stop Light (CHMSL)

1. Remove the two screws securing the CHMSL.

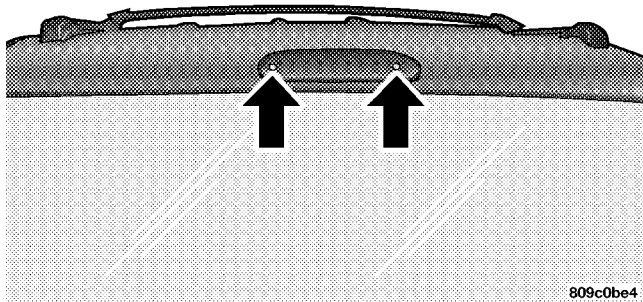

2. Twist the bulb socket to remove from the CHMSL housing.
3. Pull the bulb out of the socket.
4. Replace the bulb, reinstall the socket and reattach the CHMSL.

License Light

1. Remove the two lens assembly mounting screws.
2. Pull the bulb out of the socket. Replace the bulb and reattach the lens assembly.

FLUIDS AND CAPACITIES

	U.S.	Metric
Fuel (Approximate) 87 Octane	20 Gallons	76 Liters
Engine Oil-with filter		
2.4 Liter Engines (SAE 5W-30, API Certified)	5.0 qts	4.7 Liters
3.3 & 3.8 Liter Engines (SAE 5W-20, API Certified)	5.0 qts	4.7 Liters
Cooling System *		
2.4 Liter Engines (Mopar® Antifreeze/Coolant 5 Year/100,000 Mile Formula or equivalent)	11.4 qts	10.7 Liters
3.3 & 3.8 Liter Engines (Mopar® Antifreeze/Coolant 5 Year/100,000 Mile Formula or equivalent) †	13.4 qts	12.6 Liters

* Includes heater and coolant recovery bottle filled to MAX level.

† * Add 2.9 quarts (2.8 liters) if equipped with a rear heater.

FLUIDS, LUBRICANTS AND GENUINE PARTS**Engine**

Component	Fluids, Lubricants and Genuine Parts
Engine Coolant	Mopar® Antifreeze/Coolant 5 Year/100,000 Mile Formula HOAT (Hybrid Organic Additive Technology) or equivalent
2.4 Liter Engine Oil	Use API Certified SAE 5W-30 engine oil. Refer to your oil filler cap for correct SAE grade, meeting DaimlerChrysler Material Standard MS-6395.
3.3/3.8 Liter Engine Oil	Use API Certified SAE 5W-20 engine oil. Refer to your oil filler cap for correct SAE grade, meeting DaimlerChrysler Material Standard MS-6395.
Oil Filter 2.4 liter engines	Mopar 4105409AB or equiv.
Oil Filter 3.3/3.8 liter engines	Mopar 5281090 or equiv.
Spark Plugs	Refer to the Vehicle Emission Control Information label in the engine compartment.
Fuel Selection	87 Octane

Chassis

Component	Fluids, Lubricants and Genuine Parts.
Automatic Transmission	Mopar® ATF+4 Automatic Transmission Fluid.
Brake Master Cylinder	Mopar® DOT 3, SAE J1703 should be used. If DOT 3, SAE J1703 brake fluid is not available, then DOT 4 is acceptable. Use only recommended brake fluids.
Power Steering Reservoir	Mopar® ATF+4 Automatic Transmission Fluid.

MAINTENANCE SCHEDULES

CONTENTS

■ Emission Control System Maintenance	448	□ Schedule “B”	451
■ Maintenance Schedules	448	□ Schedule “A”	463

EMISSION CONTROL SYSTEM MAINTENANCE

The “Scheduled” maintenance services, listed in **bold type** must be done at the times or mileages specified to assure the continued proper functioning of the emission control system. These, and all other maintenance services included in this manual, should be done to provide best vehicle performance and reliability. More frequent maintenance may be needed for vehicles in severe operating conditions such as dusty areas and very short trip driving.

Inspection and service also should be done any time a malfunction is suspected.

NOTE: Maintenance, replacement, or repair of the emission control devices and systems on your vehicle may be performed by any automotive repair establishment or individual using any automotive part which has been certified pursuant to U.S. EPA or, in the State of California, California Air Resources Board regulations.

MAINTENANCE SCHEDULES

There are two maintenance schedules that show the **required** service for your vehicle.

First is Schedule “**B**”. It is for vehicles that are operated under the conditions that are listed below and at the beginning of the schedule.

- Day or night temperatures are below 32° F (0° C).
- Stop and go driving.
- Extensive engine idling.
- Driving in dusty conditions.
- Short trips of less than 10 miles (16 km).
- More than 50% of your driving is at sustained high speeds during hot weather, above 90° F (32° C).
- Trailer towing. ◇

- Taxi, police, or delivery service (commercial service). ◇
- Off-road or desert operation.

NOTE: Most vehicles are operated under the conditions listed for Schedule "B".

Second is Schedule "A". It is for vehicles that are not operated under any of the conditions listed under Schedule "B".

Use the schedule that best describes your driving conditions. Where time and mileage are listed, follow the interval that occurs first.

CAUTION!
Failure to perform the required maintenance items may result in damage to the vehicle.

At Each Stop for Fuel

- Check the engine oil level about 5 minutes after a fully warmed engine is shut off. Checking the oil level while the vehicle is on level ground will improve the accuracy of the oil level reading. Add oil only when the level is at or below the ADD or MIN mark.
- Check the windshield washer solvent and add if required.

Once a Month

- Check tire pressure and look for unusual wear or damage.
- Inspect the battery and clean and tighten the terminals as required.
- Check the fluid levels of coolant reservoir, brake master cylinder and transmission; add as needed.

450 MAINTENANCE SCHEDULES

- Check all lights and all other electrical items for correct operation.

At Each Oil Change

- Change the engine oil filter.
- Inspect the exhaust system.

- Inspect the brake hoses.
- Inspect the CV joints and front suspension components.
- Check the automatic transmission fluid level.
- Check the coolant level, hoses, and clamps.

SCHEDULE "B"

Follow schedule "B" if you usually operate your vehicle under one or more of the following conditions. Change the automatic transmission fluid and filter every 60,000 miles (96 000 km) if the vehicle is usually operated under one or more of the conditions marked with an \diamond .

- Day or night temperatures are below 32° F (0° C).
- Stop and go driving.
- Extensive engine idling.
- Driving in dusty conditions.
- Short trips of less than 10 miles (16 km).
- More than 50% of your driving is at sustained high speeds during hot weather, above 90° F (32° C).
- Trailer towing. \diamond
- Taxi, police, or delivery service (commercial service). \diamond
- Off-road or desert operation.

452 SCHEDULE "B"

Miles (Kilometers)	3, 000 (5 000)	6, 000 (10 000)	9, 000 (15 000)	12, 000 (20 000)	15, 000 (25 000)	18, 000 (30 000)
Change engine oil and engine oil filter.	X	X	X	X	X	X
Rotate Tires		X		X		X
Inspect the brake linings.			X			X
Inspect the engine air cleaner filter, replace if necessary. *	X	X	X	X		X
Replace the engine air cleaner filter. *					X	
Inspect and adjust the power steering pump belt tension on 2.4 liter engines.					X	
Inspect the generator belt on 2.4 liter engines, replace if necessary.					X	
Replace the air conditioning filter.				X		

Miles (Kilometers)	21, 000 (35 000)	24, 000 (40 000)	27, 000 (45 000)	30, 000 (50 000)	33, 000 (55 000)	36, 000 (60 000)
Change engine oil and engine oil filter.	X	X	X	X	X	X
Rotate Tires		X		X		X
Inspect the brake linings.			X			X
Inspect the engine air cleaner filter, replace if necessary. *	X	X	X		X	X
Replace the engine air cleaner filter.				X		
Replace the spark plugs 2.4 liter engines.				X		
Inspect the tie rod ends and boot seals.				X		
Inspect and adjust the power steering pump belt tension on 2.4 liter engines.				X		
Inspect the generator belt on 2.4 liter engines, replace if necessary.				X		
Inspect the PCV valve and replace as necessary.*				X		
Replace the air conditioning filter.		X				X

454 SCHEDULE "B"

Miles (Kilometers)	39, 000 (65 000)	42, 000 (70 000)	45, 000 (75 000)	48, 000 (80 000)	51, 000 (85 000)	54, 000 (90 000)
Change engine oil and engine oil filter.	X	X	X	X	X	X
Rotate Tires		X		X		X
Inspect the brake linings.			X			X
Inspect the engine air cleaner filter, replace if necessary. *	X	X		X	X	X
Replace the engine air cleaner filter. *			X			
Inspect and adjust the power steering pump belt tension on 2.4 liter engines.			X			
Inspect the generator belt on 2.4 liter engines, replace if necessary.			X			
Replace the air conditioning filter.				X		

Miles (Kilometers)	57, 000 (95 000)	60, 000 (100 000)	63, 000 (105 000)	66, 000 (110 000)	69, 000 (115 000)	72, 000 (120 000)
Change engine oil and engine oil filter.	X	X	X	X	X	X
Rotate Tires		X		X		X
Inspect the brake linings.			X			X
Inspect the engine air cleaner filter, replace if necessary. *	X		X	X	X	X
Replace the engine air cleaner filter.		X				
Replace the spark plugs on 2.4 liter engines.		X				
Replace the ignition cables on 2.4 liter engines.		X				
Inspect the tie rod ends and boot seals.		X				
Inspect and adjust the power steering pump belt tension on 2.4 liter engines.		X				
Inspect the generator belt on 2.4 liter engines, replace if necessary.		X				
Inspect the PCV valve and replace if necessary.*		X				
Inspect the serpentine drive belt on 3.3 liter and 3.8 liter engines, replace if necessary.		X				
Change the automatic transmission fluid and filter. ◇		X				
Replace the air conditioning filter.		X				X

456 SCHEDULE "B"

Miles (Kilometers)	75, 000 (125 000)	78, 000 (130 000)	81, 000 (135 000)	84, 000 (140 000)	87, 000 (145 000)	90, 000 (150 000)
Change engine oil and engine oil filter.	X	X	X	X	X	X
Rotate Tires		X		X		X
Inspect the brake linings.			X			X
Inspect the engine air cleaner filter, replace if necessary. *		X	X	X	X	
Replace the engine air cleaner filter	X					X
Replace the spark plugs on 3.3 liter and 3.8 liter engines.	X					
Replace the ignition cables on 3.3 liter and 3.8 liter engines.	X					
Replace the spark plugs on 2.4 liter engines.						X
Inspect and adjust the power steering pump belt tension on 2.4 liter engines.	X					X
Inspect the generator belt on 2.4 liter engines, replace if necessary.	X					X
Inspect the tie rod ends and boot seals.						X

Miles (Kilometers)	75,000 (125,000)	78,000 (130,000)	81,000 (135,000)	84,000 (140,000)	87,000 (145,000)	90,000 (150,000)
Inspect the serpentine drive belt on 3.3 liter and 3.8 liter engines, replace if necessary. †	X					X
Check the PCV valve and replace if necessary. Not required if previously changed.*						X
Replace the engine timing belt on 2.4 liter engines.*						X
Replace the air conditioning filter.				X		

458 SCHEDULE "B"

Miles (Kilometers)	93, 000 (155 000)	96, 000 (160 000)	99, 000 (165 000)	102, 000 (170 000)	105, 000 (175 000)
Change engine oil and engine oil filter.	X	X	X	X	X
Rotate Tires		X		X	
Inspect the brake linings.			X		
Inspect the engine air cleaner filter, replace if necessary. *	X	X	X	X	
Replace the engine air cleaner filter *					X
Inspect and adjust the power steering pump belt tension on 2.4 liter engines.					X
Inspect the generator belt on 2.4 liter engines, replace if necessary.					X
Inspect the serpentine drive belt on 3.3 liter and 3.8 liter engines, replace if necessary. ‡					X
Flush and replace the engine coolant.				X	
Replace the air conditioning filter.		X			

Miles (Kilometers)	108, 000 (180 000)	111, 000 (185 000)	114, 000 (190 000)	117, 000 (195 000)	120, 000 (200 000)
Change engine oil and engine oil filter.	X	X	X	X	X
Rotate Tires	X		X		X
Inspect the brake linings.	X			X	
Inspect the engine air cleaner filter, replace if necessary. *	X	X	X	X	
Replace the engine air cleaner filter .					X
Replace the spark plugs on 2.4 liter engines.					X
Replace the ignition cables on 2.4 liter engines.					X
Inspect and adjust the power steering pump belt tension on 2.4 liter engines.					X
Inspect the generator belt on 2.4 liter engines, replace if necessary.					X
Inspect the serpentine drive belt on 3.3 liter and 3.8 liter engines, replace if necessary. †					X
Inspect the tie rod ends and boot seals.					X
Inspect the PCV valve and replace as necessary.*					X
Change the automatic transmission fluid and filter. ◇					X
Replace the air conditioning filter.	X				X

460 SCHEDULE "B"

Miles (Kilometers)	123, 000 (205 000)	126, 000 (210 000)	129, 000 (215 000)	132, 000 (220 000)	135, 000 (225 000)
Change engine oil and engine oil filter.	X	X	X	X	X
Rotate Tires		X		X	
Inspect the brake linings.		X			X
Inspect the engine air cleaner filter, replace if necessary. *	X	X	X	X	
Replace the engine air cleaner filter.					X
Inspect and adjust the power steering pump belt tension on 2.4 liter engines.					X
Inspect the generator belt on 2.4 liter engines, replace if necessary.					X
Inspect the serpentine drive belt on 3.3 liter and 3.8 liter engines, replace if necessary. ‡					X
Replace the air conditioning filter.				X	

Miles (Kilometers)	138, 000 (230 000)	141, 000 (235 000)	144, 000 (240 000)	147, 000 (245 000)	150, 000 (250 000)
Change engine oil and engine oil filter.	X	X	X	X	X
Rotate Tires	X		X		X
Inspect the brake linings.			X		
Inspect the engine air cleaner filter, replace if necessary. *	X	X	X	X	
Replace the engine air cleaner filter.					X
Replace the spark plugs on 2.4 liter, 3.3 liter and 3.8 liter engines.					X
Inspect and adjust the power steering pump belt tension on 2.4 liter engines.					X
Inspect the generator belt on 2.4 liter engines, replace if necessary.					X
Inspect the serpentine drive belt on 3.3 liter and 3.8 liter engines, replace if necessary. ‡					X

462 SCHEDULE "B"

Miles (Kilometers)	138, 000 (230 000)	141, 000 (235 000)	144, 000 (240 000)	147, 000 (245 000)	150, 000 (250 000)
Inspect the tie rod ends and boot seals.					X
Inspect the PCV valve and replace as necessary.*					X
Replace the air conditioning filter.			X		

* This maintenance is recommended by the manufacture to the owner but is not required to maintain the emissions warranty.

‡ This maintenance is not required if previously replaced.

◇ This maintenance is required only for police, taxi, limousine type operation, or trailer towing.

Inspection and service should also be performed anytime a malfunction is observed or suspected. Retain all receipts.

SCHEDULE "A"

Miles (Kilometers) [Months]	6, 000 (10 000) [6]	12, 000 (20 000) [12]	18, 000 (30 000) [18]	24, 000 (40 000) [24]	30, 000 (50 000) [30]	36, 000 (60 000) [36]
Change engine oil and engine oil filter.	X	X	X	X	X	X
Rotate Tires	X	X	X	X	X	X
Inspect the brake linings.			X			X
Inspect the engine air cleaner filter, replace if necessary. *	X	X	X	X		X
Replace the engine air cleaner filter.					X	
Replace the spark plugs on 2.4 liter engines.					X	
Inspect the tie rod ends and boot seals.					X	
Inspect and adjust the power steering pump belt tension on 2.4 liter engines.					X	
Replace the air conditioning filter.		X		X		X

464 SCHEDULE "A"

Miles (Kilometers) [Months]	42, 000 (70 000) [42]	48, 000 (80 000) [48]	54, 000 (90 000) [54]	60, 000 (100 000) [60]	66, 000 (110 000) [66]	72, 000 (120 000) [72]
Change engine oil and engine oil filter.	X	X	X	X	X	X
Rotate Tires	X	X	X	X	X	X
Inspect the brake linings.			X			X
Inspect the engine air cleaner filter, replace if necessary. *	X	X	X		X	X
Replace the engine air cleaner filter.				X		
Replace the spark plugs on 2.4 liter engines.				X		
Replace the ignition cables 2.4 liter engines.				X		
Inspect and adjust the power steering pump belt tension on 2.4 liter engines.				X		
Inspect the tie rod ends and boot seals.				X		
Inspect the generator belt on 2.4 liter engines, replace if necessary.	X					X

Miles (Kilometers) [Months]	42, 000 (70 000) [42]	48, 000 (80 000) [48]	54, 000 (90 000) [54]	60, 000 (100 000) [60]	66, 000 (110 000) [66]	72, 000 (120 000) [72]
Check the PCV valve and replace, if necessary.*				X		
Inspect the serpentine drive belt on 3.3 liter and 3.8 liter engines, replace if necessary. ‡				X		X
Flush and replace the engine coolant at 60 months or 100,000 miles, whichever comes first.				X		
Replace the air conditioning filter.		X		X		X

466 SCHEDULE "A"

Miles (Kilometers) [Months]	78, 000 (130 000) [78]	84, 000 (140 000) [84]	90, 000 (150 000) [90]	96, 000 (160 000) [96]	100, 000 (165 000)
Change engine oil and engine oil filter.	X	X	X	X	
Rotate Tires	X	X	X	X	
Inspect the brake linings.			X		
Inspect the engine air cleaner filter, replace if necessary. *	X	X		X	X
Replace the engine air cleaner filter .			X		
Replace the spark plugs on 2.4 liter engines.			X		
Inspect the tie rod ends and boot seals.			X		
Inspect and adjust the power steering pump belt tension on 2.4 liter engines.			X		
Check and replace the PCV valve , if necessary.*			X		
Inspect the serpentine drive belt on 3.3 liter and 3.8 liter engines, replace if necessary. ‡			X		

Miles (Kilometers) [Months]	78, 000 (130 000) [78]	84, 000 (140 000) [84]	90, 000 (150 000) [90]	96, 000 (160 000) [96]	100, 000 (165 000)
Replace the spark plugs 3.3 liter and 3.8 liter engines.					X
Replace the ignition cables 3.3 liter and 3.8 liter engines.					X
Flush and replace the engine coolant at 60 months or 100,000 miles, whichever comes first.					X
Replace the air conditioning filter.		X		X	

468 SCHEDULE "A"

Miles (Kilometers) [Months]	102, 000 (170 000) [102]	108, 000 (180 000) [108]	114, 000 (190 000) [114]	120, 000 (200 000) [120]
Change engine oil and engine oil filter.	X	X	X	X
Rotate Tires	X	X	X	X
Inspect the brake linings.		X		
Inspect the engine air cleaner filter, replace if necessary. *	X	X	X	
Replace the engine air cleaner filter.				X
Replace the spark plugs on 2.4 liter engines.				X
Replace the ignition cables 2.4 liter engines.				X
Inspect and adjust the power steering pump belt tension on 2.4 liter engines.				X
Inspect the generator belt on 2.4 liter engines, replace if necessary.	X			
Inspect the tie rod ends and boot seals.				X
Check the PCV valve and replace, if necessary.*				X

Miles (Kilometers) [Months]	102, 000 (170 000) [102]	108, 000 (180 000) [108]	114, 000 (190 000) [114]	120, 000 (200 000) [120]
Inspect the serpentine drive belt on 3.3 liter and 3.8 liter engines, replace if necessary. ‡	X			X
Replace the engine timing belt on 2.4 liter engines only.				X
Flush and replace the engine coolant at 120 months, if not done at 100,000 miles (160 000 km).				X
Replace the air conditioning filter.		X		X

470 SCHEDULE "A"

Miles (Kilometers) [Months]	126, 000 (210 000) [126]	132, 000 (220 000) [132]	138, 000 (230 000) [138]	144, 000 (240 000) [144]	150, 000 (250 000) [150]
Change engine oil and engine oil filter.	X	X	X	X	X
Rotate Tires	X	X	X	X	X
Inspect the brake linings.	X			X	
Inspect the engine air cleaner filter, replace if necessary. *	X	X	X	X	
Replace the engine air cleaner filter.					X
Replace the spark plugs on 2.4 liter engines.					X
Inspect and adjust the power steering pump belt tension on 2.4 liter engines.					X
Inspect the generator belt on 2.4 liter engines, replace if necessary.		X			
Inspect the tie rod ends and boot seals.					X
Check the PCV valve and replace, if necessary.*					X

Miles (Kilometers) [Months]	126, 000 (210 000) [126]	132, 000 (220 000) [132]	138, 000 (230 000) [138]	144, 000 (240 000) [144]	150, 000 (250 000) [150]
Inspect the serpentine drive belt on 3.3 liter and 3.8 liter engines, replace if necessary. ‡		X		X	
Replace the air conditioning filter.		X		X	

* This maintenance is recommended by the manufacture to the owner but is not required to maintain the emissions warranty.

‡ This maintenance is not required if previously replaced.

Inspection and service should also be performed anytime a malfunction is observed or suspected. Retain all receipts.

WARNING!
You can be badly injured working on or around a motor vehicle. Do only that service work for which you have the knowledge and the right equipment. If you have any doubt about your ability to perform a service job, take your vehicle to a competent mechanic.

IF YOU NEED CONSUMER ASSISTANCE

CONTENTS

■ Suggestions For Obtaining Service For Your Vehicle	474	■ Reporting Safety Defects	477
□ Prepare For The Appointment	474	□ In Canada	477
□ Prepare A List	474	■ Publication Order Forms	478
□ Be Reasonable With Requests	474	■ Department Of Transportation Uniform Tire Quality Grades	479
■ If You Need Assistance	474	□ Treadwear	479
■ Warranty Information (U.S. Vehicles Only)	477	□ Traction Grades	480
■ Mopar® Parts	477	□ Temperature Grades	480

SUGGESTIONS FOR OBTAINING SERVICE FOR YOUR VEHICLE**Prepare For The Appointment**

If you're having warranty work done, be sure to have the right papers with you. Take your warranty folder. All work to be performed may not be covered by the warranty, discuss additional charges with the service manager. Keep a maintenance log of your vehicle's service history. This can often provide a clue to the current problem.

Prepare A List

Make a written list of your vehicle's problems or the specific work you want done. If you've had an accident, or work done that is not on your maintenance log, let the service advisor know.

Be Reasonable With Requests

If you list a number of items, and you must have your vehicle by the end of the day, discuss the situation with the service advisor and list the items in order of priority. At many dealers you may obtain a rental vehicle at a minimal daily charge. If you need a rental, it is advisable to make these arrangements when you call for an appointment.

IF YOU NEED ASSISTANCE

The manufacturer and its dealers are vitally interested in your satisfaction. We want you to be happy with our products and services.

Warranty service must be done by an authorized Chrysler, Dodge, or Jeep dealer. We strongly recommend that you take your vehicle to your selling dealer. They know you and your vehicle best, and are most concerned that you get prompt and high quality service. The manufacturer's dealers have the facilities, factory-trained

technicians, special tools, and the latest information to assure your vehicle is fixed correctly and in a timely manner.

This is why you should always talk to your dealer's service manager first. Most matters can be resolved with this process.

- If for some reason you are still not satisfied, talk to the general manager or owner of the dealership. They want to know if you need assistance.
- If your dealership is unable to resolve the concern, you may contact the Manufacturer's Customer Center.

Any communication to the Manufacturer's Customer Center should include the following information:

- Owner's name and address
- Owner's telephone number (home and office)
- Dealership name

- Vehicle identification number
- Vehicle delivery date and mileage

DaimlerChrysler Motors Corporation Customer Center
P.O. Box 21-8004
Auburn Hills, MI 48321-8004
Phone: (800) 992-1997

DaimlerChrysler Canada Inc. Customer Center
P.O. Box 1621
Windsor, Ontario N9A 4H6
Phone —(800) 465-2001

In Mexico contact:
Av. Prolongacion Paseo de la Reforma, 1240
Sante Fe C.P. 05109
Mexico, D. F.
In Mexico (915) 729-1248 or 729-1240
Outside Mexico (525) 729-1248 or 729-1240

Customer Assistance For The Hearing Or Speech Impaired (TDD/TTY)

To assist customers who have hearing difficulties, the manufacturer has installed special TDD (Telecommunication Devices for the Deaf) equipment at its Customer Center. Any hearing or speech impaired customer who has access to a TDD or a conventional teletypewriter (TTY) in the United States can communicate with the manufacturer by dialing 1-800-380-CHRY.

Service Contract

You may have purchased a service contract for your vehicle to help protect you from the high cost of unexpected repairs after your manufacturer's new vehicle limited warranty expires. The manufacturer stands behind only the manufacturer's Service Contracts. If you purchased a manufacturer's Service Contract, you will receive Plan Provisions and an Owner Identification Card in the mail within three weeks of your vehicle delivery date. If you have any questions about your service

contract, call the manufacturer's Service Contract National Customer Hotline at 1-800-521-9922.

The manufacturer will not stand behind any service contract that is not the manufacturer's Service Contract. It is not responsible for any service contract other than the manufacturer's Service Contract. If you purchased a service contract that is not a manufacturer's Service Contract, and you require service after your manufacturer's new vehicle limited warranty expires, please refer to your contract documents, and contact the person listed in those documents.

We appreciate that you have made a major investment when you purchased your new vehicle. Your dealer has also made a major investment in facilities, tools, and training to assure that you are absolutely delighted with your ownership experience. You'll be pleased with their sincere efforts to resolve any warranty issues or related concerns.

WARRANTY INFORMATION (U.S. Vehicles Only)

See the Warranty Information Booklet for the terms and provisions of DaimlerChrysler's warranties applicable to this vehicle.

MOPAR® PARTS

Mopar® fluids, lubricants, parts, and accessories are available from your dealer. They will help you keep your vehicle operating at its best.

REPORTING SAFETY DEFECTS

In the 50 United States and Washington D.C.: If you believe that your vehicle has a defect which could cause a crash or cause injury or death, you should immediately inform the National Highway Traffic Safety Administration (NHTSA) in addition to notifying the manufacturer.

If NHTSA receives similar complaints, it may open an investigation, and if it finds that a safety defect exists in a group of vehicles, it may order a recall and remedy

campaign. However, NHTSA cannot become involved in individual problems between you, your dealer, and the manufacturer.

To contact NHTSA, you may either call the Auto Safety Hotline toll free at 1-888-327-4236 (TTY: 1-800-424-9153), or go to <http://www.NHTSA.gov>. or write to: NHTSA, U.S. Dept. of Transportation, Washington DC 20590. You can also obtain other information about motor vehicle safety from the Hotline.

In Canada:

If you believe that your vehicle has a safety defect, you should contact the Customer Service Department immediately. Canadian customers who wish to report a safety defect to the Canadian government should write to Transport Canada, Motor Vehicle Defect Investigations and Recalls, 2780 Sheffield Road, Ottawa, Ontario K1B 3V9.

PUBLICATION ORDER FORMS

To order the following manuals, you may use either the website or the phone numbers listed below. Visa, Mastercard, American Express, and Discover orders are accepted. If you prefer mailing your payment, please call for an order form.

NOTE: A street address is required when ordering manuals. (No P.O. Boxes).

- *Service Manuals.*

These comprehensive service manuals provide the information that students and professional technicians need in diagnosing/troubleshooting, problem solving, maintaining, servicing and repairing DaimlerChrysler Corporation vehicles. A complete working knowledge of the vehicle, system and/or components is written in straightforward language with illustrations, diagrams and charts.

- *Diagnostic Procedure Manuals.*

Filled with diagrams, charts and detailed illustrations, these practical manuals make it easy for students and technicians to find and fix problems on computer-controlled vehicle systems and features. They show exactly how to find and correct problems the first time, using step-by-step troubleshooting and driveability procedures, proven diagnostic tests and a complete list of all tools and equipment.

- *Owner's Manuals.*

These manuals have been prepared with the assistance of service and engineering specialists to acquaint you with specific Chrysler group vehicles. Included are starting, operating, emergency and maintenance procedures as well as specifications, capabilities and safety tips.

Call Toll Free at:

- 1-800-890-4038 (U.S.)
- 1-800-387-1143 (Canada)

Or

Visit us on the World Wide Web at:

- www.techauthority.daimlerchrysler.com
- www.daimlerchrysler.ca/manuals

DEPARTMENT OF TRANSPORTATION UNIFORM TIRE QUALITY GRADES

The following describes the tire grading categories established by the National Highway Traffic Safety Administration. The specific grade rating assigned by the tire's manufacturer in each category is shown on the sidewall of the tires on your car.

All Passenger Car Tires Must Conform to Federal Safety Requirements in Addition to These Grades.

Treadwear

The treadwear grade is a comparative rating based on the wear rate of the tire when tested under controlled conditions on a specified government test course. For example, a tire graded 150 would wear one and a half (1 1/2) times as well on the government course as a tire graded 100. The relative performance of tires depends upon the actual conditions of their use, however, and may depart significantly from the norm due to variations in driving habits, service practices and differences in road characteristics and climate.

Traction Grades

The traction grades, from highest to lowest, are AA, A, B, and C. Those grades represent the tire's ability to stop on wet pavement as measured under controlled conditions on specified government test surfaces of asphalt and concrete. A tire marked C may have poor traction performance.

WARNING!

The traction grade assigned to this tire is based on straight-ahead braking traction tests, and does not include acceleration, cornering, hydroplaning, or peak traction characteristics.

Temperature Grades

The temperature grades are A (the highest), B, and C, representing the tire's resistance to the generation of heat and its ability to dissipate heat when tested under controlled conditions on a specified indoor laboratory

test wheel. Sustained high temperature can cause the material of the tire to degenerate and reduce tire life, and excessive temperature can lead to sudden tire failure. The grade C corresponds to a level of performance which all passenger car tires must meet under the Federal Motor Vehicle Safety Standard No. 109. Grades B and A represent higher levels of performance on the laboratory test wheel than the minimum required by law.

WARNING!

The temperature grade for this tire is established for a tire that is properly inflated and not overloaded. Excessive speed, underinflation, or excessive loading, either separately or in combination, can cause heat buildup and possible tire failure.

INDEX

Adding Fuel	346	Alarm Light	208
Adding Washer Fluid	299,414	Alarm System (Security Alarm)	26
Additives, Fuel	344	Alignment and Balance	336
Adjustable Pedals	153	Alterations/Modifications, Vehicle	7
Air Conditioner Maintenance	410	Antenna, Satellite Radio	269
Air Conditioning	274,279	Antifreeze (Engine Coolant)	417,418,443
Air Conditioning Controls	274	Disposal	419
Air Conditioning Filter	296,411	Anti-Lock Brake System (ABS)	315
Air Conditioning, Operating Tips	296	Anti-Lock Warning Light	207
Air Conditioning, Rear Zone	282,291	Anti-Theft Security Alarm (Theft Alarm)	26
Air Conditioning Refrigerant	410	Appearance Care	428
Air Conditioning System	274,279,284,410	Arming Theft System (Security Alarm)	27
Air Conditioning System, Zone Control	275	Ashtray	178
Air Pressure, Tires	329	Auto Down Power Windows	41
Airbag	54	Automatic Dimming Mirror	90
Airbag Deployment	66	Automatic Door Locks	19,20
Airbag Light	59,60,68,84,206	Automatic Headlights	145
Airbag Maintenance	68	Automatic Temperature Control (ATC)	284
Airbag, Window (Side Curtain)	55	Automatic Transaxle	309

Interlock System	310	Belts, Drive	405
Reset Mode	311	Body Mechanism Lubrication	413
Selection Of Lubricant	425,445	B-Pillar Location	324
Shifting	311	Brake Fluid	445
Special Additives	427	Brake, Parking	313
Automatic Transmission	424	Brake System	314,421
Adding Fluid	426	Anti-Lock (ABS)	315
Fluid and Filter Changes	427	Fluid Check	423
Fluid Change	427	Hoses	422
Fluid Level Check	426	Warning Light	205
Fluid Type	425,445	Brakes	314,421
Ball Joints	412	Brake/Transmission Interlock	310
Battery	409	Break-In Recommendations, New Vehicle	82
Gas Caution	409	Bulb Replacement	438
Jump Starting	387	Bulbs, Light	437
Keyless Transmitter Replacement (RKE)	25	Calibration, Compass	159
Saving Feature (Protection)	145	Capacities, Fluid	443
Bearings	428		

Caps, Filler		
Fuel	346	
Oil (Engine)	404	
Radiator (Coolant Pressure)	418	
Car Washes	429	
Carbon Monoxide Warning	345	
Cargo Compartment		
Luggage Carrier	190	
Cargo (Vehicle Loading)	189	
Cassette Tape and Player Maintenance	272	
Cassette Tape Player	214,234,238	
Catalytic Converter	407	
Caution, Exhaust Gas	37,83,345,415	
CD (Compact Disc) Changer	223,230,242,255,256	
CD (Compact Disc)		
Player	220,224,228,234,240,244,247,251,254	
CD (Compact Disc) Player Maintenance	273	
Cellular Phone	94,274	
Center High Mounted Stop Light	442	
Center Lap Belts	51	
Chains, Tire	339	
Changing A Flat Tire	368	
Chart, Tire Sizing	321	
Check Engine Light		
(Malfunction Indicator Light)	210,399	
Child Restraint	69	
Child Restraint Tether Anchors	74	
Child Safety Locks	33	
Child Seat	69,76	
Clean Air Gasoline	342	
Climate Control	274	
Clock	212	
Coat Hook	189	
Compact Disc (CD) Maintenance	273	
Compact Disc (CD) Player	214,220	
Compact Spare Tire	332	
Compass	159	
Compass Calibration	159	

Compass Variance	160	Cup Holder	177,432
Computer, Trip/Travel	162	Customer Assistance	474
Console, Overhead	158	Daytime Running Lights	145
Console, Removable	184,185	Dealer Service	400
Contract, Service	476	Defroster, Rear Window	300
Coolant Pressure Cap	418	Defroster, Windshield	84,279,290
Cooling System	416	Diagnostic System, Onboard	398
Adding Coolant (Antifreeze)	418	Dimmer Control	144
Coolant Capacity	443	Dipsticks	
Coolant Level	416,419	Automatic Transmission	426
Disposal of Used Coolant	419	Oil (Engine)	401
Drain, Flush, and Refill	417	Disabled Vehicle Towing	391
Inspection	419	Disarming, Theft System	27
Points to Remember	420	Disposal	
Pressure Cap	418	Antifreeze (Engine Coolant)	419
Radiator Cap	418	Engine Oil	405
Selection of Coolant (Antifreeze)	417,443,444	Domelight	144
Cruise Control (Speed Control)	155	Door Ajar Light	205
Cruise Light	211		

Door Locks	17	Air Cleaner	407
Door Locks, Automatic	19	Air Cleaner Filter	406
Door Opener, Garage	167	Block Heater	309
Drive Belts	405	Break-In Recommendations	82
Drive Shaft Universal Joints	413	Checking Oil Level	401
Driving		Compartment	396,397
On Slippery Surfaces	389	Coolant (Antifreeze)	444
		Cooling	416
Electric Remote Mirrors	92	Exhaust Gas Caution	37,345
Electrical Power Outlets	175	Fails to Start	305,307
Electronic Speed Control (Cruise Control)	155	Fuel Requirements	342,443
Electronic Vehicle Information Center (EVIC)	163	Oil	401,443,444
Emergency, In Case of		Oil Change Interval	403
Hazard Warning Flasher	366	Oil Disposal	405
Jacking	368,369,381	Oil Filler Cap	404
Jump Starting	387	Oil Filter Disposal	405
Overheating	367	Oil Selection	403,443
Emission Control System Maintenance	399,448	Oil Synthetic	405
Engine	396,397	Overheating	367

Temperature Gauge	208	Fluid Level Checks	
Exhaust Gas Caution	37,83,345,415	Automatic Transmission	426
Exhaust System	415	Brake	423
Extender, Seat Belt	53	Power Steering	412
Exterior Folding Mirrors	91	Fluids	444
Filters		Fluids, Lubricants and Genuine Parts	444
Air Cleaner	406	Fog Light Service	440
Air Conditioning	296,411	Fog Lights	146,440
Automatic Transaxle	427	Fold in Floor (Stow 'n Go) Seating	123
Engine Oil	405,444	Freeing A Stuck Vehicle	390
Engine Oil Disposal	405	Fuel	342
Flashers		Adding	346
Hazard Warning	366	Additives	344
Turn Signal	205,439,441	Clean Air	342
Flat Tire Stowage	377	Filler Cap (Gas Cap)	346
Fluid Capacities	443	Gasoline	342
Fluid Leaks	84	Gauge	204
		Hoses	424
		Light	204

Octane Rating	342,444	Glass Cleaning	431
Requirements	342,443	Grocery Bag Retainer	136
Tank Capacity	443	Gross Axle Weight Rating	348,351
Fuel System Caution	344	Gross Vehicle Weight Rating	348,351
Fueling	346	Hands-Free Phone (UConnect™)	94
Fuses	434	Hazard Warning Flasher	366
Garage Door Opener (HomeLink®)	167	Head Phones	264
Gas Cap (Fuel Filler Cap)	346	Head Restraints	119
Gasoline, Clean Air	342	Headlights	143
Gasoline (Fuel)	342	Bulb Replacement	438
Gasoline, Reformulated	343	High Beam/Low Beam Select Switch	148
Gauges		Lights On Reminder	145
Coolant Temperature	208	Replacing	438
Fuel	204	Time Delay	146
Speedometer	205	Heated Seats	119
Tachometer	207	Heater	274
Gearshift	311	Heater, Engine Block	309
General Information	16,25,339		

Hitches		Integrated Child Seat	69
Trailer Towing	353	Integrated Power Module	434
HomeLink® (Garage Door Opener) Transmitter . . .	167	Interior Appearance Care	430
Hood Release	141	Interior Lights	143,144
Hook, Coat	189	Intermittent Wipers (Delay Wipers)	149,296,298
Hoses	421,424	Introduction	4
Ignition		Jack Location	370,372,382,383
Key	12	Jack Operation	368,372,383
Illuminated Entry	16	Jacking Instructions	372,383
Immobilizer (Sentry Key)	13	Jump Starting	387
Indicator, Traction Control	210	Key, Programming	15
Infant Restraint	70	Key, Replacement	15
Information Center	163	Key, Sentry (Immobilizer)	13
Information Center, Vehicle	163	Key-In Reminder	13
Inside Rearview Mirror	90	Keyless Entry System	20
Instrument Cluster	202,203,204	Keys	12
Instrument Panel and Controls	201	Knee Bolster	59
Instrument Panel Lens Cleaning	432		

Lap/Shoulder Belts	43	Door Ajar	205
LATCH (Lower Anchors and Tether for Children)	74	Engine Temperature Warning	208
Latches		Fog	146,440
Hood	141	Hazard Warning Flasher	366
Lead Free Gasoline	342	Headlight Switch	143
Life of Tires	335	Headlights	438
Liftgate	34	Headlights On Reminder	145
Lights	84,142	High Beam Indicator	209
Airbag	59,68,84,206	High Beam/Low Beam Select	148
Alarm	208	Illuminated Entry	16
Anti-Lock	207	Interior	143,144
Automatic Headlights	145	License	442
Back-Up	441	Liftgate Ajar	205
Battery Saver	145	Lights On Reminder	145
Brake Warning	205	Low Fuel	204
Bulb Replacement	437,438	Malfunction Indicator (Check Engine)	210
Center Mounted Stop	442	Oil Pressure	209
Cruise	211	Park	143,439
Dimmer Switch, Headlight	144	Passing	148

Reading	158	Lower Anchors and Tether for CHildren (LATCH)	74
Rear Servicing	441	Lubrication, Body	413
Rear Tail	441	Luggage Rack (Roof Rack)	190
Seat Belt Reminder	207	Lumbar Support	122
Security Alarm (Theft Alarm)	208	Maintenance, Airbag	68
Service	437,438	Maintenance Free Battery	409
Service Engine Soon (Malfunction Indicator)	210	Maintenance Procedures	401
Side Marker	441	Maintenance Schedule	448
Theft Alarm (Security Alarm)	208	Schedule "A"	463
Turn Signal	147,439,441	Schedule "B"	451
Voltage	207	Maintenance, Sunroof	175
Warning (Instrument Cluster Description)	204	Malfunction Indicator Light (Check Engine)	210,399
Washer Fluid	209	Manual, Service	478
Load Leveling System	193	Map/Reading Lights	158
Loading Vehicle	189,348,349	Mini-Trip Computer	162
Capacities	349	Mirrors	90
Tires	324	Automatic Dimming	90
Locks		Electric Remote	92
Door	17		

Exterior Folding	91	Checking	401
Heated	93	Disposal	405
Outside	92	Filter	405,444
Rearview	90	Filter Disposal	405
Vanity	93	Identification Logo	404
Modifications/Alterations, Vehicle	7	Materials Added to	405
Monitor, Tire Pressure System	337	Recommendation	403,443
Mopar Parts	400,477	Synthetic	405
Multi-Function Control Lever	147	Viscosity	404,443
		Onboard Diagnostic System	398,399
Navigation System	257	Opener, Garage Door (HomeLink®)	167
New Vehicle Break-In Period	82	Operator Manual (Owner's Manual)	4
		Outside Rearview Mirrors	90
Occupant Restraints	42	Overdrive	312
Octane Rating, Gasoline (Fuel)	342	Overhead Console	158
Odometer	211	Overhead Travel Information Center	158
Oil, Engine	401,444	Overheating, Engine	208,367
Capacity	443	Owner's Manual (Operator Manual)	4,478
Change Interval	403		

Panic Alarm	23	Steering, Checking	412
Parking Brake	313	Sunroof	173
Parking On Hill	313	Windows	41
Passing Light	148	Power Steering Fluid	445
Pedals, Adjustable	153	Pregnant Women and Seat Belts	53
Pets, Transporting	78	Preparation for Jacking	369,381
Phone, Cellular	94	Pretensioners	
Phone, Hands-Free (UConnect™)	94	Seat Belts	51
Placard, Tire and Loading Information	324	Programmable Electronic Features	164,169,172
Power		Programming Transmitters	
Brakes	314	(Remote Keyless Entry)	23,169,172
Distribution Center	434	Radial Ply Tires	331
Door Locks	18	Radiator Cap (Coolant Pressure Cap)	416,418
Lift Gate	35	Radio Broadcast Signals	212
Mirrors	92	Radio Operation	234,252,274
Outlet (Auxiliary Electrical Outlet)	175	Radio Remote Controls	258,270
Seats	118	Radio, Satellite	266
Sliding Door	30	Radio (Sound Systems)	214,224,234,244,251
Steering	317		

Rear Air Conditioning	282,291	Reporting Safety Defects	477
Rear Cup Holder	179	Restraint, Head	119
Rear Heater	282	Restraints, Child	69,76
Rear Seat Removal	133,135	Restraints, Infant	70
Rear Seating Flexibility	138,139	Rocking Vehicle When Stuck	390
Rear Window Defroster	300	Roof Rack (Luggage Rack)	190
Rear Window Features	296	Rotation, Tires	341
Rear Wiper/Washer	297,298	Safety Checks Inside Vehicle	83
Rearview Mirrors	90	Safety Checks Outside Vehicle	84
Reclining Front Seats	120	Safety Defects, Reporting	477
Recreational Towing	363,392	Safety, Exhaust Gas	37
Reminder, Seat Belt	52	Safety Information, Tire	320
Remote Control	258	Safety Tips	83
Remote Keyless Entry (RKE)	20	Satellite Radio	266
Remote Sound System (Radio) Controls	270	Satellite Radio Antenna	269
Removable Floor Console	184,185	Schedule, Maintenance	448
Replacement Keys	15	Seat Belt Maintenance	432
Replacement Parts	400	Seat Belt Reminder	52
Replacement Tires	335		

Seat Belts	42	Lumbar Support	122
Adjustable Shoulder Belt	48	Power	118
Adjustable Upper Shoulder Anchorage	48	Reclining	120,122
And Pregnant Women	53	Removal	131,133,135
Center Lap Belt	51	Stow 'n Go (Fold in Floor)	123
Child Restraint	69	Tilting	129
Extender	53	Security Alarm (Theft Alarm)	26
Front Seat	43	Selection of Coolant (Antifreeze)	417,444
Pretensioners	51	Sentry Key (Immobilizer)	13
Rear Seat	43	Sentry Key Programming	15
Untwisting Procedure	49	Service Assistance	474
Seats	117	Service Contract	476
Adjustment	117	Service Engine Soon Light (Malfunction Indicator)	210
Bench	135,137	Service Manuals	478
Easy Entry	129	Setting the Clock	212
Easy-Out Roller	135	Shoulder Belts	43
Fold in Floor (Stow 'n Go)	123	Signals, Turn	147,205,439,441
Heated	119	Sliding Door	28
Integrated, Child	69	Slippery Surfaces, Driving On	389

Snow Chains (Tire Chains)	339	Storage, Vehicle	295,436
Snow Tires	340	Storing Your Vehicle	436
Spare Tire	332,333,371,382	Stow 'n Go (Fold in Floor) Seats	123
Spark Plugs	406	Sun Roof	173
Speed Control (Cruise Control)	155	Sun Visor Extension	93
Speedometer	205	Sunglasses Storage	159
Starting	304	Sunroof Maintenance	175
Engine Fails to Start	305,307	Supplemental Restraint System - Airbag	54
Starting and Operating	304	Synthetic Engine Oil	405
Steering		System, Navigation	257
Column Controls	147	Tachometer	207
Linkage	413	Tape Player	238
Power	317,412	Temperature Control, Automatic (ATC)	284
Shaft Seal	413	Temperature Gauge, Engine Coolant	208,367
Tilt Column	150	Tether Anchor, Child Restraint	74
Steering Wheel Mounted Sound System		Theft Alarm (Security Alarm)	26
Controls	270	Theft System Arming	27
Storage	180,436	Theft System Disarming	27
Storage Bin	180		

Theft System (Security Alarm)	26	Load Capacity	324,325
Tilt Steering Column	150	Pressure Monitor System (TPMS)	337
Tire and Loading Information Placard	324	Quality Grading	479
Tire Identification Number (TIN)	323	Radial	331
Tire Markings	320	Replacement	335
Tire Safety Information	320	Rotation	341
Tires	84,328,479	Safety	320,328
Aging (Life of Tires)	335	Sizes	321
Air Pressure	328	Snow Tires	340
Alignment	336	Spare Tire	371,382
Chains	339	Spinning	333
Changing	368	Tread Wear Indicators	334
Compact Spare	332	Tongue Weight/Trailer Weight	356
Flat Changing	377	Towing	350
General Information	328	Disabled Vehicle	391
High Speed	330	Guide	353
Inflation Pressures	329	Recreational	363,392
Jacking	368,369,381	Weight	353
Life of Tires	335	Traction Control	150,210,318

Traction Control Switch	150,318	Transmitter, Garage Door Opener (HomeLink®)	167
Trailer Towing	350	Transmitter Programming (Remote Keyless Entry)	23
Cooling System Tips	363	Transmitter, Remote Keyless Entry (RKE)	20
Hitches	353	Transporting Pets	78
Minimum Requirements	358	Tread Wear Indicators	334
Trailer and Tongue Weight	356	Trip Odometer	211
Wiring	361	Trip Odometer Reset Button	212
Trailer Towing Guide	353	Turn Signals	147,205,439,441
Trailer Weight	353	Uniform Tire Quality Grades	479
Transaxle	309	Universal Joints	413
Automatic	309	Universal Transmitter	167
Operation	309	Unleaded Gasoline	342
Overdrive	312	Untwisting Procedure, Seat Belt	49
Selection of Lubricant	425,445	Vanity Mirrors	93
Transmission	424	Variance, Compass	160
Automatic	424	Vehicle Certification Label	348
Filter	427	Vehicle Identification Number (VIN)	6
Fluid	425,445		
Transmitter Battery Service (Remote Keyless Entry)	25		

Vehicle Information Center	163	Power	41
Vehicle Loading	325,348,349	Rear Vent	40
Vehicle Modifications/Alterations	7	Windshield Washers	148,414
Vehicle Storage	295,436	Windshield Wiper Blades	414
Vehicle Theft Alarm (Security Alarm)	26	Windshield Wipers	148
		Wiper Blade Replacement	414
Warning Flasher, Hazard	366	Wiper, Rear	298
Warning Lights (Instrument Cluster Description)	204	Wipers, Intermittent	149
Warnings and Cautions	6		
Warranty Information	477	Zone Control (Temperature Control)	275
Washer, Adding Fluid	299,414		
Washer, Rear	297,298		
Washing Vehicle	429		
Wheel Alignment and Balance	336		
Wheel and Wheel Trim	430		
Wheel Bearings	428		
Wind Buffeting	41,175		
Window Fogging	295		
Windows	40		

NOTES

NOTES

NOTES
