

TABLE OF CONTENTS

SECTION		PAGE
1	INTRODUCTION	3
2	THINGS TO KNOW BEFORE STARTING YOUR VEHICLE	9
3	UNDERSTANDING THE FEATURES OF YOUR VEHICLE	55
4	UNDERSTANDING YOUR INSTRUMENT PANEL	123
5	STARTING AND OPERATING	173
6	WHAT TO DO IN EMERGENCIES	235
7	MAINTAINING YOUR VEHICLE	249
8	MAINTENANCE SCHEDULES	295
9	IF YOU NEED CONSUMER ASSISTANCE	317
10	INDEX	327

INTRODUCTION

CONTENTS

■ Introduction	4	■ Warnings And Cautions	7
□ Roll Over Warning	4	■ Vehicle Identification Number	7
■ How To Use This Manual	6	■ Vehicle Modifications / Alterations	8

INTRODUCTION

Thank you for selecting a Jeep® Grand Cherokee and welcome to our worldwide family.

This is a specialized utility vehicle designed for both on-road and off-road use. It can go places and perform tasks for which conventional two-wheel drive vehicles were not intended. However, on-road ride and handling will have a different feel from what drivers experience with other vehicles, so take time to become familiar with your vehicle.

The two-wheel drive utility vehicle was designed for on-road use only. It is not intended for off-road driving or use in other severe conditions suited to a four-wheel drive vehicle.

Before you start to drive this vehicle, read this manual. Be sure you are familiar with all vehicle controls, particularly those used for braking, steering and transmission and transfer case shifting. Learn how your vehicle

handles on different road surfaces. Your driving skills will improve with experience. When driving off-road or working the vehicle, don't overload it or expect it to overcome the laws of nature. Always observe federal, state, provincial, and local laws wherever you drive.

As with other vehicles of this type, failure to operate this vehicle correctly may result in loss of control or an accident. Be sure to read "On-Road/Off-Road Driving Tips" in Section 5 of this manual.

Roll Over Warning

Utility vehicles have a significantly higher roll over rate than other types of vehicles. This vehicle has a higher ground clearance, higher center of gravity, and narrower track than many passenger cars. It is capable of performing better in a wide variety of off-road applications. Driven in an unsafe manner, all vehicles can be caused to go out of control. Because of the higher center of gravity

and the narrower track, if this vehicle is out of control it may roll over when some other vehicles may not.

Do not attempt sharp turns or abrupt maneuvers or other unsafe driving actions that can cause loss of vehicle control. Failure to operate this vehicle safely may result in an accident, roll over of the vehicle, and severe or fatal injury. Drive carefully.

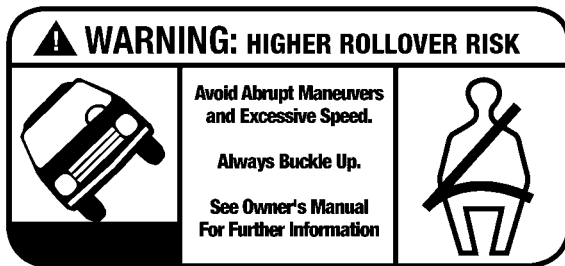

80bfe0f0

Failure to use driver and passenger seat belts provided is a major cause of severe or fatal injury. In fact, the U.S. government notes that the universal use of existing seat belts could cut the highway death toll by 10,000 or more each year, and could reduce disabling injuries by 2 million annually. In a roll over crash an unbelted person is significantly more likely to die than a person wearing a seat belt. Always buckle up.

This manual has been prepared with the assistance of service and engineering specialists to acquaint you with the operation and maintenance of your new vehicle. It is supplemented by a Warranty Information Booklet and various customer oriented documents. You are urged to read these publications carefully. Following the instructions and recommendations in this manual will help assure safe and enjoyable operation of your vehicle.

NOTE: After you read the manual, it should be stored in the vehicle for convenient reference and remain with the vehicle when sold so that the new owner will be aware of all safety warnings.

When it comes to service, remember that your authorized dealer knows your vehicle best, has the factory-trained technicians and genuine Mopar® parts, and is interested in your satisfaction.

WARNING!

Engine exhaust, some of its constituents, and certain vehicle components contain or emit chemicals known to the State of California to cause cancer and birth defects or other reproductive harm. In addition, certain fluids contained in vehicles and certain products of component wear contain or emit chemicals known to the State of California to cause cancer and birth defects or other reproductive harm.

HOW TO USE THIS MANUAL

Consult the table of contents to determine which section contains the information you desire.

The detailed index, at the rear of the manual, contains a complete listing of all subjects.

WARNINGS AND CAUTIONS

This manual contains **WARNINGS** against operating procedures which could result in an accident or bodily injury. It also contains **CAUTIONS** against procedures which could result in damage to your vehicle. If you do not read this entire manual you may miss important information. Observe all Warnings and Cautions.

VEHICLE IDENTIFICATION NUMBER

The vehicle identification number (VIN) is found on a stamped plate located on the left front corner of the instrument panel pad, visible from outside of the vehicle through the windshield. This number also appears on the Automobile Information Disclosure Label affixed to a window on your vehicle. Save this label for a convenient record of your vehicle identification number and optional equipment.

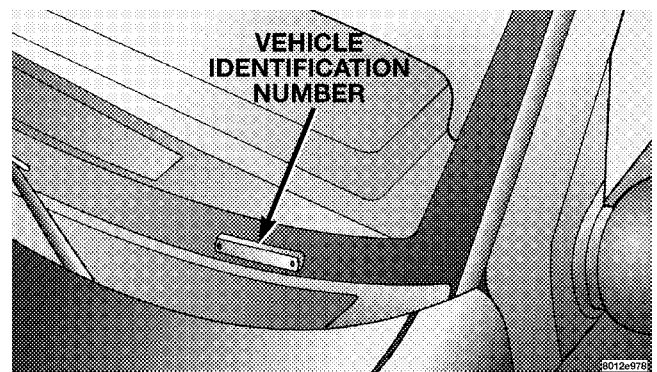

NOTE: It is illegal to remove the VIN plate.

VEHICLE MODIFICATIONS / ALTERATIONS

WARNING!

Any modifications or alterations to this vehicle could seriously affect its roadworthiness and safety and may lead to an accident resulting in serious injury or death.

THINGS TO KNOW BEFORE STARTING YOUR VEHICLE

CONTENTS

■ A Word About Your Keys11	■ Door And Liftgate Locks15
□ Ignition Key11	□ Liftgate Flipper Glass15
□ Key-In-Ignition Reminder12	□ Door Locks17
■ Sentry Key Immobilizer System — If Equipped . . .12		□ Power Door Lock System18
□ Important Note About Service13	■ Remote Keyless Entry20
□ Replacement Keys13	□ To Unlock The Doors And Liftgate20
□ Customer Key Programming14	□ To Lock The Doors And Liftgate21
□ General Information14	□ Using The Panic Alarm21
■ Illuminated Entry15	□ General Information21

10 THINGS TO KNOW BEFORE STARTING YOUR VEHICLE

□ Programming Additional Transmitters	22	□ Energy Management Feature	32
□ Transmitter Battery Replacement	22	□ Rear Center Lap Belt	33
■ Security Alarm System — If Equipped	23	□ Enhanced Driver Seat Belt Use Reminder System (BeltAlert)	33
□ To Set The Alarm	23	□ Seat Belts And Pregnant Women	34
□ To Disarm The System	23	□ Seat Belt Extender	35
■ Power Windows	24	□ Driver And Front Passenger Supplemental Restraint Systems (SRS)	35
□ Auto Down Feature — If Equipped	25	□ Child Restraint	44
□ Wind Buffeting	25	■ Engine Break-In Recommendations	51
■ Occupant Restraints	26	■ Safety Tips	51
□ Lap/Shoulder Belts	27	□ Exhaust Gas	51
□ Lap/Shoulder Belt Operating Instructions	28	□ Safety Checks You Should Make Inside The Vehicle	52
□ Adjustable Upper Shoulder Belt Anchorage	30	□ Safety Checks You Should Make Outside The Vehicle	53
□ Automatic Locking Mode — If Equipped	31		

A WORD ABOUT YOUR KEYS

The keys for your new vehicle are enclosed in a plastic bag with the key code number on it. If you received your keys without the bag, ask your authorized dealer to give you the number. The key code can also be obtained by your authorized dealer from your vehicle invoice.

Ignition Key

Insert the key fully, then turn the switch to one of the four illustrated positions. The key can be inserted or withdrawn only in the LOCK position. The gearshift lever must be in the P (Park) position.

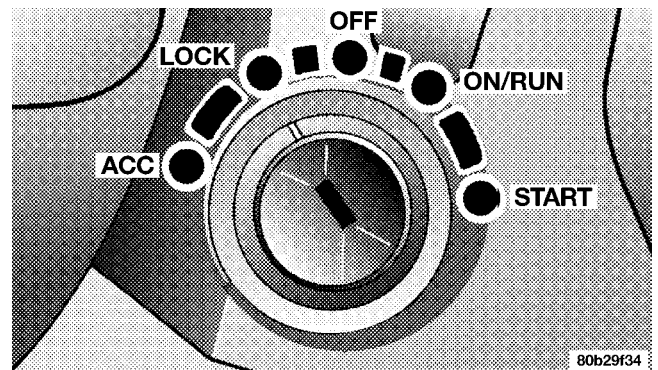

To remove the ignition key, place the gearshift lever in P (Park), turn the ignition key to LOCK and remove the key.

Key-In-Ignition Reminder

If the driver's door is opened when the key is in the ignition and not turned to the ON position, a chime will sound to remind you to remove the key.

CAUTION!

Always remove the key from the ignition, and lock all doors when leaving the vehicle unattended.

SENTRY KEY IMMOBILIZER SYSTEM — IF EQUIPPED

The Sentry Key Immobilizer System (SKIS) prevents unauthorized operation of the vehicle by disabling the engine. The system will shut the engine down after 2 seconds of running if an invalid key is used to start the vehicle. This system utilizes ignition keys which have an electronic chip (transponder) embedded into them. Only

keys that have been programmed to the vehicle can be used to start and operate the vehicle for longer than the 2 second validation time period.

The Sentry Key Immobilizer System does not need to be armed or activated. Operation of the system is automatic regardless of whether or not the vehicle is locked or unlocked. During normal operation, the SKIS indicator light will come on for 3 seconds immediately after the ignition switch is turned on for a bulb check. Afterwards, if the bulb remains on, this indicates a malfunction in the electronics. If the bulb begins to flash immediately after the ignition switch is turned on, this indicates that an invalid key is being used to start the vehicle. Both of these conditions will result in the engine being shut down after 2 seconds of running. Keep in mind that a key which has not been programmed is also considered an invalid key even if it is cut to fit the ignition for that vehicle.

If the SKIS indicator light comes on during normal vehicle operation (it has been running for longer than 10 seconds) a fault has been detected in the electronics and the vehicle should be serviced as soon as possible.

NOTE:

- The Sentry Key Immobilizer System is not compatible with remote starting systems. Use of these systems may result in vehicle starting problems and loss of security protection.
- Mobil Speedpass™, additional Sentry Keys, or any other transponder equipped components on the same keychain will not cause a key-related (Transponder) fault unless the additional part is **physically held against the ignition key** being used when starting the vehicle. Also, cell phones, pagers, or other RF electronics will not cause interference with this system.

All of the keys provided with your new vehicle have been programmed to the vehicle electronics.

Important Note About Service

A four digit PIN number is needed to service the Sentry Key Immobilizer System. This number can be obtained from your authorized dealer. However, this number can also be found on your customer invoice that you were given upon receipt of your vehicle.

Replacement Keys

NOTE: Only keys that have been programmed to the vehicle electronics can be used to start the vehicle. Once a Sentry Key has been programmed to a vehicle, it cannot be programmed to any other vehicle.

At the time of purchase, the original owner is provided with a four digit PIN number. This number is required for dealer replacement of keys. Duplication of keys may be performed at an authorized dealer or by using the Customer Key Programming procedure. This procedure

14 THINGS TO KNOW BEFORE STARTING YOUR VEHICLE

consists of programming a blank key to the vehicle electronics. A blank key is one which has never been programmed.

NOTE: When having the Sentry Key System serviced, bring all vehicle keys to the dealer.

Customer Key Programming

You can program new keys to the system if you have two valid keys by doing the following:

1. Cut the additional Sentry Key Transponder blank(s) to match the ignition switch lock cylinder key code.
2. Insert the first valid key into the ignition switch and turn the ignition switch ON for at least 3 seconds but no longer than 15 seconds. Turn the ignition switch OFF and remove the first key.
3. Insert the second valid key and turn the ignition switch ON within 15 seconds. After ten seconds, a chime

will sound and the SKIS indicator light will begin to flash. Turn the ignition switch OFF and remove the second key.

4. Insert a blank Sentry Key into the ignition switch and turn the ignition switch ON within 60 seconds. After 10 seconds, a single chime will sound. The SKIS indicator light will stop flashing, turn on for 3 seconds; then turn off.

The new Sentry Key has been programmed. Repeat this process to program up to a total of 8 keys.

General Information

The Sentry Key Immobilizer System complies with FCC rules part 15 and with RSS-210 of Industry Canada. Operation is subject to the following two conditions:

1. This device may not cause harmful interference.

2. This device must accept any interference that may be received, including interference that may cause undesired operation.

ILLUMINATED ENTRY

The interior lights come on when you open any door. They will remain on for about 30 seconds after all doors are closed then fade to off.

The lights also will fade to off if you turn on the ignition after you close all the doors.

DOOR AND LIFTGATE LOCKS

NOTE: The master key that is used to start the vehicle is used to lock or unlock the driver's door. To unlock the driver's door insert the key into the lock and turn.

To open the liftgate, pull out on the handle and lift.

WARNING!

Driving with the liftgate open can allow poisonous exhaust gases into your vehicle. You and your passengers could be injured by these fumes. Keep the liftgate closed when you are operating the vehicle.

2

Liftgate Flipper Glass

The liftgate flipper glass is also unlocked when the liftgate is unlocked. To open the flipper glass, push up on the window switch located on the liftgate. Once the liftgate flipper glass has been opened, connection to the rear window wiper is interrupted, preventing activation of the rear wiper blade while the flipper glass is open.

NOTE: If a power malfunction to the power liftgate latch should occur, an emergency liftgate latch release

16 THINGS TO KNOW BEFORE STARTING YOUR VEHICLE

can be used to open the liftgate. The emergency liftgate latch release can be accessed through a snap-in cover located on the liftgate trim panel.

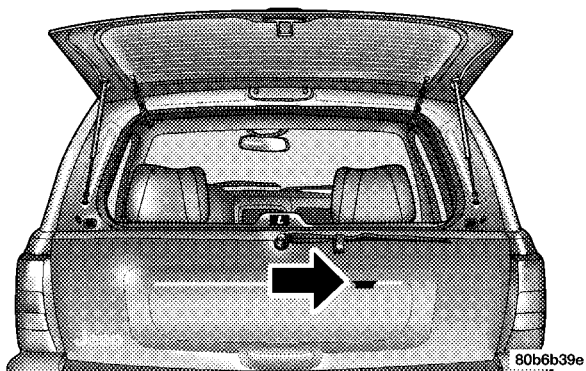

80b6b39e

WARNING!

Driving with the flipper glass open can allow poisonous exhaust gases into your vehicle. You and your passengers could be injured by these fumes. Keep the flipper glass closed when you are operating the vehicle.

Door Locks

All doors are equipped with a slide-type interior door lock. To manually lock a door, slide the lever rearward (toward the rear of the vehicle) to the "Lock" position.

Once locked, the rear doors cannot be opened from the inside until the lock lever has been released. However, the front doors can be opened using the inside door handle.

To manually unlock a door, slide the lever forward (toward the front of the vehicle) to the "Unlock" position.

WARNING!

For personal security reasons and safety in a collision, lock the vehicle doors when you drive and when you park and leave the vehicle.

WARNING!

When leaving the vehicle always remove the key from the ignition lock, and lock your vehicle. Do not leave children unattended in the vehicle, or with access to an unlocked vehicle. Unsupervised use of vehicle equipment may cause severe personal injuries and death.

Child Protection Locks

The rear doors of your vehicle are equipped with child protection locks. If you push up on the lever on the open edge of the door it cannot be opened from the inside of the vehicle. Push the lever down to disengage the child protection locks.

WARNING!

Avoid trapping anyone in the vehicle in a collision. Remember that the rear doors can only be opened from the outside when the child protection locks are engaged.

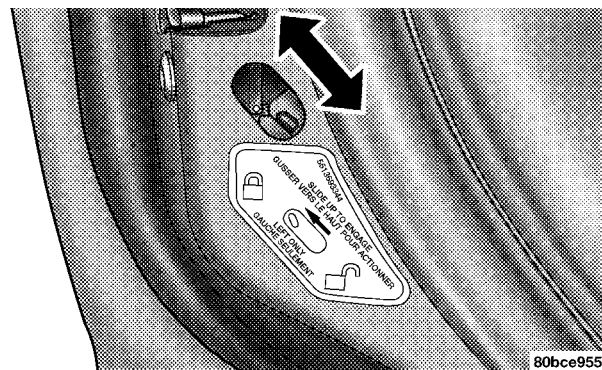

Power Door Lock System

The power door locks are on a paddle-type switch. Pressing the switch toward the rear of the vehicle will "Lock" all doors. Pressing the switch toward the front of the vehicle will "Unlock" all doors. The driver's and passenger's switch locks and unlocks all doors and the liftgate.

As a safety feature, the power door lock switch will not lock when the door is open and the key is in the ignition.

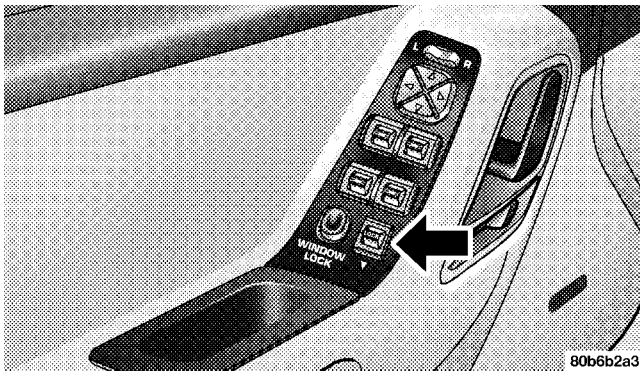

Once locked, the rear doors cannot be opened from the inside until the lock lever has been released. However, both front doors can be opened using the inside door handle.

Automatic Door Locks

If this feature is selected your door locks will lock automatically if the vehicle speed is above 15 mph (24 km/h) and all doors are closed. It will reset whenever a door is opened.

This feature is selectable and can be turned on or off. Refer to “Overhead Console — Customer Programmable Features” in Section 3 of this manual or see your authorized dealer.

Automatic Unlock on Exit Feature — Only Available if Auto Lock is Enabled

This feature will unlock all the doors when the driver's door is opened if the vehicle is stopped and in P (Park) or N (Neutral). Refer to “Overhead Console — Customer Programmable Features” in Section 3 of this manual or see your authorized dealer.

REMOTE KEYLESS ENTRY

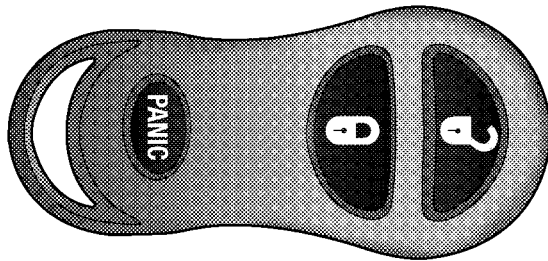

80b6f052

This system allows you to lock or unlock the doors and liftgate or activate the panic alarm from distances up to about 23 feet (7 meters) using a hand held radio transmitter. The transmitter need not be pointed at the vehicle to activate the system.

To Unlock the Doors and Liftgate

Press and release the "Unlock" button on the key fob once to unlock the driver's door, or twice (within 5 seconds) to unlock all doors and liftgate. The illuminated entry system will also come on.

NOTE: The system can be programmed to do the following:

- unlock all the doors on the first button press
- flash the turn signals with unlock
- On vehicles equipped with an overhead console these functions can be selected at the overhead console using the "Customer Programmable Features." Refer to "Overhead Console — Customer Programmable Features" in this section, otherwise see your authorized dealer.

To Lock the Doors and Liftgate

Press and release the “Lock” button on the key fob to lock all doors and liftgate. If you wish, the horn can be programmed to chirp once and/or the turn signals can be programmed to flash once to show the system is activated. For customer programmable features, refer to “Overhead Console” in this section for programming details, otherwise see your authorized dealer.

Using the Panic Alarm

To turn on the panic alarm feature, press and release the PANIC button with the ignition off. When the panic alarm is on the headlights and marker lights will flash, the horn will pulse on and off and the interior lights will turn on.

The panic alarm will stay on for 3 minutes unless you turn it off by pressing the PANIC button a second time or by starting the vehicle and accelerating to 15 mph (24 km/h).

General Information

This device complies with FCC rules part 15 and with RSS-210 of Industry Canada. Operation is subject to the following two conditions: (1) This device may not cause harmful interference and (2) This device must accept any interference that may be received, including interference that may cause undesired operation.

If your transmitter fails to operate from a normal distance, check for these two conditions.

1. Weak batteries in transmitter. The expected life of batteries is from one to two years.
2. Closeness to a radio transmitter such as a radio station tower, airport transmitter, military base, and some mobile or CB radios.

Programming Additional Transmitters

Up to four transmitters can be programmed. See your authorized dealer.

Transmitter Battery Replacement

The recommended replacement battery is a Panasonic CR2016 or equivalent.

NOTE: Do not touch the battery terminals that are on the back housing or the printed circuit board.

1. With the transmitter buttons facing down, use a thin coin to pry the two halves of the transmitter apart. Make sure not to damage the rubber gasket during removal.

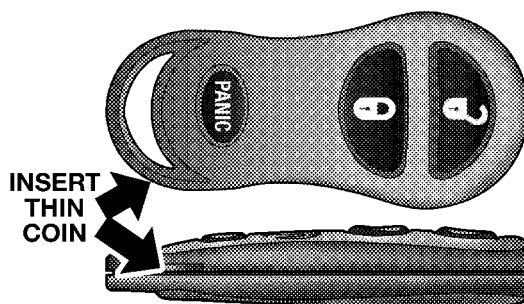

80b6f053

2. Remove and replace the batteries. Avoid touching the new batteries with your fingers. Skin oils may cause battery deterioration. If you touch a battery, clean it with rubbing alcohol.

3. To reassemble the transmitter case snap two halves together. Make sure there is an even "gap" between the two halves.

4. Reset the transmitter by pressing the “Unlock” button six times. Test the transmitter operation.

SECURITY ALARM SYSTEM — IF EQUIPPED

This system monitors the vehicle doors, liftgate, liftgate flipper glass, and ignition for unauthorized operation. When the alarm is activated, the system provides both audible and visual signals. The horn will sound repeatedly for three minutes and the headlights and taillights will flash for an additional 15 minutes.

To Set the Alarm

The alarm will set when you use the remote keyless entry transmitter to lock the doors and liftgate or when you use the power door lock switch while the door is open. After all the doors are locked and closed, a red light on top of the instrument panel will flash rapidly for about 16 seconds to signal that the system is arming. During this 16 second pre-arm period, opening any door or the

liftgate will cancel the arming. If the system successfully arms, the red light will flash at a slower rate to indicate the alarm is set.

To Disarm the System

To disarm the system, use the remote keyless entry transmitter or the key to unlock the driver’s door. If something has triggered the system in your absence, the horn will sound three times when you unlock the doors. Check the vehicle for tampering.

The Security Alarm System is designed to protect your vehicle; however, you can create conditions where the system will arm unexpectedly. If you remain in the vehicle and lock the doors with the transmitter, once the system is armed (after 16 seconds), when you pull the door handle to exit the alarm will sound. If this occurs, press the “Unlock” button on the remote keyless entry

24 THINGS TO KNOW BEFORE STARTING YOUR VEHICLE

transmitter to disarm the system. You may also accidentally disarm the system by unlocking the driver's door with the key and then locking it. The door will be locked but the Security Alarm will not arm.

POWER WINDOWS

The power window controls are located on the driver's door trim panel. There is a single switch on the front passenger door which operates the passenger door window.

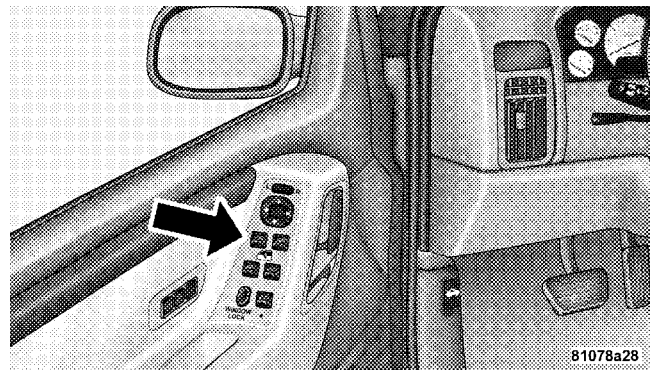

The window lock switch located next to the power door lock switch allows you to disable the rear passenger window switches that are located on the rear door trim panels.

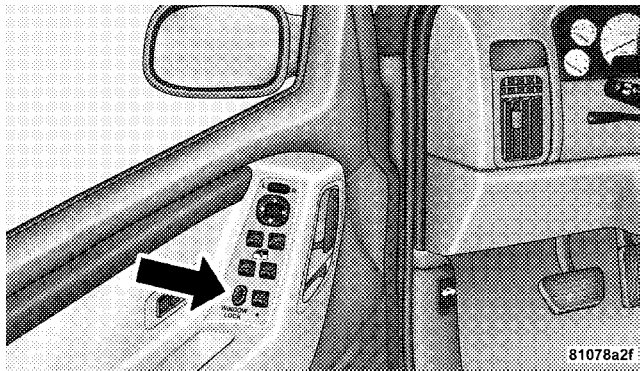

Auto Down Feature — If Equipped

The driver's door window switch has an "Auto Down" feature. Press the window switch past the detent, release, and the window will go down automatically.

To open the window part way, press the window switch part way and release it when you want the window to stop.

The power window switches remain active for up to 45 seconds after the ignition switch has been turned off. Opening a vehicle front door will cancel this feature.

Wind Buffeting

Wind buffeting can be described as the perception of pressure on the ears or a helicopter type sound in the ears. Your vehicle may exhibit wind buffeting with the windows down, or the sunroof (if equipped) in certain

open or partially open positions. This is a normal occurrence and can be minimized. If the buffeting occurs with the sunroof open, adjust the sunroof opening to minimize the buffeting.

OCCUPANT RESTRAINTS

Some of the most important safety features in your vehicle are the restraint systems. These include the front and rear seat belts for the driver and all passengers, front airbags for both the driver and right front passenger, and, if equipped, window bags for the driver and passengers seated next to a window. If you will be carrying children too small for adult-size belts, your seat belts also can be used to hold infant and child restraint systems.

NOTE: The front airbags have a multi stage inflator design. This allows the airbag to have different rates of inflation that are based on collision severity.

Please pay close attention to the information in this section. It tells you how to use your restraint system properly to keep you and your passengers as safe as possible.

WARNING!

In a collision, you and your passengers can suffer injuries, including fatalities, if you are not properly buckled up. You can strike the interior of your vehicle or other passengers, or you can be thrown out of the vehicle. Always be sure you and others in your vehicle are buckled up properly.

Buckle up even though you are an excellent driver, even on short trips. Someone on the road may be a poor driver and cause a collision which includes you. This can happen far away from home or on your own street.

Research has shown that seat belts save lives, and they can reduce the seriousness of injuries in a collision. Some of the worst injuries happen when people are thrown from the vehicle. Seat belts reduce the possibility of ejection and the risk of injury caused by striking the inside of the vehicle. **Everyone** in a motor vehicle should be belted at all times to reduce or prevent injuries.

Lap/Shoulder Belts

The outboard front and rear seats of your vehicle have combination lap/shoulder belts.

The belt webbing retractor is designed to lock during very sudden stops or collisions. This feature allows the shoulder part of the belt to move freely with you under normal conditions. But in a collision, the belt will lock and reduce the risk of you striking the inside of the vehicle or being thrown out.

WARNING!

- **Wearing a seat belt incorrectly is dangerous. Seat belts are designed to go around the large bones of your body. These are the strongest parts of your body and can take the forces of a collision the best. Wearing your belt in the wrong place could make your injuries in a collision much worse. You might suffer internal injuries, or you could even slide out of part of the belt. Follow these instructions to wear your seat belt safely and to keep your passengers safe, too.**
- **Two people should never be belted into a single seat belt. People belted together can crash into one another in an accident, hurting one another badly. Never use a lap/shoulder belt or a lap belt for more than one person, no matter what their size.**

Lap/Shoulder Belt Operating Instructions

1. Enter the vehicle and close the door. Sit back and adjust the seat.
2. The seat belt latch plate is above the back of your seat. Grasp the latch plate and pull out the belt. Slide the latch plate up the webbing as far as necessary to make the belt go around your lap.

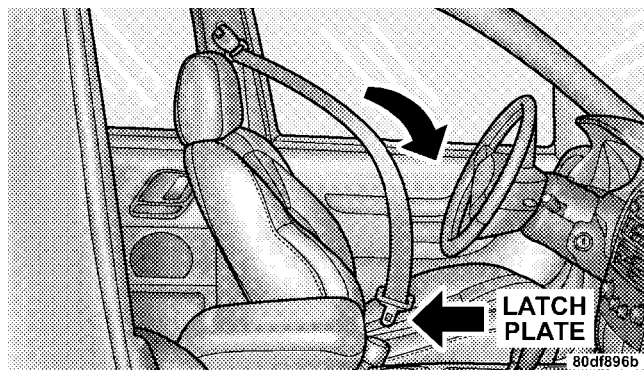

3. When the belt is long enough to fit, insert the latch plate into the buckle until you hear a "click."

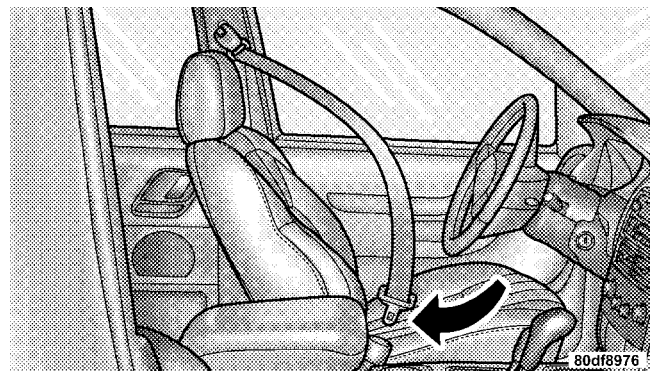

WARNING!

- A belt that is buckled into the wrong buckle will not protect you properly. The lap portion could ride too high on your body, possibly causing internal injuries. Always buckle your belt into the buckle nearest you.
- A belt that is too loose will not protect you as well. In a sudden stop you could move too far forward, increasing the possibility of injury. Wear your seat belt snugly.
- A belt that is worn under your arm is very dangerous. Your body could strike the inside surfaces of the vehicle in a collision, increasing head and neck injury. A belt worn under the arm can cause internal injuries. Ribs aren't as strong as shoulder bones. Wear the belt over your shoulder so that your strongest bones will take the force in a collision.
- A shoulder belt placed behind will not protect you from injury during a collision. You are more likely to hit your head in a collision if you do not wear your shoulder belt. The lap and shoulder belt are meant to be used together.

4. Position the lap belt across your thighs, below your abdomen. To remove slack in the lap portion, pull up a bit on the shoulder belt. To loosen the lap belt if it is too tight, tilt the latch plate and pull on the lap belt. A snug belt reduces the risk of sliding under the belt in a collision.

WARNING!

- A lap belt worn too high can increase the risk of injury in a collision. The belt forces won't be at the strong hip and pelvic bones, but across your abdomen. Always wear the lap part of your seat belt as low as possible and keep it snug.
- A twisted belt can't do its job as well. In a collision it could even cut into you. Be sure the belt is straight. If you can't straighten a belt in your vehicle, take it to your authorized dealer and have it fixed.

5. Position the shoulder belt on your chest so that it is comfortable and not resting on your neck. The retractor will withdraw any slack in the belt.

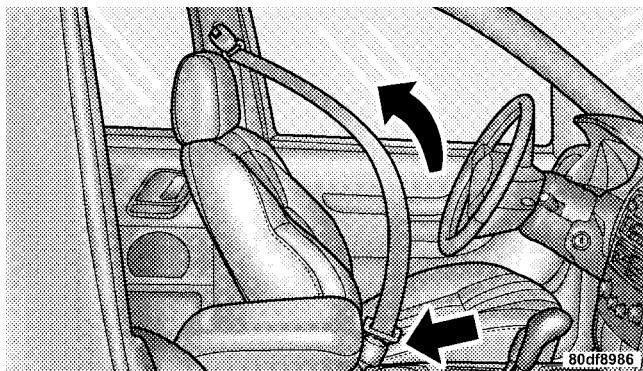

6. To release the belt, push the red button marked PRESS on the buckle. The belt will automatically retract to its stowed position. If necessary, slide the latch plate down the webbing to allow it to retract fully.

WARNING!

A frayed or torn belt could rip apart in a collision and leave you with no protection. Inspect the belt system periodically, checking for cuts, frays, or loose parts. Damaged parts must be replaced immediately. Do not disassemble or modify the system. Seat belt assemblies must be replaced after an accident if they have been damaged (bent retractor, torn webbing, etc.).

Adjustable Upper Shoulder Belt Anchorage

In the front seating positions, the shoulder belt can be adjusted upward or downward to position the belt away from your neck. Press the release button to release the anchorage, and then move it up or down to the position that serves you best.

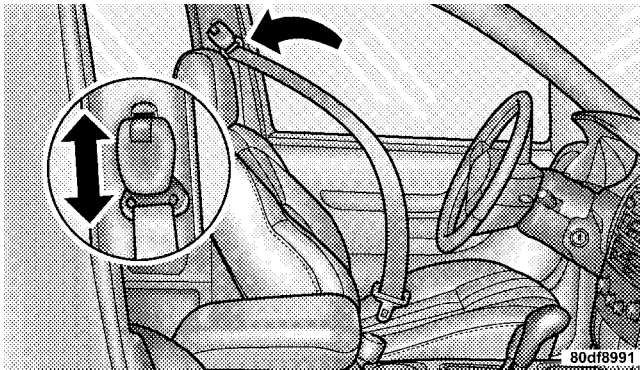

As a guide, if you are shorter than average, you will prefer a lower position, and if you are taller than average, you'll prefer a higher position. When you release the anchorage, try to move it up or down to make sure that it is locked in position.

Automatic Locking Mode — If Equipped

In this mode, the shoulder belt is automatically pre-locked. The belt will still retract to remove any slack in the shoulder belt.

When To Use The Automatic Locking Mode

Anytime a child safety seat is installed in a passenger front seating position. Children 12 years old and under should be properly restrained in the rear seat whenever possible.

How To Use The Automatic Locking Mode

1. Buckle the combination lap and shoulder belt.
2. Grasp the shoulder portion and pull downward until the entire belt is extracted.
3. Allow the belt to retract. As the belt retracts, you will hear a clicking sound. This indicates the safety belt is now in the automatic locking mode.

How to Disengage The Automatic Locking Mode

Disconnect the combination lap/shoulder belt and allow it to retract completely to disengage the automatic locking mode and activate the vehicle sensitive (emergency) locking mode.

Energy Management Feature

This vehicle has a safety belt system with an energy management feature in the front seating positions to help further reduce the risk of injury in the event of a head-on collision.

This safety belt system has a retractor assembly that is designed to release webbing in a controlled manner. This feature is designed to help reduce the belt force acting on the occupant's chest.

WARNING!

- **After a vehicle collision, the front passenger out-board seat belt system must be checked by a qualified technician to verify that the “automatic locking retractor” feature for child seats is still functioning properly. In addition, all seat belts should be checked for proper function.**
- **The belt and retractor assembly must be replaced if the seat belt assembly “automatic locking retractor” feature or any other seat belt function is not working properly when checked according to the procedures in the Service Manual.**
- **Failure to replace the belt and retractor assembly could increase the risk of injury in collisions.**

Rear Center Lap Belt

The rear center seating position has a lap belt only. To fasten the lap belt, slide the latch plate into the buckle until you hear a “click.”

To lengthen the lap belt, tilt the latch plate and pull. To remove slack, pull the loose end of the webbing. Wear the belt snug against the hips. Sit back and erect in the seat, then adjust the belt as tightly as is comfortable.

WARNING!

- **A lap belt worn too loose or too high is dangerous.**
- **A belt worn too loose can allow you to slip down and under the belt in a collision.**
- **A belt that is too high will apply crash forces to the abdomen, not to the stronger hip bones. In either case, the risk of internal injuries is greater. Wear a lap belt low and snug.**

Enhanced Driver Seat Belt Use Reminder System (BeltAlert)

If the driver's seat belt has not been buckled within 60 seconds of starting the vehicle and if the vehicle speed is greater than 5 mph (8 km/h), the Enhanced Warning System (BeltAlert) will alert the driver to buckle their seat belt. The driver should also instruct all other occupants to buckle their seat belts. Once the warning is triggered, the Enhanced Warning System (BeltAlert) will continue to chime and flash the Seat Belt Warning Light for 96 seconds or until the driver's seat belt is buckled. The Enhanced Warning System (BeltAlert) will be reactivated if the driver's seat belt is unbuckled for more than 10 seconds and the vehicle speed is greater than 5 mph (8 km/h).

The Enhanced Warning System (BeltAlert) can be enabled or disabled by your authorized dealer or by following these steps:

NOTE: The following steps must occur within the first 60 seconds of the ignition switch being turned to the ON or START position. The manufacturer does not recommend deactivating the Enhanced Warning System (BeltAlert).

1. Turn the ignition switch to the OFF position, and fasten the driver's seat belt.
2. Start the engine, and wait for the Seat Belt Warning Light to turn off.
3. Within 60 seconds of starting the vehicle, unbuckle and then re-buckle the driver's seat belt at least three times, ending with the seat belt buckled.
4. Turn off the engine. A single chime will sound to signify that you have successfully completed the programming.

The Enhanced Warning System (BeltAlert) can be reactivated by repeating this procedure.

NOTE: Although the Enhanced Warning System (BeltAlert) has been deactivated, the Seat Belt Warning Light will continue to illuminate while the driver's seat belt remains unfastened.

Seat Belts and Pregnant Women

We recommend that pregnant women use the seat belts throughout their pregnancy. Keeping the mother safe is the best way to keep the baby safe.

Pregnant women should wear the lap part of the belt across the thighs and as snug across the hips as possible. Keep the belt low so that it does not come across the abdomen. That way the strong bones of the hips will take the force if there is a collision.

Seat Belt Extender

If a seat belt is too short, even when fully extended and when the adjustable upper shoulder belt anchorage (if equipped) is in its lowest position, your authorized dealer can provide you with a seat belt extender. This extender should be used only if the existing belt is not long enough. When it is not required, remove the extender and store it.

WARNING!

Using a seat belt extender when not needed can increase the risk of injury in a collision. Only use when the lap belt is not long enough when it is worn low and snug, and in the recommended seating positions. Remove and store the extender when not needed.

Driver And Front Passenger Supplemental Restraint Systems (SRS)

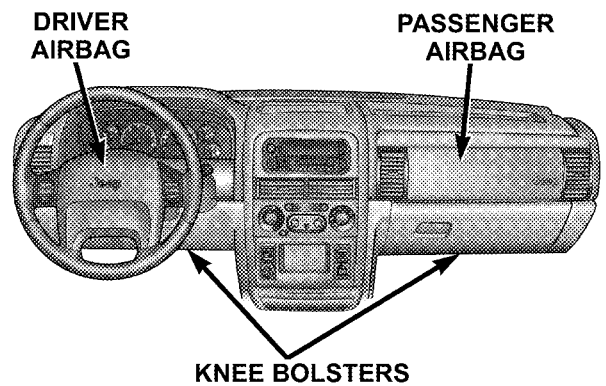

80f44e47

This vehicle has airbags for both the driver and right front passenger as a supplement to the seat belt restraint systems. The driver's front airbag is mounted in the steering wheel. The passenger side airbag is mounted in

36 THINGS TO KNOW BEFORE STARTING YOUR VEHICLE

the instrument panel, above the glove compartment. The words SRS/AIRBAG are embossed on the airbag covers.

NOTE: The front airbags are certified to the Federal regulations that allow less forceful deployment.

The front airbags have a multi stage inflator design. This allows the airbag to have different rates of inflation that are based on collision severity.

This vehicle may also be equipped with window bags to protect the driver, front, and rear passengers sitting next to a window. If the vehicle is equipped with window bags, they are located above the side windows. Their covers are also labeled SRS/AIRBAG.



NOTE: Airbag covers may not be obvious in the interior trim; but they will open to allow airbag deployment.

WARNING!

- **Do not put anything on or around the front airbag covers or attempt to manually open them. You may damage the airbags and you could be injured because the airbags are not there to protect you. These protective covers for the airbag cushions are designed to open only when the airbags are inflating.**
- **If your vehicle is equipped with window bags, do not stack luggage or other cargo up high enough to block the location of the window bag. The area where the window bag is located should remain free from any obstructions.**
- **If your vehicle is equipped with window bags, do not have any accessory items installed which will alter the roof, including adding a sunroof to your vehicle. Do not add roof racks that require permanent attachments (bolts or screws) for installation on the vehicle roof. Do not drill into the roof of the vehicle for any reason.**
- **Do not cover or place items on the airbag covers. These items may cause serious injury during inflation.**

The front airbags have a multi stage inflator design. This allows the airbag to have different rates of inflation that are based on collision severity. Along with the seat belts, front airbags work with the instrument panel knee bolsters to provide improved protection for the driver and front passenger. Window bags also work with seat belts to improve occupant protection.

The seat belts are designed to protect you in many types of collisions. The front airbags deploy in moderate to severe frontal collisions. If your vehicle is so equipped, the window bag on the crash side of the vehicle is triggered in moderate to severe side collisions. In certain types of collisions, both the front and side airbags may be triggered. But even in collisions where the airbags work, you need the seat belts to keep you in the right position for the airbags to protect you properly.

Here are some simple steps you can take to minimize the risk of harm from a deploying airbag.

38 THINGS TO KNOW BEFORE STARTING YOUR VEHICLE

1. Children 12 years and under should always ride buckled up in a rear seat.

Infants in rear facing child restraints should **NEVER** ride in the front seat of a vehicle with a passenger airbag. An airbag deployment could cause severe injury or death to infants in that position.

Children that are not big enough to properly wear the vehicle seat belt should be secured in the rear seat, in a child restraint or belt-positioning booster seat. Older children who do not use child restraints or belt-positioning booster seats should ride properly buckled up in the rear seat. Never allow children to slide the shoulder belt behind them or under their arm.

If a child from 1 to 12 years old must ride in the front passenger seat because the vehicle is crowded, move the seat as far back as possible, and use the proper child restraint. See "Child Restraint" in this section.

You should read the instructions provided with your child restraint to make sure that you are using it properly.

2. All occupants should use their lap and shoulder belts properly.

3. The driver and front passenger seats should be moved back as far as practical to allow the front airbags room to inflate.

4. If your vehicle has window bags, do not lean against the door or window, airbags will inflate forcefully into the space between you and the door.

WARNING!

- Relying on the airbags alone could lead to more severe injuries in a collision. The airbags work with your seat belt to restrain you properly. In some collisions the airbags won't deploy at all. Always wear your seat belts even though you have airbags.
- Being too close to the steering wheel or instrument panel during airbag deployment could cause serious injury. Airbags need room to inflate. Sit back, comfortably extending your arms to reach the steering wheel or instrument panel.
- If the vehicle has window bags, they also need room to inflate. Do not lean against the door or window. Sit upright in the center of the seat.

Airbag System Components

The airbag system consists of the following:

- Airbag Control Module (ACM)
- Airbag Warning Light
- Driver Airbag
- Passenger Airbag
- Window Bags above Side Windows (If Equipped)
- Side Impact Sensors (If Equipped)
- Steering Wheel and Column
- Instrument Panel
- Crash Sensor
- Interconnecting Wiring
- Knee Impact Bolsters

How The Airbag System Works

- The **Airbag Control Module (ACM)** determines if a frontal collision is severe enough to require the airbags to inflate. Based on the level of collision severity, the front control module determines the proper rate of inflation. The front airbag inflators are designed to provide different rates of airbag inflation.
- The ACM, along with the remote side impact sensors detects side impact.
- The ACM will not detect roll over, or rear impacts.
- The ACM monitors the readiness of the electronic parts of the system whenever the ignition switch is in the START or ON positions. These include all of the items listed above except the steering wheel and column and the knee bolsters. If the key is in the OFF position, in the ACC position, or not in the ignition, the airbags are not on and will not inflate.

Also, the ACM turns on the AIRBAG warning light in the instrument panel for 6 to 8 seconds when the ignition is first turned on, then turns the light off. If it detects a malfunction in any part of the system, it turns on the light either momentarily or continuously.

WARNING!

Ignoring the AIRBAG warning light in your instrument panel could mean you won't have the airbags to protect you in a collision. If the light does not come on, stays on after you start the vehicle, or if it comes on as you drive, have the airbag system checked right away.

- The **Driver and Passenger Airbag/Inflator Units** are located in the center of the steering wheel and the right side of the instrument panel. When the ACM detects a collision requiring the airbags, it signals the inflator

units. A large quantity of nontoxic gas is generated to inflate the front airbags. Different airbag inflation rates are possible, these rates are determined by the front airbag control module based on collision severity. The steering wheel hub trim cover and the upper right side of the instrument panel separate and fold out of the way as the bags inflate to their full size. The bags fully inflate in about 30–70 milliseconds. This is about half of the time it takes to blink your eyes. The bags then quickly deflate while helping to restrain the driver and front passenger.

The driver front airbag gas is vented through the airbag material towards the instrument panel. The passenger front airbag gas is vented through the airbag material on the sides of the airbag. In this way, the airbags do not interfere with your control of the vehicle.

- The **Side Impact SRS Window Bags** are designed to activate only in certain side collisions. When the airbag control module (ACM), along with the remote side impact sensors detects a side impact collision requiring the window bags to inflate, it signals the inflators on the crash side of the vehicle. A quantity of nontoxic gas is generated to inflate the window bag. The inflating window bag pushes the outside edge of the headliner out of the way and covers the window. The airbag inflates in about 30 milliseconds (about one quarter of the time it takes to blink your eyes) with enough force to injure you if you are not belted and seated properly, or if items are positioned in the area where the window bag inflates. This especially applies to children. The window bag is only about 3½ inches (9 cm) thick when it is inflated.
- The **Knee Impact Bolsters** help protect the knees of the driver and the front passenger's, and position everyone for the best interaction with the front airbag.

If A Deployment Occurs

The airbag system is designed to deploy the airbags when the impact sensors detect a moderate-to-severe frontal collision, to help restrain the driver and front passenger, and then immediately deflate.

NOTE: A frontal collision that is not severe enough to need airbag protection will not activate the system. This does not mean something is wrong with the airbag system.

If you do have a collision which deploys the airbags, any or all of the following may occur:

- The nylon airbag material may sometimes cause abrasions and/or skin reddening to the driver and front passenger as the airbags deploy and unfold. The abrasions are similar to friction rope burns or those you might get sliding along a carpet or gymnasium floor. They are not caused by contact with chemicals. They are not permanent and normally heal quickly.

However, if you haven't healed significantly within a few days, or if you have any blistering, see your doctor immediately.

- As the airbags deflate you may see some smoke-like particles. The particles are a normal by-product of the process that generates the nontoxic gas used for airbag inflation. These airborne particles may irritate the skin, eyes, nose, or throat. If you have skin or eye irritation, rinse the area with cool water. For nose or throat irritation, move to fresh air. If the irritation continues, see your doctor. If these particles settle on your clothing, follow the garment manufacturer's instructions for cleaning.
- It is not advisable to drive your vehicle after the airbags have deployed. If you are involved in another collision, the airbags will not be in place to protect you.

WARNING!

Deployed airbags can't protect you in another collision. Have the airbags replaced by an authorized dealer as soon as possible.

Maintaining Your Airbag System**WARNING!**

- Modifications to any part of the airbag system could cause it to fail when you need it. You could be injured if the airbag system is not there to protect you. Do not modify the components or wiring, including adding any kind of badges or stickers to the steering wheel hub trim cover or the upper right side of the instrument panel. Do not modify the front bumper or vehicle body structure.
- You need proper knee impact protection in a collision. Do not mount or locate any aftermarket equipment on or behind the knee bolsters.
- It is dangerous to try to repair any part of the airbag system yourself. Be sure to tell anyone who works on your vehicle that it has an airbag system.

Airbag Warning Light

You will want to have the airbag system ready to inflate for your protection in an impact. The airbag system is designed to be maintenance free. If any of the following occurs, have an authorized dealer service the system promptly:

- Does not come on during the 6 to 8 seconds after the ignition switch is first turned on.
- Remains on after the 6 to 8 second interval.
- Comes on for any period of time while driving.

Child Restraint

Everyone in your vehicle needs to be buckled up all the time — babies and children, too. Every state in the United States and all Canadian provinces require that small children ride in proper restraint systems. This is the law, and you can be prosecuted for ignoring it.

Children 12 years and under should ride properly buckled up in a rear seat, if available. According to crash statistics, children are safer when properly restrained in the rear seats rather than in the front.

WARNING!

In a collision, an unrestrained child, even a tiny baby, can become a missile inside the vehicle. The force required to hold even an infant on your lap can become so great that you could not hold the child, no matter how strong you are. The child and others could be badly injured. Any child riding in your vehicle should be in a proper restraint for the child's size.

Infants and Small Children

There are different sizes and types of restraints for children from newborn size to the child almost large

enough for an adult seat belt. Always check the child seat owner's manual to ensure you have the right seat for your child. Use the restraint that is correct for your child:

- The rearward-facing infant restraint is for babies weighing up to about 20 lbs (9 kg), and one year old or more. The infant restraint must **NEVER** be used in the front seat of a vehicle with a passenger side airbag unless the airbag is turned off. An airbag deployment could cause severe injury or death to infants in this position. The infant restraint is held in the vehicle by the lap belt, lap/shoulder belt, or the LATCH child restraint anchorage system. Refer to "Lower Anchors and Tether for CHildren (LATCH)" in this section.
- Children under one year of age should continue to ride in a rear-facing infant seat, even if they weigh more than 20 lbs (9 kg). A "convertible" child seat, one that is designed to be used either rearward-facing or forward-facing, should be used for children who are too heavy for the infant carrier, but who are too young to face forward in the vehicle.
- The forward-facing child seat is for children from about 20 lbs (9 kg) to 40 lbs (18 kg), and more than one year old. The child seat is held in the vehicle by the lap belt, lap/shoulder belt, or the LATCH child restraint anchorage system. Refer to "Lower Anchors and Tether for CHildren (LATCH)" in this section.
- The belt-positioning booster seat is for children weighing more than 40 lbs (18 kg). If the child cannot sit with knees bent over the seat cushion while the child's back is against the seat back, they should use a belt-positioning booster seat. The child and booster seat are held in the vehicle by the lap/shoulder belt. (Some booster seats are equipped with a front shield and are held in the vehicle by the lap portion or lap belt.)

- For additional information, refer to www.seatcheck.org.

WARNING!

- **Improper installation can lead to failure of an infant or child restraint. It could come loose in a collision. The child could be badly injured or killed. Follow the manufacturer's directions exactly when installing an infant or child restraint.**
- **A rearward facing infant restraint should only be used in a rear seat. A rearward facing infant restraint in the front seat may be struck by a deploying passenger airbag which may cause severe or fatal injury to the infant.**

Here are some tips for getting the most out of your child restraint:

- Before buying any restraint system, make sure that it has a label certifying that it meets all applicable Safety Standards. The manufacturer also recommends that you try a child restraint in the vehicle seats where you will use it before you buy it.
- The restraint must be appropriate for your child's weight and height. Check the label on the restraint for weight and height limits.
- Carefully follow the instructions that come with the restraint. If you install the restraint improperly, it may not work when you need it.

- The passenger seat belts are equipped with cinching latch plates, which are designed to keep the latch portion tight around the child restraint so that it is not necessary to use a locking clip. Pulling up on the shoulder portion of the lap/shoulder belt will tighten the belt. The cinching latch plate will keep the belt tight, however, any seat belt system will loosen with time, so check the belt occasionally and pull it tight if necessary.
- In the rear seat, you may have trouble tightening the lap/shoulder belt on the child restraint because the buckle or latch plate is too close to the belt path opening on the restraint. Disconnect the latch plate from the buckle and twist the short buckle-end belt several times to shorten it. Insert the latch plate into the buckle with the release button facing out.
- If the belt still cannot be tightened, or if pulling and pushing on the restraint loosens the belt, disconnect the latch plate from the buckle, turn the buckle around, and insert the latch plate into the buckle again. If you still cannot make the child restraint secure, try a different seating position.
- Buckle the child into the restraint exactly as the manufacturer's instructions tell you.
- When your child restraint is not in use, secure it in the vehicle with the seat belt or remove it from the vehicle. Do not leave it loose in the vehicle. In a sudden stop or collision, it could strike the occupants or seat backs and cause serious personal injury.

Lower Anchors and Tethers for Children (LATCH)
Your vehicle is equipped with the child restraint anchor-age system called LATCH, which stands for Lower

48 THINGS TO KNOW BEFORE STARTING YOUR VEHICLE

Anchors and Tethers for CHildren. The LATCH system provides for the installation of the child restraint without using the vehicle seat belt. The two rear outboard seating positions have exclusive lower anchorages located at the rear of the seat cushion. They are round bars, part of the seat and body structure, and are readily visible.

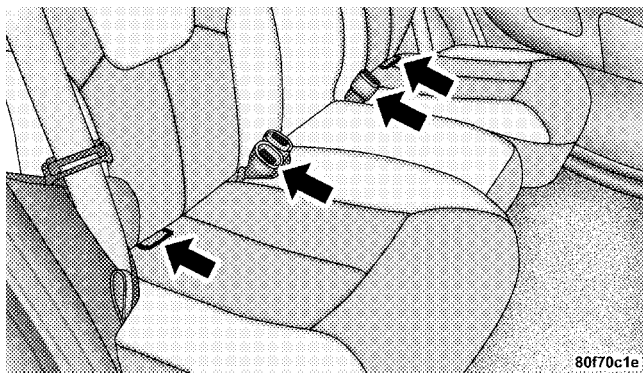

In addition, there are tether anchors above the rear liftgate opening behind each rear outboard seat. The anchors are covered by hinged plastic caps.

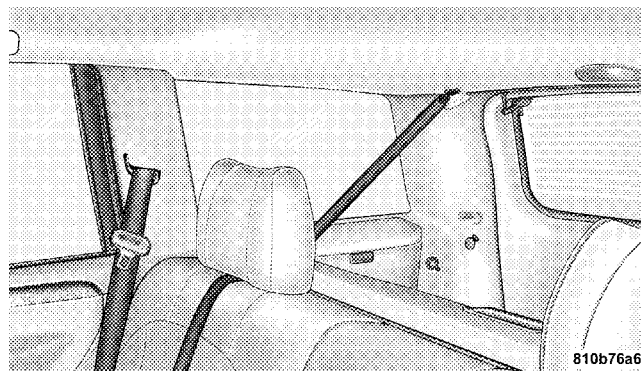

To attach a child restraint tether strap hook, pull down on the cover of the anchor directly behind the seat where you are placing the child restraint. Raise the head restraint and route the tether strap under the head restraint

and between the two posts. Attach the tether strap hook to the anchor loop. Install the child restraint according to the manufacturer's instructions, and tighten the vehicle seat belt. Remove the slack from the tether strap according to the manufacturer's instructions.

Child restraints systems having attachments designed to connect to the lower anchorages are now available. Child restraints having tether straps and hooks for connection to the top tether anchorage have been available for some time. In fact, many child restraint manufacturers will provide add-on tether strap kits for some of their older products. Tether anchorage kits are also available for most older vehicles.

NOTE: If your child restraint is not LATCH compatible, install the restraint using the vehicle seat belts.

Because the lower anchorages are to be introduced to passenger carrying vehicles over a period of years, child restraint systems having attachments for those anchorages will continue to have features for installation in

vehicles using the lap or lap/shoulder belt. They will also have tether straps, and you are urged to take advantage of all of the available attachments provided with your child restraint in any vehicle.

Installing the Child Restraint System

There are LATCH anchorages at the two rear outboard seating positions and tether strap anchorages above the rear liftgate opening behind each rear outboard seat.

We urge that you carefully follow the directions of the manufacturer when installing your child restraint. Many, but not all, restraint systems will be equipped with separate straps on each side, with each having a hook or connector and a means for adjusting the tension in the strap. Forward-facing toddler restraints and some rearward-facing infant restraints will also be equipped with a tether strap with a hook and means for adjusting the tension in the strap.

In general, you will first loosen the adjusters on the lower and tether straps so that you can more easily attach the hook or connector to the lower and tether anchorages. The tether strap should be routed under the center of the head restraint and attached to the tether anchor above the rear liftgate opening behind each rear outboard seat. Then tighten all three straps as you push the child restraint rearward and downward into the seat.

Not all child restraint systems will be installed as we have described here. Again, carefully follow the instructions that come with the child restraint system.

WARNING!

Improper installation of a child restraint to the LATCH anchorages can lead to failure of an infant or child restraint. The child could be badly injured or killed. Follow the manufacturer's directions exactly when installing an infant or child restraint.

Children Too Large for Booster Seats

Children who are large enough to wear the shoulder belt comfortably, and whose legs are long enough to bend over the front of the seat when their back is against the seat back should use the lap/shoulder belt in a rear seat.

- Make sure that the child is upright in the seat.
- The lap portion should be low on the hips and as snug as possible.
- Check belt fit periodically. A child's squirming or slouching can move the belt out of position.
- If the shoulder belt contacts the face or neck, move the child closer to the center of the vehicle. If this doesn't help, move the child to the center rear seating position and use the lap belt. Never allow a child to put the shoulder belt under an arm or behind their back.

ENGINE BREAK-IN RECOMMENDATIONS

A long break-in period is not required for the engine in your new vehicle.

Drive moderately during the first 300 miles (500 km). After the initial 60 miles (100 km), speeds up to 50 or 55 mph (80 or 90 km/h) are desirable.

While cruising, brief full-throttle acceleration, within the limits of local traffic laws, contributes to a good break-in. Wide open throttle acceleration in low gear can be detrimental and should be avoided.

The engine oil installed in the engine at the factory is a high quality energy conserving type lubricant. Oil changes should be consistent with anticipated climate conditions under which vehicle operations will occur. The recommended viscosity and quality grades are shown in Section 7 of this manual. **NON-DETERGENT OR STRAIGHT MINERAL OILS MUST NEVER BE USED.**

A new engine may consume some oil during its first few thousand miles (kilometers) of operation. This should be considered as a normal part of the break-in and not interpreted as an indication of difficulty.

SAFETY TIPS**Exhaust Gas****WARNING!**

Exhaust gases can injure or kill. They contain carbon monoxide (CO) which is colorless and odorless. Breathing it can make you unconscious and can eventually poison you. To avoid breathing (CO) follow the safety tips below.

- Do not inhale exhaust gases. They contain carbon monoxide, a colorless and odorless gas which can kill. Never run the engine in a closed area, such as a

garage, and never sit in a parked vehicle with the engine running for an extended period. If the vehicle is stopped in an open area with engine running for more than a short period, adjust the ventilation system to force fresh, outside air into the vehicle.

- Guard against carbon monoxide with proper maintenance. Have the exhaust system inspected every time the vehicle is raised. Have any abnormal conditions repaired promptly. Until repaired, drive with all side windows fully open.
- Always run the climate control in panel or floor mode when driving with any windows open, even if only slightly, to help keep fresh air circulating inside vehicle. Otherwise poisonous gases could be drawn into the vehicle.

Safety Checks You Should Make Inside The Vehicle

Seat Belts

Inspect the belt system periodically, checking for cuts, frays and loose parts. Damaged parts must be replaced immediately. Do not disassemble or modify the system.

Seat belt assemblies must be replaced after an accident if they have been damaged (bent retractor, torn webbing, etc.). If there is any question regarding belt or retractor condition, replace the belt.

Airbag Warning Light

The light should come on and remain on for 6 to 8 seconds as a bulb check when the ignition switch is first turned on. If the bulb is not lit during starting, have it replaced. If the light stays on or comes on while driving, have the system checked by an authorized dealer.

Defrosters

Check operation by selecting the defrost mode and place the blower control on high speed. You should feel the air directed against the windshield.

Safety Checks You Should Make Outside The Vehicle**Tires**

Examine tires for excessive tread wear or uneven wear patterns. Check for stones, nails, glass, or other objects lodged in the tread. Inspect for tread cuts or sidewall cracks. Check wheel nuts for tightness and tires (including spare) for proper pressure.

Lights

Have someone observe the operation of all exterior lights while you work the controls. Check turn signal and high beam indicator lights on the instrument panel.

Fluid Leaks

Check area under vehicle after overnight parking for fuel, coolant, oil or other fluid leaks. Also, if gasoline fumes are detected, the cause should be located and corrected immediately.

UNDERSTANDING THE FEATURES OF YOUR VEHICLE

CONTENTS

■ Mirrors59	■ Seats63
□ Inside Day/Night Mirror59	□ Front Manual Seat Adjustment63
□ Inside Automatic Dimming Mirror — If Equipped60	□ Front Seat Adjustment — Recline63
□ Exterior Mirrors Folding Feature61	□ Head Restraints64
□ Outside Mirrors61	□ Power Seat Adjuster — If Equipped65
□ Heated Remote Control Mirrors — If Equipped61	□ Memory System — If Equipped68
□ Power Remote Control Outside Mirrors61	□ Heated Seats — If Equipped71
□ Lighted Vanity Mirrors — If Equipped62	□ 60/40 Split Rear Seat71
		■ To Open And Close The Hood74

56 UNDERSTANDING THE FEATURES OF YOUR VEHICLE

■ Lights	75	□ Headlight Dimmer Switch	79
□ Interior Lighting	75	□ Passing Light	79
□ Front Map/Reading Lights	75	□ Headlight Time Delay	80
□ Multi-Function Control Lever	76	■ Windshield Wipers And Washers	80
□ Battery Saver Feature—Exterior/Interior Lights	76	□ Mist	81
□ Headlights And Parking Lights	77	□ Speed Sensitive Intermittent Wiper System	81
□ Automatic Headlight System — If Equipped	77	□ Rain Sensitive Wiper System — If Equipped	82
□ Instrument Panel And Interior Lights	78	■ Tilt Steering Column	84
□ Daytime Running Lights — Canada Only	78	■ Adjustable Pedals — If Equipped	84
□ Lights-On Reminder	78	■ Electronic Speed Control	86
□ Fog Lights — If Equipped	79	□ To Activate	86
□ Turn Signals	79	□ To Set At a Desired Speed	86
		□ To Deactivate	86

<hr/>		UNDERSTANDING THE FEATURES OF YOUR VEHICLE	57
<input type="checkbox"/> To Resume Speed	<input type="checkbox"/> When Your Vehicle Is New 107
<input type="checkbox"/> To Vary The Speed Setting	<input type="checkbox"/> Programming Homelink 108
<input type="checkbox"/> To Accelerate For Passing	<input type="checkbox"/> Gate Operator/Canadian Programming 111
<input type="checkbox"/> Driving Up Or Down Hills	<input type="checkbox"/> Using Homelink 111
■ Overhead Console	■ Power Sunroof — If Equipped 112
<input type="checkbox"/> Dome/Reading Lights	<input type="checkbox"/> Express Open Mode 112
<input type="checkbox"/> Electronic Vehicle Information Center	<input type="checkbox"/> Manual Open Mode 112
<input type="checkbox"/> Tire Pressure Monitor System — If Equipped	<input type="checkbox"/> Closing Operation 113
<input type="checkbox"/> General Information	<input type="checkbox"/> Vent Operation 113
<input type="checkbox"/> Customer Programmable Features	<input type="checkbox"/> Ignition Off Operation 113
<input type="checkbox"/> Compass/Temperature/Trip Computer	<input type="checkbox"/> Sunshade Operation 114
<input type="checkbox"/> Trip Computer	<input type="checkbox"/> Maintenance 114
■ Garage Door Opener — If Equipped	■ Power Outlet 115

58 UNDERSTANDING THE FEATURES OF YOUR VEHICLE

■ Glove Compartment	116	□ Retractable Cargo Area Cover — If Equipped	118
■ Cup Holders	116	□ Cargo Tie-Down Hooks	119
■ Cargo Area Features	118	■ Roof Luggage Rack	121
□ Cargo Light	118		

MIRRORS

Inside Day/Night Mirror

The mirror should be adjusted to center on the view through the rear window. A two-point pivot system allows for horizontal and vertical adjustment of the mirror. The mirror should be adjusted while set in the day position (toward windshield).

Annoying headlight glare from vehicles behind you can be reduced by moving the small control under the mirror to the night position (toward rear of vehicle).

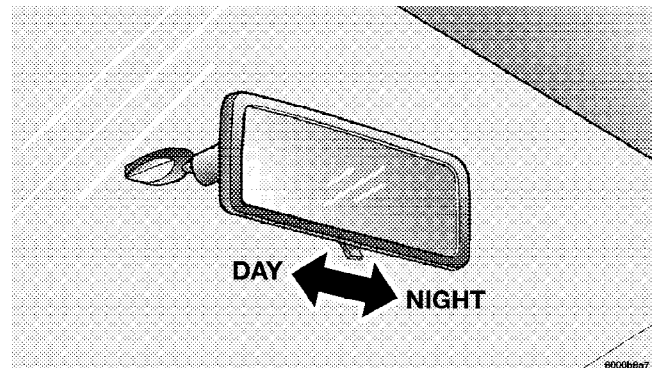

Inside Automatic Dimming Mirror — If Equipped

This mirror automatically adjusts for annoying headlight glare from vehicles behind you. You can turn the feature on or off by pressing the button at the base of the mirror. A light in the button will indicate when the dimming feature is activated.

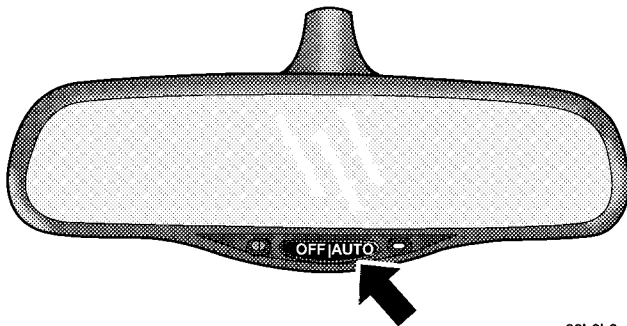

80b6b3a6

CAUTION!

To avoid damage to the mirror during cleaning, never spray any cleaning solution directly onto the mirror. Apply the solution onto a clean cloth and wipe the mirror clean.

Driver's Outside Automatic Dimming Mirror — If Equipped

If your vehicle is equipped with a driver's outside automatic dimming mirror, it operates when the inside automatic dimming mirror is on. This outside mirror operates off the inside mirror switch and will automatically adjust for annoying headlight glare when the inside mirror does.

NOTE: The passenger outside mirror does not have this dimming feature.

Exterior Mirrors Folding Feature

All exterior mirrors are hinged and may be moved either forward or rearward to resist damage. The hinges have three detent positions; full forward, full rearward, and normal.

Outside Mirrors

To receive maximum benefit, adjust the outside mirrors to center on the adjacent lane of traffic with a slight overlap of the view obtained on the inside mirror.

WARNING!

Vehicles and other objects seen in the right side convex mirror will look smaller and farther away than they really are. Relying too much on your right side mirror could cause you to collide with another vehicle or other objects. Use your inside mirror when judging the size or distance of a vehicle seen in the right side mirror.

Heated Remote Control Mirrors — If Equipped

 These mirrors are heated to melt frost or ice. This feature is activated whenever you turn on the rear window defrost.

Power Remote Control Outside Mirrors

The controls for the power mirrors are located on the driver's door trim panel above the window switches.

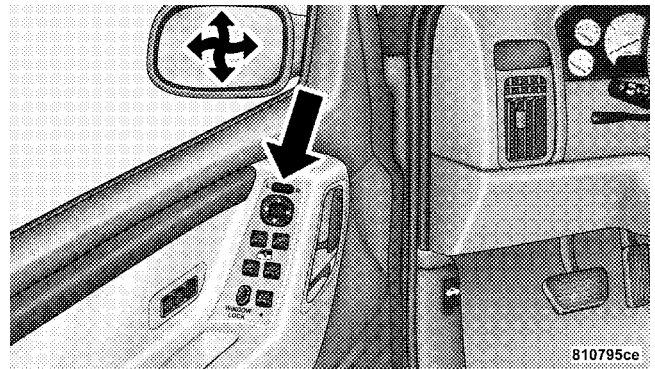

62 UNDERSTANDING THE FEATURES OF YOUR VEHICLE

Set the top switch to the left or right for the left or right mirror, and set it to the center off position to prevent accidentally moving a mirror when you are finished adjusting the mirror. To adjust a mirror, select left or right with the top switch, and press one of the four arrows for the direction you want the mirror to move.

Lighted Vanity Mirrors — If Equipped

To access a lighted vanity mirror, flip down one of the visors.

Lift the cover to reveal the mirror. The light will turn on automatically. Sliding the button up or down will vary the intensity of the light.

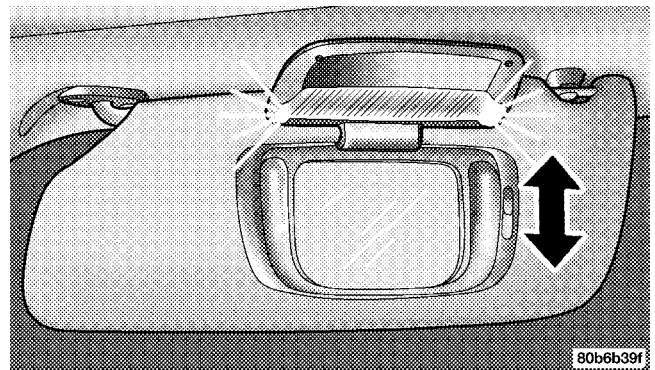

SEATS**WARNING!**

Adjusting a seat while the vehicle is moving is dangerous. The sudden movement of the seat could cause you to lose control. The seat belt might not be properly adjusted and you could be injured. Adjust any seat only while the vehicle is parked.

Front Manual Seat Adjustment

Move the seat forward or rearward using the adjustment bar. Lift up on the bar located on the front of the seat near the floor. Position the seat and be sure the latch engages fully.

Front Seat Adjustment — Recline

To adjust the seatback, lift the lever located on the outboard side of the seat, lean back, and release the lever at the desired position. To return the seatback, lift the lever, lean forward, and release the lever.

WARNING!

Do not ride with the seatback reclined so that the seat belt is no longer resting against your chest. In a collision you could slide under the seat belt and be seriously or even fatally injured. Use the recliner only when the vehicle is parked.

WARNING!

- It is extremely dangerous to ride in a cargo area, inside or outside of a vehicle. In a collision, people riding in these areas are more likely to be seriously injured or killed.
- Do not allow people to ride in any area of your vehicle that is not equipped with seats and seat belts.
- Be sure everyone in your vehicle is in a seat and using a seat belt properly.

Head Restraints

Head restraints can reduce the risk of whiplash injury in the event of impact from the rear. Adjustable head restraints should be adjusted so that the upper edge is as high as practical. The head restraints have a locking button which must be pushed in to lower the head

restraint to all positions, except the full-down position. To lower the head restraint to the full-down position, the button does not have to be pushed in. The restraints may be raised without pushing in the button.

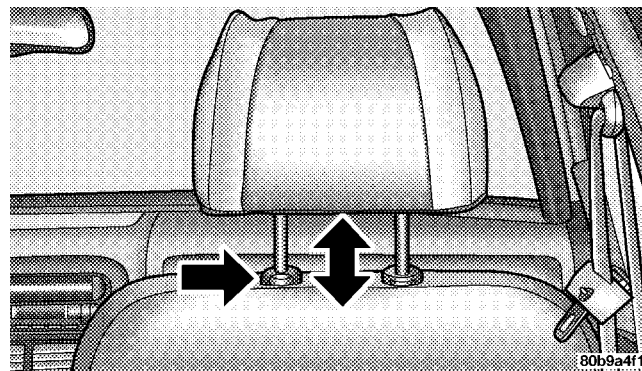

Power Seat Adjuster — If Equipped**WARNING!**

Do not ride with the seatback reclined so that the shoulder belt is no longer resting against your chest. In a collision you could slide under the seat belt and be seriously injured or even fatally injured. Use the recliner only when the vehicle is parked.

The power seat adjuster switches are located on the outboard side of the seat.

6-Way Power Seat with Manual Recliner — If Equipped

This seat switch is on the outboard side of the seat near the floor. Use this switch to move the seat up or down, forward or rearward, or to tilt the seat.

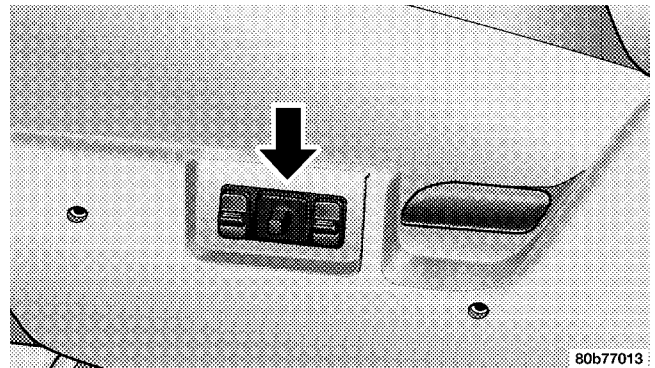

3

80b77013

This seat also has a manual recline lever located just to the rear of the power seat switch. Pull up on the lever to recline the seat.

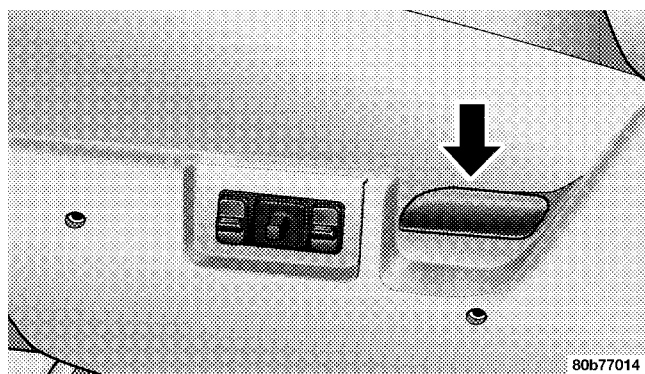

10-Way Power Seat with Power Recliner and Power Lumbar — If Equipped

These seat switches are located on the outboard side of the seat near the floor. Use these switches to move the seat up or down, forward or rearward, to tilt the seat, to recline the seat, or to increase/decrease the amount of lumbar support.

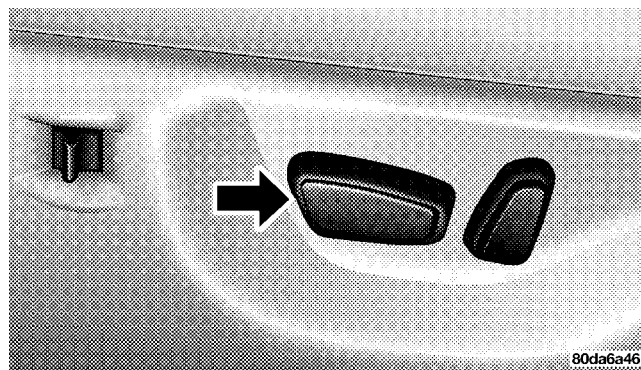

CAUTION!

Do not put anything under a power seat. It may cause damage to the seat controls.

Power Lumbar

The power lumbar control is located on the outboard side of the seat. Use this switch to increase or decrease the desired amount of lumbar support.

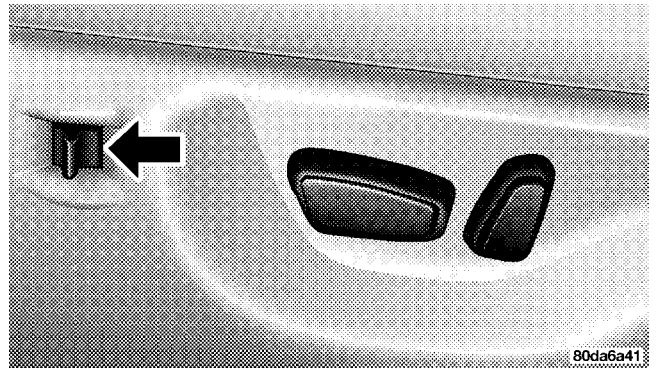

Power Reclining Seat

The recliner control is on the outboard side of the seat. Use this switch to recline the seatback and to return the seatback to the upright position.

WARNING!

Do not ride with the seatback reclined so that the seat belt is no longer resting against your chest. In a collision you could slide under the seat belt and be seriously or even fatally injured. Use the recliner only when the vehicle is parked.

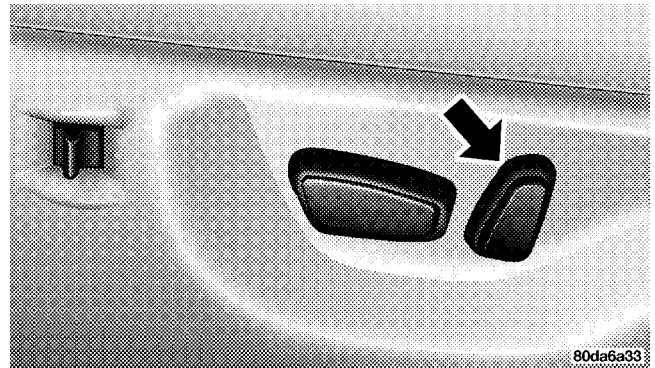

Memory System — If Equipped

If your vehicle is equipped with this system, your Remote Keyless Entry Transmitter or Memory System Buttons on the driver's door panel can be used to recall the driver's seat, driver's outside rear view mirror, and radio station presets to saved positions.

The Memory Position Buttons located on the driver's door will always recall stored settings. The Remote Keyless Entry Transmitters can be programmed to recall positions when the "Unlock" button is pressed. For customer programmable features refer to the section on "Overhead Console" for programming details, otherwise see your authorized dealer.

NOTE: The vehicle must be in P (Park), and the seat belt cannot be latched if the ignition is in the ON position, to recall memory positions.

Your vehicle was delivered to you with two remote keyless entry transmitters. They are color coded to match the memory buttons on the driver's door. These transmitters work in conjunction with the number "1" (black) and number "2" (gray) memory seat buttons on the driver's door. Once the memory button has been set, the corresponding remote keyless entry transmitter is also set.

NOTE: If the memory system is not set to your desired positions, the seat and driver's mirror will default to the factory setting each time the Keyless Entry Transmitter is used.

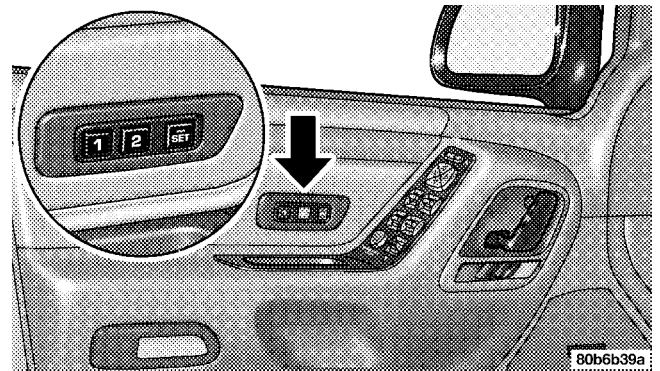

3

To set the memory buttons follow this procedure:

1. Turn the ignition key to the ON position.

2. Press the memory button "1" if you are setting the memory for driver one or number "2" if you are setting the memory for driver two.
3. Adjust the seat, recliner, and driver's outside rear view mirrors to the desired position.
4. Set the radio station presets as you desire (up to 10 AM and 10 FM station settings).
5. Press and release the SET button. An indicator light on the set switch will flash, telling you that you are in the set memory mode.

6. Press and release button number "1" or number "2" on the driver's door, depending on which transmitter you're using. The flashing indicator light on the set switch will go out telling you that the driver memory has been set.

If your remote keyless entry transmitter is lost, you may order a new transmitter from your local authorized dealer. You must designate transmitter #1 or #2. Your authorized dealer will have to program your vehicle to match the new transmitter.

Heated Seats — If Equipped

This feature heats the driver's and passenger's front seats. The controls for the heated seats are located on the instrument panel below the heater/air conditioning controls. After turning on the ignition you can choose from HI, OFF, or LO heat settings.

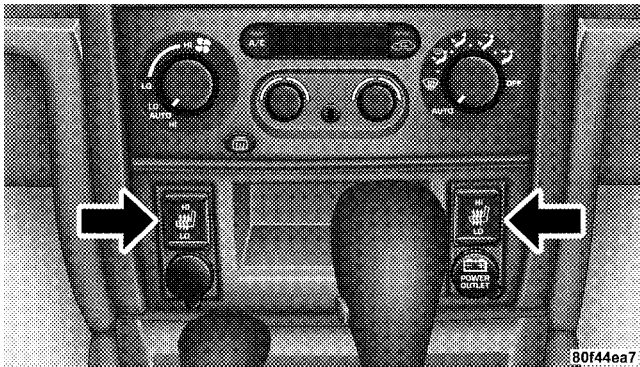

An indicator on the switch shows which setting has been selected. To turn off the heated seats, position the switch in the middle.

60/40 Split Rear Seat

Either side of the rear seat can be folded flat to allow for extended cargo space and still maintain some rear seating room.

NOTE: Be sure that the front seats are fully upright and positioned forward. This will allow the rear seatback to fold down easily.

To fold the 60/40 rear seat perform the following steps:

1. Use the pull straps available on each seat cushion section; pull the strap forward and pivot the cushion forward flush with the front seatback.

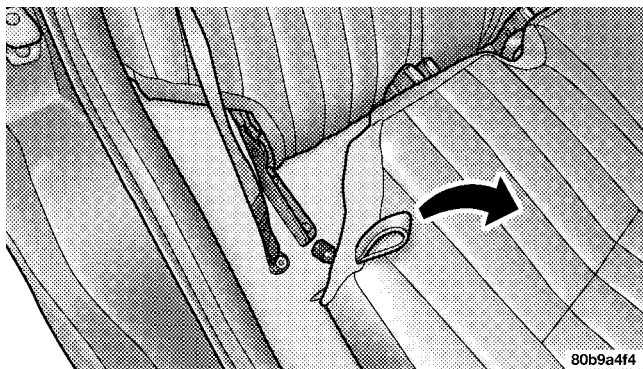

2. Remove the headrests from the rear seatback. Press the button and pull the headrest from the seatback.

The headrest posts can be fitted into the openings provided in the folded seat cushion for storage.

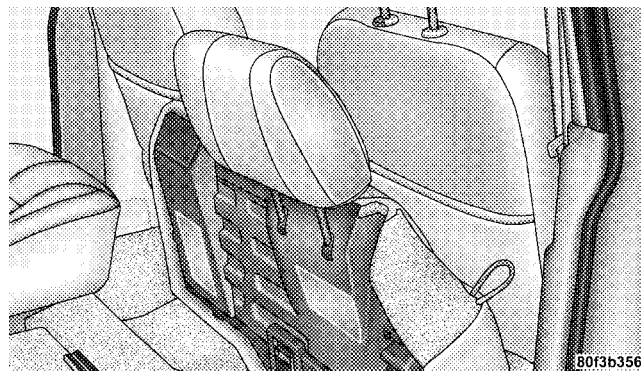

3. Locate the seatback release handle on the outboard top side of each rear seatback; lift up on the handle, and rotate the lever forward until the seatback releases. Fold the seatback completely forward.

NOTE: When lifting up on the release handle, the seatback will release easier if you do not pull forward on the seatback; only lift up on the release handle until the seatback disengages, then fold the seat forward.

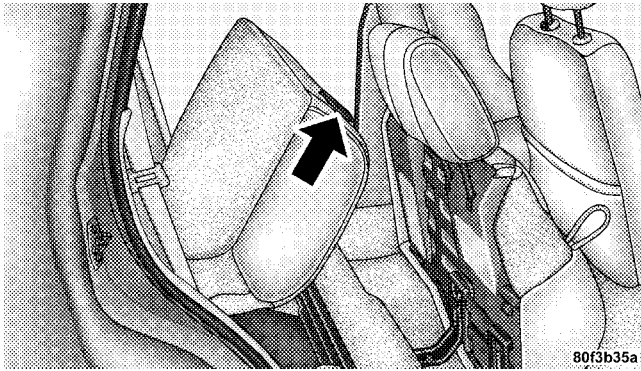

To restore the 60/40 rear seat to the upright position perform the following steps:

Raise the seatback and lock it into place. If interference from the cargo area prevents the seatback from fully locking, you will have difficulty returning the seat cushion to its proper position. Remove the headrests from the cushion panel storage position and reinstall into the rear seat back.

3

WARNING!

Be certain that the seatback is securely locked into position. If the seatback is not securely locked into position the seat will not provide the proper stability for child seats and/or passengers. An improperly latched seat could cause serious injury.

Rotate the seat cushion rearward until it is latched into place.

TO OPEN AND CLOSE THE HOOD

To open the hood, pull the release lever inside your vehicle located below the instrument panel and in front of the driver's door.

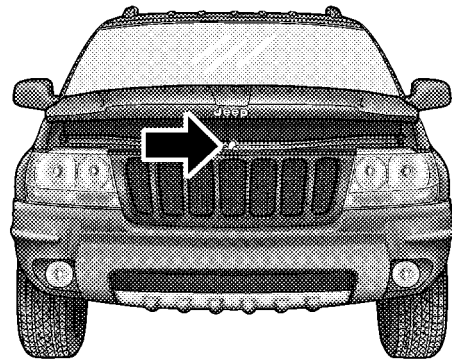
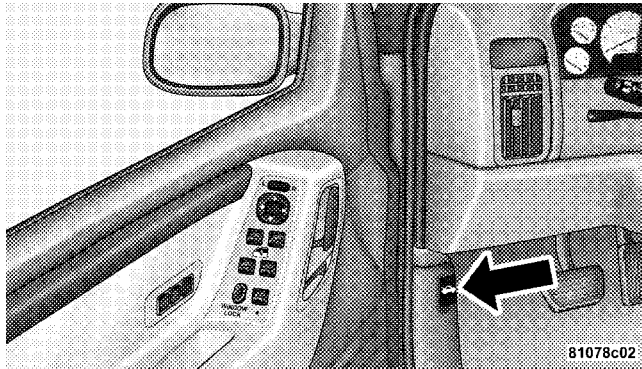

Then reach under the hood and pull upward on the safety latch and lift the hood. To prevent possible damage, do not slam the hood to close it. Use a firm downward push at the center of the hood to ensure that both latches engage.

WARNING!

If the hood is not fully latched, it could fly up when the vehicle is moving and block your forward vision. Be sure all hood latches are fully latched before driving.

LIGHTS**Interior Lighting**

The interior lighting consists of courtesy lights mounted below the instrument panel, an overhead console light assembly which contains both driver and passenger reading lights, reading lights located above the rear doors, and a rear cargo light. Opening a door or turning the center of the multi-function control lever to the extreme up position will activate all interior courtesy lights.

Front Map/Reading Lights

These lights are mounted in the overhead console. Each light can be turned on by pressing the recessed area of the lens. To turn these lights off, press the recessed area of the lens a second time. There are also reading lights located above the rear doors. Each light can be turned on by pressing the front recessed area of the lens. To turn these lights off, press the recessed area of the lens a second time.

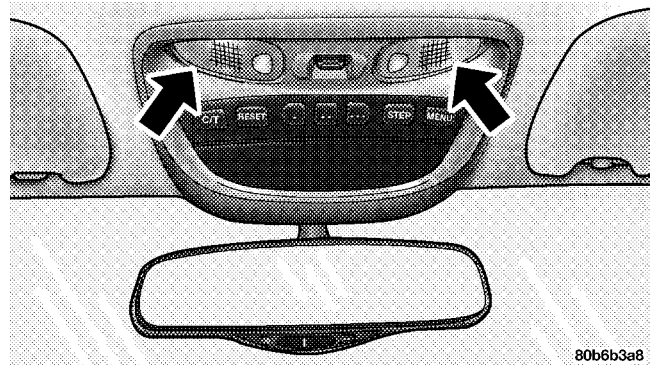

Multi-Function Control Lever

The multi-function control lever controls the operation of the headlights, turn signals, headlight beam selection, instrument panel light dimming, passing light, interior courtesy/dome lights, and optional fog lights.

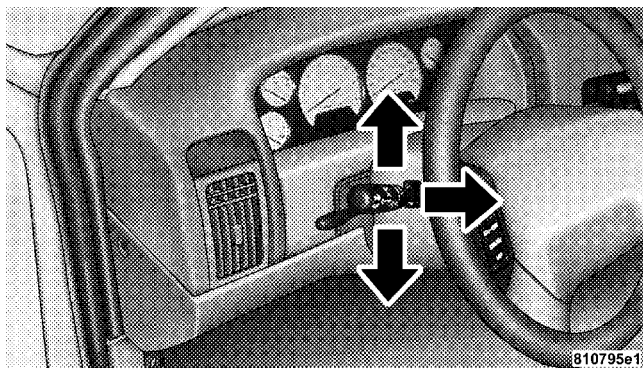

Battery Saver Feature—Exterior/Interior Lights

If the multi-function control lever is left in the interior light position, parking light position, or the headlight position when the ignition switch is moved to the OFF position, the battery saver feature will automatically turn off the exterior and interior lights after eight minutes. Normal operation will resume when the ignition is turned ON or when the headlight switch is turned to another position.

Headlights and Parking Lights

Turn the end of the multi-function control lever to the first detent for parking light operation. Turn to the second detent for headlight operation. Turn to the third detent for "Auto" headlights operation (if equipped).

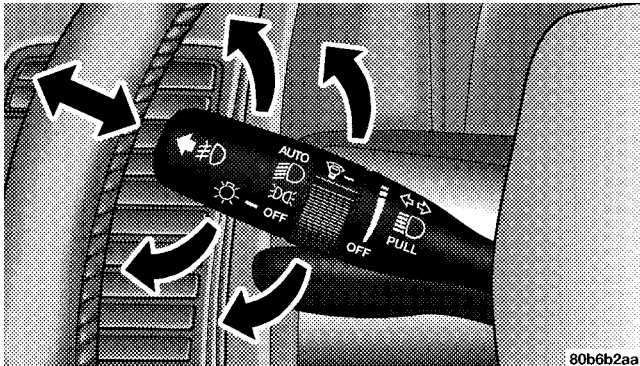

80b6b2aa

Automatic Headlight System — If Equipped

Turn the end of the multi-function control lever to the third detent to activate the automatic headlight system.

This system performs two functions. With the engine running and the multi-function control lever in the AUTO position, the headlights will turn on and off based on the surrounding light levels.

Headlights On Automatically With Wipers

If your vehicle is equipped with Automatic Headlights it also has this customer programmable feature. When your headlights are in the automatic mode they will automatically turn on when the wiper system is on.

If your vehicle is equipped with a "Rain Sensitive Wiper System," and it is activated, the headlights will automatically turn on after the wipers complete three wipe cycles within approximately thirty seconds, and they will turn off approximately three minutes after the wipers completely stop. Refer to "Overhead Console" in this section

to turn this feature on or off. Also, refer to “Windshield Wipers and Washers” in this section for more information

NOTE: When your headlights come on during the daytime, the instrument panel lights will automatically dim to the lower nighttime intensity. Refer to “Instrument Panel and Interior Lights” below for setting the instrument panel lights to full daytime intensity.

Instrument Panel and Interior Lights

When the multi-function control lever is in the parklight, headlights, or AUTO position (if equipped), rotating the center portion of the lever up and down will increase and decrease the brightness (dimmer control) of the instrument panel lights. Full daytime brightness on all electronic displays (odometer, overhead console, radio, and Automatic Climate Control (if equipped)) is obtained by rotating the center portion of the control to the first detent above the dimmer range. Rotating the control to the second detent above the dimmer range turns the

interior lights on. Rotating the control to the “Off” (extreme bottom) position disables all the interior lights, even when the doors and liftgate are open. While in the “Off” position the instrument panel lighting is at the lowest light level and may not be suitable for night driving.

Daytime Running Lights — Canada Only

The headlights come on at a low intensity level whenever the engine is running. The lights remain on until the ignition switch is turned OFF or the parking brake is engaged. The headlight switch must be used for normal night time driving.

Lights-On Reminder

If the headlights or parking lights are on after the ignition is turned OFF, a chime will sound when the driver’s door is opened.

Fog Lights — If Equipped

#0 The fog light switch is located in the multi-function control lever. To activate the fog lights, turn on the park/turn lights, low beam headlights, or AUTO headlights and pull out the end of the multi-function control lever. A light in the instrument cluster shows when the fog lights are on.

NOTE: Turning on the high beam headlights turns off the fog lights.

A front fog light is a lighting device providing illumination forward of the vehicle under conditions of fog, rain, snow, or dust. Principally, the front fog light supplements the lower beam of a standard headlight system.

NOTE: Proper aim and adjustments of the front fog lights should be made to prevent excessive glare for other drivers.

Turn Signals

Move the multi-function control lever up or down and the arrows on each side of the instrument cluster will flash to show proper operation of the front and rear turn signal lights. You can signal a lane change by moving the lever partially up or down.

Headlight Dimmer Switch

Pull the multi-function control lever towards you to switch the headlights to “High” beam. The “High Beam Indicator Light” on the instrument cluster will illuminate. Pull the multi-function control lever a second time to switch the headlights to “Low” beam.

Passing Light

You can signal another vehicle with your headlights by lightly pulling the multi-function control lever toward the steering wheel. This will cause the headlights to turn on at high beam and remain on until the lever is released.

Headlight Time Delay

There is also a feature that delays turning off the vehicle lights for 30, 60, or 90 seconds after the ignition switch is turned OFF. To activate the headlight delay, the multi-function control lever must be rotated to the "Off" position after the ignition switch is turned OFF. Only the headlights will illuminate during this time. See "Overhead Console" in this section to turn this feature "On/Off" or set the time interval.

WINDSHIELD WIPERS AND WASHERS

The front and rear wipers and washers are operated by a switch in the right side control lever. Turn the end of the control lever to select "Lo," "Hi," or one of the five speed sensitive intermittent windshield wiper speeds. Refer to "Speed Sensitive Intermittent Wiper System" in this section. For information on the rear wiper and washer refer to "Rear Window Features" in this section.

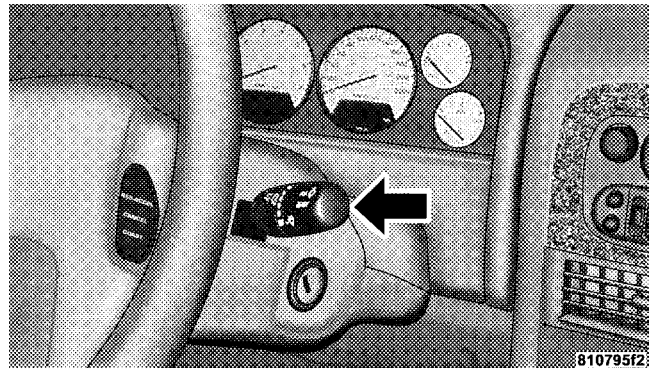

NOTE: Always remove any build-up of snow that prevents the windshield wiper blades from returning to the OFF position. If the windshield wiper switch is turned off and the blades cannot return to the OFF position, damage to the wiper motor may occur.

To use the washer, pull the lever toward you and hold while spray is desired. If the lever is pulled while in the

delay range, the wiper will operate for several seconds after the lever is released, and then resume the intermittent interval previously selected.

If the lever is pulled while in the OFF position, the wipers will operate for several wipe cycles, then turn off.

WARNING!

Sudden loss of visibility through the windshield could lead to an accident. You might not see other vehicles or other obstacles. To avoid sudden icing of the windshield during freezing weather, warm the windshield with the defroster before and during windshield washer use.

Mist

Use this feature when weather conditions make occasional usage of the wipers necessary. Pull down and release the control lever for a single wiping cycle.

Speed Sensitive Intermittent Wiper System

Use one of the five intermittent wiper speeds when weather conditions make a single wiping cycle, with a variable pause between cycles, desirable. Turn the end of the lever to one of the five delay positions for the desired delay interval. The delay can be regulated from a maximum of approximately 18 seconds between cycles, to a cycle every 1/2 second.

NOTE: The wiper delay times depend on vehicle speed. If the vehicle is moving less than 10 mph (16 km/h), delay times will be doubled.

Rain Sensitive Wiper System — If Equipped

The rain sensitive wiper system provides you with the convenience of automatically detecting moisture on your windshield and turning on the wipers at the appropriate speed. The Rain Sensor is located above the rear view mirror and reacts to any moisture present in the area of the sensor.

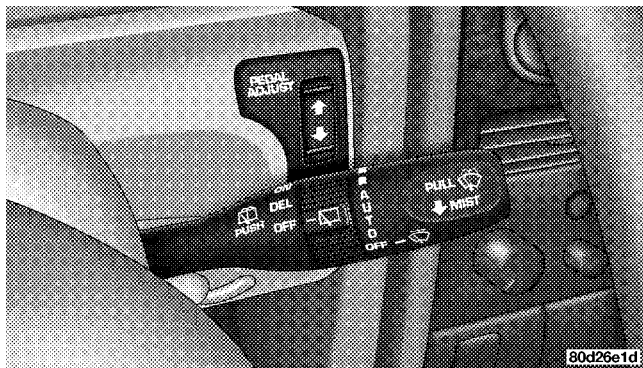

To activate the rain sensitive wiper system, turn the front wiper control lever to AUTO. When you turn the lever to AUTO, the wipers will operate a single wipe cycle. The wipers will also cycle once when you start the vehicle if the lever was left in AUTO.

There are five AUTO positions on the lever to allow you to select system sensitivity that best suits you. The lowest position (closest to OFF) is the least sensitive to rain and the highest position is the most sensitive. If you select a low sensitivity position on the control lever, the system will be slower to react to rain and wipe only after some rain accumulates on the windshield. If you select a high sensitivity position, the system will be very quick to react to rain drops and will wipe more often. If it is raining steadily, the wipers will wipe continuously regardless of what sensitivity the lever is. If the rain is heavy, the wipers will operate in high speed. Every time you move the lever to a higher sensitivity, the wipers will immediately operate a single wipe cycle.

NOTE: Since the rain sensor is designed to detect moisture, road spray, smashed bugs, and moisture from passing trucks may occasionally cause the wipers to cycle if the lever is in AUTO. Also, manual intervention may be necessary under certain conditions: Additional wipes may be desired, in foggy/misty mornings, where condensation builds up very slowly on the windshield, or when water accumulated on the roof of the vehicle runs down the windshield, but not over the sensor.

Fewer wipes and/or washer fluid may be desired when salty road spray is encountered, where the operator may want to turn the "Auto" feature off and use the "Wash" and/or "Mist" functions.

CAUTION!

Turn the wiper lever to the OFF position to avoid wiper damage when driving through an automatic car wash.

3

WARNING!

Turn the wiper lever to the OFF position when cleaning your windshield to avoid injury.

TILT STEERING COLUMN

To tilt the column, pull the small lever, located behind the turn signal control, toward you and move the wheel up or down, as desired. Release the lever to lock the wheel firmly in place.

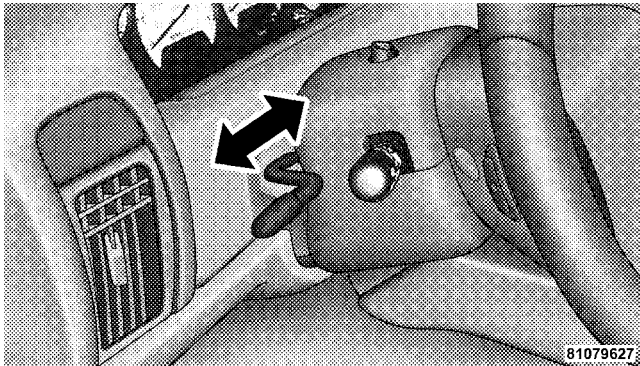

WARNING!

Tilting the steering wheel column while the vehicle is moving is dangerous. Without a stable steering column, you could lose control of the vehicle and have an accident. Adjust the tilting mechanism only while the vehicle is stopped. Be sure it is locked before driving.

ADJUSTABLE PEDALS — IF EQUIPPED

This feature allows both the brake and accelerator pedals to move toward the driver to provide improved position with the steering wheel. The adjustable pedal system is designed to allow a greater range of driver comfort for steering wheel tilt and seat position. The position of the brake and accelerator pedals can be adjusted without compromising safety or comfort in actuating the pedals.

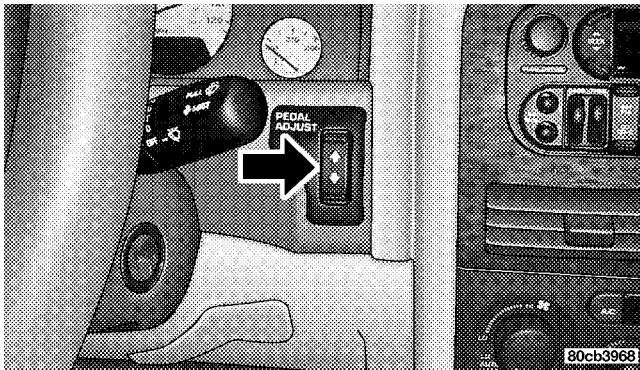

Press the top of the button to move the pedals rearward (toward the front of the vehicle).

Press the bottom of the button to move the pedals forward (toward the driver).

- The pedals can be adjusted with the ignition OFF.
- The pedals can be adjusted while driving.

- The pedals **cannot** be adjusted when the vehicle is in R (Reverse) or when the Speed Control is ON. A message will be displayed on the Overhead Console if the pedals are attempted to be adjusted when the system is locked out (“Adjustable Pedal Disabled — Cruise Control Engaged” or “Adjustable Pedal Disabled — Vehicle In Reverse”).

3

CAUTION!

Do not place any article under the adjustable pedal’s or impede its ability to move as it may cause damage to the pedal controls. Pedal travel may become limited if movement is stopped by an obstruction in the adjustable pedal’s path.

ELECTRONIC SPEED CONTROL

When engaged, this device takes over accelerator operations at speeds greater than 40 mph (60 km/h). The controls are mounted on the steering wheel and consist of ON·OFF, SET, RES·ACCEL, CANCEL, and COAST controls.

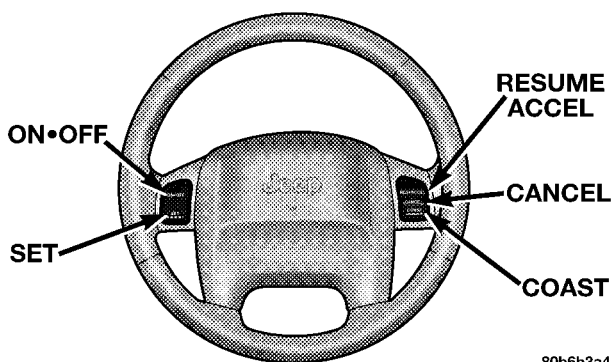

80b6b3a4

To Activate

Press the ON·OFF button to turn the system ON. To turn the system OFF, press the ON·OFF button again. The system should be turned OFF when not in use. The CRUISE indicator light in the instrument cluster will illuminate when the system is ON.

To Set at a Desired Speed

When the vehicle has reached the desired speed, press and release the SET button. Release the accelerator and the vehicle will operate at the selected speed.

To Deactivate

A soft tap on the brake pedal, normal braking, or pressing the CANCEL button will deactivate the Speed Control without erasing the memory. Pressing the ON·OFF to turn the system OFF or turning off the ignition erases the memory.

To Resume Speed

To resume a previously set speed, press and release the RES-ACCEL button. Resume can be used at any speed above 30 mph (48 km/h).

To Vary the Speed Setting

When the Speed Control is ON, speed can be increased by pressing and holding the RES-ACCEL button. When the button is released, a new set speed will be established.

Tapping the RES-ACCEL button once will result in a 2 mph (3 km/h) speed increase. Each time the button is tapped, speed increases, so tapping the button three times will increase speed by 6 mph (10 km/h), etc.

To decrease speed while Speed Control is ON and SET, press and hold the COAST button. Release the button when the desired speed is reached, and the new speed will be set.

To Accelerate for Passing

Depress the accelerator as you would normally. When the pedal is released, the vehicle will return to the set speed.

NOTE: When driving uphill, at elevations above 2,000 feet (610 meters), or when the vehicle is heavily loaded (especially when towing) the vehicle may slow below the SET speed. If the vehicle speed drops below 30 mph (48 km/h), the Speed Control will automatically disengage. If this happens, you can push down on the accelerator pedal to maintain the desired speed.

Vehicles may exhibit several 4-3 downshifts under the above conditions. To reduce the frequency of the downshifts and to improve vehicle performance, it is advisable to lock out overdrive. Press the O/D OFF button on the side of the shift lever.

WARNING!

Leaving the Speed Control ON when not in use is dangerous. You could accidentally set the system or cause it to go faster than you want. You could lose control and have an accident. Always leave the system OFF when you aren't using it.

Driving Up or Down Hills

When going up or down hills, it is possible for your vehicle to lose or gain speed, even though the Speed Control is engaged. If going down a hill steep enough to cause the vehicle to gain speed, press the brake pedal, which will disengage the Speed Control and help slow your vehicle.

WARNING!

To help keep your vehicle under control, do not use Speed Control under these conditions:

- When it is not possible to keep your vehicle at a set speed.
- On slippery roads, such as on snow or ice.
- In heavy or varying traffic volume, in traffic that varies in speed, or on winding roads.
- Be sure to turn the Speed Control switch to the OFF position when not in use to avoid accidental engagement.

OVERHEAD CONSOLE

The overhead console contains dome/reading lights, an optional universal garage door opener (HomeLink®), an optional sunroof switch, and an Electronic Vehicle Information Center (EVIC) that consists of the following:

- Compass/temperature display
- Trip information displays
- Vehicle information warning message displays
- Customer programmable features

Pressing the MENU button will change the displayed programming features. Pressing the STEP button will select the available choices. Pressing the C/T (Compass/Temperature) button will return the display to the normal compass/temperature display.

Dome/Reading Lights

Located in the overhead console are two dome/reading lights.

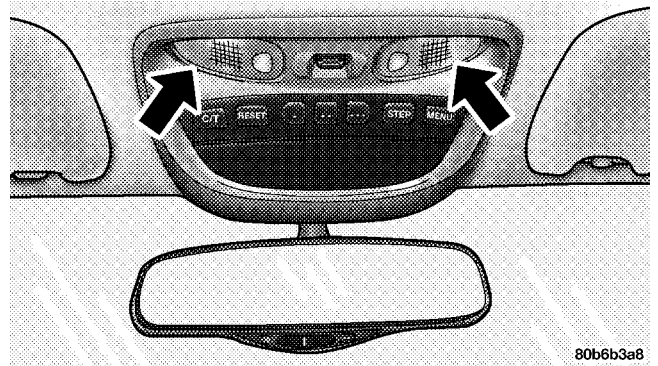

90 UNDERSTANDING THE FEATURES OF YOUR VEHICLE

The dome/reading lights illuminate when a door or the liftgate is opened or when the interior lights are turned on by rotating the dimmer control located on the multi-function lever.

The reading lights are activated by pressing on the recessed area of the corresponding lens.

NOTE: The dome/reading lights will remain on until the switch is pressed a second time, so be sure they have been turned off before leaving the vehicle.

Electronic Vehicle Information Center

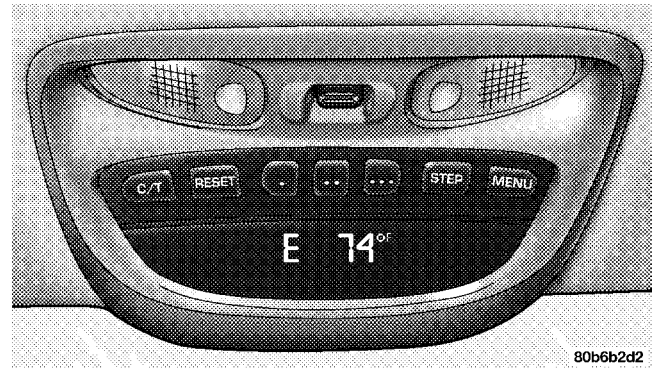

The electronic vehicle information center (EVIC), when the appropriate conditions exist, displays the following messages and symbols. Each message is accompanied by a series of beeps:

- TURN SIGNALS ON (with graphic)

- PERFORM SERVICE
- DOOR OPEN (one or more, with graphic)
- LIFTGATE OPEN (with graphic)
- LIFTGLASS OPEN (with graphic)
- WASHER FLUID LOW (with graphic)
- MEMORY SEAT DISABLED
- MEMORY #1 POSITIONS SET
- MEMORY #2 POSITIONS SET
- PEDAL ADJUST DISABLED
- LEFT FRONT LOW PRESSURE
- LEFT FRONT HIGH PRESSURE
- RIGHT FRONT LOW PRESSURE
- RIGHT FRONT HIGH PRESSURE
- LEFT REAR LOW PRESSURE
- LEFT REAR HIGH PRESSURE
- RIGHT REAR LOW PRESSURE
- RIGHT REAR HIGH PRESSURE
- SPARE LOW PRESSURE (5 Tire TPM System Only)
- SPARE HIGH PRESSURE (5 Tire TPM System Only)
- TIRE PRESSURE UNAVAILABLE
- TIRE PRESSURE NOW AVAILABLE
- TIRE SENSOR BAD/MISSING
- SPARE SWAP DETECTED (5 Tire TPM System Only)
- REMOVE MAGNET FROM SPARE (5 Tire TPM System Only)

Tire Pressure Monitor System — If Equipped

The Tire Pressure Monitor (TPM) system uses wireless technology to monitor tire pressure levels. Sensors, mounted to each wheel as part of the valve stem transmit tire pressure readings to a receiver located in the overhead console.

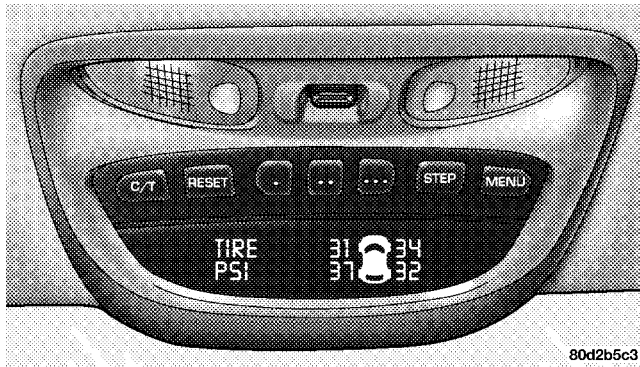

The tire pressure is shown in the Electronic Vehicle Information Center (EVIC) display. The TPM system remains active even if it is not displayed in the EVIC.

CAUTION!

The TPM system is designed to monitor your tire pressure and will not function as a tire pressure gauge while adjusting the pressure in your tires. There will be a delay between the instant you adjust the air pressure in a tire and when the system updates the display.

NOTE: The TPM system can inform you about a low or high tire pressure condition, but it does not replace normal tire maintenance.

The TPM system is not intended to provide you with notification of rapid pressure loss.

1. If any tire pressure has exceeded the low or high pressure (refer to STARTING AND OPERATING — TIRES AND WHEELS), the TPM system will display a message in the EVIC and sound a chime. It will then go into the tire pressure display screen and flash the pressure value of the tire that is low or high. This will be displayed for the rest of the ignition cycle, or until either the C/T, MENU, STEP, or RESET button is pressed.

NOTE: This display will return 60 seconds after either the C/T, MENU, STEP, or RESET button is pressed. If a tire is low or high, you should correct your tire inflation pressure as soon as possible and inspect all of your tires. Refer to STARTING AND OPERATING — TIRES AND WHEELS for more details.

Once the low or high tire pressure message has occurred, it will continue to blink until the tire pressure is corrected.

2. If the spare tire pressure has exceeded the low or high pressure allowed, the TPM system will display a message in the EVIC for 60 seconds and sound a chime per every ignition cycle (5 Tire TPM System Only).

NOTE: This message will return every ignition cycle, until the tire pressures are corrected.

3. When the vehicle is moving and the EVIC cannot receive a valid sensor signal from the tire pressure sensors, the TIRE PRESSURE UNAVAILABLE message will be displayed for 5 seconds along with a chime. The display will then shift to the individual tire pressure display screen and display dashes for the tire or tires that are affected. Once the TIRE PRESSURE UNAVAILABLE message has been displayed, and valid sensor signals are received, the EVIC will display the TIRE PRESSURE NOW AVAILABLE message for 5 seconds along with a chime. This is meant to inform you when the TPM system has returned to its normal operation. This will occur

when valid tire pressure sensor messages have been received from all 4 road tires. TPM system function is temporarily unavailable due to external electromagnetic interference, such as electronic devices or nearby radio or TV towers.

4. In addition to monitoring the vehicle tires, the TPM system monitors faults within the system. When any fault has been set, the TPM system will display TIRE SENSOR BAD/MISSING. Be sure to inspect your tires for proper inflation pressure. After you determine that your tires are properly inflated, see your authorized dealer for service to diagnose the problem with the TPM system.

5. With the 5 Tire TPM System, if a road tire is replaced by the spare, the TPM system will automatically detect that the tires have been switched (after the ignition has been cycled) and display SPARE SWAP DETECTED along with a chime. This could take up to 10 minutes with vehicle speed above 25 mph (40 km/h).

6. With the 4 Tire TPM System, if a road tire is replaced by the spare, the TPM system will display TIRE SENSOR BAD/MISSING. This is due to the spare tire not being equipped with a tire pressure sensor. Once the road tire is repaired and/or installed back on the vehicle with the proper tire pressure the message will be removed. This could take up to 10 minutes with vehicle speed above 25 mph (40 km/h).

General Information

This device complies with FCC rules part 15 and with RSS-210 of Industry Canada. Operation is subject to the following conditions:

1. This device may not cause harmful interference
2. This device must accept any interference that may be received, including interference that may cause undesired operation

Changes or modifications not expressly approved by the party responsible for compliance could void the user's authority to operate the device.

For further assistance, questions, or comments about the TPM system, please call **1-877-774-8473**.

Customer Programmable Features

Press the MENU button until one of the display choices following appears:

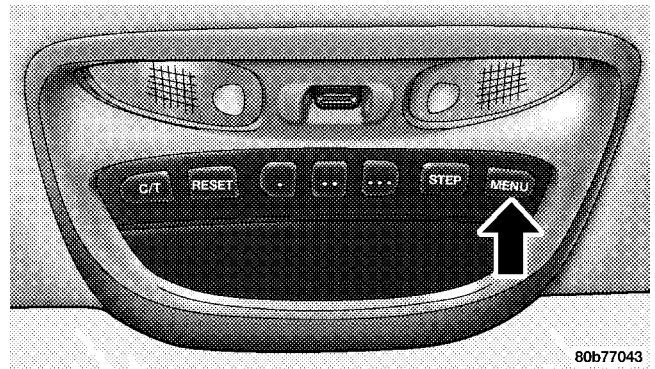

Language?

When in this display you may select one of five languages for all display nomenclature, including the trip computer functions. Press the STEP button while in this

display selects English, Francais, Deutsch, Italiana, or Espanol. As you continue the displayed information will be shown in the selected language.

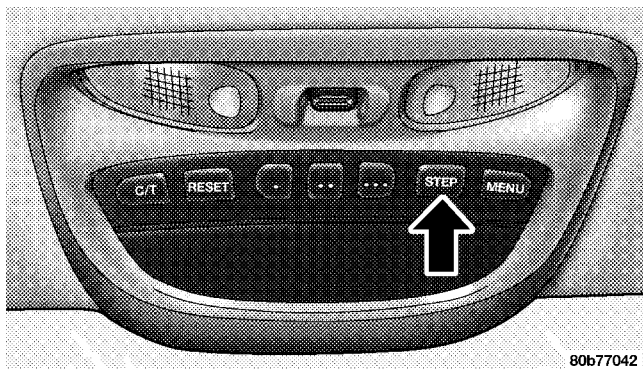

Display U.S. or Metric?

Pressing the STEP button when in this display selects US or Metric. The overhead console and instrument panel displays will be in the selected units.

Auto Door Locks?

When this feature is selected, all doors and the liftgate lock automatically when the speed of the vehicle reaches 15 mph (25 km/h). Pressing the STEP button when in this display will select "Yes" or "No."

Auto Unlock On Exit? (Available Only When the AUTO DOOR LOCKS Feature is Turned On)

When this feature is selected all the vehicle's doors will unlock when the driver's door is opened if the vehicle is stopped and the transmission is in P (Park) or N (Neutral) position. Pressing the STEP button when in this display will select "Yes" or "No."

Remote Unlock Driver's Door 1st?

When this feature is selected only the driver's door will unlock on the first press of the remote keyless entry unlock button and require a second press to unlock the remaining locked doors and liftgate. When **REMOTE UNLOCK ALL DOORS** is selected all of the doors and

the liftgate will unlock at the first press of the remote keyless entry unlock button. Pressing the STEP button when in this display will select DRIVER'S DOOR 1ST or ALL DOORS.

Remote Linked To Memory? (Available with Memory Seat Only)

When this feature is selected the memory seat, mirror, and radio settings will return to the memory set position when the remote keyless entry "Unlock" button is pressed. If this feature is not selected then the memory seat, mirror, and radio settings can only return to the memory set position using the door mounted switch. Pressing the STEP button when in this display will select "Yes" or "No."

Sound Horn On Lock?

When this feature is selected a short horn sound will occur when the remote keyless entry "Lock" button is pressed. This feature may be selected with or without the

flash lights on lock/unlock feature. Pressing the STEP button when in this display will select "Yes" or "No."

Flash Lights On Lock/Unlock?

When this feature is selected, the front and rear turn signals will flash when the doors are locked or unlocked using the remote keyless entry transmitter. This feature may be selected with or without the sound horn on lock feature selected. Pressing the STEP button when in this display will select "Yes" or "No."

Headlamp Delay

When this feature is selected the driver can choose, when exiting the vehicle, to have the headlamps remain on for 30, 60, or 90 seconds, or not remain on. Pressing the STEP button when in this display will select 30, 60, 90, or OFF.

Headlamp On With Wipers? (Available with Auto Headlights Only)

When this feature is selected and the headlight switch has at least once been moved to the AUTO position, the

headlights will turn on when the wipers are turned on. The headlights will also turn off when the wipers are turned off if they were turned on in this way. Pressing the STEP button when in this display will select “Yes” or “No.”

NOTE: Turning the headlights on during the daytime causes the instrument panel lights to dim. To increase the brightness, refer to “Lights” in this section.

Service Interval

When this feature is selected a service interval between 2,000 (3 200 km) and 6,000 miles (10 000 km) in 500 mile (800 km) increments may be selected. Pressing the STEP button when in this display will select distances between 2,000 (3 200 km) and 6,000 miles (10 000 km) in 500 mile (800 km) increments.

Reset Service Distance (Displays Only if Service Interval was Changed)

When this feature is selected the current accumulated service distance can be reset to the newly selected service interval. Pressing the STEP button when in this display will select “Yes” or “No.”

Low Fuel Chime?

When this feature is selected a chime will sound when the “Low Fuel Indicator Light” is displayed in the instrument panel cluster. Pressing the STEP button when in this display will select “Yes” or “No.”

Easy Exit Seat? (Available with Memory Seat Only)

When this feature is selected, the driver’s seat moves rearward 2 inches (5 cm) or to the farthest rearward position if this distance is less than 2 inches (5 cm) when the key is removed from the ignition switch so that the driver can more easily exit the vehicle. The seat will return to the memorized seat location (if REMOTE LINK

TO MEMORY is set to YES) when the remote keyless entry transmitter is used to unlock the door. Pressing the STEP button when in this display will select "Yes" or "No."

Retrain Tire Sensors? (Available with TPM System Only)

When this feature is selected, the TPM system will start the retraining procedure (Refer to Training Procedure below). Pressing the STEP button when in this display will select "Yes" or "No." Then, press the MENU button to enter selection.

WARNING!

Death or serious injury can occur if magnetically sensitive devices are exposed to this magnet. Magnets can affect pacemakers.

NOTE: The tire pressure sensors must be retrained after rotating the tires or replacing one or more sensors. If a wheel rotation is not followed by the retrain procedure, the system will not properly inform you of the correct vehicle location for a low or high pressure tire.

The following describes how to use this feature:

1. Locate the training magnet under the spare tire (shaped like a doughnut).
2. Press the MENU button until RETRAIN TIRE SENSORS is displayed.
3. Press the STEP button to select YES to retrain TPM sensor.
4. Press the MENU button to enter selection.
5. Display will read TRAIN LEFT FRONT TIRE.

100 UNDERSTANDING THE FEATURES OF YOUR VEHICLE

NOTE: There is a 60 second timer for training the first tire and a 30 second timer between training the remaining tires. If either of these timers expire, the EVIC will abort the training procedure.

6. Starting at the left front tire, place the training magnet over the valve stem until the horn chirps (This takes approximately 5 seconds).

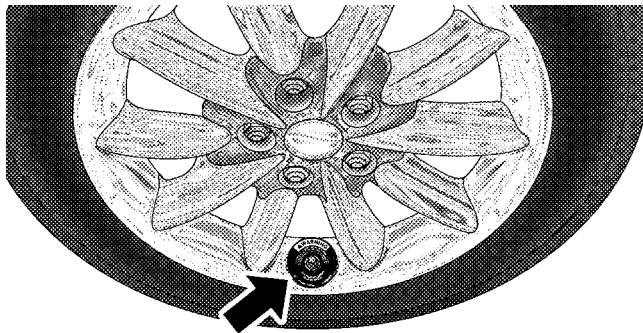

80d236ef

7. Repeat step 6 working clockwise around the vehicle (Left Front, Right Front, Right Rear, Left Rear, Spare) until all five TPM sensor positions are trained.

NOTE: The spare tire is only trained with the 5 Tire TPM System.

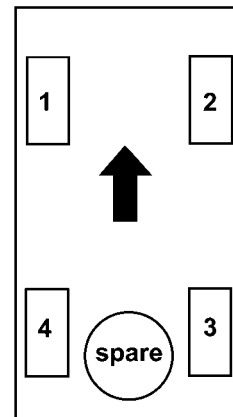

80ce79be

8. Return magnet to storage location.

If the display reads TRAINING COMPLETE, pressing either the STEP, C/T, RESET, or MENU buttons will exit the training mode.

If the display reads TRAINING ABORTED, move the vehicle ahead at least 1 foot and complete steps 1–8 again.

For further assistance, questions, or comments about the Tire Pressure Monitor system, please call 1-877-774-8473.

Compass/Temperature/Trip Computer

This display provides the outside temperature, one of the eight compass headings to indicate the direction the vehicle is facing, and vehicle trip information. The compass and temperature display is the normal display. When the C/T button is pressed the compass/temperature display returns.

3

WARNING!

Even if the display still reads a few degrees above 32°F (0°C), the road surface may be icy, particularly in woods or on bridges. Drive carefully under such conditions to prevent an accident and possible personal injury or property damage.

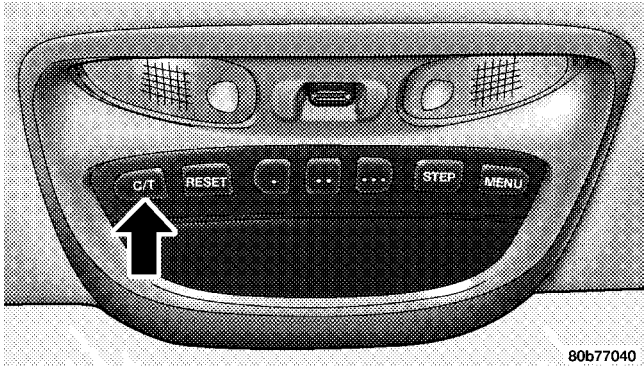
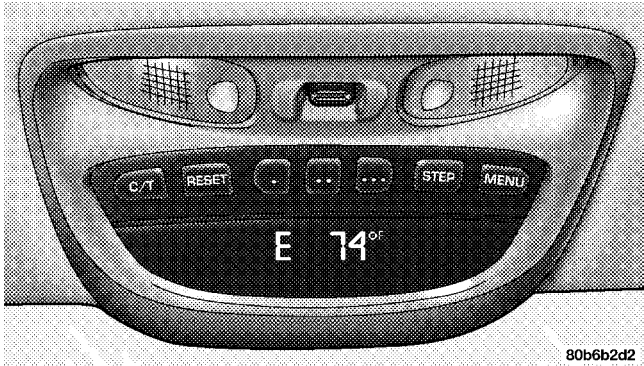

Trip Computer

This feature, located in the overhead console, displays the following information when the display is in the “Compass/Temperature” mode and the STEP button is pressed:

Step Button

Press the STEP button to cycle through all of the Compass/Mini-Trip Computer displays.

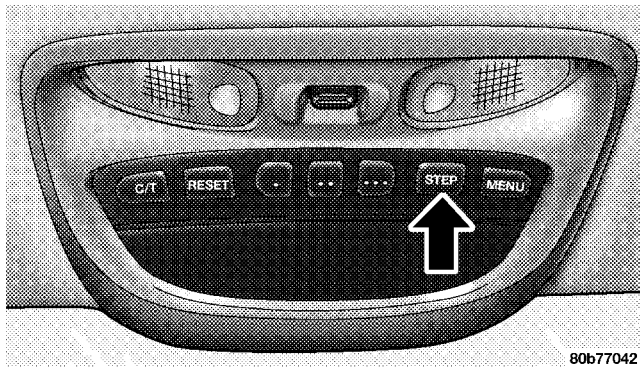

90b77042

Average Fuel Economy

Shows the average fuel economy since the last reset.

Distance To Empty

Shows the estimated distance that can be travelled with the fuel remaining in the tank. This is calibrated using the miles per gallon for the last few minutes.

Trip Odometer

Shows the distance travelled since the last reset.

Elapsed Time

Shows the accumulated ignition ON time since the last reset.

Miles to Service

Shows the distance remaining to require service.

NOTE: This display can be reset to the set service interval by pressing and holding the RESET button for 3 seconds.

Tire Pressure Display — If Equipped

Shows the current pressure of all 4 road tires.

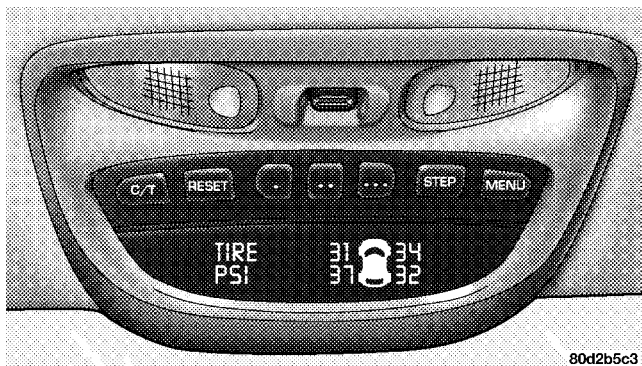

NOTE: Tires heat up during normal driving conditions. Heat will cause the tire pressure to increase from 2 to 6 psi (14 to 41 kPa) during normal driving conditions. Refer to “Tire Inflation Pressures” in Section 5 for additional information.

Blank Screen

Shows a blank screen. Pressing the C/T button returns to the compass/temperature display.

Automatic Compass Calibration

This compass is self-calibrating which eliminates the need to manually set the compass. When the vehicle is new, the compass may appear erratic and the CAL symbol will be displayed.

After completing one 360 degree turn, with the vehicle traveling less than 5 mph (8 km/h), in an area free from large metal or metallic objects, the CAL symbol will turn off and the compass will function normally.

Manual Compass Calibration

If the compass appears erratic and the CAL symbol does not appear, you must manually put the compass into the “Calibration” mode.

NOTE: To ensure proper compass calibration, make sure the compass variance is properly set before manually calibrating the compass. Refer to Variance Map.

To Put Into a Calibration Mode

Turn on the ignition and set the display to “Compass/Temperature.” Press and hold the RESET button to change the display between VAR (compass variance) and CAL (compass calibration) modes. When the CAL symbol is displayed complete three 360 degree turns in an area free from large metal objects or power lines. The CAL symbol will turn off and the compass will function normally.

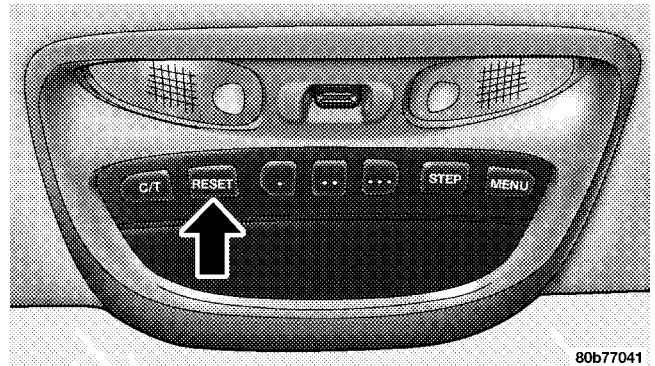

Compass Variance is the difference between magnetic north and geographic north. In some areas of the country, the difference between magnetic and geographic north is great enough to cause the compass to give false readings. If this occurs, the compass variance must be set according to the Compass Variance Map.

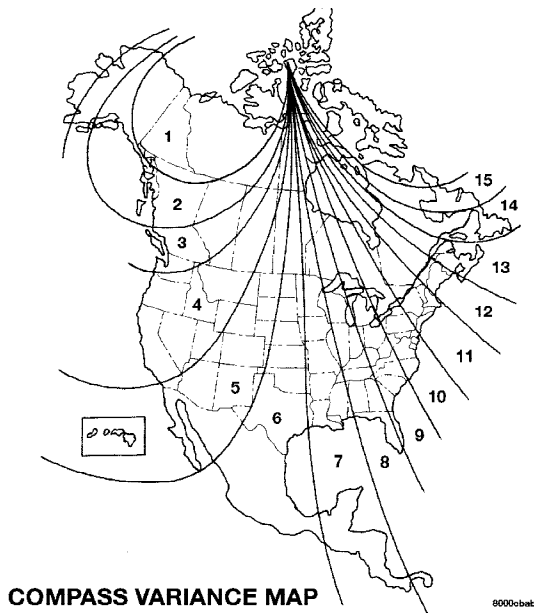

To set the variance: Turn the ignition ON and set the display to "Compass/Temperature." Press the RESET button approximately five seconds. The last variance zone number will be displayed. Press the STEP button to select the new variance zone and press the RESET button to resume normal operation.

GARAGE DOOR OPENER — IF EQUIPPED

The HomeLink® Wireless Control System provides a convenient way to replace up to three hand-held radio-frequency (RF) transmitters used to activate devices such as gate operators, garage door openers, entry door locks, security systems, even home lighting. Additional HomeLink information can be found at: www.homelink.com or by calling 1-800-355-3515.

WARNING!

Before programming HomeLink to a garage door opener or gate operator, make sure that people and objects are out of the way of the device to prevent potential harm or damage. When programming a garage door opener, it is advised to park outside of the garage. Do not use HomeLink with any garage door opener that lacks safety stop and reverse features as required by U.S. federal safety standards (this includes any garage door opener model manufactured before April 1, 1982). A garage door that cannot detect an object - signaling the door to stop and reverse - does not meet current U.S. federal safety standards. For more information, contact HomeLink at: www.homelink.com or by calling: 1-800-355-3515.

Retain the original transmitter of the RF device you are programming for use in other vehicles as well as for future HomeLink programming. It is also suggested that upon the sale of the vehicle, the programmed HomeLink buttons be erased for security purposes. To erase the programmed buttons, perform the procedure shown below under "When Your Vehicle Is New", or, for assistance, contact HomeLink at: www.homelink.com or by calling: 1-800-355-3515.

When Your Vehicle Is New

Prior to programming HomeLink for the first time the factory test codes must be erased. To erase HomeLink memory, press and hold the two outer HomeLink buttons (buttons one and three). The message CLEARING CHANNELS will appear on the HomeLink display. After approximately 20 seconds, the message CHANNELS CLEARED will appear on the EVIC display. Do not hold the buttons for longer than 30 seconds.

Programming HomeLink

NOTE: It is recommended that a new battery be placed in the hand-held transmitter of the device being programmed to HomeLink for quicker training and accurate transmission of the radio frequency signal.

WARNING!

Vehicle exhaust contains carbon monoxide, a dangerous gas. Do not run the vehicle's engine while programming HomeLink. Exhaust gas can cause serious injury or death.

WARNING!

Your motorized door or gate will open and close while you are programming HomeLink. Do not program HomeLink if people or pets are in the path of the door or gate. A moving door or gate can cause serious injury or death to people and pets or damage to objects.

1. Position the end of your hand-held transmitter 1-3 inches (5-14 cm) away from the lower left corner of the EVIC display while keeping the display in view.

NOTE: Some gate operators and garage door openers may require you to replace the next step with procedures noted in the "Gate Operator/Canadian Programming" section.

2. Simultaneously press and hold both the desired HomeLink button and the hand-held transmitter button.

After a short time, the message TRAINING will show on HomeLink display. **Do not release the buttons until the next step has been completed.**

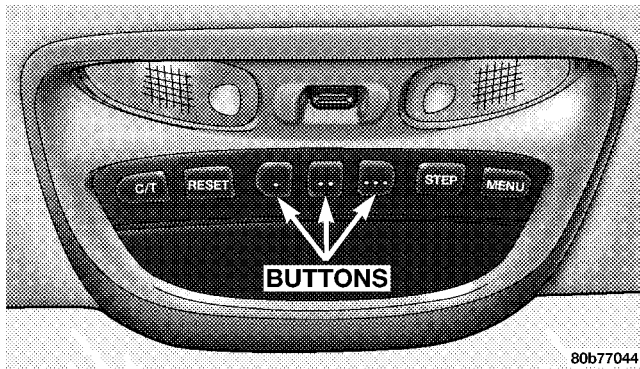

3. When the message TRAINED appears on the HomeLink display, release both the HomeLink and hand-held transmitter buttons.

NOTE: If the HomeLink display does not change to TRAINED, contact HomeLink at www.homelink.com or call 1-800-355-3515 for assistance.

4. Press and hold the just-trained HomeLink button. TRANSMIT should appear on the display.

If your device activates when the HomeLink button is depressed and released, programming is complete.

NOTE: To program the remaining two HomeLink buttons, simply repeat the "Programming HomeLink" process.

If the message TRANSMIT appears on the HomeLink display but your device does not activate, the device may be equipped with a "rolling code" system. Continue with steps five through seven below to complete the programming of a rolling code equipped device (most commonly a garage door opener).

5. At the garage door opener receiver (motor-head unit) in the garage, locate the "learn" or "smart" button. This can usually be found where the hanging antenna wire is attached to the motor-head unit.

6. Firmly press and release the "learn" or "smart" button. (The name and color of the button may vary by manufacturer.)

NOTE: There are 30 seconds in which to initiate the next step.

7. Return to the vehicle and firmly press, hold for two seconds and release the programmed HomeLink button. Repeat the "press/hold/release" sequence a second time, and, depending on the brand of the garage door opener (or other rolling code equipped device), repeat this sequence a third time to complete the programming process.

HomeLink should now activate your rolling code equipped device.

NOTE: To program the remaining two HomeLink buttons, simply repeat the "Programming HomeLink" process.

If, after programming the HomeLink Wireless Control System, the hand-held transmitter and/or other HomeLink units in other vehicles fail to activate the rolling code equipped device, you may need to clear (or "erase") the device's receiver memory. Refer to your garage door opener's Owner's Manual for the procedure or contact HomeLink at 1-800-355-3515 or on the Internet at www.homelink.com. After clearing the receiver, you must reprogram the original hand-held transmitter(s) to the receiver using the procedure in the garage door opener's Owner's Manual. Finally, reprogram the hand-held transmitter(s) to HomeLink using the steps under "Programming HomeLink".

Gate Operator/Canadian Programming

Canadian radio-frequency laws require transmitter signals to "time-out" (or quit) after several seconds of transmission - which may not be long enough for HomeLink to pick up the signal during programming. Similar to this Canadian law, some U.S. gate operators are designed to "time-out" in the same manner.

If you live in Canada or you are having difficulties programming a gate operator by using the "Programming HomeLink" procedures (regardless of where you live), replace step two with the following:

NOTE: If programming a garage door opener or gate operator, it is advised to unplug the device during the "cycling" process to prevent possible overheating.

Press and hold the HomeLink button while you press and release - every two seconds ("cycle") your hand-held

transmitter button until the radio signal has successfully been accepted by HomeLink. (The message TRAINED will appear on the HomeLink display.)

Proceed with the remaining steps under "Programming HomeLink" to complete.

Using HomeLink

To operate, simply press and release the programmed HomeLink button. Activation will now occur for the trained device (i.e. garage door opener, gate operator, security system, entry door lock, home/office lighting, etc.). For convenience, the hand-held transmitter of the device may also be used at any time. In the event that there are still programming difficulties or questions, contact HomeLink at: www.homelink.com or 1-800-355-3515.

POWER SUNROOF — IF EQUIPPED

The sunroof is electrically operated from a switch located in the overhead console. To operate the sunroof, the ignition switch must be in the ON or ACC position. The sunroof has “Manual” and “Express Open” modes of operation when opening.

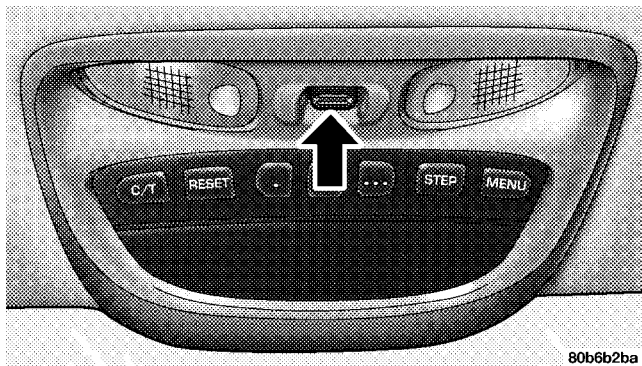
**Express Open Mode**

To open the sunroof in the Express Open mode, press the switch rearward for less than one second. This causes the sunroof glass to automatically retract and stop at the full open position. This glass position provides the largest possible opening while minimizing low-speed wind buffeting. If wind buffeting does occur, adjusting the sunroof glass position may reduce the intensity of the buffeting.

Manual Open Mode

The sunroof can also be opened by pressing and holding the switch rearward. Once the switch is held rearward for more than one second, releasing the switch at any time during travel will cause the sunroof to stop at the current position.

Closing Operation

To close the sunroof from an open position, press the switch forward and hold it until the sunroof glass comes to a complete stop. Releasing the switch at any time in this mode will cause the sunroof to stop at the current position.

Vent Operation

Opening the glass panel to the vent position will improve interior ventilation. To open the sunroof to the vent position from the closed position, press the switch forward and hold. Releasing the switch at any time during travel will cause the sunroof to stop at the current vent position. To reach the fully vented position, continue to hold the switch forward until vent motion stops. To close the sunroof from the vent position, press and hold the switch rearward until the glass comes to a complete stop.

Ignition Off Operation

The sunroof will also operate up to 45 seconds after the ignition has been turned off. The sunroof operation will be canceled if either of the front doors are opened during the 45 second time period.

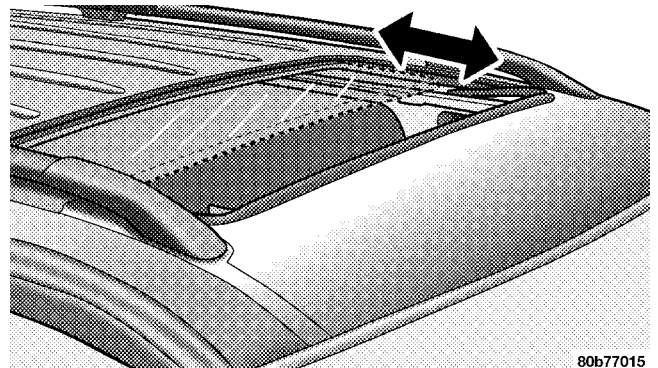

80b77015

Sunshade Operation

The sunshade covering the glass in the panel will open with the sunroof and must be closed manually. It can also be opened and closed manually without activating the sunroof. This will allow you to enjoy the warmth of the sun during the winter months.

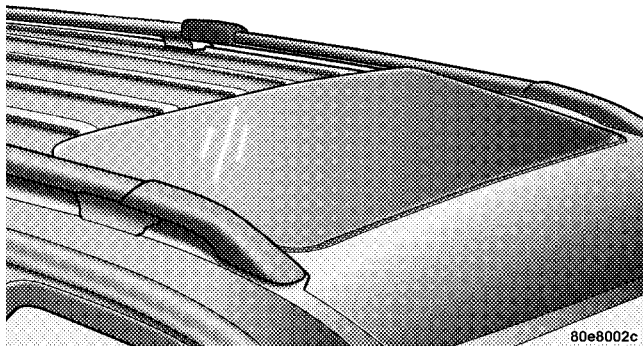

WARNING!

In an accident, there is greater risk of being thrown from a vehicle with an open sunroof. You could be seriously injured or killed. Always fasten your seat belt properly and be sure all passengers are properly secured too.

Maintenance

Care should be taken in cleaning the inside of the glass. Use only nonabrasive cleaners and a soft cloth.

WARNING!

Do not allow small children to operate the sunroof, and never allow objects to project through the sunroof opening. Injury may result.

POWER OUTLET

To the right of the convenience tray (lower center of instrument panel) is an outlet for electrically powered accessories. Pull lightly on the tab of the plastic cover to access the outlet.

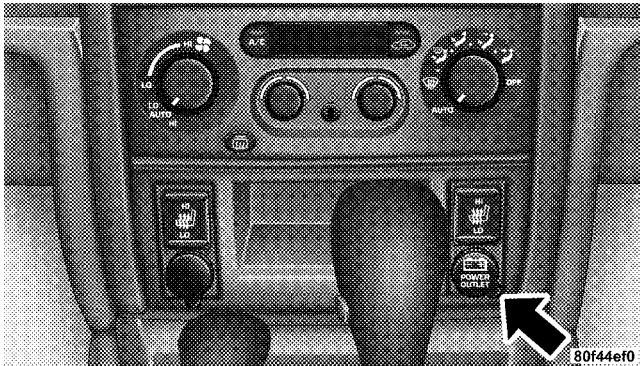

There is a rear power outlet located in the right rear cargo area rearward of the storage bin/CD changer (if equipped).

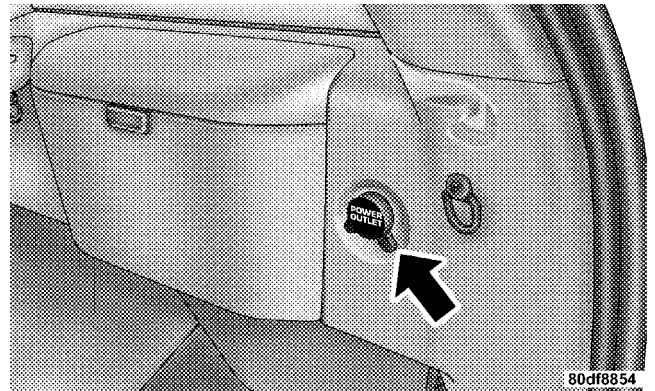

Rear Power Outlet

The power outlets are a direct feed from the battery so they receive power whether the ignition is in the ON or OFF position.

All accessories connected to this outlet should be removed or turned off when the vehicle is not in use to protect the battery against discharge.

CAUTION!**Electrical Outlet Use With Engine Off**

- Many accessories that can be plugged in draw power from the vehicle's battery, even when not in use (i.e., cellular phones, etc.). Eventually, if plugged in long enough, the vehicle's battery will discharge sufficiently to degrade battery life and/or prevent engine starting.
- Accessories that draw higher power (i.e., coolers, vacuum cleaners, lights, etc.) will degrade the battery even more quickly. Only use these intermittently and with greater caution.
- After the use of high power draw accessories, or long periods of the vehicle not being started (with accessories still plugged in), the vehicle must be driven a sufficient length of time to allow the generator to recharge the vehicle's battery.

GLOVE COMPARTMENT

The glove compartment light will remain on if the glove box door is not securely closed, causing an unnecessary drain on the battery.

CUP HOLDERS

In the center console there are two cup holders for the front seat passengers.

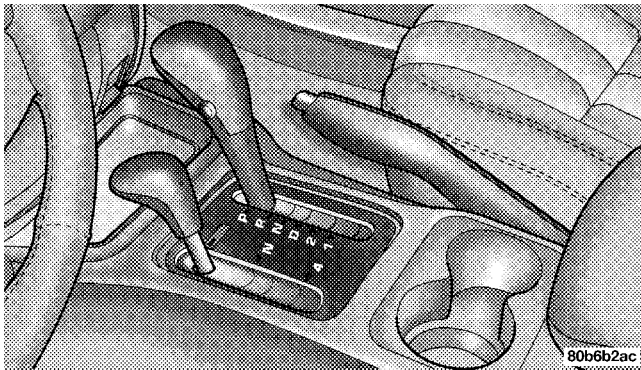

Front Cup Holders

NOTE: The cup holder insert is removable, from the console, for cleaning. It can be reinstalled with the larger cup depression towards the passenger seat, but the top surface will not be flush with the console surface.

The rear passengers have access to two cup holders that pull out from the rear of the center console.

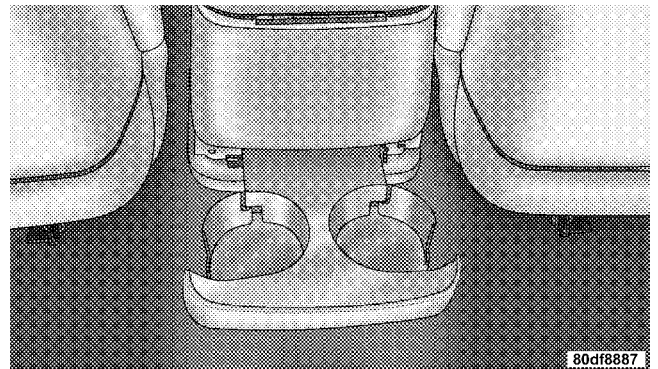

Rear Cup Holders

CARGO AREA FEATURES

Cargo Light

The cargo area light is activated by opening the liftgate, opening any door, or by rotating the dimmer control on the multi-function control lever to the extreme top position. If all doors are closed and only the liftgate is open, pushing on the cargo light lens surface will turn off all interior lamps. Push on the lens surface a second time to restore the interior lights to normal operation.

Retractable Cargo Area Cover — If Equipped

To cover the cargo area:

1. Grasp the cover at the center handle. Pull it over the cargo area.
2. Insert the pins on the ends of the cover into the slots in the pillar trim cover.
3. The liftgate may be opened with the cargo cover in place.

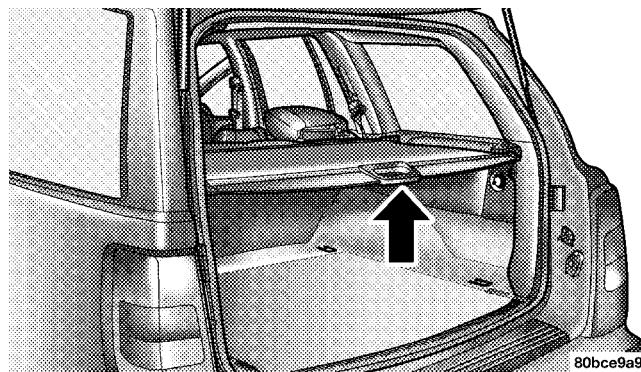

WARNING!

In an accident a cargo cover loose in the vehicle could cause injury. It could fly around in a sudden stop and strike someone in the vehicle. Do not store the cargo cover on the cargo floor or in the passenger compartment. Remove the cover from the vehicle when taken from its mounting. Do not store in the vehicle.

Cargo Tie-Down Hooks

The tie-downs located on cargo area floor should be used to safely secure loads when vehicle is moving.

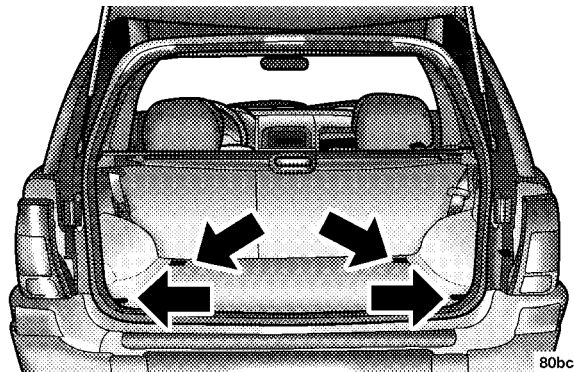

80bce9a8

WARNING!

- **Cargo tie-down hooks are not safe anchors for a child seat tether strap. In a sudden stop or collision a hook could pull loose and allow the child seat to come loose. A child could be badly injured. Use only the anchors provided for child seat tethers.**
 - **The weight and position of cargo and passengers can change the vehicle center of gravity and vehicle handling. To avoid loss of control resulting in personal injury, follow these guidelines for loading your vehicle:**
- Do not carry loads which exceed the load limits described on the label attached to the left door or left door center pillar. Refer to "Vehicle Loading" in Section 5 for additional information on cargo weights.

- Always place cargo evenly on the cargo floor. Put heavier objects as low and as far forward as possible.
- Place as much cargo as possible in front of the rear axle. Too much weight or improperly placed weight over or behind the rear axle can cause the rear of the vehicle to sway.
- Do not pile luggage or cargo higher than the top of the seatback. This could impair visibility or become a dangerous projectile in a sudden stop or collision.

WARNING!

To help protect against personal injury, passengers should not be seated in the rear cargo area. The rear cargo space is intended for load carrying purposes only, not for passengers, who should sit in seats and use seat belts.

ROOF LUGGAGE RACK

External racks do not increase the total load carrying capacity of the vehicle. Be sure that the total occupant and luggage load inside the vehicle, plus the load on the luggage rack, do not exceed the rated vehicle capacity.

This vehicle is not equipped with roof rack cross rails as built, unless ordered as optional equipment. Cross rails must be installed prior to carrying loads on the roof rack. If not equipped, your authorized dealer can order and install Mopar® cross rails built specifically for this roof rack system or a number of after market rails that are tailored to your life-style or activities.

CAUTION!

- To prevent damage to the roof of your vehicle, **DO NOT** carry any loads on the roof rack without cross rails installed. The load should be secured and placed on top of the cross rails, not directly on the roof. If it is necessary to place the load on the roof, place a blanket or some other protection between the load and the roof surface.
- To avoid damage to the roof rack and vehicle, do not exceed the rated load capacity of your cross rail system or the roof rack system maximum load capacity of 150 lbs (68 kg). Always distribute heavy loads as evenly as possible and secure the load appropriately.
- Long loads which extend over the windshield, such as wood panels or surfboards, should be secured to both the front and rear of the vehicle.
- Travel at reduced speeds and turn corners carefully when carrying large or heavy loads on the roof rack. Wind forces, due to natural causes or nearby truck traffic, can add sudden upward loads. This is especially true on large flat loads and may result in damage to the cargo or your vehicle.

WARNING!

Cargo must be securely tied before driving your vehicle. Improperly secured loads can fly off the vehicle, particularly at high speeds, resulting in personal injury or property damage. Follow the roof rack "Cautions" when carrying cargo on your roof rack.

UNDERSTANDING YOUR INSTRUMENT PANEL

CONTENTS

■ Instrument Panel And Interior Controls	126	□ Electrical Disturbances	136
■ Instrument Cluster	127	□ AM Reception	136
□ Instrument Cluster — If Equipped	128	□ FM Reception	136
■ Instrument Cluster Description	129	■ Sales Code RBK—AM/ FM Stereo Radio With CD Player And CD Changer Controls	136
■ Electronic Digital Clock	135	□ Radio Operation	136
□ Clock Setting Procedure	135	□ CD Player Operation	139
■ Radio General Information	135	□ CD Changer Control Capability — If Equipped	140
□ Radio Broadcast Signals	135	□ Radio Display Messages	142
□ Two Types Of Signals	135		

- Sales Code RBP—AM & FM Stereo Radio With Cassette Tape Player, CD Player, And Optional CD/DVD Changer Controls143
 - Radio Operation143
 - Tape Player Operation147
 - CD Player Operation149
 - CD/DVD Changer Operation — If Equipped150
- Sales Code RB1—AM/FM Stereo Radio With DVD/GPS Navigation System152
- Satellite Radio — If Equipped152
 - System Activation152
 - Electronic Serial Number/Sirius Identification Number (ENS/SID)153
 - Selecting Satellite Mode In RBB And RBK Radios153
 - Selecting Satellite Mode In RBP, RBU, RAZ, And RBQ Radios154
 - Selecting a Channel154
 - Storing And Selecting Pre-Set Channels155
 - Using The PTY (Program Type) Button (If Equipped)155
 - PTY Button "Scan"155
 - PTY Button "Seek"155
 - Satellite Antenna155
 - Reception Quality156
- 10-Disc Remote CD Changer156
 - Loading The CD Changer156

<hr/>		UNDERSTANDING YOUR INSTRUMENT PANEL 125
■ Remote Sound System Controls — If Equipped . . .	160	
□ Radio Operation	161	□ Blower Control 165
□ Tape Player	161	□ Temperature Control 165
□ CD Player — Single Disc In Radio	162	□ Mode Selection 166
□ CD Player — 10 Disc In Cargo Area	162	□ Infrared Dual-Zone Climate Control — If Equipped 167
■ Cassette Tape And Player Maintenance	162	□ Window Fogging 170
■ CD/DVD Disc Maintenance	163	■ Rear Window Features
■ Radio Operation And Cellular Phones	164	□ Rear Window Wiper/Washer 170
■ Climate Controls	164	□ Rear Window Defroster 171
□ Air Conditioning	164	

INSTRUMENT PANEL AND INTERIOR CONTROLS

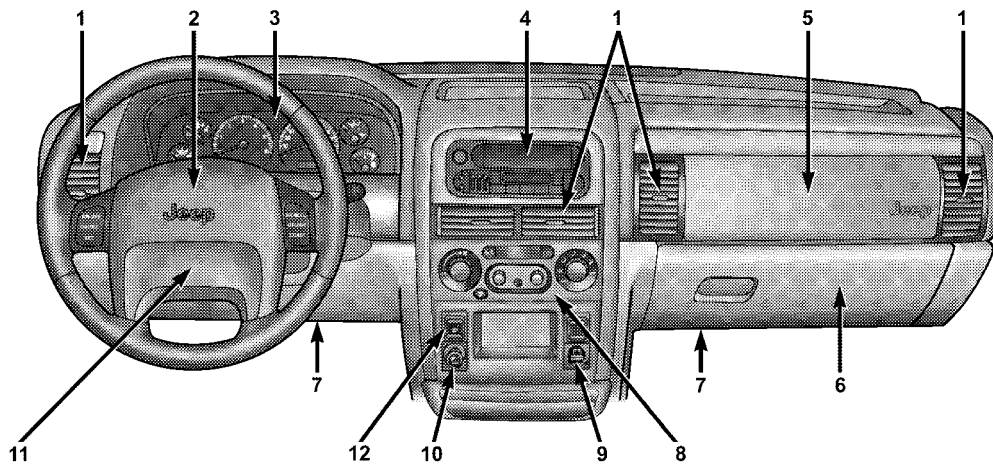

- 1. Air Outlet
- 2. Driver's Airbag
- 3. Instrument Cluster
- 4. Radio
- 5. Passenger Airbag
- 6. Glove Compartment
- 7. Knee Bolster
- 8. Climate Controls
- 9. Power Outlet
- 10. Cigar Lighter - If Equipped
- 11. Horn
- 12. Heated Seats - If Equipped

80F44f0e

INSTRUMENT CLUSTER

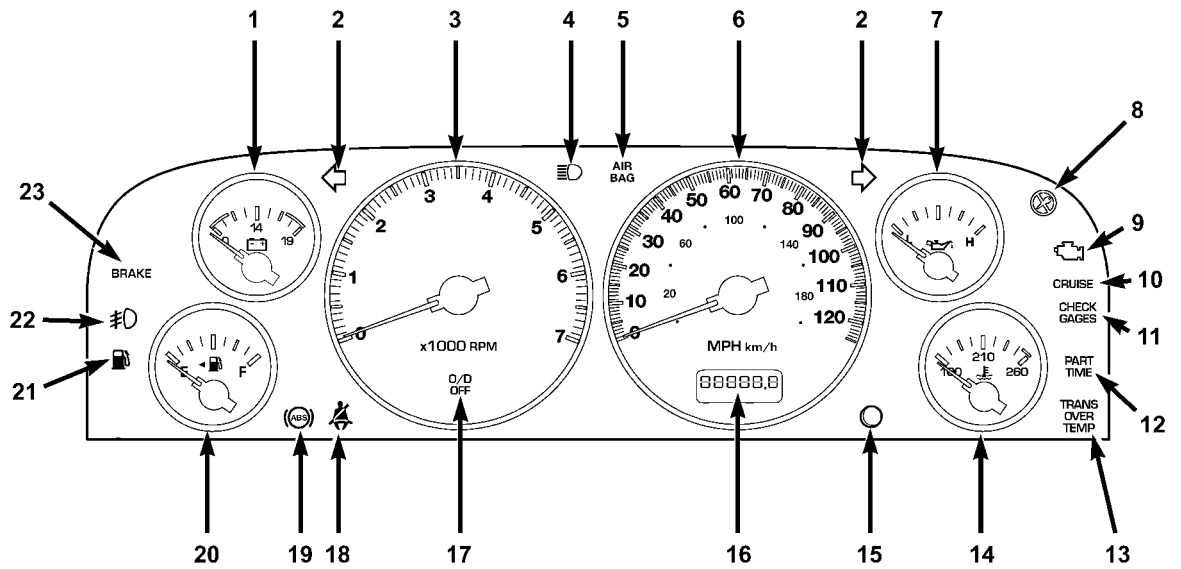

80e78660

INSTRUMENT CLUSTER — IF EQUIPPED

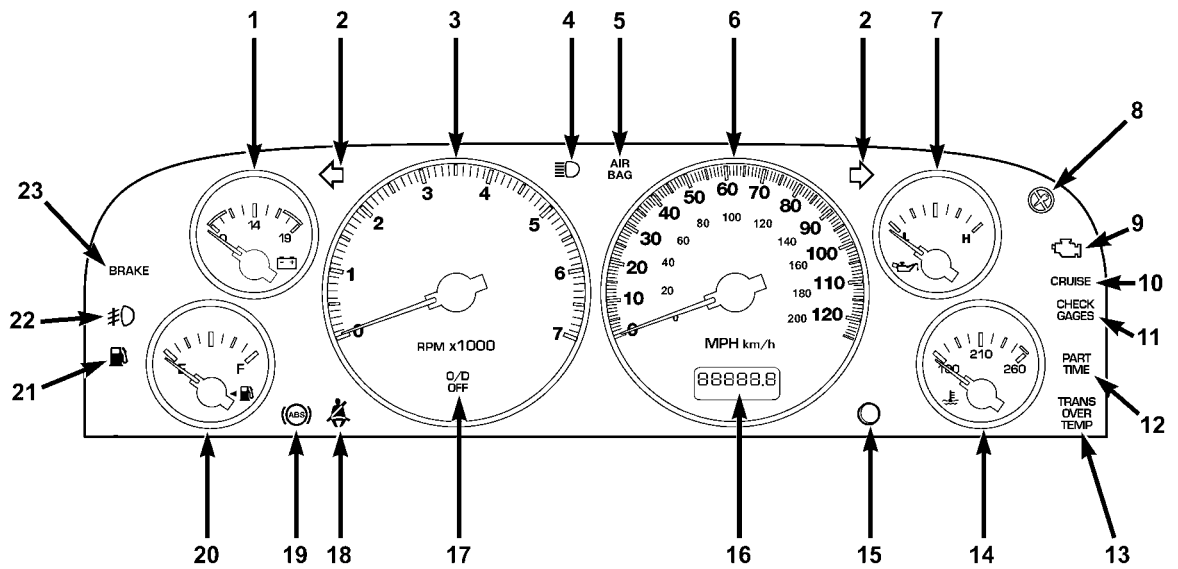

80e78671

INSTRUMENT CLUSTER DESCRIPTION**1. Voltmeter**

 Indicates available battery voltage and charging system operation. The lower red zone shows that the battery charge may be too low to start the engine. With the engine running, the normal operating range is between 11 and 15 volts. Prolonged gage readings between 9-11 (undercharge) or above 15 (overcharge) indicate possible malfunction of the generator, voltage regulator or battery. See your dealer if such signs occur.

2. Turn Signal Indicator Light

 The arrows will flash in unison with the exterior turn signals, when using the multi-function control lever. When the hazard warning system is activated, both the indicator lights will flash simultaneously.

3. Tachometer

Indicates the engine speed in revolutions per minute.

CAUTION!

Do not operate the engine with the tachometer pointer in the red area. Engine damage will occur.

4. High Beam Indicator Light

 This light shows that the headlights are on high beam. Pull the multi-function control lever towards the steering wheel to switch the headlights from high to low beam.

5. Airbag Warning Light

AIR This indicator lights and remains lit for 6 to 8
BAG seconds when the ignition is first turned on. If the bulb does not come on during starting, have it serviced. If the light stays on or comes on while driving, have the airbag system checked by an authorized dealer.

6. Speedometer

Indicates vehicle speed.

7. Oil Pressure Gage

 Indicates the engine oil pressure. This gage does not measure oil level. Pressure varies with engine speed, temperature, and oil viscosity. Normal oil pressure will be midway between the lowest and highest limit marks.

8. Sentry Key Indicator Light — If Equipped

Refer to “Sentry Key Immobilizer System” in Section 2 of this manual for more information.

9. Malfunction Indicator Light

This light is part of an onboard diagnostic system called OBD II which monitors engine and automatic transmission control systems. This light will illuminate when the ignition is in the ON position before engine start. If the bulb does not come on when turning the ignition key from OFF to ON, have the condition checked promptly.

Certain conditions such as a loose or missing gas cap, poor fuel quality, etc. may illuminate the light after engine start. The vehicle should be serviced if the light stays on through several typical driving cycles. In most situations, the vehicle will drive normally and will not require towing.

When the engine is running, the “Malfunction Indicator Light” may flash to alert of serious conditions that could lead to immediate loss of power or severe catalytic converter damage. The vehicle should be serviced as soon as possible if this occurs.

10. Cruise Indicator Light

CRUISE This indicator lights when the electronic speed control system is turned ON.

11. Check Gages Warning Light

CHECK GAGES This light illuminates when the voltmeter, oil pressure, or temperature gages indicate a reading

either too high or too low. Examine the gages carefully, and follow the instructions above for each indicated problem.

NOTE: When the ignition switch is turned to OFF, the fuel gage, voltmeter, oil pressure, and temperature gages will not show any readings. When the engine is not running, turn the ignition switch to ON to obtain accurate readings.

12. Part Time Indicator Light

PART TIME This light alerts the driver that the vehicle is in the PART TIME four-wheel drive mode, and the front and rear driveshafts are mechanically locked together forcing the front and rear wheels to rotate at the same speed.

13. Transmission Over Temperature Warning Light

TRANS OVER TEMP This light indicates that there is excessive transmission fluid temperature that might occur with severe usage such as trailer towing or snow plowing. If this light

comes on, stop the vehicle and run the engine at idle or faster, with the transmission in N (Neutral) until the light goes off.

14. Temperature Gage



Indicates engine coolant temperature. Any reading within the normal range indicates that the cooling system is operating satisfactorily.

The gage pointer will likely indicate a higher temperature (above center scale) when driving in hot weather, up mountain grades, or when towing a trailer. It should not be allowed to exceed the upper limits of the normal operating range.

If the pointer rises to the 260° (Hot) mark, pull over and stop the vehicle. Do not turn the engine off. Idle the vehicle with the air conditioning turned off, until the pointer drops back into the normal range.

CAUTION!

Driving with a hot cooling system could damage your vehicle. If the temperature gage reads high, pull over and stop the vehicle. Idle the vehicle with the air conditioner turned off until the pointer drops back into the normal range. If the pointer remains in the high range, turn the engine off immediately, and call for service.

15. Reset Button

Press this button to toggle between the odometer and trip odometer display. When in the trip odometer mode, holding the button in resets the trip odometer.

16. Odometer/Trip Odometer

The odometer shows the total distance the vehicle has been driven. There are six digits including leading zeros. The odometer is tamper-resistant.

U.S. federal regulations require that upon transfer of vehicle ownership, the seller certify to the purchaser the correct mileage that the vehicle has been driven. Therefore, if the odometer reading is changed during repair or replacement, be sure to keep a record of the reading before and after the service so that the correct mileage can be determined.

The trip odometer records distance in miles from whenever the "Reset" button is pushed. To switch from the odometer being displayed to the trip odometer being displayed, press the "Reset" button.

17. O/D (Overdrive) Off Indicator Light

O/D OFF This light will illuminate when the O/D OFF button has been selected. The O/D OFF button is located on the gear shift lever.

18. Seat Belt Indicator Light

When the ignition switch is first turned ON, this light will turn on for 5 to 8 seconds as a bulb check.

During the bulb check, if the driver's seat belt is unbuckled, a chime will sound. After the bulb check or when driving, if the driver seat belt remains unbuckled, the Seat Belt Warning Light will flash or remain on continuously. Refer to "Enhanced Driver Seat Belt Reminder System (BeltAlert™)" in the Occupant Restraints section for more information.

19. Anti-Lock Warning Light

The amber ABS warning light will come on when the ignition is first turned on, and stay on briefly as a bulb check. If the bulb does not come on during starting, have the bulb repaired promptly. This light also illuminates to indicate that the Antilock Brake System self-check is in process at vehicle start-up.

If the light remains on after start-up, or comes on and stays on at road speeds, it may indicate that the ABS has detected a malfunction or has become inoperative. In this case, the system reverts to standard non-antilock brakes.

Turn the engine off and on again to reset the Antilock Brake System. If the light remains on, see your authorized dealer. If both the red BRAKE and amber ABS warning lights are on, see your authorized dealer immediately.

20. Fuel Gage

The pointer shows the level of fuel in the fuel tank when the ignition key is in the ON position. A small arrow indicates the side of the vehicle where the filler cap (gas cap) is located.

21. Low Fuel Warning Light

 When the fuel level reaches approximately 1.5 U.S. Gallons (6L) this light will come on and remain on until fuel is added. The “Low Fuel Warning Light” may turn on and off again, especially during and after hard braking, accelerations, or turns. This occurs due to the shifting of the fuel in the tank.

Your vehicle has a programmable electronic feature that will sound a chime when the “Low Fuel Warning Light” comes on. See the information on “Overhead Console — Customer Programmable Features” in Section 3 to turn this feature on.

22. Fog Light Indicator Light

 This light shows when the fog lamps are on.

23. Brake Warning Light

BRAKE The red BRAKE warning light will come on when the ignition is first turned on, and stay on briefly as a bulb check. If the bulb does not come on during starting, have the bulb repaired promptly. If the light stays on longer, it may be an indication that the parking brake has not been released.

If the light remains on when the parking brake is off, it indicates a possible brake hydraulic system malfunction or low fluid level. In this case, the light will remain on until the cause is corrected. If a brake malfunction is indicated, immediate repair is necessary and continued operation of the vehicle in this condition is dangerous.

ELECTRONIC DIGITAL CLOCK

The clock and radio each use the display panel built into the radio. A digital readout shows the time in hours and minutes whenever the ignition switch is in the ON or ACC position and the time button is pressed.

When the ignition switch is in the OFF position, or when the radio frequency is being displayed, time keeping is accurately maintained.

Clock Setting Procedure

1. Turn the ignition switch to the ON or ACC position and press the time button. Using the tip of a ballpoint pen or similar object, press either the hour (H) or minute (M) buttons on the radio.
2. Press the H button to set hours or the M button to set minutes. The time setting will increase each time you press a button.

RADIO GENERAL INFORMATION

Radio Broadcast Signals

Your new radio will provide excellent reception under most operating conditions. Like any system, however, car radios have performance limitations, due to mobile operation and natural phenomena, which might lead you to believe your sound system is malfunctioning. To help you understand and save you concern about these “apparent” malfunctions, you must understand a point or two about the transmission and reception of radio signals.

Two Types of Signals

There are two basic types of radio signals... AM or Amplitude Modulation, in which the transmitted sound causes the amplitude, or height, of the radio waves to vary... and FM or Frequency Modulation, in which the frequency of the wave is varied to carry the sound.

Electrical Disturbances

Radio waves may pick up electrical disturbances during transmission. They mainly affect the wave amplitude, and thus remain a part of the AM reception. They interfere very little with the frequency variations that carry the FM signal.

AM Reception

AM sound is based on wave amplitude, so AM reception can be disrupted by such things as lightning, power lines and neon signs.

FM Reception

Because FM transmission is based on frequency variations, interference that consists of amplitude variations can be filtered out, leaving the reception relatively clear, which is the major feature of FM radio.

SALES CODE RBK—AM/ FM STEREO RADIO WITH CD PLAYER AND CD CHANGER CONTROLS

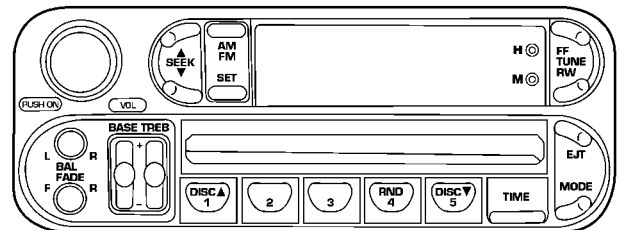

80e571f6

Radio Operation

Power/Volume Control

Press the ON/VOL control to turn the radio on. Turn the volume control clockwise to increase the volume.

NOTE: Power to operate the radio is supplied through the ignition switch. It must be in the ON or ACC position to operate the radio.

Seek

Press and release the SEEK button to search for the next station in either the AM or FM mode. Press the top of the button to seek up and the bottom to seek down. The radio will remain tuned to the new station until you make another selection. Holding the button in will bypass stations without stopping until you release it.

Tune

Press the TUNE control up or down to increase or decrease the frequency. If you press and hold the button, the radio will continue to tune until you release the button. The frequency will be displayed and continuously updated while the button is pressed.

Balance

The Balance control adjusts the left-to-right speaker balance. Press the BAL button in and it will pop out. Adjust the balance and push the button back in.

Fade

The Fade control provides for balance between the front and rear speakers. Press the FADE button in and it will pop out. Adjust the balance and push the button back in.

Bass and Treble Tone Control

The tone controls consist of 2 separate bands. The bass band is on the left, and the treble band is on the right. Each band is adjusted by a slider control with a detent at the mid-position. Moving the control up or down increases or decreases amplification of that band. The mid position provides a balanced output.

AM/FM Selection

Press the AM/FM button to change from AM to FM. The operating mode will be displayed next to the station frequency. The display will show ST when a stereo station is received.

To Set The Radio Push-Button Memory

When you are receiving a station that you wish to commit to push-button memory, press the SET button. SET 1 will show in the display window. Select the "1-5" button you wish to lock onto this station and press and release that button. If a button is not selected within 5 seconds after pressing the SET button, the station will continue to play but will not be locked into push-button memory.

You may add a second station to each push-button by repeating the above procedure with this exception: Press the SET button twice and SET 2 will show in the display window. Each button can be set for SET 1 and SET 2 in

both AM and FM. This allows a total of 10 AM and 10 FM stations to be locked into push-button memory. The stations stored in SET 2 memory can be selected by pressing the push-button twice. Every time a preset button is used a corresponding button number will be displayed.

Time

Press the TIME button to change the display between radio frequency and time.

General Information

This radio complies with Part 15 of FCC rules and with RSS-210 of Industry Canada. Operation is subject to the following conditions:

1. This device may not cause harmful interference,
2. This device must accept any interference received, including interference that may cause undesired operation.

NOTE: Changes or modifications not expressly approved by the party responsible for compliance could void the user's authority to operate the equipment.

CD Player Operation

NOTE: The ignition switch must be in the ON or ACC position and the volume control ON before the CD player will operate.

Inserting The Compact Disc

CAUTION!

This CD player will accept 4 ¾ inch (12 cm) discs only. The use of other sized discs may damage the CD player mechanism.

You may either insert or eject a disc with the radio OFF.

If you insert a disc with the ignition ON and the radio OFF, the display will show the time of day.

If the power is ON, the unit will switch from radio to CD mode and begin to play when you insert the disc. The display will show the track number and index time in minutes and seconds. Play will begin at the start of track one.

Seek

Press the top of the SEEK button for the next selection on the CD. Press the bottom of the button to return to the beginning of the current selection, or return to the beginning of the previous selection if the CD is within the first second of the current selection.

EJT — Eject

Press the EJT button and the disc will unload and move to the entrance for easy removal. The unit will switch to the radio mode.

If you do not remove the disc within 15 seconds, it will be reloaded. The unit will continue in radio mode.

The disc can be ejected with the radio and ignition OFF.

FF/TUNE/RW

Press FF (Fast Forward) and the CD player will begin to fast forward until FF is released. The RW (Reverse) button works in a similar manner.

Random Play — RND/Program Button 4

Press the RND (button 4) button while the CD is playing to activate Random Play. This feature plays the tracks on the selected disc in random order to provide an interesting change of pace.

Press the SEEK button to move to the next randomly selected track.

Press the RND (button 4) button a second time to stop Random Play.

Mode

Press the MODE button repeatedly to select between the CD player, the optional remote CD changer and the Satellite Radio (if equipped). When Satellite Radio (if equipped) is selected "SA" will appear in your radio display.

A CD or tape may remain in the player while in the Satellite mode.

Time

Press the TIME button to change the display from elapsed CD playing time to time of day.

CD Changer Control Capability — If Equipped

This radio is compatible with a remote mounted CD changer available through Mopar Accessories. The following instructions are for the radio controls that operate this CD changer.

Mode Button

To activate the CD changer, press the MODE button until CD information appears on the display.

Push-Button

While the CD changer is playing, press the NUMBER 1 push-button or the NUMBER 5 push-button to select a disc numbered higher or lower than the one currently being played.

Seek Button

Press the SEEK up or down to select another track on the same disc. A SEEK symbol will appear on the display.

Fast Forward And Rewind Buttons

Press and hold the FF button for fast forward. Press and hold the RW button for fast reverse.

The audio output can be heard when fast forward and fast reverse are activated.

Random Play (RND)

Press the Random button to play the tracks on the selected disc in random order for an interesting change of pace.

Random can be cancelled by pressing the button a second time or by ejecting the CD from the changer.

CD Diagnostic Indicators

When driving over a very rough road, the CD player may skip momentarily. Skipping will not damage the disc or the player, and play will resume automatically.

As a safeguard and to protect your CD player, one of the following warning symbols may appear on your display.

A CD HOT symbol indicates the player is too hot.



CD HOT will pause the operation. Play can be resumed when the operating temperature is corrected or another MODE is selected.

An ERR symbol will appear on the display if the laser is unable to read the Disc data for the following reasons:

- Excessive vibration
- Disc inserted upside down
- Damaged disc
- Water condensation on optics

Radio Display Messages

Your radio has been designed to display certain messages when a problem is detected with the CD player.

DISPLAY	EXPLANATION	WHAT TO DO
E-01	Deadlock problem	See your dealer for service
E-02	Disc eject problem	See your dealer for service
E-06	Elevator problem	See your dealer for service
E-07	Magazine eject problem	Check that magazine is OK- if not see your dealer for service
	No discs in magazine.	Load discs in magazine.
	Player overheating.	Allow to cool down.

805c2ab6

SALES CODE RBP—AM & FM STEREO RADIO WITH CASSETTE TAPE PLAYER, CD PLAYER, AND OPTIONAL CD/DVD CHANGER CONTROLS

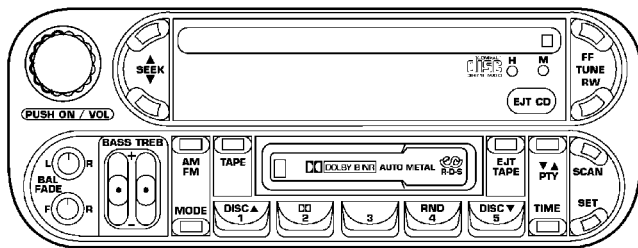

80e7c9a0

Radio Operation

Power/Volume Control

Press the ON/VOL control to turn the radio on. Turn the volume control to the right to increase the volume.

NOTE: Power to operate the radio is supplied through the ignition switch. It must be in the ON or ACC position to operate the radio.

PTY (Program Type) Button

Pressing this button once will turn on the PTY mode for 5 seconds. If no action is taken during the 5 second time out the PTY icon will turn off. Pressing the PTY button within 5 seconds will allow the program format type to be selected. Many radio stations do not currently broadcast PTY information.

Toggle the PTY button to select the following format types:

Program Type	Radio Display
Adult Hits	Adlt Hit
Classical	Classicl
Classic Rock	Cls Rock
College	College
Country	Country
Information	Inform

Program Type	Radio Display
Jazz	Jazz
Foreign Language	Language
News	News
Nostalgia	Nostalgia
Oldies	Oldies
Personality	Persnlty
Public	Public
Rhythm and Blues	R & B
Religious Music	Rel Musc
Religious Talk	Rel Talk
Rock	Rock
Soft	Soft
Soft Rock	Soft Rck
Soft Rhythm and Blues	Soft R&B
Sports	Sports
Talk	Talk
Top 40	Top 40
Weather	Weather

By pressing the SEEK button when the PTY icon is displayed, the radio will be tuned to the next frequency station with the same selected PTY name. The PTY function only operates when in the FM and Satellite (if equipped) modes.

The radio display will flash "SEEK" and the selected PTY program type when searching for the next PTY station. If no station is found with the selected PTY program type, the radio will return to the last preset station.

If a preset button is activated while in the PTY (Program Type) mode, the PTY mode will be exited and the radio will tune to the preset station.

Pressing PTY, then SCAN will scan the FM Band and stop at all RDS stations that broadcast the station type. Each RDS station will be played for a 5 second scan once around the FM Band and stop at the last station. The PTY icon will then turn off.

Seek

Press and release the SEEK button to search for the next station in either the AM or FM mode. Press the top of the button to seek up and the bottom to seek down. The radio will remain tuned to the new station until you make another selection. Holding the button in will bypass stations without stopping until you release it.

Scan

Press and release the SCAN button to search for the next station in either the AM or FM mode. The radio will pause for 5 seconds at each listenable station before continuing to the next. To stop the search, press the SCAN button a second time.

Tune

Press the TUNE control up or down to increase or decrease the frequency. If you press and hold the button, the radio will continue to tune until you release the button. The frequency will be displayed and continuously updated while the button is pressed.

Balance — BAL

The Balance control adjusts the left-to-right speaker balance. Press the BAL button in and it will pop out. Adjust the balance and push the button back in.

Fade

The Fade control provides for balance between the front and rear speakers. Press the FADE button in and it will pop out. Adjust the balance and push the button back in.

Tone Control

The tone controls affect the BASS and TREBLE frequency bands. Each is controlled by a slider control with a detent at the mid position. Moving a control up or down increases or decreases amplification of the band. The mid position provides a balanced output.

AM/FM Selection

Press the AM/FM button to toggle between AM and FM mode. The operating mode will be displayed next to the station frequency. The display will show "ST" when a stereo station is received (FM only).

To Set The Radio Push-Button Memory

When you are receiving a station that you wish to commit to push-button memory, press the SET button. SET 1 will now show in the display window. Select the "1-5" button you wish to lock onto this station and press and release that button. If a button is not selected within 5 seconds after pressing the SET button, the station will continue to play but will not be locked into push-button memory.

You may add a second station to each push-button by repeating the above procedure with this exception: Press the SET button twice and SET 2 will show in the display window. Each button can be set for SET 1 and SET 2 in both AM and FM. This allows a total of 10 AM and 10 FM stations to be locked into push-button memory. The stations stored in SET 2 memory can be selected by pressing the push-button twice.

Time

Press the TIME button to change the display between radio frequency and time.

To set the clock, use a ballpoint pen or similar object to press the hour (H) or minute (M) buttons on the radio. The time setting will increase each time you press the button. Press any other button to exit from the clock setting mode.

General Information

This radio complies with Part 15 of FCC rules and with RSS-210 of Industry Canada. Operation is subject to the following conditions:

1. This device may not cause harmful interference,
2. This device must accept any interference received, including interference that may cause undesired operation.

NOTE: Changes or modifications not expressly approved by the party responsible for compliance could void the user's authority to operate the equipment.

Tape Player Operation

Insert the cassette with the exposed tape side toward the right and the mechanical action of the player will gently pull the cassette into the play position.

NOTE: When subjected to extremely cold temperatures, the tape mechanism may require a few minutes to warm up for proper operation. Sometimes poor playback may be experienced due to a defective cassette tape. Clean and demagnetize the tape heads at least twice a year.

Tape Side — $\nabla\Delta$ /PTY

Pressing the $\nabla\Delta$ button during tape mode will cause the other side of the tape to be played. The display will confirm the selected tape play direction. The time is always displayed.

Tape

Press the TAPE button to select the Tape mode.

Seek

Press the SEEK button up for the next selection on the tape and down to return to the beginning of the current selection.

Press the SEEK button up or down to move the track number to skip forward or backward 1 to 7 selections. Press the SEEK button once to move 1 selection, twice to move 2 selections, etc. the display will show the total number of times the SEEK button was pushed. The SEEK function will be cancelled by pressing either the FF/RW or AM/FM button.

Fast Forward — FF

Press the FF button up momentarily to advance the tape in the direction that it is playing. The tape will advance until the button is pressed again or the end of the tape is reached. At the end of the tape, the tape will play in the opposite direction.

Rewind — RW

Press the RW button down momentarily to reverse the tape direction. The tape will rewind until the button is pressed again or until the beginning of the tape is reached. At the beginning of the tape, the tape will play in the opposite direction.

EJT Tape

Press the EJT TAPE button and the cassette will disengage and eject from the radio.

Metal Tape Selection (70µs)

If a standard 70 µ (metal) tape is inserted into the player, the player will automatically select the correct equalization.

Pinch Roller Release

If ignition power or the radio ON/OFF switch are turned off, the pinch roller will automatically retract to protect

the tape from any damage. When power is restored to the tape player, the pinch roller will automatically reengage and the tape will resume play.

Dolby Noise Reduction

The Dolby Noise Reduction System* is on whenever the tape player is on, but may be switched on/off.

To turn the Dolby Noise Reduction System on/off: Press the Dolby NR button (button 2) after you insert the tape. The NR light in the display will go off when the Dolby System is off.

* "Dolby" noise reduction manufactured under license from Dolby Laboratories Licensing Corporation. Dolby and the double-D symbol are trademarks of Dolby Laboratories Licensing Corporation.

CD Player Operation

NOTE: The ignition switch must be in the ON or ACC position and the volume control ON before the CD player will operate.

Inserting The Compact Disc

You may either insert or eject a disc with the radio OFF.

If you insert a disc with the ignition ON and the radio off, the display will show CD and the time of day will be displayed.

If the power is on, the unit will switch from radio to CD mode and begin to play when you insert the disc. The display will show the track number and index time in minutes and seconds. Play will begin at the start of track 1.

Seek

Press the top of the SEEK button for the next selection on the CD. Press the bottom of the button to return to the

beginning of the current selection, or return to the beginning of the previous selection if the CD is within the first second of the current selection.

Scan

Press the SCAN button to play 10 seconds of each selection. Press the SCAN button a second time to cancel this feature.

EJT CD

Press the EJT CD button and the disc will unload and move to the entrance for easy removal. The unit will switch to the radio mode.

If you do not remove the disc within 15 seconds, it will be reloaded. The unit will continue in radio mode.

The disc can be ejected with the radio and ignition off.

FF/TUNE/RW

Press FF (Fast Forward) and the CD player will begin to fast forward until FF is released. The RW (Reverse) button works in a similar manner.

Random Play — RND/Program Button 4

Press the RND (button 4) button while the CD is playing to activate Random Play. This feature plays the selections on the compact disc in random order to provide an interesting change of pace.

Press the top of the SEEK button to move to the next randomly selected track.

Press the RND (button 4) button a second time to stop Random Play.

MODE

Press the MODE button to select between the CD player, remote CD/DVD changer (if equipped), or satellite radio (if equipped).

To select Satellite Radio (if equipped), press the MODE button until the word SIRIUS™ appears. The following will be displayed in this order: After three seconds, the current channel name and number will be displayed for five seconds. The current program type and channel number will then be displayed for five seconds. The current channel name and number will then be displayed until an action occurs. A CD or tape may remain in the player while in the Satellite Radio mode.

Time

Press the TIME button to change the display from elapsed CD playing time to time of day.

CD/DVD Changer Operation — If Equipped**MODE**

Press the MODE button to select between the CD player, and the CD/DVD changer (if equipped).

Disc Up/Program Button 1

Press the DISC (button 1) button to play the next available disc.

Random Play — RND/Program Button 4

Press the RND (button 4) button while the CD is playing to activate Random Play. This feature plays the selections on the currently playing compact disc in random order to provide an interesting change of pace.

Press the top of the SEEK button to move to the next randomly selected track.

Press the RND (button 4) button a second time to stop Random Play.

FF/RW — TUNE

Press and hold the FF button for fast forward. Press and hold the RW button for fast reverse. The audio output can be heard when fast forward and fast reverse are activated.

Disc Down/Program Button 5

Press the DISC (button 5) button to play the previous disc.

Seek

Press the top of the SEEK button for the next selection on the CD. Press the bottom of the button to return to the beginning of the current selection, or return to the beginning of the previous selection if the CD is within the first second of the current selection.

Time

Press the TIME button to switch between time of day and CD track time.

Scan

Press the SCAN button to play 10 seconds of each track. Press the SCAN button a second time to cancel the feature.

SALES CODE RB1—AM/FM STEREO RADIO WITH DVD/GPS NAVIGATION SYSTEM

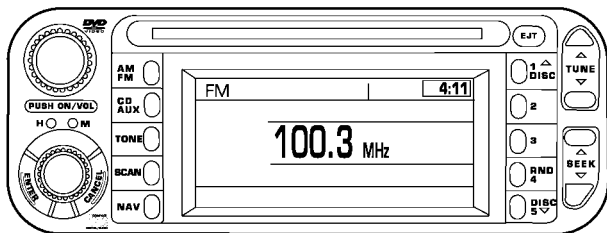

810774da

The navigation system provides maps, turn identification, selection menus and instructions for selecting a variety of destinations and routes. Refer to your “Navigation User’s Manual” for detailed operating instructions.

SATELLITE RADIO — IF EQUIPPED

Satellite radio uses direct satellite to receive broadcasting technology to provide clear digital sound, coast to coast. The subscription service provider is Sirius™ Satellite Radio. This service offers up to 100 channels of music, sports, news, entertainment, and programming for children, directly from its satellites and broadcasting studios.

System Activation

To activate your Sirius Satellite Radio service, call the toll-free number 888-539-7474, or visit the Sirius web site at www.sirius.com. Please have the following information available when activating your system:

1. The Electronic Serial Number/Sirius Identification Number (ESN/SID).
2. Credit card information.
3. Your Vehicle Identification Number.

Electronic Serial Number/Sirius Identification Number (ENS/SID)

The Electronic Serial Number/Sirius Identification Number is needed to activate your Sirius Satellite Radio system. To access the ESN/SID, refer to the following steps:

ESN/SID Access With RBB and RBK Radios

With the ignition switch in the ACCESSORY position and the radio OFF, press the Tape Eject or CD Eject (depending on the radio type) and Time buttons simultaneously for 3 seconds. The first four digits of the twelve-digit ESN/SID number will be displayed. Press the SEEK UP button to display the next four digits. Continue to press the SEEK UP button until all twelve ESN/SID digits have been displayed. The SEEK DOWN will page down until the first four digits are displayed. The radio will exit the ESN/SID mode when any other button is pushed, the ignition is turned OFF, or 5 minutes has passed since any button was pushed.

ESN/SID Access With RBP, RBU, RAZ, and RBQ Radios

With the ignition switch in the ACCESSORY position and the radio OFF, press the CD Eject and TIME buttons simultaneously for 3 seconds. All twelve ESN/SID numbers will be displayed. The radio will exit the ESN/SID mode when any other button is pushed, the ignition is turned OFF, or 5 minutes has passed since any button was pushed.

Selecting Satellite Mode in RBB and RBK Radios

Press the MODE button repeatedly until "S A" appears in the display. A CD or tape may remain in the radio while in the Satellite radio mode.

Selecting Satellite Mode in RBP, RBU, RAZ, and RBQ Radios

Press the MODE button repeatedly until the word "SIRIUS" appears in the display. These radios will also display the following:

- After 3 seconds, the current channel name and channel number will be displayed for 5 seconds.
- The current program type and channel number will then be displayed for 5 seconds.
- The current channel number will then be displayed until an action occurs.

A CD or tape may remain in the radio while in the Satellite radio mode.

Selecting a Channel

Press and release the SEEK or TUNE buttons to search for the next channel. Press the top of the button to search up and the bottom of the button to search down. Holding the TUNE button causes the radio to bypass channels until the button is released.

Press and release the SCAN button (if equipped) to automatically change channels every 7 seconds. The radio will pause on each channel for 7 seconds before moving on to the next channel. The word "SCAN" will appear in the display between each channel change. Press the SCAN button a second time to stop the search.

NOTE: Channels that may contain objectionable content can be blocked. Contact Sirius Customer Care at 888-539-7474 to discuss options for channel blocking or unblocking. Please have your ESN/SID information available.

Storing and Selecting Pre-Set Channels

In addition to the 10 AM and 10 FM pre-set stations, you may also commit 10 satellite stations to push button memory. These satellite channel pre-set stations will not erase any AM or FM pre-set memory stations. Follow the memory pre-set procedures that apply to your radio.

Using the PTY (Program Type) Button (if equipped)

Follow the PTY button instructions that apply to your radio.

PTY Button "SCAN"

When the desired program type is obtained, press the "SCAN" button within five seconds. The radio will play 7 seconds of the selected channel before moving to the next channel of the selected program type. Press the "SCAN" button a second time to stop the search.

NOTE: Pressing the "SEEK" or "SCAN" button while performing a music type scan will change the channel by one and stop the search. Pressing a pre-set memory button during a music type scan, will call up the memory channel and stop the search.

PTY Button "SEEK"

When the desired program is obtained, press the "SEEK" button within five seconds. The channel will change to the next channel that matches the program type selected.

Satellite Antenna

To ensure optimum reception, do not place items on the roof around the rooftop antenna location. Metal objects placed within the line of sight of the antenna will cause decreased performance. Larger luggage items should be placed as far forward as possible. Do not place items directly on or above the antenna.

Reception Quality

Satellite reception may be interrupted due to one of the following reasons.

- The vehicle is parked in an underground parking structure or under a physical obstacle.
- Dense tree coverage may interrupt reception in the form of short audio mutes.
- Driving under wide bridges or along tall buildings can cause intermittent reception.
- Placing objects over or too close to the antenna can cause signal blockage.

10-DISC REMOTE CD CHANGER**Loading the CD Changer****Removing the CD Changer Magazine**

NOTE: Always keep the CD changer door closed except when ejecting or installing the magazines. The door is designed to keep dust, dirt, and foreign objects out of the CD changer. Handle the magazine with reasonable care. The magazine may crack if dropped or knocked against a hard surface.

1. Open the CD changer compartment located in the right rear cargo area.

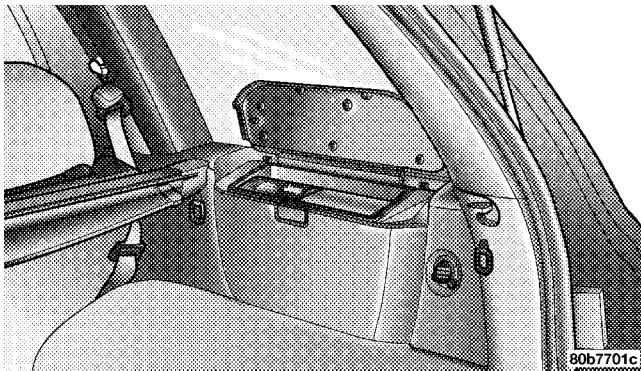

2. Slide the CD changer door all the way to the right.

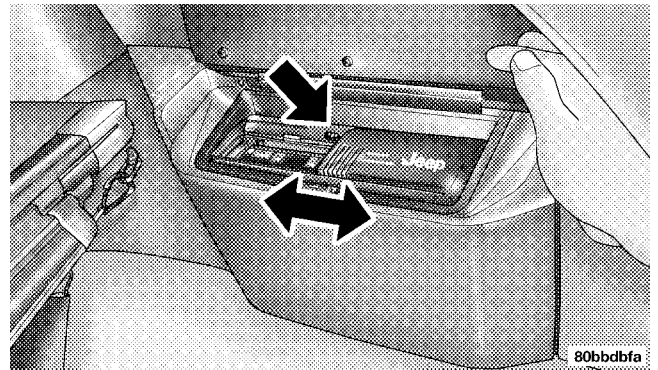

3. Press the EJECT button.

4. Gently remove the magazine by pulling it up and out of the CD changer.

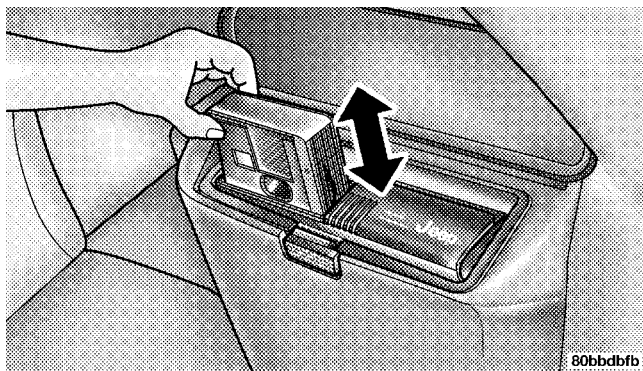

5. Close the CD changer door by sliding it to the left.

Loading Discs into the Magazine

Gently slide the discs into the magazine with the disc label in the direction indicated on the magazine label (up to 10 discs). If the discs are installed upside down "CD Err" will be displayed on the radio.

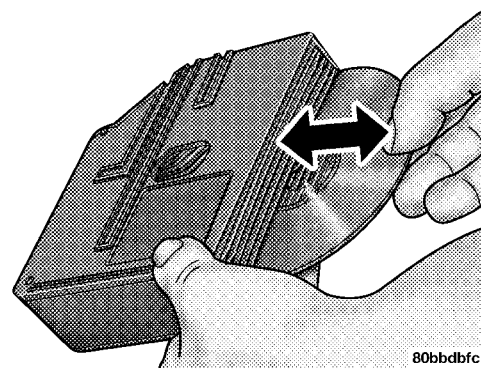

NOTE: Do not use 3 inch (8 cm) discs in the magazine. If a CD adaptor for 3 inch (8 cm) discs is used, the disc will not be ejected.

Removing Discs from the Magazine

To remove the disc, gently press on the exposed edge of the disc. There is a light spring tension holding the disc in place.

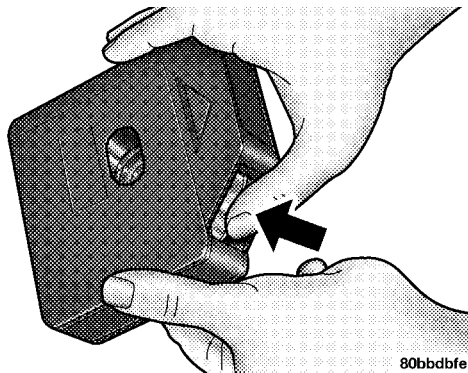

NOTE: Do not attempt to disassemble the magazine.

Installing the CD Changer Magazine

1. Open the CD changer compartment located in the right rear cargo area.
2. Slide the CD changer door all the way to the right to access the magazine slot.

3. Insert the magazine into the changer slot with the writing on the magazine label facing in the same direction as the word **Jeep**® on the changer door (disc loading slots facing to the right).

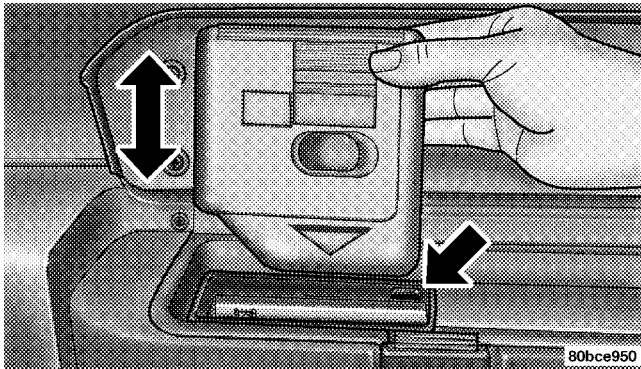

4. Slide the changer door to the left to close the changer door.

REMOTE SOUND SYSTEM CONTROLS — IF EQUIPPED

The remote sound system controls are located on the rear surface of the steering wheel. Reach behind the wheel to access the switches.

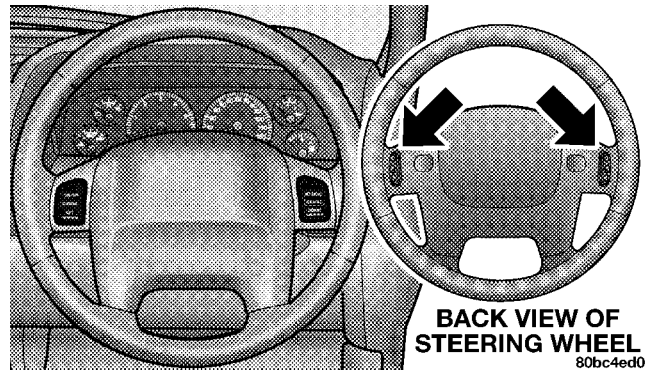

The right hand control is a rocker type switch with a push-button in the center and controls the volume and

mode of the sound system. Pressing the top of the rocker switch will increase the volume and pressing the bottom of the rocker switch will decrease the volume.

Pressing the center button will make the radio switch between the various modes available (AM/FM/TAPE/CD, Etc.).

The left hand control is a rocker type switch with a push-button in the center. The function of the left hand control is different depending on which mode you are in.

The following describes the left hand control operation in each mode.

Radio Operation

Pressing the top of the switch will "Seek" up for the next listenable station and pressing the bottom of the switch will "Seek" down for the next listenable station.

The button located in the center of the left hand control will tune to the next preset station that you have programmed in the radio preset push-button.

Tape Player

Pressing the top of the switch once will go to the next selection on the cassette. Pressing the bottom of the switch once will go to the beginning of the current selection or to the beginning of the previous selection if it is within the first 5 seconds of the current selection.

If you press the switch up or down twice it plays the second selection, three times, it will play the third, etc.

The button in the center of the left hand switch switches the side of the tape to be played.

CD Player — Single Disc in Radio

Pressing the top of the switch once will go to the next track on the CD. Pressing the bottom of the switch once will go to the beginning of the current track or to the beginning of the previous track if it is within one second after the current track begins to play.

If you press the switch up or down twice it plays the second track, three times, it will play the third, etc.

The button in the center of the left hand switch has no function in this mode.

CD Player — 10 Disc in Cargo Area

Pressing the top of the switch once will go to the next track on the CD. Pressing the bottom of the switch once will go to the beginning of the current track or to the beginning of the previous track if it is within one second after the current track begins to play.

If you press the switch up or down twice it plays the second track, three times, it will play the third, etc.

The button in the center of the left hand switch will cause the CD changer to play the next available disc in the 10-disc magazine.

The center button will skip to the next CD in the 10-disc magazine.

CASSETTE TAPE AND PLAYER MAINTENANCE

To keep the cassette tapes and player in good condition, take the following precautions:

1. Do not use cassette tapes longer than C-90; otherwise, sound quality and tape durability will be greatly diminished.
2. Keep the cassette tape in its case to protect from slackness and dust when it is not in use.

3. Keep the cassette tape away from direct sunlight, heat and magnetic fields such as the radio speakers.
4. Before inserting a tape, make sure that the label is adhering flatly to the cassette.
5. A loose tape should be corrected before use. To rewind a loose tape, insert the eraser end of a pencil into the tape drive gear and twist the pencil in the required directions.

Maintain your cassette tape player. The head and capstan shaft in the cassette player can pick up dirt or tape deposits each time a cassette is played. The result of deposits on the capstan shaft may cause the tape to wrap around and become lodged in the tape transport. The other adverse condition is low or "muddy" sound from one or both channels, as if the treble tone control were turned all the way down. To prevent this, you should periodically clean the head with a commercially available WET cleaning cassette.

As preventive maintenance, clean the head about every 30 hours of use. If you wait until the head becomes very dirty (noticeably poor sound), it may not be possible to remove all deposits with a simple WET cleaning cassette.

CD/DVD DISC MAINTENANCE

To keep the CD/DVD discs in good condition, take the following precautions:

4

1. Handle the disc by its edge; avoid touching the surface.
2. If the disc is stained, clean the surface with a soft cloth, wiping from center to edge.
3. Do not apply paper, paper CD labels, or tape to the disc; avoid scratching the disc.
4. Do not use solvents such as benzine, thinner, cleaners, or antistatic sprays.
5. Store the disc in its case after playing.

6. Do not expose the disc to direct sunlight.
7. Do not store the disc where temperatures may become too high.

RADIO OPERATION AND CELLULAR PHONES

Under certain conditions, the cellular phone being On in your vehicle can cause erratic or noisy performance from your radio. This condition may be lessened or eliminated by relocating the cellular phone antenna. This condition is not harmful to the radio. If your radio performance does not satisfactorily “clear” by the repositioning of the antenna, it is recommended that the radio volume be turned down or off during cellular phone operation.

CLIMATE CONTROLS

Air Conditioning

The controls for the heating/air conditioning and ventilation system in this vehicle consist of a series of rotary knobs. These comfort controls can be set to obtain desired interior conditions.

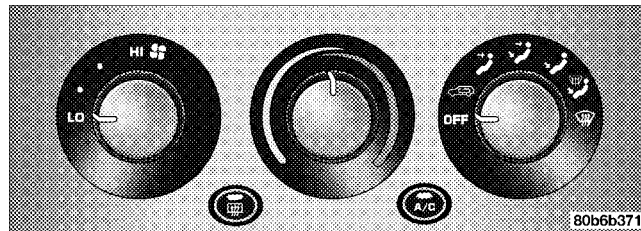

Air conditioning can be obtained by depressing the “A/C” button on the control panel and setting the appropriate rotary knobs to obtain the desired comfort level.

Blower Control

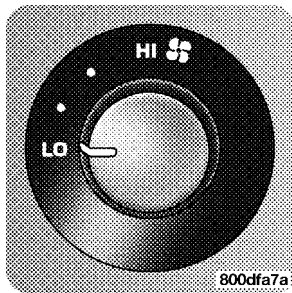

The rotary knob on the left controls the blower and can be set in one of four positions from LO to HI. **The blower fan motor will remain on until the system is turned to the OFF position or the ignition is turned OFF.**

Temperature Control

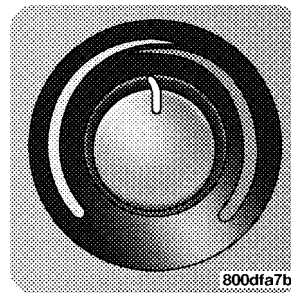

The degree of comfort can be selected by rotating the temperature control knob in the center. The coldest temperature setting is on the extreme left and the warmest setting is on the extreme right of the rotation. The knob can be positioned at any point on the dial.

Mode Selection

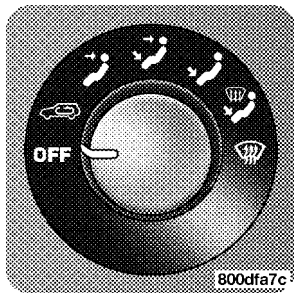

The mode selector (the right rotary knob) can be set in any of the following positions:

OFF

This position turns off the blower motor and outside air will not pass through any outlets.

Recirculation

 The recirculation feature can be selected with the mode control knob. Outside air is normally drawn into the vehicle in all of the other modes, such as panel air, bi-level, floor, floor/defrost, and the defrost air

distribution outlets. Air flows through the outlets located in the instrument panel. Use this mode to rapidly cool the inside of the vehicle. The Recirculation mode can also be used to temporarily block out outside odors, smoke, and dust.

Panel

 Air flows through the outlets located in the instrument panel.

Bi-Level

 Air flows both through the outlets located in the instrument panel and those located on the floor.

Floor

 Air flows through the floor outlets located under the instrument panel and into the rear seating area through vents under the front seats.

Defrost/Floor

 Air flows through the front and rear floor outlets and the outlets at the base of the windshield.

Defrost

 Air is directed to the windshield through the outlets at the base of the windshield.

NOTE: To improve fuel economy, leave in defrost only when necessary.

Infrared Dual-Zone Climate Control — If Equipped

The Infrared Dual-Zone Climate Control System automatically maintains the interior comfort level desired by the driver and passenger. This is accomplished by using a dual infrared sensor located in the face of the control unit. The dual infrared sensor independently measures the surface temperature of the driver and passenger. Based on the sensor input, the system automatically adjusts the air flow temperature, the air flow volume, and

amount of outside air recirculation. This maintains a comfortable temperature even under changing conditions.

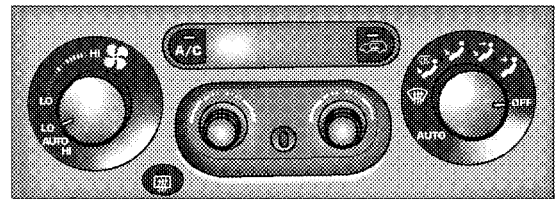

80b6b2d9

Operation of the system is quite simple. Begin by turning the right mode knob to AUTO. Dial in the temperature you would like the system to maintain by rotating the driver's or passenger's control knob. Once the comfort

level is displayed the system will maintain that level automatically using the heating system. Should the desired comfort level require air conditioning, the system will automatically make the adjustment.

You may notice the blower speed getting lower as the difference between the driver and passenger temperature settings gets larger. This is an extreme condition and the airflow may not perform as anticipated.

The temperature can be displayed in U.S. or Metric by selecting the US/M customer programmable feature. Refer to the “Overhead Console-Customer Programmable Features” in Section 3 of this manual.

The left knob controls the blower fan. Within the AUTO setting on this control, you can select a HI volume of air from the blower or a LO volume. Once the system is set up for your comfort level, it is not necessary to change the setting. You will experience the greatest efficiency by simply allowing the system to function automatically.

Manual Operation

However, this system does offer a full complement of manual override features. There is a manual blower range used when the AUTO setting is not desired. The left control can be set to any fixed blower speed by rotating the knob from LO to HI on the upper portion of the dial.

The operator can override the AUTO mode setting and select the direction of the air by rotating the right mode knob to one of the following positions.

- **Defrost**



Air is directed to the windshield through the outlets at the base of the windshield.

- **Defrost/Floor**



Air flows through the front and rear floor outlets and the outlets at the base of the windshield.

- **Floor**



Air flows through the floor outlets located under the instrument panel and into the rear seating area through vents under the front seats.

- **Bi-Level**



Air flows both through the outlets located in the instrument panel and those located on the floor.

- **Panel**



Air flows through the outlets located in the instrument panel.

- **OFF**

This position turns off the entire system.

Depress the A/C button to turn on and off the air conditioning during manual operation only. Conditioned outside air is then directed through the outlets selected on the mode control dial.

When the outside air contains smoke, odors, high humidity, or if rapid cooling is desired you may wish to recirculate interior air by pressing the “Recirculate” icon button. The recirculation mode should only be used temporarily. The light on the A/C and “Recirculate” icon buttons will illuminate when these buttons are selected. You may use these features separately or with one another. Push in on the buttons a second time to change the functions.

NOTE: If the interior of the windows begins to fog, press the “Recirculate” icon button to return to outside air. Some temp./humidity conditions will cause captured interior air to condense on windows and hamper visibility. For this reason, the system will not allow “Recirculate” to be selected while in the defrost or defrost/floor modes.

To provide you with maximum comfort in the automatic mode, during cold start-ups the blower fan will remain

off until the engine warms up. However, the fan will engage immediately if the defrost mode is selected or if you select a fixed blower speed.

Window Fogging

Vehicle windows tend to fog on the inside in mild rainy or humid weather. To clear the windows, use the A/C, panel, and blower controls. Direct the panel outlets toward the side windows. Recirculate without A/C should not be used for long periods as fogging may occur. Interior fogging on the windshield can be quickly removed by using the defrost mode.

REAR WINDOW FEATURES

Rear Window Wiper/Washer

A switch on the right side of the steering column controls operation of the rear wiper/washer function. Rotating the center of the switch up to the DEL (Delay) position or the ON position will activate the wiper. Push the lever forward to initiate the wash function in any of the three

positions. The wash pump will continue to operate as long as the button is pressed. Upon release, the wipers will cycle three times before returning to the set position.

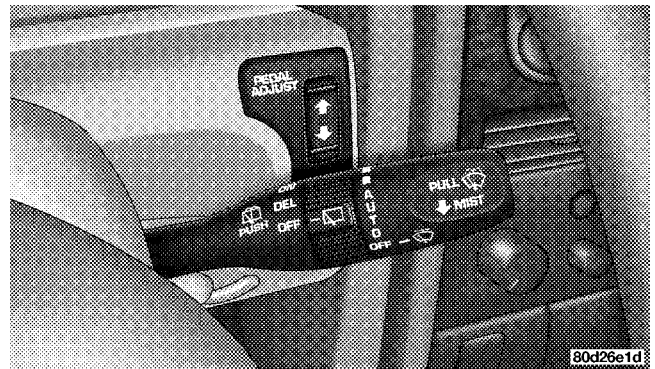

If the rear wiper is operating when the ignition is turned OFF, the wiper will automatically return to the "Park" position.

If the liftgate flipper glass is open, connection to the rear window wiper is interrupted preventing activation of the rear wiper blade. When the liftgate flipper glass is closed, the rear wiper switch or the ignition switch needs to be turned OFF and ON to restart the rear wiper.

Adding Washer Fluid

The fluid reservoir for the windshield washers and the rear window washer is shared. It is located in the front of the engine compartment on the passenger side and should be checked for fluid level at regular intervals. Fill the reservoir with windshield washer solvent (not radiator antifreeze) and operate the system for a few seconds to flush out the residual water.

Rear Window Defroster

 In the lower left of the climate control panel is a push button for rear window defrosting. An amber indicator in the push button will light when the defroster is turned on. Push again to turn off the defroster prior to an automatic time-out.

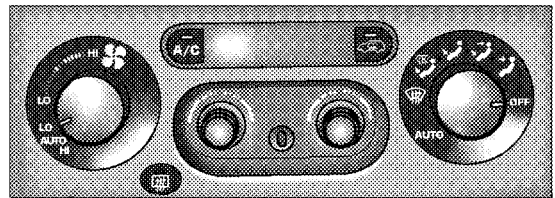

The defroster will automatically turn off after about ten minutes. For about five more minutes of operation, push the button again. To prevent excessive battery drain, use the defroster only when the engine is operating. The push button also activates the heated exterior mirrors, if so equipped.

CAUTION!

Use care when washing the inside of the rear window to prevent damage to heating elements. Use a soft cloth and a mild washing solution, wiping parallel to the heating elements. Also, keep all objects a safe distance from the window to prevent damaging the heating elements.

STARTING AND OPERATING

CONTENTS

■ Starting Procedures	176	□ Electronically Controlled Five Speed Automatic Transmission (4.7L Engine Only)	180
□ Normal Starting	176	□ Protect Mode - Electronically Controlled Transmission (4.7L Engine Only)	180
□ Extreme Cold Weather (Below -20°F (-29°C) . . .	177	□ Gear Ranges	181
□ If Engine Fails To Start	177	□ Over Temperature Mode	185
□ After Starting	178	□ Torque Converter Clutch	185
■ Engine Block Heater — If Equipped	178	□ Rocking The Vehicle	186
■ Automatic Transmission	179	■ Four-Wheel Drive Operation	186
□ Brake Transmission Shift Interlock System (BTSI)	180		

174 STARTING AND OPERATING

□ Selec-Trac® Operating Instructions/Precautions	186	□ When To Use 4 Lo (Low) Range	200
□ Shift Positions	188	□ In Snow, Mud And Sand	200
□ Shifting Procedure	189	□ Hill Climbing	200
□ Quadra-Trac II® Operating Instructions/Precautions — If Equipped	191	□ Traction Downhill	201
□ Shift Positions	192	□ After Driving Off-Road	202
□ Shifting Procedure	193	■ Tire Safety Information	203
□ Quadra-Drive® System — If Equipped	194	□ Tire Markings	203
■ Vari-Lok Front And Rear Axles — If Equipped	194	□ Tire Identification Number (TIN)	206
■ Parking Brake	194	□ Tire Loading And Tire Pressure	207
■ Anti-Lock Brake System	197	■ Tires — General Information	211
■ On-Road Driving Tips	199	□ Tire Inflation Pressures	212
■ Off-Road Driving Tips	200	□ High Speed Operation	213
		□ Radial-Ply Tires	214

□ Tire Spinning	214	□ MMT In Gasoline	223
□ Tread Wear Indicators	215	□ Sulfur In Gasoline	223
□ Replacement Tires	215	□ Materials Added To Fuel	224
□ Alignment And Balance	217	■ Fuel Tank Filler Cap (Gas Cap)	224
■ Tire Pressure Monitor System — If Equipped	217	■ Trailer Towing	226
□ Tire Pressure Monitor System Tire/Wheel Rotation And Sensor Replacement — If Equipped	218	□ Trailer And Tongue Weight	228
□ General Information	219	□ Cooling System Tips—Trailer Towing	229
■ Tire Chains	220	□ Minimum Vehicle Requirements For Trailer Towing	230
■ Tire Rotation Recommendations	220	■ Recreational Towing (Behind Motorhome, Etc.)	231
■ Fuel Requirements	221	□ Shifting Into Neutral (N)	232
□ Reformulated Gasoline	222	□ Shifting Out Of Neutral (N)	233
□ Gasoline/Oxygenate Blends	222	■ Snow Plow	234

STARTING PROCEDURES

Before starting your vehicle, adjust your seat, adjust both inside and outside mirrors, and fasten your seat belts.

WARNING!

Do not leave children or animals inside parked vehicles in hot weather. Interior heat build up may cause serious injury or death.

The gear selector must be in the N (Neutral) or P (Park) position before you can start the engine. Apply the brakes before shifting to any driving gear.

Normal Starting

Normal starting of either a cold or a warm engine is obtained without pumping or depressing the accelerator pedal. Turn the key to the START position and release when the engine starts. If the engine fails to start within 10 seconds, turn the key to the OFF position, wait 5 seconds, then repeat the normal starting procedure.

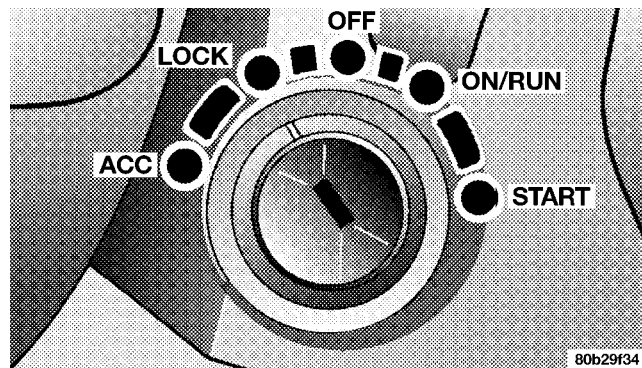

WARNING!

Never pour fuel or other flammable liquids into the throttle body air inlet opening in an attempt to start the vehicle. This could result in a flash fire causing serious personal injury.

Extreme Cold Weather (below –20°F (–29°C))

To insure reliable starting at these temperatures, use of an externally powered electric engine block heater (available from your authorized dealer) is recommended.

If Engine Fails to Start

If the engine fails to start after you have followed the “Normal Starting” or “Extreme Cold Weather” procedures, it may be flooded. Push the accelerator pedal all the way to the floor and hold it there while cranking the engine. This should clear any excess fuel in case the engine is flooded.

NOTE: To prevent damage to the starter, do not crank the engine for more than 15 seconds at a time. Wait 10 to 15 seconds before trying again.

If the engine has been flooded, it may start to run, but not have enough power to continue running when the key is released. If this occurs, continue cranking with the accelerator pedal pushed all the way to the floor. Release the accelerator pedal and the key once the engine is running smoothly.

If the engine shows no sign of starting after two 15-second periods of cranking with the accelerator pedal held to the floor, the “Normal Starting” or “Extreme Cold Weather” procedures should be repeated.

After Starting

The idle speed will automatically decrease as the engine warms up.

CAUTION!

Long periods of engine idling, especially at high engine speeds can cause excessive exhaust temperatures which can damage your vehicle. Do not leave your vehicle unattended with the engine running.

ENGINE BLOCK HEATER — IF EQUIPPED

The engine block heater warms engine coolant and permits quicker starts in cold weather. Connect the cord to a standard 110-115 volt AC electrical outlet with grounded, three wire extension cord.

Use the heater when temperatures below 0°F (-18°C) are expected to last for several days.

The engine block heater cord is located:

- 6-cylinder engine — bundled and fastened to the injector rail between injectors 1 and 2.
- V-8 engine — coiled and strapped to the transmission filler tube.

WARNING!

Remember to disconnect the cord before driving. Damage to the 110-115 volt AC electrical cord could cause electrocution.

AUTOMATIC TRANSMISSION

The pointer on the selector indicates the transmission gear range (selector is illuminated for night driving). Start the engine with the selector lever in N (Neutral) or P (Park) position.

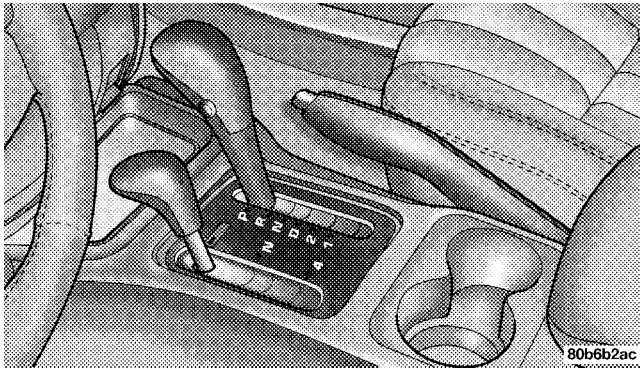

NOTE: When the ignition is in the ON position, the brake pedal must be pressed to move the gearshift lever out of P (Park).

WARNING!

It is dangerous to shift the selector lever out of “P” or “N” if the engine speed is higher than idle speed. If your foot is not firmly on the brake pedal, the vehicle could accelerate quickly forward or in reverse. You could lose control of the vehicle and hit someone or something. Only shift into gear when the engine is idling normally and when your right foot is firmly on the brake pedal.

Brake Transmission Shift Interlock System (BTSI)

This vehicle is equipped with a brake transmission shift interlock system (BTSI) that holds the gearshift lever in the P (Park) position when the ignition switch is in an unlocked position. To move the gear selector lever out of the P (Park) position, the ignition switch must be turned to the OFF, ON, or START position, the brake pedal and the button on the front side of the shifter handle must be depressed.

Electronically Controlled Five Speed Automatic Transmission (4.7L Engine Only)

This electronically controlled transmission provides a precise shift schedule. The transmission electronics are self calibrating; therefore, the first few shifts on a new vehicle may be somewhat abrupt. This is a normal condition, and precision shifts will develop within a couple hundred miles (kilometers).

Protect Mode - Electronically Controlled Transmission (4.7L Engine Only)

This transmission is monitored electronically for abnormal conditions. If an abnormal condition is detected, the transmission's electronic controller will automatically select direct gear (in the Drive position) or 2nd gear (in the 2 or 1 position). This feature will allow the vehicle to be driven to the dealer for service minimizing any damage to the transmission. Some conditions that will cause the transmission to use this alternate gear selection are momentary and the transmission can be reset to the normal shift program by performing the following:

- Stop the vehicle and shift into P (Park).
- Turn the ignition key to the OFF position and then restart the engine.
- Shift into the desire shift range and resume driving.

NOTE: Even if the transmission can be reset, it is recommended that you see your dealer at your earliest possible convenience. Your dealer has the proper diagnostic equipment to determine if the problem could recur. If the transmission cannot be reset, dealer service is required.

Gear Ranges

DO NOT race the engine when shifting from P (Park) or N (Neutral) position into another gear range.

P—Park

Supplements the parking brake by locking the transmission. The engine can be started in this range. Never use P (Park) while the vehicle is in motion. Apply the parking brake when leaving the vehicle in this range. Always apply the parking brake first, then place the selector in P (Park) position.

WARNING!

Unintended movement of a vehicle could injure those in and near the vehicle. As with all vehicles, you should never exit a vehicle while the engine is running. Before exiting a vehicle, you should always shift the vehicle into P (Park), remove the key from the ignition, and apply the parking brake. Once the key is removed from the ignition, the transmission shift lever is locked in the P (Park) position, securing the vehicle against unwanted movement. Furthermore, you should never leave children unattended inside a vehicle.

The following indicators should be used to ensure that you have engaged the transmission shift lever into the P (Park) position:

- When shifting into P (Park), depress the button on the shift lever and firmly move the lever all the way forward until it stops.
- Look at the shift indicator window on the console to ensure it is in the P (Park) position.
- When engaged in P (Park), you will not be able to move the shifter rearward without depressing the shift lever button.

CAUTION!

Before moving the shift lever out of P (Park), you must turn the ignition from LOCK to ON so steering wheel and shift lever are released. Otherwise, damage to steering column or shifter could result.

R—Reverse

Use this range only after the vehicle has come to a complete stop.

N—Neutral

Shift to N (Neutral) when the vehicle is standing for prolonged periods with the engine running. The engine may be started in this range. Set the parking brake if you must leave the vehicle.

Overdrive

D For most city and highway driving. The transmission contains electronically controlled 4th and 5th gears (Overdrives) and will automatically shift from D (Drive) to 4th and 5th gears if the following conditions are present:

- The transmission selector is in D (Drive).
- The O/D OFF switch has not been activated.

- Vehicle speed is above approximately 30 mph (48 km/h).
- Transmission has reached normal operating temperature.

When frequent transmission shifting occurs while using overdrive, such as when operating the vehicle under heavy load conditions (for example, in hilly terrain, strong head winds, or trailer towing), turning off overdrive will improve performance and extend transmission life by reducing excessive shifting and heat buildup.

4th and 5th gears (Overdrive) can be locked out by pressing the O/D OFF switch located on side of the gearshift lever. The O/D OFF indicator light will illuminate to show that the switch has been activated. When the light is on, 4th and 5th gears (Overdrive) are locked out. Pressing the switch a second time restores the Overdrive function. The lockout feature is useful when towing a trailer or carrying a heavy load.

The O/D OFF feature must be selected, if desired, each time the engine is started.

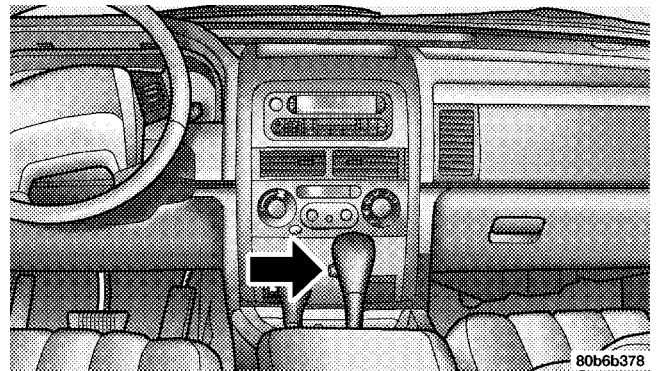

5

NOTE: If the vehicle is started in cold outside temperatures, shifts into Overdrive may be delayed (4.7L engines only). Normal Overdrive and shifting operation will resume when the temperature of the transmission

reaches the appropriate temperature. Refer to the “Note” under “Torque Converter Clutch” later in this section.

If the transmission temperature gets too hot, the transmission may downshift out of Overdrive or engage overdrive at higher vehicle speeds (4.7L engines only) until the transmission cools down. After cooldown, Overdrive will resume normal operation.

2—Second

For driving slowly in heavy city traffic or on mountain roads where more precise speed control is desirable. Use it also when climbing long grades, and for engine braking when descending moderately steep grades. To prevent excessive engine speed, do not exceed 45 mph (72 km/h) in this range.

1—First

For driving up very steep hills and for engine braking at low speeds (25 mph (40 km/h) or less) when going downhill. To prevent excessive engine speed do not exceed 25 mph (40 km/h) in this range.

CAUTION!

Never race the engine with the brakes on and the vehicle in gear, and never hold the vehicle on an incline without applying the brakes. These practices can cause overheating and damage to the transmission.

Over Temperature Mode

The transmission electronics constantly monitor the transmission oil temperature. If the transmission gets too hot, the transmission will change the way it shifts to help control the condition. This may result in a slightly different feeling or response during normal operation in D (Drive) position. If the transmission becomes hot enough the O/D OFF indicator light and TRANS OVER TEMP warning light in the instrument cluster may come on. After the transmission cools down, it will return to normal operation.

Torque Converter Clutch

A feature designed to improve fuel economy has been added to the automatic transmission of this vehicle. A clutch within the torque converter engages automatically at calibrated speeds. This may result in a slightly different feeling or response during normal operation in high gear. When the vehicle speed drops or during acceleration, the clutch automatically and smoothly disengages.

NOTE:

- The torque converter clutch will not engage until the transmission fluid and engine coolant are warm (usually after 1–3 miles (1.6–4.8 km) of driving). Because engine speed is higher when the torque converter clutch is not engaged, it may seem as if the transmission is not shifting into “Overdrive” when cold. This is considered a normal condition. Pressing the “O/D OFF” switch will show that the transmission is able to shift into and out of “Overdrive.”
- If the vehicle has not been driven for several days, the first few seconds of operation after shifting the transmission into gear may seem sluggish. This is due to the transmission fluid partially draining from the torque converter into the transmission. This is considered a normal condition and will not cause damage to the transmission. The torque converter will refill within 5 seconds of shifting from P (Park) into any other gear position.

Rocking the Vehicle

If the vehicle becomes stuck in snow, sand, or mud, it can often be moved by a rocking motion. Move the gear selector rhythmically between “First” and R (Reverse), while applying slight pressure to the accelerator.

The least amount of accelerator pedal pressure to maintain the rocking motion without spinning the wheels or racing the engine is most effective. Racing the engine or spinning the wheels, due to the frustration of not freeing the vehicle, may lead to transmission overheating and failure. Allow the engine to idle with the transmission selector in N (Neutral) for at least one minute after every five rocking-motion cycles. This will minimize overheating and reduce the risk of transmission failure during prolonged efforts to free a stuck vehicle.

CAUTION!

When “rocking” a stuck vehicle by moving between “First” and R (Reverse), do not spin the wheels faster than 15 mph (24 km/h), or drivetrain damage may result.

FOUR-WHEEL DRIVE OPERATION

Selec-Trac® Operating Instructions/Precautions

The Selec-Trac® transfer case provides five mode positions — two (rear) wheel drive high mode, part-time four wheel drive high range, full-time four wheel drive high range, neutral, and four wheel drive low range.

This transfer case is equipped with an inter-axle differential which allows driving the vehicle in the 4 FULL TIME position at all times on any given road surface including dry hard surfaced roads. The 4 FULL TIME

mode allows the front and rear wheels to rotate at different speeds which eliminates driveline binding and component wear that is normally associated with driving the vehicle in the 4 PART TIME position on dry hard surfaced roads. This feature provides the safety, security, and convenience of operating in 4 wheel drive at all times regardless of road conditions.

When additional traction is required, the 4 PART TIME and 4LO positions can be used to lock the front and rear driveshafts together through the transfer case inter-axle differential and force the front and rear driveshafts to rotate at the same speed. This is accomplished by simply moving the shift lever to these positions. The 4 PART TIME and 4LO positions are intended for loose, slippery road surfaces only. Driving in the 4 PART TIME and 4LO positions on dry hard surfaced roads may cause increased tire wear and damage to driveline components.

The PART TIME indicator light, located in the instrument panel, alerts the driver that a four wheel drive mode which locks the front and rear driveshafts together has been selected. This light illuminates when the transfer case is shifted to either the 4 PART TIME or 4LO positions. There is no light for the 2WD, 4 FULL TIME, or N (Neutral) positions.

NOTE: Do not attempt to make a shift while only the front or rear wheels are spinning. The Selec-Trac® transfer case is not equipped with a synchronizer and therefore the front and rear driveshaft speeds must be equal for the shift to take place. Shifting while only the front or rear wheels are spinning can cause damage to the transfer case.

When operating your vehicle in 4LO, the engine speed is approximately three times that of the 4 ALL TIME position at a given road speed. Take care not to overspeed the engine and do not exceed 25 mph (40 km/h).

Proper operation of four wheel drive vehicles depends on tires of equal size, type, and circumference on each wheel. Any difference will adversely affect shifting and cause damage to the transfer case.

Because four wheel drive provides improved traction, there is a tendency to exceed safe turning and stopping speeds. Do not go faster than road conditions permit.

WARNING!

You or others could be injured if you leave the vehicle unattended with the transfer case in the N (Neutral) position without first fully engaging the parking brake. The transfer case N (Neutral) position disengages both the front and rear driveshafts from the powertrain and will allow the vehicle to move regardless of the transmission position. The parking brake should always be applied when the driver is not in the vehicle.

Shift Positions

For additional information on the appropriate use of each transfer case mode position, see the information below:

2WD

Rear Wheel Drive High Range — Normal street and highway driving. Dry hard surfaced roads.

4 PART TIME

Part Time 4 Wheel Drive High Range — Locks the transfer case inter-axle differential. Forces the front and rear wheels to rotate at the same speed. Additional traction for loose, slippery road surfaces only.

4 FULL TIME

Full Time 4 Wheel Drive High Range — Employs inter-axle differential. Allows front and rear wheels to rotate at different speeds. All roads surfaces.

N (Neutral)

Neutral — Disengages both the front and rear driveshafts from the powertrain. To be used for flat towing behind another vehicle. Refer to “Recreational Towing” in Section 5 of this manual.

4LO

Part Time Four Wheel Drive Low Range — Low speed 4 wheel drive. Locks the transfer case inter-axle differential. Forces the front and rear wheels to rotate at the same speed. Additional traction and maximum pulling power for loose, slippery road surfaces only. Do not exceed 25 mph (40 km/h).

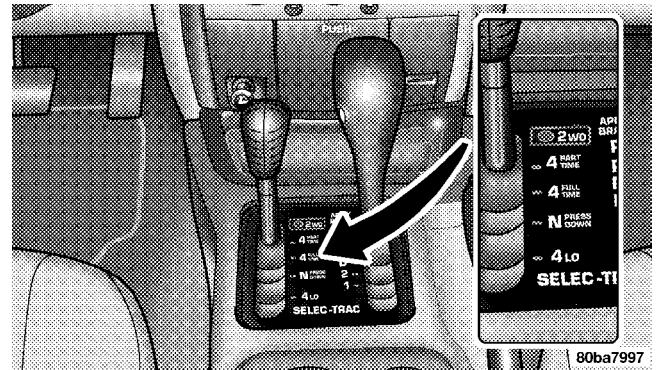
Shifting Procedure**2WD to 4 PART TIME or 4 PART TIME to 2WD**

Shifting between 2WD and 4 PART TIME can be made with the vehicle stopped or in motion. If the vehicle is in motion, shifts can be made up to 55 mph (88 km/h). With the vehicle in motion, two momentary releases of the accelerator pedal may be required after shifting. This will

induce a torque interrupt and allow full engagement of the newly selected position. With the vehicle stationary, it may be necessary to shift from D (Drive) to R (Reverse) and back to D (Drive) after shifting. This will allow full engagement of the newly selected position. Apply a constant force when shifting the transfer case lever.

4 PART TIME to 4 FULL TIME or 4 FULL TIME to 4 PART TIME

Shifting between 4 PART TIME and 4 FULL TIME can be made with the vehicle stopped or in motion. If the vehicle is in motion, shifts can be made up to 55 mph (88 km/h). With the vehicle in motion, two momentary releases of the accelerator pedal may be required after shifting. This will induce a torque interrupt and allow full engagement of the newly selected position. With the vehicle stationary, it may be necessary to shift from D (Drive) to R (Reverse) and back to D (Drive) after shifting. This will allow full engagement of the newly selected position. Apply a constant force when shifting the transfer case lever.

4 FULL TIME to 4 LO or 4 LO to 4 FULL TIME

With the vehicle rolling at 2 to 3 mph (3 to 5 km/h), shift the transmission into N (Neutral). While the vehicle is coasting at 2 to 3 mph (3 to 5 km/h), shift the transfer case lever firmly to the desired position. Do not pause in transfer case N (Neutral).

NOTE: Pausing in transfer case N (Neutral) in vehicles equipped with an automatic transmission may require shutting the engine OFF to avoid gear clash while completing the shift. If difficulty occurs, shift the transmission to N (Neutral), hold foot on brake, and turn the engine OFF. Make shift to desired mode.

NOTE: Shifting into or out of 4LO is possible with the vehicle completely stopped, however difficulty may occur due to the mating clutch teeth not being properly aligned. Several attempts may be required for clutch teeth alignment and shift completion to occur. The preferred method is with the vehicle rolling 2 to 3 mph (3 to

5 km/h). Avoid attempting to engage or disengage 4LO with the vehicle moving faster than 2 to 3 mph (3 to 5 km/h).

Quadra-Trac II® Operating Instructions/Precautions — If Equipped

The Quadra-Trac II® transfer case is fully automatic in the normal driving 4 ALL TIME mode. The Quadra-Trac II® transfer case provides three mode positions — four wheel drive high range, neutral, and four wheel drive low range.

This transfer case is fully automatic in the 4 ALL TIME mode. The 4 ALL TIME mode transmits torque to the rear axle during normal driving, similar to a rear wheel drive vehicle. When speed difference is increased between the front and rear driveshafts the majority of engine torque can be transmitted to the front driveshaft.

When additional traction is required, the 4LO position can be used to lock the front and rear driveshafts together

and force the front and rear wheels to rotate at the same speed. The 4LO position is intended for loose, slippery road surfaces only. Driving in the 4LO position on dry hard surfaced roads may cause increased tire wear and damage to driveline components.

When operating your vehicle in 4LO, the engine speed is approximately three times that of the 4 ALL TIME position at a given road speed. Take care not to overspeed the engine and do not exceed 25 mph (40 km/h).

Proper operation of four wheel drive vehicles depends on tires of equal size, type, and circumference on each wheel. Any difference will adversely affect shifting and cause damage to the transfer case.

Because four wheel drive provides improved traction, there is a tendency to exceed safe turning and stopping speeds. Do not go faster than road conditions permit.

WARNING!

You or others could be injured if you leave the vehicle unattended with the transfer case in the N (Neutral) position without first fully engaging the parking brake. The transfer case N (Neutral) position disengages both the front and rear driveshafts from the powertrain and will allow the vehicle to move regardless of the transmission position. The parking brake should always be applied when the driver is not in the vehicle.

Shift Positions

For additional information on the appropriate use of each transfer case mode position, see the information below:

4 ALL TIME

Normal All Wheel Drive High Range — All roads surfaces such as ice, snow, gravel, sand, and dry hard pavement.

N (Neutral)

Neutral — Disengages both the front and rear driveshafts from the powertrain. To be used for flat towing behind another vehicle. Refer to “Recreational Towing” in Section 5 of this manual.

4LO

Four Wheel Drive Low Range — Low speed 4 wheel drive. Locks the front and rear driveshafts together. Forces the front and rear wheels to rotate at the same

speed. Additional traction and maximum pulling power for loose, slippery road surfaces only. Do not exceed 25 mph (40 km/h).

Shifting Procedure

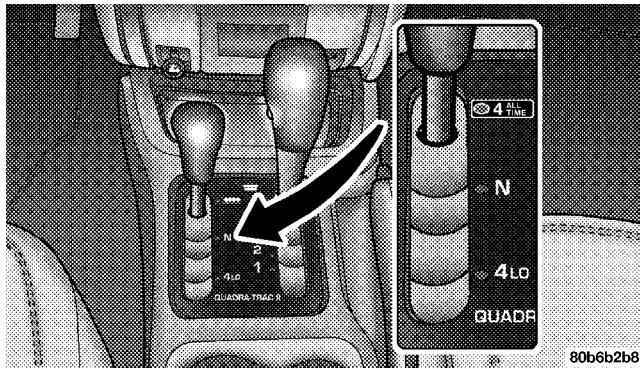

4 ALL TIME to 4 LO or 4 LO to 4 ALL TIME

With the vehicle rolling at 2 to 3 mph (3 to 5 km/h), shift the transmission into N (Neutral). While the vehicle is

coasting at 2 to 3 mph (3 to 5 km/h), shift the transfer case lever firmly into the desired position. Do not pause in transfer case N (Neutral).

NOTE: Pausing in transfer case N (Neutral) in vehicles equipped with an automatic transmission may require shutting the engine OFF to avoid gear clash while completing the shift. If difficulty occurs, shift the transmission into N (Neutral), hold foot on brake, and turn the engine OFF. Make shift to desired mode.

NOTE: Shifting into or out of 4LO is possible with the vehicle completely stopped, however difficulty may occur due to the mating clutch teeth not being properly aligned. Several attempts may be required for clutch teeth alignment and shift completion to occur. The preferred method is with the vehicle rolling 2 to 3 mph (3 to 5 km/h). Avoid attempting to engage or disengage 4LO with the vehicle moving faster than 2 to 3 mph (3 to 5 km/h).

Quadra-Drive® System — If Equipped

The optional Quadra-Drive® System features three torque transfer couplings. The couplings include Vari-Lok front and rear axles and Quadra-Trac II® transfer case. The optional Vari-Lok axles are fully automatic and require no driver input to operate. Under normal driving conditions the units function as standard axles balancing torque evenly between left and right wheels. With a traction difference between left and right wheels the coupling will sense a speed difference. As one wheel begins to spin faster than the other, torque will automatically transfer from the wheel that has less traction to the wheel that has traction. While the transfer case and axle couplings differ in design, their operation is similar. Follow the Quadra-Trac II® transfer case shifting information, preceding this section, for shifting this system.

VARI-LOK FRONT AND REAR AXLES — IF EQUIPPED

The optional Vari-Lok axle is fully automatic and requires no driver input to operate. Under normal driving conditions the unit functions as a standard axle balancing torque evenly between left and right wheels. With a traction difference between left and right wheels the coupling will sense a speed difference. As one wheel begins to spin faster than the other, torque will automatically transfer from the wheel that has less traction to the wheel that has traction.

PARKING BRAKE

To set the parking brake, pull the lever up as firmly as possible. When the parking brake is applied with the ignition ON, the “Brake Warning Light” in the instrument cluster will light.

NOTE: The instrument cluster “Brake Warning Light” indicates only that the parking brake is applied. It does not indicate the degree of brake application.

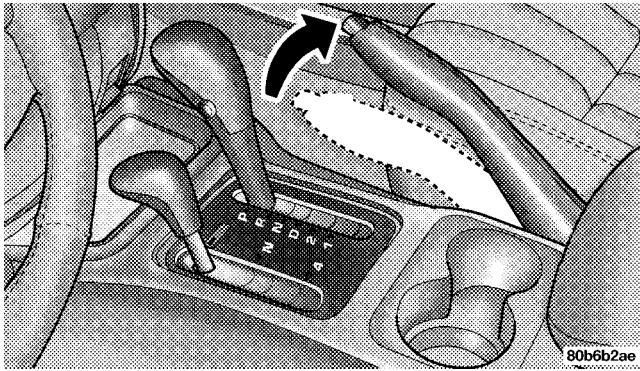

Before leaving the vehicle parked on a hill, you must make sure the parking brake is fully applied and place the gear selector in the P (Park) position. Make certain the transfer case is in gear. Failure to do so may cause the vehicle to roll and cause damage or injury.

When parking on a hill, it is important to set the parking brake before placing the gear selector in P (Park), otherwise the load on the transmission locking mechanism may make it difficult to move the selector out of P (Park).

The parking brake should always be applied when the driver is not in the vehicle.

WARNING!

- Leaving children unattended in a vehicle is dangerous for a number of reasons. A child or others could be injured. Children should be warned not to touch the parking brake or the gear selector lever. Don't leave the keys in the ignition. A child could operate power windows, other controls, or move the vehicle.
- Do not leave children or animals inside parked vehicles in hot weather. Interior heat build up may cause serious injury or death.

To release the parking brake, pull up slightly, press the center button, then lower the lever completely.

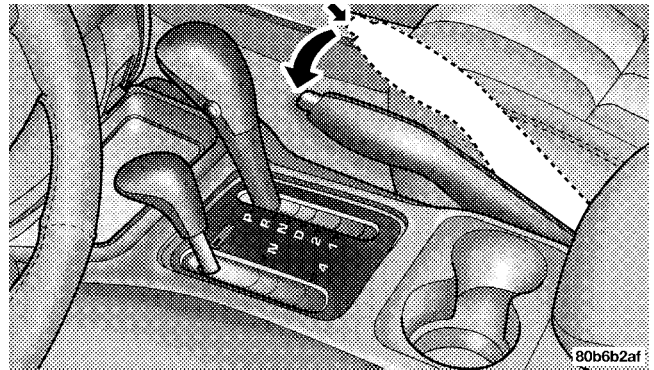

Be sure the parking brake is fully disengaged before driving. Failure to do so can lead to brake failure.

NOTE: Parking brake adjustment and maintenance should be performed by your authorized dealer.

ANTI-LOCK BRAKE SYSTEM

The Anti-Lock Brake System (ABS) is designed to aid the driver in maintaining vehicle control under adverse braking conditions. The system operates with a separate computer to modulate hydraulic pressure to prevent wheel lock-up and help avoid skidding on slippery surfaces.

All vehicle wheels and tires must be the same size and type and tires must be properly inflated to produce accurate signals for the computer.

WARNING!

Significant over or under inflation of tires, or mixing sizes of tires or wheels on the vehicle can lead to loss of braking effectiveness.

The Anti-Lock Brake System conducts a low-speed self-test at about 12 mph (20 km/h). If you have your foot lightly on the brake while this test is occurring you may feel slight pedal movement. The movement can be more apparent on ice and snow. This is normal.

The Anti-Lock Brake System pump motor runs during the self-test at 12 mph (20 km/h) and during an ABS stop. The pump motor makes a low humming noise during operation, which is normal.

WARNING!

Pumping of the Anti-Lock Brakes will diminish their effectiveness and may lead to an accident. Pumping makes the stopping distance longer. Just press firmly on your brake pedal when you need to slow down or stop.

WARNING!

- Anti-lock system (ABS) cannot prevent the natural laws of physics from acting on the vehicle, nor can it increase braking or steering efficiency beyond that afforded by the condition of the vehicle brakes and tires or the traction afforded.
- The ABS cannot prevent accidents, including those resulting from excessive speed in turns, following another vehicle too closely, or hydroplaning. Only a safe, attentive, and skillful driver can prevent accidents.
- The capabilities of an ABS equipped vehicle must never be exploited in a reckless or dangerous manner which could jeopardize the user's safety or the safety of others.

CAUTION!

The Anti-Lock Brake System is subject to possible detrimental effects of electronic interference caused by improperly installed after-market radios or telephones.

NOTE: During severe braking conditions, a pulsing sensation may occur and a clicking noise will be heard. This is normal, indicating that the Anti-Lock Brake System is functioning.

WARNING!

To use your brakes and accelerator more safely, follow these tips:

- Do not “ride” the brakes by resting your foot on the pedal. This could overheat the brakes and result in unpredictable braking action, longer stopping distances, or brake damage.
- When descending mountains or hills, repeated braking can cause brake fade with loss of braking control. Avoid repeated heavy braking by downshifting the transmission or locking out overdrive whenever possible.
- Engines may idle at higher speeds during warm-up, which could cause rear wheels to spin and result in loss of vehicle control. Be especially careful while driving on slippery roads, in close-quarter maneuvering, parking or stopping. Remember, always engage 4-wheel drive when driving on slippery roads (Selec-Trac only). The Quadra-Trac II transfer case engages four-wheel drive automatically when required.
- Do not drive too fast for road conditions, especially when roads are wet or slushy. A wedge of water can build up between the tire tread and the road. This hydroplaning action can cause loss of traction, braking ability, and control. Under such conditions, engage 4-wheel drive (Selec-Trac only).
- After going through deep water or a car wash, brakes may become wet, resulting in decreased performance and unpredictable braking action. Dry the brakes by gentle, intermittent pedal action while driving at very slow speeds.

ON-ROAD DRIVING TIPS

Utility vehicles have higher ground clearance and a narrower track to make them capable of performing in a wide variety of off-road applications. Specific design characteristics give them a higher center of gravity than ordinary cars.

An advantage of the higher ground clearance is a better view of the road, allowing you to anticipate problems. They are not designed for cornering at the same speeds as conventional 2-wheel drive vehicles any more than low-slung sports cars are designed to perform satisfactorily in off-road conditions. If at all possible, avoid sharp turns or abrupt maneuvers. As with other vehicles of this type, failure to operate this vehicle correctly may result in loss of control or vehicle rollover.

OFF-ROAD DRIVING TIPS

When To Use 4 LO (Low) Range

When off-road driving, shift to 4 LO for additional traction in moving forward or descending a hill, for low-speed pulling power or to improve handling and control on slippery or difficult terrain. Also use 4 LO range on the road in rain, ice, snow, mud or sand to get heavy loads rolling, or whenever "High" range four-wheel drive traction is insufficient.

In Snow, Mud and Sand

In heavy snow, when pulling a load, or for additional control at slower speeds, shift the transmission to a low gear and shift the transfer case to 4 LO if necessary. Don't shift to a lower gear than necessary to maintain headway. Over-revving the engine can spin the wheels and traction will be lost.

Do not downshift on icy or slippery roads, because engine braking may cause skidding and loss of control.

Hill Climbing

Before climbing a steep hill, shift the transmission to a lower gear and shift the transfer case to 4 LO. Use first gear and 4 LO for very steep hills.

If you stall or begin to lose headway while climbing a steep hill, allow your vehicle to come to a stop and immediately apply the brakes. Restart the engine and shift to R (Reverse). Back slowly down the hill allowing the compression braking of the engine and transmission

to help regulate your speed. If the brakes are required to control vehicle speed, apply them lightly and avoid locking or skidding the tires.

WARNING!

If the engine stalls or you lose headway or cannot make it to the top of a steep hill or grade, never attempt to turn around. To do so may result in tipping and rolling the vehicle. Always back carefully straight down a hill in R (Reverse) gear. Never back down a hill in N (Neutral) using only the brake.

Remember, never drive diagonally across a hill—always drive straight up or down.

If the wheels start to slip as you approach the crest of a hill, ease off the accelerator and maintain headway by

turning the front wheels sharply left and right. This will provide fresh “bite” into the surface and will usually provide traction to complete the climb.

Traction Downhill

Shift the transmission into a low gear and the transfer case to 4 LO range. Let the vehicle go slowly down the hill with all four wheels turning against engine compression drag. This will permit you to control the vehicle speed and direction.

When descending mountains or hills, repeated braking can cause brake fade with loss of braking control. Avoid repeated heavy braking by downshifting the transmission whenever possible.

After Driving Off-Road

Off-road operation puts more stress on your vehicle than does most on-road driving. After going off-road it is always a good idea to check for damage. That way you can get any problems taken care of right away and have your vehicle ready when you need it.

- Completely inspect the underbody of your vehicle. Check tires, body structure, steering, suspension, and exhaust system for damage.
- Check threaded fasteners for looseness, particularly on the chassis, drivetrain components, steering, and suspension. Retighten them, if required, and torque to the values specified in the Service Manual.
- Check for accumulations of plants or brush. These things could be a fire hazard. They might hide damage to fuel lines, brake hoses, axle pinion seals, and propeller shafts.

- After extended operation in mud, sand, water, or similar dirty conditions, have brake rotors, wheels, brake linings, and axle yokes inspected and cleaned as soon as possible.

WARNING!

Abrasive material in any part of the brakes may cause excessive wear or unpredictable braking. You might not have full braking power when you need it to prevent an accident. If you have been operating your vehicle in dirty conditions, get your brakes checked and cleaned as necessary.

- If you experience unusual vibration after driving in mud, slush or similar conditions, check the wheels for impacted material. Impacted material can cause a wheel imbalance and freeing the wheels of it will correct the situation.

TIRE SAFETY INFORMATION

Tire Markings

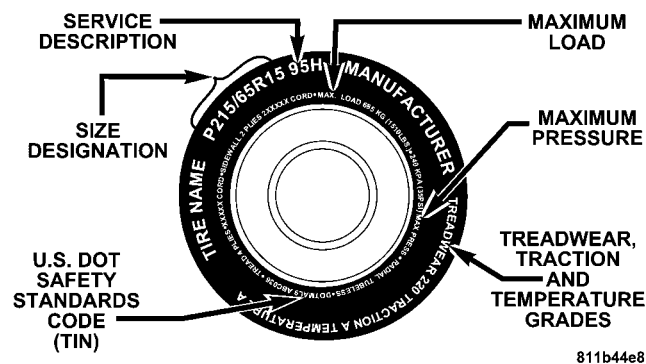

NOTE:

- P(Passenger)-Metric tire sizing is based on U.S. design standards. P-Metric tires have the letter "P" molded into the sidewall preceding the size designation. Example: P215/65R15 95H.

- European Metric tire sizing is based on European design standards. Tires designed to this standard have the tire size molded into the sidewall beginning with the section width. The letter "P" is absent from this tire size designation. Example: 215/65R15 96H
- LT(Light Truck)-Metric tire sizing is based on U.S. design standards. The size designation for LT-Metric tires is the same as for P-Metric tires except for the letters "LT" that are molded into the sidewall preceding the size designation. Example: LT235/85R16.
- Temporary Spare tires are high pressure compact spares designed for temporary emergency use only. Tires designed to this standard have the letter "T" molded into the sidewall preceding the size designation. Example: T145/80D18 103M.
- High Flotation tire sizing is based on U.S. design standards and begins with the tire diameter molded into the sidewall. Example: 31x10.5 R15 LT.

Tire Sizing Chart

EXAMPLE:
Size Designation: P = Passenger car tire size based on U.S. design standards "...blank..." = Passenger car tire based on European design standards LT = Light Truck tire based on U.S. design standards T = Temporary Spare tire 31 = Overall Diameter in Inches (in)
215 = Section Width in Millimeters (mm)
65 = Aspect Ratio in Percent (%) —Ratio of section height to section width of tire. 10.5 = Section Width in Inches (in)
R = Construction Code —"R" means Radial Construction. —"D" means Diagonal or Bias Construction.
15 = Rim Diameter in Inches (in)

EXAMPLE:**Service Description:****95 = Load Index**

—A numerical code associated with the maximum load a tire can carry.

H = Speed Symbol

—A symbol indicating the range of speeds at which a tire can carry a load corresponding to its load index under certain operating conditions.

—The maximum speed corresponding to the Speed Symbol should only be achieved under specified operating conditions. (ie. tire pressure, vehicle loading, road conditions and posted speed limits).

Load Identification:**"...blank..." = Absence of any text on sidewall of the tire indicates a Standard Load (SL) Tire****Extra Load (XL) = Extra Load (or Reinforced) Tire****Light Load = Light Load Tire****C,D,E = Load range associated with the maximum load a tire can carry at a specified pressure****Maximum Load** — Maximum Load indicates the maximum load this tire is designed to carry.**Maximum Pressure** — Maximum Pressure indicates the maximum permissible cold tire inflation pressure for this tire.

Tire Identification Number (TIN)

The TIN may be found on one or both sides of the tire however the date code may only be on one side. Tires with white sidewalls will have the full TIN including date code located on the white sidewall side of the tire.

Look for the TIN on the outboard side of black sidewall tires as mounted on the vehicle. If the TIN is not found on the outboard side then you will find it on the inboard side of the tire.

EXAMPLE:	
DOT MA L9 ABCD 0301	
DOT	= Department of Transportation —This symbol certifies that the tire is in compliance with the U.S. Department of Transportation tire safety standards, and is approved for highway use.
MA	= Code representing the tire manufacturing location.(2 digits)
L9	= Code representing the tire size.(2 digits)
ABCD	= Code used by tire manufacturer.(1 to 4 digits)
03	= Number representing the week in which the tire was manufactured.(2 digits) —03 means the 3rd week.
01	= Number representing the year in which the tire was manufactured.(2 digits) —01 means the year 2001. —Prior to July 2000, tire manufacturers were only required to have 1 number to represent the year in which the tire was manufactured. Example: 031 could represent the 3rd week of 1981 or 1991.

Tire Loading and Tire Pressure

Tire Placard Location

NOTE: Some vehicles have a "Tire and Loading Information" placard located on the driver's side "B" pillar.

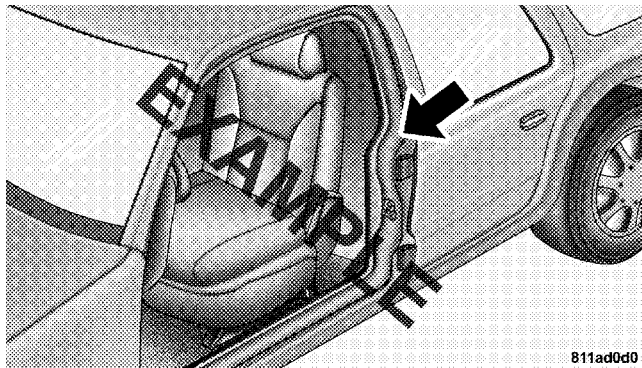

Tire and Loading Information Placard

TIRE AND LOADING INFORMATION

SEATING CAPACITY - TOTAL 5 FRONT 2 REAR 3

THE COMBINED WEIGHT OF OCCUPANTS AND CARGO SHOULD NEVER EXCEED XXX KG OR XXX LBS.

TIRE	FRONT	REAR	SPARE
ORIGINAL TIRE SIZE	P195/70R14	P195/70R14	T125/70D15
COLD TIRE INFLATION PRESSURE	200kPa, 29PSI	200kPa, 29PSI	420kPa, 60PSI

SEE OWNER'S MANUAL FOR ADDITIONAL INFORMATION 4N109268

811b5a9a

This placard tells you important information about the,

- 1) number of people that can be carried in the vehicle
- 2) the total weight your vehicle can carry
- 3) the tire size designed for your vehicle
- 4) the cold tire inflation pressures for the front, rear and spare tires.

Loading

The vehicle maximum load on the tire must not exceed the load carrying capacity of the tire on your vehicle. You will not exceed the tire's load carrying capacity if you adhere to the loading conditions, tire size and cold tire inflation pressures specified on the Tire and Loading Information placard and the Vehicle Loading section of this manual.

NOTE: Under a maximum loaded vehicle condition, gross axle weight ratings (GAWR's) for the front and rear axles must not be exceeded. For further information on GAWR's, vehicle loading and trailer towing, see the Vehicle Loading section of this manual.

To determine the maximum loading conditions of your vehicle, locate the statement "The combined weight of occupants and cargo should never exceed XXX kg or XXX lbs." on the Tire and Loading Information placard. The combined weight of occupants, cargo/luggage and trailer tongue weight (if applicable) should never exceed the weight referenced here.

Steps for Determining Correct Load Limit

1. Locate the statement "The combined weight of occupants and cargo should never exceed XXX pounds" on your vehicle's placard.
2. Determine the combined weight of the driver and passengers that will be riding in your vehicle.

3. Subtract the combined weight of the driver and passengers from XXX kilograms or XXX pounds.
4. The resulting figure equals the available amount of cargo and luggage load capacity. For example, if "XXX" amount equals 1400 lbs. and there will be five 150 lb. passengers in your vehicle, the amount of available cargo and luggage load capacity is 650 lb. (1400-750 (5 x 150) = 650 lb.)
5. Determine the combined weight of luggage and cargo being loaded on the vehicle. That weight may not safely exceed the available cargo and luggage load capacity calculated in step 4.

6. If your vehicle will be towing a trailer, load from your trailer will be transferred to your vehicle. Consult this manual to determine how this reduces the available cargo and luggage load capacity of your vehicle.

NOTE: The following table shows examples on how to calculate total load, cargo/luggage and towing capacities of your vehicle with varying seating configurations and number and size of occupants. This table is for illustration purposes only and may not be accurate for the seating and load carry capacity of your vehicle.

NOTE: For the following example the combined weight of occupants and cargo should never exceed 865 lbs. (392 Kg).

210 STARTING AND OPERATING

Occupants			Combined weight of occupants and cargo from Tire Placard	MINUS	Combined Occupant's weight	=	AVAILABLE Cargo/Luggage and Trailer Tongue Weight
TOTAL	FRONT	REAR					
EXAMPLE 1			865 lbs	minus	670 lbs	=	195 lbs
5	2	3					
EXAMPLE 2			865 lbs	minus	540 lbs	=	325 lbs
3	2	1					
EXAMPLE 3			865 lbs	minus	400 lbs	=	465 lbs
2	2	0					

EXAMPLE

Occupant 1: 200 lbs
 Occupant 2: 130 lbs
 Occupant 3: 160 lbs
 Occupant 4: 100 lbs
 Occupant 5: 80 lbs
 TOTAL WEIGHT: 670 lbs

Occupant 1: 210 lbs
 Occupant 2: 180 lbs
 Occupant 3: 150 lbs
 TOTAL WEIGHT: 540 lbs

Occupant 1: 200 lbs
 Occupant 2: 200 lbs
 TOTAL WEIGHT: 400 lbs

WARNING!

Overloading of your tire is dangerous. Overloading can cause tire failure, affect vehicle handling, and increase your stopping distance. Use tires of the recommended load capacity for your vehicle. Never overload them.

TIRES — GENERAL INFORMATION

Proper tire inflation pressure is essential to the safe and satisfactory operation of your vehicle. Three primary areas are affected by improper tire pressure:

1. Safety—**WARNING!**

Improperly inflated tires are dangerous and can cause accidents.

- Under inflation increases tire flexing and can result in tire failure.
- Over inflation reduces a tire's ability to cushion shock. Objects on the road and chuck holes can cause damage that results in tire failure.
- Unequal tire pressures can cause steering problems. You could lose control of your vehicle.
- Overinflated or under inflated tires can affect vehicle handling and can fail suddenly, resulting in loss of vehicle control.

Always drive with each tire inflated to the recommended pressure.

2. Economy—

Improper inflation pressures can cause uneven wear patterns to develop across the tire tread. These abnormal wear patterns will reduce tread life resulting in a need for earlier tire replacement. Under inflation also increases tire rolling resistance and results in higher fuel consumption.

3. Ride Comfort and Vehicle Stability—

Proper tire inflation contributes to a comfortable ride. Over inflation produces a jarring and uncomfortable ride. Both under inflation and over inflation affect the stability of the vehicle and can produce a feeling of sluggish response or over responsiveness in the steering.

Unequal tire pressures can cause erratic and unpredictable steering response.

Unequal tire pressure from side to side may cause the vehicle to drift left or right.

Tire Inflation Pressures

The proper cold tire inflation pressure for passenger cars is listed on either the face of the driver's door or the driver's side "B" pillar. For vehicles other than passenger cars, the cold tire inflation pressures are listed on either the "B" pillar or the Certification Label.

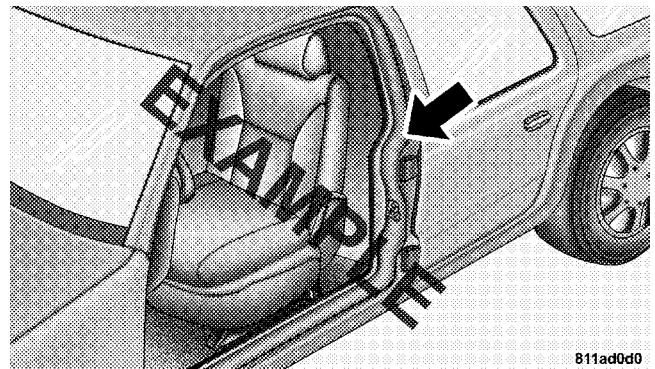

811ad0d0

The tire pressure should be checked and adjusted at least once every month. Check more often if subject to a wide range of outdoor temperatures, as tire pressures vary with temperature changes.

Inflation pressures specified on the label are always "Cold Inflation Pressure." Cold inflation pressure is defined as the tire pressure after the vehicle has been idle for at least 3 hours, or driven less than a mile after a 3 hour period. The cold inflation pressure must not exceed the maximum values molded into the tire sidewall.

Tire pressures may increase from 13 to 40 kPa (2 to 6 psi) [0.138 to 0.414 bar] during operation. DO NOT reduce this normal pressure buildup.

High Speed Operation

WARNING!

High speed driving with your vehicle under load is dangerous. The added strain on your tires could cause them to fail. You could have a serious accident. Don't drive a vehicle loaded to maximum capacity at continuous speeds above 75 mph (120 km/h).

5

The manufacturer advocates driving at safe speeds within posted speed limits. Where speed limits or conditions are such that the vehicle can be driven at high speeds, correct tire inflation pressure is very important.

Radial-Ply Tires

WARNING!

Combining radial ply tires with other types of tires on your vehicle will cause your vehicle to handle poorly. The instability could cause an accident. Always use radial tires in sets of four. Never combine them with other types of tires.

Cuts and punctures in radial tires are repairable only in the tread area because of sidewall flexing. Consult your dealer for radial tire repairs.

Tire Spinning

When stuck in mud, sand, snow, or ice conditions, do not spin your vehicle's wheels above 35 mph (55 km/h).

WARNING!

Fast spinning tires can be dangerous. Forces generated by excessive wheel speeds may cause tire damage or failure. A tire could explode and injure someone. Do not spin your vehicle's wheels faster than 35 mph (55 km/h) when you are stuck. And don't let anyone near a spinning wheel, no matter what the speed.

Tread Wear Indicators

These indicators are narrow strips 1/16 inch (1.6 mm) thick and are found in the tread pattern grooves.

When the tread pattern is worn down to these treadwear indicators, the tires should be replaced.

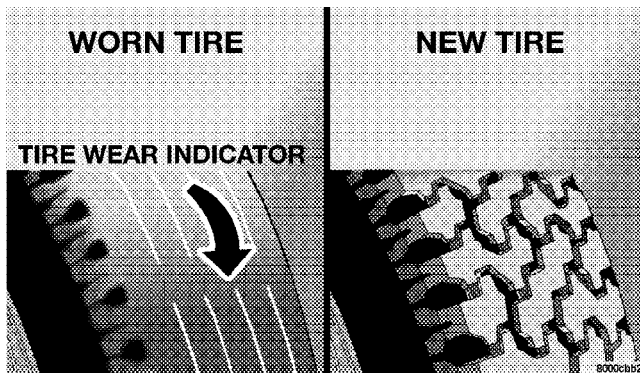

Overloading your vehicle, long trips in very hot weather, and driving on bad roads may result in greater wear.

Replacement Tires

The tires on your new vehicle provide a balance of many characteristics. They should be inspected regularly for wear and correct inflation pressure. The manufacture strongly recommends that you use tires equivalent to the originals in quality and performance when replacement is needed (see section on tread wear indicators). Failure to use equivalent replacement tires may adversely affect the safety, handling, ride and fuel economy of your vehicle. We recommend that you contact your original equipment tire dealer on any questions you may have on tire specifications or capability.

WARNING!

- Do not use a tire, wheel size or rating other than that specified for your vehicle. Some combinations of unapproved tires and wheels may change suspension dimensions and performance characteristics, resulting in changes to steering, handling, and braking of your vehicle. This can cause unpredictable handling and stress to steering and suspension components. You could lose control and have an accident resulting in serious injury or death. Use only the tire and wheel sizes with load ratings approved for your vehicle.
- Never use a tire smaller than the minimum tire size listed on your vehicle's tire label. Using a smaller tire could result in tire overloading and failure. You could lose control and have an accident.
- Failure to equip your vehicle with tires having adequate speed capability can result in sudden tire failure and loss of vehicle control.
- Overloading your tires is dangerous. Overloading can cause tire failure. Use tires of the recommended load capacity for your vehicle - never overload them.

CAUTION!

Replacing original tires with tires of a different size may result in false speedometer and odometer readings. Check with your dealer before replacing tires with a different size.

Alignment and Balance

The suspension components of your vehicle should be inspected and aligned when needed, to obtain maximum tire tread life.

Poor suspension alignment may result in:

- reduced tread life;
- uneven tire wear, such as feathering and one-sided wear;
- vehicle pull to the right or to the left.

Tires may also cause the vehicle to pull left or right. Alignment will not correct this problem. See your dealer for proper diagnosis of the problem.

Improper alignment will not normally cause vehicle vibration, which may be a result of tire and wheel out-of-balance. Proper balancing will reduce vibration and avoid tire cupping and spotty wear.

TIRE PRESSURE MONITOR SYSTEM — IF EQUIPPED

The Tire Pressure Monitor System (TPM) monitors the pressure in all 4 road tires and the full size spare (5 Tire TPM System Only). The TPM system uses wireless technology to monitor tire pressure levels. Sensors, mounted to each wheel as part of the valve stem, transmit tire pressure readings to a receiver located in the overhead console. The tire pressure status is shown in the Electronic Vehicle Information Center (EVIC) display. Refer to “Overhead Console” in Section 3 for more information. The TPM system functions even when the EVIC is not set on the tire pressure display screen.

The TPM system informs you of a low or high tire pressure condition. If this occurs, correct your tire inflation pressure as soon as possible, and inspect all of your tires. Be sure to use a high quality gauge when adjusting pressure. The TPM system is designed to monitor your tire pressure but will not function as a tire pressure

gauge. There will be a delay between the instant you adjust the air pressure in a tire and when the system updates the display. The TPM system is not intended to provide you with notification of rapid air loss.

The following chart indicates the TPM system pressure levels. A threshold is the level at which the TPM system provides you with an indication.

High Pressure Threshold	45 psi (310 kPa)
Placard Pressure (Cold)	33 psi (227 kPa)
Low Pressure Threshold	25 psi (172 kPa)

NOTE: A TPM system does not replace normal tire maintenance.

CAUTION!

The TPM system has been optimized for the original equipment tires and wheels. TPM system pressures have been established for the tire size equipped on your vehicle. Undesirable operation or sensor damage may result when using replacement equipment that is not of the same size, type, and/or style. Aftermarket wheels can cause sensor damage. Do not use tire sealant or balance beads if your vehicle is equipped with TPM system as damage to the sensors may result.

Tire Pressure Monitor System Tire/Wheel Rotation and Sensor Replacement — If Equipped
With the 5 Tire TPM System, if a road tire and wheel is replaced by the spare, the TPM system will detect the swap automatically (after the ignition has been cycled)

and display SPARE SWAP DETECTED along with a chime. This could take up to 10 minutes with vehicle speed above 25 mph (40 km/h).

With the 4 Tire TPM System, if a road tire and wheel is replaced by the spare, the TPM system will display TIRE SENSOR BAD/MISSING. This is due to the spare tire not being equipped with a tire pressure sensor. Once the road tire is repaired and/or installed back on the vehicle with the proper tire pressure the message will be removed. This could take up to 10 minutes with vehicle speed above 25 mph (40 km/h).

The tire pressure sensors **must** be retrained following a wheel rotation or sensor replacement. Refer to “EVIC — Retrain Tire Sensors” in Section 3 for more information. It is necessary to program the EVIC with the new sensor(s) or the new position of each sensor as it is rotated to a different corner of the vehicle.

If a wheel rotation is not followed by the retrain procedure, the system will not properly inform you of the correct vehicle location of a low or high tire pressure.

General Information

This device complies with part 15 of the FCC rules and RSS 210 of Industry Canada. Operation is subject to the following conditions:

- This device may not cause harmful interference.
- This device must accept any interference received, including interference that may cause undesired operation.

The tire pressure sensors are covered under one of the following licenses:

United States KR5S120123
 Canada 2671-S120123

TIRE CHAINS

Certain models have sufficient tire-to-body clearance to allow use of tire chains. **Install chains on rear tires only.** Follow these recommendations to guard against damage and excessive tire and chain wear:

- Do not install tire chains or traction devices on vehicles with larger than P225/75R16 size tires. These tires are too large for sufficient body clearance with chains or other traction devices.
- Use SAE class “S” tire chains or traction devices only.
- Follow tire chain manufacturer’s instructions for mounting chains.
- Install chains snugly and tighten after 1/2 mile (1 km) of driving.
- **Do not** exceed 35 mph (56 km/h), unless otherwise specified by the chain manufacturer.
- Drive cautiously, avoiding large bumps, potholes and extreme driving maneuvers.

TIRE ROTATION RECOMMENDATIONS

Tires on the front and rear axles of vehicles operate at different loads and perform different steering, handling, and braking functions. For these reasons, they wear at unequal rates, and develop irregular wear patterns.

These effects can be reduced by timely rotation of tires. The benefits of rotation are especially worthwhile with aggressive tread designs such as those on On/Off Road type tires. Rotation will increase tread life, help to maintain mud, snow, and wet traction levels, and contribute to a smooth, quiet ride.

Follow the recommended tire rotation frequency for your type of driving found in the “Maintenance Schedules” Section of this manual. More frequent rotation is permissible if desired. The reasons for any rapid or unusual wear should be corrected prior to rotation being performed.

NOTE: The Tire Pressure Monitor system must be retrained following a tire rotation. See your authorized dealer for service.

The suggested rotation method is the “forward-cross” shown in the following diagram.

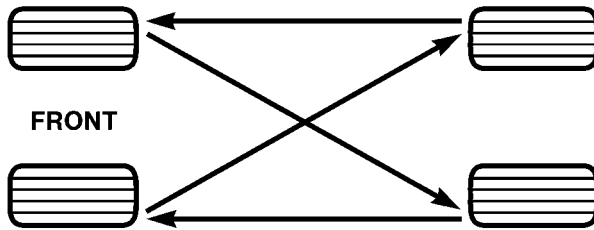

8031e864

FUEL REQUIREMENTS



Your engine is designed to meet all emissions regulations and provide excellent fuel economy and performance when using high quality unleaded gasoline having an octane rating of 87. The use of premium gasoline is not recommended. The use of premium gasoline will provide no benefit over high quality regular gasoline, and in some circumstances may result in poorer performance.

NOTE: 4.7L HO Engines (If Equipped): High quality premium unleaded gasoline with an octane rating of 91 is recommended but not required.

Light spark knock at low engine speeds is not harmful to your engine. However, continued heavy spark knock at high speeds can cause damage and immediate service is required. Engine damage resulting from operation with a heavy spark knock may not be covered by the new vehicle warranty.

Poor quality gasoline can cause problems such as hard starting, stalling and hesitations. If you experience these symptoms, try another brand of gasoline before considering service for the vehicle.

Over 40 auto manufacturer's world wide have issued and endorsed consistent gasoline specifications (the Worldwide Fuel Charter, WWFC) to define fuel properties necessary to deliver enhanced emissions, performance, and durability for your vehicle. The manufacturer recommends the use of gasoline that meets the WWFC specifications if they are available.

Reformulated Gasoline

Many areas of the country require the use of cleaner burning gasoline referred to as Reformulated Gasoline. Reformulated gasoline contains oxygenates, and is specifically blended to reduce vehicle emissions and improve air quality.

The manufacturer strongly supports the use of reformulated gasoline. Properly blended reformulated gasoline will provide excellent performance and durability for the engine and fuel system components.

Gasoline/Oxygenate Blends

Some fuel suppliers blend unleaded gasoline with oxygenates such as 10% ethanol, MTBE, and ETBE. Oxygenates are required in some areas of the country during the winter months to reduce carbon monoxide emissions. Fuels blended with these oxygenates may be used in your vehicle.

CAUTION!

DO NOT use gasoline containing METHANOL. Gasoline containing methanol may damage critical fuel system components.

MMT In Gasoline

MMT is a manganese containing metallic additive that is blended into some gasoline to increase octane. Gasoline blended with MMT provides no performance advantage beyond gasoline of the same octane number without MMT. Gasoline blended with MMT reduces spark plug life and reduces emission system performance in some vehicles. The manufacturer recommends that gasoline without MMT be used in your vehicle. The MMT content of gasoline may not be indicated on the gasoline pump, therefore, you should ask your gasoline retailer whether or not his/her gasoline contains MMT.

It is even more important to look for gasoline without MMT in Canada because MMT can be used at levels higher than allowed in the United States. MMT is prohibited in Federal and California reformulated gasoline.

Sulfur In Gasoline

If you live in the northeast United States, your vehicle may have been designed to meet California low emission standards with clean burning, low sulfur, California gasoline. Gasoline sold outside of California is permitted to have higher sulfur levels which may affect the performance of the vehicle's catalytic converter. This may cause the "Malfunction Indicator Light" to illuminate.

Illumination of this light while operating on high sulfur gasoline does not necessarily mean your emission control system is malfunctioning. The manufacturer recommends that you try a different brand of unleaded gasoline having lower sulfur to determine if the problem is fuel related prior to returning your vehicle to an authorized dealer for service.

CAUTION!

If the "Malfunction Indicator Light" is flashing, immediate service is required. See "Onboard Diagnostic System" in Section 7 of this manual.

Materials Added To Fuel

All gasoline sold in the United States is required to contain effective detergent additives. Use of additional detergents or other additives is not needed under normal conditions.

FUEL TANK FILLER CAP (GAS CAP)**WARNING!**

To avoid fuel spillage and overfilling, do not "top off" the fuel tank after filling.

The gas cap is located behind the fuel filler door, on the left side of the vehicle. If the gas cap is lost or damaged, be sure the replacement cap has been designed for use with this vehicle. When the gas cap is removed for refueling, it can be placed in the fuel filler door while filling the fuel tank.

CAUTION!

Damage to the fuel system or emission control system could result from using an improper fuel tank filler cap (gas cap). A poorly fitting cap could let impurities into the fuel system.

WARNING!

- Remove the fuel cap slowly to prevent fuel spray from the filler neck which may cause injury.
- The volatility of some gasoline may cause a buildup of pressure in the fuel tank which may increase while you drive. This pressure can result in a spray of gasoline and/or vapors when the cap is removed from a hot vehicle. Removing the cap slowly allows the pressure to vent and prevents fuel spray.
- Never add fuel when the engine is running.
- Never have any smoking materials lit in or near the vehicle when the fuel cap is removed or the tank filled.

TRAILER TOWING

In this section you will find information on limits to the type of towing you can reasonably do with your vehicle. And you will find safety tips. Before towing a trailer carefully review this information to tow your load as efficiently and safely as possible.

The factory-installed Class III and Class IV Trailer Tow Packages include a frame mounted receptacle and the above required equipment. They also include some necessary provisions for connecting an aftermarket electric brake controller. It is a light blue wire, identified with a tag, located under the instrument panel behind the brake pedal. Other equipment, such as trailer sway controls and braking equipment, trailer equalizing (leveling) equipment and low profile mirrors, may also be required or strongly recommended.

To maintain warranty coverage, follow the requirements and recommendations in this manual concerning vehicles used for trailer towing.

Perform maintenance services as prescribed in the appropriate "Maintenance Schedule." Refer to Section 8 of this manual. When your vehicle is used for trailer towing, never exceed the gross axle weight rating (GAWR) by the addition of:

- The tongue weight of the trailer.
- The weight of any other type of cargo or equipment put in or on your vehicle.

WARNING!

Improper towing can lead to an injury accident. Follow these guidelines to make your trailer towing as safe as possible:

- Be sure a trailer is loaded heavier in front, about 10% to 15% of gross trailer weight. Loads balanced over the wheels or heavier in the rear cause the trailer to sway **severely** side to side which will cause loss of control of the vehicle and trailer. Failure to load trailers heavier in front is the cause of many trailer related accidents.
- Do **not** interconnect the hydraulic brake system of your vehicle with that of the trailer. This could cause inadequate braking and possible personal injury.
- **Trailer brakes are required for trailers in excess of 2,000 lbs (907 kg).**
- Do **not** connect a trailer lighting system directly to the lighting system of your vehicle. Use an approved trailer wiring harness. Failure to do so could damage the vehicle electrical system and/or result in personal injury.
- When hauling cargo or towing a trailer, **do not** overload your vehicle or trailer. Overloading can cause a loss of control, poor performance or damage to brakes, axle, engine, transmission, steering, suspension, body structure or tires.
- Make certain that the load is secured in the trailer and will not shift during travel.

- It is recommended that **any** hitches installed on your vehicle be factory installed, or installed by a dealer using factory approved parts. Factory approved parts are specifically engineered with your vehicle's performance in mind, including the possibility that it will be involved in an accident. Other hitches may not have been so engineered. Vehicle performance, including vehicle damage in an accident situation, may therefore be different.
- If trailer towing is required and your vehicle is not equipped with a trailer tow package, the Mopar® accessory towing harnesses are the only approved method to provide for trailer lights. These harnesses are designed to provide current to the trailer lights but bypass the module designed to monitor tail lights. Refer to the package instructions for details.

Trailer and Tongue Weight

Gross Trailer Weight (GTW) means the weight of the trailer plus the weight of all cargo, consumables and equipment loaded on the trailer when in actual underway towing condition. The best way to measure GTW is to put your fully loaded trailer on a vehicle scale. The entire weight of the trailer must be supported by the scale.

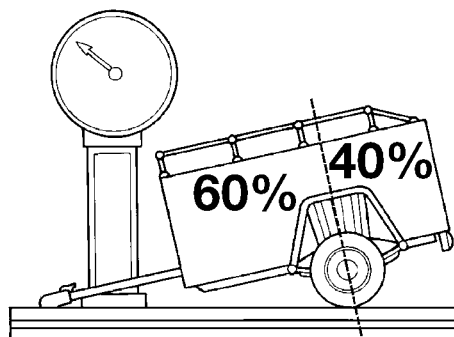

8020-090

Always load a trailer with 60% of the cargo weight in the front of the trailer. This places approximately 10% to 15% of the GTW on the tow hitch of your vehicle. This portion of the GTW becomes the tongue weight.

Trailer sway control and equalizing hitch are required for tongue weights above 350 lbs (159 kg), i.e., trailer weights heavier than 3,500 lbs (1 587 kg).

Cooling System Tips—Trailer Towing

To reduce potential for engine and transmission overheating in high ambient conditions, take the following actions:

- **City Traffic**

When stopped, put transmission in N (Neutral) and increase engine idle speed.

- **Highway Driving**

Reduce speed.

- **Air Conditioning**

Turn off temporarily.

To reduce the potential for transmission overheating, turn the “Overdrive” off when pulling any trailer or shift the transmission to Drive position 2 on more severe grades. Move the shift lever to the next lower position to eliminate excessive transmission shifting. This action will also reduce the possibility of transmission overheating and provide better engine braking.

Minimum Vehicle Requirements for Trailer Towing

Trailer Type	Gross Trailer Weight	Tongue Weight (See Note 1)	Towing Pkg.	GCWR (Max.) (See Note 2)	Engine	Transmission	Steering System	Cooling	Axle	Minimum Tire Size
Class I • 32 ft2 (2.9m2) or Less Frontal Area • Up to 2,000 lbs. (907 kg) GTW • 20 ft. Maximum Trailer Length	2,000 lbs. (907 kg) (Max.)	300 lbs. (91 kg) (Max.)	Class I Hitch (Light Duty)	4x2 5,781 lbs. (2,627 kg) 4x4 6,060 lbs. (2,754 kg)	All	All	All	All	All	P225/75R16
Class III • 64 ft2 (5.8m2) or Less Frontal Area • Up to 5,000 lbs. (2,268 kg) GTW • 25 ft. Maximum Trailer Length	5,000 lbs. (2,268 kg) (Max.)	750 lbs. (340 kg) (Max.)	Class III Hitch (Heavy Duty)	4x2 8,781 lbs. (3,983 kg) 4x4 9,550 lbs. (4,332 kg)	All	All	HE-Temp.*	Trailer Tow or Trailer Tow Prep	3.73:1 Ratio with synthetic lube	P225/75R16
Class IV • 64 ft2 (5.8m2) or Less Frontal Area • Up to 6,500 lbs. (2,948 kg) GTW • 30 ft. Maximum Trailer Length	4x2† 6,700 lbs. (3,039 kg) (Max.)	750 lbs. (340 kg) (Max.)	Class IV Hitch (Heavy Duty)	4x2 and 4x4 10,500 lbs. (4,763 kg)	4.7L	All	HE-Temp.*	Trailer Tow	3.73:1 Ratio with synthetic lube	P225/75R16

¹ The towing vehicle payload should be reduced by the tongue load (for a dead weight hitch) to keep the rear axle loading below GAWR (Gross Axle Weight Rating) of 2,950 lbs. (1,338 kg).
² GCWR = Total combined weight of trailer and tow vehicle.
 * Class III and Class IV towing requires special power steering pumps and gears with high temperature seals.
 † 4x4 6,500 lbs. (2,948 kg) (Max.).

NOTE: If you tow a trailer frequently, especially in hilly country or when the outdoor temperature is high, we recommend that you change the transmission fluid at 30,000 mile (48 000 km) intervals.

CAUTION!

When pulling a heavy load or driving a fully loaded vehicle use a premium unleaded fuel to help prevent spark knock. If spark knock persists, lighten the load. Otherwise, engine piston damage may result.

Other restrictions apply concerning trailer type, trailer frontal area and tongue weight. Carefully review the "Minimum Vehicle Requirements" chart in this section before towing a trailer.

RECREATIONAL TOWING (BEHIND MOTORHOME, ETC.)

CAUTION!

Internal damage to the transfer case will occur if a front or rear wheel lift is used when recreational towing.

NOTE: The transfer case must be in the N (Neutral) position, and the transmission must be in the P (Park) position for recreational towing. **(Recreational towing is not available on Quadra-Trac I equipped vehicles.)**

Shifting Into Neutral (N)

Use the following procedure to prepare your vehicle for recreational towing.

CAUTION!

It is necessary to follow these steps to be certain that the transfer case is fully in N (Neutral) before recreational towing to prevent damage to internal parts.

1. Depress brake pedal.
2. Shift transmission into N (Neutral).
3. Shift transfer case lever into N (Neutral).
4. Start engine.
5. Shift transmission into D (Drive).
6. Release brake pedal and ensure that there is no vehicle movement.
7. Shut the engine OFF and place the ignition key into the unlocked OFF position.
8. Shift transmission into P (Park).
9. Apply parking brake.
10. Attach vehicle to the tow vehicle with tow bar.
11. Release parking brake.

CAUTION!

Transmission damage may occur if the transmission is shifted into P (Park) with the transfer case in N (Neutral) and the engine running. With the transfer case in N (Neutral) ensure that the engine is OFF prior to shifting the transmission into P (Park) (refer to steps 7 – 8 above).

Shifting Out Of Neutral (N)

Use the following procedure to prepare your vehicle for normal usage.

1. Shift transmission into N (Neutral).
2. Shift transfer case lever to desired position.
3. Shift transmission into D (Drive).

NOTE: When shifting out of transfer case N (Neutral), turning the engine OFF may be required to avoid gear clash.

WARNING!

You or others could be injured if you leave the vehicle unattended with the transfer case in the N (Neutral) position without first fully engaging the parking brake. The transfer case N (Neutral) position disengages both the front and rear driveshafts from the powertrain and will allow the vehicle to move regardless of the transmission position. The parking brake should always be applied when the driver is not in the vehicle.

CAUTION!

- Do not use a bumper mounted clamp-on tow bar on your vehicle. The bumper face bar will be damaged.
- Do not disconnect the rear driveshaft because fluid will leak from the transfer case and damage internal parts.

WARNING!

Do not add a snow plow, winches, or any other aftermarket equipment to the front of your vehicle. This could adversely affect the functioning of the airbag system and you could be injured.

SNOW PLOW

Snow plows, winches, and other aftermarket equipment should **not** be added to the front end of your vehicle. The airbag crash sensors may be affected by the change in the front end structure. The airbags could deploy unexpectedly or could fail to deploy during a collision.

WHAT TO DO IN EMERGENCIES

CONTENTS

■ Hazard Warning Flashers	236	□ Tire Changing Procedure	242
■ If Your Engine Overheats	237	■ Jump Starting Procedure	246
■ Changing A Flat Tire	238	■ Emergency Tow Hooks — If Equipped	248
□ Jack And Lug Wrench Locations	238	■ Towing A Disabled Vehicle	248
□ Spare Tire Location	239		

HAZARD WARNING FLASHERS

Your vehicle's hazard warning flasher is an emergency warning system. When you activate it, all front and rear directional signals will flash intermittently. Use it when your vehicle is disabled on or near the road. It warns other drivers to steer clear of you and your vehicle. This is an emergency warning system, not to be used when the vehicle is in motion.

To activate the warning flasher, push down on the button on top of the steering column until it latches. To turn the warning flasher off, push down again to unlatch the button.

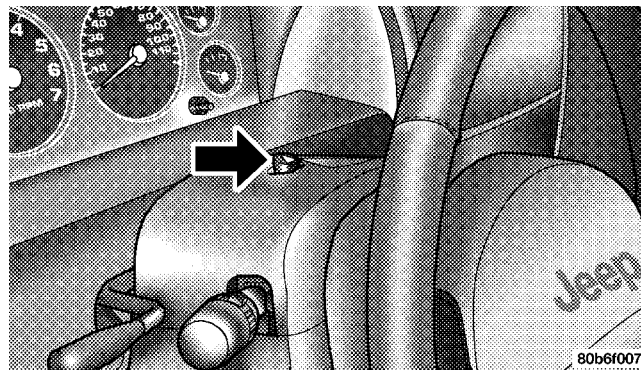

NOTE: With extended use, the flasher may run down your battery.

IF YOUR ENGINE OVERHEATS

In any of the following situations, you can reduce the potential for overheating by taking the appropriate action.

- On the highways — Slow down.
- In city traffic — While stopped, put transmission in N (Neutral), but do not increase engine idle speed.

NOTE: There are steps that you can take to slow down an impending overheat condition. If your air conditioner is on, turn it off. The air conditioning system adds heat to the engine cooling system and turning off the A/C removes this heat. You can also turn the Temperature Control to maximum heat, the Mode Control to floor, and the Fan Control to High. This allows the heater core to act as a supplement to the radiator and aids in removing heat from the engine cooling system.

CAUTION!

Driving with a hot cooling system could damage your vehicle. If the temperature gauge reads “H”, pull over and stop the vehicle. Idle the vehicle with the air conditioner turned off until the pointer drops back into the normal range. If the pointer remains on the “H”, and you hear continuous chimes, turn the engine off immediately, and call for service.

CHANGING A FLAT TIRE

Jack And Lug Wrench Locations

The three piece tool set, consisting of two snap-together extensions that operate the jack and a wheel wrench that also is used as a crank for the jack, is stored under the right rear seat. The scissor-type jack is located under the left rear seat.

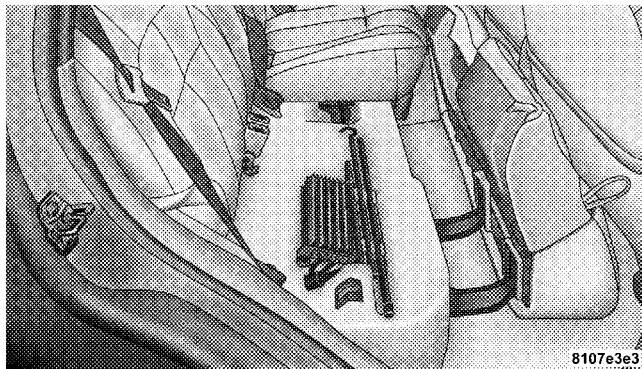

To remove the jack from its stowage position, turn the wing nut counterclockwise to loosen the jack assembly, and then remove it.

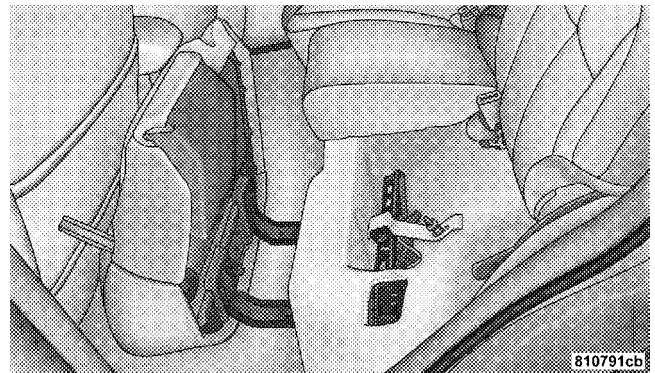

WARNING!

- Always store the jack, lug wrench and spare, flat or damaged tire securely in the proper place. Never leave them loose in the vehicle where they could become dangerous projectiles during a quick stop or collision.
- The jack is designed to use as a tool for changing tires only. The jack should not be used to lift the vehicle for service purposes, unless suitable supports are placed under the vehicle as a safety measure. The vehicle should be jacked on a firm level surface only. Avoid ice or slippery areas.

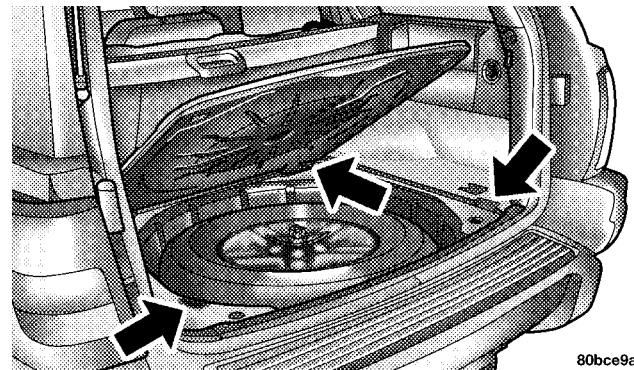
Spare Tire Location**To Remove the Spare Tire**

80bce9a6

6

1. Open the liftgate.
2. Grasp the cover on both sides at the edge adjacent to the carpet depressions and lift the cover to unlatch. **The cover may be placed forward to lean against the rear**

seatback or completely removed from the vehicle. It can also be kneeled down upon and used as ground cover to prevent clothing from getting soiled.

3. Remove the nut and tire.

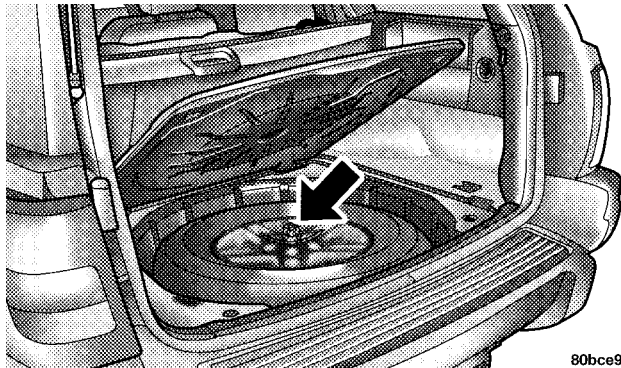

80bce9a7

To Replace the Spare Tire

1. Place the tire into the rear compartment with the wheel facing upward:
 - a. Replace the hold-down nut.
 - b. Reinstall the cover by inserting the hinges through the carpet into the brackets at about a 30 degree angle and lower into position. Press down to lock the cover in position.
2. Your vehicle is equipped with either a temporary-use spare tire or a conventional spare tire. Maintain the temporary-use spare tire pressure at 60 psi (420 kPa), and the conventional spare at 33 psi (228 kPa).

WARNING!

Temporary-use spare tires are for emergency use only. With these tires, do not drive more than 50 miles (80 km) or exceed 50 mph (80 km/h). Temporary-use spare tires have a total tread life of 3,000 miles (4 800 km). Be sure to follow the warnings which apply to your spare. Failure to do so could result in spare tire failure and loss of vehicle control.

Compact Spare Tire

- Your vehicle is equipped with either a temporary-use spare tire or a conventional spare tire. Maintain the temporary-use spare tire pressure at 60 psi (420 kPa), and the conventional spare at 33 psi (228 kPa).
- Temporary use spare tires are for emergency use only, and are not intended for driving more than 50 miles (80 km) or exceeding 50 mph (80 km/h).
- Never drive your vehicle with more than one compact spare installed at any time.
- If your vehicle is equipped with Selec-Trac, avoid using four-wheel drive when a compact spare is installed. You should use 2WD only unless 4WD is necessary. 4 FULL TIME should be used if 4WD is required.

Tire Changing Procedure

Preparation

WARNING!

You can be injured or killed if you try to change a wheel too close to moving traffic. Pull far enough off the road to avoid being hit when operating the jack or changing the wheel.

- Park on a firm, level surface well off the road to provide ample work space. Put the transmission in P (Park) and stop the engine. Set the parking brake firmly and activate the hazard warning flasher.

Avoid jacking up the vehicle with occupants inside. If the jack should fall, someone in the vehicle could be hurt.

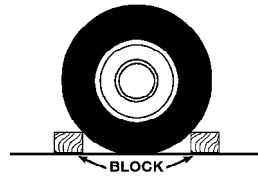

- Block the front and rear of the diagonally opposite tire. For example, if the right front tire is being changed, block the left rear wheel.

Instructions

1. Remove the spare tire from under the cargo floor, jack and jack tools from under the left and right rear seat.
2. Loosen the lug nuts one-half turn counterclockwise.
3. Assemble the jack and jacking tools as shown. Connect jack handle driver (A) to extension (B), then to the lug wrench (C).

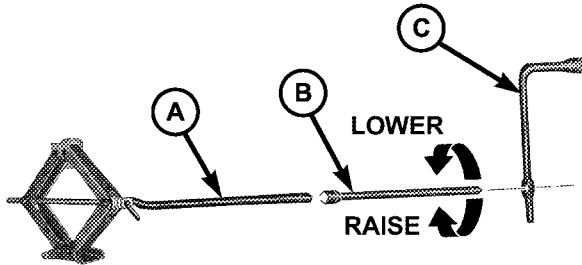

8107e507

4. Locate the jack as shown. For the front axle, place it under the axle near the wheel to be changed. For the rear axle, place it under the axle as shown.

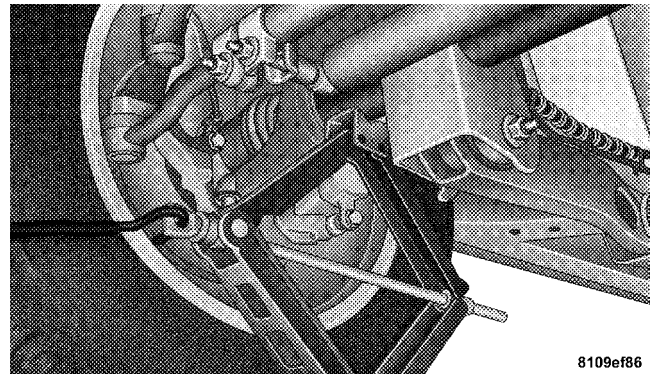

8109ef86

Front Jacking Location

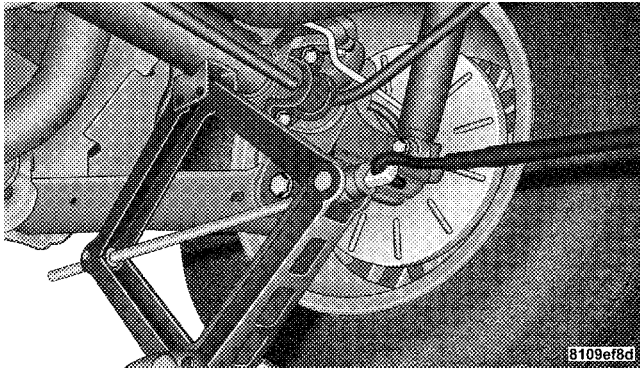

Rear Jacking Location

5. Raise the vehicle by turning the jack handle clockwise until the tire clears the ground.

WARNING!

Raising the vehicle higher than necessary can make the vehicle less stable and cause an accident. It could slip off the jack and hurt someone near it. Raise the vehicle only enough to remove the tire.

6. Remove the lug nuts and wheel.
7. Position the spare wheel/tire on the vehicle and install the lug nuts with the cone-shaped end toward the wheel. Lightly tighten the nuts until they are equally snug, using a crisscross pattern. To avoid the risk of forcing the vehicle off the jack, do not tighten the nuts fully until the vehicle has been lowered.
8. Lower the vehicle and remove the jack and wheel blocks.

9. Tighten the lug nuts securely in a crisscross pattern. Have an authorized service technician check that the torque is 85-115 ft.lbs. (115-156 N·m) as soon as possible.

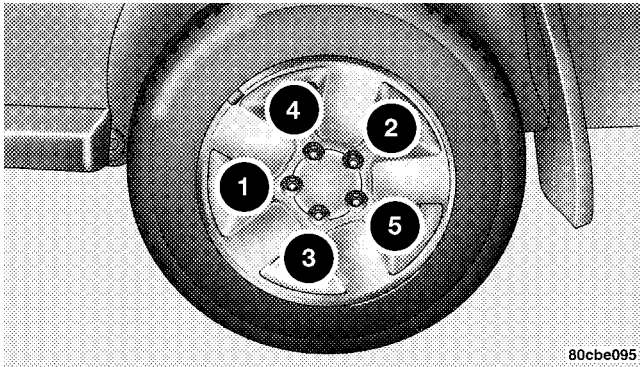

10. Secure the jack, lug wrench, jack handle and tire in the proper locations.

WARNING!

- A loose tire or jack thrown forward in a collision or hard stop could injure someone in the vehicle. Always stow the jack parts and the extra tire and wheel in the places provided.
- Carefully follow these tire changing warnings to help prevent personal injury or damage to your vehicle:

- Always park on a firm, level surface as far from the edge of the roadway as possible before raising the vehicle.
- Block the wheel diagonally opposite the wheel to be raised.
- Apply the parking brake firmly before jacking.
- Never start the engine with the vehicle on a jack.

6

- Do not let anyone sit in the vehicle when it is on a jack.
- Do not get under the vehicle when it is on a jack.
- Only use the jack in the positions indicated.
- If working on or near a roadway, be extremely careful of motor traffic.

JUMP STARTING PROCEDURE

NOTE: Check the charge indicator on top of the battery. If the indicator is light or yellow, replace the battery.

1. Wear eye protection and remove any metal jewelry such as watch bands or bracelets that might make an unintended electrical contact.
2. When boost is provided by a battery in another vehicle, park that vehicle within booster cable reach but without letting the vehicles touch. Set the parking brake, place the transmission in P (Park), and turn the ignition to OFF for both vehicles.
3. Turn off the heater, radio and all unnecessary electrical loads.
4. Connect one end of a jumper cable to the positive terminal of the discharged battery. Connect the other end of the same cable to the positive terminal of the booster battery.
5. Connect the other cable, first to the negative terminal of the booster battery and then connect the other end to a non-paint metal surface on the engine of the vehicle with the discharged battery. Make sure you have a good contact on the engine.
6. Start the engine in the vehicle which has the booster battery, let the engine idle a few minutes, then start the engine in the vehicle with the discharged battery.
7. When removing the jumper cables, reverse the above sequence exactly. Be careful of the moving belts and fan.

NOTE: To start the vehicle following connection of a booster battery, the Security Alarm System must first be disabled by cycling a front door key cylinder or by using the keyless entry transmitter.

WARNING!

Jump starting can be dangerous. To avoid personal injury or damage to electrical components in vehicle, observe the following warnings:

- Battery fluid is a corrosive acid solution and can burn or even blind you. Don't allow battery fluid to contact your eyes, skin, or clothing. Don't lean over a battery when attaching clamps. If acid splashes in eyes or on skin, flush the area immediately with large amounts of water.
- Do not use a booster battery or any other booster source that has a greater than 12-volt system, i.e., do not use a 24-volt power source.
- Never attempt to jump start a discharged battery that is frozen, because it could rupture or explode during jump starting.
- Be sure your vehicle is not touching the jump start vehicle.
- Observe all Battery Warnings in Section 7 of this manual, while jump starting your vehicle.

WARNING!

Do not attempt to push or tow your vehicle to get it started. Unburned fuel could enter the catalytic converter and, once the engine has started, ignite and damage the converter and vehicle.

EMERGENCY TOW HOOKS — IF EQUIPPED

If your vehicle is equipped with tow hooks, they will be mounted in the front of the vehicle.

CAUTION!

Tow hooks are for emergency use only, to rescue a vehicle stranded off road. Do not use tow hooks for tow truck hookup or highway towing. You could damage your vehicle.

WARNING!

Stand clear of vehicles when pulling with tow hooks. Tow straps and chains may break, causing serious injury.

TOWING A DISABLED VEHICLE

The manufacturer recommends towing with all four wheels off the ground. Acceptable methods are to tow the vehicle on a flatbed or with one end of the vehicle raised and the other end on a towing dolly.

MAINTAINING YOUR VEHICLE

CONTENTS

■ 4.0L Engine	251	□ Drive Belts - Check Condition And Tension . . .	261
■ 4.7L/4.7 HO Engine	252	□ Spark Plugs	261
■ Onboard Diagnostic System — OBD II	253	□ Catalytic Converter	261
■ Emissions Inspection And Maintenance Programs	254	□ Crankcase Emission Control System	263
■ Replacement Parts	255	□ Fuel Filter	263
■ Dealer Service	255	□ Air Cleaner Filter	264
■ Maintenance Procedures	256	□ Maintenance-Free Battery	264
□ Engine Oil	256	□ Air Conditioner Maintenance	265
		□ Power Steering Fluid Check	266

<input type="checkbox"/> Driveline And Steering Component Lubrication	267	<input type="checkbox"/> Appearance Care And Protection From Corrosion	281
<input type="checkbox"/> Body Lubrication	267	■ Fuse Panel	286
<input type="checkbox"/> Windshield Wiper Blades	268	<input type="checkbox"/> Interior Fuses	286
<input type="checkbox"/> Windshield Washers — Front And Rear	268	<input type="checkbox"/> Underhood Fuses (Power Distribution Center)	288
<input type="checkbox"/> Exhaust System	269	■ Vehicle Storage	289
<input type="checkbox"/> Cooling System	269	■ Replacement Bulbs	289
<input type="checkbox"/> Hoses And Vacuum/Vapor Harnesses	274	■ Fluid Capacities	291
<input type="checkbox"/> Brake System	274	■ Recommended Fluids, Lubricants And Genuine Parts	292
<input type="checkbox"/> Automatic Transmission	277	<input type="checkbox"/> Engine	292
<input type="checkbox"/> Transfer Case	280	<input type="checkbox"/> Chassis	293
<input type="checkbox"/> Front/Rear Axle Fluid	281		

4.0L ENGINE

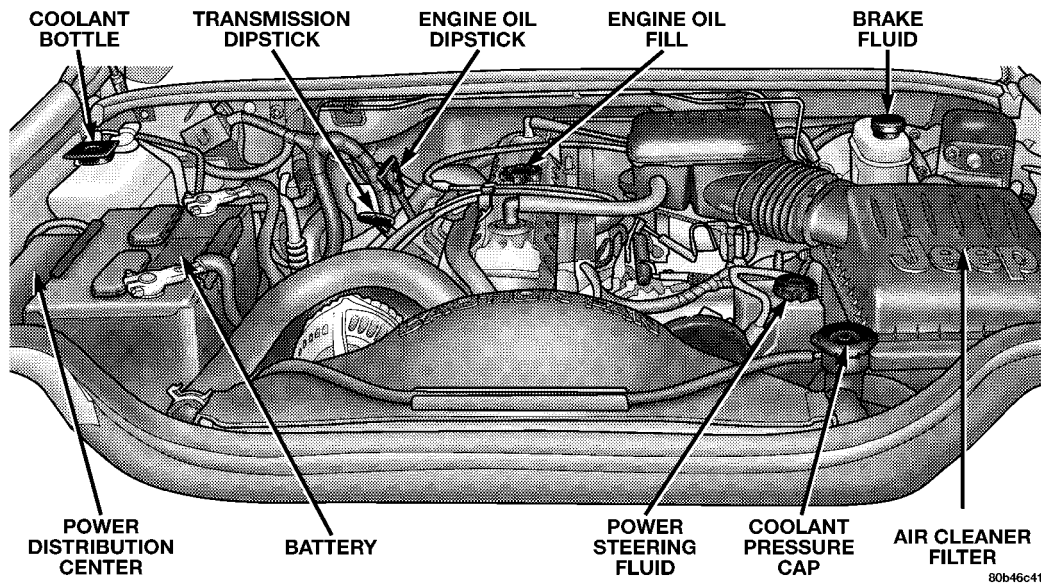

4.7L/4.7 HO ENGINE

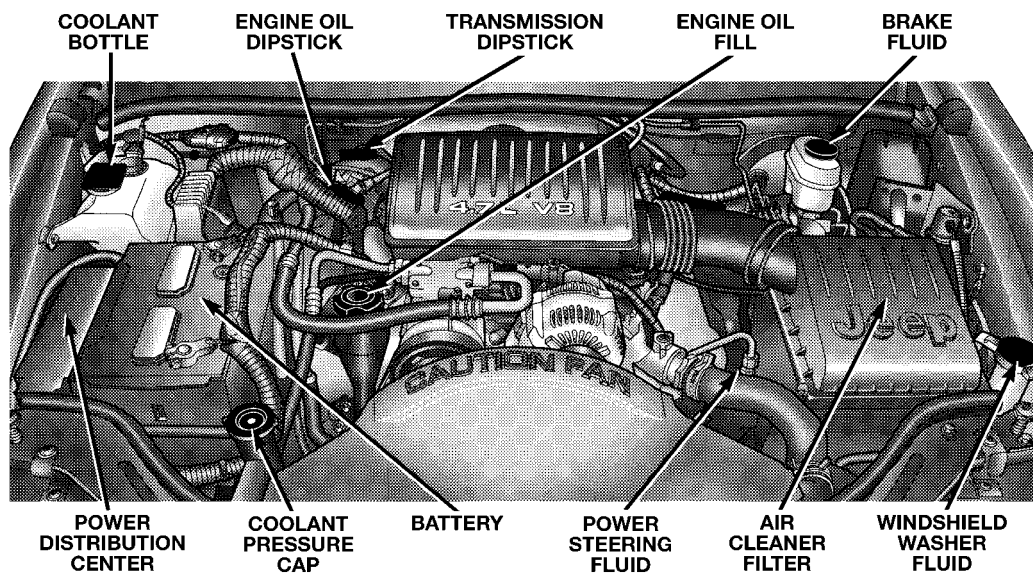

ONBOARD DIAGNOSTIC SYSTEM — OBD II

Your vehicle is equipped with a sophisticated onboard diagnostic system called OBD II. This system monitors the performance of the emissions, engine, and automatic transmission control systems. When these systems are operating properly, your vehicle will provide excellent performance and fuel economy, as well as engine emissions well within current government regulations.

If any of these systems require service, the OBD II system will turn on the “Malfunction Indicator Light.” It will also store diagnostic codes and other information to assist your service technician in making repairs. Although your vehicle will usually be drivable and not need towing, see your dealer for service as soon as possible.

CAUTION!

- **Prolonged driving with the “Malfunction Indicator Light” on could cause further damage to the emission control system. It could also affect fuel economy and driveability. The vehicle must be serviced before any emissions tests can be performed.**
- **If the “Malfunction Indicator Light” is flashing while the engine is running, severe catalytic converter damage and power loss will soon occur. Immediate service is required.**

EMISSIONS INSPECTION AND MAINTENANCE PROGRAMS

In some localities, it may be a legal requirement to pass an inspection of your vehicle's emissions control system. Failure to pass could prevent vehicle registration.

 For states which have an I/M (Inspection and Maintenance) requirement, this check verifies the following: the MIL (Malfunction Indicator Lamp) is functioning and is not on when the engine is running, and that the OBD (On Board Diagnostic) system is ready for testing.

Normally, the OBD system will be ready. The OBD system may **not** be ready if your vehicle was recently serviced, if you recently had a dead battery, or a battery replacement. If the OBD system should be determined not ready for the I/M test, your vehicle may fail the test.

Your vehicle has a simple ignition key actuated test which you can use prior to going to the test station. To check if your vehicle's OBD system is ready, you must do the following:

1. Insert your ignition key into the ignition switch.
2. Turn the ignition to the ON position, but do not crank or start the engine.
3. If you crank or start the engine, you will have to start this test over.
4. As soon as you turn your key to the ON position, you will see your MIL symbol come on as part of a normal bulb check.
5. Approximately 15 seconds later, one of two things will happen:
 - a. The MIL will flash for about 10 seconds and then return to being fully illuminated until you turn off the

ignition key or start the engine. This means that your vehicle's OBD system is **not ready** and you should **not** proceed to the I/M station.

b. The MIL will not flash at all and will remain fully illuminated until you turn off the ignition key or start the engine. This means that your vehicle's OBD system is **ready** and you can proceed to the I/M station.

If your OBD system is **not ready**, you should see your authorized dealer or repair facility. If your vehicle was recently serviced or had a battery failure or replacement, you may need to do nothing more than drive your vehicle as you normally would in order for your OBD system to update. A recheck with the above test routine may then indicate that the system is now ready.

Regardless of whether your vehicle's OBD system is ready or not ready, if the MIL symbol is illuminated during normal vehicle operation, you should have your

vehicle serviced before going to the I/M station. The I/M station can fail your vehicle because the MIL symbol is on with the engine running.

REPLACEMENT PARTS

Use of genuine Mopar® parts for normal/scheduled maintenance and repairs is highly recommended to insure the designed performance. Damage or failures caused by the use of non-Mopar® parts for maintenance and repairs will not be covered by the manufacturer's warranty.

DEALER SERVICE

Your dealer has the qualified service personnel, special tools and equipment to perform all service operations in an expert manner. Service Manuals are available which include detailed service information for your vehicle. Refer to these manuals before attempting any procedure yourself.

NOTE: Intentional tampering with emissions control systems can result in civil penalties being assessed against you.

WARNING!

You can be badly injured working on or around a motor vehicle. Do only that service work for which you have the knowledge and the proper equipment. If you have any doubt about your ability to perform a service job, take your vehicle to a competent mechanic.

MAINTENANCE PROCEDURES

The pages that follow contain the **required** maintenance services determined by the engineers who designed your vehicle.

Besides the maintenance items for which there are fixed maintenance intervals, there are other items that should operate satisfactorily without periodic maintenance. However, if a malfunction of these items does occur, it could adversely affect the engine or vehicle performance. These items should be inspected if a malfunction is observed or suspected.

Engine Oil**Checking Oil Level**

To assure proper engine lubrication, the engine oil must be maintained at the correct level. Check the oil level at regular intervals, such as every fuel stop.

The best time to check the engine oil level is about 5 minutes after a fully warmed engine is shut off or before starting the engine after it has sat overnight.

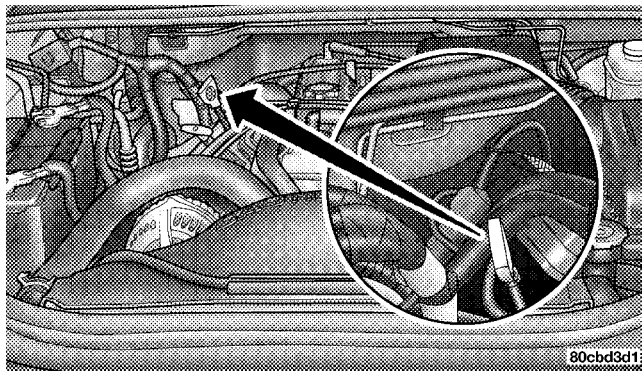

4.0L Engines

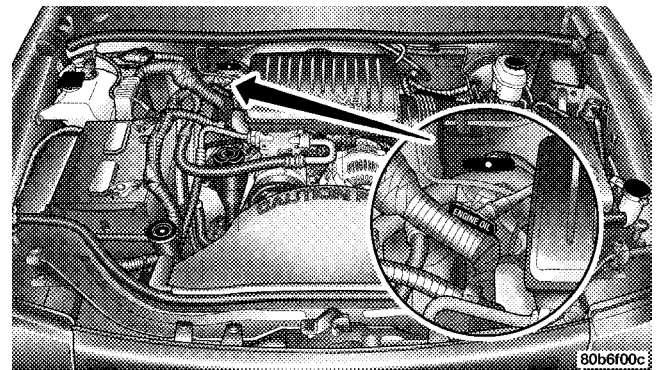

4.7L Engines

Checking the oil while the vehicle is on level ground will improve the accuracy of the oil level readings. Maintain the oil level between the MIN and MAX or ADD and SAFE markings on the dipstick. Adding 1 U.S. Quart (0.95L) of oil when the reading is at the MIN mark will result in a MAX reading on these engines.

CAUTION!

Overfilling or underfilling the crankcase will cause aeration or loss of oil pressure. This could damage your engine.

Change Engine Oil

Road conditions as well as your kind of driving affect the interval at which your oil should be changed. Check the following to determine if any apply to you:

- Day or night temperatures are below 32°F (0°C)
- Stop and go driving
- Extensive engine idling
- Driving in dusty conditions
- Short trips of less than 10 miles (16.2 km)

- More than 50% of your driving is at sustained high speeds during hot weather, above 90°F (32°C)
- Trailer towing
- Taxi, Police, or delivery service (Commercial Service)
- Off road or desert operation
- If equipped for and operating with E-85 (ethanol) fuel

If **ANY** of these apply to you, then change your engine oil every 3,000 miles (5 000 km) or 3 months, whichever comes first, and follow the maintenance recommendations in “Maintenance Schedule B.”

If none of these apply to you, then change your engine oil every 6,000 miles (10 000 km) or 6 months, whichever comes first.

NOTE: Under no circumstances should oil change intervals exceed 6,000 miles (10 000 km) or 6 months whichever comes first.

Engine Oil Selection

For best performance and maximum protection for all engines under all types of operating conditions, the manufacturer recommends engine oils that are API Certified and meet the requirements of DaimlerChrysler Material Standard MS-6395.

American Petroleum Institute (API) Engine Oil Identification Symbol



This symbol means that the oil has been certified by the American Petroleum Institute (API). The manufacturer only recommends API Certified engine oils.

Engine Oil Viscosity Chart

The proper SAE viscosity grade of engine oil should be selected based on the following recommendation and be within the operating temperature shown in the engine oil viscosity chart.

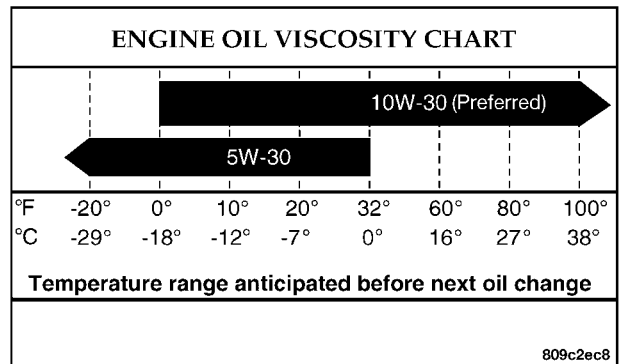

4.0L Engines

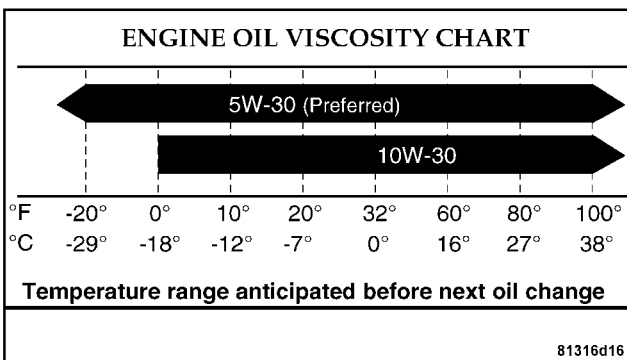

4.7L/4.7L HO Engines

Materials Added to Engine Oils

The manufacturer **strongly recommends** against the addition of any additives (other than leak detection dyes) to engine oil. Engine oil is an engineered product and its performance may be impaired by supplemental additives.

Disposing of Used Engine Oil

Care should be taken in disposing of the used engine oil from your vehicle. Used oil, indiscriminately discarded, can present a problem to the environment. Contact your local authorized dealer, service station, or governmental agency for advice on how and where used oil can be safely discarded in your area.

Engine Oil Filter

The engine oil filter should be replaced with a new filter at every oil change.

Engine Oil Filter Selection

All of the manufacturer's engines have a full-flow type disposable oil filter. Use a filter of this type for replacement. The quality of replacement filters varies considerably. Only high quality filters should be used to assure most efficient service. Mopar® engine oil filters are high quality oil filters and are recommended.

Drive Belts - Check Condition and Tension

At the mileages shown in the appropriate "Maintenance Schedule," check all drive belts for condition and proper tension. Improper belt tension can cause belt slippage and failure.

Inspect the drive belt for evidence of cuts, cracks, or glazing and replace them if there is any sign of damage which could result in belt failure. If adjustment is required, adjust the belts according to the specifications and procedures shown in the Service Manual.

Special tools are required to properly measure tension and to restore belt tension to factory specifications. Also, check belt routing to make sure there is no interference between the belts and other engine components.

Spark Plugs

Spark plugs must fire properly to assure engine performance and emission control. New spark plugs should be installed at the specified mileage. The entire set should be replaced if there is any malfunction due to a faulty spark plug. Refer to the "Vehicle Emission Control Information" label in the engine compartment for spark plug information.

Catalytic Converter

The catalytic converter requires the use of unleaded fuel only. Leaded gasoline will destroy the effectiveness of the converter as an emission control device.

Under normal operating conditions, the catalytic converter will not require maintenance. However, it is important to keep the engine properly tuned to assure proper catalyst operation and prevent possible catalyst damage.

CAUTION!

Damage to the catalytic converter can result if your vehicle is not kept in proper operating condition. In the event of engine malfunction, particularly involving engine misfire or other apparent loss of performance, have your vehicle serviced promptly. Continued operation of your vehicle with a severe malfunction could cause the converter to overheat, resulting in possible damage to the converter and vehicle.

WARNING!

A hot exhaust system can start a fire if you park over materials that can burn. Such materials might be grass or leaves coming into contact with your exhaust system. Do not park or operate your vehicle in areas where your exhaust system can contact anything that can burn.

In unusual situations involving grossly malfunctioning engine operation, a scorching odor may suggest severe and abnormal catalyst overheating. If this occurs, stop the vehicle, turn off the engine and allow it to cool. Service, including a tune up to manufacturer's specifications, should be obtained immediately.

To minimize the possibility of catalytic converter damage:

- Do not shut off the engine or interrupt the ignition when the transmission is in gear and the vehicle is in motion.
- Do not try to start the engine by pushing or towing the vehicle.
- Do not idle the engine with any spark plug wires disconnected or removed, such as when diagnostic testing.
- Do not idle the engine for prolonged periods during very rough idle or malfunctioning operating conditions.
- Do not allow vehicle to run out of fuel.

NOTE: Intentional tampering with emissions control systems can result in civil penalties being assessed against you.

Crankcase Emission Control System

Proper operation of this system depends on freedom from sticking or plugging due to deposits. As vehicle mileage builds up, the PCV valve and passages may accumulate deposits. If a valve is not working properly, replace it with a new valve. **DO NOT ATTEMPT TO CLEAN THE OLD PCV VALVE!**

Check ventilation hose for indication of damage or plugging deposits. Replace if necessary.

Fuel Filter

A plugged fuel filter can cause hard starting or limit the speed at which a vehicle can be driven. Should an excessive amount of dirt accumulate in the fuel tank, frequent replacement of the fuel filter which is mounted in the fuel tank may be necessary.

Air Cleaner Filter

Under normal driving conditions, replace the air filter at the intervals shown on "Maintenance Schedule A." If, however, you drive the vehicle frequently under dusty or severe conditions, the filter element should be inspected periodically and replaced if necessary at the intervals shown on "Maintenance Schedule B."

WARNING!



The air cleaner can provide protection in the case of engine backfire. Do not remove the air cleaner unless it is necessary for repair or maintenance. Make sure that no one is near the engine compartment before starting the vehicle with the air cleaner removed. Failure to do so can result in serious personal injury.

Maintenance-Free Battery

Your vehicle is equipped with a maintenance-free battery. You will never have to add water, nor is periodic maintenance required.

WARNING!

Battery posts, terminals, and related accessories contain lead and lead compounds. Always wash hands after handling the battery.

BATTERY CONDITION INDICATOR	O.K. TO JUMP START	 	DARKENED INDICATOR WITH GREEN DOT <ul style="list-style-type: none"> • BATTERY CHARGE OK • FLUID LEVEL OK DARKENED INDICATOR NO GREEN DOT <ul style="list-style-type: none"> • BATTERY CHARGE LOW • FLUID LEVEL OK
	DO NOT JUMP START		YELLOW OR BRIGHT INDICATOR <ul style="list-style-type: none"> • BATTERY CHARGE UNKNOWN • FLUID LEVEL LOW (CHARGE MAY STILL BE SUFFICIENT TO START YOUR CAR)

8000ebce

To determine the battery charge, check the battery test indicator (if equipped) on top of the battery. Refer to the illustration.

CAUTION!

It is essential when replacing the cables on the battery that the positive cable is attached to the positive post and the negative cable is attached to the negative post. Battery posts are marked (+) positive and negative (-) and identified on the battery case. Also, if a “fast charger” is used while battery is in the vehicle, disconnect both vehicle battery cables before connecting the charger to battery. Do not use a “fast charger” to provide starting voltage.

Air Conditioner Maintenance

For best possible performance, your air conditioner should be checked and serviced by an Authorized Dealer at the start of each warm season. This service should include cleaning of the condenser fins and a performance test. Drive belt tension should also be checked at this time.

WARNING!

- Use only refrigerants and compressor lubricants approved by the manufacturer for your air conditioning system. Some unapproved refrigerants are flammable and can explode, injuring you. Other unapproved refrigerants or lubricants can cause the system to fail, requiring costly repairs.
- The air conditioning system contains refrigerant under high pressure. To avoid risk of personal injury or damage to the system, adding refrigerant or any repair requiring lines to be disconnected should be done by an experienced repairman.

Refrigerant Recovery and Recycling

R-134a Air Conditioning Refrigerant is a hydrofluorocarbon (HFC) that is endorsed by the Environmental Protection Agency and is an ozone-saving product. However, the manufacturer recommends that air conditioning service be performed by dealers or other service facilities using recovery and recycling equipment.

NOTE: Air Conditioning systems found to be contaminated with A/C System Sealers, Stop Leak Products, Seal Conditioners, Compressor Oil, or Refrigerants not approved by the manufacturer, voids the warranty for the Air Conditioning system.

Power Steering Fluid Check

Checking the power steering fluid level at a defined service interval is not required. The fluid should only be checked if a leak is suspected, abnormal noises are

apparent, and/or the system is not functioning as anticipated. Coordinate inspection efforts through a certified "DaimlerChrysler Dealership."

WARNING!

Fluid level should be checked on a level surface with the engine off to prevent injury from moving parts, and to insure accurate fluid level reading. Do not overfill. Use only the manufacturer's recommended fluid.

If necessary, add fluid to restore to the proper indicated level. With a clean cloth, wipe any spilled fluid from all surfaces. Refer to Recommended Fluids, Lubricants, and Genuine Parts for correct fluid type.

Driveline And Steering Component Lubrication

U-joints (cardan joints) are sealed and do not require lubrication. Prop shafts, yokes, ball joints and other driveline and steering components may be provided with grease fittings for lubrication. Lubrication of these components at the intervals specified in the appropriate "Maintenance Schedule" in Section 8 is very important, particularly if your vehicle is subjected to off-road or other heavy-duty use. See your authorized dealer for complete service information.

Body Lubrication

Locks and all body pivot points, including such items as seat tracks, doors, tailgate and hood hinges, should be lubricated periodically to assure quiet, easy operation and to protect against rust and wear. Prior to the application of any lubricant, the parts concerned should be wiped clean to remove dust and grit; after lubricating excess oil and grease should be removed. Particular

attention should also be given to hood latching components to insure proper function. When performing other underhood services, the hood latch, release mechanism and safety catch should be cleaned and lubricated.

The external lock cylinders should be lubricated twice a year, preferably in the fall and spring. Apply a small amount of a high quality lubricant such as Mopar® Lock Cylinder Lubricant directly into the lock cylinder.

Windshield Wiper Blades

The rubber edges of the wiper blades and the windshield should be cleaned periodically with a sponge or soft cloth and a mild nonabrasive cleaner to remove accumulations of salt or road film.

Operation of the wipers on dry glass for long periods may cause deterioration of the wiper blades. Always use washer fluid when using the wipers to remove salt or dirt from a dry windshield.

Avoid using the wiper blades to wipe frost or ice from the windshield. Keep the blade rubber out of contact with petroleum products such as engine oil, gasoline, etc.

Windshield Washers — Front and Rear

On vehicles equipped with a Vehicle Information Center, the low washer fluid level will be indicated. When the sensor detects a low fluid level, the windshield will light on the vehicle graphic outline and the “Washer Fluid Low” message will be displayed.

The fluid reservoir for the windshield washers and the rear window washer is shared. It is located in the front of the engine compartment on the passenger side and should be checked for fluid level at regular intervals. Fill the reservoir with windshield washer solvent (not radiator antifreeze) and operate the system for a few seconds to flush out the residual water.

WARNING!

Commercially available windshield washer solvents are flammable. They could ignite and burn you. Care must be exercised when filling or working around the washer solution.

Exhaust System

The best protection against carbon monoxide entry into the vehicle body is a properly maintained engine exhaust system.

If you notice a change in the sound of the exhaust system; or if the exhaust fumes can be detected inside the vehicle; or when the underside or rear of the vehicle is damaged; have an authorized technician inspect the complete exhaust system and adjacent body areas for broken, damaged, deteriorated, or mispositioned parts. Open seams or loose connections could permit exhaust fumes to seep

into the passenger compartment. In addition, inspect the exhaust system each time the vehicle is raised for lubrication or oil change. Replace as required.

Cooling System**WARNING!**

You or others can be badly burned by hot coolant or steam from your radiator. If you see or hear steam coming from under the hood, don't open the hood until the radiator has had time to cool. Never try to open a cooling system pressure cap when the radiator or coolant bottle is hot.

Coolant Checks

Check coolant protection every 12 months (before the onset of freezing weather, where applicable). If coolant is

dirty or rusty in appearance, the system should be drained, flushed and refilled with fresh coolant.

Check the front of the radiator for any accumulation of bugs, leaves, etc. Clean the radiator by gently spraying water from a garden hose at the back of the core.

Check the engine cooling system hoses for condition and tightness of connection. Inspect the entire system for leaks. Any hoses that show cuts or severe abrasion must be replaced.

Cooling System — Drain, Flush, And Refill

At the intervals shown in the appropriate "Maintenance Schedule," the system should be drained, flushed, and refilled.

If the solution is dirty and contains a considerable amount of sediment, clean and flush with reliable cooling system cleaner. Follow with a thorough rinsing to remove all deposits and chemicals.

Engine Coolant Disposal

Used ethylene glycol-based engine coolant is a regulated substance requiring proper disposal. Check with your local authorities to determine the disposal rules for your community. Do not store ethylene glycol-based engine coolant in open containers or allow it to remain in puddles on the ground. Prevent ingestion by animals and children. If ingested by a child, contact a physician immediately. Clean up any ground spills immediately.

Selection Of Coolant

Use only the manufacturer's recommended coolant, refer to Recommended Fluids, Lubricants, and Genuine Parts for correct coolant type.

CAUTION!

- **Mixing of coolants other than the specified HOAT coolant may result in decreased corrosion protection and engine damage that may not be covered under the new vehicle warranty. If a non-HOAT coolant is introduced into the cooling system in an emergency, it should be replaced with the specified coolant as soon as possible.**
- **Do not use plain water alone or alcohol base antifreeze products. Do not use additional rust inhibitors or antirust products, as they may not be compatible with the radiator coolant and may plug the radiator.**
- **This vehicle has not been designed for use with Propylene Glycol based coolants. Use of Propylene Glycol base coolants is not recommended.**

Adding Coolant

When adding coolant, a minimum solution of 50% recommended HOAT ethylene glycol coolant in water should be used. Use higher concentrations (not to exceed 70%) if temperatures below -37°F (-38°C) are anticipated.

Use only high purity water such as distilled or deionized water when mixing the water/antifreeze solution. The use of lower quality water will reduce the amount of corrosion protection in the engine cooling system.

Please note that it is the owner's responsibility to maintain the proper level of protection against freezing according to the temperatures occurring in the area where the vehicle is operated.

NOTE: Mixing coolant types will decrease the life of the engine coolant and will require more frequent engine coolant changes.

Cooling System Pressure Cap

The cap must be fully tightened to prevent loss of coolant, and to insure that coolant will return to the radiator from the coolant reserve tank.

The cap should be inspected and cleaned if there is any accumulation of foreign material on the sealing surfaces.

WARNING!

The warning words **DO NOT OPEN HOT** on the cooling system pressure cap are a safety precaution. Never add coolant when the engine is overheated. Do not loosen or remove the cap to cool an overheated engine. Heat causes pressure to build up in the cooling system. To prevent scalding or injury, do not remove the pressure cap while the system is hot or under pressure.

Coolant Level

Check the coolant level at least once a month or more often in hot weather. Check the level when the engine is at normal operating temperature. Check the coolant level only in the coolant recovery bottle. The coolant level must be between the FULL and the ADD mark on the bottle.

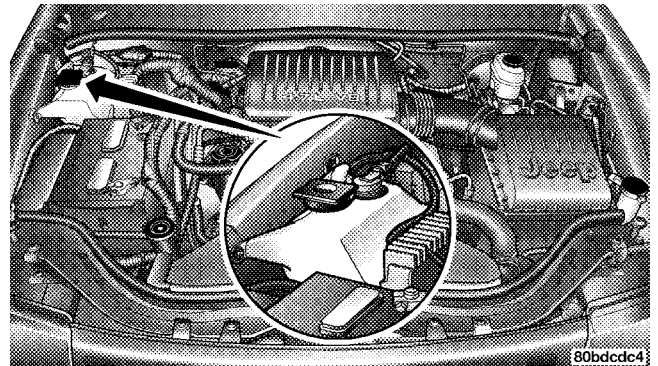

See your authorized dealer if the coolant level drops quickly.

Points To Remember

NOTE: When the vehicle is stopped after a few miles of operation, you may observe vapor coming from the front of the engine compartment. This is normally a result of moisture from rain, snow, or high humidity accumulating on the radiator and being vaporized when the thermostat opens, allowing hot coolant to enter the radiator.

If an examination of your engine compartment shows no evidence of radiator or hose leaks, the vehicle may be safely driven. The vapor will soon dissipate.

- Do not overfill the coolant bottle.
- Check coolant freeze point in the system.
- If frequent coolant additions are required, or if the level in the recovery bottle does not drop when the engine cools, the cooling system should be pressure tested for leaks.
- Maintain coolant concentration at 50% ethylene glycol antifreeze (minimum) in water for proper corrosion protection of your engine that contains aluminum components.
- Make sure that the radiator and coolant bottle hoses are not kinked or obstructed.
- Do not change the thermostat for summer or winter operation. If replacement is ever necessary, install **ONLY** the correct type thermostat. Other designs may result in unsatisfactory cooling performance, poor gas mileage, and increased emissions.

Hoses and Vacuum/Vapor Harnesses

Inspect surfaces of hoses and nylon tubing for evidence of heat and mechanical damage. Hard or soft spots, brittle rubber, cracking, tears, cuts, abrasions, and excessive swelling indicate deterioration of the rubber.

Pay particular attention to the hoses nearest to high heat sources such as the exhaust manifold. Inspect hose routing to be sure hoses do not touch any heat source or moving component that may cause heat damage or mechanical wear.

Insure nylon tubing in these areas has not melted or collapsed. Inspect all hose connections such as clamps and couplings to make sure they are secure and no leaks are present. Components should be replaced immediately if there is any evidence of degradation that could cause failure.

Brake System

In order to assure brake system performance, all brake system components should be inspected periodically. Refer to the appropriate "Maintenance Schedule" in Section 8 for suggested service intervals.

WARNING!

Riding the brakes can lead to brake failure and possibly an accident. Driving with your foot resting or riding on the brake pedal can result in abnormally high brake temperatures, excessive lining wear, and possible brake damage. You wouldn't have your full braking capacity in an emergency.

Brake and Power Steering System Hoses

When servicing the vehicle for scheduled maintenance, inspect surface of hoses for evidence of heat and mechanical damage. Hard and brittle rubber, cracking, tears,

cuts, abrasion, and excessive swelling suggest deterioration of the rubber. Particular attention should be made to examining those hose surfaces nearest to high heat sources, such as the exhaust manifold.

Inspect all hose clamps and couplings to make sure they are secure and no leaks are present.

NOTE: Often fluids such as oil, power steering fluid, and brake fluid are used during assembly plant operations to ease the assembly of hoses to couplings. Therefore, oil wetness at the hose-coupling area is not necessarily an indication of leakage. Actual dripping of hot fluid when systems are under pressure (during vehicle operation) should be noted before hose is replaced based on leakage.

NOTE: Inspection of brake hoses should be done whenever the brake system is serviced and every engine oil change.

WARNING!

Worn brake hoses can burst and cause brake failure. You could have an accident. If you see any signs of cracking, scuffing, or worn spots, have the brake hoses replaced immediately.

Brake Master Cylinder

The fluid level in the master cylinder should be checked when performing under hood services, or immediately if the brake system warning lamp shows system failure

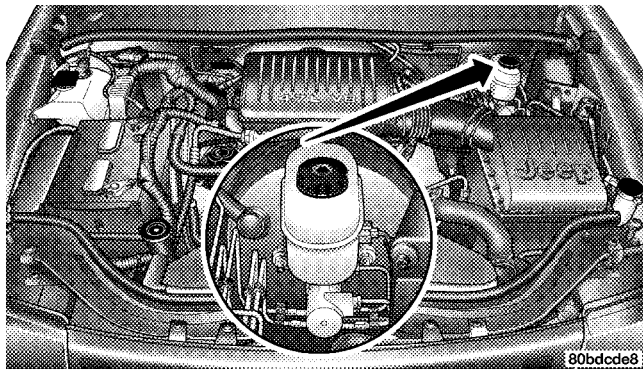

Be sure to clean the top of the master cylinder area before removing the cap. If necessary, add fluid to bring the fluid level up to the requirements described on the brake

fluid reservoir. With disc brakes, fluid level can be expected to fall as the brake pads wear. However, low fluid level may be caused by a leak and a checkup may be needed.

Use only manufacturer's recommended brake fluid, refer to Recommended Fluids, Lubricants, and Genuine Parts for correct fluid type.

WARNING!

Use of a brake fluid that may have a lower initial boiling point or unidentified as to specification, may result in sudden brake failure during hard prolonged braking. You could have an accident.

WARNING!

Overfilling the brake fluid reservoir can result in spilling brake fluid on hot engine parts and the brake fluid catching fire.

Use only brake fluid that has been in a tightly closed container to avoid contamination from foreign matter. Do not allow petroleum base fluid to contaminate the brake fluid as seal damage will result.

Automatic Transmission**Selection of Lubricant**

It is important that the proper lubricant is used in the transmission to assure optimum transmission performance. Use only manufacturer's recommended transmission fluid, refer to Recommended Fluids, Lubricants, and

Genuine Parts for correct fluid type. It is important that the transmission fluid be maintained at the prescribed level using the recommended fluid.

CAUTION!

Using a transmission fluid other than the manufacturer's recommended fluid may cause deterioration in transmission shift quality and/or torque converter shudder. Using a transmission fluid other than the manufacturer's recommended fluid will result in more frequent fluid and filter changes. Refer to Recommended Fluids, Lubricants, and Genuine Parts for correct fluid type.

Fluid Level Check – 4.0L Engines (42RE)

This fluid level should be checked when the engine is fully warmed up and the fluid in the transmission is heated to its normal operating temperature. Operation of

the transmission with an improper fluid level will greatly reduce the life of the transmission and of the fluid.

To check the automatic transmission fluid level properly, the following procedure must be used:

1. The vehicle must be on level ground.
2. The engine should be running at curb idle speed for a minimum of 60 seconds.
3. Fully apply parking brake.
4. Apply the brakes and shift the transmission into P (Park).
5. The fluid **MUST** be checked with the transmission in P (Park) to be sure that the fluid is accurate.
6. Wipe the dipstick clean and reinsert until seated. Remove dipstick and note reading.

At normal operating temperature (approximately 180° F (82° C), the fluid level is correct if it is in the HOT region (cross-hatched area) on the oil level indicator. The fluid level indicator should be in the COLD region at 70° F (21° C) fluid temperature.

If the fluid level is low, add sufficient fluid to bring to the proper level. Refer to Recommended Fluids, Lubricants and Genuine Parts for correct fluid type.

Fluid is added through the dipstick tube.

NOTE: To prevent dirt and water from entering the transmission after checking or replenishing fluid, make certain that the dipstick cap is properly reseated.

Fluid Level Check – 4.7L Engines (5–45RFE)

Check the fluid level while the transmission is at normal operating temperature 180°F (82°C). This occurs after at

least 15 miles (25 km) of driving. At normal operating temperature the fluid cannot be held comfortably between the fingertips.

To check the automatic transmission fluid level properly, the following procedure must be used:

1. Operate the engine at idle speed and normal operating temperature.
2. The vehicle must be on level ground.
3. Fully apply the parking brake and press the brake pedal.
4. Place the gear selector momentarily in each gear position ending with the lever in P (Park).
5. Remove the dipstick, wipe it clean and reinsert it until seated.
6. Remove the dipstick again and note the fluid level on both sides. The fluid level should be between the "HOT"

(upper) reference holes on the dipstick at normal operating temperature. Verify that solid coating of oil is seen on both sides of the dipstick. If the fluid is low, add as required into the dipstick tube. **Do not overfill.** After adding any quantity of oil through the oil fill tube, wait a minimum of two (2) minutes for the oil to fully drain into the transmission before rechecking the fluid level.

NOTE: If it is necessary to check the transmission **below** the operating temperature, the fluid level should be between the two "COLD" (lower) holes on the dipstick with the fluid at approximately 70°F (21°C) (room temperature). If the fluid level is correctly established at room temperature, it should be between the "HOT" (upper) reference holes when the transmission reaches 180°F (82°C). Remember it is best to check the level at the normal operating temperature.

CAUTION!

Be aware that if the fluid temperature is below 50°F (10°C) it may not register on the dipstick. Do not add fluid until the temperature is elevated enough to produce an accurate reading.

7. Check for leaks. Release parking brake.

To prevent dirt and water from entering the transmission after checking or replenishing fluid, make certain that the dipstick cap is properly reseated. It is normal for the dipstick cap to spring back slightly from its fully seated position, as long as its seal remains engaged in the dipstick tube.

Special Additives

The manufacturer recommends against the addition of any additives to the transmission. Exception to this policy is the use of special dyes to aid in detecting fluid leaks.

Transfer Case**Fluid Level Check**

Inspect the transfer case for fluid leaks. If a fluid leak is found, the transfer case fluid level can be checked by removing the filler plug located on the back side of the transfer case. The fluid level should be at the bottom edge of the filler plug hole when the vehicle is in a level position.

Adding Fluid

Add fluid at the filler hole until it runs out of the hole when the vehicle is in a level position.

Drain

First remove fill plug, then remove drain plug. Recommended tightening torque for drain and fill plugs is 15–25 ft. lbs (20–34 N·m).

CAUTION!

When installing plugs, do not overtighten. You could damage them and cause them to leak.

Selection of Lubricant

Use only manufacturer's recommended fluid, refer to Recommended Fluids, Lubricants, and Genuine Parts for correct fluid type.

Front/Rear Axle Fluid**Fluid Level Check**

Lubricant should be 1/2" (1 cm) below the oil fill hole.

Adding Fluid

Add lubricant only at the fill hole and only to the level specified above.

Selection of Lubricant

Use only manufacturer's recommended fluid, refer to Recommended Fluids, Lubricants, and Genuine Parts for correct fluid type.

Appearance Care And Protection From Corrosion**Protection of Body and Paint from Corrosion**

Vehicle body care requirements vary according to geographic locations and usage. Chemicals that make roads passable in snow and ice, and those that are sprayed on trees and road surfaces during other seasons, are highly corrosive to the metal in your vehicle.

The following maintenance recommendations will enable you to obtain maximum benefit from the corrosion resistance built into your vehicle.

What Causes Corrosion?

Corrosion is the result of deterioration or removal of paint and protective coatings from your vehicle.

The most common causes are:

- Road salt, dirt and moisture accumulation.
- Stone and gravel impact.
- Insects, tree sap and tar.
- Salt in the air near seacoast localities.
- Atmospheric fallout/industrial pollutants.

Washing

- Wash your vehicle regularly. Always wash your vehicle in the shade using a mild car wash soap and rinse the panels completely with clear water.
- If insects, tar or other similar deposits have accumulated on your vehicle, wash it as soon as possible.
- Use Mopar® Auto Polish to remove road film and stains and to polish your vehicle. Take care never to scratch the paint.
- Avoid using abrasive compounds and power buffing that may diminish the gloss or thin out the paint finish.

CAUTION!

Do not use abrasive or strong cleaning materials such as steel wool or scouring powder, which will scratch metal and painted surfaces.

Special Care

- If you drive on salted or dusty roads or if you drive near the ocean, hose off the undercarriage at least once a month.
- The drain holes in the lower edges of the doors, rocker panels, and rear liftgate must be kept clear and open.
- If you detect any stone chips or scratches in the paint, touch them up immediately. The cost of such repairs is considered the responsibility of the owner.
- If your vehicle is damaged due to an accident or similar cause which destroys the paint and protective coating, have your vehicle repaired as soon as possible. The cost of such repairs is considered the responsibility of the owner.
- If you carry special cargo such as chemicals, fertilizers, de-icer salt, etc., assure that such materials are well packaged and sealed.
- If a lot of driving is done on gravel roads, consider mud or stone shields behind each wheel.
- Use Mopar® Touch-Up Paint on scratches as soon as possible. Your authorized dealer has touch-up paint to match the color of your vehicle.
- Aluminum wheels should be cleaned regularly with mild soap and water to prevent corrosion. To remove heavy soil, select a nonabrasive, non-acidic cleaner. Do not use scouring pads or metal polishes. Avoid automatic car washes that use acidic solutions or harsh brushes that may damage the wheels' protective finish.

Interior Care

Use Mopar® Fabric Cleaner to clean fabric upholstery and carpeting.

Use Mopar® Vinyl Cleaner to clean vinyl upholstery.

Mopar® Vinyl Cleaner is specifically recommended for interior vinyl trim.

Do not use silicon based cleaning products on leather seats. They could cause cracking of the seat leather.

Leather Seat Care & Cleaning

Leather is best preserved by regular cleaning with a damp soft cloth. Small particles of dirt can act as an abrasive and damage the leather surface and should be removed promptly with a damp cloth. Stubborn soils can be removed easily with a soft cloth and Mopar® Total

Clean. Care should be taken to avoid soaking the leather with any liquid. Please do not use polishes, oils, cleaning fluids, solvents, detergents, or ammonia based cleaners to clean the leather. Application of a leather conditioner is not required to maintain the original condition.

Glass Surfaces

All glass surfaces should be cleaned on a regular basis with any commercial household-type glass cleaner. Never use an abrasive type cleaner. Use caution when cleaning inside rear windows equipped with electric defrosters. Do not use scrapers or other sharp instruments which may scratch the elements.

When cleaning the rear view mirror, spray cleaner on the towel or rag that you are using. Do not spray cleaner directly on the mirror.

WARNING!

Do not use volatile solvents for cleaning purposes. Many are potentially flammable, and if used in closed areas they may cause respiratory harm. Do not use gasoline, turpentine, kerosene, etc. for cleaning. Use the Mopar® recommended products or the equivalents.

Carpet

Vacuum your carpet regularly to prevent a soil build-up. Shampoo soiled carpet with a reliable upholstery cleaner, using a natural sponge or soft bristle brush. After carpet dries, vacuum it thoroughly.

Seat Belt Maintenance

Do not bleach, dye or clean the belts with chemical solvents or abrasive cleaners. This will weaken the fabric. Sun damage will also weaken the fabric.

If the belts need cleaning, use a mild soap solution or lukewarm water. Do not remove the belts from the vehicle to wash them.

Replace the belts if they appear frayed or worn or if the buckles do not work properly.

Maintenance After Off-Pavement Driving

After extended operation in mud, sand or water, or similar dirty conditions, have your brake drums, brake linings, and axle joints inspected and cleaned as soon as possible. This will prevent any abrasive material from causing excessive wear or unpredictable braking action.

Following off-pavement usage, completely inspect the underbody of your vehicle. Check tires, body structure, steering, suspension and exhaust system for damage. Check threaded fasteners for looseness, particularly on the chassis, drivetrain components, steering and suspension. Retighten, if required, to torque values specified in the Service Manual. Also check for accumulations of

vegetation or brush that could become a fire hazard, or conceal damage to fuel lines, brake hoses, axle pinion seals, and propeller shafts.

CAUTION!

Under frequent heavy-duty driving conditions, change all lubricants and lubricate body components, all driveline joints and steering linkage more often than in normal service to prevent excessive wear.

FUSE PANEL

Interior Fuses

The fuse panel is on the lower instrument panel just to the left of the steering column. A label is stamped on the fuse panel cover to identify each fuse for ease of replacement.

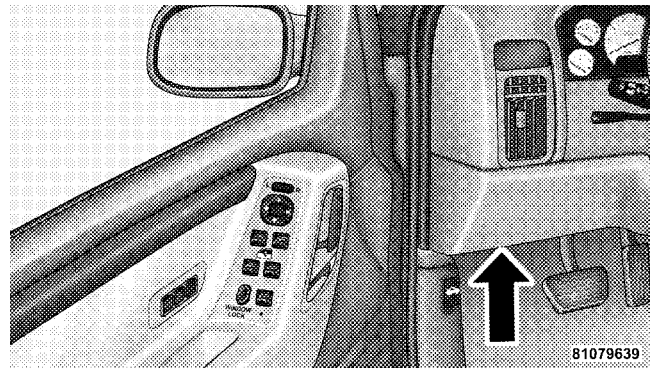

Cavity	Fuse	Description
1	Spare	
2	Spare	
3	10 Amp Red	Headlight High Beam Left
4	15 Amp Lt. Blue	Flasher
5	25 Amp Natural	Radio/Amplifier
6	15 Amp Lt. Blue	Park Lights
7	10 Amp Red	Interior Lights
8	15 Amp Lt. Blue	Overhead Console, Rear Wiper, IP Lights, Rear Flipper Glass Solenoid
9	20 Amp Yellow	Power Outlets
10	20 Amp Yellow	Adjustable Pedals
11	10 Amp Red	Rear Window Defroster Indicator
12	10 Amp Red	Auto Shut Down Relay/"Fuel"

Cavity	Fuse	Description
13	Spare	
14	10 Amp Red	Headlight Low Left
15	10 Amp Red	Headlight Low Right
16	10 Amp Red	Headlight High Right
17	10 Amp Red	Instrument Cluster, Diagnostic Connector
18	30 Amp	Trailer Tow
19	10 Amp Red	Antilock Brakes
20	10 Amp Red	Ignition Run
21	10 Amp Red	Ignition Run/Start - PDC
22	10 Amp Red	Ignition Run/Start
23	15 Amp Lt. Blue	Brake Switch
24	15 Amp Lt. Blue	Fog Lamps
25	20 Amp Yellow	Accessory Delay Relay (Sunroof)

Cavity	Fuse	Description
26	15 Amp Lt. Blue	Cigar
27	15 Amp Lt. Blue	Rear Fog Lamps (If Equipped)
28	10 Amp Red	Body Control Module, Acc/Run
29	10 Amp Red	Rear Wiper Switch, Washer Motors
30	15 Amp Lt. Blue	Radio
31	10 Amp Red	Ignition Start
32	10 Amp Red	Ignition Run/Start- Airbag
33	10 Amp Red	Ignition Run/Only - Airbag
C1	20 Amp	Wiper (Circuit Breaker)
C2	20 Amp	Seats (Circuit Breaker)
C3		Spare

Underhood Fuses (Power Distribution Center)

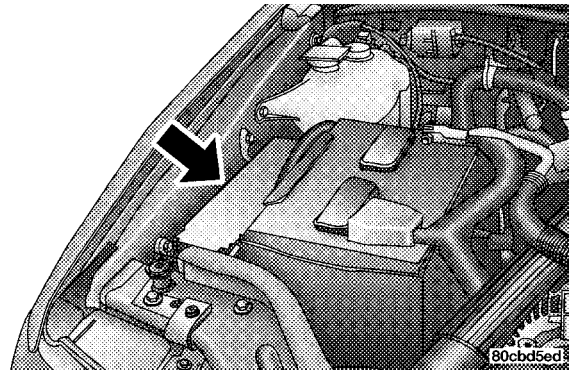

Your vehicle is equipped with an electrical power distribution center located in the engine compartment near the battery. This power center houses plug-in “Cartridge” fuses which replace in-line fusible links. The power center also contains “Mini” fuses and plug-in full and mini ISO relays. A label inside the latching cover of the

center identifies each component for ease of replacement, if necessary. "Cartridge" fuses and relays can be obtained from your authorized dealer.

VEHICLE STORAGE

If you are leaving your vehicle dormant for more than 21 days you may want to take steps to protect your battery. You may:

- Remove Cartridge fuse #15 in the Power Distribution Center labeled Ignition-Off Draw (IOD).
- Store the removed IOD fuse in the Power Distribution Center location #11 labeled "IOD Storage."
- Or, disconnect the negative cable from the battery.
- Anytime you store your vehicle, or keep it out of service (i.e. vacation) for two weeks or more, run the air conditioning system at idle for about five minutes in the fresh air and high blower setting. This will

insure adequate system lubrication to minimize the possibility of compressor damage when the system is started again.

REPLACEMENT BULBS

Interior Lights	Bulb Type
A/C Heater	Not Serviceable
Ashtray Receiver Light	161
Climate Control (Dual Zone Automatic)	Not Serviceable
Climate Control (Manual A/C).	74
Front Reading	192
Glove Box Light	194
Overhead Console	192
Radio	ASC
Rear Cargo Light	214-2
Passenger Assist Handle Lights	214-2
Lighted Vanity Mirror *.	P/N 6501966

Interior Lights	Bulb Type
Underpanel Courtesy Lights	906
Instrument Cluster (General Illumination)	103
Telltale/Hazard Light	74

* Available only from authorized dealers.

Exterior Lights	Bulb Type
Backup Lights	3157A
Center High-Mounted Stoplight	921
Fog Lights	9145
Front Park Lights (Limited)	194NA
Front Park Lights (Laredo)	194NA
Front Park/Turn Light (Limited)	3157A

Exterior Lights	Bulb Type
Front Park/Turn Light (Laredo)	3157A
Front Side Marker (Limited)	194NA
Front Side Marker (Laredo)	194NA
Headlights (Low Beam)	9006XS
Headlights (High Beam)	9005XS
Rear License Plate Light	168
Rear Stop/Tail Lights	3157A
Rear Turn Signal Lights (2)	3157A

NOTE: Numbers refer to commercial bulb types that can be purchased from your authorized dealer.

If a bulb needs to be replaced, visit your authorized dealer or refer to the applicable Service Manual.

FLUID CAPACITIES

	U.S.	Metric
Fuel (Approximate)	20 Gallons	76 Liters
Engine Oil with Filter		
4.0 Liter Engine (SAE 10W-30, API Certified Engine Oil)	6 Qts	5.7 Liters
4.7, 4.7HO Liter Engine (SAE 5W-30, API Certified Engine Oil)	6 Qts	5.7 Liters
Cooling System *		
4.0 Liter Engine (Mopar® Antifreeze/Coolant 5 Year/100,000 Mile Formula)	15 Qts	14.1 Liters
4.7 & 4.7HO Liter Engine (Mopar® Antifreeze/Coolant 5 Year/100,000 Mile Formula)	14.5 Qts	13.7 Liters

* Includes heater and coolant recovery bottle filled to MAX level.

RECOMMENDED FLUIDS, LUBRICANTS AND GENUINE PARTS**Engine**

Component	Fluid, Lubricant, or Genuine Part
Engine Coolant	Mopar® Antifreeze/Coolant 5 Year/100,000 Mile Formula HOAT (Hybrid Organic Additive Technology)
Engine Oil	API Certified SAE 10W-30 Engine Oil is recommended for the 4.0L engine. API Certified SAE 5W-30 Engine Oil is recommended for the 4.7L/4.7LHO engine. Refer to oil viscosity chart for correct SAE grade meeting DaimlerChrysler Material Standard MS-6395.
Oil Filter (All Engines)	Mopar® Oil Filter (P/N 05281090)
Spark Plugs	Refer to the Vehicle Emission Control Information label in the engine compartment.
Fuel Selection	87 Octane (91 Octane is recommended but not required for the 4.7LHO)

Chassis

Component	Fluid, Lubricant, or Genuine Part
Automatic Transmission	Mopar® ATF+4 Automatic Transmission Fluid
Transfer Case	Selec-Trac Models - Mopar® ATF+4 Automatic Transmission Fluid. Quadra-Trac Models - Mopar® Transfer Case Fluid (P/N 05016796)
Axle Differential (front-rear)	Mopar® Synthetic Gear Lubricant or equivalent of SAE 75W-140 (API-GL5) if equipped with a Vari-Lok® front axle. Mopar® Gear Lubricant or equivalent of SAE 80W-90 (API-GL5) if not equipped with a Vari-Lok® front axle. Mopar® Synthetic Gear Lubricant or equivalent of SAE 75W-140 (API-GL5) if equipped with a Dana M35 or M44 Vari-Lok® rear axle. Mopar® Gear Lubricant or equivalent of SAE 80W-90 (API-GL5) if equipped with a Dana M44 rear axle without Vari-Lok®. For trailer towing applications, use a SAE 75W-140 Synthetic Gear Lubricant in rear axle. Vari-Lok® equipped axles require a friction modifier additive.
Brake Master Cylinder	Mopar® DOT 3, SAE J1703 should be used. If DOT 3, SAE J1703 brake fluid is not available, then DOT 4 is acceptable. Use only recommended brake fluids.
Power Steering Reservoir	Mopar® Power Steering Fluid (MS-5931)
Ball Joints, Prop Shafts, U-Joints, Yokes, & Wheel Bearings	Mopar® Multi-Purpose Lube NLGI Grade 2 EP, GC-LB

MAINTENANCE SCHEDULES

CONTENTS

■ Emission Control System Maintenance	296	□ Schedule "B"	299
■ Maintenance Schedules	296	□ Schedule "A"	310

EMISSION CONTROL SYSTEM MAINTENANCE

The "Scheduled" maintenance services, listed in **bold type** must be done at the times or mileages specified to assure the continued proper functioning of the emission control system. These, and all other maintenance services included in this manual, should be done to provide best vehicle performance and reliability. More frequent maintenance may be needed for vehicles in severe operating conditions such as dusty areas and very short trip driving.

Inspection and service also should be done any time a malfunction is suspected.

NOTE: Maintenance, replacement, or repair of the emission control devices and systems on your vehicle may be performed by any automotive repair establishment or individual using any automotive part which has been certified pursuant to U.S. EPA or, in the State of California, California Air Resources Board regulations.

MAINTENANCE SCHEDULES

There are two maintenance schedules that show the **required** service for your vehicle.

First is Schedule "B". It is for vehicles that are operated under the conditions that are listed below and at the beginning of the schedule.

- Day or night temperatures are below 32°F (0°C)
- Stop and go driving
- Excessive engine idling
- Driving in dusty conditions
- Short trips of less than 10 miles (16.2 km)
- More than 50% of your driving is at sustained high speeds during hot weather, above 90°F (32°C)
- Trailer towing

- Taxi, police, or delivery service (commercial service)
- Off-road or desert driving
- **If equipped for and operated with E-85 (ethanol) fuel.**

NOTE: Most vehicles are operated under the conditions listed for Schedule “B.”

NOTE: If ANY of these apply to you, change your engine oil every 3,000 miles (5 000 km) or 3 months, whichever comes first, and follow the maintenance recommendations in “Maintenance Schedule B.”

Second is Schedule “A”. It is for vehicles that are not operated under any of the conditions listed under Schedule “B.”

Use the schedule that best describes your driving conditions. Where time and mileage are listed, follow the interval that occurs first.

CAUTION!

Failure to perform the required maintenance items may result in damage to the vehicle.

At Each Stop for Fuel

- Check the engine oil level about 5 minutes after a fully warmed engine is shut off. Checking the oil level while the vehicle is on level ground will improve the accuracy of the oil level reading. Add oil only when the level is at or below the ADD or MIN mark.
- Check the windshield washer solvent, add as required.

Once a Month

- Check the tire pressure and look for unusual wear or damage.
- Inspect the battery and clean and tighten the terminals as required.
- Check the fluid levels of the coolant reservoir, brake master cylinder, and transmission, and add as needed.
- Check all lights and all other electrical items for correct operation.

At Each Oil Change

- Change the engine oil filter.
- Inspect the exhaust system.
- Inspect brake hoses.
- Check the coolant level, hoses, and clamps.
- Rotate the tires at each oil change interval shown on Schedule "A" 6,000 miles (10 000 km) or every other interval shown on Schedule "B" 6,000 miles (10 000 km).
- After completion of off-road operation, the underside of the vehicle should be thoroughly inspected. Examine threaded fasteners for looseness.

Schedule "B"

Follow this schedule if you usually operate your vehicle under one or more of the following conditions.

- Day or night temperatures are below 32°F (0°C)
- Stop and go driving
- Excessive engine idling
- Driving in dusty conditions
- Short trips of less than 10 miles (16.2 km)
- More than 50% of your driving is at sustained high speeds during hot weather, above 90°F (32°C)

- Trailer towing
- Taxi, police, or delivery service (commercial service)
- Off-road or desert driving
- **If equipped for and operated with E-85 (ethanol) fuel.**

NOTE: If ANY of these apply to you, change your engine oil every 3,000 miles (5 000 km) or 3 months, whichever comes first, and follow the maintenance recommendations in "Maintenance Schedule B."

300 SCHEDULE "B"

Miles (Kilometers)	3,000 (5 000)	6,000 (10 000)	9,000 (14 000)	12,000 (19 000)	15,000 (24 000)
Change the engine oil and engine oil filter.	X	X	X	X	X
Inspect the engine air cleaner filter, replace if necessary.					X
Lubricate the upper knuckle ball stud at steering & suspension ball joints.		X		X	
Drain and refill the front and rear axles.				X	
Inspect the brake linings.				X	
Clean and lubricate the brake caliper pins.				X	

Miles (Kilometers)	18,000 (29 000)	21,000 (34 000)	24,000 (38 000)	27,000 (43 000)	30,000 (48 000)
Change the engine oil and engine oil filter.	X	X	X	X	X
Inspect the engine air cleaner filter, replace if necessary.					X
Inspect the PCV Valve, replace if necessary. ◇					X
Replace the spark plugs.					X
Lubricate the upper knuckle ball stud at steering & suspension ball joints.	X		X		X
Drain and refill the front and rear axles.			X		
Inspect the brake linings.			X		
Clean and lubricate the brake caliper pins.			X		
Drain and refill the automatic transmission fluid, and change filter (4.0L Only).					X
Drain and refill the automatic transmission fluid, and replace main sump filter (4.7L Only).					X
Drain the transfer case and refill (Quadra-Trac Models Only).					X

302 SCHEDULE "B"

Miles (Kilometers)	33,000 (53 000)	36,000 (58 000)	39,000 (62 000)	42,000 (67 000)	45,000 (72 000)
Change the engine oil and engine oil filter.	X	X	X	X	X
Inspect the engine air cleaner filter, replace if necessary.					X
Drain and refill the front and rear axles.		X			
Inspect the brake linings.		X			
Lubricate the upper knuckle ball stud at steering & suspension ball joints.		X		X	
Clean and lubricate the brake caliper pins.		X			
Inspect and replace drive belt, if necessary (4.0L Only).					X

Miles (Kilometers)	48,000 (77 000)	51,000 (82 000)	54,000 (86 000)	57,000 (91 000)	60,000 (96 000)
Change the engine oil and engine oil filter.	X	X	X	X	X
Inspect the engine air cleaner filter, replace if necessary.					X
Inspect the PCV Valve, replace if necessary. ◇					X
Replace the spark plugs.					X
Lubricate the upper knuckle ball stud at steering & suspension ball joints.	X		X		X
Clean and lubricate brake caliper pins.	X				X
Inspect the brake linings.	X				X
Drain and refill the front and rear axles.	X				X
Drain and refill the automatic transmission fluid, and change filter (4.0L Only).					X
Drain and refill the automatic transmission fluid, and replace main sump filter (4.7L Only).					X
Inspect the drive belt and replace as needed. Not required if belt was previously replaced (4.0L Only).					X
Drain and refill the transfer case fluid (Selec-Trac and Quadra-Trac Models).					X

304 SCHEDULE "B"

Miles (Kilometers)	63,000 (101 000)	66,000 (106 000)	69,000 (110 000)	72,000 (115 000)	75,000 (120 000)
Change the engine oil and engine oil filter.	X	X	X	X	X
Inspect the engine air cleaner filter, replace if necessary.					X
Lubricate the upper knuckle ball stud at steering & suspension ball joints.		X		X	
Inspect the brake linings.				X	
Clean and lubricate the brake caliper pins.				X	
Drain and refill the front and rear axle fluid.				X	
Inspect the drive belt and replace as needed. Not required if belt was previously replaced (4.0L Only).					X
Inspect the drive belt and replace as needed (4.7L Only).					X

Miles (Kilometers)	78,000 (125 000)	81,000 (130 000)	84,000 (134 000)	87,000 (139 000)	90,000 (144 000)
Change the engine oil and engine oil filter.	X	X	X	X	X
Inspect the engine air cleaner filter, replace if necessary.					X
Inspect the PCV Valve, replace if necessary. ◇					X
Replace the spark plugs.					X
Lubricate the upper knuckle ball stud at steering & suspension ball joints.	X		X		X
Drain and refill the transfer case fluid (Quadra-Trac Models Only).					X
Inspect the brake linings.			X		
Clean and lubricate the brake caliper pins.			X		
Drain and refill the front and rear axle fluid.			X		
Drain and refill the automatic transmission fluid, and change filter (4.0L Only).					X

306 SCHEDULE "B"

Miles (Kilometers)	78,000 (125 000)	81,000 (130 000)	84,000 (134 000)	87,000 (139 000)	90,000 (144 000)
Drain and refill the automatic transmission fluid, replace main sump filter, and spin-on cooler return filter (if equipped) (4.7L Only).					X
Inspect the drive belt and replace as needed. Not required if belt was previously replaced.					X

Miles (Kilometers)	93,000 (149 000)	96,000 (154 000)	99,000 (158 000)	102,000 (163 000)	105,000 (168 000)
Change the engine oil and engine oil filter.	X	X	X	X	X
Inspect the engine air cleaner filter, replace if necessary.					X
Lubricate the upper knuckle ball stud at steering & suspension ball joints.		X		X	
Inspect the brake linings.		X			
Clean and lubricate the brake caliper pins.		X			
Drain and refill the front and rear axle fluid.		X			
Inspect the drive belt and replace as needed. Not required if belt was previously replaced.					X
Flush and replace the engine coolant.				X	

308 SCHEDULE "B"

Miles (Kilometers)	108,000 (173 000)	111,000 (178 000)	114,000 (182 000)	117,000 (187 000)	120,000 (192 000)
Change the engine oil and engine oil filter.	X	X	X	X	X
Inspect the engine air cleaner filter, replace if necessary.					X
Inspect the PCV Valve, replace if necessary. ◇					X
Replace the spark plugs.					X
Lubricate the upper knuckle ball stud at steering & suspension ball joints.	X		X		X
Inspect the brake linings.	X				X
Clean and lubricate the brake caliper pins.	X				X
Drain and refill the front and rear axle fluid.	X				X
Drain and refill the automatic transmission fluid, and change filter (4.0L Only).					X
Drain and refill the automatic transmission fluid, and replace main sump filter (4.7L Only).					X

Miles (Kilometers)	108,000 (173 000)	111,000 (178 000)	114,000 (182 000)	117,000 (187 000)	120,000 (192 000)
Inspect the drive belt and replace as needed. Not required if belt was previously replaced.					X
Drain and refill the transfer case fluid (Selec-Trac and Quadra-Trac Models).					X

Inspection and service should also be performed anytime a malfunction is observed or suspected. Retain all receipts.

◇ This maintenance is recommended by the manufacturer to the owner, but is not required to maintain emissions warranty.

‡Off-highway operation, trailer towing, taxi, limousine, bus, or other types of commercial service or prolonged operation with heavy loading, especially in hot weather, require front and rear axle service indicated with a ‡ in Schedule "B". Perform these services if the vehicle is usually operated under these conditions.

310 SCHEDULE "A"

Schedule "A"

Miles (Kilometers) [Months]	6,000 (10 000) [6]	12,000 (19 000) [12]	18,000 (29 000) [18]	24,000 (38 000) [24]	30,000 (48 000) [30]
Change the engine oil and engine oil filter.	X	X	X	X	X
Inspect the engine air cleaner filter, and replace if necessary.					X
Replace the spark plugs.					X
Lubricate the upper knuckle ball stud at steering & suspension ball joints.		X		X	
Inspect the brake linings.			X		
Clean and lubricate the brake caliper pins.			X		
Inspect transfer case fluid (Selec-Trac Models Only).					X
Drain the transfer case and refill (Quadra-Trac Models Only).					X

Miles (Kilometers) [Months]	36,000 (58 000) [36]	42,000 (67 000) [42]	48,000 (77 000) [48]	54, 000 (86 000) [54]
Change the engine oil and engine oil filter.	X	X	X	X
Inspect the brake linings.	X			X
Lubricate the upper knuckle ball stud at steering & suspension ball joints.	X		X	
Clean and lubricate the brake caliper pins.	X			X

312 SCHEDULE "A"

Miles (Kilometers) [Months]	60,000 (96 000) [60]	66,000 (106 000) [66]	72,000 (115 000) [72]	78,000 (125 000) [78]
Change the engine oil and engine oil filter.	X	X	X	X
Inspect the engine air cleaner filter, and replace if necessary.	X			
Inspect the PCV Valve, replace if necessary. ◇	X			
Replace the spark plugs.	X			
Lubricate the upper knuckle ball stud at steering & suspension ball joints.	X		X	
Inspect and replace the drive belt if necessary (4.0L Only). Not required if belt was previously replaced.	X			X
Flush and replace the engine coolant.	X			
Inspect the brake linings.			X	
Clean and lubricate the brake caliper pins.			X	
Inspect transfer case fluid (Selec-Trac Models Only).	X			
Drain the transfer case and refill (Quadra-Trac Models Only).	X			

Miles (Kilometers) [Months]	84,000 (134 000) [84]	90,000 (144 000) [90]	96,000 (154 000) [96]	102, 000 (163 000) [102]
Change the engine oil and engine oil filter.	X	X	X	X
Inspect the engine air cleaner filter, and replace if necessary.		X		
Inspect the PCV Valve, replace if necessary. ◇		X		
Replace the spark plugs.		X		
Lubricate the upper knuckle ball stud at steering & suspension ball joints.	X		X	
Clean and lubricate the brake caliper pins.		X		
Inspect the brake linings.		X		
Inspect the drive belt, and replace as needed. Not required if previously replaced.		X		
Flush and replace the engine coolant if not replaced at 60 months.				X
Drain and refill the automatic transmission fluid, and change filter (4.0L Only).				X

314 SCHEDULE "A"

Miles (Kilometers) [Months]	84,000 (134 000) [84]	90,000 (144 000) [90]	96,000 (154 000) [96]	102, 000 (163 000) [102]
Drain and refill the automatic transmission fluid, replace main sump filter, and spin-on cooler return filter (if equipped) (4.7L Only).				X
Inspect the transfer case fluid (Selec-Trac Models Only).		X		
Drain the transfer case and refill (Quadra-Trac Models Only).		X		

Miles (Kilometers) [Months]	108,000 (173 000) [108]	114,000 (182 000) [114]	120,000 (192 000) [120]
Change the engine oil and engine oil filter.	X	X	X
Inspect the engine air cleaner filter, and replace if necessary.			X
Inspect the PCV Valve, replace if necessary. ◇			X
Replace the spark plugs.			X
Lubricate the upper knuckle ball stud at steering & suspension ball joints.	X		X
Inspect the brake linings.	X		
Clean and lubricate the brake caliper pins.	X		
Inspect and replace the drive belt if not previously replaced.	X		X
Drain the transfer case and refill (Selec-Trac and Quadra-Trac Models).			X

Inspection and service should also be performed anytime a malfunction is observed or suspected. Retain all receipts.

◇ This maintenance is recommended by the manufacturer to the owner, but is not required to maintain emissions warranty.

WARNING!

You can be badly injured working on or around a motor vehicle. Do only that service work for which you have the proper equipment. If you have any doubt about your ability to perform a service job, take your vehicle to a competent mechanic.

IF YOU NEED CONSUMER ASSISTANCE

CONTENTS

■ Suggestions For Obtaining Service For Your Vehicle	318	■ Warranty Information	321
□ Prepare For The Appointment	318	■ Mopar® Parts	323
□ Prepare A List	318	■ Reporting Safety Defects	323
□ Be Reasonable With Requests	318	□ In Canada	323
■ If You Need Assistance	318	■ Publication Order Forms	324

SUGGESTIONS FOR OBTAINING SERVICE FOR YOUR VEHICLE**Prepare For The Appointment**

If you're having warranty work done, be sure to have the right papers with you. Take your warranty folder. All work to be performed may not be covered by the warranty, discuss additional charges with the service manager. Keep a maintenance log of your vehicle's service history. This can often provide a clue to the current problem.

Prepare A List

Make a written list of your vehicle's problems or the specific work you want done. If you've had an accident, or work done that is not on your maintenance log, let the service advisor know.

Be Reasonable With Requests

If you list a number of items, and you must have your vehicle by the end of the day, discuss the situation with the service advisor and list the items in order of priority. At many dealers you may obtain a rental vehicle at a minimal daily charge. If you need a rental, it is advisable to make these arrangements when you call for an appointment.

IF YOU NEED ASSISTANCE

The manufacturer and its dealers are vitally interested in your satisfaction. We want you to be happy with our products and services.

Your selling dealer is best equipped and most anxious to provide prompt resolution for any warranty issue or related matter that you may experience. The manufacturer's dealers have the facilities, factory-trained technicians, special tools, and the latest information to assure your vehicle is fixed correctly and in a timely manner.

The manufacturer has empowered its dealers to make warranty and repair decisions that ensure you are not inconvenienced. There is no need for you to wait for a decision from the manufacturer. If a special circumstance occurs that requires information from the manufacturer, we have asked the dealer's service management to make the contact on your behalf.

This is why you should always talk to your dealer's service manager first. Most matters can be resolved with this process.

- If for some reason you are still not satisfied, talk to the general manager or owner of the dealership. They want to know if you need assistance.
- If your dealership is unable to resolve the concern, you may contact the Manufacturer's Customer Center.

Any communication to the Manufacturer's Customer Center should include the following information:

- Owner's name and address
- Owner's telephone number (home and office)
- Dealership name
- Vehicle identification number
- Vehicle delivery date and mileage

DaimlerChrysler Motors Corporation Customer Center

P.O. Box 21-8004

Auburn Hills, MI 48321-8004

Phone: (800) 992-1997

DaimlerChrysler Canada Inc. Customer Center

P.O. Box 1621

Windsor, Ontario N9A 4H6

Phone —(800) 465-2001

In Mexico contact:

Av. Prolongacion Paseo de la Reforma, 1240
Sante Fe C.P. 05109
Mexico, D. F.
In Mexico (915) 729-1248 or 729-1240
Outside Mexico (525) 729-1248 or 729-1240

Customer Assistance For The Hearing Or Speech Impaired (TDD/TTY)

To assist customers who have hearing difficulties, the manufacturer has installed special TDD (Telecommunication Devices for the Deaf) equipment at its Customer Center. Any hearing or speech impaired customer who has access to a TDD or a conventional teletypewriter (TTY) in the United States can communicate with the manufacturer by dialing 1-800-380-CHRY.

Service Contract

You may have purchased a service contract for your vehicle to help protect you from the high cost of unexpected repairs after your manufacturer's new vehicle limited warranty expires. The manufacturer stands behind only the manufacturer's Service Contracts. If you purchased a manufacturer's Service Contract, you will receive Plan Provisions and an Owner Identification Card in the mail within three weeks of your vehicle delivery date. If you have any questions about your service contract, call the manufacturer's Service Contract National Customer Hotline at 1-800-521-9922.

The manufacturer will not stand behind any service contract that is not the manufacturer's Service Contract. It is not responsible for any service contract other than the manufacturer's Service Contract. If you purchased a service contract that is not a manufacturer's Service Contract, and you require service after your manufacturer's new vehicle limited warranty expires, please refer to your contract documents, and contact the person listed in those documents.

We appreciate that you have made a major investment when you purchased your new vehicle. Your dealer has also made a major investment in facilities, tools, and training to assure that you are absolutely delighted with your ownership experience. You'll be pleased with their sincere efforts to resolve any warranty issues or related concerns.

WARRANTY INFORMATION

See your manufacturer's Warranty Information Booklet for information on warranty coverage and transfer of warranty.

322 IF YOU NEED CONSUMER ASSISTANCE

DESCRIPTION	1 Yr/ 12,000	2 Yr/ 24,000	3 Yr/ 36,000	3 Yr/ 50,000	3 Yr/ Unimtd	5 Yr/ 100,000	7 Yr/ 70,000	8 Yr/ 80,000
Basic Limited Warranty Coverage								
Special Extended Warranty Coverage								
Powertrain Limited Warranty (\$100 deductible)				1st Owner & 2nd Owner with Paid Powertrain Transfer				
	2nd Owner if Powertrain Not Transferred and 3rd (And After) Owners							
Anti-Corrosion Perforation Limited Warranty: All Panels								
Outer Panels								
Federal Emission Warranty								
Federal Emission Warranty - Specified Components								
California Emission Warranty								
California Emission Warranty - Specified Components								

NOTE: Vehicles used as a police vehicle, taxi, limousine, postal delivery vehicle, ambulance or rental vehicle are covered only under the 3 year/36,000 mile Basic Limited Warranty. 8132c269

MOPAR® PARTS

Mopar® fluids, lubricants, parts, and accessories are available from your dealer. They will help you keep your vehicle operating at its best.

REPORTING SAFETY DEFECTS

In the 50 United States and Washington D.C.: If you believe that your vehicle has a defect which could cause a crash or cause injury or death, you should immediately inform the National Highway Traffic Safety Administration (NHTSA) in addition to notifying the manufacturer.

If NHTSA receives similar complaints, it may open an investigation, and if it finds that a safety defect exists in a group of vehicles, it may order a recall and remedy campaign. However, NHTSA cannot become involved in individual problems between you, your dealer, and the manufacturer.

To contact NHTSA, you may either call the Auto Safety Hotline toll free at 1-800-424-9393 (or 366-0123 in Washington DC area) or write to: NHTSA, U.S. Dept. of Transportation, Washington DC 20590. You can also obtain other information about motor vehicle safety from the Hotline.

In Canada:

If you believe that your vehicle has a safety defect, you should contact the Customer Service Department immediately. Canadian customers who wish to report a safety defect to the Canadian government should write to Transport Canada, Motor Vehicle Defect Investigations and Recalls, 2780 Sheffield Road, Ottawa, Ontario K1B 3V9.

PUBLICATION ORDER FORMS

To order the following manuals, you may use either the website or the phone numbers listed below. Visa, Mastercard, American Express, and Discover orders are accepted. If you prefer mailing your payment, please call for an order form.

NOTE: A street address is required when ordering manuals. (No P.O. Boxes).

- *Service Manuals.*

These comprehensive service manuals provide the information that students and professional technicians need in diagnosing/troubleshooting, problem solving, maintaining, servicing and repairing DaimlerChrysler Corporation vehicles. A complete working knowledge of the vehicle, system and/or components is written in straightforward language with illustrations, diagrams and charts.

- *Diagnostic Procedure Manuals.*

Filled with diagrams, charts and detailed illustrations, these practical manuals make it easy for students and technicians to find and fix problems on computer-controlled vehicle systems and features. They show exactly how to find and correct problems the first time, using step-by-step troubleshooting and driveability procedures, proven diagnostic tests and a complete list of all tools and equipment.

- *Owner's Manuals.*

These manuals have been prepared with the assistance of service and engineering specialists to acquaint you with specific Chrysler group vehicles. Included are starting, operating, emergency and maintenance procedures as well as specifications, capabilities and safety tips.

Call Toll Free at **1-800-890-4038** (U.S.) or **1-800-387-1143**
(Canada)

Or

Visit us on the World Wide Web at:

www.techauthority.daimlerchrysler.com or
www.daimlerchrysler.ca/manuals

INDEX

Adding Washer Fluid	171	Antifreeze (Engine Coolant)	291
Adjustable Pedals	84	Anti-Lock Brake System	197
Air Cleaner, Engine	264	Anti-Lock Warning Light	133
Air Conditioner Maintenance	265	Anti-Theft System	23
Air Conditioning	164	Appearance Care	281
Air Conditioning Refrigerant	266	Arming Theft System	23
Air Conditioning System	164	Automatic Dimming Mirror	60
Air Filter	264	Automatic Door Locks	19
Air Pressure, Tires	212	Automatic Headlights	77
Airbag	35	Automatic Temperature Control	167
Airbag Deployment	42	Automatic Transmission	179,277
Airbag Light	44,52,129	Adding Fluid	278,279
Airbag Maintenance	43	Fluid and Filter Changes	277
Alarm	23	Fluid Level Check	277,278
Alarm, Panic	21	Fluid Type	277
Alarm System	23	Gear Ranges	181
Alignment and Balance	217	Overdrive	182
Alterations/Modifications, Vehicle	8	Shifting	179
Antenna, Satellite Radio	155	Special Additives	280

Torque Converter	185	Brake/Transmission Interlock	180
Auxiliary Electrical Outlet	115	Break-In Recommendations, New Vehicle	51
Auxiliary Power Outlet	115	Bulb Replacement	289
Battery	264	Calibration, Compass	104
Emergency Starting	246	Capacities, Fluid	291
Keyless Transmitter Replacement	22	Caps, Filler	
Saving Feature	76	Fuel	224
Belts, Drive	261	Radiator	272
Belts, Seat	27	Car Washes	282
Body Mechanism Lubrication	267	Carbon Monoxide Warning	51
B-Pillar Location	207	Cargo Area Cover	118
Brake System	274	Cargo Area Features	118
Anti-Lock	133,197	Cargo Compartment	118
Hoses	274	Light	118
Master Cylinder	276	Luggage Carrier	121
Parking	194	Cargo Light	118
Trailer Towing	227	Cargo Tie-Downs	119
Warning Light	134	Carpeting	285

Cassette Tape and Player Maintenance	162	Compact Spare Tire	241
Cassette Tape Player	143,147	Compass	101,104
Catalytic Converter	261	Compass Calibration	104
Caution, Exhaust Gas	51	Compass Variance	105
CD Changer	140,150,156	Computer, Trip/Travel	101
CD Player	136,139,143,149	Console, Overhead	89
CD Player Maintenance	163	Contract, Service	320
Cellular Phone	164	Converter, Catalytic	261
Center Lap Belts	33	Cooling System	269
Chains, Tire	220	Adding Coolant (Antifreeze)	271
Chart, Tire Sizing	204	Coolant Capacity	291
Check Engine Light	130	Coolant Level	272
Checks, Safety	52,53	Disposal of Used Coolant	270
Child Restraint	44	Drain, Flush, and Refill	270
Child Restraint Tether Anchors	47	Inspection	269
Child Safety Locks	18	Points to Remember	273
Climate Control	164	Pressure Cap	272
Clock	135	Radiator Cap	272
Compact Disc Maintenance	163	Selection of Coolant	270,291

Temperature Gauge	131	Disarming, Theft System	23
Crankcase Emission Control System	263	Disposal	
Cruise Control	86	Engine Oil	260
Cruise Light	130	Used Engine Fluids	260
Cup Holder	116	Door Locks	15,17
Customer Assistance	318	Door Locks, Automatic	19
Daytime Running Lights	78	Door Opener, Garage	106
Dealer Service	255	Drive Belts	261
Defroster, Rear Window	171	Driving	199
Defroster, Windshield	53,167,168	Off-Pavement	200
Deploying, Airbag	42	On Hills	200
Diagnostic System, Onboard	253	On Slippery Surfaces	200
Dimmer Switch, Headlight	79	Electric Remote Mirrors	61
Dipsticks		Electrical Outlet, Auxiliary	115
Automatic Transmission	278	Electronic Speed Control	86
Oil (Engine)	256	Electronic Vehicle Information Center	90
Power Steering	266	Emergency, In Case of	
Disabled Vehicle Towing	248	Brake Warning Light	134

Coolant Temperature Gauge	131	Malfunction Indicator	130
Engine Oil Pressure Gauge	130	Oil	291
Freeing Vehicle When Stuck	186	Oil Change Interval	258
Hazard Warning Flasher	236	Oil Disposal	260
Jacking	242	Oil Filter	260
Jump Starting	246	Oil Filter Disposal	260
Tow Hooks	248	Oil Pressure Gauge	130
Emission Control System Maintenance	254,296	Oil Selection	291
Engine		Overheating	237
Air Cleaner	264	Starting	176
Block Heater	178	Temperature Gauge	131
Break-In Recommendations	51	Engine Oil Viscosity Chart	259
Compartment	251,252	Entry System, Illuminated	15
Cooling	269	Exhaust Gas Caution	51
Exhaust Gas Caution	51	Exhaust System	269
Fails to Start	177	Extender, Seat Belt	35
Flooded, Starting	177	Exterior Finish Care	282
Fuel Requirements	221,291		
Jump Starting	246		

Filters		Four-Way Hazard Flasher	236
Air Cleaner	264	Freeing A Stuck Vehicle	186
Engine Fuel	263	Front Axle	281
Finish Care	282	Fuel	221
Flashers	236	Filler Cap	224
Hazard Warning	236	Filler Door	224
Turn Signal	129	Filter	263
Flat Tire Changing	240	Gasoline	221
Flipper Glass, Tailgate	15	Gauge	133
Flooded Engine Starting	177	Light	134
Fluid Capacities	291	Materials Added	224
Fluid Leaks	53	Octane Rating	221
Fluid Level Checks		Requirements	291
Automatic Transmission	277,278	Tank Capacity	291
Engine Oil	256	Fuel System Caution	225
Power Steering	266	Fuses	286
Fog Lights	79		
Four Wheel Drive		Garage Door Opener	106
Operation	186	Gas Cap	224

Gasoline	221	Headlights	77
Gasoline, Reformulated	222	High Beam	129
Gasoline/Oxygenate Blends	222	On With Wipers	77
Gauges		Heated Mirrors	61
Coolant Temperature	131	Heated Seats	71
Fuel	133	Heater, Engine Block	178
Odometer	132	Holder, Cup	116
Oil Pressure	130	Homelink Transmitter	106
Speedometer	129	Hood Release	74
Tachometer	129	Hoses	274
Voltmeter	129	Identifying Your Engine	251,252
Gear Ranges	181	Ignition	
General Information	219	Key	11
Glass Cleaning	284	Illuminated Entry	15
Glove Compartment	116	Infant Restraint	44
Hazard Warning Flasher	236	Inflation Pressure Tires	212
Head Restraints	64	Information Center, Vehicle	90
Head Rests	64	Inside Rearview Mirror	59

Instrument Cluster	127	Keys	11
Instrument Panel and Controls	126	Lane Change and Turn Signals	129
Interior Appearance Care	284	Lap Belts	33
Interior Fuses	286	Lap/Shoulder Belts	27
Interior Lighting	75	LATCH (Lower Anchors and Tether for Children)	47
Interior Lights	75,78	Lead Free Gasoline	221
Intermittent Wipers	81	Leaks, Fluid	53
Introduction	4	Liftgate Flipper Glass	15
Jack Location	238	Liftgate Window Wiper/Washer	170
Jack Operation	242	Lights	53,75
Jacking Instructions	242	Airbag	44,129
Jump Starting	246	Alarm	52
Key, Programming	14	Anti-Lock	133
Key, Replacement	13	Automatic Headlights	77
Key, Sentry	12	Battery Saver	76
Key-In Reminder	12	Brake Warning	134
Keyless Entry System	20	Cargo	118
		Check Engine	130

Check Gauges	130	Seat Belt Reminder	133
Cruise	130	Sentry Key	130
Daytime Running	78	Transfer Case	131
Dimmer Switch, Headlight	76,79	Transmission Warning	131
Dome	89	Turn Signal	76,79,129
Fog	79	Vanity Mirror	62
Fuses	286	Warning (Instrument Cluster Description)	129
Hazard Warning Flasher	236	Loading Vehicle	
Headlight Switch	77	Tires	207
Headlights On With Wipers	77	Locks	15
High Beam Indicator	129	Automatic Door	19
Instrument Cluster	77,78	Child Protection	18
Interior	75,78	Door	15,17
Lights On Reminder	78	Liftgate, Tailgate	15
Low Fuel	134	Power Door	18
Malfunction Indicator	130	Lower Anchors and Tether for CHildren (LATCH)	47
Map Reading	75	Lubrication, Body	267
Passing	79	Lug Nuts	245
Reading	75,89	Luggage Rack	121

Lumbar Support	67	Electric Powered	61
Maintenance, Airbag	43	Electric Remote	61
Maintenance Free Battery	264	Exterior Folding	61
Maintenance Procedures	256	Heated	61
Maintenance Schedule	296	Outside	61
Schedule "A"	310	Rearview	59
Schedule "B"	299	Vanity	62
Maintenance Schedules	296	Modifications/Alterations, Vehicle	8
Maintenance, Sunroof	114	Monitor, Tire Pressure System	92,217
Malfunction Indicator Light	130,254	Mopar Parts	255,323
Manual, Service	324	Multi-Function Control Lever	76
Map/Reading Lights	75,89	Navigation System	152
Master Cylinder	276	New Vehicle Break-In Period	51
Memory Seat	68	Occupant Restraints	26
Memory Seats and Radio	68	Octane Rating, Gasoline	221
Mini-Trip Computer	103	Odometer	132
Mirrors	59	Trip	132
Automatic Dimming	60		

Off-Pavement Driving	285	Paint Care	281
Off-Road Driving	200,285	Paint Damage	281
Oil, Engine		Panic Alarm	21
Capacity	291	Parking Brake	194
Change Interval	258	Passing Light	79
Dipstick	256	Pedals, Adjustable	84
Identification Logo	259	Placard, Tire and Loading Information	207
Materials Added to	260	Polishing and Waxing	282
Pressure Gauge	130	Power	
Recommendation	259,291	Distribution Center	288
Viscosity	291	Door Locks	18
Onboard Diagnostic System	253,254	Mirrors	61
Opener, Garage Door	106	Outlet	115
Outside Rearview Mirrors	61	Seats	65
Overdrive	132,182	Steering	266
Overhead Console	89	Sunroof	112
Overheating, Engine	237	Windows	24
Owner's Manual	324	Pregnant Women and Seat Belts	34
		Preparation for Jacking	242

Pressure Gauge, Oil	130	Reclining Front Seats	63
Programmable Electronic Features	95	Recommended Fluids, Lubricants and Genuine Parts	292
Programming Transmitters	22	Recreational Towing	231
Quadra-Trac	191	Shifting into Transfer Case Neutral (N)	232
Radial Ply Tires	214	Shifting out of Transfer Case Neutral (N)	233
Radio	136,143	Reformulated Gasoline	222
Radio Broadcast Signals	135	Refrigerant	266
Radio Operation	136,143,164	Reminder, Lights On	78
Radio, Satellite	152	Reminder, Seat Belt	33
Rain Sensitive Wiper System	82	Remote Keyless Entry	20
Rear Axle	281	Remote Sound System Controls	160
Rear Liftgate	15	Replacement Bulbs	289
Rear Seat, Folding	71	Replacement Keys	13
Rear Window Defroster	171	Replacement Parts	255
Rear Window Features	170	Replacement Tires	215
Rear Wiper/Washer	170	Reporting Safety Defects	323
Rearview Mirrors	59	Restraints, Child	44
		Restraints, Occupant	26

Retractable Cargo Area Cover	118	Extender	35
Rocking Vehicle When Stuck	186	Front Seat	27
Roof Type Carrier	121	Inspection	52
Rotation, Tires	218,220	Maintenance	52
Safety Checks Inside Vehicle	52	Rear Seat	33
Safety Checks Outside Vehicle	53	Reminder	133
Safety Defects, Reporting	323	Shoulder Belt Anchorage	30
Safety Information, Tire	203	Seats	63
Safety Tips	51	Adjustment	63
Satellite Radio	152	Head Restraints	64
Satellite Radio Antenna	155	Heated	71
Schedule, Maintenance	296	Memory	68
Seat Belt Maintenance	52	Power	65
Seat Belt Reminder	33	Rear Folding	71
Seat Belts	27	Reclining	63
Adjustable Upper Shoulder Anchorage	30	Security Against Theft	17
And Pregnant Women	34	Security Alarm	23
Child Restraint	44	Selection of Oil	259
		Selec-Trac Operation	186

Sentry Key	12	Speed Control	86
Sentry Key Programming	14	Speedometer	129
Sentry Key Replacement	13	Starting	176
Service Assistance	318	Automatic Transmission	176
Service Contract	320	Cold Weather	177,178
Service Manuals	324	Emergency (Jump Starting)	246
Setting the Clock	135	Engine Block Heater	178
Shifting		Engine Fails to Start	177
Automatic Transmission	179	Starting Procedures	176
Shoulder Belts	27	Steering	
Signals, Turn	79,129	Power	266
Slippery Surfaces, Driving On	200	Wheel, Tilt	84
Snow Chains	220	Steering Wheel Mounted Sound System	
Snow Plow	234	Controls	160
Spare Tire	239,241	Storage	289
Spark Plugs	261	Storage, Vehicle	289
Specifications		Storing Your Vehicle	289
Fuel	221	Sun Roof	112
Oil	259	Sunroof Maintenance	114

Supplemental Restraint System - Airbag	35	Alignment and Balance	217
System, Navigation	152	Chains	220
Tachometer	129	Changing	238,242
Tape Player	147	Compact Spare	241
Temperature Control, Automatic	167	General Information	211
Temperature Gauge, Engine Coolant	131	High Speed	213
Tether Anchor, Child Restraint	47	Inflation Pressures	212
Theft System Arming	23	Jacking	242
Theft System Disarming	23	Load Capacity	207,208
Tie Down Hooks, Cargo	119	Pressure Monitor System	92,217
Tilt Steering Column	84	Radial	214
Time Delay, Headlight	80	Replacement	215
Tire and Loading Information Placard	207	Rotation	218,220
Tire Identification Number (TIN)	206	Safety	53,203
Tire Markings	203	Sizes	204
Tire Safety Information	203	Spare Tire	239
Tires	53,211	Spinning	214
Air Pressure	212	Tread Wear Indicators	215
		Wheel Mounting	244

Wheel Nut Torque	245	Warning Light	131
Tongue Weight/Trailer Weight	228	Transmitter Battery Service	22
Torque Converter Clutch	185	Transmitter, Garage Door Opener	106
Tow Hooks, Emergency	248	Transmitter Programming	22
Towing	226,248	Tread Wear Indicators	215
Disabled Vehicle	248	Trip Odometer	132
Recreational	231	Trip Odometer Reset Button	132
Trailer Towing	226	Turn Signals	79,129
Cooling System Tips	229	Underhood Fuses	288
Minimum Requirements	230	Universal Transmitter	106
Tips	229	Upholstery Care	284
Trailer and Tongue Weight	228	Vacuum/Vapor Harnesses	274
Warnings	227	Vanity Mirrors	62
Transfer Case	280	Variance, Compass	105
Maintenance	280	Vehicle Identification Number	7
Transmission		Vehicle Loading	208
Automatic	179,277	Vehicle Modifications/Alterations	8
Maintenance	277		
Shifting	181		

Vehicle Storage	289	Wheel Mounting	244
Vinyl Trim	284	Wheel Nut Torque	245
Voltmeter	129	Wind Buffeting	25
Warning Flasher, Hazard	236	Window Fogging	170
Warning Lights (Instrument Cluster Description)	129	Windows	
Warnings and Cautions	7	Power	24
Warranty Information	321	Windshield Defroster	53,167,168
Washer, Adding Fluid	171	Windshield Washers	80
Washers, Windshield	80,268	Fluid	268
Washing Vehicle	282	Windshield Wiper Blades	268
Waxing and Polishing	282	Windshield Wipers	80
Wheel Alignment and Balance	217	Wipers, Intermittent	81
Wheel Changing	242	Wipers, Rain Sensitive	82